

August

15 Cents

# POPULAR MECHANICS MAGAZINE

WRITTEN SO YOU CAN UNDERSTAND IT

TRADE MARK



See Page 173

Copyrighted material

Popular Mechanics Offers No Resubscriptions; Does Not Join in Clubbing Offers and Employs No Subscription Solicitors

# \$699

## BUYS THE MATERIAL To Build This Harris Home

**Cut-to-Fit  
that Builds  
to Stay**

### 4

**Big Lumber  
Shipping Points**

See the 100  
Modern Harris  
Homes in our  
free \$10,000 Book  
of Plans shipped  
"direct to you" from  
our four big ship-  
ping points con-  
veniently located.

**No Money Down  
Save 1/3 to 1/2**

**Write Today**

We will name you freight  
prepaid prices on every-  
thing—lumber, millwork, hard-  
ware, plumbing, heating, etc., that  
will mean a saving of from 1/3  
to 1/2. Upwards of 20,000,000  
feet of brand new lumber is in  
our mammoth stock at all  
times, and we will ship without  
one cent down. Get our plan.

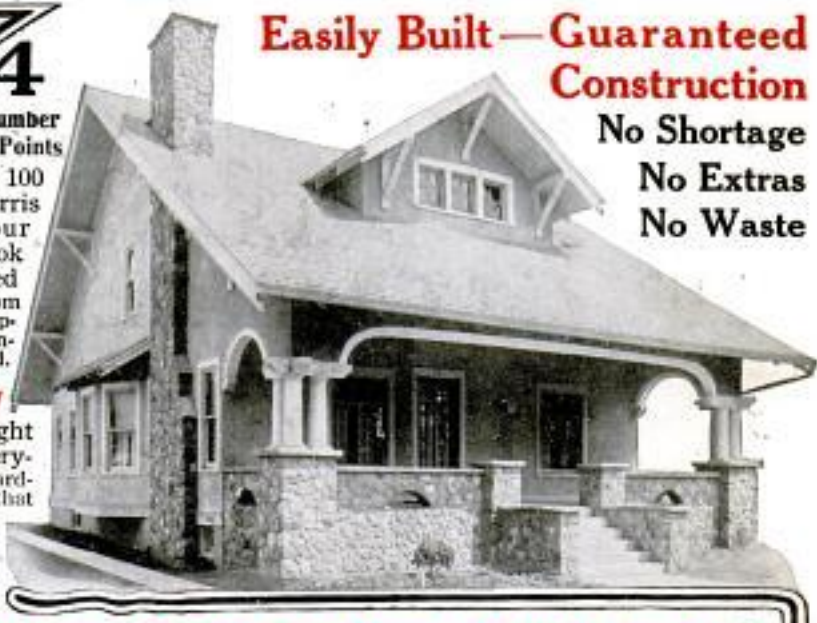

**Easily Built—Guaranteed  
Construction**

**No Shortage**

**No Extras**

**No Waste**

**Build Your Home at the Price You Ought to Pay**  
**23 YEARS OF EXPERT PLANNING**

**Our Guarantee  
Protects You**

Greatest of all is this Harris Home Building Plan, a truly wonderful offer—clean and straightforward. The first real helpful home building plan—the opening wedge that made it possible for thousands of satisfied Harris Home owners to realize their dream of years. In dealing with us you reap the benefits of these vital essentials—**23 Years of Expert Planning, Designing and Close Study of Economy** in material and labor. Through all these years we have maintained with ease, our lead, never finding it necessary to recognize competition. Make us prove this to your satisfaction. It won't cost you a penny to get our offer now—to-day. Our binding guarantee backed by every cent of our ten million dollar capital stock, gives you an iron clad protection. You can't possibly go wrong, for we take all the risk, you take none.

these years we have maintained with ease, our lead, never finding it necessary to recognize competition. Make us prove this to your satisfaction. It won't cost you a penny to get our offer now—to-day. Our binding guarantee backed by every cent of our ten million dollar capital stock, gives you an iron clad protection. You can't possibly go wrong, for we take all the risk, you take none.

**THE DESIGN** The Harris Home No. 161, above, is a perfect combination of comfort, convenience and economy; modern in every respect. Six rooms, bath, large closets, pantry and modern interior. This is but one of the many splendid designs which can be carefully studied from our **Free Plan Book** in your own home during your leisure hours. Mail the coupon below for your copy of our Plan Book today.

**THE MATERIAL** Knotless lumber for all outside finish, interior finish, flooring and Cedar Shingles, No. 1 Dimension Lumber. **Ready-Cut the Harris Way**; all glass in and back puttied—saves time and labor. Up-to-date Antique Copper or Lemon Brass Finish Hardware. Harris Homes are architecturally correct in every detail.

**Mail Coupon  
Below Today**

**PLANS FREE** We will send you a complete set of blue print plans, such as would cost you from \$25 to \$100 if drawn up by any reputable architect, upon receipt of the coupon below and \$1. We will also include along with the plans, free of charge, Specifications, Material List and a guaranteed delivered price to your station. If you decide to purchase, you will be credited with this remainder of \$1 on your bill, so you see this service is absolutely free. If the plans did not suit and you are not ready to buy, return them, and 50c will be refunded.

Dept. CF7

**Harris Bros. Co.**

Send me your Free  
\$10,000 Plan Book I  
am also interested in

Name \_\_\_\_\_

Address \_\_\_\_\_

**Plumbing and Heating**

You can easily install your own heating plant and plumbing material with the assistance of our free expert engineering service. We show you how to eliminate much of the biggest expense. Mail the coupon for your copy of our new plumbing and heating book. Complete bathroom outfits, \$37.50. Engineered lock-ups as low as \$13. Warm air heating plants, \$67. Steam heating plants, \$85. Hot water heat plants, \$95.

**Quality Roofing**

Our new roofing book is full of practical information. Tells you the correct grade and style of material adapted to your particular purpose. Everything explained by diagrams. Biggest values ever offered, in ready roofing, metal roofing, siding, ceilings, etc. Prices represent savings of from 1/3 to 1/2 in every instance. Mail coupon for FREE copy today.

**Building Material**

Mail the coupon today for our 200-page building material book, replete with bargains in lumber, doors, windows, millwork, paint, roofing, plumbing, hardware, lighting fixtures, mantles, grates, colonnades—in fact, everything in structural materials for the construction of any building. Substantial savings evident in every instance.

**Our every transaction guaranteed and backed  
up by our capital stock of \$10,000,000.00**

# HARRIS BROTHERS CO. 35th & Iron Sts. CHICAGO



## It's easy to learn the new dances with the music of the Victrola

With a Victrola you can repeat at will all the latest dance numbers and practice a dance over and over until you have mastered it completely.

You can have an impromptu dance whenever you wish—the Victrola is always ready and plays as long as any one wants to dance.

The Victrola makes dancing a pleasure that can be enjoyed in *every* home.

Any Victor dealer will gladly play the newest dance music or any other music you wish to hear. There are Victors and Victrolas in great variety of styles from \$10 to \$250.

**Victor Talking Machine Co., Camden, N. J., U. S. A.**

Berliner Gramophone Co., Montreal, Canadian Distributors



Always use Victor Machines with Victor Records and Victor Needles—*the combination*. There is no other way to get the unequalled Victor tone.

New Victor Records demonstrated at all dealers on the 28th of each month

## WHY REPLACE ROTTEN WOOD WITH WOOD THAT WILL ROT?

When you repair the roof, the porch,  
the barn, the fence, or anything else,

**WHY, OH, WHY  
DON'T YOU INSIST ON**

# CYPRESS

"THE WOOD ETERNAL"

CYPRESS DEFIES ALL ROT INFLUENCES. Get your CYPRESS ("and no substitutes!") from your nearest Lumber Dealer. Write our "All-round Helps Dept." TODAY. Tell us your plans—and needs—and we'll send you at once the Vol. of Cypress Pocket Library that fits your case. (Full of VALUABLE POINTERS.)

**So. Cypress Mfrs. Assn.** Dept. NEW ORLEANS, LA., or  
1219 JACKSONVILLE, FLA.

## "THE WOOD THAT LASTS SHALL BE FIRST."



Write Quickly for Vol. 18 of the famous Cypress Pocket Library with complete Specifications and Working Plans (that you can build from) of this \$3,000 CYPRESS HOME. "Build of Cypress and you build but once."



Sent free by our "All-Round Helps" Manager.

**So. Cypress Mfrs. Assn.** Dept. NEW ORLEANS, LA., or  
1219 JACKSONVILLE, FLA.

## "YES, I ADMIT I'M GETTING INTERESTED IN

# CYPRESS

"THE WOOD ETERNAL"

**"I ALSO ADMIT THAT  
IT WONT DO ME MUCH  
GOOD UNLESS I INSIST  
ON GETTING CYPRESS  
'& NO SUBSTITUTES."**

CYPRESS DEFIES ALL ROT INFLUENCES. Get your CYPRESS ("and no substitutes!") from your nearest Lumber Dealer. Write our "All-round Helps Dept." TODAY. Tell us your plans—and needs—and we'll send free at once the Vol. of Cypress Pocket Library that fits your case. (Full of VALUABLE POINTERS.)

**So. Cypress Mfrs. Assn.** Dept. NEW ORLEANS, LA., or  
1219 JACKSONVILLE, FLA.



## "STOP DEPRECIATION BEFORE IT BEGINS— USE CYPRESS AT 1st."

"Do you like this style of a home instead of a Bungalow? — Then Let's Get It!"

Complete Working **PLANS** and Detailed Specifications **FREE in Vol. 29**



CYPRESS  
POCKET  
LIBRARY

Write our "All-Round Helps" Manager for it TODAY.

**So. Cypress Mfrs. Assn.** Dept. NEW ORLEANS, LA., or  
1219 JACKSONVILLE, FLA.

# Popular Mechanics Magazine

6 N. Michigan Avenue, Chicago, U. S. A.

EDITED BY H. H. WINDSOR

England: The International News Co.  
5 Breems Bldg., Chancery Lane, London, E. C.

Australia:  
The Australasian News Co.

ISSUED MONTHLY

SUBSCRIPTION:

SINGLE COPY, 15 CENTS

In United States, and its possessions, Cuba and Mexico, per year, postpaid - - - \$1.50  
To Canada - - - - - 1.75  
To all other countries in the Postal Union - - - - - 2.50

All subscriptions are discontinued at expiration. Please examine the date printed on your wrapper.  
Entered as Second Class Matter Sept. 15, 1903, at the Post Office at Chicago, Illinois, under Act of March 3rd, 1879.  
Entered as Second Class Matter at the Post Office Department, Canada.

Published monthly by POPULAR MECHANICS CO.

Copyright, 1915, by H. H. WINDSOR.  
Copyright, in France.

*Air Cushions Take Place of Springs for Car 208*

## Contents for August, 1915

Advertisement, Using Time-Honored Joke as.....	221	Coal Combustion of, Aided by Pulverizing It.....	234
Advertising, Kodak Bug, Electric, Used for.....	165	Compass, Prismatic, for Night Marching.....	164
Aeroplane, Soldiers Fell Trees to Rescue.....	203	Concrete Keelson for Sailing Boat.....	235
Airman Drops Wreath Where Beachey Fell.....	163	Conveyor, Endless-Chain, for Machine Shop.....	257
Airship-Zeppelin Loses Battle with Monoplane.....	199	Cord Cutter, Simple, with Guarded Blade.....	237
Amphitheater, Concrete, for Dental Clinics.....	183	Coupling, Simple Flexible, for Propulsion Shaft.....	227
Amusement-Park Thriller, New.....	135	Crane, Novel, is Employed in Erecting Building.....	206
Artillery, Heavier Field, for United States.....	235	Crossing Traffic, Electric Control System for.....	239
Automobile, Barge That is Propelled by.....	173	Desk for Cramped Office Seats Two Persons.....	227
Automobile Body Shaped Like Loaf of Bread.....	232	Dirigible, First, Ordered for American Navy.....	206
Automobile, Curious-Looking, Built for City Streets.....	172	Draftsmen, Combination Instrument for.....	279
Automobile Horns, Switching Signals Given with.....	241	Drill, Electric Core, Made for Mine Prospecting.....	278
Automobile Industry, Growing Importance of.....	180	Dynamite Explodes in Motor Car.....	200
Automobile, New, for Passenger Service.....	177	Electric Irons and Curlers, Using for Cooking.....	223
Automobile Owner, Machine-Shop Equipment for.....	233	Electric Lamp, Socket for, Fitted with Lock.....	166
Automobile Portable House for Tourist Family.....	261	Electricity, Odd Succession of Deaths Caused by.....	268
Automobile, Runaway, Floods City Streets.....	209	Elevator Tower is Built like Pneumatic Tube.....	182
Automobile, Sight-Seeing, Gasoline-Electric Power for.....	236	Engine, Miniature Steam, Built by Switchman.....	258
Automobile Spring, New Principle Used in.....	273	Envelopes, High-Speed Machine Built for Sealing.....	261
Automobile Springs, How Tested.....	232	Excavation Cost Lessened in Sinking Shaft.....	222
Automobiles, New Baggage Carrier for.....	186	Excavator, Big Electric Drag-Line.....	238
Automobiles, Parking Lanes for in Washington Streets.....	222	Explosion, Strange Sewer, Caused by Flood.....	179
Automobiles, Used, are Sold in Public Market.....	231	Fan, Electric, for Dining Table, New Type of.....	226
Awning Arm Made to Fold Neatly When Raised.....	178	Fertilizer, Chemically Treated Waste Matter as.....	254
Baseball Pitchers, Train with Bull's-Eye Box.....	271	Fire Engine with Fixed Axles, Motor-Driven.....	245
Bath Trains Constructed for German Troops.....	248	Fire Escape, Folding, Made for Residence Use.....	232
Bathing Outfit, Motor-Car, Designed for Army Use.....	184	Fire Fighting Car, for Coal Mine.....	263
Belgians, Business with America Planned by.....	202	Fish Killed by Severe Hailstorm.....	172
Blasting Charge Bombs Dwelling House.....	237	Fisheries, Bureau of, All-Steel Car for.....	272
Boat-Launching Apparatus, Rapid.....	246	Flag, Civic, is Adopted by Pennsylvania Town.....	198
Boats Used on Interior Rivers of Canada.....	230	Flag, International, for Western Hemisphere.....	201
Boiler-Scale Deposit Prevented by Zinc.....	249	Flagstaff, Big, for London Botanical Garden.....	232
Bridges and Roadbeds, Railway, Development of.....	235	Flies, Chicago League Fights in New Way.....	187
Bridges, How Affected by Fast Locomotives.....	253	Floats, Unusual, Used at California Fete.....	265
Building, Exposition, Has 50 Flagpoles.....	221	Flying Boat, High-Speed of New Type.....	223
Bullets, Sceng Fly, by Edward C. Crossman.....	230	Fortifications, State of Washington Asks for.....	227
Camera Shows Wonders of Minute Objects.....	181	Food-Gathering Device Resembles Umbrella.....	233
Canal, Cape Cod, Deep Water Through Planned.....	188	Fruit-Sorting Machine Works in Novel Way.....	272
Canoe Trip, Across-Country, Planned for Summer.....	170	Garages, Attractive, at Moderate Costs.....	242
Cap, Motor, with Goggles Built in.....	278	Gasoline Pump for Motor-Car Supply Depots.....	224
Car, Wooden Interurban, Crushed by Engine.....	233	Gloves, Shining, are Worn by Traffic Regulators.....	180
Car, Overnight, Flag Station Becomes.....	204	Golf Club, Handy Attachment for.....	234
Cliffs, Imitation, Zoological Garden with.....	270	Golf Course is Preserved by Use of Cement.....	187
Clock, Electric, Designed for Motor Car.....	177	Golf-Playing Device Made for Home Amusement.....	273
Clock, Ingenious Gravity, Requires No Winding.....	237	Gravure Process, Heat Used Instead of Ink in.....	269
Clock, Street, Placed High on Corner of Building.....	234	Harbor, Boston, Studying Defense of.....	244
		Hardware Display, Novel, at San Francisco.....	253
		Heating Plant, Hot Air, for Orange Grove.....	275
		Hedge, Beautiful, Produced in Few Weeks.....	206
		Hoe, Horse-Driven Rotary, New Farm Implement.....	264
		"House Electrical" Shown at Exposition.....	183

[Continued on Page 6]

Popular Mechanics offers no premiums; does not join in "clubbing offers," and employs no solicitors to secure subscriptions. It is for sale by nearly every newsdealer in the United States and Canada.

*X In some of N. S. E. - 2  
regular edition B, 2/2 2/15*

This One



PRAD-27X-93WS

## [Contents—Continued]

House Plan—Brick Bungalow Adapted to Warm Climate	320	Tractor, Electric, of Novel Design	257
House, Sod, New and Up-to-Date	321	Tractor, Farm, Fords Ditch and Climbs Embankment	190
Hydroelectric Plant, New, of Large Capacity	203	Train, Device for Regulating Speed of	249
Ironing Board, New, Folds into Closet	180	Transportation Afforded across Central Africa	168
Kite Flying Contest Held by School Children	201	Trap, Compact Hand, Made for "Pigeon"	172
Lamp, Porch, Placed Inside of Building	245	Throwing	172
Lantern, Acetylene Signal, for Forest Service	256	Tree Digger, New, for Forestry Service	268
Library, Public, Making Use of Pamphlets in	270	Tree in Middle of Street Holds Danger Signal	172
Lighting, Painting Machines White to Aid in	168	Tricycle Chairs Employed on Exposition Grounds	223
Lincoln Highway Pictured by Moving-Picture Camera	262	Trucks, Heavily Loaded, Handled with Ease	274
Locomotives, Double End, Built for France	164	Trucks with Turntables Built for Navy Yard	192
Lumber Piles, Protecting from High Winds	255	Villa Sites, Government to Sell at Auction	221
Lunch Car for Golfers, Railroad Runs	194	Walking Machine Designed for Indoor Exercise	231
Mails, Transatlantic, Handling in War	229	War, European:	
Manicuring Work, Electric Machine Devised for	178	Dardanelles, Expeditionary Force Lands at	210
Meter, Electric, Outdoor Housing Designed for	170	Gases, Poison, Combating in Allied Trenches	213
Monument to Discoverer of Nitroglycerin	184	German Infantry in Action on Firing Line	216
Motorcycle, Loaded Buggy is Pulled Uphill by	255	Heligoland German Submarine and Aero Base	209
Motorcycle Sidecars Carry Band in Night Parade	161	Home Forces in Training for Emergencies	212
Motorists Put on Honor in California County	241	Interesting Side Lights on	218
Mount Vernon Site, Saving from Destruction	180	Italian People, War Demonstrations Made by	210
Mountain Peak, Snow-Clad, Forest Lookout Point	247	Odd Phases of, Reported by Camera	217
Moving-Picture Field, New Achievements in	189	Scottish Troop Train in Fatal Collision	211
Moving-Picture Film, Ton of, Burned in Experiment	265	Soldier, Promoting Welfare of	220
Moving Pictures, Taking Chances to Put Thrills in	174	Trenches, Scenes in, and Devices Used for Defense	215
Muscles, Device Records Fatigue of	252	Warfare, Modern, No "Smoke of Battle" in	169
Museum, National, Room Kept for Children at	251	Water, Ice, Two Prices for at Fountain	207
Naval-Pageant Through, Unusual Picture of	230	Water Wheel Erected on Bank of Stream	273
Navy Helmsmen, Training on Dry Land	224	Water Wheel Transported on Mule Back	176
Novel and Practical Devices for the Home	278	Weather Report Service to be Extended	185
Oil, Part of Government's Supply Stolen	280	Wedge, Expanding, for Tool Heads	280
Park, Picturesque, for California Resort	220	Wire, Barbed, Sent Abroad for Use of Armins	170
Phonograph and Harp are Combined	220	Wireless—Intensify Radio Impulses with New Instrument	244
Phonograph, Novel Post-Card Records for	273	Wreck—Oil Train Burns for Many Hours	223
Photographs, Stereoscopic, Made in New Manner	256	Wrench, Steel, Corrugating a	237
Piles, Bearing Power of, Tested by Concrete Load	180	Yale Bowl, Ancient Grecian Play Staged in	220
Pipe Line, Repairing in Frozen River	260	<b>SHOP NOTES</b>	
Platform, Well Appointed, for Traffic Officer	190	Anchor Plates for Machinery Foundations, Proportioning	226
Plating Metallic Surfaces, Pistol Used for	263	Automobile Frame, Strained, Reinforcing	224
Plow, Man Power, Designed for Filipino Farmers	195	Automobile Hoods, Waterproofing Hinge Joints on	226
Plow, Pavement, Timesaver for Traction Company	240	Automobile Spring Clip, Broken, Substitute for	233
Postal Savings Banks, Scope of, Broadened	186	Boat Landing, Floating	232
Prairie Schooner, Motorcycle-Drawn, Built for Long Trip	181	Cableway to Procure Water for Mountain Lodge	236
Punch, Center, That Strikes Blow Automatically	280	Cart, Carpenter's Tool Chest	231
Railroad Operation, Mysterious Menace in	233	Clutch, Cone, To Make Engage Smoothly	300
Railroad Station Housed in Passenger Cars	201	Concrete Ceiling, Protecting the Eyes When Making Hole in	226
Road, Mountain, is Built by Montana Students	196	Cradle, Homemade	237
Roller Skate with Safety Attachments	234	Cutting Tool for Packing	237
Rubbish Box, Convenient Cover Devised for	173	Dynamo, Small, Others for	209
Safe, Burglar-Proof, Made of Manganese Steel	269	Etching Fluid	220
Saw Leaves No Big Stumps after Felling Trees	221	Eye Dropper, Emergency	231
Sawing Stumps Level with Ground, Machine for	263	Gas Mantle, Protecting	236
Scissors, Novel, Needles Threaded Quickly by	280	Gauge, Grinding	239
Sewage, How Purified by Bacteria	182	Glass, Using to Grind Glass	220
Sewerage System, Modern, for Cairo, Egypt	184	Grabhook, Makeshift, for Well Bucket	228
Sewing Machine Sews Comforters Automatically	251	Headlight, Temporary Reflector for	235
Ship—Dreadnaught Arizona, Launching of	193	Home, Building a:	
Ship—Dreadnaught, Overhauling after Sham Battle	171	Part V—Lath and Plaster	221
Ship's Hold, Indicator for Doors in	258	Hose Connection between Engine and Radiator, Support for	226
Ship's Hull, Curious Plan for Closing Hole in	275	Motors and Generators, Reading Performance Curves of	227
Shoestrings, Fastening Device is Made for	278	Name Plates, Easily Made	232
Sign, Novel, for Promoting Relief of Belgians	194	Radiator, Motor Truck, Screen for	229
Sleeping Bag Flaps, Simple Way of Fastening	271	Refrigerator, Proper Way to Put Ice in	227
Smoke, Ship's, Eliminated by New Furnace Equipment	250	Roofing, Old Tin, Tool for Removing	227
Smokestack is Corroded from Unusual Cause	200	Scales, Dividing Tool for Graduating	225
Soldering Iron, Automatic, New Tool for Tinner	279	Screen, Wire, Painting	226
Speedway, Logic in Design Shown by Chicago Races	202	Setcrew, Handle to Hold While Smoothing Head	226
Steam Pipes, Inexpensive Insulation for	228	Shock Absorber, Spring, for Crutches	222
Steam Roller is Employed as Pavement Cutter	178	Soldering Iron, Ordinary, Electric-Heating Coil for	223
Strike, Car, Chicago Getting to Work during	199	Staples to Hold Door Hasps, Substitute for	220
Submarine Depot, Floating, for Brazilian Navy	168	Steam Pipes, Iron Cement for	229
Submarines, German, Cruising Radius of Latest	162	Sterilizer, Steam, Attaching to Hot-Water Tank	229
Sugar Beets, Protecting from Moths	260	Tent House, A, by L. P. Pasewalk	225
Surfacing Tool, Electric, for Concrete Work	236	Trap, Automatic Condensation-Discharge, for Compressed-Air Tanks	223
Surveys, Public-Land, Iron Corner Posts for	228	Wax, Powdered, for Ballroom Floors	221
Tape, Steel, for Measuring Hell Gate Span	162	Window, French, Waterproof Joint for	220
Telephone, Pocket, New Type of	233	Wrench, Quickly Made	222
Track Inspection, Motor-Driven Rail Car for			

[Contents Continued on Page 8]

# No Money In Advance

## This Marvelous CAMERA ON FREE TRIAL!



Only 10,000 of these marvelous instantaneous picture-taking and making cameras to be sent out absolutely on approval without a penny in advance just to prove that it is the most wonderful invention—the camera sensation of the age. So you must send for it quick! Just think of it—the new Mandel-ette

### Takes and Makes Finished Pictures INSTANTLY!

You press the button, drop card in developer and in one minute take out a perfect, finished post-card photo  $2\frac{1}{2} \times 3\frac{1}{8}$  inches in size. Camera itself is about  $4\frac{1}{2} \times 5 \times 7$  inches. Loads in daylight 16 to 50 post-cards at one time.

### No Films—No Plates—No Dark Room

Not a bit of the muss and bother of the ordinary kodak or camera. It is instantaneous photography! Universal focus lens produces sharp pictures at all distances. Pictures develop and print automatically. Can't overdevelop. Results positively amazing.

## We Trust You

No difference who you are or where you live we will send you the complete Mandel-ette outfit absolutely on approval and give you 10 days to test it. If not satisfactory return it. If you wish to keep it, simply pay \$1.00 on arrival and \$1.00 per month until our special price of only \$5.00 is paid. When you see what elegant pictures it takes—so quick, so easy, with no trouble at all—you'll be surprised.

### Easy Payments —No Reference

No red tape of any kind.  
Monthly payments  
so small you'll not

Chicago Ferrottype Co.,  
Desk 86 Ferrottype Building,  
Chicago, Illinois

Send me at once one complete model Mandel-ette Camera outfit including supply of postcards and instructions. I agree to pay \$1.00 when camera arrives, examine and test it thoroughly and if satisfied keep it and pay you \$1.00 a month until your special price of \$5.00 is paid. Otherwise I will return it at the end of 10 days.

Name.....

Street and No.....

Town..... State.....

#### More Than Pleased

Your camera reached me O. K. and I was surprised at the work it does. I have taken several photos and some as good as I have ever seen taken with any camera. Everybody that sees the "Mandel-ette" says it is fine and I am more than pleased with it.  
VERNIE BOYLE,  
Northome, Minn.

#### Beats All Things Yet

The "Mandel-ette" received and opened and in 20 minutes I took a splendid picture of my wife, fully developed and ready to look at. My, this beats all things yet.  
T. J. HOUTS, Pastor,  
Methodist Episcopal Church,  
South, Welch, West Va.

#### Takes Pictures On Dark Day

I am perfectly delighted with the "Mandel-ette." I have had very good success never before to have handled a camera at all. I can say it will do all you claim. I have taken a picture which shows a Mt. more than 4,000 feet away and on a very dark day.  
JAS. H. HUBBARD,  
Penhook, Va.

**Anyone Can Use Them**  
Received the "Mandel-ette" and supplies Saturday evening. Sunday morning we began to take pictures and had very good luck. It is sure simple enough. Anyone can use them. We couldn't get along without ours.  
MRS. R. U. IDDINGS,  
Mapleton, Ia.

**Amazed At Minute Camera**  
I am enclosing pictures taken with my "Mandel-ette" to show you gentlemen what I am making. Nobody taught me but your instructions. I am making pictures with great pleasure and my friends are amazed at your very high grade minute camera.  
C. SATURN,  
Sasta Ana, Alaska.

notice them. Simply fill out and mail coupon today. Send no money. No references required. Lots of fun—big profits.

### No Experience Required

Plain instructions and everything complete with outfit so you can begin taking pictures the moment it arrives. We guarantee that even a child can operate it. Mail coupon now. No risk or obligation to keep camera.

Chicago Ferrottype Co., Desk 86 Ferrottype Bldg.  
Chicago, Illinois.

## Get Into the Auto Business

— We are prepared to make an expert of you and then assist you in getting started—without capital.

**LET US** DESCRIBE OF **DYKE'S** NEW IDEA **WORKING MODEL SYSTEM** ONE OF THE **POPPERS** NOW **TEACHING BY MAIL** **THESE BOOKS LETS** **FREE** **SEND FOR THEM**

**TESTIMONIALS** PROOFS SAMPLE PAGES, CHARTS OPPORTUNITIES MOTOR BUSINESS

**SHOW YOU** **EMPLOYMENT** **HOW WE START YOU** **A NEW PLAN**

We've helped hundreds of others and can help YOU. We are ready to substantiate our claims with *Proofs*.

### Write Today for Free Literature

Who knows; it may be the stepping stone to a future for you—it has been for others—costs you but 1c to investigate.

### WHY DYKE'S COURSE OF AUTOMOBILE ENGINEERING IS THE BEST

- (1) Written by a pioneer of 18 years' experience, who has had practical experience and knows just what the student ought to learn in order to properly care for and repair cars.
- (2) The course is simplified and up-to-date—all late electric systems; 6, 8 and 12 cylinder engines simplified.
- (3) The Dyke Working Models make possible our claims to teach you by mail.
- (4) Our plan to assist you in getting started is the only practical plan.

### DYKE'S SCHOOL OF MOTORING

Box 190, ST. LOUIS, MO.

The original working model system. This system endorsed by leading authorities of the world.



**HERE YOU ARE, BOYS** A medallion pin of Foxy Grandpa. Everyone will notice it on the lapel of your coat and try to get a closer look at it. All you have to do is press the bulb.—Foxy Grandpa will finish the job by squirting a fine stream of water over the inquisitive one. Will squirt 20 feet. Great joke out. Order one today and fool your friends. Price 15c. Foxy Grandpa and Hoedigan both for 25c. 5 for 90c or 1 doz. for \$1.00. A beautiful fountain pen free with every \$1.00 order.

AMERICAN SUPPLY CO., 918 Union St., St. Paul, Minn.

Learn to **PAINT** **SHOW CARDS** **SIGNS** **and** **SHOW CARDS**

I'll teach you personally by mail. 16 years' successful teaching. Big field for men and women. You can Earn \$18.00 to \$45.00 a Week

Tarbell (Ill.) writes "Price of course too cheap. Best in existence." Ask for our new circulars.

**DETROIT SCHOOL OF LETTERING**  
Chas. J. Strout, Founder Dept. 208, Detroit, Mich.



## (Contents—Continued from page 6)

### AMATEUR MECHANICS

Bird House Made of Kegs.....	306
Camping Out, The Tricks of, by Stillman Taylor: Part II—Cooking in the Woods.....	307
Door Latch, Quickly Made.....	313
Drinking-Glass Holder.....	306
Fish, Electric Lure for.....	313
Gourd Float for a Fishline.....	317
Hammocks, How to Make, by Charles M. Miller: Part II—A Netted Hammock.....	314
Hat Marker.....	313
Lawns, Seeding Bare Spots on.....	305
Light, Homemade Arc.....	317
Mold for Making Hollow Candy Figures.....	312
Monoplane, Old Four, How to Make a Model, by Ralph M. Brown.....	301
Needle Threader for Sewing Machine.....	306
Pen, Kuling, Revolving Wheel.....	306
Springs, Winding Coiled.....	306
Stump, Old Tree, Ornamenting.....	313
Swing, Porch.....	305
Trammels, How to Make Pair of.....	304
Water Bag, Camp.....	312

### PATENTS

Automobile, Convertible.....	319
Bomb-Firing Device for Air Craft.....	318
Clothes Wringer, Conveyor Attachment for.....	319
Dish with Drain Receptacle.....	318
Hammers with Nail-Holding Attachments.....	318
Holding-Down Device for Boiling.....	319
Household Implements, Holder for.....	319
Lamp for Lighting Running Board of Motor Car.....	318
Nut Dish.....	319
Potato Digger.....	319
Scow, Self-Dumping.....	319
Searchlight That can be Used under Water.....	318
Ships, Safety Appliance for.....	318
Shoe, Spring Heel for.....	319
Square and Protractor, Combined.....	318
Truck, Apparatus for Swinging Both Axles of.....	318
Wagon Tongue, Feeding Attachment for.....	319
Walking Stick and Camera Stand, Combined.....	318
Weeder and Hoe, Combined.....	318
Work Holder.....	318

## J-M ASBESTOS ROOFINGS

Sometimes called "The Everlasting Roof." Investigate J-M Roof Registration always mindful of J-M Roofing Responsibility.

**H. W. JOHNS-MANVILLE COMPANY**  
3126 New York and Every Large City

## FREE "Linene" COLLAR



State size on postal and whether you want collar like cut or low turnover style.

REVERSIBLE COLLAR CO., Dept. U, Boston, Mass.

**123** Place the 9 figures so the 2nd row is twice as much as top row and bottom row as much as top and 2nd row added together. All correct replies will receive 25 cents' worth of our iron puzzles with catalog postpaid. Answers not correct will receive solution, Catalog of 200 puzzles and one of our leading 15c. products. All answers to enclose 10c. in stamps or coin to cover mailing, packing, etc.

**456**

**789**

**WESTERN PUZZLE WORKS, St. Paul, Minn.**

# HELP WANTED

## \$65 TO \$150 A MONTH

Railway Mail Clerks—City Mail Carriers—Postoffice Clerks  
—Rural Carriers—Panama Canal Clerks—Steady Work—  
Vacations with Full Pay—Rapid Promotion—"Pull" Unnecessary—Common Sense Education Sufficient—Many Positions for Women

Write today—before you forget—for list and description of positions now open to you; and free sample examination questions. It will cost a 2c stamp—it may bring you thousands of dollars.

**FRANKLIN INSTITUTE, Department C106, ROCHESTER, N. Y.**

NAME.....

ADDRESS.....

**FRANKLIN INSTITUTE**  
Dept. C 106, Rochester, N. Y.

This coupon, filled out as directed, entitles the sender to free specimen questions; a free copy of our book, "Government Positions and How to Get Them," a list of Government positions now obtainable, and to consideration for Free Coaching for the examination here checked.

- .. Railway Mail Clerk .. (\$300 to \$1000)  
.. Bookkeeper .. (\$300 to \$1000)  
.. Postoffice Clerk .. (\$300 to \$1200)  
.. Postoffice Carrier .. (\$300 to \$1200)  
.. Rural Mail Carrier .. (\$300 to \$1100)  
.. Auto Checker ..  
.. Customs Positions .. (\$300 to \$1000)  
.. Stenographer .. (\$300 to \$1500)  
.. Internal Revenue .. (\$700 to \$1000)  
.. Clerk at Panama Canal .. (\$1200 to \$1000)  
.. Canadian Gov't Positions ..



# Stop Forgetting!



**Prof. Henry Dickson**  
America's foremost authority on Memory Training and Principal of the Dickson Memory School, Hearst Bldg., Chicago.

## Forgetfulness—the Cause of Man's Inefficiency Perfect Memory—The Key To Success

A man's best possession is a perfect memory because the secret of business success depends quite as much upon a well developed ability to retain a vivid memory of perceptions and experiences as it does upon "bustle." In social life a good memory is the fundamental pre-requisite to brilliancy in conversation and the confidence of our acquaintances. Good memory is the stepping stone to responsible, honorable, high-salaried positions, and without the ability to remember you can never hope to make good. A good memory, however, is not a gift—peculiar to some few—it is the result of training—you can acquire it.

### The Dickson Method of Memory Training Will Make YOU "Forget Proof"

Ten minutes a day of your spare time will give you this training and not interfere with your work in any way.

My course is not a theory, but a purely and absolutely scientific method of easy practical home lessons which anyone can readily understand and master. It is the result of many years of personal contact with thousands of students as their instructor in leading schools and colleges, searching their developing minds for means of strengthening their memories. My method of memory training enables you to classify impressions, ideas, names, facts and arguments without effort—trains you to think on your feet—to overcome self-consciousness and bashfulness. My system of memory training has transformed thousands of failures into successes—it will make you "forget proof."

#### De Luxe Book of Facts, "How to Remember," Absolutely Free

It explains clearly the course that has raised thousands of men from failure to great success. My free book is the first step. Don't delay. Age, education, vocation or place of residence makes no difference. Mail the Coupon or Postal today.

#### How to Get a Free Copy of This Valuable Book

"How to Speak in Public." De Luxe edition handsomely illustrated, richly bound. Is exactly suited to meet the needs of the man or woman who desires to be a successful public speaker. The price of this 1915 de luxe edition is \$2.00. Write today and learn how to obtain free copy.



Mail Coupon Before You Forget

Prof. HENRY DICKSON, Principal,  
Dickson School of Memory,  
705 Hearst Bldg., Chicago

Send me your Free Memory Test, Free Book "How to Remember," and also full particulars how to obtain a free copy of Dickson's "How to Speak."

NAME.....

ADDRESS.....

## The Power of Law Training

WRITE today for our new 171 page free book "The Power of Law Training." It carries a vital and inspiring message to every ambitious man. If you know law, greater and bigger accomplishments are yours—in all lines of business as well as in the profession itself. Master minds of the law will train you.

### Write Today for New 171 Page Book

No obligations. Your copy of "The Power of Law Training" is ready. You should read it. Write for it now. It's free. American Correspondence School of Law, C119 Manhattan Bldg., Chicago, Ill.

## DON'T TRY TO BE A CHAUFFEUR

or go to ANY SCHOOL to learn, or part with your hard earned dollars until you have read our valuable guide FIRST. It tells what you should PAY and what you should GET. Do not be deceived by schools which claim everything and give you nothing. YOU CAN'T AFFORD TO SPEND ONE CENT TILL YOU GET OUR GUIDE. It costs nothing and may save you many dollars. Write now for this FREE BOOK.

PRACTICAL AUTO SCHOOL, 68 Beaver St., New York

## LEARN TO WRITE EARN \$25 to \$100 A WEEK

We can positively show you by mail How to increase your salary. BOOK MAILED FREE. PAGE-DAVIS CO., 112 Page Building Chicago Ill., or 150 Nassau St., New York

*Learn to Write*

BEGIN TODAY  
WRITE for my FREE BOOK

I can make a good penman of you at home during spare time. Write for my free book, "How to Become a Good Penman." It contains specimens and tells how others mastered penmanship by the Tamblin System. Your name will be elegantly written on a card if you enclose stamp to pay postage.

FREE Write for it Today BOOK

F. W. Tamblin, 418 Meyer Bldg. Kansas City, Mo.

## Be Traffic Manager



Get into the profession where men are in demand. Be the man who knows—the man who directs and the man who gets the fat pay envelope. Thousands of positions are open in the Traffic Profession. Few men have the training they need to hold the big jobs. But you can get it. Yes, you will get just the kind of training you need—right in your own home.

### Big Salaries Are Offered

From \$1,500 to \$10,000 a year is not out of the ordinary for a Traffic Man. It frequently happens that the profits of the whole concern depend upon his knowledge. And men are needed. Every day calls are being made for men who have the proper training.

Name.....

Address.....

Interstate Traffic School  
Dept. C119, Ft. Wayne, Ind.

Gentlemen:—Send me absolutely free and prepaid, your new book that tells me about the opportunities for making money in the Traffic Profession.

## Send the Free Coupon for New Book

Put your name and address on the coupon or on a letter or a postcard and get the big new traffic book absolutely free. No obligations. Find out about the golden opportunities that await you. Act now! Immediately. Don't delay. Write today sure.

INTERSTATE TRAFFIC SCHOOL

Dept. C119

FT. WAYNE, IND.

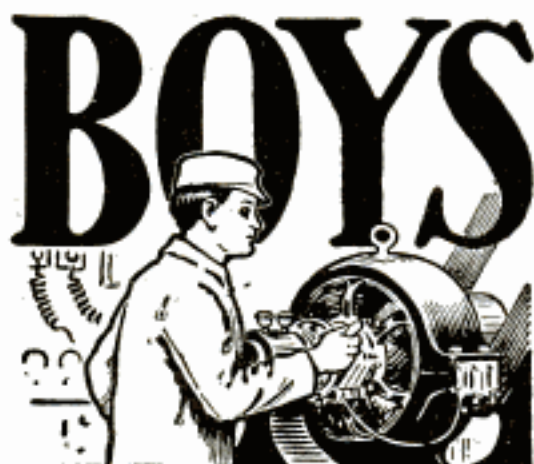

## Big Money in Electricity

The electrical industries offer wonderful opportunities for boys with a liking for electricity. The salaries paid to trained men are large—promotion comes rapidly, and, best of all, the profession is not overcrowded.

The development of new branches from time to time (such as wireless telegraphy and telephony) promise fascinating and paying fields to those who wish to specialize. The *will to do* and *Special Training* will bring success to you.

The International Correspondence Schools can help you to make you expert in electrical work. Thousands of boys have won success through I. C. S. help—YOU can do the same. Everything is made so clear that you can learn in your spare time no matter where you live or what you do.

Take the first step toward success today by marking and mailing the coupon to the I. C. S. It costs you nothing to find out about it.

**Mark the Coupon—NOW**

### INTERNATIONAL CORRESPONDENCE SCHOOLS

Box 872B, SCRANTON, PA.

Explain, without obligation to me, how I can qualify for the position before which I mark X.

- |   |  |
|---|--|
| <input type="checkbox"/> Automobile Running     | <input type="checkbox"/> Stenog. and Typewriting   |
| <input type="checkbox"/> Motor Boat Running     | <input type="checkbox"/> Bookkeeping               |
| <input type="checkbox"/> Electrical Engineering | <input type="checkbox"/> R. R. Accounting          |
| <input type="checkbox"/> Electric Lighting      | <input type="checkbox"/> Good English for Everyone |
| <input type="checkbox"/> Electric Railways      | <input type="checkbox"/> Civil Service             |
| <input type="checkbox"/> Dynamo Running         | <input type="checkbox"/> Architecture              |
| <input type="checkbox"/> Telep. and Teleg. Eng. | <input type="checkbox"/> Contracting & Building    |
| <input type="checkbox"/> Mechanical Engineering | <input type="checkbox"/> Structural Engineering    |
| <input type="checkbox"/> Mechanical Drafting    | <input type="checkbox"/> Plumbing and Heating      |
| <input type="checkbox"/> Shop Practice          | <input type="checkbox"/> Civil Engineering         |
| <input type="checkbox"/> Steam Engineering      | <input type="checkbox"/> Salesmanship              |
| <input type="checkbox"/> Mine Foreman and Supt. | <input type="checkbox"/> Advertising               |
| <input type="checkbox"/> Chemistry              | <input type="checkbox"/> Agriculture               |

Name \_\_\_\_\_

Street and No. \_\_\_\_\_

City \_\_\_\_\_ State \_\_\_\_\_

Present Occupation \_\_\_\_\_

Please Mention Popular Mechanics



## To Be a Traveling Salesman

by mail in eight weeks and our Free Employment Bureau will assist you to secure a position where you will have an opportunity to earn big pay while you are learning. No former experience required. Write today for large list of good openings and testimonials from hundreds of our students who are now earning \$100 to \$500 a month. Address nearest office.

Dept. 507, NATIONAL SALESMEN'S TRAINING ASSOCIATION  
Chicago New York San Francisco

## GOVERNMENT POSITIONS

offer employment for life at a salary ranging from \$800 to \$1800 per year, with short hours under pleasant conditions and no fear of "lay-offs" or strikes. American citizens 18 or over are eligible. Our 64-page booklet contains list of positions, requirements, etc., and tells how you can prepare for "Exams" under the personal supervision of a former U. S. Civil Service Secretary-Examiner. Booklet is FREE, without obligation. Write today.

PATTERSON CIVIL SERVICE SCHOOL  
108 Irving Place ROCHESTER, N. Y.



## Drafting Will Promote You!

These courses will give you the knowledge that means promotion and big salary. Architectural, Mechanical and Structural Drafting and Design, Estimating and Contracting, Builders' Courses and Plan Reading.



**DRAFTING** Complete \$15.00  
Outfit and all Blue  
Print Plans FREE.

Day, Evening, Home-Study Courses. Write today.  
CHICAGO TECHNICAL COLLEGE  
1050 Lake View Building CHICAGO, ILL.

## LEARN WATCH REPAIRING

Be a watchmaker—you can learn this profitable trade by correspondence in a few weeks in your own home by the DeSelms Chart System. After you complete the course you will know a watch from A to Z. You will know just what the matter is and how to repair one. When you graduate you will be a practical watchmaker and repairer and competent to fill any position. Positions for our graduates.

Ask for our Free Book. It explains our system and terms.  
THE DeSELMS WATCH SCHOOL  
23 Perry Street ATTICA, INDIANA



**Be an Auctioneer** Travel over the country and make big money. No other profession can be learned so quickly, that will pay as big wages. Write today for big free catalogue of Home Study Course, as well as the Actual Practice School. Largest in the world. W. B. Carpenter, Pres.  
Missouri Auction School 330 HALL BLDG. KANSAS CITY, MO.



## IF YOU STAMMER

attend no stammering school till you get my large FREE book and special rate. Largest and best school in the world curing by natural method. Write today.  
Lee Wells Millard, Pres., North-Western School, Inc.  
2317 Grand Avenue Milwaukee, Wis.

## BE A DETECTIVE

Earn from \$150.00 to \$300.00 per month; travel over the world. Write  
C. T. LUDWIG, 133 Westover Bldg., Kansas City, Mo.



## \$100.00 EARNED BY YOUNG ARTIST IN 2 DAYS

Capable commercial artists who have obtained practical training from members of our faculty have earned \$100 in two days, often more. Master in your spare time by our Home Study Method, the essentials of an unexcelled profession, which pays salaries far greater than average. High authorities endorse course. Send today for full of commercial illustrations, and FREE book, "Your Future," containing complete information.  
Federal School of Commercial Designing, Inc.  
605 Warner Bldg. Minneapolis, Minn.

# Turn the Summer Months Into Profit!

## SIX WEEKS IN THE Sweeney Automobile School



equips you with a splendid paying trade for the fall — hundreds of good jobs open to young men mechanically inclined. My big illustrated book fully explains the opportunities open to you as a mechanic, chauffeur, repair man, salesman, garage owner, etc.

### Tear Off and Mail the Coupon Herewith Today—Right Now

It may mean to you all the difference between success and failure. Will you idle this summer, or will you, by training yourself in a few short weeks, become a competent, expert automobile man? **Cash in on your time.** How would you like this fall to have an earning capacity of \$5 a day and up? How would you like to have a trade that will always insure you good wages, independence, opportunity to see the world? How would you like to be in demand? Have employers looking for you—have big opportunities for a successful career spread out before you? Now young man, you can't do this simply by wishing. You have to take **action.** This Automobile School has over 2000 successful graduates. Practically all came here without the slightest experience. But all had **ambition and resolution.** If you have these qualities you can be sure of success. The **first step** is to send the coupon and get the big free book. It obligates you in no manner — binds you to nothing. But it gives you without cost or trouble all the facts you should know. Learn how others have made good. A post card or coupon brings this book today.

## The Sweeney System of Practical Auto Instruction

is now universally recognized as a most thorough, practical and interesting course of automobile instruction, leading to certain and profitable **EMPLOYMENT.** It embraces every point worth knowing, including vulcanizing, brazing, oxy-acetylene welding, lathe work, machine shop practice, testing, driving, truck repairing and operating, etc. **AND YOU LEARN** by doing the work on **REAL CARS** under the watchful eyes of skilled instructors.

## Our Men Learn Quickly and Easily, Because Practical Experience Is the Best Teacher

This is the only way to learn. Do things with your own hands. Practice beats theory. We do not merely tell you how; we show you how, and you then do the work yourself. We have over 40 cars of all makes on our floor, eight trucks, five tractors, and our **DRIVING TEACHERS** keep out on the road nearly twelve hours a day. **YOU GET PLENTY** of WORK of all sorts.

## No Books Used; Tools Furnished Free

The tuition is low and after you have paid that there are **NO MORE** expenses or extras you have to buy. If you could learn from a book there are lots published you could read at home, but **PRACTICAL WORK** is the only method, and this is what makes my School so successful.

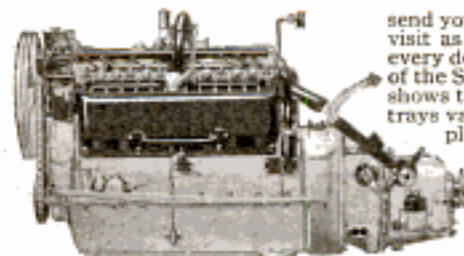

Side View of the Packard Twelve Power Plant

send you my automobile book. This book is almost like a visit as it has 123 illustrations showing men at work in every department. It pictures the wonderful equipment of the Sweeney School. It shows how you are taught, shows the class of men you will associate with, portrays various phases of the automobile industry, explains how, when and where you begin to earn money, in a word is a complete encyclopedia of the subject. I don't urge you to send for it unless you really want it, but to every young man mechanically inclined I will be very glad indeed to mail it free, together with my regular magazine. Simply send name and address today.

## Twin Six Packard

The Sweeney School claims the most complete equipment of any school in the world; it claims to have more pupils, more successful graduates, to afford better practical instruction. We want every young man to investigate these claims and to see for himself before he pays down one cent of tuition.

To show you how we keep up to date—we have just ordered the new 12 Cylinder Packard, and will have the first delivered in Kansas City. This alone represents a substantial investment. We were the first school to teach all types of self starters; the first to buy an 8 cylinder Cadillac; the first to give a complete course in Traction Engines.

We own 5 tractors and in our own factory are building the famous Sweeney Tractor, thus giving students a wonderful advantage in factory experience. This feature alone offers a unique opportunity to young men who wish to become experts in the tractor field.

We have spent thousands of dollars this summer on new equipment. For instance, we have put in a new 8 cylinder Buda Motor, a Fellowes Gear Shaper, 18-inch American Quick-Change Lathe, and a 24-inch Planer. In our machine shop we make our own gears, in a word the very latest developments are put in the hands of our students, as we know our success depends on making you competent to handle any mechanical proposition and of being strictly abreast of the very latest developments.

## This Big Book Costs Me 50 Cents BUT I SEND IT FREE

If you are interested in planning your future and mean to investigate the opportunities before you, I will gladly

### Free Coupon

E. J. SWEENEY, Pres.  
SWEENEY AUTO SCHOOL  
1164 E. 15th St.,  
Kansas City, Mo.

Send free catalog. Also magazine.

Name.....

Address.....

E. J. SWEENEY

**SWEENEY AUTOMOBILE SCHOOL**  
1164 E. 15th Street KANSAS CITY, MO.

# Learn Electricity!



**"I'll Pay You \$175 to \$300 Per Month!"**

That's what many superintendents and managers have said to OUR GRADUATES. That's what one will say to YOU. It's not out of the ordinary. In fact it is just what can happen if you become a COYNE trained man. It means success for you for life. Any man between the ages of 15 and 50 who has ambition, no matter how little education, can learn this big paying trade in our schools in a short time and at small expense.

## COYNE NATIONAL TRADE SCHOOLS

Largest and best equipped trades school in America.

For 15 years we have sent hundreds of men out annually as skilled mechanics to help supply the rapidly increasing demand. Let us train you for one of these big jobs. Our employment bureau places graduates into big paying positions free of charge.

### Men Wanted For These Trades



Our Own Building

We teach all these big paying trades under actual working conditions. We do not have classes, do not use books, do not teach by correspondence. Each man is instructed individually right in our big shops. Drafting, Estimating and Plan Reading included IN ALL courses.

We charge a small tuition fee which can be made in easy payments if desired. All tools, equipment and material is furnished by the school FREE. Our institution is open Day and Evening. Many of our students earn a part or all of their expenses while attending. Our employment bureau is always ready to assist a man to earn expenses, without charge.

### SEND COUPON FOR FREE BOOK

#### FREE COUPON

B. W. COOKE, Manager  
COYNE NATIONAL  
TRADE SCHOOLS  
Dept. 119Z  
39-51 E. Illinois St., CHICAGO, ILL.

Without any obligations on me whatsoever, please send me your book of trades and full particulars—ALL FREE.

Name.....

Address.....

Be a man of action. Send today for our book of trades—fully illustrated. It costs you nothing and shows how you can earn more money, make a bigger success than you ever dreamed of. If you live near come over and go through our shops—visitors are always welcome.

B. W. COOKE, Manager  
COYNE NATIONAL  
TRADE SCHOOLS  
DEPT. 119Z  
39-51 E. Illinois St.  
CHICAGO, ILL.

**Electricity  
Plumbing  
Bricklaying  
Motion Pic. Opr.  
Mech. Drafting**

## LEARN THE Auto Business

**Earn a Splendid Salary**

Over 3000 graduates of our school are now receiving big salaries as Chauffeurs, Testers, Mechanical Experts, Demonstrators, etc., etc. There are greater opportunities now than ever before in the auto business—for properly trained men.

**UP-TO-DATE TRAINING IN 4 WEEKS**  
including expert instruction on latest starting and lighting systems, newest types of motors, etc., and repairing and driving high powered cars. 11 years of success—oldest and best established school west of New York. Tuition and board reasonable.

*Call or write us today for catalog*

**Cleveland Automobile School** 2338 Euclid Ave.  
Cleveland, Ohio

## The Best Art School

Correspondence and Resident Instruction in Designing, Cartooning, Illustrating, Chalk-talking and Lettering. Most thorough, practical and best courses obtainable. We can prove it. Send at once for FREE fine illustrated catalog.

THE LOCKWOOD ART SCHOOL, KALAMAZOO, MICH., Dept. 35

**You Can Earn a 5-Passenger, 28 H. P. BUSH TOURING CAR**

self-starter, electric lights and the agency for your territory by qualifying through a course in Driving, Repairing and Selling Automobiles. An opportunity of a lifetime. THE OFFER IS LIMITED. WRITE TO-DAY

Dept. 817, BUSH MOTOR COLLEGE, Inc., J. H. Bush, Pres.  
Bush Bldg., Clark St. and Chicago Ave., CHICAGO, ILL.

## LAW STUDY AT HOME BECOME AN LL.B.

Only recognized resident law school in U. S. Conferring Degree of Bachelor of Laws—LL. B.—by correspondence. Only law school in U. S. conducting standard resident school and giving same instruction, by mail. Over 450 class-room lectures. Faculty of over 30 prominent lawyers. Guarantees to prepare graduates to pass bar examination. Only law school giving Complete Course in Oratory and Public Speaking. School highly endorsed and recommended by Gov. Officials, Business Men, Noted Lawyers and Students. Send today for Large Handsomely Illustrated Prospectus. Special Course for Business Men and Bankers.

HAMILTON COLLEGE OF LAW, 405 Advertising Bldg., CHICAGO, ILL.

## LEARN PIANO TUNING AT HOME

My Patented Tune-a-Phone method makes it easy. Eliminates guess work. Anyone can learn. A. D. Pope, Texas, made \$82 first ten days. Course guaranteed as represented. Diploma granted. Write for free booklet, graduate's records, etc.

Niles Bryant School of Piano Tuning, 448 Inst. Bldg. Battle Creek, Michigan

## LEARN WATCHMAKING

and become independent. Good-paying positions secured. Easy to learn. Send for FREE CATALOG.

ST. LOUIS WATCHMAKING SCHOOL, Dept. 5, ST. LOUIS, MO.

## LEARN WATCHMAKING AND ENGRAVING

Earn while learning. Most practical watch school. Individual instructions. Graduates in great demand. Book free.

Chicago School of Watchmaking, 63 E. Van Buren St., Chicago

## ARITHMETIC SELF-TAUGHT

A plain, easily-understood volume for all who have not had the opportunity of learning this subject thoroughly, or who have forgotten what they once learned. 257 Pages. Requires no teacher. This great little book sent postpaid for 60 CENTS. Stamps accepted.

GEO. A. ZELLER BOOK CO.  
Est. 1876. 4472 W. Belle Place ST. LOUIS, MO.

SPANGENBERG'S  
PRACTICAL  
ARITHMETIC  
Self-Taught

# Know Your Car— It Means Money to You

Audels Automobile Guide—the world's most scientific book on automobiles will positively enable you to quickly solve every problem pertaining to driving, repairing, locating of trouble. It is recognized as the authority by experts. Its value is unlimited. It tells you everything you should know. Sent to you for free examination.

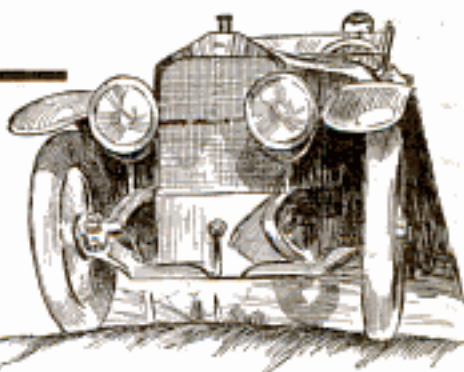

## If you are an Owner

You are losing money every time you run with ill-adjusted Carburetor, with faulty ignition, with your engine at the wrong speed, or with a score of other faults. You may be a careful student of your car and take all the precautions you know of. But unless you know the technical details of driving and operation, and know them right, your car is an expense burden instead of a pleasure.

## If you are a Chauffeur

We don't need to mention the things you must have at your fingers' ends in order to manage your car at top efficiency. Here are a few of the points you may be in doubt about. How to care for batteries and keep them operating at maximum voltage. How to wire a car for Electric Starting, Lighting and Ignition according to the most modern systems. How a car is best lubricated.

## If you are a Mechanician

Then more than anyone else you will realize the importance of knowing the details of design of every part of your car. New inventions in design and construction are coming up every day, which puzzle the untrained man. Do you know these things? Methods of cooling—Timing and Balancing—Designing Clutches—Design of ball and roller bearings, etc.

# Audels Automobile Guide

Solves every single one of these problems and solves them in a way that you can understand. It tells the story in the best known way, namely by

**Questions and Answers** Technical terms are explained or made clear by the wording of the answer which is always brief and concise. The book is handsomely bound in durable Full leather, Pocket size. It is easy to handle and easy to study. There are 30 chapters covering every single phase of Automobile engineering and Automobile operation. Every chapter is modern, concise and practical.

## Written by Practical Men FOR PRACTICAL MEN

There is no idle theory in Audels Automobile Guide. Every paragraph is written to help you in the easiest, most practical way. The chapters on carburetors, ignition, gas engine operation, How to run an Automobile, overhauling the car, Battery Troubles, or Starting and Lighting Systems, are alone worth the price asked for the 30 complete chapters. There are 700 information-full pages, with 550 illustrations that show you in picture just what you want to see.

## Sent to You FREE

We don't ask you to take our word for the merits of this book. We will send you the book without deposit. Use it seven days in connection with your car. Then if you are not satisfied that Audels Automobile Guide is positively the best book on the subject, send it back to us. But if on the other hand you decide that you need this book, that it is the one book for you, remit us only \$1.50.

**Use this Coupon** Cut out the coupon and fill in your name and address plainly at the bottom.  
**MAIL FREE COUPON**

Do not delay an instant. Put your name and address on the coupon today. The book will be mailed to you for free examination. Convince yourself of the wonderful assistance this book will be to you. If you decide it is the book you want, remit to us only \$1.50. Send for it today—now.

**THEO. AUDEL & CO., 72 Fifth Ave., New York**

### HERE ARE SOME OF THE SUBJECTS

Parts—Operation—Care—Management—  
Road Driving—Carburetor—Wiring—Timing—  
Ignition—Motor Trouble—Lubrication—  
Tires, etc. Chapters on Storage Batteries—  
Electric Vehicles—Overhauling Car—Appendix on Self-Starters and Lighting Systems, etc.

### FREE Examination Coupon

Theo. Audel & Co., 72 Fifth Ave., New York

Without obligation please mail for free examination "AUDELS AUTOMOBILE GUIDE." If I find it satisfactory I will remit \$1.50. Otherwise return it to you.

Name .....

Occupation .....

Address .....

P. M. Aug.



# Come to Detroit the automobile center and

# LEARN THE AUTOMOBILE BUSINESS

## Big Opportunities Everywhere for Detroit- Trained Automobile Men

Interesting, pleasant, and a money making business. Every locality needs ambitious men to start garage and repair shops in down town and residence districts. Learn now, become competent and efficient.

## Earn \$75 to \$300 a Month

It's the business of the hour. We will teach you to handle any auto proposition. Our equipment is complete. Students actually build new cars from start to finish, getting regular factory training in assembling, block-testing, road-testing, etc. That's the Detroit way. All leading types of starting, lighting and ignition systems, in operation. Learn to time motors, adjust carburetors, magnetos, valves, bearings, etc. New six-cylinder Luster Touring Car just finished by our students, will be used for road instruction. We have a new 8-cylinder King Chassis and will soon add a 12-cylinder motor as a part of our regular equipment, exclusively for students; not a private car brought around for them to look at once in a while.

**Detroit is the Place to Learn. Start Any Time** There are 44 auto factories in Detroit. Our students have the privilege of going through any or all of them, including Detroit Electric service department, while taking our course. You can't get these advantages and opportunities anywhere else. Detroit is the automobile center. Our students are in the midst of this activity. You make faster time here and you get practical instruction. Come to Detroit and learn the business right. Enter classes any time—start the same day you arrive if you like.

### Great Demand for Detroit Trained Automobile Men

Auto factories have been advertising nearly every day for months past for competent automobile mechanics, but can't get them. Garages throughout the country write us for men. We have had more calls for men than we have been able to fill. Why not fit yourself for one of these good paying positions?

### Demand Greater Than Supply for Competent Men

Following clipped from daily papers—all parts of U. S. "Experienced motor mechanic, bearing scrapers, assemblers, repairmen; good wages. Henderson, Motorville Co." "10 road testers, 20 garage repairmen, final assemblers, 40 drivers—Come ready to work. Maxwell Motor Co., Inc., Oakland Avenue Plant." "Block Testers. Apply Continental Motor Mfg. Co." "Wanted—High grade retail automobile sales manager. Box E, No. 22."

**Write for Full Particulars**—ask for "Auto School News"—it's free—or better still jump on a train and come to Detroit, hundreds have done it.

Dept. P. M. 8, No. 11 to 13 Selden Ave.  
**Detroit, Mich., U. S. A.**

### Our Guarantee

We guarantee to qualify you for a position as chauffeur, repairman, tester, salesman, demonstrator or garage man, paying from \$75 to \$300 in a short time or refund your money. We have constantly more requests for men, at good salaries, than we can supply.



## PRACTICAL ART

You can make good at it. Invest your spare time. Learn Card Writing, Sign Painting or Commercial Lettering and Design. It will pay you a good salary or establish you in a business of your own with a steadily increasing income. My students become competent, so can you. Individual instructions with Personal Guidance make the course self-pacing. Investigate now. Write for full information and beautifully illustrated new booklet.

**ROSE SCHOOL OF LETTERING AND DESIGN 728 Selma Bldg., Cleveland, Ohio**



## I TEACH Penmanship BY MAIL

I won the World's First Prize in Penmanship. By my new system many are becoming expert penmen. Am placing my students as instructors in commercial colleges. If you wish to become a better penman, write me. I will send you FREE one of my Favorite Pens and a copy of the Ransomian Journal.

**C. W. RANSOM, 425 Essex Bldg., Kansas City, Mo.**

## "The law trained man"

is a remarkable 128-page book sent free on request showing why more law trained men are wanted AT ONCE. To succeed under modern conditions, you MUST be law-trained. The book tells you WHY, and also explains how men who are unable to leave their home or business can, for the first time, become law trained in spare time by a method which is prepared by 60 eminent legal authorities and is endorsed by lawyers and judges everywhere. Easy to understand and interesting. Write now for SPECIAL OFFER and free book. No obligation.

**Blackstone Institute, 20 W. Jackson Blvd., 135C, Chicago, Ill.**

## CIVIL SERVICE

positions are in all parts of the country. Good pay steady work, life positions, congenial surroundings, promotions on merit, short hours, annual vacation and sick leave with pay. Many thousands appointed yearly. Both sexes. No political pull. Nearly 300,000 classified positions. Common school education sufficient. Full information and questions used by the Civil Service Commission free.

**COLUMBIAN CORRESP. COLLEGE, Washington, D. C.**

## WANTED Railway Mail Clerks \$900 to \$1800 a Year



Pleasant Work—Continually Traveling

Rapid advancement to higher Government Positions. "No lay-offs" because of STRIKES, WARS, FINANCIAL FLURRIES or the WHIMS OF SOME PETTY BOSS. THE POSITION IS YOURS FOR LIFE.

Country residents and city residents stand the same chance for immediate appointment. Common-sense education sufficient. Political influence NOT REQUIRED.

Write immediately for schedule showing the places and dates of THE COMING Gov't examinations. Don't delay. Every day you lose means the loss of just so much coaching before the rapidly approaching examinations.

**FRANKLIN INSTITUTE, Dept. C104, Rochester, N. Y.**

FRANKLIN INSTITUTE (The Pathway to Plenty), Dept. C104, ROCHESTER, N. Y.

This coupon, filled out as directed, entitles the sender to free specimen questionnaires, a free copy of our book, "Government Positions and How to Obtain Them," a list of Government positions now obtainable, and to consideration for Free Coaching for the examination here checked.

COUPON	
.. Railway Mail Clerk... (\$900 to \$1800)	.. Customs Positions... (\$800 to \$1100)
.. Bookkeeper... (\$900 to \$1800)	.. stenographer... (\$800 to \$1100)
.. Postoffice Clerk... (\$800 to \$1200)	.. Internal Revenue... (\$700 to \$1000)
.. Postoffice Carrier... (\$800 to \$1200)	.. Clerk in the Departments
.. Rural Mail Carrier... (\$500 to \$1100)	.. at Washington... (\$800 to \$1500)
.. Auto Chauffeur.....	.. Canadian Gov't Positions.....

Name..... Address..... C104  
Use this before you lose it. Write plainly.

**You Can Make This Jump Easy!**



Become an **EXPERT ACCOUNTANT**

**\$3,000 to \$10,000 Yearly**

Accountants at salaries of \$3,000 to \$10,000 yearly. Right now railroads, corporations and other big firms need Expert Accountants. The need for experts is greater than the supply, and possibilities for advancement into big, powerful executive positions of prosperity are excellent everywhere. Become an Expert Accountant and name your own salary—be your own boss—build a future of prosperity and independence. Be a big man—an important factor.

**We Train You By MAIL!**

You can become an Expert Accountant—we make it easy, no matter what you work at now, your wages or education. If you can read and write English, the LaSalle Extension University can qualify you for this remarkable vocation at home, in spare time. It is not necessary that you already understand bookkeeping. For those who need elementary training, we have devised a general Course in Bookkeeping that prepares you from the ground up for more advanced work in Higher Accountancy. The LaSalle Course is thorough, advanced, comprehensive. Prepared by some of the world's most noted Expert Accountants and covers Theory of Accounts, Practical Accounting, Cost Accounting, Auditing, Business Organization and Management, Business Law, etc. Administered under the supervision of William Arthur Chase, a nationally recognized leader, Ex-President American Association C. P. A. Examiners and Ex-Soc'y Ill, State Board Examiners in Accountancy. Prepares you for C. P. A. examinations in any state.

**Remarkable Book FREE**—What Every Bookkeeper Should Know—tells information you need—studies, kind of examinations, State regulations, salaries, positions to be had, etc. Send coupon now for free copy.

**Special Reduced Rate**

**LIMITED OFFER!** This offer is limited and may be withdrawn any day, so do not delay. Send NOW for facts.

**ACT**

prove that we can qualify you for one of these opportunities. Don't let money worry you—we make terms to suit you. Mail coupon now. Send no money—all free.

LaSalle Extension University  
Dept. H-693 Chicago, Ill.

Let us tell you how, for a limited time only, to secure Special Extra Reduced Rate Scholarship. This offer is limited and may be withdrawn any day, so do not delay. Send NOW for facts. Let us tell you about the success of LaSalle students and the success possible now for Expert Accountants with LaSalle training. Let us send you free book, How to Become an Expert Accountant, and details of your Course in Higher Accountancy; also facts about Reduced Rate. I am obligated in no way.

Name.....  
Address.....  
LaSalle Extension University  
Dept. H-693 Chicago, Ill.

**MONEY-BACK GUARANTEE BOND**

So thorough in the LaSalle Home Study Course—so exceptional has been the success of LaSalle students—that we issue with each LaSalle Course a legal, binding guarantee to refund the entire tuition fee if after you complete the Course you are not perfectly satisfied. This guarantee is backed by our entire capital and resources of more than one million dollars, which assures your absolute success.

**BE AN ILLUSTRATOR** by mail how to draw for magazines and newspapers. Send for Catalog

Learns to draw. We will teach you school of illustration 112 Page Bldg Chicago, Ill.

**SOCIALISM** The problems of wealth and poverty, unionism, wages, strikes, lockouts, injunctions, profit sharing, shorter work day and hundreds of other vital subjects in our new book "GETTING A LIVING." 800 big pages, silk cloth binding, introductory price \$1.00. Sent on approval. Money back in 10 days if not satisfied. Address: The Riverside Publishing Company, 140 South Dearborn St., Chicago

**DO NOT STAMMER**

My book, "How to Stop Stammering"—a treatise on "Scientific Talking and Psychic Training." School and circular literature FREE. M. L. HATFIELD, Prin. of The Pacific School for Stammerers, 1918 Grove St., OAKLAND, CAL.

**OHIO AUTO SCHOOL**

Before enrolling with any school, get proposition. It will interest and please you. Learn the auto business, the opportunity of the 20th Century. Write us. 108, 1521 Prospect Ave., CLEVELAND, OHIO

**LEARNED BY ALMOST ANYONE AT HOME SMALL COST**

**VENTRILOQUISM**

Send today 2c stamp for particulars and proof. O. A. SMITH, Room D 127, 823 Bigelow St., PEORIA, ILL.

**Learn Watchmaking At Home**

You can learn by our modern and original system of instruction every part of the Watchmaker's Trade at home as good or better than at a shop. You can earn money while learning and secure a well paying position or start in business after completing our course of instruction. Good watchmakers are always in demand and earn from \$20 to \$35 per week. For particulars apply to the Wisconsin School of Watchmaking, 50th Bldg., Milwaukee, Wis.

**COPY THIS SKETCH**

and let me see what you can do with it. Illustrators and cartoonists earn from \$20 to \$125 a week or more. My practical system of personal individual lessons by mail will develop your talent. Fifteen years' successful work for newspapers and magazines qualifies me to teach you. Send me your sketch of President Wilson with 5c in stamps and I will send you a test lesson plate, also collection of drawings showing possibilities for you.

**The Landon School of Illustrating and Cartooning**  
1438 Schottfield Building, CLEVELAND, O.

**A GOOD POSITION**

with **UNCLE SAM** is most desirable. Life positions, pleasant surroundings, good pay, steady work, short hours, promotions on merit. Both sexes. No political pull. Thousands of appointments yearly. Most thorough preparation \$5. Returned if not appointed. Full information and questions used by the Civil Service Commission free.

**AMERICAN CIVIL SERVICE SCHOOL WASHINGTON, D. C.**

**Be A Meter Engineer**

Thousands of meter engineers needed!! Get in the new profession. We can teach you meter engineering by mail at your own home during spare time. Successful graduates everywhere.

**Earn \$3,000.00 a Year** Central stations must have Electrical Meter Engineers. They pay high salaries. Thousands of new positions open. Write today. Just your name and address on a postal or a letter and we will send you full particulars and big handsome FREE book.

**Ft. Wayne Correspondence School, Dept. C119 Ft. Wayne, Ind.**

**SHORTHAND IN 30 DAYS**

Word Syllabic System—written with only nine characters. No "positions"—no "ruled lines"—no "shading"—no "word-signs"—no "cold notes." Speedy, practical system that can be learned in 30 days of home study, utilizing spare time. For full descriptive matter, free, address—Chicago Correspondence Schools, 983 Unity Building, Chicago, Ill.



PROF. F. W. FOOTE  
Psychologist

#### VITAL QUESTIONS

1. For what goal are you aiming?
2. Are you satisfied with your present success?
3. Have you Power of Concentration?
4. Is Self-Control and Poise yours?
5. Do you desire to increase your Personal Power?
6. Would you like to develop a Master Mind?
7. Do you possess Mental Control?

MY BOOK Will Tell You HOW to Obtain This Power

FREE BOOK COUPON P.M. 8-15

Prof. Frederick W. Foote  
The Chicago Institute of Mental Culture  
—A School of Applied Psychology  
30 No. Michigan Blvd., Chicago, Ill.  
Send me Free Book "Masters of Destiny" and all particulars of your Mental Success Training Course

Name.....

Address.....

## CONCENTRATION! POISE! PERSONAL POWER!

These Qualities are Results—the Results of Mental Control. Through my Scientific Mental Success Training Course I will personally teach you the positive laws which will enable you to so control your Brain Power that you will be Master of your Thinking and Acting.

## PSYCHOLOGY

—which is the systematic study of mental laws—is the one great science by which you can obtain your goal. My method of teaching is unique. The facts are given to you in simple English—you cannot fail. Write for my wonderful book to-day, it's Free.



MASTERS  
DESTINY

## JENNER MEDICAL COLLEGE

AFTERNOON AND EVENING SESSIONS

Five Year Course College Has Full Recognition  
Hospital Internships guaranteed for all graduates. Evening preparatory course for those lacking the required high school education for admission to the Medical Course. Twenty-third Annual Session begins September 13th, 1915. YOU MAY MATRICULATE NOW.  
For catalog and other information address

DR. JOHN D. MACKELLAR, Sec., Box 12-705 S. Wood St., Chicago, Ill.

**FREE** Send for large  
Catalogue of  
**Practical Mechanical BOOKS**  
FOR HOME STUDY

F. J. Drake & Co., Dept. 8, 1325 Michigan Ave., Chicago

## There is MONEY in SOFT DRINKS

Dubelle's Famous Formulas  
Containing Over 500 Receipts

for Fruit Syrups, Fruit Essences, Fruit Phosphates, Soluble Flavoring Extracts and Essences, Fruit Punches, Fruit Champagnes, New Italian Lemonades, Soluble Bitters Extracts, and many other delicious beverages.

Mailed to any address for \$1.00

Spon & Chamberlain 123 P. M. Liberty St.  
NEW YORK, U. S. A.

**GACHOO!** Make the whole family "just sneeze their heads off" without knowing why, with **Cachoo**, the new long distance harmless snuff. Sent anywhere for 10c. 3 for 25c. 1 doz. and special premium for 90c. AMERICAN SUPPLY CO., St. Paul, Minn.



## DRAWING

Caricature, Cartoon, Comic, Commercial, Fashion, Newspaper and Magazine Illustrating taught by mail. Illustrated books 6c in stores. THE BOSTON SCHOOL OF DRAWING, 755M Boylston St. BOSTON, MASS.



## MUSIC TAUGHT FREE AT YOUR HOME

Write Today for our booklet. It tells how to learn to play Piano, Organ, Violin, Mandolin, etc. Beginners or advanced pupils.

AMERICAN SCHOOL OF MUSIC, 50 Lakeside Bldg., Chicago, Ill.

## LEARN JEWELERS' ENGRAVING

A high selected and easily learned trade, taught thoroughly by mail. We will teach the beginner better engraving than he can gain in years of rigid apprenticeship. We will also improve the skill of any engraver ordered for our course. The Engraving School, 111 Page Bldg., Michigan Ave., Chicago, Ill.

BE A DETECTIVE \$25 to \$75 weekly; see the world with expenses paid. Write LORRAINE DETECTIVE SYSTEM, Inc., Dept. 304, Boston, Mass.

## The Library of Original Sources

gives inside, rock-bottom facts on every subject. 10 magnificent vols. Great bargain. Small monthly payments. Send for information. UNIVERSITY RESEARCH Dept. G, MILWAUKEE, WIS.



## Every Boy His Own Toymaker

Greatest boys' book ever written. Tells how to make a Steam Engine, Telephone, Music Lantern, Boats, kites, balloons, electrical and mechanical toys, traps, fishing tackle, 200 illustrations; also contains 150 puzzles, Keller's Magic Ace Trick Card and "DOUBLE THROAT" warbler and bird call all for only 10c. WESTERN PUZZLE CO., ST. PAUL, MINN.



## Agents \$60 WEEKLY

Robinson Folding Bath Tub. Big seller. Costs little, no plumbing, little water. Weight 15 pounds, folds into small roll. Full length baths, far better than tin tubs. Guaranteed 10 years. \$10 a day easily made. Write for free offer. Robinson Cabinet Mfg. Co., 351 Factory Bldg., Toledo, O.

## Get Into a Business that Pays Big Money

Driving \$80 to \$125 a Month — Repairmen and Salesmen \$300 and Up!

Lots of driving and touring jobs now open in all large cities and good chances (if you are ambitious) to start a garage, do repairing, sell cars, etc. 400,000 more automobiles this year than last. Every small town in the country needs a Real Expert Auto Repairman. We teach you—and we do it right—the way you would like to learn. We put you to work into overalls, with tools, on all kinds of automobiles, in a real shop and garage. Plenty of actual driving and repairing. Our method is down-in-the-grease—and out-on-the-road. No time limit—you stay till you learn thoroughly and are perfectly satisfied. Here is a chance to "Double Your Pay." If you are out of work or dissatisfied with your present job, change now—Get into

THE COMING BUSINESS  
NATIONAL AUTO SCHOOL 2625 Reading Rd., CINCINNATI, O.

Write your name and address on margin of this page, tear out and mail to us—we'll send you our catalog and full information.







### Learn a Paying Profession

that assures you a good income and position for life.  
For twenty years we have successfully taught

## PHOTOGRAPHY

Photo-Engraving and Three-Color Work

Our graduates earn \$25 to \$50 a week. We assist them to secure these positions. Learn how you can become successful. Terms easy—living inexpensive. Write for catalogue—NOW!

ILLINOIS COLLEGE OF PHOTOGRAPHY, 999 Wabash Avenue, Effingham, Ill.

## Michigan College of Mines

HOUGHTON, MICHIGAN

A STATE institution offering engineering courses leading to degree of Engineer of Mines. Unexcelled facilities for instruction in mining and metallurgy offered by its location in the famous Lake Superior mining region, whose mines, mills and smelters are accessible for college work. Field courses in surveying and other lines especially well developed. Special short courses offered for mature practical men.

FOR YEAR BOOK AND BOOKLET OF VIEWS  
ADDRESS THE SECRETARY

## New York ELECTRICAL School

Gives you a complete training by actual practice. You get the knack of "HOW" together with the theory of "WHY" and the best business methods used in the World of Electrical Activity.

The N. Y. Electrical School is the pioneer and premier school of the "Learn by Doing" method. When you have completed this Course you shall be fully qualified to handle ALL branches of Electrical industry.

The equipment of this School is unequalled and up-to-the-minute. No preparation needed to become a "learner" in this school. You can start to learn on any day of any week throughout the whole year.

Visitors heartily welcomed. Send for catalogue.

44 West 17th St. New York City  
N. Y. ELECTRICAL SCHOOL

## LEWIS INSTITUTE

An Endowed Polytechnic School for Both Sexes. College Work in Mechanical and Electrical Engineering, and in Mechanic, Household, and Liberal Arts, leading to degree of B. S. High School Instruction in Science, Literature and Technology. Well equipped Shops and Laboratories. Day and Evening Sessions. Fall Term opens Sept. 14. For Bulletin, address, LEWIS INSTITUTE, Dept. 9, Madison and Robey Sts., CHICAGO

### Do You Like to Draw?

Cartoonists Are Well Paid

We will not give you any grand prize if you answer this ad. Nor will we claim to make you rich in a week. But if you are anxious to develop your talent with a successful cartoonist, so you can make money, send a copy of this picture, with 5c in stamps for portfolio of cartoons and sample lesson plate, and let us explain.

The W. L. Evans School of Cartooning  
821 Leader Bldg., Cleveland, O.



# Make Electricity Work for You

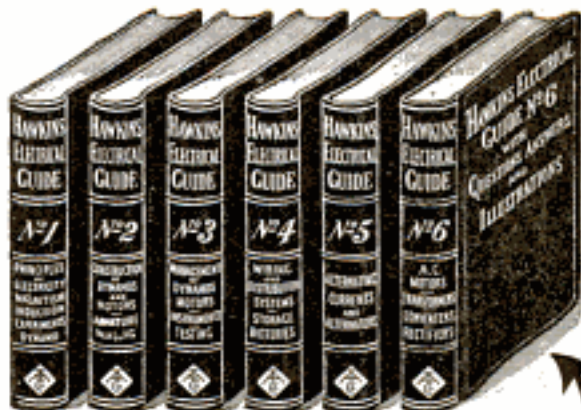

Electricity is the keynote of our twentieth century life. Our progress, our inventions, our manufacturers, our daily customs are linked with and regulated by electrical science. Our best engineers, our most successful scientists have built their reputation on electrical knowledge. Avail yourself at once of this wonderful source. Send for free examination of these books today. They are the greatest ever written on electricity. Regardless of your knowledge they will benefit you—enable you to cope with problems heretofore believed impossible. Sent to you for free examination. Fill out the free coupon. Mail it today—now.

## Shipped to You FREE

Send no money. Examine the books first. Decide for yourself that they are the most complete library of electricity ever published. They cover every phase of electrical science. They are written in a way that you can understand. The binding is in flexible black leather with gold edge—very durable and attractive. Send for your set today. Settlement can be made at only \$1.00 a month.

## Easy Payments

Accept this great offer now—today. Every book is complete in itself. Each page—every illustration will convince you of the big value we are offering. See the books first, then decide. Our special price is only \$1.00 per copy. The complete set is the best bargain. Send for it today. If you decide to keep them you can make settlement at only \$1.00 monthly until paid for. Convince yourself of the wonderful value we are offering. Send for free examination today—now.

### A FEW SUBJECTS

Magnetism—Induction—Experiments—Dynamo—Electric Machinery—Motors—Armatures—Armature Windings—Installing of Dynamos—Electrical Instruments Testing—Practical Management of Dynamos and Motors—Distribution Systems—Wiring—Wiring Diagrams—Sign Flashers—Storage Batteries—Principles of Alternating Currents and Alternators—Alternating Current Motors—Transformers—Converters—Rectifiers.

## Mail Coupon Today

Just put your name and address on the coupon and send it to us at once. Absolutely no obligations of any kind. We will send the books for free examination. Convince yourself of their wonderful value. Do it today—now.

FREE COUPON

Theo. Audel & Co.  
72 5th Ave., New York

Please submit me for examination Hawkins Electrical Guides (Price \$1.00 each). Ship at once, prepaid the 6 numbers; if satisfactory I agree to send you \$1.00 within seven days and to further mail you \$1.00 each month until paid.

Theo. Audel

& Co.

Dept. 00  
72 Fifth Ave.  
NEW YORK

Signature .....

Occupation .....

Business Address .....

Residence .....

Reference .....

Aug. P.M.

# Free!

## Complete Set of Drawing Instruments

Yes, I will give you this complete set of drawing instruments absolutely free. They are regular working instruments—the kind I use myself and they do not cost you a penny. And besides the instruments in this exquisite plush lined leather case, I will give you absolutely free a 20x25 inch drawing board, a 24 inch T-square, a 12 inch rule, a supply of drawing paper, two triangles and a French curve, pencils, erasers, thumb tacks, etc., etc. A complete draftsman's working outfit. And I give it to the men who get my personal instruction absolutely free.

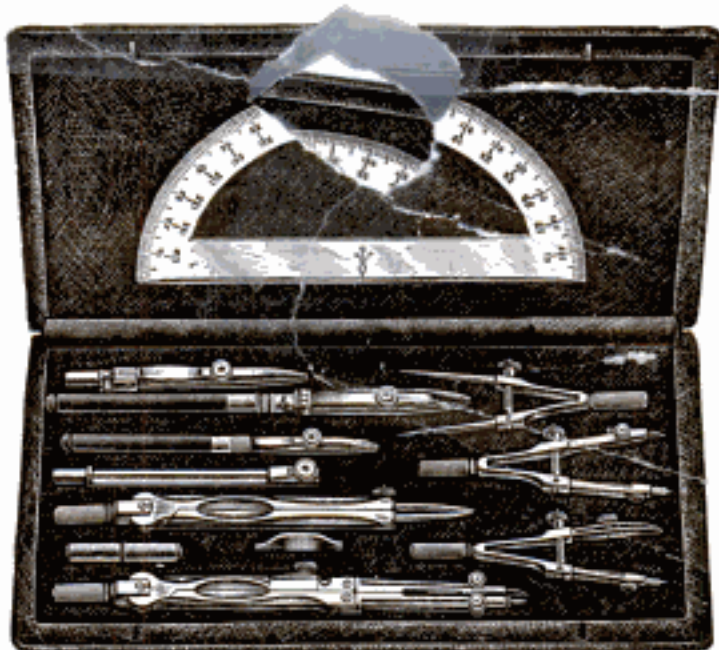

# Be a Draftsman!

## Draw \$125 to \$175 Per Month

There is an urgent demand for skilled draftsmen. Companies are issuing calls every day for men to fill positions paying from \$125.00 to \$175.00 per month. Work is light, pleasant and profitable.

## Chief Draftsman Will Instruct You Personally

I am Chief Draftsman of a large and well known firm. I have been doing the highest paying expert drafting work for a quarter of a century and I know just the kind of training that is demanded from men who get the big salaries. I will give you personal instruction, deal individually with you and give you up-to-date, practical working plans just as your ability and advancement require. I train you by giving you actual work—practical work, the kind that you must be able to do in order to hold permanent, big paying positions. I give you my individual instruction. If your work is right, I will advance you rapidly. If it is wrong, I will show you where, and make you do it right, and do all I can to make you Write today without fail an expert draftsman and designer in a short time.

Pay as You Wish! What I want is the RIGHT KIND of men. Don't bother about expense. I will give you the working outfit free if you get in at once. I charge a very small fee for training you to be an experienced draftsman. You can pay the small cost as suits you best. My object is to develop experienced draftsmen.

Chief Draftsman Dobe  
Engineer's Equipment Co.  
Div. C119 Chicago, Ill.

Without any obligation on me whatsoever, please mail your book "Successful Draftsmanship" and full particulars of your liberal "Personal Instruction" offer to a few students. It is understood that I am obligated in no way whatever.



## Send the Coupon for My Big New Book

Put your name and address on the free coupon or a letter or a post card and send it to me today. I will send you absolutely free and postpaid my new book "Successful Draftsmanship," and the great special offer that I am now making on which you get the \$15.00 Draftsman's Working Outfit absolutely free. You assume no obligations of any kind in sending in the coupon. Get in line now for a big paying position. Getting the book and full particulars of the special offer is the first step. Write today—now.

**Chief Draftsman Dobe**  
Engineer's Equipment Co., Inc., Div. C119. CHICAGO, ILL.

NAME.....

ADDRESS.....

# CLASSIFIED ADVERTISEMENTS

We have records to prove that a classified ad in these columns will find a buyer for almost anything which can be sold. Doubtless you have some article of value to some one else which you no longer need. Why not turn it into money?

Advertisements in this section, 15 cents per word, each insertion, minimum 10 words, payable in advance. To insure ads being inserted under proper classified head in the September issue, copy must reach this office not later than August 1st.

May 21, 1915.

Popular Mechanics Magazine, Chicago, Illinois

Gentlemen: In response to your inquiry of May 18th, I wish to state that our replies from Popular Mechanics have been more than satisfactory. In fact we consider Popular Mechanics the very best medium on our list, securing inquiries from agents much cheaper than from any other publication we have yet tried. Our records show that for the first five months of 1915 our advertising in Popular Mechanics has cost us \$23.40 and we have to date received 333 inquiries, making the cost per inquiry only a little more than 6.5 cents. With the inquiries still to come we are sure the cost will not exceed 6 cents each. We will always place Popular Mechanics at the head of our list when seeking agents.

Sincerely yours,

MARVELLO COMPANY.

P. S. We might add that we shall discontinue, temporarily, advertising for agents with the June issue because our campaign has brought us all we can handle for the present.

## AUTOMOBILES

ARSENAL School of Automobile Electricity. Specializes on Electric starting and Lighting systems and Storage batteries. Six weeks' course, class-room lectures and actual shop work. Fall term starts, Sept. 7th. New classes every month. No mail course. Students enrolling now. Send for free prospectus giving rates, subjects covered, etc. Arsenal School of Automobile Electricity, 339-25th St., Rock Island, Ill.

A WRITTEN guarantee for 5,000 miles without puncture. European Motorists are getting 10,000 miles out of their tires by increasing them about one-half inch in size. In eight months, 20,000 American Motorists have followed their example. It's so easy that you can do it in your own garage in thirty minutes, no matter what condition your tires are in. Send for free catalog, sample and copy of guarantee. Colorado Tire & Leather Co., 843 Tread Bldg., Denver, Colo.; Dept. H45, Box 228, Chicago, Ill.; Suite 438, 162 W. 34th St., New York, N. Y.

AUTO Gasoline 3c a gallon. Sounds wonderful, but it's a fact, and what is better, power and speed as never before. Carbon evil eliminated. All these good things and more come when "Gas-Tonic" is added to ordinary Gasoline. Mileage increased 40%. Scientifically right. Quart can treats 200 gallons of gasoline. \$2 prepaid. Results guaranteed. Motorists enthusiastic wherever "Gas-Tonic" is tried. Circular and convincing details free. Great opportunity for live dealers and agents. White Mfg. Co., Dept. 112A, Cincinnati, Ohio.

\$260 TAKES my 1914 Trumbull Runabout, with top, electric lamps, and horn; first-class condition; 35 miles per gallon of gasoline. Parkinson, 184 Japonica St., Pawtucket, R. I.

CAN you sell a device that appeals to every automobile owner regardless of the make or kind he drives? The "U-Can-G" Rain Shield assures the driver clear vision in all storms. Sells at sight for \$1.50. A few sales mean a good day's wage, but we want clean cut men who can make real salaries from their commissions. Frey Manufacturing Company, 1314 Michigan Ave., Chicago, Ill.

CYLINDER regrinding or reboring. Extra light pistons and perfect rings inserted. Accuracy guaranteed. Crankshaft grinding. Worn or broken parts duplicated. Prompt service. Evans Machine Co., 14 Hicks St., Hartford, Conn.

STEAM automobile boilers bought, sold, and repaired. Send for List No. 31. Lucas & Son, No. 3 Fox St., Bridgeport, Conn.

ELECTRIC Lights for your auto or motorboat. Write for particulars. Ajax-Volta Co., 1329 Michigan Ave., Chicago.

LIGHT car parts; Motors, Transmissions, Rims, Wheels, Steering Gears, Front and Rear Axles. Catalog free. Palmer Bros., Coscob, Conn.

HOW to operate and repair automobiles. Book 15c. Richard Devine, M1145 Wells St., Chicago.

CYLINDER Regrinding — First-class equipment, fifteen years' experience, and specializing in this work enable us to do high-grade work at lowest prices. We manufacture the "Neverleak" individual cast piston rings. Prices will interest you. Bridgeport Piston Ring Co., 346 Connecticut Ave., Bridgeport, Conn.

PAINT Your Car Yourself—Save \$25 to \$75 by doing the work at home with the Arsenal system. Our big free booklet "The Car Beautiful" tells how. Send for it today Arsenal Varnish Co., Dept. P, Rock Island, Ill.

## AUTOMOBILE SUPPLIES

AUTOMOBILE tires (new). 30x3 shoe \$5.83, red tube \$1.95, 30x3½ shoe \$7.29, red tube \$2.50. Send for further particulars and complete price list. Grossman Auto Parts Company, White Plains, N. Y.

GARFORD "30" and "40" Parts for Sale at Bargain Prices. Only opportunity to buy these parts direct from the company at below cost. All offers subject to stock being unsold. If interested, this is your chance to pick up some of these repairs cheap. Write for list and prices. H. A. Wagner, Studebaker Corporation, South Bend, Indiana.

DOUBLE Tires give 6,000 miles and upwards. 30% to 50% saved. Positive guarantee. Some prices, 30x3 \$6.75, 30x3½ \$8.50, 32x3½ \$9.25, 33x3 \$11.50, 34x3 \$12.40, 36x4½ \$15.25. Send for list now! State size. Anglo Tire Company, 838 7th Ave., New York.

WE repair any magneto or coil. Large stock of repair parts, also magnetos and coils. Write for prices. Pellet's Magneto Exchange, 1696 Michigan Avenue, Chicago, Illinois.

CARBURETORS — Stromberg, Rayfield and Model L. Schobler in nearly all sizes, \$8 each. Condition guaranteed. Henry A. Currier, West Newton, Mass.

FLEXIBLE Metal Tubing. Better than rubber. Inflates tires. Covers wires. Cools and silences exhaust. Improves carburetors. Conveys oil, gas, etc. Protects Speedometer drives. Catalog free. Breeze, Newark, N. J.

EFFERVESCENT Carburetors are more economical and give your engine 50% greater efficiency. Effervescent Carburetor Co., Offices 2214 Dimw Bank Bldg., Detroit, Mich.

PLACE your order now and secure the \$5.00 "Automatic Steam Vulcanizer" for \$2 prepaid. Circular on request. Halsey Mfg. Co., 320 Broadway, New York.

HAYWOOD Vulcanizer, complete equipment, air bag mounds and bags, \$160. Cost \$350. Excellent condition. Box 338, Henderson, N. C.

RECTIFIERS for garages. All sizes. Charge one to eight batteries, \$12 upwards. American Battery Company, 1129 Fulton St., Chicago.

TIRE covers 70 cents, summer robes \$1.25, rubber blow-out boots 39 cents, goggles with glass lenses 10 cents, and others at equally astonishing prices. Piston rings any size twenty-five cents. Grossman Auto Parts Company, White Plains, N. Y.

FORD Sale — 6-cylinder Gasoline engine and magneto, in good condition, \$73. 20-H. P. White steam engine and generator, \$75. 4½-H. P. Locomobile steam engine, \$16. 6-H. P. single-cylinder gasoline engine, suitable for stationary use, \$25. 1423 North Ave., Bridgeport, Conn.

GOVERNORS, fans, jack shafts, etc., for motor engines when used as stationary. Circulars. Box 50, Taft, Calif.

\$5.00 KLAXON Style Stewart Automobile Signal Horns, \$2.95. Send for circular. W. E. Wandersco Co., 129 Gratiot Ave., Detroit, Mich.

OUR Double-Tread Tires are Guaranteed (written) for 3,500 miles. Two tires in one. Big, strong, extra heavy. 30x3½, \$7.00; 34x4, \$9.25; 36x4½, \$12.00; 37x5, \$13.00. Big saving on other sizes also. Send for list now! State size and type rim. Max Libben & Company, 295B West 48th, New York.

GENERATORS, Batteries, Compressors, Dies, Engines, Lathes, Kefel Dynamo Wks., Chicago.

KNOWLSON'S Spring Spreader. Guaranteed. Stops the squeak. Gives 100% easier riding. Prolongs life of springs. Drop-forged, nickel-plated, highly finished. Sent anywhere for \$1.50. Springfield Lubricator Co., Dept. H, Ann Arbor, Mich.

KEYSEATING Attachments for small lathes. Elder Manufacturing Co., Indianapolis, Ind.

CLINCHER Tire Tool. Fastest selling accessory on market. Garagemen—Salesmen, get agency proposition. Demonstration tool at actual cost. Bateman Bros., Centerville, Iowa.

VULCANIZER for shop. Bargain. Vanderpool's, Springfield, Ohio

MOUNT power vacuum cleaner on your auto. Buy parts, assemble. \$50 cost—earns \$15 daily. Vacuum Supply Co., Ann Arbor, Mich.

"THE How and Why of the Automobile" —A 200-page book of practical information for seekers after the fundamental facts regarding the gasoline engine and its application to the motor car. Interesting and instructive to both the beginner and the expert. Bound in full cloth—250 illustrations. Price \$1 postpaid. Popular Mechanics Book Dept., 6 N. Michigan Ave., Chicago.

FOR Sale—Wagner Rectifier. Charges one to four 6-volt batteries. Good as new. Cost \$12.00. Sell for \$25. Winnetka Motor Co., Winnetka, Ill.

## FORD ACCESSORIES

FORD Starter. Garagemen—Salesmen, get our agent proposition. Retail at the lowest price, gives biggest margin of profit. Bateman Bros., Centerville, Ia.

MAN with Ford Car to demonstrate and sell to dealers a new and long-needed attachment for Fords. Good commission paid. Sample attachment furnished free. For full particulars, address Room 926, 78 E. Madison St., Chicago.

FORD owners and dealers, send 25c for sample "Handy Pet Cock Opener." Don't crawl under your Ford to turn pet cocks. Money promptly returned if not satisfied. Agents wanted. Chief Specialty & Mfg. Co., 1288-92 N. High St., Columbus, Ohio.

NEW 200-page book on the Ford car for every Ford owner, dealer and repairman. Deals fully with construction, operation and repair. 100 engravings. Best and most complete Ford book ever published. Price, \$1 postpaid. Also Ford Engine Chart—25x 38 in. Location of engine troubles made easy. Price, 25c postpaid. Your money back if not satisfied. Popular Mechanics Book Dept., 6 N. Michigan Ave., Chicago.

**FORD Racers**—Rebuild your Ford car into a racer. Sketches, specifications, instructions. Information two-cent stamp. T. M. Co., Box 212, Woodfords, Maine.

**VOLTA Electric Generator and Ajax Guaranteed long-life Storage Battery**, can't be beat for efficiency, easy to install. Ajax Volta Co., 1329 Michigan Ave., Chicago.

#### WELDING

**BIG opportunity for profits in the welding business.** You can increase the business of your repair shop or start in yourself at a small cost. The Peerless Welding and Carbon Removing Outfit opens up a field for you in which there is a big, sure business with big profits. Not mere wages but real money. On many jobs you can make \$15 to \$20 clear and the cost of the entire machine is only \$70. Anyone can do this work. Full and simple operating directions given. Start work immediately on receipt of outfit. Write at once for further information about this money-maker to Economy Welding Machine Co., Gateway Station, Kansas City, Mo. Makers of famous Economy Welding and Cutting Devices.

**OXYGEN Tank**; 200 cubic feet, extra strong, \$25. Welding Supplies. Denver Brass Works, Denver, Colorado.

**WELDING Plants**, \$25 to \$250. Liberal terms. Write Berne Co., Omaha, Nebr., U. S. A.

**OXY-ACETYLENE Welding and Cutting** is the title of a brand new practical instruction book on the methods of doing this work. It includes the operation and care of Acetylene Generating Plants and the Oxygen Process for removal of carbon. 200 pages, 76 illustrations, pocket size, cloth, \$1.00; leather, \$1.50 postpaid. Popular Mechanics Book Dept., 6 N. Michigan Ave., Chicago.

#### MOTORCYCLES, BICYCLES & SUPPLIES

**MOTORCYCLE Bargains**—N. S. U. twin, \$49; Reading Standard, \$40; Detroit Special, \$35; Excelsior, \$40; Harley-Davidson, \$40; Flying Merkel twin, \$75; Indian twin, \$75; Indian twin, \$50; Henderson 4-cylinder, \$175. Send for our Big Bargain Sheet of one hundred slightly used machines. Sent C. O. D., with privilege of examination. W. E. Wandersee Co., 129 Gratiot Ave., Detroit, Mich. Largest motorcycle dealers in United States.

**LIVE agents wanted for the new Eagle motorcycles.** Write for Proposition P. Get our bargain list M-79 of new and rebuilt machines. Write quick. Sterling Motor Co., Brockton, Mass.

**USED Motorcycles**, \$20 up. Real Bargains. Overstocked. All makes. Werner, 532 Main, Passaic, N. J.

**MOTOR Bicycles**, \$85. Motor bicycle attachments, \$24.85. Catalog free. Kopp Motor Works, D. A., Cleveland, Ohio.

**\$5,000 WORTH of Used Motorcycles**, all makes. Twin and Single Cylinder Machines from \$25 to \$290. Send for our list at once; will give you a detailed description of each machine and guarantee to furnish you a motorcycle exactly as per description or money will be returned. C. H. Lang, 1744 Michigan Ave., Chicago.

**200 REBUILT Motorcycles**, standard makes, new list. Chicago Motorcycle Works, 3911 Clarendon Ave., Chicago.

**\$50 TO \$150 buys the best motorcycles**; every make and model in our large stock must be cleared. Half price. Send for list today. Brown Music Co., 9119 Commercial Ave., Chicago, Ill.

**TWIN Harley**, 1914, perfect condition. Presto tank, head and tail lights, \$160, \$25 cash, balance collect. F. J. Van Voorhis, Mt. Vernon, Ohio.

**BARGAIN**—Harley-Davidson two-speed twin. Winger, Point Pleasant, W. Va.

**1914 TWIN Indian**, perfect, not ridden 1,000 miles, equipped, \$165. Lyle, 411 Ashmead, Germantown, Pa.

**INDIAN 1914 twin**, nearly new, \$180. Harry Moss, Norfolk, Nebr.

**EAGLE twin**, equipped, absolutely perfect, \$135. Inquire W. Chann, Concord, Nebraska.

**CAN you sell yourself a motorcycle and save \$25 to \$50? And sell a couple others too.** Let us tell you how. Our bargain bulletin is free; over 100 machines, \$20 up, rebuilt, guaranteed. Write today—it'll help us both. Western Supplies Co., 1450 Larimer, Denver, Colo.

**A BARGAIN**—Twin-cylinder, five-horse, 1919 Indian; overhauled, \$100. Coufal, 67 West 23rd St., New York.

**EXCELSIOR 9-hp.** Excellent condition. Purchased 1914. \$100. G. B. Blatt, Neoga, Ill.

**BARGAINS** in all kinds of motorcycles. Everett Green, Wilbraham, Mass.

**1913 EXCELSIOR Twin** (Chain), fine condition, \$87.50. W. B. Barr, Charleston, W. Va.

**MOTORCYCLE cylinder** reground, refitted with new piston, \$5. Irvin Depoy, Muncie, Ind.

**BIG bargains in good motorcycles** we have taken in exchange on new ones. Send for special bargain list. Shaw Mfg. Co., Galesburg, Kansas.

**1912 HARLEY**, \$70. 1911 Harley, \$35. 1912 Indian, \$60. 1913 Indian, \$75. 1911 Excelsior twin, \$70. 1914 Excelsior twin, \$125. Excellent conditions. Arthur Henderson, Crown Point, Ind.

**INDIAN**, \$12, \$20; twin, \$50; Minneapolis, \$20; two-speed, \$40. Thors, Excelsiors, Harleys, every make. Easiest terms, quick buyers. Knights, 1195 Olive, St. Louis, Mo.

**GET your motorcycle at your price.** Used motorcycles, \$18 up. Write for big Bargain Bulletin, American Motorcycle Company, 1527 Carrol Ave., Chicago, Ill.

**BARGAINS** in motorcycle supplies. Electric horns, 98c; leather leggings, 98c; Good-year 28x3 inner tubes, 98c; spark plugs, 15c; large saddles, \$2.48; large rubber grips, 25c pair. Send for our big bargain sheet of accessories. W. E. Wandersee Co., 129 Gratiot Ave., Detroit, Mich.

**THREE Dandy Motorcycles**, excellent condition, \$60 each. Waldorf, 14 Grove St., Middletown, New York.

**DON'T buy a Bicycle Motor Attachment** until you get our catalogue and prices. Shaw Mfg. Co., Dept. 27, Galesburg, Kansas.

**SEND for latest Bulletin of real Motorcycle Bargains**, used and slightly used, all makes, models and prices; if you have \$25 and really want a powerful Motorcycle, send for this Bulletin; hundreds of machines at all prices, new ones on easy payments; tell us what you want and how much you can pay; we can fix you up. Peerless Motorcycle Co., Dorchester, Mass.

**WANT to sell your motorcycle?** I have a method which has sold many. Write me today for free information. F. W. Johnson, Room 980, 78 E. Madison St., Chicago.

**BIG bargains in second-hand motorcycles**, \$25 up. Indians, Harleys, Thors, Excelsiors and Merbels. Write for descriptions. Howard A. French & Co., Baltimore, Md.

**SUPPLIES**—Our big catalogue with prices lower than usual sent free to motorcycle owners. Meco, Hammondsport, N. Y.

**NEW Motorcycle Book**—Just Published—Motorcycles, Side Cars and Cyclecars, Their Construction, Management and Repair—570 pages, cloth, 250 illustrations. The Dealer, Mechanic and Rider will find this treatise a work of reference without an equal. Price \$1.50 postpaid. Popular Mechanics Book Dept., 6 N. Michigan Ave., Chicago.

**1913 10-H. P. MICHAELSON Motorcycle**, thoroughly overhauled. Fully equipped. Bargain, \$135. Leo H. Drahnmann, Perham, Minn.

#### CYCLECARS

**FOR Sale**—Owego Cyclecar, with top, windshield, electric lights; used very little, \$165. H. S. Bryan, Elmira, N. Y.

#### CYCLECAR MATERIAL

**CYCLECAR Friction Transmissions**, Aluminum disc, tarred fiber wheel, roller bearings. Guaranteed. Cogwell Manufacturing Co., Hall St., Springfield, Mass.

**FOR Sale**—Cyclecar parts very cheap. Tribune Engineering Co., Inc., Owego, N. Y.

#### AERONAUTICS

**MOTOR perfection** as described in our aeronautical motor catalogue, just off the press, 4 red stamps. Blue prints \$1.75, all standard aeroplanes and aerial driven cyclecars. The latest fad, "Heath" propellers for air, water and land, represent the survival of the fittest. Six years propeller production proves perfection. 3 red stamps for propeller catalogue. Heath Aerial Vehicle Co., Chicago.

**MODEL Aeroplanes** (steel). Files over 200 feet. Operated by cord, \$1 prepaid. Satisfaction guaranteed. Benjamin-Sellar Mfg. Co., 358 W. Quincy St., Chicago.

**COMPLETE Plan**, drawn to scale, with precise instructions for building a Curtiss 3-foot Model Flying Boat, 25c. Other plans: Bleriot, 15c; Wright, 25c; Nieuport, 25c; Curtiss Hydro, 35c; "Peoli" Racer, 25c. Set of six, \$1.25. 48-pp. Model Supply catalogue, 5c. Ideal Aeroplane Co., 82½ West Broadway, N. Y.

**EXHIBITION Biplane**, Hall-Scott 60, \$350, demonstrated. Monoplane, Anzani 50 Hp., demonstrated, \$750. Several Bleriot, 30 Hp., \$500 each. Motors, parts, etc. Curran, 217 W. 33rd St., N. Y. C.

**MORANE 35-H. P. Monoplane**, complete exhibition outfit. Used season 1913. Perfect condition, \$300. Automobile or motorcycle. Ernest Hall, Warren, Ohio.

**AEROPLANE supplies**—Motors—Equipment. Write for catalog. American Aviation Company, 1354 Maplewood, Chicago.

**FOR Sale**; 6-cylinder 75-hp. Roberts aviation motor in good condition with propeller, \$475 cash. National Aeroplane Company, Machinery Hall, Chicago.

**AVIATION Motors**, all makes, up to 150 H.P., \$250 up. Complete aeroplanes, all types, \$300 up. State your needs. Aero Exchange, 38 Park Row, N. Y. C.

**BEST and lowest priced aeroplanes**, motors and propellers. Bates, 104 Oak, Chicago.

**MODEL Aeroplanes**—Te brings greatest handbook and catalog, Cheapest supplies. Walter Phipps, 503 5th Ave., New York.

**LIGHT Weight**, Gasoline Engines, 2½ hp. Guaranteed ¼ H. P. The Weiss Co., Torrington, Conn.

**HOW to Make a Biplane Glider**—Our book "Amateur Mechanics No. 2" contains a complete detailed description of how to make one. Price of book, 25c postpaid. Popular Mechanics Book Dept., 6 N. Michigan Ave., Chicago.

**BUILDING and Flying an Aeroplane**—160-page handbook covering the building of small models and full sized gliders and machines. In both biplane and monoplane models the well-known Curtiss and Bleriot types are followed. Fully illustrated with detail drawings. Price, \$1 postpaid. Popular Mechanics Book Dept., 6 N. Michigan Ave., Chicago.

#### BOOKS AND PERIODICALS

**MY Book Cement** contains directions for building beautiful homes, and for manufacturing many valuable articles from reinforced stone and woodfiber concrete. Price fifty cents postpaid. Peter De Linde, Zion City, Ill.

**MATHEMATICAL Revelation**—Comparative Cancellation—Solves all problems with ease, accuracy and large saving of figures. 150 pages, cloth bound, \$1 postpaid. Money back if dissatisfied. Circulars free. Herriek & Horton, Publishers, Princeton, Ill.

**53,000 BOOKS**, new and old. Lists, 6c. Mention subject. Higener's, C-2441 Post, San Francisco.

**THE Great Book of Wonders, Secrets, and Mysteries**, 100 formulas—all for 10c. H. B. Essex, Box 476, Baltimore, Md.

**LEARN to Play Clappers** ("bones"). Complete instructor, 10c. G. Elsea, Owosso, Mich.

**SMALLEST Bible**—Size postage stamp, 10c. Busy Print Shop, Asheville, N. C.

**AUTOMOBILE Troubles and how to remedy them**. Cloth, \$1; leather, \$1.50. Many other practical and reliable mechanical books. Send for circular. Chas. C. Thompson Co., Dept. C, 501-509 Plymouth Ct., Chicago.

**ENGINEERS' questions and answers** for license, by Hobson, for twenty-five cents, postpaid. Send stamps. Rilly's Book Store, Philadelphia, Pa.

**METAL Work and Etching**—A 96-page hand book for art metal workers telling how to make a great variety of useful and ornamental objects, such as desk sets, art-crafts, jewelry, etc. Price, 50c postpaid. Popular Mechanics Book Dept., 6 N. Michigan Ave., Chicago.

**FREE Catalog of Mechanical Books**—Our 96-page catalog of 500 books on 109 different subjects will show you where to find that particular information you are in need of on any mechanical subject. Send for it today. Popular Mechanics Book Dept., 6 N. Michigan Ave., Chicago.

**BINDER** for Popular Mechanics magazines. Best adjustable magazine binder on the market made especially to hold any number from one to six copies of this magazine with name "Popular Mechanics" in gold letters on front cover. No laces or cutting or perforating of pages necessary. Simple, unique adjustment; handsome, durable and neat. We buy in quantities and can offer our readers this regular \$1.50 binder for \$1.25, all shipping charges prepaid. Address Popular Mechanics Book Dept., 6 N. Michigan Avenue., Chicago.

**READ** these great books about the War: 1. Germany and the Next War, by Gen. F. Von Bernhardi (discloses Germany's war plans for crushing England and France. Price 85 cents). 2. Secrets of the German War Office (by A. K. Graves, for twelve years a spy in the Kaiser's service. Price \$1.60). 3. Germany's Fighting Machine (by E. F. Henderson. Divided into three parts, The War, The Army and The Navy. Price \$1.35). 4. Men Around the Kaiser (by P. W. Wile. Tells about those men who figure most prominently in the affairs of Germany at the present time. Price \$1.35). 5. The Germans (by I. A. R. Wylie. A graphic picture of the German people on the eve of the great conflict. Price \$2.15). 6. The War and America (by Hugo Munsterberg, the great German-American. Price \$1.10). 7. War's Aftermath (a study of the deterioration of the quality of stock occasioned by the lamentable waste of war. Price 85 cents). Popular Mechanics Book Dept., 6 N. Michigan Ave., Chicago.

#### EDUCATIONAL AND INSTRUCTION

**POSITIONS** Guaranteed—Typewriters, business, agricultural, English, drawing, engineering, salesmanship, real estate and law courses by correspondence; tuition payable monthly. College Bulletin free. Address Carnegie College, Rogers, Ohio.

**LEARN** to use a Slide Rule! The Gilson Slide Rule will solve any mathematical calculation with ease and rapidity. Price with complete instructions, 50c. Circulars sent free. The Gilson Slide Rule Co., Niles, Mich.

**WONDERFUL** mathematical marvel; quit adding, let Halsey's Adding Chart show footings; mental addition unnecessary. Price 50c each. J. G. Halsey, 6248 Drexel Ave., Chicago, Ill.

**BRIEFHAND** enables you to write 100 words a minute using lighthand letters. Home study. Quickly learned. Sample lesson free. Premier Briefhand School, Dept. 4, Washington, D. C.

**LEARN** Sign Painting, taught by an expert; 25 years' experience in America and abroad. Booklet free. Wensinger School Lettering, Dept. 47, 625 Chestnut, Toledo, Ohio.

**LEARN** Show-card writing—Our system teaches this fascinating profession. Earn \$25 to \$35 weekly or start a shop of your own. Write Gilson Co., Dept. 8, Harbor Springs, Michigan.

**MATHEMATICS**—including trigonometry, geometry, mechanical drawing and plotting problems—worked by Arcascope triangle. Fifty cents. Leshman Arcascope Company, Ogden, Utah.

**SUCCESS!** How? Study at home; fit yourself for a better paying position through one of our 40 courses, including Business, Normal, Kindergarten, Agriculture, Engineering, and Law. Thousands of successful graduates. Chartered 1903. Write for free 50-page catalog, stating instruction wanted. The Modern School of Correspondence, San Francisco, Cal., Dept. M.

**ARTIFICIAL** Marble, sanitary flooring, ornamental casting, concrete, plaster, paper-mache, interior decorations, garden furniture, statuary, life casting, elastic moulds, electro bronze depositing (immensely profitable work), complete instructions \$1; particulars, 209 Illustrations free. Mahler, D-117 Russell St., Brooklyn, N. Y.

**GOOD Opportunities** for Veterinarians. Send for catalogue. Grand Rapids Veterinary College, Dept. Z, Grand Rapids, Mich.

**EIGHTEEN Ways** to Make Money! Interesting, isn't it? If you are mechanically or electrically inclined don't fail to write for our free book. Emigley Company, 184-A, East 16th St., New York.

**EXPERIMENTS.** A new 256 page book that gives practical information for building simple, efficient apparatus at small cost, conducting tests and experiments, establishing a laboratory and applying the best experimental methods. Shows you what you can do with your own brains and hands. Both amateur and commercial work is covered. Send for complete description free or book itself sent postpaid upon receipt of price, \$1.50. Popular Mechanics Book Dept., 6 N. Michigan Ave., Chicago, Ill.

**WANT** to secure a marine or steam engineers' license? For that great class of ambitious and hard working men, the oilers, coal-passers, water-tenders, firemen or anyone who wants real practical and useful information regarding the every-day operation of a steam plant, Chief McAllister of the U. S. Revenue Cutter Service has written an engineering story called "McAndrew's Floating School," that makes it possible for those who have not had previous training to absorb the necessary information. Cloth, 250 pages and 37 diagrams. Price, \$2. Popular Mechanics Book Dept., 6 N. Michigan Ave., Chicago.

**IRREGULAR** handwriting changed to a rapid business style by mail. Journal free. F. B. Courtney, Box A 492, Detroit, Mich.

#### ARTISTS' MATERIALS

**USE** my new pantograf and save time and labor by enlarging or diminishing your designs, sketches, etc. Write for particulars. F. DeArstell, Box 462, Harrisburg, Pa.

**FOR Sale**—New section liner; cheap. A. Lawrence, Connersville, Ind.

#### TELEGRAPHY

**TELEGRAPHY**—Morse and Wireless—taught at home in half usual time. The Omnigraph Automatic Transmitter combined with sounder or buzzer sends you messages, any speed, just as expert operator would. Used by U. S. Gov't to examine all applicants for licenses. Trifling cost. Catalog free. Omnigraph Mfg. Co., 41-G Cortlandt St., New York.

**TELEGRAPHY**—Morse and Wireless—also Station Agency taught. R. B. and Western Union wires and complete Marconi Wireless Station in school. Graduates assisted. Marconi Co. employs our wireless graduates. Low living expense—easily earned. Largest school—established 40 years. Investment \$25.00. Correspondence courses also. Catalog free. Dodge's Institute, 15th St., Valparaiso, Ind.

#### TRADE SCHOOLS

**LEARN** Watchmaking, Engraving, Jewelry Work. School established 26 years. Over 1,000 successful graduates holding positions or owning jewelry stores. Catalogue free. Bosman Technical School, Lancaster, Pa.

**ELECTRICITY,** Plumbing, Bricklaying, Mechanical and Architectural Drafting taught by practical instruction. This is largest and best equipped practical school in America. Short time required and small expense. Positions secured. Earn expenses while learning. Write for big illustrated book. It's free. Coyne Trade School, Dept. 819 Z, Chicago.

**PAINTING,** Decorating, Paper Hanging taught by actual practice. Free catalogue. Chicago School of Painting, 150 West Austin Ave., Chicago.

**AUTOMOBILE** Instruction. A complete home study course that shows you exactly what you want to know about the automobile. 220-page book, giving definite, thorough, authentic and practical detailed information about every part of the automobile as well as thorough instruction in regard to driving, repairing and general care of the complete car. 100 illustrations, \$1.50 postpaid. Popular Mechanics Book Dept., 6 N. Michigan Ave., Chicago.

#### WIRELESS

**WE** teach Wireless by Mail. Catalog tells how. National Radio School, 1401 You St., Washington, D. C.

#### PICTURES, POSTCARDS, PENNANTS

If you really want to exchange postcards, try our splendid club. Lists circulate in many countries. Membership, 10c. Halcyon Club, Box 133, Erie, Pa.

**EXCHANGE** pretty postcards with our members far and near. Best card club. Membership, 10c. Jolly Card Exchange, Box 126, Decatur, Indiana.

**POSTCARD** Stamp Exchange. Members wanted. Universal Correspondence Club, Copenhagen, Denmark.

**PERMANENT,** hand-painted enlargements, 8x10, mounted, postpaid, \$1.00. Larger proportionately cheap. Send negatives. Photo Enlargers, Tomarier, N. J.

**16 BEAUTIFUL** Assorted College Pennants only 50 cents. Pacific Specialties, Los Angeles, California.

**POSTCARDS** from everywhere. Join our jolly club. Send 10c. H. J. Toopie, Decatur, Indiana.

**200 ILLUSTRATIONS** Free, Beautiful art casts. Mahler, K-117 Russell St., Brooklyn, N. Y.

**JOIN** our Post-Card Exchange. Results Guaranteed. Membership 15c. Popular Exchange, Windsor, N. C.

**BOOKS** and pictures; 2c stamp brings catalogue. Duff, 2713 Mezzart, Chicago.

**3,000 SELECTED** Cartoons for \$3. A Panorama of World Events, Political, Industrial—Social—Humorous—Tragic—all of intense human interest. A wonderful collection of 3,000 cartoons reproduced from the newspapers of the United States, Canada, Mexico, Cuba and the cities of the Old World, has been made by Cartoons Magazine from more than one hundred and fifty thousand published cartoons, and bound in an artistic and durable cover, are now ready for your library table. Vol. I, Jan.-June, 1912—\$1. Vol. II, July-Dec., 1912—\$1. Vol. III, Jan.-May, 1913—\$1. Cartoons, 78 E. Madison St., Chicago.

**CROSS-SECTIONAL** view of ocean liner "Britannic," showing interior arrangement of ship in colors, size, 14x20 inches, on heavy plate paper for framing or hanging. Very interesting. Reproduced from front cover design of July issue Popular Mechanics. Will be sent postpaid to any address in the world on receipt of 4 cents in stamps to cover packing and mailing. Popular Mechanics Magazine, 6 N. Michigan Ave., Chicago.

#### CAMERAS AND PHOTO SUPPLIES

**SAVE** money on developing and printing. Best work, lowest prices. Cash prizes for pictures. Write Miles Greenwood, 84 Cottage St., Melrose, Mass.

**POSTALS.** Professional prints beautifully colored, 5c; dozen, 50c. Send negatives. Albert Gilson, 11 Sheldon, Chicago.

**TRANSFER** Printed Pictures to glass, china or paper. 150 valuable formulas, 20c. Ideal Book Shop, 3311-H, Belleplaine Ave., Chicago.

**KODAK** Finishing. Prints, 1 1/2c up. Send film and dime for sample work and prices. Square-Deal Photo Shop, 15 Main, West Cairo, Ohio.

**GOOD** Pictures—Same day, postpaid. Films developed, 10c a roll. Prints, 30c to 50c a doz. Send for our Free Booklet, "Good Pictures." Newton Drug Co., Dept. K, Sandwich, Ill.

**HAVE** you a Camera? Write for samples of my magazines, American Photography and Popular Photography, which tell you how to make better pictures and earn money. F. R. Frapric, 126 Pope Bldg., Boston.

**SECOND-HAND** Lenses. All makes and sizes. Work just as well as new ones. Send for our bargain list. Hyatt's Photo Supply House, St. Louis, Mo.

**HIGH** Grade Amateur Finishing. We cater particularly to those who want good work, not cut prices. Send for price list D. L. M. Prince Co., 108 W. 4th St., Cincinnati, Ohio.

**RECORD** books for amateur photographers. You need them. Circular free. H. E. Evans, Ayer, Mass.

**FOR Sale**—3x7 Auto Graflex, 5.6 lens, carrying case, etc. Cost over \$200.00. Price, \$100. E. H. Truiber, Scotland, S. Dak.

**INSTRUCTIONS** and Formulas for Photo-processes. Photos, Disappearing Photos. Photos on apples, cloth, chinaware, etc. Simple Enlarger, Trick Pictures, 25 in all, for 25c. Disappearing Photo free with each order. Money-back basis. P. Benson, Stewartville, Minn.

**ONE Minute Camera and Complete Outfit, \$1.** express prepaid. Takes, finishes, delivers photos instantly. Particulars free. Devcon Sales Agency, Williamsburg, Maryland.

**HAVE your films retouched and Prints Hand-spotted.** A customer writes our work is 50% better than eight other finishing companies he has sent films to. "We Finish your Kodak Pictures Better." Let us "show you." Developing 5c Roll, Prints 3c. Returns 24 hours. Colonial Art Co., Box 566, St. Louis, Mo.

**SAMPLE offer:** one film roll (only developed 5c; prints from same 2c each; to show high quality work. Moser & Son, A20 Arcade, Cincinnati, O.

**"JONPHO Quality"** Developing, Printing, Enlarging. Send negative for Sample Print and Booklet, Developing 10c roll. Velox Prints 2 1/2 x 3 1/4, 3c. 8 x 10 enlargements 25c unmounted. Jones Photo Co., P. O. Box 1984, Boston, Mass.

**ENLARGEMENTS** four times size your negative, 15c. Mala Photo Co., Grove Hall Sta., Boston.

**PIRE** Developing, Postcards and prints 2c. Postpaid. Sprauer, Hamilton, Ohio.

**THE Triple Alliance in Photography** for a two-cent stamp. Exposure Meters of Merit—the Best Round-Cornered Film Camera Made in America—the Best Anastigmat Lenses on Earth, Laury Co., 305 North Fifth Ave., Chicago.

**SEND Negative** for free sample print. Developing 10c roll. Prints 3c up. Velox Paper, New Modern Equipment. 500 rolls daily capacity. 8th year. 24-hour service. We make enlargements. Littlefield & Son, Dept. F, Delavan, Wis.

**IF you have a High-grade Camera, Lens or Kodak** and want to turn it into cash, write us today. State particulars, price, etc. We buy and trade, sell or exchange. Prompt, satisfactory service. Everything in cameras from Vest Pocket to Graflex. A square deal to all. David Stern Co., 1047M W. Madison St., Chicago. In business since 1885.

**ROLL Films** Developed 10c per roll. Printing Post Cards 3c each. 15 years' experience. Give me a trial. You will be pleased. F. C. Hoyt, Sac City, Iowa.

**50c TRIAL offer** for 10c. Send one roll of film, any size, 6 or 12 exposures (or film pack); we will develop film or pack and make total of 6 pictures from best negatives for 10c (stamps). Beautiful 10-inch mounted enlargements, 25c. Price list and sample print free upon request. Roanoke Cycle Company, Roanoke, Va.

**CAMERA and Lens Bargains.** Cut Rate Photo Bargain List just off the press. Send stamp. Willoughby, 810 Broadway, New York.

**WE buy, sell and exchange.** Bargains in Microscopes, Telescopes, Binoculars, Cameras, etc. Bargain list sent. Kahn & Son, Opticians, No. 54 John St., New York. Established 62 years.

**FILMS** developed 10c, prints 3c to 5c. A reputable Incorporated Company, conducting largest existing plant. Price list and special offer. Enlargements our specialty. Chicago Photo Finishing Co., 54 W. Lake St., Dept. A, Chicago.

**KODAK Films** Developed, 10c per roll, any size. Prompt attention given mail orders. Prints, 2 1/2 x 3 1/4 to 3 1/2 x 4 1/4. 3c; 4 x 5 to 3 1/2 x 5 1/2, 4c. J. M. Manning, Box B, 1052 Third Ave., New York City.

**FILMS** developed 5c, prints 3c, all sizes. Johnson's Studio, Oswego, N. Y.

**BIG Money Saved** on Photographic Lenses and Apparatus—goods exchanged; repairing done. Ralph J. Golsen, 65 East 46th St., Chicago, Department P.

**FILMS** developed 10c, all sizes. Prints 2 1/2 x 3 1/4, 3c; 2 1/2 x 4 1/4, 3 1/2 x 3 1/2, 3 1/2 x 4 1/4, 4c; Post Cards, 50c doz. Work guaranteed and returned 24 hours after receiving. Postpaid. Send negatives for samples. Girard's Commercial Photo Shop, Holyoke, Mass.

**SAVE 40%** on Photo Paper from factory, prepaid. "Instanto" has a sparkling quality no other gaslight paper possesses, quick printing develops easy. Money back guarantee. Send 25c for 3 dozen postals or 4x5 size, price list and full directions. Photo Products Co., Dept. J, 6100 La Salle St., Chicago.

**ROLL Film** developed, 10c a roll. Prints 20c each; Prints, Brownies, 2c; 1a, 2x4, 3x5, and Post Cards, 3c each. Work returned next day. Postage paid. Kodak Film Finishing Co., 112 Merchants Station, St. Louis.

#### MOTION PICTURES

**MAKE \$150.00 a week clear.** We start you in the moving-picture business with complete outfit on the installment plan. Write for free catalog, Monarch Film Service, Dept. P, Memphis, Tennessee.

**MOTION Picture machines** half price. Bargain lists free. National Employment Company, Duluth, Minn.

**BIG money** writing Photo-plays; details free to beginners. No correspondence course. Producers League, 220 Wainwright, St. Louis.

**DYNAMOS Special** for Arc Light, \$75; payments, \$5 monthly. Hobart Bros., Troy, Ohio.

**MOVING Picture Machine, complete,** \$50. Harold Brassell, P. O. Box 1851, New York City.

**HOW did most writers start?** By writing stories in spare time. Try it. Big demand for photoplays. Pays well. Talent unnecessary. We'll help you. Giese Co., 202 Whiteman St., Cincinnati.

**MAKE big money** writing moving picture plays. Previous experience, literary talent or correspondence course unnecessary. Free details and special offer. E-Z Scenario Co., 311 West 93d St., New York.

**WRITE Moving-Picture Plays.** Good prices. Devote all or spare time. No correspondence school. Details free. Atlas Publishing Co., 304, Cincinnati.

**WE accept manuscripts** in any form; criticize free; sell on commission. Don't waste money on "instructions." Write us. Story Revision Co., 283 Main, Smethport, Pa.

**\$35 PROFIT** Nightly—Moving Picture Business—small capital starts you, no experience needed. Teach you—furnish everything. Ralph J. Golsen, 65 E. 46th St., Chicago, Dept. M.

**HAVE you manuscripts to sell?** We can show you how to market them profitably. No courses. Criticize free. Sell on commission. Write immediately. 300 Main, Hazelhurst, Pa., Manuscript Sales Company.

#### DUPLICATORS AND DEVICES

**MALALANE Duplicators** excel all. 10x12 size \$2.50. Sent on 2 months' trial. Ask booklet. Malalane, 1765 Southern Boulevard, New York.

**THE B. & B. Duplicator** will print 150 copies in ten minutes, pen, pencil or type-written original. Letter size, \$1.75. Booklet free. Brody & Rustenberg Duplicator Co., Desk P, 1126 S. Halsted St., Chicago, Ill.

**MULTIGRAPHIS** (rebuilt). Perfect. 1/4 cost. Guaranteed. Ship on approval. John Paul, Bourse Bldg., Philadelphia, Pa.

**OUR "Modern" Duplicator—Yours** for \$2.40. No Glue or Gelatin. Always ready. All sizes. Free trial. 31,000 users. Standard for 15 years. Booklet free. Sole mfrs., J. E. Durkin & Reeves Co., 339 Fifth Ave., Pittsburgh, Pa.

#### BUSINESS FOR SALE

**FOR Sale—Auto repair shop,** thoroughly, fully equipped. 16'x35' lath, drill, grinder, small tools, supplies. 50'x50' floor space. Located in a garage of 125 car capacity. Geo. Matson, 1337 Irving Park Blvd., Chicago, Ill.

**GARAGE, best of location,** town 990, only power shop, 44172, over 250 autos. Poor health. Auto Repair Shop Davison, Mich.

#### MAIL-ORDER SUPPLIES

**SELL Joker's Novelties!** 16 samples, 10c. Chambers Works, Plainwell, Mich.

**INCREASE your sales.** Place your proposition before the readers of "Cartoons Magazine." 30,000 copies guaranteed every month. Classified rate 2c per word. Mail in a trial ad today. Cartoons Classified Dept., 78 E. Madison St., Chicago.

#### BUSINESS OPPORTUNITIES

**WE have an exceptionally good opportunity** to offer men with selling ability who can invest from \$100 to \$500. You handle your own money, and we guarantee absolute protection. No chance to lose. We stand ready to prove money earning possibilities of our proposition, and invite strictest investigation. Reliable references furnished. Write us today for full information. Marshall Dobbins Co., 1422-A Marquette Bldg., Chicago.

**MONEY made** contracting. Spread San-O-Tex floors; sanitary; fire-proof. \$150 to \$300 made monthly contracting Kitchen Floors alone. Instructions telling how to make and spread sold outside this district for \$3. San-O-Tex Company, Washington, Indiana.

**20,000 FORMULAS, recipes, etc.,** 500 p. volume, alphabetically indexed, \$1 prepaid. Ideal Book Shop, 3311-H, Belleplaine Ave., Chicago.

**OPERATE a B. G. T. Electric Popcorn Fritter Machine,** 400% profit. Big field Details free. Boxill-Bruel, Dept. 60, Cincinnati, O.

**YOUR 25-word advertisement** placed in all of 30 good monthly magazines once for only \$1.25, three months \$2.50. Write for list. P. L. Miller, Syracuse, N. Y.

**MEN and women** for easy business. No interference with present position. Good money. Free information. F. Leonard Eager, Waterbury, Conn.

**WE manufacture** the most complete assortment novelties, tricks, and puzzles in the world. Agents, Dealers, Supply Houses and Jobbers are making big money. Fast Sellers. Low Quantity Prices. Start a new money-making mail-order business with our line. Catalog plans, etc. free. Oaks Magic Co., Dept. 233, Oshkosh, Wis.

**NEW Way to Paint Signs—Our patterns** do the work. Complete alphabet 50c. Butts Advertising Co., 15 W. 10th St., Kansas City, Mo.

**INVENTIONS** commercialized on cash and royalty basis. Write Adam Fisher Mfg. Co., D61, St. Louis, Mo.

**LEARN "Expert Collecting."** Earn \$25 to \$50 week; good opportunity for ambitious man in every town. Write "Expert," Post-office Box 512, Woodward, Oklahoma.

**BIG Profits** in Home Gardens. Plant Ginseng and Golden Seal. Small plot brings more money than many farms. Free booklet tells how. Rising Sun Ginseng Nursery, Box 225, Narrows, Ky.

**WANTED—Some one** to help finance practical invention of merit. Prefer man with mechanical skill. Splendid opportunity. Worth investigating. Write Leland B. Spiers, Guy, New Mexico.

**TWENTY Years Ago** I started a small mail-order business at home in spare time with a few dollars capital. I wanted to make \$30 or \$40 a month, evenings. The net profits the first year averaged \$200 a week. Five years' work netted me \$30,000. I will show you how to start a small mail-order business. Send today for my proposition. It's interesting. No canvassing. Heacock, Box 867, Lockport, N. Y.

**AFRICAN Dips** gets the money at Picnics, Parks, Carnivals and Fairs. Complete outfit direct from the manufacturer, including carrying trunk, \$47. Cooley, 553 W. Monroe, Chicago.

**OWN a business.** Co-operate with me evenings at home. Everything furnished. Don't worry about capital. Boyd H. Brown, Dept. K-8, Omaha, Neb.

**RE-SILVERING Mirrors;** guaranteed process; 150 formulas, 20c. Ideal Book Shop, 3311-H, Belleplaine Ave., Chicago.

**WANT Big Profits?** Learn Tartaric Mirror Silversing. New process! Open enormously profitable business; particulars free. H. Barstow, 514 23rd St., Oakland, Cal.

**\$60 WILL buy 1,000 mail-order books** worth \$1,000. Circular describing books free. Address Chemist Brown, 214 Kasota Bldg., Minneapolis, Minn.

**WANTED—Representatives** to sell standard American watches. William Mulhally, 10 S. 12th St., Newark, N. J.

**50 MONEY-MAKING Plans** Free. Daly, 1116 Monroe, Rochester, N. Y.

**"HIRE Yourself as Boss."** Big corporation will back you in Money-Making Mail-Order Business selling Guaranteed Goods. Start spare time. Small capital. No canvassing. Wm. J. Dick, Mgr., Dept. M-10, 20 W. Lake St., Chicago.

**\$\$\$ MADE** mailing circulars, spare time. Particulars Free. Menard Supply House, 1023 N. Menard Ave., Chicago.

**WE Start You in Business,** furnishing everything; men and women \$30.00 to \$200.00 weekly operating our "New System Specialty Candy Factories" home or small room anywhere; no canvassing. Opportunity lifetime; booklet free. W. Ragsdale Co., East Orange, N. J.

**\$2.50 POCKET Adder.** Sells easily. Bassett, 5921-F, Indiana Ave., Chicago.

**OPERATE** Mail-Order Book Business. Best money-making proposition in Mail-Order field; 300% profit; small outlay; everything furnished. Send for descriptive folders. Rollins Company, Dept. 25, Boston.

**EIGHT** new money-making plans and other information; start with little capital; \$1.00. "Opportunity," Box 714, Kalamazoo, Mich.

**"DOLLARS"** yearly in your back yard. No ginseng, mushroom dope. New ideas never before published, particulars free. Metz, M. 313 East 89th St., New York.

**WOULD** you like to own a good-paying Mail-Order Business? We have a line that gets repeat orders all the time. You can start in spare time; invest a dollar or two a week and soon own a nice business of your own. Particulars free. Nadico, 4313 Lincoln Ave., Chicago.

**CONDUCT** a "Candy Kitchen"—Clear \$10 daily; practically no capital required; booklet free. The Kennon School, 142 W. Ontario St., Dept. A, Chicago.

**INDEPENDENCE** and fortune quickly attained in the Manufacturing Mail Order business. I furnish Formulas, Manufacturing Processes and Trade Secrets in all lines. Sold under positive guarantee; 18 years' practical experience. Revision and improvement of Formulas and Processes—reduction of manufacturing cost—utilization of waste materials, etc., a specialty. Booklet, Formula List, and Valuable Information Free. W. L. Cummings, Ph. D., 127 Standard St., Syracuse, N. Y.

**PATENTABLE** ideas wanted—Send for 3 free books. B. B. Owen, 30 Owen Bldg., Washington, D. C.

**400 MONEY** Making formulas. Yours for 25 cents postpaid. Address H. Davenport, Bector St., Perth Amboy, N. J.

**DYE** Stuffs in all Colors. Dry. for Wood and Artificial Marble, etc. Complete instructions. Stamp for particulars. Both A. 45 Frost St., Brooklyn, N. Y.

**MONEY—\$5** For Wise Men—\$4. Key free. F. G. Hyde, Oakland, Md.

**NEW Mirror-Silvering** plans sent free. Wallace Abell, Davenport, Iowa.

**AT Last!** A sure easy way to start a fast-growing mail-order business on small capital. Get particulars. Industrial Co., Box 15-P, Rochester, N. Y.

**TURN** your ideas into money. We accept manuscripts in any form; criticize free; sell on commission. Good ideas bring big prices. Write us. Story Revision Co., 99 Main, Smeethport, Pa.

**WRITE** Moving-Picture Plays. Good prices. Devote all or spare time. No correspondence school. Details free. Atlas Publishing Co., 3046, Cincinnati.

**ADVERTISERS, Mail Dealers:** Our 1915 Rate Book lists 2,000 Principal Publications, rates, circulation. Includes 30 Mail-Order Plans. Price 10c. Dearborn Advertising Agency, 210 Franklin Bldg., Chicago.

**LEARN** the Real Estate Business. Our complete instruction book teaches: Listing, Appraising, Management, Salesmanship, Insurance, Brokerage, Advertising, Renting Agency, Forms, etc. 121 subjects. Excels \$20.00 correspondence course. Buckeye cover, 75c. Silk cloth \$1.00 postpaid. Realty Book Company, 3982 Euclid Ave., Cleveland, Ohio.

**LET** the parcels post help you. Add (\$15 to \$25 weekly) to your present salary or income. Start during spare time and build up a permanent mail-order business of your own. We show you how and help you make good. No canvassing. Experience unnecessary. The Parcels Post makes success doubly sure. Our new ideas and up-to-date plans bring the money. No so-called "Course of Instruction" to sell. We give that free. Write today. Address Peace Mfg. Co., Inc., Dept. A, 79 Broadway, Buffalo, N. Y.

**HOW** to Operate a Mail Order Business. 20 Big Profit Plans and year's Mailing service sent for 10c. Mail Dealers' Wholesale House, 521 Franklin Bldg., Chicago.

**BE** Wise. Don't experiment in mail order. I can tell you how to succeed. B. Newham, Waukegan, Ill.

**MANUFACTURERS, Promoters and Patent Buyers** are invited to write us stating the line of invention in which they are interested, as we can supply their wants in any class of patents. Victor J. Evans & Co., 162 Ninth St., Washington, D. C.

**LEARN** to collect money. Good income; quick results. Send for free booklet, "Skillful Collecting." Collectors' Association, Long Street, Newark, Ohio.

**STOP** Here! Let me start you in a home business that will bring you money every day. Experience unnecessary. Spare time. No canvassing. I furnish everything. Send for proofs. Voorhies, Desk C. R., Omaha, Neb.

**I WANT** to send you proof of the wonderful pulling power of Popular Mechanics classified pages. What's your proposition? Write me today. F. W. Johnson, Classified Dept., Popular Mechanics Magazine, 6 N. Michigan Ave., Chicago.

**MAKE** Money "on the Side." We have the handiest proposition for ambitious men to handle our "direct-to-customer" selling machines. Users everywhere reporting great success. A big, wide-open market. Our machines carry everything from matches to candy. Merchants are demanding them to reduce selling cost and to increase small, profitable sales. Our machines are easy to install. They need least attention. Guaranteed for five years. They must pay for themselves. Few good territories still open. Write today for interesting proposition. Do it Now, Illinois Vending Company (Incorporated), 561-517 South Jefferson Street, Chicago, Illinois.

**WE** have several openings for establishment of independent mail order business. Character more important than capital. Spare time at first. Send for particulars. Opportunities Exchange, Buffalo, N. Y.

**BIG** Money making up and selling curios at home. Spare time. No competition in this business. We furnish material wholesale. Send 25c for samples and instructions. Marine Still-Life Curio Co., Pacific Grove, Calif.

**AGENCIES** being established every town in the United States. Zip Hand Soap, an antiseptic soap for cleaning dirty and grimy hands, used by automobilists, mechanics, printers, motormen, etc. Liberal profit offered to the right parties. Sample can, 1 1/2 lbs., 15 cents. Zip Soap Co., 2299 Broadway, N. Y. City.

**\$50** to \$75 a week; as manufacturers we offer our dealers who have small capital full co-operation of our new mail order system; warehouse privileges; co-workers say: "Wish I'd heard of you before." Big opportunity for the ambitious. Kimo Mfg. Co., Dept. 267, Kimo Bldg., Buffalo, N. Y.

#### FOR ADVERTISERS

**WRITER'S** Weekly Market Report, 10,000 circulation. \$1 inch display. Prize Contests listed. Markets reported. Trial subscription—2 weeks, dime. 28 Marshall St., Boston.

**YOUR** 30-word ad in our big postcard magazine, 25c. Inch display, 50c. Elite Exchange, 3684 Milwaukee Ave., Chicago.

**16,000 BOYS** read our 2x12 magazine. Display 8c line; minimum 50c. Classified 1c word; minimum 25c. Two insertions, 15% discount. Youths' Magazine, Chicago.

**BARGAIN**—20-word advertisement, one insertion, 35,000 circulation, and one year subscription, 25c; extra words one cent. Digest, Grand Rapids, Mich.

**ADVERTISE** in Achievement, classified 20 words 25c, extra 1c, 175 Tremont St., Boston, Mass.

#### PERSONAL

**ANTINIC.** The efficient and only Nicotine Neutralizer, not a Tobacco-Habit Cure, but makes same unnecessary. Send postal for details. Box 1129, Los Angeles, Cal.

**FREE**—Stop using Tobacco. Free. We will give free information how to conquer the habit easily and permanently. Results Guaranteed. Anti-Tobacco League, 618 Paxton Block, Omaha, Neb.

**BROTHER**—Accidentally discovered roof cures tobacco habit. Gladly send particulars. F. Stokes, Mohawk, Florida.

#### AGENTS WANTED

**MEN** and Women Agents: Money talks—how much are you making? If you are earning less than \$200 a month, no matter what your locality, you will positively be delighted with our Sentinel Burglar Alarm proposition. Many agents easily earn \$15.00 daily. Brand new invention. Sells quickly on sight to homes, offices. Patented. No competition. Free exclusive territory. Instantly attached any door knob. Impossible turn knob without ringing bell. No batteries, screws, nails. Handsomely nickel-plated. Retail \$1.00. Provides cheap burglar insurance. It's a big money maker. Let us prove why. If you mean business write today for liberal terms to agents. Marshall Dobbins & Co., Manufacturers, 1422 Marquette Bldg., Chicago.

**AGENTS** Wanted—Right here is the one big chance of your life. If you want to make good money—\$10 a day or more, as easy as rolling off a log, and get your swell clothes free besides, you can do it by acting as our agent. We are the biggest people in the business and want our agents to make big money and be nifty, stylish dressers. Send a postal today for free \$10 outfit, including a big book of nobby suiting samples to select your swell agent's suit from. Then take orders from people who admire your nifty clothes. They come to you—not you to them. This is the way to get rich—the sure, easy way. Remember, you need no money—everything is furnished by us free. We pay express on everything. Just send a postal, but do it today. You can't get started too quick, making this big money and wearing these stylish clothes. Address card to Paragon Tailoring Co., Dept. 814, Chicago, Ill.

**AGENTS**—Big profits selling our New Adjustable Electric Light specialty to offices, homes, stores, factories, hotels, etc. Greatest convenience and most practical device ever invented. Sells rapidly. Demonstration means sale. Write quick for excellent proposition and exclusive territory. International Automatic Utilities Co., 305 Old Colony Bldg., Chicago.

**FREE** samples for men and women agents; double your money selling Deihare's Naptha Washing Tablets; washes clothes without rubbing; cleans floors, woodwork, pots, pans and dishes; polishes silverware; send for sample and particulars; not sold in stores. Manufactured and sold only by Naptha Washing Tablet Company, 716 So. Dearborn St., Chicago.

**INEXPERIENCED** schoolboy makes \$5.50 first hour. Marvelous invention. Agents amazed, immense profits. Silver cleaned by electricity. No drudgery, chemistry's mighty forces do the work. Safe, sure, sanitary; saves silver, time, labor. Patented, absolutely guaranteed. Chemists, silversmiths, endorse it. Women delighted. Particulars, overwhelming proof, free. Write today. Conklin Company, Huntington, New York.

**\$61.50 WEEKLY** introducing and selling a new gas light burner for kerosene lamps. Beautiful light. No chimney. No mantle. Perfectly safe. Simple in construction. Nothing to get broken or out of order. Will not burn out. Durable. Will last for years. Low price. Easy to sell. 200 per cent profit. Experience not necessary. Sample free. Why not try one on your lamp? Beware of imitations. No branch offices. Luther Manufacturing Co., Dept. 86, Cincinnati, Ohio.

**MAKE** \$5 to \$10 daily selling hosiery, underwear, sweaters. Everybody needs them. Many years our incomparable goods have pleased thousands. Permanent business. Exclusive territory. Agents wanted Iowa, Nebraska, Colorado. Write quick. Hunt, 923 16th Street, Denver.

**AGENTS** to sell Klausen's E-Z Klean Cloth. The cloth with the patent glove that protects the hand. Greatest household necessity on market. Send twenty-five cents for sample. Repeat orders absolutely certain. We will prove this a big seller or refund your money. Textile Utilities Corporation, Mfgs., Dept. P, 110-112 West 30th Street, New York City.

**AGENTS** are coming money selling our big 10c Packages of 20 Assorted Postal Cards. "5,000 Varieties." "Big Profits." Sell everywhere at sight. Sample Packages 10c. Particulars Free. Sullivan Card Co., 1214 Van Buren St., Chicago, Ill.

**HIGH** Grade quality, unique construction, quick selling possibilities, easy payment plan, are the distinctive features of Kit Multiple-Head Pliers. Particulars free. Currier-Koeth Mfg. Co., 201 West Ave., Coudersport, Pa.

**YOU** can make big profits selling our Pure Aluminum Kitchen Utensils—Guaranteed for 20 years. Our specialties are not sold in stores, and they get the business for you. \$200,000 firm and liberal credit plan backs you. We have an attractive General Agency offer. Wm. J. Dick, Manager, Dept. M-21, 20 W. Lake St., Chicago.

**PHOTO** Pillow Tops, Portraits, Frames, Sheet Pictures, Photo Plates, Pennants. Refects credited. Prompt shipments; samples and Cat. free to agents. 30 days' credit. Jas. C. Bailey Co., Desk R-2, Chicago.

**\$150 PER** month and expenses—Salary or Commission—Introducing our King Butter Separator. Produces best grade of butter from cream or milk, sweet or sour, in less than 5 minutes. Retail \$5 up. Write for free sample and salary proposition. De King Mfg. Co., Dept. 13K, Chicago, Ill.

**AGENTS Wanted**—If you know a chance when you see it you'll see this one now. Big money—stylish, nifty clothes—little work—no experience or capital needed—can you beat that? We want agents everywhere to take care of our business in their localities and to advertise our nobby, nifty suits by wearing them. We furnish everything, complete, and charge nothing for agent's outfit. The swiftest dressers everywhere are our agents, and all we ask is that you tell people who inquire about your fine clothes where and how they can get them. You make big money—\$10 a day—without trouble. Just a postal brings you full outfit free. Big, new sample book of up-to-the-minute suitings sent so you can pick out your first suit; also measuring blanks and everything you need. We pay express on everything—not a penny for you to pay. Send quick before some one else gets the agency there—mail postal today to the American Woolen Mills Co., Dept. 814, Chicago, Ill.

**\$25.00 TO \$30.00 per week easily earned** in your home town by representing reliable concerns, selling their live line of household necessities. Exclusive rights granted. Apply at once. Dept. 29, Consumer's Direct Supply Co., 48 Hanover Street, Boston, Mass.

**EXCLUSIVE Agency**—"Hygienic Phosphate." Improves Telephone Service. Every phone user a prospect. 300% profit. Send 5c for sample and exclusive proposition. Circular free. Hygienic Phosphate Co., 797 Spitzer, Toledo, Ohio.

**ALUMINUM Milk Bottle Covers** \$4.50 gross, sample 10c. Gold Fountain Pens, sample 6c, sell \$2.00, equal to \$5.00 pens. Machine Razor Blade Sharpener 90c, sell \$2.50. Blades used 100 times. Magic Ink Erasers, sample 10c, sell 25c to 35c. Other good money-makers. E. Mfg. Co., 41 Warren St., N. Y. Dept. H.

**AGENTS, make \$5,000 this year.** Be your own boss—Independent—abundant money—your time your own. All or spare time—at home or traveling. Write today for full particulars. E. M. Feldman, Sales Mgr., 569 Third St., Cincinnati, Ohio.

**DON'T be an Agent—Own your own business.** We furnish complete, practical, low-price outfits for plating in Gold, Silver, Copper, Nickel, etc. We furnish recipes, formulas, trade secrets. Work easy, profit enormous. Send today for particulars. Gray & Co. Plating Works, 736 Gray Bldg., Cincinnati, O.

**POURTRAIT Agents:** Our goods will make you big profits. Delivery guaranteed. Returns credited. Prompt shipments. Low prices. Send for latest catalog and prices. Adam J. Kroll & Co., 692 Blue Island Ave., Chicago, Ill.

**WANTED—10,000 Agents** at once to sell our new sanitary Shake—Less salt and pepper sifters; 100% profit. Write us; it's a winner. The Oster-Barr Co., Rockford, Ill.

**AGENTS wanted to sell E. Z. Safety Steerer for Ford Cars.** Makes them keep the road. Insures safety, comfort. Saves labor, tires. Sells easily at \$1.75. Good profit. Satisfaction guaranteed. Address I. Wilson, 915 Northwestern Bldg., Minneapolis, Minn.

**KEY Checks, German-Silver lodge emblems and plain.** Your address stamped. Send 25c. Agents wanted. A. M. Spang, Huntingdon, Pa.

**TRIP to the Panama Exposition** and big cash profits to agents. Sample and particulars, 10c. Golden Specialty Co., 1625 Greenleaf Ave., Chicago.

**AGENTS—Big profits, Business and Calling Cards; Commercial Printing; Outfit Free.** Printing Man, 226 So. 52d, Philadelphia.

**NEW \$2.50 pocket adler.** Sell 10 daily easy. Excellent profit. Everyone buys. No competition. H. Bassett, 5921 Indiana Ave., Chicago.

**AGENTS—100% profit; article used every home.** Repeats. Sample 25c. Full details for stamp. Sumner Specialty Co., 5446 Augusta St., Chicago.

**WANTED—Agents with buggy** to sell necessary articles to buggy owners. All or spare time. Perfecto, Box 186, Des Moines, Iowa.

**\$187.00 A MONTH.** Just spare time. One agent writes you may do better. \$2.50 outfit for 25c. Charges prepaid. J. A. Walters Supply Co., Box 55, Pandora, Ohio.

**ESTABLISH yourself for life as a branch manager.** With character and brains you need no capital; if you act now, everywhere in your city costly marble is ruined for lack of proper cleaners. Free from all acid, grit, grease, "Marble-tone" is a revelation; cleanses, enlivens, enriches granite, onyx, porcelain, tiles, enamel, metal woodwork. Homes, consume pints; stores, banks, hotels, office buildings, gallons. You also can take big cleaning contracts. Write immediately for full particulars. A. Ryan, American Marble Cleaning Co., 158 E. 30th, New York.

**AGENTS—New, mighty money-making marvel.** World startled. New marvelous clothes washing crystal. Clothes washing ideas revolutionized; positively abolishes rubbing, washboards, washing machines; women astounded, wild over it; absolutely harmless, \$1,000 guarantee goes with it. Make \$50 to \$100 weekly easy. Marshall of Pa. amazed. Telegraphs, "rush 5,000 packages." Exclusive territory; no experience necessary; credit granted; own a business; supply customers; pocket big profits; nature's mighty elements do work. Hurry! Write today—get overwhelming proof, all free. Equitable Corporation, Dept. 312, 215 W. Superior, Chicago.

**BIG Summer Seller.** Make \$t to \$12 a day. You can do it. "My wife and I made \$39 this week," writes F. L., Orlas, Tex. Woods made \$16 first day. Harris made \$9 one hour. Others coin money. Sell Concentrated Soft Drink Extracts. Delicious drinks for the home, picnics, parties, fairs, ball games, etc. Very popular drink. Always ready, just add water. Guaranteed under U. S. Pure Food Laws, 250 other fast-selling household necessities; all big repeaters; 100% profit. Territory going fast. Outfit furnished. Sample case free. Be quick—just a postal today. The American Products Co., 2232 Third St., Cincinnati, O.

**AGENTS:** There will be a great deal of money made within the next few years selling the "Jules Folding Portable Electric Lamp," containing ten feet of concealed extension cord that can be automatically lengthened or shortened; also many other new features. A few minutes' demonstration insures sales in every home, office, factory, hospital and to students. Enormous profits. Address for full particulars, Rose-Strauss Co., 215-A West 48th Street, New York.

**DISTRICT Managers,** we are giving State rights for the control of the "Jap-80K" non-breakable gas mantle; new in America; lasts longer; throws greater light; fits standard inverted burners; rapid seller. If you have a little capital, can handle sub-agents and see the trade, you can make from \$2,000 to \$5,000 yearly. A. Jules Electric Co., 290 W. 48th St., New York.

**NEWEST wonder of the age!** Silveron, the polish that silver-plates. Actually rubs on sterling silver. Used everywhere. Sells on sight. Repeat orders. Big profits. Protection. Secure now, introductory offer. Free sample. P. Cariss Co., 157 Cedar St., New York.

**RELIABLE agents** are coinng big money introducing our large changeable letter signs. Sell for 50c complete with 250 letters. 250% profit. Every merchant buys on sight. Don't delay. Write today. Changeable Sign Co., 587 East 102nd, Cleveland, Ohio.

**AGENTS—You can make big money** handling Sliding Casters, Picture Hooks, and Rug Fasteners. A good proposition. Write today. G. K. Wardle & Co., Dickey Bldg., Chicago.

**FORD agents** make big money selling Oil Guardsman. Automatically warns driver when oil reaches danger level. Retail \$5. Attractive agents' proposition. Advance Mfg. Co., Dept. F, Kalamazoo, Mich.

**MANUFACTURER** will pay a man \$100 per month traveling expenses and commission to call on automobile trade. Dept. 12, Sales Engineering Company, 5925-35 Wabash Ave., Chicago.

**AGENTS—Best selling article** in 20 years. Used home and office. Big demand: \$30 to \$50 week assured. Thiele Co., 5 E. Austin Ave., Chicago, Ill.

**AGENTS wanted everywhere** to sell our goods by mail. Clean, reliable business, protected, fast selling merchandise, effective selling plan, and large profits. Spare or all time week earns \$5 to \$50 weekly. Instructions free. Expert, 420 Home Bank, Baltimore, Md.

**AGENTS wanted for fast selling household articles,** 100% profit. Pelham Manufacturing Co., Pelham, N. Y.

**AGENTS: \$1,000 to \$2,000 yearly** selling over eighty every-day articles to farmers. Pleasant, permanent business. Full instructions. Big chance. Write quick. Duoform Factories, Duoform Company, North Java, N. Y.

**WONDERFUL Kitchen Invention,** saves \$30 yearly. Demonstration creates sensation; coats 10c, sells 50c; 750,000 sold in Chicago. Leave over night, collect next day. Triumph Works, Monon Bldg., Chicago.

**AGENTS Wanted Everywhere—New device** mends automobile tires in one minute. \$3 complete. Guaranteed or money refunded. Experience unnecessary. Particulars free. Humphries Co., Dept. 7, McGraw, N. Y.

**AGENTS with Crews—Two new articles** sell like wildfire. Nothing like them on market. Healy Company, Buffalo.

**YOU can easily make \$15 a week** working your spare time selling E. P. P., an automobile necessity of unusual merit. Big profits and re-orders. Exclusive territory to live men who wish to build a permanent business of their own. Economy Auto Supply House, 834 E. 43rd St., Chicago.

**AGENTS—New invention, Electric Cigar** Lighter. Used on cigar cases. Quick seller to Hotels, Drugstores, Restaurants, Pool-halls, Cafes, Big profits. Special offer. Drake Mfg. Co., 142 Reed St., Milwaukee, Wis.

**AGENTS—\$10 Daily, Red-Hot Sellers** for Homes, Stores, Garages, etc. Something New. Write quickly. Particulars free. Smith, Box 42, Camden, N. J.

**SHAVE with pleasure—Use Damascus** razor strip dressing; one 25c cake will last for years. Try it, guaranteed. Agents wanted. Brandenburg Chemical Wks., Manitowoc, Wisconsin.

**AGENTS—Quick money! "Liberty Bell"** Medal, gold-plated; "Bell" one side, State House reverse; ribbon attached. 15c each, \$1 doz., \$9 gro. Phila. Badge Co., 172 N. 8th St., Phila., Pa.

**SELL a line of Monogram Stationery** and Calling Cards. Big profit. Samples Free. Frederick H. Leder, 109 South Charles, Baltimore, Md.

**U-KAN-PLATE—The polish** that silver-plates; \$18-\$40 week year round; Exclusive field; Free Booklet. Infico Co., 427 Presser Bldg., Philadelphia, Pa.

**WINDOW Lettering Business.** We start you free. Stahlrite Co., Dept. P, Long Island City, N. Y.

**A DOLLAR a minute** can't be made, but good money can, with quick sellers—not in stores. Write "Show Me!" S Mfg. Co., 41H Warren St., New York.

**WE need one active, reliable person** in every community to take orders for our popular mechanical books. You don't have to be a book agent. These books do their own talking. Simply show them. They contain just that sort of information about how to do and make things that every mechanically inclined person is looking for. And they are reasonable in price. We allow you a liberal commission for this pleasant work which you can do during spare time without interfering with your regular occupation. Don't neglect this real opportunity, but write now for full details to Manager Book Dept., Popular Mechanics Magazine, 6 N. Michigan Ave., Chicago.

**AGENTS—Automobile Specialties.** Attractive proposition. Ill. Auto Specialties Co., 503 Mallers Bldg., Chicago.

**THE Simplex Container—Sells on sight.** Sample One Dollar. No circulars. Arthur Krull, 276 Humboldt Parkway, Buffalo, N. Y.

**AGENTS make large profits** selling our repeat order articles. Easy to sell. Catalog free. Mulvaney & Riemann Co., Allen, Neb.

**MAKE and sell your own goods.** Formulas by Expert Chemists. Manufacturing Processes and Trade Secrets. Formula Catalog for stamp. B. Mystic Company, Washington, D. C.

**ICELESS Milk-Bottle Cooler.** Keeps milk and cream from souring. Absolutely new. Retail 50c. Dept. 445-D, Edmund Feeny Co., Muncie, Ind.

**POSTCARDS 50c per 1,000 up.** Fly-catchers, Fountain Pens, etc. Particulars free, or 10c for all three samples. Gross Guard Co., C2147 Arthur Ave., New York.



**AGENTS**, do not take any agency until getting free samples and plans on Ho-Ru-Co Skin and Scalp Soap and Toilet Articles. Our proposition different. Hothco, 212 N. 2nd St. Louis, Mo.

**AGENTS**—A big advance in Post Cards; the world's greatest sellers; your profit enormous. Samples, 10c. Particulars, International Postal Card Service, Box 404, Tacoma, Wash.

**DOLLAR** hourly, selling gas lighters; lights instantly by thrusting into gas flow. Sample 25c. H. & S. Company, Indianapolis, Indiana.

**REPRESENT** me in your town. New invention, household article, 100% profit. Send 10c for sample and particulars. Marvel Mfg. Co., Dept. 10, New Haven, Conn.

**BIG** profits selling Perfection Lawnmower Sharpener; particulars, sample 25c. Box 444, North Battleford, Saskatchewan.

**AGENTS** wanted for the latest novelty game. Bend. Levi, 257 West Broadway, New York City.

**ART** Calendars for 1916. Sample and agent's terms 10c. H. W. Rankin, Plainfield, N. J.

**AGENTS**—I print labels, furnish formulas. Samples free. Lem. Ives, Loveland, Colo.

**HOUSEHOLD** and Automobile Novelties. Address Masterson Specialty Co., Cincinnati, O.

**200% PROFIT.** You can't beat it. Sells everywhere. Free pocket sample. Our goods get the orders. Wm. J. Dick, Mgr., Dept. M-4, 20 W. Lake St., Chicago.

**AGENTS** Wanted—Agents make 500 per cent profit selling "Novelty Sign Cards." Merchants buy 10 to 100 on sight. 800 varieties. Catalogue free. Sullivan Co., 1234 Van Buren St., Chicago, Ill.

**MAKE \$10 to \$20** per day selling Multiple-Head Pliers. Free particulars. Currier-Koeth Mfg. Co., 201 West Ave., Coatesport, Pa.

**AT last**—something new. Crystal Garter for men. No metal to corrode. No elastic to rot. No cords to break. Clean as a bound's tooth. 100% profit. Send 12c for sample pair. Colonial Art Co., Northboro, Mass.

**AGENTS**, sell our Adjustable Spring Steel Skirt Holder. Sample 25c. Exclusive territory. State rights for sale. Williams Mfg. Co., 157 Yesler Way, Seattle, Wash.

**SILVER** Plated, Self-Filling Pen. No dropper required. No rubber ink-bag. No "mussy" fingers. Dip pen in ink, reservoir fills instantly. Lasts indefinitely. Agents wanted everywhere. Quick sales, big profits. Sample ten cents; none free. Ed. H. Irwin, Box 1201, Carthage, Mo.

**AGENTS** wanted in every county to sell specialties, farmers' and auto supplies. Becknell, Janesville, Wis.

**WANTED**—Men and women canvassers to handle new kitchen article. Easy seller, never been seen before. Exclusive sale to hustlers in outside towns. Experience unnecessary. Satisfaction guaranteed. Write Kobbelle Mfg. Co., 602 Summit St., Toledo, O.

**AGENTS**, Cost 3c, sell 25c. Gold window letters. Any one can apply. Samples free. Chicago Letter Co., 848 Altgeld St., Chicago.

**AGENTS**, general, to control exclusive territories. Biggest legitimate Automobile money-maker in country. Steady repeat business. Choice territories going fast. H. Sloan, Distributor, 40 Liberty St., New York.

**AGENTS**—Brand new specialty Aluminum Triplicate Sauce Pan with detachable handle. Cooks 3 different foods on one burner. Saves gas. Lasts lifetime. \$100 to \$200 per month easy. Send for our catalogue of 400 other specialties. American Aluminum Mfg. Co., Div. J. 10, Lemont, Ill.

**ANYBODY** can make big money selling the Midget Telescope (imported). A great novelty and souvenir showing beautiful views of Panama Canal. Send 25c coin for sample. George Mayerle, Sr., Optometrist, 950 Market St., San Francisco.

**MONTAROMA**, concentrated perfume of the mountains. Youth restoring, health giving invigorant. Sample 20 cents. Myrt. Strong, Ward, Colo.

**AGENTS**—Salary or commission. Greatest seller yet. Every user pen and ink buys on sight. 200 to 500 per cent profit. One agent's sales \$620 in six days; another \$32 in two hours. Monroe Mfg. Co., X-C, La Crosse, Wis.

**AGENTS**—Write for information on brand new 25c kitchen utensil. Donahue writes: "I sell nine out of ten." Scranton makes over \$10 weekly. Biggest money you ever made. Sample 25c. H. W. E. Mfg. Co., 6 8th St., Binghamton, N. Y.

**BIGGEST** money-maker out. Newly invented "Linefinder and Copy Holder" for stenographers. Greatest time saver. Exclusive territory. Lineguide Mfg. Co., 160 N. 5th Ave., Chicago.

**LISTEN!** Can you sell gasoline at one cent per gallon? If so, sell "Gaso-Tonic." Gives 40% more gasoline mileage; eliminates carbon. Auto owners grabbing for it. \$10 a day easy. Helsey made \$25 first day. Act quick, man. Details free. White Mfg. Co., Dept. 112-B, Cincinnati, O.

**AGENTS**—\$50 weekly. We manufacture the best needle case made; a wonderful seller; 300% to 500% profit; talking unnecessary; our "Trust Scheme" envelopes do the work; general agents can make \$100 weekly; particulars free; 25c sample outfit for 10c; buy direct from the factory. Paty Needle Co., 102 Davis Sq., W. Somerville, Mass.

**SIGN** Letter Agents and Painters; 500% Profit Gold and Silver Sign Letters for Stores and Office Windows. Anyone can put on. Big demand. Free samples. Metallic Letter Co., 404 N. Clark St., Chicago.

**YOUNG** Man, would you accept a tailor-made suit just for showing it to your friends? If you live in a town smaller than 10,000, write Banner Tailoring Co., Dept. 100, Chicago, and get beautiful samples, styles and a wonderful offer.

**\$1,000 PER** Man per County. Strange invention startles world—agents amazed. Ten inexperienced men divide \$40,000. Korstad, a farmer, did \$2,200 in 14 days. Schleicher, a minister, \$195 first 12 hours. \$1,200 cold cash made, paid, banked by Stoneham in 30 days; \$15,000 to date. A hot or cold running water bath equipment for any home at only \$6.50. Self-heating. No plumbing or waterworks required. Investigate. Exclusive sale. Credit given. Send no money. Write letter or postal today. Allen Mfg. Co., 4137 Allen Bldg., Toledo, Ohio.

**KEROSENE** Gas Burners in Cook Stoves or Ranges stop use of wood or coal. Recently patented. Money-maker for agents. The Vapor-Gas Burner Co., Desk 8, Columbus, Ohio.

**\$15.00 MADE** first day by 13-year-old boy with Shomescope. Woman made \$8.00 first hour. Particulars free. Shomescope Mfg. Co., 523 W. 13th St., Kansas City, Mo.

**GET** into your own business. Cut loose from lay-offs, short hours and wage slavery. Our catchy soap and toilet combinations have put thousands on Prosperity Road. Tremendous saving to consumer—200% profit for you. Send postal quick for details. E. M. Davis Co., 864 Davis Bldg., Chicago.

**SELL** "Changeable Signs." \$10.00 daily. Very attractive proposition. Write Powell Bros., 4150 Madison St., Chicago.

**AGENTS** Wanted—To advertise our goods by distributing free sample to consumer. 69 cents an hour. Write for full particulars. The Favori Company, 1002 West St., Dayton, O.

**AGENTS**—\$5 daily selling our Handy Tool, 12 articles in one. Lightning seller. Sample free. Thomas Mfg. Company, 462 Third St., Dayton, Ohio.

**SELL** Dry Goods Remnants. Greatest bargains on earth. Remnant Store Co., Cincinnati, Ohio.

**OUR** Sanitary Wire Frame Brushes and Cleaning Specialties are sold only by Kleanol agents. Household necessities. Good territory still open for state agents. Kleanol Brush Company, 71 Taylor St., Springfield, Mass.

**WE** are the largest manufacturers of twisted Wire Brushes in America. Highest grade goods, best service, largest profits. Our new Auto Specials are winners. Send for catalog. Fuller Brush Company, Hartford, Conn.; Rock Island, Ill.

**AGENTS**—Here's a winner. The Midget Vest Pocket Garment Hanger—sells on sight. The most attractive proposition ever offered. 150% profit. No competition, as article is fully protected by U. S. and foreign patents. Address: Dept. "M." The Silver Company, 171 Madison Ave., New York.

**AGENTS**—Men and women, newest invention. Wing Self Heating Flat Iron; guaranteed sells everywhere. Women delighted. Write for particulars. Wing Mfg. Co., 1608 Fulton St., Chicago.

**SELL** Typewriters in your town. Good profits. Write me for wholesale prices and plan. A. E. Atchison, 1930 South Sawyer Avenue, Chicago.

**GET** cash for names, information, ideas, formulas. Turn what you see, hear and know into money. Instructive booklet for stamp. Information System, 230, Marietta, Ohio.

**NEW** 1915 Model—Send no money. Just your name on a postal card, and learn by return mail how to get the best Vacuum Cleaner made, without costing you one cent. Shipped direct from factory, guaranteed for 5 years. Reliable, live agents wanted. The Warner Company, Dept. Z, Muncie, Indiana.

**AGENTS**—Sell the Primus, genuine Swedish wickless, coal-oil stove. Smokeless, odorless. Twice the heat of gasoline at one-eighth the cost. No danger of explosion. Big profits. James Anderson & Sons, Sidney, Ohio, American distributors.

**AGENTS** make big money and become sales managers for our goods. Fast office sellers. Fine profits. Particulars and samples free. One Dip Pen Company, Dept. 2, Baltimore, Md.

**READ** the Agents Magazine and make more money. 2 issues 10c. Agent's Magazine, Chicago.

**AGENTS**—Air Cell Washing Machine. New, marvelous invention. Exceeds work of washers costing \$25.00 and up. Sells only \$1.00. No wonder every home buys. Exclusive territory free. Nearly 200% profit. Write today. Air Cell Washer Co., 3037 Detroit Ave., Toledo, Ohio.

**AGENTS**—Average \$5 to \$12 daily selling astonishing Aztec massage machine. New. Just patented. Different. No electricity or water power required. Nothing complicated. Affords exhilarating massage without cent expense. Lowest priced, but best outfit. Retail \$2.50 allowing you big end of the profit. Particulars and "beauty" folder free. Aztec Remedy Co., Dept. 132, Toledo, Ohio.

**AGENTS**—Sell rich-looking imported 36x 68 Rugs, \$1 each. Carter, Tenn., sold 115 in 4 days. Profit, \$57. You can do same. Write for sample offer selling plan; exclusive territory. Sample rug by parcel post prepaid, 98c. Condon, Importer, Stonington, Maine.

**500% PROFIT** selling our wonderful sign letters for office windows, store fronts and glass signs; resembles finest job; easily applied; samples free. Metallic Letter Co., 406 N. Clark St., Chicago.

**AGENTS**—Stamping names on Pocket Key Protectors; sample Check with your name and address, 15c. Stamping Outfits, Emblem Checks, Check Fobs, Name Plates, Hart Mfg. Co., Desk 2, 303 DeGrae St., Brooklyn, N. Y.

**300 TO 400% Profit** to Agents selling our guaranteed U. S. Fire Extinguishers. Tremendous demand. Orders repeat. Exclusive territory to county and district managers. United Mfg. Co., 1508 Oakwood, Toledo, Ohio.

**ENDLESS** Neckties—Something new, twelve ties in one; costs no more than old style; man made \$79, three days; woman made \$92, week; write for special agents' offer. Endless Necktie Mfg. Co., Dept. 10, Kansas City, Mo., or Universal Products Co., Toronto, Canada.

**SELL** Our Attractive Brass Easel Poster Frames to picture theatres, also changeable letter signs for every store; big demand; easy sales; liberal commissions. Newman Manufacturing Company, Cincinnati, Ohio.

**JUST** show them—The new adjustable floor and wall mops, dustless dusters and sanitary brushes sell themselves. Big line. Big profits. Agents write Silver-Chamberlain Co., Dept. M, Clayton, N. J.

**YOU** can be your own boss with our Key Check Outfit. Good for \$5 a day stamping names on pocket key checks, fobs, etc. Sample check with your name and address, 15 cents. Pease Die Works, Dept. M, Winchester, N. H.

**STOP** Here! Let me start you in a home business that will bring you money every day. Experience unnecessary. Spare time. No canvassing. I furnish everything. Send for proofs. Voorhies, Desk C. R., Omaha, Neb.

**BIG** Profits for You! Manufacture Barley Crisp. New Confection. 5c package costs you 1c. Machine, instructions complete \$7.50 prepaid. Send 10c for samples. Barley Crisp Co., 1205 Broadway, San Francisco.

**AGENTS** make \$180 monthly selling our 500 handy household articles. Catalogue free. Scheff Company, DesPlaines, Ill.

**EASY pleasant work for Mechanics, Shop Men, Clerks, during spare hours, will add many dollars to their salaries. Also want persons who can give full time. Big wages assured. Novelty Cutlery Co., 67 Bar St., Canton, Ohio.**

**MEDALLIONS—300% profit. Make up your own goods and be independent. Catalogue free. Resag Co., 1205 Randolph St., Chicago.**

**MAIL-ORDER Opportunities: 25 new Propositions. No competition! Make 95c profit on dollar order; complete outfit 10c. Mail Dealers Wholesale House, 521 Franklin Bldg., Chicago.**

**AGENTS make \$5 to \$10 a day on the start. Atkinson writes: "The best proposition I have found in my forty years' canvassing." Permanent work. Household necessity. Saving 80%. Write today for General or Local Agents terms. Free sample. C. H. Stuart & Co., 18 Union St., Newark, New York.**

**YOU can make \$448 as our general or local agent. Household necessity; saves 80 per cent; permanent business; exclusive territory; salary or commission; free sample; credit. J. Pitkin, 113 Redd St., Newark, N. Y.**

**AGENTS of ability and high character wanted on a new household article. Over 100 per cent profit. Special selling plan that pulls results. Address Merritt & Brock, 59 to 69 Temple Place, Boston, Mass.**

**RESIDENT Agent wanted to handle all makes of Factory Rebuilt Typewriters all or part time. Postal brings particulars. Trull Wright Co., 112 N. LaSalle St., Chicago, Ill.**

**SELLS like hot cakes. New Ironing Wax, boiler and asbestos rest. Perfumes clothes. Nothing like it. Working outfit 5c. MBH Mfrs., 12 Water St., N. Y.**

**100% PROFIT: High Grade Safety Razor; something different; full particulars and sample, 25c. Rigdon, 340 North Central, Chicago.**

**GET next to Berg's Specialties. New, snappy, up-to-date. No stale stuff. Others make big money. Why not you? Berg & Beard Inc., 61 Fleet Place, Brooklyn, N. Y.**

**AGENTS, everyone that drinks from a bubbling fountain wants the new Sanigard Drinking Device. It sells for a dime, and sells to men, women and children everywhere. For particulars write the Sanigard Co., Los Angeles, Cal.**

#### AGENCIES WANTED

**WE will sell your manufactured products. Communicate with Mercantile Brokers Exchange, Washington, D. C.**

#### SALESMEN WANTED

**BIG money in Real Estate business by my methods (not old-time ones of books). I made \$25,000.00 in three years (city and country). Costs nothing to start the business. For free particulars, address Mead, 277 Broadway, New York.**

**BEST Selling Bank Specialty on market. New Splendid side line. Every bank buys dozens. Sample, literature, order book postpaid fifty cents. Box 1061. Theo. Tandberg, Thief River Falls, Minn.**

**WANTED—Hunters to take orders for made-to-measure high-grade men's tailored suits from \$9.00 to \$22.00. Make \$25.00 to \$50.00 weekly. Elegant large book outfit free. Experience unnecessary. No pocket folder affair. Splendid opportunity to make money. Handy Dandy Line, Dept. 8, Nagsamom St., Chicago.**

**GREAT opportunity for General Agents selling New Specialty to merchants. Returns \$5, \$10, \$15 each. Your profit 200%. No competition. Exclusive territory. Free samples. Bayers Co., 468 Wainwright, St. Louis, Mo.**

**SALESMEN—Make big money selling our magnets and coil points. Points sold on a guarantee. Every garage buys. Write us. L. & L., 751 Academy St., Kalamazoo, Mich.**

**\$139 HAS been earned in 3 days by our representatives, some even better, introducing our new advertising method which solves the advertising problem for merchants in smaller cities and towns. If you are or want to be a salesman I will show you how to build up a big profitable repeat business quick. Whole or part time. Big money if you act now. Write Salesmanager, Winslow Cabot Company, 64 Congress Bldg., Boston, Mass.**

**HELP-A-PHONE. Salesmen make \$100 weekly. Write Edward, 415 Belden Ave., Chicago.**

**SALESMAN. Sell beautiful 28x58 Ariz-kraft felt rags for \$13.50 per doz. Your profit, \$3 per doz. Kelso, Battle Creek, Mich., sold 30 doz. last week. His profit, \$90. Write for exclusive territory and selling plan. Prepaid sample, \$1.50, refunded on first order. H. Condon, Mgr., Stonington, Maine.**

**SALESMEN Wanted—Salesmen and Manufacturers' Agents to represent us everywhere among the Superintendents, Engineers and Purchasing Agents of Manufacturing Plants. Four famous Federal Products—Pulley Facing, Roofing Cement, Metal Paints and Graphites. The Federal Graphite Mills, Cleveland, Ohio.**

**SALESMEN: Pocket side line; new, live proposition; all merchants in towns of 100,000 and under want it. Pays \$5.00 commission on each sale. No collecting, no risk to merchant. We take back unsold goods. Easiest, biggest paying side line ever offered. Canfield Mfg. Co., 298 Sagel St., Chicago.**

**GENERAL. Sales Agents in several big cities and local men in smaller towns for a specialty selling to every retail store. Commission \$5.00 to \$12.00 per sale. Work spare or full time. Exclusive territory. Newman Novelty Mfg. Co., 836 E. 43rd St., Chicago.**

**SALESMEN—We have some excellent territory open to salesmen of ability. This is a proposition that appeals to the best class of concerns. Sales are easy and your profits large. Write us today for catalogue P. M., covering the Schick All-Steel Paper Baler, Davenport Mfg. Company, Davenport, Iowa.**

**SALESMEN—Manufacturer's Agent. In every city. New Metal Interchangeable Letter Signs and Flashers. Largest sellers, all styles. Write for particulars. Chicago Metal Mfg. Co., 163 North Wabash, Chicago, Ill.**

**SALESMEN—Get our plan for Monogramming Automobiles and Motorcycles by transfer method. Very large profits. Motorists' Accessories Co., Ashland, O.**

**SALESMEN, Agents, everywhere; New auto fuel. Permanent, profitable. Tankil Chemical Sales Co., Cleveland, Ohio.**

**WANTED—Representatives everywhere. Exclusive territory. Gold sign letters for stores and office windows. Any one can put on. Write today for free sample. Metallic Letter Co., 493 N. Clark St., Chicago.**

**BIG Opportunity for Hustling Salesmen. Selling Sandho Two-Compression Starters for Ford's. \$14. Guaranteed to start. Great demand. Salesmen with Ford's preferred. Write Sandho Starter Co., Desk A, Rock Island, Ill.**

#### HELP WANTED

**YOUR services are needed as Topographic Draftsman at excellent salary. You can learn from us soon. Get particulars, Columbia School of Drafting, McLachlen Bldg., Washington, D. C.**

**WESTERN Manufacturer needs ten more Eastern crew managers at once. Wonderful new invention. Sells hard times, good times, all the time. The Far West Sales Company, Albany, Oregon.**

**MEN—Become Chauffeurs, \$18 week. Earn while learning. Sample lesson free. Franklin Institute, Dept. A-302, Rochester, N. Y.**

**INVENTORS Wanted. Your ideas may mean fortune. Send Sketch. Patents secured through new credit system. Book and advice free. Waters & Co., 4102 Warder Bldg., Washington, D. C.**

**SILVERING mirrors. Plating tableware, auto-brass. Home booklet plans free. Clarence Sprinkle, Dept. 28, Marion, Ind.**

**MEN-Women Wanted. \$75.00 Month. List Government Jobs open—free. Franklin Institute, Dept. A-31, Rochester, N. Y.**

**SPEND summer gathering insects, butterflies. I pay big prices. Many worth \$5.00-\$10.00. All salable. Men, Women. Get instructions, price-list, pictures, descriptions of valuable ones. Send stamp. Sinclair, Box 244, D-6, Los Angeles, Cal.**

**BOYS, free—\$1.25 League Ball—selling 30 packages postcards at 10c package. Fielder's glove or gold-plated watch for selling 25 packages. Hayson Company, 123 N. Central Ave., Chicago, Ill.**

**GET a Government Job! See ad on page 10. Write now—today! Patterson Civil Service School, Rochester, N. Y.**

**OWN a business. Co-operate with me earnings at home. Everything furnished. Don't worry about capital. Boyd H. Brown, Dept. K-8, Omaha, Nebr.**

**MEN and Women Wanted Everywhere. Government Jobs, \$70 month. Short hours. Vacations. Rapid advancement. Steady work. Write immediately for list of positions now obtainable. Franklin Institute, Dept. A-21, Rochester, N. Y.**

**WANTED—Men and women to qualify for Government positions. Several thousand appointments to be made next few months. Full information about openings, how to prepare, etc., free. Write immediately for booklet G-29. Earl Hopkins, Washington, D. C.**

**GUARANTEED Salary to trustworthy man or woman this locality to distribute hosiery direct mill to wearer. Position permanent. No experience. All or spare time. For complete outfit and particulars apply International Mills, Inc., Dept. L, Norristown, Pa.**

**U. S. GOVERNMENT Wants Clerks. Men, Women, 18 or over. \$75.00 month. List of positions now obtainable free. Write immediately. Franklin Institute, Dept. A-21, Rochester, N. Y.**

**WANTED—Men to represent us in your own territory; \$35.00 per month, traveling expenses and commission. Experience unnecessary. Write quick. R. D. Martel, 2909 Indiana Ave., Dept. A O, Chicago.**

**HIGH Grade Opportunity for Persons with spare time; no canvassing; commercial information wanted; good pay; confidential. "Clo." PMC, Evansville, Indiana.**

**MAKE \$50 week. Pocket Check Protector. Sells on sight. Write quick. Sample and terms, 25c. Smith, Box 42, Camden, N. J.**

**YOU Are Wanted. Government Jobs, \$70 month. Vacations. Write immediately for list positions now obtainable. Franklin Institute, Dept. A-21, Rochester, N. Y.**

**A MONEY Proposition—Co-operate with me in a profit-sharing mail-order business. Will place trial advertisement, furnish printed matter, goods to fill orders and divide the profits. Particulars, Desk 133, Hazen A. Horton, Tekonsha, Mich.**

**FIREMEN, Brakemen, on all railroads; \$120 monthly. Experience unnecessary. Railway Association, Dept. 298, Brooklyn, N. Y.**

**MAKE \$50 a month extra, reporting sales information. Dignified, fascinating, spare-time work. Send stamp for particulars. National Enterprise Association, 37 Bevers St., Portland, Maine.**

**RAILWAY Mail Clerks Wanted. \$75 month. Examinations coming everywhere. Specimen questions free. Write immediately. Franklin Institute, Dept. A-21, Rochester, N. Y.**

**DISTRIBUTORS Wanted—Good pay; steady work; giving away packages Perfumed Borax Soap Powder with Soaps, etc. No capital or experience needed. S. Ward & Co., 218 Institute Pl., Chicago.**

**LEARN Automobile Repairing in fully-equipped machine shop, driving on up-to-date cars, also Electricity. Many positions secured. Board, rooms while learning. Low Exposition Rate. Catalog free. National School of Engineering, Los Angeles. Established 1905.**

**WANTED—Men to get members and establish lodges on commission basis for the Owls, South Bend, Indiana.**

**WRITE Moving-Picture Plays. Good prices. Devote all or spare time. No correspondence school. Details free. Atlas Publishing Co., 3945, Cincinnati.**

**EARN \$20 weekly collecting names and information. What you see, hear and know is worth money. Send stamp for instructive booklet. Information System, 239, Marietta, Ohio.**

**MEN to refinish lighting fixtures, brass beds, etc. All or spare time. No capital or canvassing. Experience unnecessary. Information free. Gunmetal Co., Dept. G, Decatur, Ill.**

**BE a Detective—Earn from \$150.00 to \$200.00 per month. Travel over the world. Write C. T. Ludwig, 340 Westover Building, Kansas City, Mo.**

**STOP Here! Let me start you in a home business that will bring you money every day. Experience unnecessary. Spare time. No canvassing. I furnish everything. Send for proofs. Voorhies, Desk C. R., Omaha, Neb.**

**WANTED—An Idea! Who can think of some simple thing to patent? Protect your ideas; they may bring you wealth. Write for "Needed Inventions" and "How to Get Your Patent and Your Money." Randolph & Co., Patent Attorneys, Dept. 144, Washington, D. C.**

GO on the Stage. Vaudeville career offered you. Experience unnecessary. Managers endorse my method. Instructive vaudeville book free. Write today. Fred-eric Labelle, Sta. 10, Jackson, Mich.

GOVERNMENT Examinations. Most thorough preparation, \$5; returned if not appointed; particulars free. American Civil Service School, Washington, D. C.

WE have several openings for establishment of independent mail order business. Character more important than capital. Spare time at first. Send for particulars. Opportunities Exchange, Buffalo, N. Y.

FIREMEN and brakemen: \$100 Monthly; experience unnecessary; hundreds needed by the best railroads everywhere. Particulars free. 709 Railway Bureau, East St. Louis, Ill.

#### WANTED

WANTED—Articles suitable for parcel-post business. My client seeks attractive items to sell by mail and deliver through parcel-post. Household or personal necessities and conveniences that can sell at two dollars or less preferred. He will also consider the marketing of patented articles on terms to be agreed upon. Will pay from \$5.00 to \$50.00 for suggestions which are accepted. I have entire confidence in the good faith of my client. In writing please be definite and give name and address carefully. John L. Cough (Advertising Agency), No. 1016 Merchants Bank Bldg., Indianapolis, Ind.

#### FOR SALE

15-LIGHT Acetylene Gas Plants, Generator, Fixtures, Chandeliers, Pipe, Brighter than Electricity. Fully guaranteed, easily worth \$60.00. All complete for \$25.00. Write Daniel Zimmerman, Magley, Ind.

DOUBLE action Harp, "Browne & Buckwell," full size, almost new, cost \$750, will take \$250. Job Wright, Amarillo, Texas.

FOR Sale—1 Remy magneto and coil, 1 Schebler carburetor, 1 set machinist's tools, 1 Colt automatic revolver, 1 Winchester automatic rifle, 1 electric fan. Write for prices. W. H. Kerley, Peck, Kans.

TYPE and Printing Material at bargain prices. Now is the time to buy. Catalogue free. Philadelphia Printers Supply Co., 14 S. 5th St., Philadelphia.

FOR Sale—30-H. P. steam traction engine, drag saw and International truck. Bargains for cash. Lewis Eckhoff, Nunda, Mich.

DEER head 10 point antlers \$25. B. Masters, Bowerston, Ohio.

GAS Heating Furnace for Annealing and hardening small work. Good condition; inside measurements, 9x5x18. Keating Co., 715 Sanson, Philadelphia.

SMOKESTACK, 19 in. diameter, 48 ft. long, used 18 months, good condition. \$30.00 f. o. b. cars. Anton Evensdahl, Lakota, N. Dak.

OLIVER Typewriter. Like new. \$25.00. Office, 604, 180 N. Dearborn St., Chicago.

EDISON Moving Picture Machine. Best condition. \$60. Reynard H. Worthington, Sumner, Fla.

COMPLETE surveying outfit; two clarinets; all practically new. Chas. Eads, Valentine, Neb.

PRINTING press, 1x11; 14 fonts type, etc. Cost \$150, sell for \$70. Dennis Shea, 47 Newton, New Bedford, Mass.

FIELD and Marine Day and Night Glasses with sunshade and case, 25 mile adjustment, \$30 value, only \$7.50. Write for our telescope and binocular list. Wells Curiosity Shop, 20 S. Second St., Philadelphia, Pa.

VACUUM cleaner pumps and parts for assembling, save 75%. Vacuum Supply Co., Ann Arbor, Mich.

#### SALE OR EXCHANGE

DAIRY Utensil Patent for citrus land, South Florida. Lock Box 1140, Manilla, Philippine Islands.

PATENT on Auto Accessory. Dies for manufacturing. What have you? Box 177, Russellville, Arkansas.

3-HORSE Detroit marine engine for diamond. I. S. P., Box 271, Clinton, Okla.

#### GUNS, SPORTING GOODS, ETC.

PERLESS famous combination spring exercisers with patented grip handles. Just the thing for athletes, business men, women, boys or girls. All the gymnasium advantages in your own home. Prices 85c to \$4.00. Five styles, three tensions. Send for complete manufacturer's catalogue. Peerless Athletic Supply Co., 283 Pearl St., Brooklyn, N. Y.

FIREARMS—Old-time and modern. Buy, sell, exchange all sorts. Stephen Van Rensselaer, West Orange, New Jersey.

#### MACHINERY, TOOLS AND SUPPLIES

AN advanced method of thread cutting in the lathe, and two useful samples type-written blueprint charts of tap drill sizes, 25 cents. J. A. Campbell, M. M., Denver, Colo.

TOOLS, guns and fixtures never rust if Imprints are used. Metal box of six last indefinitely. Ten cents. Rivad, Box 13, Cedar Falls, Iowa.

PIPE cut to sketch, supplies for steam, gas and water. Write me your needs. W. E. Klinge, Jr., 1047 Fulton St., Brooklyn, N. Y.

PULLEYS, Gears, Sprockets, Shafting, Hangers; see page 126. W. A. Jones Foundry & Machine Co., Chicago.

ENGINE Users: Power Grindstone Shafts, \$1.25; Jointer Heads, \$12. Circulars free. John Whisler, Gibson, Iowa.

PLUG Tobacco manufacturing machinery. List free. W. H. Miller, Madison, Ind.

ELECTRICAL machinery bought, sold New or old. Stearns, Paxton, Illinois.

18" LATHE, \$149. Other bargains. Gasoline engines, 1/2 h. p. up. Line-shaft equipment, auto supplies. Agents wanted. Hicknell Mfg. Co., Janesville, Wis.

VACUUM cleaner pumps, tools, etc., for stationary house or wagon outfit. Vacuum Supply Co., Ann Arbor, Mich.

TEN Lincoln milling machines with vice \$50.00 each. Lucas & Son, Bridgeport, Conn.

FOR Sale—All sizes new and second-hand Pulleys, Belting, Shafting, Hangers, Couplings, Pillow Blocks, Collars, etc. Passman Bros., 28 and 30 So. Green Street, Chicago, Ill.

HAVE for sale several sizes of lathes, milling machines, drill presses, punch presses, shapers, planers, boilers, steam engines, oil, gas and gasoline engines and wood-working machinery. Pinner, 122 Water St., New York, N. Y.

ENGINE Lathe, swings 9 1/2 in., takes 25 in. between centers. Complete set gears cutting all size threads 3 in. to 40 in., \$43.50. Grammes & Sons, Allentown, Pa.

FOR Sale Cheap—New Universal Grinder with complete equipment. Lahr Motor Sales Co., Bismarck, N. D.

#### ENGINES, MOTORS AND DYNAMOS

FOR Sale—40-H. P. Fairbanks-Morse type "N" stationary oil engine, with clutch, sheaves, idler for rope drive and 1,200 gal. fuel tank; \$600. B. F. Koch, 215 Englewood Ave., Chicago.

EXCEPTIONAL values, single and three-phase alternating and direct current motors, guaranteed one year. Fan bargains. Motors bought, sold, repaired. Send for bargain lists, motors and supplies. Satisfaction guaranteed or money refunded. Hye Electric Co., 413-J, S. Dearborn St., Chicago.

20-H. P., 210-volt direct current Triumph Motor for sale. Factory rebuilt. Like new. Bargain. Reno-Kaetler Co., Cincinnati, O.

SMALL dynamo and motors. Low and standard voltages. Low price. Write for new Special List. Johnston, Evans Ave., Ingram, Pa.

FOR Sale—10-H. P. Steam Marine Engine and boiler, A1, \$150. Lucas & Son, Bridgeport, Conn.

REBUILT Engines—We have on hand a number of rebuilt "Buffalo" engines, guaranteed, at greatly reduced prices. Write for bargain list. Buffalo Gasoline Motor Co., 1293-1295 Niagara Street, Buffalo, N. Y.

JUST Issued—Amateur Mechanics No. 6. Another great book of 203 articles for those who like to make things. Similar in style to the other numbers in the series. 128 pages, 241 illustrations. Paper. Price 25 cents postpaid. Popular Mechanics Book Dept., 6 N. Michigan Ave., Chicago.

#### FLOUR & FEED MILLING MACHINERY

SPECIAL bargains in second hand Attrition mills, burr mills, crushers, corn shellers, bran dusters, dust collectors, purifiers, reels, double, single, 2 and 3-pair high roller mills, sieve bolters, receiving separators, scorers, etc. Write for description and prices. Sprout, Waldron & Co., P. O. Box 429, Muncy, Pa.

#### ENGINE CASTINGS AND BLUE PRINTS

CASTINGS, four-cycle. Stamp for particularers. Nice, 4613 James St., Phila.

GASOLINE Engine Castings, with drawings. Cheap. Catalog for stamp. Novelty Manufacturing Co., 853 West 4th St., Cincinnati, Ohio.

#### CEMENT

IF you want the best information on cement and concrete construction, subscribe for Concrete-Cement Age, leading cement and concrete monthly. Sample copy, 10 cents. Yearly subscription, \$1.50. Concrete-Cement Age, 135 Newberry Bldg., Detroit, Mich.

#### FOR THE SHOP

FOR That Boy—He will appreciate a copy of the great boy's book "The Boy Mechanic" that tells about 700 different things for boys to do and has 800 pictures, 430 (7x10) pages, cloth, big, handsome book for the price, \$1.50 postpaid. Popular Mechanics Book Dept., 6 N. Michigan Ave., Chicago.

#### BOATS, LAUNCHES, ACCESSORIES

FOR Sale—3-H. P. Canoe Engine, complete outfit for boat, \$60. H. S. Bryan, Elmira, N. Y.

MOTORCRAFT Encyclopedia—A 150-page book that tells 1041 things every motor boatman should know. How to overcome engine troubles. Price \$1, postpaid. Popular Mechanics Book Dept., 6 N. Michigan Ave., Chicago.

#### BLACKSMITHS

BLACKSMITHS, get out of the rut; be progressive. Get Toy's modern methods of doing hard jobs easy. Make solid welds. Temper all tools to a standard with Toy's Colored Tempering Charts. Do the job the other smith can't do. All for \$1. Send for free samples. W. M. Toy, Sidney, Ohio.

SHOP Notes—Many valuable hints for blacksmiths are contained in our series of Shop Notes books, 10 volumes, 50c each, postpaid, or \$5 per set prepaid. Popular Mechanics Book Dept., 6 N. Michigan Ave., Chicago.

#### ELECTRICAL

50-LIGHT Dynamo, \$55, in monthly payments of \$5. Hobart Bros., Troy, Ohio.

"BOY Electrician." Make Batteries, Dynamos, Motors, Electric Engine, Telephone, etc. 75 illustrations, 14c. Renew Dry Batteries, 3 guaranteed processes, 25c. Both, 25c. Ideal Book Shop, 3311-H, Belleplaine Ave., Chicago.

#### STAMP COLLECTING

FOREIGN Stamps Free; 52 different foreign, including China and Venezuela, to all who apply for our high grade approval sections. Send two-cent stamp for return postage. Edgewood Stamp Co., Dept. H, Milford, Conn.

POSTER Stamps; assortment "KK" 25, all different advertising poster stamps, ten cents postpaid. Poster Stamp Distributing Service, P. O. Box 75, East Liverpool, Ohio.

STAMPS on approval. U. S. postage and revenue. Reference necessary. Good premiums. Mrs. Louise Kellogg, West Hartford, Conn.

STAMPS sent on approval at 70% discount. Reference required. Procancelers at 1/2c each. Emory Remoll, Hanover, Penna.

25 DIFFERENT British Colonials to applicants for stamps on approval who send 2c postage. Nickles, 122 Florida Ave., Washington, D. C.

STAMPS—105 China, etc., stamp dictionary and list, 2c. Bullard, Sta. A, Boston.

**STAMP** Album with 538 Genuine Stamps, incl. Old Mexico, Malay (tiger), China (dragon), Tasmania (landscape), Jamaica (waterfalls), etc., 10c. 100 diff. Jap. N. Sid., etc., 5c. Big List, Coupons, etc. Free! We Buy Stamps. Hussman Stamp Co., St. Louis, Mo.

**STAMPS**, 100, all different, free. Postage 2c. Mention paper. Quaker Stamp Co., Toledo, Ohio.

**24 VARIETIES** Cuban stamps, 10 cents. List of 6,000 low-priced stamps free. Chambers Stamp Co., 111 P. Nassau St., New York City.

**PACKET** of 23 stamps; no two countries alike, 500 hinges. Set of \$1 and \$2 U. S. Rev., all for 5c. Mention paper. Miami Stamp Co., Toledo, Ohio.

#### RARE COINS

**COIN** Premium book, 15c. 5 foreign and 124, 10c. Moore Coin Company, Commerce, Texas.

**TEN** different foreign coins, 15c; 19 from warring nations, 25c. J. Drows, P. O. Box, 185, Chicago, Ill.

**10 FOREIGN** coins, 15c; 10 from Warring Nations, 20c; 5 old bills, 15c; 200 different stamps, 15c. Burgess Co., 322-B, Beacon, Toledo, Ohio.

**COINS**, notes, stamps and curios exchanged for United Profit Sharing Coupons. Send stamp for book. Coin Exchange, New Rochelle, N. Y.

**\$50.00 PAID** for Dollar 1873 8. Mint; \$2.09 for 1904 Dollar, proof; \$7.09 for 1833 quarter, no arrows, etc. Many valuable coins in circulation. Watch your change. Look up your old money; you may have or get coins of premium value. Don't let a valuable coin slip away from you. Get Posted. Send only 4c. Get our Large Illustrated Coin Circular. It may mean large profits to you. You certainly have nothing to lose. Send Now to Numismatic Bank, Dept. H, Fort Worth, Texas.

**\$4.25 EACH** Paid for U. S. Flying Eagle Cents dated 1856. We pay cash premiums on hundreds of Old Coins. Send ten cents at once for New Illustrated Coin Value Book 4x7. It may mean your fortune. Clarke & Co., Coin Dealers, Box 15, Le Roy, N. Y.

#### SAFETY BLADES SHARPENED

**SAFETY** Razor Blades Resharpener by our "New Process." Guaranteed better than new. 2c each. Each Blade Honed, Hair-tested, Sterilized and wrapped individually. Jones Keenedge Co., P. O. Box 1884, Boston, Mass.

**SAFETY** razors sharpened; two cents each. Guaranteed. Blade box free. Electro Strapping Co., 134 Shelby St., Detroit, Mich.

#### FOR THE HOME

**UNIQUE** utensil. Combination egg separator, egg beater and cream whip. Tin plated. Post paid 25 cents. T. A. Burke, 263 S. Pearl St., Galesburg, Ill.

**BEAUTIFUL** arts-crafts lamps—Anyone can make them out of paper, cardboard and wood. 16 designs. Inexpensive yet artistic. Complete book of instructions. Price, 50c postpaid. Popular Mechanics Book Dept., 6 N. Michigan Ave., Chicago.

**ARTISTIC** Lamps and Shades in metal and art glass easily made by the amateur craftsman from instructions given in our book of 18 designs ranging from ordinary reading lamps to pretentious chandeliers. Expense only slight. Price of book 50c postpaid. Popular Mechanics Book Dept., 6 N. Michigan Ave., Chicago.

#### INVALID FURNITURE

**ROLLING** Chairs. We make 70 styles. Carrying Chairs, Invalids' Lifts, Beds, Tables, Bed Trays, Back Rests, Commodes, etc. Catalog "B" illustrates—describes free. Send for it. Geo. F. Sargent Co., 284 Fourth Ave., New York.

#### MUSIC

**TALKING** Machine Records—Edison Standard, 3c; Blue Amberol, 25c; Victor, 15c. Also permanent Jewel needle. \$1. Jewel point attachment for Victrola or Grafonola to play Edison Disc Records, \$2. Send for our Record List. Wells Curiosity Shop, 29 S. 2nd St., Phila., Pa.

#### DIAMONDS, WATCHES AND JEWELRY

**GENUINE** Perfect Cut Diamonds, \$97.50 per carat! Direct from the importer to you. We eliminate middlemen's profits and thus save you 35%. Any selection shipped for free examination without obligating you to buy. Written Money-Back Contract with every diamond. In this we certify carat weight and value; allows full price in exchange any time; allows 99% cash refund any time within one year. Write for our big valuable Basch De Luxe Diamond Book free! Beautiful illustrations of thousands of articles of jewelry. Shows how to buy diamonds intelligently. Write to L. Basch & Co., Dept. H-2490, State and Quincy Streets, Chicago.

#### PIANOS AND MUSICAL INSTRUMENTS

**"CLEANNOTE** Pad" Improves play, lessens scratch, 25c. "Recordsare" lubricates and troubles life records, \$1. "Talkoll" (in tubes), perfect motor oil, 25c. "Talkolmer" insures correct speed, 10c. Circulars, Vox-Humana Talking Machine Co., Nantucket, Mass.

**FINE** Violins for quick sale. Low price. Easy payments. Sent on approval. Wilfred Munk, Watertown, N. Y.

#### BUSINESS SERVICE

**HOUSE** to House distributing of circulars, booklets, samples, etc., in any city or town in Mass. Special distributing to Stationery, Grocery, Jewelry, Drug, Hardware stores, or tradesmen of any occupation within a fifty-mile radius of Boston. Bay State Distributing Service, 121 Mt. Auburn St., Cambridge, Mass., Room 17.

**\$1 BRINGS** the correct answer to any engineering or scientific question, or money refunded. Thomas Mfg. Co., Dept. D, Rockaway, N. J.

**INCORPORATE** in South Dakota. Write us at capital. Western Charter Co., Pierre, South Dakota.

#### FORMULAS AND TRADE SECRETS

**HIGHGRADE** guaranteed formula for a washing compound, metal polish and furniture polish. Complete for 50c. M. Box 25, Surrey, N. B.

**150 FORMULAS** 25c. resilver mirrors, Tattoo remove. Renew Dry Batteries. Make Printing Cuts 20c each. All 50c prepaid. Ideal Book Shop, 3311-H, Belleplaine Ave., Chicago.

**CLEAN** wall paper, big money. I tell you how. Attorney, Formula Specialist, Bellingham, Wash.

#### GAMES AND ENTERTAINMENTS

**QUARTERBACK** is real Football for the home. It's all there is to Football, except the physical effort. Most wonderful game in years. Recommended by famous coaches. \$2 at your dealers or direct postpaid from Olympia Games Company, 126 S. Clinton St., Chicago, Ill.

**FREE—55** Valuable Formulas, Tricks, Illusions and Household Hints, together with interesting magazines for two issues. Sent absolutely free. Postcard will do. C. Steenburgh, Box 101, St. Mary's, Pa.

**BE** a handcuff king. We teach you. Escape from handcuffs, boxes, ropes, etc. Secrets of 29 sensational escapes \$1. Particulars free. The Magiera Co., Dept. A, Box 251, Detroit, Mich.

**FORD** joke books, containing 130 jokes on Ford auto, 27c, by mail. Box 64, Norwich, N. Y.

**MAGIC** Bargain Sheet Free. Catalog 2c. Fake Money, Our Buffalo Greenback, Roll 10c. Gilnovco, Morgan Park Chicago.

**FREE—Latest** Novelty Comic Felt Motto, Catchy sayings. Send 10c for postage, etc. Catalogue Free. M. Zoellner, 412-B, 105 W. Monroe St., Chicago.

**ESCAPES**. Everything in escapes. Write for particulars. James Flynn, Leominster, Mass.

**NEW** Pocket Trick, including Professional Catalog, 6c. Magic Supply, 219 West 38th Street, New York.

**MAGIC** Catalogue, 100 pages, greatest on earth, ten cents. Learn magic at home. We teach you to do these tricks as good as the great professionals—escape acts, rope ties, mind reading, handcuff secrets. Satisfaction guaranteed. Chicago Magic Co., Dept. B, 72 W. Adams St., Chicago, Ill.

#### MAILING LISTS

**TWENTY** thousand classified names, 99% correct. Just collected; never sold before, 100, 50c; 250, \$1.00; 500, \$1.50; 1,000, \$2.50. Brehman, 538 Minor Ave., San Jose, California.

**FREE** to business men, copy of our comprehensive "Silent Salesman." Contains over 2,400 different classifications of Mailing lists with number and price of each list, and information every business man needs. Accept this free offer. Trade Circular Addressing Co., G 164½ W. Adams, Chicago.

#### TYPEWRITERS AND SUPPLIES

**A FEW** Olivets, Remingtons—like new, \$25.00 shipped prepaid. Don't buy junk. These in our office since May only. White's Chewing Gum, 183 N. Dearborn St., Chicago.

**TYPEWRITERS**, all makes, factory-rebuilt by famous "Young Process." Look like new, wear like new, guaranteed like new. Our big business insures "Square Deal" and permits lowest cash prices—\$10 and up. Also, machines rented—or sold on time. No matter what your needs are, we can beat some you. Write and see—now. Young Typewriter Company, Dept. 163, Chicago.

**TYPEWRITER** Ribbons re-linked, "Guaranteed." Mail your ribbons and half price they cost you now, with return postage to J. Humes, 4235 Cook, St. Louis, Mo.

**PRICES** on all Slightly Used Late-Model Typewriters cut from \$100 to from \$30 to \$50 cash; mail course free; for price list and "monthly payment plan," address Carnegie College Co., Rogers, Ohio.

**LARGEST** Stock of Typewriters in America—All makes: Underwoods, Olivets, Remingtons, etc., one-fourth to one-half manufacturers' prices, \$15 up, rented anywhere, applying rent on price; free trial; installment payments if desired. Write for catalogue L. Typewriter Emporium (Estab. 1892), 24-36 West Lake Street, Chicago, Illinois.

**GOOD**, serviceable typewriters \$1.50 and up. Post card brings list. First class ribbons any machine, 25c. Hub Typewriter Co., 298 Devonshire St., Boston.

#### PRINTING, ENGRAVING AND MULTIGRAPHING

**HAMMERMILL** Bond letterheads and envelopes, 250 of each, \$2. 1,000 Bristol business cards, \$1.35. Billheads, circulars and typewritten letters at lowest prices. Work guaranteed. Jones Press, P. O. Box 1984, Boston, Mass.

**SIMPLIFIED** STATIONERY—Requires no envelope. A new idea in business correspondence that will save you money and increase sales. Other new sizes, \$2.25 1,000. Catalogue free. Ryder-Kallenbaugh Company, Barnerville, New York.

**50 WEDDING** Announcements, printed \$4, engraved \$6.50. Fountain pens repaired. Nichol, 1916 Chestnut, Philadelphia.

**250 EACH—Bond** Letterheads and Envelopes, \$1.30; 100, 80c. Hoyt Brothers, Pittsfield, N. H.

**\$1 BUYS** 100 each 8½x11 and 5½x8½ Bond letterheads and No. 6½ envelopes, nicely printed. Prepaid. Money-back guarantee. Samples? Pamco Press, 402N Seventh St., St. Louis.

**MULTIGRAPH** Letters, Letterheads—1,000 complete, \$3. Letters purple, heads black. Samples for stamp. Perfection Letter Company, Muncie, Indiana.

**FREE** Portfolio low-priced letterheads. McCleary Printing Company, Box G, Stromsburg, Neb.

**HAMMERMILL** Bond Letterheads and Envelopes, 100 of each, and 100 white wove return envelopes, \$1.00 postpaid. Samples Free. Toledo Press, Box 184C, Toledo, Ohio.

**1,000 LETTERHEADS**, \$1. P. M. Orvis, 309 E. 22nd St., New York.

**PREPAID**, 500 6½ XX White Envelopes \$1.00. Acme Supply Co., Covington, Ky.

**ADVERTISEMENTS**—Here's your opportunity. 25 word classified ad inserted in "Cartoons Magazine" for 50c; one inch display ad \$1.25. 20,000 copies guaranteed. Send in your ad for the next issue. Cartoons Classified Dept., 78 E. Madison St., Chicago.

**EMBOSSED** Letterheads—Envelopes, price of common printing. Samples. Turner & Dunlap, Wilkes-Barre, Pa.

**GUMMED Labels**—3,600 \$1.00. 46-pg. Catalogue, 2c. MacFarrar, 1235 Arch, Philadelphia, Pennsylvania.

**PRINTING**—500 either notecards, envelopes, statements, cards, \$1; 1,000, \$1.50; 1,600 linen finish letterheads or envelopes, \$2.50; 1,000 typewriter letters, \$2. Samples. Model Company, Manchester, Iowa.

1,600 BOND Letterheads, 8 1/2 x 11, \$1.00. Samples free. Burton Bros., E. Louisville, Ky.

50 CALLING Cards, 10c. 25 Envelopes, 10c. F. Shepard, Rome, N. Y.

250 BOND Letterheads and 250 Envelopes, printed, \$1.65, prepaid. Samples. W. Kinzier, Box 298, Brooklyn, N. Y.

1,600 BOND Letterheads, Envelopes, Cards, Circulars, \$1.75 up. Perfect imitation typewritten letters, \$3.50 complete. Quick Delivery. Get Samples. Franklin Press, Waukegan, Ill.

**PRINTING Outfits**—Presses, type, supplies, type novelties. Send stamp for catalogue. Model Press, York, Penna.

**PRINTING Presses, Type and Supplies.** Big bargain sheet for stamp. Popular Barcard, Richland, Pa.

**GOOD Printing at low prices.** 1,600 good letterheads, envelopes, cards, billheads, labels, circulars, \$2.50. Samples free. Catalogues, booklets, and circulars our specialty. Ernest L. Fantus Co., 523 S. Dearborn St., Chicago.

### PATENT ATTORNEYS

**PATENTS**—100 mechanical movements, 50 perpetual motions. Free. Send 10 cents postage for mailing. F. G. Dieterich & Co., 60 Ouray Bldg., Washington, D. C.

**INVENTORS** will receive prompt attention and advice from Edwin S. Clarkson, Patent Lawyer, 505 Victor Bldg., Washington, D. C. Established 1890.

**PATENT Your Invention.** It may make your fortune. I secure valuable protective patents. Full information on request. Lester Sargent, 769 9th St., Wash., D. C.

**PATENTS**—Edward Bruce Moore, Former Commissioner of Patents—Patents, Trade-marks and Copyrights. Sole offices Barrister Bldg., Washington, D. C. See advertisement page 118, this issue.

**PATENTS**, one of the best books printed sent free. Illustrated. Edgar B. McBeth, 154 8th St., Washington, D. C.

**PATENT your invention** without delay. It may bring riches. No attorney's fee until patent allowed. Request particulars. Jaynes & Jaynes, 635 Kellogg, Washington, D. C.

**PATENT application** fully prepared, \$10. Why pay more? Particulars free. Patent News, Dept. 112, Washington, D. C.

"**PATENTS and Patent Possibilities**" is a 72-page treatise which tells all about patents, what to invent and where to sell it. It gives honest advice to inventors, and is full of valuable and interesting information. Write for it today! It is Free. H. S. Hill, 965 McClachlen Bldg., Washington, D. C.

**PATENT** what you invent. It may be valuable. Write me. No attorney's fee until patent is allowed. Estab. 1882. "Inventor's Guide" Free. Franklin H. Hough, 522 Loan & Trust Bldg., Washington, D. C.

**PATENTS secured or fee returned.** Send sketch for free search. Latest and most complete patent book ever published for free distribution. George P. Kimmel, attorney, 212 Barrister Bldg., Washington, D. C.

**PATENTABLE Ideas Wanted**—Send for 3 free books. R. B. Owen, 30 Owen Bldg., Wash., D. C.

**THE Patents** is free. An education in obtaining patents. Established 1863. Anderson & Son, Attorneys, 707 7th St., Washington, D. C.

**PATENTS** of highest order secured for modest fees, information free. Burton T. Davis, Attorney, Washington, D. C.

**PATENTS Secured**—Take advantage of my personal experience; send sketch or model. Get my free book containing 200 mechanical movements. W. N. Roach, Jr., 950 McGill Bldg., Washington, D. C.

**PATENTS**—Trade-Marks. Send for my free book, "How to Get Them." It's full of information you should know. Joshua R. H. Poets, 8 Dearborn St., Chicago; 929 Chestnut St., Philadelphia; 895 G. St., Washington.

**PATENTS explained** in my free books, telling what you should know—what to invent—what not to invent—how to sell your patent, etc. Write today. H. L. Woodward, 892 G St., Washington, D. C.

**PROTECTIVE patents** procured promptly. 112 page blue book on patents sent on request. Trade-marks registered. Robb & Robb, 211-215 Southern Bldg., Washington, D. C.

**PATENTS**—Herbert Jenner, patent attorney and mechanical expert, 406 F St., Washington, D. C. I report free of charge if a patent can be had and its exact cost. Send for circular.

**WANTED**—New Ideas. Write for List of Inventions Wanted, \$1,000,000 in prizes offered for inventions. Our Four Books sent free upon request. Victor J. Evans & Co., 166 Ninth St., Washington, D. C.

**PATENT your invention.** \$10,000 offered for inventions wanted. Booklet and opinion free. Milo B. Stevens & Co., established 1864, 485 F St., Washington; 333 Mount-nock Block, Chicago.

**PATENTS**—Send sketch for free search and report. Books on patents and book of reference letters sent free. John S. Duffie & Co., 610 F St., Washington, D. C.

**PATENTS** build fortunes for you. Our free booklets tell how; what to invent, how to choose an attorney. Write today. D. Swift, 317 Seventh St., Washington, D. C. Established 1889.

**PATENTS That Pay.** Proof given. Two wonderful guide books free. E. E. Vrooman & Co., 871 F St., Washington, D. C.

**C. L. PARKER**, Ex-member Examining Corps, Patent Office, Patent Attorney, 919 G St., Washington, D. C. Inventor's handbook, "Protecting, Exploiting and Selling Inventions," sent free upon request.

**PATENTS** that protect and pay. Advice and books free. Rates reasonable—highest references; best results. Watson E. Coleman, Patent Lawyer, 624 F St., N. W., Washington, D. C.

No Attorney fees until patent allowed. Send sketch for free report. Books free. Frank Fuller, Washington, D. C.

### TRADE MARKS, COPYRIGHTS, ETC.

**TRADEMARKS** registered; all countries; protect your trade name or symbol, it is your business reputation; terms low; literature free. Sanders, 7 Webster Building, Chicago, Ill.

**COPYRIGHTS** procured; all countries; protect your literary, dramatic, musical, etc., works; terms low. Sanders, 7 Webster Building, Chicago, Ill.

### FOR INVENTORS

**WANTED**—Models, Tools and Light Special Machinery to build. We have the Experienced Mechanics and Facilities to build perfect Working Models. Accurate, reliable and confidential work of every description. Regal Model & Tool Works, Chicago.

We desire to purchase meritorious patents or ideas for household or office specialties, either for cash or a royalty basis. Marshall Dobbins & Company, 1422 Marquette Bldg., Chicago, Ill.

**DRAWINGS** made for inventors. Consulting Engineer, PM-3240 Seminary Ave., Chicago.

**SELL your patent** through the Patent Publicity Company, Browning Building, New York City. Particulars free.

**HOW to Protect Inventions Before Patent** Without Cost, and Patent News 1 year, \$1. Patent News, Dept. 111, Washington, D. C.

**INVENTIONS commercialized** on cash and royalty basis. Write Adam Fisher Mfg. Co., D-61, St. Louis, Mo.

\$6,000 FOR an idea—chance for inventors. Inventors' Advocate, Dept. 113, Washington, D. C.

"**INVENTORS**": Let us sell your Patent. We are Manufacturers' Agents. Send your specifications for contracts, etc. Atlantic Supply Company, Long Branch, N. J.

**PATENT specification** and drawing prepared \$10.00. Free particulars. Seaver Company, 1109 New York Avenue, Washington.

**MECHANICAL engineer** expert on manufacturing methods and designer of special machinery, will develop your ideas and inventions into commercially practical forms. Albert S. Kux, 185 W. Monroe St., Chicago.

**PATENTABLE Ideas Wanted**—Send for 3 free books. R. B. Owen, 30 Owen Bldg., Wash., D. C.

**HAVE You an Idea?** If so, you should protect it by a patent. Send us a model or sketch for free opinion as to patentability. Write for our Four Books sent free to any address. Victor J. Evans & Co., 157 Ninth St., Washington, D. C.

**INVENTORS!** Send 4c postage for Hand-some Book on Patents and List of Inventions Wanted. Sanders, 7 Webster Building, Chicago.

**PATENTS, Trade-Marks and Copyrights.** Our handbook on patents will be sent free on request. All patents secured through us are described without cost to the patentee in the Scientific American. Mann & Co., Patent Attorneys, 673 Woolworth Bldg., N. Y. Washington, D. C., office, 425 F St.

**WIRE goods** all kinds made to order. Cooley, 553 W. Monroe, Chicago.

**PATENTS and Patentable Ideas** sold on commission. Best location and facilities. Absolutely reliable. Fuller Company, 560 Fifth Ave., New York.

**INVENTORS:** My patent made a fortune. Particulars free. Let me sell yours. Eugene Pearl, 323 Union Square, New York.

**HAVE you a Patent to sell?** You'll be interested in my proposition. Write now for free particulars. F. W. Johnson, 6 N. Michigan Ave., Chicago.

**WANTED**—An Idea! Who can think of some simple thing to patent? Protect your ideas; they may bring you wealth. Write for "Needed Inventions" and "How to Get Your Patent and Your Money." Randolph & Co., Patent Attorneys, 620 F St., Washington, D. C.

**PATENTS** without advance attorney's fees. Send sketch for free report. Books free. Frank Fuller, Washington, D. C.

**BEFORE applying for patent** get complete list of patents already issued on your subject. Profit by other inventors' ideas and improve your own. Prevent infringement; save time and expense. Complete list, \$5. F. A. Vitkus, 30 E. 23rd St., New York.

### PATENTS FOR SALE

**BEST yet;** nothing like it on market. Every lady wants it. Great profit. Fortune selling this by mail. Will sell copyright or royalty. Reason other business. Free particulars. Clark Downey, West Point, Ga.

**AEROPLANE Device;** lifts machine directly upward, eliminating long forward movement. Has other practical advantages. Investigate. Harrell & Daily, 41 Michigan St., Argos, Ind.

**FOR Sale**—Patent No. 1,117,932, an improvement in putty production. Can be made very cheaply. Address, William W. Watson, Weir, Miss.

**MOTORCYCLE Frame**—Semi-elliptic springs. Send for drawings and patent claim now; first check for five thousand takes it. A. S. Terhaar, 1918 Julian Ave., San Diego, Calif.

**PATENT for Sale**—Cutlery cleaner; will retail for 10c. Write for circulars. John Helstrom, Sea Bright, N. J.

**OUTRIGHT or royalty,** Household Article of great necessity. Wm. Monahan, 1161 6th St., North, Minneapolis, Minn.

**5 PLUMBING Patents,** cash or royalty. E. Gehrke, Lincoln, Neb.

**FOR Sale**—My invention—wire splicer and mender. Write C. A. Baldwinbridge, Leander, Texas.

**FOR Sale**—U. S. Patent No. 1,118,826, Aerial Toy. H. C. Tanabe, Marysville, Cal. No. 133225, NON-REFILLABLE bottle. Inquire E. Mats, Universal City, Calif.

**FOR Sale**—Two Patents on Pole and Stack climbing. Address Charles Stoddard, Kelsin, Arizona.

**PATENT for Sale;** trade for land. A. Boughton, Lawrence, Kans.

**I HAVE** now Gas Saving, quick heating and cooking devices; saves 1/3 of fuel, I need honorable men to market same. John D. Betts, 2559 Washington Blvd., Chicago, Ill.

**COMBINATION Cash Register and Adding Machine.** Standard, dependable, simple, low cost. Combination Bag Lock, also Trunk Lock; dependable, opened quickly without light. C. E. Neff, Warsaw, Indiana.

**FOR Sale**—Patent on device enabling automobiles, trucks, etc., to pull themselves from mire or hole with own power. C. J. Chloupek, Green Bay, Wis.

**AUTOMOBILE Electro-indicator,** automatic, gasoline, oil, water, temperature; one dial. N. J. Nees, M. D., Sioux Falls, S. D.

**CANADIAN Patent Rights** for sale outright. Automobile accessory. New. Stamped from light sheet metal. Geo. Bennett, Seventeen Spruceville, Hamilton, Ont.

**DERRICK.** Always ready for use. Quickly prepared at any emergency. Model ready for examination. Steven Kaakota, 1440 Lyons Ave., Lansing, Mich.

**NON-REFILLABLE Bottle.** Very practical. Will bear investigation. Particulars free. A. L. Beauchaine, 35 Ontario St., Toledo, Ohio.

**PATENT** Buyers are invited to address our sales department for information on any class of Patents they wish to purchase or lease on a royalty. We have secured a number of valuable patents in all lines of invention. Mail Order, Department Store and Household Novelties a specialty. Victor J. Evans & Co., 169 Ninth St., Washington, D. C.

#### MODELS AND MODEL SUPPLIES

**MODEL** Making. Inventions developed. Write for estimate. Stearns, Paxton, Illinois.

**MODELS**—Experimental work, dies, metal specialties and castings. Ohio Valley Specialty Company, 2129 Barnard St., Cincinnati, Ohio.

We develop and perfect working models for inventors. Light machinery building, scientific experiment work. Dies made and stamping done. Modern Die & Tool Company, 79 Ship St., Providence, R. I.

**MODELS**, dies, and manufacturing for inventors, by builders of "Tools That Work." La Croix Tool Co., 214 N. 21st St., St. Louis, Mo.

**INVENTORS:** We manufacture metal articles of all kinds to order. Also, special machinery, tools and dies, punchings, lathes and screw machine work, metal springings, castings, plating, wood and metal patterns, etc. Send sample for estimate and expert advice, free. The Eagle Mfg. Co., Dept. B., Cincinnati, O.

**MODELS** made for inventors; general machine work; designing and perfecting; developing automatic devices and machinery. In a position to do all kinds of light tool and machine work. Prices reasonable; estimates cheerfully given. Ideal Machine Works, 62 Ann Street, New York City.

We make working models for inventors; also dies and stamping of specialties, and carry a complete stock of brass gears and model supplies. Send for catalogue. The Pierce Model Works, 3405 Pierce Ave., Chicago, Ill.

**SPECIAL** Electrical and Mechanical devices built to order. Models, Tools, Dies. Benj. Levi, 357 West Broadway, N. Y. City.

#### MANUFACTURING

**MANUFACTURING:** Everything in Metal. Lyons Machine Works, Lyons, Iowa.

**WIRE**, wire goods and springs. Thomas Hamilton, 4588 N. Broad St., Phila., Pa.

**WIRE** Goods, all kinds, made to order. Cooley Mfg. Co., 533 W. Monroe St., Chicago.

#### REAL ESTATE AND FARM LANDS

**CALIFORNIA**—Get Your Railway Fare Applied. Going to the Expositions? See "Our Money-Making Homes in Orange Land." Round Trip Refunded if you buy. No extra expense see orange groves. Write for information. Be our agent. Sierra Vista Ranch Company, 1109 First National Bank Building, San Francisco.

**SOUTH** Dakota Estate to be sold. The Cheapest Proven, Corn and Alfalfa Lands in United States. For sale by J. E. Stanley, Oacoma, So. Dak.

**BEAUTIFUL** summer resort lot valued at \$50, will sell for \$30. An ideal spot, fine surroundings. B. H. Welch, Racine, Wis.

**PROFITABLE** little farms in valley of Virginia, 5 and 10 acre tracts, \$250 and up. Good fruit and farming country. Send for literature now. F. La Baume, Agri. Agt., N. & W. Ry., 253 Arcade Bldg., Roanoke, Va.

**8 ACRES** (4 cultivable) in mountains; log house furnished; spring; fences; chicken house; mineral rights; raise oats, hay, vegetables, stock; near Cripple Creek, \$408.00. Harrison, Goldfield, Colorado.

**SELL** your property quickly for cash, no matter where located. Don't pay big commissions. Particulars free. Real Estate Salesman Co., Desk B, Lincoln, Neb.

**CATTLE** Ranches from \$1,000 up. Free homesteads. Big Ranch Catalogue. Ranch Exchange, Douglas, Wyo.

**VISIT** San Joaquin Valley, California, this year. See the Expositions, too!!! Low fares for great World's Expositions at San Francisco-San Diego enable you to see wondrously fertile San Joaquin Valley as well, via "Santa Fe." Look 1-to this Promised Land of the Homeseeker now. Combine education, enjoyment and exploration. For free literature write C. L. Seagraves, Gen. Colonization Agent, AT&P Ry., 1851 Ry. Exchange, Chicago.

**FARMS** for sale or exchange anywhere in the U. S. or Canada, direct from the owners. State where you want to locate. Information free. American Investment Association, 57 Palace Bldg., Minneapolis, Minn.

**MICHIGAN** Fruit Land Bargain on easy terms, 40 or 80 acres in Lake County, Mich., at only \$10 per acre for quick sale. Good for Fruit, Kye, Clover, Alfalfa or Vegetables. Edgar W. Herbst, 39 S. La Salle St., Chicago, Ill.

**MANATEE** County, Florida. Choice citrus and truck land for sale in the Manatee River section. Ideal location, water fronts. Send for copy of soil survey and views. Manatee River Land Company, 101 1/2 Franklin St., Tampa, Florida.

**FOR** Sale—Southwest Georgia Farms. Wonderfully fertile. Ten acres up. Ten dollars up. Terms. Farmers Land Loan & Title Co., Albany Ga.

#### GINSENG

**GINSENG** and Golden Seal roots and seed for planting. Ginseng Culture, 10c. Golden Seal Booklet, 10c. W. N. Long, Florence, Ky.

**1,400,000** GINSENG seed at a sacrifice. Send for price list. Plymouth Ginseng Gardens, Plymouth, Wis.

**GINSENG** seed and plants, best quality, furnished for the least money. Send for free price list and instructions. Daniel Wyss, New Philadelphia, Ohio.

**MANY** common weeds of great value. Send Thirty Cents for Treatise on Roots, Herbs and Barks. Collecting, Curing, Selling, and best American markets. L. J. Brown & Co., Muskegon, Mich.

**GINSENG** seeds, \$1 thousand; planting instructions free. Specialty Farm, Rockford, Minn.

#### DOGS, BIRDS, POULTRY, PETS

**THE** Southern Farm Coonhound Kennels, Selmer, Tennessee. Largest institution of its kind in the world and home of the highest class coonhounds and combination night hunting dogs; ship anywhere on free trial. Beautiful, profusely illustrated catalog, 10c.

**MALE** Fox Terrier Pups, \$10. Walter Macy, Springfield, S. Dak.

**RAISE** Belgian Hares for us. We furnish stock and pay you \$2.00 each. Also Carles, Skunk, Mink, Squabs, Frogs, etc. Send dime for booklet and contract. Particulars free. The Belgian Hare, Box 2, Holmes Park, Mo.

**FOR** Sale—Pedigreed Boston Terriers. Prize-winning dog at stud. State your wants. Daltax Kennels, Dallas, Texas.

**PURE** White Coillies, registered, best of white breeding. Also sables and tricolors. Prices reasonable. Thos. Shover, Mount-Carlo, Iowa.

#### MISCELLANEOUS

**NEW** modern trade-secrets, reliable formulas of latest specialties in all lines. Solidified Alcohol, Save-ice Cloths, Trust Maple Flavor, Raisin Wine, Orangeade, Barbo-Compound, Wolcott's Pain Paint, Brick Massage Cream, and 1,000 other valuable formulas of every description. Strictly reliable; all for \$1.25 postpaid. My latest formula lists and information regarding any formula or preparation for stamp. H. Liscomb Miller, Manufacturer's Chemist, Tampa, Florida.

**MEL** Soldering Flux. Solders all solderable metals. Invaluable to Machinists, Electricians, Plumbers. Price, 50c. Agents wanted. F. G. Hodges & Co., 145 Centre Ave., New Rochelle, N. Y.

**STATIONERY**—Embossed by hand, initials, monograms or full name and address; circular stamp. R. W. Shouse, Box 416, Findlay, Ohio.

**MONEY** in minerals! Many common minerals have market value. List, 10c. Minerals identified, 25c. Mineralogist, 620 Joplin St., Joplin, Mo.

**HOW** to open any lock pin-tumbler cylinder without keys, picks or tools. Wonderful secret. Copyrighted instructions. \$1. R. L. Dodd, Rome, Ga.

**GRANDFATHER'S** Clock Works, \$5. Slightly shop-worn, quantity limited, others with chimes, all prices; also several nice Grandfather's Clock cases, exceptional bargains. Clock Company, 1673 Ruffner St., Philadelphia, Pa.

**BIG** Mail Free. Your name listed once, 35,000 circulation and magazine one year 10c. Digest, Grand Rapids, Mich.

**SPEND** summer gathering insects, butterflies, I pay big prices. Many worth \$5.00, \$10.00. All salable. Men, Women. Get instructions, price-list, pictures, descriptions of valuable ones. Send stamp. Sinclair, Box 214, D6, Los Angeles, Cal.

**MANSFIELD'S** Patent Automatic Electric Water Finders. For Accurately Arriving at Position and Quantity of Water in Underground Streams or Springs. Send for Particulars and Testimonials. Mansfield Company, Electrical Engineers, New Brighton, England.

**HOW** to make Printing Cuts cheaply, 150 selected formulas, 20c. Ideal Book Shop, 3311-H, Belleplaine Ave., Chicago.

**CUTS.** Anybody can make them. Instructions, 25c. A. S. Quinn, Girard, Pa.

**\$2.50** POCKET Adder. Send for circular. Bassett, 5921-G, Indiana Ave., Chicago.

**ATTENTION, Hand-Crafters!** I will buy useful and ornamental hand-made articles. Must be unique in design or use and moderately priced. Write details to Progress Sales Co., Box 1353, Pittsburgh, Pa.

**CUTS** anybody can make. Simple Etching Process, \$1. Particulars, specimens, for stamp. M. Day, Windfall, Ind.

# \$2,500<sup>00</sup> a Year!

**HAVE** you the training that is necessary to fill a \$2,500 job? Are your services in demand? Salaries are paid to the men who know. If you are ambitious to get into the big money class, send the coupon and find out about the opportunities in our profession. We need ambitious men and will give you the proper training right in your own home. Don't miss this wonderful offer. Send the free coupon today—do it right now.

## Be a Signal Engineer

Be the man who gets \$2,500 a year. Complete Signal Engineering is one of the most fascinating of professions. As a railroad man you travel from coast to coast. You are the man who tells the other fellow what to do. You can be the man who holds the big job.

## More Men Are Needed

Railroads are constantly looking for competent Signal Engineers. Thousands and thousands of miles of track are now being equipped with automatic signals. Many new positions will be open. Men are needed.

## Two Big Outfits FREE

We give each of our students a Complete Signal Engineer's outfit and a draftsman's outfit—absolutely free.

Send the Coupon for Big New Book Put your name and address on the coupon or a letter or a post card and get the big new Signal book absolutely free. No obligations. The book is free. Write today—Now.

Department of Signaling, 1810 Wilson Ave., Room C119, Greenwood Sta., Chicago, Ill.

Dept. of Signaling  
1810 Wilson Ave.  
Room C119  
Greenwood Sta.  
Chicago

Gentlemen: Please send me absolutely free and prepaid your big new Signal book. It is distinctly understood that I assume no obligations of any kind.

Name.....

Address.....



# Men Wanted!

**\$75 to \$300 Or More Per Month**

As Proprietor or Manager of Garage, Salesman, Demonstrator, Driver, Factory Tester, Ignition

and Starter Expert, Repair Man or Tractor Engineer!

With two million automobiles, trucks and "jitney" busses in service at this time and the number increasing at the rate of hundreds of thousands every year, it is becoming a problem to supply enough capable men to handle the thousands of positions that are being created in all departments of this great industry.

The Automobile Training School has to its credit the making of more than 6,500 automobile experts. We have one of the largest and most completely equipped institutions of the kind in the world. Our staff of instructors is made up of high salaried experts who have secured their training from years of practical experience in all departments of the automobile industry.

Our training system has been perfected to such an extent that in as little as six weeks' time you can complete our big combination course and be ready to step into a good position, or to take charge of a business of your own within six weeks.

**Be An Automobile Expert In Six Weeks!**

**No Books—Free Tools—All Practical Work**

There is no time limit to your scholarship. You can complete the work in six weeks or you can take more time if you desire. More than six thousand five hundred men have already graduated from this school and have gone out into the automobile world, and have taken up high salaried positions or have become established in very profitable businesses of their own. There is, no doubt, an opening right now in your locality for an automobile agency, an up-to-date garage or repair shop, and if you decide to establish an independent business you can depend upon us to help you and cooperate with you in every way.

**Write Today For \$50 Scholarship and 60-page Book Both Free!**

As a very special inducement to enroll the full capacity of our school without delay, we are including with our regular automobile training, absolutely free of any extra cost, our big, new combination \$50.00 Course in Tractor and Stationary Gas Engineering and Electric Starting and Lighting. There will only be a limited number of these free scholarships issued, and if you want to be sure of getting in on this special offer, we would advise that you clip the coupon which appears below and mail to us at once.

We will also mail you, free and postpaid, a copy of our big, 60-page book, "How to Make Money in The Automobile Business"—filled with scores of illustrations of our school, scores of letters from successful graduates, endorsements from automobile manufacturers, and providing in all one of the most interesting business stories ever written. This book and the \$50.00 scholarship are yours for the asking. Sign your name and address on the accompanying coupon and mail it to us today.

HENRY J. RAHE, President

**AUTOMOBILE TRAINING SCHOOL**  
1099 Locust St. KANSAS CITY, MO.

**FREE SCHOLARSHIP AND BOOK COUPON.**

Henry J. Rahe, Pres., AUTOMOBILE TRAINING SCHOOL, 1099 Locust St., Kansas City, Mo. Send me, free and postpaid, your big, 60-page illustrated book, also the free \$50.00 Scholarship Certificate covering Course in Tractor and Stationary Gas Engineering and Electric Starting and Lighting, as offered in your advertisement. This request does not obligate me in any way.

Name..... R. F. D.....  
Postoffice..... County..... State.....



**FREE!**  
Complete New Course in  
Tractor, Stationary, Gas, Engineering and Power Farming



Please Mention Popular Mechanics

# VALPARAISO UNIVERSITY

Accredited Founded 1873  
VALPARAISO, INDIANA



Group of Valparaiso University Buildings, including the Departments of Medicine and Dentistry, Located in Chicago

One of the Largest Institutions of Learning in the United States

Thorough Instruction at Lowest Expense

## Valparaiso University

was founded with the idea of giving to every person, whether rich or poor, a chance to obtain a thorough practical education at an expense within his reach. That it is performing this mission is indicated by the numbers who avail themselves of the advantages offered.

**This Institution** was founded with 3 departments, 4 instructors, and an annual enrollment of 210 different students. Now there are 21 departments, 218 instructors and an annual enrollment of more than 5000 different students.

The reason for this growth is in the fact that this University constantly increases its facilities, strengthens its courses of study, and offers additional advantages without making the expense to the student any greater. The University is well equipped with buildings, libraries and laboratories for giving instruction in the following:

**Departments** Preparatory, High School, Primary Methods, Kindergarten Methods, Commerce, Phonography and Typewriting, Review for Teachers, Education, Arts and Sciences, Engineering, Architecture, Manual Training, Agriculture, Expression and Public Speaking, Music, Fine Art, Domestic Science, Pharmacy, Law, Medicine and Dentistry.

While the expense in all the Departments is exceedingly low, it has not been made at the sacrifice of a high grade of instruction, but by applying business principles to

### "The Cost of Living"

so that the most satisfactory accommodations for board and room may be had at from \$26 to \$41 per quarter of twelve weeks. Tuition \$20.00 per quarter, or \$65.00 if paid in advance, for a year of forty-eight weeks. If the entire tuition is paid in advance for the year it includes all the departments, excepting Medical, Dental and private lessons in Music.

The total expense of board, tuition and furnished room for the regular school year (thirty-six weeks), need not exceed \$153; or for forty-eight weeks \$169.

For Free Catalog Address

**HENRY B. BROWN, President** or  
**OLIVER P. KINSEY, Vice-President**  
Box 7, University Hall, Valparaiso, Ind.  
The Forty-Third Year Will Open Sept. 21, 1915

Please Mention Popular Mechanics

## ARMOUR Institute of Technology

CHICAGO, ILL.



Main Building

Offers complete courses in Mechanical, Electrical, Civil, Chemical, Fire Protection Engineering, Architecture, and Industrial Arts. All courses four years in length, and lead to the degree of Bachelor of Science. Fully Equipped Shops and Laboratories. 21st annual day session begins September 7, 1915. Bulletins sent on request. **Armour Institute, Box 36, 33rd & Federal Sts., Chicago, Illinois**

## Get into Electrical Work Right

The big electrical industries want trained men and pay big wages. Fit yourself—at our school—to fill the place with a future. We teach all branches of Electrical Science and Engineering by practical methods under actual working conditions. Individual instruction by electrical masters. You begin where you are able to grasp the subject and advance as rapidly as you can.

This is the practical school whose students do actual electrical work and designing—the only one of its kind in the U. S.—highly endorsed by leading electrical employers. It's the school you should attend because it fits you to step right out fully qualified to successfully hold down a responsible position at good pay. Write today for Free Illustrated Catalog.

Fall Term Opens September 1st

School of Engineering of Milwaukee, 202 State Bldg., Milwaukee, Wis.

**ELECTRICAL ENGINEERING** men with training are always in demand. Having trained over 2000 young men in the past 22 years in the fundamentals of Applied Electricity, **The Bliss Electrical School**, with its well-equipped shops and laboratories, is peculiarly well qualified to give a condensed course in Electrical

## ENGINEERING



including Mathematics, Steam and Gas Engines, Mechanical Drawing, Shop Work, and Theoretical and Practical Electricity, in all branches. Students construct dynamo, install wiring and test efficiency of electrical machinery. Course, with diploma, complete

## IN ONE YEAR

For practical young men with limited time. 23rd year opens Sept. 22nd. Catalogue on request. 105 Takoma Ave., Washington, D. C.

## VILLANOVA

One of the foremost Institutes of Technology in the country. Civil, Electrical and Mechanical Courses. Classical and Commercial Courses. For catalog address **REV. EDWARD G. DOHAN, S. T. L., O. S. A., Pres., Box 55, Villanova, Pa.**

## COLLEGE

## THE OHIO MECHANICAL INSTITUTE, CINCINNATI, O.

Institute of Applied Arts

Mechanics, Electricity, Industrial Design, Domestic Science, Lithography, Special Applied Art Trades. Catalogue on Application. **JOHN L. SHEARER, President.**

## EARN TELEGRAPH

More and Wireless—E. R. Accounting (Station Agency) taught. Splendid opportunities. Positions secured. Marconi Co. takes our wireless graduates. We own and exclusively occupy two large modern buildings equipped with E. R. and Western Union wires and complete 25,000 Marconi Wireless Station. Largest School—established 40 years. Investment \$25,000. Endorsed by Railroad, Marconi and Western Union Officials. Expert, practical teachers. Low living expenses; easily earned if desired. Tuition low. Easy payments. Correspondence courses also. Catalogs Free.

Dodge's Telegraph, Rr. & Wireless Institute  
8th Street, Valparaiso, Ind.



# The Navy as a Career

**T**HE U. S. NAVY is a vast training school, in which many thousand young men receive valuable instruction each year, and are given a start in life. They are accepted without previous experience, provided they are American citizens of good character, and are between 17 and 25 years of age. Men with trades may be enlisted if not over 30 years old.

THE NAVY provides every recruit with a complete uniform outfit free; pays his transportation, meals (and if night ride, berth in sleeper) to the training station, gives him a six months' course of practical instruction, and if he passes the requirements, he is advanced in pay and rating before he is assigned to sea duty. His pay begins at enlistment, and continues throughout his term, whether sick or well. Promotion comes to those who earn it. He has no board bill to pay, and his wages are practically clear. He can deposit his savings with the Government at 4% interest. Pay increases with each reenlistment. Write for full particulars regarding the Navy's liberal offer.

## **Of Special Interest to Honorably Discharged Men:**

A recent act of Congress provides substantial inducements for men who have had creditable service in the U. S. Navy, to reenlist. It is worth your while to inquire. Full information will be sent on request.

ADDRESS BOX 66

## **BUREAU OF NAVIGATION**

NAVY DEPARTMENT

WASHINGTON, D. C.

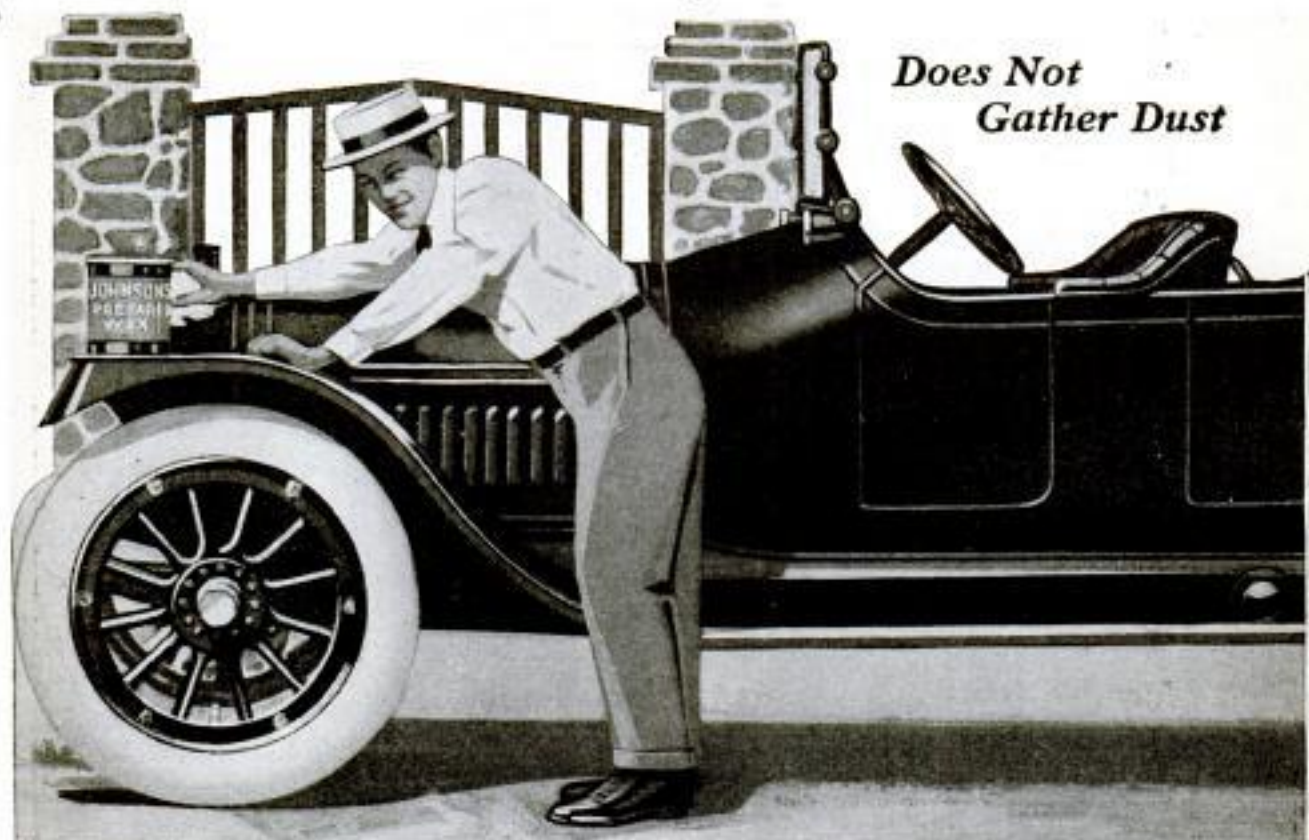

## Keep Your Car Like New With **JOHNSON'S PREPARED WAX**

It cleans, polishes and finishes in one operation. It will keep the body, hood and fenders of **new cars** bright and good looking for an indefinite time—and will make **old cars** look as well as a coat of paint and varnish.

Johnson's Prepared Wax imparts a perfectly hard, dry, glasslike finish that cannot collect dust. It forms a thin, protecting film over the varnish—greatly prolonging its life. It prevents checking and cracking—covers up small scratches and

### *"Sheds Water Like a Duck's Back"*

There are dozens of uses for Johnson's Prepared Wax—you will find it splendid as a polish for

**Floors**  
**Linoleum**  
**Woodwork**

**Pianos**  
**Furniture**  
**Leather Goods**

**Desks**  
**Golf Clubs**  
**Gun Stocks, etc.**

S. C. JOHNSON & SON, Racine, Wis. PAS

I enclose 10c for Instruction Book on Home Beautifying and a can of Johnson's Prepared Wax—sufficient for a small floor, an automobile, a piano or several pieces of furniture.

Name.....

Address.....

City & State.....

Johnson's Prepared Wax gives perfect results over any finish—varnish, shellac or oil.

Send us the coupon and 10c for a can of Johnson's Prepared Wax—sufficient for polishing an automobile, a piano, or several pieces of furniture.

**S. C. JOHNSON & SON**  
"The Wood Finishing Authorities"  
RACINE, WIS.

"Makes a 'wash' last four weeks instead of one."

J. H. Williams,  
1019 Hearst Bldg.  
Chicago

"Made my car like new again."

Edwin F. Kuhn,  
Ormond, N. J.

"Can't be beat for polishing a car."

J. E. Emmour,  
Greenwood, Miss.

"I have put it to every conceivable test, and as a chauffeur of 10 years standing, I can safely say that your Wax is par-excellence."

R. T. Lee, 89 Albion St.,  
Branford, Ont.

Please Mention Popular Mechanics

# Popular Mechanics Magazine

REGISTERED IN U. S. PATENT OFFICE

WRITTEN SO YOU CAN UNDERSTAND IT

Vol. 24

AUGUST, 1915

No. 2

## Sidecars Carry Band in Night Cycle Parade

*# Hugh Sharp, 2720 Clarence St. Milwaukee*

ONE of the interesting features of an unusual motorcycle demonstration recently held at Milwaukee, Wis., was the way in which a 25-piece brass band was carried along the streets of the city during its participation in a night parade. Each member of the band was seated in a sidecar, the leader preceding the players and directing them by using a baton fitted at the tip with a small incandescent light which could be clearly seen by all the musicians following.

The problem of illuminating the music held on the instruments of the various players was solved in a simple manner. A small-globed electric lamp, mounted in a reflector and connected with a storage battery carried under the seat, was provided in each sidecar. The lights were pinned to the caps, or coats, worn by the members of the band, while the wires connecting with them extended over the men's shoulders, so that they were entirely out of the way and did not interfere with the playing. This feature

of the parade was sufficiently novel to attract much attention.

Six motorcycle policemen rode at the head of the parade, and at the rear there were industrial divisions made up of sidevans and three-wheeled trucks.



During a Night Parade of Motorcycles at Milwaukee Recently, a 25-Piece Brass Band was Carried in Sidecars. Individual Lights Illuminated the Players' Music, While an Electric-Lighted Baton was Used by the Director

9592  
**A NEW TYPE OF POCKET  
TELEPHONE**

A new pocket telephone that has just been placed on the market is designed for the convenience of linemen, and others who find it desirable, in connection with their work, to communicate with headquarters from points between stations. The telephone set is housed in a case that is about the size of a pocket camera, the whole apparatus weighing only  $2\frac{3}{4}$  lb. To use the telephone the cover is swung open to expose the transmitter and receiver, the cover in this position



Talking with Headquarters by Means of the Pocket Telephone: This Instrument is Easily Connected with the Telephone Line, and, When Closed, Is About the Size and Shape of a Pocket Camera

acting as a sounding board. Wires run from the instrument to a pole equipped with hooks with which connection is made with the telephone line. Current is supplied by a four-cell battery.

9850  
**CRUISING RADIUS OF LATEST  
GERMAN SUBMARINES**

Engineering 4-16-15  
When the German submarine "U-51" attacked and sank the British battleships "Majestic" and "Triumph" in the Dardanelles after making the voyage from Wilhelmshaven, Germany, to the scene of the encounter, a convincing demonstration was given of the efficiency of this class of fighting vessel. If the submarine followed the route around the north of Scotland—and it is not likely that it could have made its way through the closely patrolled English Channel—the distance traveled was between 4,000 and 5,000 miles, and so far as is known there were no bases along the route at which supplies could be renewed. This is close to the limit, 5,000 miles, heretofore accepted as the greatest possible cruising radius of the largest submarines. According to the conclusion reached by an English engineering journal, however, based on studies of the data given out by a German officer, the cruising radius of the latest and largest German submarines is practically limited by the endurance of the crew.

With an 800-ton submarine equipped with Diesel engines the oil consumption is estimated at about ten tons for each 1,000 miles. It is believed that there is storage capacity for 50 tons of oil, giving a cruising radius of 5,000 miles. This can be greatly increased by carrying oil in the water-ballast tanks. There is a limit, however, to the time that a crew can stay on board such a vessel. The quarters, especially at the beginning of a cruise when all available space is filled with stores, are seriously restricted, there is a continual oozing of oil from the bulkheads and doors throughout the ship, and the conditions as a whole are such as to tax the endurance of the crew.

## AIRMAN DROPS WREATH WHERE BEACHEY FELL

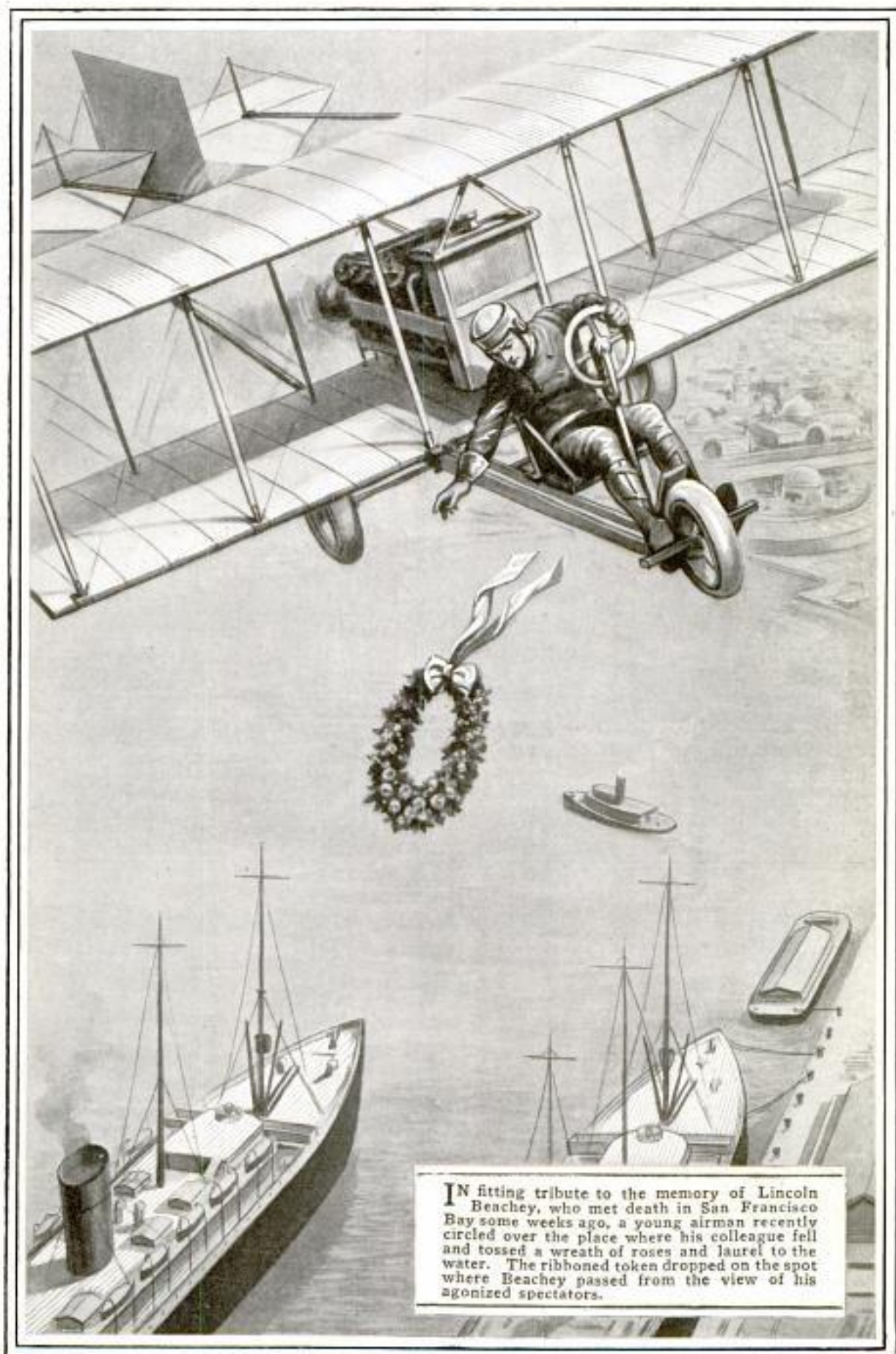

9874  
**PRISMATIC COMPASS FOR  
 NIGHT MARCHING**

Leading troops across country by compass bearing with as much certainty by night as by day is made possible through the use of a prismatic compass just brought out in England. The name given this compass is due to the prism fitted to one side of the frame, although this is not the most important feature of the instrument. The dial, which is made of mother-of-pearl, has a center coated with luminous paint, and in addition to this there are luminous patches on the lid by which the instrument is readily sighted at night. When a night march is to be undertaken the instrument is opened and exposed to the daylight for half an hour. This is sufficient to make the dial center and sighting patches luminous for from six to nine hours. In the latest form of the instrument this exposure to daylight is unnecessary, owing to the use of radium, a substance that is always self-luminous. The dial is graduated with two sets of figures, one set being designed for use with the prism. The hinged lid consists of a circular metal frame in which is a glass window, and across this window is an engraved sighting line. On the rotating glass cover that protects the dial

is a black line called the index line. In taking a bearing the instrument is raised to the eye, the user looking through the slot over the prism and through the lid at the object sighted on, and reading at the same time the angle under the prism. By means of graduations on the side of the case the instrument can then be set and clamped so that when the index line is turned to the north point the instrument is on the bearing taken, there being no further need for reference to the figures on the dial. At night the lid is opened out horizontally and the sight is taken through the slot and over the luminous patches on the lid, the luminous dial center enabling the user to see when the compass needle and index line are at the right setting. When the instrument cannot be set by sighting, it is laid down and adjusted over a line drawn on a map.

9959 — J. Parkin  
**DOUBLE-END LOCOMOTIVES  
 BUILT FOR FRANCE**

One hundred narrow-gauge locomotives of the Pechot type, each mounted on two bogies and provided with double-barreled boilers and two fire boxes, were recently made in America and shipped abroad for the use of the French government. Although these

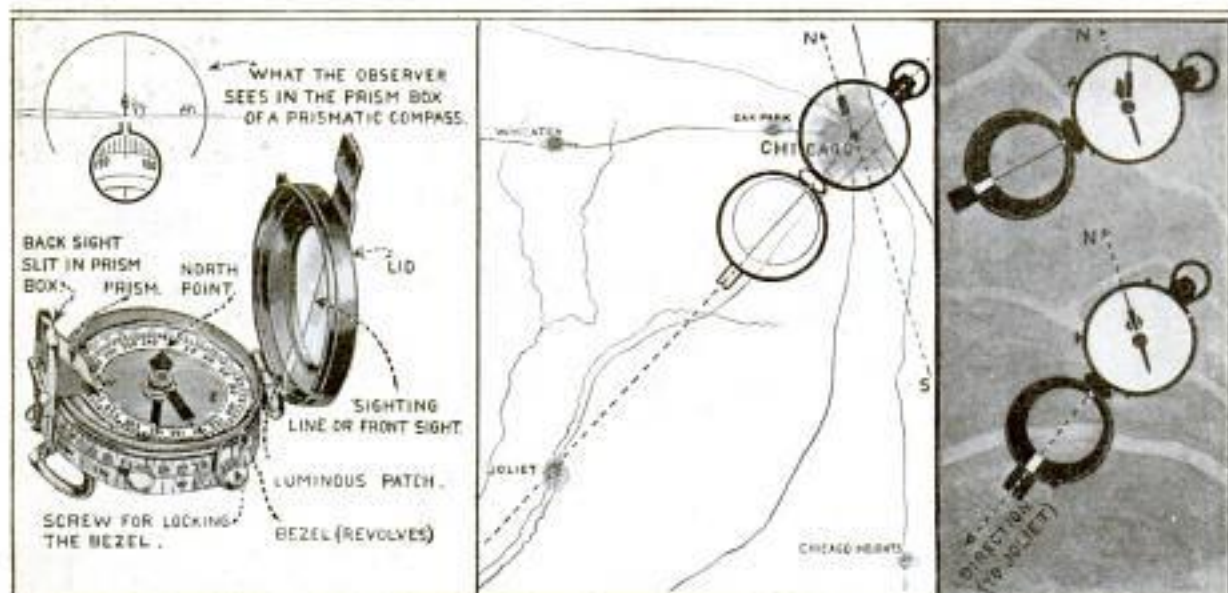

With the Compass Held Level the Observer Places His Eye to the Slit and Sights through Line on Lid

When a Direct Sight cannot be Taken, the Compass is Adjusted to a Line Drawn on a Map

At Night, the Course is Found by Sighting over the Luminous Patches

F. Bassett & Son, Ltd.  
 Sun Dial House, 1/2 Clerkenwell Road,  
 London, E.C.

*Baldwin Locomotive Works*  
500 Broad St., Philadelphia

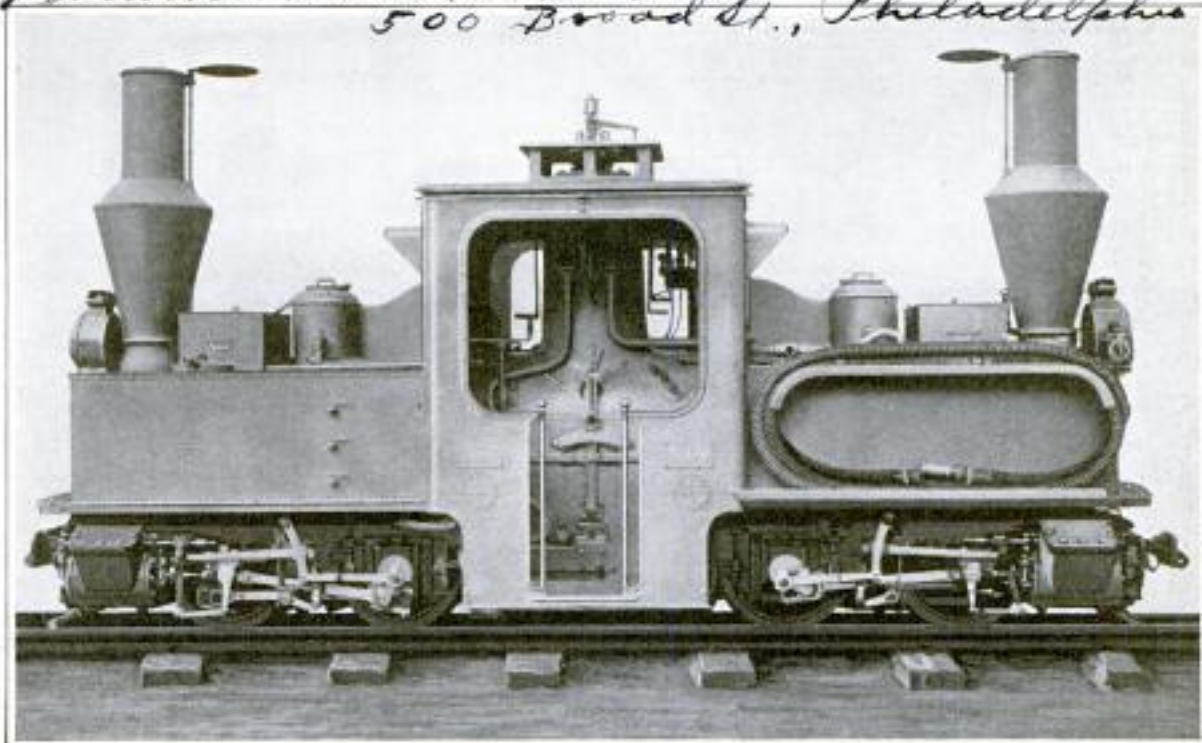

One of the Curiously Designed, Double-Ended Locomotives Built in America for the French Government

engines are of a design entirely foreign and were constructed according to metric measurements, they were built and the last one shipped seven weeks after the order was received.

Because of its great flexibility, which allows its use on narrow, uneven tracks where sharp curves are frequent, this engine is being employed by the French, particularly in drawing its munition trains over hurriedly built lines leading to its war camps. The engine is not double-ended only in appearance, but is built much the same as if the rear parts of two small locomotives were joined. Each boiler barrel has a separate set of tubes and is supported on saddles placed immediately over the center pins of the bogies. An outside shell, between the two trucks, and supported on plate frames riveted to the saddles, carries the two fire boxes. The inside of these is made of copper, the tubes are of brass, and the boiler shell of steel.

Water is carried in four separate tanks mounted beside the boiler barrels. The two of these placed on the fireman's side, however, are made shorter than the others to allow space for coal bunkers adjacent to the cab in the middle of

the locomotive. Each fire box is independent of the other. When it is desired, the engine can be operated by a single bogie.

### ELECTRIC KODAK BUG USED FOR ADVERTISING

Desiring a novelty which would enliven his display windows and at the same time embody a certain significance, a Los Angeles dealer in photograph supplies ingeniously constructed what he terms a "kodak bug." It is made of electric bulbs of different sizes and is provided with highly colored wings of stained glass. The bug is perched in quite lifelike manner on the top of a camera in the middle of the window display, and is illuminated intermittently by a flasher. The device attracts the attention of many passers-by.



# Edholm

9700

**SOCKET FOR ELECTRIC LAMP  
IS FITTED WITH LOCK**

In order to prevent the theft of electric bulbs from lighting fixtures in public places, a socket has recently been



introduced which is fitted with a lock, allowing a globe to be removed only by the aid of a key. When a bulb is locked in place and the key removed, it may be turned freely, since the screw shell swivels, but cannot be taken out. This offers a safeguard

against injury to the lamp or its socket should an attempt be made to remove the former without a key. In many buildings and

other places where electric lighting is employed the theft of globes presents a quite serious problem, which is responsible for the designing of locking sockets.

9981 —  
**FLOATING SUBMARINE DEPOT  
FOR BRAZILIAN NAVY**

*Times (London) 5/21/15*  
At Spezia, an Italian company is building a motor-propelled submarine tender for the Brazilian navy which will be one of the most thoroughly equipped ships of its kind ever constructed. It is to be 326 ft. in length, 51 ft. in beam, and will have a draft of 13 ft., while its two six-cylinder Diesel engines, which are to be of the two-cycle, single-acting type, will together be capable of developing 6,600 hp. Six submarines of less than 400 tons displacement will be carried by the parent ship. It will be provided with the necessary auxiliary equipage for charging the accumulators and air reservoirs of the underwater craft, and at sea will serve as a base for them.

9975

**NEW ACHIEVEMENTS IN THE MOVING-PICTURE FIELD**

Two ingenious developments in the art of motion-picture projection have recently been made which may add somewhat to the spectators' pleasure as well as broaden the photoplay field. Each achievement, while in a manner related to the other, is different both in purpose and means of execution. One makes it possible to show a film in a sun-filled room, while the other enables pictures to be displayed in open air at night under the full glare of powerful electric lights.

Daylight movies are a result of the invention of a translucent screen which allows a picture to be projected from the back of it instead of the front, as is customarily done. This of course makes it necessary to provide a dark room extending some distance to the rear of the screen in order that the light may be properly focused. The light thus reaches the audience by direct projection, not reflection. The

screen consists of a gelatinous sheet, spongy in appearance like art gum, made of chemicals. It is said to be durable and capable of resisting heat and water. The chief difficulty in using this system is the necessity of providing extra space back of the screen, which in many theaters and pavilions is unavailable.

A plan has been worked out at one of the Chicago amusement parks which enables the film drama to be shown at night in the open without being interfered with by the powerful arcs and thousands of colored incandescent lamps illuminating the grounds. The light from these sources is shielded from the screen by means of a large shadow box which intercepts the rays and absorbs and deflects them, preventing their reaching the curtain. The screen, which is 20 ft. in width and 16 ft. high, stands approximately 25 ft. from the front of the stage. Extending diag-

*Kleine Optical Co.  
166 No State, Chicago*

*Refer to Francis C. Hough Co. N.O. Co.*

*Richard Harise main steps  
to telephone department, has  
R 807-30 Broad St. New York*



onally from each side of this and reaching probably 15 feet outwardly, are multi-angle shadow curtains made of black cloth fitted over a framework. A large number of black drop curtains are hung forward above the screen, while an incline extends out from it at the bottom. The projector is supplied with a special 10-in. lens, through which the light is focused on the screen 186

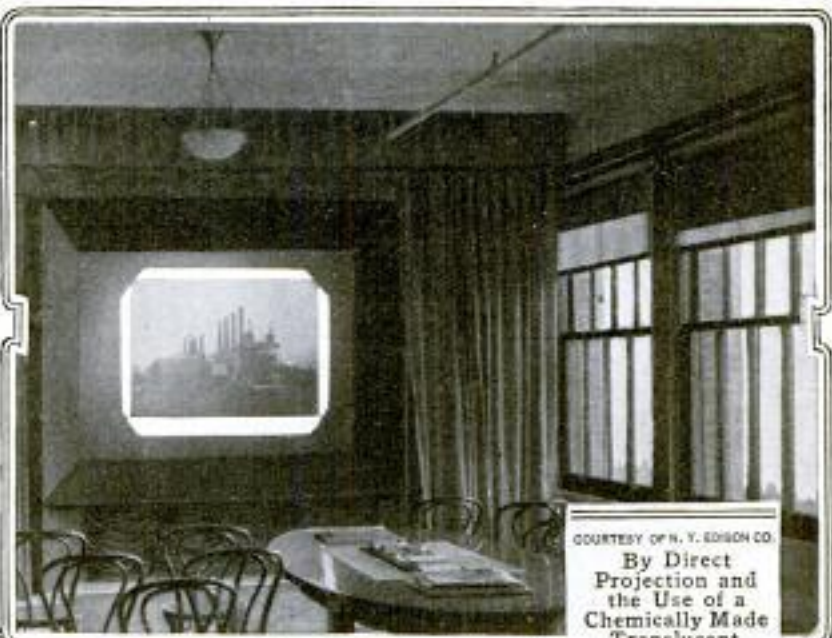

COURTESY OF N. Y. EDISON CO.  
By Direct  
Projection and  
the Use of a  
Chemically Made  
Translucent  
Screen, Movie  
Films are Shown in  
Sunlight Rooms



Rays from Myriad Lamps are  
Deflected and the Screen Shielded  
by Shadow Box and Drops



This Gives a Partial Idea of the  
Arrangement of the Deflecting Curtains  
at Opposite Ends of the Screen. These  
Radiate Diagonally Upstage and Consist  
of a Series of Panels, Each of Which is  
Set on an Increasing Angle so That the  
Shields Intercept the Light Rays but do  
Not Obstruct the Audience's  
View of the Screen

ft. away; a remarkably long throw and one known to be exceeded only in a single instance in this country, and in that case through darkness. All of the space between the lantern and the screen is roofed with colored lights, beneath which the "spot" has to be projected. On all sides the grounds are also brightly illuminated. The pictures presented are clear.

PAINTING MACHINES WHITE  
TO AID IN LIGHTING

TRANSPORTATION AFFORDED  
ACROSS CENTRAL AFRICA

That good lighting in the workshop not only facilitates the work directly, but is of the greatest indirect value because of the feeling of security and cheerfulness given the workers, is a fact that is becoming more generally rec-

With the final completion of the last link in the water-land route between the mouth of the Congo River and Lake Tanganyika, direct river and rail communication is now established across Central Africa from Banana on the West Coast to Dar-es-Salaam on the East Coast. Liners are able to reach Matadi, 85 miles inland, from where a railway extends to Stanley Pool, a distance of 260 miles. From

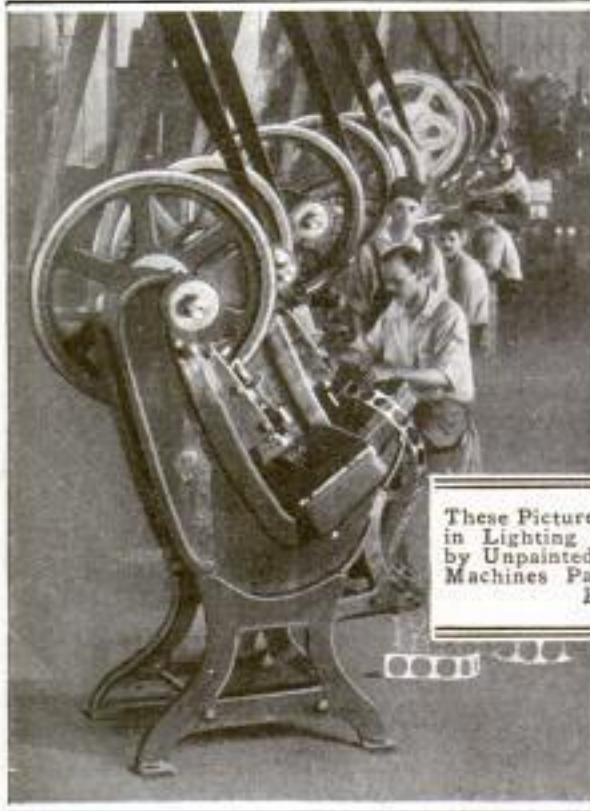

These Pictures Show Difference in Lighting Effects Produced by Unpainted Machines and by Machines Painted with White Enamel

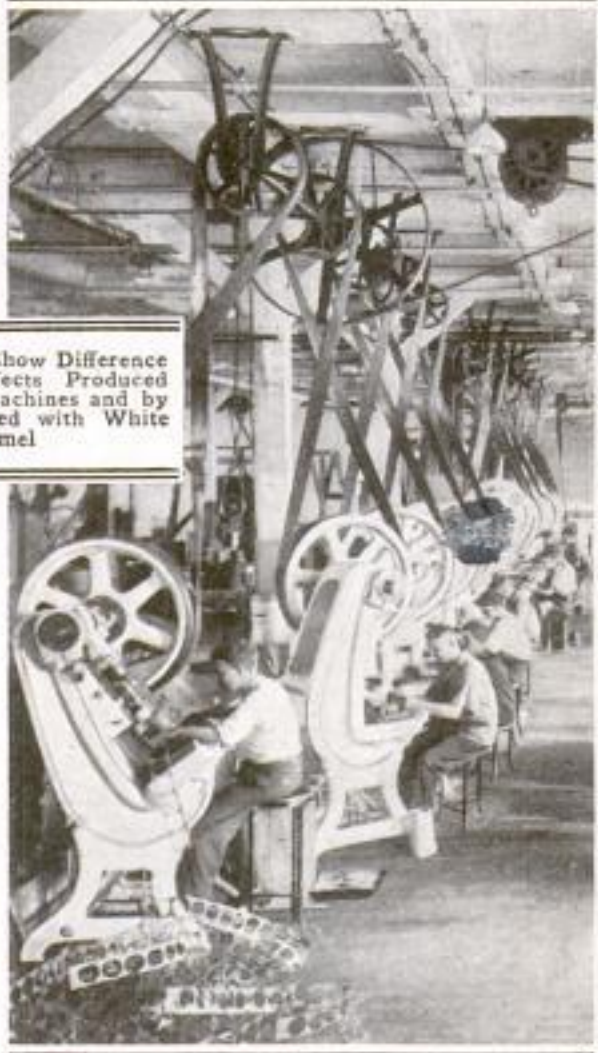

ognized every day. Indirect artificial lighting has long been in use, and recently there has developed a movement for increasing the effect of daylight by means of white enamel. For this purpose a white, oil-proof enamel that will not turn yellow if kept clean, is used, both the ceiling of the shop and the machines themselves being painted with this material. It is reported that remarkable results in the way of better lighting and the elimination of shadows are obtained in this way, these results being due to the fact that black absorbs the light while white reflects it with little loss. In making the accompanying illustrations seven times as long an exposure of the negative was required for the unpainted machines as for those that had been painted white.

that point the river is navigable for 1,000 miles. Wherever feasible, water transportation is used.

It is said that the only standard of size that is uniform all over the world is that of moving-picture films, which are universally made 1 3/8 in. wide.

## NO "SMOKE OF BATTLE" IN MODERN WARFARE

# J. C. McCarthy, *Evening Star, Washington, D.C.*

ONE of the marked features of the European conflict that distinguishes it from the wars of the past is the absence of smoke on the firing lines. Owing to the use of smokeless powder, no smoke is made when a rifle is discharged, while the heaviest artillery throws off nothing more than a thin mist that is invisible a hundred yards away and disappears within a few seconds after the gun is fired. Only when shrapnel or a shell explodes in the enemy's lines is there anything visible in the way of smoke, the whole purpose being to conceal the position of the guns throwing the projectiles while making the points where the projectiles explode clearly visible. The expression, "the smoke of battle," so faithfully descriptive of the wars of the past, has little meaning when applied to a modern war.

The so-called smokeless powders used in modern guns are not entirely smokeless, but are sufficiently so for all practical purposes. When gunpowder explodes something like half of its substance takes the form of finely divided solids, and it is this that causes the dense smoke resulting from the explosion. Practically all of a modern propellant, and by this term is meant the smokeless powder used for propelling the projectile from the gun, is, on the contrary, converted into a true gas. In modern warfare every precaution is taken to keep the location of a battery hidden from the enemy, for artillery fire has become so accurate that when a position is once known there is little difficulty in raining shells on it. But the use of smokeless powder is not all that is required in many cases. Care must be taken to prevent the raising of dust by the blast of gas and air resulting from the discharge of the gun, and for this reason positions for batteries are chosen, when possible, on ground that is not of a dusty nature.

In addition to their smokeless feature the modern propellants have enormously greater power than gunpowder. In the days of the Civil War the distances between the opposing

lines were seldom more than a mile, and it is said that the average distance was considerably less than this in the battle of Gettysburg. The effective range for modern artillery varies with the caliber of the gun, and ranges ordinarily from 2,000 to 12,000 or 15,000 yd. The 3-in. field gun used in the United States Army can be sighted up to 6,500 yd., or nearly four miles, while the new fieldpiece now being made is designed to have an effective range of 23 miles. In the European war most of the artillery engagements are fought at a range of more than four miles.

Since shrapnel is designed to burst in the air and rain its bullets on the troops at which it is aimed, it is necessary for the officer directing the fire to see just where the shells explode. For this reason the shrapnel shell contains, in addition to the high explosive, a smoke-producing charge that forms a matrix in which the shrapnel balls are imbedded. When the time fuse sets off the bursting charge in the base of the shell this matrix ignites and produces a ball of black smoke that serves as a marker easily visible to the officer directing the fire. In the case of shells that explode when they strike, no special arrangement of this kind is necessary, as the high explosives used in shells generate a black or colored smoke, depending on the explosive used, that provides a sufficient means for determining and maintaining the range. In this connection it is necessary to distinguish between the propellant used for firing the shell and the high explosive used in the shell itself. A propellant is designed to force the shell forward with gradually increasing velocity until it leaves the muzzle, without endangering the gun by excessive gas pressure. The charge in the shell, on the other hand, is designed to shatter and destroy by the generation of the greatest pressure in the shortest possible time.

The gases thrown out by a bursting projectile are often poisonous, but the possibility of injury from this cause is considered negligible except when the explosion takes place in an inclosure

# 9532  
# Roy W. Allison  
170 Rosville av.,  
Newark, N. J.

that tends to confine the gases. No definite information as to the fatalities resulting from this cause are available, but there have been occasional dispatches from the battle fields of Europe telling of soldiers overcome or killed, apparently from the effects of the gases, following the explosion of a shell within a building.

9532

### OUTDOOR HOUSING DESIGNED FOR ELECTRIC METER

For use in the irrigating districts of Oregon where many of the agriculturists employ electric energy for pumping purposes, a light and power company has designed an inexpensive outdoor housing for its meters. This consists of a wooden box divided into two parts, the upper of which incloses the switchboard and fuses, and the lower, the meter. A door gives immediate access to the switches and fuses, while a cover plate securely screwed in place over the second compartment protects the meter, which, however, is visible for reading. The box is supported on a substantial framework several feet from the ground.

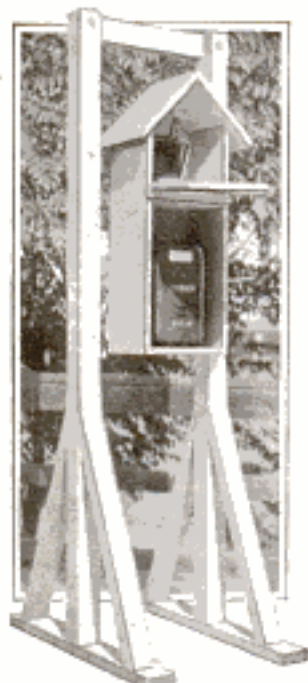

2

### ACROSS-COUNTRY CANOE TRIP PLANNED FOR SUMMER

C. S. Monita 5-8-15  
Two eastern sportsmen contemplate starting from Jersey City, N. J., for the Pacific coast on what is one of the most unusual canoe trips ever attempted in this country. The men expect to make their way across the continent by plying various rivers, lakes,

and canals that will gradually lead them westward until they strike the Columbia River, down which they plan to paddle to the ocean. From Jersey City the route goes by way of canal to the Delaware River, thence to Delaware Bay and through Chesapeake Canal to the Potomac. It then extends up the latter stream to the Chesapeake and Ohio Canal, through that to Cumberland, Md., from where small rivers will be followed to near the headwaters of the Monongahela River, which leads the party to Pittsburgh, from where the Ohio River is followed to Cairo, Ill. From here they anticipate making their way against the current of the Mississippi to the Missouri, thence to the mouth of the North Platte and on to the Yellowstone and Snake rivers. Then by following intervening streams the route extends to the Columbia. A lightly rigged 18-ft. canoe equipped with a portable motor is to be used. The men expect to spend five months in making the trip.

9872

### BARBED WIRE SENT ABROAD FOR USE OF ARMIES

Iron Age 4-22-15  
Thousands of tons of barbed wire have been shipped abroad, since the

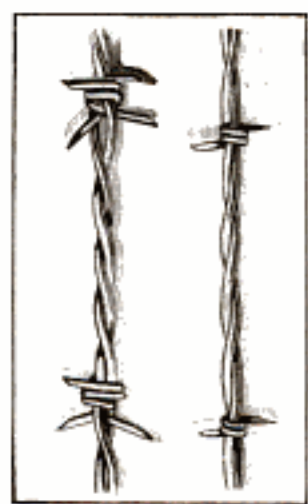

outbreak of the European conflict, for the use of belligerent armies. For the most part this has been unlike that used domestically for fencing purposes, inasmuch as it has been of a four-point type. The barbed wire ordinarily used in rural districts of America for

land inclosures has two short-pointed barbs, approximately 1 1/2 in. in length and spaced about 3 in. apart. That sent to Europe, to be used particularly in constructing barbed-wire entanglements, has four long-pointed barbs.

*Battle Ship Florida*

# OVERHAULING DREADNAUGHT AFTER SHAM BATTLE

9997

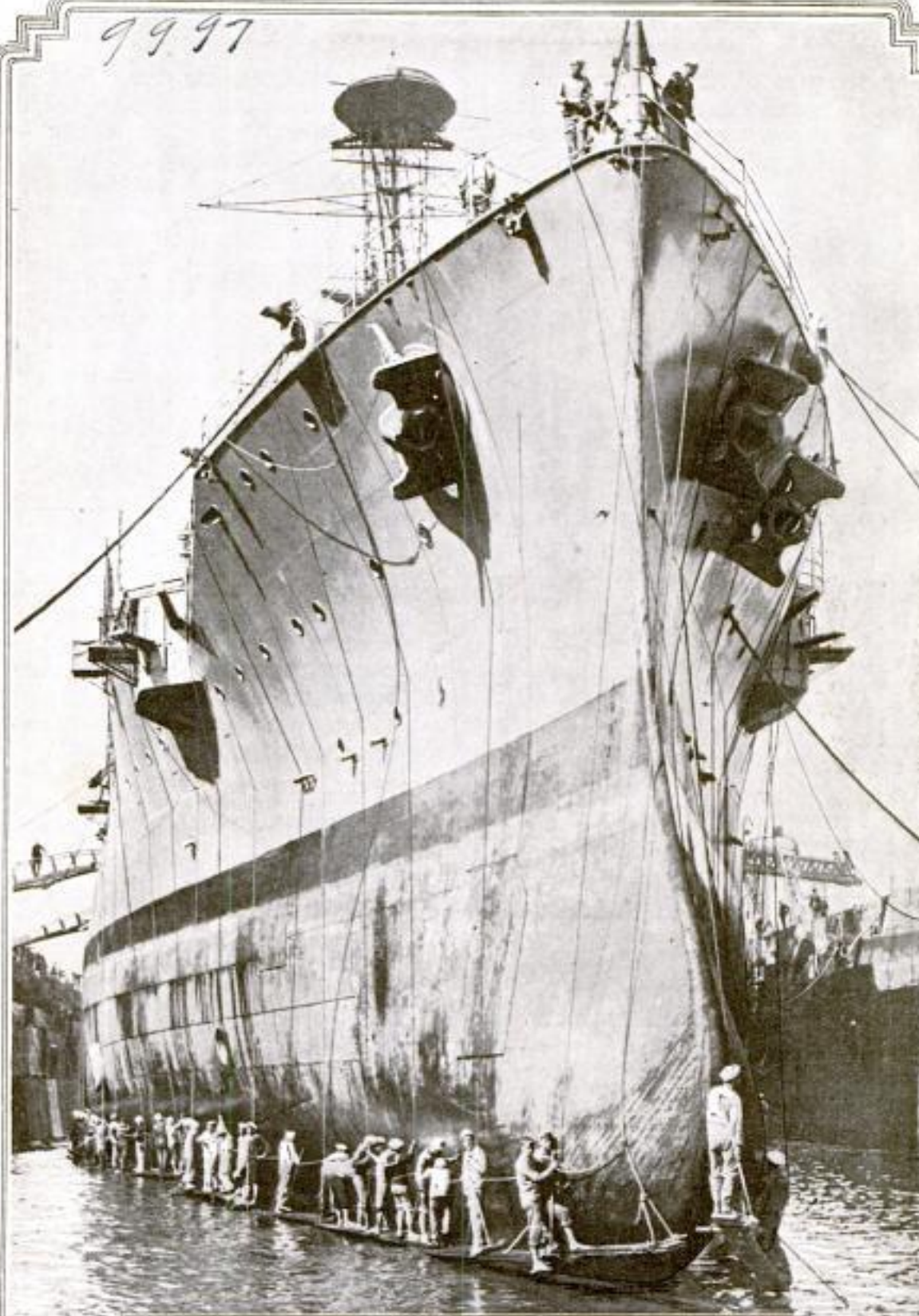

Dreadnaught "Florida" in Dry Dock at New York Navy Yard Following Its Participation in the Recent Naval Maneuvers off the East Coast. The Sailors are Engaged in Cleaning Bottom and Sides of the Great Hull

COPYRIGHT, UNDERWOOD & UNDERWOOD

*417-5th Av. New York*

**COMPACT HAND TRAP MADE FOR "PIGEON" THROWING**

For the use of the sportsman who enjoys target shooting, a compact hand trap for throwing clay pigeons has

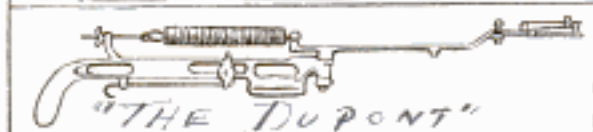

The Trap Throws Clay Pigeons in Almost Any Manner Desired by the Gunner

been brought out which is easily carried and provides endless opportunities for unusual trap shooting. It is built of metal and fitted with a heavy spring which actuates a lever arm, hurling the targets in various ways, providing "climbers," "skimmers," "jack rabbits," "twisters," or whatever is wanted. The weight of the device is 6 1/4 lb., while its size allows it to be carried in a suitcase, handbag, or special case, as is most convenient. With it trap shooting may be indulged in on camping junkets, or during motorboat or yachting trips. Shooting pigeons from a rapidly moving motorboat on choppy water is an unusually fast game which is made possible with the new trap.

**FISH KILLED BY SEVERE HAILSTORM**

An almost complete extinction of the fish in several small streams was caused by a severe hailstorm that visited Texas recently. A succession of torrential rains had not only raised the streams to a flood stage but had made their waters so muddy that the fish were compelled to come to the surface in order to breathe. The rains were followed by a hailstorm during which the fish received the full impact of hailstones of enormous size, and after the storm had passed the streams were found to be littered with thousands of dead fish.

**TREE IN MIDDLE OF STREET HOLDS DANGER SIGNAL**

Squarely in the middle of one of the principally traveled streets in a Los Angeles suburb is a beautiful old sycamore tree of unusual size. Because of its position much objection has been raised against it at different times and numerous attempts made to cause its removal. Adjacent property owners, however, have fought this vigorously, and in order to prevent accidents occurring at night, have had a parking built



To Prevent the Removal of This Tree, Property Owners Built a Curb about It and Erected a Danger Signal to Warn Night Drivers

about the tree and a red-colored electric lamp fixed to its trunk as a danger warning.

H. H. Bennett  
902 S. Winnetka Ave.,  
Dallas, Texas.

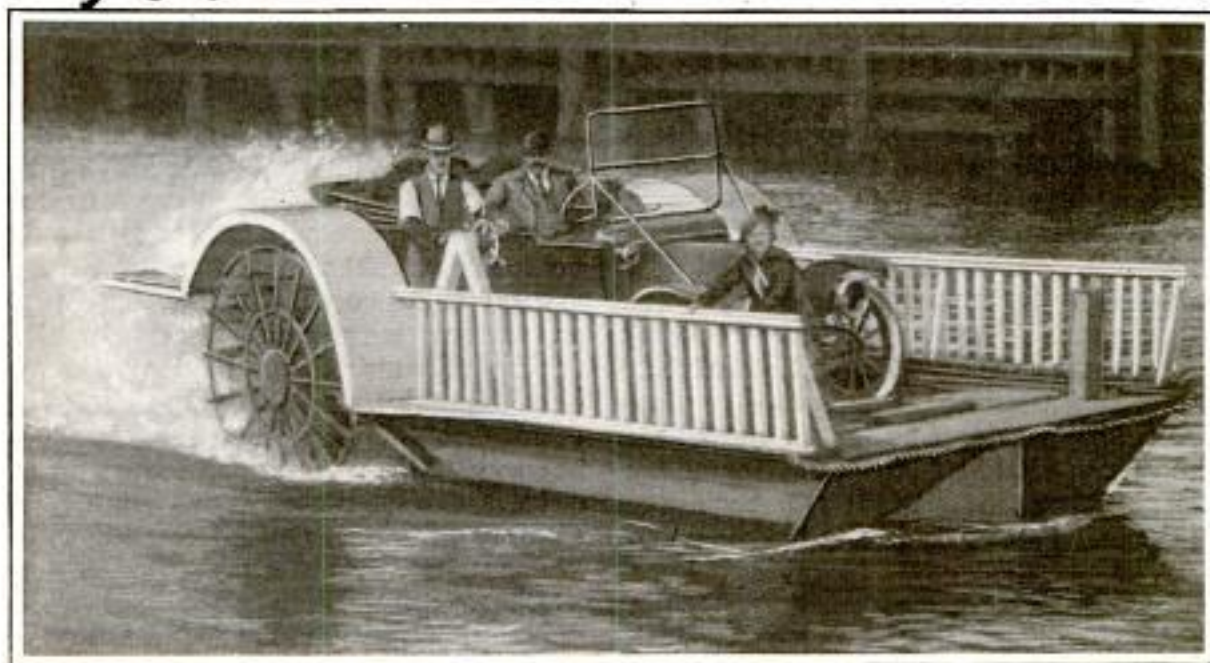

Automobile in Place for Driving Barge across a Bay on the Pacific Coast

### BARGE THAT IS PROPELLED BY AUTOMOBILE

For crossing a bay 20 miles wide connected at each end with a fine driving beach along the seashore, a motorist of Aberdeen, Wash., uses a barge built for less than \$100 and so equipped that it can be driven by the automobile that it transports across the water. A propeller wheel, that is housed for safety, is located at each side of the barge near the stern. The axle of each wheel is at the right height to come in line with the rear car axle when the end of the car is raised a few inches above the deck of the barge, and is capped with a hardwood wheel, 18 in. in diameter and 2 in. thick. On each wheel are leather clamps for securing it to the spokes of the car wheel. With the rear of the car raised so that the wheels are clear of the deck and these wheels connected with the propellers by the straps, the barge is ready for operation by the engine of the automobile. The work of placing the car aboard the barge and making it ready for use requires about eight minutes. The barge can easily make eight miles an hour when propelled by a light car and considerably more than this with a high-power car.

9913

### CONVENIENT COVER DEvised FOR RUBBISH BOX

Receptacles for rubbish and waste paper, which were placed along the streets of Columbus, Ohio, some time ago were not provided with covers. The result was very unsatisfactory, for whenever the wind was high, loose papers were lifted out of the cans and swept along the thoroughfares. A top which is somewhat different from the ordinary style has been devised recently and fitted to some of the cans. This has both overcome the difficulty previously encountered and escaped the objection which had been voiced against the employment of closed covers or lids for the boxes. It is arched so that trash may be thrown into the can easily, while the content is protected from both rain and wind. It is hinged in place and may be tilted.



*John N. Schilling*

*Columbus, O.*

9427

# TAKING CHANCES TO PUT THRILLS IN THE MOVIES

*# Marple*

**T**HAT motion pictures in the making often require the players to face real and serious danger, and even the possibility of sudden death, is a feature of the movies that few persons realize. The popular notion is that any act involving danger is "faked"—that in a fall, for instance, the actual fall is made by a dummy and not by a living player. This was true of motion-picture making in the past, and to a limited extent is true even at the present time. Some of the feats shown on the screen could never be performed by a living person without the certainty of death. But competition between the leading producers has become so keen and the taste of the public so exacting, that a thrilling act must as a rule be the perfection of realism, and this usually means that it must be the real thing. In meeting this requirement the players go to the limit of safety—and beyond.

One of the most daring of recent feats is a fall now being shown in one of

the big plays. The actor is seen standing on a balcony 20 ft. above the ground. Suddenly he clutches at his breast as if shot and pitches backward off the balcony, turning over during the descent. This entire act is performed by a living actor who makes falling his business and who is said to have fallen a total of more than five miles in the past three years. In an act like this, the actual tumble would formerly have been made by a dummy, and the effect of continuity in the pictures would have been given by stopping and starting the camera at just the right instants as the dummy was substituted for the actor and as the actor took his position on the ground in place of the fallen dummy. Another act of a startling nature, shown in the illustrations, is that of a fugitive dropping from a signal bridge to the top of a moving locomotive. This feat was performed without injury to the actor while the locomotive was running at a speed of 17 miles an hour. The fight on the



In this Scene a Living Actor, Apparently Shot, Falls Headlong the Full Length of the Stairs



Dropping from a Signal Bridge to the Top of a Moving Locomotive





In This Slide  
down a Precipitous Hillside  
the Player  
Escaped Injury  
but Motorcycle  
was Wrecked

Getting Out of  
the Way of a  
Moving Train:  
The Drop Made  
by the Three  
Players Was  
About 20 Feet

A Thrilling  
Fight on the  
Pilot of a  
Moving Locomotive:  
Taken  
from the Rear of  
a Train Ahead

A Rescue Scene  
That Made a  
Real Rescue  
Necessary  
After the Act  
was Finished

pilot of a locomotive was staged with the locomotive running at a speed of 20 miles an hour and the pictures were made from the rear of a train ahead. A single careless movement of either of the actors might easily have resulted in the death of one or both. The scene in which a man is shown letting himself and a rescued maiden down the face of a cliff by means of a rope was followed by a real rescue. The base of the cliff is fully exposed to the waves of the ocean and is considered one of the most dangerous points on the California coast. Just as the picture was finished the actor was struck by a wave and thrown violently against the cliff, and in his helpless condition would have been washed out to sea and drowned if aid had not been at hand.

The work of staging plays in which wild animals are used is always tense with the possibility of danger. Mistakes are sometimes made, and at best the player must get out of the way at just the right moment, with the margin between safety and danger narrowed

down to a matter of seconds. In a jungle play recently produced the heroine was supposed to cross an open space a few seconds before a lion appeared. Through some mistake the lion was liberated too soon. In her fright the actress stumbled and fell. Just as the lion was about to attack, the trainer rushed to the scene and drove the enraged animal back with an iron rod, giving the actress time to reach a safety cage. In one film play three persons representing children are shown playing with a lion cub. Hearing a rustling in the leaves they drop the cub, run out of the picture and reach a hidden safety cage at the same instant that a furious lioness comes leaping through the reeds seeking her young. A moment's hesitation at the critical time would probably have meant the death of at least one of the players. These few instances are typical of the dangers the motion-picture players as a class are facing every day in order to satisfy the popular demand for thrill and realism.

9697

### WATER WHEEL TRANSPORTED ON MULE BACK

Getting a 100-hp. water wheel into the interior of Mexico on mule back was the problem presented to the managers of a mine located in a section of that country where there were no roads over which vehicles could be operated. In order to make this possible the wheel was built in sections so that it could be taken apart and transported across the mountains in pieces. The wheel was made in 56 parts, comprising the four quadrants of the wheel

with the four bolts for fastening them together, and the 16 buckets with the 32 bolts for attaching them to the wheel. The nozzle with its controlling valve was also made in sections, these sections, with the bolts for assembling, making a total of 53 pieces. The different parts were packed in boxes of the proper size and weight for carrying on mule back.

The Wheel  
Packed for  
Transport on  
Mule Back; at  
Right, Wheel  
Assembled  
for Operation

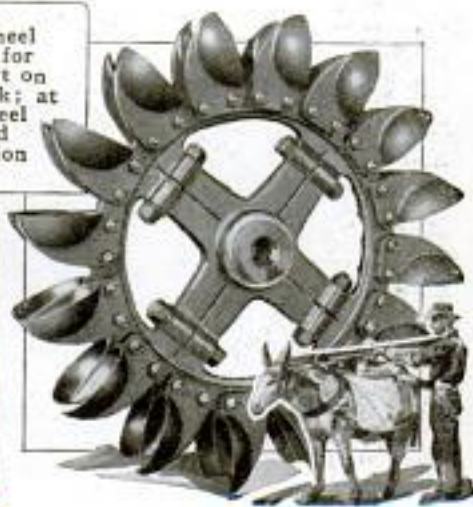
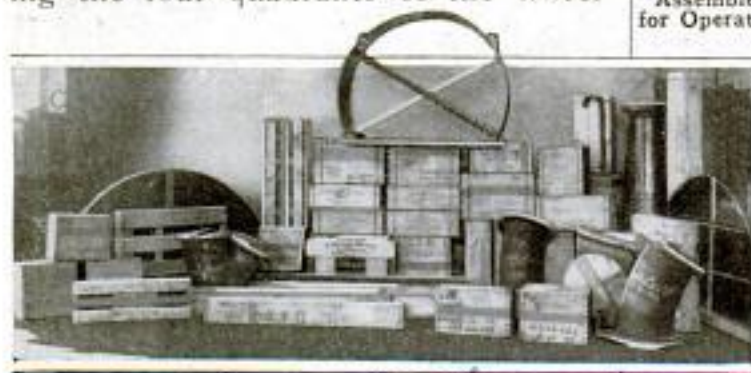

*Pelton Water Wheel Co.,  
19th and Harrison,  
San Francisco.*

Body - McKean Motor Car Co.  
 Omaha, Neb.  
 Truck - United Motor Truck Co., Grand Rapids  
 Mich.<sup>177</sup>  
 18 POPULAR MECHANICS

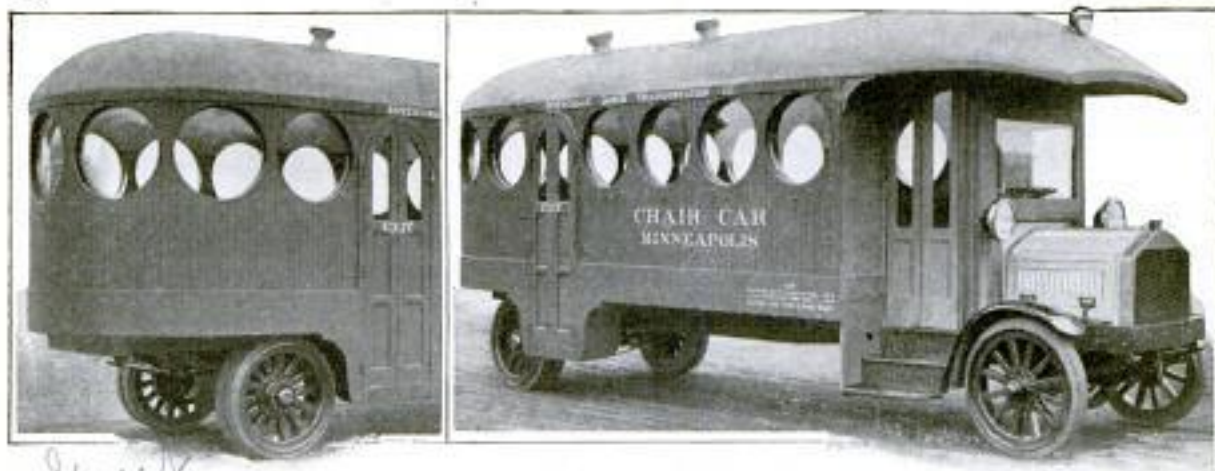

This Motor Car, of a New Type Now being Introduced, Has Individual Seats for 27 Passengers and can Operate Anywhere That Fairly Good Roads Are Available

### NEW MOTOR VEHICLE FOR PASSENGER SERVICE

A number of novel features are embodied in a new passenger-carrying vehicle that has just been brought out and is designed to operate anywhere that fairly good roads are available. This vehicle is gasoline-driven, is a combination of motor truck and coach body, and is intended for city, suburban, or interurban service. The chassis consists of a 3½-ton truck with a wheel base of 23 ft. 10¾ in., while the body is built much like a Pullman car. Individual chairs, mounted on special springs for absorbing shock, are provided for 27 passengers. It is claimed that this arrangement, together with the springs on which the body is mounted, provides the maximum of comfort under road conditions that are far from good. Along the sides of the car are round windows, about 24 in. in diameter, which are hinged at the top and can be swung inward against the top of the car in pleasant weather. The car is electrically lighted and is provided with heating and ventilating facilities, the heat being supplied by the exhaust from the engine. The car is made to be operated on the prepayment plan. Entrance is through a door placed at the front end and at the right side adjacent to the driver, who acts as both motorman and conductor. The exit door is at the right side and near the rear, and both doors are under the control of the driver. For taking on

or discharging passengers the car is driven up to the curb on the right-hand side of the street. Owing to the length of the chassis, the driving shaft is made in two sections with a bearing at the middle of the frame. The forward section connects with the transmission and with a short shaft supported in this bearing by means of universal joints, while the rear section is connected in like manner with the short shaft and the rear axle.

9925—  
**ELECTRIC CLOCK DESIGNED FOR MOTOR CAR**

One of the latest accessories to be developed for the motor car is an electric clock which winds of its own ac-



Electric Clock Built Particularly for Motor-Car Use

cord at intervals of three minutes. A balance wheel is used in the instrument instead of a pendulum. When the mechanism slackens its speed slightly, a contact is made which closes a cir-

9926 - Stewart-Warner Speedometer Corp's  
 1826 Diversey Blvd., Chgo.

cuit and energizes an electromagnet. This gives the clock sufficient force to run for three minutes, when the operation is repeated. A dry cell, or current from a storage battery, may be used.

**9905**  
**ELECTRIC MACHINE DEvised FOR MANICURING WORK**

Operating in much the same manner as a dentist's drill, an electric manicuring machine has recently been designed



This Electric Manicuring Machine Works in Much the Same Manner as a Dentist's Drill

by a Los Angeles woman. It consists essentially of a small motor to which is attached a flexible shafting, by which the various instruments are actuated. All the tools are made in disk form so that the trimming, cleaning, and polishing of the nails is done without the use of knives or scissors. While the apparatus is such as would be serviceable for the professional manicurist, because of the rapidity with which it does its work, it is also intended for personal use.

In the construction of an elevated structure in New York a pipe chute, which does away with the tossing of red-hot rivets, is used for conveying the rivets from the forge to the riveter.

**9862**  
**STEAM ROLLER IS EMPLOYED AS PAVEMENT CUTTER**

In an attempt to lessen both the labor and time consumption ordinarily attending the removal of worn asphalt preparatory to resurfacing street pavement, an engineering company recently devised a cutting apparatus which proved quite efficient. Two pieces of 3-in. angle iron were curved to fit at the rear of a steam roller and sharpened so as to serve as cutting members. By driving the roller along the pavement, the irons pierced the asphalt and made sharp, clean cuts through the surface. In this specific instance a strip of pavement approximately 2,000 feet long and 8 feet wide was to be removed. By setting the irons to bracket the proper space, it was necessary only to drive the roller along the street to make the parallel cuts, which would have required several days of labor by a gang of men, had the work been done by hand.

**9698**  
**AWNING ARM MADE TO FOLD NEATLY WHEN RAISED**

Intended particularly for use on ground-floor store windows, a jointed awning arm which folds back compactly, presenting a neat appearance when the canvas is raised, has recently been invented. When the awning is lowered the arm projects at right angles and is braced by a member which is pivoted to the bars. To hold the arm in its proper position, preventing sagging and also allowing the awning to lift slightly under a heavy wind pressure so that the canvas is relieved from unnecessary strain, a spring is secured to the bracket. This arm may be used with nearly any kind of awning.



Walger Awning Co.  
215 W. Ohio St.

Inventor: Mrs. F. A. Scott  
406 Burnley Bldg.  
Los Angeles, Calif.

# To Roy W. Allison  
170 Riverside Dr.,  
Newark, N. J.

See in use show  
7/11/15



Iron Cover Plate Blown from a Sewer Manhole through an Adjacent House: The Barrel Marks the Position of the Sewer Vent, While the Dotted Line Indicates the Course Taken by the Heavy Cap

In the course of its fall it curiously enough tore away the foot of a bedstead in a chamber on the top floor, veered, crashed through the flooring and repeated the performance on another bed faced in the opposite direction in a first-floor room. Both beds were occupied at the time, but no one was injured.

9980

**STRANGE SEWER EXPLOSION  
 CAUSED BY FLOOD**

Following heavy rains which caused a sudden rise of water in a sewer under construction at St. Louis, a very puzzling explosion occurred which hurled a 76-lb. cover plate of a manhole through an adjacent building. The iron cap sealed an air shaft 50 ft. distant from the house which was struck by it. It is assumed that sewer gas was compressed by the rising water, but whether this was exploded through ignition or not, is subject to conjecture. What happened otherwise, however, was that the cover plate was thrown entirely over a two-story house, striking a second building and passing through it to the first floor.

9930 *Auto General*  
**CURIOUS-LOOKING RUNABOUT  
 BUILT FOR CITY STREETS**

Constructed with a chassis shaped like a rhomboid, a new motor car of an unusual type has made its appearance in the streets of New York. The

*"Serpentina"*



Odd-Appearing Car Which can be Turned Completely Around in Its Own Length

*Inv. & Bldr*  
*Chas. Fitzgerald*  
*1765 Broadway, New York*  
*C/o. Noncarbine Co.*

machine is designed particularly to meet the difficulties encountered in navigating narrow thoroughfares where traffic is congested and turning room reduced to the minimum. It is capable of making a complete turn in its own length, and this feature is the excuse given for its introduction. The wheels are placed at the four points of the rhomboid, the steering being done on the front and rear wheels, while the driving power is applied to the two side wheels. Although the present lines of the car are not appealing, particularly from the standpoint of beauty, the capabilities of the machine appear to have merit.

### NEW IRONING BOARD FOLDS INTO CLOSET

A telescoping ironing board that fits into a recessed closet and is easily let down to position for use has recently

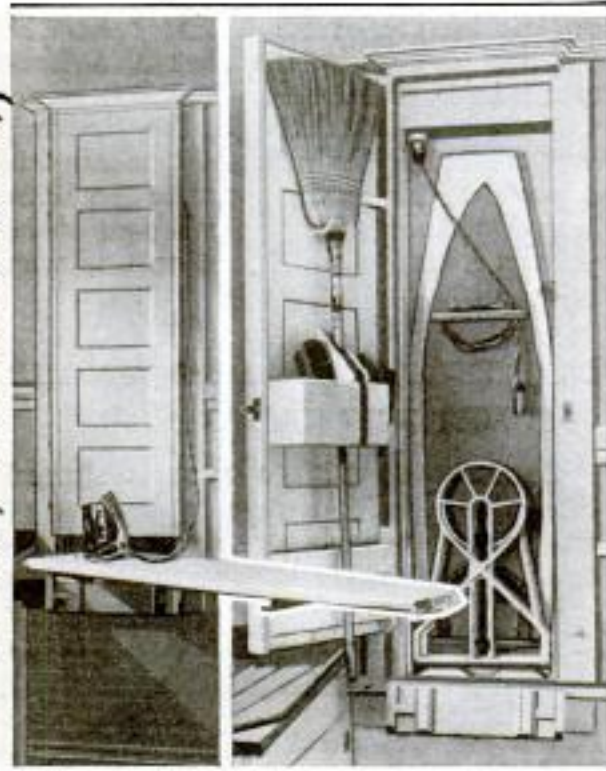

At Left, Telescoping Ironing Board is Shown in Position for Use; at Right, It is Shown Folded into Closet

been invented and is soon to be placed on the market. When folded into the closet the board is concealed by a door. When it is to be used the board is let down to a horizontal position at right

angles to the wall and is then pulled out until it stops. It can then be swung horizontally to any desired position. The board is permanently mounted on a pivoted support, placed within the closet, which is so arranged that it holds the board firmly without the necessity for a leg or other support at the outer end.

### GROWING IMPORTANCE OF MOTOR-CAR INDUSTRY

*The Motor June 1915*  
An idea of the importance that the motor-car industry has assumed in this country is given in statistics recently issued for 1914. In that year there were 1,666,984 pleasure cars and 44,355 motor trucks, or a total of 1,711,339 motor vehicles, in operation in the United States. These vehicles paid more than \$12,000,000 for the privilege of using the roads. In addition to this, owners and chauffeurs paid a total of \$127,179 for the right to drive, while manufacturers paid an additional \$21,255 for the privilege of running cars necessary to their business.

### SAVING MOUNT VERNON SITE FROM DESTRUCTION

The high bluff on which stands Mount Vernon, the home of our first president, has for years been in danger of gradually sliding into the Potomac. This danger became acute a few years ago when it was discovered that a new landslide was beginning that threatened to destroy the broad lawn in front of the mansion, if not the foundations of the mansion itself, and engineering work, recently completed, was begun at that time to save the historic site from further damage. The ground slopes from the mansion to the edge of the bluff and from this point drops steeply for a hundred feet or more, to the edge of the Potomac. The river at this point is a wide tidal estuary and the action of the waves has caused a steady erosion at the foot of the bluff. Underlying the bluff are strata of sand, clay, and soft sandstone, which, on investigation, were found to be saturated with

#H. D. Young, 1329 Corbett St., Portland, Oregon.  
 See June 15-894



*14th St & New York Av., Washington D.C.*  
 COPYRIGHT, LEE BROTHERS  
 The Mansion and Lawn at Mount Vernon: The Gradual Destruction of This Historic Site has been Stopped by Engineering Work Recently Completed

water, and this, combined with the erosion of the waves, has resulted in landslides that have doubtless been going on intermittently for ages. To cure the trouble a small drainage tunnel was first driven in the bottom of the sandstone stratum and carried back from the river front a distance of about 200 feet. From this tunnel a heavy flow of water immediately started and this flow continued for several months. At the end of that time the flow diminished to a moderate amount and has remained practically constant ever since. To prevent further erosion at the foot of the bluff through the action of the waves a heavy masonry wall was then built along the edge of the river. It is hoped that danger of future slides has been eliminated.

### MODERN PRAIRIE SCHOONER 5 BUILT FOR LONG TRIP

In preparing to make an overland trip from Stamford, Conn., to San Francisco, a motorcycle enthusiast has developed a truly modern prairie schooner which is no less an innovation than it is a curiosity. It consists of a light, covered wagon mounted on cycle wheels and drawn by a single-cylinder motorcycle hitched, horse-fashion, before it. The interior of the trailer is comfortably appointed with folding beds and specially designed cabinets for provisions, cooking utensils, and other paraphernalia. The builder of the vehicle will be accompanied on the journey across country by his wife and two children.

*Trailer*

This Modern Counterpart of the Prairie Schooner of Pioneer Days has been Built for a Transcontinental Trip

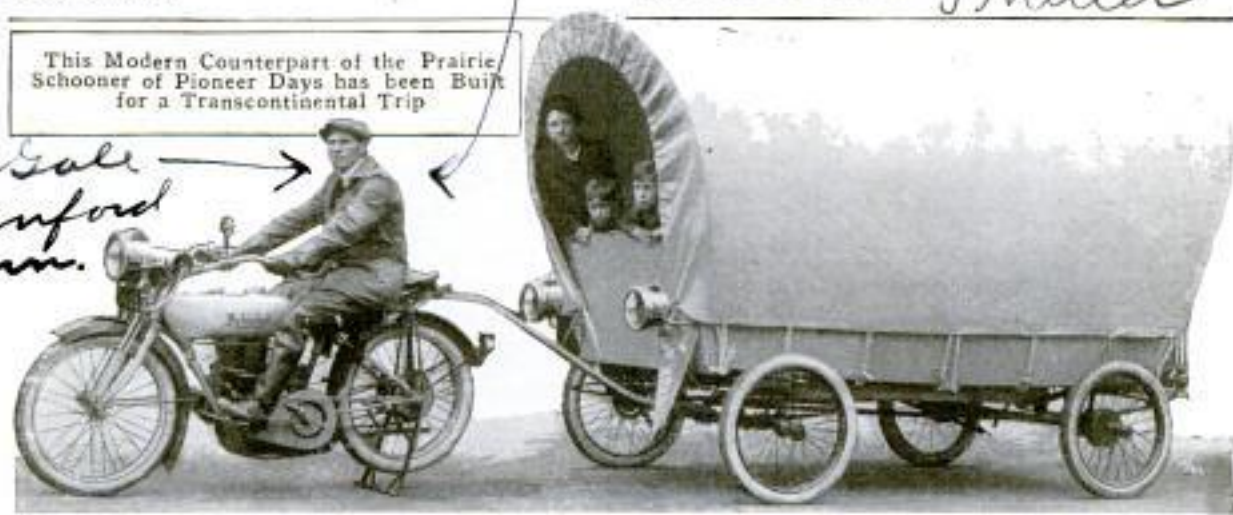

*E.H. Gale  
 Stamford  
 Conn.*

*U. & U., 417 5th Av., N.Y.C.*

*F.S. McKel Motor Co.*

9153

H. E. A. Speer, Atlanta, Ga.

## HOW SEWAGE IS PURIFIED BY BACTERIA

ONE of the best examples of modern methods and equipment for sewage purification is the plant recently built for treating the sewage at Atlanta, Ga., where the first Imhoff septic tanks ever installed in this country are in service. Septic tanks of this type, though a comparatively recent invention, are already in common use in the Ems River valley, and other sections of Germany, and are said to have proved the best means yet discovered for the first stage in the bacterial treatment of sewage. The Imhoff tank is simply a modification of the ordinary septic tank, which is itself an enlarged and improved cesspool. As in the case of the cesspool the process of treating sewage by this method depends on the action of bacteria, but in the septic tank this action is carried out rapidly and on a large scale.

The raw sewage enters the Imhoff tank through a series of inlets spaced across the end. It then flows slowly through the tank, and the liquid is finally discharged through outlets at the opposite end which lead to the filtering beds. The first bacterial action on the sewage takes place during its passage through this tank. There is nothing done to bring this about or to assist it, the action being a natural one exactly like the decomposition that takes place in a cesspool. Much of the solid matter contained in the sewage is decomposed before it sinks and is transformed into a liquid, but the heavier parts settle through a slot into a compartment below known as the sludge-digestion chamber. The process does not end with this. The deposit of sludge is being constantly decomposed and transformed into a liquid by the bacteria, so that the accumulation of sludge is so slow that the chamber can ordinarily go for months without being cleaned out.

The bacteria that do the work in the septic tank are called anaerobic, a term used to designate bacteria that do not require oxygen for their growth. One of the features about the Imhoff tank is that the gases produced in the decomposition of the sludge do not pass up through the tank itself, but are led

up the sides to vents. How this is done is shown in the diagram illustrating a typical arrangement for Imhoff tanks.

When the liquid leaves the septic tank it flows to the filter beds, where the last stage in purification takes place. In the Atlanta plant, the liquid is sprayed over the bed by sprinklers, a method that causes an even distribution in the right quantities. Here the liquid is attacked by bacteria of another class, known as aerobic, or those that require oxygen for their growth. Practically, the process is one of aeration, and to assure a sufficient supply of oxygen, the air is conducted into the filter beds through a series of small ventilating funnels which revolve easily on their vertical axes, and are equipped with wind vanes so that they will always face the wind. Every speck of filtering material is covered with bacteria which attack the liquefied sewage and transform it into a harmless liquid. Tests show that when the liquid is finally discharged from the filtering beds at Atlanta it is 98 per cent pure.

When the sludge is to be removed from the sludge-digestion chamber, it is simply forced out through a pipe by the hydrostatic pressure of the liquid in the tank. It is a semiliquid substance that flows readily on a steep grade, and it is transferred to the sludge-drying beds by gravity, or by means of pumps, depending on the relative elevation of the septic tank and the drying beds. Here the sludge spreads out in a thin layer and is left to drain and dry. During this process the bacteria keep up their work, and by the time the sludge is sufficiently dried to be spaded into wagons and hauled away, it has been transformed into an unobnoxious and harmless substance which is valuable as a fertilizer.

Exportation of olive oil has been prohibited by Spain and Italy, but through the U. S. State Department special arrangements have been made for its shipment to this country, providing the importers give bond against its subsequent disposal in foreign markets.



Pacific Flush Tank Co., Inc. 9153  
 4241 Ravenswood Av. Chgo.  
 149 Broadway New York  
 POPULAR MECHANICS  
 American agents for Dr. Karl Imhoff.



In the Pictures Above Two Views are Given of the Concrete Aqueduct, 276 Feet Long, That Forms Part of the Sewage Disposal System at Atlanta, Ga.



At Left, the Filter Beds in Operation: The Liquefied Sewage is Sprayed over the Beds, under Which Air is Introduced by the Ventilating Funnels

A General View of the Imhoff Septic Tanks is Given Below. After being Treated in These Tanks the Sewage Goes to the Filter Beds for Final Purification



The Transverse Section at the Left Shows a Typical Arrangement of the Parts of an Imhoff Tank, While the Course of the Sewage through the Tank is Indicated in the Longitudinal Section at the Right

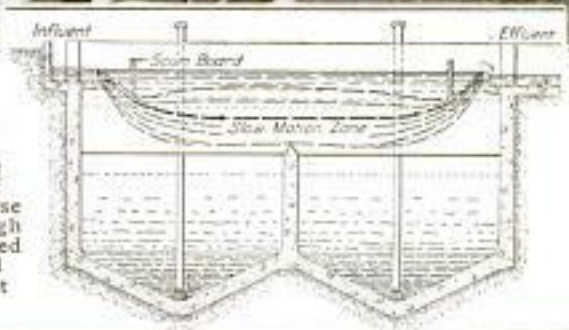

As the Sludge is Taken from the Septic Tanks It is Pumped or Conveyed by Gravity to the Drying Beds, Where It is Allowed to Drain and Dry before being Removed. There is Practically No Odor from These Beds



Do not design & instal plants  
 Royalties-(about) \$2500 12000, 250 people  
 9000. " 500000.

**MONUMENT TO DISCOVERER  
OF NITROGLYCERIN**

At Turin, Italy, a monument has been erected in memory of Ascanio

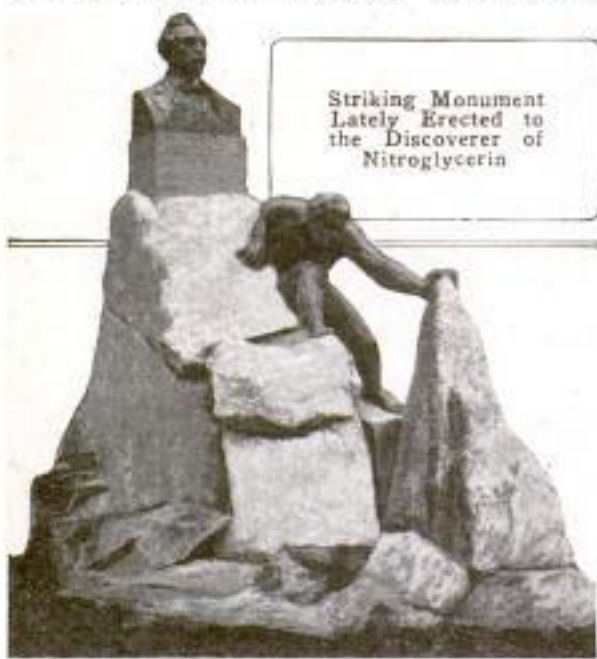

Striking Monument  
Lately Erected to  
the Discoverer of  
Nitroglycerin

*Int. News Service  
23 William St., N.Y.C.*  
Sobrero, who in the course of laboratory work in 1846 obtained nitroglycerin for the first time. The work is particularly of interest because of the simple, forceful way in which its sculp-

tor has depicted the outstanding accomplishment of the Italian to whom it is raised. A bust of Sobrero surmounts a rugged pile of rocks. At one side and below the bust is a figure of a Hercules, personifying the explosive, braced as if exerting his superhuman strength to break apart the rocks with one mighty move.

*9757 Bath Truck*  
**MOTOR-CAR BATHING OUTFIT  
DESIGNED FOR ARMY USE**

*The Car 3-24-15*  
Another use of the motor car in war has been found by a British company which is now manufacturing portable bathing equipments for the British soldiers at the front. The motor bath car carries 12 folding tubs made of specially prepared canvas and provided with substantial iron frames which hold their form rigidly when extended. When in use, these are placed in rows on each side of the car and covered by a tent made by drawing out canvas pieces fixed to the top of the machine, and securing them to tent poles. Two boilers, each of which heats approximately two gallons of water a minute, are mounted in the car. Paraffin sprayed under pressure is the fuel used with these. A 50-gal. water tank is fixed to one of the runboards, and to replenish it, water is drawn in by means of a hose and hand pump. For transportation, the tubs are folded compactly, so that the entire equipment is readily carried in the body of the machine, which is lined with sheet iron and provided with shelves.

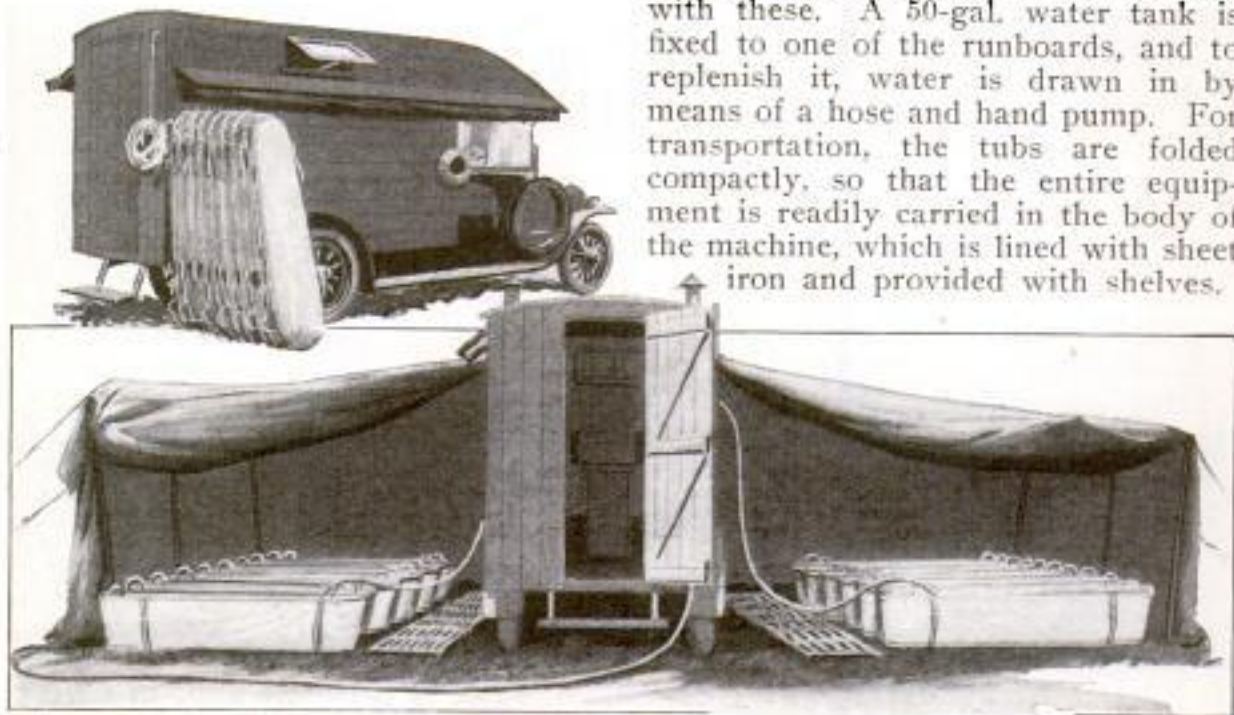

Motor Bath Car Developed in Great Britain for the Use of English Soldiers Fighting at the Front. Above, the Tubs are Shown Folded in Readiness to be Placed in the Machine for Transportation

*Drawn, Hughes Strachan, Ltd.,  
Holland Gate, High St., Kensington W.,  
London.*

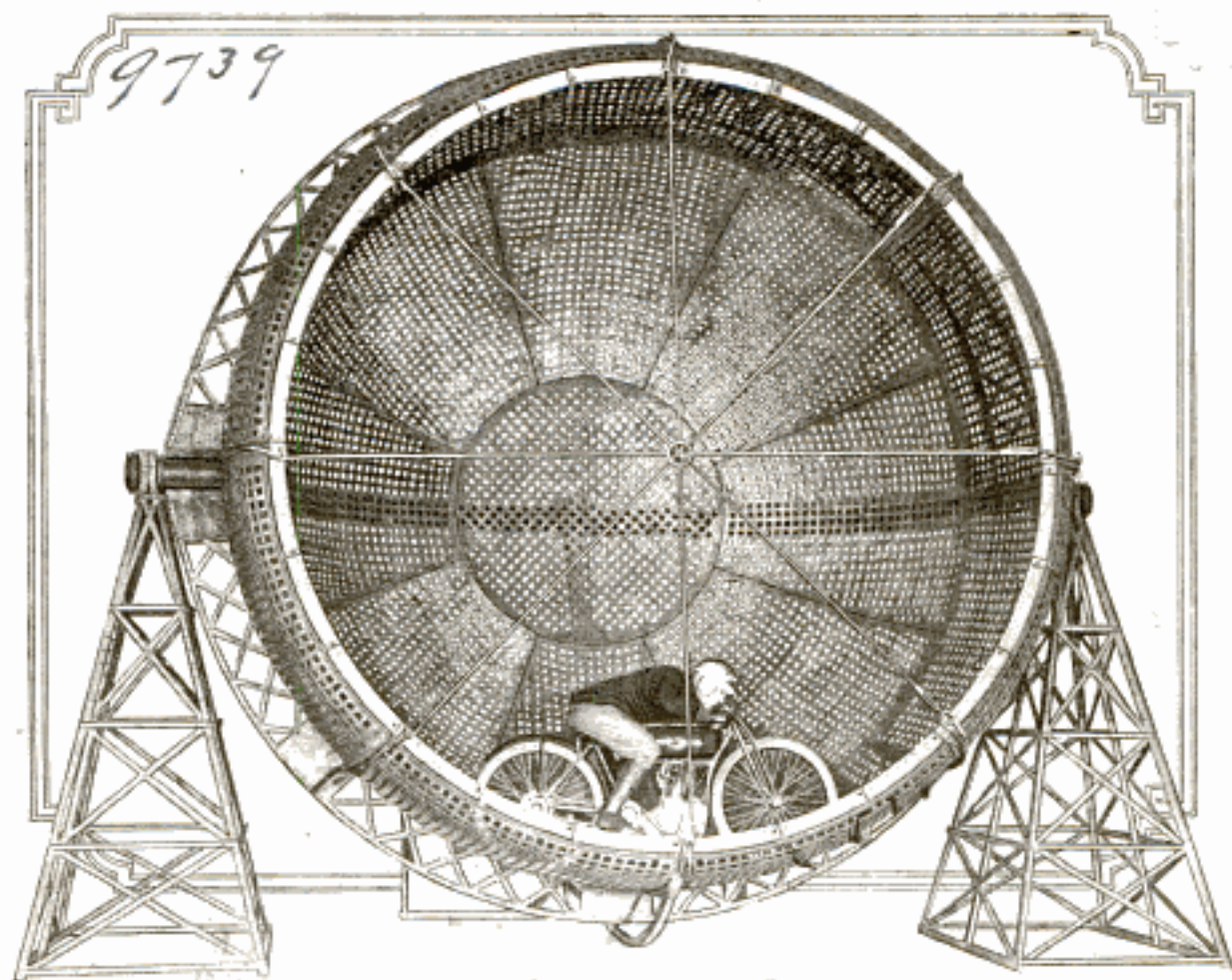

New "Bowl of Death" Which Turns from a Horizontal to a Vertical Position and Back Again as the Rider Drives His Motorcycle at High Speed around the Rim

## A NEW AMUSEMENT-PARK

### THRILLER

The latest thriller for amusement parks and similar institutions is a so-called "bowl of death" which turns from a horizontal to a vertical position and then back again as the rider drives his motorcycle at high speed around the rim. The bowl is made up of segments of perforated steel, is 15 ft. in diameter, and is hemispherical in shape except for a flat section at the center and a sharp inward curve at the rim designed to furnish the rider some degree of protection against the danger of running off the edge. When the motorcyclist begins his ride the bowl is horizontal, with the open side up. As soon as the machine attains sufficient speed to ride on the vertical edge the bowl is slowly swung to a position in which the open side is vertical. Following this the rider loops the loop one

or more times. To end the ride it is necessary for the bowl to be swung back to its original position, when the rider slowly cuts down the speed until the machine is brought to a stop at the center. The bowl is carried on bearings supported on small towers as shown. The turning device consists of a pinion mounted on a tower at the rear and meshing with a rack on the back of the bowl.

## WEATHER-REPORT SERVICE TO BE EXTENDED

Because of the interest of such information to the public at large as well as its practical value in many lines of manufacturing, daily reports made by the U. S. Weather Bureau will in future include the humidity at 2 p. m. At present, observations are made only at 8 o'clock in the morning and 8 o'clock in the evening.

Dept. of Agriculture.

Dr. W. R. Hess (Inventor)  
University of Zurich

186

POPULAR MECHANICS  
Zurich, Switz.

STEREOSCOPIC PHOTOGRAPHS

SCOPE OF POSTAL SAVINGS

9835 MADE IN NEW MANNER

9983 BANKS BROADENED

After a great many failures in attempts to make stereoscopic views which would not necessitate the use of

In order to accommodate persons living in sparsely settled districts where post offices are not designated as postal savings banks, an extension of the service has been made which allows accounts to be opened and banking done by mail. By this plan the intending depositor makes application through his local postmaster, who identifies him at the nearest authorized office. Subsequently, transactions may be made direct to the postmaster at the banking point and money sent either by postal order or registered mail. Withdrawal of all or any part of a savings account may be effected by mail and without previous notice being given. Any person, ten or more years of age, is entitled to open an account in this manner. The amount of any account cannot be disclosed to other than its depositor, and married women may place money free from the control of their husbands. Printed instructions in 22 foreign languages concerning this new service are to be distributed to all post offices.

Press Notice  
J. O. S.



This Illustration Gives an Idea of How the New Stereoscopic View Looks When Held at the Proper Distance from the Eyes

sphero-prismatic lenses for transmitting the double images to the eyes of an observer, a German scientist has developed a distinctly new process which apparently accomplishes this and at the same time holds out certain promises for the eventual production of stereoscopic motion pictures. The method consists essentially of coating a plate with a film, the front of which bears a series of ridges that present convex refracting surfaces to the light and serve as minute magnifying lenses. The thickness of this film is necessarily equal to the focal length of the refracting mediums. A double impression is obtained on the back of the film when an exposure is made, so that when viewed from a certain distance through the grooved side, a stereoscopic picture is seen. The ridged film is exposed in the same manner as smooth ones and does not necessitate the use of a two-lens camera.

### NEW BAGGAGE CARRIER FOR 9660 AUTOMOBILES

One of the latest types of baggage carriers for automobiles is a sheet-steel case that is secured to the running board and is designed to hold a removable vulcanized-fiber suitcase. On an ordinary touring car about four of these cases may be used to advantage, arranged as shown in the illustration. An incidental advantage is that when the car is stopped over night the suitcases can be removed and the accessories of the car locked up in the carriers.



Cory Metal Products  
Cory, Penna.

*Redlands Country Club*  
*Redlands, Calif*

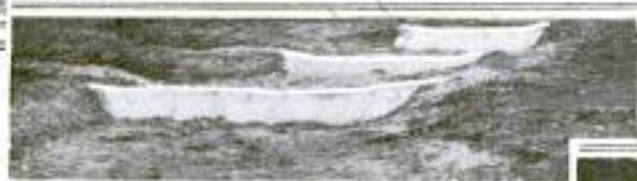

The Banks of the Cuts are Reinforced with Cement, to Preserve Golf-Links Hazards

In Certain of the Channels Concrete Dams have been Built to Lessen the Force of the Flow. At the Right is Shown a Cemented Path Leading from a Channel



9888 *Link*  
**GOLF COURSE IS PRESERVED BY USE OF CEMENT**  
*# Marple*

Cement has been used extensively at a country club on the Pacific coast in preserving a golf course which was gradually being ruined by cuts washed through it by storm water. The course lies in a valley, and following heavy rains a large flow of water is drained through it from the surrounding hills. The banks of the various cuts have been lined adequately with cement, so that the periodical rushes of water are now restrained from breaking through the sides of the ditches and starting new cuts, or broadening the old ones. Some of these are little more than two feet in width, while others vary from 10 to 15 feet across. In many of the channels, especially at points where the water rushes most swiftly, a series of low dams has been built several feet apart in order to break the force of the streams. In this way the injurious effects of the washes have been largely overcome, while the advantage of having the cuts as natural hazards has been retained.

**CHICAGO LEAGUE FIGHTS 9979 FLIES IN NEW WAY**

Through the organization of a new antifly-campaign league, a movement has been started at Chicago which will, if successful, have the effect of causing a national boycott against dealers in food supplies who refuse to protect their stocks from infection by this pest. The work is essentially a propaganda of education directed at the housewife and depends largely upon her for its results. It aims to stimulate such a feeling of loathing against the fly and food infested with flies, that merchants in general will be compelled to conduct pestless, sanitary shops, or close their doors for lack of patronage.

*Boycott the Fly League*  
*1422 Linton Blvd.*  
*14 E. Jackson St.*  
*Chgo*

**"HOUSE ELECTRICAL" SHOWN  
AT EXPOSITION**

By the person who is only superficially familiar with the myriad of practical electrical appliances which have been developed for the home, a model Spanish bungalow, at the Panama-Pacific Exposition, in which electricity is made to perform nearly every domestic and personal service worthy of consideration, could not be looked upon as other than Utopian.

The rooms are heated, cleaned, lighted, and the air in them purified and cooled, by electricity, while intercommunicating telephones are provided between them. There are an electric fireplace with a luminous radiator in the living room, an electric piano player, electric door bells with an annunciator for the servants, and, also, an illuminated house number on the outside. In the dining room, the buffet and table hold sufficient equipment to allow a light, quick meal to be prepared without entering the kitchen. A warming closet is provided at the entrance to the butler's pantry, while at one side of the dining room is a breakfast alcove.

In the butler's pantry are a special dish washer for delicate ware, a disk stove for various purposes, an electric silver buffer, and other conveniences. The kitchen has an electric range, an

electric water heater, and an ozonator and exhaust fan to carry off cooking odors. An electrically lighted and cooled refrigerator as well as a power-driven cream freezer is likewise provided. Electric toilet articles are placed in the bedchamber, dressing room, and toilet. A master switch with which every light in the house may be turned on is supplied. The toys in the nursery are electrical, the laundry is thoroughly equipped with power apparatus, as is also the workshop and garage, and the creamery is fitted out with an electrically driven separator, churn, and washer.

9999 —  
**DEEP WATER THROUGH CAPE  
COD CANAL PLANNED**

*C. S. Monita 5-8-15*  
Preliminary preparations are being made for deepening the new Cape Cod Canal to a 35-ft. waterway in order that it may be able to accommodate the largest battleships of the United States Navy. At the present time it receives vessels having a draft of 18 ft. or less. It is expected also that before long steps will be taken to protect the channel by erecting fortifications at its terminals. The waterway was recently constructed at a cost of about \$12,000,000 and shortens the distance between Boston and Atlantic coast ports, south of Cape Cod, by 70 miles.



In This Bungalow Electricity is Made to Perform Practically All Domestic and Personal Services. The Meals are Cooked, the House Cleaned, the Rooms Heated and the Air Freshened by Pushing a Button

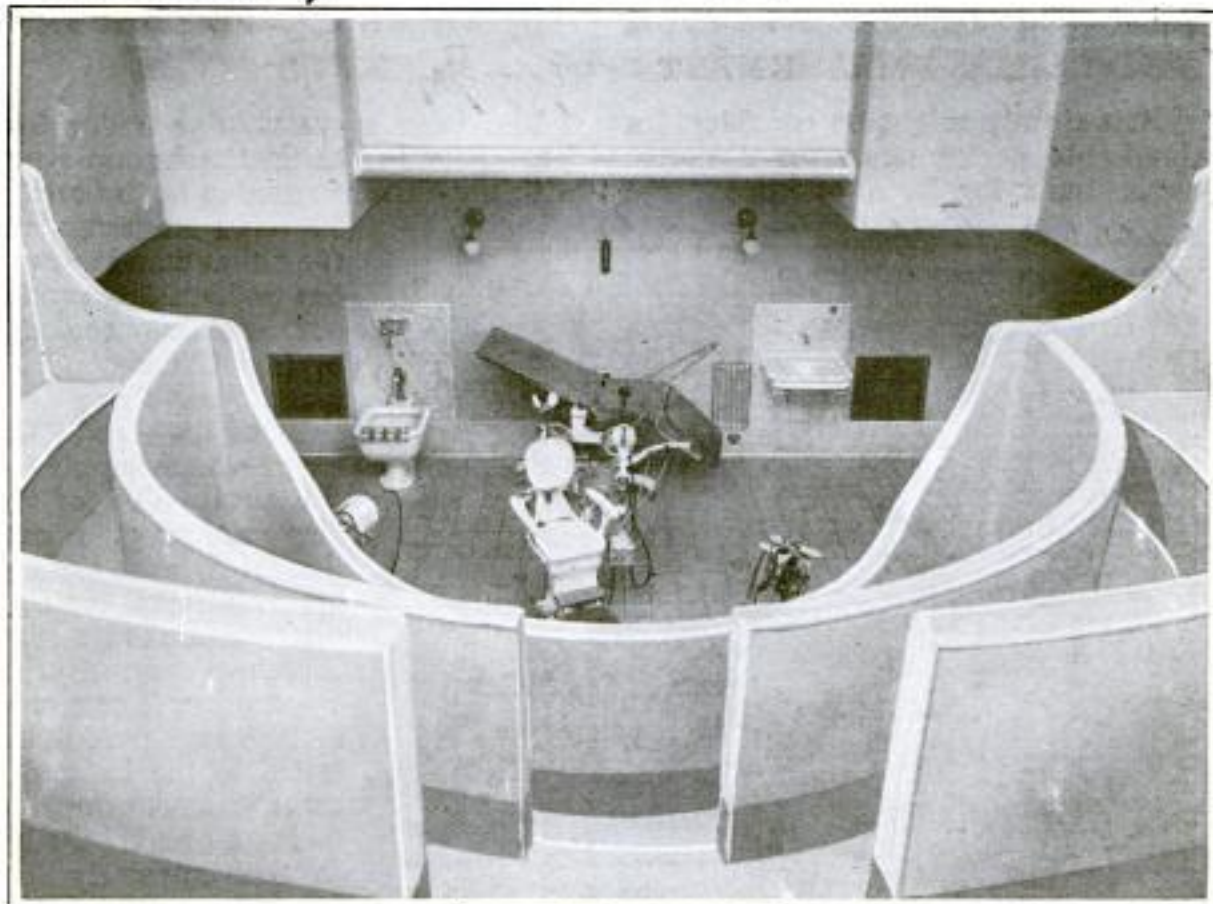

Concrete Amphitheater in Children's Dental Infirmary Recently Erected at Boston: The Ease with Which Cement Work may be Kept in a Sanitary Condition Makes Its Use Desirable in Hospitals

9822

**CONCRETE AMPHITHEATER  
 FOR DENTAL CLINICS**

Concrete has been used in the construction of a clinic room in a new dental infirmary for children which has just been completed at Boston. This material was employed in preference to others because of its value from the point of sanitation. The benches, as well as the flooring, of the amphitheater are thus much more readily kept clean than if they were made of wood, as has most often been the case in older institutions. Concrete is rapidly coming to be more and more used in hospital construction, as it has been found particularly satisfactory for the purpose.

One hundred tons of the leaves used in making absinthe have been publicly burned at Pontarlier, France, in accordance with the new legislation prohibiting the manufacture of this beverage.

9744

**SHINING GLOVES ARE WORN  
 BY TRAFFIC REGULATORS**

Traffic policemen at St. Louis have

been provided with white patent-leather gauntlet gloves which they are supposed to wear when directing vehicular travel at night or during heavy fogs. The reason for this is that the glossy surface of the gloves reflect the rays of light directed against



them from street and motor-car lamps, which makes them so conspicuous that they can often be seen by a driver before the figure of the officer is discernible.

# Nov 3, 1901  
 Washington Herald,  
 St. Louis.

Yuba Construction Co.  
Marysville, Calif.

190  
9441

POPULAR MECHANICS

433 Calif. St. San Francisco Water

FARM TRACTOR FORDS DITCH  
AND CLIMBS EMBANKMENT

REPAIRING PIPE LINE IN  
FROZEN RIVER

What rightly might be considered a remarkable performance for a motor tractor built for farm purposes, was

9792 Repairing a water pipe under four feet of ice in the Saskatchewan River with the current running at the rate of

"Yuba Ball Tread Tractor"



Fording an Irrigation Ditch with a Farm Tractor in Order to Save Time

accomplished recently when one of these machines was made to ford a steep-sided irrigation ditch in California. The feat was not performed as a test, nor as a demonstration of the machine's power, but merely to save the time which otherwise would be consumed in driving a mile to the first substantial bridge. It made its way through the water and up the opposite embankment without difficulty. The performance illustrates graphically the capabilities of this type of machine and tends to demonstrate how it would act in working on soft or sandy soil.

at each trip. The pipe line was found to be covered with silt and gravel and it was necessary to remove this to get to the break. At the end of the lane farthest from the shore a pile was driven and to this was fixed a sheave through which was run a cable for working a bucket shovel, the cable and shovel being operated by a donkey engine mounted on the shore. With this equipment the pipe line was uncovered, the silt and gravel being piled up in an incline toward the shore, and the final work of repairing the break was done with little difficulty.

9810

CAMERA SHOWS WONDERS OF MINUTE OBJECTS

Photomicrography, which consists principally in making greatly enlarged photographs of microscopic objects, is an art which has been developed of recent years and is coming more and more into popular notice. It is particularly of interest because it uncovers to

the naked eye the remarkable beauties of minute things, as well as worlds or fairylands of the tiniest, most infinitesimal sort, which have never before been so open to general appreciation as now because their study has not been possible without the aid of a microscope.

# Francis J. Bivie  
18 Hammer E. Edmonton, Alberta, Canada  
Bellamy St.



Edward F. Bigelow  
*Arcadia, Sound Beach, Conn.*  
 POPULAR MECHANICS, 9810<sup>191</sup>  
 News Contributor.

9810  
 Photomicrographs of Objects, so Tiny as to be Invisible to the Naked Eye, are Taken with This Apparatus, Which Consists of a Camera, Microscope, and Two High-Power Lights

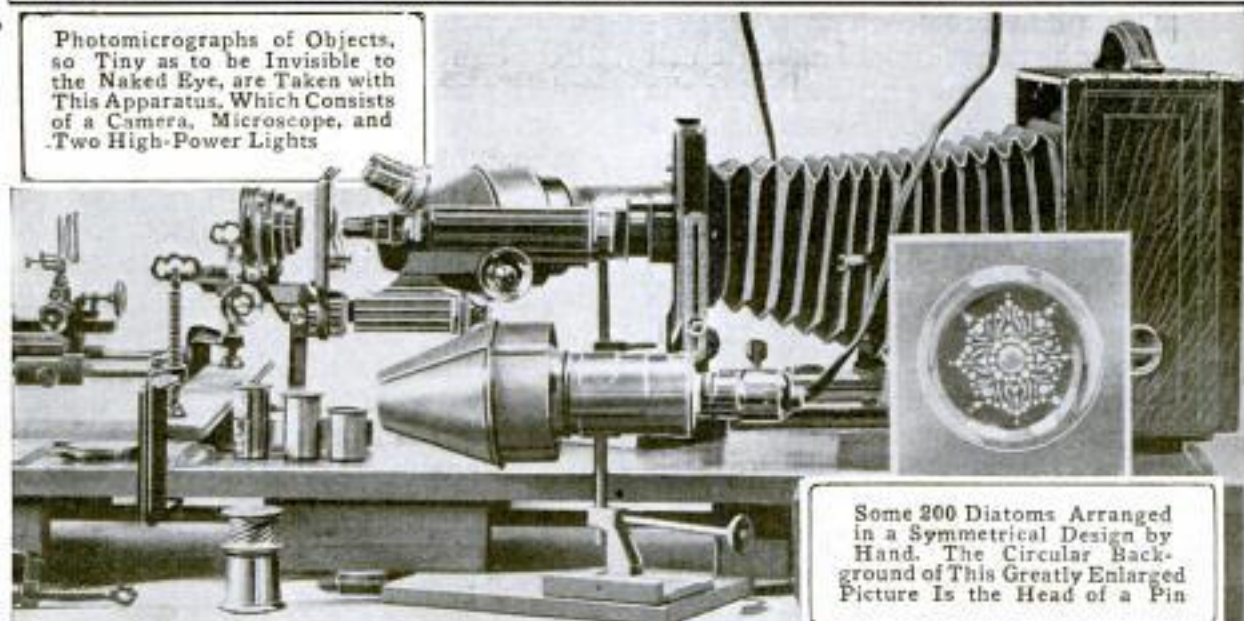

Some 200 Diatoms Arranged in a Symmetrical Design by Hand. The Circular Background of This Greatly Enlarged Picture Is the Head of a Pin

At the Left Is a Photomicrograph of a Design Much Smaller Than a Pin Head

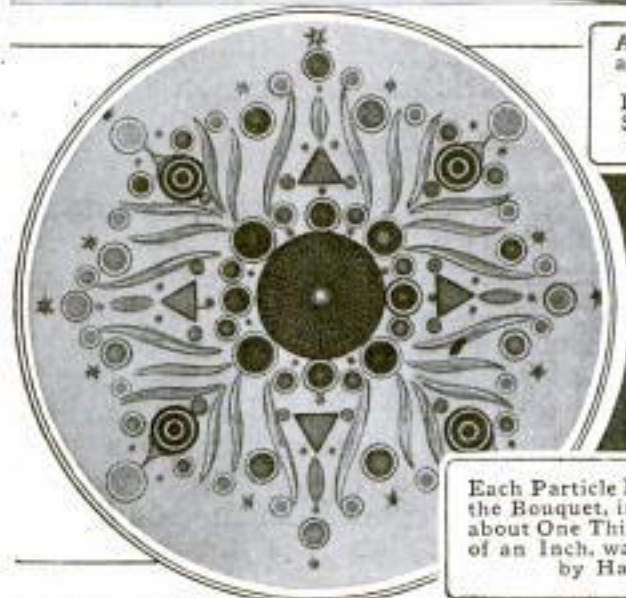

Each Particle Making Up the Bouquet, in Diameter about One Thirty-Second of an Inch, was Grouped by Hand



PHOTOS BY EDWARD F. BIGELOW

*Arcadia Sound Beach Conn.*

At present, however, photographs of this nature are becoming more or less common, making it convenient for the layman to see, as has the scientist and student for years past, many of the striking phases of microscopic matter.

Some years ago an eastern jeweler engraved the Lord's Prayer on the head of a pin. This was justly considered a remarkable example of skill. It was also a thing which interested many persons who never saw the work itself, for its nature could be readily understood and appreciated without being illustrated. This, on the other hand, is not true of some work of much the same character and even greater interest which has been accomplished.

A bouquet with all the beauty of form that characterizes a flower-filled vase, or a shower of daisies, and yet smaller in size than the head of a pin, is one example of the things which, except for photomicrography, could not be fully appreciated by the average person. Bouquets of this tiny size have been made by persons adept at such work, as have other things of equal curiosity, and then photographed. The resulting pictures, several of which are shown in the accompanying illustrations, have been enlarged to such a point that unless informed as to their nature a casual observer would pass them over as being photographs of the ordinary kind.

These minute "bunches of flowers"

are made of diatoms, which are vegetable growths consisting of a single cell whose wall becomes petrified after the death of the organism. By the use of a hair, these plants, smaller than a fine grain of dust, are lifted and grouped in symmetrical forms, several hundred of them often being used to make a single design. They are then covered with an extremely thin leaf of glass and preserved.

In taking the pictures of these tiny objects an apparatus consisting of a camera, a microscope, and high-power lighting equipment is used. The work may be done in different ways, but especially good results have been obtained by using reflected light, gained by placing projectors on two sides of the camera and focusing their light upon the object while making the ex-

posure through a microscope. When a direct light is used it is of less intensity and is placed immediately back of the object. When an object and a plate are equidistant from a lens, the image impressed upon the plate by exposure is of the same size as the object. So, by setting the lens of a camera at its proper focal length from the object, and then placing the plate a number of feet back of the lens and beyond the focal distance, an enlargement is obtained. A long camera with a short-focus lens is frequently employed, as is also a long-focus camera when the plate is set four or five feet from the lens. Sometimes, by the use of section boxes, a plate is put as far as 24 ft. back of the camera lens in order to obtain the desired magnification, although this cannot be said to be a common practice.

9824

### TRUCKS WITH TURNTABLES BUILT FOR NAVY YARD

Electric shop tractors of a special design have recently been built for the government and are to be used at the Bremerton, Puget Sound, Navy Yard in moving heavy steel structural members between different points. They are reinforced to carry three-ton loads and when operating on the level are capable of maintaining a maximum speed of approximately five and a half miles an hour and cover about 30 miles on a single charge. Surmounting the steel platforms of both the trucks and

their trailers are broad turntables which enable the longest beams that can be carried on standard flat cars to be transported without difficulty. These devices turn freely, making it possible for the tractors and cars to turn the corners of buildings and pass from main runways into cross aisles with their unwieldy loads. The driver's seat is offset from the body of the machine so that it is not in the way when it is necessary to place a beam in advance of the fore part of the tractor. Cast-steel wheels with 24-in. solid tires are used, while the power is derived from a 30-cell storage battery.

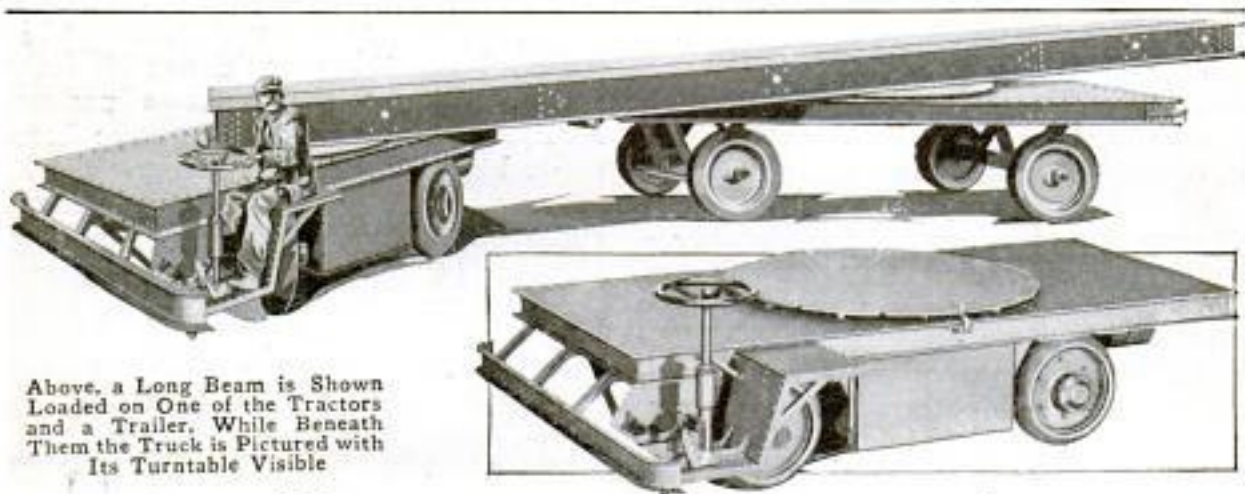

Above, a Long Beam is Shown Loaded on One of the Tractors and a Trailer, While Beneath Them the Truck is Pictured with Its Turntable Visible

The Inverter Electric Co.  
Indianapolis, Ind.

## LAUNCHING OF GREAT AMERICAN DREADNAUGHT

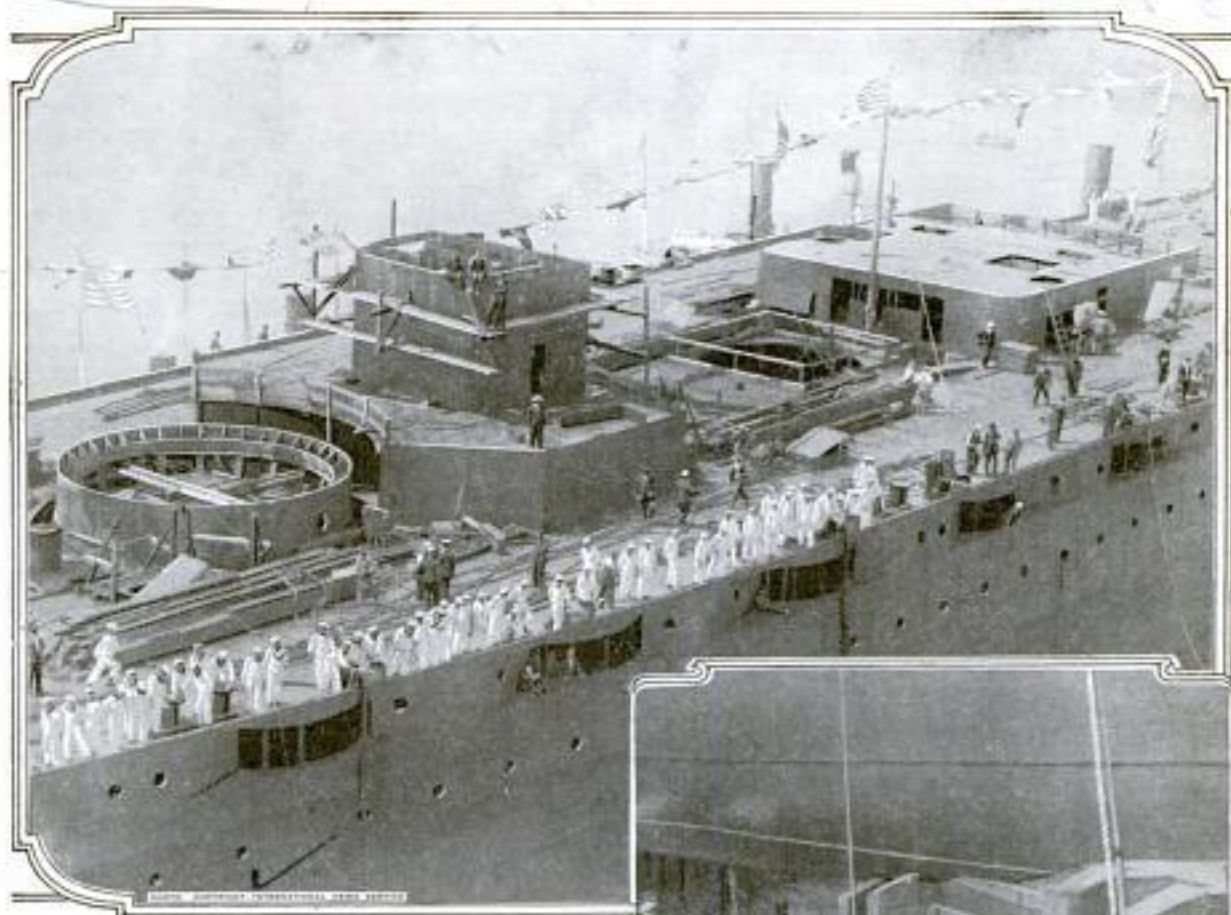

Deck View of the "Arizona," Showing the Base of One of the Revolving Turrets at the Left, as the Vessel was Towed to a Dock after Its Maiden Plunge in East River

Before throngs of cheering people the U. S. S. "Arizona," the sister ship of the "Pennsylvania," was launched in East River at the New York Navy Yard, June 19. When it is completed the dreadnaught will be one of the largest and most powerful war vessels afloat. It measures 608 ft. in length, has a 97-ft. beam and will be equipped with oil-burning engines. Its main battery will consist of twelve 14-in. guns and the secondary battery of twenty-two 5-in. rapid-fire pieces. The "Arizona" was christened not only with champagne, but also with a bottle of water—the first to flow through the Roosevelt Dam spillway. This was preserved at the time the dam was finished and saved for the recent ceremonies. The christening party, consisting of the secretary of the navy, the governor of the state, and others, occupied the official stand, while the

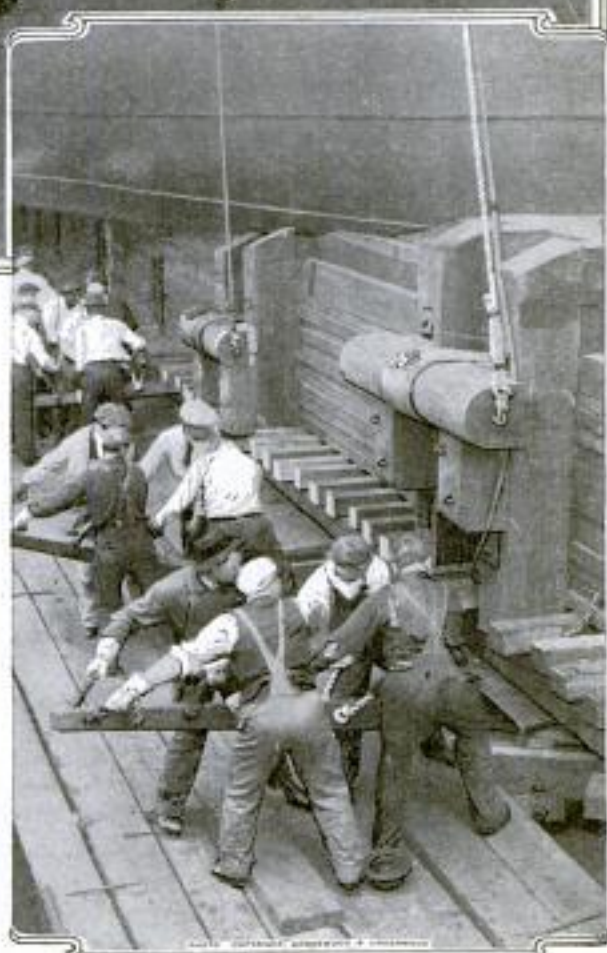

An Interesting Launching View, Showing Workmen Releasing the "Arizona" from the Ways

ship's sponsor, an Arizona young woman, broke the bottle over the bow of the vessel, naming it "Arizona."

## RAILROAD RUNS LUNCH CAR 52 FOR GOLFERS

A special lunch car for the convenience of golfers bound for golf links in the suburbs has been placed in op-

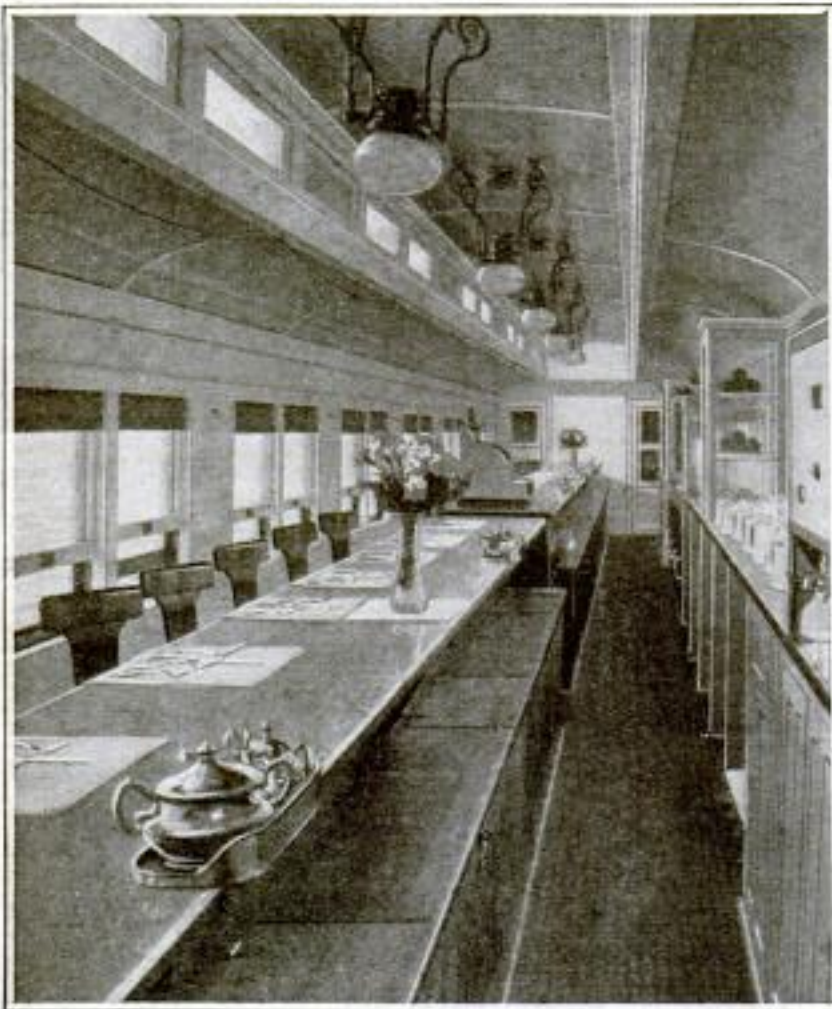

Interior of Lunch Car Placed in Service by a Western Railroad for the Convenience of Golfers

eration by one of the railroads running out of Chicago, and by making use of this car with its quick service, the golfer is ready for the game as soon as he reaches his destination. This car regularly carries players to more than a dozen links scattered along the lake shore north of the city.

ⒸAn automobile club in St. Louis employs a "first-aid" squadron consisting of expert mechanics who go out along the roads within 15 miles of the city on Sundays and stand ready to give aid to any car that is broken down or stalled.

## MODERN SEWERAGE SYSTEM 129 FOR CAIRO, EGYPT

For disposing of the sewage of Cairo, Egypt, a modern system that has been under construction for about

six years was placed in service in March, 1915. The principal feature of the system is a sewage farm containing 3,000 acres and located in the desert about 12 miles from the city. The central part of the city is divided into districts, each of which drains to a central station. From these stations the sewage is pumped by compressed-air ejectors to a central pumping plant from which it is forced through a long outfall sewer to the sewage farm by pumping machinery capable of delivering approximately 1,800 cu. ft. a minute against a head of 250 ft. Although placed in service, the sewerage system is only partly completed, the work having been seriously interrupted by the war. The farm is designed to utilize

the sewage of a population of about 750,000.

## 35 NOVEL SIGN FOR PROMOTING RELIEF OF THE BELGIANS

A novel and effective method of appealing for aid in feeding the starving Belgians is being used in Pittsburgh. On a signboard, 17 ft. high and 49 ft. long, are painted various appeals for aid as well as a picture of an ocean liner putting out to sea past the statue of Liberty, while above the board there project two smokestacks and a real steamboat whistle. The

E. Bancroft James, Engineer



Realistic Sign Used in Pittsburgh in Appealing for Aid for the Belgians

whistle blows at intervals and smoke issues continually from the smoke-stacks. Steam for the whistle is furnished by a boiler used on a near-by construction job, while smoke for the stacks is furnished by stoves placed at the rear of the board.

using crooked sticks or hitching two or more men or women to small plows. With the new tool it is possible for one man to do more and much better work than formerly has been accomplished

9931  
**MAN-POWER PLOW DESIGNED FOR FILIPINO FARMERS**

Intended particularly for use in the Philippine Islands, where beasts of burden are scarce and human labor cheap, a man-power plow is being built which represents a great improvement over the crude implements heretofore employed by the natives for tilling the soil. It is provided with a single wheel at the front which by adjustment regulates the depth of the furrow to be turned. The propulsion power is gained by a long lever, extending in the rear of the implement, which when raised and lowered actuates an arm that pushes the share ahead. Because of the expense of draft animals, small farmers in the past have plowed their patches of ground for the most part by

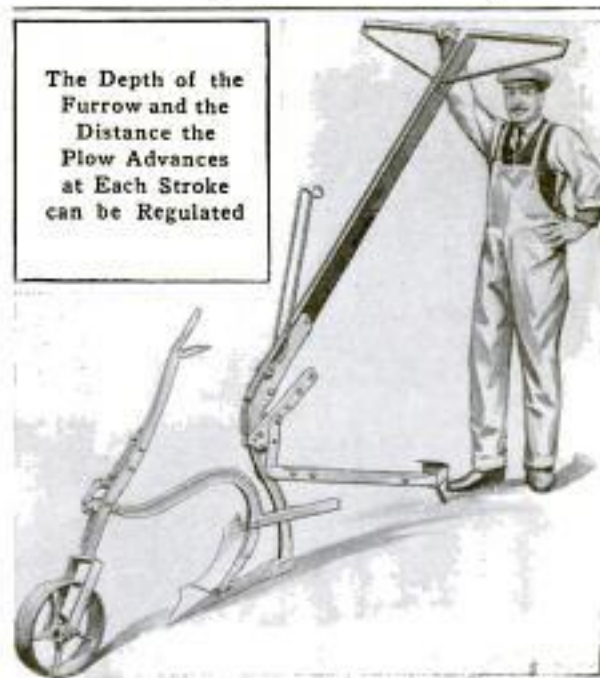

COURTESY OF FARM AND FIRESIDE

by three, for with moderate exertion he can plow a fifth of an acre in a day.

Salvador  
 Taro, (Inventor)

# Geo. H. Mosser  
Mqr. Chamber of Commerce  
Altoona Pa

*116*  
*116*

68 **CIVIC FLAG IS ADOPTED  
BY PENNSYLVANIA TOWN**

*c.s. Moneta 5-13-15*

Following a local competition, the city council of Altoona, Pa., officially adopted a design for a municipal flag.

The purpose of the banner is



*Designed by Donald Howard*

Official Flag of City of Altoona,  
Pennsylvania

*Dept of Public Safety  
Altoona*

to arouse civic pride, advertise the community and stimulate allegiance to its home industries. The flag has a dark-blue rectangular field, one and one-twelfth times as long as it is wide, surrounded by a gold border. The design consists of a large keystone of blue outlined with white, on which is placed the seal of the city. At the top of the keystone is the coat of arms of Pennsylvania done in gold, black, pale green, and pale blue.

72 **MOUNTAIN ROAD IS BUILT  
BY MONTANA STUDENTS**

As evidence of the democratic spirit which is manifesting itself in many of our state educational institutions, students at the University of Montana who were in need of part-time employment during the winter months accepted the work of building a road to the top of Mount Sentinel, at the foot of which the university campus is situated. The forestry school of the university is now to build a lookout for forest fires on the mountain.

116 **ZEPPELIN LOSES BATTLE  
WITH MONOPLANE**

Official announcement of the most spectacular exploit so far performed in Europe's titanic conflict was made June 7 by the secretary of the British admiralty. It concerned the destruction of a Zeppelin dirigible in a daring aerial encounter 6,000 ft. above Ghent in Belgium. Six bombs were dropped on the hull of the German craft by Sub-Lieutenant R. A. J. Warneford, R. N., who attacked the enemy single-handed in a small Morane monoplane.

The battle in mid-air took place at three o'clock in the morning after the British airman had sighted the larger craft on the horizon between Ghent and Brussels while doing reconnaissance work. He flew directly over the airship and within 50 ft. of its upper surface. The last bomb burst the envelope, causing a terrific explosion which sent the bulky ship to earth, a fiery mass. The force of the detonation capsized the monoplane, but the pilot was able to regain control of it and make a spiral glide to the ground. He thereupon restarted his engine and escaped, subsequently landing on French soil near Cape Griz-Nez. A few days later while trying out a new machine, Warneford was killed in a fall with an American newspaper correspondent. It is reported that the kaiser, upon hearing of the airman's death, remarked, "He was a brave enemy."

Accomplishments similar to this were accredited to Roland Garros and other military fliers during the early part of the war. At first they were generally accepted as true, but since, most of the feats have been refuted. This is the first time that official announcement has been made of the destruction of an enemy Zeppelin in mid-air by a British, French, or Russian airman dropping bombs. Warneford, still a boy in appearance, was awarded the Victoria Cross by King George, and the Cross of the Legion of Honor by the French minister of war, for his bravery.

# Percy N. Stone  
416 E. Pine St.  
Missoula, Mont.

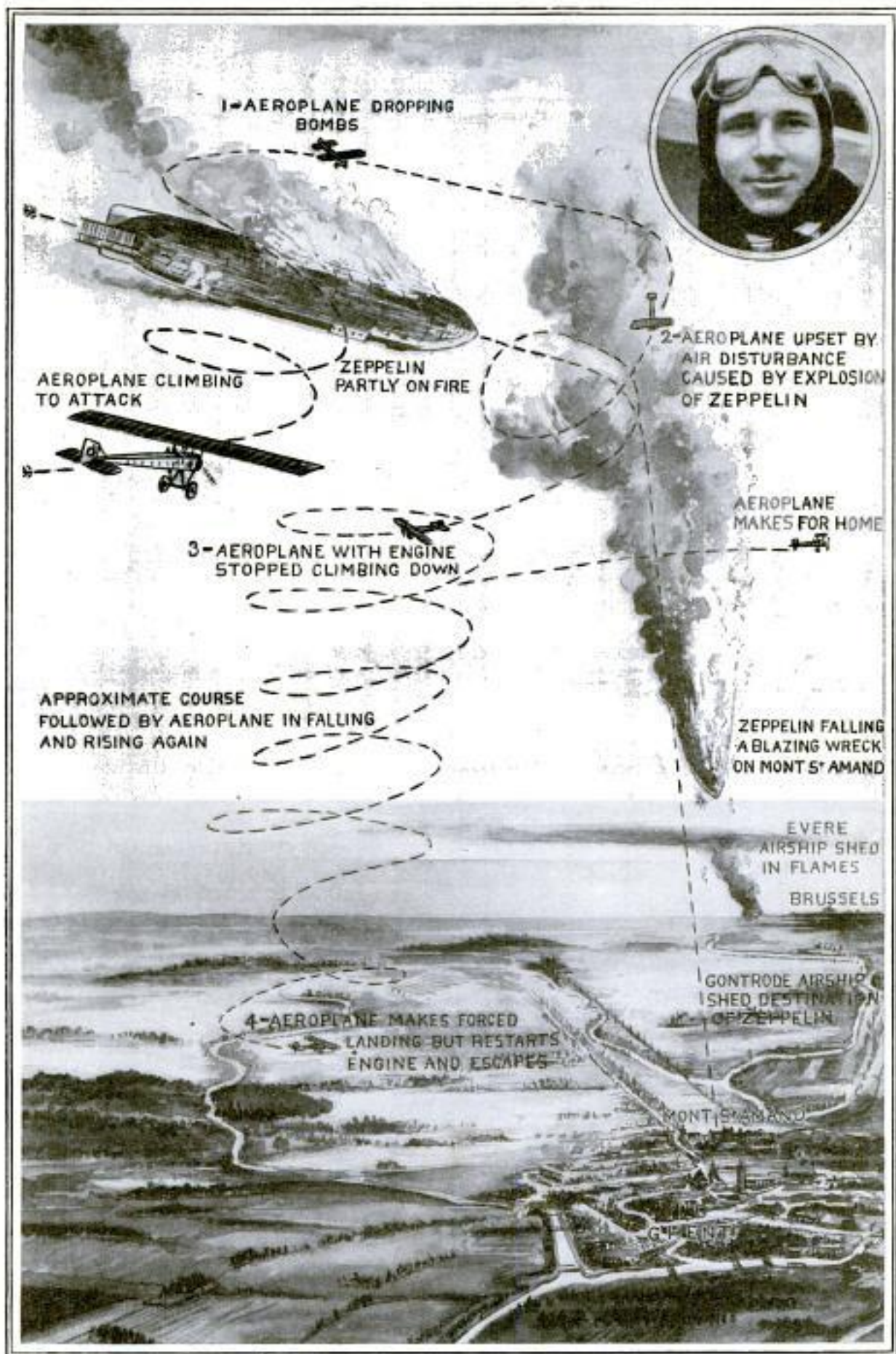

COPYRIGHT BY THE SPHERE, LONDON

6/12/15

This Illustration Shows Graphically How a British Airman Flying a Monoplane Attacked and Destroyed a Zeppelin over the City of Ghent Early One Morning in June. The Airman, Sub-Lieutenant R. A. J. Warneford, Now Deceased, is Shown in the Insert

54 **ELEVATOR TOWER IS BUILT LIKE PNEUMATIC TUBE**

To supersede the old-time Ferris wheel and giant seesaw for amusement purposes, an observation tower of very novel character has been constructed at one of Chicago's summer parks.

pneumatic or hydraulic plunger to push it. The car is raised and lowered in the steel and glass tower in precisely the same way that an engine piston is driven in a cylinder by steam pressure.

The tower, lately completed, has been in course of construction for several years. It is claimed that 150,000

tons of steel was used in it, while it is provided with more than a thousand separate window sashes and over 15,000 small plate-glass panes, which allow the passengers to see in all directions about them as they make the trip. The air is forced into the tower beneath the car by pumps which are driven by two electric motors, one of 100 hp. and the other of 125 horsepower.

The pressure of the air amounts to approximately one-fourth pound to the square inch, giving a lifting force of more than 25,000 pounds. Since the glass is able to withstand a pressure of 10 lb. to the square inch, there is no danger of its being blown out by this force. The elevator makes the trip to the top of the shaft in about two and one-half minutes, while its speed in returning to the bottom depends upon the weight of its load. Air

escaping gradually through rotary fans at the bottom of the tube allows the car to descend slowly on a pneumatic cushion. Portholes at the upper part of the tower permit air to escape when the elevator reaches the top, thus preventing it from being pushed out of the shaft. The operation of the device has been successful.



Remarkable Glass and Steel Tower in Which, without Cables or Plungers, a Large Elevator is Raised on a Cushion of Air to a Height of More than 200 Feet

The structure, which is built entirely of steel and plate glass, is twelve-sided in form, rises to a height of 214 ft., and is 30 ft. in diameter. Fitted in this, like a carrier in a pneumatic tube, is an elevator capable of holding 125 persons. This is literally blown to the top of the shaft by air pressure. There are no cables to lift it, nor is there a



# CHICAGO GETTING TO WORK DURING CAR STRIKE

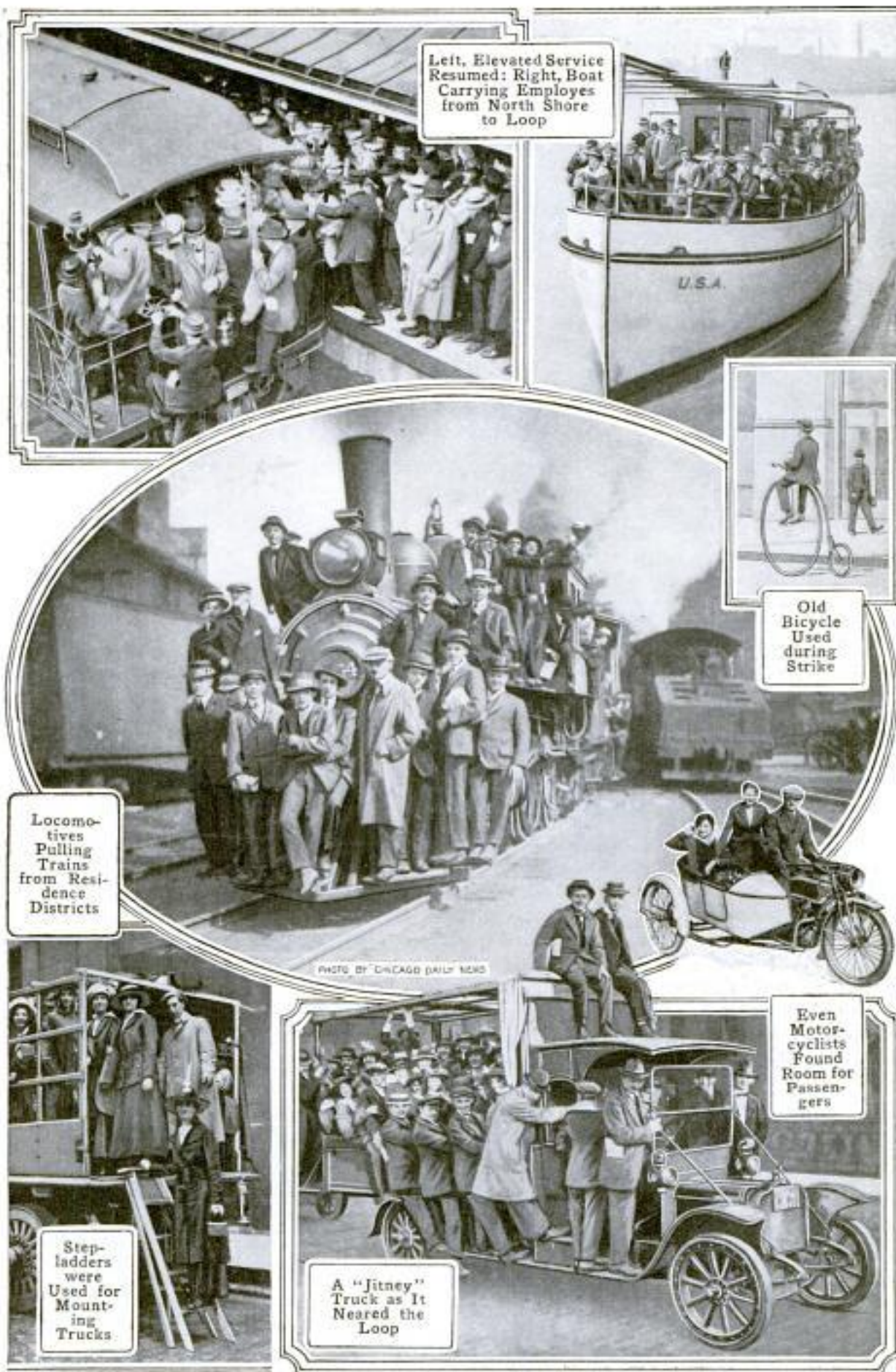

Left, Elevated Service Resumed: Right, Boat Carrying Employes from North Shore to Loop

Old Bicycle Used during Strike

Old Bicycle Used during Strike

Locomotives Pulling Trains from Residence Districts

PHOTO BY "CHICAGO DAILY NEWS"

Even Motorcyclists Found Room for Passengers

Step-ladders were Used for Mounting Trucks

A "Jitney" Truck as It Nears the Loop

**BOX OF DYNAMITE EXPLODES  
 9932 IN MOTOR CAR**

Four persons were killed and 18 others injured recently when a case

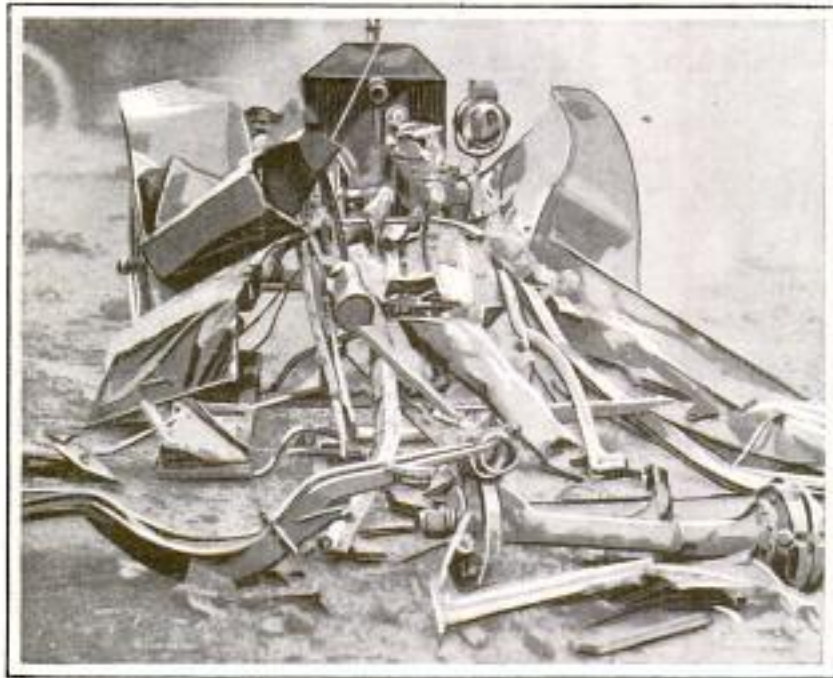

The Remains of the Motor Car After the Explosion Occurred

of dynamite loaded in a motor car suddenly exploded. The accident occurred on the bank of a creek in New York state where a searching party was working to recover the body of a boy who had drowned in the water previously. The victims of this second tragedy, with one exception, were spectators who had been attracted to the place by the dynamiting of the waters. While the cause of the detonation is not definitely known, it is assumed that the man in charge of the explosive, who was fixing percussion caps for the dynamite, accidentally caused a concussion of some nature. The car was completely demolished back of the front wheels and radiator, which, oddly enough, were not destroyed.

Many of the natives of Guatemala are expert toy makers, and a movement is now under way for developing the industry and making it a source of supply for the American market, formerly supplied by European makers.

**131 OPENING OF TUNNEL UNDER  
 JURA MOUNTAINS**

With the opening of the tunnel under the Jura Mountains on May 15, 1915, the last link was completed in the new low-grade railway route passing through Switzerland and connecting France with Italy. Work on the tunnel was begun in 1910 and was expected to be completed in May, 1914, but water bursts and other unexpected difficulties delayed the completion of the work for a year. The link of which the tunnel forms a part is 15 miles long, 13½ miles being in France and 1½ miles in Switzerland. The tunnel has a length of 6,670 yd., or nearly four

miles. Owing to the heavy pine forests along the route the new line is well protected from snowstorms.

**9976 SMOKESTACK IS CORRODED  
 FROM UNUSUAL CAUSE**

Within a comparatively short time after the erection of a large business building at Chicago, it became necessary to remove the top section of the steel smokestack, which was badly cor-



Because the Smokestack and Condenser Adjoined, Acid was Formed Which Corroded the Metal

# Diamond Lou Kaenel  
 317 Wendell St.  
 Chgo.

Mont d'Or Tunnel

*Journal*

131  
 N.Y. Age Gazette 6/11/15

#Walter Brickman  
Times-Star  
Cinti.

9917  
KITE-FLYING CONTEST HELD  
BY SCHOOL CHILDREN

roded. Responsible for this was the fact that the steam condenser and the stack had been placed side by side with their rims at the same level. This resulted in the sulphur gases and the condensed steam combining to the for-

Pupils of two rival schools at Cincinnati were recently pitted against each other in a kite-flying con-

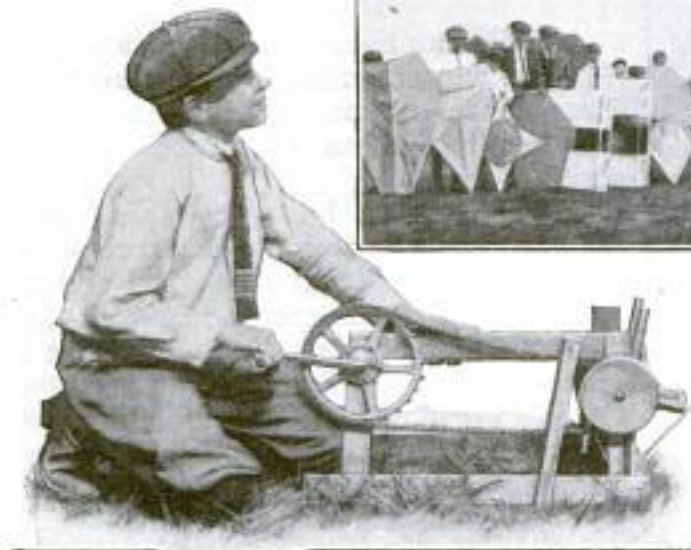

Improved Reel for Kite String



Some of the Kites Entered in the Flying Contest Recently Held by the Pupils of Two Rival Cincinnati Schools

test in which numerous kites of odd design were entered. Some of them were built like biplanes, pointed stars, and butterflies, while the old-fashioned bow kites as well as box kites, and others, were also in evidence. Prizes were awarded to the contestant who put his kite to the highest altitude, the one who let out the greatest yardage of cord, and to the boy owning the kite exerting the greatest pulling strength. In these events the bow kites showed their superiority over the others, for one of them succeeded in rising to a height of 705 ft. and another in flying at the end of 2,400 ft. of cord. The boy who won the latter event had constructed a reel, by using the sprockets of his bicycle, which proved to be of assistance in letting out and drawing in his kite.

mation of sulphuric acid, which in turn caused the rapid deterioration of the metal.

132  
INTERNATIONAL FLAG FOR  
WESTERN HEMISPHERE

6. J. Novita 6-7-15  
At the recent Pan-American conference in Washington, D. C., where means for establishing closer commercial relations between the United States and the countries of Central and South America were carefully considered, a movement was started for the adoption of an international flag to be used by the merchant marine of all the nations of the western hemisphere. A flag, made by the great-granddaughter of the colonial seamstress who made the first flag for the United States, was presented to the conference for consideration. This flag is white and bears a single blue star.

ⒸThe latest feature in office buildings is a garage located in the basement for the convenience of tenants.

RAILROAD STATION HOUSED  
IN PASSENGER CARS

After a railway station at Michigan City, Ind., had been destroyed by fire, leaving the companies which had occupied it without facilities for handling their local business, a number of passenger coaches were set out on an adjacent siding and converted into a complete depot. These served adequately to house the ticket, telegraph, and baggage offices and also provided

Otto Merz  
P. M. M. at Dept.

comfortable waiting rooms for the patrons. The locations of the various offices were indicated by overhead



An Improvised Railway Depot at Michigan City, Indiana

signs extended from the car platforms, while the customary bulletin board announcing the time of arrival and departure of different trains was attached to one side of the car which served as a ticket office.

## 69 BUSINESS WITH AMERICA PLANNED BY BELGIANS

For the purpose of introducing our products on a large scale in their country following the close of the war, a group of Belgian business men have formed an organization which is now making arrangements for the eventual establishment of American manufacturing agencies in the principal cities of the kingdom. The plan contemplates giving employment to many Belgians who have been partly ruined financially, but who still have sufficient capital for such ventures.

*Mr. Willy Lamot (of Antwerp)  
Shardhighs, Halstead, Essex, Eng.  
(Temporary address)*

## 174 LOGIC IN SPEEDWAY DESIGN SHOWN BY CHICAGO RACES

*Seale Hendee*

Five world records were established without a death or accident occurring when Chicago's new speedway, a two-mile board oval, was opened with a 500-mile derby on June 26th. In spite of the unprecedented speed, averaging 97.6 miles an hour, which was attained by the winning motor car, at no time was there an excuse for a sense of danger to obsess the minds of the spectators.

The track is built for speed and safety, and the results of this race serve to uphold its design as logical and to indicate that sane motor racing is mechanically possible. On this course a race instead of being a battle between tires, is a contest between finely tuned motors. This was responsible for the establishment of a new racing record won by an English car which completed the distance without making a stop and finished fourth after averaging 95.06 miles an hour. The machine entered with its gas and water tanks full and coasted across the finish mark with them dry. Its pilot did not once take his hands from the wheel throughout the entire race and experienced no tire trouble whatever.

Some 5,500,000 ft. of lumber was used in constructing the oval, which was erected in the remarkably short space of 36 days. It is surfaced with 2 by 4-in. tamarack timber laid edge-wise, forming a cool running base which is supported by square, 12-in. uprights placed on concrete foundations. The course has a width varying from 60 to 80 ft., and at the ends is gracefully banked to a height of 40 ft. The curves are graduated from 3° in the straightaways to 19° at the turns. It is this engineering feature which largely contributes to the success of the track, the design of which, it is believed, will be followed closely in building future speedways. The course is so laid that a car running at high speed has a tendency to keep to the oval instead of shooting to the outside, or off it, on the turns. This re-

# Julian D. Smith, Manager,  
The Cedars Rapids Hy & Power Co.,

9477 POPULAR MECHANICS  
Power Bldg., Montreal, Que.

203

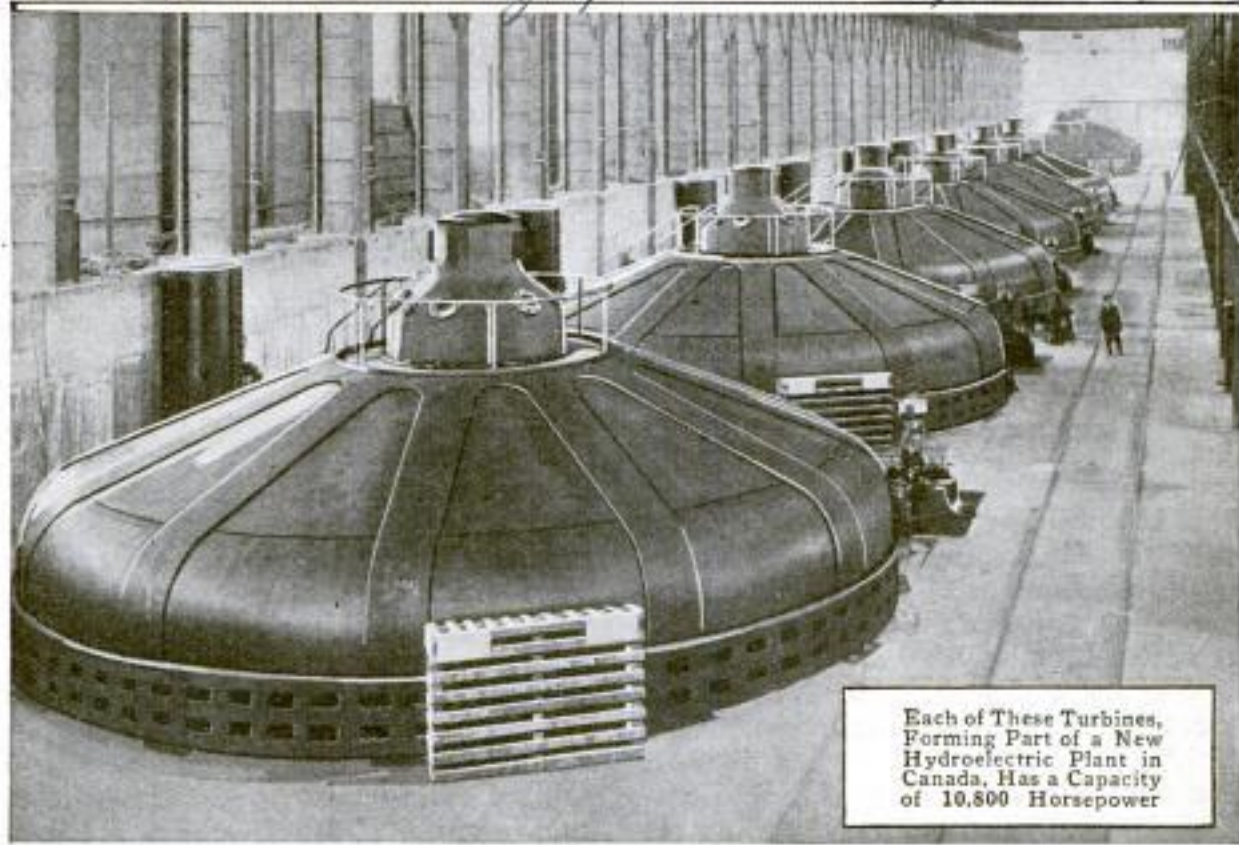

Each of These Turbines,  
Forming Part of a New  
Hydroelectric Plant in  
Canada, Has a Capacity  
of 10,800 Horsepower

*See card for construction.*

lieves the drivers of much strain, besides greatly minimizing danger.

The Chicago speedway has several interesting features in embryo which are more or less distinctive. It is backed by an association organized for the purpose of maintaining a year-around athletic field for outdoor sports of all kinds, motor racing being merely one of several activities fostered by it. The erection of an elaborate clubhouse equipped with sleeping and dining accommodations, ballrooms, and gymnasiums, is supposed to be started immediately. The membership of the club shares in the profits of the enterprise and is admitted free to all events. An 18-hole golf course is to be constructed in the 160-acre infield space, as are also tennis courts. Fifty-six acres of land has been reserved for a polo field and shooting range, while provisions have been made for a bridle path and a fast driving track. Both aviation and motorcycle events are planned to be held at the park, as are also military reviews and similar attractions which draw large crowds. These details are still to be worked out.

## NEW HYDROELECTRIC PLANT OF LARGE CAPACITY

Hydroelectric units that are the largest in the world in point of size and have the greatest capacity of any low-head turbines ever built have recently been installed and placed in operation at Cedars, Quebec, Canada. The plant now consists of ten 10,800-hp. main units and three 1,500-hp. exciters, and is to have ultimately 18 main units and six exciters of the same capacities. The turbines operate under a head of 30 ft. There is no dam, the water being conveyed to the turbines through a head-race that connects with the St. Lawrence River two miles above the plant. To save expense in the concrete in the substructure as well as to lessen the vibration in the units, the thrust bearings were placed at the tops of the generators.

With a powerful wireless station, erected in Russia since the outbreak of the war, direct communication has been established between that country and England.

74

*a City Point on the James River*

## FLAG STATION BECOMES CITY OVERNIGHT

SEVEN or eight months ago Hopewell, Va., was an obscure flag station on a branch line of the Norfolk and Western Railway some 15 miles from Petersburg. It was an unpeopled and practically unknown point out in a sleepy stretch of country where land could be purchased readily for \$50 an acre. Today it is a city of probably more than 18,000 persons, where small lots are being sold for as much as \$3,000 and \$4,000 each and in some cases rented for \$200, or more, a month.

It is a raw, wild, excited boom town with factories running day and night, with block after block of dwellings springing up as rapidly as a new street is marked off; with barracks, shacks, and tents everywhere, and hundreds more in the course of erection. Like Goldfield and Gary in earlier days, it has dozens of saloons, fly-infested eating houses, and improvised stores where a gaudy outlay of goods is displayed on packing boxes in crude, hurriedly built shacks made of rough lumber. Its buildings are unscreened, and sanitation is unknown. Garbage is thrown into the streets, and sewage carried off in open ditches. Drinking water is drawn from shallow wells. Flies swarm in clouds. Yet, in spite of all this, the town—which doesn't even know its real name and is called by a half dozen different ones—is one of the most interesting in America. Its population six months, or more, from now, it is estimated, may range between 25,000 and 35,000.

War orders from Great Britain and her allies for ammunition and high explosives so completely swamped a large American powder company that it was compelled to increase its factory facilities. The city of Hopewell, Va., is the result. Shortly before the first of this year agents for the corporation quietly purchased 1,200 acres of farm land adjacent to the flag station. This was inclosed by a 10-ft. barbed-wire barricade. Several hundred men were imported and set to work throwing up brick and concrete factory buildings.

On April 1 the place had a population of 500 persons. On June 1 about 13,000 employes were listed on the company's pay rolls, and the inhabitants of Hopewell numbered approximately 18,000. Each day these numbers are increased.

Every minute of the day and night the factory site is patrolled by several hundred armed guards. No person other than an employe, unless he has a written permit issued at the main offices of the company in Delaware, is allowed within the barricade. The output of the plant is not publicly known. Two factories are engaged in the manufacture of guncotton and a third is producing cordite.

The town is properly divided into two sections. One of these is owned by the powder company, which has constructed approximately 500 neatly painted cottages for the better class of its workers. These dwellings are provided with piped water, fire-protection and sewage-disposal facilities. For the most part they are small houses of three or four rooms which company employes rent for from \$6 to \$10 a month. This district also has a large number of one-story barracks, built like packing or storage shanties, in which the laborers are housed.

The main street of Hopewell, like other sections of the town which are outside of the company's holdings, bears all of the appearances of the midway of a typical western mining town of the gold-fever days. It flanks the railway, which has grown from a single spur to a network of tracks, with a double row of shacks and tents.

So far, the company has been silent regarding the permanency of the plant. No encouragement has been given by it to induce persons to make their residence or invest their money in the town. Nevertheless Hopewell continues to boom. Its development has been more rapid than that of any town ever before established in Virginia, and its existence is being felt by business firms in adjacent localities. Nearly every available motor car in



Back of These Barracks Are the Smokestacks of Some of the Powder Plants



The Tent Occupies a Lot 25 Feet by 75 Feet, Which was Sold for \$400

This Shows a Section of a New Street being Rushed to Completion at Hopewell



This Photograph, Taken near One End of the Midway, Shows a Typical Row of Store Buildings. In Most of These, Packing Boxes Serve as Counters



Employees' Cottages Built by Company



the immediate vicinity has been pressed into service to carry persons between Petersburg and the new town. In the former place, scores of residences have been turned into boarding houses in order to care for the influx of people. Already a traction system is

being projected between the two points, while electric transmission lines have been extended to Hopewell so that incandescent and arc lights are rapidly replacing the flaming torches at first used to illuminate the shop fronts along the main street.

### 37 RUNAWAY MOTOR CAR FLOODS CITY STREET

An imitation geyser, from which the water gushed 30 ft. into the air, was



Imitation Geyser Caused by the Collision of a Runaway Motor Truck with a Water Hydrant in a Street in Seattle

made recently at Seattle, when a motor truck ran away down a hillside and snapped off a water hydrant. In an instant the busiest thoroughfare in the city was transformed into a torrent, and people and vehicles alike were compelled to scurry for safety. The flood continued for half an hour before the water could be shut off.

owing to the scarcity of men through enlistment in the army it is planned to employ women in the surface works of a coal mine near Durham, England.

### 61 BEAUTIFUL HEDGE LIKE WALL PRODUCED IN FEW WEEKS

Ordinarily years of time and much attention are required in growing a high, thick hedge, but at the Panama-Pacific Exposition only a few weeks were consumed in producing a magnificent wall of greenery which towers several feet above the heads of persons of average stature and has attracted the admiration of thousands of visitors at the fair. While from a distance of but a few feet it bears all of the appearance of being a remarkable growth of hedge, it is in reality an artificially built wall which is made up of hundreds of shallow boxes of a shrub which has fleshy leaves and delicate white flowers. The plant was grown in the

boxes until its greenery completely covered their top surfaces. The cases were then bound with wire netting, to hold the soil in place, and built one on top of another.

### 9831 NOVEL CRANE IS EMPLOYED IN ERECTING BUILDING

In constructing a building at Norwalk, Ohio, a contracting firm put into use a somewhat unusual elevating device to secure greater efficiency in handling and placing cut stone. It consists of a revolving derrick with a

# Mrs. H. J. ...  
of ...  
Empire ...  
San Francisco



*Children's Home, Norwalk, O.*

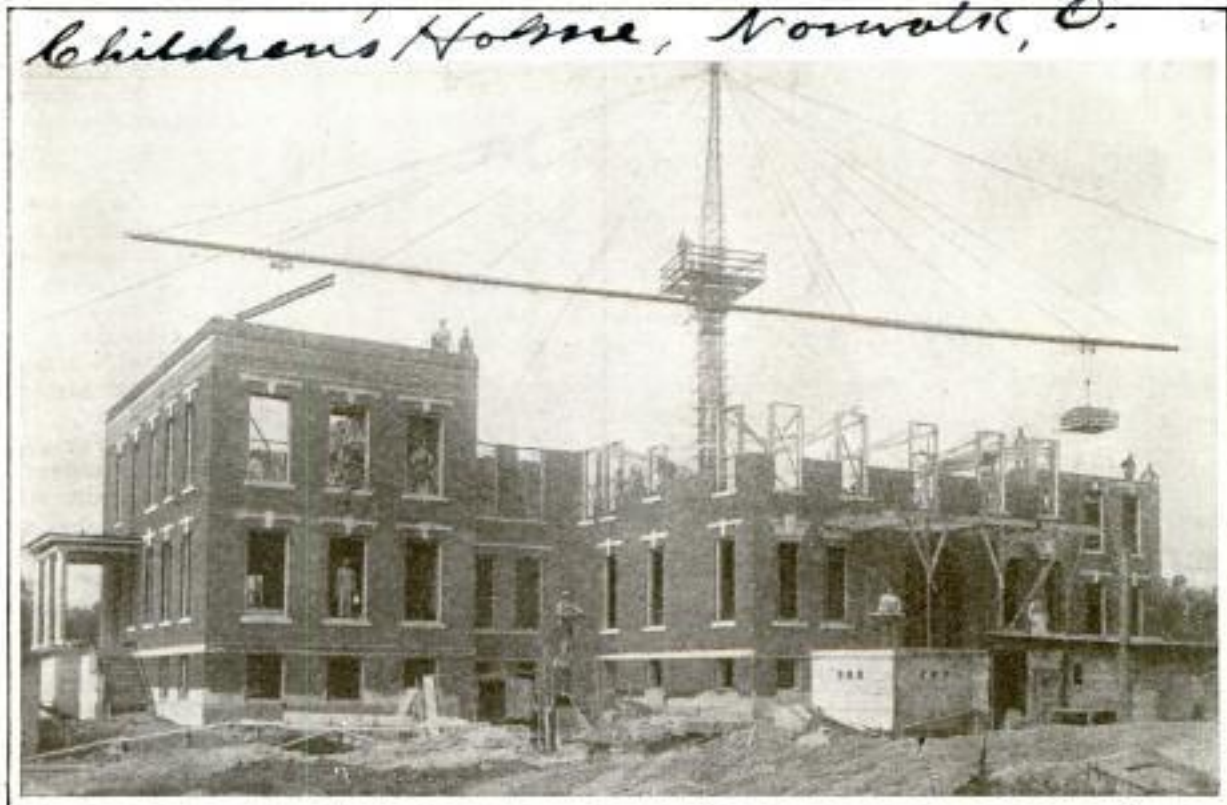

Odd Derrick Used in the Construction of a Building in an Ohio Town

horizontal boom fitted with a trolley on each arm. The tower, which is placed in the middle of a building when construction is begun, is built up of angle posts and steel lattice, while the boom, which extends equidistant on both sides of the mast and reaches the four walls of the structure, is made of 8-in. web plate, under which angles are riveted to serve as a track for the trolley wheels. The hoisting is done by a 5-hp. motor, mounted at the base of the tower, which also furnishes energy for moving the trolleys in or feeding them out. The crane is rotated by a handwheel fixed in the crow's nest, where the braking is also done. It is claimed that on this particular building the cost of handling the construction materials was lessened approximately a third through the use of this hoisting apparatus.

ⒸThe Federal courts have prohibited the sale to any foreign government of the Bliss-Leavitt torpedo, which was first manufactured under contract for use by the United States.

9921  
**TWO PRICES FOR ICE WATER CHARGED AT FOUNTAIN**

An unusual ice-water vending fountain is installed on one of the business thoroughfares at Los Angeles.

It is provided with two separate slots, one for the insertion of nickels and the other for pennies. The reason for this is that the cent piece has not the circulation in California that it has in middle-western and Atlantic-coast states and is more or less rare. Thus if a would-be patron of the fountain is without a penny he is still able to purchase a glass of water by depositing a nickel. The drinking glass is washed by hydrant water before being used.



*# Alan D. Withersley  
 5424 East View Park  
 Chicago*

*Central Magazine Store, Inc.  
 940-942 Magazine St. Seattle, Wash.*

## SOLDIERS FELL TREES TO RESCUE AEROPLANE

AFTER every other plan of attempted rescue had failed to release a military biplane caught in the tops of three trees near one of the war camps in France, the trees were carefully cut down and the machine recovered in a damaged but not irreparable condition. The pilot, failing to estimate his clearance correctly while flying low, sailed into the uppermost branches. The momentum of the craft was sufficiently great to cause the body to rise to the position shown in the first photograph, which suggests that the machine had plunged head downward. The airman is seen crawling along one of the planes, while, beneath, an officer is climbing to the crippled machine to offer his assistance. In the lower photograph the French machine is shown on the ground after the trees which had snagged it had been felled.

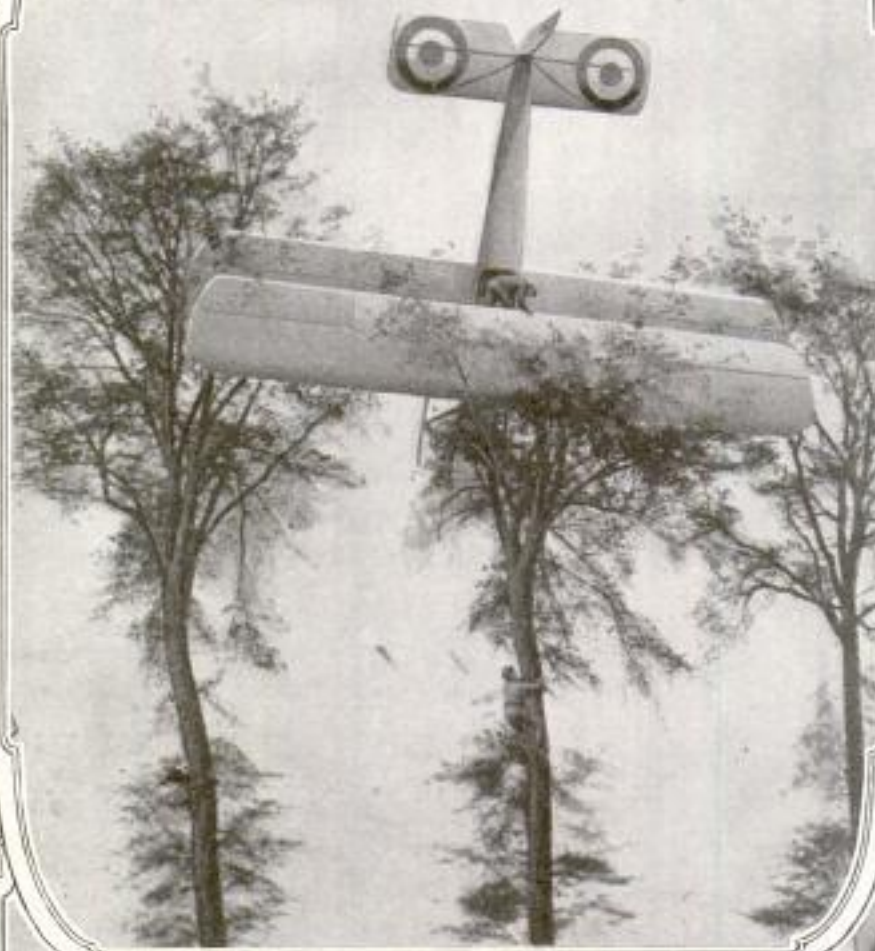

APRIL 1918. COURTESY INTERNATIONAL NEWS SERVICE

## HELGOLAND GERMAN SUBMARINE AND AERO BASE



Helgoland, Which 25 Years Ago Passed from British into German Possession, Is Now by the Irony of Fate the Kaiser's Dirigible Base for Operations against the English Coast. It Also Serves as a Supply Depot for Submarines in the North Sea and Is Convenient to Emden, Wilhelmshaven, and Cuxhaven

## EXPEDITIONARY FORCE LANDS AT DARDANELLES



Half-Starved Turkish Soldiers Shown Here Are Willing Prisoners of the British, Who are Interning Them in Captured Territory on the Gallipoli Peninsula



Allied Expeditionary Forces Making a Landing at the Dardanelles: The Open Boats, Filled with Men from an Adjacent Transport, are being Towed Ashore in the Face of the Enemy's Fire

## SCOTTISH TROOP TRAIN IN FATAL COLLISION



One of the Worst Wrecks in British Railway History Occurred Recently When a Fast Limited Plowed into the Debris of a Scottish Troop Train and a Passenger Local Which had Collided a Moment Before. More than 150 Men were Killed and 200 Seriously Injured. A Track-Side Hospital is Shown Above; Smoldering Cars. Below



## HOME FORCES IN TRAINING FOR EMERGENCIES

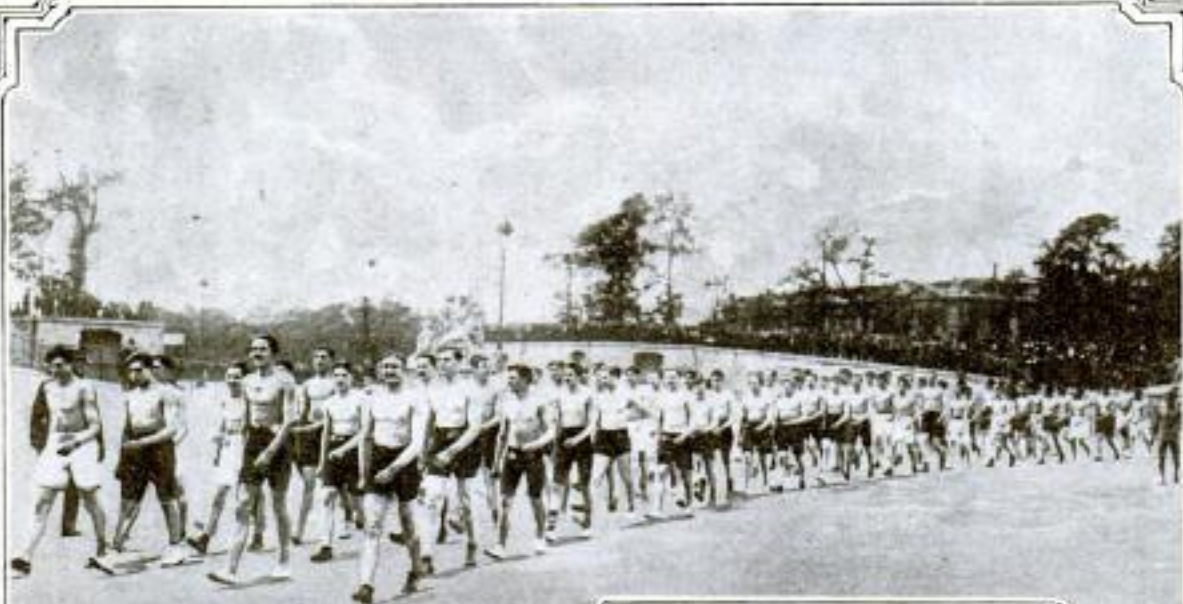

Young Men Unfit for Army Service are being Given Daily Physical-Culture Drills in Paris. This Shows Some of Them on Their Way to the Tuileries Gardens

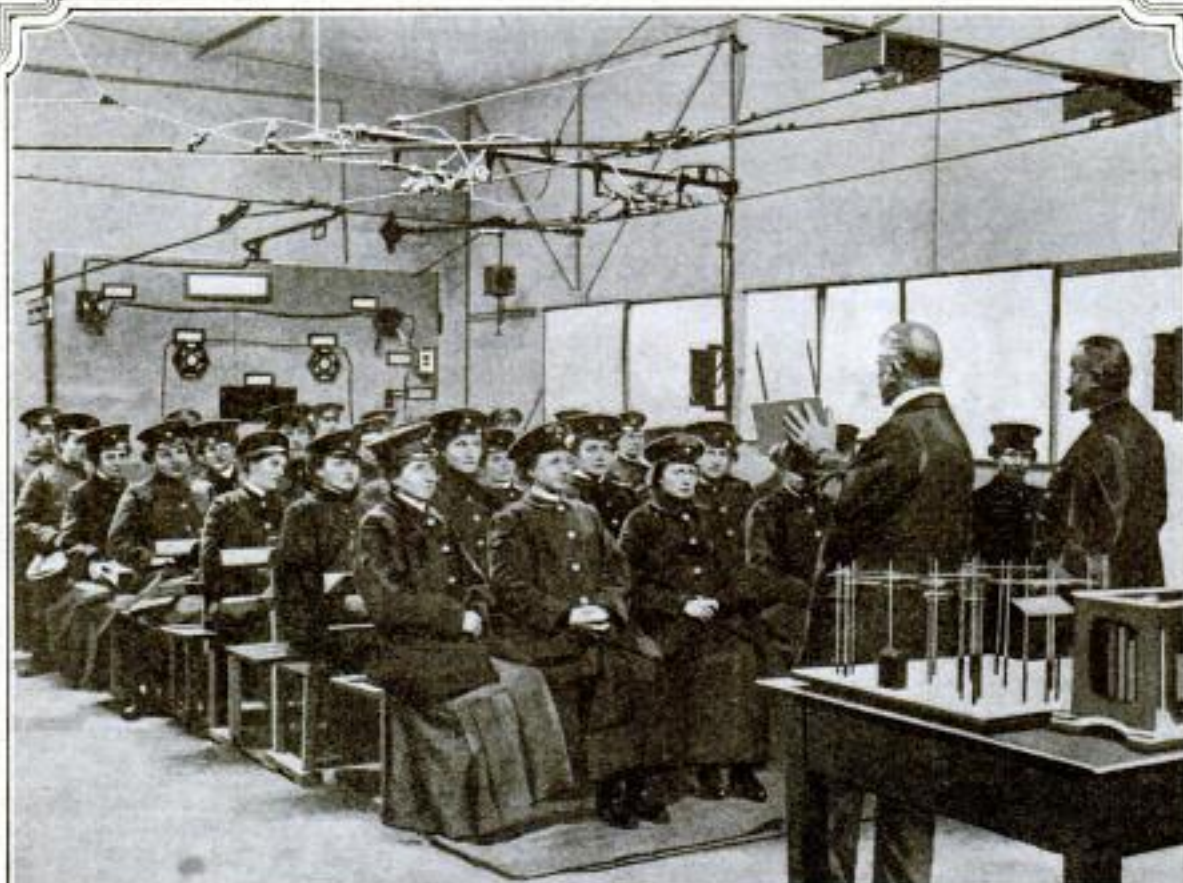

Women are Filling the Vacancies Created in Germany's Industries by the War and Keeping Various Public Utilities in Operation. Here a Class is being Instructed Preliminary to Serving as Street-Car Conductors. Those Who Act as Motorwomen Receive Careful Technical Drills

# COMBATING POISON GASES IN ALLIED TRENCHES

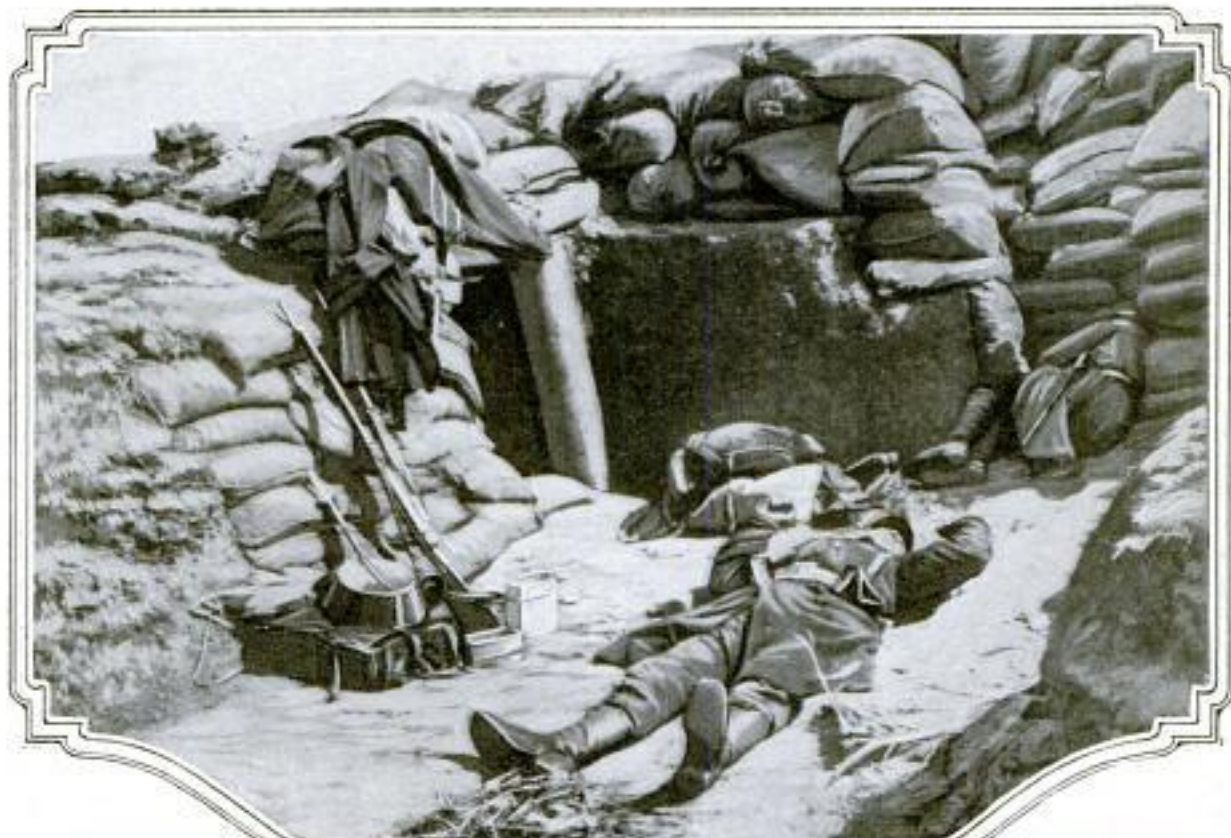

Cotton and Gauze with an Elastic Band Make Good Respirators

The Perils of German Gas Bombs Are Not Fictitious. This Glimpse of a French Trench Shows the Effect of the Heavy Vapors Which Spread over a Large Area



British Women have Made Thousands of Respirators for the Troops



English Soldiers Well Protected against Asphyxiating Gases and Prepared to Take Their Turns in the Trenches

## STRIKING SCENES IN BULLET-SWEPT TRENCHES



COURTESY GARDNER & WHARFOLD  
 This Trench, Occupied by Native Soldiers in Austria, Extends along One Edge of a Forest and is Concealed by Underbrush and the Mottled Bark of the Birch

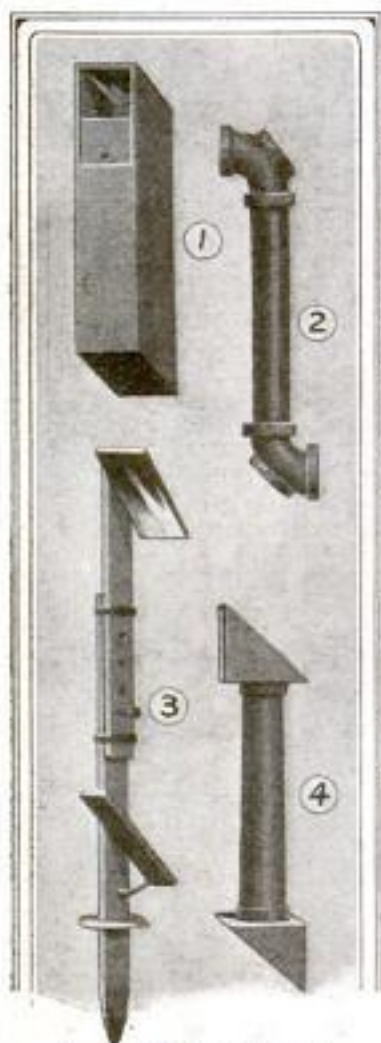

Forms of Khaki-Colored Periscopes on Sale at Many London Sporting-Goods Houses. Figures 1 and 4 Show Sheet-Iron Periscopes, While 2 is Made of Gas Pipe and 3 is an Adjustable Wood Frame with Unprotected Mirrors. Most of the Devices are About 30 Inches in Length



Austrian Artillery Officer Using a Distance-Measuring Glass on a Russian Position



AND INTERESTING DEVICES USED FOR DEFENSE



A War Photograph Which Speaks Volumes: A British Trench in Flanders Which the Men have Tried to Brighten with Pictures Taken from Ruined Homes



COURTESY, INTERNATIONAL NEWS SERVICE

In the River before This Austrian Trench Is a Wall Built to Conceal the Position and Protect the Men from the Ricocheting Bullets of the Enemy



Crossbows Shooting Bomb-Headed Arrows are being Used by the French. This Shows a Member of One of the Archery Squads



A Bell Warns These French Sentries of Surprise Attacks. A Wire Leads from the Gong to Advance Entanglements

# GERMAN INFANTRY IN ACTION ON FIRING LINE



Lined for a Considerable Distance along the Water's Edge, a Strong German Wing is Here Attempting to Defend an Important River Bank of Which It has Gained Possession



COPYRIGHT,  
UNDERWOOD &  
UNDERWOOD

German Infantrymen being Rushed to the Firing Lines to Fill the Gaps Cut in Their Advance Ranks during a Sudden and Persistent Assault by the Enemy's Forces.

Machine-Gun Operator Carrying His Rifle on His Back to the Rear of the Lines so That it may be Cleaned and Put in Order

PHOTOS COPYRIGHTED BY

BROWN & DABSON FROM UNDERWOOD & UNDERWOOD

# ODD PHASES OF WAR AS REPORTED BY CAMERA



COPYRIGHT  
INTERNATIONAL NEWS SERVICE

Wire Netting is Used to Cover This Trench in Order to Protect the Soldiers from Bombs Dropped by German Airmen



PHOTO INTERNATIONAL NEWS SERVICE

Above is a Three-Blade Propeller Used on Zeppelin Bombs Such as the Exploded Ones Shown Below

COPYRIGHT INTERNATIONAL NEWS SERVICE

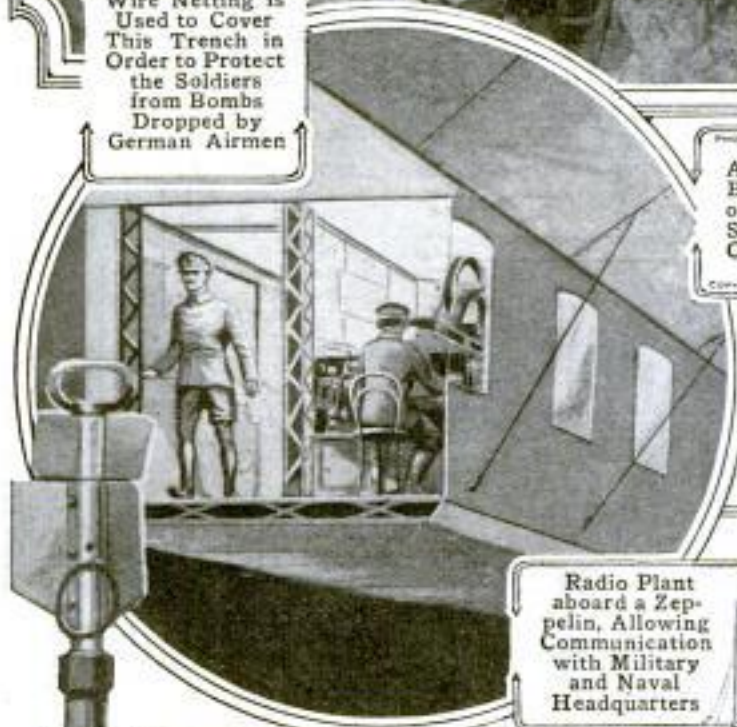

Radio Plant aboard a Zeppelin. Allowing Communication with Military and Naval Headquarters

British Aerial Bomb Weighing 20 Pounds



"La Foudre" of the French Navy Provided with a Hangar for Sheltering the Flying Boat Canard Voisin

## INTERESTING SIDE LIGHTS ON EUROPEAN WAR



Housed in This Curious-Looking Tent, Erected in a Russian Camp near Warsaw, Is a Complete Field Bakery Which Supplies Bread for a Large Detachment of Soldiers.

SPRINGFIELD UNDERWOOD & UNDERWOOD

German Soldiers Snatching a Few Minutes' Rest, on Improvised Beds Built in a Church, during a Lull in the Fighting between the Meuse and Moselle Rivers in North-eastern France.



## WAR DEMONSTRATIONS MADE BY ITALIAN PEOPLE



## PROMOTING THE WELFARE OF THE SOLDIER

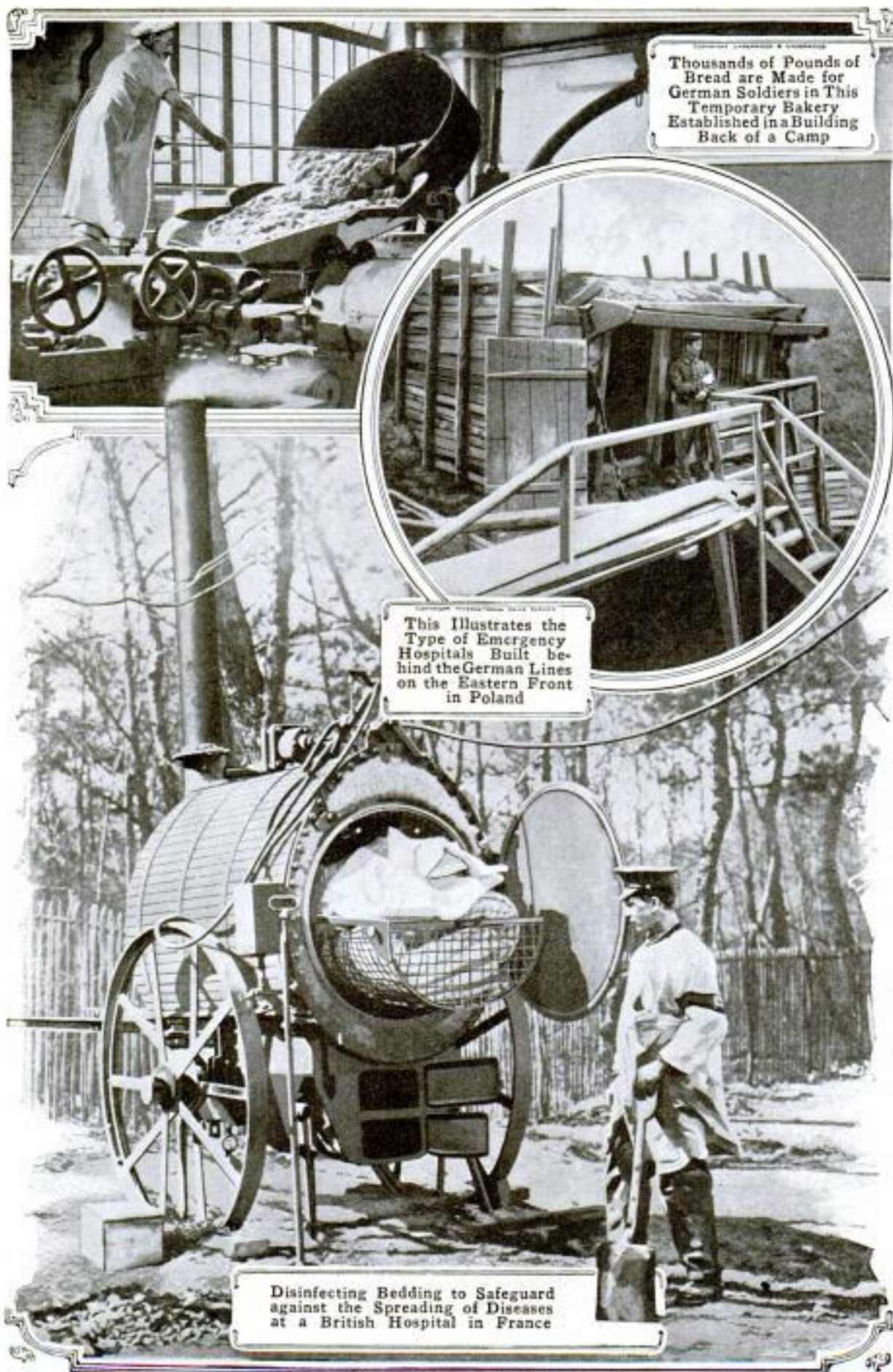

*Dept. of Interiors*

*# D. S. Roosevelt  
Berkeley Calif.*

*9803*

**GOVERNMENT TO SELL VILLA  
38 SITES AT AUCTION**

Twenty-one villa sites fronting on Flathead Lake in Montana are to be sold at auction by the government, the sale to begin on July 26, 1915, at Polson, Mont., and to continue as long as may be necessary for disposing of the land. The sites range from two to five acres in area. They are valuable not only as locations for summer residences but for raising fruit and vegetables. Each site is to be offered to the highest bidder, but will not be sold for less than \$10 an acre. A cash payment of 25 per cent of the price bid will be required of each buyer on the date of the sale, the remainder to be paid in from one to three years, depending on the total amount bid for the site. Bids may be made either in person or by an agent, but no bids can be made by mail. There are no restrictions as to age or citizenship.

**EXPOSITION BUILDING HAS  
FIFTY-TWO FLAGPOLES**

No other building in the world, so far as can be learned, has as many flag-

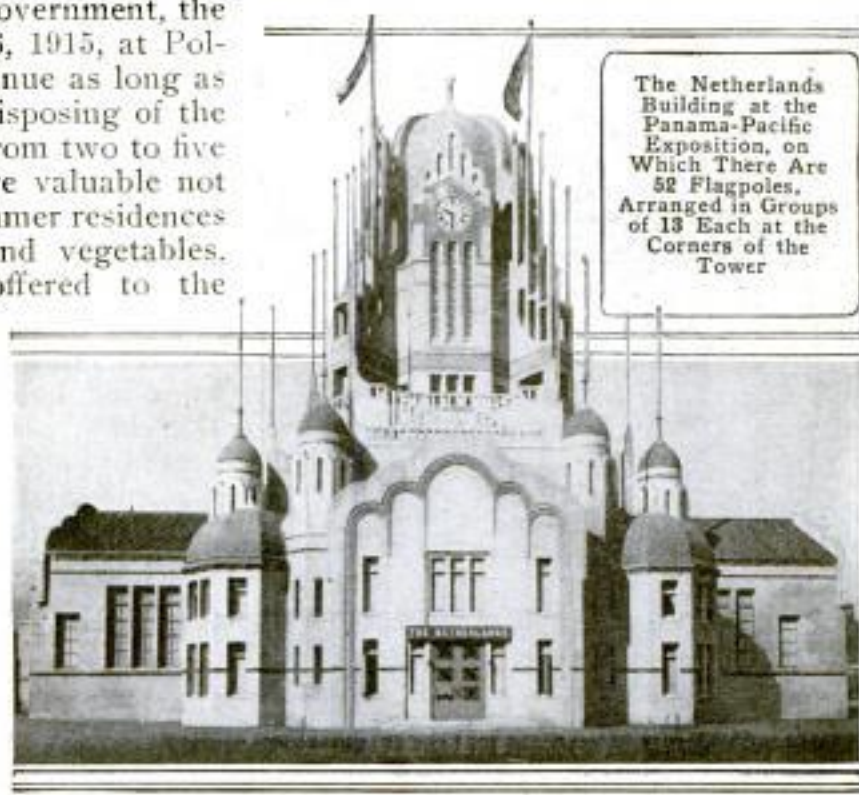

The Netherlands Building at the Panama-Pacific Exposition, on Which There Are 52 Flagpoles, Arranged in Groups of 13 Each at the Corners of the Tower

poles as the quaint structure in which the exhibit of the Netherlands at the Panama-Pacific Exposition is housed. Grouped about each corner of the tower are 13 flagpoles, making a total of 52 carried on the entire building.

**USING TIME-HONORED JOKE AS  
9632 ADVERTISEMENT**

In Ellensburg, Wash., a tailor who has a sense of humor and believes that the same is true of most persons, employs a barrel as a sign. For the benefit of the few who are possibly ignorant of one accredited use of barrels and who therefore might miss the significance of the object before his place of business, he has attached a placard which is more candid than subtle.



**9536 SAW LEAVES NO BIG STUMPS  
AFTER FELLING TREES**

A machine designed particularly for cutting trees close to the ground, so that large stumps will not be left projecting above the surface after timber is cleared from lands, has recently been perfected by two Maine inventors. The apparatus consists essentially of a low framework which carries a large saw and fits about the base of a tree close to the ground, or beneath the normal level in case excavating is first done about the roots. Two horizontal arms extending at the front of the frame, adjacent to the saw edge, are intended to be adjusted so that they fit about a trunk to hold the device rigid during

*H. C. LeMurray  
1728 W. 4th St  
Los Angeles*

*Forest King Machine Co.  
Mechanic*

*Inventors:  
Forest W. Barker  
Daniel W. Smith*

# A. B. Niess  
 R. 730 Treasury Bldg.  
 Wash., D.C.

the work, while the saw is operated by one or more men by working a vertical frame which extends to a height that makes it unnecessary for them to bend

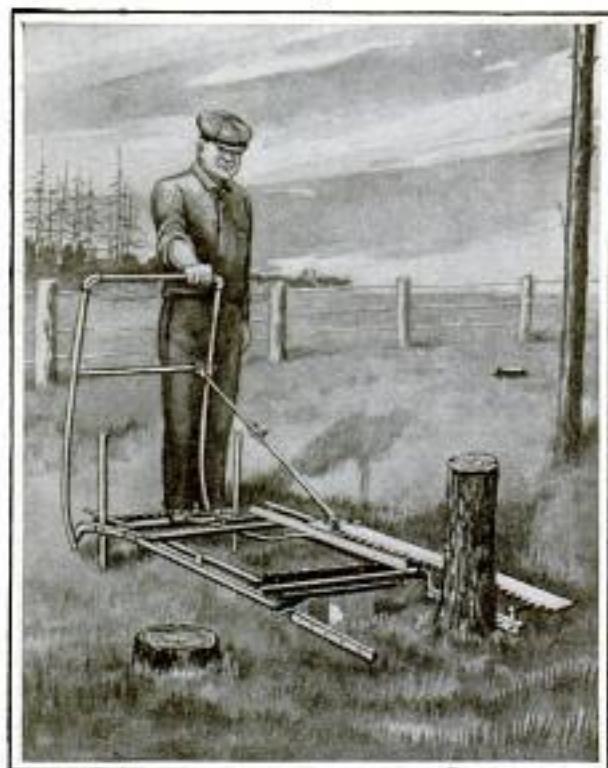

Unlike the Ordinary Crosscut Saw, This Device may be Operated by One Man

over in cramped or unnatural positions while felling a tree. A member on which a lumberman places one of his feet while working, serves to brace the frame and hold it firmly to the ground.

**EXCAVATION COST LESSENED 85% IN SINKING SHAFT**

An interesting piece of engineering work was recently accomplished in New York when a permanent shaft was sunk at the foot of Broad Street to enable the construction of Rapid-Transit tubes under East River. A material saving in the expense of the undertaking was made by employing a method which cut down half the amount of excavating that had to be done under air pressure. This was accomplished by cutting only a ring under the exterior wall of the round caisson, instead of removing all the earth. By this plan a core was left within the ring, to be removed after the caisson was sunk and sealed to

rock. In constructing the latter, a concrete ring about 16 feet in height was made after the cutting edge had been completed. This was then sunk until its top was a couple of feet above the surface, when it was stopped and the second ring poured. The sinking was then continued, the forms reset, and the third ring molded.

9929  
**PARKING LANES FOR MOTORS IN WASHINGTON STREETS**

As has been the case in many cities, the question of where the motor cars of business men could best be parked during office hours in the down-town section of Washington, D. C., has presented more or less of a problem. For a number of months, however, lanes have been chalked off in the middle of some of the thoroughfares on which there are no car tracks, and used for this purpose. The plan has tended to keep the curb lines unobstructed and allow freer access through the streets than in the past. While in some cities the idea has not worked out so well as



How Washington, D. C., Keeps Its Curbs in the Business Section Unobstructed by Motor Cars during Office Hours

it was at first hoped it would, it is apparently solving the question so far as Washington is concerned.

For Public Service Commission:  
 Geo. S. Rice, Engr. first division  
 Wm. H. Snow, Section Engr. at shaft.

Flinn-O'Rourke Co. Ltd. (Contractor)  
 A. A. Brewer Eng. in Charge  
 J. C. Maitland (Supt. at shaft.)



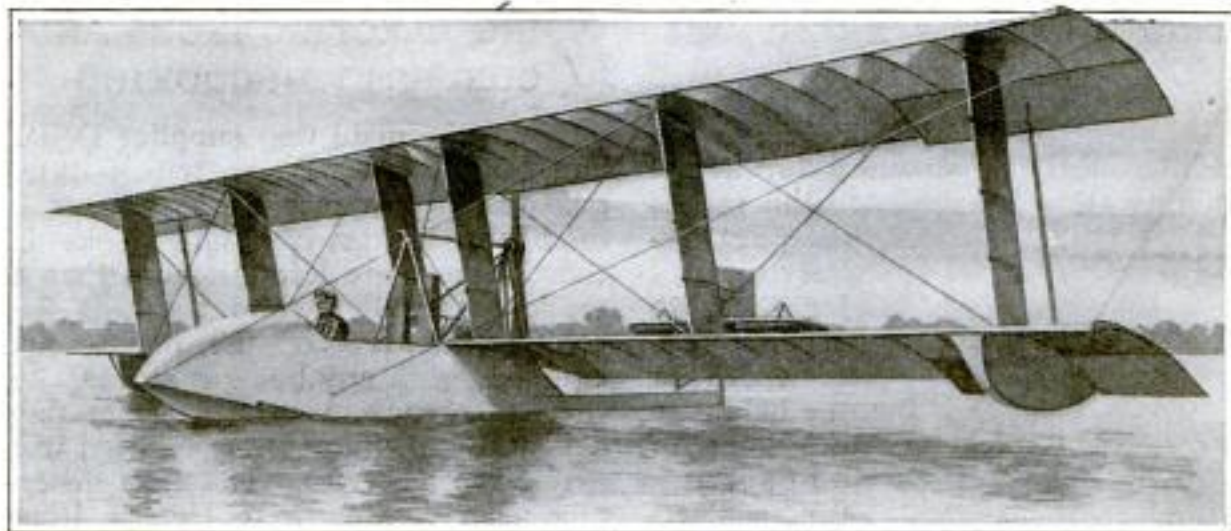

This Flying Boat Made a Record of 80 Miles an Hour in Recent Trial Flights over the Patapsco River, near Baltimore

9816

**HIGH-SPEED FLYING BOAT  
 OF A NEW TYPE**

A flying boat of a new type that has just been subjected to tests over the Patapsco River at Fort McHenry, Baltimore, Md., has shown remarkable speed on the water and has made a record of 80 miles an hour in the air. The planes in this craft are staggered, the upper plane extending about 18 in. to the front of the lower plane, and it is claimed that this feature adds greatly to the lifting power of the machine. The uprights, of which there are six, are shaped like thin partitions, with edges to the front and rear, and are designed to offer the least possible resistance to the wind. They are attached to the centers of the planes. The hull of the boat is 25 ft. long over all, and in it are placed the control, engine, and seats for the pilot and three passengers. The covering of the bow is in the form of a half dome, and is made in two parts so that one part may be removed. The hull is provided with a V-shaped bottom, a construction that enables the craft to rise from the water without creating any considerable amount of suction, and to land on the surface of the water without excessive splashing.

¶The production of Fuller's earth in the United States for 1915 was 2,387 tons greater than that for 1914, the difference in value being \$33,896.

9935

**TRICYCLE CHAIRS EMPLOYED  
 ON EXPOSITION GROUNDS**

An adaptation of the wheeled chairs, commonly used on the walks at various seashore resorts, has made its appearance at San Francisco in the form of tricycle chairs which are being used extensively at the exposition grounds. These vehicles are built with frames which at the rear are similar to those of ordinary cycles, so that they may be propelled by foot power, instead of being pushed, and cover ground much more rapidly than their predecessors.



PHOTO BY ROCKWELL FEATURE SERVICE  
 Combination Wheel Chair and Bicycle Which is being Used in Carrying Patrons about the Exposition Grounds at San Francisco

A comfortable wicker armchair is carried at the front of the chassis, while the steering is done by means of two handles.

*The Washington Co.*  
*Esquia, O.*

*# Rockwell Feature Service*  
*Berkeley, Calif*  
 Copyrighted material

# Otis W. Howard  
Lieut. J. S., Ill. N. R.  
2304 7th av.

# T H Barrett  
202 So. Wismetka St.  
Dallas  
Tex.

224

POPULAR MECHANICS  
Moline, Ill.

TRAINING NAVY HELMSMEN  
9424 ON DRY LAND

USING ELECTRIC IRONS AND  
31 CURLERS FOR COOKING

Members of the naval reserve are afforded little opportunity for actual training aboard a ship, and this makes

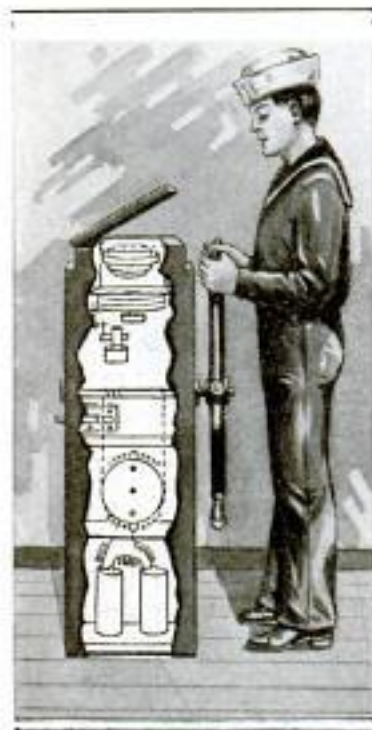

it particularly difficult for them to become experienced at the helm. In the hope of offsetting this, a steering machine has been constructed which is intended to drill on land recruits who are totally unfamiliar with marine navigation, in the art of handling a wheel.

The device consists of a box, approximately a foot square and four feet high, attached to which is a steering wheel and within which is a compass mechanism that serves to present the novice with routine conditions encountered in navigation. At the top of this box is a standard compass, beneath which, and turning on the same axis as the compass card, is a wheel on which a bar magnet is mounted. The steering wheel controls through a rheostat a small motor geared to the magnet wheel, so that by turning the former to the left, for instance, the motor is started and the compass card moved to the right. A switch controlled by the instructor also allows the motor to be operated independently of the steering wheel, so that the card may be moved out of the course and the helmsman given an opportunity to learn how to bring his ship back in the course.

It is claimed that men drilled in this manner have later shown good work at the wheel on a training ship.

When the main that supplies Dallas and Fort Worth, Texas, with natural gas was broken recently as the result of floods, housewives and cooks in those cities were left for more than a week practically without means for cooking, as few of the houses are equipped with any but gas stoves. In this emergency every heat-generating device that could possibly be used was pressed into service. The most generally used devices were electric irons and curlers. Many housewives found that they could broil meat successfully on an electric iron, and that an electric curler served very well for making coffee.

9890  
GASOLINE PUMP FOR MOTOR-CAR SUPPLY DEPOTS

For curb-line use before garages and motor-supply stations, a somewhat new type of gasoline pump has been developed that is fitted with safety devices which are said to reduce the danger of fire and explosions materially. Its mechanism is double-acting, so that a continuous flow of measured gasoline is available when needed.



Both a discharge register and spring lock, as well as a filter, are provided, while a quantity meter is also supplied which keeps an accurate record in the aggregate of all pumping up to 100,000 gal. The pump is incased in a cast-iron cabinet from which a 1½-in. feed pipe extends to the supply tank buried beneath the ground. Surmounting the pillarlike cabinet is a post carrying a spherical globe inclosing an electric bulb which when illuminated is readily seen by passing motorists at night.

The American Oil Pump  
& Tank Co.  
Cincinnati, O.

Copyrighted material

9909

### PICTURESQUE PARK FOR CALIFORNIA RESORT

Along the cliffs facing the Pacific Ocean at Ocean Beach, Cal., one of the most picturesque parks in the country is now being developed. The work is being done by Japanese and the park is to be Japanese in style. The sandstone cliffs stand from 20 to 40 ft. above the ocean and have been worn into fantastic shapes by the continual pounding of the waves. This feature is taken full advantage of in the development of the park.

Some of the miniature cañons cut back into the cliff are spanned by arched wooden bridges of a novel type for this country, but common in Japan. All beams and posts for the bridges, as well as the posts for the fences, are first charred. The charred parts are then scraped off until a surface



One of the Concrete Bridges in the New Park at Ocean Beach, California



An Arched Bridge Built of Charred Wood; the Lamp-Post was Made from a Tree and Has a Bark Cover

mottled with brown and black is exposed. This process not only results in beautiful coloring, but brings out the grain of the wood. The bridges and the grounds generally are lighted at night by lamps set on lamp-posts made of trees of odd shapes, the lamps having conical covers made of bark

and supported on the cut-off branches of the trees. The sunshades scattered about the grounds are also made from trees in which the branches have been cut off at just the right height to support the umbrellalike shades. In making the shades, a light framework of lath is attached to the branches and over this framework palm leaves are laid. The steps and walls are formed of rounded stones picked up on the beach and imbedded in concrete.



Palm-Leaf Sunshade; Typical Walls Made from Beach Stones Imbedded in Concrete

NEW TYPE OF ELECTRIC FAN  
FOR DINING TABLE

9601

Intended especially for use on a dining table, an electric fan has been made which throws a continuous, indirect

INEXPENSIVE INSULATION

9773 FOR STEAM PIPES  
Power 4-15-15

For covering low-pressure steam pipes with a cheap insulating medium, the use of a paste composed of starch and sawdust has been found satisfactory by engineers at Boulogne, France. The material may be prepared and applied easily. The sawdust is sifted so that the larger particles of wood are removed, the screening then being mixed with a very thin paste made of two parts wheat starch and one part rye starch. If the pipes to be covered are either cast or wrought iron, the paste adheres well, providing all grease is first removed from them. In the case of copper pipes, however, a thin priming coat of potter's clay should first be applied with a brush,

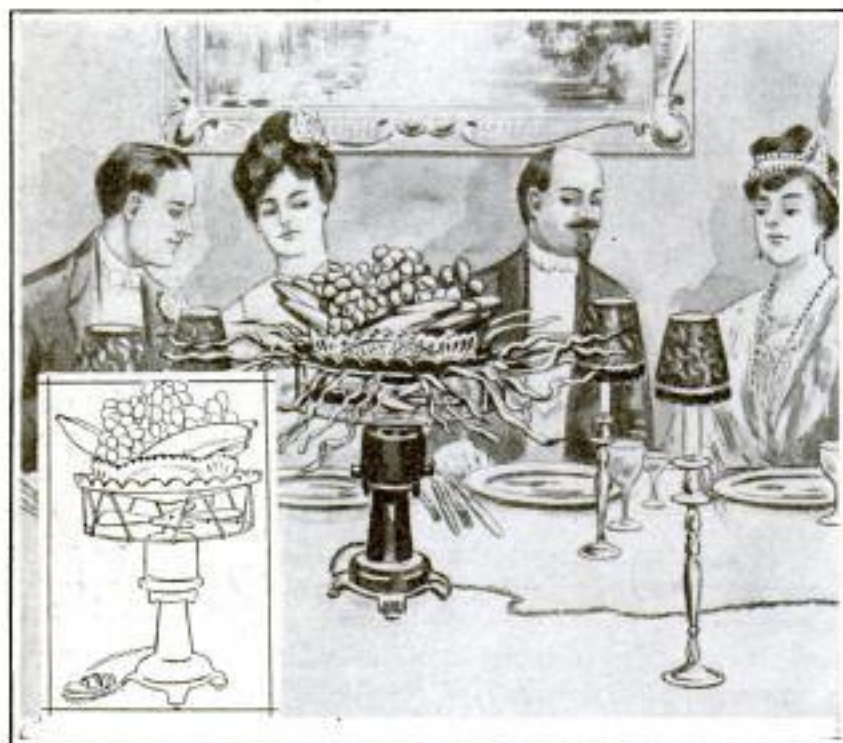

The Electric Fan Throws a Cool, Even Breeze to All Sides of the Table Continuously

breeze in all directions. The blades are mounted at the end of a vertical shaft so that they revolve in a horizontal plane. Immediately above the fan is a deflector which spreads the air to all sides of a table. This provides a light, cool current of air instead of a heavy, concentrated draft, and does not have a fatiguing effect upon persons seated near the table.

while it has also been found advisable in all cases to wind a string spirally around the pipes to be treated. The spirals should be kept about a half inch apart. After the original coat of paste has set, other applications may be made until a covering of the required thickness has been built. Protection against the weather is given by painting the material with coal tar.

9893

ANCIENT GRECIAN PLAY STAGED IN YALE BOWL

Twelve thousand persons occupied a small section of the great Yale bowl at New Haven recently when Euripides' romantic drama, "Iphigenia in Tauris," was given in English for the first time in this country with an outdoor setting. The temple of Artemis, before which Iphigenia in the play performs rites of offering human sacrifices to the gods, was constructed in imitation of

marble at one end of the gridiron before the audience. A stage made of painted canvas was arranged before this, in the middle of which was an altar about which the chorus was grouped when rendering its part in the performance. Because of the position of the audience, the usual difficulty of hearing the dialogues in outdoor plays was not experienced. The words could

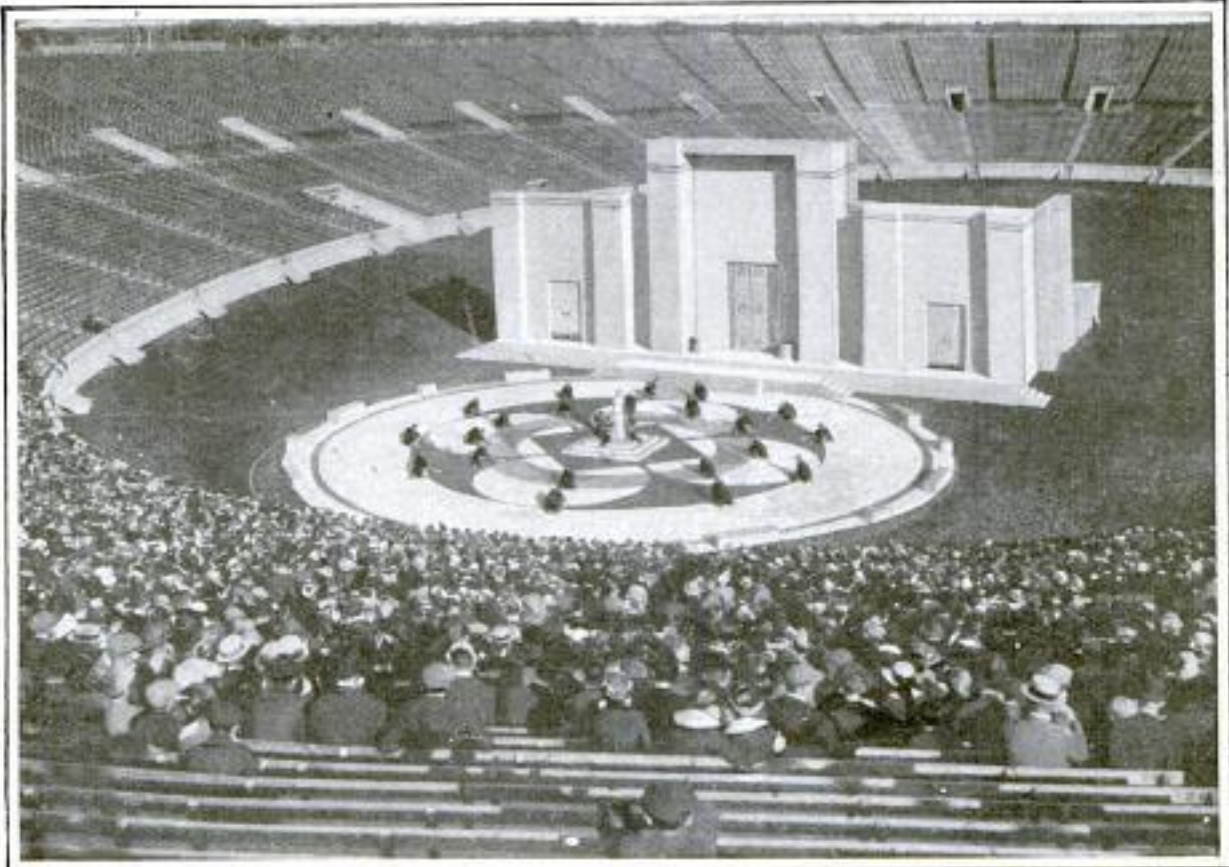

COPYRIGHT, UNDERWOOD & UNDERWOOD

Twelve Thousand Persons in the Yale Bowl Witnessing an Outdoor Production of "Iphigenia," an Ancient Grecian Drama

be heard distinctly. The vastness of this stadium can best be appreciated by comparing the blocks of vacant seats with those which were occupied. While a fourth of the stadium was reserved for the drama, and 12,000 persons attended, only a little more than one-half of the seats were used.

### STATE OF WASHINGTON ASKS FOR FORTIFICATIONS

Adequate fortifications for protecting the coast from invasion from the Pacific is asked for in a memorial recently submitted to the President and the Congress of the United States by the state government of Washington. In this report the defenselessness of the coast of Washington and Oregon is given in detail. Particular emphasis is laid on the strategic value of Grays and Willapa harbors to an invading force, and the necessity of providing strong fortifications at these points.

### SIMPLE FLEXIBLE COUPLING FOR PROPULSION SHAFT

A flexible shaft coupling has recently been invented which is very simple in form and apparently equally dependable. Flanges fixed at the adjacent ends of the shafts to be joined are toothed like an ordinary sprocket. A chain is linked about these, holding them firmly but with sufficient play to allow the shafts to center themselves readily. Flexibility is given at all speeds, and the coupling, when used in a power boat, is able to take the thrust and pull of a propeller without trouble. An additional feature is the readiness with which a connection or disconnection may be made. When it is desired, a grease-tight housing is provided for the chain.



Clark Flexible Coupling Co.  
 (Inc.) 27 Waller St.  
 New York

Copyright material

8945

### IRON CORNER POSTS FOR PUBLIC-LAND SURVEYS

In all public-land surveys made by the U. S. General Land Office, hollow iron posts filled with concrete are now



The Brass Cap of One of the Iron Corner Posts; the Designation of the Corner is Marked with a Steel Die on This Cap

Corner Posts Stowed in a Pannier for Transport across Country on Mule Back



used for marking the corners in place of the old-style corner stone, which was easily removed or destroyed. Each post is equipped with a brass cap, on which the designation of the corner is marked with a steel die, and has a spreading flange at the bottom. The posts are 3 ft. long and are made in three diameters. For marking township corners, the 3-in. post, weighing 30 lb., is used; for section corners, the

2-in. post, weighing 13 lb., and for quarter-section corners, the 1-in. post, weighing 6 lb. They are always set so that the markings on the caps are read from the south side of the corner. The posts are usually stowed in panniers designed for the purpose and transported to the required points on mule back.

9884

### WRECKED OIL TRAIN BURNS

FOR MANY HOURS

J. V. DABBS, FORT SCOTT, KAN.

Thousands of barrels of petroleum and gasoline were consumed by fire when an oil train on the M., K. & T. Railway was wrecked recently near Fort Scott, Kan. A number of tank cars in the middle of the train left the track on a sharp curve. Several of them were hurled into a heap, while others were strewn along the right of way for nearly a hundred yards. Almost simultaneous with this accident, an explosion occurred which threw sheets of flaming oil over the greater part of the wreckage, causing the contents of nearly all the tank cars to ignite. Flames and clouds of dense black smoke enveloped the train for many hours. In all, 17 cars are reported to have been destroyed. A number of others at each end of the train failed to leave the track, and these were saved by timely work. The fore part of the train was disconnected and run into Fort Scott, while the caboose and four tank cars at the rear were drawn away from the burning debris by a local freight train which arrived at the scene shortly after the wreck occurred.

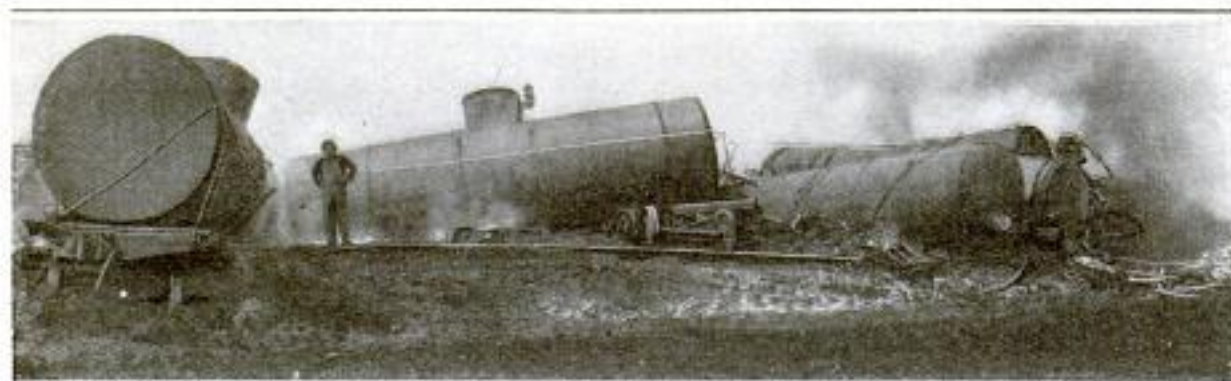

This Shows a Part of the Wreckage of an Oil-Tank Train as It Appeared after the Fire

## HANDLING TRANSATLANTIC MAILS IN WAR

J. S. Mc. Carthy, Ev. Star, Wash. D. C.

**B**EFORE the outbreak of the war the Atlantic Ocean was interlaced with the paths of steamers carrying mail to and from Europe. This well-organized and efficient service was disarranged and all but destroyed, practically in a day, when the bulk of the international shipping was driven from the sea at the beginning of hostilities, and with the progress of the war the problem of maintaining any kind of regular service is becoming increasingly difficult. There are now only five routes regularly available for carrying the mails between this country and European ports. Most of the fast steamers have been withdrawn, sailings are frequently canceled, and of the ships remaining in the service few are able to maintain regular schedules. At the same time there has been only a slight decrease in the volume of mail transmitted, a feature that adds greatly to the problem confronting the postal authorities. The decrease in commercial mail has been offset by an increase in mail of a personal nature, and as a result the total amount handled is almost as great as it was before the beginning of hostilities. Increased correspondence between residents of the United States and friends and relatives in countries engaged in the war is given as the main reason for the enormous increase in personal mail.

In spite of the reduction in facilities for transmitting the mail, a fairly regular and thoroughly reliable service is being maintained, and this service extends not only to the allies but to Germany and Austria, countries that are practically hemmed in by their enemies. The reliability of the service is indicated by the fact that the 82 bags of mail that went down with the "Lusitania" was the first mail to be lost at sea by the United States as a result of the war.

With the allies in control of the sea, the transmission of mail to Germany and Austria is made possible only by the observance of international law by the allies. Such mail can only be landed at a neutral port. Mail matter

carried on a neutral vessel bound for a neutral port cannot lawfully be interfered with, and the vessel carrying it, unless it also carries contraband of war, is subject only to the unavoidable dangers connected with traversing the war zone. If a vessel carrying such mail goes into a port of one of the belligerents, however, all mail matter bound for an enemy nation may be lawfully seized. For this reason any ship bound for Rotterdam, Holland, or a Scandinavian port and carrying mail for Germany or Austria is in effect barred from putting in at Liverpool or any French port.

Two old-world ports, Liverpool and Rotterdam, are now handling the greater part of the mail for the whole of Europe. All of the mail for England and most of that for France is landed at Liverpool, the latter being forwarded through London and across the English Channel. There is an occasional shipment direct from this country to Havre, France. All of the mail for Germany and Austria must now go through Rotterdam, Christiania, or Copenhagen, the greater part going through Rotterdam, from which port it is forwarded by rail to its final destination. Before Italy entered the war a large part of the mail for Austria went through Naples, but that avenue is now closed. Practically all mail for Russia goes to Christiania and thence overland to its destination. So far as the handling of the mails is concerned, Luxemburg and that portion of Belgium in possession of the Germans has the same status as German territory, the mail being landed at Rotterdam.

Contrary to popular belief, none of the mail matter sent abroad from this country is censored by the United States postal authorities, the situation in this respect being exactly the same as it was before the war. The letters for a belligerent nation are simply placed in bags and these bags are sealed before they leave the country. On the arrival of the mail at its destination the responsibility of the United States ceases and any question of open-

ing and examining the mail, like that of censoring outgoing mail, is a matter subject to the military regulations of the country to which it is sent.

When a state of war exists between two countries, peaceful relations of every kind are cut off automatically, and this condition applies as rigidly to the transmission of mail as to commerce and diplomatic exchanges. There is now no regular way, for example, for getting mail from England to Germany. There is doubtless some secret communication between persons in these two countries, but there is no way of forwarding letters except by a personal carrier or through an agent in a neutral country.

In times of peace most of the mail for England and a great part of that addressed to points on the continent was landed at Plymouth, England, a port that has since been closed as a result of the war. The continental mail was then rushed through London

to Newhaven or Dover, where fast steamers were in readiness to carry it across the English Channel. The reason for this arrangement was that faster time could be made than by landing the mail at a continental port. Under normal conditions mails were delivered at almost any point on the continent within 24 hours from the time it had crossed the English Channel. Mail addressed to Berlin reached Plymouth in from six to seven days after leaving New York and was in Berlin 30 hours later. Now it takes from 10 to 12 days for the mail to reach Rotterdam and as much as 14 days to reach Christiania or Copenhagen, with an additional period of from 24 to 36 hours for forwarding to Berlin. Formerly practically all of Europe received at least four mails a week from this country. Now there is an average of two mail shipments a week to Plymouth, while Germany is receiving from four to six mail shipments a month.

9914

### UNUSUAL PICTURE OF NAVAL-PAGEANT THRONGS

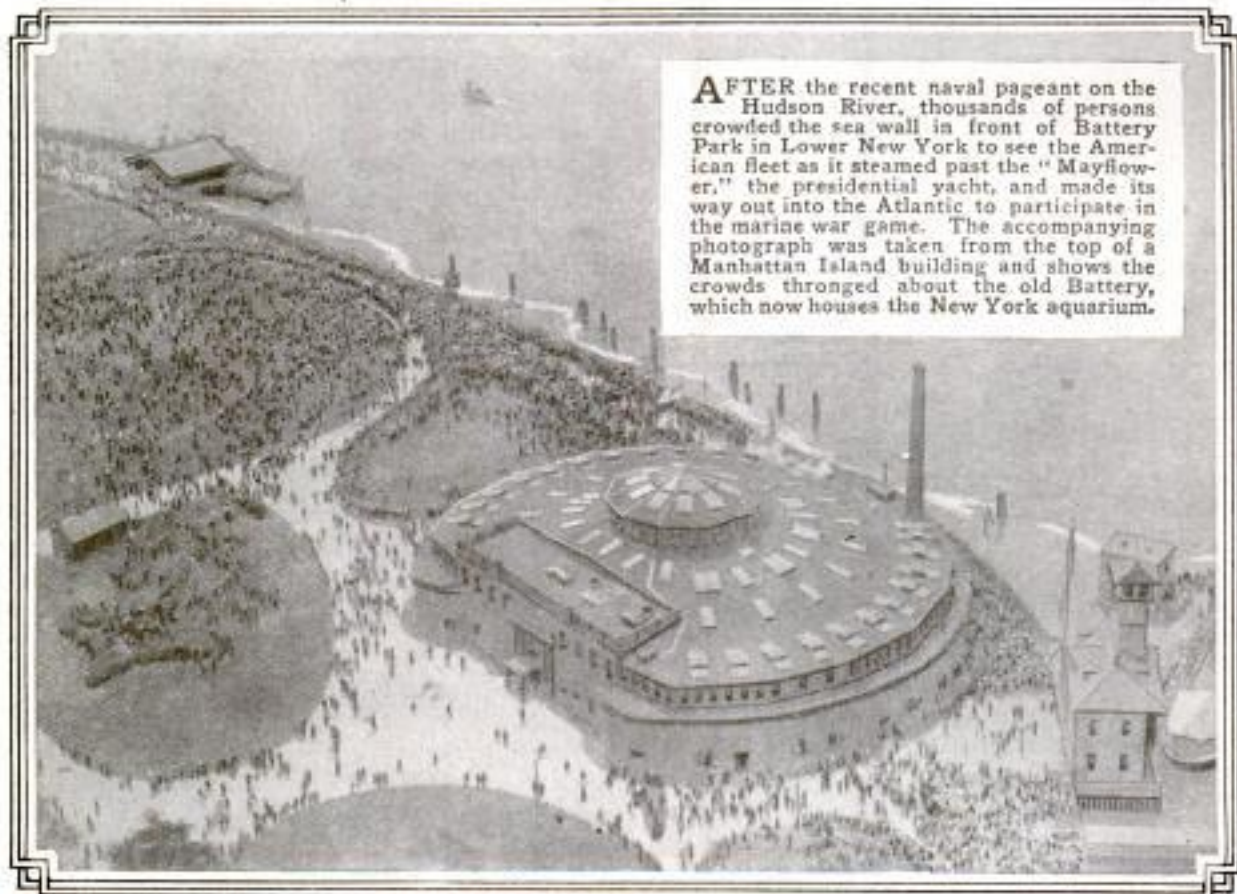

**A**FTER the recent naval pageant on the Hudson River, thousands of persons crowded the sea wall in front of Battery Park in Lower New York to see the American fleet as it steamed past the "Mayflower," the presidential yacht, and made its way out into the Atlantic to participate in the marine war game. The accompanying photograph was taken from the top of a Manhattan Island building and shows the crowds thronged about the old Battery, which now houses the New York aquarium.

J. N. S.





Both the Buyer and the Seller of a Used Motor Car are Benefited by the Open-Air Mart

9902  
**USED MOTOR CARS ARE SOLD  
 IN PUBLIC MARKET**

# *Mayale*

In one of the western cities a distinctly new institution, an open-air public market for used motor cars, has made its appearance. The purpose back of the plan is to eliminate the commissions paid to selling agents under the customary method of making such transactions. In this case the owner pays \$2.50 a week for the privilege of parking his machine in the mart. It is then continually on display and will be demonstrated to prospective purchasers by attendants without additional cost to the owner. Motorcycles are handled in the same way, although at a lower rate. The purchaser of a car is able to deal with the proprietor of the market, if he desires, or may negotiate directly with the owner. In this way both the owner and the purchaser of a car are benefited.

9610  
**WALKING MACHINE DESIGNED  
 FOR INDOOR EXERCISE**

To make it possible to take long walks even on unpleasant days when the weather does not permit her leaving the hotel, a treadmill walking machine has been constructed for a prima donna who carries out a daily program of exercises in an attempt to ward off obesity. The machine is

X *Carolina White*  
 # *Oscar A. Doob*  
*Timo-Star*  
*Cinti.*

placed in one of the rooms of her suite where she uses it when an outdoor walk would not be agreeable. Attached to it is a meter which indicates the mileage traveled and enables her to keep account of the distance walked at different times during the day.



This Machine Makes It Possible for a Prominent Opera Singer to Take Long Walks in Her Own Apartment When the Weather Prohibits Outdoor Exercise

*Inv. Geo. V. Brown*  
*Champion Pedestrian*  
 Copyrighted material  
 Oct. 10, 1911

See Feb'y '14 - 138  
"Aug" '14 - 208  
210 York

9574

**FOLDING FIRE ESCAPE MADE FOR RESIDENCE USE**

Made light and compact so that it is readily portable, a folding steel ladder has been designed as an emergency fire

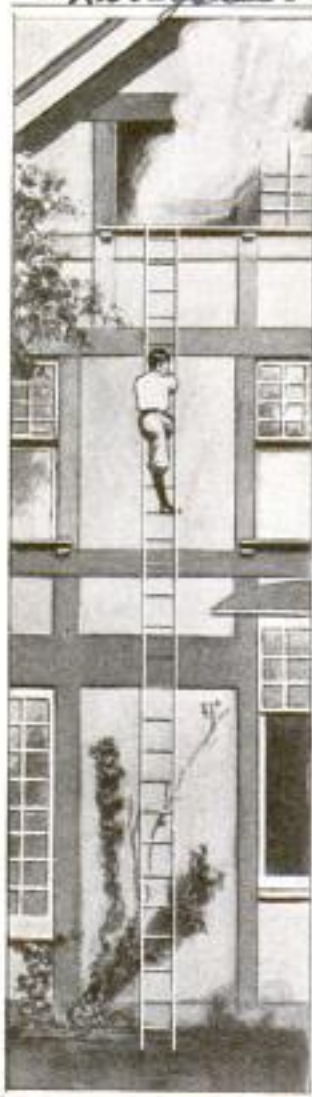

Folding Steel Ladder Designed as a Fire Escape for the Home

escape for residence, city-apartment, or factory - building use. When folded it may be stored in a fiber telescope out of the way, or kept in an accessible place in a case which is made for it. In the event of fire, the ladder may be unfolded quickly and lowered from a window to the ground. As this is done each segment locks automatically with the straightening of the ladder, so that it is held with a certain rigidity. At the same time it has the advantage of flexibility so that it may be used over a mansard roof, or the top of an intervening porch, for instance, without difficulty. Although light enough in weight so that it may be carried to a window and dropped by the average woman, it is sufficiently strong to support as many persons as can conveniently use it at one time. A third-story ladder of this type weighs about 40 pounds.



escape for residence, city-apartment, or factory - building use. When folded it may be stored in a fiber telescope out of the way, or kept in an accessible place in a case which is made for it. In the event of fire, the ladder may be unfolded quickly and lowered from a window to the ground. As this is done each segment locks automatically with the straightening of

**BIG FLAGSTAFF FOR LONDON BOTANICAL GARDEN**

A flagstaff, 216 ft. long, has been made at Vancouver, British Columbia, and is to be shipped to England, where it will be erected in the Kew Botanical Gardens, a few miles out of London. The tree from which it was made was a perfect specimen of fir pine and the staff is straight and without flaw or defect. It is 32 in. square at the butt, tapering to a diameter of 12 in. at the top. The flagstaff will make a deck load for one of the big liners running out of Vancouver. It is said to be the longest flagstaff ever produced from the forests of British Columbia.

**ROLLER SKATE WITH SAFETY ATTACHMENTS**

A roller skate that is practically accident-proof has been invented for preventing the bad falls that often occur through overconfidence or lack of skill in beginners. At the back of the skate is a steel bracket carrying an adjustable bearing plate. The bearing plate consists simply of a special head on a bolt and is easily adjusted for height with washers, as shown. In case the skate starts to fly out forward this plate comes down on the pavement or floor, stops the movement, and gives the skater a chance to recover equilibrium. As an additional precaution there is placed at the back of the forward rollers a small friction device that



Roller Skate Equipped with Attachments for Preventing Falls

instantly binds the wheels at the slightest backward motion, but is inoperative so long as the skate moves forward.

W. A. Summerhays  
1306 E. 72d Pl.  
Chicago

Inventors:  
 Robert Fountain, Jno. K. Waters, and  
 Winfield C. Winchester - all of  
 POPULAR MECHANICS  
 Banning, Calif.

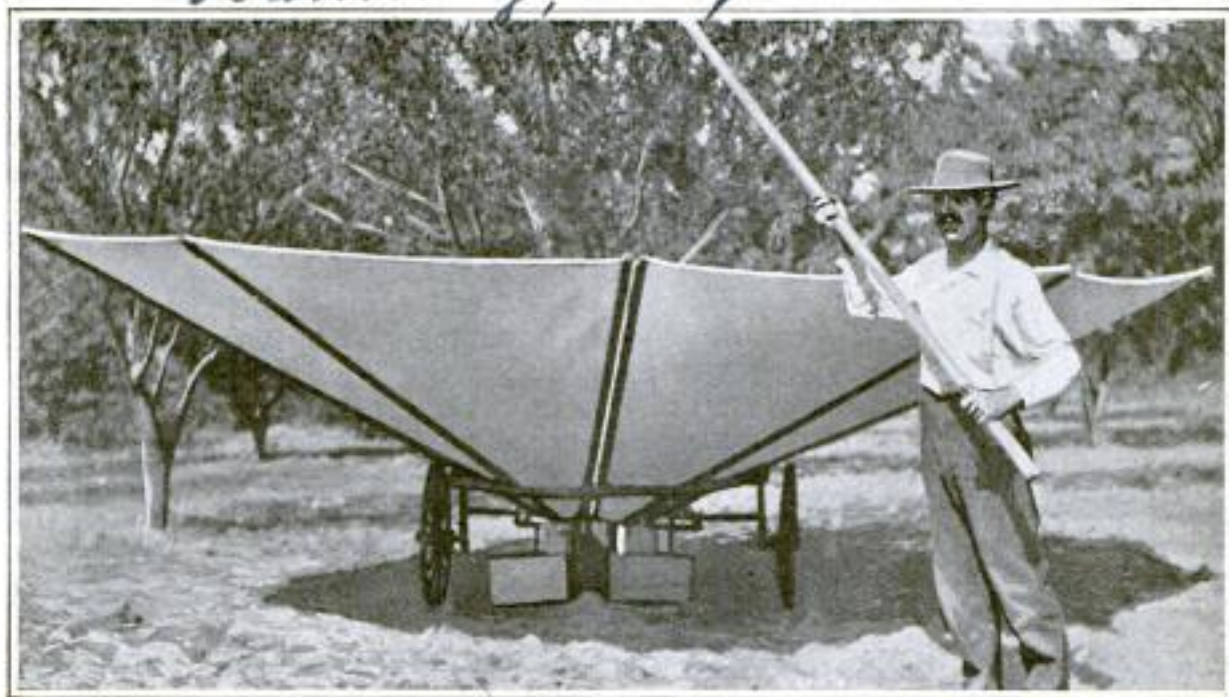

The Frame of the Apron Enables the Device to be Placed about the Trunk of a Tree

9712

### FRUIT-GATHERING DEVICE RESEMBLES UMBRELLA

To simplify the work of gathering fruit which does not necessarily require hand picking, a canvas-apron device has been invented which in appearance is similar to a large umbrella. It is so arranged that it may be placed about the trunk of a tree, forming a funnel into which apples or oranges are caught as a tree is shaken. In the center of the device is a cloth arranged in such manner as to break the fall of the fruit as it rolls into the chutes and is discharged in baskets or boxes placed on the ground. The canvas is supported by radial arms which may be folded over on one side to permit the device, which is mounted on a cart, to be wheeled between the various rows of trees in an orchard.

either a forward or backward direction, which eliminates the necessity of turning the car around when the course of travel is reversed. The motor is of a simple type which is easily kept in running order. The wheel base of the machine is short and the weight light, so that it may be carried in a baggage car and received or deposited at a sta-

### MOTOR-DRIVEN RAIL CAR FOR

### 9891 TRACK INSPECTION

Quite a novel-appearing motor-propelled car for the use of roadmasters engaged in railway-track inspection has recently been developed. It is equipped with a light, two-cycle, 4-hp. engine which is capable of driving it at a speed of from 3 to 40 miles an hour in

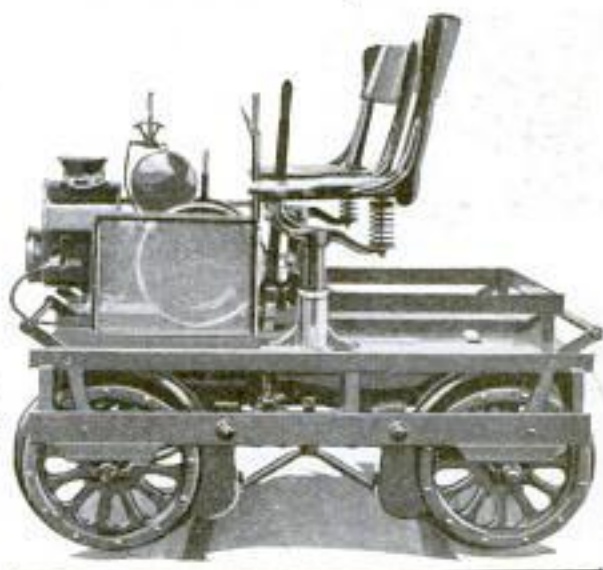

Track-Inspection Car Which may be Driven  
 in Either Direction Equally Well

tion without especial difficulty. Instead of the usual bench seat, the car is equipped with two swivel chairs which may readily be faced toward either end.

Fairmont Machine Co.  
 Fairmont Minn.

9901  
# *Marysle*  
**STREET CLOCK PLACED HIGH  
ON CORNER OF BUILDING**

In placing a large double-faced clock on a Los Angeles building, the usual practice of employing brackets to support it over the sidewalk was discarded and the dials were put on adjacent sides of the corner column of the structure between the fourth and fifth floors. The reason for placing it at this rather unusual height was the belief that at such a point it could be readily seen by more persons than if it were set closer to the street level.



The faces of the clock are 5 ft. in diameter, while its finish is made to harmonize with that of the building, which is constructed of light-colored brick.

9998  
**COMBUSTION OF COAL AIDED  
BY PULVERIZING IT**

See  
00'13  
574  
See  
Jan 07  
154  
Certain fuel authorities are advocating that for railway and industrial purposes in large cities, coal should be ground into a fine powder and shot into furnaces under air pressure instead of being used as it now is. By so doing, it is claimed, there is less waste of energy because the combustion is more complete. Another advantage of almost equal importance is that the smoke nuisance is materially lessened. For railway purposes the coal is

ground, dried, and kept in an air-tight tank on the tender, in much the same way as oil is carried when used for fuel. It is forced into the fire box under pressure, exploding to the formation of gas without lowering the temperature or adding moisture. More than \$200,000,000 is expended annually by railroad companies for coal, and it is estimated that by using this system of firing, the saving would be tremendous. Although the plan has been advanced at Chicago as a solution of the smoke problem and a substitute for the electrification of the railway terminals, there is considerable dispute about its value in the latter case.

9644  
**HANDY ATTACHMENT FOR  
GOLF CLUB**

A true "lazy-man's device" is now being introduced for the convenience of golfers. This device consists simply



of a metal clip mounted on the handle of a golf club and so shaped that the player can pick up or tee the ball without having to stoop.

See  
Wm. C. Conroy  
Washington D. C.  
An exhaustive agricultural atlas of the United States is being prepared by the government. Pending its

completion, a smaller work of approximately 100 pages of maps, text, and diagrams is to be issued dealing with relief, soils, climate, crops, rural population, live-stock distribution, and the size and value of farms.



8608 Two Bridges of Different Periods Which Illustrate the Advance Which has been Made in Railway-Bridge Construction

#### DEVELOPMENT OF RAILWAY ROADBEDS AND BRIDGES

Although the contrast is not so striking to the casual observer, the changes in roadways and track structures which have accompanied the rapid development of larger and heavier locomotives and rolling stock have been almost as great in the former as in the latter. If the original railway roadbed and trackage were to be compared with those of today, the difference would be almost as noticeable as that between Stephenson's famous "Rocket" and the new articulated compound engine of the Erie Railroad which weighs 422½ tons. The accompanying photograph shows two railway bridges which illustrate two separate periods in bridge construction. The smaller one was built in 1889, and the larger about 20 years later. If it were not that the former structure was built with nearly twice the amount of steel actually needed at the time of its erection, it would be incapable of supporting many of the trains which are now run across it.

Ⓒ Diamonds having a total value of nearly \$27,000,000 were taken from the South African mines in 1914.

#### CONCRETE KEELSON FOR 9772 SAILING BOAT

Concrete employed in place of lead as a material for the keel of a small sailing craft, is the somewhat unusual use found for cement by a Pennsylvania yachtsman. A concrete keelson weighing 2,200 lb. was fitted on the auxiliary yawl "Florence," a 32½-ft. boat with a 10½-ft. beam, at a cost of \$25, as against an expenditure of approximately \$225 if lead had been used. So far the experiment has proved successful, as the vessel has seen hard service and been aground several times, while the keelson is apparently still in good condition.

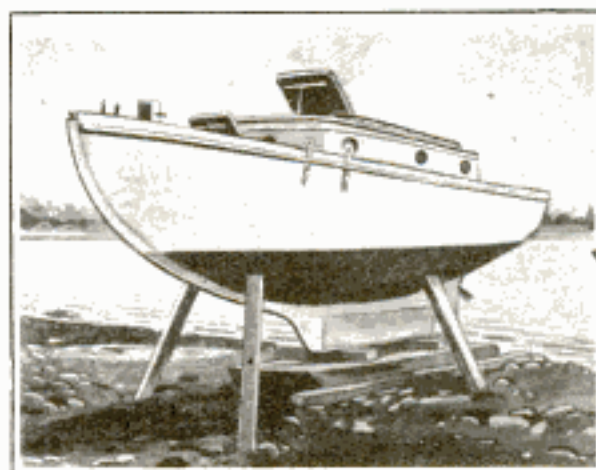

An Auxiliary Yawl with a Concrete Keelson Weighing 2,200 Pounds

Keight Portland Cement Co.  
 1100 N. 11th St., Allentown, Pa.  
 1100 N. 11th St., Allentown, Pa.  
 1100 N. 11th St., Allentown, Pa.

Mr. John E. Berg  
4. Elevator Supply & Repair Co.,  
Willow Av., 15th & 16th Sts.

236

POPULAR MECHANICS

Hoboken, N. J.

**ELECTRIC SURFACING TOOL  
FOR CONCRETE WORK**

For smoothing the surface of a concrete wall, dressing down the form marks, and providing a good base for a cement wash, an electric planing tool has been invented which operates at high speed and leaves the work dry and slightly porous. In the past this has been done chiefly by hand, a carborundum stone being employed and water used to eliminate the grit. By that method

a paste is formed and rubbed into the pores, frequently with unsatisfactory after results. The new machine, instead of grinding the surface away, chips it. This is done by a cutter disk which is provided with 24 wheels, set in pairs



8755  
see letter of  
J. O. B. in book  
B. file 6/19/15

and each having two dozen, or more, teeth which act as miniature hammers and are so directed that their edges strike the surface squarely. The disk is driven at a speed of about 2,000 revolutions a minute by a flexible shaft that extends to an incased motor strapped at the waist of the operator. The apparatus complete weighs about 20 lb., and will take either a 110 or 220-volt current. The machine also may be employed in surfacing stone.

**9130  
GASOLINE-ELECTRIC POWER  
FOR SIGHT-SEEING CAR**

The latest development in gasoline-electric motor cars is a sight-seeing car that has just been placed in service at Durban, Natal, Africa. This kind of equipment, while not new, is still uncommon. It is being used to a limited extent on interurban cars and on at least one automobile, which was described in a recent number of this magazine. Its application to a sight-seeing car capable of carrying 18 passengers, such as the one at Durban, is believed to be new. In this car a 40-hp. internal-combustion engine is used to drive an electric generator from which the power both for driving and for lighting the car is taken. The car is to be used for touring the country around Durban, where some of the finest scenery in South Africa is to be found.

This Sight-Seeing Car, Recently Placed in Service for Touring the Country around Durban, Natal, Africa, is Driven by Gasoline-Electric Power and is Capable of Carrying 18 Passengers

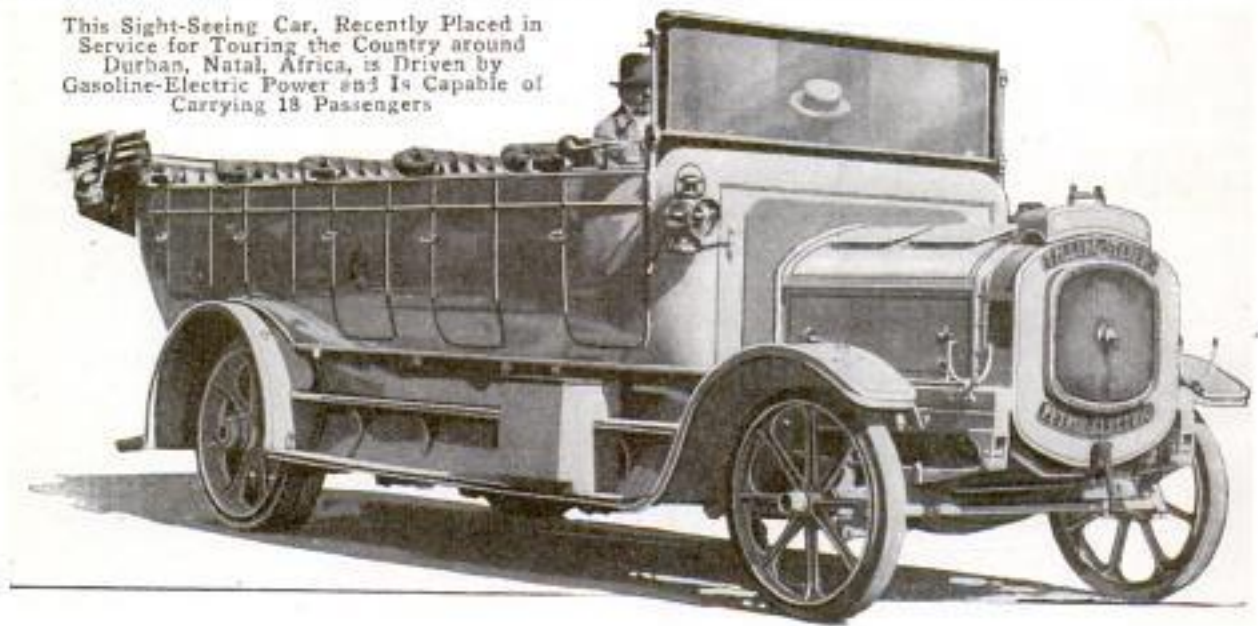



Two-Ton Rock Hurlled against Dwelling House by a Heavy Blasting Charge: Part of This Rock Went through the House, Taking the Breakfast Table with It

*Wm. P. Watson, Morton, Pa.*  
**BLASTING CHARGE BOMBARDS**  
**9609 DWELLING HOUSE**

A dwelling house in Manyunk, Pa., was almost wrecked and the inmates narrowly escaped death from the bombardment of stones that resulted from the firing of a heavy charge in connection with blasting operations in the outskirts of that city. One two-ton rock was hurled against the house, making an enormous hole in the wall, and part of the rock crashed entirely through the house into the yard beyond. This rock demolished the table at which the family was eating breakfast, but without injuring any member of the family.

Another rock tore away part of the cornice and crashed through the roof, seriously injuring one of the family asleep in an upstairs bedroom and wrecking most of the furniture.

**CORRUGATING A STEEL**  
**9123 WRENCH**

Through some oversight a steel wrench was left in a pack of sheets which were to be corrugated, and was passed through the corrugating machine. Although the pack of sheets alone was all that the machine was guaranteed to handle, a perfect  $2\frac{1}{2}$ -in. corrugation was put into the wrench, and, according to reports, without any injury to the machine or dies. The



Appearance of a Steel Wrench After It had Passed through a Corrugating Machine

handle of the wrench is made of two  $\frac{1}{2}$ -in. round steel bars, while the jaws are of steel  $\frac{5}{8}$  in. thick. It is no longer of any value as a wrench.

*O. O. Poorman Co.*  
*New Bremen, O.*

9187  
*Bryant Co.,  
 So. Milwaukee, Wis.*

## BIG ELECTRIC DRAG-LINE EXCAVATOR

What is said to be the largest electric drag-line excavator in the world is being used in excavating the Calumet-

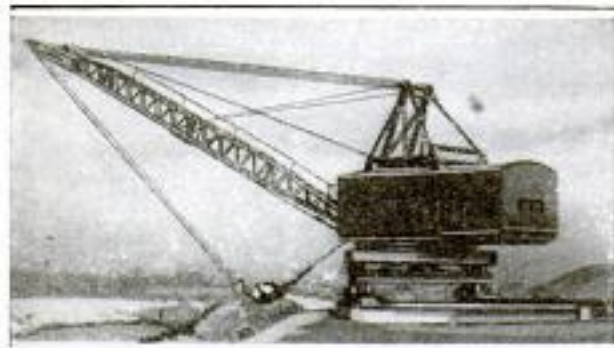

This Machine, Used in Drainage-Channel Excavation, is Said to be the Largest Electric Drag-Line Excavator in the World

Sag Canal, an important drainage channel near Chicago. This machine weighs about 225 tons and has a steel boom 125 ft. long. The bucket is designed to hold 3½ cu. yd., but can easily be made to hold 4 cu. yd., when the material is heaped up. The machine is both operated and propelled by electric current taken from the wires of a public-service corporation

and first passed through a transformer wagon which steps the current down from 2,000 volts to 440 volts. One of the ingenious features of the equipment is the sectional track on which the excavator runs. Each of these sections is made up of heavy structural-steel shapes and is curved so that the outer rail is 12 ft. long and the inner rail 8 ft. long, each section being 30 ft. wide. In going around a curve the sections are assembled long side to long side, but in working on a straight section of the canal the sections are jointed so that the 8-ft. section of one abuts against the 12-ft. section of the other. As the sections are short, the curvature in each is slight, and with the sides so alternated the machine travels practically in a straight line.

⌈The toothbrush has been condemned as a dangerous instrument which should be abandoned. Its sterilization is claimed impossible and its effect detrimental. Use of dental floss and the massaging and cleaning of the gums and teeth with the forefinger is advocated.

9829  
*Maraxi Equip*

## MACHINE-SHOP EQUIPMENT FOR MOTOR-CAR OWNER

Combining a number of different instruments in one compact piece, a serviceable tool for the private garage in which the owner of a car does much of his own repair work, has lately been brought out. It consists principally of a multi-vise and drill press built together. Coupled with these are an adequate anvil and a tool-steel cutting hardy. The apparatus is mounted on a swivel base so that it may be turned freely or set in various working positions. A vise with quick-acting jaws is afforded which operates independently of the

drill press, making it unnecessary to feed the vise jaws when feeding the drill. Any-size hole may be bored as accurately, it is claimed, as if the work were done in an average lathe. With its mounting, the tool weighs approx-

*"Trident Drill-Press Combination  
and Multi-Vise"*

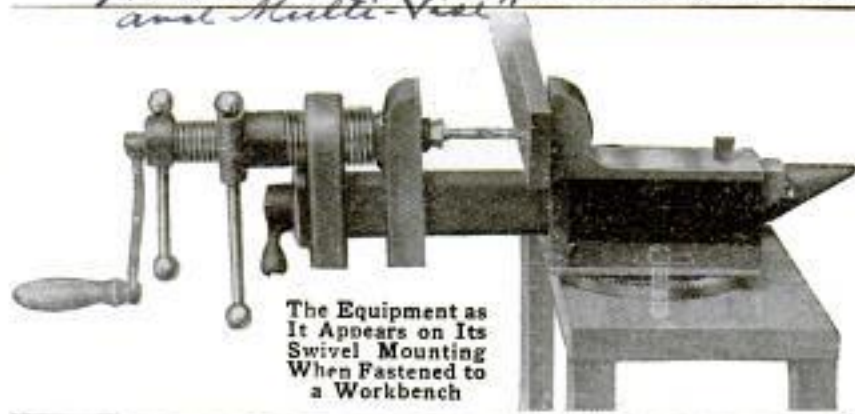

The Equipment as It Appears on Its Swivel Mounting When Fastened to a Workbench

imately 60 pounds. The swiveling feature is particularly valuable when working long pieces in a small place.

*Newhall Chain Forge & Iron Co.  
 90 West St., New York  
 15 E. Lake, Chgo.*





With This Crossing-Signal System, Installed at Cleveland, Ohio, the Traffic is Controlled Entirely by the Red and Green Lights; the Crossing Officer is Stationed in the Booth at the Left

### ELECTRIC-CONTROL SYSTEM FOR CROSSING TRAFFIC

A new control system for crossing traffic, that has been installed in Cleveland, Ohio, is designed to give unmistakable indications to approaching vehicles and to do away with the possibility of conflicting signals. Electric lights, facing oncoming vehicles and hid from view in the opposite direction, are placed on the right-hand side of each street. A red light denotes "Stop" and a green light "Proceed." The red light is placed on the near side of the intersecting street and the green light on the farther side. All these lights are controlled by switches placed in the officer's booth, and are so interlocked that when the green light is given for one route the red light automatically goes on for the

other route. To clear the crossing in case of fire, the officer simply throws an emergency switch which sounds an alarm bell and turns on the red lights at all the corners, instantly stopping traffic from all directions.

### A MYSTERIOUS MENACE IN RAILROAD OPERATION

Transverse fissures that begin apparently with a nucleus formed at the time the rail is rolled and gradually spread as the rail is subjected to the strain of traffic constitute one of the most puzzling problems with which railroads and the makers of rails have to deal. Faults of this kind, which are usually hidden inside the metal beyond the possibility of detection by the keenest inspector, seem to be characteristic

*Fuller & Smith  
The Engineer's Bldg.  
Cleveland, O.*

of the open-hearth steel now generally used for making rails. They have been likened to "cancer spots" which start with a point of infection and eat



Rails That Broke as the Result of Transverse Fissures: The Nucleus from Which the Fault Spread in All Directions can be Seen in Each of the Rails

through the heart of the metal. This term may or may not properly describe the process. Rail experts are inclined to believe that the trouble is caused not by any deterioration of the metal, but is the result of the mechanical development of a crack that starts from a weak point originally in the rail.

## 9774 STEEL TAPE FOR MEASURING HELL GATE SPAN

For checking the locations of the ends of the span by direct measurement after they had been established by triangulation, the engineers in charge of the Hell Gate arch bridge now being built to connect New York City with Long Island used a steel tape 1,050 ft. long. The span of the main arch is 977½ ft. between centers of end pins, and at the time the measurement was made the towers had been built up to the level of the roadway. A wire was stretched between the towers, and one end of the tape was then attached to the wire and pulled across to the opposite tower. The tape hung free between end supports and was subjected to a pull of about 71 lb. while the measurement was being made. The tape is 1/32 in. thick and 3/32 in. wide, and was specially made for this measurement.

## 8919 PAVEMENT PLOW TIMESAVER FOR TRACTION COMPANY

For the purpose of removing granite block, or similar, pavements preliminary to relaying street-car tracks on paved thoroughfares, a plow has been devised by a traction company in Cleveland which accomplishes the work of approximately 500 laborers. The plow weighs 3,500 lb., has a cast-steel prow,

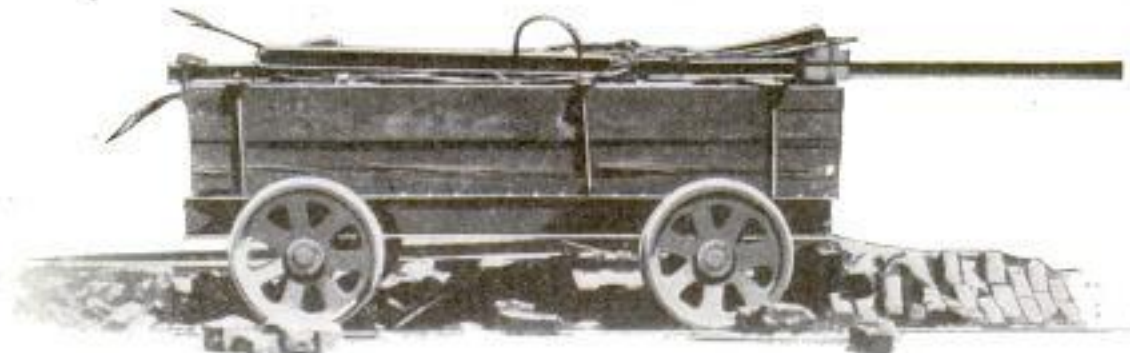

Pavement Plow Used by a Surface-Traction Company Which is Said to Do the Work of 500 Laborers

Such faults have been under investigation by rail experts for several years, but neither the cause nor the cure for the trouble has yet been found.

10 ft. in length, and is mounted on trucks which are weighted down by eight tons of scrap-iron ballast. A heavy cable connects it with a service

*The Cleveland Railway Co.  
Cleveland, O.*



A Signboard Which Fresno County, California, has Found More Effective Than Motor Police in Minimizing Speeding on Its Highways

car, driven by four motors, which is used to draw it. In addition to a motorman and trolleyman, only two men are required in operating the apparatus, which turns up the pavement blocks with apparently the same ease that an ordinary plow cuts through soft loam. In two or three hours' time the device can open up enough trackage to keep a rail gang busy for a week. It is claimed by the company that on one occasion the plow succeeded in tearing up the pavement along a 4,500-ft. stretch of track in 28 minutes.

### MOTORISTS PUT ON HONOR IN CALIFORNIA COUNTY

Fresno County in California has taken an interesting step in dealing with the motorists who use its highways. It has adopted a policy of placing every driver completely on his honor and then not employing speed patrolmen to trail cars and arrest violators of the road rules. At one side of each of the various highways entering the county a large signboard has been erected which informs all foreign motorists of the "honor system," of the absence of "speed cops," and that the speed limit is set at 30 miles an hour. This plan has been in force for some weeks and, as might be expected, has served its purpose admirably. As a result a movement is now being pro-

moted to obtain the removal of motor police in all of the San Joaquin Valley counties, so that motor tourists using the valley route between San Francisco and Los Angeles will be controlled solely by the honor system.

### SWITCHING SIGNALS GIVEN WITH AUTO HORNS

Ten electric automobile horns mounted on telegraph poles and all controlled by one push button in the scale house are used for signaling the switching crew in handling trains over the railroad switching "hump" at Inman, Ga. Signals given by these horns take the place of signaling by hand and are said to give much better results, especially at night or in foggy weather. The switchmen can move about at will without the necessity of continually watching for signals, while the whole crew of a long train is certain to get the same signal at the same time, in unmistakable if raucous tones, from the horns spaced along the track on the telegraph poles.

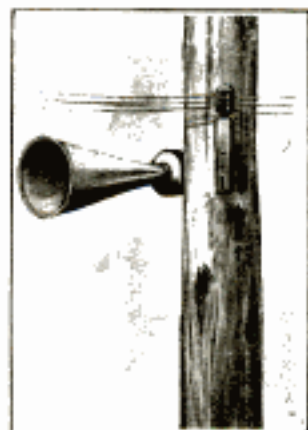

# N. R. Cooper,  
Fresno, Calif.

Southern Ry.

## ATTRACTIVE GARAGES AT MODERATE COSTS

9828

# BY ALBERT MARPLE

**I**N designing private garages for family motor cars, the attempt to procure architectural harmony between them and the dwellings, as well as other adjacent buildings on residential grounds, is becoming more and more general. The remarkably rapid development of the automobile industry, which quite naturally caused stables to be remodeled and rough housings to be erected without much thought being given to other than their utilitarian side, has been largely responsible for the backwardness manifested in this particular.

As new homes have been constructed, however, more attention has been paid to the exterior appearance of garages, and of late this has often shown itself to be true even in the case



This Garage, Which Has Room for Four Machines, is Fitted with Sleeping Quarters on Second Floor

A Pergola before the Entrance of a Garage Usually Adds Much to Its Appearance and may be Built Inexpensively

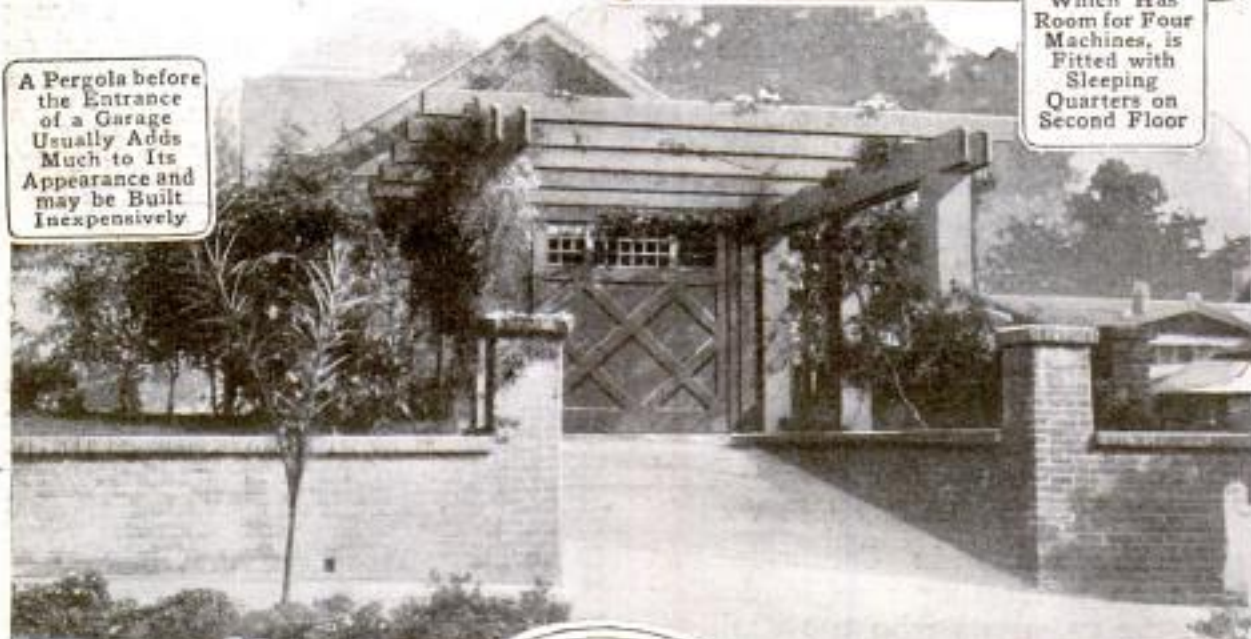

This Shingled Housing, Accommodating One Car, can be Built for a Very Moderate Price in Nearly Any Locality

With Space for Four Cars and Sleeping Rooms, This Structure Cost Only \$600

Building a Housing in a Side of a Hill Solves the Problem in Many Places Where Natural Surroundings Permit



Twin Structure  
of Pleasing  
Appearance That  
Costs Little  
Where  
Cobblestones  
Are Available



Modest  
Building  
Which Is Very  
Attractive and  
is Easily Built  
Anywhere

An Elaborate  
Structure of  
Three Floors.  
The Second Story  
is Used as a  
Billiard Room.  
It is Elegantly  
Fitted  
Throughout



With Hollow Tile  
This was Erected for  
Less than \$200

of the least expensive structures. While there are hundreds of examples of elegant housings built on the same lines as the homes to which they belong, most of which are out of the financial reach of the average owner of a small car, there are probably as many others, representing modest investments, which fit their surroundings with equal taste.

The cost of erecting the garages shown in the accompanying illustrations varied from approximately \$150 to \$4,000, although the latter figure is an excessive one. The buildings were designed to meet the needs of the respective owners and at the same time harmonize with the residences. In each instance the flooring is of cement and has provisions for draining it properly. The shingled garage, which is shown, is 16 by 18 ft. in size, is provided with six windows furnishing an abundance of light, has a cement driveway, and cost approximately \$150 to build. The exterior of another structure, in which hollow tile has been used for the walls, is finished in plaster. The eaves of its nearly flat roof overhang about a foot and a half. In size the garage is 14 by 16 ft., while the expense of erecting it amounted to about \$175.

One garage, which could easily be reproduced on grounds where there are hills, is built into a side of a knoll. It is formed much like a vault, with concrete walls 6 in. in thickness and a reinforced roof. It measures 11 by 16 ft. and cost \$200. An artistic twin garage built of cobblestones and placed between two residences at the front of the property, but on a lower level, cost \$300 each to construct. On either side are broad steps extending over the terrace above. The driveways are separated. The walls, which are approximately a foot in thickness, are reinforced with steel rods. A concrete garage which could be duplicated in most localities for about \$300 is shown at the right of these double houses. It is unusually pleasing in appearance, has an abundance of small-paned windows, and is 12 by 18 ft. in dimensions.

A large structure capable of accommodating four cars and provided with living quarters for servants on the sec-

ond floor, can be built with reinforced-concrete walls for about \$600. The floor measures 24 by 34 ft. and the roof is made of red tile. Access to the upper story is gained by a stairway on the outside. Another structure which is especially effective is built with overhanging eaves and a broad, vine-covered pergola which extends over the approach. The brickwork here harmonizes with the bungalow, which is of similar architecture. A three-story building of rather odd design is made of reinforced concrete and elaborately fitted on the interior. The cars are kept on the first floor, the second story is used as a billiard room, and the chauffeur's quarters occupy the top rooms. On the front of the building is a large clock equipped with chimes which ring every half hour. Although \$4,000 was expended on the structure, it could be built for considerably less if fitted in the customary manner, and still be equally serviceable.

8972

## STUDYING THE DEFENSE OF BOSTON HARBOR



I. N. S.

COPYRIGHT, INTERNATIONAL NEWS SERVICE

**COAST-ARTILLERY** officers have to master harbor-defense problems as carefully as the Navy does. The officers shown here are studying Boston Harbor and trying to find a flaw in its fortifications that would permit a hostile ship to enter.

Sheboygan Gas Light Co.  
 Robert Young, Secy. Sheboygan, Wis.  
 (inventor)

9044  
**MOTOR-DRIVEN FIRE ENGINE WITH FIXED AXLES**

In designing a new motor-driven fire engine a New York inventor has departed from the established plan in automobile construction of applying

9722  
**PORCH LAMP PLACED INSIDE OF BUILDING**

A porch lamp of a new type, just placed on the market, is made to be installed inside the building so that it is not only protected from the weather

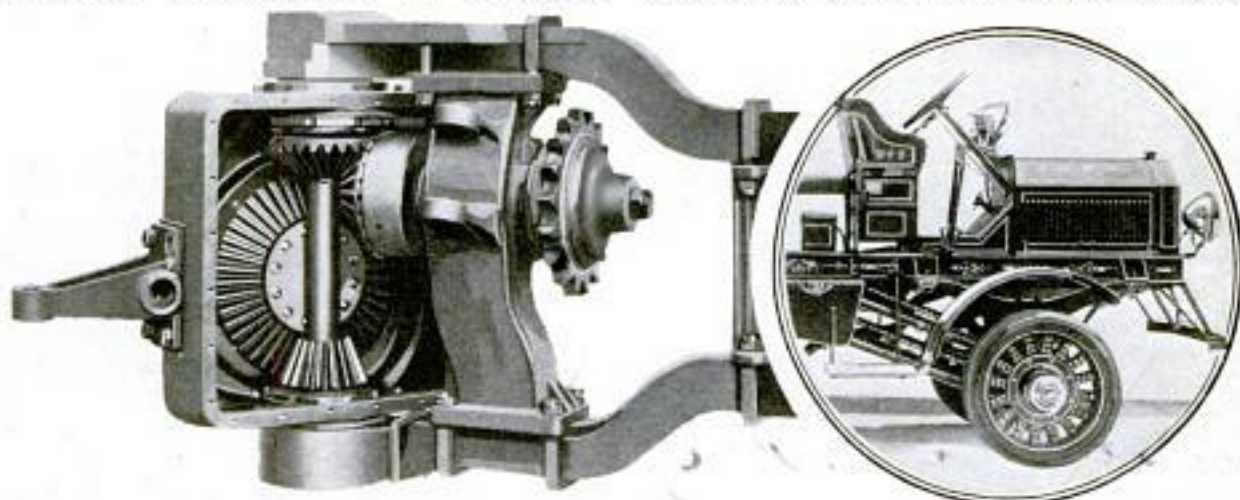

In Applying Power to the Front, or Steering, Wheels of This New Fire Engine, the Designer Invented a Mounting Which Allows the Wheels to be Swung While the Axle is Fixed Rigidly to the Chassis

power to the rear axle and has devised a means of transmitting it to the forward wheels. This, figuratively, separates the vehicle into two distinct parts, the front, or motor-truck section, and the rear, or fire-engine part, which is essentially no different from the corresponding part of the ordinary fire engine of the horse-drawn type. The plan of placing the drive chains on the front wheels involves the invention of a mounting that enables the latter members to be swung about substantially vertical axes adjacent to the outer ends of immovable axles. As may be readily seen by the accompanying photograph, one of the driving chains extends from the propulsion shaft to the gear end of a short transmission shaft, mounted in the extremity of the fixed axle, the other end of which meshes with gears in the pivoted bearing-block housing which provides a solid support for the wheel hub and at the same time allows it to be turned freely, independent of the axle, which is fixed rigidly to the chassis.

but serves to illuminate the hall or front room as well as the porch. The lamp is mounted inside the wall adjacent to the porch. Part of the light is diffused through the room, while a part of the horizontal rays are transmitted through a 1 1/4-in. tube to a globe mounted on the outside of the wall, where, with the aid of a reflector, it is uniformly distributed over the porch. The lamp is adapted to other purposes as well, such, for example, as the lighting of clothes closets.



Some of the Horizontal Rays from This Lamp Pass through the Tube to the Globe Outside, Illuminating the Porch as Well as the Hall

ⒸThe total value of fish caught in Canadian waters in 1914 was \$33,207,748.

Serial 799730  
 (Mrs) Ralph H. Med. with, Edinboro, N. Y.  
 Assignor to Abner C. Edinboro N. Y.

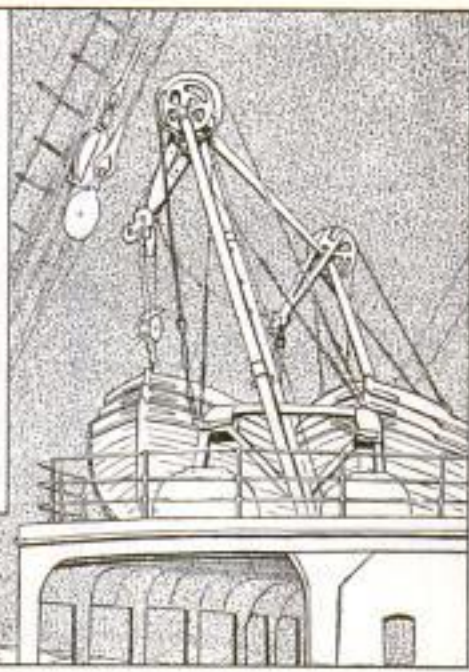
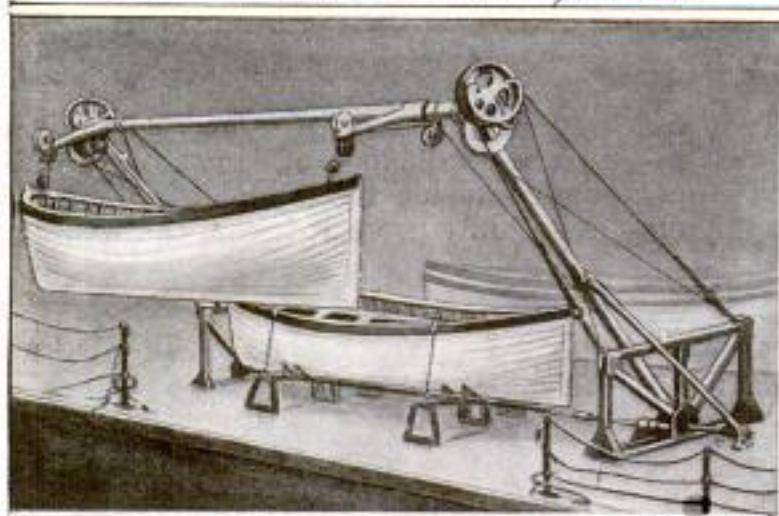

With This Apparatus the Boat is First Lifted from the Chocks and Then Swung Horizontally across the Deck and over the Side of the Ship. One of the Greatest Advantages in the Apparatus Is That Boats can be Launched with It from Either Side of the Ship

*Adopted by C. P. Ry.*  
**RAPID BOAT-LAUNCHING**  
**APPARATUS**  
 9054

To nest boats entirely across any convenient part of the deck and then launch them rapidly with a single pair of davits, is the purpose of a new boat-launching apparatus that has already been installed for test on two seagoing vessels. The novel feature about this apparatus is that the boat is first lifted from the chocks and then swung horizontally over the deck and beyond the side of the ship. This is accomplished by two arms that are fixed to a horizontal shaft extending between the tops of the pair of davits. These arms hang vertically as long as the davits are in a vertical position, but swing out horizontally through the action of

lines passing over eccentric sheaves as the davits are swung to an inclined position. The arms carry the lifting lines, and the davits are spaced a sufficient distance apart to permit the boats to swing clear between them.

*9440*  
**SNOW-CLAD MOUNTAIN PEAK**  
**FOREST-LOOKOUT POINT**

One of the important lookout stations used by rangers in the west throughout the summer when a careful vigil is maintained for forest fires, is the summit of Lone Mountain, on the divide between the Gallatin and Madison rivers in southwestern Montana. This peak, although snow-covered much of the season, is the home of a lookout from July to October. It has

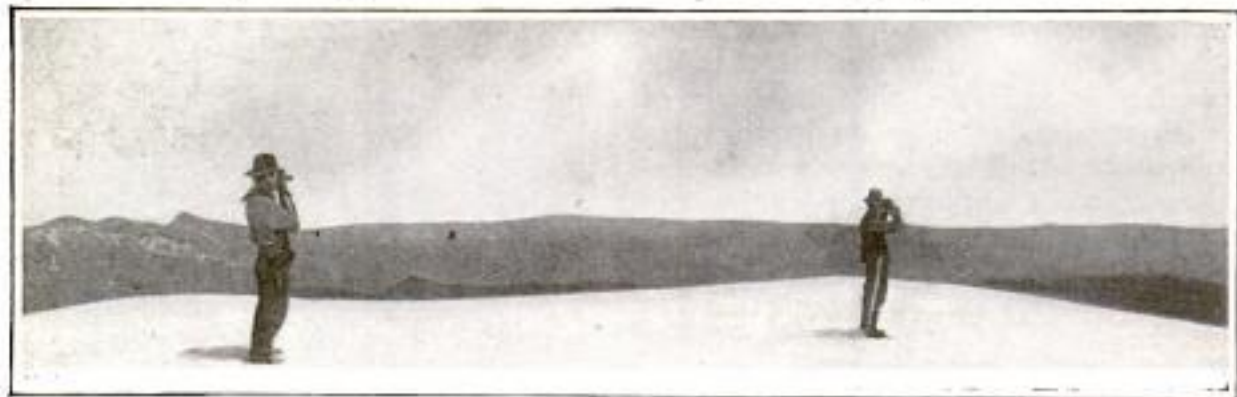

From This Peak Seven Different Forest Preserves are Watched during the Season When Forest Fires Are Prevalent



an altitude of more than 11,000 ft. and furnishes a vantage point from which seven different forest preserves in Montana, Wyoming, and Idaho can be watched through binoculars. Telephone connections are maintained with the several forests, so that rangers may be notified the moment a fire is discovered.

is designed to be permanently mounted on a counter or table. All that is necessary for mounting it is to sink the end

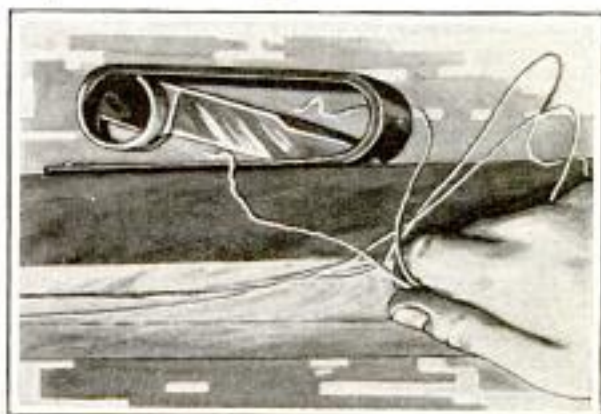

How the New Cord-Cutting Device is Used

of the blade into the wood until the lower part of the guard rests on the counter top and then secure it with a single screw.

9665  
**DESK FOR CRAMPED OFFICE  
SEATS TWO PERSONS**

Among the new fixtures which are being introduced for offices is a flat-top desk designed for the use of two persons. It is intended particularly for offices in which space is limited, and takes up no more room than an ordinary single desk. The two long sides are made alike, each with three drawers and adequate knee space. The drawers on one side, however, are opposite the knee space on the other side, which allows the two occupants of the



Two Persons may Work Comfortably at This Desk, Which is Designed for Offices with Limited Floor Space

desk to work at different ends. It is 60 in. in length and 34 in. wide, while the drawers are 26 in. long and 14 in. wide.

9447  
**INGENIOUS GRAVITY CLOCK  
REQUIRES NO WINDING**

Designed so that it does not require winding, a novel clock which is said to keep very accurate time has recently been invented by a Californian. Its mechanism is controlled by an ingenious system of weights and the propulsion power



Curious Rolling Clock Which Has No Springs and does Not Require Winding

gained by allowing the instrument to roll slowly down an 18-in. incline. This short journey is completed in 30 days, when, instead of being wound, the clock is returned to the top of the incline. The cylindrical case of the instrument revolves while the dial remains in its normal position with the figure 12 at the top. The hands are moved and the rolling of the clock controlled by the arrangement of weights in the interior of the case.

9480  
**SIMPLE CORD CUTTER WITH  
GUARDED BLADE**

In a simple cord cutter that has just been invented and patented the knife blade is held in a sloping position, with the edge down, by a curved arm that is made of the proper shape and width to serve as an effective guard. The cutter

Inventor & Patent.  
Walter Comness  
702 14th St. (off Church)  
San Francisco  
Pat. not yet issued.

Winnabago Furniture Mfg. Co.  
Fond du Lac,  
Wis.

9565  
**INTENSIFY RADIO IMPULSES  
WITH NEW INSTRUMENT**

By an ingenious combination of detectors of the "audion" type, an instrument has been devised for increasing



"Audion"

the strength of radio impulses, at a receiving station, to as much as 600 times their original intensity. One of these detectors resembles a low-power electric lamp within

parallel metallic plates with an incandescent filament between them. The

action of the heated air between these plates rectifies and strengthens the incoming signals. When a second bulb is placed in the circuit in a certain manner the impulses are intensified from five to ten times, while the introduction of two more bulbs causes the incoming signal to be increased from 125 to 1,000 times, the average, however, being 600 per cent. When a loud-speaking telephone is used in connection with this amplifier, signals which could hardly be recorded by an ordinary detector can be heard plainly across a large room. Messages from stations in Germany, Honolulu, and other distant points, have been picked up at New York by the instrument. As an illustration of its sensitiveness, an experiment was made in which it was used as a stethoscope. The result was that the beating of a human heart resembled thunder crashes, while the sound of normal breathing was highly intensified.

9916  
**BATH TRAINS, CONSTRUCTED FOR GERMAN TROOPS**

One of the most serious situations which invariably faces an army in the field is the lack of proper bathing facilities for the men. Until very recently this has been particularly true in nearly all the war camps of Europe. Of late, however, a step has been taken by the Germans which apparently will go far in

ameliorating the insanitary conditions which have heretofore prevailed. This



Shower Facilities in Cars Intended for Privates. The Officers' Compartments are Provided with Tubs and Dressing Rooms



Exterior of One of the German Bath Trains Recently Sent into Northern France for the Benefit of the Kaiser's Forces

ameliorating the insanitary conditions which have heretofore prevailed. This

of summer were sent into districts occupied by the enemy in northern France. These trains consist of an engine and tender, a large tank car carrying water, and a number of cars

*Matthies & Hegeler Zinc Co., La Salle Ill*

*Rolled Zinc Plates 1/2" - 6" x 12" - 3/16" center hole*  
*restriction of use. Zinc must be practically pure*

**POPULAR MECHANICS**

*Use confined almost exclusively to ocean going vessels.*

fitted with shower baths, together with others provided with tubs and lockers as well as dressing rooms for the officers. Sufficient water can be carried in one of these tanks, which is similar to those used in transporting oil, for approximately 1,000 persons.

that move along silver segments of various heights corresponding to different speeds. Each of these segments is electrically connected with one of

*Metal Industry, X 111 Nov 1915*  
**SCALE DEPOSIT IN BOILERS**

**PREVENTED BY ZINC**

European engineers have found a use for zinc which is comparatively unknown in this country. It consists of employing it as a means of preventing foam and the deposit of scale in boilers. Plates of pure zinc, 6 in. long, 4 in. wide, and 1/2 in. thick, each with a 1/2-in. hole punched through the center, are being shipped abroad in large quantities. In using these, a steel rod is passed through a side of a boiler and the plates, separated by steel or iron washers, are strung on it. The zinc and iron members are constantly in contact and form a bar extending across a boiler, within which a galvanic current is created which prevents scale formation. This keeps a boiler clean for an indefinite period without requiring the use of chemical agents, it is asserted.

*also of interest*



With This Device the Train is Made to Run Constantly at the Speed for Which the Pointer on the Dial is Set

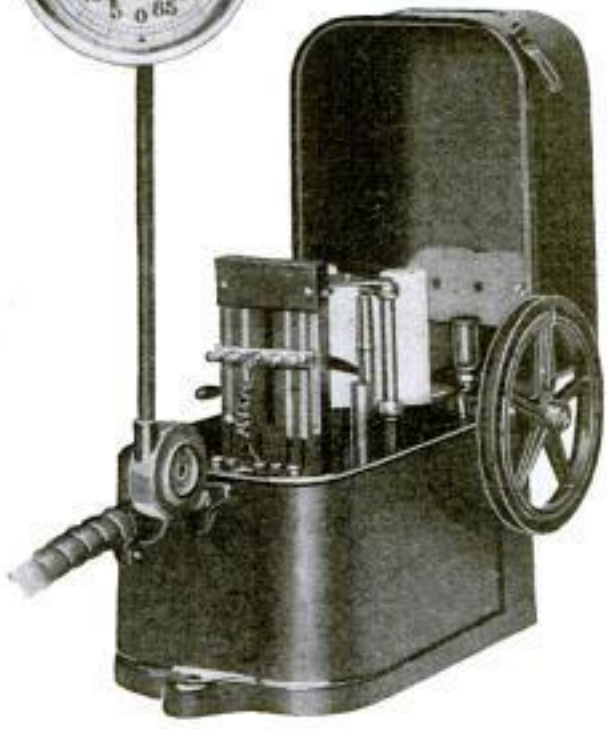

**DEVICE FOR REGULATING SPEED OF TRAIN**

*9696*

With an electro-mechanical device recently invented a train may be kept at a constant speed regardless of grades and curves and without the necessity for any attention on the part of the engineer. This device, which can be installed on any car of the train, or on the locomotive, is operated by a belt that runs over the car or locomotive axle. The belt works a small pump which forces oil into a cylinder with increasing velocity as the speed increases. In the cylinder is a piston that is pushed up by the oil as well as an opening through which the oil escapes at a constant rate, so that the piston rises or falls as the speed is increased or decreased. Connected with the piston are platinum points

the contacts on the dial, so that a circuit is completed through a given segment when the pointer is set on the contact that corresponds to the required speed. With the throttle open the proper amount, the speed increases until it is the same as that for which the pointer is set. When the speed goes above this, the platinum point rises to an insulated section of the segment, and the circuit is broken. As long as the circuit is closed it holds up a solenoid magnet that keeps inoperative a valve in the train line. When the circuit is broken, the magnet is deenergized, the air pressure opens the valve, and a service application of the brakes is made. The brakes stay on until the platinum point lowers to the silver segment, when the circuit is again closed, the valve is closed through the energizing of the magnet, and the brakes are released.

*Julian-Beggs Signal Co.*  
*Terre Haute, Ind.*

*Car Signal & Train Control Systems*

## SEEING BULLETS FLY

By EDWARD C. CROSSMAN

OUR first experience was while shooting light loads in an 8-millimeter (about .25 in.) Mannlicher rifle at a white rock lying on a burned-over hillside across a cañon from us, and distant 300 yd. The sun shone at nearly right angles to the line of fire. The bullet had nearly dead-black for a background.

The second shot I noted a silvery streak about halfway across the gulch, curving gently down toward the stone. I kept quiet about it, put the opera glasses on the spot, and waited. The next shot there came plainly into the field of the glasses the silvery bullet—really not a bullet in appearance, but a silvery line. I traced its course clear to the stone, and called it mentally a miss before the puff of black dust corroborated me.

With the full-service load, that now used in the German army by the second-line troops, the "Landwehr," we could still see the bullet, but the time used in flight was too short to allow any mental decision as to where the missile was going to strike. The upward curve of the bullet in its flight was plain. Strangely enough, it seemed to curve far out to the right, too.

In later years we found that the big .45-caliber revolver bullets under certain conditions were easily seen, particularly with a telescope, such as is used on the target range. Here the bullet looks like a big bumblebee, hastily approaching the paper.

When the very high velocity, .22 high-power rifle came out, the lady of the family discovered that that bullet could be seen from nearly any position ahead of or back of the firer. I was firing to her right and over her head to study the noise made by the bullet, when she called back that she could see the bullet coming. I took her place and investigated. Sure enough, the bullet could be seen plainly, first a long gray stem, opening out like the

petals of a flower, then the black whirling thing that represented the bullet coming in my direction.

Here the bullet is but .22 in. across, and travels at 2,800 ft. per second, about the speed of the German and American army bullets. The appearance, however, we found to come from tiny particles of tin or lead from the core, thrown off by the bullet in flight, and so we saw sort of an aureole, not the bullet itself.

The most amazing sight in our experience was the United States service bullet with its speed of 2,700 ft. per second. Here we saw the bullet itself, not flying particles. The sun was low over the eastern hills. Its rays came through a break in the ridge bordering the range, lighting up most of the course of the bullet up to the target 200 yd. away, but leaving the target and the firing point in deep shadow. The first bullet was seen by some one, and not a man present missed the strange sight later on. The appearance was a very brilliant silvery flash, as vivid and quick as a flash of lightning.

But two things are necessary to see bullets fly, a dark background, and the sun at right angles to its course. Big-gun projectiles are of course nearly always visible, and it is not hard to see a charge of shot in flight if one knows what to look for and where to stand.

9268  
SHIP'S SMOKE ELIMINATED BY  
NEW FURNACE EQUIPMENT

That the smoke from a steamship can be almost entirely eliminated has been demonstrated by tests recently carried out with the "Seneca," of the United States coast-guard service, which is provided with a new type of furnace equipment that brings about a practically perfect combustion of the coal. Photographs of the top of the funnel of this vessel taken once a minute for 60 consecutive minutes while the vessel was running at 11½ miles

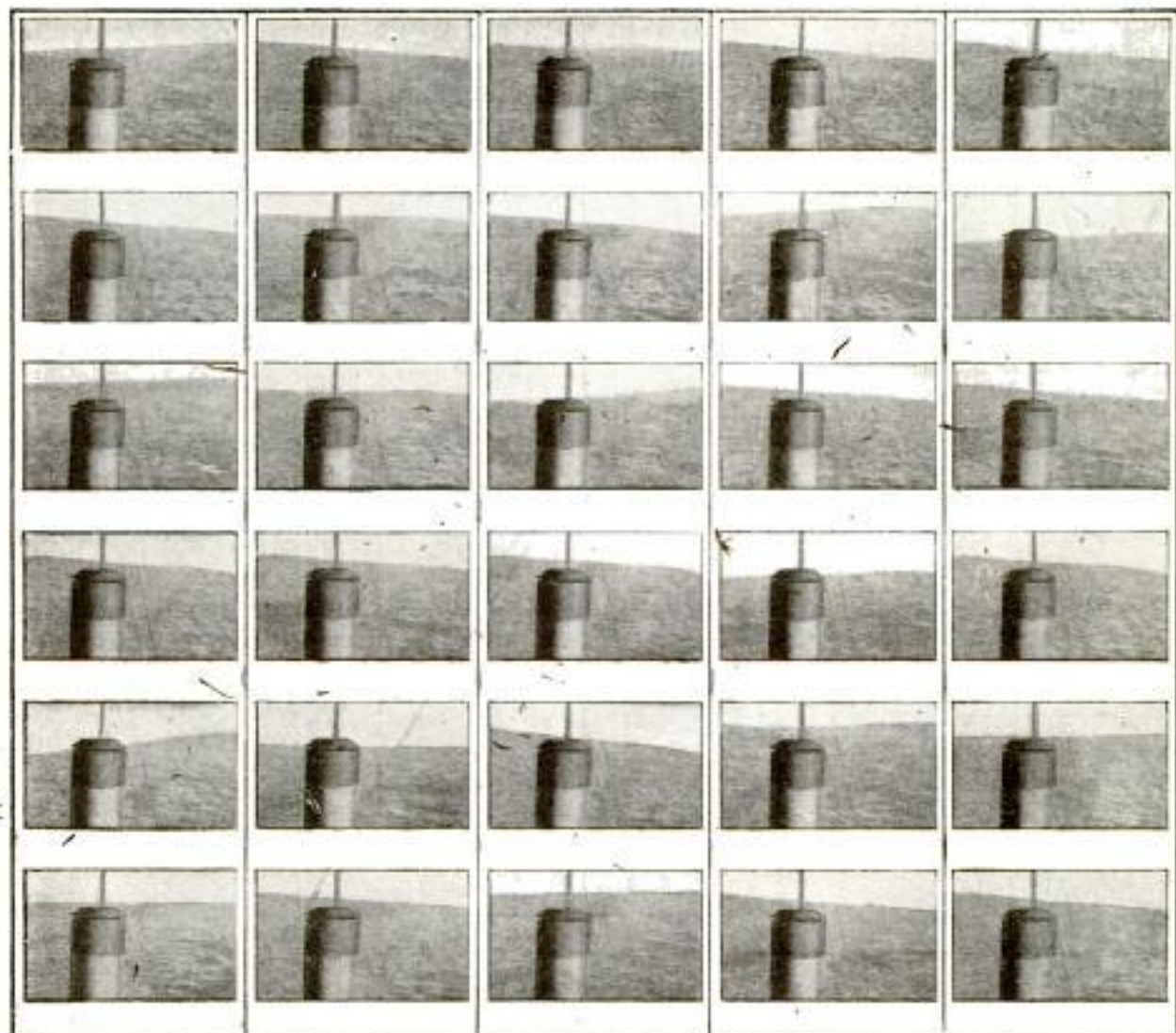

These Photographs, of the Smokestack of the U. S. S. "Seneca," were Taken at Intervals of One Minute to Show the Almost Total Elimination of Smoke Brought About by the Use of a New Type of Furnace Equipment

an hour, show traces of smoke in only two or three instances. The equipment is likely to be installed on the ships of the United States Navy, since by its operation the telltale smoke by which vessels may be sighted at great distances would be lacking. In addition to the elimination of smoke, it is reported that the equipment brings about a saving of about 16 per cent in the amount of coal consumed. One of the important features is the use of shaking grate bars instead of the usual bars of the nonmovable type.

One of the largest walnut-packing and cleaning establishments in the world is soon to be placed in operation in California, where over 20,000,000 lb. of walnuts are produced each year.

9849  
**ROOM KEPT FOR CHILDREN  
 AT NATIONAL MUSEUM**

One of the special rooms at the Smithsonian Institution at Washington inaugurated by the late Dr. Samuel Langley, is devoted exclusively to exhibits intended to interest children in natural science. Its conception grew out of its originator's realization that museums as a whole are not arranged in a way which makes them especially appealing to the minds of young children. So to offset this condition and provide a means of attracting juveniles to the institution, a children's display was prepared. All the wall cases, which contain large numbers of birds arranged in classifications designed to draw the interest of youngsters, are

built low so that everything within them is plainly visible to the youthful visitors. The "largest and smallest birds of prey," the "eagle and elf owls," and curious birds, including the toucan, umbrella bird, and others, are repre-

sented, while bright-colored and curious-shaped shells, strange insects, specimens of different minerals, fossils, and coral formations are also shown. Experience has shown that Langley's idea was a good one.

*extended over seven years.*

8969 *Railroads*

### HOW BRIDGES ARE AFFECTED BY FAST LOCOMOTIVES

*American Engineering & Maintenance of Way Assn.*

Tests recently made by an engineering association throw an interesting light on the severe vibration to which

connection. With this arrangement it is possible to counterbalance perfectly for only one speed, so that with the

locomotive running at either greater or less speed than this there is sure to be pounding. This becomes a serious matter when the locomotive is running at a speed greatly in excess of that for which its drivewheels are counterbalanced, the wheels lifting from the rails a small fraction of an inch at each revolution and then falling back with a hammer blow. Every bridge span has a natural rate of vibration, depending on its length and construction. When the pounding of the locomotive corresponds to this natural rate of vibration the result is excessive vibration, the effect being exactly like that of pushing a swing at just the right intervals. The speed at which this occurs for any particular bridge is known as its critical speed. In the case illustrated, the maximum bending of

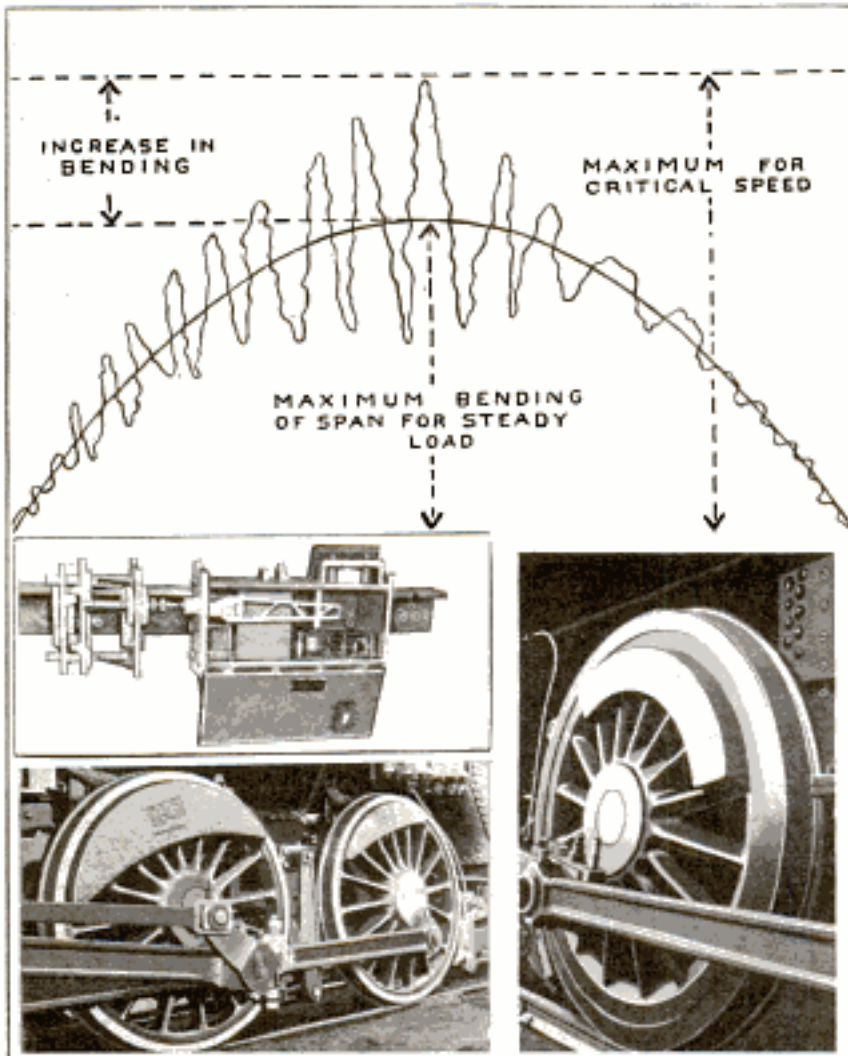

The Diagram Shows the Vibration Caused in a Bridge Span by a Locomotive Running at the Critical Speed; the Pictures below the Diagram Show Typical Counterbalanced Drivewheels and the Instrument with Which the Vibrations were Measured

railroad bridges are subjected by locomotives running at high speed. Every locomotive drivewheel is counterbalanced to neutralize the weight of the driving rods, the counterbalancing metal being cast adjacent to the rim on the side opposite the driving-rod

the span under the critical speed is about 50 per cent greater than that caused by a steady load of the same amount. It has been found that this effect is practically absent for speeds under 15 miles an hour and for speeds greatly in excess of the critical speed.

# T.T. Sturgeon 620 Broad St.  
Los Angeles

9878

**WOODEN INTERURBAN CAR  
CRUSHED BY ENGINE**

An accident which serves as a striking commentary on the use of wooden carriers for passenger traffic occurred in Los Angeles when a steam locomotive crashed into an electric interurban car, completely demolishing it and kill-



The Result of a Collision between a Locomotive and Interurban Car at Los Angeles

ing six of its occupants. Although the car was reduced to little else than kindling, the engine was practically uninjured, the impact merely displacing the rear trucks and knocking the steps off the tender. The collision happened at a crossing while the locomotive was moving at a speed said to have been not greater than eight miles an hour. The car was struck in the middle, carried approximately 25 feet, and pushed against an electric-light pole. None of its passengers escaped injury.

**WELL-APPOINTED PLATFORM  
FOR TRAFFIC OFFICER**

What is undoubtedly as pretentious a platform as is provided any traffic policeman, has been placed in Washington Square, at Newport, R. I., for the use of an officer who has distinguished himself in 103 runaways. The man, who has on a number of occasions been awarded medals for his bravery, was presented with the stand by summer residents of the resort as a token of their respect and appreciation

of his work. The platform is enameled in white, partly surrounded by a railing and protected from the heat and rain by a large umbrella. The trimmings are of brass, and the base of the stand is carpeted with a rubber mat.



Traffic Policeman's Platform at Busy Newport Street Intersection

*Officer Coggershall*

8553 **A NEW AND UP-TO-DATE  
SOD HOUSE**

Building a sod house in this country in the year 1914 is a thing that seems rather out of keeping with the times,



This Sod House, Built in 1914, is Located in a Timberless Section of Montana, 40 Miles from the Nearest Railroad

but there was evidently good reason for this antiquated mode of construction in the house illustrated, because of the difficulty of obtaining any other kind of building material. This sod house is located in a timberless section of Montana 40 miles from the nearest railroad.

8842 **CHEMICALLY TREATED WASTE  
MATTER AS FERTILIZER**

*Dept. of Agric.*  
Nitrogenous products such as hair, fur, garbage, and similar waste matter are being used as bases for different

commercial fertilizers. When in their raw state such substances contain nitrogen in certain quantities but in a form which is not readily broken up by the soil bacteria. Because of this, sulphuric acid and strong alkalis are being employed in treating these materials to make their fertilizing content more easily

attacked by the bacteria and thereby more readily available for plant absorption.

Ⓒ In Wyoming, where agriculture depends almost entirely on irrigation, careful measurements of all the water resources of the state are being made.

9475 **MACHINE SEWS COMFORTERS AUTOMATICALLY**

Guided mechanically so that unskilled labor may be employed in operating it, a power-driven sewing ma-

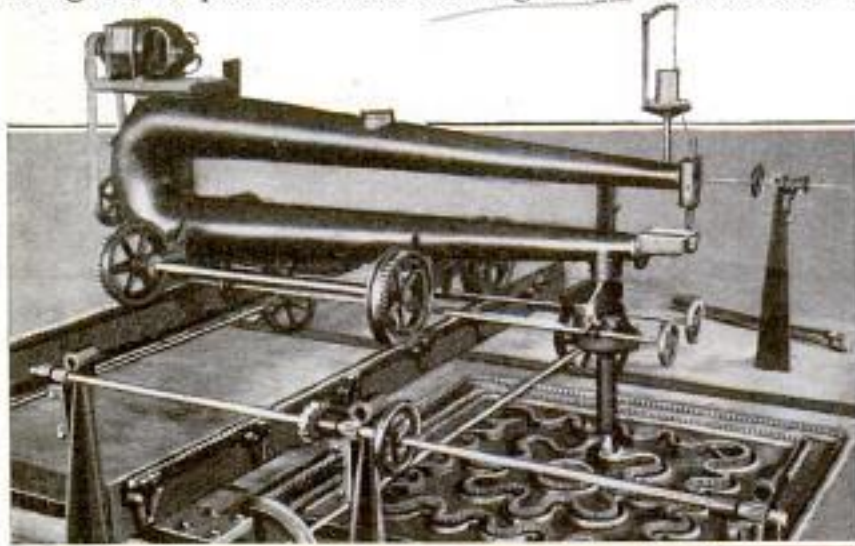

One of the Power-Driven Machines Used in the Manufacture of Comforters

chine has been developed for use in the manufacture of comforters. The ac-

tion of the apparatus is the inverse of that of ordinary sewing machines, for in this case the needle moves over the

work, following a set pattern, instead of the latter being guided beneath it. In order to make this possible the machine is mounted on tracks which allow it to be moved in almost any direction. The work is held in a frame and passed between the parallel arms of the machine. The guiding member is extended beneath the lower arm and consists of a shaft, at the end of which is a cogwheel that travels

along a cogged pattern placed on the floor.

*Used by Standard Textile Co.*

*Glens Falls, N. Y.*





Twin-Cylinder Motorcycle Pulling an 1,188-Pound Load up a 24-Per-Cent Grade

*Hendee Mfg Co., Springfield, Mass.*

9635  
**LOADED BUGGY IS PULLED  
 UPHILL BY MOTORCYCLE**

In order to demonstrate the hill-climbing power of a twin-cylinder, three-speed motorcycle, a novel test was recently made on a steep grade in a Pennsylvania town. A buggy with two persons seated in it, was hitched to the cycle, on which two other men were riding. The weight which the machine was expected to pull amounted to 1,188 lb., while the hill, it is claimed, has approximately a 24-per-cent grade. The machine with its added load made the climb on low speed without especial difficulty.

9851  
**PROTECTING LUMBER PILES  
 FROM HIGH WINDS**

When lumber piles are built in an open yard where they are unprotected by sheds, there is always some danger of the boards being blown about during high windstorms. To overcome this a lumber company has adopted a simple plan of utilizing the weight of the boards as a means of tying them down. In erecting a pile a spacer plank near the top is allowed to project for approximately a foot on opposite sides.

Then when the pile is completed, a second plank is laid across the top of it, paralleling the one beneath. The protruding ends of these two cross strips are fastened together by means of a square frame which binds the upper part of the pile and prevents the top boards from being moved by wind.



A Lumber Yard in Which the Unprotected Piles of Boards are Held Intact by Binding Members

# C. C. Lynde  
 See P. 262

9710 **ACETYLENE SIGNAL LANTERN  
FOR FOREST SERVICE**

The new acetylene signal lantern used in the national forest service for signaling by the Morse telegraphic



code works so successfully that messages can be read by the naked eye at a distance of 15 miles in clear weather, and the lantern has been worked to good advantage over a distance of 19 miles when good binoculars were used at the receiving station. The gas is produced by the ordinary carbide and water, and the tank, which is adjustable to the back of the lantern, is sufficiently large for about three hours of signaling. When burning normally only enough gas is admitted to the lantern to maintain a minute flame, but when the controlling key is depressed the gas aperture is enlarged and the flame flares up instantly, producing a "flash," which continues so long as the key is kept depressed. The dots and dashes of the Morse code are produced by the manipulation of the key.

9870 # Mc Carthy **HEAVIER FIELD ARTILLERY  
FOR UNITED STATES**

As a result of the demonstrated value in the European war it is probable that heavy field guns will soon become an important part of the fighting equipment of the United States. The 6-in. howitzer now in use throws a projectile weighing 120 lb. Experiments are now being made by the ordnance experts with a gun of 7.6-in. caliber that throws a 240-lb. projectile;

with one of 9.5-in. caliber that throws a 450-lb. projectile, and with one of 11-in. caliber that throws a projectile weighing close to 750 lb. The 11-in. gun has an estimated range of from 15,000 to 16,000 yards, or about nine miles. An interesting feature in connection with the experiments is that the experts are said to have little faith in guns larger than 11-in. caliber for field operations. In addition to the contemplated use of heavy field artillery, plans are being considered for the installation of high-power coast-defense guns that can be transported on specially built railroads from established bases located inland to strategic points on the coast line. This system would permit a rapid concentration of a great number of guns about any port that might be attacked by a hostile fleet.

9755 **NOVEL POST-CARD RECORDS  
FOR PHONOGRAPH**

Post cards on which miniature disk-phonograph records are pasted are



novelties which are becoming more or less popular in certain parts. The cards employed are of standard size, while the records, which are secured in the middle, occupy about one-half of the space on the side to which they are attached. They are not dissimilar to many of the sample records which from time to time have been used for ad-

vertising purposes, excepting that they are slightly smaller in size. While they are not of indefinite life, the records give surprising results the first time or two they are used.

Federal Novelty  
Importing Co.,  
108 North St., N. Y. C.

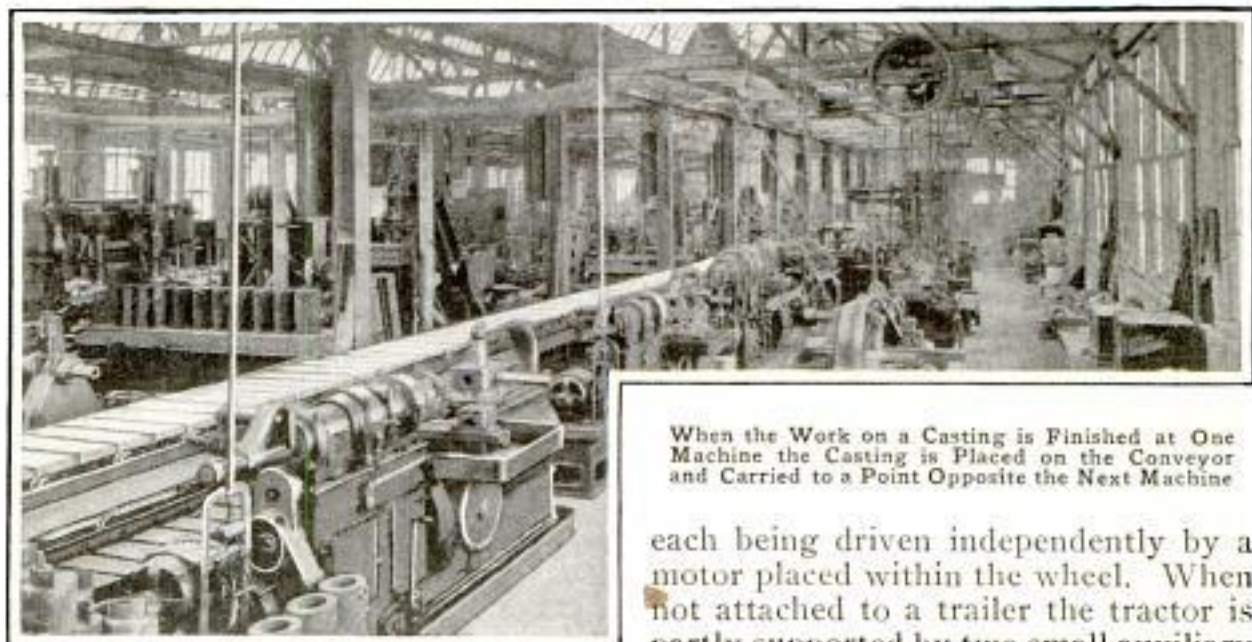

When the Work on a Casting is Finished at One Machine the Casting is Placed on the Conveyor and Carried to a Point Opposite the Next Machine

8502 **ENDLESS-CHAIN CONVEYOR  
FOR MACHINE SHOP**

The problem of conveying the work from one machine to the next has been solved in one large machine shop by the installation of an endless chain, or platform, running the entire length of the shop. The conveyor does not run continuously, but intermittently, being timed to move a certain distance every 20 minutes, which is the time required for the longest operation on a piece of work. When a workman finishes working on a casting he places it on the platform and at the proper time it is carried forward to a point opposite the next machine, where it is removed by the workman who does the next machining job on it. By the time the various castings have reached the end of the line, all the operations have been completed, and the parts are ready to be assembled or placed in storage.

8526 **ELECTRIC TRACTOR OF  
NOVEL DESIGN**

An electric front-drive tractor, now being used in hauling lumber, is so designed that when attached to a trailer it acts with the trailer as one vehicle. Power is furnished by a storage battery and is applied through the front wheels,

each being driven independently by a motor placed within the wheel. When not attached to a trailer the tractor is partly supported by two small auxiliary wheels at the rear. The rear of the body consists of two beams which are shaped to fit into corresponding pockets at the sides of the trailer. During the operation of loading, the ordinary front-axle construction is used and the trailer is hauled by horses. As soon as it is loaded, the trailer is jacked up, the front axle is removed, the trac-

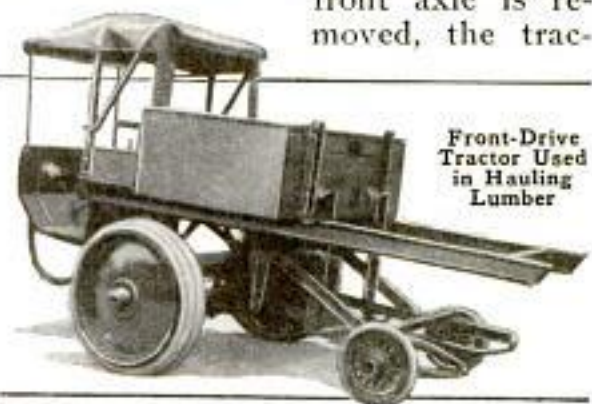

Front-Drive Tractor Used in Hauling Lumber

tor is backed in so that the projecting rear ends of the frame slide into the metal pockets of the trailer, and the two vehicles are secured together by hooks. The small rear wheels of the tractor then clear the ground about 6 in. and the two vehicles are handled as one. The center of gravity of the tractor is well back of the front axle so that there is enough weight on the small wheels to preserve its stability when it is detached. As a further precaution against upsetting forward, rounded skids are provided that project downward from the front of the tractor.

*Eldridge Mfg. Co.,  
541 Tremont St., Boston, Mass.*

9183 **MINIATURE STEAM ENGINE  
BUILT BY SWITCHMAN**

Without any experience as a mechanic, a railway switchman at Lorain, Ohio, has constructed a perfect-work-



Miniature Steam Locomotive Built from Crude Materials by a Man without Mechanical Training

ing, miniature steam locomotive of the Pacific type. The man drew his own patterns, did the molding and casting of the various parts from crude materials, executed the machine work, and assembled the engine. Combined with the tender the total length of the locomotive is only 16 in. The driving wheels are  $1\frac{1}{4}$  in. in diameter, the wheel base  $7\frac{1}{8}$  in., and the cylinders  $1\frac{3}{32}$  in. in diameter with a  $\frac{1}{2}$ -in. stroke. The boiler has a working pressure of 30 lb. The fire box, which is  $1\frac{3}{4}$  in. long and  $1\frac{3}{8}$  in. wide, is fitted with an alcohol burner which is fed by gravity from the supply tank. Placed between the frames back of the cylinder saddle is a pump which takes the water from the tank on the tender and keeps the

boiler properly supplied. The locomotive has a headlight, whistle, safety valve, and water glass, all of which are in working order.

9787 **INDICATOR FOR DOORS IN  
SHIP'S HOLD**

An important safety feature now being installed on seagoing vessels is an electrical apparatus for closing the water-tight doors between the bulkheads of the hold combined with an indicator that shows when each individual door is closed, both the indicator and the door-closing apparatus being located on the bridge. The indicator is housed in a teak case and consists of a plan view showing the various decks and the location of the bulkheads and doors. Each door is indicated by a small window fitted with ruby glass, and when the door is closed an electric lamp behind the window is lighted. Two lamps are provided for each of the windows as a precaution in case of the failure of one of the lamps. An additional window placed in the corner of the indicator shows whether or not the current is on.

9894 **NOVEL HARDWARE DISPLAY  
AT SAN FRANCISCO**

One of the large hardware-manufacturing companies has constructed an exhibit at the Panama-Pacific Exposition which has attracted considerable attention because of the ingenious way in which it has been executed. A stage on which a river and mill scene is shown has been produced by grouping thousands of different pieces of hardware, while adjacent to this is a clock tower similarly built.

The old mill, standing at one side of a river, with characteristic waterfall, spillway, and revolving wheel, is formed entirely by articles with which almost every one is familiar. Moving nicked chains and revolving auger bits are used to produce the effect of running water, which, when viewed from a short distance, looks very real-

Siemens Bros. Co., Wash., D. C.  
McDonald, London, D. C.

istic. A steamboat crossing the stream in the background is composed of a saw, carpenter's level, hose nozzle, and a mallet, while a windmill on one of

clock tower is an anvil chorus which is manipulated mechanically so that each 15 minutes two smiths at each end of the row of manikins raise their

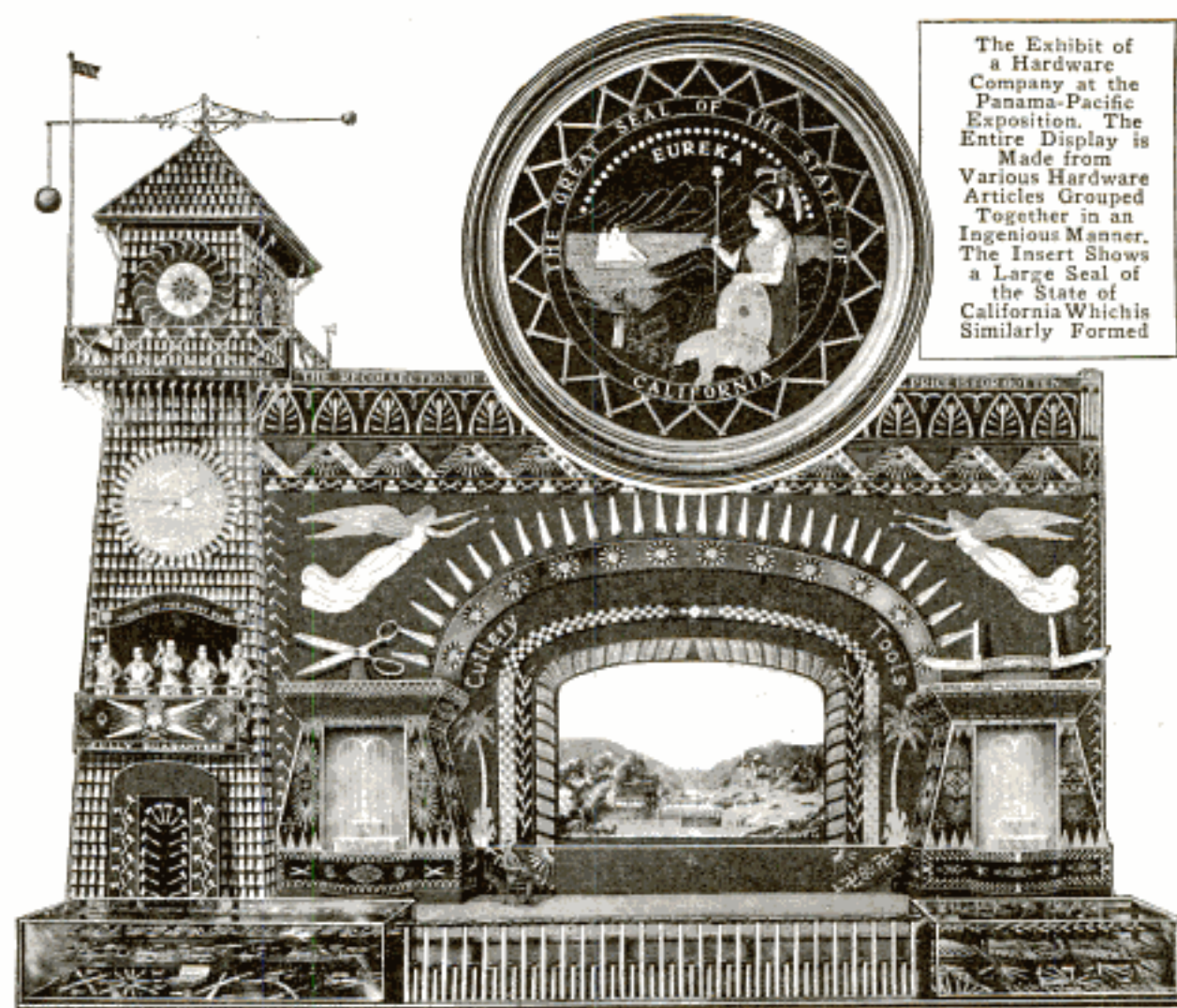

The Exhibit of a Hardware Company at the Panama-Pacific Exposition. The Entire Display is Made from Various Hardware Articles Grouped Together in an Ingenious Manner. The Insert Shows a Large Seal of the State of California Which is Similarly Formed

PHOTOS BY ROCKWELL FEATURE SERVICE

the river banks consists of cleavers, penholders, and lead pencils. The water wheel is made of files, saws, drill bits, and hammer handles.

On each side of the stage are artificial fountains which are so well worked out that the illusion is nearly perfect. Fine chains, which at first sight appear as a spray, rise and fall as if impelled by varying water pressure, while spinning auger bits are again used to produce the whirling effect of water falling from the upper to the lower basins. Door hinges, compasses, and chains are used in forming the palm trees set at the sides of the fountains.

In a balcony on the front side of the

hammers and apparently play the chimes on their anvils. The figure in the center strikes the hours with a heavy sledge.

A seal of the state of California, formed from approximately 900 different pieces of hardware, is placed on another side of the tower. This is about six feet in diameter and is built against a background of black velvet. The helmet and crest, worn by the goddess, are made of a hatchet and sickle fitted together, while both the hair and cloak are formed of brass chains; the armor, of nicked chains; the shield, of the copper bottom of a boiler; the bear, of steel wool, and other objects of similar materials.

### PROTECTING SUGAR BEETS FROM MOTHS

9237  
# Etholm

The principle contained in the old story of the moth and the candle is applied in an effective way in California

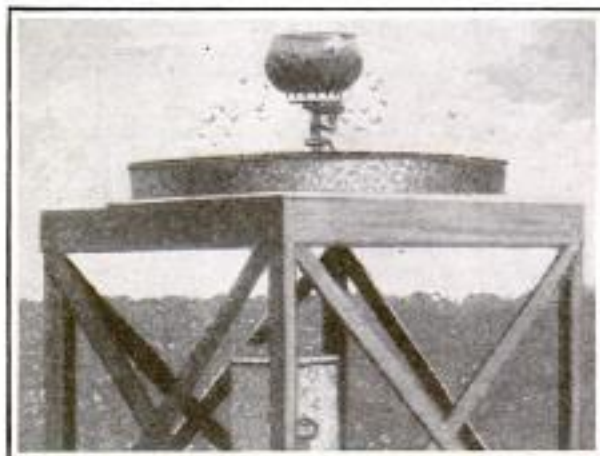

Thousands of Moths are Destroyed Every Night through the Fascination of This Acetylene Lamp Set in the Middle of a Sugar-Beet Field

for protecting sugar beets from the moth of the cutworm. For this purpose an acetylene-gas light is used, the lamp being set upon a platform in the field. Below the lamp is a pan, 4 ft. in diameter, which is partly filled with oil. The moths fly to the light by the thousands and after striking the globe

fall into the oil where the moths, with the eggs they carry, are destroyed. As many as 7,000 moths have been found in one pan after a night's exposure.

### BEARING POWER OF PILING TESTED BY CONCRETE LOAD

9005  
# Genl. Works.

In the construction of 1,000-ft. piers in New York Harbor for the accommodation of the large modern ocean liners, it was necessary to use piles 90 ft. in length driven to a footing in soft mud. To determine the bearing power of the piles, a novel method of testing was adopted. The tops of the piles were covered with a platform, and on this platform 240 tons of concrete blocks were loaded. The first two tests resulted in a failure in the piling, which necessitated changes in construction, but the last test, in which the concrete blocks were left in place for six months, proved that the bearing power of the piling was sufficient. The concrete blocks had been made for a river wall around Manhattan Island and will be used for that purpose after all tests are completed.

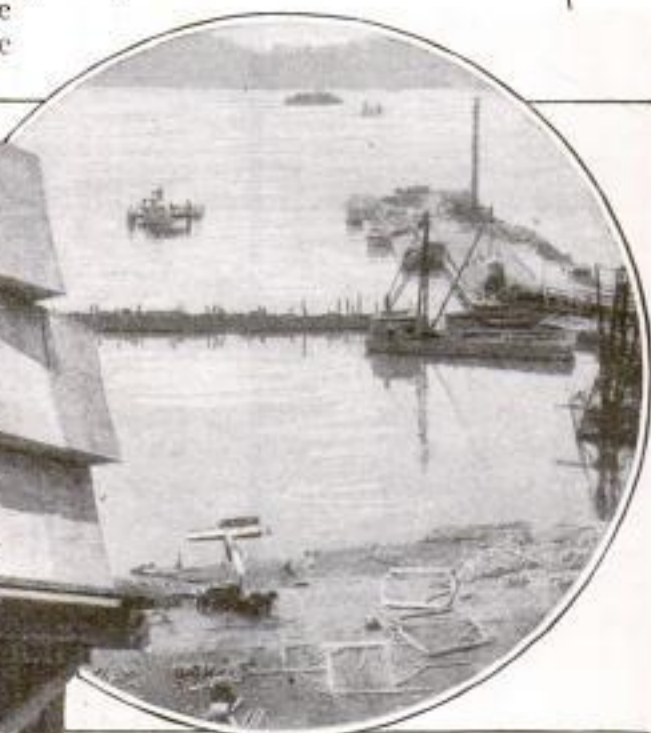

These Concrete Blocks, Weighing 240 Tons in All, were Loaded on Successive Sections of the New 1,000-Foot Piers in New York Harbor to Test the Bearing Power of the Pile Foundations

9161 **HIGH-SPEED MACHINE BUILT FOR SEALING ENVELOPES**

Capable of handling approximately 30,000 separate pieces of mail an hour, an envelope-sealing machine has been developed by a government employe and patented with the provision that the invention may be used by either the government or individuals without the payment of royalty. It is driven by electricity and works on the endless-belt principle. The letters are fed flat, with their flaps pendent, into the machine from a hopper at the right end, passed between the surfaces of two narrow, rapidly moving belts; the flaps moistened, folded back and sealed by rollers, and the envelopes deposited in a stacker at the left end. In front of the hopper is a separating roll which allows only one envelope to be fed at a

time, this from the bottom of the stack. As an envelope is carried along, the flap is raised by a lifting plate so that it passes over a moistening roller which revolves in heated water. A curved plate is then encountered, which turns

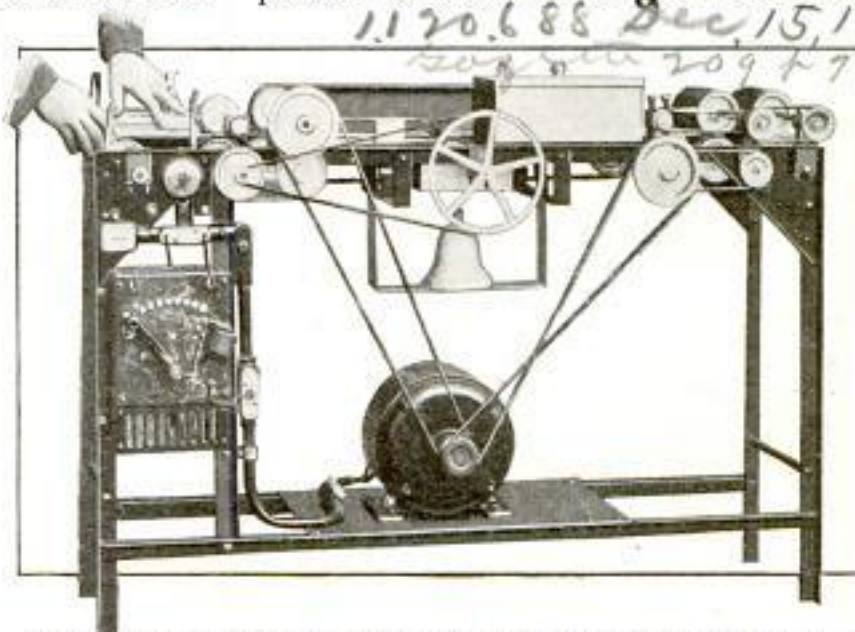

This Machine is Said to Work Efficiently While Sealing Five Hundred Envelopes a Minute

the flap down and brings it in contact with the back of the envelope, which is then shot between two sets of rollers, sealed and placed in the stacker.

8948 **MOTOR-CAR PORTABLE HOUSE FOR TOURIST FAMILY**

In preparing for a transcontinental motor trip, a New Jersey man has constructed a touring body for his car which is essentially a portable, light-housekeeping apartment. It answers this description, for it is intended not merely as a sleeping compartment, but also as a dining room and kitchen during unpleasant weather, as well as a living room and storage place for much of the equipment which is being carried. It is covered with a heavy-canvas top which is adequate to keep out water and cold. The cross-country trip is being made by a man

and his wife who expect to make their car their home throughout the journey, cooking all of their own meals and escaping hotels entirely.



The House on Wheels Which a New Jersey Family is Using on a Transcontinental Trip

\* *Harry C. Kromer, Camden, N. J.*  
*Old fashioned Conestoga Wagon built on an Autocar chassis.*

# Chas. C. Lynde  
P. O. Box 468, Pittsburgh, Pa.

8615 HOW AUTOMOBILE SPRINGS ARE TESTED

When automobile springs are tested they are placed in a testing machine which subjects them to the most severe vibrations that it is possible for them to receive in ac-

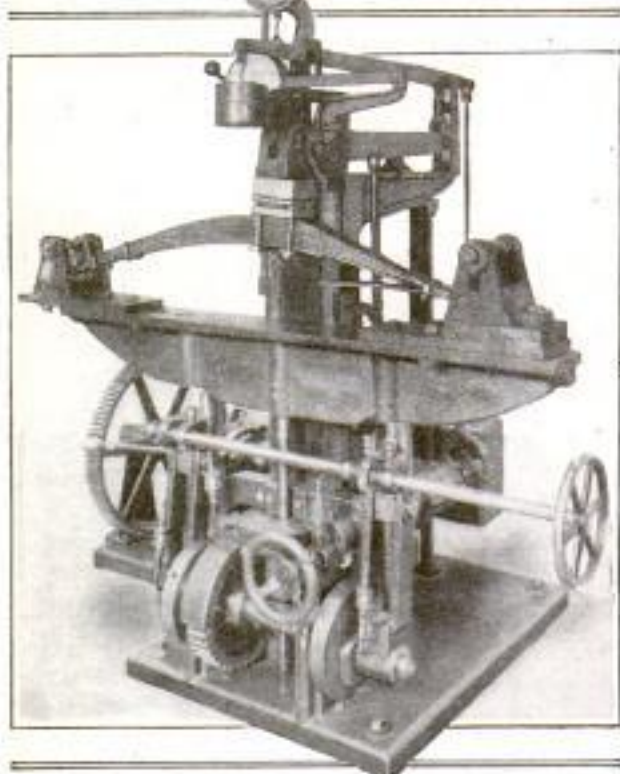

This Machine for Testing Automobile Springs Subjects Them to the Most Severe Usage That It Is Possible for Them to Receive in Actual Service

tual service. The spring illustrated stood up under more than 1,000,000 vibrations of 1/4 in. each, under a load corresponding to the weight of car and passengers that it would have borne if it had been in actual service. None of the leaves except those that broke showed any effect of the test. The operating speed of the testing machine was 24 vibrations a minute, and more than 28 days of continuous running was required to break the springs as shown.

Frame buildings on the Canal Zone are made ant-proof by resting the posts on concrete footings having shallow gutters. The gutters are kept filled with the standard larvacide used by the sanitary department.

9987 LINCOLN HIGHWAY PICTURED BY MOVIE CAMERA

Motion pictures are now being made of the Lincoln Highway, dealing with the road conditions along the entire route between New York and San Francisco, as well as the scenery and points of historical and industrial interest. Between 7,000 and 10,000 feet of film will be exposed and subsequently shown in various cities in different parts of the country, including all points touched by the transcontinental road. The tour is being made by official cars of the highway commission and will be completed some time in September. The purpose of the undertaking is to give publicity to the highway and stimulate an added interest in its upbuilding and use.

9174 AUTOMOBILE BODY SHAPED LIKE LOAF OF BREAD

When a garage in Indianapolis burned recently all the cars were destroyed except one, an electric brougham. The coach body of this car was burned off and the aluminum battery-box covers were melted, but the battery, frame, and chassis were uninjured. What was left of the car was acquired by an enterprising baker, who fitted it with a new body consisting of an enormous model of a loaf of bread in which seats were arranged for four or



Electric Car Used by an Indianapolis Baker for Advertising His Bread

five persons. The car is now driven about the streets regularly as an advertisement of the baker's product.

Chassis by  
Kearney Co.

#  
Dir. of Publicity  
Lincoln Highway Assn.,  
Chicago, Ill.



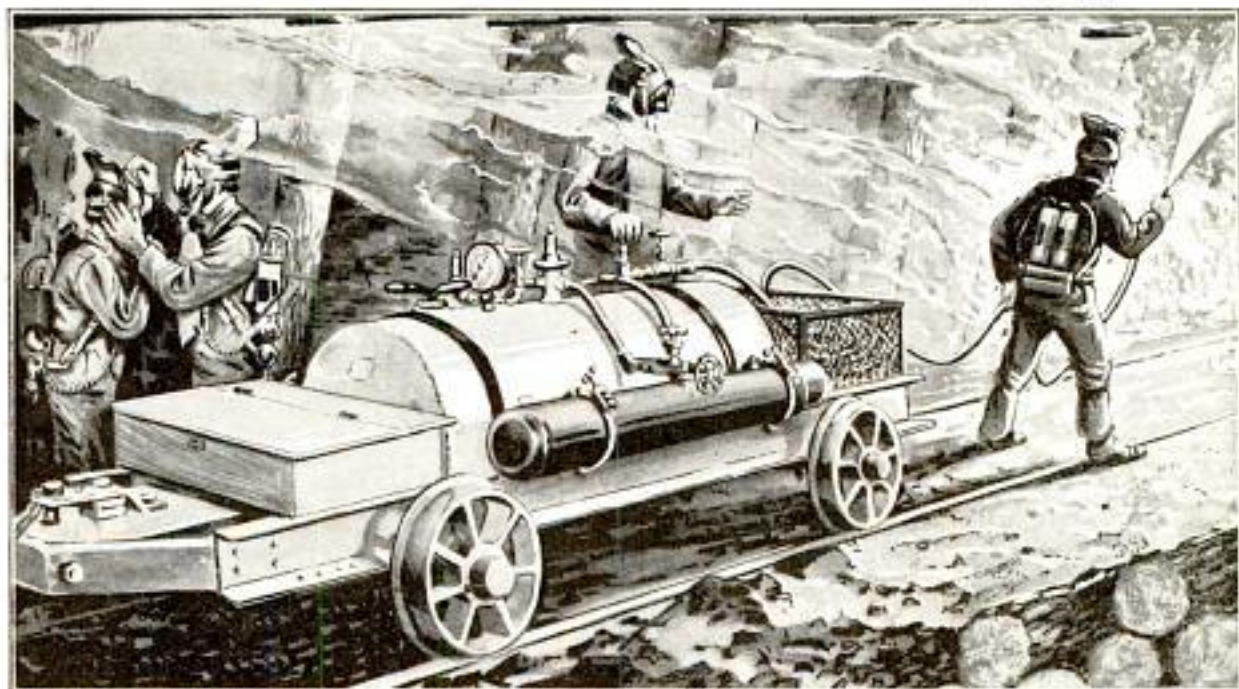

Chemical Car Used in a Pennsylvania Coal Mine for Laying the Dust and Fighting Mine Fires

### 9462 FIRE-FIGHTING CAR FOR COAL MINE

An apparatus that works on much the same principle as the chemical engines used by fire departments has been placed in service in a coal mine in Pennsylvania for sprinkling the dust and extinguishing mine fires. It consists of a tank car mounted on track wheels so that it can be quickly hauled by a motor to any part of the workings. The tanks are of such capacity that an ample supply of chemicals can be carried.

### 9639 PISTOL USED FOR PLATING METALLIC SURFACES

Bearing much the appearance of an automatic pistol, an ingenious electric instrument has been invented for plating metal surfaces. The barrel of the device, which is approximately six inches long and an inch square, is lined with sheets of mica. A flexible shaft on one side of the apparatus actuates a pair of small rollers through which a thin ribbon of the plating agent is fed into contact with a carbon plate fitted in the breech. When the ribbon touches the carbon an electric current

is short-circuited, resulting in a flash which melts the agent and simultaneously ignites an oxyhydrogen gas that is carried into the "pistol" through a tubing extending into the stock. The

Silverplating a Spoon with the Electric-Gas Pistol: In Most Instances the Instrument is Held so That the Muzzle Is Approximately Six Inches from the Article to be Plated



explosion blows the molten metal out of the barrel with sufficient force to make it adhere to the metallic surface against which it is directed. While the device is in operation, the explosions

Invented by C. Francis Jenkins  
5502 16th St., N. W.,  
Washington, D. C.

follow in rapid succession, sending out a stream of silver, gold, copper, nickel, or other metal or alloy of which the ribbon may be composed.

### MACHINE FOR SAWING STUMPS LEVEL WITH GROUND

An ingenious but simple machine for sawing stumps off level with the ground has been invented by a farmer



This Stump-Sawing Machine Consists of a Band Saw Driven by a Gasoline Engine

in eastern Arkansas, where there are thousands of acres of newly cleared land containing from 10 to 50 stumps to the acre. The machine is mounted on a sort of sled that is dragged over the ground by a team and consists of

a band saw run by a gasoline engine. The band saw runs on two wheels which are carried on a counterweighted frame, one end of which is pivoted to the sled. The machine is dragged up to the side of a stump, the engine is started, and the frame is swung so that the saw exerts the right pressure against the wood. The wheels are of such size that the top of the saw clears the highest stump.

### HORSE-DRIVEN ROTARY HOE NEW FARM IMPLEMENT

A rotary hoeing machine has recently been invented which is intended for different kinds of cultivating work on a farm. It is made with a series of revolving prongs fixed in separate sets on parallel axles which operate and are regulated independently of one another. The machine may be used for cultivating the soil between rows of young plants, or for breaking up heavy clods and putting a field in shape after plowing. The radiating fingers are long and, when set to do so, dig deeply into the ground, breaking through the crust and loosening the soil to a depth of several inches.



This Shows the Implement in Use on Plowed Ground, Breaking Clods and Loosening the Soil

*John Frier (Ans.)*  
*9664*  
*Manuel Tree, Ark.*  
*9502*  
 Pat. O. Co., Canton, Ill.  
 (Ans.) Wm. S. Graham " " "

## UNUSUAL FLOATS USED AT A CALIFORNIA FETE



"The Bungalow," a New Idea in Floats, Particularly Appropriate for a California Parade



A Graceful Chariot Float Which was Exquisitely Developed in Flowers



A Marine Float, Beautifully Executed in Flowers and Gauze, Attracted Much Attention

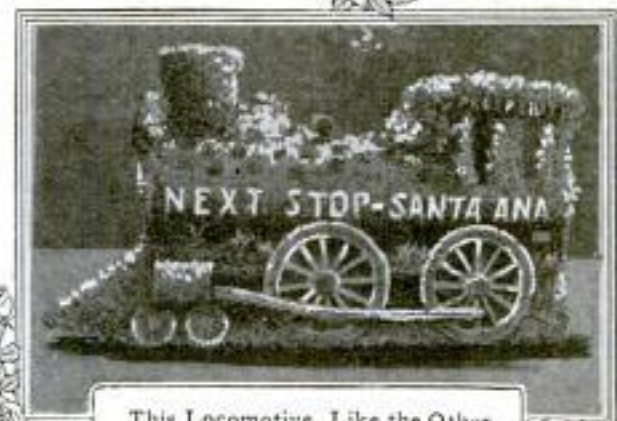

This Locomotive, Like the Other Floats Shown Here, was Mounted on a Motor Truck

9954  
**TON OF MOVIE FILM BURNED  
 IN MAKING EXPERIMENT**

*Mo. Pic. World 5-5-15*  
 Approximately 2,000 lb. of nitro-cellulose film was burned during a test conducted before underwriters, fire experts, and motion-picture men at Leonia, N. J., recently, in an attempt to determine the proper size for gas vents in film-storage vaults. The experiment was carried out in a vault built particularly for the purpose. It had a capacity of 133 cu. ft., was constructed of 12-in. terra-cotta tile, and provided with a glass-covered vent 285 sq. in. in area. The interior was fitted with racks on which the incased reels were placed, the spaces between each being packed with unprotected film. The ignition of the inflammable mate-

rial was effected by means of a spark plug. The flash shattered the glass covering of the vent and caused a jet of flame to shoot more than 70 ft. from the aperture in the wall. The heat of the fire, which burned for three minutes, was so intense that rocks 50 ft. away were crumbled by it. The experiment merely served to show that the size of the gas vent had been rightly figured, for had it been too small, an explosion would have occurred which would have instantly wrecked the vault.

↙ ↘ 200  
 (The Navy Department has recently issued and placed on sale a book containing engraved reproductions in colors of the flags of all maritime nations.

97<sup>15</sup>  
**DEVICE RECORDS FATIGUE  
OF MUSCLES**

A simple but effective device is now being used at a western university for studying the fatigue of muscles. With

this device the record is made on a smoked plate by a stylus mounted on a swinging arm, the stylus being pulled along

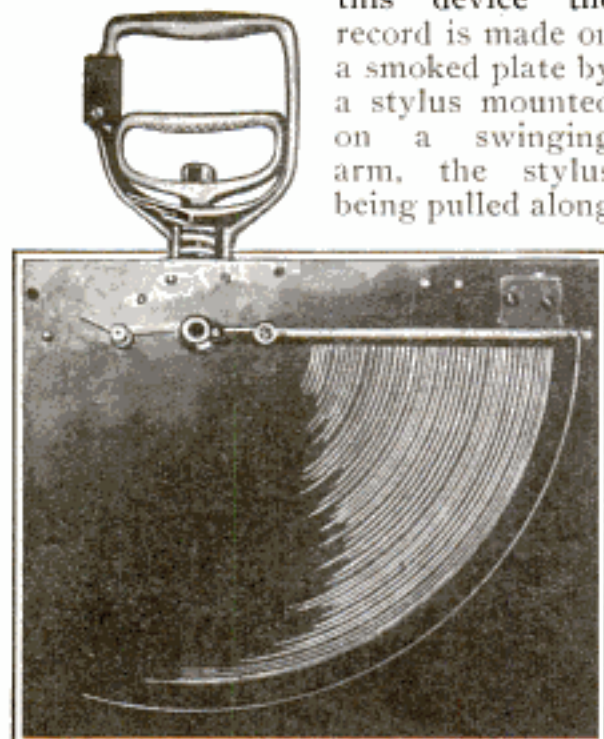

Device for Studying the Fatigue of Muscles, with a Typical Record

the arm at a regular rate by clockwork. At each tick of the metronome the person being experimented on grips the handle with all his strength. This swings the arm downward and the stylus traces an arc on the smoked plate, the angle covered by the arc showing the amount of force exerted. As the stylus is drawn inward by the clockwork each arc is spaced inside the one preceding it, and the record made in this way shows just how fast the muscles tire and how long it takes for them to become too fatigued to continue the process.

4  
**FIRST DIRIGIBLE ORDERED  
FOR AMERICAN NAVY**

Definite steps have been taken by the navy in carrying out its aviation program, which was outlined with the army's plans in the February issue of this magazine. Secretary Daniels re-

Connecticut Aircraft Co.  
New Haven  
Conn.

cently approved a contract for the construction of the first dirigible to be built for the navy. This, it is expected, will be delivered in September at the Pensacola, Fla., aeronautic station, where it will be used particularly for experimental and training purposes.

The craft will be 175 ft. in length, 55 ft. in height, and of 110,000 cu. ft. gas capacity. It will be capable of carrying eight men, will have a speed of approximately 25 miles an hour, and, when loaded to its capacity, a radius of action of about two hours. This, however, can be increased by lessening the number of occupants and replacing their weight with gasoline. The contract price of the craft is \$45,636.

Two new flying boats of the Curtiss type have been delivered to the navy of late, while three Burgess machines are to be ready this summer. Bids for three additional craft are to be asked immediately. The armored cruiser "North Carolina," which spent the winter in the Mediterranean, is to become the new aviation ship, after it has been thoroughly overhauled, and will be stationed at Pensacola.

5554  
**BOATS USED ON INTERIOR  
RIVERS OF CANADA**

In the interior of some of the northern provinces of Canada transportation facilities are nearly as primitive today as they were a hundred years ago. It is in these wild districts, where many of the forests are still undisturbed, that the native hunter and trapper are as much in evidence as ever, and the trading post also. The rivers for this reason are used for transporting food stores and supplies to the fur posts.

North of the fifty-third parallel birch-bark canoes are rarely if ever seen, even with the Indian tribes, for what little birch there is in those parts is too small for canoe purposes. For this reason the Indians build their canoes, much the same as many of the South American and other tribes of Indians, by hollowing out the trunk of a large tree. This is done by chopping and burning, and generally the re-

Francis J. Dickie  
17-18 Harbor Bldg  
Billings St.  
Edmonton, Alta.



One of the Big Freight Scows Shooting a Fall on Its Way Downstream. These Craft are Employed in Carrying Supplies into Canadian Wildernesses

Above Is One of the Hollowed Canoes Used by Certain Tribes of Indians in the North. While at the Side is Shown a Freight Scow on Its Return Trip, being Drawn by Its Crew

Row of Newly Built Scows Lined on a Bank Prior to being Placed in Service as Freight Carriers between River Trading Points in the Interior of Canada

sult is an ill-balanced and heavy craft. With the coming of the white men into the North, however, a new boat was introduced. It is a large scow built of heavy timbers; a craft which long ago was used on many of the rivers of this country. It is of light draft and so heavily constructed that it easily withstands the rough waters of the northern rivers, readily carrying a number of men and several tons of freight.

The streams flow into the wilderness, and down them, over falls and through tossing rapids, the raftlike scows plunge with their loads, continuing

often for hundreds of miles into the interior. When their destination is reached they are reloaded, this time with furs, and ropes tied to their bows by which the half-breed crews pull them back whence they came. Often the shore line is too steep to be followed, which means that the men must take to the water. In the spring this is ice-cold and they wade ahead through it, often wet up to their waists, for hours at a time. Many of these return trips take from six to eight months to complete, although possibly not more than a month was consumed on the downstream journey.

9678  
**ODD SUCCESSION OF DEATHS  
 CAUSED BY ELECTRICITY**

Three persons, each ignorant of the real source of danger, were killed one after the other in a peculiar manner when a 2,200-volt electric wire fell into the back yard of a Los Angeles residence some time ago, and caught on a wire fence. The first victim, a man, went through the rain to a rabbit hutch at the rear of the property. As he placed one of his hands on the latch of the hutch gate he was thrown to the earth and killed by the electricity which passed through his body. His wife, seeing him fall, rushed to his assistance and, being unaware of what

had caused his death, bent over him. The heavy current shot through her, ending her life.

A neighbor seeing short, blue flames leaping from the ground about the bodies of the man and woman, and also ignorant of their nature, rushed forward with a bucket of water, intending to extinguish the mysterious fire. As he dashed the water to the ground the current followed the stream and killed him. The wife of this man and a policeman then started into the death trap, but were hurled to the earth and merely stunned before reaching the spot of greatest danger. Subsequently the cause of the trouble was ascertained.

5805  
**NEW TREE DIGGER FOR FORESTRY SERVICE**

*Frank A. ...*  
 # Bristow Okla  
 An interesting apparatus for loosening and lifting seedling trees for field

*Forest Service, Wash. D. C.*  
 not injured, the depths usually required ranging from 10 to 16 in. After this

blade has passed under the seedlings, they are easily lifted out by hand. The blade is mounted on a frame made up of 5-in. channel iron, and is pulled through the ground by a cable attached to an ordinary stump puller which is worked by one



Apparatus Installed in Forest-Service Nursery for Loosening Seedling Trees for Field Planting

planting has been installed in a forest-service nursery in Nebraska. The cutter consists of a sloping blade, 7 ft. long and 12 in. wide, which is drawn through the soil under the trees so that the roots are



*Inventor*  
*John W. Robbins* (Boston)  
*Farmington Conn.*

or two horses. With this apparatus the trees can be taken out at a trifle less than half the cost of digging them out with a spade.

fect the inner wall from direct attack. The inner wall is solid, while the middle and outer walls are perforated with small vertical slots. Corresponding

9776 **HEAT USED INSTEAD OF INK IN GRAVURE PROCESS**

An American artist has originated a new process for printing pictures which, aside from producing unusual effects, is in its technique a complete departure from established methods, most of which are of European origin. The originality of the process lies in the fact that heat is employed instead of ink in making imprints. The system is a very difficult and delicate one and is not intended for ordinary commercial purposes. Also, practice has narrowed the choice of paper that may be used in the work to Japanese vellum and Manila stock. A series of plane surfaces, from high to low, the former for producing the dark values, the latter for high lights, and the intermediate ones for the half-tones, are etched on a brass plate. This is then heated to a temperature that scorches the paper when in contact. The result is claimed to be a remarkable softness and transparency. Responsibility for this is due to the color being in the paper itself, rather than on its surface as when ink is employed. It is necessary, however, that extreme care be exercised throughout to properly control the heat so that excessive carbonization of the paper does not occur.

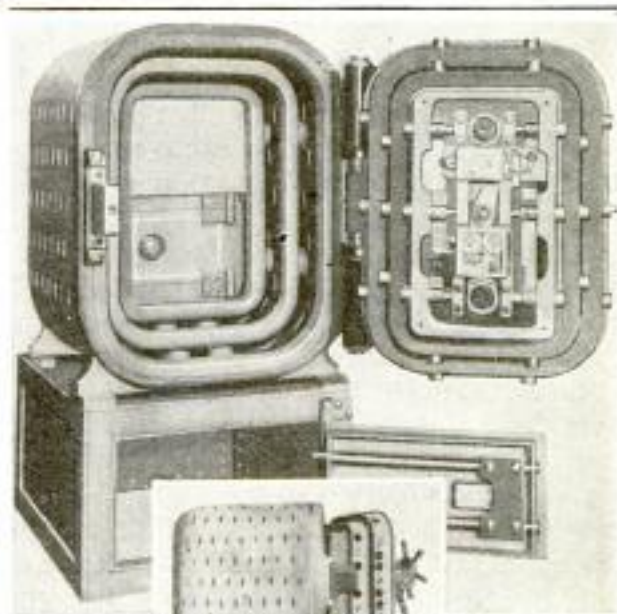

View of Safe with Door Open, Showing Wall Construction

System of Perforations for Giving Vent to Explosive Charge, Shown Below

9542 **BURGLAR-PROOF SAFE MADE OF MANGANESE STEEL**

Unless professional cracksmen are able to devise some mode of attack more effective than any now known, they are likely to find themselves completely and permanently baffled by a new type of burglar-proof safe that has just appeared on the market. This safe is made of manganese steel, a metal so hard that it is practically impossible to drill it, and has three walls with intervening air spaces of about an inch, the outer walls serving to pro-

tect the inner wall from direct attack. The inner wall is solid, while the middle and outer walls are perforated with small vertical slots. Corresponding slots in the two walls are offset with reference to each other so that it is impossible to pass a drill or torch through them to attack the inner wall. There are three doors which work on a single hinge and act as one. These are arranged like the walls and are perforated, each door locking with the corresponding wall. In tests made with powerful charges of dynamite and nitroglycerin placed between the inner and middle walls it was found that the perforations furnished sufficient relief for the gases, and that this, combined with the great strength of the walls, prevented the safe from being damaged in any way. In these tests the flames produced by the explosion shot out through the perforations for a distance of 10 feet or more. Attempts to blow open the doors resulted in the same way. The base chest on which the safe rests is made of ordinary steel and is not burglar-proof, being designed to utilize space that would otherwise be wasted.

*Johnson-Bradford Safe Co.*  
*715 Thurman St.*  
*Portland, Oregon*

# W. B. Coffant  
Concord, Mass.

*C. S. Monitor 5-8-15*

**9969 MAKING USE OF PAMPHLETS  
IN PUBLIC LIBRARY**

To enable a more practical use to be made of the thousands of pamphlets and bulletins dealing with current topics, received at the Chicago Public Library, this material is being classified according to subjects and placed in heavy paper holders which may be taken from the building upon application. While in the past it has only been possible for a person seeking the latest available information on subjects covered in documents of this kind to enjoy the privileges of the reading room, compilations of these pamphlets are now being sent into the grammar and high schools when they are wanted. Each box collection carries a typewritten list of its contents. A quite broad range of subjects is included in this packet library, and by making use of this opportunity it is frequently possible to obtain later information than can be found in reference books of even comparatively recent publication.

**9055 ZOOLOGICAL GARDENS WITH  
IMITATION CLIFFS**

Cliffs built of concrete, with dens and caves for wild animals, form a striking feature of the zoological gardens at Regents Park, London, which were completed in 1914. These cliffs are popularly known as the "Rocky Mountains," and were built particularly for animals of the temperate zone. The cavities in the lower part of the structure are for such animals as bears, wolves, and lynxes, while those at the top are for chamois and other mountain-climbing animals. A concrete pool at the foot of the slope serves as a home for wild fowl of various kinds. The whole structure is of poured concrete, the surface of which is finished to look like natural stone. To enable visitors to see the animals in what seem to be their natural haunts, passageways, protected by iron railings, are provided along two levels. The cliff masses give an illusion of height and distance in excess of the reality.

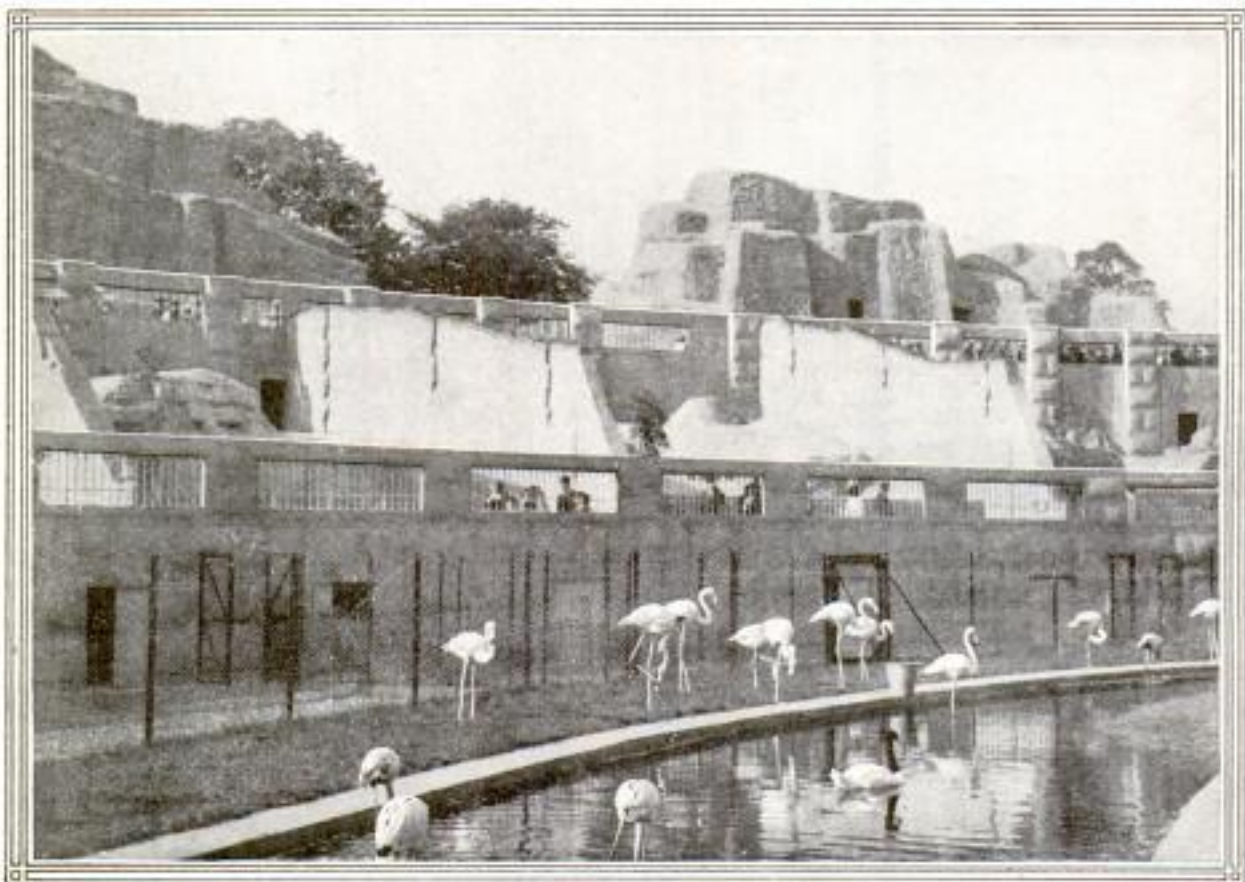

Concrete Cliffs in the New Zoological Gardens at Regents Park, London



Coach at Harvard



This Box Target was Employed by Harvard's Baseball Coach in Trying Out New Pitching Material and Drilling Candidates and Others in Control

9688 TRAIN BASEBALL PITCHERS WITH BULL'S-EYE BOX

For drilling pitchers and teaching them control, as well as for trying out new material, the coach of Harvard's baseball team developed a pitching box which proved useful during the spring training season. The device consists of a large canvas and board box approximately six feet in height and two feet in depth. In the middle of the front side is a rectangular hole, 3 ft. by 2 ft., while within the box, against the back wall, is a red-flannel bull's-eye, 1 ft. in diameter. When in use, the box is placed at a distance from the pitcher's mound which corresponds to the home plate. To hit the bull's-eye is in this instance the thing to be avoided. The pitcher must throw a curve which breaks quickly, so that the ball after entering the aperture does not strike the red flannel. This readily shows the pitcher, and his coach as well, what he can do. It also does away with all arguments on the part of young pitchers who are often prone to accuse a catcher of reaching forward and pulling a ball away from the plate.

It is proposed to station a squadron of eight aeroplanes at Governor's Island as one element in the defense of New York City.

9618 SIMPLE WAY OF FASTENING SLEEPING-BAG FLAPS

La Nature 2/20/15  
Intended especially for fastening together the two flaps of a sleeping bag or tent, an ingenious device has been introduced abroad which is apparently very satisfactory and easily employed. It consists of a series of small metal locking members which are attached



Sleeping Bag Fitted with New Fastening Device, the Detail Construction of Which is Illustrated in the Insert

firmly to the two edges, or seams, of the opening. These individual pieces are tubelike and, in the case of those

9618. Sleeping Bag, "The Alerts" sold by Pestour, 45 rue Cassmartin Paris

fastened to one seam, are each provided at the bottom with a small hook which projects downward. The members on the opposite seam are each fitted with a slotted projection at the top and a small knob at the bottom. A locking device, which, when the flaps are opened, remains at the bottom of the sleeping bag, brings these fasteners together, so that the hook of one engages with the slot of the other, when it is drawn to the top. To open the bag it is only necessary to pull the flaps in opposite directions as if ripping the seam apart. This disengages the hooks and pushes the locking member back to the bottom.

### ALL-STEEL CAR FOR BUREAU OF FISHERIES

9852  
An all-steel railway car to be used in distributing fish has been ordered by the government and is to be placed in service by the Bureau of Fisheries as soon as completed. The car is 65 ft. long over all and is fully equipped for movement in fast passenger trains. Some of the special features of the equipment are refrigerator tanks for carrying live fish, tanks for the storage of water, and a steam boiler for heating the car and for operating the pumps in the renewal and aeration of the water supply. Living, dining and sleeping accommodations are provided for a crew of five men, who will make the car their home. In 1914 the five fish cars now operated by the bureau traveled an aggregate distance of 131,156 miles and covered practically every state in the union. This record is to be bettered by the new car.

### FRUIT-SORTING MACHINE WORKS IN NOVEL WAY

For sorting various kinds of fruit according to size and weight preparatory to packing, an automatic machine has been invented which is said to operate accurately and without injury to the fruit. At one end of the device is a long table, the bottom of which is formed by a moving belt that carries apples, for instance, to the opposite end, where they are deposited one at a time into conical cups attached to the ends of arms mounted on springs. These cups are drawn back, by cam action, into the proper positions to receive the fruit as it is carried forward. The springs act in the same capacity as scales, the amount of their deflection being in accord with the weight of the fruit. As an apple is deposited in one of these pockets the spring is released and the fruit thrown forward into the air for a distance which is determined by its weight. Before this table is a series of bins above which are canvas hoppers into which the apples fall as they are pitched from the conical cups. Since the weight of each apple determines the force with which it is thrown, the same property also determines into what bin it will fall. The machine is driven electrically and requires only that the fruit be deposited on a feed incline at one end and removed from the respective bins as they are filled. It is asserted that ripe fruit is not bruised by the sorting and that even eggs have been handled by the machine without breakage. The machine is especially useful when competent help is scarce.

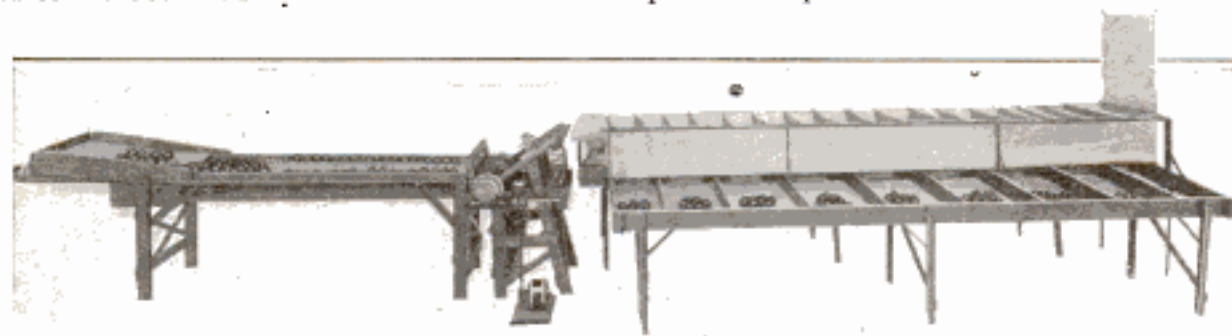

The Weight of the Fruit Determines the Distance It is Thrown and into Which of the Pockets It will Fall

Harlan Hollingsworth, Corp.,  
Wilmington, Del.

#1 No. Second St., No. Yonkers, N.Y.

9354 **GOLF-PLAYING DEVICE MADE FOR HOME AMUSEMENT**

Designed for use on the lawn, in the home gymnasium, or on the decks of a steamer, a small golf machine has been constructed which registers the length of a drive and indicates how the ball would have flown; whether it would have gone high, clearing a bunker, or low, had it been free. It is made to be attached to some solid base and has a captive ball held at one end of an arm, the other end of which is fitted with a ring that slips over a spindle. This latter member is also at the end of a pivoted arm, attached beneath which is an indicator that moves over the face of a dial when the ball is struck. The force of the stroke revolves the ball about the spindle and moves the latter member and its arm forward. This reg-



Golf Machine Made for Home Use Which Shows on a Dial the Distance a Ball would be Carried by the Force of the Stroke Made against the Captive Ball  
isters the force of the drive in terms of yards. By the position assumed on the spindle by the metal ring the distance the ball would have risen from the ground is also shown approximately.

9113 **TALKING MACHINE AND HARP ARE COMBINED**

In an attempt to improve the tone quality and volume of the phonograph, a machine has been constructed that has a series of harp strings stretched across the front of its cabinet over the sound hole, which is the end of the horn. Except in this particular, the design of the instrument is quite similar to that of others. The side of the cabinet serves as a sounding board for

the harp, broadening and mellowing the tones produced by the strings vi-



The Harp Strings Vibrate in Sympathy with the Tones Sounded by the Phonograph

brating in sympathy with the notes sounded by the phonograph.

**NEW PRINCIPLE USED IN MOTOR-CAR SPRING 8209**

An entirely new principle in automobile construction is involved in the design of a motor-car spring recently brought out. In the usual spring arrangement the shock that occurs when the wheel strikes an obstruction acts in a vertical direction. The new spring is designed to cause the shock to act in an upward and rearward direction, and it is claimed that this feature eliminates the necessity for a shock absorber. The forward end of the frame is curved upward instead of downward, as is the common practice, while the usual semielliptic spring is replaced by a rigid steel bar pivoted to the forward end of the frame and clamped to

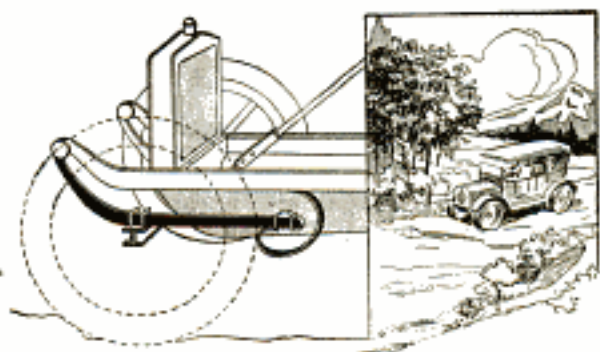

With This Form of Spring, Road Shocks Act in an Upward and Rearward Direction

the axle in the usual way. A C-shaped spring connects the rear end of the bar with the frame.

Klingsor Talking Machine National Box Spring Co.  
415 Armour St., Park Bldg., Pittsburgh, Pa.  
Chgo.

### WATER WHEEL ERECTED ON BANK OF STREAM

A curious water wheel that has just been patented is designed to be erected on the bank of a stream. The feature

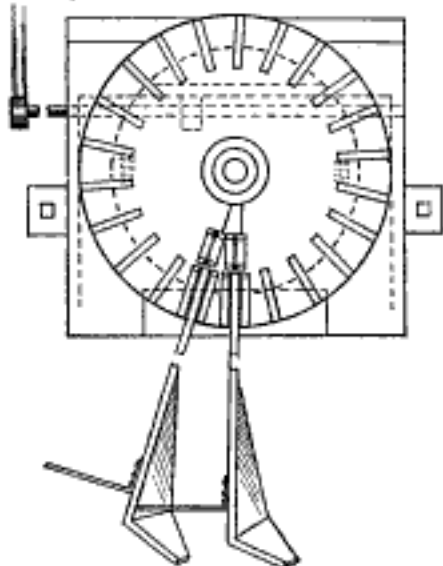
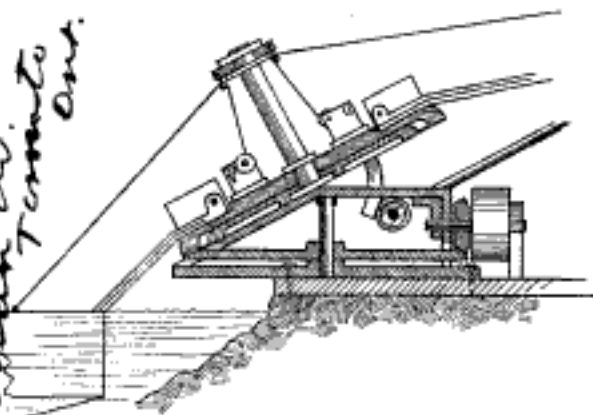

In This Curious Water Wheel the Buckets are Immersed in the Water as They Pass Downstream, but Swing Out over the Bank and Clear of the Ground on the Upstream Movement

about this apparatus is that the buckets and the circular plate on which they are mounted rotate in an inclined plane, so that the buckets are immersed in the water as they pass downstream, but swing out over the bank and clear of the ground on the upstream movement. The buckets are carried on arms that are pivoted to the revolving plate, and are easily adjusted to varying stages of the water by means of lines and windlasses, as shown. Placed on the lower side of the rim of the revolving plate is a series of gear teeth which mesh with a beveled gear at the low side, when the plate is in the inclined position. At the opposite end

of the shaft, on which the beveled gear is carried, is a pair of beveled gears through which the power is transmitted to a belt pulley. The rotating plate is mounted on a pivoted base plate, and by means of a rack and pinion it may be swung to a horizontal position, and the buckets lifted clear of the water.

8752

### HEAVILY LOADED TRUCKS HANDLED WITH EASE

In order to make it possible for a workman to manage a heavily loaded two-wheeled hand truck with less physical exertion than is ordinarily required, an attachment has been devised which holds the cargo in place, allowing the mass to be tilted forward until its center of gravity is over the wheel axle. When wheeling on level flooring, a man is thus relieved of the weight of the article he is moving, his concern being merely to maintain its balance while propelling the truck. This enables him to handle a much greater load than could be negotiated otherwise. The device consists of an anchor-and-chain attachment housed in a tube which is attached beneath a truck. By tipping the latter forward against the object it is to carry, the chain is drawn out to the required length, locked by dropping one of the links into a narrow

"The Anchor Truck Attachment"

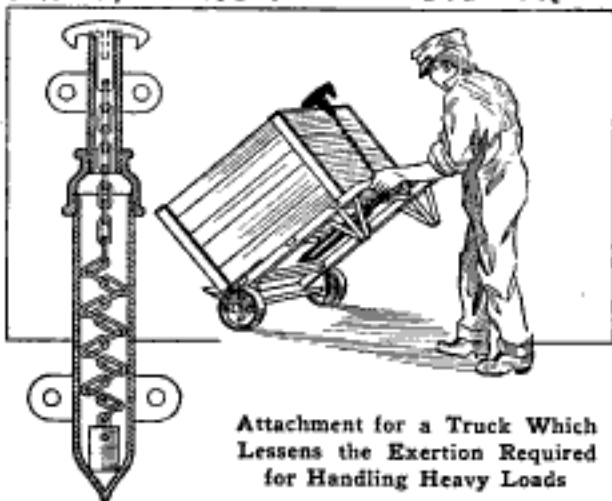

Attachment for a Truck Which Lessens the Exertion Required for Handling Heavy Loads

slot in the neck of the tube, and the hook engaged at any convenient point. The device may be attached to any two-wheeled truck.

(Inventor)  
Walter E. Emmert  
111 Newton St., Denver,  
Colo.

Englishman Pat. Invt. J. D. Rifeason  
 #1214 Exchange St. Rochester N. Y.  
 M. G. Journal (Wit. S. Whithyhead  
 #1500 Clendeman Ave. Toronto Ont.

*Law. Jas. L. Cardin  
Los Angeles*

1.111.993 Sept 29-1914 filed May 2, 1913, Serial 765156.

**HOT-AIR HEATING PLANT FOR  
ORANGE GROVE**

8520

One of the greatest handicaps in raising oranges, and other fruits that are easily killed, is the danger from frost, and to overcome this a number of ingenious methods have been invented. The latest of these is a patented system with which heated air under pressure, supplied from a central heating and compressing plant, is discharged among the branches of each tree, the heated air being conveyed to the trees by underground pipes. Mains are laid in alternate lanes between the rows of trees, and from these a lateral goes to each tree. At the end of each lateral is a vertical pipe that extends up the trunk to the lower branches. This pipe is capped with a spring valve that is closed normally but opens readily when the air in the pipe is under pressure. When heat is to be supplied to the orchard the air com-

pressor is first started, the compressed air passing through the coils of the heater and then to a storage tank. When the pressure in the tank has been raised to the right degree to open the valves in the vertical pipes and give

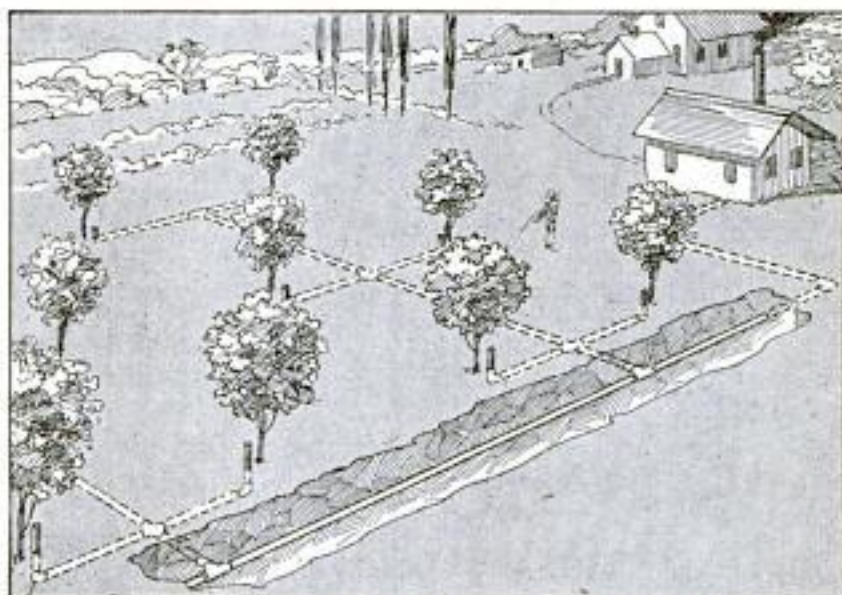

Orchard in Southern California Equipped with Hot-Air Heating Plant

the escaping air a spray effect, the valve connecting with the pipe system is opened. The compressor and heater are then kept going until all danger of frost has passed. One of the advantages in this system is that there is no smoke or odor.

**CURIOUS PLAN FOR CLOSING  
HOLE IN SHIP'S HULL**

7563

Water-tight curtains carried on rollers in recesses in the keel of a ship and arranged to be drawn up over a leak or a hole in the hull are the basis of the most curious of recent inventions relating to safety at sea. The plan is to have one curtain on each side extending the full length of the ship, and to each curtain lines are attached running up to drums on the deck. To a stiffening beam fixed to the free end of the curtain, blocks are attached that are intended to run in slot ways in the side of the ship and guide the curtain as it is raised.

The invention was apparently suggested by a plan occasionally resorted

to in the days of sailing vessels for stopping leaks, which consisted in dropping a tarpaulin over the bow and then working it back over the leak by

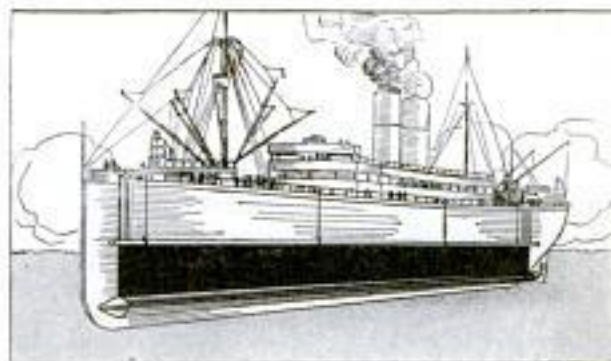

Water-Tight Curtain Designed to be Drawn Up over a Leak or Hole in the Side of the Ship

attached lines running up the sides of the ship.

*Law. Tomasz Czerniawski*

*By...*

1.099.167 Ser. 825858 Filed 3/19/14 New York Copyrighted material

## NOVEL AND PRACTICAL DEVICES FOR THE HOME



1  
New Style Teakettle  
Cover

for setting a dish when it is desired to keep its contents warm. A small spring door in the bottom of the concave device is opened by the force of

*"Perfection"*



2  
Convenient Shoe Cleaner

water flowing from a faucet when the container is being filled. By the action of a specially designed spring, a shoe-cleaning device, lately designed, adjusts itself readily to any-size boot. It is intended to be fastened to the flooring of a porch, or put in some similar place where it may be used conveniently during rainy weather. The cleaning is done by moving a shoe back and forth between the brushes.



3  
Eye Shade of Novel Form

Designed so that it may be carried in a pocket case if desired, an eye shade has been devised which is made in much the same form as a pair of nose glasses. Two small shades which come close to the brows are secured to a bridge that fits over the nose.

An artistically shaped cruets, intended to be used at a dining table in mixing French salad dressing, is being

made in crystal. It is about seven and one-half inches in height and so marked that the proper proportion of vinegar and oil may be poured into it readily without being measured in a separate vessel. After the seasoning is added and the contents of the vial shaken, the dressing is ready for use.

In an attempt to overcome the inconvenience attending the use of an electric iron to which feed wires are attached, a new apparatus has been brought out. In this case the wires connect with a heating standard that holds a switch which turns the current on or off, as the iron is set in place or removed.



4  
Vial for Salad Dressing

Fitted with an adjustable lamp that may be turned to various angles, a magazine and book rest has been built with a collapsible brass stand. The rack may be swung from either the right or left side of the standard, as desired, and used beside an armchair or couch, or employed as a music holder.



5  
Electric Iron without  
Wires

Copper tubes, mounted on a ring,



6  
Book Rest and Reading  
Lamp

containing hooked rods that may be extended to various lengths, constitute a new fixture that has been introduced in France for hanging heavy oil paintings and other framed pictures. The sliding members when drawn out to the required length are secured by set-screws.

Provided with bolts which slide into vertical sockets instead of horizontal ones, a new lock has been designed which is supposed to hold most strongly when force is brought against it in an attempt to open it illicitly. It is made particularly to resist a burglar's jimmy, which when used against it meets much the same condition as if an attempt were made to force a door hinge by pushing, against one side of it.

Intended to be attached to traveling bags to identify them in case of their loss, a small metal box, bearing the name and address of the owner and containing stamps with which to notify him where his property may be claimed, has been invented in Germany. The device has much the appearance of an ordinary grip tag, except that it is provided with a small lock and carries directions for opening it so

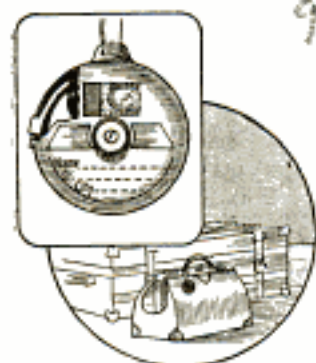

Identification Tag for Bags

that it is provided with a small lock and carries directions for opening it so

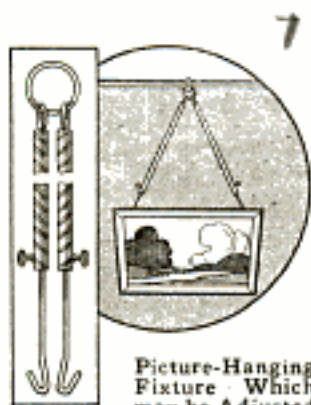

Picture-Hanging Fixture Which may be Adjusted

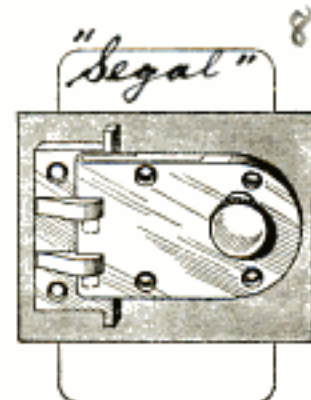

Burglar-Proof Door Lock

dress of the owner and containing stamps with which to notify him where his property may be claimed, has been invented in Germany. The device has much the appearance of an ordinary grip tag, except that it is provided with a small lock and carries directions for opening it so

that it is provided with a small lock and carries directions for opening it so

that the finder of the lost baggage may obtain the stamps contained within it.

Made in the form of a heat deflector for wall or floor registers, a simple device to keep the atmosphere in a furnace-heated room properly moistened has been introduced. It is made of metal, is wedge-shaped, and holds approximately two gallons of water, so that frequent refilling is unnecessary. Perforations in the top provide for the evaporation.

Application for patent rights has been made by the inventor of a shoe which opens at the back and fastens on the outer side with buckles, dispensing with both buttons and laces. The opening extends upward from the counter.

A baby buggy, now being brought out, is so built as to enable the body to be faced in either a forward or backward position. By means of a foot lever the carriage may also be raised several inches, making it possible for a nurse to attend an infant's needs without bending over uncomfortably.

Grass-green uniforms have been supplied to the German forces for the summer campaign.

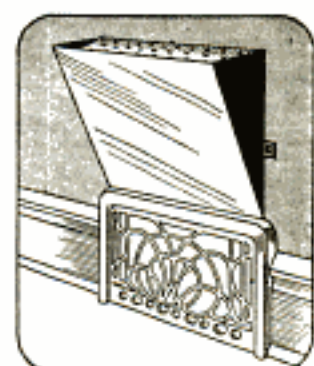

Air Moistener of Odd Form



Shoe Opens at the Back



Reversible Body on Baby Buggy

(Inv.) W. H. Casheimer  
304 Center St.

278

### POPULAR MECHANICS

Bethlehem, Pa.

#### FASTENING DEVICE IS MADE FOR SHOESTRINGS

7552



A Pennsylvania inventor has devised a shoe-lace clasp which eliminates the necessity of tying one's shoestrings and also prevents them from becoming unfastened. It consists of a metal catch which fastens at the top of a shoe and holds a string tightly in place. When

the device is used the usual method of lacing is altered, one end of the string being looped in the first eyelet of the shoe. A slip catch on the outer side of the clasp holds the loose end of a lace.

#### MOTOR CAP WITH GOGGLES BUILT IN

A cap to which is attached goggles that can be folded under the crown and out of the way when not in use is one of the latest conveniences for motorists and golf players. The cap is made in two styles, one for men and the other for women, the latter being so made that it

covers and protects the hair. A slight pull brings the goggles into use.



#### ELECTRIC CORE DRILL MADE FOR MINE PROSPECTING

8921

An electric drill for mineral prospecting has been invented which is fitted with a core-lifting mechanism so arranged that the core may be raised independently of the drill tube. This latter member, as in similar drills, con-

sists of a series of hollow rods, each section of which is from 5 to 10 ft. in length and lap-jointed. In the new drill it is only the bottom segment of this tube which is rotated, which eliminates the drag and permits the diamond bit to revolve at high speed, regardless of the depth at which it is cutting. This is possible because all of the driving mechanism is contained

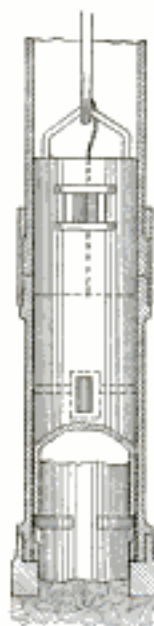

within the drill rod and operated electrically, instead of the casing being driven, shaftlike, by power applied at the surface of the ground. The core-lifting mechanism itself is not different from what is ordinarily used, except that it is raised or lowered within the tube by means of a steel cable instead of requiring the drill rods to be hoisted out of the bore. In other words it is not a fixed part of the drill. The cable is attached to the

stator, containing an electric motor and automatic clutch, which is maintained in proper alinement by roller bearings which separate it from the revolving drill pipe. The electric wires leading to the motor are also incased in the hoisting line. The chief advantage of the plan is that less time is consumed in removing the cylindrical core as it is cut. This is ordinarily done about once for each 10 ft., and the time consumed in this operation, which includes the replacing of the rods in the bore, is about equivalent to the time actually spent in drilling. This time consumption is materially lessened by the new drill, the work is done more quickly, and the cost thereby greatly lowered.

Parrots are much disturbed and screech loudly upon the approach of aeroplanes. Attempts are being made in Europe to use them as aerial sentinels.

(Inv.) R. J. McGill  
2031 Eastwood Av.  
Chgo.

See to Go Motor Caps Co.  
1627 Washington N. E.  
St. Louis, Mo.



See Jan 15  
141 Ad P

9410 COMBINATION INSTRUMENT FOR DRAFTSMEN

By the use of a transparent triangle of special form, recently placed on the market, a draftsman is enabled to perform many of the operations that formerly required special instruments. When the triangle is worked against a straightedge, angles of 15°, 45°, 60°, 75° and 90° may be laid out with the sides alone. With the ordinary triangle only three angles can be laid out in this way. By using the sides of the long slot in combination with two of the sides, angles of 15° and 30° may be drawn, while any angle less than 90° may be laid out to the nearest degree by means of the protractor placed in one of the corners. In addition to the slot cut into the triangle there is also an irregular, or "French," curve, an instrument that is used frequently in certain kinds of drafting. The long side of the triangle is graduated to inches and sixteenths. At each inch mark there is a

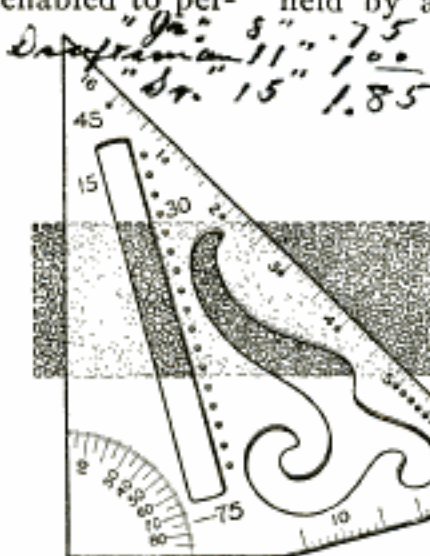

perforation, while the sixth inch is perforated at each eighth-inch mark. By placing a pencil point through one of the perforations and rotating the triangle around another perforation held by a pin point, it is possible to

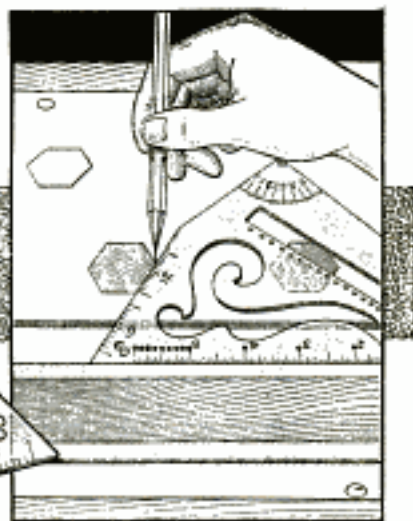

By Using This Instrument Alone a Draftsman is Enabled to Perform Many of the Operations That Formerly Required Special Instruments

draw circles with radii of from 1/8 in. to 6 in. On one side the division of an inch into tenths and twelfths is also given. Parallel with the slot is a series of perforations placed 1/4 in. apart. These are used for drawing closely spaced parallel lines by working a pencil point through successive perforations and sliding the triangle against a straightedge.

9316 AUTOMATIC SOLDERING IRON NEW TOOL FOR TINNER

Intended for use in shops where a large amount of plain soldering is done, a new iron has been devised which performs much the same function for the tinner that a fountain pen does for one who is continuously writing. The tool is fitted with a hollow, projectile-shaped head that serves as a melting pot for the metal and is mounted at right angles to the handle. The solder is fed through a small hole in the point of the iron, the flow being controlled by a plunger within the receptacle. This is actuated by a lever, rod, and spring mechanism which is governed by a trigger placed near the grip.

While the heating may be done electrically, gas or gasoline is ordinarily used as fuel. The burners placed at one



Ingenious Soldering Iron Which on Plain Work Saves Much of a Workman's Time

side of the iron keep the latter hot and the metal within it melted so that it flows readily.

It is reported that a French firm is manufacturing an excellent cement from the scum formed in boiling beets in the process of making sugar.

(Inv.) L. M. Hasley,  
5720 Powell Valley Rd.,  
Portland, Ore.

**EXPANDING WEDGE FOR TOOL HEADS**

8440

A new wedge for holding the heads of hammers and other tools in place consists of a pair of tapered side plates

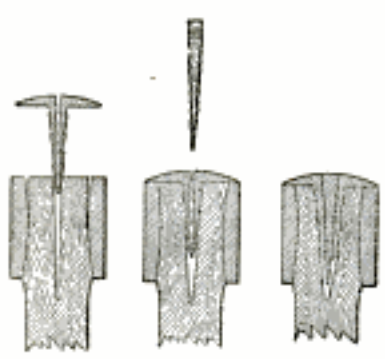

pinned together at the thin ends for convenience in fixing, and a central wedge used in expanding the side plates. The inner and

outer faces of the side plates and both faces of the wedge are serrated, so that slipping is prevented. In applying the device a saw cut is made in the end of the handle, the head of the tool is placed in position and the pair of side plates is driven in far enough to give the flanges a firm bearing on the end of the handle. The central wedge is then driven between the side plates. This breaks the pin holding the side plates together, and the driving is continued until the wood of the handle is wedged out and completely fills the hole in the tool head.

**NEEDLES THREADED QUICKLY BY NOVEL SCISSORS**

8208

Eliminating the difficulty ordinarily encountered in threading fine needles by performing the operation mechanically



in a few seconds, an instrument is being used which also serves as work-basket shears. It is approximately the size of most button-hole scissors,

but has a small tube on its upper side, which, when the shears are closed, admits a needle. By slowly opening the

"Niff-T"  
 2 1/4" Grs

West, Bingham & Pante  
 230 S. 5th St.  
 Chgo

blades in the ordinary manner the needle is automatically adjusted so that a hook is passed through its eye, extending entirely through the tube, so as to receive the thread. By then closing the instrument, the hook is withdrawn, pulling the thread through the needle.

8726

**CENTER PUNCH THAT STRIKES BLOW AUTOMATICALLY**

A new time-saving device for metal workers is a center punch that strikes a blow automatically when pressed against the metal, thus relieving the workman of the necessity of holding the tool in place with one hand while he reaches for a hammer with the other. With the tool in place the top or handle is pressed down.



This compresses a spring within the casing, and at the end of the movement a trip releases the spring, which expands suddenly against a small hammer and causes it to strike a sharp blow against the top of the punching tool. The entire mechanism is contained within the casing, the tool having much the appearance of an ordinary center punch.

This compresses a spring within the casing, and at the end of the movement a trip releases the spring, which expands suddenly against a small hammer and causes it to strike a sharp blow against the top of the punching tool. The entire mechanism is contained within the casing, the tool having much the appearance of an ordinary center punch.

**PART OF GOVERNMENT'S OIL SUPPLY STOLEN**

9947 A & N Journal 5-8-15

That most of the oil in the government oil fields of California has already been taken by private parties contrary to law is the substance of a report recently made to the Navy Department, and prosecutions are to be instituted if sufficient evidence can be obtained against the offenders. These oil fields form part of the oil supply reserved by the government for the use of the navy in case of emergency.

Thomson & Sharpe  
 Danielson, R. S. & Co.  
 1712 West 1st St. Chicago



### Powdered Wax for Ballroom Floors

To make a powdered wax for a ballroom floor, melt in benzine as much wax—paraffin will do—as the liquid will take up, then stir in some talcum powder to form a fairly stiff paste. Rub this through a No. 1 sieve, then spread it out thinly on trays to permit the evaporation of the benzine. Be careful to keep it away from a flame. When the mass has become perfectly dry, pulverize it and place in tin cans with perforated tops. Use it by sifting the powder on the floor. — Contributed by A. Kelly, Malvern, Pa.

### An Emergency Eye Dropper

The value of a saturated solution of boric acid as an eye-wash is now quite generally known. The small glass dropper with which to apply this and other eye remedies is so fragile that it is nearly always found chipped or broken; and if it has escaped unharmed, it is usually discovered that some one has been filling a fountain pen with it. When confronted by such a contingency, simply take an ordinary drafting or ruling pen, and, after wiping it clean, dip it into the solution and with the points well separated touch the moist eyelid, which will instantly cause the liquid to flow in.—Contributed by John D. Adams, Phoenix, Arizona.

### A Carpenter's Tool-Chest Cart

*S.N. X111(17) 2547*

In my carpenter work I have many odd jobs, which makes it necessary to call a drayman for hauling the chest of tools each way, and this added expense on small jobs makes them unprofitable. To eliminate this expense I constructed a tool-chest cart that can be easily pushed along on a sidewalk, paved street, or smooth roadway, by hand.

The frame of the cart is made of  $\frac{1}{2}$ -in. pipe set on 20-in. bicycle wheels using pneumatic tires. The

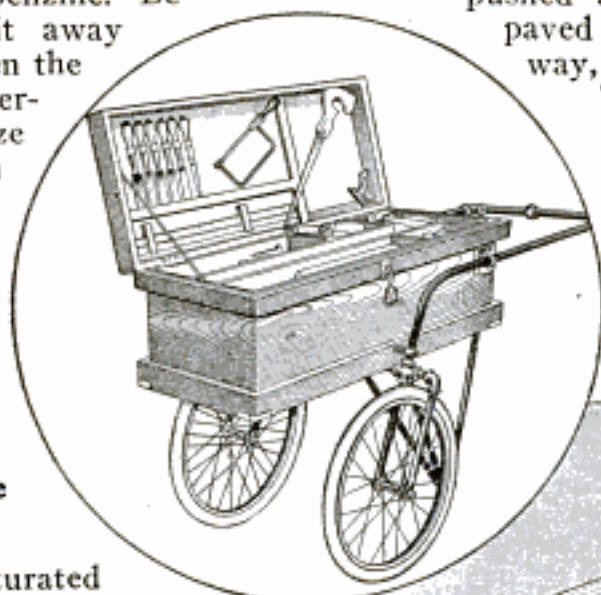

The Tool Chest can be Easily Carted to Any Place and the Workman Is Sure to Have All Tools at Hand

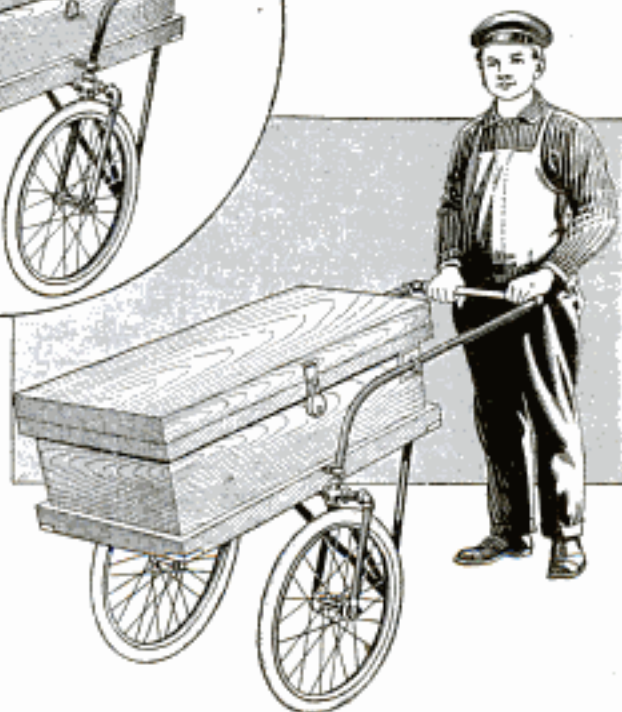

wheels are set far enough forward so that there is considerable weight on the post at the rear when standing still. When lifted, the handle is of convenient height for pushing, and it balances well on the wheels.

It is much easier to push the cart than to carry a few tools in a hand box on the shoulder, and when I arrive at the work I have everything I need, including screws, brads, and nails of various sizes.—Contributed by Sim Goddard, Sheridan, Wyo. *Box 515*

### A Floating Boat Landing

Where the tide rises and falls the float shown makes a convenient landing for a small boat. Four posts are set, one at each corner of a suitable-



The Floating Platform Makes an Excellent Landing Place for Small Boats in Tidewaters

size platform, allowing some space to make the platform free. The structure should be built near a dock or stationary high landing. Make up the platform strongly and bend a loop of heavy iron rod around each post and flatten the ends for bolt holes. Drill two holes in each end for bolts and fasten them to the platform.

Steps, or a stairway, are constructed and hinged to the dock so that the lower end will rise and fall with the movements of the platform.—Contributed by Fred L. King, Islip, N. Y.

Ⓒ When mounting an emery wheel, tap it lightly to see whether it is sound or cracked.

### Easily Made Name Plates

Brass or copper-faced name plates for machinery, doorplates, etc., can be made easily and cheaply as follows: Set up the desired lettering in rubber, or metal, type and make a plaster-of-paris impression. Then inclose it in a small frame the size of the desired plate and  $\frac{1}{16}$  in. deep. Use either copper or brass filings for the facing material. These must be thoroughly washed in soldering flux and allowed to dry, after which they are well sprinkled in the impression left by the type.

Fuse a compound of seven parts lead to three parts of block tin and pour it into the open mold. When the metal becomes a little cool, but is still soft, press it with a flatiron, or a similar object, to force the metal well into the corners and to remove all air. When cool remove carefully, trim and finish on the face with a piece of emery cloth laid flat on a board.

Before pouring, or before applying the filings, the mold should be carefully dusted with black lead. If this precaution is not observed, the mold is liable to be damaged when the casting is removed. If only one plate is to be made, this caution need not be considered.

### Spring Shock Absorber for Crutches

The jarring experienced when using crutches can be greatly reduced if spring shock absorbers, as shown in the illustration, are fastened at the bottom. The device consists of a metal tube, open at both ends, but provided with a solid partition in the center. The lower end contains a shock-absorbing spring, and a loosely fitting reciprocating plug, to one end of which is attached a rubber tip, while the other end is provided with a stud, threaded on the end for an adjusting nut. The partition should be drilled to fit the stud. With spring and plug in place,



the nut should be put on, and the spring adjusted for the desired amount of compression. The shock absorber can then be fastened on the crutch with a small bolt and nut, allowing sufficient clearance between the end of the crutch and the top of the reciprocating plug, so these will not strike together.—Contributed by M. Morris, Toronto, Canada.

#### Automatic Condensation-Discharge Trap for Compressed-Air Tanks

Considerable difficulty was experienced from water condensation in the compressed-air tanks passing up through the return pipes and into the pneumatic tools that were used in the shop. A large number of such tools as motor drills, pneumatic hammers, etc., were used by the men in the erecting shop, and the presence of water in any of these tools did not take long in making itself known, which caused damage to the sensitive parts. As the condensation of water in any like case is irregular, depending on the condition of the atmosphere drawn by the compressors, it is hard to keep a tank drained and free from water at all times.

The sketch is descriptive of the manner in which an automatic condensation-discharge trap for this water was inexpensively constructed and operated in connection with the tank and pipe lines. An old 10-in. air cylinder was utilized, with two heads to fasten tightly on the top and bottom. The 8-in. copper ball, or float, pulls the valve from its seat when the water lifts it. When the least amount of air begins to escape the valve is instantly drawn to its seat. The valve seat and guide spindle worked very nicely soldered directly on the copper ball, or float. One of the traps was worked in connection with the large storage tanks and another installed at the end of the air pipe line in the erecting shop.

In the case mentioned the traps at once made their value apparent, for no further difficulty was experienced by

the men using pneumatic tools in the erecting shop, and also the automatic draining of the storage tanks relieved

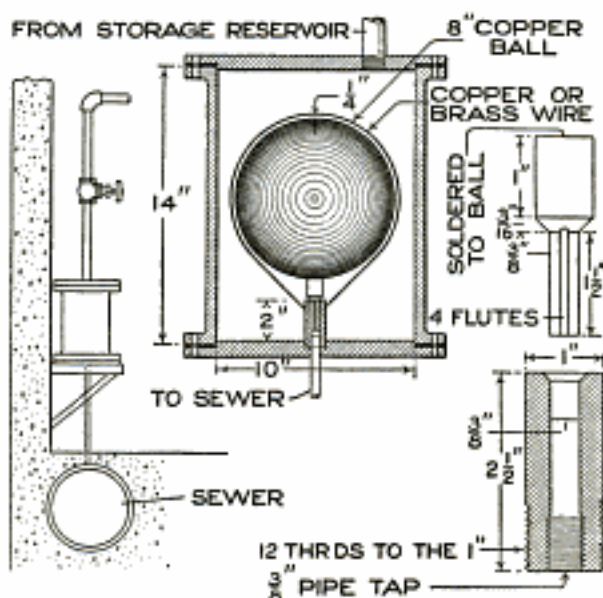

Trap for Use in a Pipe Line or at a Tank to Remove Water from Condensation

the engineer's mind of a matter which had previously been of no little concern.—Contributed by F. W. Bentley, Jr., Missouri Valley, Iowa.

#### Substitute for a Broken Automobile-Spring Clip

A clever substitute for a broken spring clip is shown in the illustration. The clip broke at the point indicated in Fig. 1, and to repair it was practically out of the question. A piece of cold-rolled stock,  $\frac{3}{8}$  in. thick and  $1\frac{1}{4}$  in. wide, was cut to the proper shape to fit over the spring; two bolts of the proper size and length were procured, and the assembling was made as shown

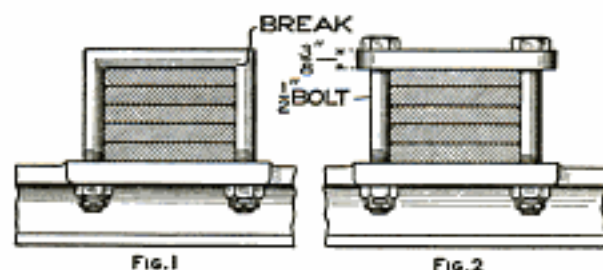

Substitute for a U-Bolt Clip, to Hold an Automobile Spring on the Axle

in Fig. 2. The job was quickly done, and a great deal of time saved, as it would have taken several days to procure a new clip.

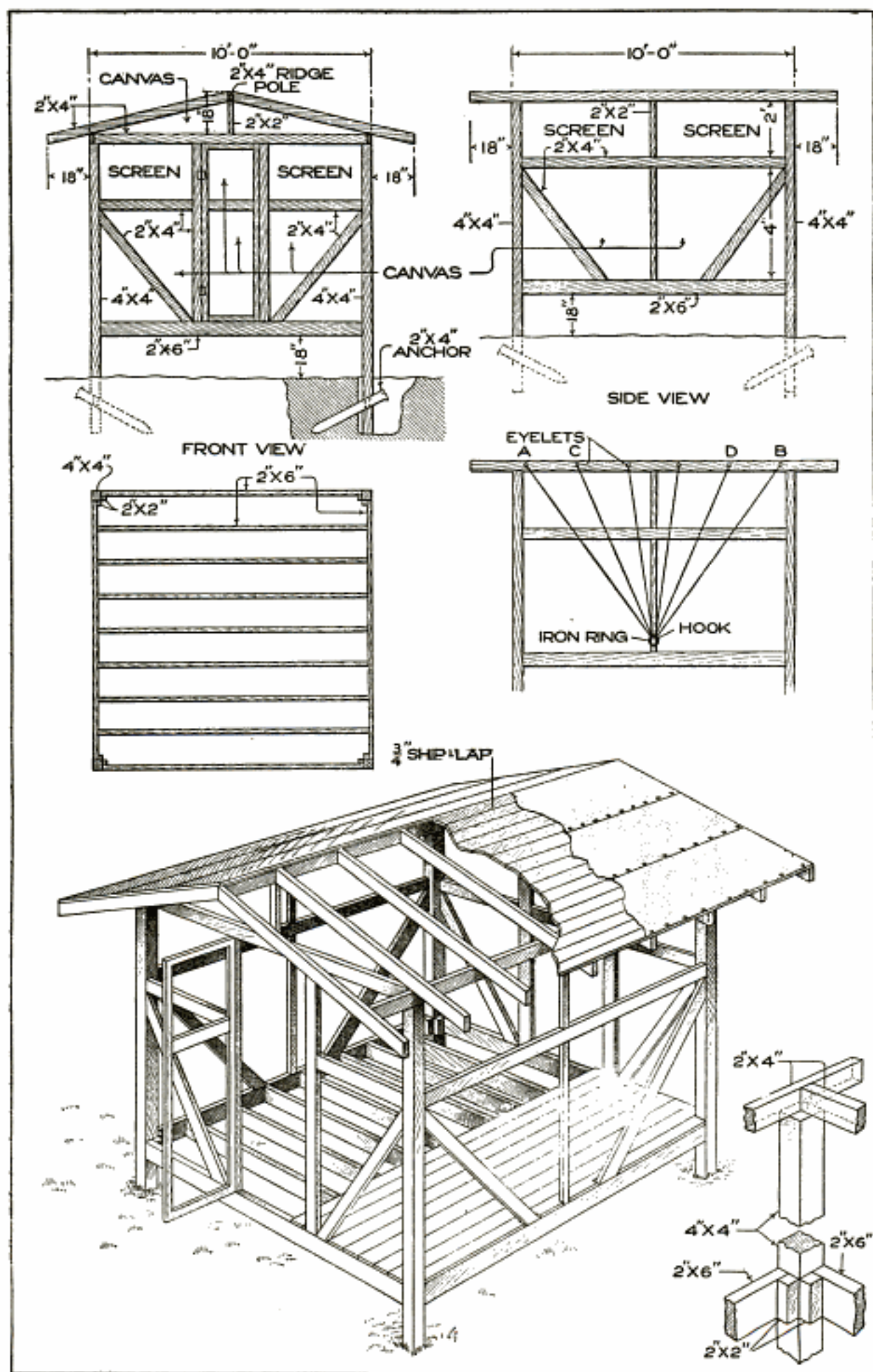

See June 15 - 1926

## A Tent House

By L. P. PASEWALK

**T**HIS tent house, or sleeping bungalow, was the result of an urgent need of a place for sleeping out in the open, which would afford the advantages of a house. It was built in a convenient place in the yard on four posts, 9 ft. long and 4 in. square. These posts were set in the ground in a perfect square, 10 ft. on the sides, and to a depth of about 18 in., then anchored with pieces of 2 by 4-in. material nailed across their ends. Before tamping in the dirt, however, the posts were merely set in the holes dug for them, then the framework was joined to the posts.

The floor sills were first cut to length to fit in between the posts, each being 9 ft. 4 in. long and squared to make a good joint. These were fastened to the posts with toenails, and further strengthened with blocks, as shown in the ground plan. At a point 4 ft. above the sills, pieces of 2 by 4-in. material, in the same lengths and attached in the same manner, were placed between the posts.

The plates for the rafters to rest on consist of 2 by 4-in. material, set on edge so that their outside surfaces were flush with the outside of the posts, two pieces being 13 ft., and two pieces, 9 ft. 4 in. long.

The rafters were cut from 2 by 4-in. material, 6 ft. long, this length being sufficient to cut the angles on the ends to make the fit at the ridge. Studs were set in at one end to provide an opening for the door, which was merely a frame covered with canvas.

After the framework was fastened together solidly, the dirt was tamped into the holes about the posts.

Sheathing boards were laid closely together on the rafters and prepared-roofing material placed on them. The sides were covered with canvas up to the noggin, or rail, set in 4 ft. from the sills. An ordinary floor was laid on the joists, set in between the sills. The 2-ft. space above this point was left open, except that it was covered with screen, and an adjustable covering, operated by cords, provided a means of closing up one or all of the openings at will, the several cords controlling one covering being operated by one common point at a ring.

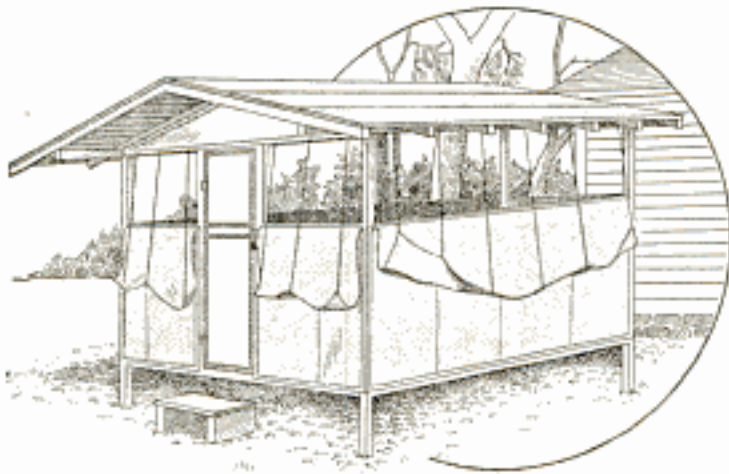

The Tent House Has All the Comforts of a Home and the Advantages of Sleeping in the Open Air, Protected from Rain and Bad Weather

The arrangement of this covering is shown. It was constructed of canvas, of a size to fit the opening, fastened to the lower edge of the rail and allowed to hang down on the outside. The cords controlling the coverings, or flaps, were at-

tached to the loose end of the canvas and run through eyeleted holes in the plate. The cord from A runs to a ring, then to B; from C to the ring and to D, and so on. When the ring is drawn down and hooked over a nail at the bottom on the inside, the flap is pulled up over the screened opening.

This made an excellent sleeping place, like a tent and outside, yet it provided a comfortable place when a storm came up during the night.

**C**If an automobile is left standing in a garage for any length of time, raise the axles on supports to remove the weight from the tires. Weight flattens the tire in one place, causing a crease in the fabric which weakens it to some extent.

### Support for Hose Connection between Engine and Radiator

In certain types of automobiles the radiator is supported at the top by the

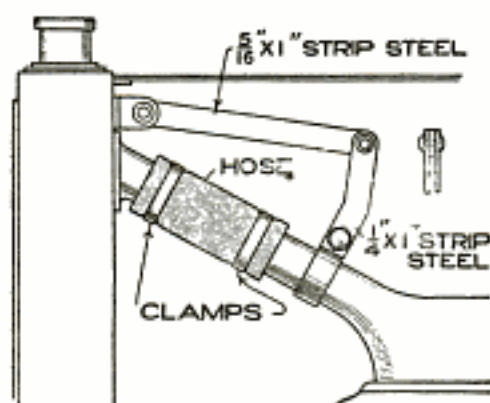

Supporting Bar to Take Up Vibrations of the Radiator to Prevent Strains on the Hose Connection

rubber hose which connects the manifold to the radiator. The constant

vibration of the radiator and its forward and backward movements are all imparted to the rubber hose with the result that it becomes badly warped and twisted, and it does not take long before the hose is useless. Trouble of this nature can be eliminated to a great extent by introducing a connection between the radiator and manifold so that the latter, being made of cast iron, will more readily stand the strains than the rubber hose. A piece of steel is firmly clamped to the manifold and is in turn connected to the radiator by another piece of steel. Such a connection is very flexible and therefore is capable of withstanding high strains and vibrations.

CA shaft bearing will take only so much oil, and it is a waste to use more.

### Cableway to Procure Water for a Mountain Lodge

The water used in my mountain lodge was procured from a stream 50 ft. below, and not being acclimatized, the lightness of the air made it an exceedingly hard task for



A Cableway Run from a Mountain Lodge to a Stream Below on Which a Trolley is Operated with a Windlass, to Obtain Water

me to carry it up in pails. To do away with this old-time method, I constructed a cableway with a trolley operated by a windlass, which served the purpose well and required very little effort. I first secured a strong telegraph wire for the cable and fastened one end to the eave of the veranda and the other to the base of a

tree at the opposite side of the stream. Two pieces of board and two old iron pulleys were procured and fashioned into a trolley to run on the wire. A block and pulley was then hung to the lower edges of the boards. A rope was fastened to a pail and run up through the pulley block and to a windlass drum placed between two posts of the veranda.

A bumper was attached to the wire at a point over the stream, and a coil spring run on the wire in front of the bumper block. A knot was tied into the rope 4 ft. from the pail. To obtain a pail of water it is only necessary to let out the rope on the windlass until the trolley strikes the bumper and it is lowered





into the stream until filled. When the windlass is turned the pail is drawn up until the knot strikes the pulley block, and then it travels up the cableway until it can be taken in by hand.—Contributed by P. E. Ogilvie, Glace Bay, Cape Breton.

### Cutting Tool for Packing

To cut packing in some of the shapes necessary for gasoline-engine heads is quite a difficult task. The irregular shape can be easily cut by the use of two tools, made similar to the regular cold chisel, as shown in the illustration. The tools are forged just like making a cold chisel, after which the flattened edge is made rounding on a  $\frac{3}{8}$ -in. radius for the larger tool and a  $\frac{3}{16}$ -in. radius for the smaller, the widths being  $\frac{9}{16}$  in. and  $\frac{1}{4}$  in., respectively.

The large one will cut out circles or holes, of any shape, from  $\frac{9}{16}$  in. up;



The Curved Edge of the Chisels Makes It Easy to Cut a Curved Opening

and the small one from  $\frac{1}{4}$  in. to  $\frac{9}{16}$  in. in any kind of packing.—Contributed by John P. Kolar, Ithaca, N. Y.

### A Homemade Cradle

The cradle illustrated has all the advantages of any rocker cradle, and besides it is much easier for the mother to take the baby from it while lying in bed, as the supports run under and cause the basket to tip toward the bed.

It is constructed of a clothes basket, several pieces of  $\frac{3}{4}$ -in. pipe and 2 two-way side-outlet tees. The standards are 38 in. long, ornamented on their upper ends with brass bedpost balls. The spreader is 44 in. long. Each extension for the supports is 13 in. long, bent as shown, and fitted with a caster on the lower end. About  $6\frac{1}{2}$  in. from the upper ends of the standards holes

are drilled and hooks fastened by riveting the ends of the hook material. These hooks hold the ends of the ropes



A Clothes Basket Swung between Standards Made of Gas Pipe for a Cradle

attached to the sides of the basket. The inside of the basket is upholstered, and the whole frame and basket is given a coat of white-enamel paint.

### Tool for Removing Old Tin from Roofs

An effective tool for removing old tin from roofs can be made from a piece of steel and a 3-ft. length of  $\frac{3}{4}$ -in. pipe. The steel is formed into the shape of a hook and welded to one end of the pipe, the other end being fitted with a spade handle. To use the tool, the roof is marked off into strips, about 10 ft. wide, with a chalk line, and the hook is pulled along on the line, cutting up the tin into large sheets ready to be rolled up. When a soldered joint is

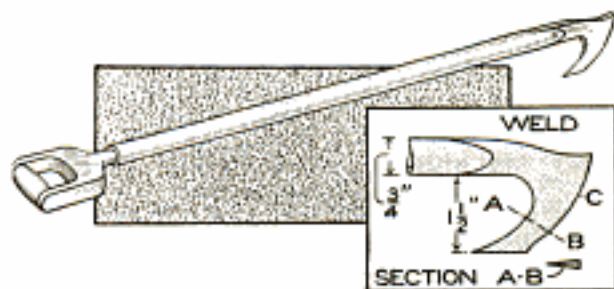

Tool for Cutting Old Tin Roofing into Strips So That It can be Rolled

encountered the workman strikes the boss C with a hammer to drive the blade through it.—Contributed by Wilbert Bernhardt, South Bend, Ind.

### Electric-Heating Coil for an Ordinary Soldering Iron

An ordinary soldering copper may be easily converted into an electrically heated one by placing a heating element about the body of the iron. Proper means, of course, must be provided for

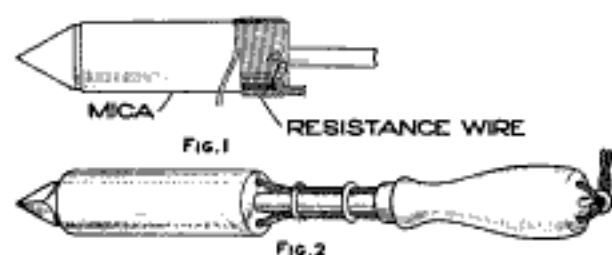

A Coil of Resistance Wire Built Up about an Ordinary Soldering Copper for Heating by Electricity

connecting the heating element to a source of electrical energy. The size and amount of wire for the heating element will depend upon the degree of heat required and the weight of iron being heated. A soldering iron weighing about 2 lb. is a very common and useful size, and it will be assumed that such an iron is to be supplied with a heating coil.

Place several thin layers of mica, about .002 in. in thickness, around the body of the iron, and fasten it in place temporarily with several turns of small wire. Procure 20 ft. of No. 26 gauge nichrome resistance wire. Attach one end of the resistance wire to a piece of asbestos-insulated copper wire, of at least No. 16 gauge and about 15 in. long. Anchor the junction of the resistance wire and copper wire to the soldering iron a short distance from the end nearest to the handle, making sure they are well insulated from the metal part of the iron. Wind the resistance wire around the iron, separating the various layers from each other, to within a short distance of the other end of the iron, as shown in Fig. 1. Place a layer of thin mica around the iron and wind on another layer of the resistance wire in the reverse direction from the first layer. This will give a noninductive winding, or one that can be used on either a direct or alternating-current circuit. Continue in this manner until

all the resistance wire is placed about the iron, and then attach a piece of copper wire to the outside end, just the same as for the inside end. A layer of mica is then placed on the outside of the completed winding and fastened with several turns of wire.

The iron is now ready for a trial test, and this should be made before proceeding with the construction. Connect the free ends of the two pieces of copper wire to the terminals of a 110-volt circuit, and allow the current to flow through the iron for four or five minutes. If the iron becomes too hot, the resistance of the heating element is not high enough. If it does not heat up sufficiently, its resistance is too large. To decrease the temperature, add more resistance, and to increase it, remove some of the wire. If either of these changes is required, it must be made before the iron is completed.

The mica covering will not stand very much rough usage and a protection must be provided for it. A cover for the mica can be made from a piece of thin sheet iron, formed into a tube of proper length and diameter to completely envelop the heating element over the mica insulation. The joint in this tube is formed by bending the edges together. Two holes are drilled lengthwise through the handle for the copper wires attached to the heating element. The free ends of these copper wires are soldered to the ends of a piece of lamp cord. If the holes in the handle are drilled large enough, the joints where the copper wires are attached are placed within the handle. A screw eye is fastened in the end of the handle, into which the lamp cord is anchored to prevent any strain coming on the wires attached to the heating element. In Fig. 2 is illustrated the completed iron.

### Temporary Reflector for a Headlight

New reflectors or lenses for automobiles are seldom found in stock, and when one is broken, a lamp may be useless for some time before replacement can be made. For temporary

service, cut out a disk of bright tin of the proper diameter, insert it and hold in place with small wedges. A bright bottom from a nonfluid-oil pail will do as well, if one is at hand. A prevention is better than a cure, and barring accidents, broken lenses usually are caused by the flame being blown backward by a leak around the door. The owner should occasionally examine the fit of the lamp doors and see that they are tight.

### A Grinding Gauge

A very efficient and easily made grinding gauge for tool and gauge grinders can be made from a piece of machine steel,  $2\frac{1}{8}$  in. square by  $\frac{3}{32}$  in. thick. The  $60^\circ$  angle is for grinding or turning lathe centers, and similar work. The  $59^\circ$  angle is for drills, countersinks, center drills, etc., while the  $45^\circ$  angle gives the correct slope for the chamfers on reamers and taps.

The  $45^\circ$  angle should be large, as shown, so that reamers up to 2-in. may be gauged. The surface forms a square

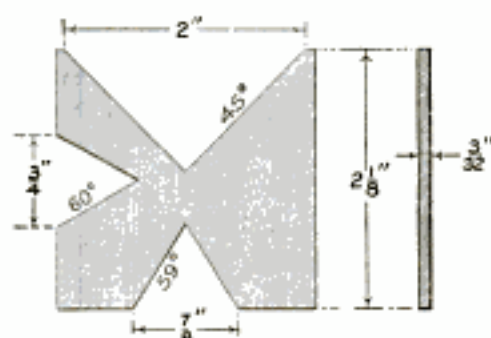

Gauge for Toolmakers and Grinders to Determine the Proper Angles for Tools

and also a straightedge for showing clearance. This tool, unlike protractors, is always set and never slips.

### Screen for a Motor-Truck Radiator

Radiator accidents of a serious nature usually can be avoided by providing a protecting screen. The one illustrated is inexpensive and is readily attached to a truck frame in front of the radiator. It consists of an angle-iron frame with a screen made of strips of metal,  $\frac{3}{4}$  in. wide by  $\frac{3}{16}$  in. thick.

The entire frame is held firmly to the truck frame by means of four braces,

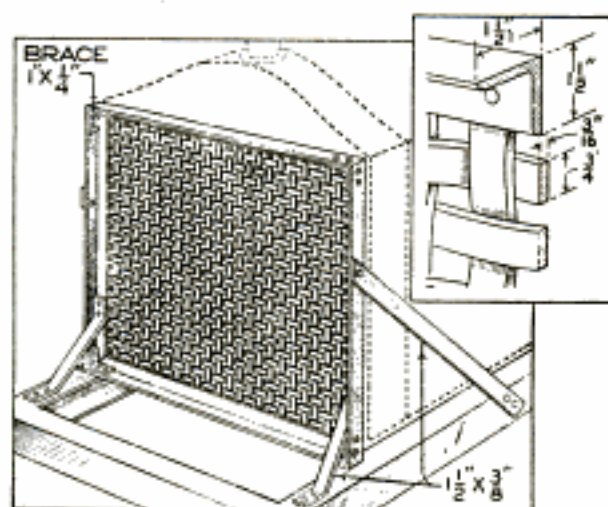

A Protecting Screen Made of Steel Strips to Avoid Serious Damage to Truck Radiators

two on each side, all made of flat steel  $1\frac{1}{2}$  in. wide and  $\frac{3}{8}$  in. thick.

### Iron Cement for Steam Pipes

To make a permanent cement to be used for stopping leaks in steam pipes, where calking or plugging is impossible, mix black oxide of manganese and raw linseed oil, using enough oil with the manganese to bring it to a thick paste. Apply this to the pipe joint or leak. It is best to remove pressure from the pipe and keep it sufficiently warm to absorb the oil from the manganese. In about a day the cement will be as hard as the pipe.

### Protecting the Gas Mantle

"One fly-power" is not much force, but when these pests make a thoroughfare of the gas chimney the incandescent mantle is liable to suffer breakage during the procession. To avoid this, slip a paper bag over the chimney and secure it at the bottom with a rubber band. This will effectively shut out the flies and keep the chimney clean as well.

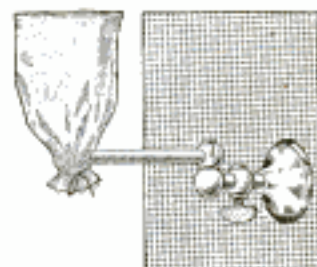

### Waterproof Joint for a French Window

To make a French or swing-in window strictly waterproof, set the stool in so that when the window is hung, it will project out over the stool about  $\frac{3}{8}$  in. Make a weather stop,  $\frac{7}{8}$  by 1 in., beveled on top to shed the water, and as long as the window is wide. Procure some pieces of  $\frac{1}{4}$  by  $1\frac{1}{4}$ -in. lattice, about  $1\frac{1}{4}$  in. long, and fasten them with nails on top of the window sill just outside of the stool. Nail the weather stop on top of these pieces, and any water that gets in between it and the window will run off the drip formed by the V-shaped notch, or rabbet, in the bottom of the window, down the weather stop, and out under it. This makes the window waterproof in any storm.—Contributed by Bert Fish, E. Rochester, N. Y.

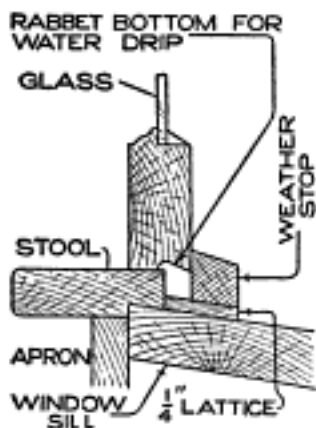

### Oilers for a Small Dynamo

A dynamo installed for lighting only in an automobile had no provision for oiling except an oil hole in each journal. The owner neglecting the oiling, frequent trouble occurred from hot bearings, which finally had to be renewed. To prevent this semi-annual expense, a pair of self-feeding oilers were made as shown. The lower side of the frame and the bushing were drilled and tapped, and a piece of  $\frac{3}{8}$ -in. brass was screwed into the hole. This piece of brass was threaded on the projecting end and had a  $\frac{7}{32}$ -in. hole drilled through it. A piece of

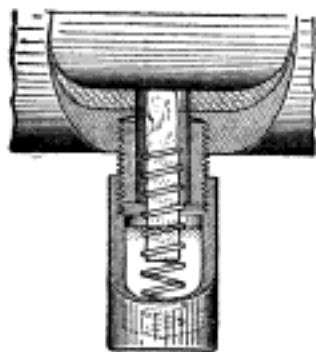

$\frac{7}{16}$ -in. brass was tapped to screw on the outside of the projecting plug and drilled out for almost its entire length. This gave an oil-storage space.

To carry the oil to the shaft, a piece of belt leather was shaped to make a sort of round pin,  $\frac{3}{16}$  in. in diameter. This was screwed into a light compression spring which kept it constantly up against the shaft and its lower end dipped into the oil. While the leather did not act as a wick, it served the same purpose and carried up sufficient oil to the shaft to keep it well lubricated. Filling was only necessary at long intervals.

### Substitutes for Staples to Hold Door Hasps

The ordinary hasp for a door attached with staples does not provide a very secure fastening when used in connection with a padlock. A much safer holding device is obtained by the use of carriage bolts. The bolts are bent, as shown, the threaded end is run through the door, and a nut is turned on the threaded end. The bolt cannot be pulled out like a staple.—Contributed by Chas. H. McElroy, Indianapolis, Indiana.

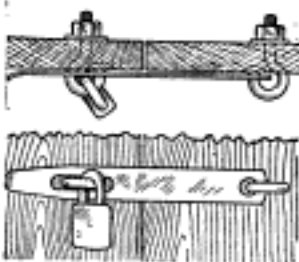

### Using Glass to Grind Glass

It is not generally known that glass will cut glass. If a little work on smoothing the edge of some glass object is desired, procure a circular disk of glass, such as a round eyeglass or watch crystal, and mount it as follows: Turn a wood base to fit in the chuck of a jeweler's, or other, lathe and fasten the glass with the concave side against the wood by using some shellac as a cement. If it is properly centered and made to revolve rapidly, the edge can be used to grind and smooth other glass pieces.

# BUILDING A HOME

By Geo. M. Petersen

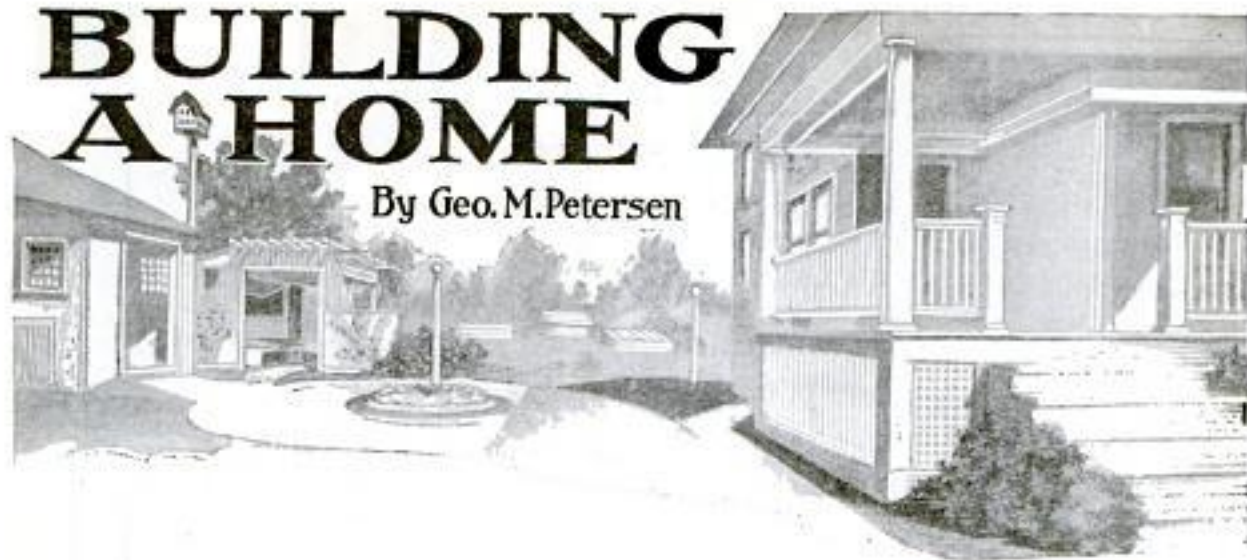

## PART V—Lath and Plaster

**P**RESENT-DAY plastering is known as one, two, and three-coat work. In some localities two-coat work is termed "skim coat." Plaster may be applied over wood or metal lath, or applied directly to the surface of hollow tile, or concrete blocks.

One coat of modern patent plaster is superior to the old three-coat work so far as durability is concerned, although the surface cannot be finished smooth and it dries out a cement gray. Patent plaster is composed of gypsum, cement, hair, and sand, ready to mix and apply. It can be finished so as to appear well by applying a coat of white finish over it. This white finish is put on as thin as possible, evens up the little imperfections on the patent plaster, and leaves the whole wall white instead of a gray. It is because the white finish is put on so thin that it is called "skim-coat" work.

Two-coat work is put on in the same manner as a skim coat, but the finish coat is fairly thick instead of being merely skimmed on.

Three-coat work, as its name indicates, is put on in three coats, the first one being the "scratch" coat; the second, the brown coat, and the third, the white coat, skim coat, or finish.

The scratch coat is always rich in lime and hair, while the brown coat is mostly sand with a little lime and hair added. The finishing coat is usually composed of lime putty and beach sand, in equal parts. This coat may be

given a sand finish—a coarse finish resembling sandpaper—by using a coarser sand and a larger percentage of it for the smooth finish. The sand finish is usually troweled down with a wood, or cork, float.

"Hard-finish" plaster generally means a composition of lime putty and plaster of paris, and sometimes marble dust. Hard plaster is often used to imitate Keen's cement for wainscot work in bathrooms and kitchens, and for similar uses.

The important part of plastering which the owner should watch is that all lime used is well slaked. If the lime is not properly slaked, it will cause discoloration of the paper or paint placed over it, and will also cause hair checks in the finish surface. Lime should be mixed not less than four days before using, and some authorities claim that seven days is the proper time.

The cost of plaster varies considerably with conditions, such as spacing of lath, thickness of plaster, wood or metal lath, etc. If wood lath are spaced more than  $\frac{1}{4}$  in. on ceilings, or more than  $\frac{3}{16}$  in. on the side walls, more plaster is forced in between the lath than is necessary to key it, and considerable waste occurs. The cost of lath and plaster is about 25 cents per square yard for one-coat work; 28 cents, for skim-coat; 32 cents for two-coat work, and 36 cents for three-coat work. The prices on metal lath are

about 15 cents per square yard higher. Wood lath should be well seasoned, free from sap, bark, and dead knots. Bark on lath is sure to stain the plaster, and hard pine is too full of pitch for a really good job. All lath should be 4 ft. long, and never be run from one room to another, or behind partitions. The best lath is made of white pine, spruce, hemlock, or fir.

The durability of plaster is pretty well known to the average person. When it is put on with sufficient force to insure good, strong clinches, it will stand up for years. Plaster, however, will crack readily from concussion, or a sharp vibration of the wall, or dampness may loosen the bond and allow it to drop from the lath. Because of this tendency of the plaster to drop from the lath upon the slightest provocation, there are several manufacturers who are making wall boards with more or less success.

Good wall board is gaining considerable favor, but many products of a cheap grade have discouraged the sale a great deal. They may be divided into three classes. The first one is boards made from news stock and refuse material, and as they are made of cheap stock they do not stand up under ordinary conditions, and the material used is decidedly insanitary as well as presenting a surface which is not adapted to a good paper or paint decoration. Many of these inferior wall boards are put together with tar, asphalt, pitch, and similar materials, which are very

stock. Generally speaking they have the same disadvantages as those mentioned in the first classification, inasmuch as they have not the strength or durability necessary to give lasting satisfaction. Many of these boards have a center made of news stock and refuse material with the outer layer of wood fiber. The fibers used are generally short and hard and they are easily affected by outside conditions. There are other boards made up of asphalt and special clay preparations for the center of the panels. In the construction of some boards full-size lath are used as a backing, while others are little more than pieces of 1/4-in. yellow pine painted with pitch and covered with strawboard.

The third class comprises boards made entirely of wood fiber, of which there are only three or four on the market. Wall boards, like other building material, are not adaptable to all conditions. A board made entirely of wood fiber will not make a good surface for paper, as it will expand and contract with the atmospheric conditions and cause the paper to crack. On the other hand, beautiful designs may be worked in paint and these are far superior to paper. Tiffany blends and stencils are used to advantage on this class of board, and really wonderful effects can be obtained.

There are also wall boards that are finished to imitate quarter-sawed oak, Circassian walnut, black walnut, mahogany, etc., as well as waterproof

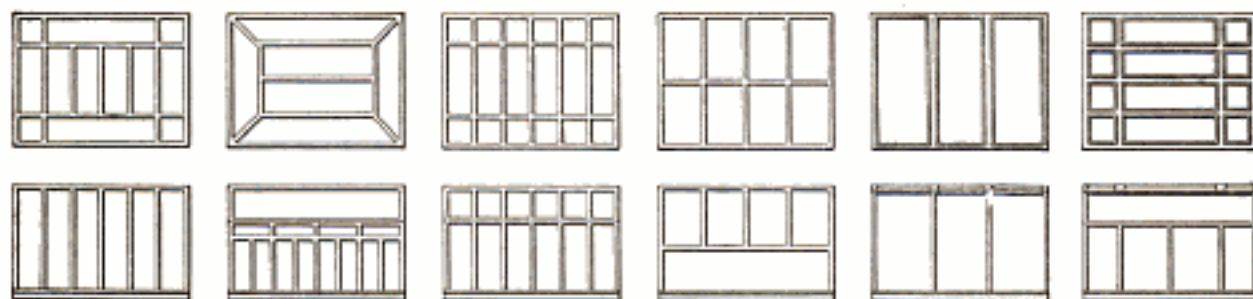

FIG. 1

The Most Important Part of Applying Wall Board Is the Laying Out of the Panel Designs and Fastening Them in Place, as Many of the Failures can be Traced to Improper Installation

inflammable and therefore impractical for walls and ceilings.

The second is boards made of a combination of wood fiber, pulp, and news

boards. Waterproof board can be made, but is unsatisfactory because the surface cannot be painted or papered with satisfactory results, as it is fin-

ished with wax. Boards having imitation-wood finishes are not in very great demand.

Perhaps the most important part of a wall-board job is the laying out of the panel design. The illustration shows several wall and ceiling-panel designs. The manner of nailing the board in place is shown by the numbers, which designate the order in which to drive the nails. Most of the wall-board failures can be traced directly to an improper installation of the board itself. Wall boards can be purchased at from \$18 to \$36 per 1,000 sq. ft., but most reliable boards can be had for \$25 to \$32 per thousand.

There are hundreds of color schemes and designs which may be used in decorating wall boards, varying from flat color with a plain line border to the most elaborate blends and stipple effects with complicated stencils, as mentioned heretofore. If a little study is given to the panel designs for each room, some really delightful effects may be obtained by using wall boards. Most of the wall-board manufacturers are also making an imitation tile for bathrooms and kitchens. This material, when enameled, resembles tile or Keen's cement very closely and makes a fair job.

Metal ceilings and wainscoting are rapidly coming into favor, although they have their faults as well as other

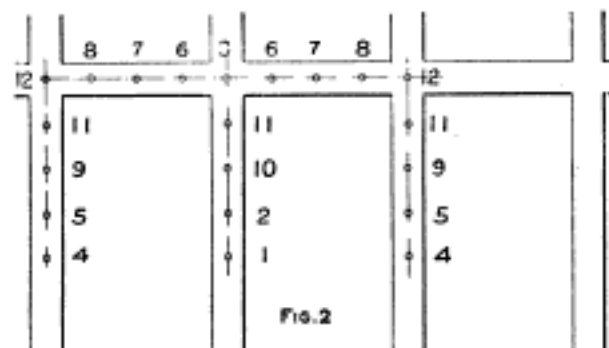

The Figures Designate the Order in Which to Drive the Nails for Holding the Wall Board

building materials. Metal ceilings can be installed for eight cents or more per square foot, according to the design and the amount of labor involved in matching, and the number of offsets

and angles to be treated. Metal wainscot can be installed for seven cents per square foot on the bare studding, but to do a good job the space over which the metal is to be placed should be

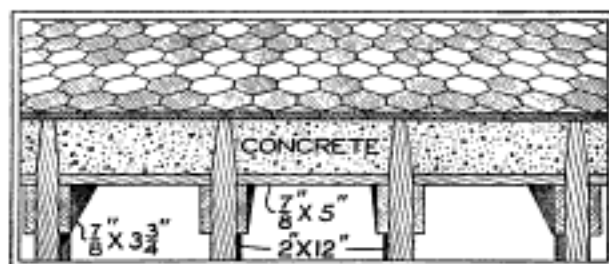

FIG. 3

Concrete-Floor Construction as a Floor Base over Which a Tile Floor is Laid

sheathed with  $\frac{1}{2}$  or  $\frac{7}{8}$ -in. lumber and the metal nailed to this backing. The wood backing not only affords an even nailing surface, but backs up the metal and protects it from dents and corrosion. Metal wainscot is usually finished with a wood base and cap to imitate tile.

Metal ceilings can be given two coats of flat white and one coat of enamel, or it may be tinted to any shade or color desired, using a lead and oil paint, the same as for wood. Metal wainscot, however, is generally enameled white, and the wood cap and base are finished to match the tiling. Inside and outside beads are made so that the corners can be finished neatly. All stamped metal work will rust out in time, but the low cost of renewal overcomes this objection to a large extent.

Tile is undoubtedly the most popular material for bathroom floors and wainscot, but because of the price it is not used in cheaper houses. Tile floors may be laid for from 25 cents a square foot up, with the average price around 60 cents a square foot. The cheaper price means skimping on the base, using a second grade of some cheap tile and naturally a quick job of laying, which means slovenly work. Tile wainscot costs in the neighborhood of \$1 per square foot and is laid in cement on metal lath. The wainscot tile should be thoroughly soaked in water before using, then laid to a straight edge and well tamped into place.

The No. 1 grade of tile is clean, smooth, and has a clear color, while the No. 2 grade is slightly off-color, usually a little yellow. The second grade is generally used for servants' bathrooms and pantries, although a

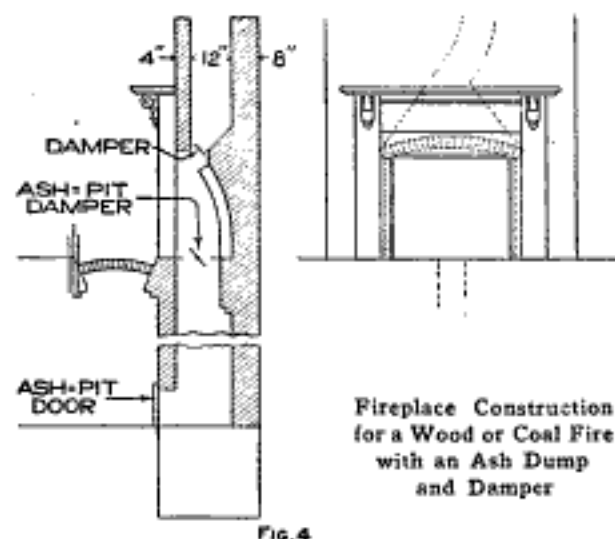

comparatively small amount of other tile work is laid with seconds. Some of the tile seconds, as well as most of the cheaper grades, are porous and absorbing, so that they really do not meet sanitary requirements.

All tile work should be scrubbed with a solution of hydrochloric acid shortly after the cement has set. This solution removes all stray cement from the face of the tile and leaves it clean. Care must be taken to flush and scrub the tile with clean water as soon as the acid has done its work, or the acid will eat its way between the tiles, which not only results in a bad-looking floor, but will leave cracks and seams that cannot be kept clean.

A gas-burning fireplace is constructed so that the flue runs straight up the chimney, but one burning wood or coal must have the flue start as close to the front of the opening as possible and without any turns. Care must be taken to see that the flues are the same size all the way up, or are even larger at the top than at the bottom, and that no short turns are made in the lining. All fireplaces should be equipped with a damper, ash pit and clean-out door in the cellar, or basement.

Any design desired can be readily

obtained, as the range of color, size, and texture of the fireplace brick now on the market is almost unlimited. The mortar can also be colored so that it will either blend with the color of the brick or make a decided contrast. The latter effect is the one most desired at present, and black mortar is the most popular. The hearths are laid either with the same brick or with various kinds of tile, the red "promenade" being very popular. The tapestry and coarse-texture bricks make a very handsome fireplace, but the pressed brick is by far the most sanitary and most easily cleaned, while it is very difficult to remove the dust and dirt from the pores of the coarse-textured brick.

### Reinforcing a Strained Automobile Frame

The frame of a light delivery wagon became badly strained from an accident, so badly, in fact, that some method of reinforcing the rear portion of it became absolutely necessary. It was done in the following manner: Two channel pieces were riveted diagonally between the two cross members directly above the rear axle. The ends were cut out, as shown at A, so that the riveting was done on the upper and lower flanges only. It was sur-

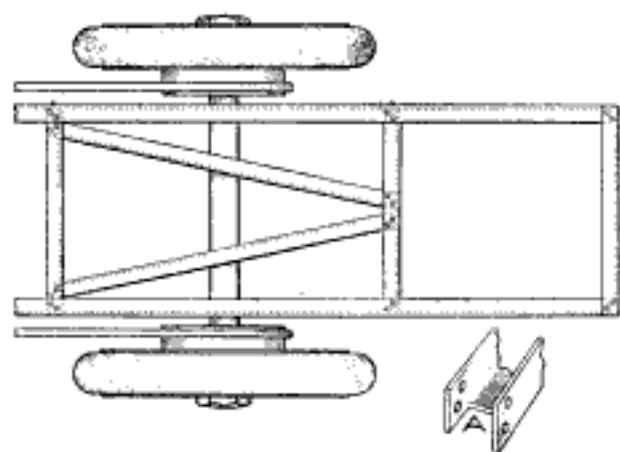

Braces Put in the Rear Part of an Automobile Frame to Stiffen It after an Accident

prising how rigid the frame became after these braces were in place.—Contributed by Adolph Kline, New York City.



### Dividing Tool for Graduating Scales

A tool designed for graduating any flat surface in any number of parts, up to  $\frac{1}{64}$  in., is shown in the illustration. By changing the feed screw and nut to the metric system, graduations for these scales can also be made.

The frame consists of a length of machine steel,  $\frac{1}{16}$  in. square, drilled for the feed screw A and the guide rod B, then tapped for  $\frac{1}{4}$ -in. clamp screws, as shown. The two collars C and D serve to prevent longitudinal play, and the latter also serves as an indicator, being divided into four equal parts, as shown, and graduated accurately, then marked 0, 1, 2, and 3. The feed screw has 16 threads to the inch, so that one turn makes the marking guide E move  $\frac{1}{16}$  in., while a half turn moves the guide  $\frac{1}{32}$  in., and so on. The threads on the screw should be carefully cut and lapped to fit snugly in the threads of the guide E. The beveled face of the collar D being divided into four parts, the screw may be accurately moved quarter turns, thus spacing to  $\frac{1}{64}$  in., which is usually fine enough for any scale.

While the instrument is small, it will accurately graduate a scale, rule, or tape of any length. In use, the surface to be graduated must be cleaned and coated with copperas, then lines must be made with a scribe lengthwise of the scale, the first  $\frac{3}{32}$  in. from the edge, the next  $\frac{1}{8}$  in. from the edge, and so on. Place the work on the frame F, and fasten it down with the clamps G. The marking guide E is run up to the head of the tool and set flush with the end of the scale to be graduated, and the tool is ready.

Give the thumbscrew H one quarter turn, then make a clear scratch on the prepared surface, drawing the scribe along the side of the guide E; give the screw H another quarter turn, and repeat until the whole length is marked. This spaces the marks  $\frac{1}{64}$  in. When the length of the lead screw has been graduated, return and space a half turn for  $\frac{1}{32}$  in., and continue so until the scale is graduated as desired.

In case of a long scale, graduate each length at a time, setting the last graduation for the first mark and repeating

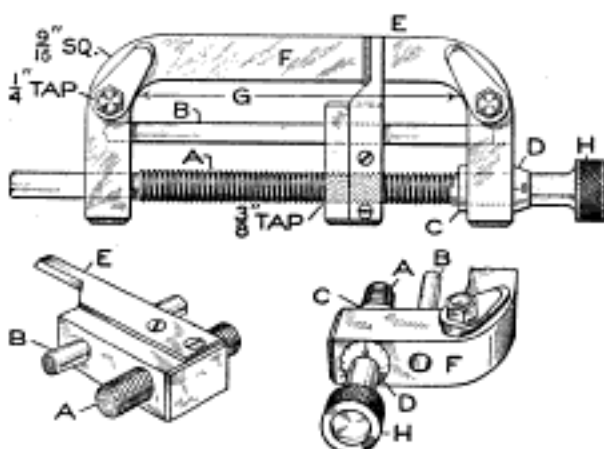

Hand Tool for Accurately Marking Divisions on Scales and Rules of Special Construction

each operation. With this tool many novel, useful, and accurate forms of scales may be easily made. While this instrument will not compare with machine-made tools of the latest patterns, or with the automatic dividing engines, it is quite rapid and is absolutely accurate.—Contributed by J. B. Murphy, Plainfield, N. J.

### A Quickly Made Wrench

The illustration shows how a wrench for a hexagonal nut can be quickly made. A piece of ordinary tubing, with an outside diameter equal to the dimension across the flats of the nut and about 5 in. long, is thoroughly annealed. The nut which the wrench is to fit is heated to a red heat, and the tube is hammered down over it to make the shape as shown. The nut will

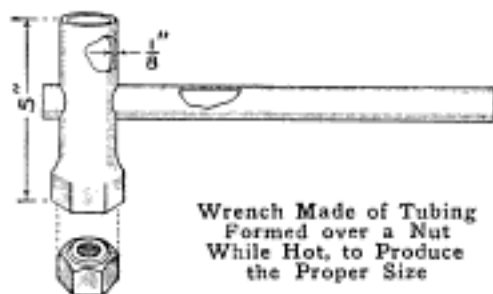

Wrench Made of Tubing Formed over a Nut While Hot, to Produce the Proper Size

contract a little in cooling, sufficiently to allow the wrench to slip over it freely. Another piece of tubing is used as a handle.

### Painting Wire Screen

Procure a board, about 10 in. long, 8 in. wide, and  $\frac{3}{4}$  in. thick, that is



slightly curved as shown. Fasten a piece of round wood, 2 in. in diameter and 6 in. long, to its center on one side for a handle. Hold the board

under the screen the same as holding a plasterer's trowel and paint on the upper side, applying the paint quite freely. Allow the screen to stand for a time, then brush dry to remove the surplus paint.—Contributed by J. L. Riley, Dallas, Tex.

### Makeshift Grabhook for a Well Bucket

As I happened to lose the water bucket from the rope in the cistern and had no grabhook, I managed to get the bucket out very easily as follows: A rope was tied to a claw hammer, as shown in the illustration, which served as a hook that was easily passed into the bucket bail, so the bucket could be drawn out.—Contributed by A. Jaminet, Denver, Colorado.



### Handle to Hold Setscrew While Smoothing Head

As it was necessary to smooth down the edges on the head of a short case-hardened setscrew, and I found that a file made no impression on the hardened surfaces, the only other thing to do was to use a grinder. To facilitate holding the screws while grinding I made a short handle of hard

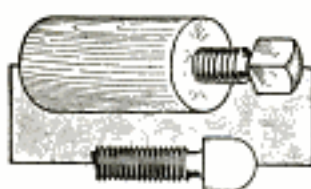

wood, bored a hole of sufficient size for the threads to cut their way in, and turned the setscrew into the hole. This held the screw firmly so the grinding could be done with ease.—Contributed by James M. Kane, Doylestown, Pa.

### Protecting the Eyes When Making Hole in Concrete Ceiling

In making some holes in a concrete ceiling for bolts, a millwright experienced considerable trouble with particles falling in his face and eyes. To protect the eyes, a piece of celluloid was slipped over the chisel. This did not obstruct the view or prevent particles from falling to one side.—Contributed by J. J. Kolar, Maywood, Ill.



### Waterproofing Hinge Joints on Automobile Hoods

Automobiles of the cheaper grades, of which there are many, never are supplied with a covering on the hood hinges to keep out the rain. This trouble may be overcome by placing a bent strip of metal over the hinges, the upper part being soldered to the top of the hood while the lower part is bent to form a close fit with the vertical side, but left unsoldered to permit the opening of the hood.

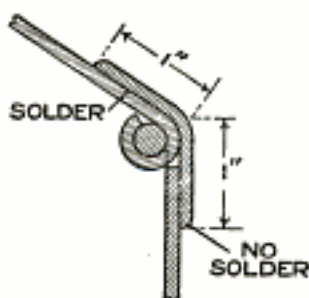

ⒸPrestolite gas run too low for lighting the lamps can be revived temporarily to finish a run by heating the tank, which releases some of the gas from the absorbent.

### Reading Performance Curves of Motors and Generators

It is quite essential that persons owning, or expecting to own or have charge of, electric motors or generators, should be sufficiently familiar with the performance curves of the machine in use to determine its main characteristics. These performance curves tell, graphically, the whole story of the capabilities of the machine, and it is an easy matter for one experienced in reading such curves, or familiar with them, to determine these capabilities almost at a glance.

Machines, more than ever before, are sold on their performance characteristics, as shown by curves, and the prospective customer usually demands certain characteristics of the selling company. It is no longer possible for the salesman merely to give the horsepower and voltage of a motor, and expect the purchaser to make a selection from this information alone. Characteristic curves are usually demanded. The same is true with generators.

The sketch shows the performance curves of an 80-volt direct-current series motor, such as is used on electric vehicles, and the complete behavior of the motor in operation may be determined from an inspection of these curves. In this case the various curves are all drawn with reference to the current taken by the motor, the current being plotted along the horizontal and the other quantities on the vertical lines.

The "torque" is the turning effort of the machine measured in pounds at a distance of 1 ft. from the center of the shaft. The efficiency is the output of the machine, expressed as a percentage of the input and abbreviated "eff." The "R. P. M." is the revolutions of the armature shaft per minute, and "B. H. P." is the brake horsepower.

When this motor is taking a current of 40 amperes it is operating at a speed of 460 revolutions per minute; developing a torque of 37 lb. at a radius of 1 ft.; the horsepower output is 3.25, and the efficiency is about 77 per cent. The

above values of speed, torque, horsepower, and efficiency are determined by following the vertical line corresponding to 40 amperes upward until the various curves are encountered,

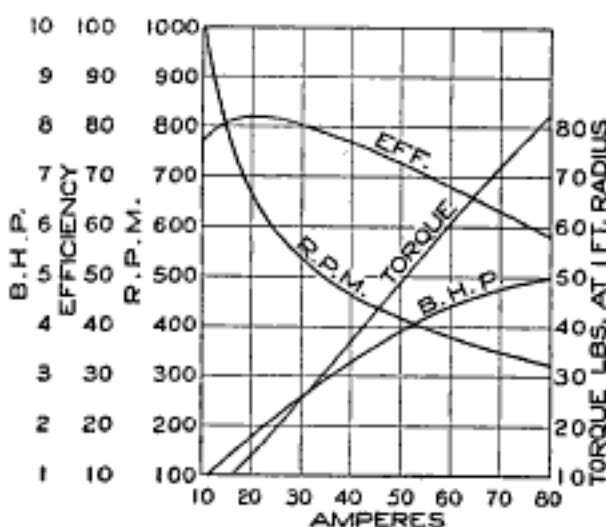

A Performance Curve of an Eighty-Volt Direct-Current Series Motor Used on Automobiles

and then along horizontal lines from the points of intersection to the various vertical scales where the values can be read. If any one of these quantities is given, all the others may be determined in a manner similar to that indicated above. Thus, if a machine is operating at a speed of 400 revolutions per minute, it will take a current of 53.5 amperes, the efficiency will be 71 per cent, the torque will be 53 lb. at a radius of 1 ft., and the horsepower will be a little less than 4.1.

### The Proper Way to Place Ice in a Refrigerator

As heat always travels to the top of an inclosure, it does so also within the walls of a refrigerator; hence, if a piece of ice is not large enough to fill the ice space, lay it in such a position that the largest portion is at the bottom of the cavity. This will save considerable ice where a small quantity is used at a time.

ⒸThe presence of sulphur in a silver-plating solution will cause patchy deposits. The sulphur comes from the rubber used about the plating solutions.

### Proportioning Anchor Plates for Machinery Foundations

It is frequently necessary for the mechanic installing machinery to make the foundation anchor plates in the

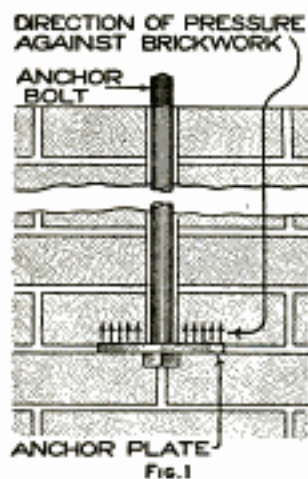

Fig. 1

field. This is particularly true when an installation is in a small town or city where standard anchor-plate castings are not available. The following tells how satisfactory anchor plates can be proportioned and made from wrought-iron plate.

The function of an anchor plate is to prevent the withdrawal of the anchor bolt from the foundation, or to anchor the holding-down bolt in the masonry. An anchor bolt and plate in position in a brick foundation is shown in Fig. 1. The strains which are imposed upon an anchor plate are indicated by the arrows. When the nut on an anchor bolt is screwed down to clamp the machine bedplate in position, the force is transmitted through the bolt to the anchor plate and then presses up against the masonry in which it is imbedded. The total force in pounds with which an anchor plate bears upwardly against the foundation masonry is equal to the tension in pounds to which the anchor bolt is subjected by screwing down the nut. In proportioning an anchor plate, it can be assumed that this load is equally distributed on the portion of the upper surface of the anchor plate outside of the bolt.

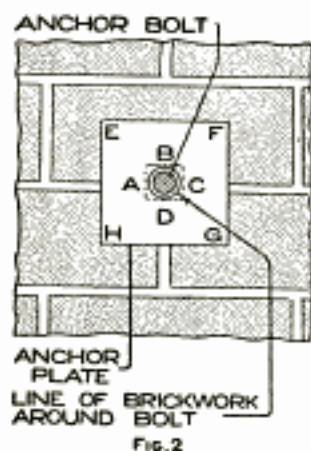

Fig. 2

wardly against the foundation masonry is equal to the tension in pounds to which the anchor bolt is subjected by screwing down the nut. In proportioning an anchor plate, it can be assumed that this load is equally distributed on the portion of the upper surface of the anchor plate outside of the bolt.

When the nut on an anchor bolt is screwed down to clamp the machine bedplate in position, the force is transmitted through the bolt to the anchor plate and then presses up against the masonry in which it is imbedded. The total force in pounds with which an anchor plate bears upwardly against the foundation masonry is equal to the tension in pounds to which the anchor bolt is subjected by screwing down the nut. In proportioning an anchor plate, it can be assumed that this load is equally distributed on the portion of the upper surface of the anchor plate outside of the bolt.

In proportioning the bearing area of the anchor plate—that is, the area of the plate that pushes, or rests, against the masonry—the following rule should be observed: The area, in square inches, of the anchor plate that bears against the foundation multiplied by the safe compressive strength of the material of the foundation, in pounds per square inch, should at least equal the tension which the bolt is capable of sustaining. For example, the tensile strength of wrought iron is about 20 times the compressive strength of brick, hence the bearing area of a plate resting against a brick foundation

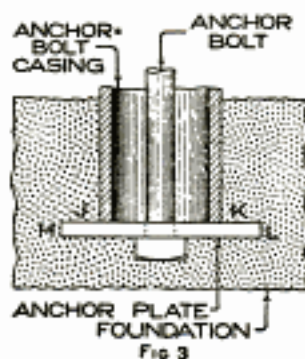

Fig. 3

should be at least 20 times the cross-sectional area of the bolt.

Observing the foregoing rule and referring to the case of the anchor plate in question, the area EFGH, in Fig. 2, which shows a top view of the anchor plate, should be equal to at least 20 times the area of the bolt for a brick foundation.

Obviously, in figuring the effective area of the plate, the area of the circular surface ABCD must be subtracted because this area does not bear against the brick of the foundation. For materials other than brick, the ratio between the bearing area of the plate and the cross-sectional area of the anchor bolt will, of course, be different than 20 to 1. The reason for this is that other materials have different compressive strengths than brick. The compressive strengths of the various masonry materials can be found in some of the many handbooks and will not be given here.

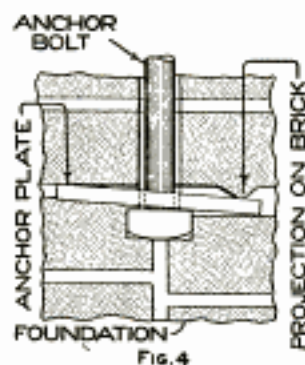

Fig. 4

From the description the procedure

in determining the area desirable for an anchor plate that is to be used in any kind of masonry will be obvious. In determining the effective bearing area of an anchor placed in a casing, as shown in Fig. 3, certain precautions must be observed. For example, only a portion of the anchor plate, indicated by HJ and KL, is effective in pushing against the masonry. The effective area of the plate is greatly reduced, due to the presence of the casing. Corrections for this condition can be readily made and the proper area of the plate computed from the suggestions which have been given.

The thickness of the anchor plate must be such that it will not bend or buckle when the bolt impresses a strain upon it. For a rough and ready rule, the thickness of a steel or iron-plate anchor may be taken as equal to .4, or possibly .5, of the diameter of the foundation bolt with which it is to be used. For example, if the foundation bolt is 1 in. in diameter the thickness of an anchor plate, in iron or steel, should be at least .4 in., or possibly .55 in. This rule is obviously a rough and ready one, and cannot be followed in all instances, although it will give safe results in the average case.

The transverse strains that are imposed on an anchor plate, due to unequal loading, may be very great. It sometimes occurs, due to the inequalities in the surfaces of bricks or stones used in a foundation, that an anchor plate will bear against the masonry at only two or three points, as shown in Fig. 4. In such a case the load is not uniformly distributed, and extensive strains are therefore imposed on the anchor plate and on the masonry. To protect against such conditions, it is well to so proportion anchor plates that their factors of safety will be ample.

ⒸThe presence of boracic acid in a nickelplating solution will cause the whitening of the deposit, and also makes it softer and eliminates the tendency to pit.

### Attaching Steam Sterilizer to Hot-Water Tank

If a hot-water tank be connected up as shown, it can be used not only for its regular service to furnish hot water, but, by a proper manipulation of valves,

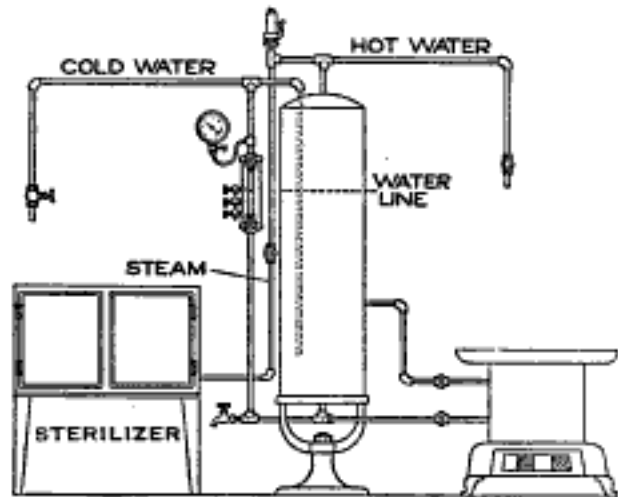

Obtaining Steam from a Hot-Water Boiler for Use in a Sterilizer

will serve also as a boiler in furnishing steam for sterilizing purposes.

To this end, the regular connection of the stove water back to the tank should remain unchanged except for a tee in the drain pipe of the tank. This tee should have its side outlet turned vertically, so that a connection can be made with the lower end of a boiler water column, which should be placed to indicate both steam and water when about one-quarter of the tank's capacity is filled with steam. The upper end of the water column connects with the side outlet of a tee provided in the cold-water supply line. On the regular hot-water outlet at the top of the tank is connected a cross fitting. To one of its horizontal outlets is connected a short length of pipe, provided with a stop valve at the extreme end, for the purpose of relieving the vacuum when draining the tank, or permitting the escape of air when filling it with water. The opposite outlet of the cross is connected through a stop valve, conveniently placed, with the sterilizer. In order to prevent excessive pressure caused by the generation of steam, a safety valve must be provided, which

should be connected in the main outlet line so as to have no valve between it and the tank, thereby preventing any possibility of an explosion by carelessly shutting off the operation of the safety valve. The steam pressure should at all times be indicated, and for this purpose a steam gauge should be attached to the water column through a circular or U-loop, which is for the purpose of retaining water at all times so the steam cannot come in direct contact with the gauge and injure it.

When using the heater for regular service, the sterilizer stop valve should first be shut off. Then the cold-water valve can be opened to fill the tank, the air of the tank meanwhile being relieved by the valve at the end of the short pipe.

In using the sterilizer in connection with the tank, the cold-water supply

should first be shut off. Then the water in the tank may be drained off until the water level shows about half-way in the water column, the vacuum in the tank meanwhile being relieved by the valve at the end of the short pipe line. When the proper level has been obtained, the vacuum-relieving valve should be shut off and steam may be raised as required. Should the amount of steam become excessive, part of the tank water may be drained off, and an equal amount of cold water added; this will tend to condense the steam and relieve the pressure. The water level should be regulated so it can always be seen in the gauge glass; if it is too high, part of it should be drained off; if too low, an extra amount must be added from the cold-water supply.—Contributed by W. N. House, Great Neck, N. Y.

### To Make a Cone Clutch Engage Smoothly

A cone clutch that cannot be made to engage smoothly, can be remedied to some extent as follows: Make six or

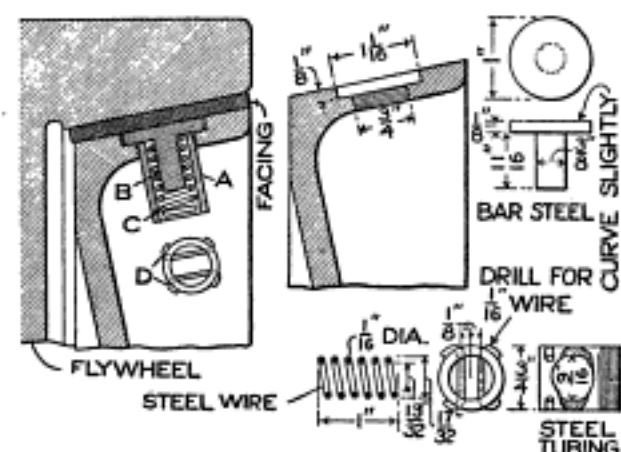

Pressure Buttons to Raise the Surface of a Clutch, to Make It Take Hold Slowly

more sets of pressure springs and place them in the clutch face, as shown. Each set consists of a collar, A, which is screwed into the face of the clutch; a plunger, B, operating in the collar and against the action of a coil spring, C, which is held in position by means of two pins, D. The shape and dimen-

sions of these various parts are shown in the sketch.

The portion of the clutch facing, directly above the plunger B, is raised a trifle higher than its normal height, due to the pressure of the spring, with the result that the entire surface of the facing does not come in contact when the clutch is engaged, and the sudden gripping is entirely eliminated.

### Etching Fluid

An excellent fluid for etching steel, either for making a beautiful frosted effect, or for deep etching of names and trade-marks, is made up as follows: Mix together  $\frac{1}{4}$  oz. of powdered table salt and 2 oz. of copper sulphate with  $\frac{1}{2}$  pt. of vinegar and 40 drops of nitric acid. The parts not to be etched are covered with paraffin or beeswax. Deep etching or frosting is effected by leaving the article to the action of the fluid for a longer or shorter time.

It is dangerous to put a large washer on one side and a small one on the other of an emery wheel.



## How to Make a Model Old-Four Monoplane

By RALPH M. BROWN

**T**HE old-four monoplane model, made famous by its wonderful flights, is one of the most graceful that has been built. Its large size and slow, even glide make it a much more desirable flier than the ordinary dartlike model. It gives one a true insight into the phenomena of heavier-than-air flight. This machine, when complete, should weigh 9 oz. and fly 1,200 ft., rising from the ground under its own power and landing lightly. Its construction is simple, and with careful reference to the sketches, an exact reproduction may be made.

For the motor bases, A, Fig. 1, secure two spruce sticks, each 48 in. long,  $\frac{3}{8}$  in. wide, and  $\frac{1}{4}$  in. thick, and fasten a wire hook on one end of each stick with thread wound around after giving it a coat of glue. These hooks are to hold one end of the rubber bands that act as the motive power, and are designated by the letter B. At the opposite ends of the sticks, at C, bearings are provided, which consist of blocks of wood, each 1 in. long, 1 in. wide, and  $\frac{3}{8}$  in. thick. These are also bound in place with thread after gluing them. Holes are drilled through the blocks lengthwise and then lined with bushings made of

brass tubing,  $\frac{1}{16}$  in. in inside diameter. The two motor bases A are connected with four cross sticks, D, each 9 in. long and  $\frac{3}{16}$  in. square. These are bound and glued on the under side, one near each end and the others equidistant each from the other and from the nearest end stick. The front bumper E is made of round rattan,  $\frac{1}{8}$  in. in diameter.

The alighting gear is next in order of construction. This is made as shown

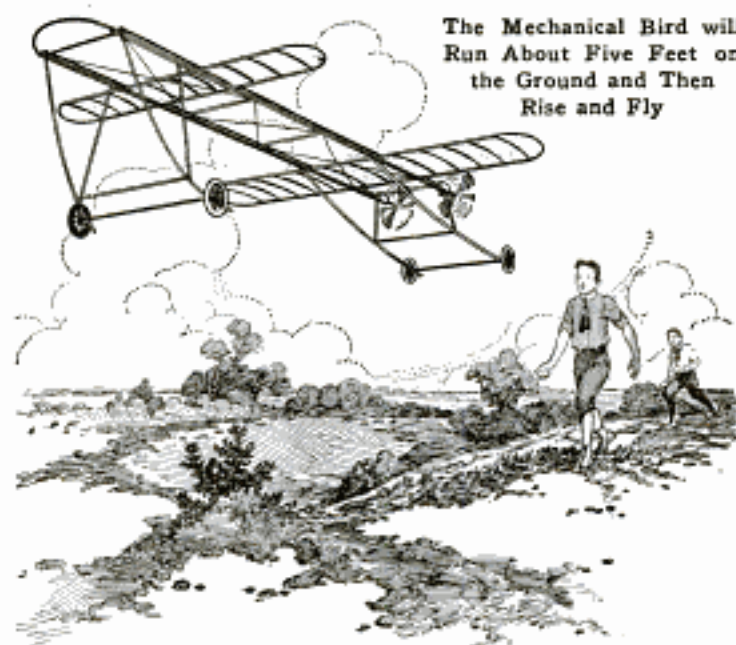

entirely of bamboo,  $\frac{3}{16}$  in. square. The pieces marked F are 11 in. long; G,  $9\frac{1}{2}$  in. long, and the cross bar H, 11 in. long. At the rear, the pieces J are 13 in. long; K,  $4\frac{1}{2}$  in. long, and the cross piece L, 11 in. long. The distance between the points M and N, Fig. 2, is 6

in., and between O and P, 9 in. The bamboo is easily curved by wetting and holding it for an instant in the flame of a candle. It will hold its shape just as soon as it becomes cold. The wheels are made of tin,  $1\frac{1}{2}$  in. in diameter, borrowed from a toy automobile. The axles are made from wire,  $\frac{1}{16}$  in. in diameter.

The wing spars Q are made of spruce,  $\frac{3}{16}$  in. wide and  $\frac{1}{4}$  in. thick. Those for the front are 30 in. long, and

for the rear, 36 in. long. The ribs R are made of bamboo pieces,  $\frac{1}{16}$  in. square, 5 in. long for the front plane, and 6 in. for the rear. These are bound and glued on top of the spars, 3 in. apart. They are given a slight upward curve. The round ends are made of  $\frac{1}{16}$ -in. rattan.

It is rather difficult to make good propellers, but with a little time and patience they can be shaped and formed into good proportions. Procure two clear, straight-grained blocks of white pine, 8 in. long,  $1\frac{1}{2}$  in. wide, and  $\frac{3}{4}$  in. thick. Draw a diagonal line on one block from opposite corners, as shown at S, Fig. 3, then on the other block T, draw the line in an opposite direction. Turn the blocks over and draw opposite diagonals, as shown by the dotted lines. Draw a circle on each side exactly in the center,  $\frac{1}{2}$  in. in diameter. Drill  $\frac{1}{16}$ -in. holes through the centers of the circles for the propeller shafts. The wood is then cut down to the lines drawn, leaving only enough material so that they will not break easily. The face of the blades should be flat and the back rounded. Leave plenty of stock near the hub. After the faces have been finished, the blades are shaped as shown at U. The propellers should be finished with sand-

Aluminum paint costs but little, and it makes a fine finish for a model aeroplane.

The propeller shafts V, Fig. 1, 2, and 4, are cut from bicycle spokes. An eye for the rubber band is bent in the spoke, about 2 in. from the threaded end. The end having the threads is run through the bearing block C, Fig. 4, and the propeller fastened on with a small washer on each side of it by means of two nuts, W, cut from a bicycle nipple. These nuts may be turned up tightly with pliers.

The planes are covered with tissue paper put on tightly over the tops of the ribs, using a flour paste. The planes are movably fixed on the motor bases A by tying at the four points of contact with rubber bands. This makes it possible to adjust the fore-and-aft balance of the machine by changing the position of the planes.

The motive power, which is the most important part of the entire machine, consists of rubber bands. There are three ways of obtaining these bands. It is best, if possible, to purchase them from an aeroplane supply house. In this case, procure about 100 ft. of  $\frac{1}{16}$ -in. square rubber, 50 ft. for each side. These are wound closely between the hooks X. This rubber can be taken

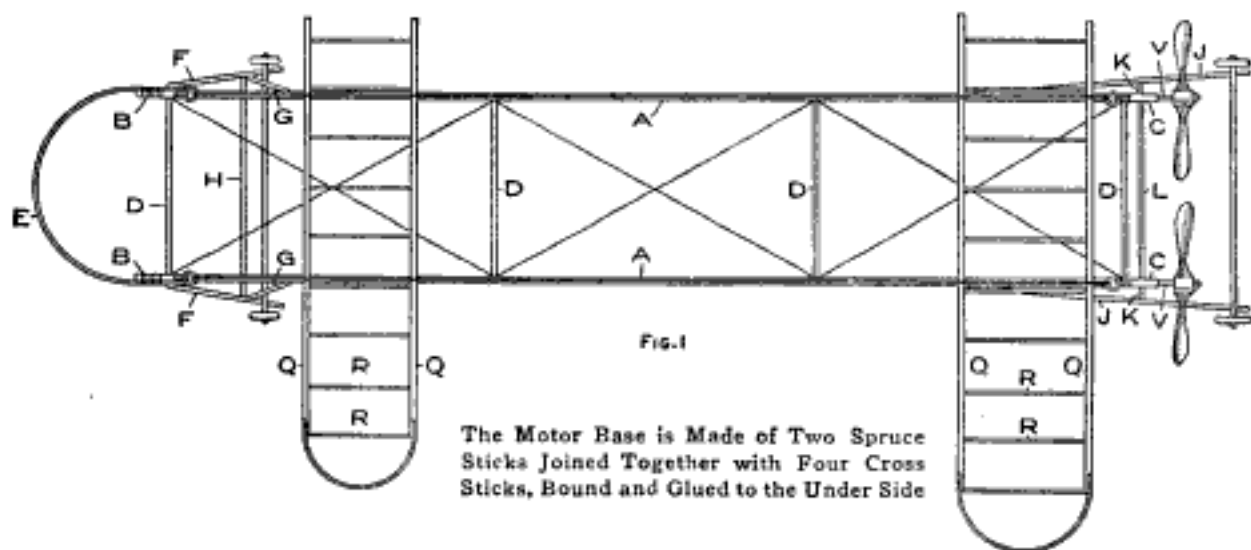

The Motor Base is Made of Two Spruce Sticks Joined Together with Four Cross Sticks, Bound and Glued to the Under Side

paper to make them perfectly smooth, as much of the success of the model will depend upon them. It will be a good plan to shellac them, and also the frame and the alighting gear.

from a golf ball. It will require about 40 strands of this rubber, which is removed by cutting into the ball, on each propeller. Another way of obtaining the bands is to purchase No. 19 rubber



bands and loop them together, chain-fashion, to make them long enough to reach between the hooks without stretching. About 30 strands on each

machine and hooked into the eye in the drill. Stretch the rubber out for about 10 ft., and as it is wound up, let it draw back gradually. Wind up the propel-

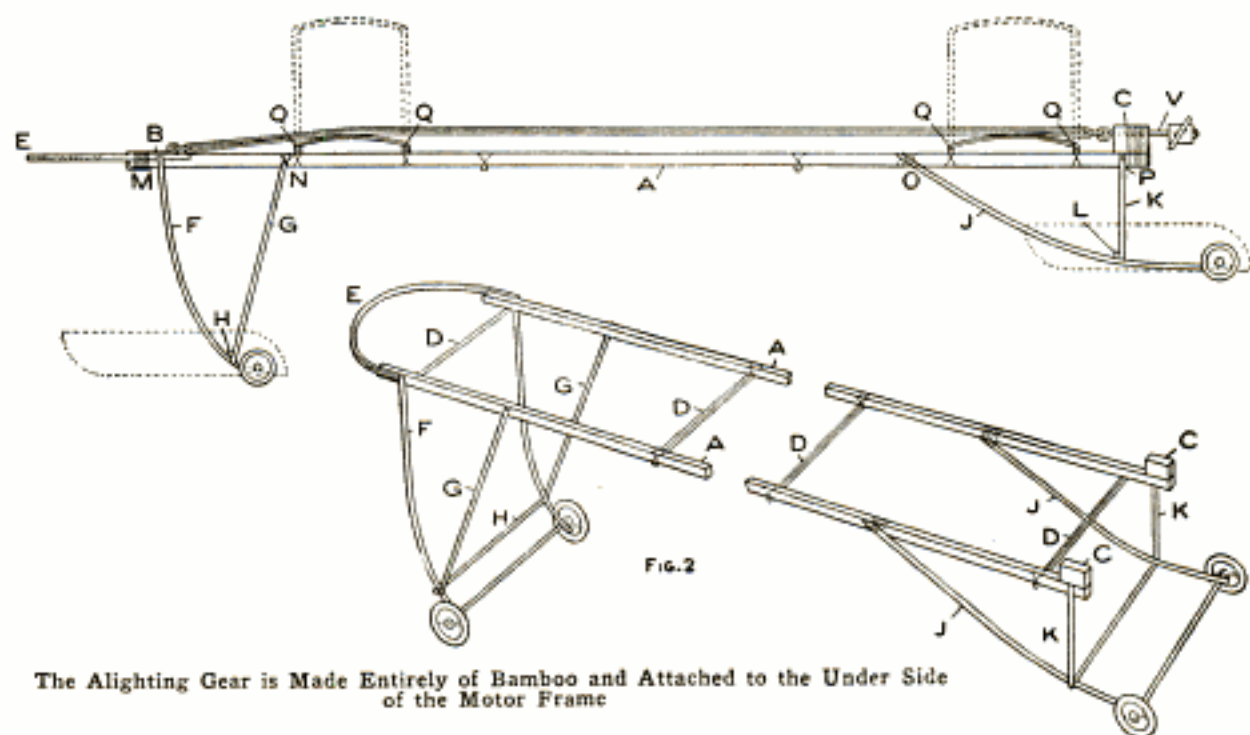

propeller will be sufficient. The hooks X are made in the shape of the letter "S," to provide a way for taking out the rubber bands quickly. To prevent the hooks from cutting the rubber, slip some  $\frac{1}{16}$ -in. rubber tubing over them. The rubber bands, or motor, when not in use, should be kept in a cool, dark place and powdered with French chalk to prevent the parts from sticking together.

With the model complete, flying is the next thing in order. With a machine as large as this one, quite a field will be necessary to give it a good flight. Test the plane by gliding it, that is, holding it up by the propellers and bearing blocks on a level with your head and throwing it forward on an even keel. Shift the planes forward or back until it balances and comes to the ground lightly.

Winding up the propellers is accomplished by means of an eye inserted in the chuck of an ordinary hand drill. While an assistant grasps the propellers and motor bearings the rubber is unhooked from the front of the

propellers in opposite directions, turning them from 400 to 800 revolutions. Be sure to wind both propellers the same number of turns, as this will assure a straight flight.

Set the machine on the ground and release both propellers at once, and at the same time push it forward. If

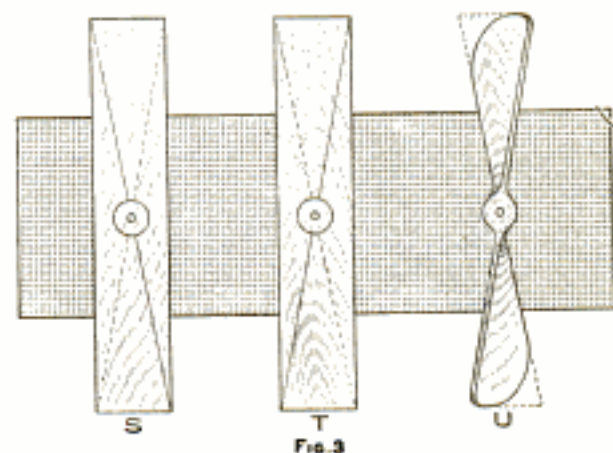

The Most Difficult Part of Making the Propellers can be Overcome with a Little Patience

everything is properly constructed and well balanced, the mechanical bird will run about 5 ft. on the ground and then

rise to 15 or 20 ft. and fly from 800 to 1,200 ft., descending in a long glide and alighting gracefully.

If the machine fails to rise, move the

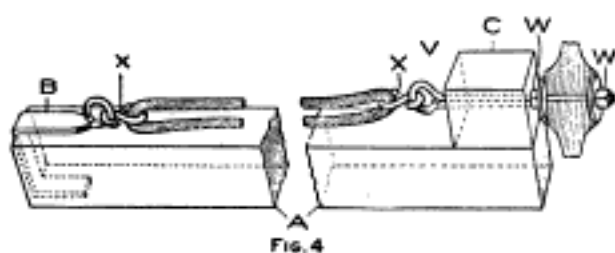

FIG. 4

The Motive Power, Which Is the Most Important Part of the Machine, Consists of Rubber Bands

forward plane toward the front. If it climbs up suddenly and hangs in the air and falls back on its tail, move it toward the back.

After the novelty of overland flights has worn off, try flights over the water. To do this the wheels must be removed and four pontoons put in their place, as shown by the dotted lines in Fig. 2. The pontoons are made over a light frame, constructed as shown in Fig. 5. The frame pieces are bamboo,  $\frac{1}{8}$  in. square. Each one is 8 in. long, 4 in. wide, and 2 in. deep. The covering consists of writing paper glued in place, after which the whole surface is covered with melted paraffin to make it water-tight.

No doubt various methods will be suggested by the time such flights are made, such as smaller planes for racing, larger ones for altitude and duration, etc. To make the machine carry weights, build a duplicate set of planes

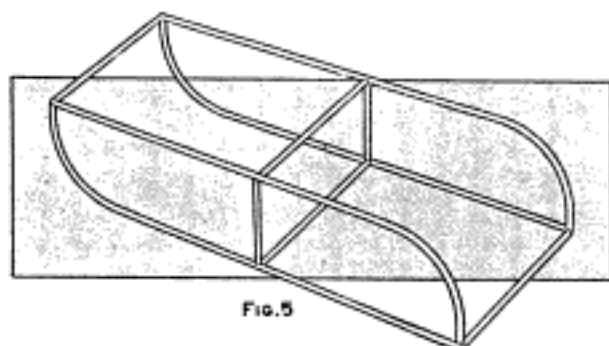

FIG. 5

Framework for Constructing Pontoons by Covering Them with Writing Paper Soaked in Paraffin

and fasten them 6 in. above the others by means of struts,  $\frac{3}{16}$  in. square, forming a tandem biplane, as shown by the dotted lines in Fig. 2.

Patience is the one thing necessary in model building. Sometimes a machine carefully made will not fly, and no one can make it do so until some seemingly unimportant alteration is made.

### How to Make a Pair of Trammels

The making of these trammels is a very nice workshop problem for a school, as it requires a very small amount of stock and a corresponding degree of skill, and at the same time adds a little something to the general shop equipment.

The brass is best procured in strips, which may be had in different widths, except the bar, which is  $\frac{1}{4}$  in. thick and not less than  $\frac{3}{4}$  in. wide. The steel for the points may be the ordinary steel,

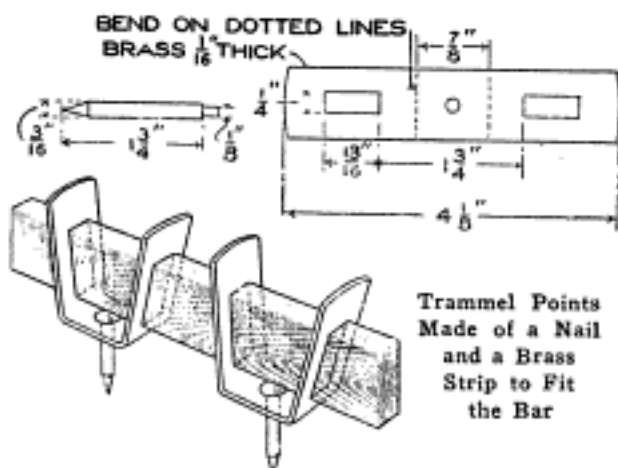

Trammel Points Made of a Nail and a Brass Strip to Fit the Bar

or if the trammels are to be used on woodwork, very satisfactory points can be made of heavy nails.

Cut two pieces of brass,  $4\frac{1}{4}$  in. long, and straighten them with a wood or rawhide mallet on a surface plate. Draw center lines both ways through each piece and lay out the openings for the bar with a sharp scribe, and make a center-punch mark for the  $\frac{1}{8}$ -in. hole that is to be drilled at the intersection of the center lines. Mark the lines where the piece is to be bent, and with a pair of dividers lay out the ends and shape them with a file.

The center hole and bar openings are next drilled, and the latter finished by filing. It is better to plane up a short piece of hard wood,  $\frac{1}{4}$  by  $1\frac{3}{16}$  in., and

use it as a gauge in filing the rectangular openings than to try to make them by measurement. Polish the brass pieces with a piece of fine emery cloth or paper, rubbing it in straight lines lengthwise of the stock.

The bending is done by clamping the pieces in a vise and bending first one side and then the other on the lines indicated. This will require some care, as the upper ends should be  $1\frac{1}{4}$  in. apart on the inside when the bending is complete. To insure the same angle on both sides, a template of wood is used, and the pieces are carefully bent to fit it.

The holes for the points are reamed tapering from the inside, where they are riveted in place. The points are filed to shape and polished, which is best accomplished in a lathe. Clamp one of the points in an upright position in a vise with the shouldered end up. Slip one of the brass pieces in place and rivet by upsetting the projecting end with a light hammer.—Contributed by J. A. Shelly, Brooklyn, N. Y.

### Seeding Bare Spots on Lawns

A lawn that shows patches of grass with bare spots, or only partly covered with grass can be sown with seed that will fill the uncovered places by using the tool illustrated. It is made of a block of wood, 1 in. thick, into which several large nails are driven so that their ends project about  $1\frac{1}{2}$  in. Another block is fastened on top of the nail heads to keep them from pushing out of their holes. A handle is attached to the latter block.

The tool is used by driving it into the earth where there is no grass, or in thin places, and the grass seed is sprinkled into the holes. In raking over the lawn the young grass is not so apt to be torn out and destroyed before it gets a good root.—Contributed by Edmund H. Trabold, Orange, N. J.



### A Porch Swing

The seat of the swing consists of a board, 30 in. long, 14 in. wide, and 1 in. thick, with holes bored in each cor-

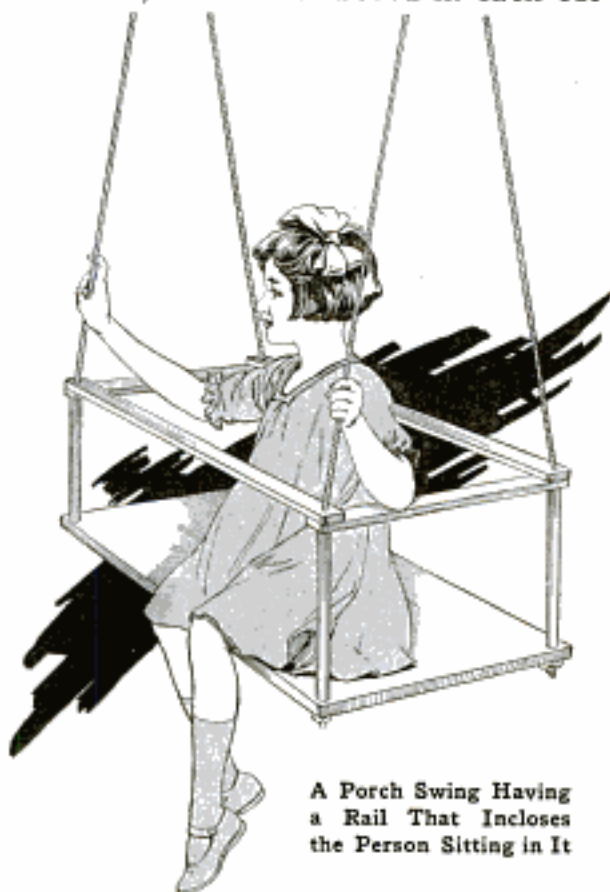

A Porch Swing Having a Rail That Incloses the Person Sitting in It

ner for the ropes. The rail at the top is made of four oak pieces, two of them 30 in. long, for the sides, and the other two 18 in. long, for the ends; all 3 in. wide and  $\frac{7}{8}$  in. thick. The ends of these pieces are finished rounding, and holes are bored in them for the supporting ropes. The supports for the rails consist of four pieces of  $\frac{3}{4}$ -in. pipe, 15 in. long. The ropes are run through the holes in the ends of the rails, down through the pipes and through the holes in the seat board, where they are knotted.

A rope tied to a convenient post or screw hook makes a handy way to give motion by pulling. To get into the swing, raise one of the side rails on the rope.—Contributed by Ward M. Mills, Bakersfield, Cal.

☞Cover the top and side of ice in a refrigerator with a piece of Canton flannel, and the ice will last longer.

### Bird House Made of Kegs

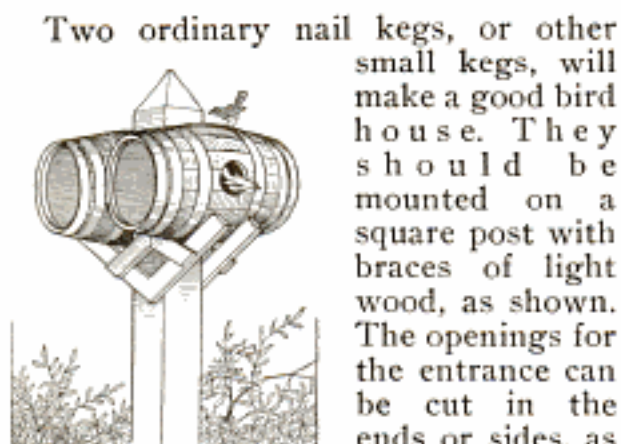

Two ordinary nail kegs, or other small kegs, will make a good bird house. They should be mounted on a square post with braces of light wood, as shown. The openings for the entrance can be cut in the ends or sides, as desired. If cut

### A Drinking-Glass Holder

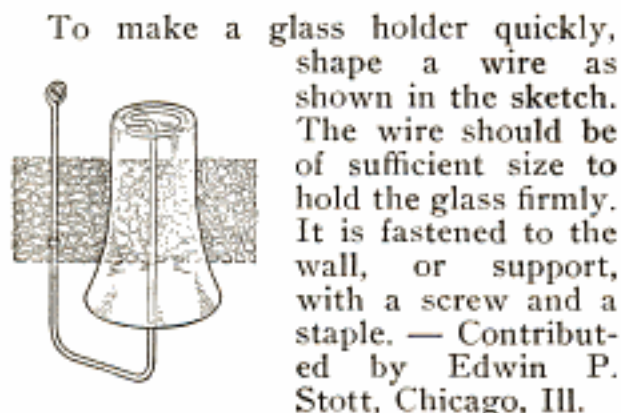

in the sides, be sure to make the hole between two staves. To make a glass holder quickly, shape a wire as shown in the sketch. The wire should be of sufficient size to hold the glass firmly. It is fastened to the wall, or support, with a screw and a staple. — Contributed by Edwin P. Stott, Chicago, Ill.

### Needle Threader for a Sewing Machine

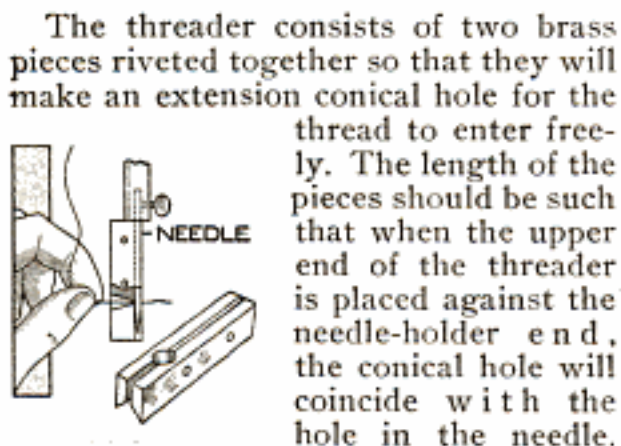

The threader consists of two brass pieces riveted together so that they will make an extension conical hole for the thread to enter freely. The length of the pieces should be such that when the upper end of the threader is placed against the needle-holder end, the conical hole will coincide with the hole in the needle. A piece of thin sheet metal is placed between the pieces above the conical hole to make an opening below for the thread to pass through when the threader is removed. The opposite

edges of the brass pieces from the large part of the conical hole are filed to a bevel so that when they are riveted together they will form a V-shaped groove to center the needle.—Contributed by Harriet M. Kerbaugh, Allentown, Pa.

### Winding Coiled Springs

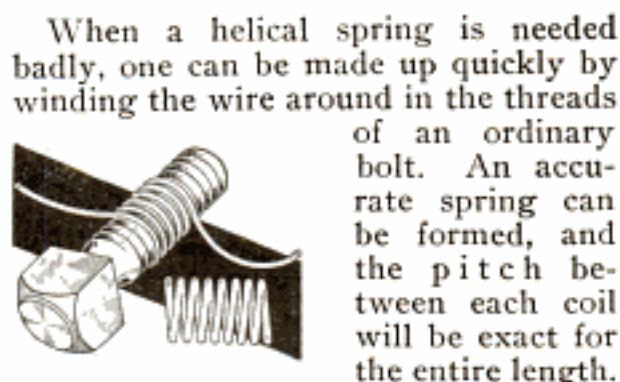

When a helical spring is needed badly, one can be made up quickly by winding the wire around in the threads of an ordinary bolt. An accurate spring can be formed, and the pitch between each coil will be exact for the entire length. In removing the spring from the bolt, grasp the coil in one hand and turn the bolt with the other.

### Revolving-Wheel Ruling Pen

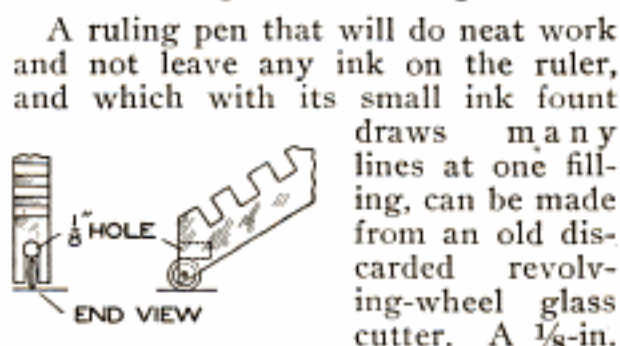

A ruling pen that will do neat work and not leave any ink on the ruler, and which with its small ink fount draws many lines at one filling, can be made from an old discarded revolving-wheel glass cutter. A  $\frac{1}{8}$ -in. hole is drilled in the body, or handle part, just above the wheel. The hole is filled with a piece of felt—a piece cut from an old felt hat will do—rolled to fit snugly, so that it will bear lightly against the wheel. The felt is soaked with the ink to be used, and the pen is ready for use.—Contributed by Bert Fish, Rochester, N. Y.

ⒸAn excellent method of closing a crack in a wall before papering is to paste a thin strip of linen over the crack. This not only makes a smooth job, but prevents the paper from tearing, should the crack widen.

# The Tricks of Camping Out

By STILLMAN TAYLOR

## PART II—Cooking in the Woods

**C**OOKING in the woods requires more of a knack than equipment, and while a camp stove is well enough in a permanent camp, its weight and bulk makes this article of camp furniture unsuited for transportation by canoe. Patent cooking grates are less bulky, but the woodsman can learn to do without them very nicely. However, the important item which few woodsmen care to do without is the folding baker, or reflector. The baker is folded flat and carried in a canvas case, including baking pan and a kneading board. The largest size, with an 18-in. square pan, weighs about 5 lb., and the smallest, with an 8 by 12-in. pan in aluminum, only 2 lb. In use, the reflector is placed with the open side close to the fire, and cooking is accomplished evenly and well in any kind of weather. Bread, fish, game, or meat are easily and perfectly cooked, and the smaller size is amply large for a party of two or three.

The camp fire is one of the charms of the open, and if it is built right and of the best kind of wood, cooking may be done over it as well as over a forest range. Many woodsmen prefer to build a second and smaller fire for cooking, and although I have never found this necessary, excepting in large camps where a considerable quantity of food must be prepared, the camper can suit himself, for experimenting is, after all, a large part of the fun of living in and off the woods.

A satisfactory outdoor cooking range may be fashioned by roughly smoothing the top and bottom sides of two green logs, and placing them about 6 in. apart at one end and about 2 ft. apart at the opposite end. At the wide end a few stones are built up, and across these, hickory, ash, and other sticks of hard wood are placed. The reflector is placed close to the coals at this end, and the fire is built between the logs, the broiling and frying being done at the narrow-end opening. Woods that burn slowly when green should be used for backlogs and end logs; chestnut, red oak, butternut, red maple, and persimmon being best adapted for this purpose.

The hard woods are best for cooking and heating, since they burn more slowly, and give out considerable heat

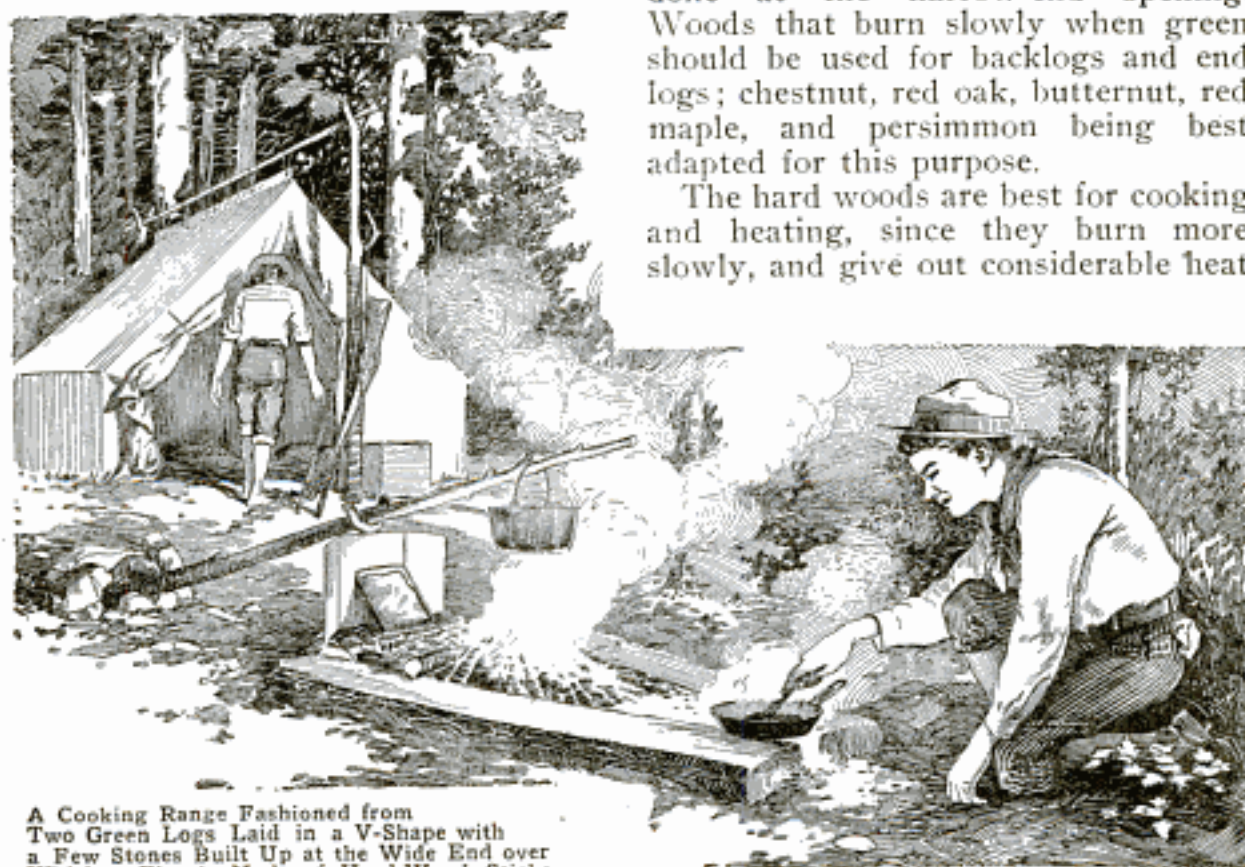

A Cooking Range Fashioned from Two Green Logs Laid in a V-Shape with a Few Stones Built Up at the Wide End over Which a Fire is Made of Hard-Wood Sticks

and burn down to a body of glowing coals. Soft woods are quick to catch fire, burn rapidly, and make a hot fire, but burn down to dead ashes. Hickory is by far the best firewood of the North, in that it makes a hot fire, is long-burning, and forms a large body of coals that gives an even and intense



A Green Pole Placed in a Forked Stick Provides a Pot Hanger for a Noonday Meal

heat for a considerable length of time. Next to hickory comes chestnut; the basket oaks, ironwood, dogwood, and ash are the woodsman's favorites. Among the woods that are easy to split are the red oak, basket oak, white oak, ash, and white birch. Some few woods split more easily when green than after seasoning, and among them are hickory, dogwood, beech, sugar maple, birch, and elm. The most stubborn woods to split are the elder, blue ash, cherry, sour gum, hemlock, sweet gum, and sycamore. Of the softer woods, the birches make the best fuel; black birch in particular makes a fine camp fire, and it is one of the few woods that burns well when green. The dry bark of the hemlock makes a quick and hot fire, and white birch takes fire quickly even though moist. Driftwood is good to start a fire with, and dry pine knots—the limb stubs of a dead pine tree—are famous kindlers. Green wood will, of course, burn better in winter when the sap is dormant, and trees found on high ground make better fuel than those growing in moist bottom lands. Hard woods are more plentiful on high ground, while the softer woods are found in abundance along the margins of streams.

For cooking the noonday meal a small fire will suffice to boil the pot and furnish the heat sufficient to make a fry. Simply drive a forked stick in the ground and lay a green stick in the fork with the opposite end on the

ground with a rock laid on it to keep it down, and hang the pot on the projecting stub left for this purpose. A long stick with projecting stubs, planted in the ground to slant over the fire at an angle, will serve as well. Let the pot hang about 2 ft. from the ground, collect an armful of dry twigs and plenty of larger kindling sticks. Now shave three or four of the larger sticks and leave the shavings on the ends, stand them up beneath the pot, tripod fashion, and place the smaller sticks around them to build a miniature wigwam. While the pot is boiling get a couple of bed chunks, or andirons, 4 or 5 in. in diameter, set and level these on each side of the fire, and put the frying pan on them. When the pot has boiled there will be a nice bed of coals for frying that will not smoke the meal.

When the woodsman makes "one-night stands," he will invariably build the fire and start the kettle boiling while he or a companion stakes the tent, and as soon as the meal is prepared, a pot of water is started boiling for dish washing.

For roasting and baking with the reflector, a rather high fire is needed and a few sticks, a yard or more long, resting upright against a backlog or rock, will throw the heat forward. When glowing coals are wanted one can take them from the camp fire, or split uniform billets of green, or dead, wood about 2 in. thick and pile them in the form of a hollow square, or crib. The fire is built in the center of the crib and more parallel sticks are laid on top until it is a foot or more higher. The crib will act as a chimney, and a roaring fire will result, which upon burning down will give a glowing mass of coals.

Camp cookery implies the preparation of the more simple and nutritious foods, and in making up a list it is well to include only the more staple food-stuffs, which are known to have these qualities. Personal ideas are certain to differ greatly, but the following list may be depended upon and will serve as a guide.

**Provision List**

This list of material will be sufficient for two persons on an outing of two weeks. Carry in a stout canvas food bag 12 lb. of common wheat flour. The self-raising kind is good, but the common flour is better. It is well to bring a little yellow, or white, corn meal, about 6 lb., to be served as a johnny cake, hot, cold, or fried mush. It is fine for rolling a fish in for frying. Rice is very nutritious, easily digested, and easy to cook. It is good when boiled with raisins. When cold, it can be fried in slices. About 3 lb. will be sufficient. Oatmeal is less sustaining than rice, but it is good for porridge, or sliced when cold and fried. Take along about 3 lb. About 2 lb. of the self-raising buckwheat flour should be taken along, as it is the favorite for flapjacks or griddle cakes. Beans are very nutritious, and about 2 lb. of the common baking kind will be required, to boil or bake with the salt pork. For soups, take 2 lb. of split peas. They can also be served as a vegetable. Salt pork is a stand-by, and 5 lb. of it is provided and carried in friction-top tins or a grease-proof bag. It should be parboiled before adding to the beans or when fried like bacon. The regulation meat of the wilderness is bacon, and 5 lb. of it is carried in a tin or bag. Carry along 3 lb. of lard in a tin or bag, for bread-making and frying. About 3 lb. of butter is carried in a friction-top tin. For making rice puddings, take along 1 lb. of raisins. About 1 lb. of shredded codfish is good for making fish balls. Other small articles, such as 1/2 lb. of tea; 1 lb. of coffee; 3 lb. of granulated sugar; 1 pt. of molasses; 1 pt. of vinegar; 4 cans of condensed milk; 1 can of milk powder, a good substitute for fresh milk; 1 can egg powder, good for making omelets or can be scrambled; 1 lb. salt; 2 oz. pepper; 1 package each of evaporated potatoes, onions, and fruits, and 3 packages of assorted soup tablets.

This list is by no means complete, but it will suffice for the average person on the average trip, since the occasional addition of a fish or game will

help to replenish the stores. When going very light by pack, only the most compact and nutritious foods should be selected, while on short, easy trips the addition of canned goods will supply a greater variety.

**Woodcraft**

While shooting and fishing and camping out are chapters in the book of woodcraft, the word is generally de-



A Limb Supported at an Angle over the Fire Is Another Means of Hanging the Pot

finer to mean the knack of using the compass, the map, and in making use of the natural signs of the woods when traveling in the wilderness. If the camper keeps to the beaten paths and does not stray far from the frequently used waterways, he needs no compass, and sufficient knowledge of the ways of the woods may be acquired from the previous articles, but if the outer ventures into an unknown region the value of more intimate knowledge increases as the distance to civilization lengthens, because it will enable him to keep traveling in the desired direction and prevent the "insane desire to circle," should one discover he has lost the trail.

**The Emergency "Snack" and Kit**

The woodsman well knows that it is an easy matter to stray farther from camp than he intended to when starting out, and that it is a common enough occurrence to lose one's bearings and become temporarily lost. To prepare for this possible emergency and spend a comfortable night away from the

camp, he carries in his pocket a little packet of useful articles and stows away a tiny package containing a small amount of nutritious food. When

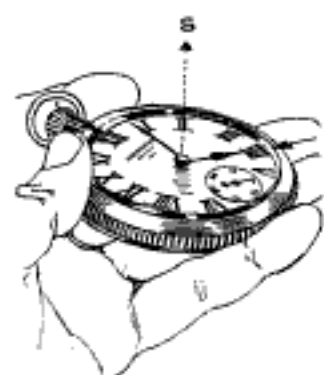

leaving camp for a day's hunting and fishing, the usual lunch is, of course, included, but in addition to this, the woodsman should carry a couple of soup tablets, a piece of summer sausage, and some tea. Wrap this in oiled silk, and pack it in a flat tin box. It will take up very little room in the pocket.

The emergency kit is merely a small leather pouch containing a short fishing line; a few fishing hooks; 1 ft. of surgeon's adhesive plaster; needle and thread; a few safety pins, and a small coil of copper or brass wire. These articles, with the gun and a few spare cartridges, or rod; a belt knife; match safe; compass; map; a little money, pipe, and tobacco, make up the personal outfit without which few woodsmen care to venture far from camp. In addition to the above, I carry a double-edge, light-weight ax, or tomahawk, in a leather sheath at the belt and a tin cup strung to the back of the belt, where it is out of the way and unnoticed until wanted.

#### The Compass

A small pocket compass affixed to a leather thong should be carried in the breast pocket and fastened to a button of the shirt. An instrument costing \$1 will be accurate enough for all purposes. Many of the woodsmen as well as the Indians do not use a compass, but even the expert woodsman gets lost sometimes, and it may happen that the sun is obscured by clouds, thus making it more difficult to read the natural signs of the wilderness. The compass is of little value if a person does not know how to use it. It will not tell in what direction to go, but

when the needle is allowed to swing freely on its pivot the blue end always points to the magnetic north. The true north lies a degree or more to either side. In the West, for instance, the needle will be attracted a trifle to the east, while on the Atlantic coast it will swing a trifle to the west of the true north. This magnetic variation need not be taken into account by the woodsman, who may consider it to point to the true north, for absolute accuracy is not required for this purpose. However, I would advise the sportsman to take the precaution of scratching on the back of the case these letters, B—N, meaning blue equals north. If this is done, the novice will be certain to remember and read the compass right no matter how confused he may become on finding that he has lost his way. The watch may be used as a compass on a clear day by pointing the hour hand to the sun, when the point halfway between the hour hand and 12 will be due south.

The compass needle is attracted to iron and steel, therefore keep it away from the gun, hatchet, knife, and other

metal articles. Hold the compass level and press the stop, if it has one, so that the needle may swing free. Note some landmark, as a prominent tree, high cliff, or other conspicuous object lying in the direction of travel, and go directly to this object.



Consult the compass frequently when making a detour, or when the landmark passes out of sight. When this mark is reached, select another farther on and continue the travel, always picking out new marks along the line indicated by the compass. When making camp, consult a map, study it, and so gain a good general idea of the surrounding country; and when leaving



camp, take the bearings from the compass. By so doing a person will know in what direction he is traveling, and when the course is changed, keep the general direction in mind. When climbing a hill or making detours, take a mental note of the change in direction and the bearings will not be lost.

#### Maps

The maps of the U. S. Geological Survey are drawn to a scale of 2 in. to the mile and cost 5 cents each. On the back of each map are printed the



symbols showing the character of the land, the contours, roads, and all important rivers and lakes in the district. For convenience, the map should be pasted on a backing of cotton cloth and then cut up into handy sections. Number the sections from left to right and paste a key to the pieces on the back of one of them.

#### Natural Signs

When traveling through underbrush the woodsman cannot see far ahead, and so lays a true course by noting the position of the sun. For example, here in the northern hemisphere the sun

rises just south of east and sets somewhere south of due west. Therefore, if a person is going north, he should keep the sun on the back and to the right shoulder in the morning hours; full on the back at noon, and on the



Note Some Landmark, as a Prominent Tree, High Cliff, or Other Conspicuous Object Lying in the Direction of Travel and Go Directly to the Object, and Look for the Old Blaze Marks

back and over the left shoulder throughout the afternoon.

If the day is cloudy, set the point of a knife blade on the thumb nail, twist it around until the full shadow is cast on the nail, thus indicating the position of the sun.

The direction of the wind is apt to change and for this reason is an unreliable guide, while the so-called signs of the woods, such as the tips of evergreen trees pointing north, bark being thicker on the north side of trees, or moss growing thicker on the north side of the trees, are by no means to be depended upon. There is absolutely nothing in these signs. However, every woodsman is aware that the foliage of trees grows somewhat thicker on the south side, and that the branches are rather shorter and more knotty on the north side, but these and other signs are scarcely infallible, and if they were, few tenderfeet would recognize them.

When traveling by night, look for the Big Dipper or Great Bear, as the two end stars are known as the pointers, pointing to the north star.

#### Marking the Trail

When traveling over old and blind trails, look for the old blaze marks, and if doubtful about them, make new ones by breaking down the brushes every 15 or 20 ft., the bent part pointing in the direction of travel. If a road is encountered, it is easy to tell if it is a tote or logging road, for tote roads are crooked and wind about the trees and rocks, while the logging road is fairly straight and broad. Of course, tote roads lead nowhere in particular, but all logging roads are sure to come to a fork and lead to water. When breaking a new trail, blaze it by taking a single clip from a tree from the side it is approached, and on the opposite side make two blazes, indicating the way from the camp. If this is done, a person will always know the way back if the trail is crossed from side to side. This is the rule of the wilderness, but is not always observed to the letter, for many woodsmen blaze their trail by clipping the trees as they pass them. Be sure to blaze your own trail correctly, and when you come to a place where two roads or trails fork, set a stick to indicate the right direction.

When a person becomes lost in the

woods, as every woodsman is sure to do sometimes, sit down and think it over. Many times a person is nearer camp and companions than it is possible to realize, and if a straight direction is taken, a lumber road or a stream will be found that will give one his bearings. Above all, do not become frightened. If the emergency kit and lunch have not been forgotten, a day and night in the woods alone is not a hardship by any means. Avoid wasting energy by rushing madly about and forgetting to blaze the trail that is being made. Bend the points of the brushes down in the direction of travel. Do not shoot the last cartridge to attract attention, and do not shout until hoarse. Sit down and build a fire of green wood, damp leaves or moss, so that it will smoke. Build a second fire a short distance from the first. This is the recognized signal of the one who is lost. The afternoon may be windy, but the wind is certain to die away at sundown, and the smoke rising from the fires will be visible from a considerable distance. When an Indian gets lost he merely camps on the spot and awaits the next day for picking up the trail.

#### A Camp Water Bag

While out on a camping trip I devised a way to supply the camp with cool water. A strip of heavy canvas



was cut about 2 ft. long and 1 ft. wide, and the edges were sewed up to make a sack 1 ft. square. In one upper corner a large porcelain knob insulator was sewed in for a mouth piece; the groove around it made a water-tight joint with the cloth. Two metal rings were sewed in the cloth at the top for attaching a strap to carry it. The side and top seams were made as tight as possible.

In use this sack was filled with as cool water as possible and tightly corked. It was then hung in the shade where a breeze would strike it. The water gradually seeped through the cloth and this, in evaporating, kept the contents cool. This sack also came in handy while fishing or on the road.—Contributed by Earl Zander, Three Rivers, Mich.

#### A Mold for Making Hollow Candy Figures

Those semitransparent candies made up in the shapes of animals which are brought out for the holidays and are so dear to the children have caused many to desire to know how they are made hollow. It is a little trick of the candy-maker, which is perfectly clear to mechanics. The candies are cast in metal

molds just as babbitt bearings are cast for motor cars. One-half of such a mold is shown in the sketch. A concave recess in the face gives the shape of a horse, dog, or sheep, and another half with a similar recess is laid on and located with two dowels. In use the halves are set on a table resting on the back face A, the hot liquid is poured in at B until the mold is full, then it is allowed to set for a minute, during which the portion in contact with the cold metal hardens, whereupon the mold is turned over and the still liquid center is poured out. This leaves a

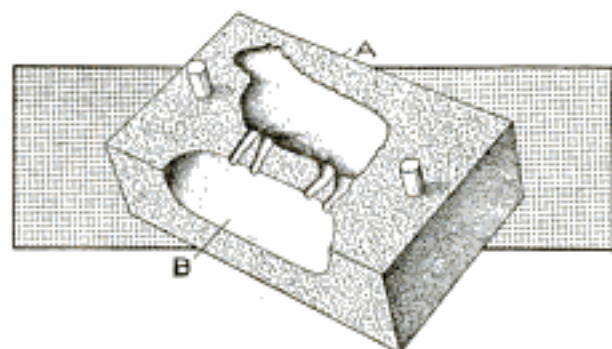

One-Half of a Mold Cut in Metal and Used in Pairs to Make Hollow Candy Objects

glossy surface like candy, a delight to the child, that saves money for the maker and because of its thin walls makes eating easy.

#### Ornamenting an Old Tree Stump

An old stump remaining after cutting down a large tree in front of a



house was made into an ornamental object in the following manner: A cap was made of concrete, reinforced with a square piece of netting. A concrete vase was made and set on the cap. It is only necessary to make a square box from a few scrap boards of the desired size, built up around the stump top. A neat mixture of cement is made and poured in around it, and allowed to set.

#### Marker for a Hat

A quick and convenient way of marking a hat is to take a visiting card and cut it down in the manner shown in the illustration, then make two small slits in the sweatband of the hat and insert the ends of the card. If the card becomes soiled it can be easily replaced with another. The address can be added if desired.—Contributed by James F. Hatch, Raleigh, N. C.



#### A Quickly Made Door Latch

A door latch that is efficient as well as simple may be made by bending a piece of iron rod and pointing one end, as shown in the illustration, then securing it to the door with staples; or small rods may be bent in the shape of a staple and the ends threaded for nuts. The door is locked by turning the handle in the position shown by the dotted lines and securing it with a padlock.—Contributed by Claud M. Sessions, Waynesville, Ill.

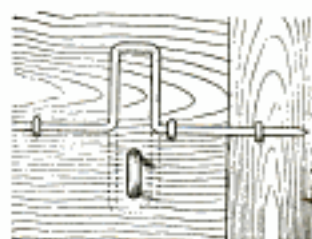

#### An Electric Lure for Fish

Every good fisherman knows that a light will attract fish. A simple light can be made by taking a pint fruit jar, cutting a 1/4-in. hole in the top of the cover, inserting a piece of gas pipe in the hole and soldering it to the cover. Insulated wires are run through the pipe, and a small electric globe is attached to the ends in the jar. The other ends of the wires are attached to a pocket battery. The jar is placed under water and the light turned on, which attracts the fish.

See July 15  
p. 153

# How to Make Hammocks

By CHARLES M. MILLER

am. N. 8-87b

## PART II—A Netted Hammock

**A** GOOD hammock should be about 12 ft. long, which includes 8 ft. of network and 2 ft., at each end, of long cords that are attached to rings. Seine

the same radius,  $1\frac{1}{2}$  in., cut the arc AB at E and F. With E and F as centers draw the curves of the end of the shuttle. The reason for placing the centers outside of the shuttle lines is to obtain a longer curve to the end. The curves can be drawn free-hand, but will then not be so good.

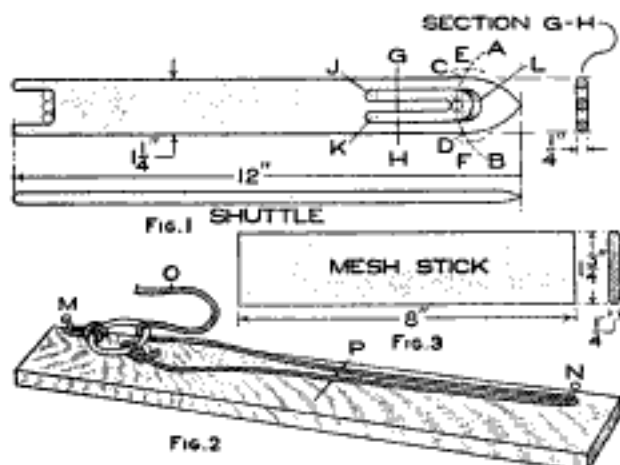

The Tools Necessary Consist of a Needle, or Shuttle, a Gauge Board, and a Mesh Stick

twine, of 24-ply, is the best material and it will take  $1\frac{1}{2}$  lb. to make a hammock. The twine comes in  $\frac{1}{2}$ -lb. skeins and should be wound into balls to keep it from knotting before the right time. Two galvanized rings, about  $2\frac{1}{2}$  in. in diameter, are required.

The equipment for netting a hammock consists of a wood needle, or shuttle, a gauge board for the long meshes at the ends, and a mesh stick for the regular netting of the main body of the hammock, all of which will be described in detail.

The shuttle is made of wood and is 12 in. long,  $\frac{1}{4}$  in. wide, and  $\frac{1}{4}$  in. thick. The best material to use is maple or other hard wood, but very satisfactory ones can be cut from good-grained pine. The sketch, Fig. 1, shows the general shape of the shuttle, one end being pointed and the other forked. Lay out the pointed end before beginning to cut down to size. Place a compass at the center of the end, and with a radius of  $1\frac{1}{2}$  in. describe the arc AB. With the intersections of this arc and the side lines of the needle, C and D, as centers, and

The space across the needle at GH is divided into five  $\frac{1}{4}$ -in. divisions. The centers of the holes J and K at the base of the tongue are  $3\frac{1}{2}$  in. from the pointed end. The opening is  $2\frac{3}{4}$  in. long. Bore a  $\frac{1}{4}$ -in. hole at the right end of the opening, and just to the left three holes, as shown by the dotted lines. With a coping saw cut out along the lines and finish with a knife, file, and sandpaper. Round off the edges, as shown by the sectional detail. It is well to bevel the curve at L so that the shuttle will wind easily. The fork is  $\frac{3}{4}$  in. deep, each prong being  $\frac{1}{4}$  in. wide. Slant the point of the shuttle and round off all edges throughout and sandpaper smooth.

The gauge board, Fig. 2, is used for making the long meshes at both ends of the hammock. It is a board about 3 ft. long, 4 in. wide, and 1 in. thick. An eight-penny nail is driven into the board 1 in. from the right edge and 2 in. from the end, as shown by M, allowing it to project about 1 in. and slanting a little toward the end; the other nail N will be located later.

The mesh stick, Fig. 3, should be made of maple, 8 in. long,  $1\frac{3}{4}$  in. wide, and  $\frac{1}{4}$  in. thick. Round off the edges and sandpaper them very smooth.

The making of the net by a specially devised shuttle is called "natting," or netting, when done with a fine thread and a suitably fine shuttle. Much may be done in unique lace-work designs, and when coarser material and larger shuttles are used, such articles as fish nets, tennis nets and hammocks may be made. The old knot used in natting was difficult to learn and there was a knack to it that was easily forgotten,

but there is a slight modification of this knot that is quite easy to learn and to make. The modified knot will be the one described.

The shuttle is first wound by looping the cord over the tongue, as shown in Fig. 4, then bringing it down to the forked end and up to the opening on the opposite side; then the cord is again looped over the tongue and returned to the fork or place of starting. Continue winding back and forth until the shuttle is full. The shuttle will accommodate from 20 to 35 complete rounds. If the shuttle is too full it crowds in passing through the meshes and delays the work.

Attach one of the galvanized rings by means of a short cord to the nail in the gauge board, as shown in Fig. 2. At a point 2 ft. from the lower edge of the ring, drive an eight-penny finishing nail, N. Tie the cord end of the shuttle to the ring, bring the shuttle down and around the nail N; then bring it back and pass it through the ring from the under side. The cord will then appear as shown. A part of the ring projects over the edge of the board to make it easier to pass the shuttle through. Draw the cord up tightly

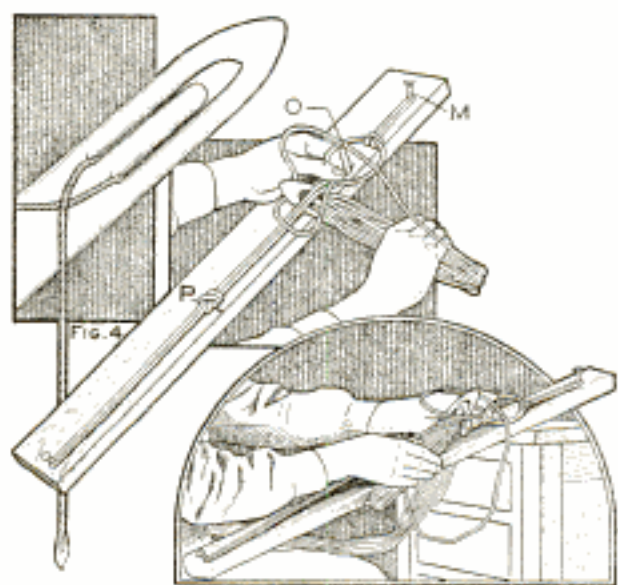

The Shuttle is First Wound and the Long Loops at One End Formed over the Gauge Stick

and put the thumb on top of the cord O, Fig. 5, to prevent it from slipping back, then throw a loop of the cord to

the left over the thumb and up over a portion of the ring and pass the shuttle under the two taut cords and bring it up between the thumb and the two

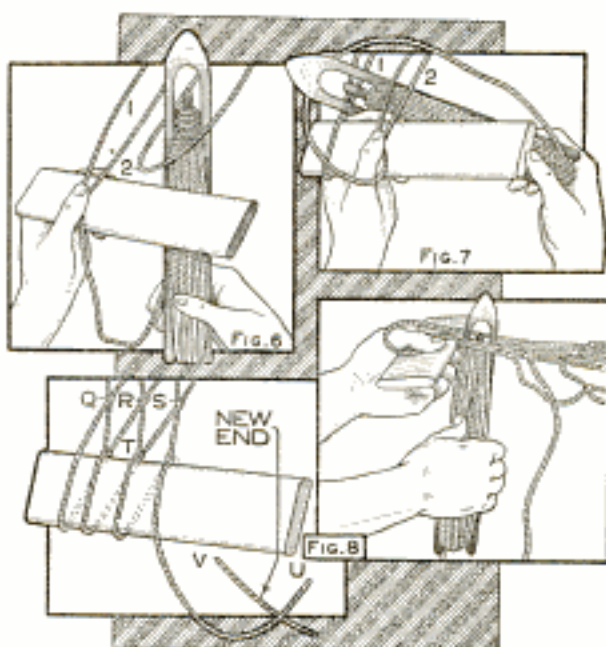

After the Completion of the Long Meshes, the Ring is Anchored and the Mesh Stick Brought into Use

cords, as shown. Draw the looped knot tight under the thumb. Slip the long loop off the nail N and tie a simple knot at the mark P. This last knot is tied in the long loop to prevent looseness. Proceed with the next loop as with the first and repeat until there are 30 long meshes.

After completing these meshes anchor the ring by its short cord to a hook or other stationary object. The anchorage should be a little above the level for tying the knots of the net. Tie the cord of the shuttle to the left outside loop and always work from the left to the right; and the first time across see that the long meshes do not cross over each other, but are kept in the order in which they are attached to the ring.

After tying the cord to the mesh 1, Fig. 6, bring the mesh stick into use. Pass the cord down over the mesh stick, drawing the lower end of the loop down until it comes against the upper side of the mesh stick and put the thumb down upon it in this position to prevent slipping. Pass the shut-

tle up through the loop 2 and draw that down to the mesh stick. Shift the thumb from the first position to the second. Throw the cord to the left over the thumb and about the loop 2, as shown in Fig. 7, and bring the shut-

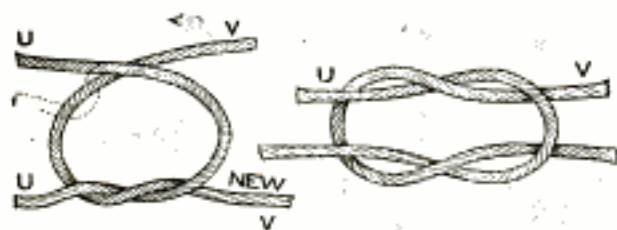

Fig. 9  
A Square Knot is Used to Join the Ends of the Cord When Rewinding the Shuttle

tle under both of the cords of mesh 2 and up between the large backward loop and the cords of the mesh 2. Without removing the thumb draw up the knot very tight. This makes the first netting knot. Continue the cord around the mesh stick, pass it up through mesh 3, throw the backward loop, put the shuttle under and up to the left of the mesh 3 and draw very tight, and do not allow a mesh to be drawn down below the upper side of the mesh stick. Some of these cautions are practically repeated, but if a mesh is allowed to get irregular, it will give trouble in future operations.

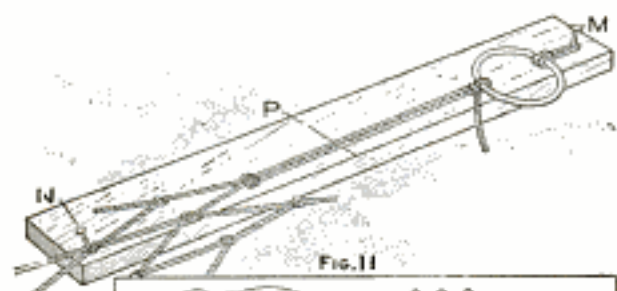

Fig. 11  
The Gauge Board is Again Used for the Long Loops at the Finishing End, Then the Cords are Wound

Continue across the series until all of the long loops have been used and this will bring the work to the right side. Flip the whole thing over, and

the cord will be at the left, ready to begin again. Slip all the meshes off the mesh stick. It makes no difference when the meshes are taken off the stick, but they must all come off before a new row is begun. Having the ring attached to the anchorage by a cord makes it easy to flip the work over. Be sure to flip to the right and then to the left alternately to prevent the twisting, which would result if turned one way all the time.

The first mesh each time across is just a little different problem from all the others, which may be better understood by reference to Fig. 8. The knots Q, R, and S are of the next previous series. The cord is brought down over the mesh stick and up through mesh 1, and when the loop is brought down it may not draw to the mesh stick at its center; it is apt to do otherwise and a sideway pull is necessary, which is pulled so that the knots Q and R are side by side, then the knot at T may be tied. When the mesh 2 is drawn down it should pull to place without shifting, and also all the others of that row.

Continue the use of the mesh stick until a net 8 ft. long is made. When the cord gives out rewind the shuttle and tie with a small knot that will not slip. The weaver's knot is good if known, or the simple square knot shown in Fig. 9 is very good. It is too easy to make to need direction, but unless it is thrown over just right it will slip. Let U, Fig. 8, represent the short cord and V the new piece to be added. Place the cord V back of U and give U a complete turn around V, Fig. 9, and bring them together at a point above U, then to the front. Repeat the complete turn of U about V, shown by the dotted line, and pull tightly. If analyzed, it consists of two loops that are just alike and linked together as shown in Fig. 10.

When the 8 ft. of netting has been completed, proceed to make the long loops as at the beginning. The same gauge board can be used, but the tying occurs at both ends, and since the pairs cannot be knotted in the center, two

or three twists can be given by the second about the first of each pair. The long loops and the net are attached together as shown in Fig. 11. Slip one of the meshes of the last run over the nail N, and when the cord comes down from the ring, the shuttle passes through the same mesh, and when drawn up, the farthest point of the mesh comes against the nail. After this long loop has been secured at the ring, the first mesh is slipped off and the next put on. All of the long loops at this end will be about three inches shorter than at the other end, unless the finishing nail N is moved down. This will not be necessary.

### Gourd Float for a Fishline

A unique as well as practical fishing-line float can be made of a small gourd. After the gourd has dried sufficiently, wire loops, to hold the line, are inserted, or rather, a single wire is run through and looped at both ends. The contents of the gourd need not be removed. Dip the float in a can of varnish, or apply the varnish with a brush.

### Homemade Arc Light

Those who wish to produce an arc light for experimental purposes, or for the brief periods required by photography, will find the method of construction shown in the sketch very simple and inexpensive. Using the short lengths of carbons discarded by moving-picture operators, there is no difficulty in maintaining a good arc for 15 minutes, or more, without once manipulating the adjusting screw at the top.

Only three pieces of wood are necessary besides the base, and in the preparation of these no particular care is necessary except to have the top arm swing freely up and down without any appreciable side movement. The carbon holders are merely strips of heavy tin, which need only be screwed up sufficiently tight to hold the carbons in place and yet permit their being pushed up when the top adjusting

With a piece of cord about six feet long, start quite close to the ring and wind all the cords of the long loops together. The winding should be made very tight, and it is best to loop under with each coil. This is shown in Fig. 12.

The hammock is now ready for use. Some like a soft, small rope run through the outside edges lengthwise, others prefer a fringe, and either can be added. The fringe can be attached about six meshes down from the upper edge of the sides. The hammock should have a stretcher at each end of the netted portion, but not as long as those required for web hammocks.

screw will no longer operate. This adjustment may be readily taken care of by means of a long, slender wood screw with the point filed off and a metal

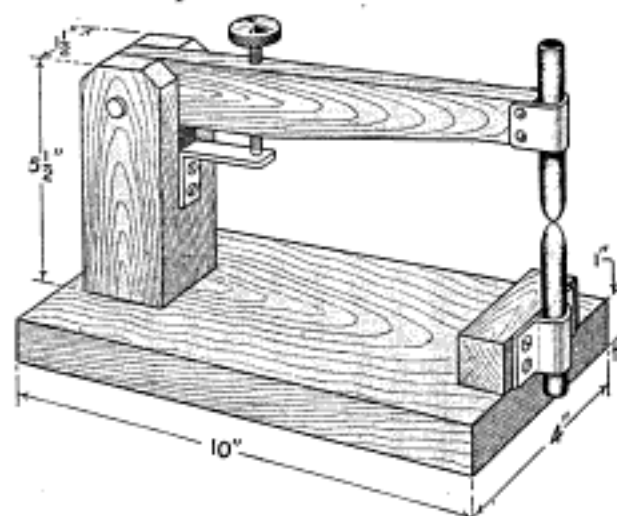

An Efficient Arc Light for Purposes Where a Light is Required for a Short Time

disk soldered to the top. Connections are made to the carbon holders either under a screw head or by soldering the wires to the metal.

In operating any arc light on the commercial 110-volt current some resistance must be placed in the circuit. An earthen jar of water with two strips of tin or lead for electrodes, will answer every purpose.

ⒸA small leak in an oil or water pipe on an automobile can be temporarily stopped by melting a piece of rubber over the hole.

## INTERESTING NEW PATENTS



Fig. 1

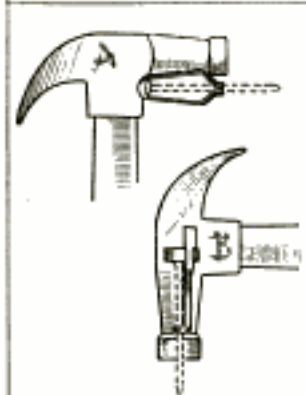

Fig. 3



Fig. 5

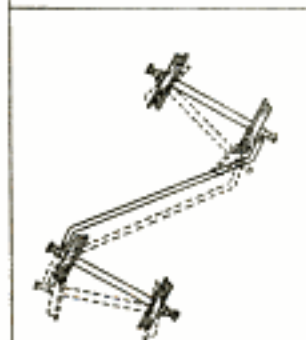

Fig. 7

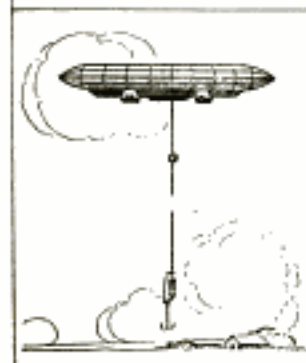

Fig. 9

**LAMP FOR LIGHTING RUNNING BOARD OF MOTOR CAR (Fig. 1)**—This device is a combination side light and light for illuminating the running board and the ground at the side of the car. The lamp is mounted in a rectangular frame of the ordinary type which is carried on the dash. By means of mirrors a portion of the light is deflected downward and to the rear through a bull's-eye at the rear of the frame.

**COMBINED WALKING STICK AND CAMERA STAND (Fig. 2; American patent to an Englishman)**—Just below the crook of the handle the stock divides into three parts, one being a rigid extension of the handle portion and the other two being hinged to it. When spread out, the walking stick forms a three-legged stand for the camera.

**HAMMERS WITH NAIL-HOLDING ATTACHMENTS (Fig. 3)**—The purpose of each of these two inventions is to provide a means for attaching the nail so that it is held securely to the hammer head while the initial blow is being struck, the attachment in each case being such that with the nail started in the wood the hammer can easily be disengaged from it. In one case the attachment consists of a two-pronged holder fixed under the sleeve and poll of the hammer head. In the other case the side of the driving head is grooved to receive the nail and the nail is held in place by a lug and spring clip mounted on the side of the poll.

**SEARCHLIGHT THAT CAN BE USED UNDER WATER (Fig. 4)**—The light is provided with a rubber cover, with glass end, which does away with the danger of short-circuiting when the light is used about or under water.

**DISH WITH DRIP RECEPTACLE (Fig. 5; British patent)**—Extending entirely around the edge is a deep groove designed to catch any drippings that may fall from the dish. The dish is evidently intended for the use of children.

**SAFETY APPLIANCE FOR SHIPS (Fig. 6)**—Collapsed inflatable bags are housed in pockets spaced around the hull just above the water line, and all these bags are connected by a pipe system with storage tanks from which they can be quickly filled with compressed air. When the air is turned into the bags the expansion of each bag automatically releases a latch that holds the hinged cover of the pocket in place, and the bag is then free to expand until it is completely inflated. The idea is to provide a sufficient number of these bags to keep the ship afloat in case the hull is punctured.

**APPARATUS FOR SWINGING BOTH AXLES OF A TRUCK (Fig. 7)**—The feature of this invention is the diagonal bar that connects one end of one axle with the opposite end of the other axle, the action of the bar being such that the axles are swung in opposite directions when the truck is being turned. Each axle is pivoted to swing on one end instead of on the center.

**WORK HOLDER (Fig. 8)**—This holder consists of two vises mounted to slide on the same base. A rod which has a right-hand thread at one end and a left-hand thread at the other passes through the vises, and the rotation of this rod causes them to be moved toward or away from each other. In a somewhat similar manner each vise can be moved transversely of the main base.

**BOMB-FIRING DEVICE FOR AIR CRAFT (Fig. 9)**—The bomb is suspended from the air craft by a cable so that it hangs a short distance above the ground, and below this hangs a double grappling hook. When the hook engages a strongly resisting object, such as a building, it actuates a trigger that explodes the bomb. The bomb can also be exploded by a weight that slides down the cable when released.

**COMBINED WEEDER AND HOE (Fig. 10)**—This implement has four tines projecting in one direction and a hoe blade projecting in the other. To change from one class of work to the other, all that is necessary is to turn the implement over.



Fig. 2



Fig. 4



Fig. 6



Fig. 8



Fig. 10

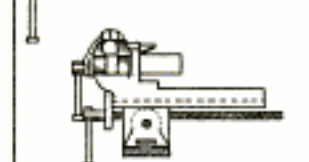

Fig. 7



Fig. 5



Fig. 3

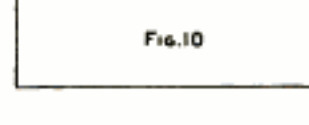

Fig. 1



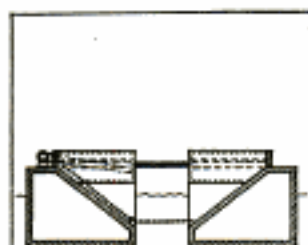

Fig. 11

**SELF-DUMPING SCOW** (Fig. 11)—This scow consists of two hulls so shaped that they form a hopper when they are drawn together. They are held in the same plane, whether drawn together or separated, by a series of sliding beams mounted on one hull and working in corresponding guideways on the other hull. The load is dumped simply by forcing the hulls apart.

**NUT DISH** (Fig. 12)—This nut dish is divided into two compartments by a vertical partition, one of the compartments being intended to hold the hulls and the unhulled nuts, and the other the meats. The upper edge of the partition is made trough-shaped to serve as a holder for the nut pick.



Fig. 12

**CONVERTIBLE MOTOR CAR** (Fig. 13)—The object of this invention is to provide a car body that can easily be made into a passenger-carrying body or a motor-truck body, as required. When used for carrying passengers, the body is of the ordinary touring-car type with two seats available for use. When it is to be converted into a truck, the front seat is first folded and lowered, and the back seat, which is mounted on pivoted arms, is swung over it. The body, which has telescoping parts, is then extended to the rear by means of a rack and pinion operated by the motor.

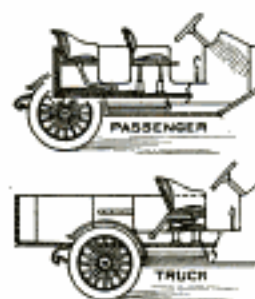

Fig. 13

**FEEDING ATTACHMENT FOR WAGON TONGUE** (Fig. 14)—Two buckets, one for each horse, are mounted on arms that are fixed to a bracket on the wagon tongue. The device is fastened together by sockets so that the buckets and arms are easily removed when not in use.

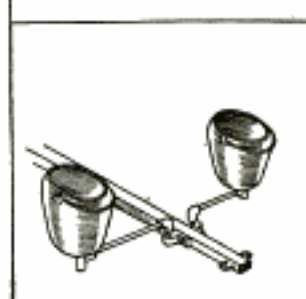

Fig. 14

**HOLDING-DOWN DEVICE FOR BOILING** (Fig. 15; British patent)—This device is designed for keeping either vegetables or clothes submerged during the boiling process. It consists simply of a vertical strip of metal formed to a circular frame in which is mounted a perforated shield made of expanded metal or woven wire. The frame is equipped with a pivoted handle.



Fig. 15

**COMBINED SQUARE AND PROTRACTOR** (Fig. 16)—The square is simply a rectangular metal frame with all sides marked with inches and fractions. On a diagonal strip is a circular arc graduated for laying off angles and marked with lines for laying off the common fractional pitches. The under side of the square is provided with a guide flange.

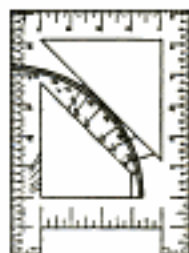

Fig. 16

**HOLDER FOR HOUSEHOLD IMPLEMENTS** (Fig. 17)—This holder is made from a single piece of wire bent to the required shape. It has eyelets so that it can be attached to the wall with nails or screws, two hooks for supporting a mop or other implement laid horizontally, and spring loops for supporting a second implement vertically.

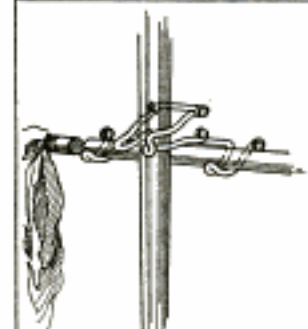

Fig. 17

**SPRING HEEL FOR SHOE** (Fig. 18)—Attached to the shoe is a hollow section in which the heel proper slides vertically, while between the bottom of the shoe and the sliding heel is a coil spring. A flange prevents the spring from thrusting the heel out of the hollow space.



Fig. 18

**POTATO DIGGER** (Fig. 19)—The implement is made of the right length to enable a workman to stand practically upright when using it. At the top of each arm is a handle and at the bottom is a head to which digging tines are attached, the tines being so shaped that they pass under the potatoes when the handles are drawn together. The arms are connected by a pivot fixed to one arm and working in a slot in the other. By working the arms longitudinally with reference to each other, the dirt is easily dislodged from the potatoes as they are lifted out of the ground.



Fig. 19

**CONVEYOR ATTACHMENT FOR CLOTHES WRINGER** (Fig. 20)—The conveyor consists of an endless belt mounted on a table and working over end rollers, as shown. The belt is operated by the wringer, one of the rollers being equipped with a gear that meshes with a gear on the wringer. As the clothes drop from the wringer they are carried forward by the belt and are deposited in a tub or other receptacle placed at the opposite side of the table.



Fig. 20

## BRICK BUNGALOW ADAPTED TO WARM CLIMATE

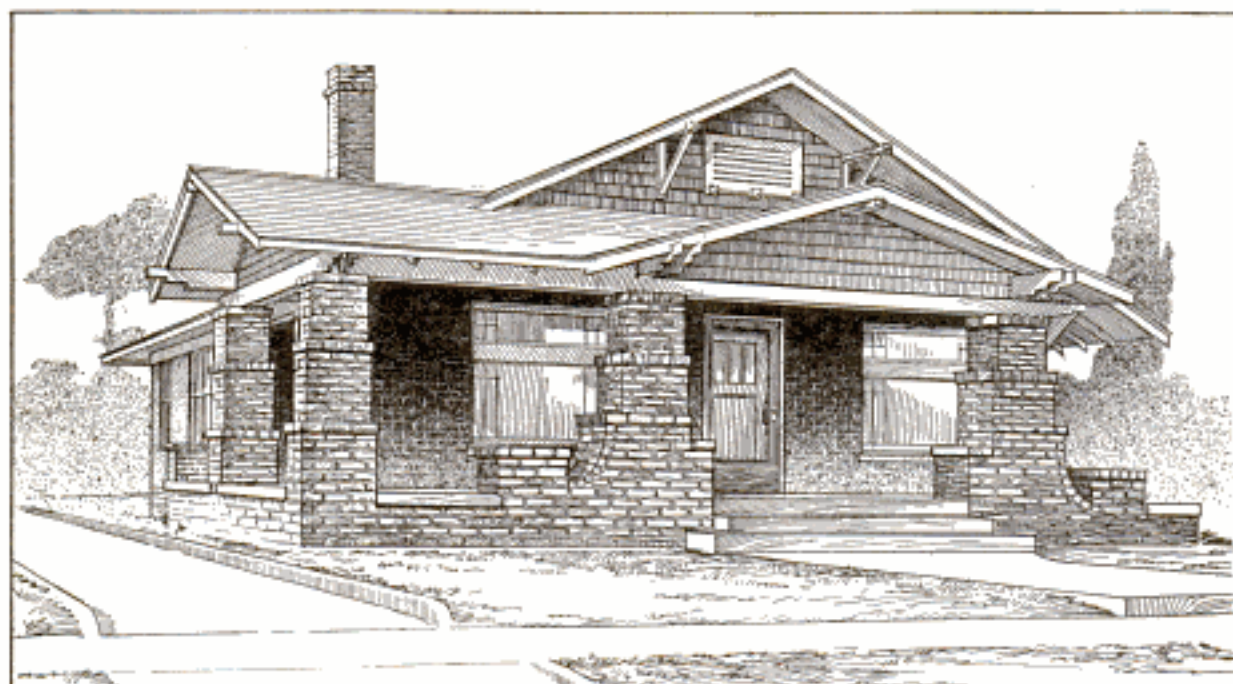

GATES SPECIAL SERVICE, ARCHITECTS, DALLAS, TEXAS

**T**HIS five-room brick bungalow was designed to suit the conditions that prevail in the Southwest, particularly in Texas, the idea being to provide not only a conveniently arranged house, but one that will have ample facilities for comfortable living during the southern summer.

Although substantially built and carefully finished throughout, the house is within the reach of the home builder of small means, the estimated cost being \$2,500, exclusive of the basement and heating plant. One of its principal features is the roomy porch extending entirely across the front, with massive rustic columns built of brick. At the rear is a screened porch evidently intended to be used as a sleeping porch. The interior is unusually well arranged. The living room and dining room occupy the entire front of the house and comprise practically one large room, being connected by a wide opening flanked by massive columns. Both of these rooms have beamed ceilings. At the sides of the brick mantel in the living room are built-in bookcases, and above each bookcase is a casement window. The dining room and kitchen are connected by a pass-pantry which is fitted with china closet and shelves. The bathroom is placed at the rear of the house, at the end of a hallway that makes it easily accessible from the living room, kitchen and two bedrooms. The kitchen is provided with a store-room adequate for all needs, and, through the screened porch, is easily reached by tradesmen. An attractive feature of the design is the arrangement of windows in the living room and dining room by which a clear out-

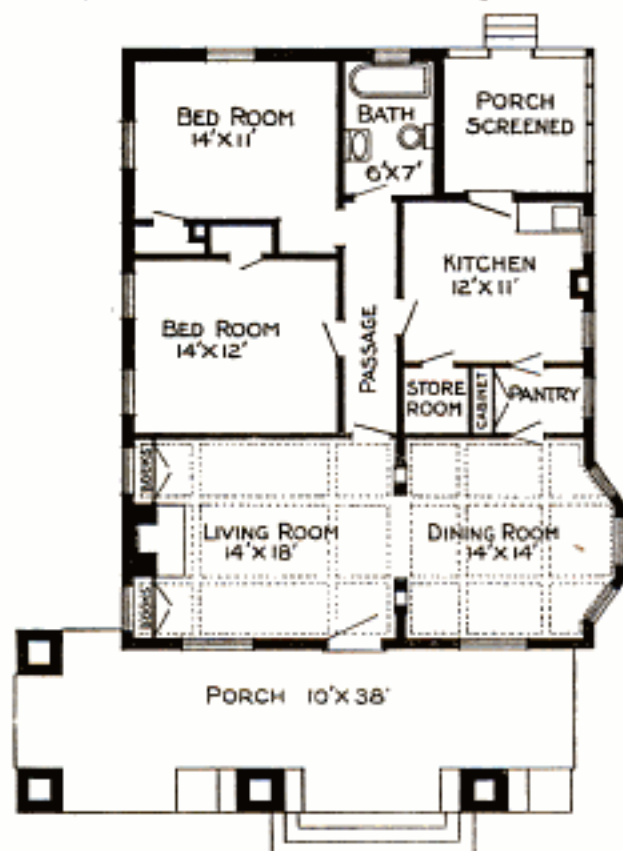

look is given to the front and side of the house. The arrangement of the gabled roof is not only such as to produce an attractive effect, but serves to shelter the interior from the heat of the sun by providing air spaces over practically all of the building.

# "I Saved \$900."

## Mich. Man Saved \$300

I think your system of building is a great one and a money saver. In fact, I saved at least \$300 on my Aladdin.  
—Fred D. Glaspie, Mich.

## Ind. Man Saved Half

To show you how much I saved, a bungalow across the street with the same amount of room as mine and not near as nice finish cost \$2400.00, while mine will cost less than \$1200.00 complete. I have all kinds of faith in the Aladdin way.  
—Thos. R. Stemen, Indiana.

## Minn. Man Saved \$300

We got very good material; everything fitted together nicely and consider we saved \$300.00 on the deal. Our contractor said that the lumber alone would have cost us \$1000.00 here, while we only paid you \$697.00 for everything, including paint, hardware, etc.—R. B. Ralls, Minn.

## Ky. Woman Saved \$500

My Aladdin is beautiful and elegant, being well built and I cannot find words to express my good treatment from your company. You did all you promised and more. I figure I saved about \$500.00, and expect to build another Aladdin as soon as I can make arrangements.—Mrs. A. Von Lepel, Kentucky.

## Wis. Man Saved \$300

Your company surely does what is right with its customers. I am well satisfied with my "Detroit" bungalow which I built at a saving of \$300.00 and will be glad to recommend you to my friends.  
—Milton Loew, Wisconsin.

## Mass. Man Saved \$200

I take pleasure in telling you that I am very proud of my bungalow and it was very warm this winter. My wife says she would live in no other house. I find that I saved \$200.00 in buying from you.  
—Gilbert Cochois, Mass.

## W. Va. Man Saved \$400

I figured that I saved from \$400.00 to \$600.00 by ordering from you and have better material than I would have received here. You may be sure when I get ready to build another house, you will get the order.  
—S. H. Bartlett, West Virginia.

# \$595

For This  
**ALADDIN**  
Complete



## "We Saved \$500," "Saved Over a Third" Read These Letters From Owners

**SAVED!** That's the story in one word of the many thousands of Aladdin home owners throughout the country. "Saved \$500," "Saved a third." Every day we receive hundreds of letters from Aladdin customers who **have saved**. From every village, from every city, from entire communities who have built Aladdin Homes, it is the same story—"Aladdin Saved Us Money."

## Build Now—Save a Third

What would it mean to you to be able to say, "That is my home—I OWN IT. I saved \$575 on building before lumber went up?" That is what our customers are saying. Aladdin Homes will help you get your full share of these low prices. Seven Aladdin Mills, immediate shipment. Investigate now. Send for the Aladdin book of homes. It points the way.

## Aladdin Price Includes Everything

You get material absolutely guaranteed to be sufficient for the completion of your house, as follows: Sills, cut to fit; joists, cut to fit; studing, cut to fit; building paper; sub-floor, cut to fit; rafters, cut to fit; roof sheathing, cut to fit; Knotless siding, cut to fit; Knotless outside finish, cut to fit; Knotless porch columns, baluster, rail, Knotless flooring, framework, cut to fit; Knotless flooring, cut to fit; lath and plaster or plaster board, Knotless inside finish, Knotless doors, Knotless casings, Knotless base board, Knotless windows, Knotless sash, glass, nails of all sizes, locks, hinges, tin flashing, paints, oils, varnishes, stains, putty and shellac, with complete drawings, illustrations and instructions for erection—**The Complete House**—also barns, poultry houses, hog houses, and other modern farm buildings. (Ask about the famous Aladdin Dollar-a-Knot Guarantee). The big Aladdin catalog No. 180 tells all the interesting facts.



## Ill. Man Saved \$250

We are well pleased with our home and know that we have been able to heat our house cheaper than any house in town with lath and plaster. I saved \$250.00.  
—Wm. D. Matney, Illinois.

## N. Y. Man Saved \$800

I am more than pleased with my house and everything was as represented. The material is fine and the inside finish especially has a beautiful grain. I feel that I saved about \$800 on my house.  
—Geo. L. Knox, New York.

## Iowa Man Saved 50%

Everything for our Aladdin went together O. K., and I figure we saved 50% on the cost of building. In building again, I wouldn't think of building anything but an Aladdin house.  
—W. E. Mackay, Iowa.

## Mo. Man Saved \$300

I cannot recommend you too highly, for in your treatment you filled your promises to the very letter and then some. We lived in our Aladdin last winter and found it O. K. If I were to build a hundred houses, I would send for the ready-cut Aladdin, as I saved close to \$300.00 on mine.  
—A. S. Young, Missouri.

## Ohio Man Saved \$500

I erected my Aladdin in 1912 and am well satisfied with it. First, material was first-class in every way. I saved at least \$500.00 by not building thru my home contractors and getting my material of you. My carpenter said it was the best material he had for years. If I were to build again it would be an Aladdin house.  
—Fred W. Smith, Jr., Ohio.

## N. J. Man Saved \$250

Am writing to tell you our house is finished and I am very well satisfied. The lumber is first-class, everything \$65 O. K., and I saved from \$250.00 to \$300.00.  
—Wm. W. Thomas, New Jersey.

## Penn. Man Saved \$300

Everyone who sees our Aladdin bungalow is very much pleased with the material and general construction. I assure you Mrs. Schmitt and I are both well satisfied, as we figure that we saved all of \$300.00 and had better material.  
—W. J. Schmitt, Penn.

# North American Construction Co.

Mills in Michigan, Florida, Louisiana and Oregon, U. S. A., Toronto, Ottawa and Vancouver, Can.

966 Aladdin Ave.

Bay City, Mich.

# TEMCO

Automobile  
and Garage  
Necessities



## TEMCO -Altas

Universal Shock Absorber

**\$12**

COMPLETE REAR SET

Make

Every Road  
A Good Road

TEMCO-ALTAS make you forget the "thank-you-mams." They take your car over the roughest places *with all four wheels on the ground*—smoothly and evenly, without oscillation, swinging or vibration.

Each set contains over 15 feet of the finest heat-treated steel. This is actually added to the springs of your car, taking all the road shocks, jolts and jars.

Temco-Altas contain only the highest grade materials and are sold on an unlimited guarantee of complete satisfaction to the user.

Equip your car with Temco-Altas today!

They are exceedingly simple and easy to install. No holes to drill—no adjustments to make. They can be easily and quickly put on every  $\frac{3}{4}$  elliptic spring car, such as

Overland  
Studebaker  
Maxwell  
Buick  
Chevrolet

Reo  
Dodge  
Chalmers  
Oakland  
Mitchell

Ohio Electric  
Chicago Electric  
And a large list of other leading cars.

Insist upon having Temcos. Your dealer has them or can quickly get them for you. Most dealers will gladly install them and let you give them a thorough trial. If you have any trouble getting Temcos write to us. We will see that you are supplied. Write today for complete descriptive matter.

The Temco Electric Motor Co., 117 Sugar St., Leipsic, O.



TEMCO Improved  
Master Vibrator  
For FORD Cars **\$12.50**



Write  
for full  
Information about  
**TEMCO**  
Portable  
Electric  
Drill



TEMCO Shock  
Absorbers  
For FORD Cars  
Complete  
Set of 4 **\$15**

# Smith & Wesson Automatic

*Doubly Safe*



Safety for American homes  
—against intruders and carelessness

Once in a lifetime you need a pistol. You owe it to your family to be prepared.

You also owe it to your family to afford them this protection without any danger from unintentional discharge, thoughtlessness, and children's curiosity—a safe pistol.

The Smith & Wesson Automatic is *the* pistol for American homes: Safe at all times—two safety devices. It shoots when you mean to—never before. Easy to aim; easy to clean; strong and accurate, like other Smith & Wesson Pistols.

Why not get facts about this remarkable pistol? Ask your dealer to show you the special features of the Smith & Wesson Automatic.

*Send the coupon for Booklet.*



**SMITH & WESSON**  
SPRINGFIELD, MASS.

FOLD, TEAR OFF, FILL IN, MAIL

Name.....  
Address.....  
Smith & Wesson, Springfield, Mass.

814  
8-15

Send  
me book  
on S.&W.  
Automatics.

## No such thing as "rubber roofing"

A lot of manufacturers call their roofing "Rubber Roofing," "Rubberine," "Rubberoid"—Rubber-this and Rubber-that. The life is all out of rubber if exposed to the daylight for six months. It would be silly to put rubber in roofing, and rubber costs more per pound than roofing sells for for a hundred pounds. There is no such thing as "Rubber Roofing" of any kind. There is no rubber in

# Certain-teeed

## Roofing



It is made of the very best Roofing Felt thoroughly saturated in our properly blended asphalts and coated by a harder grade of asphalt which keeps the soft saturation within—the life of the Roofing—from drying out quickly. We have found from long experience in every part of the world and under all kinds of conditions that these are the materials that give the best and the longest service on the roof.

**Certain-teeed** Roofing is guaranteed 5, 10 or 15 years according to whether the thickness is 1, 2 or 3 ply respectively, and if the roof fails to make good you have a responsible guarantee to fall back on. Beware of the product which is misrepresented to you in any way. Your local dealer will quote you reasonable prices on our goods.

### General Roofing Manufacturing Company

World's Largest Manufacturers of Roofing and Building Papers

New York City Chicago Philadelphia St. Louis Boston Cleveland Pittsburgh Detroit Cincinnati  
San Francisco Minneapolis Kansas City Seattle Atlanta Houston London Hamburg Sydney



Design No. 584  
by Jud Yoho,  
Estimated Cost  
\$2500.

## All About Bungalows

**Bungalow Book, 1915 De Luxe Edition.** Contains the cream of 1000 practical and distinctive bungalows actually built for \$400 to \$4000, suited to any climate, with photos of exterior and interior views, plans, size of rooms, cost, etc.

Also valuable suggestions on bungalow building written by an expert. **The largest exclusive Bungalow Book published. 112 pages. Price 100 Postpaid**

Worth many times its cost to any prospective builder. A smaller book 50 cents. Send check, money-order or stamps.

**MONEY BACK IF NOT SATISFIED**

JUD YOH0, The Bungalow Craftsman, 52 Bungalow Bldg., SEATTLE, WASH.

**ARBOR DAY OBLIGATORY IN SPAIN**—The satisfactory results obtained since the introduction of an arbor day in Spain, in 1898, has induced the Spanish government to make arbor day general throughout the kingdom and declaring the annual celebration of this day obligatory in every township and municipality.

## THIS BUNGALOW \$900 CAN BE BUILT FOR

This and many others in my new book, **Building Plans for Modern Homes**, will save you hundreds of dollars. One of the most complete and comprehensive books of plans ever published by any architect. Fifth edition just off the press.

Two hundred and fifty floor plans and photographs of bungalows, etc., costing from \$200 up; gives sizes and cost to build. **Sent postpaid for \$1.00**



**FREDERICK H. GOWING ARCHITECT**

18 Tremont St., BOSTON, MASS.

## STERLING System Built HOMES

BUY a Sterling Home direct from the largest forest and mill owners in America. Save 40% on building materials, 55% on carpenter bills and weeks of time. Pay part cash and balance in 24 small monthly installments. Price includes everything from ground up (even nails). All lumber comes measured and cut to fit.

Cottages, Bungalows and Large Dwellings **\$296.50 to \$2200**

Send postal today for the latest Sterling Book—the "Famous Fifty." **Free to Home Builders**  
INTERNATIONAL MILL & TIMBER CO., Dept. Q-8, Bay City, Mich.



## 3 YEARS TO PAY

**Meister Piano** 30 days free trial in your own home

**\$1 A WEEK or \$5 A MONTH** Price **\$175.00**

No cash payment down. No interest—no extras. Piano stool and scarf free

**ROTHSCHILD & COMPANY**  
Dept. 16H CHICAGO, ILL.

## Runs on Alcohol

At Cost of Less than  $\frac{1}{2}$ ¢ an Hour



anywhere without electricity, springs or batteries. Superb construction. 12-inch blades. Adjustable roller bearing. Reliable. A proved comfort. Prompt delivery. The original and only Lake Breeze Motor manufactured according to the design of the inventor and under his direct and personal supervision.

### Keep Cool

Writes for prices and free circular  
Lake Breeze Motor, 122 N. Jefferson St., Chicago



# GRAFLEX CAMERAS

PICTURES LIKE THESE ARE EASY TO MAKE—when you use a Graflex Camera.

In shade or sun, indoors or out, the Graflex is always ready to make the kind of pictures you have always wanted. And when you use a Graflex there is no uncertainty. A glance in the focusing hood shows the image the size it will appear in the finished picture, right side up, and the image remains brilliantly visible up to the instant of exposure. It is not necessary to estimate the distance between the camera and the subject; focusing scale and finder are done away with.

Every Graflex Camera is equipped with a Graflex Focal Plane Shutter—the shutter that works at all speeds from "time" to 1-1000 of a second, and enables your lens to work at its full efficiency.

Graflex Cameras are fully described in our 64-page illustrated Graflex Catalog. Your copy will be mailed for the asking.

**Folmer & Schwing Division**  
EASTMAN KODAK COMPANY  
Rochester, N. Y.



# Typewriter Sensation



## Free Trial

Use As You Pay

Only \$3.00 a month until the low total price of \$48.30 is paid, and the machine is yours

This is absolutely the most generous typewriter offer ever made. Do not rent a machine when you can pay \$3.00 a month and own one. Think of it—Buying a \$100.00 machine for \$48.30. Cash price, \$45.45. Never before has anything like this been attempted.

## Standard Visible L. C. Smith

Perfect machines, Standard size, Keyboard of Standard Universal arrangement writing 76 characters—universally used in teaching the touch system. (Keyboard writing 84 characters \$2.00 extra.) The entire line of writing completely visible at all times, has the tabulator, the two color ribbon, with automatic reverse, the Back Spacer, in fact every late style feature and modern operating convenience. Comes to you with everything complete, tools, cover, operating book and instructions, ribbon, practise paper—nothing extra to buy. You cannot imagine the perfection of this beautiful typewriter until you have seen it. I will send it to you F. O. B. Chicago for five days' free trial. It will sell itself, but if you are not satisfied that this is the greatest typewriter you ever saw, you can return it at my expense. You won't want to return it after you try it—you cannot equal this wonderful value anywhere.

## You Take No Risk—Put In Your Order Now

When the typewriter arrives deposit with the express agent \$9.30 and take the machine for five days' trial. If you are convinced that it is the best typewriter you ever saw, keep it and send me \$3.00 a month until our bargain price of \$48.30 is paid. If you don't want it, return it to the express agent, receive your \$9.30 and return the machine to me. I will pay the return express charges. This machine is guaranteed just as if you paid \$100.00 for it. It is standard. Over one hundred thousand people own and use these typewriters and think them the best ever manufactured.

The supply at this price is very limited, the price will probably be raised when my next advertisement appears, so don't delay. Fill in the coupon today—mail to me—the typewriter will be shipped promptly. There is no red tape. I employ no solicitors—no collectors—no chattel mortgage. It is simply understood that I retain title to the machine until the full \$48.30 is paid. You cannot lose. It is the greatest typewriter opportunity you will ever have. Do not send me one cent. Get the coupon in the mails today—sure.

Harry A. Smith, 231 N. Fifth Ave., Chicago

H. A. SMITH, 231 N. Fifth Ave., Chicago, Ill.

Ship me a No. 2 L. C. Smith F. O. B. Chicago, as described in this advertisement. I will pay you the \$39.00 balance of the SPECIAL \$48.30 purchase price, at the rate of \$3.00 per month. The title to remain in you until fully paid for. It is understood that I have five days in which to examine and try the typewriter. If I choose not to keep it I will carefully repack it and return it to the express agent. It is understood that you give the standard guarantee for one year.

NAME .....

ADDRESS .....

Pop. Mech. Aug.

OVER 70 YEARS' EXPERIENCE

# PATENTS

TRADE MARKS  
DESIGNS  
COPYRIGHTS, &c.

Anyone sending a sketch and description may quickly ascertain our opinion free whether an invention is probably patentable. Communications strictly confidential. HANDBOOK on Patents sent free. Oldest agency for securing patents. Patents taken through Munn & Co. receive special notice, without charge, in the

## Scientific American.

A handsomely illustrated weekly. Largest circulation of any scientific journal. Terms, \$3 a year; four months, \$1. Sold by all newsdealers.

**MUNN & CO.** 672 Woolworth Bldg., NEW YORK

Washington Office, 625 F St., Washington, D. C.

## BUY YOUR FURNACE \$10 DOWN \$10 A MONTH



Our monthly payment plan of selling direct saves you the dealer's profits and charges for installation. The

## JAHANT FURNACE

with the patented "Down Draft System" is best for residences, schools, hotels, churches, etc., because it delivers plenty of heat wherever and whenever desired at a saving of  $\frac{1}{3}$  to  $\frac{1}{2}$  in fuel bills. Install the JAHANT yourself. We send complete outfit, freight prepaid with special plans, detailed instructions and all necessary tools for installation. Satisfaction guaranteed or money refunded.

WRITE FOR FREE ILLUSTRATED BOOK  
THE JAHANT HEATING CO.

200 Steiner Avenue

AKRON, OHIO

## Save $\frac{1}{3}$ to $\frac{1}{2}$ on Fuel Bills

An automobile expert states that one-half of all the motor cars in this country are owned by farmers.

Mushrooms  
GROW  
THEM

Big Profits  
50c to \$1 lb.

Learn How  
FREE

At Home  
All Year

Write NAT'L SPAWN CO.,

Cellars  
Stables, Boxes  
Dept. 12, BOSTON, MASS.



## POULTRY PAPER

44-124 PAGE periodical, up-to-date; tells all you want to know about care and management of poultry for pleasure or profit. Four months for 10 cents. POULTRY ADVOCATE, Dept. 98, SYRACUSE, N. Y.

## 1900 Motor Washer

Electric or Water Power

on Free Trial to Readers of Popular Mechanics

Reduce household expenses by using this great laundry outfit. Cuts cost of washing to 2 cents per week. Write for Free Book, giving full details, to

1900 WASHER CO., 6190 Court St., Binghamton, N. Y.

Address Canadian 1900 Washer Co., 355 Yonge St., Toronto if you live in Canada



## Small Engines

Our little guaranteed engines are unequalled for operating small machinery, washing machines, grinders, etc.

**FORD** AUTO SEAT STARTER \$15.00

Shipped on trial. Send stamp for Booklet and Special Offer  
Sieverkropp Engine Co., 1224 18th St., Racine, Wis.





**REMINGTON  
UMC**

## REPEATING SHOTGUNS

REG. U.S. PAT. OFF.

### *Two Guns That Are Sportsmen's Favorites*

**T**HERE are many kinds of repeating shotguns—both pump action and autoloading—some to be had at very low prices. But it is typical of sportsmen that the great majority prefer Remington-UMC by reason of Remington-UMC achievements in arms and ammunition, and the performance of Remington-UMC Pump and Autoloading Shotguns in the hands of the average man.

*Remington-UMC Pump Gun*—"The Good Old Standby"—six shots, bottom ejection, solid breech, hammerless, safe.

*Remington-UMC Autoloading Shotgun*—"The Auto Shotgun that Works." 5 shots—simply pull the trigger for each shot. Solid breech, hammerless, safe.

Go to the Remington-UMC dealer. He can give you all the mechanical details—he knows the difference in guns.

Whichever you prefer—Pump or Autoloading—you can put your money into a Remington and be sure of getting a real gun.

**REMINGTON ARMS-UNION METALLIC  
CARTRIDGE CO.**

Woolworth Bldg. (233 Broadway) New York City



LYNN  
BOGUE  
HUNT

Please Mention Popular Mechanics



Don't use expensive ammunition where a cheap cartridge is just as good. Buy a

# Marlin

## Rim Fire Repeater

for squirrels, rabbits, hawks, woodchucks, skunks, muskrats, foxes, etc.—and save price of your rifle in the reduced cost of cartridges.

**.25 Rim Fire**—cheap, powerful and reliable—will kill foxes, skunks, woodchucks, muskrats, etc. as quickly and surely as more expensive ammunition.

**Model 27 Marlin** is the only repeater made for this splendid cartridge—so powerful it is used successfully for deer, so cheap you can shoot it freely at slight expense. Take-down; splendid sight; 8 shots; with 24-inch Round Barrel, \$13.15; Octagon, \$15.00.

**.22 Rim Fire**  
All Marlin .22 Repeaters shoot all .22 short, .22 long and .22 long-rifle cartridges—for rabbits, squirrels, hawks, crows and all small game up to 200 yards.

**.22 Lever Action**  
**Model 1897**—the best made .22 rifle in the world. Take-down; convenient to carry and clean; tool steel working parts; Ivory Bead sight; as steady and reliable as a big game rifle. With 24-inch Round Barrel, \$14.50; Octagon, \$16.00. **Model 1892** is similar, but not take-down; with 24-inch Round barrel, \$12.15; Octagon, \$13.15.

**.22 Pump Action**  
**Model 29** has 23-inch Round barrel; take-down; a first-class repeating rifle; 15 shots; \$9.25.

**Model 20** has 24-inch Octagon, heavier barrel; take-down; Ivory Bead sight; 15 shots; \$11.50.

**Model 20 Full Magazine Rifle**—the only pump action repeater giving 25 shots at one loading; \$11.50.

**.32 Rim Fire—Model 1892**, with lever action—uses .32 short, long and long-rifle rim fire cartridges; also .32 short, long and long-rifle center fire; 17 shots. A splendid all-around rifle for settled districts. With 24-inch Round Barrel, \$12.15; Octagon, \$13.15.

Send 3 stamps postage for new catalog, showing complete line of Marlin repeaters, rifles and shotguns.

**Ideal Hand Book** tells all about reloading cartridges. Mailed for 6c in stamps.

**The Marlin Firearms Co.**  
65 Willow St., New Haven, Conn.

Model 27

# 4 Weeks' Trial

Choice of 33 Styles

Yes, we will ship you on four weeks' absolutely free trial direct from our own factory your choice of 33 new styles of the highest-grade Wing Piano or Player Piano. No obligations—no C.O.D.—no security.



One of 33 Styles

## No Money Down—Not a Cent of Freight

Use it and enjoy it four full weeks; then, if you wish, ship it back at our expense. You alone are the judge. You will be amazed at our rock-bottom, direct price on the superb Wing, guaranteed 40 years. Easy monthly payments or cash. Write today.

**Valuable Book—FREE** "The Book of Complete Information About Pianos" sent free and post-paid. Valuable 136-page book. Tells how to judge pianos. Beautiful art catalog also sent and particulars of great Free Shipment Offer. Write today. **Wing & Son (Est. 1868)**, Wing Building, 9th Ave. & 13th St., Dept. C119, New York

## TYPEWRITERS SUMMER PRICES

Look at these bargains! Typewriters Rebuilt in our own Factories, and guaranteed for one year.

- Remingtons \$20 to \$55
- Smiths \$13 to \$40
- Underwoods \$35 to \$60
- Royals \$25 to \$45
- L. C. Smiths \$30 to \$50
- Olivers \$20 to \$35

We have others, of course. Send for catalog describing them, and address of nearest branch office.

**American Writing Machine Co., Inc.**, 345 Broadway, N. Y.



## "Vulcan" Ink Pencils

RED OR BLACK  
Inexpensive and Durable. Unequaled for general writing  
ONLY Non-Leakable moderate price INK PENCIL made

ORDER EXTRA SIZE 8 INC. \$1.25  
TO DAY \$1.25

AGENTS TERRITORY OPEN  
**J.C. ULLRICH & CO.** 27 THAMES ST. NEW YORK

**WOOD IN MODERN BATTLESHIPS**—The recent rapid growth of the European fleets has caused an enormously increased use of teakwood in spite of the marked tendency to employ as little wood as possible in the construction of warships. About 1,000 tons, or approximately half a million board feet, of the best grades of teak are used in the construction of a modern man-of-war. In order to replace the ships which have thus far been sunk or otherwise destroyed in the European war, hundreds of millions of feet will be required.

SUPERIOR SINCE 1904

## OVER 100,000 IN USE

Mostly sold through recommendation. For Personal Desk or General Office. It checks mental calculations. Buy through your stationer. Write for 10-Day Trial Offer. E. Goucher A. A. M. Co., 148 Duane St., New York

### Golden Gem Adding Machine

PORTABLE \$10

Multiples—Subtracts

Agents Wanted

## Amazing Bargain!

Genuine Standard Visible Oliver Typewriter—the very latest Model 5, with back spacer, tabulator, color writing-ruling device, disappearing indicator. Nothing lacking—metal case, tools, instruction book. Life guarantee. We have sold 26,000.

**FREE TRIAL—No Advance Payment**  
Send a little bit each month until our very small price is paid. No interest—no red tape. Send for our amazing Bargain Offer and FREE Typewriter Book today. No obligation.

Typewriters Distributing Syndicate  
1510-30F Wabash Avenue, Chicago

Please Mention Popular Mechanics

# Make Your "Bike" a Motorcycle



Yes, thousands of others have turned their old-fashioned bicycles into up-to-date, swift, sure, easy riding, high power motorcycles with the easily attached, inexpensive *Shaw motorcycle attachment!*

Fits bicycles of any make or size. Everything is complete and we send it to you all ready to attach to your bicycle in just a few minutes without the aid of an expert mechanic and without any special tools—just an ordinary wrench and screwdriver.

Built of highest grade, most serviceable materials; every part guaranteed; plain, easily understood directions sent with each equipment. Thousands of enthusiastic owners everywhere. Here is your chance to get a powerful, dependable, durable, fine looking and speedy motorcycle at a price so small you will wonder how you ever got along with the old-fashioned "leg power" machine!

## Read What These Users Say of the Shaw Motorcycle Attachment

**"Will Go Up Hills That Other Motors Get Stalled On"**  
Shaw Manufacturing Co., Galesburg, Kansas. Route 2, Stroudsburg, Pa.  
Gentlemen: I received my Motor Attachment and am well pleased with it. I am surprised at the power it has. I can go up hills that other big motors get stalled on. I made a small trip Saturday and went up hills without any trouble whatever. I live in a hilly country and can climb grades from about 15% to 25%. I couldn't have gotten a better motor if I would have paid four times the price.

**"Everybody Likes the Way the SHAW Works"**  
Raeford, N. Car.

Shaw Manufacturing Co., Galesburg, Kansas.  
Gentlemen: The Motor I received from you about one month ago is doing extra fine. It is just what I have been looking for. I have not had any trouble with it at all. It is giving perfect satisfaction. Everybody in my town likes the way the SHAW Motor works. It is something that has never been seen in the town of Raeford, N. C. before.

H. H. McALLISTER.

**"Good As Money Can Buy"**  
Milwaukee, Wis., 1629 Port Wash. Rd.

Shaw Manufacturing Co., Galesburg, Kansas.  
Gentlemen: The little 2½ H. P. Bicycle Attachment which I purchased from you last year is as good a little motor that money can buy, and it is everything you claim it to be for power and speed. I am greatly surprised at the steep and long hills it can climb, as I have a very heavy frame, and I, myself, weigh 160 lbs. I never expected the little motor to pull me up the hills it has, and I can prove it to anyone who wishes to see me try it out. Thanking you for the good Attachment you sent me, I remain

W. P. LANGROFF.

## Write For FREE BOOK!

We want to send you, free and postpaid, a copy of our booklet illustrating and fully describing the SHAW Motorcycle Attachment. When you read about the simplicity and the low cost of the SHAW attachment you will no longer be satisfied with your old-fashioned, slow-going, tiresome bicycle, but will want to send and join forces with the thousands of other go-getters who are now hitting the high speed trail with a SHAW!

Send name on the coupon or postal card for the free booklet today

**Shaw Manufacturing Co.**  
Department 128 Galesburg, Kans.

**"Speedy and Good Hill Climber"**

184 W. Robbins St., Covington, Ky.  
Shaw Manufacturing Co., Galesburg, Kansas.

Gentlemen: I take pleasure in writing and telling you my 2½ H. P. Motor Attachment is all that it is claimed to be. It is speedy and a good hill climber, and will recommend it to anyone wanting a good, cheap motorcycle. Everybody has gone wild about it down here.

JAS. F. GIVEN.



Thousands in Use  
in America and  
Foreign  
Countries

**SHAW**  
Manufacturing Co.  
Dept. 128, GALESBURG, KANSAS

Please send me, free and postpaid, copy of your book illustrating and describing the SHAW Motorcycle Attachment as advertised in the August issue of POPULAR MECHANICS. Quote me your lowest net cash, factory price.

NAME .....

ADDRESS .....



## Ideal For Motorboat Use

The Champion "Spark-in-Water" plug positively cannot be short-circuited.

The sparking point is a fine platinum wire, entirely protected from corrosive action by being baked in the porcelain. The tip is brought exactly flush with the insulator surface.

The spark is so intensified that its great heat instantly destroys any short circuiting matter. Rain, spray, soot and oil are actually consumed.

Water shipped directly over the engine will not interfere with its operation. No protecting hood is needed when the Champion "Spark-in-Water" plug is used.

This plug is self-cleaning. It requires absolutely no attention. The price is \$1.00.

## Motorcycle Spark Plugs



**Champion  
Heavy-Duty  
\$1.00**

This motorcycle plug is made in one piece and cannot leak. It is of extra heavy and durable construction throughout.

Over 75% of all gasoline engines built in America are factory equipped with Champion Spark Plugs. This is a fact worth considering. Insist on Champions. Your dealer can supply them.

See him today or write direct to us

**Champion Spark Plug Company**  
404 Avondale Ave. TOLEDO, OHIO

Please Mention Popular Mechanics

## STOP THAT SQUEAK



with 3-in-One Oil. It will make door hinges work noiselessly. For longer wear and easier work use 3-in-One on your:

Sewing machine, typewriter, talking machine, ice cream freezer, bicycle, skates, music box, lawn mower, cream separators, clocks, locks, hinges, bolts, catches, pulleys, scales, scissors and everything else *around your home* that ever needs oiling.

3-in-One is a clear, light oil preparation that cuts out all dirt and never gums or cakes. It lubricates perfectly every action part and prevents wear. No grease; no acid.

3-in-One also cleans and polishes all wood and metal surfaces—absolutely prevents rust and tarnish, indoors and out.

**FREE** Write for generous *free* sample of 3-in-One, today. Give it a good hard test. Sold everywhere in 3 size bottles: 10c (1 oz.), 25c (3 oz.), 50c (8 oz., ½ pint). Also in new patented Handy Oil Can containing 3½ ozs. of oil, 25c.

**3-IN-ONE OIL CO.**  
42 CNS. Broadway, NEW YORK CITY

**3**

The foreign trade of the United States in fruits and nuts amounted to \$92,840,172 in the calendar year 1914. The largest single item was bananas, with a total value of \$16,000,000.

If You Have a High-Grade Camera, Lens or Kodak with you today. State full particulars, price, make, etc. We buy, trade, sell, exchange everything in the line of Cameras, from Vest Pocket to Graflex. Prompt, satisfactory service. **DAVID STERN COMPANY** 1047P W. Madison St., Chicago, Ill. IN BUSINESS SINCE 1882.

**EXCELSIOR MOTOR MFG. & SUPPLY CO.**  
**SEVEN MODELS**  
Singles, Twins  
Two Speed  
Chain and  
Belt Drive  
Write for Catalog  
**ALWAYS MAKES GOOD**  
EXCELSIOR MOTOR MFG. & SUPPLY CO., 3702 Cortland St., CHICAGO

**High Grade Violins 30 Days' Free Trial**  
Your choice from a large and carefully graded stock of representative instruments from the leading foreign violin makers. Strictly hand made and of superior tone, these violins are far superior to the average old violins sold at four times the price.  
**Write Today.** Don't fail to send your name and address today for the superb Lewis catalog sent free and postpaid. Of value to everyone interested in high grade instruments. Learn how you can have your choice of these superb instruments on a free trial in your home. Write today.  
Wm. Lewis & Son, Dept. C119, 225 S. Wabash Ave. Chicago  
**OUR SPECIALTIES:** Imported wood-varnishes and tools for violin makers.

**3 1/3 c a Day**  
now buys a dazzling Lachnite Gem. Their brilliance is eternal—they stand fire and acid tests and out-glass the diamonds. Cost but one-third as much. Set in solid gold. The newest designs. Sold on Free Trial. See our new jewelry book.  
**Write for Big Jewelry Book** Your name and address is enough. No obligations whatever. Write today—now.  
**HAROLD LACHMAN COMPANY**  
12 N. Michigan Avenue, Dept. C119 Chicago, Ill.





The Service that  
shines through  
**MAZDA**

*'Not the name of a thing' but the mark of a Service'*

Back of the MAZDA Lamps that light your home stands a Service the like of which the world has never seen—scientific research organized and carried on for the purpose of making electric lighting better, and even more inexpensive than it is.

Centering in our Research Laboratories at Schenectady, where scores of experts delve into many fields of science, MAZDA Service seeks always for new ideas in illumination, new materials and new methods of manufacture.

And when these are attested and approved, they are at once transmitted to our manufacturing centers at Cleveland and Harrison, and to other manufacturers entitled to receive this Service, for embodiment in the MAZDA Lamps they make.

And so when you see the Mark of this Service—that word MAZDA—etched upon a lamp, you may be sure that lamp sums up the latest efforts of the world's ablest lamp investigators.

GENERAL ELECTRIC COMPANY 

6021

*Please Mention Popular Mechanics*



## Steer Without Strain This Guides Your Ford Straight!

Don't grapple the steering wheel like grim death, to keep your car out of the ditch. Let the famous Walker Steer-ezer right your front wheels automatically the instant they strike "rough going." Steering without it invites calamity, frays your nerves and tires your muscles. Then some fatal day the wheel is jerked from your grip. Don't risk it.

Our engineers overcame all faults found in previous devices. Then they produced this perfect steering contrivance. They simplified construction, so cut cost

way down. Now for \$3.75 you can make your Ford steer like a high-priced car. Just slip it over the tie-rod and clamp to axle—applied with wrench in a jiffy. Outlasts the car.

Walker  
**Steer-ezer** \$3.75  
For Ford Cars

**Free Introductory Offer!**

Words can't tell the ease, the joy, the safety of driving a Ford with the Steer-ezer. So we authorize any dealer to put one on your car FREE. Return it if you want after 15 days, else pay him only \$3.75. We ship on free trial, prepaid, if your dealer can't supply you. Send to money—only your name and dealer's name.

**THE WALKER MFG. CO., 1511 Michigan Ave., Chicago. Factory, Racine, Wis.**

**5¢ A DAY BUYS A GIBSON**

Terms as low as \$1.00 down and \$1.50 per month. Mandolin or Guitar sent on approval. Get our new **FREE BOOK**—100 pages, 50 illustrations. Valuable information for player and teacher. Explains wonderful new violin construction with carved and graduated Top and Back and Stradivarius Arching. Also **FREE** treatise on "How to practice".

**TEACH AND SELL THE GIBSON—BIG MONEY**

Become a teacher. Splendid opportunities for Mandolin and Guitar teachers—either solo in every locality, private and class instruction, and sale of Gibsons. The Gibson has made many a teacher professionally and financially. C. A. Tompkins, Sioux City, Iowa, writes, "If it were not for the Gibson I would not be in the teaching business." Wm. Place, Jr., Providence, R. I., Star Soloist for Victor, uses and endorses the Gibson.

**Write Today.** If a teacher, become our agent, do business on our capital. Instruments furnished. We help sell. Agents' territory protected. You make the profits. We pay the advertising. You pay for goods when sold; return goods not sold. Try our "Still Hunt". Catalog and Thermic List Free.

**GIBSON MANDOLIN GUITAR COMPANY**  
185 Harrison Court, Kalamazoo, Mich.

OPEN—Permanent teaching and business opportunity. Either sex. Write now. Other positions pending.

**Made-to-Measure**  
**EXPRESS PREPAID \$2.75**

Pants cut in the latest style. Made to your individual measure. Fit, workmanship and wear guaranteed.

**No Extra Charge** for peg tops, no matter how extreme you order them.

**Agents** A good live hustler in every town to take orders for our **Wanted** celebrated made-to-measure clothes. Samples of all latest materials **FREE**.

**We Pay Big Money** to our agents everywhere. Turn your spare time into cash by taking orders for our stylish clothes. Write today for beautiful **FREE** outfit.

**THE PROGRESS TAILORING CO.**  
Dept. 107, CHICAGO, ILL.

The Baltic has the greatest wreck record of all the seas, the average being one a day.

About a score of orders of knighthood for women exist in Europe. The oldest is the Prussian Order of the Swan, founded in 1440.

**White Valley Gems Look Like Diamonds**  
Will cut glass. Brilliance guaranteed 25 years. 14k solid gold diamond mountings. Will send you any style ring, pin or stud for examination—no charge prepaid. No money in advance. Money refunded if not satisfactory. Write today for free catalog.

**WHITE VALLEY GEM CO., 1101 Wulsin Bldg., Indianapolis**

**The UNICYCLE**  
**HURRAH!**

They furnish great sport for the BOYS. Are you interested in selling them?  
**DO YOU WANT ONE?**

WRITE  
Thomas B. Bemis, Indianapolis, Indiana

**PRINCE ALBERT**  
the national joy smoke

1½ to 18  
H. P.

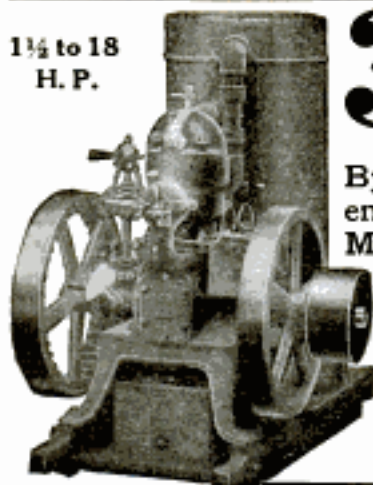

**34c** Runs this 6 H. P. Engine for a  
**10 hour day on KEROSENE**

By means of the patent throttle you can run it as a 4 H. P. engine for 23 cents a day, or as a 2 H. P. for 12 cents a day. Many other strong points; force-feed lubrication; uniform speed; sight-feed fuel supply; automobile muffler; no cranking; runs either way; uses any fuel oil satisfactorily. And it's **Guaranteed for 10 Years**. Write for catalogue and 30 days' free trial.

**WE PAY THE FREIGHT**

**ELLIS ENGINE CO., 2871 East Grand Blvd., Detroit, Mich.**



# Tobacco Habit BANISHED

## in 48 to 72 Hours

### No Desire After First Dose

Trying to quit the tobacco habit unaided is a losing fight against heavy odds, and means a serious shock to your nervous system. So don't try it! Make the tobacco habit quit you. It will quit you if you will just take Tobacco Redeemer according to directions.

It doesn't make a particle of difference whether you've been a user of tobacco for a single month or for 50 years, or how much you use, or in what form you use it. Whether you smoke cigars, cigarettes, pipe, chew plug or fine cut or use snuff Tobacco Redeemer will positively remove all craving for tobacco in any form in from 48 to 72 hours. Your tobacco craving will begin to decrease after the very first dose—there's no long waiting for results.

Tobacco Redeemer is absolutely harmless and contains no habit-forming drugs of any kind—the most marvelously quick and thoroughly reliable remedy for the tobacco habit the world has ever known.

### Not a Substitute

Tobacco Redeemer is in no sense a substitute for tobacco, but is a radical, efficient treatment. After finishing the treatment you have absolutely no desire to use tobacco again or to continue the use of the remedy. It quiets the nerves, and will make you feel better in every way. If you really want to quit the tobacco habit—get rid of it so completely that when you see others using it, it will not awaken the slightest desire in you—you should at once begin a course of Tobacco Redeemer treatment for the habit.

### Results Absolutely Guaranteed

A single trial will convince the most skeptical. Our legal, binding, money-back guarantee goes with each full treatment. If Tobacco Redeemer fails to banish the tobacco habit when taken according to the plain and easy directions, your money will be cheerfully refunded upon demand.

### Let Us Send You Convincing Proof

If you're a slave of the tobacco habit and want to find a sure, quick way of quitting "for keeps" you owe it to yourself and to your family to mail the coupon below or send your name and address on a postal and receive our free booklet on the deadly effect of tobacco on the human system, and positive proof that Tobacco Redeemer will quickly free you from the habit.

**Newell Pharmacal Company**  
Dept. 300., St. Louis, Mo.

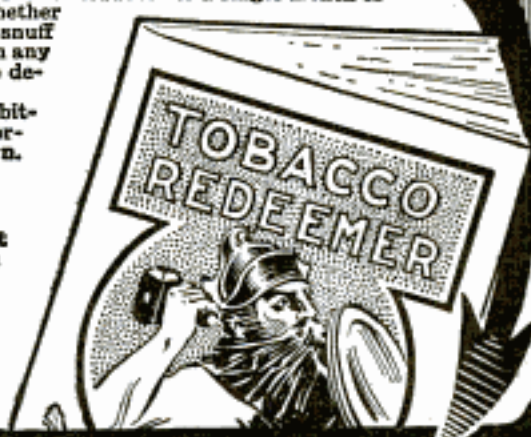

## Mail Coupon NOW for FREE Booklet

**NEWELL PHARMACAL CO.,**  
Dept. 300., St. Louis, Mo.

Please send, without obligating me in any way, your free booklet regarding the tobacco habit and proof that Tobacco Redeemer will positively free me from the tobacco habit.

Name .....

Street and No. ....

Town..... State.....

Please Mention Popular Mechanics



# I Will Make YOU Prosperous

**Y**OU can start right now making the **BIG MONEY**. No experience necessary. I have positively the most staggering and sensational **MONEY-MAKING** offer to all ambitious men and women ever made. My line of household necessities is known all over the country. The demand is enormous and is growing by leaps and bounds.

**\$25 to \$50 a Week for Good Men or Women**

More money in one month with my goods than in six with many others. No limit to what you may earn. My unique selling plans are a phenomenal success because of the novel method of presenting my line—soaps, perfumes, creams, powders, etc., with unheard of prices; and you offer a **FREE Gold Monogram 42 Piece Dinner Set Coupon** to each customer.

**200% Commission—Free Circulars and Advertising Matter**

I go the limit in helping you win success and a permanent income. My **6 story factory stands back of you**. Remember **\$5 a day is easy**—many often make \$10 to \$20 daily. Are you ready for the **Big Money**? I can now offer you territory right at home.

**E. M. DAVIS, Pres., E. M. DAVIS SOAP COMPANY, 964 Davis Bldg., Chicago**

**Write me to-day** for beautifully colored circulars and full particulars. **Hurry** and by next month you can be spending the **Big Profits**. Such a Golden opportunity may never come your way again. **RUSH** application to-day.

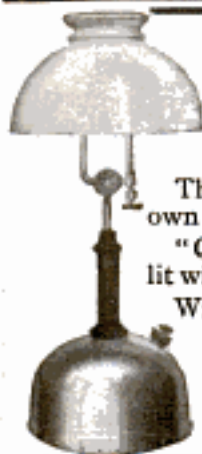

**300 Candle Power of Light at a Cost of 1-8c Per Hour**

**Burns Kerosene**

This lamp generates and burns its own gas from ordinary kerosene.

"**QUICKLIT**" gasoline lamps can be lit with an ordinary match like city gas.

Write today for illustrated catalog of our complete line of kerosene and gasoline lamps, lanterns and lighting systems. **Agents Wanted**

**THE NAGEL-CHASE MFG. CO.**  
174 East Erie St., CHICAGO

**FITS-UR-POT**



**FITS ANY COFFEE POT**

Just out. Going with a rush. Every home a prospect. Converts any pot into percolator. Makes better coffee—saves third to half. Aluminum. Quick sales.

**Profits \$24 to \$36 a Week**

Most percolators cost \$3 to \$5. **FITS-UR-POT** sells for \$1. Practical—absolutely new. Our free premiums stimulate sales. Write quick for agency.

**Standard Spinning & Stamping Company**  
108 Smead Ave. Toledo, Ohio

**AGENTS WANTED**

Champion Racer



**MODEL AEROPLANES**

Send 2c postage for Complete handbook of Models and Supplies.

**WADING RIVER MFG. CO.**  
WADING RIVER, N. Y.

Our set contains this and 9 other drawings, with instructions for building ..... **\$1.00**

**RISE a RANGER**



1915 Model bicycle and know you have the best. Buy a machine you can prove before accepting.

**DELIVERED FREE ON APPROVAL** and 30 days' trial. No expense to you if you do not wish to keep it. **LOW FACTORY COST**, great improvements and values never before equalled in our 1915 models.

**WRITE TODAY** for our big catalog showing our complete line of 1915 bicycles, **TIRES**, sundries and parts, and learn the wonderful new offers and terms we will give you. Auto and Motorcycle Supplies at factory to user prices. Do not buy until you know what we can do for you.

**MEAD CYCLE CO. DEPT. F108 CHICAGO**

**PATENTS IN 1914**—According to the annual report of the Commissioner of Patents there were received, in 1914, 70,228 applications for new patents, and 41,000 new patents were issued. The number of patents that expired was 22,098.

**You Can Make Big Money**

C. F. Larsen has made over \$1000, selling Matchless Gas Lighters. E. C. Halses made \$17.10 in one day. You too can make big money. The Matchless Gas Lighter lights gas or gasoline. Safer, cleaner, handier and cheaper than matches.

Send 25c for agents' sample and big money making offer.

**STEEL STAMPING CO., Dept. 28, 143 W. Austin Avenue, CHICAGO**



**GENUINE MOGUL \$100**

**DIAMOND 1.**

Absolutely the nearest approach to a real diamond. Only experts can tell the difference. Cut like a diamond. Unending in brilliancy. Gold filled diamond mounting. Guaranteed 25 years. 1 karat stone. Rings, pins, studs or earrings, \$1.00 and up. Sent on approval. Mention for lady or gentleman. Write today for complete catalog.

**FREY SPECIALTY CO., 108 Frey Building, NEW CASTLE, PA.**

**Here's Health and Power, Vim and Vigor**

All yours! Strength that is more than mere muscular strength. The strength, health, power and vigor of youth is now within your reach through the **White Cross Electric Vibrator**. Be strong—be healthy. Enjoy things the way you used to. You can be strong and healthy if you will.

**White Cross Electric Vibrator**

With this machine in your home you can give yourself the same treatments for which specialists receive \$5 to \$5. Can be connected up as easily as an electric lamp. Or if your home is not wired for electricity, it will run perfectly on its own batteries.

**Write Today for Big Free Book** Just your name and address on a letter or postcard is enough. We will send you absolutely free and prepaid, our new book, "Health and Beauty." It tells you all about vibration and our special 60 day price reduction offer. Write today.

**Lindstrom-Smith Co., 1102 S. Wabash Ave., Dept. C119, Chicago**



**BIG CHANCE FOR AGENTS**



**You can earn BIG MONEY**

selling the most complete line of guaranteed transparent handle Knives and Razors with Photo, Name and Lodge Emblem—also full line of cutlery. Write today for catalogue and terms. **Golden Rule Cutlery Co., 554 W. Lake St., Dept. 207, Chicago, Ill.**

**Hartman Will Trust You**

**Rock Bottom Prices**

**Furniture, Carpets, Rugs, Etc.**

**Easiest Terms** Hartman's credit terms easiest, most liberal ever offered. No security—no notes—no mortgage. Free from all objections. At the end of a month you may return anything unsatisfactory.

**30 Days Approval** Hartman refunds your money including freight.

**FREE—Big Bargain Book** Over 8,000 bargains. Write today for FREE copy.

**HARTMAN FURNITURE AND CARPET CO.**  
2945-47 Wentworth Av., Chicago





# GENUINE PERFECT CUT DIAMONDS \$97.<sup>50</sup> Per Carat

**A Clear Saving of 35%**  
Genuine perfect cut Diamonds at world's competition - amazing price, \$97.50 per carat. Full \$150.00 per carat value at retail.

**And here's the reason:**  
No middlemen's tax included in our sensational low direct import price! Cash buying from the diamond cutters, plus our "Small profits, many sales" plan, give you a clear saving of at least 35 per cent of regular retail prices.

**Free Examination!**  
You prove our claims yourself at our expense! Select any carat size diamond—choose any mounting from the thousands we illustrate in our catalogue. We ship entirely at our expense—allow full examination and comparison without obligating you to buy. Absolute satisfaction assured you by buying the Basch way.

**L. BASCH & CO.**  
Dept. H2470  
State and Quincy Sts.  
**CHICAGO, U. S. A.**

**Our Money Back GUARANTEE!**  
A written Least Contract to refund in cash full price less 10 per cent should you wish to return your diamond any time within one year; also guarantee full price in exchange any time. Certificate carat weight and value! No protection equal to this in the whole diamond business. See that your diamond is Basch guaranteed.

**1915 Basch De Luxe Diamond Book, FREE**  
Complete, valuable and authoritative! Given you expert facts needed to buy intelligently. Helpful guide to select gifts for all occasions. Thousands of illustrations of diamonds, watches, platinum and gold jewelry, silverware, cut glass, etc.—all priced to you remarkably low. You cannot afford to buy your diamond or jewelry without a copy of this complete catalogue. Mail coupon or write us a letter or post card for your free copy, NOW.

**FREE DIAMOND BOOK COUPON**  
Please mail me FREE, without it obligating me, 1915 Basch De Luxe Diamond Book.

Name .....

Address .....

L. BASCH & CO., Dept. H2470 State and Quincy Sts., CHICAGO

**G01—3/8 c. Dia. Compl. \$38.25**

**G02 Compl. \$3.95**

**G11 This Mounting Complete With**  

1/8 c. Dia.	\$12.00
1/4 c. Dia.	21.25
3/8 c. Dia.	35.00
1/2 c. Dia.	48.75
3/4 c. Dia.	71.25
1 c. Dia.	101.25

**G03 Solid Gold Dia. Set \$1.75 per Pair**

**G04—1/2 c. Dia Compl. \$50.50**

**G05—Solid Gold Dia. set Compl. \$1.00**

**G06—1/8 c. Dia. Compl. \$12.00**

**G07 Compl. \$8.75**

**G08 Dia. Pearls Compl. \$5.75**

**G09 Compl. \$3.95**

**G10 Compl. \$3.95**

**BIG CATALOG OF BAND INSTRUMENTS**

**FREE** The way to save money on the purchase of a band instrument is to send for the Lyon & Healy Band Catalog, and take advantage of our low prices. The biggest value at the lowest price has always been our motto. A \$50.00 Cornet for \$30.00. What instrument are you interested in? Write today.

**LYON & HEALY, 33-39 Adams St., Chicago**

## When You Build

please bear in mind that there is still plenty of

### WHITE PINE

Send for our free booklet, "WHITE PINE IN HOME-BUILDING."

**WHITE PINE BUREAU**  
1626 Merchants' Bank Bldg. ST. PAUL, MINN.

**10 Days Free Trial**

Play on the violin of your choice—and test it for 10 days before you decide to buy. Send it back at our expense or pay for it at the rate of only a few cents a day.

**WURLITZER** We supply the best U. S. Guit.

The products of the leading violin makers of the world are yours to choose from—Fanny, Haader, Glier, Heberlein, Fiedler, Wurlitzer, etc.

**Write Today** for Special Circular. No obligations. Get full details of our offer direct to you. Write today.

The Rudolph Wurlitzer Company, Dept. C 919  
8. Wabash Avenue, Chicago E. 4th Street, Cincinnati, Ohio

**Amazing Profits In Mushrooms**

Anybody can add \$8 to \$40 per week to their income, in spare time, entire year growing mushrooms in cellars, sheds, barns, boxes, etc. I tell you where to sell, at highest prices.

**Free Illustrated Instruction Booklet**

**HIRAM BARTON**  
Desk 2, 329 W. 48th St., New York

**TYPEWRITERS ALL MAKES**

Prices \$15.00 up, SOLD or RENTED ANYWHERE at 1/4 to 1/2 MANUFACTURERS' PRICES, allowing RENTAL TO APPLY ON PRICE. Free Trial. Installment payments if desired. Write for Catalog L.

TYPEWRITER EMPORIUM, 34-26 W. Lake St., Chicago, Ill.

**TYPEWRITERS ALL MAKES**

Underwoods, Remingtons, Oliviers, Smiths, from \$10 to \$60. Guaranteed 5 years. 500 Typewriters at \$12.50, every one perfect. Write for liberal FREE trial offer at once.

All Makes Typewriter Exchange Co., 188 N. Dearborn St., Chicago, Ill.

Hand Forged Razor Steel Blades. No. 57

## This \$2 KNIFE 83¢

DIRECT AT FACTORY PRICE

Handy shaped blade makes this knife best for mechanics, sportsmen and farmers; light but strong; resharpened easily. Stag handle, German silver finish; blades file tested, hand forged from razor steel and warrant ed. Sample 83c, 3 for \$2 postpaid. Cheapest post \$2 each.

Send for our 80 Page List and "How to use a Razor" **FREE**

**MAHER & GROSS CO., 106 A. St., Toledo, Ohio.**

# Patents

**Trade Marks and  
Copyrights Secured  
or Fee Returned**

## Special Offer—Free Search of Patent Office Records

Send us a model or sketch and description of your invention, and we will make a *Free Search* of the *Patent Office Records* to ascertain if it is patentable. If we report the invention patentable, we will guarantee to obtain a patent or return our fee, and furnish a certificate of patentability backed by a bonded contract to that effect.

**This Certificate of Patentability will protect the inventor and serve as proof of the invention until the case can be filed in the U. S. Patent Office.**

### Obtaining Assistance for Inventors

Our certificate is of great assistance to inventors who require financial aid to obtain patents.

### Our Five Books Mailed Free

(SEE COUPON BELOW)

to any address. Send for these books—the finest publications ever issued for free distribution.

#### How to Obtain a Patent

Our illustrated eighty-page Guide Book is a book of reference for inventors, and contains 100 mechanical movements illustrated and described.

#### Money in Patents

Tells how to invent for profit, and gives history of successful inventions.

#### What to Invent

Contains a valuable **LIST OF INVENTIONS WANTED** and suggestions concerning profitable fields of invention; also information regarding prizes offered for inventions, among which is

#### Prize of One Million Dollars

offered for one invention, and \$10,000 for others.

#### Patents That Pay

Contains letters from our clients who have built up profitable enterprises founded upon patents procured by us; also endorsements from prominent inventors, manufacturers, Senators, Congressmen, Governors, etc.

#### We Advertise Our Clients' Inventions Free

In a list of Sunday newspapers with two million circulation, in manufacturers' journals and in the *World's Progress*. Sample Copy Free. We save you time and money in securing patents. After the patent is granted we assist you **TO SELL YOUR PATENT**.

#### Foreign Patents

WE HAVE DIRECT AGENCIES IN ALL THE PRINCIPAL FOREIGN COUNTRIES and secure FOREIGN PATENTS in the shortest possible TIME and at the LOWEST COST. Write for our Illustrated Guide Book on Foreign Patents, sent free to any address.



VICTOR BUILDING

Our new \$200,000 building opposite U. S. Patent Office  
SPECIALLY ERECTED by us for OUR own use

## WANTED NEW IDEAS

Send for **LIST OF PATENT BUYERS** who consult us when purchasing patents. Contains requests from **MANUFACTURERS, MAIL ORDER HOUSES and PROMOTERS** for patents secured by us, and suggestions as to New Ideas they wish to purchase. We invite manufacturers and promoters to address our Sales Department regarding the purchase or leasing of a number of meritorious patents secured by us.

### REFERENCES

Second National Bank, Washington, D. C.; Union Savings Bank, Washington, D. C.; Chamber of Commerce, Washington, D. C.; Pitner Gasoline Lighting Co., Chicago, Ill.; R. G. Dun & Co., Washington, D. C.; Smethport Glass Co., Smethport, Pa.; The Melvin Gauge and Signal Co., Scranton, Pa.; M. Winter Lumber Co., Sheboygan, Wis.; National Savings and Trust Co., Washington, D. C.

### FREE COUPON!

## VICTOR J. EVANS & CO., Patent Attorneys

NEW YORK OFFICES: 189-191 Broadway

PHILADELPHIA OFFICES: 1429 Chestnut St.

Main Offices: 765 Ninth St., N. W., WASHINGTON, D. C.

GENTLEMEN: Please send me FREE OF CHARGE your FIVE Books as described above.

NAME..... ADDRESS.....

# WANTED IDEAS



Inquiries from Manufacturers and Other Buyers of Patents  
Who Are Looking for Good Ideas

## Protected by Owen Patents

Are constantly being received. Hundreds of ideas are wanted—a market exists for them to-day. YOURS may be one of them. Send for my free books and see for yourself—read the requests for inventions protected by me. Many are simple. You can help supply this demand.

As soon as my clients' rights are protected I aid in every practicable way, without charge, to sell. Their applications are advertised free—their patents are called to the attention of the proper prospective buyers—every necessary thing is done. Get my booklets and see.

## THESE ARE FREE

You will incur no obligation by writing me. A simple request will bring them to you—the finest, most reliable and instructive patent books published. A postal will do.

**"Successful Patents"**—a 72 page guide book, tells how to proceed; describes my advantageous business methods; gives references, testimonials, etc.

**"Stepping Stones"**—gives hundreds of hints of inventions wanted; articles from interviews of noted authorities; tells the truth about prizes for inventions.

**"Patent Promotion"**—tells you how to sell; why some inventors fail; discusses the value of your idea; how I aid my clients; manufacturing aids furnished you; recent successful patents, etc.

You will also be sent from time to time, as new inventions are wanted, full information concerning them. Only in this way can you keep up to date.

**Write for These To-day**—Advice costs nothing. All communications confidential. I secure patents or receive no compensation. Your work will receive my personal supervision—but my fees are no higher than others.

## Results Speak Loudest—But Here Are Some References

Columbia National Bank,  
Washington, D. C.

National Locktile Co.,  
Washington, D. C.

The Garnahan Press,  
Washington, D. C.

Lightning Gun & Cycle Works,  
Oklahoma City, Okla.

Antholene Mfg. Co.,  
Hutchinson, Kans.

National Back Co.,  
61 Hannover St.,  
Boston, Mass.

The C. J. Loftus Co.,  
13 Spring Common,  
Youngstown, Ohio

Whitehead Hosiery Mills,  
Burlington, N. C.

Dickinson Mfg. Co.,  
Des Moines, Iowa.

A LARGE NUMBER OF OTHERS IN MY BOOKLETS.



### Search of Records

Send sketch or model of your invention for free search of Patent Office Records and report on patentability.

**RICHARD B. OWEN** 9-303 OWEN BLDG.  
WASHINGTON, D. C.

Inventors submitting their inventions to me are protected in a tangible manner until their applications are filed.

# PATENTS THAT PROTECT and PAY

Advice free. Terms reasonable. Highest references. Best results.

Send sketch or model for FREE examination and opinion.

BONDED and recommended Patent Lawyer in the Rand-McNally Directory of Bankers and Attorneys Published by Rand-McNally & Co., Chicago, Ill. Recommended Patent Attorney in the Bankers Register and special list of selected lawyers published by the Credit Company, Pontiac Building, Chicago, Sharp & Allen's Directory of Lawyers and Bankers of Philadelphia, Martindale's American Legal Directory of New York City, and the Con. P. Curran Directory of Bankers and Lawyers of St. Louis.

**ALL BUSINESS GIVEN PROMPT AND PROPER ATTENTION**

A large list of strong recommendations furnished free

**WATSON E. COLEMAN, Patent Lawyer, 624 F St., N.W., Washington, D.C.**

## Money in Patents

Manufacturers are always looking for inventions. All patentable ideas should be protected by a patent. (By a Registered United States Patent Attorney.)

The great majority of money making inventions are thought of by persons, I will term amateur inventors, and nearly always are some very small or simple thing, for the reason that a large invention takes too much time and money for the average person to produce. I have inquiries from all over the country, in which manufacturers and business houses are looking for patents in every line of industry. Owing to these inquiries I am about to put inventors in direct touch with manufacturers who want patents, and thereby find a ready sale for their invention, which, for results, is far more practicable than any other mode of assistance to inventors.

A book "How to get your patent and make your profits thereon," which contains general patent information, is free and I would be very glad to have you write me for a copy of it.

**MANSSELL F. MILLS**

Registered United States Patent Attorney  
244 Commercial National Bank Building, WASHINGTON, D. C.

TRADE MARKS **PATENTS** COPYRIGHTS  
30 YEARS EXPERIENCE IN U.S. PATENT OFFICE

Do not waste your money for patents procured by incompetent solicitors. Such patents are worthless and manufacturers will not buy them, nor do they give absolute protection. Consult an expert who is known throughout the Patent world. **Costs you no more to be safe.** Head of the United States Patent Office and Commissioner of Patents under Presidents Roosevelt, Taft and Wilson and Assistant Commissioner under President McKinley. Thirty years' experience in the U. S. Patent Office qualifies me to give you expert service and to secure you fullest protection. Inquiries solicited.

Sole Offices, 150 Barrister Bldg., Washington, D. C.

**EDWARD BRUCE MOORE**  
PATENT COMMISSIONER UNDER THREE PRESIDENTS

### A Fortune to the Inventor

who reads and reads it, is the possible worth of the book we send for 6 cents postage. Write us at once.  
R. S. & A. B. LACEY, Dept. Y, WASHINGTON, D. C.

**PATENTS** C. L. PARKER  
Formerly Member Examining  
Corps, U. S. Patent Office  
PATENT LAWYER

210 MCGILL BLDG.  
WASHINGTON, D. C.

Patents, Trade Marks, Copyrights, Patent Litigation

Handbook for Inventors, "Protecting, Exploiting and Selling Inventions" sent free upon request.

**EXHAUST FROM GAS ENGINES USED FOR HEATING BUILDINGS**—A system for utilizing the heat of the exhaust from large gas engines to warm, through the medium of water, offices and workshops, dwelling houses and assembly halls in and about the works where such engines are required, is in successful operation at a large ironworks in Germany. The water

**PATENTS THAT PAY.** 2 BOOKS **\$600,000 MADE BY OUR CLIENTS**  
Protect Your Idea **FREE**  
Send data (model) for Search  
E. E. Vrooman & Co., 871 F St., Wash., D. C.

Send for **FREE BOOK** { **WHAT TO INVENT**  
**WHAT NOT TO INVENT**  
**HOW TO SELL YOUR PATENT**  
Copies of nearest Patents and report in every case without charge  
H. L. WOODWARD, 9th and G Sts., WASHINGTON, D. C.

**PATENT YOUR IDEAS** \$9,000 offered for certain inventions. Book "How to Obtain a Patent" and "What to Invent" sent free. Send rough sketch for free report as to patentability. Patents advertised for sale at our expense in Manufacturers' Journals.  
**CHANDLEE & CHANDLEE, Patent Attorneys**  
Established 16 years.  
953 F Street, WASHINGTON, D. C.

**Sell Your Patent**

We assure sales or profitable realization of a good Patent. Patent secured or our fee returned.  
The American European Patent Offices, Inc.  
309 Broadway, New York City  
Booklet free; English, French and German correspondence.

# Wanted—Ideas

## Inventors! Send for these Remarkable FREE BOOKS, Today

Complete and full information about patents, everything the inventor or manufacturer should know, has been included in these books. Never before has such an inexhaustible fund of valuable information been at the inventor's disposal. Regardless of the fact that the compilation of this information cost us thousands of dollars, we will send to all interested persons, any or all of these books, entirely without charge or obligation.

### "Millions In Patents"

This volume, 192 pages, tells the story of the romance of invention. The brain of the inventor is the magician that has made the ancient fairy tales come true. Millions have been paid for a hook, fortunes have come from a toy. Read "Millions in Patents," and you will realize that this country and all the nations of the world are ready to enrich you beyond your wildest dreams if you can contribute one useful or amusing thing.

### "What Is a Trademark?"

It is not an exaggeration to say that billions of dollars have been made out of trademarks, labels and copyrights. He who can fashion a trademark or design a label which will make a product stand out above all similar products, is indisputably a genius for whose brains the world offers almost unlimited money.

### "Foreign Patents"

A good invention is bought not by one country but by the world. "Foreign Patents" shows you how the inventor may be paid by other countries and other peoples, as well as by this nation, for his ideas and his inventions. It explains how we, through our representatives in the capitals of the world, maintain for your benefit an endless chain of opportunities which, if you take advantage of them, will girdle the earth and make of your product an agent that may bring back to you rich rewards.

### "Inventions Needed"

This book, 256 pages, lays before you a description of the active and profitable field of invention. It tells you the inventions the world needs today, the devices manufacturers are seeking for their business, the ideas for which the public will pay big money. It gives great men's ideas of the most important things needed in inventions now. Science is the key to wealth, and this key can be turned best by the inventor. This book tells you why.

### "How to Get Your Patent and Your Money"

The man who invents needs the co-operation of the man who invests. This book, 132 pages, is a guide to the inventor. It describes, according to the teachings of our experience and the lessons of men made rich by patents, how the inventor may secure money; the right amount of money, for the device which his brain has constructed. If you have invented something and desire to learn what it will cost you to get your patent and what you must do to find your market, read this book.

### "Special Bulletin of Patent Buyers"

This bulletin, 64 pages, contains copies of hundreds of letters from wealthy men who are seeking to purchase patents. Next to the idea of the invention itself, the most valuable thing to the inventor is a hint of where there is a man ready to buy the invention or to finance the inventor so that his device can be readily marketed. We act as intermediary, without one cent of charge, between the man who invents and the man who invests.

**We Secure Reliable Patents, Trade Marks, Copyrights, On Most Liberal Terms Ever Offered**

**Send Model or Sketch and Description of your invention for Free Search of the United States Patents**

**Rejected and Difficult Cases are Our Specialty**

**RANDOLPH & CO.**  
600 F St., N. W., Washington, D.C.

**RANDOLPH & CO.,**  
**WASHINGTON, D. C.**

Gentlemen: Please send me, without obligation on my part, the books indicated on margin of this coupon. (Write on margin of coupon, names of books desired.)

NAME.....

STREET.....

CITY.....

STATE.....

# SEBASTIAN LATHES HIGH QUALITY LOW PRICES

If you delight in good tools you will delight in Sebastian Lathes. For 25 years we have built lathes, and lathes only, employing skilled labor always, and improving equipment and machinery every year. Sebastian Lathes are

## STANDARD FOR QUALITY—LOW IN PRICE

They are accurate, economical, simple and durable. Many re-orders and voluntary letters from users of Sebastian Lathes prove this.

The Sebastian reputation is back of every Sebastian Lathe. You are judge and jury when you buy a lathe. We are not satisfied until you are. Look over the complete line in our new catalog. It shows Lathes for general repair work, garage and automobile work, etc.

When you buy a lathe, say "Sebastian"

ADDRESS (FOR THE CATALOG)

THE SEBASTIAN LATHE COMPANY, 107 Culvert St., Cincinnati, Ohio

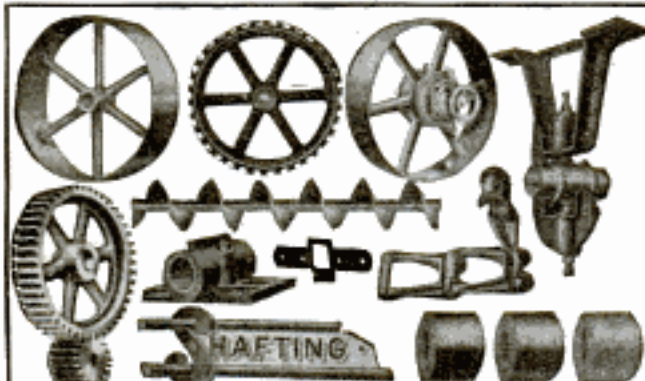
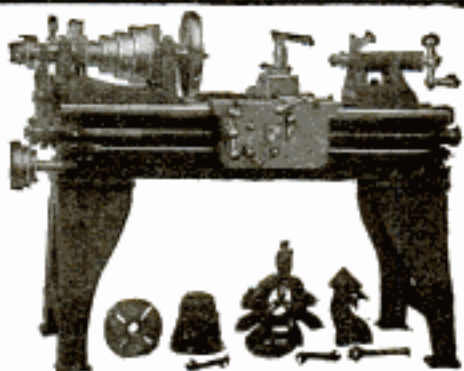

A complete line of appliances for the transmission of Power. Anything from a bolt to a complete mill or factory outfit. Send for catalogue. Largest Manufacturers of Pulleys in the country. **W. A. Jones Foundry & Machine Co.** 1400 W. North Ave. CHICAGO

## Crescent Wood Working Machinery

is high in quality, moderate in price and always gives satisfaction. Ask for catalog giving complete description of band saws, jointers, saw tables, planers, and matchers, disk grinders, variety wood workers, Universal wood workers, swing cut off saws, shapers, borers.

**The Crescent Machine Co.**  
93 Columbia St., Leontia, Ohio

## LATHES

### 9 to 18-inch Swing

List price \$75 and up according to size. When ready to buy send for Lathe Catalog and prices.

**W. F. & John Barnes Co.**  
100 Ruby Street, ROCKFORD, ILL.

is heated by the exhaust gases and circulated throughout the system by means of a small centrifugal pump driven by an electric motor. The water heaters are a form of tubular boiler, through the tubes of which the exhaust gases are discharged. As there is commonly with large gas engines an injection of cold water into the exhaust, the temperature of the gases and steam led into the

## DO YOU HAVE KNIVES TO GRIND, SILVER TO POLISH, SMALL TOOLS TO OPERATE, WASHING MACHINES OR WRINGERS TO RUN? LET THE RED DEVIL DO YOUR WORK

Attached to any water faucet will develop up to 3 Horse Power according to size of pipe and water pressure. Only perfect small motor made. Improved bucket wheel construction.

**6 in. Motor for Mechanics and Tradesmen. Washing Machines, 1/2 in. P., on 1/2 in. pipe, 80 lbs. water pressure, 1 1/2 in. P., on 3/4 in. pipe, 2 in. pipe. Net price \$5, cash with order.**

**No. 1422—4 in. Motor for grinding, polishing, fans, sewing machines; for Doctors, Dentists, Druggists, etc., with emery, buffing wheel, silver polish and pulley, \$3.**

**No. 1423—4 in. Motor and pulley only \$2.50, cash with order.** Money back for any reason. Order your motor from dealer or from us. Send your water pressure and size of supply pipe. Active Agents wanted. Catalog free.

**Only Motor to do this work**

**DIVINE WATER MOTOR CO**  
DEPT P. UTICA, N. Y.

## South Bend Lathes

For the Machine and Repair Shop

11 inch Lathe Complete	\$100.00
12 inch Lathe Complete	125.00
13 inch Lathe Complete	165.00
14 inch Lathe Complete	200.00
16 inch Lathe Complete	250.00
18 inch Lathe Complete	300.00

**How to Run a Lathe**  
A 50 cent book for 10 cents. Postpaid, stamps accepted.

**Straight or Gap Beds. Send for free catalog giving prices on entire line.**

**SOUTH BEND MACHINE TOOL CO.**  
423 Madison St., South Bend, Ind.

## MOTOR DRIVEN BENCH SAW

Saws Wood and Soft Metals  
Indispensable and most economical. For shop or private use. Full description and circular on request.

**H. G. CRANE** Cypress St. Brookline, Mass.

## GEARS SPROCKETS CHAINS

In Stock for immediate shipment  
All Kinds sizes and materials made to order.

Send for 48-page New 1915 Catalog  
**WOBURN GEAR WORKS**  
Woburn, Mass.

## Water Pumps Water

with a Rife Ram. Plenty of it for every purpose about your farm and country home—day and night, winter and summer, without fuel, labor, freezing or repairs. The

## RIFE RAM

is operated by any small stream having a fall of three feet or more and a supply of three or more gallons per minute. Fills high elevated tanks and operates air pressure system. Easy to install. First cost the only cost. Always on the job; over 11,000 in daily use. Tell us your water supply conditions. Ask for free estimate and catalog. Now is the time to install. Write today.

**RIFE ENGINE CO., 3131 Trinity Building, NEW YORK**



## This Man Makes \$2000 A Year Drilling Water Wells

"I paid for my machine in less than six months. Every dollar's income is now a dollar clear. I clean up \$2,000 every year with my

### Star Drilling Machine

Portable—Steam or Gasoline

"It's a business any man can handle—and there are contracts everywhere waiting for you to close. I never before realized what a profitable business well drilling is. And the beauty about it is, it's an all-the-year-round business."

—by a man who owns a Star Drilling Machine. We'll tell you what Star Drilling Machines will do for you if you will give us your name and address.

**Star Drilling Machine Co.**  
506 Washington St., Akron, O.



## BRASS GEARS

Cut by an entirely new process. The most accurate made and at prices that cannot be equalled by others. Every gear has a hub, center painted ebony black, edges turned iron, tightest grade red brass, and much heavier than others. We carry the largest stock in the world and every gear listed is always shipped on date of order.

SEND FOR CATALOGUE

**CHICAGO STOCK GEAR WORKS**  
16 S. Fifth Av. Chicago

## EXPERT MODEL WORKS



Die Makers and Manufacturers of  
**METAL SPECIALTIES**  
**KOHLER DIE & SPECIALTY CO.**

General Office and Works: Chicago Office and Model Works:  
DE KALB, ILL. INSURANCE EXCHANGE BLDG., CHICAGO

Advice of Our Experts Free and Confidential

heater can be regulated by increasing or diminishing the quantity of water injected. The centrifugal pump works against a head of 44 ft., and forces the water through the heater and round the circuit of conducting and heating pipes and radiators, the water entering the building at the roof level and descending through the coils and radiators to the floor level. The system has been working satisfactorily for a couple of years.



## Models and Supplies

We make working models of any description and material, also dies, tools and sheet metal stampings. Send your drawing or sample for estimate. Write for catalog of gears and model supplies.

The Pierce Model Works, 3405 Pierce Ave., Chicago, Ill.



MECHANICAL  
SUPPLIES AND MATERIAL  
of all kinds.  
EXPERIMENTAL AND  
LIGHT MACHINE WORK  
to order.

132 MILK STREET, BOSTON

## Manufacturers and Inventors:

Let us make your goods and save you putting in a large equipment. We manufacture Specialties of all kinds; Sheet Steel, Galv. Iron, Copper, Brass, Tin and Heavy Stampings. We develop new ideas, and help you put your goods on the market. Send us a sample of your work and give us a chance to figure with you. We also do Nickel-Plating, Copper-Plating and Oxidizing.

**BRAZIL STAMPING & MFG. CO., Brazil, Ind.**

Please mention Popular Mechanics



**INVENTORS** Our Brain Belongs  
Are Free of Charge. to You. Our Ideas

All we want in return is to build your model, special machinery, dies, tools and jigs to manufacture sheet metal goods, etc. We are expert mechanics, over thirty years' experience and have one of the best equipped shops in the country. Ask for Booklet No. 17. Consultation free. Experimental work strictly confidential.

**A. Naecke & Son, J. Strmann, A. Heidrich, Prop's**  
254-242 S. 9th St., Philadelphia, Pa.

Active Powers of Inventive Genius

# The Burlington Smashes

Mail the  
Coupon  
TODAY  
for Free  
WatchBook

All Watch  
Competition

## Look!



19 Ruby and Sap-  
phire Jewels—

Adjusted to the  
second—

Adjusted to tem-  
perature—

Adjusted to iso-  
chronism—

25-year gold stra-  
ta case—

Genuine Montgomery  
Railroad Dial—

New Ideas in Thin Cases.

Every fighting vessel in the  
U. S. Navy has the Burlington  
Watch aboard. This includes  
every torpedo boat—every  
submarine as well as the big  
Dreadnoughts.

**\$2.50**

**Only 2.50**  
A  
Month

And all of this for \$2.50—only \$2.50 per month—a great reduction in watch price—direct to you—positively the exact prices the wholesale dealer would have to pay. We do not care to quote these prices here, but write—write before you buy. Think of the high-grade, guaranteed watch we offer here at such a remarkable price. Indeed, the days of exorbitant watch prices have passed.

## See It First!

You don't pay a cent to anybody until you see the watch. We won't let you buy a Burlington watch without seeing it. Look at the splendid beauty of the watch itself. This model, handsomely shaped—aristocratic in every line. Then look at the works! There you see the pinnacle of watch-making. You understand how this wonder timepiece is adjusted to the very second!

## Free Watch Book

Get the Burlington Watch Book by sending this coupon now. You will know a lot more about watch buying when you read it. You will be able to "steer clear" of the double-priced watches which are no better. Send coupon today for the book and our offer.

## Free Watch Book Coupon

Burlington Watch Co.  
19th St. and Marshall Blvd.  
Dept. C119 Chicago, Ill.

Please send me (without obligations and prepaid) your free book on watches with full explanation of your cash or \$2.50 a month offer on the Burlington Watch.

**Burlington  
Watch Co.**  
19th St. & Marshall  
Bld., Dept. C119  
Chicago

Name.....

Address.....

Please Mention Popular Mechanics

## Shove the Shifter Pin

and you'll change the speed from fast to slow, or from slow to fast, without taking the drill from the work, scarcely stopping on the job. That is the big convenience of this

**"Yankee"  
Plain Hand  
Drill  
No. 1445**

A rapid worker on quick, light drilling jobs.

The speed change is only one of the many "Yankee" features in this hand drill. The spindle gears have extra strong cut teeth, not cast. The chuck accurately aligned with the axis of the tool keeps the drill point absolutely centered. Ratchet shifter has three positions—fast, slow or lock for changing drills. Polished hard wood handle is removable and contains a magazine for drill points.

**"YANKEE"  
Plain Hand Drill  
No. 1445, 3-Jaw Chuck  
No. 445, 2-Jaw Chuck  
Price, \$3.00**

15 inches long, 3½ pounds in weight, two speeds. 3-jaw chuck for round shanks, to ¾ in. diameter. 2-jaw chuck for round or square shanks.

The smallest "Yankee" hand drill made is the No. 1430. Compact, light—yet as strong and durable as the largest of them. **Price, \$1.75.**

**Your Dealer Can Supply You**

Write for "Yankee Tool Book," free. For mechanics and householders. "Yankee Tools in the Garage" free for motorists.

**NORTH BROS. MFG. CO.  
PHILADELPHIA, U. S. A.**

**"YANKEE" TOOLS**  
*Make Better Mechanics*

## The A-1 carpenter, craftsman or mechanic



Is the man who has good tools, knows how to use them and how to take care of them.

## Carborundum Sharpening Stones

are found in the tool kits and on the work benches of thousands of just such workmen.

Carborundum Stones cut quick and clean—they hold their shape, they last and they do not fill or glaze—there is a Carborundum stone for every sharpening need.

*From your hardware dealer.*

*Let us send you complete catalog and  
"The Romance of Carborundum"*

—  
The  
Carborundum Company  
Niagara Falls, N. Y.

Boston New York Philadelphia Pittsburgh  
Cleveland Cincinnati Grand Rapids Chicago  
Milwaukee Manchester, Eng. Reisholz, Ger.

*Please Mention Popular Mechanics*





## WILLIAMS' Demountable-Rim Tool

Drop-forged from a strong, tough grade of specially selected steel, each working part tempered especially for its intended use. The hammer and face of the wrench are polished bright; otherwise the tool is black-finished.

It thoroughly replaces and reliably cares for the needs of individual Screw Driver, Special Wrench, Hammer and Tire Tool, for the rapid execution of Demountable Rim and new Tire work — all tools for these purposes in one.

### List Showing Size of Nuts on Rims Which Are Usually Fitted to the Cars Mentioned

$\frac{5}{8}$ " Cadillac, Hudson, Hupmobile, Studebaker.  
 $\frac{11}{16}$ " Apperson, Cole, Locomobile, Marion, National, Packard, Pathfinder, Pierce-Arrow, White, Winton.  
 $\frac{3}{4}$ " Buick, Chalmers, Dodge, King, Oakland, Oldsmobile.  
 Openings —  $\frac{5}{8}$ ",  $\frac{11}{16}$ " and  $\frac{3}{4}$ "; length, each,  $9\frac{1}{2}$ "; weight, each, 1 lb. 6 oz. Price each, \$1.00

**J. H. WILLIAMS & CO.**  
 47 Richards St., BROOKLYN, N. Y. CITY  
 Chicago Warehouse, 36 So. Clinton St.  
 Panama-Pacific Exposition — Block 18, Machinery Palace

The total annual sulphuric-acid output of the United States is 3,250,000 tons, of which, it is estimated, the iron, steel and by-product coke industries consume 200,000 tons; the fertilizer industry, 2,400,000 tons; the petroleum industry, 300,000 tons, and explosive manufacture, 150,000 tons.

The United States is now the largest single consumer of rubber in the world.

## THE AWL YOU WANT

See That Reel



Is the genuine MYERS \$1.00 "Lock Stitch" Sewing Awl with the exclusive feature. See thread reel in front of handle under the finger tips. Natural tension. Sews heavy or light material, diamond point, full grooved needles used to protect the thread when sewing.  
**C. A. MYERS COMPANY, 6339 University Ave., Chicago, Illinois**

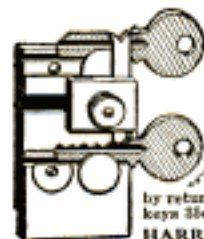

Duplicate Keys for all Pin Tumbler Locks can be made in a minute with **The Harrison M. I. P. Key Filing Machine**

Invaluable for Machinists, Building Superintendents, Hardware and Repair Shops, Locksmiths, Carpenters, Electricians, Garages, etc. Anyone can make a perfect duplicate key without injuring the original. Every machine unconditionally guaranteed. Money refunded if not entirely satisfactory. Price \$3.00 net. Send us P. O. order or N. Y. draft and receive the complete machine by return Parcel Post. Special diamond shaped files for angular keys 35c each or 4 for \$1.00. Send for circular.

**HARRISON & COMPANY, 81 NEW ST., NEW YORK**



### Tool Cases for Toolmakers and Machinists

Keep your tools orderly arranged in a Gerstner Portable Tool Case. There's a place for every tool in one of the felt lined drawers. Every up-to-date mechanic needs one and you'll find our Cases the best built, easiest and most practical on the market. We guarantee to please or refund all money. Write for our free booklet

**Gerstner Tools**

Mfrs. of Mechanics' High Grade Tool Cases  
 808 Columbia St., DAYTON, OHIO



## An Ideal Tool for Difficult Work

With the **CRESCENT THIN BENT NOSE PLIERS** you can reach work inaccessible with ordinary pliers.

The peculiar shape of the thin bent nose makes them invaluable for use on check-nuts, magnetos, terminals, etc.

**PRICE 50 CENTS**

at your dealer's or sent prepaid upon receipt of price.

Tool Catalog 111M free upon request.

Prevents  
Bruised  
Fingers

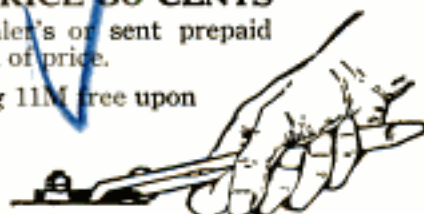

**CRESCENT TOOL COMPANY**  
 JAMESTOWN, N. Y.

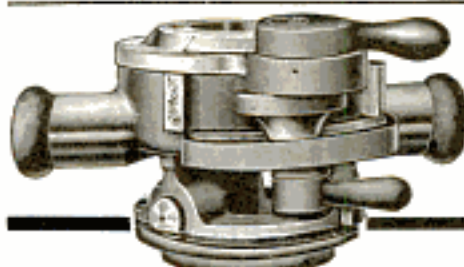

**SIX SIZES**  
 $\frac{1}{4}$ " to  $1\frac{1}{4}$ "

**80%** of your Pipe-Threading is probably in the range of this one die-stock. Bulldog Die-Stock No. 102 and the three sets of dies make a complete and profitable all-round outfit. Self-locking dies. Self-locking guides. Quick adjustment — three levers control every action. No resetting to size. No running back over newly-cut threads. Write for booklet describing Oster Die-Stocks.

**THE OSTER MFG. CO.**

2100 E. 61st St.

CLEVELAND, O.

Kindly send catalog to address below. <sup>1115</sup>

**OSTER-CUT THREADS**

Name .....

Address .....

City ..... State ..... (2100)

Please Mention Popular Mechanics

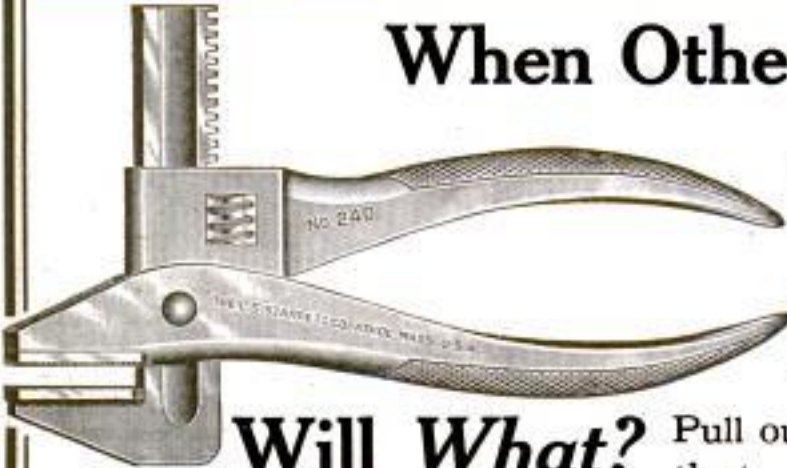

## When Other Pliers Won't Starrett Expansion Pliers Will

### Will What?

Pull out that headless nail. Start that rusted nut. Loosen that stubborn bolt. Do a hundred "mean" jobs when other tools won't.

See how they're made—the jaws are adjustable, and automatically fit the work. The fulcrum is short, giving tremendous squeeze. The handles are always right distance apart to grip with the hand. See them at your dealer's.

SEND FOR CATALOG 20 A. P.

**The L. S. Starrett Co., Athol, Mass.**  
WORLD'S GREATEST TOOL MAKERS

NEW YORK                      LONDON                      CHICAGO



### Rent This Level 9 Months — Then It's Yours

#### BUILDERS and CONTRACTORS

High price and cash payments are eliminated. For the first time it is possible to obtain a high grade Level on terms so easy that you can not afford to be without one.

**Convertible Level**



Besides its use as a Level, it can also be used for running straight lines, getting angles, taking vertical sights, etc., for which ordinarily a Transit is required.

For more than fifty years Aloe's surveying instruments have been recognized as standard instruments. This Level is offered to you with an absolute guarantee that is backed by a ten day free trial offer.

**FULL PARTICULARS** and details of our extraordinary selling plan will be sent on request.

**A. S. Aloe Co., 515 Olive St., St. Louis, Mo.**

**CHANGING THE DIET OF THE CHINESE—**  
While western peoples have to a great extent adopted the Chinese custom of taking their tea clear, without milk or sugar, the Chinese are now changing to the use of milk with their decoction of tea leaves, through the efforts of an enterprising condensed-milk company. Condensed-milk ice cream has also been introduced to the Chinese, and they like it so well that many restaurants keep it always on hand. Practically no fresh milk is to be had in China, although the natives seem familiar enough with

## BILLINGS & SPENCER

### TOOLS



When you "need them bad," you need them good

**Wrenches  
Pliers  
Scr. Drivers  
Hammers  
Ratchets  
Wrench Kits  
Tool Kits**

TRADE MARK                      HARTFORD, CT.

### Leather Case Free



#### A Handy Combination Plier

### "Red Devil" No. 1124 — 5 inch

A vest pocket tool for all around work. Grips bolts, nuts, pipes, screws, wires, etc. Thin nose for close work. Prest-o-lite opener and screw-driver. Nickel plated. A tool you'll like to work with.

Sample postpaid for 50c. Booklet free. Write today.

**SMITH & HEMENWAY CO., Inc.** 161 Chambers St. New York City

### Portable Cases

**FOR TOOL MAKERS AND MACHINISTS**

Twelve styles, felt lined drawers, solid brass trimmings, best of material, beautiful finish, low prices, satisfaction guaranteed. Ask for booklet of cases built for service.

**The Pilliod Lumber Co.**  
SWANTON, OHIO



### FREE THIS VALUABLE HAND BOOK

Tells how to help save money and make work easy for you. Just the thing for all Mechanics, Electricians, Plumbers, Steamfitters, Carpenters, Contractors, etc. Write today for this FREE handbook and state your occupation.

**VAN EXPANSION BOLT MFG. CO.**  
1209 C. East Dearborn Bldg. CHICAGO, ILL.



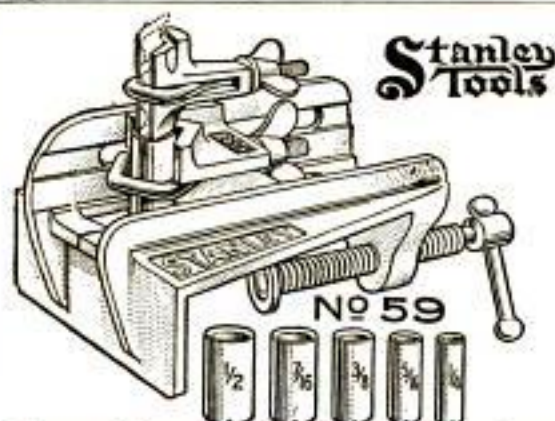

## Stanley Doweling Jig

A new and most unique tool that will enable the user to bore dowel holes in the edge, end or surface of work with the greatest ease and with absolute accuracy.

A tool that will immediately commend itself to Carpenters, Cabinet Makers, Pattern Makers,—in fact, to every artisan or amateur who has occasion to do any kind of doweling.

**Price, Each, \$1.75**

If you cannot procure this tool from your hardware dealer, we will send same, postage prepaid, on receipt of the price mentioned above.

ADDRESS

**STANLEY RULE & LEVEL CO.**  
NEW BRITAIN, CONN. U.S.A.

the virtues of both the fresh and the condensed article. Perhaps, after all, the Orientals have taken their tea clear because there was no milk to put in it and not because they thought the addition of milk ruined the beverage.

**SOLDERING MADE EASY**  
GASOLINE  
SOLDERING IRON  
BLOW-TORCH

Address Dept. 1, EMMELMANN BROS. MFG. CO., INDIANAPOLIS, IND., U.S.A.

SEND FOR OUR BOOKLET

### "The Professor and the Saw"

It tells an interesting story showing the advantages of manual training, and how to build various useful things, and contains valuable information about saws and other tools. Write for Booklet 11.

**SIMONDS MANUFACTURING CO.**  
"The Saw Makers"

5 Factories FITCHBURG, MASS. 11 Branches

Braces  
Drills

**MILLERS FALLS  
TOOLS**

Hack Saws  
Mitre Boxes

Do Better Work and Last Longer

Write for catalog showing complete line  
**MILLERS FALLS CO., Millers Falls, Mass.**



## TOOL CASES

For Up-to-Date TOOLMAKERS and MACHINISTS

We carry the finest and most complete line of mechanics' toolcases and tools in the country. We guarantee to please you or refund money. Write for free catalogue.

**J. M. WATERSTON**

177 Jefferson Ave., E. Detroit, Mich.



## A New B & S Micrometer

*Accurate—Reliable  
Popular Priced*

HERE is just the kind of Micrometer you have been looking for so long—a good-looking, reliable one at a moderate price. Because of the constant demand for such a tool, we have just brought out this new style, called the Rex. It is just as dependable in every way as any of the other 475 Micrometers in our line, which have been a standard for accurate measurements for years.

*The  
Rex*



Price  
**\$3.50**  
Less Usual  
Discounts

The improved style of frame is drop-forged and designed to combine maximum strength with lightness. The fine, dull nickel finish of the frame is pleasing and serviceable. Note the new style graduations on the hub—alternately above and below the line—making them easy reading. The measuring screw has a new and simple compensating device and the measuring surfaces are hardened. In every way it is up to the Brown & Sharpe standard and makes a handsome addition to any mechanic's kit.

Ask to see this new Micrometer at the leading hardware stores or drop us a postal for illustrated folder.

**Brown & Sharpe Mfg. Co.**  
Providence, R. I.

# BE A BIG MAN IN YOUR OWN TOWN

START A HAYWOOD  
TIRE REPAIR PLANT



## MAKE \$3000 A YEAR TO START

Sounds like a whole lot of money, and it is—looks pretty big from where you stand if you are earning just an ordinary salary at an ordinary job, but why continue 'the job? Why be on that side of the fence?

It is not every business that will permit you to start with a very small investment. Most manufacturing business require big capitalization. And rich men take the profits, while you the producer, get a salary and the small end. But here is a business that gives big returns, quick returns, and the demand for your product is ahead of the supply and increases every day in the year.

### YOUR WONDERFUL OPPORTUNITY

The certainty of success in this business is about as sure as anything in the world can be. Automobile owners increase by the thousands each year and the tires are still the least durable part of the car. Every owner tries to cut down his tire expense—every owner tries to repair his tires as long as they will hold together. Make up your mind and send for our catalog TODAY. Learn of the wonderful money making possibilities in this fascinating new business. Make something—supply a want—become a manufacturer. This is your chance. Send today for FREE catalog.

The Haywood Tire & Equipment Co., 963 N. Capitol Avenue, Indianapolis, Ind.

## "Interlox"

MASTER SLIDE RULE

Measurements of doors, windows, etc., can be taken rapidly and accurately. Also superior to all others for outside measurements of walls, ceilings, etc. If your hardware dealer hasn't this Rule, send us his name and 15c per foot (in any length from 2 to 8 ft.) and it will be sent prepaid.

SAVES TIME, TEMPER  
AND TROUBLE

The Only Interlocking Rule made—and the Only one whereby inside measurements of doors, windows, etc., can be taken rapidly and accurately. Also superior to all others for outside measurements of walls, ceilings, etc. If your hardware dealer hasn't this Rule, send us his name and 15c per foot (in any length from 2 to 8 ft.) and it will be sent prepaid.

Liberal Proposition  
for Dealers and Agents

DAHL MFG. CO., 51 E. 43rd St., NEW YORK

## WHY WELD

When you can do better work in one-fourth the time — at one-fourth the price — by using the latest great discovery

**So-Luminum**  
The Aluminum Solder

Does away with welding. No oxidization. No flux necessary. Runs at extremely low temperature. Easily applied. Gasoline torch only thing needed. Twice the strength of aluminum and much harder. **Convince Yourself by Trying It.** Price \$3.50 per lb., net cash. Tested and used already by International Motor, Locomobile, Packard, Stanley, Pierce Arrow, Brewster, Demarest, Studebaker, Simplex, Aeroplanes Mfgs. and many other companies. Write for booklet.

Sample stick (1/2 pound) \$1.50 net cash.  
SO-LUMINUM MFG. AND ENGINEERING CO., Inc.  
United States Rubber Co. Bldg., 1790 Broadway, New York  
Sole Manufacturers and owning sole rights for the whole world to sell.  
SO-LUMINUM.

DEMONSTRATIONS GIVEN



## FREE SHOE BOOK SAVES \$20

"The Sole of Steel" describes my light, springy, comfortable, economical, waterproof, all-season, general purpose shoe that saves your feet, health and money. 1 pair of "Steels" outwears 3 to 6 pairs leather workshoes. Investigate before buying shoes again. Address, "The Steel Shoe Man,"

N. M. RUTHSTEIN, Dept. 132, RACINE, WIS.



**KEEN KUTTER**  
Tools and Cutlery

Made by  
Men Who  
Know, for  
Men Who  
Know

## The Wrench of a Thousand Sizes



Universal Adjustable Wrench—a dozen wrenches in one. Instantly adjusted to grip objects of all sizes and shapes. Indispensable for the MECHANIC, CHAUFFEUR and for HOUSEHOLD purposes. From your dealer, or direct from us \$1.00 postpaid. LIVE AGENTS Wanted

THE COLYTT LABORATORIES, 567 West Washington, CHICAGO, ILL.

## Keep Tools Always Sharp with Luther Hummer Tool Grinder

Sharpens all tools quickly and easily on swift-running Dymo-Grit (artificial diamond) wheels. No water needed. Can't draw temper. Steel shaft drive. Bearings and gears enclosed and dust-proof. Perfect lubrication. Pat. adjustable tool rests. Many special attachments. Big Grinder Book Free. WHITE.



LUTHER GRINDER MFG. CO., 600 Pearl St., Milwaukee, Wis.

# DIAMONDS

ON  
CREDIT

20% DOWN

10% A MONTH

The most beautiful Diamonds are the Blue-white, especially if absolutely perfect. **LYON DIAMONDS** are 1st Quality, Blue-white. A certificate furnished with every Diamond guaranteeing its value and providing for exchange at full purchase price. Goods sent prepaid for examination and approval. Write for Catalog No. 3.

J. M. LYON & CO., (Est'd 1843) 71-73 Nassau St., NEW YORK.





The Williamson Heater Co.  
285 Fifth Ave., Cincinnati, O.

Tell me how to cut my coal bills from  
 $\frac{1}{2}$  to  $\frac{3}{4}$  with a Williamson New-Feed.

Warm Air \_\_\_\_\_ Steam or Hot Water \_\_\_\_\_  
(Mark X after System Interested in)

Name \_\_\_\_\_

Address \_\_\_\_\_

My Dealer's Name is \_\_\_\_\_

DEALER!! Let us tell you about the New-Feed UNDERFEED and our new proposition. Both are winners.

# Cut Your Coal Bills In Half Next Winter

## Guaranteed the New-Feed UNDERFEED Way

If you buy coal, you'll be glad to read this:

"I have 14 rooms and all are heated from the Underfeed furnace at a uniform temperature. I have no gas or smoke, and it gives perfect satisfaction. I use buckwheat hard coal in my furnace."

My coal bills for the past year have not exceeded \$30 where last year I heated only 6 rooms and it cost me over \$60.

There are not nearly as many ashes as from other furnaces. We feed our UNDERFEED furnace morning and evening in severe weather. At one time this spring when the weather was somewhat mild, it ran for a week without any care, and still there was fire."

(Signed) MRS. CARRIE G. YAPLES,  
239 Oak St., Binghamton, N. Y.

### How It Does It

There is always a hot fire on top of the coals in the New-Feed UNDERFEED. Fresh coal is fed from below! The fire never has to fight its way to the top. All smoke, gas and soot which must pass up through the fire are consumed and transformed into heat!

The UNDERFEED burns the cheaper grades of coal with wonderful ease and success. No smoke or dirt through the house. Few ashes. No clinkers. Adapted to warm air, steam or hot water.

A boy of 12 can operate the New-Feed UNDERFEED with "expert" results. Nothing complicated. Nothing to go wrong. No stooping. The operating principle is as simple and effective as the coal-feeding principle.

### The Williamson Heater Co.

Formerly the Peck-Williamson Co.

285 Fifth Avenue

Cincinnati, Ohio

**WILLIAMSON** CUT  
NEW-FEED COAL  
UNDERFEED BILLS  
Furnaces and Boilers  $\frac{1}{2}$ " to  $\frac{3}{4}$ "

### Get This Free Book

It will save you many an hour, and many a dollar. "From Overfed to Underfeed" tells why we can guarantee a saving of 50% in your coal bills. It also interestingly describes the wonderful principle and construction of the New-Feed UNDERFEED. Send the coupon today—NOW—for real home and pocket comfort next winter.



## Learn the perfection, luxury and economy of Colgate's Shaving Lather

STICK—POWDER—CREAM

"As You Like It"

Your dealer can supply you with the method you prefer, or we will send you a trial size of your favorite for 4 cents in stamps.

COLGATE & CO., Dept. 81, 199 Fulton St., New York

## BUILD A



## SFT. CURTISS FLYING BOAT

We have accurate scale drawings and knock-down parts of all man-carrying aeroplanes for class-room demonstrations, exhibition purposes, etc. Students of aeronautics, everyone with an inquiring turn of mind, should construct one of these fascinating models.

### PRICE OF 3 FT. SCALE DRAWINGS

Curtiss Flying Boat...25c | Wright Biplane...25c  
Nieuport Monoplane...25c | Curtiss Hydroplane...25c  
Bleriot Monoplane...15c | Cecil Peel Racer...25c

Complete set of six, \$1.25 postpaid

50 pp. "Ideal" Model Aeroplane Supply Catalog & Ideal Aeroplane & Supply Co., 82-88 West 87th St., New York

# DIAMONDS ON CREDIT

20% DOWN 10% MONTHLY

Let us send you any Diamond you may select from our catalogue so you may compare our values with those offered by other dealers; be convinced that our IMPORTER'S PRICES offer you a great saving.

We furnish a guarantee certificate with every Diamond and allow the full purchase price on all exchanges. We will send express prepaid any Diamond or other article, for examination and approval, you to be the sole judge as to whether you keep it or return it at our expense.

Write today for our free catalogue de luxe No. 9, and see how easy it is for you to own and wear a beautiful Diamond. L. W. SWEET & CO., Inc., 2 and 4 MAIDEN LANE, NEW YORK CITY.



# STOP USING A TRUSS

Do Away With Steel And Rubber Bands

## FREE TRIAL



PAT'D  
APRIL 6  
1909

Inner surface is made adhesive to secure the FLAPAO-PAD firmly to the body, keeping the PLAPAO continually applied and the pad from slipping. No straps, buckles or springs attached. Soft as velvet—easy to apply.

It's the Non-Slip- ping, yet Non-Rigid Pad and What is Within It That Counts

### FREE to 5,000 Truss Sufferers

To the first 5,000 Sufferers who write, I will send, ABSOLUTELY FREE, a sufficient quantity of the Plapao to positively convince them that this is the only logical, common-sense way of treating rupture. Plapao is a highly astringent medication placed within the Plapao-Pad and being absorbed through the skin, creates a wonderful feeling of relief and at the same time tends to strengthen the weakened muscles and thus permanently close the rupture opening. The process of recovery is natural, so you'll have no use for a truss—you can throw it away forever! Old and young have testified under oath that the Plapao-Pads cured their rupture—many of them long-standing, aggravated cases—without delay from work. Patent allowed in U. S. and foreign countries. Awarded Gold Medal at Rome and Grand Prix at Paris.

**Send No Money**—for a sufficient quantity of the Plapao is sent without charge to enable you to give it a thorough test; you pay nothing for this trial now or ever. Write for it and full information today. Address: Plapao Laboratories, Block 1427 St. Louis, Mo.



When the "boys" spy the trim, dainty figure of alluring little Miss

### SEPTEMBER MORN

so handsomely embossed on these WATCH FOBS, they go to them like hungry wolves. ROSE GOLD FINISH; twice the size shown here; genuine Leather strap. A smashing big hit!—get this classy fob and BIG MONEY agent's offer to-day, 25c. postpaid.

**BUFFALO EMBLEM JEWELRY CO.**  
411 Morgan Building, Buffalo, N. Y.



**Eckson Artificial Limb Co., 38 Wash. Av. No., Mississippi, Miss.**  
Light Socket Does Not Chafe Overheat or Drain End of Stump

We are Under Govt. Bond

## Deafness

Write today for our 168 page FREE book on DEAFNESS.

**WILSON EAR DRUM CO., Incorporated**  
715 Inter-Southern Bldg. Louisville, Ky.

## NO MORE BALD HEADS



When our VACUUM CAP is used a few minutes daily. We accept no pay until you have tried the Cap 30 days and are satisfied. The Vacuum Cap is an appliance that draws the blood to the Hair Roots and starts a new healthy crop of hair. It stops Dandruff, stops the hair from falling out. Bought by Doctors and men who

know that it is the only reasonable HAIR GROWER known to science. No Drugs Used. Write for application blank, testimonials, and booklet on "HAIR" sent sealed in plain envelope, FREE.

**THE MODERN VACUUM CAP CO.**

U. 559 BARCLAY, DENVER, COLO.

## MAKE MONEY HERE

LEARN THIS NEW WAY

**YOUR CHANCE** to Make \$5,000 a Year, AGENTS, SALESMEN,



get started in an honest, reliable, money-making business. The wonder of the 20th Century. Hickman writes, I am making \$21.00 per day. Mills made \$15.00 in 2 hours. Spain takes 9 orders first day. World's magical gift has been realized by this new invention.

### The Blackstone Water Power Massage Machine

For the Home  
Lasts a lifetime; price within reach of all. Removes black- heads, wrinkles, rounds out any part of face or body; brings back nature's beauty. Endorsed by Doctors and Masseurs, Sells itself; no experience required; we help you.

**FREE** Our big book, "The Power and Love of Beauty and Health." Investigate. Now. Today. A postal will do. A big surprise awaits you.  
**BLACKSTONE MFG. CO., 88 Meredith Bldg., TOLEDO, O.**



### I will send my 25c Book **Strong Arms** for 10c in stamps or coin

Illustrated with twenty full-page half-tone cuts showing exercises that will quickly develop, beautify and gain great strength in your shoulders, arms and hands, without any apparatus.

**PROF. ANTHONY BARKER**  
646 Barker Building, 110 W. 42nd St., NEW YORK

For **MEN, WOMEN and CHILDREN**



## ABOUT MUSHROOMS

How to really make big money in mushrooms is fully explained in the wonderful book, "The Truth About Mushrooms," a great revolutionary improvement, things many growers never knew before. Everything explained from A to Z, at first hand, from the greatest practical authority in America. Add \$10 to \$75 a week to your income. Demand exceeds supply. Grow in cellars, sheds, boxes, etc. Small capital to start. Profits larger and quicker. Anyone can do it. Women and children too. Now is best time. Send for free book.

**BUREAU OF MUSHROOM INDUSTRY, Dept. 201, 1342 N. Clark St., CHICAGO**

## BARODA DIAMONDS

FLASH LIKE THE GENUINE—AT 1-50 THE COST  
**SOLID GOLD MOUNTINGS** Stand acid test and expert examination. See them first, then pay. Catalog FREE. Patent Ring Gauge included for 5 two-cent stamps. The Baroda Co., Dept. 85, 1456 Laird Ave., Chicago



A complete collection of finished and unfinished specimens of every variety of wood known to man, from the pine of northern Wisconsin to the eucalyptus that thrives on the Australian deserts, is on exhibition at the University of Wisconsin.

## BUY PLUMBING and HEATING SUPPLIES

at **WHOLESALE** Will Save You 30%  
Don't pay retail prices. Full stock on hand for prompt shipment. Send for free catalog.

**B. P. KAROL, 800-802 South Kedzie Ave., CHICAGO**

## A NEW WAY To Get Your Clothes Free

Make Big Money During Spare Time

Something Different, bigger, more liberal than any offer ever made. Lower prices—better clothes—bigger cash profits Express paid on everything.

### Double Pay

FREE clothes and cash besides. We don't ask you to use your cash profits for your own clothes. Ours is a new and better plan. An Extra Present with every order. Not a prize scheme. Choose what you want, work for it and get it besides your Cash Profits. Complete Outfit FREE, 56 real cloth samples, 50 Fashion Plates, inside wholesale prices. Get the big money. Your name on a post card brings everything FREE.

**SPENCER MEAD CO., Dept. 607, Chicago**

# Pope Motor Cycles



Model M-15 Single Cylinder . . . \$200  
With Pope 2 Speed . . . . . 240

The most advanced type of single cylinder machine—carefully built as a high grade auto, and having many distinctive features immediately appreciated by the experienced motorcyclist.

The superiority of the POPE Overhead Valve Motor, in this model, has been thoroughly demonstrated—it develops a wonderful amount of power and takes hills impossible to other machines of its class. Model M-15 is a sturdy, comfortable riding machine, smooth running, easily controlled, swift and powerful.

The POPE Trade Mark guarantees the quality; it stands for years of practical experience and a constant endeavor to construct the very best motorcycle possible to produce.

Motor Cycles—6 models: Single cylinder—twins, 2 speeds.  
Bicycles—92 models: Special light and heavy weights and juveniles.

Send for either catalog you wish.

**THE POPE MFG. CO.**

16 Cycle Street Westfield, Mass.

**FOODSTUFF EXPORTS OF THE UNITED STATES**—A comparison of the exports of the United States for the years 1913 and 1914 shows that wheat increased from 99,360,278 bu. to 173,246,305 bu.; flour, from 12,216,515 to 12,625,135 bbl.; and oats, from 5,202,717 bu. to 35,029,585 bu., while corn decreased from 44,709,954 bu. to 15,107,410 bu. Fresh beef nearly quintupled, while pickled and salted beef slightly decreased, the former advancing from 6,618,831 to 31,245,438 lb., and the latter receding from 24,804,600 to 23,675,266 lb., though this downward tendency was reversed in the closing months of the year.

## 1915 Harley-Davidson

Winner of the International Grand Prize Race at Venice, California, April 4th.



Complete description of various models can be obtained from any dealer or catalog will be mailed on request.

**HARLEY-DAVIDSON MOTOR COMPANY**  
Producers of High Grade Motorcycles for Fourteen Years  
431 B Street Milwaukee, Wisconsin



THINK of a detachable bicycle Motor that you can attach to any bicycle in 5 minutes and ride at any speed up to 25 miles an hour—100 to 125 miles on one gallon of gasoline. Thoroughly practical—simple and economical. Full control from one small thumb lever attached to the handle bars of the bicycle. Descriptive literature on request.

**A. O. SMITH COMPANY**  
Motorwheel Division 92  
MILWAUKEE, WISCONSIN



## Firestone CYCLE TIRES

Toughest, thickest, most resilient tread. Built like a motor-car tire. All sizes: Non-Skid and corrugated tread.

Firestone Tire and Rubber Company  
Akron, Ohio—Branches and Dealers Everywhere

## BOYS The best made Bike Pumps are

### "Bridgeport" Pumps

They're strong and durable. Will out-last any other make on the market.

Send for new booklet on Pumps and "Search-Light" Lantern.

Bridgeport Brass Company  
Bridgeport, Connecticut



**Convert Your Bicycle into a Motor-Cycle** Motor fits any wheel. BEST, MOST RELIABLE. Best hill climber. More STEFFEYS in use than all others. Stamp for circulars. STEFFEY MFG. CO., 5007 Brown Street, PHILA., PA.

**We Save You \$\$\$\$**  
Buy your Motorcycle accessories from the largest supply house in the United States.  
Our 1915 catalog listing 3015 accessories sent **FREE**  
You can't be an up-to-date rider without one. It is the one others try to copy. You need it, so send us your name and address today.  
MOTORCYCLE EQUIPMENT CO., HAWMONDSPOUT, N. Y., LOS ANGELES, CAL.

**Don't Throw Away Your Worn Tires**  
For over three years European motorists have been getting from 10,000 to 15,000 miles out of their tires by "half-soiling" them with Steel Studded Treads. In eight months 20,000 American motorists have followed their example and are saving \$50 to \$200 a year in tire expense.  
**We ship on Approval** without a cent deposit, prepay the express and allow you to be the judge.  
Durable Treads double the life of your tires and are sold under a signed guarantee for 5,000 miles without puncture. Applied in your own garage in thirty minutes.  
**Special Discount** offered to motorists in new territory on first shipment direct from factory. A postal will get full information and sample within a week. Size of tires. Don't wait—write today. Address nearest factory office.

**THE COLORADO TIRE & LEATHER CO.**  
844 Tread Bldg., Denver, Colo. Dept. H44, Box 228, Chicago, Ill.  
Suite 448, 162 W. 34th St., New York, N. Y.

Please Mention Popular Mechanics

**I**F EVERY reader of this advertisement could secure a demonstration of the

## HENDERSON

—feel for himself the steady, resistless "push" of the four cylinders, he would be permanently converted to the four cylinder motorcycle. Just as the man who once rides in an "8" automobile ever after scorns those of lesser smoothness and flexibility.

**Henderson Motorcycle Company**  
1160 Cass Avenue DETROIT, MICH.

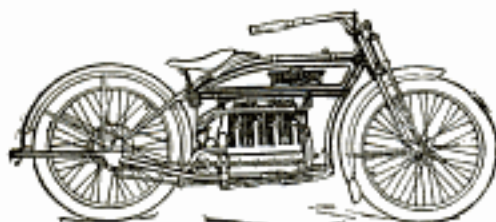

## Mobiloils

*A grade for each type of motor*

### \$40 Motorcycle



We have the largest line of new and used motorcycles and supplies in the Country at the lowest prices. Every machine guaranteed. We handle parts and repairs for any machine on the market. Send us your machine to be overhauled. We exchange motorcycles. Motors and castings for airships and railway velocipedes.

SEND FOR CATALOG

HARRY R. GEER CO., 888 McLaren Ave., ST. LOUIS, MO.

**"100 Miles for 10 Cents"**

### MIAMI MOTOR BICYCLE

**SAFE—SILENT—CLEAN**  
PRICE \$125.00 WEIGHT 110 LBS.  
SEND FOR CATALOG

THE MIAMI CYCLE & MFG. CO.  
600 Mobile Ave. Middletown, Ohio

### 5 H. P. 1915 Peerless Motorcycle



with Free Engine, Bosch Magneto, together with the best there is in Motorcycle construction, Power, Speed, Silence, Endurance, and these wearing qualities essential for low cost of maintenance.  
5 MILES FOR ONE CENT  
Agents Wanted—Liberal Discount!

PEERLESS MOTORCYCLE CO., 179 Hunting Ave., BOSTON, MASS.

## Make Over \$60 a Week Repairing Auto Tires

Go into the automobile tire repairing business and make \$60 a week and over. One man made \$45 the first day. Others are making \$25 a day. Hundreds are making \$200 to \$500 a month. No experience needed. **Be your own boss.** Very little capital required. We teach you everything. Jobs are plentiful because tires blow out and puncture every day.

### SHALER Tire Repair Outfit \$60

Does the same work as the big high priced vulcanizing outfits. You can use it. It's the only vulcanizer that has Automatic Heat Control. It can't undercure or overcure a tire. Requires no watching or regulating.

### FREE BOOK

tells how to open a Tire Repair Shop and make big money. Don't delay.

Write now—before you forget.

C. A. SHALER CO.  
1505 4th St.  
WAUPUN, WIS.

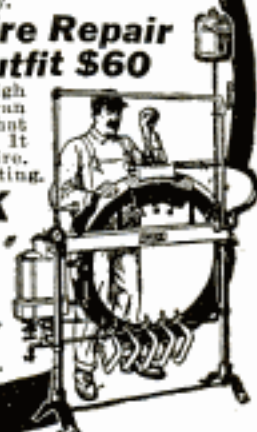

## AGENTS Wanted

Calling on Ford owners to sell necessities. **50 per cent Profit.**

**MORGAN MANFG. CO.**  
Bellevue Street NEWPORT, R. I.

**SETTING CONCRETE BY STEAM**—In the construction of a 27-mile concrete pipe line from Sooke Harbor to Vancouver, B. C., steam was successfully used for setting. Each section of the pipe was immersed in live steam for 24 hours, with the result that the concrete set as well as it would have done by a month's exposure to the air.

### \$40 Motorcycles and Bicycles at Cut Prices



Second-hand and rebuilt motorcycles, singles and twins, \$25 to \$100. Motorcycle tires, \$3; Automobile tires, \$3. Second-hand bicycles, \$5; tandems, \$10. New bicycles and motorcycles at factory prices. Buy direct, save dealer's profits.

SEND FOR CATALOG  
DENINGER CYCLE CO., Rochester, N. Y.

### The Electrically Equipped Indian Motorcycle

With Cradle-Spring Frame. Send for Free Catalog.  
Hendee Manufacturing Co., 318 31st St., Springfield, Mass.

### Drink Pure Water

Perfect health demands it. Disease lurks in impure water. Insure purity by installing a

#### Behner Self-Cleansing Filter

Gives you constant supply of crystal water, pure as ozone. Inexpensive. Anyone can install without tools. Lasts a lifetime. Full particulars on request.

Behner Mfg. Co. 10098 So. Wabash Av. CHICAGO, ILL.



Guaranteed to give satisfaction or money back if returned in 15 days.

## Garage \$69.50

10x12feet "Steelcote" Edwards ready-to-use garage, \$69.50 complete. Factory price. Fireproof. Portable. Quickly set up. All styles and sizes of garages and portable buildings. Send postal for illustrated catalog.

THE EDWARDS MFG. CO.  
320-370 Eggleston Ave., Cincinnati, O.





# BESSEMER KEROSENE ENGINE

FREE TRIAL 30 DAYS

## A Real Kerosene Engine

Bessemer Kerosene Engines are real kerosene engines, not a converted gasoline engine. The use of kerosene or lamp oil is made possible by the Bessemer Universal Fuel Feeder, controlled exclusively by us.

Or will use alcohol or gasoline. Sizes 2-4-6-8-10 H. P. Also direct connected to pumps, hoists, air compressors, electric lighting plants, saws, farm machinery, etc.

Owing to low cost of operation it is best economy to have a Bessemer wherever odd power jobs are to be done. The Bessemers are money makers for their owners, because they can be used for so many purposes. Let our free catalogue "K" give you proof and facts. Write for it today.

## Bessemer Fuel Oil Engine

Where power from 15 to 165 H. P. is required, Bessemer Fuel Oil Engines are recommended. They burn crude and fuel oil and thus run at about  $\frac{1}{3}$  to  $\frac{1}{4}$  the cost of gasoline. Now being used in irrigation, flour mills, factories, lighting plants. This engine is revolutionizing the power question. Get the facts in free catalogue "O."

**BESSEMER GAS ENGINE CO.**  
121 Lincoln Ave., GROVE CITY, PA.



**REVEGETATING KODIAK ISLAND**—After the eruption of Mount Katmai, Alaska, in June, 1912, which covered the agricultural and grazing lands of the island of Kodiak with a deep layer of volcanic ash, the U. S. agricultural experiment station at Kodiak has conducted experiments in reclaiming the waste lands for vegetation. The work has now progressed so far that the government herds of Galloway cattle have been returned to the reservations on the island. The experiments have shown that by adding nitrogen to the volcanic ash or mixing the lower

## "VIM" ENGINE



**\$25 COMPLETE**

Save money by using a **VIM 1 1/2 HP.** Farm Motor for churning, washing, pumping, separating, spraying, etc. Women operate easily. No valves, cams, gears or complicated parts. Water Cooled, automatic positive lubrication, sensitive governor. Weighs only 75 lbs. Comes ready to run. Fully guaranteed. Get catalog and special agency offer. **THE VIM MOTOR CO., 808 Water St., SANDUSKY, OHIO**

## Cushman Light Weight Engines

Easy to move around from job to job, or may be attached to other machines (moving or stationary) to drive all or part of the machinery. **4 H.P. weighs only 190 lbs.; 8 H.P. only 320 lbs. and 20 H.P. only 1200 lbs.** No heavy bases or large fly-wheels. Steady and quiet, because of sensitive **Throttle Governor** and perfect balance. Forced water cooling system. Run at any speed. Schebler Carburetor and Friction Clutch Pulley. Not a cheap engine, but cheap in the long run.

Ask for Engine Book

**Cushman Motor Works**  
882 N. 21st St., LINCOLN, NEB.

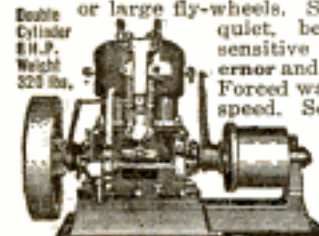

## Read these

Lower Cost of Demand for Low Prices

Price Making Lower Prices Now

Engine Power Lower Cost of Operation

Easy Terms of Purchase

Ed. H. Witte



See These Latest Prices.

## WITTE Engines

Easy To Start. No Cranking.

### Stationary

2 H.P.	\$34.95
4 H.P.	69.75
6 H.P.	97.75
8 H.P.	139.65
12 H.P.	197.00
16 H.P.	308.80
22 H.P.	389.65

### Portable

2 H.P.	\$39.95
4 H.P.	82.75
6 H.P.	127.75
8 H.P.	174.65
12 H.P.	237.00
16 H.P.	358.80
22 H.P.	442.15

### Saw-Rigs

6 H.P.	\$152.25
8 H.P.	202.15
12 H.P.	267.00

Ed. H. Witte.

These Two Pages In My Free Book Show How You Can Use Mechanical Power for Less Money Than Ever Before.

**THOUGH Low Price is important, an engine's real quality is based on Durability and Fuel Economy.** You pay a certain price to become the owner of an engine—but that does not end it. Every hour that your engine runs it uses fuel. Unless it delivers the maximum of power for fuel consumed, it is **wasting your money**—and every dollar in fuel energy wasted is more than a dollar added to that engine's cost price.

### Fuel Saving

## WITTE ENGINES

Kerosene, Distillate, Gasoline, Gas.

Cost less in the first place, and **Quickly Pay for Themselves in the Fuel they Save.** Built on the WITTE principle, the result of 28 years of my life devoted exclusively to designing and building engines. Simple, safe, easy to start, easy to run, they will do more work for less fuel and upkeep cost—all the quality any engine can have.

Direct From Factory To User.

## CASH or EASY TERMS

Liberal Five-Year Guarantee.

Send name and address, and with no obligation on your part, you will receive by return mail a copy of my latest Engine Book, telling

How To Know Engines, why WITTE engines cost less to own and operate, and explaining my New Liberal Selling Plan. See this book before you buy any engine. Write today.

Read My **FREE Engine Book**

**ED. H. WITTE,**  
Witte Engine Works,  
1742 Oakland Ave.,  
Kansas City,  
Missouri.



Please Mention Popular Mechanics

## A Real Kerosene Engine

Here's the biggest engine value ever offered in a 1½ H. P. engine. Same cylinder capacity as many 2½ H. P. engines. Throttling governor adjustable while running; crankshaft extends on both sides. Runs either way. Starts without cranking. Equipped with Ellis Patent Fuel Device, guaranteeing successful operation on cheap oils. Beautifully finished in genuine engine enamel.

**Runs on 9c a Day** Just the engine for pumping, separating, churning, corn-shelling, sawing, shop work, electric lighting and dozens of other light jobs. Sold on 30 days' trial. Guaranteed for 10 years. We make other sizes from 3 to 18 H. P., vertical and horizontal, single and double cylinders.

Ask for our free book, "ENGINE FACTS," telling how to judge and buy an engine.

**ELLIS ENGINE CO., 2873 E. Grand Blvd., Detroit, Mich.**

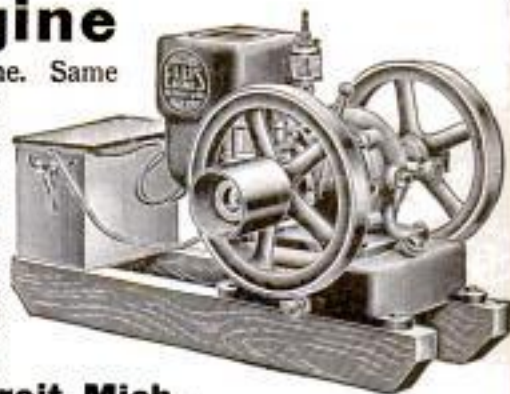

Buy  
Reliable  
Power

People who are familiar with the construction and the reliable operation of International Harvester engines—Titan or Mogul—often grow enthusiastic and declare that you would have to take all the good points on all other engines and combine them, in order to get the equal of the engine with the I H C mark.

Strictly speaking they are wrong. Such a composite would still not equal any engine in the I H C lines for it could not include the famous individual features that you find on no other engine made.

## International Harvester Engines

long ago outstripped every other brand or make or manufacture, in sales and in popularity.

Whatever your use for engine power, you cannot afford not to consider International Harvester oil engines—Titan and Mogul. Made in all styles—built for all power purposes—in sizes from 1 to 50 H. P. They run on the cheapest or most convenient fuel.

Ask us to do these two things—send you an interesting catalogue showing the I H C engine features, and tell you the name of the nearest I H C dealer.

**International Harvester Company of America**

(Incorporated) Chicago U S A  
16 Harvester Building

## 6 H.P. \$96<sup>75</sup>

1½ H.P. \$24.75	5 H.P. \$ 87.50
2 H.P. 28.75	8 H.P. 135.50
3 H.P. 53.90	10 H.P. 179.90
4 H.P. 68.90	12½ H.P. 214.90

Many other sizes—all sold direct and fully guaranteed. **EG 32-PAGE CATALOG FREE.** Write today.

**OTTAWA MFG. CO., 252 King St., OTTAWA, KANS.**

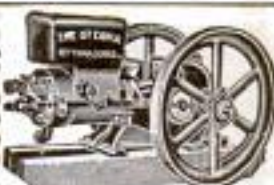

## RELIABLE POWER

Nearly 100,000 Galloway engines in daily use. Large bore, long stroke, heavy weight. Built for hard, continuous engine-users' satisfaction. All sizes, prices, styles. Modern design, few parts. Best materials, skilled labor. Positively not over-rated. Sold direct. Engine book free. Postal gets it.

Box 965

**WILLIAM GALLOWAY COMPANY**  
Waterloo, Iowa

9875  
7750  
3950  
3475  
2675  
17<sup>95</sup>  
17<sup>50</sup>  
H.P.

rich soil with the ash, excellent crops can be raised. A special plow for the latter purpose has been developed by the experiment station.

## 2 H.P. MARINE MOTOR \$29<sup>95</sup>

30  
Days  
Trial

Positively the highest grade. Best materials. Best workmanship. Simplest design. Easy to operate and install. Guaranteed for life.

### Sold Only Direct to Users

this reducing sales expense. This saving coupled with our quantity production and tremendous buying power enables us to furnish you a No. 1 motor at a fraction of the price others charge. Size range from 2 to 30 H.P. Furnished to run on gasoline or kerosene. Send for catalog "A."

**American Engine Company**  
605 Boston St.  
Detroit, Michigan

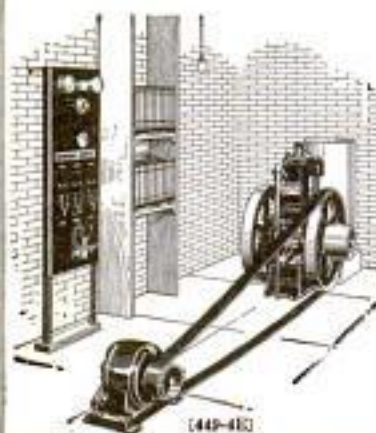

## Make Your Own Electric Light

Electric light at instant command—current under your own control—is what you secure with the Fairbanks-Morse Electric Plant. Complete—independent—very easy to operate.

## 24-Hour Service with This Electric Plant

Suited to needs of farm, home, store, or wherever lights are wanted. Not necessary to start engine to get light because batteries supply current when engine is not running. Made in sizes from 20 lights up. Write for details.

**Fairbanks, Morse & Co.**  
Chicago New York San Francisco



**A NOVO  
will prove a  
Money-Maker  
for YOU**

A **Novo** will surely increase your output, or cut down your pay roll. **You win either way.**

**Novo** simplicity, **Novo** lightness, **Novo** portability, **Novo** compactness—these "big-four" features—are found in no other engine. There isn't an engine made that will do your work at a lower-unit cost than **Novo**. One good sized job will pay for a **Novo** and a **Novo** will continue to be a money-maker for you long after cheaper engines have hit the scrap pile.

**Novo** Outfits include all kinds of Power Pumps, Hoists, Air Compressors, Saw Rigs. **Novos** are ideal for furnishing power for lighting outfits; for furnishing water for country homes and estates. Every **Novo** guaranteed against freezing.

**NOVO Engine Co.**

598 Willow St., Lansing, Mich.

Clarence E. Bement, Secy. and Mgr.  
or Station A, San Jose, Cal.

European Office: Edgar Backlund, Representative  
12-14 Broad Street House, London, E. C.

**NOVOS**  
can be  
furnished  
for  
operating  
on  
gasoline,  
kerosene,  
alcohol or  
distillate.

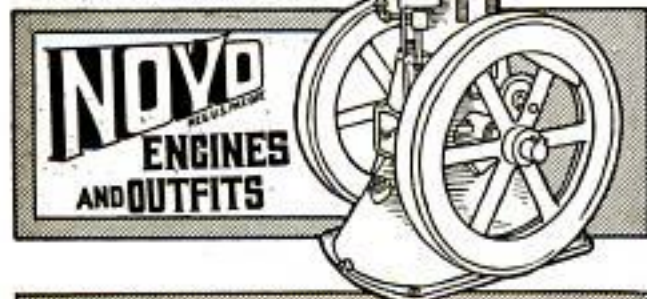

**A SWIMMING MACHINE**

Faster than the fastest swimmer.  
You need not know how to swim.

Send for Circular "E."  
**The Yankee Skipper \$5**

Delivered

Pat. App. for  
Agencies Open **THE MARINE CO., BELLEVILLE, N. J.**

**GET THIS CATALOG**  
FULL OF VALUABLE INFORMATION TO EVERY  
BOAT OWNER ON  
**RACING PROPELLER WHEELS,  
REVERSE GEARS AND  
MARINE ACCESSORIES**  
LARGE CATALOG FREE. SEND TODAY  
**MICHIGAN WHEEL CO.**  
1139 MONROE AVE., GRAND RAPIDS, MICH.

**Camp Guide FREE**

Only **\$2.25**  
Write today. Get our great "Camp Guide," which tells all about camp life; how to lay out a camp; what to take along; what to do when you get there. We will send this great book absolutely free. Just send a post card. Do it NOW.  
**Army Shelter Tent** Order at once—only \$2.25. Some tents that are in active service in U.S. army. Write for details.  
**H. Channon & Company—Dept C119—102 N. Market St., Chicago**

**KERMATH Marine Engines**

"America's Standard 4 Cycle Marine Motor"  
4 Cycle, 4 Cylinder, 12 to 20 H.P. Highest quality. Silent operation. No vibration. Controls like the finest Motor Car engine. Extremely economical on fuel. Used as standard equipment by over 80 per cent. of the world's leading boat builders. Catalog on request, \$1.00 to \$3.00 depending on equipment.  
**KERMATH MFG. CO., Dept. P., Detroit, Mich.**



## "Jack of All Trades" —or Master of One?

When Joe left school he took the first job that came his way. He didn't like it very well so he tried something else, and, drifting along from one occupation to another, realized too late that he was merely a "jack of all trades and master of none."

Bob, on the other hand, decided to fit himself for a specific position, so he worked and studied along his chosen line until he got the job he wanted. Now he's a big man in his profession, and is liberally paid for the special knowledge he possesses.

Are you dissatisfied with your work? Then make up your mind to get the training you need to enter some congenial, well-paid trade or profession. Pick out the occupation you like best and specialize in it. *Don't be a "jack of all trades"—be master of one.*

### How you can get this training

Through the American School you can obtain the training you need without leaving home—without giving up your work. No matter where you live, the American School will fit you for any position you desire or prepare you for entrance into any resident college.

Follow this advice and train yourself in your spare time for one of the countless big, well-paid positions always open. Sign the coupon and let us tell you how easy it is. We'll not send an agent to bother you in your home or at your work. All business will be carried on privately, by correspondence.

*Now is the time to take the first step—sign the coupon!*

# American School

of Correspondence, Chicago, U.S.A.

## Your Opportunity Coupon

Check the course you want and mail the coupon now

American School of Correspondence, Chicago, U.S.A.

Without any obligation on my part please send me your Bulletin and advise me how I can qualify for the position marked "X." *Pop. Mech. 8-15*

- |                               |                         |
|-------------------------------|-------------------------|
| ....Electrical Engineer       | ....Lawyer              |
| ....Elec. Light & Power Supt. | ....Business Law        |
| ....Hydroelectric Engineer    | ....Business Manager    |
| ....Telephone Engineer        | ....Auditor             |
| ....Architect                 | ....Accountant          |
| ....Architectural Draftsman   | ....Cert'd Public Acc't |
| ....Building Contractor       | ....Private Secretary   |
| ....Building Superintendent   | ....Stenographer        |
| ....Structural Engineer       | ....Bookkeeper          |
| ....Structural Draftsman      | ....Fire Ins. Inspector |
| ....Mechanical Engineer       | ....Fire Ins. Adjuster  |
| ....Mechanical Draftsman      | ....Fire Ins. Expert    |
| ....Civil Engineer            | ....Sanitary Engineer   |
| ....Steam Engineer            | ....Plumber             |
| ....Shop Foreman              | ....Reclamation Eng.    |
| ....Shop Superintendent       | ....Textile Boss        |
| ....Sheet Metal Draftsman     | ....College Preparatory |

We also prepare for civil service examinations in all engineering subjects

NAME .....

ADDRESS .....

# SATIN LINING FREE

## Our Guarantee

*We Guarantee to please you in style, fit, fabric, and workmanship or you don't pay us one cent*

## In This Handsome Blue Serge Suit

Our system of selling fine tailoring direct—through no stores, agents or dealers, saves you big money and enables you to dress better. We want you to become one of our regular customers—that's why we will make one of our regular all-wool worsted blue serge suits

**Tailored-to-Your-Measure (\$25.00 VALUE) \$15**

and line it with guaranteed \$4 satin lining free—also pay shipping charges. Head the guarantee—we take all the risk—you take none.

**NEW FALL BOOK 70 Samples Mailed FREE**

Contains generous samples of our plain and fancy suitings (prices \$15 to \$27)—explains our tailoring system—quotes lowest prices on men's furnishings, hats and shoes.

Send for your copy today to

**BERNARD-HEWITT CO. Desk D28 564 W. Monroe St. Chicago**



## BUILD THIS SPEEDY RUNABOUT—SAVE 2/3 BOAT BUILDER'S PRICE

Why not enjoy the fun of boating in your own boat—one that you can say you built yourself—and that you can feel sure is thoroughly seaworthy—built in the latest, most classy design? You can do it in spare time. It's good sport in itself—fine exercise. You create something that you can be proud to own. We make three propositions: We send full sized patterns, or knocked-down frame and patterns, or the complete knocked-down boat, every part fitted and shaped ready for you to assemble. Fully illustrated instructions always included.

**\$3 and up buys boat patterns**

Write for free boat book illustrating cruisers, motorboats, sailboats, rowboats, canoes, etc., that you can build.



**Only \$37** For the knocked-down frame of this 23-foot power boat, including full-sized patterns and illustrated instructions to finish. Write for Free Boat Book showing this and other models.

**BROOKS MANUFACTURING CO., 8208 Brooks Ave., Saginaw, Mich.**  
Largest concern of its kind in the world. Originators of the pattern system of boat-building.

## The Hand That Steers, Controls This Motor

Five speeds—two forward, a neutral and two reverse—are instantly secured by pressing a button at end of steering handle without stopping the

**CAILLE 5 Speed Motor**

Push-Button Controlled

Beautiful catalog No. 30 telling all about this and many other features, including built-in magnets, silencers, etc., mailed on request. Marine Motors from 2 to 50 H. P., described in free book No. 24.

**THE CAILLE PERFECTION MOTOR COMPANY**  
1528 Caille St., Detroit, Mich.



## WATKINS' SPECIAL MOTORS

3 H. P. Single Cylinder . . . 30 lbs.  
6 H. P. Double Cylinder . . . 68 lbs.  
12 H. P. Four Cylinder . . . 100 lbs.

A strictly HIGH GRADE Motor that will give CONSTANT and EFFICIENT service. Especially adapted for CANOES and LIGHT BOATS. Aluminum base, copper water jacket, steel shaft, bronze bearings.

**THE WATKINS MOTOR CO.**  
837-839 West Sixth Street CINCINNATI, OHIO

## VIM MOTORS

5 to 27 h. p.

1, 2 and 3 cylinder

Gasoline or Kerosene

Speed, regular, or heavy

duty. Strong, simple,

accessible—absolutely

dependable. Built for a

lifetime. The boat-builder's

stand-by, the boat-owner's

pride. Double ignition.

Non-backfiring. Heavy

brass fittings.



"Only fault with my Vim is that I did not get it sooner. It runs and sounds like an electric fan. Ran it steadily last Sunday on 6 gal. gasoline—that's a right good for a 10 H. P. engine. My friend says his motor is a gasoline eater and if he can sell it, a Vim goes in his boat." This from Rev. H. Prof. Warren, Pa.

**VIM MOTOR CO.**  
108 Water St., Sandusky, Ohio

## Engines With a Reputation for Superior Quality



**Stewart** engines are built with an eye-to-quality first, last and all the time. Strong, sturdy, simple and easy to operate—they deliver the goods right up to the mark all the time.

**Made Only in 1/2, 2, and 3 1/2 H. P. Sizes**

but every one a master product of correct design, high grade materials and superior workmanship. If you want an engine in any of the sizes named that will knock the spots off anything else made of the same horse power, get a Stewart. Write for Catalogue.

**STEWART LITTLE MAJOR**  
1/2 h. p. engine with high tension magnets, \$37.50; with battery, \$27.50

**CHICAGO FLEXIBLE SHAFT COMPANY**  
105 N. LaSalle St., Chicago

Please Mention Popular Mechanics

## GRAY MOTORS FOR ALL SIZE BOATS

Boat Builders Catalog the result of the co-operation of 50 Leading Boat Builders, with the Gray Motor Company is yours for the asking. Lists and describes 175 different boats from a \$125 fishing launch to a \$2500 mahogany finished express launch, powered with 6 cylinder self starting 4 cycle Gray Motor. **This Book is Free.** Write for it today. Also Big Gray Marine Engine Catalog showing complete line 2 and 4 cycle marine motors \$25. upwards, 1 to 6 cylinders, 3 to 50 H. P.

**GRAY MOTOR CO., 998 Gray Motor Bldg., Detroit, Mich.**

## Toledo MARINE MOTORS

"Nothing Cheap but the Price"

3 H. P. 1 cyl. complete	\$ 65.00
6 H. P. 1 " "	84.00
6 H. P. 2 " "	125.00
12 H. P. 2 " "	160.00
18 H. P. 3 " "	250.00

Fully guaranteed by a responsible concern. 2 cycle, 2 port, 3 1/2 and 4 1/2. Send for free catalog "G."

**THE UNIVERSAL MACHINE CO., Pike Ave., Bowling Green, O.**

# \$250.00 A MONTH REPAIRING TIRES

Be first to enter this new big paying business in your town. Open your pockets. Let the dollars pour in. Act quick. Automobile business growing fast. Each Auto Sold Means More Tires to Mend. Enormous field for tire repairing. Punctures and blowouts are common. Tires need retreading and vulcanizing. Something going wrong all the time. Thousands forced to buy new tires because they can't get old ones fixed. Think of the old bicycle days—repair shops on every corner—all making money—busy day and night. Autos make same proposition over again—only ten times bigger and better. Users of Haywood Tire Repair Plants are making big money. Johnson, Tex., writes, "I made as high as \$18 profit in a day." Another man who bought a plant September, 1911, writes he has cleared over \$3,000.00. Be the first to start. Experience unnecessary. You learn quick. Simply follow directions. Business comes fast and easy.

This Bunch of Tires Will Make Several Dollars Profit

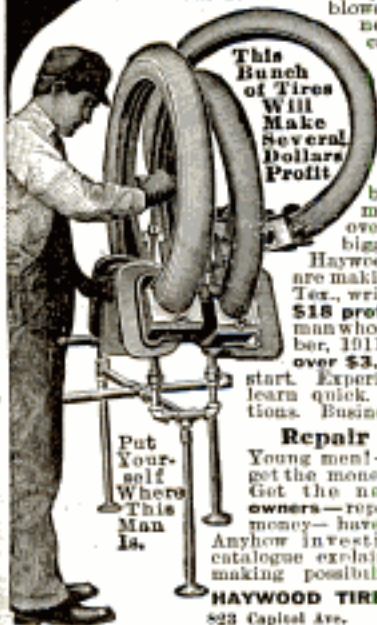

Put Yourself Where This Man Is.

### Repair Tires at Home

Young men!—repair father's tires—get the money he pays garage man. Get the neighbors' work. Auto owners—repair your own tires—save money—have outfit for home use. Anyhow investigate. Send today for catalogue explaining wonderful money making possibilities in this field.

HAYWOOD TIRE & EQUIPMENT CO.  
823 Capital Ave. INDIANAPOLIS, IND.



Cut Your Own Hair With

## McDONOUGH'S SAFETY HAIR CUTTER

This remarkable invention makes it as easy for you to cut your own hair as to shave. Safe, effective and will save you time and money. The only device of its kind on the market. Works exactly like a comb—no clipping. Send \$1 today. Or write for further information. DO IT NOW.

DEALERS:—Sell at sight. Write for our proposition. Hundreds in it for you.

AMERICAN SAFETY HAIR CUTTER CO.  
103 B. ndley Power Bldg., PITTSBURGH, PA.

## J. HARDIN CO., MANUFACTURER

J. LAVIN, PRES.

ONE THIRD SAVED  
YOU BUY DIRECT



### Free Book

Our catalog contains heating goods of every description, complete heating plants, bathroom outfits, sinks, roughing in goods, pipe, fittings, valves, etc., water pressure systems, lighting plants. In fact absolutely everything in high grade plumbing and heating supplies exclusively. Any handy man can install our goods with our free easy installing plans.

Write Today

J. Hardin Co., 40 yrs. at 4533-43 Cottage Grove Ave., Chicago



"I propose to fight it out on this line if it takes all summer"

—Gen. U.S. Grant

## Resolve to Win!

Determination made Grant one of the greatest generals in history. The world knows his story. It knows, too, the stories of thousands of other determined men, who succeeded because they had a purpose and stuck to it.

*Do you want to succeed? Do you want that better job? Do you want that increase in pay?*

If you *do* want to get out of the rut—if you *are* determined to make something of yourself, send the International Correspondence Schools the attached coupon. Tell them what kind of position you want and they will show you how you can fit yourself to get it.

More than 500 determined men and women got better positions last month solely as a result of I. C. S. training. They secured this training in their own homes, at small cost and without losing time from their every-day work.

**Determine to mark and mail the coupon to-day**

### INTERNATIONAL CORRESPONDENCE SCHOOLS

Box 872G, SCRANTON, PA.

Please explain, without further obligation on my part, how I can qualify for a larger salary and advancement to the position, trade, or profession before which I have marked X.

Electrical Engineering  
Electric Lighting  
Electric Railways  
Electrician  
Electric Car Running  
Dynamo Foreman  
Wireman  
Mining Engineer  
Tel. and Tel. Engineer  
Surveyor  
Civil Engineer  
Automobile Running  
Agriculture

Mechanical Engineer  
Mechanical Draftsman  
R. R. Construction  
Concrete Construction  
Architect  
Contracting & Build'g  
Architectural Draftsman  
Plumbing and Heating  
Chemist  
Bookkeeper  
Advertising Man  
Civil Service Exams.  
Salesmanship

Name \_\_\_\_\_

St. and No. \_\_\_\_\_

City \_\_\_\_\_ State \_\_\_\_\_

Present Occupation \_\_\_\_\_

## WONDER LIGHT OUTFIT

### Lots of Fun for Boys!

Big volt, 2 C.P. TUNGSTEN lamp, switch, socket, 30 ft. insulated wire and 3 cells of dry battery all ready to install. May be used to light a dark closet or hall.

PRICE ONLY 60c. Post. Extra 15c

### LITTLE GIANT MOTOR

Is nearly 3 in. high. Runs at high speed on a single cell of battery. Very powerful and may be used to run small toys, etc. Just the motor every boy has been looking for.

Sent postpaid for only 50c

### THE SIMPLEX TELEGRAPH OUTFIT



An opportunity for every boy to learn to telegraph and to set up a line with his class. This is a complete telegraph set, consisting of a fine key and receiver, mounted on a polished base. Will work any distance. Telegraph for Boy Scouts.



An excellent Field

Price, 98c. Postage Extra. Wt. 2 lbs.

## EXPERIMENTERS

### THIS IS THE Experimenter's Reference Book

It's the latest edition of the famous Amco Catalogue, contains over 200 pages and is fully illustrated. Complete description and prices of the latest electrical and experimental apparatus—Storage Batteries, Rectifiers, Transformers, Induction Coils, Wireless Apparatus, Lamps, Flash-light, X-Ray, tools, Electric Railways, Steam Engines, Water Motors, Dynamos, Motors, Telegraphs, Telephones, Electrical Supplies, Model Aeroplanes and Parts for building your own apparatus. 6c in stamps will bring you this wonderful book. Contains a complete list of Wireless Calls, gives Codes, Wiring Diagrams, tells how to put up an aerial and install apparatus, etc. Best catalog of Wireless and Electrical Apparatus, etc., published. Send for this catalog right away. Our prices will save you money.



### Put an Electric Headlight on Your Bicycle

Every boy wants a practical electric headlight for his bicycle. **NO MATCHES—NO OIL—NO BOTHER.** Shoots a powerful beam of light 200 ft. ahead. Burns 50 hours on one battery. Has powerful silver plated reflector and magnifying glass 4 inches in diameter. May be adjusted in any position. Comes complete with tungsten bulb, cord, battery case, etc.



PRICE ONLY

\$1.75

A FINE CANOE LIGHT



Adams - Morgan Company "The Experimenter's Supply House"  
Dept. M UPPER MONTCLAIR, N. J.

**ELECTRIC LIGHT PLANTS** Complete gasoline engine, dynamo, switchboard and storage battery \$240.  
Agents wanted. American Battery Co., 1189 Fulton St. Chicago (Estab. 1883.)

**Complete Wireless Sending and Receiving Station** \$10<sup>10</sup>  
Receives hundreds of miles. Sends 8 to 20 miles.

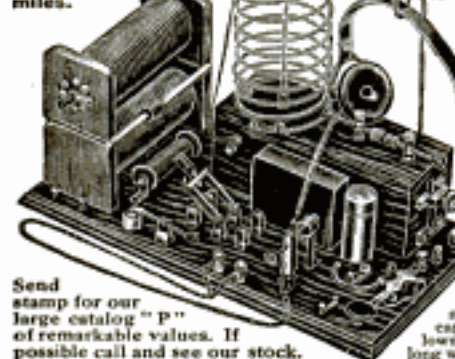

This remarkable station consists of a guaranteed 1 1/2 in. spark coil, machine turned fluted spark gap, our 1501 key, a flat plate condenser, assembled in an oak case, a large capacity helix, DPDT switch, 500 ohm potentiometer, buzzer and switch to tell if your 2 detectors are working, buzzer battery in nickelled case, tubular condenser, bare wire wound double slide tuner, number 30 silk wire wound large 5 capacity loading coil that allows you to get Arlington and long wave stations.

Send stamp for our large catalog "P" of remarkable values. If possible call and see our stock.

THE HANDEL ELECT. CO., 138-140 Centre St., NEW YORK

## WIRELESS BOYS!

### A REAL WIRELESS DETECTOR FOR 10 CENTS

To acquaint you with "Wireless", read this astounding and hitherto unattempted offer.

For 10c. we will mail you prepaid a complete wireless detector exactly as illustrated, size 2" x 1 1/2" x 1 1/4". In connection with any telephonereceiver and a wire on your roof, this detector is guaranteed to receive messages from 100 to 500 miles. Complete instructions furnished.

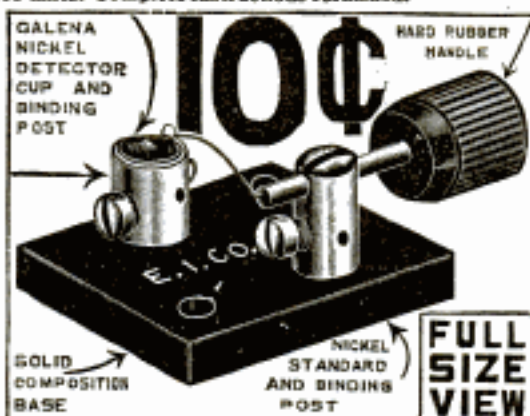

This detector is no toy, but does exactly the same work as a \$10.00 instrument. If you have no receiver get our 75 ohm Pony telephone receiver and Detector, both for 60c. prepaid. Your money back if dissatisfied.

**IMPORTANT:** Send today 4c. extra postage for our famous Electrical Cyclopedia No. 15, containing 658 illustrations, 2000 articles "Treatise on Wireless Telegraphy" and 20 coupons for free Wireless Course, also full list of all U. S. Wireless call letters. This great book has 275 pages, is 1/2" thick and weighs 1/2 lb. You can't be without it. Electro Importing Co. 233A Fulton St., N. Y. City

"Everything for the Experimenter"

**ELECTRIC HOME, FARM and STORE LIGHT PLANTS, LIGHTS, DYNAMOS, MOTORS, ENGINES, Fan Motors, Storage & Medical Batteries, Rectifiers, Silo, Sub. Bicycle, Carriage & Auto Lights, Massage, Ozone & M. P. Machines, MOTION PICTURE THEATRE Permanent and Traveling Equipments. Big Opportunity. Catalog 3 cts. OHIO ELECTRIC WORKS, CLEVELAND, OHIO**

**ELECTRICITY**  
BOYS—Send today for our new 128-page catalog of everything electrical. Motors, Dynamoes, Flashlights, Lamps, Coils, Batteries, Transformers, Magnet and Resistance Wires, Telegraph Outfits, Miniature Electrical Railways and Parts. Catalog with coupon sent only for 6c in stamps or coin. No postals answered.  
VOLTAMP ELECTRIC MFG. CO. Voltamp Block, BALTIMORE, MD.



### "The Electrical Experimenter"

The big electrical Magazine for those who dabble in electricity and Wireless. Chuck full of experiments. Intensely interesting. Monthly prizes of \$5.00 for best experiments. Amateur Electric, Wireless News, Latest Patents 100 articles, 100 to 150 illus. Read the great serial: "Baron Munchhausen's New Scientific Adventures." \$1.00 a year.

Send 10¢ for 3 issues  
Electrical Experimenter 234 Fulton Street, N. Y.  
10c a copy at News-stands

# DUCK'S NEW 325 Page Electrical and Wireless Catalog

Mailed for 8c in stamps or coin, which may be deducted from first order of \$1. Great cost of catalog and low prices prohibit distribution otherwise. Contains more valuable information on wireless and electricity than many text books. 125 pages of wireless and anything and everything in the field of electricity.  
**THE WILLIAM B. DUCK COMPANY, Arcade Bldg., TOLEDO, O.**

THE WM. B. DUCK COMPANY  
ARTISTS, ELECTRICIAN  
OF  
WIRELESS  
TOLEDO OHIO

# DIAMONDS-WATCHES ON CREDIT



**LOFTIS**  
Perfect Diamond Ring  
This Diamond Ring No. 659 is our greatest special. Finest quality pure white diamond. Mounted in our famous Loftis "Perfection" 6-prong ring 14-k solid gold. Special value

**TERMS:**  
**\$50 \$5.00 A MONTH**  
Sent on approval, all charges prepaid. Other sizes and styles at \$25, \$40, \$75, \$100. See our Catalog. Sent Free on request.

**Our Big Leader**

This splendid 16 size, new model **HOWARD WATCH** will pass inspection on any railroad, and meets the most exacting requirements where time to the second is demanded. YOU CAN NOW BUY THIS WORLD-RENOWNED HOWARD WATCH OF US AT THE CHEAPEST SPOT CASH PRICE AND PAY FOR IT IN SMALL AMOUNTS EACH MONTH. USE YOUR CREDIT. TERMS ONLY

**\$5.00 Per Month**

temperature, isochronism and 5 positions; Balance Wheel especially for hard tempered; Balance Pivots and Train Pivots made of special steel; double roller escapement; steel escape wheel; 17 selected pigeon-blood Ruby and Oriental Sapphire Jewels; Pallet stones are Oriental Sapphires; Case is extra gold filled, screw bezel, solid back, swing ring, dust and moisture proof. Guaranteed 25 years. Every Howard Watch is cased at factory, fitted and adjusted in its own case. Prices: 16 size, 17 Jewels, \$50; Terms, \$5 per mo. 16 size, 19 Jewels, \$60; Terms, \$6 per mo. 16 size, 21 Jewels, \$65; Terms, \$6.50 per mo. Write for our free Catalog, containing over 2,000 illustrations of Diamonds, Watches, Jewelry, Silverware, etc. It tells all about our easy credit plan.

**LOFTIS BROS. & CO., National Credit Jewelers**  
Dept. C894 100 to 108 N. State St. CHICAGO, ILLINOIS  
Stores also in: PITTSBURGH; ST. LOUIS; OMAHA.



No. 527

Send for Catalog



**Hello Boys!** BUILD NEW MODELS  
MAKE LOTS OF TOYS  
Help me get new models. I give 307 Prizes—first an Auto. My **ERECTOR** BIG PRIZE CONTEST is described in big folder. Send for it now. Free.

**MYSTO MFG. CO.**  
253 Feels St.  
New Haven, Conn.

Go to it!

## LIONEL STRONGFORT

Health and Strength Institute, Dept. 885, San Mateo, Cal.



DEAR STRONGFORT: I am interested in my Physical Welfare and wish to read your book, "Intelligence in Physical and Health Culture"; I enclose 4c. to cover postage. Also please write me a personal and confidential letter regarding the subjects which I have checked X. I enclose 10c. for each subject for expenses.

- |                      |                          |
|----------------------|--------------------------|
| ....Thinness         | ....Round Shoulders      |
| ....Nervousness      | ....Rapture              |
| ....Indigestion      | ....Alcohol              |
| ....Constipation     | ....Tobacco, or other    |
| ....Flat Chest       | ....Bad Habits and       |
| ....Catarrh          | ....Weakness             |
| ....Long Trouble     | ....Poor Memory          |
| ....Increased Height | ....Muscular Development |
| ....General Health   | ....Great Strength       |

Name .....

Street .....

City..... State.....

For twenty years "the strongest man in the world" and its most successful Physical Culture and Health Instructor, LIONEL STRONGFORT gives each inquiry his personal attention. **Strongfortism Spells Success.**

The total of the appropriations made by the last session of Congress was \$1,115,121,408.68, and for both sessions of the Sixty-second Congress, \$2,113,000,000.

**250 "WIRELESS" TRANSFORMER \$9.00**  
CLOSED-CORE TYPE 14000 VOLTS 3 DIFFERENT POWERS  
SELF CONTAINED Shipping Weight 20 Lbs.  
Send 2c stamp for catalogue of Wireless Supplies, folders, etc. Winger's Telegraph Code Charts free with \$2 orders; otherwise 20 cts. each. Furnished in "station" or "pocket" sizes, Continental or Morse code; please state which, otherwise Continental "pocket" size will be sent. Winger Electric & Mfg. Co., 111 So. Dearborn St., Chicago, Ill.

**FREE BOYS** Get This **20-Shot Pistol**



Shoots 20 times without reloading. Uses ordinary B. B. shot. Fine blue steel finish, looks like a regular automatic. Send 25c to pay for year's subscription to our magazine and we will send this 20-shot pistol free. This offer made to introduce

**Everyday Life, Dept. A-P-159, Chicago**

Agents and Dealers Are Making Big Money Selling Sandbo Starters

## Start Your FORD From the Seat

Attach this odd shaped wheel then you can start your car—Ford, Maxwell, Hupp, Saxon or Metz—from the seat every time. In one revolution this wheel gains six inches over the ordinary crank—that's where we have the big leverage.

**Sandbo Starter**

is the logical starter—it gives the engine a complete revolution—over two compressions past two ignition points. One pull on the next handle on the dash and your engine starts. New price, \$14.95. Write for booklet. Agents, Dealers Wanted. **SANDBO STARTER CO.** 26 Sandbo Building, Rock Island, Illinois **\$14**

## Send for a Copy of Our New Manual No. 2



Its pages give simple formulas for calculating the natural period of an antenna; capacity of a receiving or transmitting condenser; spark frequency of rotary spark gaps; tables for calculating the correct amount of wire for the construction of magnets and tuning coils; tables for ascertaining the spark lengths of different voltages; the Federal regulations regarding the restrictions of wave lengths for amateur stations; instructions for the installation, maintenance and operation of wireless stations; directions for learning the code, working diagrams and a complete list of up-to-date wireless instruments and accessories, together with other features of interest to the amateur or professional wireless enthusiast.

Containing as it does a fund of valuable information not generally contained in a catalogue, it approaches nearer a text book in the fascinating field of wireless telegraphy. It is printed on good stock with a heavy paper cover in two colors. No expense has been spared to make it accurate and reliable. We make a charge of 10c for it which amount will be allowed on an order amounting to \$1 or more.

No Wireless Experimenter Should be Without the **Mesco Wireless Manual**

**Send for Our Pocket Catalog P.28** It will contain over 200 pages, with over 1,000 illustrations, describing in plain, clear language all about Bells, Push Buttons, Batteries, Telephone and Telegraph Material, Electric Toys, Burglar and Fire Alarm Contrivances, Electric Call Bells, Electric Alarm Clocks, Medical Batteries, Motor Boat Horns, Electrically Heated Apparatus, Battery Gauges, Wireless Telegraph Instruments, Ignition Supplies, Etc.

It Means Money Saved to You to Have Our Manual and Our Catalog When You Want to Buy

**Manhattan Electrical Supply Co.** New York 17 Park Place Chicago 114 So. 5th Av. St. Louis 1106 Pine St. San Francisco 604 Mission St.

# THOUSANDS OF DOLLARS MADE REPAIRING TIRES

The amount you can make in dollars repairing tires is measured by your own energy. You can make anywhere from \$1500 to \$3000 a year above expenses. Your investment to start in business

is small, returns are quick and your income cash. Profits are large on every job you turn out. The tire repair business is in its infancy. It's growing every year, because more tires are being used every year. In almost every city and town there is a crying need for a good tire repair man. **That means opportunity for you.** Start in your home town if you want to. This is a new money making business. Don't delay getting busy. But above all be prepared with an equipment that means satisfactory work for your customers. Buy only an

## Akron-Williams Tire Repair Equipment

The better your equipment, the better your work and the greater your volume of business. Let us start you in business right. Use an equipment which is

### Endorsed by 30 Leading Tire Manufacturers

It takes you but a short time to become an expert tire repair man. We help you here. We are making an unusual offer to everybody who buys our equipment. You can become an expert by our plan.

### SEND FOR OUR 30 DAY SCHOOL PLAN

It means when you start in business, you start right. You are prepared to make money from the jump. No experimenting. No Failures. You become a practical, first-class repair man.

WRITE FOR CATALOGUE No. 244

**WILLIAMS FOUNDRY & MACHINE CO.** Main Street AKRON, OHIO

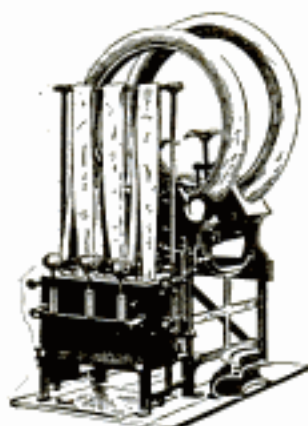

## EVINRUDE

**Detachable Rowboat and Canoe Motors** attached in a few minutes to any kind of boat, make it a power boat. Can be carried anywhere. Automatic Reverse, Built-in Magneto, Maxim Silencer. Illustrated Catalog free.

**EVINRUDE MOTOR CO.**  
31 Evinrude Block, Milwaukee, Wis., U. S. A.



## HEALTH AND FUN

**With a Skudder Car** Helps youngsters grow strong. A safe plaything for any boy or girl. Get price and circular.

**SKUDDER COMPANY, 521 Straus Bldg., CHICAGO, ILL.**

### WEAR

Trade Mark Registered **B.V.D.** U. S. Patent Office and Foreign Countries

### UNDERWEAR

## WATER MOTORS

For every purpose—attach to any faucet having 30 lbs. water pressure or more. Made in 3 sizes.

They run emery and buffing wheels, saws, tools, sharpeners, polishers, dynamos, lathes and drills, printing presses, vacuum cleaners, rotary fans, wringers, washing machines and sewing machines.

**HUDSON NOVELTY CO.**  
116 Duane Street NEW YORK CITY



Lippincott Motor Agents Wanted

## ROW BOAT MOTOR

# FERRO

Built right first and priced afterwards. Easily attached to your own or rented boat. Runs it steadily and quietly from two to ten miles an hour. Consumes but a gallon of gasoline and a quarter-pint of oil in four or five hours. Has own rudder, controlled from any part of boat.

Some Ferro features: Bosch High Tension Magneto; genuine float feed carburetor; quiet muffler (doesn't kill power); weed-proof propeller. One piece includes all. Full information in catalog. Write for it. If interested as dealer, send for prospectus No. 215. Good territory left for men who can qualify as agents. Give references.

**The Ferro Machine & Foundry Co.**  
843 Hubbard Ave. Cleveland, Ohio

**\$85** With Bosch Reversible Waterproof Magneto  
**\$65** With Waterproof Battery Ignition

**DON'T GO ROWING—GO FERROWING**



## Florida Grapefruit Land

In Hillsboro County near Tampa—fastest growing big city in U. S. Highest grade fruit, truck, poultry and dairy lands. Farms 10 to 160 acres—Lowest Prices—Easiest Terms—Best Location—Best cash markets in all Florida. Thousands of acres now being improved right here in Hillsboro County. Satisfied buyers from every State and Canada. Our high reputation and responsibility guarantees you a square deal. Big profits may be made by those who invest now in this most progressive, liveliest and healthiest district in the entire South. Write today for free Florida Book and full information.

**North Tampa Land Co., 140 S. Dearborn St., Chicago**



## Make \$5 to \$20 Weekly

**Grow Mushrooms in Spare Time**

Spawn now produced by scientific methods. Makes crops certain. Anyone anywhere can now grow mushrooms at home, in basements, barns, sheds, etc. Information free. Big opportunity to make money. Address **A. V. JACKSON, Falmouth Mushroom Cellars, Inc., 452 Gifford Street FALMOUTH, MASS.**

*Only Scientific Mushroom Farm in U. S.*

## 30 Days FREE TRIAL

and freight prepaid on the new 1915 "RANGER" bicycle. Write at once and get our big catalog and special offers before buying.

Marvelous improvements. Extraordinary values in our 1915 price offers. You cannot afford to buy without getting our latest propositions. **WRITE TODAY.**

Boys, be a "Rider Agent" and make big money taking orders for bicycles and supplies. Get our liberal terms on a sample to introduce the new "RANGER."

Tires, equipment, sundries and everything in the bicycle line half usual prices. Auto. and Motorcycle Supplies. **MEAD CYCLE CO., DEPT. F108 CHICAGO**





**\$88 Per Carat**  
 Small sizes as low  
 as \$50 per C.

Retail Value \$150 Per C

**STARTLING BARGAIN VALUES!**

**Blue White  
 PerfectCut  
 GENUINE**

**DIAMONDS**



Order No. 3C111  
 14 K. solid gold tiffany  
 style Solitaire ring.  
 Mounting only \$1.75.  
 Complete with Blue White  
 1-4 C. diamond \$28.00  
 1-4 C. diamond \$17.25  
 1-2 C. diamond \$42.00  
 1 C. diamond \$89.75



Order No. 3C112  
 14 K. solid gold men's engraved  
 ring. Mounting only \$5.98.  
 Complete with Blue White  
 1/2 C. dia. \$21.38 3/4 C. dia. \$70.12  
 1 C. dia. \$48.13 1 C. dia. \$93.83

Nowhere else can you get Blue White, perfect cut, exquisitely brilliant Diamonds for \$88 per Carat! Your only chance to buy direct from Importers. Expert comparison proves retail value \$150 per carat. You save the difference in cash. No middleman gets it. We sell at world's lowest prices, because we buy from diamond cutters at Amsterdam, London and Paris; then resell to you direct, on "many sales, each at a small profit," plan. And you get quality selected by diamond experts; greater protection.

**SEND NO MONEY IN ADVANCE!** Get our free book. Most magnificent assortment

of diamond jewelry ever shown. Simply select diamond and mounting you wish to see. Examine it free, at our risk and expense. We ship any diamond in our vast stock anywhere, without a penny's cost to you. Not the slightest obligation on your part. You may order any bargain shown in this ad for free inspection. We take all the risk. You take none.

**BANKABLE, LEGAL MONEY BACK GUARANTEE!**

This famous guarantee has revolutionized the buying of diamonds. Enables you to buy as safely as any expert. Permits you to return any diamond bought from us, through any bank in America, or direct to us, and get your money back. No red tape. No delay. Entitles you to exchange at full value forever. Legally certifies carat weight, color, value. Here at last is perfect protection for your investment. Our free book tells you more about this wonderful guarantee.

**1916 DeLuxe Book of Diamonds, FREE!**

Don't buy a diamond until you get this marvelous book. First to show 1916 styles. First to tell expert's methods, inside trade secrets, for selecting and buying diamonds. Learn how to judge diamond qualities and values; how to escape the middleman's tax and get your money's worth. See for yourself how our direct buying and selling system saves you 35% in cash. Coupon or post card brings this DeLuxe Book Free! Write today!

14 K. Misses' and Child's ring. Blue white full cut diamond. Velvet case. \$20 value.

**\$288**



**BARNARD & CO.**

Dept. 3C, N. W. Cor. Michigan & Adams St., CHICAGO

Just mail this coupon

**BARNARD & CO., Dept. 3C**  
 N. W. Cor. Michigan Av. & Adams St., CHICAGO  
 Without obligation or expense to me, please send me your 1916 De Luxe Book of Diamonds, absolutely free.

Name .....

Address .....



**TOOTH-ACHE STOP**

STOPS THE PAIN AND STOPS THE TOOTH  
 Price postpaid  
 anywhere only **25c**  
 Agents Wanted, or 3 for 50c  
 VERY EASY TO USE  
 Enough to Stop 50 Tooth-Aches  
 Squeeze a little of this Paste into the hollow in the tooth and the ache stops instantly. Then the paste hardens and forms an antiseptic stopping for the tooth, excluding the air and preventing a recurrence of the agony. Guaranteed absolutely harmless. It will not spread and burn the mouth. Place it ready for the next bad attack; worth its weight in gold at two o'clock in the morning.  
**JOHNSON SMITH & CO., 711 S. Dearborn St., CHICAGO**

**MAKE FLYING BALLOONS**

**Profits \$10 a Day**  
 We teach you how. No experience necessary. Tremendously good proposition at Parks, Squares, Depots, Fairs, Carnivals, Summer Resorts, etc. One man made \$150 in five days at the Hutchinson Fair. You can do the same. Write for FREE illustrated circular.  
**International Metal & Ferro Co.**  
 Balloon Dept. GB4 Chicago, Illinois



**Waterman PORTO**

1915 Model has reversing propeller, high tension magneto and unrestricted speed control. 3 H. P. Wt., 65 lbs. Sold direct from factory to you, freight paid. Original onboard motor-10th year-35,000 in use. Guaranteed for life. Fits any shape stern. Has automobile carburetor, removable beatings, solid bronze skeg protecting 10 1/2" x 16 in. propeller. Steers by rudder from any part of the boat. Water cooled exhaust manifold; noiseless underwater exhaust; spun copper water jacket. Demand these essentials if you want your money's worth. Write today for free book showing both onboard and inboard engine. Our prices will surprise you.  
**WATERMAN MOTOR CO.**  
 230 Mt. Elliott Ave., Detroit, Mich.



Makes Any Boat A Motor Boat

**"Billiards - The Home Magnet" - FREE!**

A handsomely illustrated book showing all Brunswick Home Carom and Pocket Billiard Tables in actual colors, giving easy terms, prices, etc. Sent Free! Write for it today.  
**THE BRUNSWICK-BALKE-COLLENDER CO., Dept. 16A, 61-633 So. Wabash Ave., Chicago**

**TIME BY WIRELESS**

is sent twice a day by the Government stations.  
**Brandes' Wireless Receivers** are best adapted for this purpose, because they are especially made for LONG DISTANCE READING.  
 Send stamp for catalogue "P" to  
**C. BRANDES, INC., 32 Union Square, New York**

**MAKE MONEY**

We start you in the **KOKO-WHEAT CRISP BUSINESS**

No experience required. The demand for this new confection is enormous. Be the first in your community. We are receiving hundreds of letters like the following, from our customers daily.

**KOKO-WHEAT CRISP**

Corneau & Co., Gentlemen:- Since writing you last I have sold over \$450.00 in two weeks. My business is growing every day and before long I hope to see a \$600.00 week business. It is the greatest money maker I have seen and I will never forget you. I will keep you posted. In the meantime I am, with kindest regards, yours very truly,  
 June 30, 1915 G. B. DETRICH, 224 N. Harvey Ave., Oak Park, Ill.

Write TO-DAY for FREE particulars. Also send 10c for LARGE CAN of SAMPLES of this delicious new confection.  
**Corneau & Co., 555 N. Parkside Ave., Dept. 7, Chicago, Ill.**

# GOODELL PRATT

## 1500 GOOD TOOLS

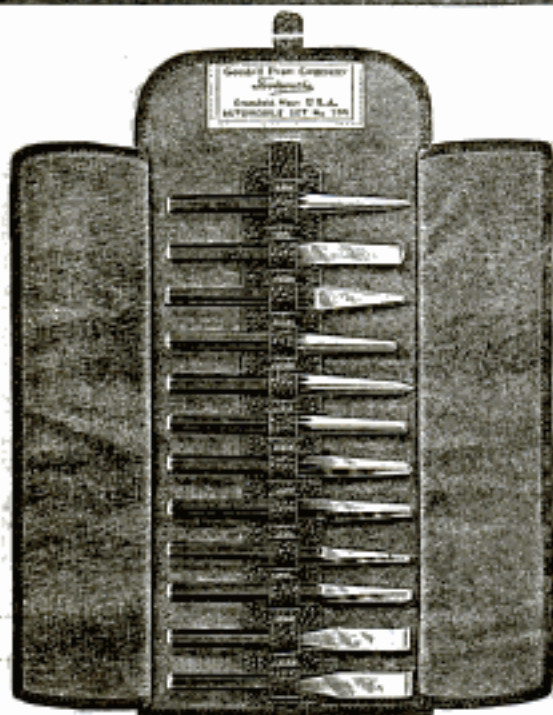

### Chisel Set No. 399

This set consists of 12 chisels and punches, carefully selected to include the tools of this kind most often used. Each one is forged from a very high grade of  $\frac{3}{8}$  inch tool steel and tempered under careful supervision. The average length is 5 inches. They are put up in a strong leather-cloth roll so that they can be easily carried in the pocket or in a small tool box.

#### Partial List of Goodell-Pratt Tools

Hand Drills  
Brest Drills  
Chain Drills  
Bench Drills  
Braces  
Screw Drivers  
Hack Saws  
Levels  
Precision Tools  
Glass Cutters  
Bench Grind'rs  
Tool Sets

Besides these chisels we make many other styles of nail sets, chisels and punches and small forged tools, such as reamers, countersinks, screw driver bits, etc.

Our catalog which shows over 1500 tools, will be sent to you free. Write for it now.



**GOODELL-PRATT  
COMPANY**

*Toolsmiths*

Greenfield, Mass., U. S. A.

# YOU

never would have believed, ten years ago, that flying in a sixty mile an hour gale were possible—and yet this problem has been solved. Now, it is the same with many other problems. For instance, there are still millions of people who would not have believed it possible to solve the following questions of ages:—

Where does **Power** and **Matter** come from? What is **Power** and **Matter**? Why did it change into a **Universe**? Why does the **Universe** rotate? What am I? Why do I exist? What am I here for? Why must we suffer so much? What becomes of myself after death? Where am I going? What becomes of my good and bad self?—and why was every human being born with a tendency to goodness and badness? Is there a self-evident answer to these questions? The answer is: That all these questions and many more problems have been solved by self-evidence after years of investigation. If you are interested to know the results of thirty years of investigation on the lines of self-evidence by Erardus Sagra, the satisfaction of understanding yourself and your surroundings, as well as the harmony between your own universal power and the universe itself, will guide you in conjunction with **Your Divine Power** within you, through the rest of your life like a true friend in adversity or prosperity. Now the author-investigator, Erardus Sagra, did nothing but unveil, classify, and state eternal plain facts (in condensed book-form and in plain popular language), which so far not even the most learned and matter-of-fact scientists could refute.

An interested progressive reader says: You do not know how much help and satisfaction the results of your investigations gave me.

Another reader said: Your production "**The Might of Truth**" is the most beautiful book I ever read.

(Retail Price—\$1.00 net. Trade Price—50c postpaid in U. S., 75c foreign. Trade Price to all readers of P. M. Magazine.)

Money refunded if anyone can prove an untruth in this announcement.

Write to the author, Erardus Sagra himself, address M. T.—Dept. Box 2034 Middle City Station, Philadelphia, Pa.



Taxidermy  
Book  
FREE

## Mount Birds

We teach you by mail to stuff and mount all kinds of **Birds, Animals, Game Heads**. Also to tan skins and make rugs. Be your own taxidermist. Decorate your home with your beautiful trophies or increase your income selling specimens and mounting for others. Easily, quickly learned in spare time by men and women. Highest endorsements by thousands of students. Write today for our great free book "**How to Mount Birds and Animals**" Free—write today.

N. W. School of Taxidermy, 6119 Elwood Bldg., OMAHA, NEB.



We will send you two card tricks, very perplexing to onlookers, yet anyone can do them. Also booklets showing over 100 different Magic Tricks and Jokes. All for **10c.**

THE MAGIC SHOP, 52 North 13th Street, Phila., Pa.

## MAGIC

### AGENTS—Make \$100 to \$300

per month easy selling our new **Triplicate Sauce Pan**. Cooking utensil for 3 different foods on one burner. **400 Specialties**—all whirlwind sellers. Write quick for exclusive territory and large catalogue.

AMERICAN ALUMINUM MFG. CO.  
Div. S 61 LEMONT, ILL.

**SOME CAR! BOYS!** Send for Booklet Today



**The Lad's Car**

Send 20c today for Booklet, telling how to build this automobile. Complete instructions and descriptions of parts and sizes, illustrated with diagrams, blue print, cuts made from photographs, and price list of parts.

**SPECIAL INDUCEMENT** to first boy in your town  
Niagara Motor Car Corp'n, Dept. A, Niagara Falls, N. Y.

# PREST-O-LITE FOR Motorcycles

## Standard Equipment with Experienced Riders

Prest-O-Lite gives you a splendid road light, ideal convenience for small expense, and requires practically no attention. Because Prest-O-Lite has proved its superiority in the hands of users everywhere, more riders use it than *all* other systems combined.

### Reliable—Convenient—Economical

Prest-O-Lite is not affected by road shocks and vibration. It is reliable under all conditions, never fails you in an emergency.

Because of its freedom from troubles and attention, Prest-O-

Lite is the most convenient lighting system.

Of all systems of brilliant lighting, Prest-O-Lite costs the least to buy and use.

### In Any Combination of Equipment Specify PREST-O-LITE

No matter what motorcycle you wish to buy, no matter what other equipment you want, specify Prest-O-Lite and you'll get it.

Any dealer can make you up a complete combination consisting of speedometer, headlamp, Prest-O-Lite, etc., at an attractive price.

### A PREST-O-LITE Has Many Uses

Prest-O-Lite Dissolved Acetylene (ready made carbide gas) has hundreds of important uses. Acetylene soldering and brazing outfits are being widely used commercially. A special stem-and-burner attachment provides an inexpensive light for contractors, etc., for indoor and outdoor lighting. For stereopticons it furnishes ideal light. Detailed information on acetylene installations of all kinds furnished on request.

**THE PREST-O-LITE COMPANY, Inc.** The World's Largest Makers of Dissolved Acetylene

Prest-O-Lite Exchange Agencies Everywhere

265 Speedway, INDIANAPOLIS, IND.

## AGENTS

The Laws of every State require this Auto and Motorcycle accessory. One of those rare chances for agents that come but once in a lifetime. Every machine must be equipped. Big demand everywhere.

### MAKE \$5 TO \$10 A DAY—EASY

No experience necessary. Auto and motorcycle owners pay up-keep of their machines and make extra profits beside, acting as our special representatives. Write quick for Special Proposition. A postal will do.

SEISS MFG. CO., 449 Dorr Street, TOLEDO, OHIO

## "REDEMOTORS"



The simplest, most dependable and only logical small gas or gasoline motors.

For every chore, from turning a grindstone or wash machine to driving a pump or railway speeder a "Redemotor" is made that will do the work at a minimum of effort and expense and a maximum of satisfaction. An engine that a woman can install and operate indoors. Send for Our Booklet *Now*.

ELGIN WHEEL & ENGINE CO., ELGIN, ILLINOIS

## ROBERTS The Speed Motor

*The Motor That Never Backfires* Lightest motor built for power developed. Cheapest, because of lowest upkeep cost. Simple, only four moving parts. Flexible, reponds instantly to your will. Satisfactory, because it's made right. Never backfires. Speedy for speed boats—powerful and strong for boats that work. 3 to 200 h. p. Write today for catalog P. M., pictures of speed boats, owners, testimony and complete description.

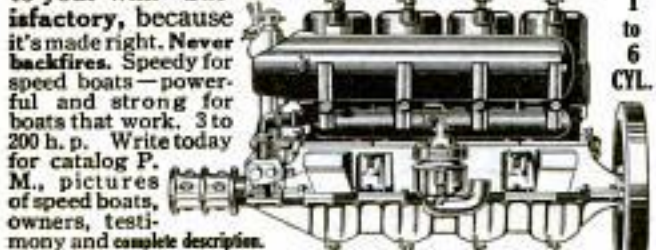

THE ROBERTS MOTOR MFG. CO., 801 Roberts Bldg., SANDUSKY, OHIO

## You Can Earn \$250 A MONTH With This NEW MACHINE



Makes big profit right at the start. Many doing \$3,000 a year and better. You can too. You need no experience. We teach you FREE in one simple lesson. Start right at home. Anywhere, every-where there's plenty of money and big cash profits waiting for ambitious men.

### THIS IS THE BUSINESS FOR YOU

A business of your own. Requires little capital and grows fast into a real factory—a real manufacturer. Open a Tire Repair Shop with Haywood Equipment. Let the money roll in. Auto tires need mending constantly. There is your profit. Owners eager to give you their business. It means a saving of money to them, and big cash returns for you.

### JUST MAIL THE COUPON For This FREE Book



be done. Shows the big profit in this new field. Write for it today. A post card will do. Get your FREE copy.

A valuable guide to riches and wealth. It gives the complete details. How to start. How to succeed. Tells all about your opportunity. Shows how easy the work can

HAYWOOD TIRE & EQUIPMENT CO.  
970 Capitol Ave.  
Indianapolis, Ind.

Gentlemen: Please send me your book as you promised to do. This of course does not oblige me in any way.

HAYWOOD TIRE AND EQUIPMENT CO.

970 CAPITOL AVE.  
INDIANAPOLIS, INDIANA

Name.....  
Address.....

Please Mention Popular Mechanics



## Unveiled—The Tire Classic For Motorcycles

Few ever questioned Goodyear's lead in giving the utmost in a Motorcycle Tire. And now comes our motorcycle masterpiece—the Blue Streak.

It's the famous Goodyear racing tire that won all notable records. But we've added new features to make a perfect road tire.

It is big and luxurious, with a swagger blue circle 'round the center, and the same All-Weather tread of deep-cut blocks that has helped win top-place for Goodyear Automobile Tires.

No rival has a tread so thick, or wide, or deep. So it grips the road securely when you take sharp turns; it protects against punctures and multiplies mileage.

Blue Streaks are built with four plies of fabric—size 28 by 3. And the inner tube of new live rubber—built layer on layer, like Goodyear Laminated Tubes for automobiles—is 30 per cent heavier!

In these and other ways we are giving \$50,000 more value in Goodyear Motorcycle Tires this year. *Yet we've cut our prices 15 per cent.*

Any dealer can supply. Go at once and see this Goodyear tire de luxe that's winning thousands.

**THE GOODYEAR TIRE & RUBBER  
COMPANY, AKRON, OHIO**

Makers of Goodyear Fortified Automobile Tires  
(2504)

Please Mention Popular Mechanics

## You Pay Less for EDWARDS Tin-Coated Metal Roofing



The good old dependable kind our grandfathers used, only in much larger, handier sheets that are easier to lay, that do stay on, and that give utmost protection under every weather condition. No leaky seams—that's because of the famous Interlocking Device—an exclusive Edwards feature. No exposed nail heads. A still further protection is insured by the Edwards Tightcote process—each sheet being dipped separately and completely in molten metal—the very edges protected as well as the sides.

### All Styles and Sizes

Edwards Tin-Coated Metal Roofing comes in sheets from 5 to 10 feet long, 24 inches wide. Hammer and nails only tools needed. Far more durable than old-style small sheets. An Edwards roof will outlast many a wooden roof. You save every way.

### Lightning Insurance Free

A \$10,000 Guarantee Bond insures you against lightning loss. Write for bargain catalog No. 850. Give size of roof for complete directions. Write today—NOW.

**The Edwards Manufacturing Co.**  
800-850 Lock Street CINCINNATI, OHIO

## Furniture On Credit

Write for Mammoth Bargain  
Book picturing 4,918 articles

**SPIEGEL, MAY, STERN CO.**  
1089 West 35th Street, Chicago

This 64-Page Free Catalog Saves You 25 to 50% on Furniture

Come-Pack Furniture, sold direct from factory to home on a year's trial, saves you 25 to 50%. Home Furnishing Department helps you make best selections. Money-Back Guarantee. Write for Catalog today.

**COME-PACK FURNITURE CO.**  
801 Fernwood Ave. Toledo, Ohio



We Teach You  
the Business  
**FREE!**

## 400% to 800% Profit in Popcorn— Crispette and Candy Business

Crowds swarm to buy our Kettle-Popped Popcorn—popped under glass—seasoned while popping!—**GREAT BIG-CRISP-FLUFFY KERNELS!** Corn pops 25 per cent bigger with the **Delzenbarger** machine and 100 per cent better product. Our delicious **CRISPETTES** melt in your mouth. Wonderful new **Automatic Crispette Press** is a regular toasty-mold! Big extra money in candy!

Course in Candy Making **FREE** with Every Outfit  
Write **AT ONCE** for FREE Catalog, new money-making plans, special prices and sensational easy payment offer. **NOW** is the time to start. No experience necessary and very little money. Write

**C. E. DELZENBARGER CO., 152 Bissel St., JOLIET, ILL.**

## Two New Fincks "Detroit Special" Garments

"THEY WEAR LIKE  
A PIG'S NOSE"

All the  
Boys are  
Wearing  
Them

They are  
Just the  
Thing for  
You

UNION MADE

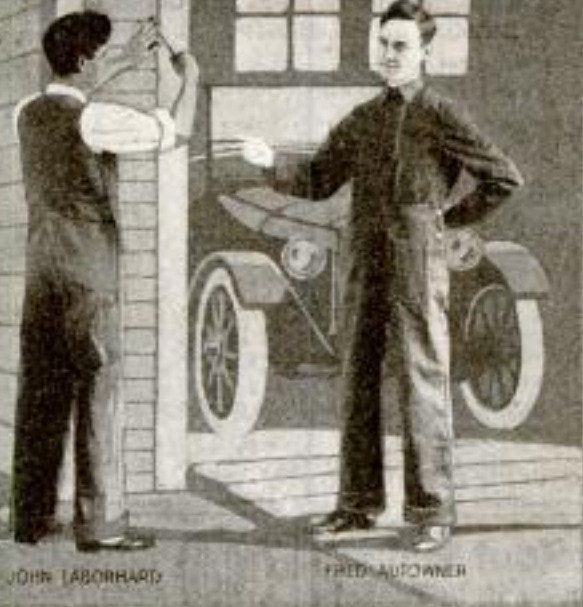

JOHN LABORHART

FRED AUTOVER

**Over All Others  
In Wear,  
In Comfort,  
and In Fit**

Union-made in a factory that has grown twenty-fold in 12 years simply on the recommendation of one satisfied customer to another.

Carried in stock by thousands of the best dealers the country over. And when you find such a merchant, stick to him, for you can be sure that he's trying to give you the best possible value all through.

Doesn't matter what your work is—mechanic, farmer, motorist, railroad man—if you need protection from dirt and grease, you'll find Finck's Detroit Special Garments a hundred per cent right.

Vest high-back retails at \$1.25. Combination Suit, \$2. If your local dealer can't supply you, send us his name, with your size and P. O. Order for the price of the garment, and we'll forward it at once by Parcel Post.

**W. M. Finck & Company, 1154 Gratiot Ave., Detroit, Mich.**

N. B. We have an exceptionally interesting proposition for new dealers—the best co-operation ever offered, and a line that makes fast friends

## THREE NEW REGALS

A LIGHT "FOUR" . . . \$ 650

A STANDARD "FOUR" 985

A NEW "EIGHT" . . . 1200

Ample power, complete equipment, streamline bodies,—beautiful, sturdy, reliable cars.

Write for Catalog **Regal Motor Car Co. 508 Piquette Ave., DETROIT**

## LAW PAYS BIG INCOMES.

Large salary positions open with big firms. Any one can learn law now. Our simplified method trains you at home, in spare time, by mail, wherever you live. Written in plain language

by greatest legal experts. Degree of LL. B. conferred. Our graduates pass bar examinations in any State—we guarantee to coach you free until successful. Complete Law Library furnished, if you enroll now.

**FREE COMPLETE COURSE** Written by Dr. Frederick B. Robinson, nationally known Lecturer. Remarkable offer—write now for facts. Everything sent Free.

LaSalle Extension University, Dept. P-694 Chicago, Ill.

## \$5000 TO \$15000 A MONTH

Not a dream—not a myth—but a reality. If you are honest—earnest, and anxious to go in business for yourself, I will help you. I have helped lots of men to make from \$500.00 to \$1,500.00 per month. It's an honorable business—can be started most anywhere, in any town of over 500 population.

### A Good Business Proposition

You want a business of your own. Get into the Popcorn Crispette business and make \$2000.00 to \$7000.00 a year. All you need is a machine, a few dollars and a good location. You can learn to make Crispettes in a day. They sell everywhere for a nickel a package. You make almost four cents profit.

**\$100. A DAY  
CAN BE MADE  
WITH THIS  
MACHINE**



Send  
For  
**FREE  
BOOK**

It tells the whole story—how and where to start, how to succeed, gives experience of others, etc. It's worth reading, even if you don't start. If you are looking for a good thing and easy money, write me today for the FREE BOOK.



**W. Z. LONG CO. 1059 High Street  
SPRINGFIELD, OHIO**

Please Mention Popular Mechanics



## Photographers The Trilux Exposure Meter

tells instantly, accurately and easily the correct time for all exposures indoors and out

Error is impossible. All timing guess work is eliminated. Insures good pictures always for everyone. Marvelously simple and easy to use—like focusing an opera glass. Shows instantly on plainly marked scale time for exposure. Makes certain an absolutely correctly timed negative. Guarantees satisfactory pictures. Can not get out of order. Neatly finished in gun metal and nickel. Is no larger than a roll of film—weighs less than three ounces. Endorsed by professional and amateur photographers. Ends disappointment and spoiled films. Use the Trilux and never lose a film.

Sent postpaid for \$2.00. Satisfaction guaranteed or money refunded. Booklet free

**Trilux Photo Company, 1402 Marquette Bldg., Chicago**

## Vitalic Bicycle Tires

It isn't merely that Vitalic Tires give more miles per dollar of cost — the reason riders like them is because of the satisfaction of *knowing* that a Vitalic Tire is dependable. That feeling of confidence in the tires makes a new sport of bicycling.

# VITALIC

## Bicycle VITAMINE Tires

(Reg. U.S. Pat. Off.)

The pure rubber innertube can't leak; the motorcycle tire fabric can't split; the heavy, pure rubber non-skid tread is good for thousands of miles of hard riding.

Send for story, "The Man Who Rode on His Rims," and for testing section.

CONTINENTAL RUBBER WORKS, 1964 Liberty St., Erie, Pa.



## Ever Lose a Foot Rule? The Security Rule Pocket

will positively prevent loss, as the rule cannot fall out of pocket, no matter what position the user is in. Fasten anywhere or remove in an instant, but designed to fit in the overalls side pocket. Made of Hard Aluminum Alloy. Light and Strong. Weight 1 oz. Will last indefinitely, rust-proof, prevents injury to rule under all conditions and figures on rule cannot wear off. Made for 4-fold 2-ft. rule, but will hold 4-fold 3-ft. rule.

Price, 25c Prepaid in U.S.

Send P. O. or Express Money Order. No stamps. Moneyback if not satisfied. Canadian Patent for sale. Security Aluminum Rule Pocket Co. IVANPAH, CALIFORNIA



## AETNA ACCUMULATIVE ACCIDENT

**POLICIES** cost little, and pay \$50 a week for disability, \$10,000 for accidental death. Investigate.

AETNA LIFE INSURANCE COMPANY

Drawer 1841

Dept. PM. 8-15

Hartford, Conn.

## New Auto Engines for Old

Noisy, wheezy, cranky, leaky, over heating, snapping, smoking auto engines can now be changed into quiet, powerful ones as if by magic. Cylinders worn egg-shaped, cause early old age of most motor cars. Now worn and scored cylinders can be ground out like new with the



### Boxill & Bruel Portable Cylinder Grinder

Its low price, compared with any other outfit for such work, puts it within reach of every high-class garage or service station. A big money-maker. Full details free.

THE BOXILL & BRUEL MACHINERY CO., Dept. 594, Cincinnati, O.

## The Acetylene Blow Torch Prest-O-Torch

Costs less to buy than a good gasoline blow torch and costs less to use.

In all soldering and brazing, the Prest-O-Torch avoids the delays and uncertainties of gasoline outfits. Provides a concentrated, intense flame that doesn't blow out even in a high wind. Needs no attention whatever. Used with handy sizes of Prest-O-Lite cylinders—ready-made gas, instantly available.

Style "A" sells for 75c. Used with the small MC size Prest-O-Lite. Will braze up to 3/8 inch round rod. This outfit can be fitted with handle and hook for added convenience in bench and overhead work. Style "C" Prest-O-Torch is recommended for large work. Will braze up to 1/2 inch round rod. Sells for \$2.25. For use with the larger sizes of Prest-O-Lites.

Write for special literature and learn where you can see the Prest-O-Torch in operation. 816 Speedway, Indianapolis, Ind. The Prest-O-Lite Co., Inc. Exchange Agencies Everywhere



## If You Are a Shallow Breather

You most certainly are in need of Conscious Evolution to become fully alive and have the benefit of living in full. Why live an inferior life when you can become superior to yourself through Conscious Evolution?

**MY NEW BOOK** explains the human body as it has never been explained before. It tells of the dangers and after effects of exercise and conscious deep breathing. My free book will prove of great value to you. If you desire to be more successful, to have greater will power and the successful powers, physical, physiological and mental, you cannot afford to be without my free book. Write for it today.

ALOIS P. SWOBODA

1311 Aeolian Hall

NEW YORK CITY

## Steer Your Ford With Ease and Safety

**Y**OU know how your Ford acts when you go above 10 miles an hour. It means both hands tight on the steering wheel, and the first turn or suggestion of wabbling spells trouble. It means turning the wheel frantically to the right and left to maintain anything like a straight course.

Stop riding with danger every day. Don't steer under this strain. The L-A Steady Steerer actually removes the cause of the trouble—does not merely counteract it. This valuable device is a strut or radius rod so connected between body and axle as to prevent absolutely all side movement between them. It makes impossible the wabbling that is the beginning of the driving trouble. And it assures as precise a course as you could steer with a Packard.

The L-A Steady Steerer is a safety factor of incalculable worth. And it is a positive insurance against unnecessary wear on parts and tires. Can you afford to be without it when so much insurance is provided at so little cost?

Lockwood-Ash Motor Company, 512 Horton St., Jackson, Mich.

Make Your Ford Walk a Chalk Line



**LA**  
STEADY STEERER

Only  
**5¢**

## Butter-Kist Pop Corn

**Fast Becoming  
Most Popular Confection!**

Once you taste it you'll never be satisfied with any pop corn less delicious. Its appeal is irresistible. Every crisp, crackling, snow-white kernel is perfectly popped and evenly buttered. The kernels at the bottom are like those at the top. No 5c treat so satisfying—perfectly pure and healthful.

Ask for Butter-Kist. Progressive merchants everywhere are installing the sanitary Butter-Kist Pop Corn Machines.

**H & H  
BUTTER-KIST  
POP CORN**  
TRADE MARK REGISTERED

**\$25**

**to \$60**

**Weekly Profits**

for merchants and others if you install the Butter-Kist Pop Corn Machine. Hundreds of storekeepers are already reaping a harvest of nickels. One of these machines installed in a store last January took in \$2,065 the first five months. Hundreds of like records prove the Butter-Kist Popper nets much more profit per square foot than anything else in the store, for 70c out of every dollar's worth of pop corn you sell is clear, clean profit. Big, constant demand. All-year, spot-cash business. No stock to carry. Butter-Kist is a trade-builder for the entire store.

### Pay from Your Sales

Only \$150 down puts this Butter-Kist Pop Corn Machine in your store with all Butter-Kist privileges. Pay balance on easy installments. Soon pays for itself out of the profit it earns.



### Get This Book Free

Facts, figures, photographs, proofs of profits, etc., shown in our new book—"The Little Gold Mine." Sent free, post-paid.

Every day gained means bigger income and new profits.

**Holcomb & Hoke  
Mfg. Co.**

1711 Van Buren Street  
INDIANAPOLIS, IND.

Please Mention Popular Mechanics



Count de Beaufort, noted war correspondent, with his Corona Typewriter, in the Belgian trenches.

### At the Front in War as in Peace

Roughing it in camps and trenches, sharing the hardships of the war reporters, the Corona writes for the whole world to read. It writes, too, the record of its own trusty service.

Here's a modern writing machine as marvellously efficient as the modern fighting machine. It weighs but 6 lbs., and takes, when folded, as little space as a fair-sized camera. Yet it has all standard typewriter features from visible writing and universal keyboard to back-spacer and two-color ribbon, at a cost of only \$50.

Its rugged, field-tried serviceability must commend the

## CORONA FOLDING TYPEWRITER

*The Machine for Personal Use*

to practical minds in all walks of life. For your home work, your business trips, your longer Summer sojourns—think of having a real, standard typewriter literally at your fingers' tips!



The above "phantom" cut shows the Corona folded in carrying case. Below you see the carrying case open.



### To See the Corona —

Simply walk in on the nearest Corona dealer, and have him put the machine through its paces. If you do not know his address, let this coupon bring it to you, together with Booklet No. 13, telling how the Corona will help you.

### Corona Typewriter Co., Inc.

Groton, N. Y.

New York Salesroom: 141 W. 42nd St.

Dealers Everywhere

Corona Typewriter Co., Inc., Groton, N.Y.  
Please send me Booklet No. 13 with name of nearest dealer. (If space for name, etc., is too small, continue on margin.)

Name .....

Address .....



Manufacturing gas tight rectangular tanks from sheet steel by oxy-acetylene welding. These tanks are part of the large acetylene purifying apparatus used at the various charging plants of The Prest-O-Lite Co., Inc., in its extensive acetylene service system.

## Every metal working establishment needs Oxy-Acetylene Welding

It effects tremendous savings of time, labor and materials. Greatly simplifies and cheapens the manufacture of intricate metal parts. Saves defective castings from the junk pile. Corrects mistakes in design. Effects immediate repairs of broken or worn equipment—making it good as new—without expensive dismantling, costly delays and replacements. Often, the time alone that is saved in this manner more than pays for necessary equipment. Remember, whenever two pieces of metal are to be joined you will find profitable use for oxy-acetylene welding.

## PREST-O-LITE Dissolved Acetylene

(Ready-made carbide gas)

renders any good make welding or cutting equipment portable,—more widely useful and efficient. Equipment needed is not costly. We furnish a thoroughly high-grade welding apparatus for \$60.00. The average user will also need gas cylinders at an additional cost, and about \$10.00 worth of welding supplies. Truck and special equipment for cutting operations at extra cost.

## Dependable Acetylene Supply

Prest-O-Lite Acetylene Service is permanent and universal, furnishes the highest grade of Dissolved Acetylene in portable cylinders, used as conveniently as you use cylinders of oxygen. Saves the large initial outlay and heavy depreciation, trouble and inconvenience of making crude Acetylene in carbide generators. Besides, Prest-O-Lite Dissolved Acetylene is perfectly dried, cleaned and purified—makes better welds and is cheaper to use.

If you use Acetylene for ANY purpose, you should have full details of this unparalleled service.

## Send for Free Literature

Others are making money by using Oxy-Acetylene welding and cutting. Send for information of how the process will help you.

**The Prest-O-Lite Co., Inc.**  
The World's Largest Makers of Dissolved Acetylene  
816 Speedway Indianapolis, Ind.

53 direct factory branches and charging plants in principal industrial centers.



## \$25 Worth of Tools for Only \$12.50

THAT'S what you get in this big, strong, everlasting combination of tools we call the STEWART HANDY WORKER. If you bought all the tools in it of the same high quality, strength and durability, and the equipment to operate them with, they would cost you at least \$25 at wholesale prices. This is what it comprises:

A strong and powerful vise, up to 4½ inches. Width of jaw, 4 inches. Cutting hardie. Pipe vise takes up to 1½ inch pipe. Drill press which may be operated at two speeds. Good sized anvil. Corundum grinding wheel, 5 inches x 1 inch. Three speeds; direct, 4 to 1 and 16 to 1.

Complete, with all attachments, only, \$12.50



Weight, boxed, 85 pounds

Each one a tool you can use every day in the year to save time and money. A complete, compact workshop that you can attach to a table or bench anywhere about the place and make it pay you every day in the year. It will enable you to quickly and easily do the many repairs that now make you chase off somewhere to get done at expense in time and money.

Send for one of these great combined outfits today with the understanding that if you don't like it in any single respect you can ship it back and we will return every cent you paid out. Of all the thousands shipped not one customer has made a single complaint. It pleases every customer, but our standing offer to return every cent paid out holds good to each purchaser.

Send only \$2.00 with your order and pay the balance when you get it. Order today or write for booklet.

**CHICAGO FLEXIBLE SHAFT CO.**  
105 N. La Salle St., Chicago

## Auto Gasoline 3¢ a Gallon

Sounds wonderful, but it's a fact; and what is better, your motor car will have "pep," "snap," power and speed never before. Carbon evil eliminated. All these good things and more come when GASO-TONIC is added to ordinary gasoline. Mileage increased 40%. Scientifically right. Quat can treat 100 gallons of gasoline, \$2 prepaid. Results guaranteed. Motorists may see GASO-TONIC wherever GASO-TONIC is tried. Circular and convincing details free. Great opportunity for live dealers. WHITE MFG. CO., Dept. 112, CINCINNATI, OHIO

## STANWELD Cold Drawn SEAMLESS STEEL TUBING

Lightest, smoothest, strongest Steel Tubing made. World's largest manufacturers of bicycles, motorcycles and automobiles use it exclusively. Send for Folder "A."

**THE STANDARD WELDING COMPANY**  
Main Office and Factory CLEVELAND, OHIO

## The Engine for you Starts on First Turn

**2 H.P. Four Cycle, Throttle Governed, Hopper Cooled**  
Cast iron gasoline tank forms part of engine. Cylinder head with valves is removable. Engine balanced. Power smooth and steady. Details on request.  
**\$35**  
The Self-contained Power Plant  
C. BENNINGHOFFEN SONS, HAMILTON, O.



## Large Profits from Small Capital

A Business of your own bringing you an income of at least \$10.00 per day with practically no experience or overhead expense.

**THE GREEN AUTOMATIC MACHINE**  
sharpens, hones and strops all kinds of safety razor blades, all in one operation, at the rate of 150 to 250 blades per hour, you can readily figure your profits. Let us send you our free booklet explaining everything.  
Am. Sharpening Machine Co., (Inc.)  
Dept. 8 184 Washington St., Chicago



Please Mention Popular Mechanics





## After Your Dip—A Cigarette Rolled In Riz La Croix Paper

gives you just the keen, lively relish you want — full of tasty mellow flavor of your favorite tobacco. That's why men who know always use these world-famous cigarette papers — Riz La Croix *Quality* guarantees 100% smoke-satisfaction.

# RIZ LA

5<sup>c</sup>

(Pronounced: REE-LAH-KROY)

**FAMOUS CIGARETTE PAPERS**

Rolled in a jiffy—presto! A round, smooth, firm cigarette that holds shape, smokes perfectly and doesn't "come undone" — that's Riz La Croix.

The thinnest, lightest, purest "papers" made. Their combustion perfect — no "paper taste" in the smoke.

Naturally adhesive, because made of best flax-linen — a pure, vegetable product.

You try Riz La Croix—today.



**FREE**

Two interesting, illustrated Booklets — one about RIZ LA CROIX Cigarette Papers, the other showing how to "Roll Your Own" cigarettes — sent anywhere in U. S. on request. Address The American Tobacco Company, Room 1124, 434 Broome St., N. Y.

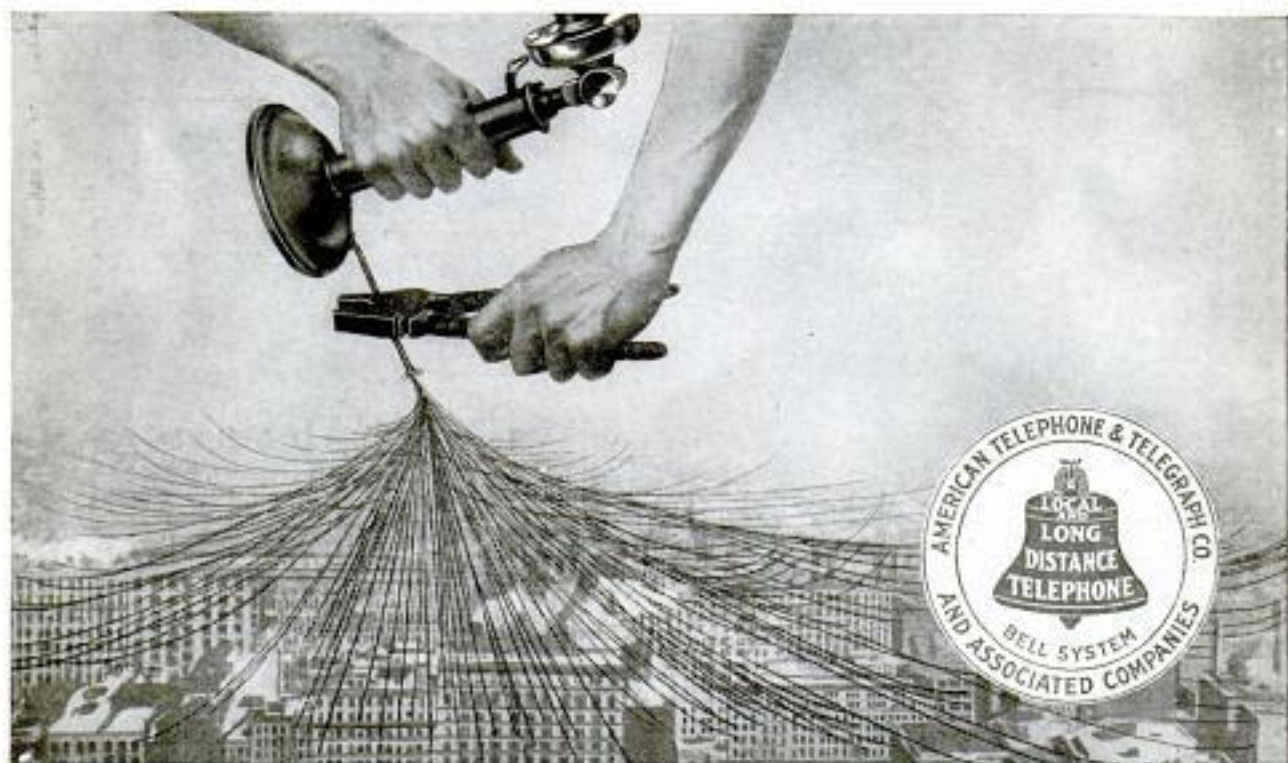

## If a Giant Cut the Wires

Suppose all telephones were silent, and that for forty-eight hours you could not even call a telephone exchange anywhere in the Bell System to ask what the trouble was!

Imagine the confusion which would prevail—with personal visits and messengers substituted for direct, instant communication; with sidewalks, street cars and elevators jammed; with every old-fashioned means of communication pressed into service and all of them combined unable to carry the load.

The instant contact of merchant with customer, of physician with patient, of friend with friend, would be severed; the business man and the housewife would lose the minutes and hours the telephone saves them. The economic loss would be incalculable.

There would not be time enough to do the things we are accustomed to do, and social as well as business life would be paralyzed.

Such a condition is almost inconceivable. The Bell System has developed telephone service to the highest degree of usefulness and made it so reliable that its availability is never questioned. It has connected cities, towns and the remotest places from coast to coast, and has taught the people the advantages of nation-wide telephone facilities.

Plans are made, buildings built and businesses run with Bell Service taken for granted, and yet we have to imagine what it would mean to be entirely without telephones before the great value of this ever-present service can really be appreciated.

**AMERICAN TELEPHONE AND TELEGRAPH COMPANY  
AND ASSOCIATED COMPANIES**

***One Policy***

***One System***

***Universal Service***

*Please Mention Popular Mechanics*

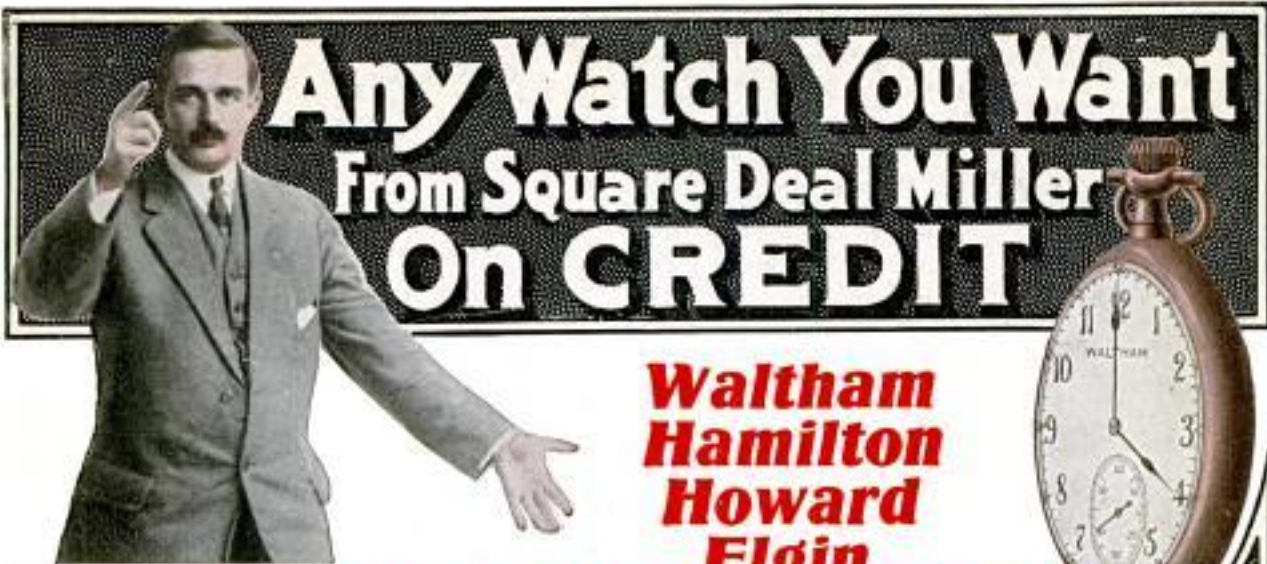

# Any Watch You Want From Square Deal Miller On CREDIT

**Waltham  
Hamilton  
Howard  
Elgin**

**Illinois, Seth-Thomas, Rockford**

## I SMASH THE TERMS!

I have well earned My title of "Terms Smashing Miller." No catalog published offers **Any Make of Watch You Want** on as Easy and as Liberal Credit Terms as the New Book sent to you Free for your name and address.

**Your Choice of  
Inlaid Enamel Cases**

**30 Days Free Trial—No Money Down  
Express Prepaid in Advance by Me**

That is the test that tells. Suppose you want a watch? Any make, any grade, any size, any case. I have it for you—just the watch that you want. **No Money Down, Express Prepaid.** You can try any one of America's best known timepieces for 30 Days. **A Free Trial, a Full Month to Carry It in Your Pocket.**

**An Open Account—No References Demanded**

The same kind of credit you get from your grocer liberally and cheerfully given. Arrangements are made for an Open Account as soon as you write. No red tape, no publicity, notes or collectors. Every transaction is strictly confidential on terms made to suit you.

**Send Coupon for Watch and Diamond Book  
Why You Should Have This Book.** It is the Encyclopedia of watches; a Dictionary explaining watch words; a History of Watch Making in America; the only Index Book of a Good Watch and an Absolute Authority on Watch Buying. Use a postcard, a letter or the convenient coupon. Know Facts on All makes of watches before buying anywhere. This book is a Key to watch buying. It tells you how to judge a good watch. Write for it today and get a letter from Square Deal Miller that makes you a friend for life.

**Square Deal MILLER, Pres.  
Miller-Hoefler Co., 493 Miller Bldg.  
Detroit  
Mich.**



**FREE  
CATALOG COUPON**

Square Deal Miller, Pres.  
493 Miller Bldg., Detroit, Mich.

DEAR SIR: Please send me, without cost or obligation, your Big Book of Facts on all makes of High Grade Watches, Genuine Diamonds and Jewelry and full information on your Easy Payment, No Money Down and 30 Days Free Trial Plan.

Name \_\_\_\_\_

Address \_\_\_\_\_



## The Great American Smoke—"Bull" Durham

Fall in line with hundreds of thousands of red-blooded smokers of the good old U. S. A. Smoke the cigarette tobacco that's been an American institution for three generations—"Bull" Durham. The rich, relishy, star-spangled taste of "Bull" puts the national spirit of get-up-and-hustle into your hand-rolled cigarette. "Bull" is the freshest, snappiest, liveliest of smokes.

# GENUINE "BULL" DURHAM SMOKING TOBACCO

"Roll your own" with "Bull" Durham and you'll find a far greater satisfaction in smoking your cigarette than you ever did before. The rich, mild tobacco leaf "Bull" is made of has that delightful mellow-sweetness which suits your taste to a "T." And its aromatic fragrance is supremely unique. Men who never smoked cigarettes before are now "rolling their own" with "Bull" Durham.

Ask for *FREE* package of  
"papers" with each 5c sack



## FREE

An Illustrated Booklet, showing correct way to "Roll Your Own" Cigarettes, and a package of cigarette papers, will both be mailed, *free*, to any address in the United States on request. Address "Bull" Durham, Durham, N. C., Room 1124.

THE AMERICAN TOBACCO COMPANY

