

June

MAY 12 1915

15 Cents

POPULAR MECHANICS MAGAZINE

WRITTEN SO YOU CAN UNDERSTAND IT

TRADE MARK

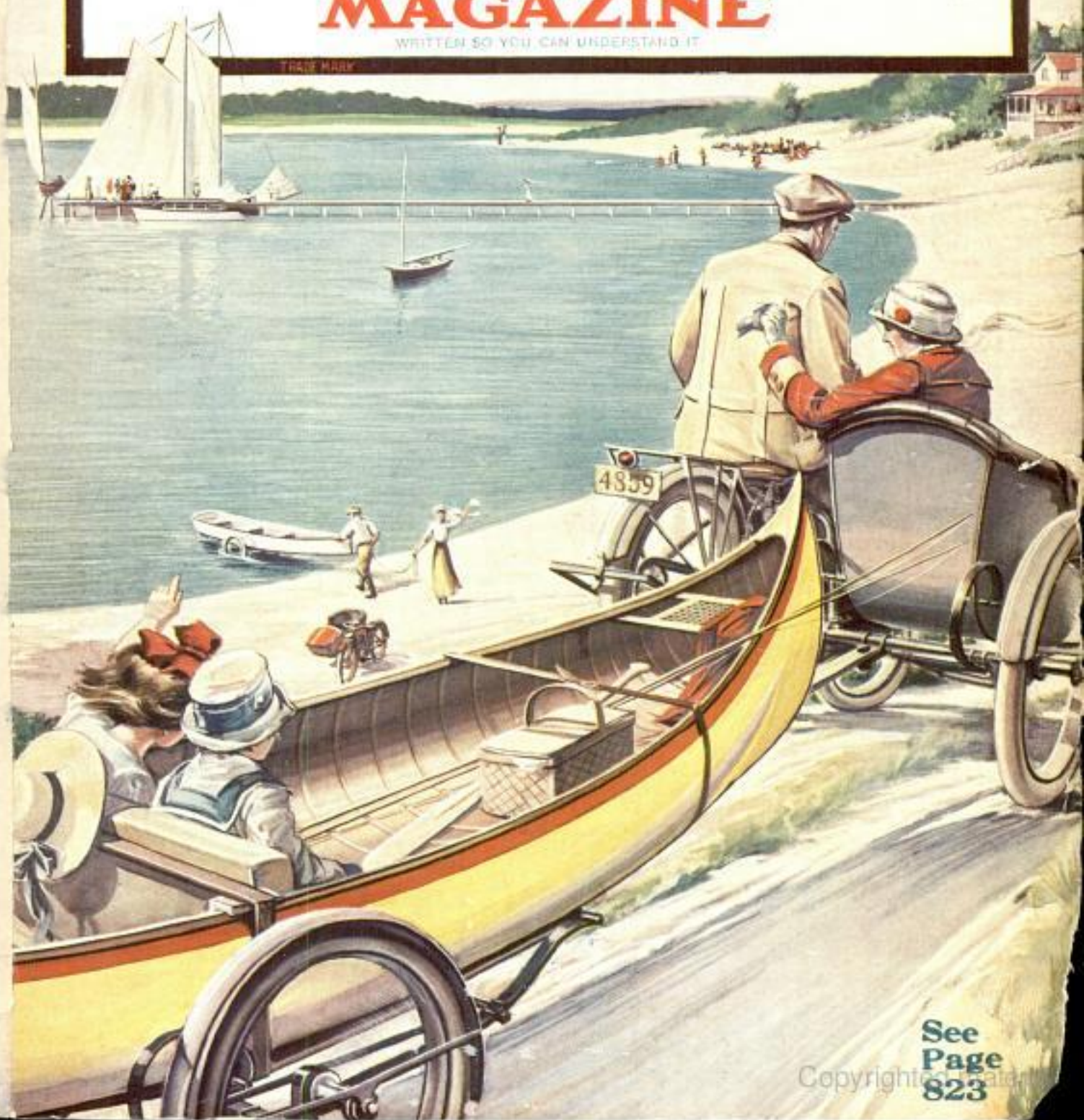

See
Page
823

\$699

BUYS THE MATERIAL To Build This Harris Home

Easily Built — Guaranteed Construction

**No Shortage
No Extras
No Waste**

**Cut-to-Fit
that Builds
to Stay**

4

**Big Lumber
Shipping Points**

See the 100 Modern Harris Homes in our free \$10,000 Book of Plans shipped "direct to you" from our four big shipping points conveniently located.

**No Money Down
Save 1/3 to 1/2**

Write Today

We will name you freight prepaid prices on everything — lumber, millwork, hardware, plumbing, heating, etc., that will mean a saving of from 1/3 to 1/2. Upwards of 20,000,000 feet of brand new lumber is in our mammoth stock at all times, and we will ship without one cent down. Get our plan.



Build Your Home at the Price You Ought to Pay
23 YEARS OF EXPERT PLANNING

**Our Guarantee
Protects You**

Greatest of all is this Harris Home Building Plan, a truly wonderful offer — clean and straightforward. The first real helpful home building plan — the opening wedge that made it possible for thousands of satisfied Harris Home owners to realize their dream of years. In dealing with us you reap the benefits of these vital essentials — **23 Years of Expert Planning, Designing and Close Study of Economy in material and labor.** Through all these years we have maintained with ease, our lead, never finding it necessary to recognize competition. Make us prove this to your satisfaction. It won't cost you a penny to get our offer now — to-day. Our binding guarantee backed by every cent of our ten million dollar capital stock, gives you an iron clad protection. You can't possibly go wrong, for we take all the risk, you take none.

THE DESIGN The Harris Home No. 161, above, is a perfect combination of comfort, convenience and economy; modern in every respect. Six rooms, bath, large closets, pantry and modern interior. This is but one of the many splendid designs which can be carefully studied from our **Free Plan Book** in your own home during your leisure hours. Mail the coupon below for your copy of our Plan Book today.

THE MATERIAL. Knotless lumber for all outside finish, interior finish, Flooring and Cedar Shingles. No. 1 Dimension Lumber. **Ready-Cut the Harris Way;** all glass in and back puttied — saves time and labor. Up-to-date Antique Copper or Lemon Brass Finish Hardware. Harris Homes are architecturally correct in every detail.

**Mail Coupon
Below Today**

PLANS FREE We will send you a complete set of blue print plans, such as would cost you from **\$25 to \$100** if drawn up by any reputable architect, upon receipt of the coupon below and **\$1.** We will also include along with the plans, free of charge, Specifications, Material List and a guaranteed delivered price to your station. If you decide to purchase, you will be credited with this remittance of **\$1** on your bill, so you see this service is absolutely free. If the plans did not suit and you are not ready to buy, return them, and 50c will be refunded.

Dept. CF7
Harris Bros. Co.

Send me your Free
\$10,000 Plan Book I
am also interested in

Name _____

Address _____

Plumbing and Heating

You can easily install your own heating plant and plumbing material with the assistance of our free expert engineering service. We show you how to eliminate much of the biggest expense. Mail the coupon for your copy of our new plumbing and heating book. Complete bathroom outfits, **\$37.50.** Enamelled bath-tubs as low as **\$13.** Warm air heating plants, **\$67.** Steam heating plants, **\$85.** Hotwater heat, plants, **\$95.**

Quality Roofing

Our new roofing book is full of practical information. Tells you the correct grade and style of material adapted to your particular purpose. Everything explained by diagrams. Biggest values ever offered, in ready roofing, metal roofing, siding, ceilings, etc. Prices represent savings of from 1/3 to 1/2 in every instance. Mail coupon for FREE copy today.

Building Material

Mail the coupon today for our 200-page building material book, replete with bargains in lumber, doors, windows, millwork, paint, roofing, plumbing, hardware, lighting fixtures, roofless, grates, colonnades — in fact, everything in structural materials for the construction of any building. Substantial savings evident in every instance.

Our every transaction guaranteed and backed up by our capital stock of \$10,000,000.00

HARRIS BROTHERS CO. 35th & Iron Sts. CHICAGO

Victor Record
of "I Hear You
Calling Me" song
by McCormack



McCormack



© James & Bushnell

Both are McCormack

The Victor Record of McCormack's voice is just as truly McCormack as McCormack himself.

Whether you hear the great Irish tenor on the Victrola or on the concert stage, it is all the same.

The same natural voice of surpassing beauty, the same distinctness of enunciation—the same McCormack.

The proof is in the hearing. Any Victor dealer in any city in the world will gladly play for you any of the eighty-nine McCormack records, or Victor Records by any other of the world's greatest artists.

There are Victors and Victrolas in great variety of styles from \$10 to \$250.

Victor Talking Machine Co., Camden, N. J., U. S. A.

Berliner Gramophone Co., Montreal, Canadian Distributors

Always use Victor Machines with Victor Records and Victor Needles—the combination. There is no other way to get the unequalled Victor tone.



New Victor Records demonstrated at all dealers on the 28th of each month

If you *must* wait awhile before building all anew—why not
**“LOVELIFY” the PRESENT HOME by ADDING
 A CYPRESS TRELIS— & AN ARBOR— & A NOOK?**

“Puttering Around” on Such Things Will Make This “The Happiest Summer Yet.”

You can do it yourself,
& WE CAN HELP

by sending you at
 once that great big

VOLUME 28

with full Working Plans of

19 ORIGINAL DESIGNS

—complete Specifications
 and an Extra Supplement
 on “What Values & When”



You will enjoy the

27 PICTURES

and 2 valuable charts, and
 will not forget to
 specify and insist on

CYPRESS (of course)

—not to please us, but
 because it is “The Wood
 Eternal” and saves you
 the bother of repair bills.

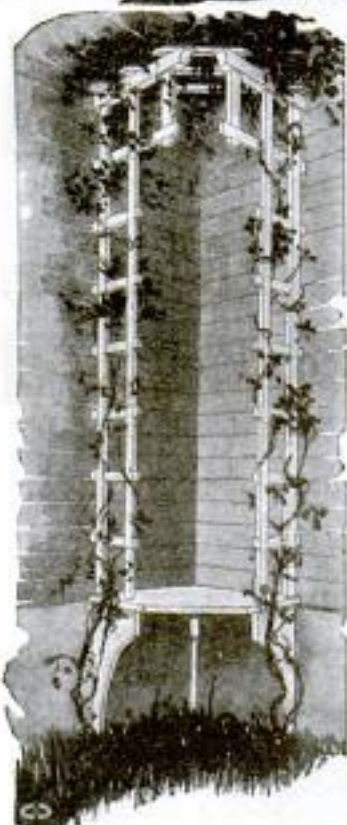

Above are four of the 19—all special designs by well-known architects—not one can be bought—but all are yours FREE with our compliments—in VOLUME 28. The 3 articles and 2 planting charts on Vines are alone worth 50 times the stamp it costs to get this book.

OUT-OF-DOOR DAYS NOW—ALSO ASK FOR VOL. 35, CYPRESS SLEEPING PORCHES, &c—7 DESIGNS

When planning a Mansion, a Bungalow, a Farm, a Sleeping-Porch, or just a Fence, remember—“With CYPRESS you BUILD BUT ONCE.”

Let our “ALL-ROUND HELPS DEPARTMENT” help YOU. Our entire resources are at your service with Reliable Counsel.

SOUTHERN CYPRESS MANUFACTURERS’ ASSOCIATION

1219 Hibernia Bank Building, New Orleans, La., and 1219 Heard Nat’l Bank Bldg., Jacksonville, Fla.

INSIST ON CYPRESS AT YOUR LOCAL DEALER’S. IF HE HASN’T IT, LET US KNOW IMMEDIATELY

CROSBY-CHICAGO

Please Mention Popular Mechanics

Copyrighted material

Popular Mechanics Magazine

6 N. Michigan Avenue, Chicago, U. S. A.

EDITED BY H. H. WINDSOR

England: The International News Co.,
5 Beams Bldg., Chancery Lane, London, E. C.

Australia:
The Australasian News Co.

ISSUED MONTHLY

SUBSCRIPTION:

SINGLE COPY, 15 CENTS

In United States, and its possessions, Cuba and Mexico, per year, postpaid - - - \$1.50
To Canada - - - - - 1.75
To all other countries in the Postal Union - - - - - 2.50

All subscriptions are discontinued at expiration. Please examine the date printed on your wrapper.

Entered as Second Class Matter Sept. 15, 1901, at the Post Office at Chicago, Illinois, under Act of March 3rd, 1879.

Entered as Second Class Matter at the Post Office Department, Canada.

Published monthly by POPULAR MECHANICS CO.

Copyright, 1915, by H. H. WINDSOR.

Copyright, in France.

Engine, Smallest Gasoline in the world 596

Contents for June, 1915

Aeroplane Propeller, Huge, Built in One Piece..	876	Curbs on Darkened Streets in Britain White-washed	813
Airman, Army, Makes Record Carrying Two Passengers	913	Cyclecars Built by Boys from Odds and Ends....	907
Airman Makes Record Fall and Escapes with Life	883	Dam, Arrowrock, Almost Ready for Use.....	814
Airship—Hardware Zeppelin Made for Window Display	903	Dentifrice Dispensing Device.....	816
Airships—Zeppelins, To Attack with Explosive Darts	802	Driveway Entrance Made of Cobblestones.....	828
Ambulances for Europe Donated by Students....	881	Electric Fuse Plugs, Four, in One.....	860
Apron, Spring Belt for.....	916	Electric Generating Unit for Use on Yacht.....	859
Automobile Accident, Odd, Which Injured No One	820	Elevator Control in the Woolworth Building....	887
Automobile, New Plan for Advertising.....	885	Explosive, New, Kills by Asphyxiation.....	812
Aviation, American, New Interest Manifested in	874	Fertilizer, Producing from Peat.....	832
Baggage Rack, New, for Railway Coaches.....	906	Fire Alarm Siren Heard Seventeen Miles.....	877
Bats, Colony of, Mosquito Pest Suppressed by	877	Fire Alarm Starts Motor Truck Engines.....	831
Bells, Church, Ringing by Electric Power.....	871	Fire Hose Couplings, Uniform Standards for	920
Bench, Artistic Concrete, for Lawn or Park....	903	Fires, Prairie, Machine Lessens Dangers of	914
Birthmarks are Removed by Use of Radium....	881	Flag, American, Made of Colored Concrete....	873
Blue Cross Work Spreads as War Progresses....	888	Flash-Light Signal Device Used by British.....	829
Boat, Power, Three-Piece for Sportsmen.....	843	Flax Straw a Valuable By-Product.....	872
Boring Mill, Huge, Built to Finish Gun Turrets	898	Fly Paper Holder, Useful.....	917
Bricks, Roller Conveyor Designed for Handling	823	Flying Boat, Lightweight, Used on Lake Michigan	872
Bridge, New, Brings Out Striking Contrast.....	905	Forest Service Badge New National Insignia... ..	886
Bridge Spans Railroaded into Place.....	818	Fork for Serving Sandwiches.....	917
Bridge, Swing, An Electrically Operated.....	832	Fruit Jar Sealed with Air Seal.....	884
Building, Administration, of Panama Canal....	889	Funeral, Weird, of Natives in Northern Siberia	911
Buildings, Old, Protect against Damp Walls....	913	Garage, Inexpensive, Built of Tank Staves....	826
Burmese Festival, Curious Feature of.....	895	Gardens, Prehistoric, Plan for Philadelphia Park	853
Cake Cutter, Novel.....	918	Gas Analyzing Apparatus for Furnaces.....	827
Camel Caravan, Algerian, Crossing Arid Region	902	Gas Engine, Compact, Made for Use in Canoe... ..	904
Cane, Hollow Walking, Used as Medicine Case	832	Gas Mains are Elevated above City Streets....	802
Canoe Attachment for Outboard Motor.....	898	Gasoline, More and Cheaper.....	887
Carbon, Solution for Preventing Deposit of	820	By Joseph E. Murphy	
Cars, Private, Placarded "Not a Jitney".....	839	Glass Partitions, Translucent, for Office Buildings	818
Cars, Two Freight, Switch with Automobile....	883	Gloves, Rubber, Examining for Electrical Workers	886
Chairs That Eliminate Unnecessary Fatigue....	910	Golf Player, Elastic Checkrein Made for.....	874
Cheese, Brick, Weight Computing Cutter for	886	Gun, Big, Looking into the Muzzle of.....	875
Chimney, Iron, Reinforced Concrete Used to Repair	832	Guns, Big Naval, Effective Firing Range of....	873
Church in a Cave a Mecca for Brazilian Pilgrims	909	Guns, High Velocity, for the German Navy....	878
Cigar Holder, Motorists', Catches Sparks.....	920	Hair, Hole Bored through, is Threaded with Silk	832
Coal, Screenless Apparatus for Sizing.....	816	Hair, Japanese, Demand for Exceeds Supply....	828
"Color Music" Introduced at New York Concert	836	Hay Baler Made of Wire and Rough Boards....	822
Colors, Different, Heat-Absorbing Qualities of	806	Heat Greater Than That of Sun, Produces	914
Commerce Raider Interned at American Port....	839	Heating Fixtures, Making Utilize Waste Space	816
Cooking Vessel, Odorless.....	917	Highway, Building across Storm King Mountain	843
Cord Adjuster, New, for Drop Lamps.....	914	"Hobo" Hotel, California Town Has.....	820
Cottonseed Flour as Food for Humans.....	860	Hoop Cycle New Vehicle for Children.....	817
Cross, Military, is New British Decoration....	826	Hose Clamp, Two Piece.....	916
Crutches, Adjustable, Used by Wounded Soldiers	892	Hotel Provides Buttons for Its Guests.....	901
		Hydroplane, New, with Aerial Propeller.....	805
		Icebergs, Submarine Telephone to Detect....	887
		Incinerator with Ash Receiver.....	917

[Continued on Page 6]

Popular Mechanics offers no premiums; does not join in "clubbing offers," and employs no solicitors to secure subscriptions. It is for sale by nearly every newsdealer in the United States and Canada

This One



1LPA-OZL-RJWZ

[Contents—Continued]

Indians, Blackfeet, Pictorial History of.....	802
Iodine, Phial of, Used by Surgeons in War.....	824
Ironing Board, Built-In, Folds into Cabinet.....	894
Kite Fighting a Popular Japanese Sport.....	810
Knife and Fork, Combination.....	835
Knife Made with Blades That may be Replaced.....	802
Lamp, Safety, is Designed for Use of Miners.....	893
Lamp, Useful Electric.....	917
Lantern, Electric, Throws Light Downward.....	893
Lattice Causes Peculiar Shadow Effect.....	897
Life Preserver, New, Saves Victim from Ex- posure.....	827
Lime, Storage House is Burned by Slaking of.....	820
Lincoln Highway, Marker for Branches of.....	915
Lumber, Drying, Electrical Process for.....	840
Man, Packing, Ready for Shipment.....	861
Maps, Road, Simple Way for Motorists to Carry.....	908
Match Box Which Carries a Windshield.....	919
Metal Chips, Shield to Catch.....	899
Mints Equipped to Make More Coins in a Day.....	855
Monument Marks Grave of Race Horse.....	841
Monument to Bismarck Erected at Nürnberg.....	822
Mosquito Screens, Using Cheesecloth Tents as.....	804
Motor Trains are Used at San Francisco.....	908
Motorcycle, Making Camping Junkeys with.....	823
Motorcycle Pedal, New, Is Breakage Proof.....	919
Moving Picture Camera Uses Plates in Place of Films.....	880
Moving Picture Films, Feeding from Center of Reel.....	894
Novel and Practical Things for Daily Use.....	916
Oil, Porpoise Jaw, Made Here for Century.....	894
Oil Stove, Glass Fuel Tank Used on.....	824
Oxyacetylene Torch, Sailor's Life Saved by.....	862
Paint, Making Wear Longer.....	900
Pens or Pencils, Elastic Holder for.....	920
Periscope, Pocket, for Use in Trenches.....	838
Pipes, Crude Clay, Used by Indian Troops.....	899
Potatoes, Seed, New Machine for Cutting.....	874
Railroad Exhibit, Novel, at San Francisco.....	812
Railroad Tracks Covered by Ice Embankment.....	830
Range Finder, Simple, for Small Arms.....	804
Rifle Aimed with Shaft of Brilliant Light.....	839
Rifle That Shoots around a Corner.....	833
Road, International Horseshoe Motor.....	880
Rule, Carpenter's, Holder for.....	920
Safety Island, Ornamental, Has Multiple Uses.....	802
Safety Razor Blades, Device for Resharpening.....	879
Sandstone Pillars Mark Path of Motor Trail.....	884
Scale Compensator, New, Gives Net Weight.....	866
Scale Registers Weight by Bending Bar.....	930
Scalp Treatment, Electric Atomizer for.....	831
Scenery, Iron, for Theater Made in Record Time.....	900
School Use, Bungalows Built for.....	819
Scow Has Hold Equipped with Tram Track.....	919
Sculpture, Photography Latest Aid in Reproduc- ing.....	892
Seaports, Inland Texas Cities to Become.....	913
Sewing Machine, Electric, Controlled by Brake.....	838
Sewing Machines, Fan Attachment Invented for.....	899
Ship—Dreadnaught "Wyoming" Steaming on High Sea.....	882
Ship's Course, Instrument for Laying.....	890
Ship's Speed, Automatic Computation of.....	818
Shock Absorber, Semielliptical Springs in.....	911
Shovel Blown Forty Miles through Pipe Line.....	873
Shovel, Coal, Oil Reservoir in Handle of.....	819
Show Window System, Novel, in New York Store.....	825
Silverware, Tarnish Removing Tray for.....	917
Siphon a Feature in Land Reclamation.....	863
Siphon for Carbonated Water Bottles.....	918
Smoke, Seeing Your Own, as Others See It.....	876
Speedometer, New, Uses Air Friction.....	915
Springs, Automobile, Oil Box for Lubricating.....	918
Staging, Temporary, Built with Ladder Brackets.....	810
Steamer, Wrecked, Rescues Self from Destruction.....	907
Steamship, Big, Floating on a Film of Air.....	828
Steel Casting, Flaws in, Shown by X-Ray.....	890
Steering Wheel That can be Slid out of Way.....	873
Stepladder and Scaffold, Combination.....	806
Street-Car Wheel, New, Noise Eliminated by.....	838
Stump, Rotary Cutter Reduces to Shavings.....	887
Submarine "F-4," Diving for.....	834
Submarine Freight Train.....	807
By Frank Parker Stockbridge	
Submarine Torpedo Boat, "Fins" of.....	801
Subsoiling Work, Simple Implement Made for.....	919
Suit, Finished, Making Uncut Cloth Look Like.....	824
Sword Given King Albert by Citizens of Paris.....	814
Tent, Cavalry, Adopted for All Army Branches.....	830
Tires, Automobile, New Armor for.....	893
Tires, Motor Truck, Antiskid Chain Invented for.....	904
Torpedo, Short Range, Used in German Sea Raids.....	906
Torpedoing of Merchantman Photographed by Passenger.....	845
Tractor, Electric, is Used for Warehouse Truck- ing.....	842
Train, Curious Freight, of Western Prairie.....	879
Trap, Novel, for Flies and Mosquitoes.....	897
Treasure Lost Over Century Ago, To Explore Sea for.....	904
Tree, Cypress, Chip Found in Heart of.....	802
Trenches, Battle, Digging with Steam Plows.....	919
Tunnel Alinement, Check with Sighting Bore.....	913
Turnips, Machine for Gathering and Cutting.....	891
Turntable, New, Car Turns Self Around on.....	871
Typewriters, Line Indicator for.....	918
Vise Holder That Fits Irregular Shapes.....	918
Wall, Retaining, Details of Shown by Model.....	889
War Chest, German, Opened after Many Years.....	894
War, European: Battle Fields, Towns of Northern France That Served as.....	850
Church, Medieval, Wrecked by German Shells.....	853
Enemy Plows Fields in France and Belgium.....	848
Hobbyhorses and Dummy Cannon in the War.....	854
Howitzer, Heavy Austrian Siege, in Action.....	849
Isolated Places Unaware of War.....	886
Riflemen in the Making and in Service.....	852
Street Cars Put to Novel War Time Uses.....	858
War Camps of the North, Scenes from.....	850
War, Lighter Side of, Seen in German Camps.....	851
War, Phases of, Seen by Men at the Front.....	855
Water Tank and Storage Room, Combination.....	879
Water Tanks on Railway Cars, Sterilizing.....	821
Watering Can for Plants on High Shelves.....	904
Wheat Seed, Machine for Cleansing of Smut.....	831
Window Locking Device, Convenient.....	916
Window Shades are Tacked to Rollers by Ma- chine.....	901
Wireless Equipment, Military, Carried on Motor- cycle.....	811
Wireless Transmission without Antennae.....	915
Wood Finishing Machine Lessens Handwork.....	859
Wood Veneered on Steel for Car Interiors.....	918
Yacht, Racing, Converted into Trader.....	864
SHOP NOTES	
Automobile, Adjustable Foot Lever for.....	929
Brass, Enlarging Holes in.....	933
Broaching Staggered Holes in Assembling Ma- chine Parts.....	923
Camp House, How to Build.....	928
Carving Knife, How to Keep Sharp.....	934
Cornet Mute, Substitute for.....	940
Coupler, Safety, for Switching Locomotives.....	929
Culvert, Concrete, Easily Constructed.....	923
Cutter, Protector, with a Double Notched Edge.....	924
Drawing Board, Extension for.....	940
Eye Magnet.....	925
Flies, Keeping Out of Ice Cream Parlor.....	939
Gas Engines, Air and Gas Mixer for.....	922
Gear Teeth on a Transmission, Support for End of.....	923
Goggles to Eliminate Glare of Headlights.....	925
Grocery Order Box for Suburbanites.....	922
Hammer for Thin Sheet Metal Work.....	929
Home, Building a: Part III—The Laying of Foundations.....	935
Leather, Restoring Tan Color to.....	929
Motor with Low Battery Consumption, Hot Spark for.....	939
Rifle, Front Sight for.....	933
Sign, Electric, of Unique Construction.....	931
Signal and Call Whistle, Electro-Pneumatic.....	930
Steady Rest Jaws, To Prevent from Marring Work.....	925
Steering Gear Lever Repair.....	940
Steering Lever, Broken, Repairing.....	938
Theater Seats, Empty, Locating Electrically.....	933
Thread Forming Tool for Thin Tubing.....	931

No Money Down

**Elgin, Waltham
Rockford All Styles
All Sizes**

There is no longer any need to buy a worthless watch just because it's cheap, or to pay a fancy price for a top-notch time-piece. If you want a highest grade watch, either ladies' or gentlemen's, or if you ever expect to own such a watch you should write today for Hartman's Free Watch Book which shows all the different styles and explains fully the details of the most startling price reducing offers ever made on highest grade, absolutely dependable watches in guaranteed cases. Adjusted to positions, adjusted isochronism and absolute accuracy to the fraction of a second, Open Face or Hunting Cases. Our ten million dollar purchasing power enables us, alone, to make such startling offers. Our wholesale prices on Elgin, Rockford or Waltham watches are the lowest ever made.

Free 30 Days Approval Test

We ship any watch shown in our big catalog on approval, all charges prepaid. You risk absolutely nothing—you pay nothing—unless you accept the watch after thorough inspection. Carry it a month. If you are not satisfied that it is the rarest watch bargain you ever heard of, return the watch at our expense.

NO REFERENCES ASKED

If you want to pay cash, you may, but it costs you absolutely not one penny extra to take advantage of Hartman's long time open account credit terms. No references asked, no embarrassing questions, no mortgage, no security, no interest, no collectors. Most liberal, satisfactory credit plan ever devised.

**Remarkable
Bargains**

- No. 9. G. 1141.** Ladies' Bracelet Watch. 20-year guarantee gold-filled thin model case, expansion bracelet. 15 Jewel lever high-grade movement. Elgin, Waltham or Swiss. **\$1.00 Per Month**
- No. 9. G. 1204.** Celebrated genuine Elgin, newest model, 7 Jewel movement, in thin, moisture, dust and wear-proof 16 size silver case. Only **50c Per Month**
- No. 9. G. 1178.** 17 Jewel Elgin, Waltham or Rockford movement. Thin model, 12 size, Hunting Case, permanent guarantee gold-filled case, bright cut in yellow and natural gold to contrast on rich red gold. Only **\$2 Per Month**
- No. 9. G. 1197.** 15 Jewel Elgin, Waltham or Rockford movement in guaranteed 16 size, thin model, 25-yr. guarantee gold-filled Hunting Case. Inlaid enameled border and monogram; any two or three letters you select in red, blue and white enamel. Only **\$2 Per Month**
- No. 9. G. 1164.** Elgin, Waltham or Rockford Ladies' watch, 14K solid gold 9 size Hunting Case Blassi model set with genuine diamond of excellent color and brilliancy. Only **\$3.50 Per Month**
- No. 9. G. 593.** Gentlemen's Gift Case, 12 size newest thin model 25 year guarantee gold-filled case, 15 Jewel Elgin Pride movement. Fine gold gold Waldemar chain, 13 1/2 in. long, and 2 blade gold stiffened Solid Gold Handle Knife in handsome black Morocco case. Remarkable bargain, only **\$2 Per Month**

FREE Hartman's Beautiful Watch and Jewelry Catalog

Send your name and address on a postal today—get your free copy. Learn our astonishingly low prices on famous Watches, Jewelry of every kind, Diamonds, etc., and easiest terms ever made. Address

HARTMAN'S Jewelry Dept.

123-25 W. 39th St.,
Chicago, Ill.

Your Credit Good

Please Mention Popular Mechanics

We Assist Students Getting Actual Driving Experience

YOU CAN LEARN the AUTOMOBILE TRADE

WITH DYKE'S NEW IDEA WORKING MODEL METHOD

IF OTHERS CAN, YOU CAN

Bert Tippey, De Soto, Ill., writes us that he knew nothing about autos when he started with us, but is now doing repair work, owns his own car, and owes his success to Dyke's Course. In a recent letter he states he began repair work before completing course and paid for course out of first job. He started in a small way, but is now doing general repair work. He grinds valves, cleans carbon, greases cars, times valves, sets magnetos, adjusts carburetors, etc., etc., and sells supplies. We started him. We first taught him the principle of all parts and then helped him get his start, just as we can do for you if you have any hustling ability.

If we prove to you that we have started hundreds of others into the repair business and as chauffeurs—who had no previous experience and who knew no more about an auto than you do right now—you must admit we can do the same for you. Write me today—now—and let me prove it.

A. M. Atkin, Repairing, Overhauling and Supplies, Lane Tree, Iowa, R. D. No. 1, in a recent letter says: "I have a lot of repairing to do; have been called upon several times to inspect second-hand cars."

Harry J. Herbin, Jamestown, Kans., was a farmer, but has doubled his income repairing and selling autos.

Mr. G. Strickland, Westport, Ont., Canada, writes us: "I am glad I took your course. Have just overhauled a car; timed the valves and set the magnetos. Owner says engine has more power. This is my first job. Thanks to your course."

Donald Stewart, Oakland City, Ind., became a chauffeur at \$25 a week. H. M. Fewins and S. F. Slayback, both graduates, are now running a Garage and Repair Shop at Woodbine, Iowa.

And we could continue until we had filled this and several more pages.



Our book of testimonials, showing photos of students and their shops—free.

All the Result of the Dyke System

We can thoroughly train you during spare time. Open a repair shop or drive a car and make many times more than you are making now. Don't forget, we help you get your start with our *Employment Plan*, if you want it.

DYKE'S NEW IDEA OF TEACHING BY MAIL WITH WORKING MODELS

is something new. We use *real* working models—not just one, but *two*. On these models you get actual practice, see the actual operation and learn more than you could from the auto itself—it's easy and quick. You don't have to study hard with this system—we teach through the eye—a new idea. We are the *originators* of the system of teaching by mail with models. We also use charts—268 of them and a 16 page manual. Our 40 instructions and Repairman's Instructions are simplicity itself—simple as A B C.

Our Employment Plan for Students

This represents years of work to provide something that no other school had, namely, a way for our students to get started in the practical line of work.

Mr. Dyke has been identified as a pioneer inventor, supply man, etc., with the auto industry since its beginning. He originated the first auto supply co. and published the first book on autos in America. No other man with such experience is to-day teaching others. And all the experience and inside information of the auto business he has thus gained, is embodied in this *Employment Plan*.

WRITE TO-DAY FOR THIS FREE BOOK

It is instructive and interesting—does not cost you a cent and places you under no obligations whatever—you need it for your own sake, not mine. Don't wait—there's no profit in waiting—WRITE NOW and learn how you can obtain all this training for only \$15, if you act immediately.



DYKE'S CORRESPONDENCE SCHOOL OF MOTORING
Box 189, Roe Bldg. ST. LOUIS, MO.

NOTE—Severe of initiators—Deal with the Originator

SPECIAL INSTRUCTION on Six and Eight Cylinder Engines
1915 Electric Starting and Generating Systems

(Contents—Continued from page 6)

Valve Guide Retainer, Broken, Repairing.....	928
Velocipedes, Tool to Replace Rubber Tires on.....	932
Watch, A Safe Way to Carry.....	935
Water, Fresh, Procuring from the Ocean.....	924
Water Pump Vane, Broken, Repairing.....	923
Window Box Flowers, Second Floor, Watering from the Outside.....	921

AMATEUR MECHANICS

Camera View Finder, Rectangular Opening to Use over.....	953
Canoe Paddle, Broken, Repairing.....	954
Clipping File Made of Envelopes.....	953
Coin Box, Mystery.....	946
Drinking Glass, Handle for.....	953
Electromagnetism, Simple Experiment in.....	956
Ferrules for Tool Handles.....	957
Fishing-Rod Making and Angling: Part IV—Trout Fishing with Fly and Bait....	947
Fountain, Electric.....	945
Fruit Blossoms, Forcing for Decorations.....	944
Gas Plant, Miniature Illuminating.....	941
Grape Arbor Built of Poles.....	944
Kites, Combined, How to Make.....	955
Lock, Double, for a Shed.....	957
Mallet Made from Wagon Wheel Felly and Spoke	957
Picture Frames, Novel Homemade.....	952
Scrubbing Brush, Corner Cleaner Attached to...	944
Silverware, Cleaning.....	954
Swimmers, Webfoot Attachment for.....	943
Table Box for Campers.....	952
Tennis Nets, Tightening Lever for.....	954
Trick—Sounding Glass, Mystery.....	957
Watch Holder, Desk.....	954

PATENTS

Air System for Hospitals.....	958
Door Knob That Illuminates Keyhole.....	955
Fruit Holder.....	958
Grinding Machine, Combination.....	959
Hanger, Garment.....	959
Hose Reel, Self Draining.....	959
Parasol Handle with Vanity Case and Coin Holder.....	958
Plant Lifting Device.....	958
Rudder, How.....	959
Satchel Latch.....	959
Screen Window.....	959
Seams, Cutter for Ripping.....	958
Shoehorn and Buttonhook, Combined.....	958
Stretcher, Adjustable Wheeled.....	958
Tenpin with Hollow Body.....	959
Tent, Telescoping and Folding.....	959
Toilet Article, Combination.....	958
Toothbrush.....	958
Tree Protector.....	959
Washing Device.....	958

LEARN TO WRITE EARN \$25 to \$100 A WEEK

How to increase your salary. BOOK MAILED FREE. PAGE-DAVIS CO., 112 Page Building Chicago Ill., or 156 Nassau St., New York

Every Boy His Own Toymaker
Greatest boys' book ever written. Tells how to make a Steam Scooter, Yo-yos, Magic Lanterns, Boats, Kites, Balloons, electrical and mechanical toys, traps, fishing tackle, 200 illustrations; also catalog of 100 puzzles, Keller's Magic Ace Trick Card and "DOLLAR TUNNY" warbler and bird call all for only 15c. WESTERN PUZZLE CO., ST. PAUL, MINN.

FREE "Linene" COLLAR
State size on postal and whether you want collar like cut or low turnover style. REVERSIBLE COLLAR CO., Dept. U, Boston, Mass.

Delivered to You Free
A sample 1915 model "Ranger" bicycle, on approval and 30 DAYS TRIAL and free riding test. Write at once for large illustrated catalog showing complete line of bicycles, tires and supplies, and the most marvelous offer ever made on a bicycle. You will be astonished at our low prices and reasonable terms. RIDER AGENTS Wanted—Boys, make money taking orders for Bicycles, Tires and Sundries from our big catalog. Do Business direct with the leading bicycle house in America. Do not buy until you know what we can do for you. WRITE TO US. MEAD CYCLE CO., DEPT. F108 CHICAGO

CLEAR A CHILD CAN UNDERSTAND EXPLANATIONS SO SYSTEMS STARTING AND LIGHTING SYSTEMS

Power of Will

Why is this man master? He is unarmed. The lion has the physical strength to tear him to shreds—his mouth is watering, yet he dares not. He is cowed—cowed by the man's POWER OF WILL



Partial List of Contents

The Law of Great Thinking.
The Four Factors on which it depends.
How to develop analytical power.
How to think "all around" any subject.
How to throw the mind into deliberate, controlled, productive thinking.
Detailed directions for Perfect Mind Concentration.
How to acquire the power of consecutive Thinking, Reasoning, Analysis.
How to acquire the skill of Creative Writing.
How to guard against errors in Thought.
How to drive from the mind all unwelcome thoughts.
How to follow lines of thought with keen, concentrated Power.
How to develop Reasoning Power.
How to handle the mind in Creative Thinking.
The secret of Building Mind Power
How the Will is made to act.
How to test your Will.
How a Strong Will is Master of Body.
What creates Human Power.
The Six Principles of Will Training
Definite Methods for developing Will.
The NINETY-NINE METHODS for using Will-Power in the Conduct of Life.
Seven Principles of Drill in Mental, Physical, Personal Power.
FIFTY-ONE MAXIMS for Applied Power of Perception, Memory, Imagination, Self-Analysis, Control.
How to develop a strong, keen gaze
How to concentrate the eye upon what is before you—object, person, printed page, work.
How to become aware of Nerve Action.
How to keep the body well-poised.
How to open the Mind and Body for reception of incoming power.
How to exercise the nerves.
How to throw off Worry.
How to overcome the tyranny of the Nervous System.
How to secure steady nerves.
How to maintain the Central Factors of Body health.
Difficulties in Mastering Harmful Habits.
The Law of Will-Power in Habits.

This is only a partial list—a complete list of contents would nearly fill this page.

Anyone Can Have an Indomitable Will

It has long been known that the will can be trained into wonderful power—like memory, or like any one of the senses—by intelligent exercise and use. The trouble with almost every one is that they do not use their wills. They carry out other people's wills, or drift along with circumstance. If you held your arm in a sling for two years, the muscles would become powerless to lift a feather. That is exactly what happens, in most people, to the faculty we call "will-power." Because we never use the Will, we finally become unable to use it. We degenerate into beings little more than slaves—unhappy, discontented, envious, hoping blindly that "some day"—without any effort—we will attain what we most want in life.

"Power of Will," by Frank Channing Haddock, Ph. D., M. S., is a scientific course in Will-Training which has helped over 50,000 people. This great work provides a thorough course in Will-Training, consisting of 28 lessons. It reveals the secrets as to how great men train their wills into wonderful power.

For Master-Men

"Power of Will" provides the shake-up that ninety-nine out of every hundred people need. Master-Men like Judge Ben B. Lindsey; Supreme Court Justice Parker; Wu Ting Fang, ex-U. S. Chinese Ambassador; Lieutenant-Governor McKelvie, of Nebraska; General Manager Christeson, of Wells-Fargo Express Co.; Asst. Postmaster-General Britt; Ernest Knaebel, Asst. Atty-Gen'l of the U. S.; E. St. Elmo Lewis, now Vice-President, Art Metal Construction Co., are owners—and literally thousands of other men of action and ambition like them—read, use, and praise "Power of Will."

Its readers talk of it as of a Bible. It has made decisive men of action out of the most miserable "down-and-outs." It has cured victims of drink and other vices. It has made big men bigger by showing them how to use their brains better. It is a goad to old and young alike. It has re-awakened ambition in men and women who have been turned from their life purposes, and shown its students how to carry forward their ambitions into consummation.

Is YOUR Will Dormant?

Look back upon your life. Once upon a time, no doubt, you weaved great dreams of what you were going to make of yourself. Are they accomplished now? Why are they not accomplished? Is it not because you lacked a strong, powerful, dominating, inflexible WILL? You allowed others to control and influence you to their ends, instead of controlling others yourself. You let insignificant daily incidents everlastingly turn you from your purpose. Gradually—like so many of us—you allowed this God-given faculty of will to become scotched and DORMANT in you. Dr. Haddock has a message for you—a real message of emancipation from the blasting human curse of indecision and blind habit—a message which every man from 20 to 60 years old should get.

Send No Money—Examine Book First

The price of the book—although it is really a complete course in Will-Training—is only \$3.00. The publishers will gladly send a copy free, for five days' inspection. Send no money now. Merely mail the coupon on the right, enclosing your business card, or giving a reference. If you decide to keep the book, send the money. If not, mail the book back. Tear out and fill in the coupon now, before you turn this page.

Pelton Publishing Co.

56 Pelton Bldg. Meriden, Conn.

What Readers Say

"Here's \$3 for you. 'Power of Will' received. It is the book I've wished for, for years."—J. L. Seawell, Clerk of Supreme Court, State of North Carolina, Raleigh, N. C.

"I am unable to do this book justice with the pen. It is a lifelong study, known and prized by those who are fortunate enough to select it out of the many."—Sam'l Ross, Jefferson Loan Society, Inc., Norfolk, Va.

"After carefully looking it over I am fully convinced that it is everything which has been claimed for it—and a great deal more. It is a wonderful book on a wonderful subject."—Gus. A. Olson, Cashier Shermerville State Bank, Shermerville, Ill.

"I specialized on psychology—and I consider 'Power of Will' the greatest book on the subject ever written. I will make it an important factor in my scheme of life."—J. H. Leventhal, Butler Hebrew Ins., Butler, Pa.

"Your book, 'Power of Will' has been carefully examined by me and I have no hesitation in saying that it greatly surpasses my highest expectations. It is a great work and I would not be without its salutary influence for ten times the price."—J. N. Toole, Post Office Inspector, United States Government, Selma, Ala.

"In my judgment, 'Power of Will' is wonderful."—Owen J. McCaughey, Secretary of Corp. Securities Co., St. Louis, Mo. *He has hundreds of such testimonials on file.*



POWER OF WILL

Pelton Pub. Co. 56 Pelton Bldg. Meriden, Conn.

Gentlemen: Please send me a copy of "Power of Will" on approval. I agree to remit \$3.00 or return the book in 5 days.

Name.....

Address.....

Name.....
 Address.....
 Western Newspaper Association
 140 South Dearborn Street, CHICAGO, ILL.

Ridpath's History of the World

At a Bargain



We will name our price only in direct letters to those sending us the Coupon. Tear off the Coupon, write name and address plainly, and mail to us now before you forget it. Dr. Ridpath is dead, his work is done, but his widow derives her support from his history, and to print our price broadcast would cause great injury to future sales.

Send the Coupon for 46-Page Booklet

Put your name and address on the coupon or on a letter or a postcard and get the beautiful sample pages absolutely free. These pages will give you some slight idea of the wonderfully beautiful style in which the work is written. It is endorsed by the scholarship of the world and a quarter million Americans who own and love it. Write today sure.

TEAR OUT, SIGN AND MAIL



GETTING THE MONEY

REPAIRING TIRES

The biggest money making field in the Automobile Industry today is in repairing tires. It is an enormous field and growing larger every year. Locations for good tire repair shops are open in every city and town in the country. You can make

\$1500 TO \$5000 A YEAR

if you learn by our system of instruction. We teach you every phase of **TIRE REPAIRING** and **TIRE CONSTRUCTION** by practical demonstration, in a school equipped with every necessary appliance. This is not a correspondence course. You get your training by actually using equipment and repair material. That's the only way.

WE TEACH YOU BUSINESS METHODS

Instruct you how to open your shop. How to take care of sales. How to retain your trade. How to make your shop pay.

WHAT OUR STUDENTS SAY

O. E. Bonnell writes, "I did a \$15,000 business last season." A. A. Robinson, "Have been in business 30 days. More than doubling expenses. Did not know money could be made so easily." C. E. Kurtz says, "We are crowded with work." G. M. Marsh, "Business coming too strong, and I have not advertised a bit." Hundreds of others tell of similar successes.

SEND FOR OUR FREE BOOKLET A

It tells all about our school, about our methods of teaching, what our students have accomplished. Be first to enter into this big paying business in your town.

CLOUSE TIRE REPAIR SCHOOL

EUCLID AVENUE AND 90th ST., CLEVELAND, OHIO

GOVERNMENT POSITIONS

offer employment for life at a salary ranging from \$800 to \$1800 per year, with short hours under pleasant conditions and no fear of "lay-offs" or strikes. American citizens 18 or over are eligible. Our 64-page booklet contains list of positions, requirements, etc., and tells how you can prepare for "Exams" under the personal supervision of a former U. S. Civil Service Secretary-Examiner. Booklet is **FREE**, without obligation. Write today.

PATTERSON CIVIL SERVICE SCHOOL

106 Irving Place ROCHESTER, N. Y.



DON'T TRY TO BE A CHAUFFEUR



or go to ANY SCHOOL to learn, or part with your hard earned dollars until you have read our valuable guide **FIRST**. It tells what you should **PAY** and what you should **GET**. Do not be deceived by schools which claim everything and give you nothing. **YOU CAN'T AFFORD TO SPEND ONE CENT TILL YOU GET OUR GUIDE.** It costs nothing and may save you many dollars. Write now for this **FREE BOOK**.

PRACTICAL AUTO SCHOOL, 68 Beaver St., New York

A GOOD POSITION

with **UNCLE SAM** is most desirable. Life positions, pleasant surroundings, good pay, steady work, short hours, promotions on merit. Both sexes. No political pull. Thousands of appointments yearly. Most thorough preparation \$5. Returned if not appointed. Full information and questions used by the Civil Service Commission free.

AMERICAN CIVIL SERVICE SCHOOL WASHINGTON, D. C.

IF YOU STAMMER



attend no stammering school till you get my large **FREE** book and special rate. Largest and best school in the world curing by natural method. Write today.

Leo Wells Millard, Pres., North-Western School, Inc.
 2317 Grand Avenue Milwaukee, Wis.

LEARN JEWELERS' ENGRAVING

A high skilled and easily learned trade, taught thoroughly by mail. We will teach the beginner better engraving than he can gain in years of rigid apprenticeship. We will also improve the skill of any engraver. Send for our catalog. The Engraving School, 112 Page Bldg., Michigan Ave., Chicago, Ill.

JEWELRY ENGRAVING

We teach you, by our new and original method of instruction, this clean, fascinating and profitable business **right at your home**, and furnish you all tools needed absolutely **free**. Write for free book to the

WISCONSIN SCHOOL OF ENGRAVING, 524 8th St., MILWAUKEE, WIS.

Learn to Write



BEGIN TODAY
 write for my **FREE** BOOK

I can make a good penman of you at home during spare time. Write for my free book, "How to Become a Good Penman." It contains specimens and tells how others mastered penmanship by the Tamblin System. Your name will be elegantly written on a card if you enclose stamp to pay postage.

FREE Write for it Today

BOOK

F. W. Tamblin, 418 Meyer Bldg., Kansas City, Mo.

DRAWING



Cartoons, Cartoon, Comic, Commercial, Fashion, Newspaper and Magazine illustrating taught by mail. Illustrated book 4c in stamps. **THE BOSTON SCHOOL OF DRAWING, 755M Boylston St. BOSTON, MASS.**

30 Days FREE TRIAL



and freight prepaid on the new 1915 "RANGER" bicycle. Write at once and get our big catalog and special offers before buying.

Marvelous improvements. Extraordinary values in our 1915 price offers. You cannot afford to buy without getting our latest propositions. **WRITE TODAY.**

Boys, be a "Rider Agent" and make big money taking orders for bicycles and supplies. Get our liberal terms on a sample to introduce the new "RANGER."

Tires, equipment, sundries and everything in the bicycle line half usual prices. Auto. and Motorcycle Supplies.

MEAD CYCLE CO., DEPT. F108 CHICAGO

Get Dickson's Great Book

-Now

Dickson's book—you can now get it free of charge and without obligation—the same book that has given thousands of men their start towards greater efficiency, bigger success, *more money*. Simply sign and send the coupon. Get "How to Remember" in your hands *now*—read it carefully, critically—judge for yourself the simple, practical method that has enabled Professor Dickson's thousands of students to develop *amazing memories*, to make themselves better, clearer thinkers, more efficient business men, and bigger money-makers. Remember—this great book is

FREE

Without a good memory all your business experience is useless—all the learning in the world will not help you. In the business battle—where you are compelled to match wits with brainy men each hour every day—the ability or inability to remember instantly and accurately means actual money gains or losses. If you have a poor memory, Dickson will give you a wonderfully good memory. If you already have an accurate memory, he will make it better, stronger, surer. There is nothing mysterious about his method. Successful men all over the country are constantly demonstrating that his SYSTEM is absolutely scientific, correct, and easily mastered. Your mind can be trained and developed exactly like your muscles. Simply give Professor Dickson ten minutes a day—*only ten minutes a day*—surely a small portion of your leisure time to spend in making yourself more efficient. You will be astonished at your progress—at your ability to think and remember. You will shake off the worry caused by wondering whether you have forgotten something. You will prevent the mistakes and serious accidents which frequently occur because men forget. You will be able to accomplish several times the work you *now* accomplish—do it better—and leave your office at the close of the business day feeling fresh and free, instead of lagged and worn.

You Can Stop Forgetting!

Simply send your name and address on the coupon for Dickson's Book. No charge of any kind—no obligation. You will find "How to Remember" your first step to a greater success than you have ever dreamed of. Get it in your hands at once. Professor Dickson will also send you a free copy of his remarkable Copyrighted Memory Test, and will tell you how you can get, *free of charge*, his famous DeLuxe book, regularly priced at \$2.00, "How to Speak in Public". Tear off the coupon, sign it, and get it in the mails immediately. Take advantage of this liberal offer at once. No cost, no obligation of any kind whatever.

**Henry Dickson, Principal,
Dickson School of Memory,
705 Hearst Building,
Chicago, Ill.**



**Prof.
Henry
Dickson**

America's foremost authority on Memory Training, Public Speaking, Self-Expression, and Principal of the Dickson Memory School, Auditorium Building, Chicago.

**Henry Dickson, Principal,
Dickson School of Memory,
705 Hearst Building, Chicago, Ill.**

Please send me, free of charge and without obligation, copy of your valuable book, "How to Remember," also your Free Copyrighted Memory Test, the most ingenious and conclusive test for your memory ever devised, and full particulars showing how I can get, free of charge, your DeLuxe booklet, "How to Speak in Public."

Name _____

Address _____

Please Mention Popular Mechanics



They Started Equal—

TRAINING Made the Difference

These two men started at the foot of the ladder—on the same job at the same pay—**EQUAL.**

One stood still. Today he is twenty years older—worn out and disheartened—but just where he started. The other—twenty years older, too, but fresh, enthusiastic, and hopeful—has advanced to a position of command and big pay.

The difference was not that one had greater opportunities or ability—but it was in the way he used his opportunities and developed his natural ability.

What are you doing to train yourself for a better job? Will twenty years find you worn out, disheartened, still toiling away?

Thousands of men have risen from the ranks to Draftsmen, Foremen, Superintendents, and Engineers solely through the help of the Home Study Courses of the International Correspondence Schools. What these men have done through the aid of the I.C.S. you can do, right in your own home during your spare time.

Just mark and mail the attached coupon. The I.C.S. will show you how they can do for you what they have done for thousands of others. **Mail the Coupon NOW.**

International Correspondence Schools

Box 872-P2, SCRANTON, PA.

Explains, without obligation to me, how I can qualify for the position before which I mark X.

Automobile Running Electrical Engineering Electric Lighting Electric Railways Dynamo Running Tel. and Tel. Engineer Mechanical Engineering Mechanical Drafting Shop Practice Steam Engineering Plumbing and Heating Civil Engineering Surveying Mine Foreman and Supt. Chemistry	Stenog. and Typewriting Bookkeeping R. R. Accounting Good English for Ev'one Civil Service Architecture Architectural Drafting Building Contracting Structural Engineering Salesmanship Advertising Window Trimming Show-Card Writing Agriculture Poultry
--	---

Name _____
 St. and No. _____
 City _____ State _____
 Present Occupation _____

Please Mention Popular Mechanics

Become a TRAFFIC EXPERT

New
Jobs
Open

The correct handling and routing of traffic by rail and water offers a vocation paying handsomely and is quickly and easily mastered. Let us explain fully the scope and tremendous possibilities in this uncrowded and lucrative field.

Men Needed

who know how to handle ocean traffic and trade. This is your opportunity to qualify for one of these big positions—to build a prosperous future.



**YOU Can
Jump Into
This Big Job**

**We Train
You By MAIL**

at home, in spare time, no matter what you work at now, if you can read and write English intelligently. The LaSalle Interstate Commerce Course is simple, practical, thorough. Our graduates are exceptionally successful. **We Make Terms to Suit You.**



MONEY-BACK GUARANTEE BOND

WRITE today for proof of positions, big salaries and how we have helped others to succeed. This is your opportunity—today is the time to begin preparation. Write now for free book, 10 Years' Promotion in One, and free facts.

So thorough is the LaSalle Home Study Course—so exceptional has been the success of LaSalle students—that we issue with each LaSalle Course a formal, binding guarantee to refund the entire tuition fee if after you complete the Course you are not perfectly satisfied. This guarantee is backed by our entire capital and resources of more than one million dollars, which assures your absolute success.

LASALLE EXTENSION UNIVERSITY
 Dept. C-625 Chicago



RAW YOUR WAY TO BIGGER PROFITS

Become an expert Commercial Letter Artist and Designer, Sign and Show Card Writer. Tremendous growth of advertising makes steady demand for graduates at good pay. **Start earning while you are learning.** My personal graduate advances you rapidly. Lessons simple and fascinating. Send today for FREE booklet and full information. **THE ROSING SCHOOL OF LETTERING AND DESIGN**
 728 UNION BLDG. CLEVELAND, OHIO

LEARN LETTERING AND DESIGN

Be an Auctioneer Travel over the country and make big money. No other profession can be learned so quickly, that will pay as big wages. Write today for big free catalogue of Home Study Course, as well as the Actual Practice School. **Missouri Auction School** Largest in the world. W. B. Carpenter, Pres.
 330 HALL BLDG. KANSAS CITY, MO.

LEARN PIANO TUNING AT HOME

My Patented Tune-a-Phone method makes it easy. Eliminates guess work. Anyone can learn. A. D. Pope, Texas, made \$27 first ten days. Course guaranteed as represented. Diploma granted. Write for free booklet, graduate's records, etc.
Niles Bryant School of Piano Tuning, 445 Inst. Bldg. Battle Creek, Michigan



DO NOT STAMMER

My book, "How to Stop Stammering"—a treatise on "Scientific Talking and Psychic Training." School and circular literature FREE. **M. L. HATFIELD,** Prin. of The Pacific School for Stammerers, 1918 Grove St., OAKLAND, CAL.

LEARN WATCH REPAIRING

Be a watchmaker—you can learn this profitable trade by correspondence in a few weeks in your own home by the DeSelms Chart System. After you complete the course you will know a watch from A to Z. You will know just what the matter is and how to repair one. When you graduate you will be a practical watchmaker and repairer and competent to fill any position. Positions for our graduates.

Ask for our Free Book. It explains our system and terms.

THE DeSELMS WATCH SCHOOL
 23 Perry Street ATTICA, INDIANA





HOW TO RUN AN AUTO

1915
EDITION

IS SELF-TAUGHT IN

1915
EDITION

AUDELS AUTOMOBILE GUIDE, \$1.50



LATE — CONCISE — PRACTICAL

THE object of this book is to give, in the easiest understood form, the information necessary for the proper operation, care and maintenance of an automobile.

To adapt the book to many needs the subject matter is presented in the form of questions and answers. Technical terms are explained or made clear by the wording of the answer, which is always brief and direct.

Any one of the definite chapters on Carburettors, Ignition, Gas Engine Operation, How to Run an Automobile, Overhauling the Car, Battery Troubles, or Starting and Lighting Systems, are alone worth the price asked for the 30 complete chapters contained in this book of 700 pages, illustrated by 550 illustrations.

The form and size are such that it is convenient to handle and study.

This book is a self-educator, hence: "He who runs may read" and improve his present knowledge of automobile engineering and proficiency.

Handsomely bound in durable Full Leather, Pocket size.

Audels Automobile Guide, \$1.50 A BOOK WORTH HAVING

"Understand Your Car" Explained in the following chapters:

1. Ready Reference Index.
2. The Automobile.
3. The Gas Engine.
4. The Cycle of a Gas Engine.
5. Brief Outline of Gas Engine Principles.
6. Cooling Systems.
7. Fuels.
8. Carburettors.
9. Ignition.
10. Timing and Balancing.
11. Gas Engine Operation.
12. Clutches.
13. Transmissions.
14. The Drive.
15. The Differential.
16. The Running Gear.
17. Tires.
18. Brakes.
19. Ball and Roller Bearings.
20. Lubricants and Lubrication.
21. Motor Cycles.
22. Electrics.
23. Electricity.
24. Dynamos and Motors.
25. Storage Batteries.
26. Methods of Circuit Changing.
27. How to Run an Automobile.
28. Overhauling the Car.
29. Starters and Starting Systems.
30. Electric Lighting and Wiring.

NONE OTHER JUST AS GOOD

Free Examination

We don't want you to take our word, or anyone else's for it. We are willing to send you the book without deposit. Use it seven days in connection with your car. Then send back the book or remit \$1.50. Could anything be fairer?

Cut out and fill in your name and address plainly at the bottom. Place it in an envelope and mail.

This Book Will Speak for Itself

Theo. Audel & Co., 72 Fifth Ave., New York

Kindly mail me copy of Audels Answers on Automobiles, and, if found satisfactory, I will immediately remit you \$1.50, or return the book to you.

NAME.....

OCCUPATION.....

ADDRESS..... June P. M.



WE ARE 3000 STRONG

COME JOIN US!

3000 Expert Automobile Men Have Graduated From the Cleveland Automobile School —

all making money in the great auto industry — the business that's in the spotlight of prosperity. The business of big possibilities — of unlimited opportunities for wide-awake, ambitious young men. Why don't you start today? Then you'll be on a real road to success. The men in the picture form only one class. There have been 3000 in all. They've found a good place in a great business. A business that's new — just beginning to develop. That means hundreds of splendid new chances every day for the man that's rightly trained.

C. H. Pratt, chief instructor, and one of his big classes. These boys have seen the big chance in the auto field and are going after it. Come and join them.

Get Into the Automobile Game—Make \$900 to \$3600 a Year

Get in and start now. Start for Cleveland just as soon as you can pack your grip. We'll get you settled, and you'll get started. That's the way to get ahead. Decide and then act on your decision. Indecision spells failure for thousands of men. Say to yourself, "By George, I'm going to have some of the good money in the auto business." Then you'll get it. These 3000 have and YOU should. Think of the autos being made and sold. Every day the demand is greater. Manufacturers can't make cars fast enough. Each one needs a driver—each one needs many repairs. Chauffeurs, Testers, Repair Men, Garage Men, Racing Drivers, Salesmen, etc., are needed everywhere. All over the country there are wonderful opportunities to go in business for yourself. Repairing brings good prices. You can handle accessories and cars and get right into the game. We teach you the whole thing from the ground up. All kinds of modern equipment and cars to practice and learn on. You learn about lighting systems, magnetos, carburetors, ignitions, valves, adjustments, etc. When you graduate you know a car from A to Z. Nobody can "queer" you on any point. Competent, enthusiastic instructors, genial companions and fellow students. Nice light work and study rooms—everything right up to the minute.

AT IT 11 YEARS—LONGEST IN THE BUSINESS



WE'VE BEEN AT IT 11 YEARS

Ours is the oldest school in existence. We've proved our value—our dependability by keeping at it year after year. You have to be good to stick as long as 11 years. Send today for copy of our School News, full particulars, testimonials, references, etc. We'll answer returns mail. The best thing to do is to board a train for Cleveland and start right in. Classes going on all the time, day or evening. Get into the automobile game and start now. You'll say it's the best move you ever made.

THE CLEVELAND AUTOMOBILE SCHOOL
(Longest in the Business)
2338 Euclid Ave. CLEVELAND, OHIO

WHY NOT BE AN ARTIST?



STUDY drawing at home under Expert Faculty. We have successful students in every part of the world. Turn your talent into money. Our students are filling high salaried positions. 14 years successful teaching. Endorsed by high authorities. 18 Courses in Commercial and Illustrative Drawing, Teachers' Normal and Applied Art, Profits or Culture. Thoroughly Equipped Residence School. Artist's Outfit FREE to Enrolled Students.

SCHOOL OF APPLIED ART, 755 Applied Art Bldg., Battle Creek, Mich.

Law Library Free

A remarkable complete and comprehensive encyclopedia of the law given away absolutely free with each Course and Service.

The Law Is Calling You A high place in the greatest profession of all time is offered to you. Wealth, power, influence, honor—all is within your reach through the law. Learn in your own home directed by master minds of the profession. Write for the new book. Write Today Send us your name and address today for free 171 page book. No obligations. Write today.

American Correspondence School of Law 1119, Manhattan Bldg., Chicago

Learn to PAINT SIGNS and SHOW CARDS



I'll teach you personally by mail. 16 years successful teaching. Big field for men and women. You can Earn \$18.00 to \$45.00 a Week. Neal Ohlin writes, "Learning easy to understand—anyone can easily learn." Send for particulars.

DETROIT SCHOOL OF LETTERING
Chas. J. Strong, Founder Dept. 294, Detroit, Mich.

BE A DETECTIVE

Earn from \$150.00 to \$300.00 per month; travel over the world. Write

C. T. LUDWIG, 133 Westover Bldg., Kansas City, Mo.

EARN \$1200 to \$2000 PER YEAR

TUNING PIANOS. Easily learned by our thorough, practical course. Taught by experts either at our school or in your own home by mail. Write for information.

LUNDBERG SCHOOL OF PIANO TUNING
Desk P M, 143 N. Dearborn Street, CHICAGO, ILL.

GOV'T JOBS OPEN

Railway Mail Clerks, City Carriers, Rural Carriers
City Postal Clerks

\$800 TO \$2000 A YEAR, FOR LIFE

Rapid advancement to higher Government Positions. No "lay-offs" because of STRIKES, FINANCIAL FLURRIES or the WHIMS OF SOME PETTY BOSS. THE POSITION IS YOURS FOR LIFE.

Country residents and city residents stand the same chance for immediate appointment. Common-sense education sufficient. Political influence NOT REQUIRED.

Write immediately for schedule showing the places and dates of the coming examinations. Don't delay. Every day you lose means the loss of just so much coaching before the rapidly approaching examinations.

FRANKLIN INSTITUTE Dept. A-104, Rochester, N. Y.

FRANKLIN INSTITUTE
The Pathway to Plenty
Dept. A-104, Rochester, N. Y.

This coupon, filled out as directed, entitles the sender to free sample questions; a free copy of our copyrighted book, "Government Positions and How to Obtain Them," full list of positions obtainable and to consideration for Free Coaching for examination here checked.

COUPON

.. Railway Mail Clerk	(\$800 to \$1800)	.. Customs Positions	(\$800 to \$1500)
.. Postoffice Clerk	(\$800 to \$1200)	.. Internal Revenue	(\$700 to \$1800)
.. Postoffice Carrier	(\$800 to \$1200)	.. Stenographer	(\$800 to \$1500)
.. Rural Mail Carrier	(\$600 to \$1100)	.. Clerk in the Departments	
.. Bookkeeper	(\$800 to \$1800)	at Washington	(\$800 to \$1200)
		.. Canadian Government Positions.	

Name.....
Address.....

Use this before you lose it. Write plainly.

COVERS
THE CONTINENT

J-M Responsibility doesn't wait for a "kick", but looks up your roof to see it's right

H. J. Sewed
Green Bay, Wis.

The number of J-M Roofs this contractor has put on in Green Bay shows that folks believe what he says about

J-M Transite Asbestos Shingles

Fire and weather-proof, last forever. Lighter than slate. Mottled Brown, Gray, Indian Red—highly artistic.

J-M Asbestos Ready Roofing

Weather-proof, protects against fire. Needs no coating. Unequaled on wood sheathing and for all slope roofs. First cost only cost.

J-M Asbestos Built-up Roofing

A monolithic structure, permanent, and protects against fire. Lightweight, smooth surfaced, perfectly clean, needs no paint. The imperishable flat roof.

J-M Regal Ready Roofing

Best of "Rubber Type" ready roofings. Excellent for general roofing purposes.

J-M Roofings for Every Requirement

J-M ROOFING Responsibility

J-M Responsibility is a Johns-Manville business principle.

The practical application of this principle to you and to your J-M Roof is provided in a new feature of our service known as

J-M Roof Registration

When you register your J-M Roof with us you say: "Here is my roof; look after it for me." We can—and will—do just exactly that; for there are enough of us to do it. We cover the continent. You do your part when you take J-M Roofings on our word that they are the best and most economical roofings you can buy. Our part is to see that J-M Roofings give complete satisfaction—that they give the Full Service they are meant to give.

Register your J-M Roof with us and J-M Responsibility, backed up by financial stability and highest commercial character, will assure you permanent satisfaction.

J-M Asbestos Roofings are examined and approved by Underwriters' Laboratories under the direction of the National Board of Fire Underwriters.

Write us about the building you wish to roof. Our roofing experience goes back fifty years, on all kinds of buildings, and we can advise you to your advantage. We will also send you Roofing Literature of value.

H. W. JOHNS-MANVILLE COMPANY

Akron	Boston	Columbus	Duluth	Kansas City	Minneapolis	Philadelphia	St. Paul	Toledo
Albany	Buffalo	Dallas	Galveston	Los Angeles	Newark	Pittsburg	Salt Lake City	Washington
Atlanta	Chicago	Dayton	Houghton	Louisville	New Orleans	Portland	San Francisco	Wilkes-Barre
Baltimore	Cincinnati	Denver	Houston	Memphis	New York	Rochester	Seattle	Youngstown
Birmingham	Cleveland	Detroit	Indianapolis	Milwaukee	Omaha	St. Louis	Syracuse	

THE CANADIAN H. W. JOHNS-MANVILLE CO., LTD., Toronto, Winnipeg, Montreal, Vancouver 3128

Let Me Qualify You to Make \$1,500 to \$3,000 Yearly As DRAFTSMAN



Right now the biggest, grandest opportunity in years is offered you to qualify for this prosperous, influential profession. Right now thousands of proficient Draftsmen are needed everywhere at big salaries. I want to show you how you, no matter who you are, can step from your present low-wage job into a big salaried position as Draftsman.

Prosperity

I teach you how to earn big money as Draftsman. I show you how competent Draftsmen can advance to big positions as Chief Draftsman, Chief Engineer, Superintendent, at tremendous salaries or open an office of your own.

I Can Train You

easily and quickly in your home, in spare time. I want to show you how plain and simple I make it for you to learn Drafting. I tell you and show you everything in a practical way.

For many years I have been a practical, high salaried Draftsman and Designer, holding big positions. I claim to be the best qualified expert in the United States to instruct others in Draftsmanship. When you follow my personal instruction you follow the instruction of a Draftsman who has personally made a success and who knows the necessities of a finished Draftsman. Let me send you the most complete and clearest Book on Drafting ever published and it's free.

Thousands Always Needed

Today big paying positions are open for the Expert Draftsman with my training. The demand for Draftsmen exceeds the supply and is constantly increasing. Never before have salaries been so high—never before such splendid opportunities for advancement. In this grand profession you can become independent—you need never be without lucrative employment. No experience needed—I show you how to start and carry you through in shortest time in easiest, most fascinating manner. It's all explained so thoroughly in my FREE BOOK.

FREE \$17.50 Draftsman's OUTFIT IF YOU ENROLL AT ONCE

If you enroll in the next 30 days I will give you, absolutely free this magnificent set of Draftsman's Drawing Instruments, valued at \$17.50—the same as I use in my professional work. Lasts a lifetime. But you must act at once to get it free.

Smallest Easiest Payments

SPECIAL TUITION OFFER

For short time only I offer my personal instruction at such small, easy payments that anyone, no matter how small his income, can now become an Expert Draftsman, and as an Extra Special inducement for prompt enrollment I offer \$25.00 Tuition Credit. I am the only expert Draftsman giving personal service at such small payments, but I must withdraw this offer before long. So send coupon today for remarkable easy terms and wonderful proposition. It means a grand opportunity for you if you act quick.



CHIEF
ENGINEER,
CHICAGO
ENGINEERING
WORKS
401 Cass St.,
Chicago, Ill.

MAIL THIS FREE COUPON

CHIEF ENGINEER, 401 Cass Street, Chicago, Ill.

Dear Sir: Without any obligation on my part, send me your book, "The Road To Success," and full particulars of your limited offer. Send everything free and prepaid.

Name.....

Address.....

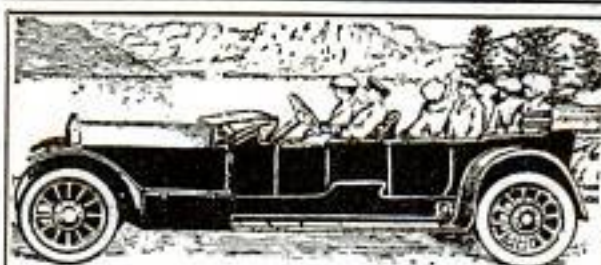

The Man at The Wheel

Has a job that not only pays him a good salary but gives him pleasant employment with congenial surroundings and a chance to see the country. You can get such a position or you can become an

Automobile Mechanic, Repair Man, Garage Manager, Salesman, Chauffeur, Demonstrator, Etc.

There are thousands of openings for the trained automobile man. More cars are being sold this year than ever before. More owners are touring than ever. A vast army of experts are required to run, handle and keep these cars in shape. This means a steady job for you just as soon as you are qualified.

You Can Be an Automobile Man

Six to eight short weeks in my big automobile school will make you a practical automobile man. 3,000 graduates testify to the value of The Sweeney System of Practical Instruction. Here you do actual work on all makes of cars. You learn to locate and repair trouble, to take down and assemble a car. We give you actual practice on all types of self-starters and electrical equipment. You are made an expert worthy of an expert's pay.

Get My Free Book Learn from it just how I teach you this fascinating business. It fully explains the wonderful opportunities the automobile industry offers automobile men, and proves conclusively that I can make you an expert. A post card brings your copy today.

EMORY J. SWEENEY, Pres.

SWEENEY AUTOMOBILE SCHOOL
1162 East 15th St. KANSAS CITY, MO.



\$4.50 STARTS YOU
Towards the
Big Job

The profession of Meter Engineering needs men. Positions are open. Big Money is being paid. Now—on a great special offer you can start for the big job for only \$4.50. **BE THE BOSS**—be the man who gets the fat pay envelope. Don't miss this offer.

Write Today for Big New Book Your name and address is enough. No obligations. Find out about the great opportunities in our profession. Write today—now, Ft. Wayne Correspondence School, Dep. A119, Ft. Wayne, Ind.

LAW STUDY AT HOME BECOME AN LL.B.

Only recognized resident law school in U. S. Conferring Degree of Bachelor of Laws—LL.B.—by correspondence. Only law school in U. S. conducting standard resident school and giving same instruction, by mail. Over 450 class-room lectures. Faculty of over 30 prominent lawyers. Guarantees to prepare graduates to pass bar examination. Only law school giving Complete Course in Oratory and Public Speaking. School highly endorsed and recommended by Gov. Officials, Business Men, Noted Lawyers and Students. Send today for Large Handsomely Illustrated Prospectus. Special Course for Business Men and Bankers.
HAMILTON COLLEGE OF LAW, 405 Advertising Bldg., CHICAGO, ILL.



LEARNED BY
**ALMOST
ANYONE
AT HOME**
SMALL COST

VENTRILOQUISM
Send today 2c stamp for particulars and proof.
O. A. SMITH, Room D 125, 823 Bigelow St., PEORIA, ILL.

ARITHMETIC SELF-TAUGHT

A plain, easily-understood volume for all who have not had the opportunity of learning this subject thoroughly, or who have forgotten what they once learned. 257 Pages. Requires no teacher. This great little book sent postpaid for **60 CENTS**. Stamps accepted.

GEO. A. ZELLER BOOK CO.
Est. 1876, 4672 W. Belle Place ST. LOUIS, MO.

SPANGENBERG'S
PRACTICAL
ARITHMETIC
Self-Taught



Learn a Paying Profession

that assures you a good income and position for life.
For twenty years we have successfully taught

PHOTOGRAPHY

Photo-Engraving and Three-Color Work

Our graduates earn \$20 to \$50 a week. We assist them to secure these positions. Learn how you can become successful. Terms easy—living inexpensive. Write for catalogue—NOW!

ILLINOIS COLLEGE OF PHOTOGRAPHY, 999 Wabash Avenue, Effingham, Ill.

The University of Chicago

HOME STUDY

in addition to resident work, offers also instruction by correspondence.

For detailed information address

23rd Year U. of C. (Div. 30) Chicago, Ill.



EARN TELEGRAPH

Morse and Wireless—R. R. Accounting (Station Agency) taught. Splendid opportunities. Positions secured. Marconi Co. takes our wireless graduates. We own and exclusively occupy two large modern buildings equipped with R. R. and Western Union wires and complete \$5,000 Marconi Wireless Station. Largest School—established 27 years. Investment \$25,000. Endorsed by Railroad, Marconi and Western Union Officials. Expert practical teachers. Low living expenses; easily earned if desired. Tuition low. Easy payments. Correspondence courses also. Catalogue Free.

Dodge's Telegraph, Ry. & Wireless Institute
6th Street, Valparaiso, Ind.



BE A TRAVELING SALESMAN

Hundreds of good positions now open. No experience required to get one of them. Write today for list of openings offering opportunities to earn Big Money while you learn and testimonials from hundreds of our students who are earning \$100 to \$500 a month. Address nearest office, Dept. 477 NATIONAL SALESMEN'S TRAINING ASSOCIATION Chicago, New York, San Francisco

CIVIL SERVICE

positions are in all parts of the country. Good pay steady work, life positions, congenial surroundings, promotions on merit, short hours, annual vacation and sick leave with pay. Many thousands appointed yearly. Both sexes. No political pull. Nearly 300,000 classified positions. Common school education sufficient. Full information and questions used by the Civil Service Commission free.

COLUMBIAN CORRESP. COLLEGE, Washington, D. C.

Do You Like to Draw? Cartoonists Are Well Paid

We will not give you any grand prize if you answer this ad. Nor will we claim to make you rich in a week. But if you are anxious to develop your talent with a successful cartoonist, so you can make money, send a copy of this picture, with 5c in stamps for portfolio of cartoons and sample lesson plate, and let us explain.

The W. L. Evans School of Cartooning
821 Leader Bldg., Cleveland, O.



Big Profits IN THE Auto Business

400,000 more cars this year than last. Thousands of new jobs as drivers, repair men, garage managers, etc.

NATIONAL AUTO SCHOOL

prepares for these jobs. Splendidly equipped workshops. Teaches its students everything about the automobile. For complete information and catalogue address

NATIONAL AUTO SCHOOL
2625 Reading Rd. Cincinnati, Ohio



Learn Electricity Learn Plumbing Learn Bricklaying

Unlimited possibilities for gaining wealth and future independence in all of these trades. They pay \$5 to \$8 a day right from the start and any one of them offers exceptional opportunities for starting a business of your own on very small capital. The same is true of



Mechanical Drawing and Moving Picture Operating

Two new, big-paying occupations that are now demanding more and more trained men everywhere and pay salaries of from

\$100 to \$250 a Month

We give you thorough, practical training—no needless theory—you learn with actual tools in your own hands under expert instruction instead of from books. No experience and no special adaptability required. Just a willingness to learn and we'll make you an expert in a surprisingly short time.



MEN WANTED

right now for all of these trades. That's why we are now making special inducements in the way of a very small tuition on easy payments if you like, agree to assist you in earning your way through school and also help to place you in a good paying position when you graduate. At this biggest and most successful of all trade schools everything has been arranged for the benefit and convenience of our students. Day or night classes as you prefer, and we even furnish



Tools Free as well as all other necessary equipment for your work Mail Coupon NOW!

Don't put it off. This is a matter of vital importance to you. Get full particulars of the wonderful opportunities this remarkable school affords. No obligation—everything free. Mail coupon today while our Special Offer is still open.



**Earn
While
You
Learn**

WE OCCUPY ENTIRE BUILDING

L. L. Cooke, Director, Coyne National Trade Schools
39-51 E. Illinois St., Dept. 119X, Chicago, Ill.

GENTLEMEN: Without any obligations on me whatsoever, please send me your school catalog and full particulars of this offer to men—all free.

NAME.....

ADDRESS.....

Please Mention Popular Mechanics

Copyrighted material

Free!

Complete Set of Drawing Instruments

Yes, I will give you this complete set of drawing instruments absolutely free. They are regular working instruments—the kind I use myself and they do not cost you a penny. And besides the instruments in this exquisite plush lined leather case, I will give you absolutely free a 20x25 inch drawing board, a 24 inch T-square, a 12 inch rule, a supply of drawing paper, two triangles and a French curve, pencils, erasers, thumb tacks, etc., etc. A complete draftsman's working outfit. And I give it to the men who get my personal instruction absolutely free.

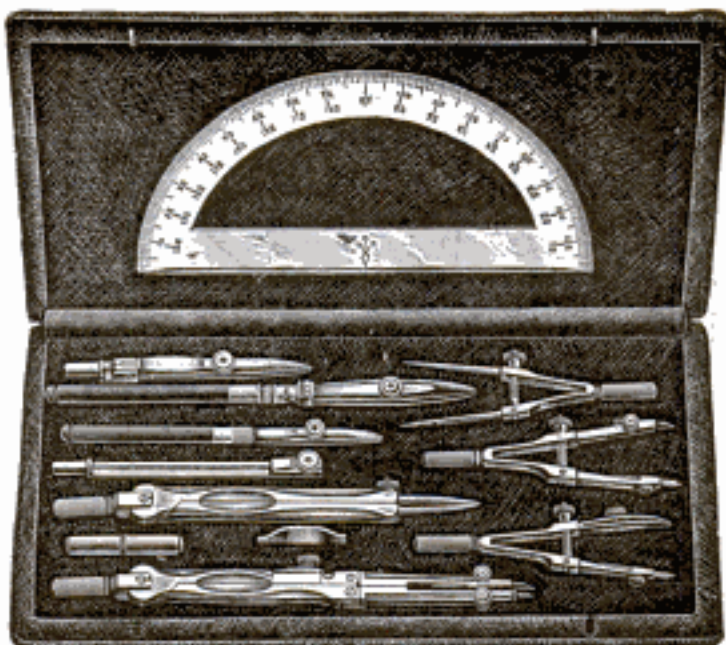

Be a Draftsman!

Draw \$125 to \$175 Per Month

There is an urgent demand for skilled draftsmen. Companies are issuing calls every day for men to fill positions paying from \$125.00 to \$175.00 per month. Work is light, pleasant and profitable.

Chief Draftsman Will Instruct You Personally

I am Chief Draftsman of a large and well known firm. I have been doing the highest paying expert drafting work for a quarter of a century and I know just the kind of training that is demanded from men who get the big salaries. I will give you personal instruction, deal individually with you and give you up-to-date, practical working plans just as your ability and advancement require. I train you by giving you actual work—practical work, the kind that you must be able to do in order to hold permanent, big paying positions. I give you my individual instruction. If your work is right, I will advance you rapidly. If it is wrong, I will show you where, and make you do it right, and do all I can to make you an expert draftsman and designer in a short time. **Write today without fail**

Pay as You Wish!

What I want is the RIGHT KIND of men. Don't bother about expense. I will give you the working outfit free if you get in at once. I charge a very small fee for training you to be an experienced draftsman. You can pay the small cost as suits you best. My object is to develop experienced draftsmen.

Chief Draftsman Dobe
Engineer's Equipment Co.
Div. A119 Chicago, Ill.

Without any obligation on me whatsoever, please mail your book "Successful Draftsmanship" and full particulars of your liberal "Personal Instruction" offer to a few students. It is understood that I am obligated in no way whatever.



Send the Coupon for My Big New Book

Put your name and address on the free coupon or a letter or a post card and send it to me today. I will send you absolutely free and postpaid my new book "Successful Draftsmanship," and the great special offer that I am now making on which you get the \$15.00 Draftsman's Working Outfit absolutely free. You assume no obligations of any kind in sending in the coupon. Get in line now for a big paying position. Getting the book and full particulars of the special offer is the first step. Write today—now.

Chief Draftsman Dobe
Engineer's Equipment Co., Inc., Div. A119, CHICAGO, ILL.

NAME.....

ADDRESS.....

CLASSIFIED ADVERTISEMENTS

We have records to prove that a classified ad in these columns will find a buyer for almost anything which can be sold. Doubtless you have some article of value to some one else which you no longer need. Why not turn it into money?

Advertisements in this section, 15 cents per word, each insertion, minimum 10 words, payable in advance. To insure ads being inserted under proper classified head in the July issue, copy must reach this office not later than June 1st.

February 25, 1915.

Popular Mechanics Magazine, Chicago, Ill.

Gentlemen: We had an advertisement of 37 words in the February issue, under "classified" in three positions, and beg to advise that results from same were nothing short of marvelous, having up to date received 628 replies. We are only sorry that through an oversight we missed the March issue. We now beg to enclose copy for the April issue.

Very truly yours,

THE ALPHARIS COMPANY.

AUTOMOBILES

A WRITTEN guarantee for 5,000 miles without puncture. European Motorists are getting 10,000 miles out of their tires by increasing them about one-half inch in size. In eight months 20,000 American Motorists have followed their example. It's so easy that you can do it in your own garage in thirty minutes, no matter what condition your tires are in. Send for free catalog, sample and copy of guarantee. Colorado Tire & Leather Co., 678 Tread Bldg., Denver, Colorado. Dept. F 43, Box 228, Chicago, Ill.

If your car hasn't the compression and power it once had, you'll probably find that your cylinders are worn or scored and need regrinding. We've reground thousands of cylinders in our six years' experience and can refer to pleased customers everywhere. Advise make of car and bore diameter, so we may quote. Do it now before you forget. Waterbury Welding Corporation, Waterbury, Conn.

LIGHT car parts: Motors, Transmissions, Rims, Wheels, Steering Gears, Front and Rear Axles. Catalog free. Palmer Bros., Coscob, Conn.

FORD Sale—Mitchell Auto Roadster, guaranteed. Dr. Wheeler, Racine, Wis.

FORD cylinders rebored, fitted with 4 oversize pistons, 12 rings, 4 wrist pins, 8 bushings. Cost of complete job \$15. Delivery in 24 hours. Every repair guaranteed. Ervarts Machine Company, 14 Hicks Street, Hartford, Conn.

GET more power out of your motor and save money. Postal brings particulars. Neverheat Company, 58 East 20th Street, Chicago, Ill.

USED Automobiles. Write us for big Bargain Bulletin. Eureka Auto Co., "Rebuilders," Heavertown, Pa.

FORD Sale cheap—One International Harvester Company light motor truck. Almost new. Box 306, Cotter, Arkansas.

YOU can earn an auto by my new, easy plan; anyone over 16 years old can get a brand-new Ford Touring Car for a little easy, respectable work among neighbors. Free Book tells all about it. Postal brings it. Send Auto Tom, 647 S. 16th St., Omaha, Neb.

1910 CHALMERS 30, 4 passenger, first-class condition. Tire stone demountable rims, extra tire, \$475. Cost \$1,800. Joseph Janz, 323 St. Mark St., Peru, Illinois.

CYLINDER regrinding or reboring. Extra light pistons and perfect rings fitted. Accuracy guaranteed. Prompt delivery. Worn or broken parts duplicated. Ervarts Machine Company, 14 Hicks Street, Hartford, Conn.

VALVE Reseating and Refacing Tools, from 1 1/2 to 2 1/2 inches. Set complete, \$15. Work equal to \$50 outfit, in less time. Private owners, you can do the work yourself and be independent of repair men. Grand agency proposition. J. W. Scott, 37 Warren St., N. Y.

HOW to operate and repair automobiles. Book 13c. Richard Devine, 31145 Wells St., Chicago.

AUTOMOBILE Instruction—\$55.25. Four weeks' course. Best-equipped school in the country. Men enrolled from all parts of the U. S. Booklet P. M. on request. West Side Y. M. C. A., 318 West 57th Street, New York.

PAINT Your Car Yourself—Save \$25 to \$75 by doing the work at home with the Arsenal system. Our big free booklet "The Car Beautiful" tells how. Send for it today Arsenal Varnish Co., Dept. P, Rock Island, Ill.

CYLINDER Regrinding — First-class equipment, fifteen years' experience, and specializing in this work enable us to do high-grade work at lowest prices. We manufacture the "Neverleak" individual cast piston rings. Prices will interest you. Bridgeport Piston Ring Co., 346 Connecticut Ave., Bridgeport, Conn.

"THE How and Why of the Automobile" — A 290-page book of practical information for seekers after the fundamental facts regarding the gasoline engine and its application to the motor car. Interesting and instructive to both the beginner and the expert. Bound in full cloth—250 illustrations. Price \$1 postpaid. Popular Mechanics Book Dept., 6 N. Michigan Ave., Chicago.

THE Last Word in Automobile Literature—New Book. "The Modern Gasoline Automobile." 700 6x9 in. pages, 500 illustrations, is superior to any treatise heretofore published. Deals with every modern improvement. Price, \$2.50 postpaid. Popular Mechanics Book Dept., 6 N. Michigan Ave., Chicago.

AUTOMOBILE SUPPLIES

GUARANTEED electric horns. Loud. Send for circular. Agents wanted. John Chadwick, Adrian, Mich.

SALESMAN—Can you sell a universal article that appeals to every automobile owner, regardless of make of car? We have that article. Sells for \$1; a few sales mean a good day's wage, but we want clean cut men capable of earning real salaries from their commissions. If you know automobiles or have one, so much the better. Frey Mfg. Co., 1514 Michigan Blvd., Chicago.

18HP. CARNATION unit power plant, \$125. 2 cyl. air cooled V type De Luxe motors, new, \$55. Splitdorf magnets, \$12.50 each. 2 cyl. Beaver water cooled, \$40. 2 cyl. air cooled eng. with planetary transmission, \$45. Auto Salvage Co., 1436 Wabash Ave., Chicago, Ill.

GENERATORS, Batteries, Rectifiers, Compressors, Engines, Mill Supplies. Box 281, Chicago.

PORTABLE Automobile Cylinder Grinders. Big Money for Garage or Individual in regrinding worn cylinders. Small capital. Bexill-Bruel, 59, Cincinnati.

AUTOMOBILE parts for any make of cars at cut prices. Send for bargain lists. Grossman Auto Parts Company, White Plains, N. Y.

FORD Sale—25-Horse Motor with transmission, Radiator, Automobile chassis with running gear complete. Tires, everything good as new, reasonable. Write now. J. M. Roth, Waldron, Ill.

GRAY & DAVIS 1915 Starting and Lighting Systems complete for any car \$115. Pellet's Magneto Exchange, 1605 Michigan Avenue, Chicago, Illinois.

PLACE your order now and secure the \$5.00 "Automatic Steam Vulcanizer" for \$2 prepaid. Circular on request. Halsey Mfg. Co., 520 Broadway, New York.

RECTIFIERS for garages. All sizes. Charge one to eight batteries, \$12 upwards. American Battery Company, 1129 Fulton St., Chicago.

FLEXIBLE Metal Tubing for carburetors, wire covering, exhaust pipes, tire inflating, speedometers and gas. Better than rubber. Indestructible. Doesn't kink. Get catalog. Breece, Newark, N. J.

NEW Live Auto Accessory. Big hit at Auto shows. State and county rights on shares. Zip Sales Co., White Plains, New York.

DOUBLE tires give 6,000 miles and upwards, 30% to 50% saved. Positively guaranteed. Some prices—32x3 1/2 \$9.25, 34x1 \$12.00, 36x4 1/2 \$15.25. Cash Profit-Sharing Coupons, too. Send for list now! State size, Anglo Tire Company, 838 Seventh Ave., New York.

SHOP Vulcanizer, Bargain. Tires at cut prices. Vanderpool, Springfield, Ohio.

USE an Air-Friction Carburetor, 1915 Improved Model C or D. Increases power and economy of motor one-half. Absolutely impossible to load or choke. Starts easy warm or cold weather. Uses either high or low grade fuels with finest results. We fit all motors and guarantee definite results or refund money if returned within thirty days. Liberal exchange allowance on other carburetors or old model air-frictions. We also make and absolutely guarantee the Air-Friction Spark Plug. Sold in sets of five only at \$3 per set. The Air-Friction Carburetor Co., Dayton, Ohio.

COMPLETE Haywood Vulcanizing Equipment, Bargain. John S. Wells, Colchester, Ill.

FORD ACCESSORIES

FORD Gasoline Savers. Guaranteed. Investigate. Erie Miscellaneous Co., Erie, Penna.

CHROME Nickel Steel pinion gear one dollar for Ford cars, differential drive ring gear three dollars. Special catalogue. Grossman Auto Parts Company, White Plains, N. Y.

WELDING

WE weld all metals. Charges reasonable. Work guaranteed. We rebores cylinders and fit pistons. Bertachy Kan-Fix It, Omaha, Neb.

WELDING Plants, \$25 to \$250. Liberal terms. Write Bermo Co., Omaha, Neb., U. S. A.

OXY-ACETYLENE Welding and Cutting is the title of a brand new practical instruction book on the methods of doing this work. It includes the operation and care of Acetylene Generating Plants and the Oxygen Process for removal of carbon. 200 pages, 76 illustrations, pocket size, cloth, \$1.40; leather, \$1.50 postpaid. Popular Mechanics Book Dept., 6 N. Michigan Ave., Chicago.

MOTORCYCLES, BICYCLES & SUPPLIES

BICYCLE Riders who use my self-healing tire preservative, laugh at punctures. Buy ingredients any general store for few cents. Big money selling this preparation. Formula with full directions 25c. No stamps. C. P. Warren, 312 Lincoln Ave., Detroit, Mich.

SEND for latest Bulletin of real Motorcycle Bargains, used and slightly used, all makes, models and prices; if you have \$25 and really want a powerful Motorcycle, send for this Bulletin; hundreds of machines at all prices, new ones on easy payments; tell us what you want and how much you can pay; we can fix you up. Peerless Motorcycle Co., Dorchester, Mass.

HARLEY-Davidson 1914 two-speed twin. Complete equipment. Perfect. \$180. Motorcycle, Box 356, South Norwalk, Conn.

TWIN Excelsior Motorcycle. Extra fine condition. Prest-o-Lite, speedometer, extra tire, tandem. Run 500 miles. \$165 cash. Helje Klang, Dysant, Ia.

BARGAIN—Pope light-weight \$65. Pierce 4-cylinder 2-speed \$150. Claude Line, Jasper, Ind.

FOR Sale—1913 Indian Twin. A. Freimuth, Crandon, Wis.

1913 EXCELSIOR magnets, clutch. Guaranteed perfect. \$60. Clinton Varma, Parkersburg, Pa.

FOR Sale—1914 Harley-Davidson Twin \$190. Absolutely alright. Oscar Olson, Eagle Grove, Ia.

FOR Sale—5 H. P. twin cylinder Indian Motorcycle, first-class condition, price low. Write for full particulars. John J. Forsythe, 688 Columbia Road, Dorchester, Mass.

NEW bicycle accessories. One agent in each locality wanted. F. M. Neal, 197 Harriet St., Bridgeport, Conn.

1912 MERKEL twin, good condition, \$85. Wilson Fife, Canonsburg, Pa.

DON'T buy a Bicycle Motor Attachment until you get our catalogue and prices. Shaw Mfg. Co., Dept. 27, Galesburg, Kansas.

MOTORCYCLE Bargains: Flying Merkel twin, \$75; Indian 1913 twin, \$85; Harley Davidson twin, \$110; Emblem 1914 single, \$70; Indian single, \$40; Henderson 4 cylinder, \$145. Write for our big bargain sheet with prices and descriptions of over one hundred second hand motorcycles. W. E. Wandersee Co., largest motorcycle dealers in Michigan, 129 Gratiot Ave., Detroit, Mich.

WANTED at once, fifty young men as factory representatives to travel and place local agencies for Eagle motorcycles. An excellent opportunity paying big profits. Sterling Motor Company, Wholesale Department, Brockton, Mass.

\$50 TO \$150 buys the best motorcycles; every make and model in our large stock must be cleared. Half price. Send for list today. Brown Music Co., 9119 Commercial Ave., Chicago, Ill.

PIERCE Four, 3 speed, just overhauled, \$65. Seeber & Hoffmans, Buffalo, N. Y.

GUARANTEED electric motorcycle horns. Loud. Light. Send for circular. Agents wanted. John Chadwick, Adrian, Mich.

FOR Sale—1 1915 3-speed Harley-Davidson motorcycle, still in the crate, \$245; \$75 down, balance C. O. D. C. A. M., P. O. Box 148, New Castle, Pa.

EXCELSIOR, Thor or Haverford, \$30 first money takes each; all in good running order. Seeber & Hoffmans, Buffalo, N. Y.

LOWEST prices on New and Used Motorcycles. Ask for list M. Prices \$20 up. Rebuilt Motorcycle Dept., 801 Center Street, Brockton, Mass.

GET Agency—Sidecars, Bicycles, Motorcycles. Buckland, Manufacturer, 1747 Noe, San Francisco.

FOR Exchange—8-cyl. V Type, 60-Hp. Boulevard aeroplane motor for good twin, two-speed motorcycle, Box 99, R. 2, San Luis Obispo, Cal.

USED Motorcycle bargains. Send for list. Seeber & Hoffmans, Buffalo, N. Y.

SPECIAL! Fourteen 4 cylinder Henderson motorcycles equipped with speedometer, electric lamp and exhaust whistle, \$175 each. These machines traded from Detroit Police Department. Write for particulars. W. E. Wandersee Co., 129 Gratiot Ave., Detroit, Mich.

NEW 1915 Excelsior three-speed twin, equipped, \$250. Louis A. Miller, Leavenworth, Kans.

LIVE agents wanted for the new 1915 Eagle motorcycles. Write quick and make good money as our local representative. Sterling Motor Company, 720 Center Street, Brockton, Mass.

BIG bargains in good motorcycles we have taken in exchange on new ones. Send for special bargain list. Shaw Mfg. Co., Galesburg, Kansas.

WANT to sell your motorcycle? I have a method which has sold many. Write me today for free information. F. W. Johnson, Room 509, 78 E. Madison St., Chicago.

FOR Sale—Harley-Davidson Motorcycle, \$60. Henry F. Pardon, Owensboro, Ky.

\$5,000 WORTH of used Motorcycles, all makes; Harley-Davidson, Indians, Excelsiors, Hendersons, etc. Twins, \$75 and up; Singles, \$25 and up. Send for our list at once. C. H. Lang, 1704 Michigan Ave., Chicago.

EAGLE—Two speed—16 horsepower—Dixie Flyer, light weight—rebuild machines, parts, accessories, clutch, 2-speed equipment for all makes. Live agents wanted. Motorcycle Parts Mfg. Works, 2127 Michigan Blvd., Chicago.

200 **REBUILT** Motorcycles, Standard makes, new list. Chicago Motorcycle Works, 3911 Clarendon Ave., Chicago.

BIG bargains in second-hand motorcycles, \$25 up. Indians, Harleys, Thors, Excelsiors and Merks. Write for descriptions. Howard A. French & Co., Baltimore, Md.

SUPPLIES—Our big catalogue with prices lower than usual sent free to motorcycle owners. Meco, Hammondsport, N. Y.

NEW Motorcycle Book—Just Published—Motorcycles, Side Cars and Cyclecars. Their Construction, Management and Repair—550 pages, cloth, 350 illustrations. The Dealer, Mechanic and Rider will find this treatise a work of reference without an equal. Price \$1.50 postpaid. Popular Mechanics Book Dept., 6 N. Michigan Ave., Chicago.

TWO Eagle 9 h. p. Motorcycles, one belt and the other chain drive, both guaranteed in best condition, will sell cheap. Gilbert Whitman, 221 Main Street, Brockton, Mass.

1914 **HARLEY**-Davidson Motorcycle Truck. Used one-half season in business. Re-enameled and in A1 condition. Will sell for \$200 cash, cost me \$425 without equipment. Elmer F. Cook, 24 E. Elm Street, Brockton, Mass.

REVISED Used Motorcycle Bulletin No. 71. Send for this list of bargains. All makes and models at remarkable prices from \$25 up. Bank handles deposits. Why take chances? Ludden & Whitten, Brockton, Mass.

CYCLECAR MATERIAL

12 **H. P.**, 2-cyl., 2-cyl., air-cooled. Duryea engine, \$60. Cyclecar front and rear axles and wheels, new, 40" tread, \$20. 2-cyl., Connecticut coil, \$10. 1912 Harley-Davidson single, fine condition, ridden 5,000 miles, \$115. Wm. M. Shoemaker, Jr., Swarthmore, Pa.

METAL Cycle car bodies, \$10. Cost \$35 to build. W. E. Wandersee Co., 129 Gratiot Ave., Detroit, Mich.

CYCLE Car wheels, All sizes. Send for Bulletin, Heath Aerial Vehicle Co., Chicago.

CYCLECAR Friction Transmissions. Aluminum disc, tarred fiber wheel, roller bearings. Guaranteed. Cogswell Manufacturing Co., Hall St., Springfield, Mass.

AERONAUTICS

GET world's largest aeronautical catalogue, 6 red stamps, or our aeronautical motor catalogue just off the press, 4 red stamps. Blue prints \$1.75, all standard aeroplanes and aerial driven cycle car. The latest fad. "Heath" Propellers for air, water and land represent the survival of the fittest. Six years propeller production proves perfection. 3 red stamps for propeller catalogue. Heath Aerial Vehicle Co., Chicago.

FOR Sale: 6-cylinder 75-hp. Roberts aviation motor in good condition with propeller, \$475 cash. National Aeroplane Company, Machinery Hall, Chicago.

"**ELBRIDGE**" 60-Horsepower, 4-cylinder aeromotor, \$85. Send for photo; genuine bargain. Gleason, Bellevue Street, Worcester, Mass.

YOU can learn to fly for \$100. Write for particulars now. Aviator, 1402 N. Hickory St., Joliet, Ill.

AEROPLANE supplies—Motors—Equipment. Interesting catalogue free. American Aviation Company, 1354 Maplewood, Chicago.

GENUINE Blériot with fifty horsepower Gnome motor. Best offer accepted. John Rhoden, 828 W. 5th St., Cincinnati, Ohio.

WILL sacrifice latest flying boat, \$775. Completely equipped. Heath Aerial Vehicle Co., Chicago.

AVIATION Motors, all makes, up to 150 H.P., \$250 up. Complete aeroplanes, all types, \$500 up. State your needs. Aero Exchange, 38 Park Row, N. Y. C.

BEST and lowest priced aeroplanes, motors and propellers. Bates, 194 Oak, Chicago.

MODEL Aeroplanes—7c brings greatest handbook and catalog. Cheapest supplies. Walter Philipps, 503 5th Ave., New York.

COMPLETE Plan, drawn to scale, with precise instructions for building a Curtiss 3-foot Model Flying Boat, 25c. Other plans: Blériot, 15c; Wright, 25c; Nieuport, 25c; Curtiss Hydro, 35c; "Pencil" Racer, 25c. Set of six, \$1.35. 48-pp. Model Supply catalogue, 3c. Ideal Aeroplane Co., 82½ West Broadway, N. Y.

LIGHT Weight, Gasoline Engines, 2½ lbs. Guaranteed ¼ H. P. The Weiss Co., Torrington, Conn.

HOW to Make a Biplane Glider—Our book "Amateur Mechanics No. 2" contains a complete detailed description of how to make one. Price of book, 25c postpaid. Popular Mechanics Book Dept., 6 N. Michigan Ave., Chicago.

BUILDING and Flying an Aeroplane—160-page handbook covering the building of small models and full sized gliders and machines. In both biplane and monoplane models the well-known Curtiss and Blériot types are followed. Fully illustrated with detail drawings. Price, \$1 postpaid. Popular Mechanics Book Dept., 6 N. Michigan Ave., Chicago.

BOOKS AND PERIODICALS

AUTOMOBILE Troubles and how to remedy them. Cloth, \$1; leather, \$1.50. Many other practical and reliable mechanical books. Send for circular. Chas. C. Thompson Co., Dept. C, 501-509 Plymouth Ct., Chicago.

REAL Bargains in high-class books on Advertising, Bookkeeping, Chemistry, Mechanics, etc. Books on approval. Write for list. Clement, Box 513, Winston-Salem, N. C.

"**THE** Practical Lumberman," 256 pages, Merits and Uses Pacific Coast Lumber, also short methods figuring lumber, logs, carrying capacity vessels. Price, \$1.50. Address R. Brereton, Box 1153, Tacoma, Wash.

CAMERISTS! Give a \$-value to your photographs. Read Photo-Era Magazine each month. Sample copy five cents. Photo-Era Magazine, Boston, Mass.

BOOKS on Pets, Animals. Prices for stamp. Hakes' Bookshop, Ludlowville, N. Y.

BOYS—10c brings big illustrated boys' magazine, one year. (Canada 20c.) Dandy stories, Mechanics, Electric, Stamps. Youths' Magazine, 3655 Ogden Ave., Chicago.

LAST Word in Mathematics—Comparative Cancellation. Solves all problems with ease. Write for free descriptive circulars. Herriek & Horton, Publishers, Princeton, Ill.

SPANISH Books—every kind published—bargains—catalog free. Bernardo Lopez Book Co., Kansas City, Mo.

READ these great books about the War: 1. Germany and the Next War, by Gen. F. Von Bernhardi (discloses Germany's war plans for crushing England and France. Price 85 cents). 2. Secrets of the German War Office (by A. K. Graves, for twelve years a spy in the Kaiser's service. Price \$1.60). 3. Germany's Fighting Machine (by E. F. Henderson. Divided into three parts, The War, The Army and The Navy. Price \$1.35). 4. Men Around the Kaiser (by P. W. Wile. Tells about those men who figure most prominently in the affairs of Germany at the present time. Price \$1.35). 5. The Germans (by I. A. R. Wylie. A graphic picture of the German people on the eve of the great conflict. Price \$2.15). 6. The War and America (by Hugo Munsterberg, the great German-American. Price \$1.10). 7. War's Aftermath (a study of the deterioration of the quality of stock occasioned by the lamentable waste of war. Price 85 cents). Popular Mechanics Book Dept., 6 N. Michigan Ave., Chicago.

THE Black Fox Magazine, the trade journal of the Canadian fox industry. Free sample copy. Dr. Randall, Truro, Nova Scotia, Canada.

3,000 SELECTED Cartoons for \$3. A Panorama of World Events, Political, Industrial—Social—Humorous—Tragic—all of intense human interest. A wonderful collection of 3,000 cartoons reproduced from the newspapers of the United States, Canada, Mexico, Cuba and the cities of the Old World, has been made by Cartoons Magazine from more than one hundred and fifty thousand published cartoons, and bound in an artistic and durable cover, are now ready for your library table. Vol. I, Jan.-June, 1912—\$1. Vol. II, July-Dec., 1912—\$1. Vol. III, Jan.-May, 1913—\$1. Cartoons, 78 E. Madison St., Chicago.

"**SOMETHING-TO-DO.**" Interesting magazine for children who like to draw, paint, read and make small useful articles. You'll like it. Send postal card for free sample copy. Something-To-Do, 120M Boylston St., Boston, Mass.

BINDER for Popular Mechanics magazines. Best adjustable magazine binder on the market made especially to hold any number from one to six copies of this magazine with name "Popular Mechanics" in gold letters on front cover. No laces or cutting or perforating of pages necessary. Simple, unique adjustment; handsome, durable and neat. We buy in quantities and can offer our readers this regular \$1.50 binder for \$1.25, all shipping charges prepaid. Address Popular Mechanics Book Dept., 6 N. Michigan Avenue, Chicago.

ENGINEERS' questions and answers for license, by Hobson, for twenty-five cents, postpaid. Send stamps. Reilly's Book Store, Philadelphia, Pa.

METAL Work and Etching—A 96-page hand book for art metal workers telling how to make a great variety of useful and ornamental objects, such as desk sets, art-crafts, jewelry, etc. Price, 50c postpaid. Popular Mechanics Book Dept., 6 N. Michigan Ave., Chicago.

FREE Catalog of Mechanical Books—Our 96-page catalog of 500 books on 100 different subjects will show you where to find that particular information you are in need of on any mechanical subject. Send for it today. Popular Mechanics Book Dept., 6 N. Michigan Ave., Chicago.

EDUCATIONAL AND INSTRUCTION

STAMMERERS! An Instructor in well-known stammering school registered for my Scientific Mental Training Course, because the school method he taught did not give him mental control, or eliminate his "Fear." Isn't that proof that my Home Study course can do? Don't go to school. Get my Book, "The Cure of Stammering," and sample lessons for \$1. Prof. F. Foote, Psychologist, 816 Michigan Boulevard Building, Chicago.

LESSON Free! Architectural drafting taught, \$25. Free \$15 outfit, payments. American School of Architectural Drafting, 5644 Bishop St., Chicago.

MECHANICAL Dentistry. Send \$1 for complete course. Dr. W. Martin, Paterson, N. J.

PARAGON Shorthand. Learned in 7 days. Valuable invention by expert—not by mere theorist. Speed capacity beyond reach of hand. Is being used in service of United States Government. Request names of writers and fee. Paragon Institute, 126 Coliseum St., New Orleans, La.

SHOW Card Writers earn \$15 to \$40 per week; complete instructions \$1. Particulars free. National Show Card School, 507 Mass. Ave., N. W., Washington, D. C.

STANDARDS—Free-hand lettering, etc., for amateur draftsmen—Blueprint form—25c. R. E. Black, 528 E. Locust St., Davenport, Iowa.

WHY go to school to learn shorthand? Complete mail course, \$3. Money back if not satisfied. Almer Agency, Jackson, Michigan.

GOOD Opportunities for Veterinarians. Send for catalogue. Grand Rapids Veterinary College, Dep't Z, Grand Rapids, Mich.

ARTIFICIAL Marble, sanitary flooring, ornamental casting, concrete, plaster, papier-mache, interior decorations, garden furniture, statuary, life casting, elastic moulds, electro bronze depositing (immensely profitable work), complete instructions \$1; particulars, 200 illustrations free. Maffler, 9-117 Russell St., Brooklyn, N. Y.

EIGHTEEN Ways to Make Money! Interesting, isn't it? If you are mechanically or electrically inclined don't fail to write for our free book. Efficiency Company, 104-A, East 16th St., New York.

EXPERIMENTS. A new 256 page book that gives practical information for building simple, efficient apparatus at small cost, conducting tests and experiments, establishing a laboratory and applying the best experimental methods. Shows you what you can do with your own brains and hands. Both amateur and commercial work is covered. Send for complete description free or book itself sent postpaid upon receipt of price, \$1.50. Popular Mechanics Book Dept., 6 N. Michigan Ave., Chicago, Ill.

FREE Tuition by Mail—Civil Service, Normal, Academic, business, agricultural, English, drawing, engineering, real estate, and law courses thoroughly taught by mail. For "Free Tuition Plan," address Carnegie College, Rogers, Ohio.

WANT to secure a marine or steam engineers' license? For that great class of ambitious and hard working men, the oilers, coal-passers, water-tenders, firemen or anyone who wants real practical and useful information regarding the every-day operation of a steam plant, Chief McAllister of the U. S. Revenue Cutter Service has written an engineering story called "McAndrew's Floating School," that makes it possible for those who have not had previous training to absorb the necessary information. Cloth, 250 pages and 37 diagrams. Price, \$2. Popular Mechanics Book Dept., 6 N. Michigan Ave., Chicago.

IRREGULAR handwriting changed to a rapid business style by mail. Journal free. F. B. Courtney, Box A 492, Detroit, Mich.

TRADE SCHOOLS

ELECTRICITY, Plumbing, Bricklaying, Mechanical and Architectural Drafting taught by practical instruction. This is largest and best equipped practical school in America. Short time required and small expense. Positions secured. Earn expenses while learning. Write for big illustrated book. It's free. Coyne Trade School, Dept. 818X, Chicago.

PAINTING, Decorating, Paper Hanging taught by actual practice. Free catalogue. Chicago School of Painting, 150 West Austin Ave., Chicago.

AUTOMOBILE Instruction. A complete home study course that shows you exactly what you want to know about the automobile. 229-page book, giving definite, thorough, authentic and practical detailed information about every part of the automobile as well as thorough instruction in regard to driving, repairing and general care of the complete car. 190 illustrations, \$1.50 postpaid. Popular Mechanics Book Dept., 6 N. Michigan Ave., Chicago.

TELEGRAPHY

TELEGRAPHY—Morse and Wireless taught at home, spare time. Big demand. \$75.00 to \$150.00 month. Graduates assisted. Money back guarantee. Booklet P-25 free. Southern Institute of Telegraphy, Lavergne, Tennessee.

TELEGRAPHY—Morse and Wireless—also Station Agency taught. R. R. and Western Union wires and complete Marconi Wireless Station in school. Graduates assisted. Marconi Co. employs our wireless graduates. Low living expense—easily earned. Largest school—established 49 years. Investment \$25.000. Correspondence courses also. Catalog Free. Dodge's Institute, 15th St., Valparaiso, Ind.

TELEGRAPHY taught in the shortest possible time. The Omnigraph Automatic Transmitter combined with standard key and sounder. Sends you telegraph messages at any speed just as an expert operator would. Five styles, \$2 up, circular free. Omnigraph Mfg. Co., 41 G, Cortland St., New York.

WIRELESS

WE teach Wireless by Mail. Catalog tells how. National Radio School, 1485 You St., Washington, D. C.

\$10 COMMERCIAL Keys for \$4. Massie Wireless Telegraph Co., Providence, R. I.

WIRELESS Set. How to Make—86-page book telling how to construct at small cost an outfit suitable for transmitting four or five miles. Price, 50 cents, postpaid. Popular Mechanics Book Dept., 6 N. Michigan Ave., Chicago.

PICTURES, POSTCARDS, PENNANTS

25 BEAUTIFUL postcards 10c. 100 for 30c. Liberal samples for 2c stamp. Mador Print, Box 1429A, Boston, Mass.

EXCHANGE pretty postcards with our members far and near. Best card club. Membership, 10c. Jolly Card Exchange, Box 126, Decatur, Indiana.

20 BEAUTIFUL, high grade, assorted view cards, membership in our Post Card and Correspondence Club, monthly magazine containing instructions "How to Read Character from Handwriting," all for 25c. Gentlemen's membership in club including 6 fine cards, 10c. Ladies, 5c. All Write Club, 4971 Seventh Ave., Newark, N. J.

BOOKS and pictures; 2c stamp brings catalogue. Duff, 2713 Mozart, Chicago.

RECEIVE Postcards from everywhere. Join our splendid club. Membership 10c. Buckeye Club, Box 349, Cleveland, Ohio.

IF you really want to exchange postcards, try our splendid club. Lists circulate in many countries. Membership, 10c. Halcyon Club, Box 133, Erie, Pa.

RECEIVE Post Cards from everywhere. Join our jolly club. Send 10c. H. J. Teeple, Decatur, Indiana.

UNEQUALLED Set 12 Comic Pictures, \$1. Unique Pub., 1399 Ave A, N. Y. City.

3,000 SELECTED Cartoons for \$3. A Panorama of World Events, Political, Industrial—Social—Humorous—Tragic—all of intense human interest. A wonderful collection of 3,000 cartoons reproduced from the newspapers of the United States, Canada, Mexico, Cuba and the cities of the Old World, has been made by Cartoons Magazine from more than one hundred and fifty thousand published cartoons, and bound in an artistic and durable cover, are now ready for your library table. Vol. I, Jan.-June, 1912—\$1. Vol. II, July-Dec., 1912—\$1. Vol. III, Jan.-May, 1913—\$1. Cartoons, 78 E. Madison St., Chicago.

CROSS-SECTIONAL view of ocean liner "Britannic," showing interior arrangement of ship in colors, size, 14x20 inches, on heavy plate paper for framing or hanging. Very interesting. Reproduced from front cover design of July issue Popular Mechanics. Will be sent postpaid to any address in the world on receipt of 4 cents in stamps to cover packing and mailing. Popular Mechanics Magazine, 6 N. Michigan Ave., Chicago.

CAMERAS AND PHOTO SUPPLIES

MANY of your choicest snapshots are "Failures" from carelessness or inexperience. Why take any chances when experts will develop and print for you as cheaply as inferior workmen? Price list and samples sent on request. W. W. Sweatman, Box 602, Portland, Me.

OUR Autostat operates any camera automatically, permitting you to take your own picture, or with friends or family. Allow any time for posing. Guaranteed. State model of camera. Prepaid, \$1.25 or write for particulars. The Autostat Company, Box M 363, Chicago, Ill.

3A KODAK with Euryon Anastigmat and Hex Acme speed shutter, all good as new for only \$40. E. Hawkins, 4826 Culum Ave., Chicago.

WE buy, sell and exchange. Bargains in Microscopes, Telescopes, Binoculars, Cameras, etc. Bargain list sent. Kahn & Son, Opticians, No. 54 John St., New York. Established 62 years.

MICROSCOPES, Telescopes, Binoculars, Kodaks, bought, sold, exchanged. Isaacs, 26 John St., New York.

FILMS developed 10c, prints 2c to 5c. A reputable incorporated company, conducting largest existing plant. Price list and special offer. Enlargements our specialty. Chicago Photo Finishing Co., 54 W. Lake St., Dept. A, Chicago.

ENLARGEMENTS 8x10—25c; 5 for \$1. Photo Co., New Dorp, N. Y.

DO you realize that you will never know what good pictures are until you possess Anastigmat Lenses? Why don't you send a two-cent stamp for our free trial offer and valuable exposure meters? Lafferty Co., 765 North Fifth Ave., Chicago.

IF you have a High-grade Camera, Lens or Kodak, and want to turn it into cash, write us today. State particulars, price, etc. We buy and trade, sell or exchange. Prompt, satisfactory service. Everything in cameras from Vest Pocket to Graflex. A square deal to all. David Stern Co., 1947M W. Madison St., Chicago. In business since 1885.

BEST quality finishing. Films developed. Two brownies 5c per spool, larger sizes 10c. Printing vest pocket and 2 brownies 2c—2a 2 brownies 4c—4x5—2a 5c each. Price lists and samples for your dealer's name. Barbeau's, 35A37 East Bridge, Oswego, N. Y.

HAVE you a Camera? Write for samples of my magazines, American Photography and Popular Photography, which tell you how to make better pictures and earn money. F. R. Fraprie, 122 Pope Bldg., Boston.

HIGH-CLASS Developing and Printing. Valuable booklet free. W. W. Sweatman, Box 602, Portland, Me.

KODAK Films developed free. Velox Prints 2 1/2 x 3 1/4, 3c; 3 1/4 x 4 1/4, 4c; 3 1/4 x 5 1/4, 4x5, 5c. F. W. Bromberg, Birmingham, Alabama.

KODAK Films Developed, 10c per roll, any size. Prompt attention given mail orders. Prints, 2 1/2 x 3 1/4, 3 1/4 x 4 1/4, 4 x 5 to 3 1/4 x 5 1/4, 4c. J. M. Manning, Box B, 1062 Third Ave., New York City.

ROLL Films Developed free. Prints 1 cent up. Send for samples. Sunset Studios, San Diego, Calif.

SAMPLE offer: one film roll (only) developed 5c; prints from same 2c each; to show high quality work. Moser & Son, A20 Arcade, Cincinnati, O.

PROSCH flashlight attachment for speed shutter work. Reliable, wonderful results. Cost \$15, sell \$6. Perfect condition. Morrissey, 104 W. 74th St., New York.

FOR Sale—\$400 Studio Outfit, \$100. Carl Beth, Choteau, Mont.

KODAK Album Free—Mention this magazine. Films developed 10c any roll, prints 2c up. We give many valuable premiums with finishing. The Fox Co., San Antonio, Texas.

CAMERA Owners—Get my free books on Photography. Guff, 3336 Indiana Avenue, Chicago.

KODAK film developed Free. Superior prints. Write "Ensign," Omaha, Neb.

FILMS developed 10c—Prints 2c each. L. Loney, 518 W. Com. St., Hartford City, Ind.

ROLL Films developed 5c, postcards, 2 1/2c, 25 for 50c. Get price list. Sprauer, Hamilton, Ohio.

GREAT bargains in Kodaks, Cameras, Balopticons, Watches, Jewelry, etc. Send for list A. Photo Novelty Co., Ellwood City, Pa.

KODAK Finishing. Quality Service. Prices right. Developing, Printing, Enlarging. Send trial order and ask for free booklet and price list. We pay return postage. The Fowler & Slater Co., 806 Huron Road, Cleveland, Ohio.

MAKE artistic photographs for pleasure, money and fame. Photo-Era Magazine tells how. Sample copy, five cents. Address Boston, Mass.

25 FORMULAS for latest fads in photography, 25c. Includes disappearing photos, Phosphorescent photos, Trick pictures; simple enlarging apparatus, Transferring to cloth, chinaware, etc. Satisfaction or money back. P. Benson, Stewartville, Minn.

AMATEURS—Expert finishing; prices right. Send three negatives and dime for sample prints. List free. J. H. Rawlings, Rockville, Conn.

PHOTOGRAPHY—High-grade finishing for particular amateurs. Send for prices. Cross Photographic Co., St. Louis, Mo.

MANDEL One-Minute Camera and others cheap. Roll films developed 5c. Prints 3c. S. J. Mathewson, Wauhay, S. D.

ROLL Films Developed 10c per roll. Printing Post Cards 3c each. 15 years' experience. Give me a trial. You will be pleased. F. C. Hoyt, Sac City, Iowa.

FILMS developed 5c, prints 2c, all sizes. Johnson's Studio, Oswego, N. Y.

YOUR film receives the personal attention of an expert. Best results, quick returns. Booklet with sample prints and enlargement free. H. Cobb Shaw, 118 Bowdoin St., Boston.

PHOTOGRAPHIC Retouching Taught: cheap course; learn at home. Y. & M. Retouching Co., Dept. M, Marshall, Mich.

KODAKS, Cameras, all makes, all sizes. Motion picture cameras, hundreds of anastigmat lenses and speed shutters of all makes at about half regular prices at New York's largest photographic store. Send for largest bargain book. Koehler's Camera Exchange, Inc., 7 East 14th Street, New York.

BIG Money Saved on Photographic Lenses and Apparatus—goods exchanged; repairing done. Ralph J. Golsen, 65 East 46th St., Chicago, Department P.

FILMS developed 10c, all sizes. Prints 2 1/2 x 3 1/4, 3c; 2 1/2 x 4 1/4, 3 1/2 x 4 1/4, 4c; Post Cards, 50c doz. Week guaranteed and returned 24 hours after receiving. Postpaid. Send negatives for samples. Girard's Commercial Photo Shop, Holyoke, Mass.

SAVE 40% on Photo Paper from factory, prepaid. "Instanto" has a sparkling quality no other gaslight paper possesses, quick printing develops easy. Money back guarantee. Send 25c for 3 dozen postals or 4x6 sized, price list and full directions. Photo Products Co., Dept. J, 6100 La Salle St., Chicago.

ROLL Film developed, 10c a roll. Packs 20c each; Prints, Brownies, 2c; 1x, 3x4, 3x5, and Post Cards, 3c each. Work returned next day. Postage paid. Kodak Film Finishing Co., 112 Merchants Station, St. Louis.

MOTION PICTURES

MAKE big money writing moving picture plays. Previous experience, literary talent or correspondence course unnecessary. Free details and special offer. E-Z Scenario Co., 311 West 33d St., New York.

WRITE Moving-Picture Plays. Good prices. Devote all or spare time. No correspondence school. Details free. Atlas Publishing Co., 304, Cincinnati.

WE accept manuscripts in any form; criticize free; sell on commission. Don't waste money on "instructions." Write us. Story Revision Co., 285 Main, Smethport, Pa.

MAKE More Money writing Photoplays! Literary experience, correspondence course unnecessary. Write for Free booklet, "How To Write Moving-Picture Plays." Lundeen Publishing Company, 289, Fergus Falls, Minnesota.

35 PROFIT Nightly—Moving Picture Business—small capital starts you, no experience needed. Teach you—furnish everything. Ralph J. Golsen, 65 E. 46th St., Chicago, Dept. M.

MAKE a complete Motion Picture Camera and Projector from instructions given in our book Amateur Mechanics No. 4. Full details given. Not hard to construct. Worlds of enjoyment taking and exhibiting subjects dear to the heart. Price of book only 25c postpaid. Popular Mechanics Book Dept., 6 N. Michigan Ave., Chicago.

MOTION Picture Work—A large 618-page book covering every phase of the moving picture, its production and its theatre. Indispensable for reference and instruction to the thousands of workers in the motion picture field. Price \$3, postpaid. Popular Mechanics Book Dept., 6 N. Michigan Ave., Chicago.

WE can show you how to sell your photoplays, stories and ideas. Quick, profitable sales. Model photoplays and criticisms free. No courses or revision. Proof free. Manuscript Sales Co., Box 309, Hazelhurst, Pa.

BUSINESS OPPORTUNITIES

698 WAYS to make money. 2,716 formulas in Encyclopedia Business Opportunities, 3 volumes, price \$3, yours for \$1. Formula Service, 3311-F, Belleplaine Ave., Chicago.

START a Business at Home. Our Big Book "Knowledge is Power" tells how. Filled with valuable facts, Plans, Formulas, etc. Limited Offer \$1 postpaid. Refunded if dissatisfied. Selby-Burrell Co., 112 Water St., Boston.

"HIRE Yourself as Boss." Big corporation will back you in Money-Making Mail-Order Business selling Guaranteed Goods. Start spare time. Small capital. No canvassing. Wm. J. Dick, Mgr., Dept. K-10, 20 W. Lake St., Chicago.

CASH—If you want to sell your patent or property, any kind, anywhere, for cash, write us. Established 1893. Northwestern Business Agency, Minneapolis, Minn.

TURN your ideas into money. We accept manuscripts in any form; criticize free; sell on commission. Good ideas bring big prices. Write us. Story Revision Co., 99 Main, Smethport, Pa.

OPERATE profitable mail order book business. 700% profit each sale; small outlay, everything furnished. Spare time. Particulars free. Rollins, Box 5273, Boston.

CLEAR \$10 daily with a "Candy Kitchen"; home or small store. Booklet free. The Kennon School, 142 West Ontario St., Dept. A, Chicago.

MAKE \$3 to \$10 daily. Wonderful new Tartaric Mirror Silvering process opens enormously profitable business. Particulars, free. A. Barstow, 514 23rd Street, Oakland, Calif.

WE analyze everything. Guaranteed formulas by experts. D. Laboratories, 902 Tinton Avenue, New York.

NEW Spare-Time Proposition. Made \$154.00 in 17 days in January. No canvassing, small outlay, experience unnecessary. Particulars free. Leicester Freeman, Glenn Falls, New York.

AGENTS wanted everywhere to handle "Fix The Fly," greatest 10c article ever produced. Other fast-selling novelties, Big Profits. Write, Berg & Beard Mfg. Co., 61 Fleet Place, Brooklyn, N. Y.

TWELVE years ago I started a small mail-order business at home in spare time with a few dollars capital. I wanted to make \$30 or \$40 a month, evenings. The net profits the first year averaged \$200 a week. Five years' work netted me \$30,000. I will show you how to start a small mail-order business. Send today for my proposition. It's interesting. No canvassing. Hancock, Box 867, Lockport, N. Y.

READ "Booster" and make more money! Operate Mail Order business during your spare time. We'll show you how! Sample copy 10c. Booster Magazine, Northwestern Building, Chicago.

RESILVERING mirrors, renewing dry batteries and book filled with formulas and trade secrets, all 25c. Formula Service, 3311-F, Belleplaine Ave., Chicago.

\$6,000 FOR an Idea—Chance for inventors. Address Patent News, Department 74, Washington, D. C.

WRITE Moving-Picture Plays. Good prices. Devote all or spare time. No correspondence school. Details free. Atlas Publishing Co., 304, Cincinnati.

WE will start you in the cleaning and dyeing business, little capital needed, big profits. Write for booklet. Ben-Vonde System, Dept. C, Charlotte, N. C.

5000 YEARLY Raising Canaries. New Industry. Start at home, spare time. Very little capital necessary. Complete instructions 50c. Service Bureau, 3311-F Belleplaine Ave., Chicago.

RESIDENT managers wanted for all open territory. Opportunity to establish your own permanent business. Must finance orders for complete Le-Ta-Co. household necessity line. Rapid sellers; big repeaters; large profits. The Mahed Co., Newark, N. J.

ONLY \$200 required to start profitable money-making business of your own, handling Punch Board Assortments, showing 100% profit. Washington Sales Co., Department P, Chicago.

OWN a business. Co-operate with me evenings at home. Everything furnished. Don't worry about capital. Boyd H. Brown, Dept. K-6, Omaha, Neb.

THE Tango Swing. Amusement Riding Device. Operators make fortunes pleasing the public. Gunn Brothers, 16 Perry St., Buffalo, N. Y.

WOOD Stains, complete instructions, \$1. Mahogany, birch, maple, ebony, mission, early English, walnut, oak, etc. Free particulars. Roth, A-25 Frost St., Brooklyn, N. Y.

POSTAL brings particulars on best Mail-order Course on the market. Write Roberts, Valley Jet, Iowa.

\$60 WILL buy 1,000 mail-order books worth \$1,000. Circular describing books free. Address Chemist Brown, 214 Kasota Bldg., Minneapolis, Minn.

BIG Money growing Golden Seal. Booklet giving information for 10 cts. Boots for Planting. W. N. Long, Florence, Ky.

OWN a Business—1,000% profit manufacturing Inks at home, spare time. Capital and experience unnecessary. Enormous commercial demand. Our secret formulas and sure selling plans insure lucrative, steadily increasing business. No canvassing. Investigate immediately. Particulars free. A. Covert, Secretary, 6935-6939 Kenwood Ave., Chicago.

START mail-order fur farming book business. Double your income. Spare time. Interesting literature free. Address, Fur Farming, Holmes Park, Mo.

BARGAINS: Complete mail-order course, two volumes (128 pages), 20c. Silvering mirrors instructions, 10c. All 25c postpaid. 23 formulas free. Edwin Terry, Huntsville, Ala.

DISTRICT Managers Wanted to handle territory. Must finance orders—Kor-Kor Puncture Cure. The Standard adds 50% to the mileage. Not a filler. Preserves the tire. Highest testimonials furnished. Proposition unusually good. Secure territory at once. Alveno Mfg. Co., 14 Bridge St., Newark, N. J.

USE your spare time to build up a mail order business of your own. We help you start for a share in profits. 27 opportunities. Particulars free. Opportunities Exchange, Buffalo, N. Y.

PATENT Application fully prepared, \$10. Why pay more? Particulars free. Patent News, Dept. 71, Washington, D. C.

FIVE to 10 dollars per day, sharpening safety razor blades. Automatic machine does all. Experience or big capital unnecessary. Details free. Henderson Machine, 201, Cincinnati.

\$30 WEEKLY manufacturing post cards. Easy to learn. Stamp for particulars. Almer Agency, Jackson, Michigan.

LARGE Chicago Advertising Organization desires local representation. Investment of \$500 necessary. Fully secured. Chance to establish in permanent and paying business. Merchants Advertising Service, 716 Medinah Bldg., Chicago.

MAIL Order Beginners, Agents, Opportunity Seekers. Write for my free literature. H. B. Essex, Box 476, Baltimore, Md.

"DOLLARS" yearly in your back yard. No ginseng, mushroom dope. New ideas never before published. Particulars free. Metz, M. 132-W, 34th St., New York.

ADVERTISERS, Mail Dealers: Our 1915 Rate Book lists 2,000 Principal Publications, rates, circulation. Includes 30 Mail-Order Plans. Price 15c. Dearborn Advertising Agency, 219 Franklin Bldg., Chicago.

HERB Recipe Book and Herb Catalog. 16c. Teaches how to make medicine from herbs for all diseases. Herb Gardens, Dept. 44, Hammond, Ind.

HOW to Operate a Mail Order Business. 30 Big Profit Plans and year's Mailing service sent for 10c. Mail Dealers' Wholesale House, 521 Franklin Bldg., Chicago.

START in the Carpet or Clothes Cleaning Business now. Thurman Vacuum Process unacquainted for commercial cleaning. We show you how. Easily learned. Only \$125 capital needed to earn good income in towns of 2,000 and over. Write today. Thurman Vacuum Cleaner Co., Manufacturers all types Vacuum Cleaners, Dept. H, St. Louis, U. S. A.

LEARN the Real Estate Business. Our complete instruction book teaches: Listing, Appraising, Management, Salesmanship, Insurance, Brokerage, Advertising, Renting Agency, Forms, etc. 121 subjects. Excels \$20.40 correspondence course. Buckeye cover. 75c. Silk cloth \$1.00 postpaid. Realty Book Company, 5982 Euclid Ave., Cleveland, Ohio.

LET the parcels post help you. Add (\$15 to \$25 weekly) to your present salary or income. Start during spare time and build up a permanent mail-order business of your own. We show you how and help you make good. No canvassing. Experience unnecessary. The Parcels Post makes success doubly sure. Our new ideas and up-to-date plans bring the money. No so-called "Course of Instruction" to sell. We give that free. Write today. Address Pease Mfg. Co., Inc., Dept. A, 70 Broadway, Buffalo, N. Y.

BE Wisc. Don't experiment in mail order. I can tell you how to succeed. B. Newham, Waukegan, Ill.

MANUFACTURERS, Promoters and Patent Buyers are invited to write us stating the line of invention in which they are interested, as we can supply their wants in any class of patents. Victor J. Evans & Co., 162 Ninth St., Washington, D. C.

WOULD You Like to Own a good-paying mail-order business? We have a line that gets repeat orders all the time. You can start in spare time; invest a dollar or two a week and soon own a nice business of your own. Particulars free. Nadico, 1664 Belmont Ave., Chicago, Ill.

INDEPENDENCE and fortune quickly attained in the Manufacturing Mail Order business. I furnish Formulas, Manufacturing Processes and Trade Secrets in all lines. Sold under positive guarantee; 18 years' practical experience. Revision and improvement of Formulas and Processes—reduction of manufacturing cost—utilization of waste materials, etc. a specialty. Booklet, Formula List, and Valuable Information Free. W. L. Cummings, Ph. D., 127 Standard St., Syracuse, N. Y.

STOP Here! Let me start you in a home business that will bring you money every day. Experience unnecessary. Spare time. No canvassing. I furnish everything. Send for proofs. Voorhies, Desk C. R., Omaha, Neb.

PATENTABLE ideas wanted—Send for 3 free books. H. B. Owen, 30 Owen Bldg., Wash., D. C.

LEARN to collect money. Good income; quick results. Send for free booklet, "Skillful Collecting." Collectors' Association, Long Street, Newark, Ohio.

I WANT to send you proof of the wonderful pulling power of Popular Mechanics classified pages. What's your proposition? Write me today. P. W. Johnson, Classified Dept., Popular Mechanics Magazine, 6 N. Michigan Ave., Chicago.

BUSINESS FOR SALE

SHOP 22x50—Universal woodworker, band, rip and cutoff saws; planer, moulder boring, mortising, etc. Six-horse engine, good condition; town, 1,600. Only power shop. C. H. Larison, Logan, Ia.

SOUTHERN California Indian Motorcycle Agency open. C. Will Risden, Distributor, Los Angeles.

TO MANUFACTURERS

SPECIALTY Manufacturers Attention: Press Nursing Bottles out of Aluminum in two pieces that screw together. Absolutely sanitary, unbreakable, scientifically correct. Will sell by the millions; sure sellers with large profits. Write E. R. Taylor, Malcom, Iowa.

PAN-AMERICAN INVESTMENTS, A. B. C. REPUBLICS, SOUTH AMERICA

FOR Sale—Coal, Iron, Petroleum, Nitrate of Soda and Borate Grounds; Copper, Tin, Silver and Gold Mining Properties; Large Land Tracts, Government or private; Forest, Grazing and Agricultural; in the A. B. C. Republics. Address, enclosing 20c in stamps, T. Dennis Locking (Pan-American Real Estate Dealer), P. O. Box 1801, Santiago, Chile.

MAIL ORDER SUPPLIES

INCREASE your sales. Place your proposition before the readers of "Cartoons Magazine." 30,000 copies guaranteed every month. Classified rate 2c per word. Mail in a trial ad today. Cartoons Classified Dept., 78 E. Madison St., Chicago.

DUPLICATORS AND DEVICES

DUPLICATOR, 9x12, price \$1. Make 50 copies from pen or typewritten original. Send for circulars. Schenck Laboratories, Dept. 1, Madison, Maine.

\$2.40—THE "Modern" Duplicator. 30 days' free trial—32,846 firms use it to make 50 to 75 duplicate ("Made in U. S. A.") copies of each letter, or anything written with pen, pencil or typewriter. Booklet free. Main office, J. E. Durkin & Reeves Co., 329 Fifth Ave., Pittsburgh, Pa.

FOR ADVERTISERS

10,000 BOYS read our 9x12 magazine. Display 8c line; minimum 42c. Classified 1c word, minimum 25c. Two insertions 15% discount. Youths' Magazine, Chicago.

BARGAIN—20-word ad, one insertion, 25,000 circulation and one year subscription, 25c; extra words 1c. Digest, Grand Rapids, Mich.

25-WORD advertisement in the "Lever" and 48 other magazines, \$1. Additional words 5c each. List free. J. Ireland Agency, Mauch Chunk, Pa.

ADVERTISE—in Barkley's Magazine, 2c word, Barkley's Magazine, Mount Pleasant, Pennsylvania.

PERSONAL

TOBACCO users, control amount used and offset its bad effects; or quit entirely, without hardship. Send names of five users and One Dollar, and we will send you prepaid, one complete treatment of Tobacco, which we have sold at three dollars for twenty years. Once only. Tobacco Cure Company, Carthage, Missouri.

FREE—Stop using Tobacco—Free. We will give you free information how to conquer the habit easily and permanently. Results guaranteed. Anti-Tobacco Remedy Co., Dept. H, Omaha, Neb.

BROTHER—Accidentally discovered root cures tobacco habit. Gladly send particulars. F. Stokes, Mohawk, Florida.

AGENTS WANTED

MEN and Women Agents: Money talks—how much are you making? If you are earning less than \$200 a month, no matter what your locality, you will positively be delighted with our Sentinel Burglar Alarm proposition. Many agents easily earn \$15.00 daily. Brand new invention. Sells quickly on sight to homes, offices. Patented. No competition. Free exclusive territory. Instantly attached any door knob. Impossible turn knob without ringing bell. No batteries, screws, nails. Handsomely nickel-plated. Retail \$1.00. Provides cheap burglar insurance. It's a big money maker. Let us prove why. If you mean business write today for liberal terms to agents. Marshall Dobbins & Co., Manufacturers, 1422 Marquette Bldg., Chicago.

AGENTS Wanted—Right here is the one big chance of your life. If you want to make good money—\$10 a day or more, as easy as rolling off a log, and get your swell clothes free besides, you can do it by acting as our agent. We are the biggest people in the business and want our agents to make big money and be nifty, stylish dressers. Send a postal today for free \$10 outfit, including a big book of nobby suiting samples to select your swell agent's suit from. Then take orders from people who admire your nifty clothes. They come to you—not you to them. This is the way to get rich—the sure, easy way. Remember, you need no money—everything is furnished by us free. We pay express on everything. Just send a postal, but do it today. You can't get started too quick, making this big money and wearing these stylish clothes. Address card to Paragon Tailoring Co., Dept. 614, Chicago, Ill.

HUSTLERS everywhere! Sell Automatic Shears. They open themselves. Demonstration convinces customers. Recently invented; guaranteed; great repeaters; 100% profit; \$25 upwards weekly; permanent; triflers not wanted. Instructions, particulars free. Write immediately. Conklin Specialty Company, Huntington, N. Y.

AGENTS: The New Automobile Radiator Lodge Emblems, all orders. Biggest seller, handsome profits. Catalogue and particulars. Phila. Badge Co., 134 N. 8th St., Phila., Pa.

AGENTS Wanted—Agents make 500 per cent profit selling "Novelty Sign Cards." Merchants buy 10 to 100 on sight. 800 varieties. Catalogue free. Sullivan Co., 1234 Van Buren St., Chicago, Ill.

AGENTS—Salary or commission. Greatest seller yet. Every user pen and ink buys on sight, 200 to 500 per cent profit. One agent's sales \$620 in six days; another \$32 in two hours. Monroe Mfg. Co., X 6, La Crosse, Wis.

SELL something people want. Anyone can sell our product. Particulars free. Sample for stamp. Frank S. Tucker, 1 Hartford St., Boston, Mass.

YOU can make big profits selling our Pure Aluminum Kitchen Utensils—Guaranteed for 20 years. Our specialties are not sold in stores, and they get the business for you. \$200,000 firm and liberal credit plan backs you. We have an attractive General Agency offer. Wm. J. Dick, Manager, Dept. K-24, 20 W. Lake St., Chicago.

WANT Big Profits? Learn Tartaric Mirror Silvering. New process opens enormously profitable business. Particulars free. H. Barstow, 514 23rd St., Oakland, Calif.

AGENTS—An article that will save money for others is bound to make money for you. Our new, sanitary "Sav-Ice" Cloth (guaranteed) prevents needless melting of ice in refrigerators; reduces ice bills half. Twenty thousand sold last two months. Regular sample 25c. Exclusive rights. Harsh Mfg. Co., Indianapolis, Ind.

ACTIVE, permanent agents (men and women) to sell Moore Self-Winding Clothes Line and Reel. Only perfected article of its kind. Line keeps clean and dry, never soils clothes, never gets tangled; easy to put up and take down; winds up automatically. Every good home a sale at \$1.25 profit. Five sales a day means \$6.25; ten sales \$12.50 profit. Send today for agent's book, "Plenty of Sales and Plenty of Profits." Moore Drop Forging Co., Dept. A, Springfield, Mass.

SIGN Letter Agents and Painters: 500% Profit Gold and Silver Sign Letters for Stores and Office Windows. Anyone can put on. Big demand. Free samples. Metallic Letter Co., 404 N. Clark St., Chicago.

AGENTS—\$50 to \$250 per week. Money's yours. Easy. Agent's landslide: 12,000,000 want it; think of it; 12,000,000 homes in U. S. and a woman in every home waiting to see; willing to buy this wonderfully easy wringer mop; easy to operate; keeps women's hands always dry; she wants it; is eager to buy. Mr. Paasch sold 3 dozen in 12 hours, profit \$20.00; Mr. Munster, Mich., made \$28, three days; agent's profit, 15c per cent; risk a penny to bring a flood of success. Send postal for agency, full description; don't wait. The U. S. Mop Co., 303 Main St., Toledo, O.

\$61.50 WEEKLY introducing and selling a new gas light burner for kerosene lamps. Beautiful light. No chimney. No mantle. Perfectly safe. Simple in construction. Nothing to get broken or out of order. Will not burn out. Durable. Will last for years. Low price. Easy to sell. 200 per cent profit. Experience not necessary. Sample free. Why not try one on your lamp? Beware of imitations. No branch offices. Leather Manufacturing Co., Dept. 65, Cincinnati, Ohio.

AGENTS Wanted—If you know a chance when you see it you'll see this one now. Big money—stylish, nifty clothes—little work—no experience or capital needed—can you beat that? We want agents everywhere to take care of our business in their localities and to advertise our nobby, nifty suits by wearing them. We furnish everything, complete, and charge nothing for agent's outfit. The swiftest dressers everywhere are our agents and all we ask is that you tell people who inquire about your fine clothes where and how they can get them. You make big money—\$10 a day—without trouble. Just a postal brings you full outfit free. Big, new sample book of up-to-the-minute suitings sent so you can pick out your first suit; also measuring blanks and everything you need. We pay express on everything—not a penny for you to pay. Send quick before some one else gets the agency there—mail postal today to the American Woolen Mills Co., Dept. 614, Chicago, Ill.

\$5 TO \$10 profit daily selling our new household article; \$2.50 premium with each \$1.98 sale makes quick profits. Itunely Polish Co., Lacon, Ill.

AGENTS! Mail dealers! Get posted where to buy direct from manufacturers. Our new directory is just off the press. Price \$1. Particulars free. National Agents' Directory, Box 404, Tacoma, Wash.

AGENTS! A big hit everywhere selling the beautiful post cards. Write. The International Postal Card Service, Box 404, Tacoma, Wash.

AGENTS Wanted—To advertise our goods by distributing free sample to consumer, 90 cents an hour. Write for full particulars. The Favori Company, 1062 West St., Dayton, O.

AGENTS: New, mighty, money-making marvel. World startled. New marvelous clothes-washing crystal. Clothes-washing ideas revolutionized, positively abolishes rubbing, washboards, washing machines; women astounded; wild over it, absolutely harmless; \$1,000 guarantee goes with it; make \$50 to \$100 weekly easy. Marshall of Pa. amazed. Telegraphs. "Rush 5,000 packages." Exclusive territory; no experience necessary; credit granted; own a business; supply customers; pocket big profits; nature's mighty elements do work. Hurry! Write today—get overwhelming proof, all free. Equitable Corporation, Dept. 287, 215 W. Superior, Chicago.

AGENTS—\$5 daily selling our Handy Tool, 12 articles in one. Lightning seller. Sample free. Thomas Mfg. Company, 462 Third St., Dayton, Ohio.

QUICKERLIGHTNING cleans the hands quickerlightning; agents wanted; exclusive territory. Joliet Novelty Co., Joliet, Ill.

DON'T be an agent—own your own business. We furnish complete, practical, low-price outfits for plating in Gold, Silver, Copper, Nickel, etc. We furnish recipes, formulas, trade secrets. Work easy, profit enormous. Send today for particulars. Gray & Co. Plating Works, 731 Gray Bldg., Cincinnati, O.

A DOLLAR a minute can't be made with our goods or anybody's, but you can make good money with our quick sellers, easily carried, not sold in stores. Some just out and all sold at large profit. Postal to us may be the best investment you ever made. S. Mfg. Co., 41 Warren St., N. Y., Dept. 893.

AGENTS: We have something entirely new that sells quickly wherever demonstrated. Offers big profit. Start right now after this money producer and increase your income wonderfully. Write now for interesting proposition. It's free. Act quick. Hyde, 1215 Wheeler Ave., New York.

GENERAL agent wanted in each city for exclusive control Safelylite Electric Automobile Signal, the only practical rear signal that does away with costly accidents and loss of life. An opportunity for a man with ability to establish a business of his own. Safelylite, 464 Electric Bldg., Cleveland, O.

SELL Dry Goods Remnants. Greatest bargains on earth. Remnant Store Co., Cincinnati, Ohio.

OUR Sanitary Wire Frame Brushes and Cleaning Specialties are sold only by Kleanol agents. Household necessities. Good territory still open for state agents. Kleanol Brush Company, 71 Taylor St., Springfield, Mass.

WE are the largest manufacturers of twisted Wire Brushes in America. Highest grade goods, best service, largest profits. Our new Auto Specials are winners. Send for catalog. Fuller Brush Company, Hartford, Conn.; Rock Island, Ill.

AGENTS Wanted—An opportunity to get into big business. We want motor truck agents in several territories to handle our well known motor trucks in three sizes—half-ton, one-ton and two-ton capacities. Must be financially capable of paying for demonstrator and contract for a number of trucks to be sold during 1915. Our agents have tremendous leverage for obtaining business through being able to sell on time payments. A rare opening for the man who wants to enter a permanent business in which there is an unlimited future with the pioneers of the motor truck industry. Address Motor Truck Manufacturers, Box 655, Waterloo, Iowa.

AGENTS for new automatic tool. Sells to mills, factories, contractors, plumbers, steam fitters, gas fitters, machinists, stationary engineers, locomotive engineers, autoists, farmers, householders; made in five sizes. Sells in sets and separately. Attractive in appearance. Guaranteed throughout. Opportunity to build permanent business. You can give whole or part time. The Craftsman Tool Co., Connecticut, Ohio.

WANTED—Agents for Billy Sunday book. Write for terms and free outfit. R. I. Hunter, Williamsburg, Va.

WE want ambitious men and women. If \$5 to \$15 weekly will interest you, write for our contract. No capital required. Lydia E. Small Co., 385 Fenway Station, Boston, Mass.

PHOTO Pillow Tops, Portraits, Frames, Sheet Pictures, Photo Plates, Pennants. Rejects credited. Prompt shipments; samples and Cat. free to agents. 30 days' credit. Jas. C. Bailey Co., Desk A-5, Chicago.

NEW Automatic \$2.50 Adding Machine. Sell 10 a day easy. Big profit. Everyone buys. No competition. Repeat orders. B. Bassett, 5921 Indiana Ave., Chicago.

GENERAL Agents—Sanitary Sugar Bowls. Greatest 50c article. Sells everywhere. 30c brings sample. Schoenheit & Pease, East End, Pittsburgh, Pa.

ICELESS Milk-Bottle Cooler. Keeps milk and cream from souring. Absolutely new. Retail 50c. Dept. 45 B. Edmund Peeny Co., Muncie, Indiana.

AGENTS—Great opportunity to be permanent representative largest manufacturers high-grade soaps and toilet goods. \$25-\$75 weekly. Write for immediate appointment. E. M. Davis Co., R. 64, Davis Bldg., Chicago.

\$60.00 PER hundred and freight prepaid for our new Ka-Taba art rugs. A bonanza for Agents. A complete salesman's outfit, consisting of three rugs of different designs and sample case, sent upon receipt of \$3.00. For our financial reliability we refer you to the Boylston National Bank of Boston and Bradstreet's or Dunn's Commercial Agencies. Dundee Mfg. Co., Inc., 95 Bedford St., Boston, Mass.

AGENTS—A big summer seller. Something new. Concentrated Soft Drinks. Just add water—Delicious Soft Drinks in a 35¢—any time—anywhere. Popular for the home, picnics, parties, socials, etc. Guaranteed under U. S. Pure Food Laws. Light-weight packages—by Parcel Post—no delay. Enormous demand—Agents coinage money—\$6 to \$12 a day. 250 other fast sellers—all big repeaters. 100% profit. Agent's outfit free—Territory going fast. Be quick—just a postal today. American Products Co., 2230 Third St., Cincinnati, O.

AGENTS—Here's a winner. The Midget Vest Pocket Garmet Hanger—sells on sight. The most attractive proposition ever offered. 150% profit. No competition, as article is fully protected by U. S. and foreign patents. Address: Dept. "M." The Silre Company, 171 Madison Ave., New York.

AGENTS to take orders for Visiting and Business Cards. Large profits, outfit free. Forman Printery, Waterbury, Conn.

MEXICAN Diamonds exactly resemble genuine; same rainbow fire; stand tests; sell on sight. We need few more live agents. Profits \$50 weekly and up. Write quick for sample case offer free. Mexican Diamond Importing Co., Box A. Las Cruces, N. Mex.

\$150 PER month and expenses—Salary or Commission—Introducing our King Butter Separator. Produces best grade of butter from cream or milk, sweet or sour, in less than 5 minutes. Retail \$5 up. Write for free sample and salary proposition. De King Mfg. Co., Dept. 203, Chicago, Ill.

AGENTS are coinage money selling our big 10c Packages of 20 Assorted Postal Cards. "5,000 Varieties." "Big Profits." Sell everywhere at Sight. Sasaple Packages 10c. Particulars Free. Sullivan Card Co., 1234 Van Buren St., Chicago, Ill.

"JIFFY" Ironing Board Cover and Clamps is the biggest red-hot seller ever invented. 150% profit. No competition. Lake Shore Manufacturing Company, Michigan City, Ind.

AGENTS: The most careful spender wants what we have to offer. Particulars free. Masterson Specialty Co., Dept. M., Cincinnati, O.

AGENTS: Grab this quick. Our "Double Suction Hand Power Vacuum Cleaner" sells rapidly, and offers big profit. Best hand power cleaner made. Write now for attractive proposition. Lueck Mfg. Co., Milwaukee, Wis.

\$15 MADE first day by 13-year-old boy with Shomescope. Woman made \$8 first hour. Particulars free. Shomescope Mfg. Co., 523 W. 13th St., Kansas City, Mo.

AGENTS—Get particulars of one of the best paying propositions ever put on the market. Something no one else sells. Make \$1,000 yearly. Address E. M. Feltman, Sales Mgr., 560 Third St., Cincinnati, O.

AMERICA'S Daily Necessity. Stamp brings sample. Simmons Co., Hicksville, O.

WANTED, representatives everywhere! Introduce our wonderful, patented, moderate-priced household specialties; quality guaranteed; universally necessary; tremendous sellers; profitable employment; repeating orders establish regular income. Peterson Supply House, Box 272, Chicago.

SELL Show Cards. 500% profit. Every merchant buys. Write Powell Bros., 4150 Madison Street, Chicago.

AGENTS — The Stop-Scorch-Stirring-Spoon, just out, finds a customer in every kitchen. Sells quick for a quarter. Richard sold two gross first day. Big easy profit. Clinch your territory—send 35c for sample now. Mountain State Specialty Co., Clerk 44, Wheeling, W. Va.

GENERAL agents living near water to demonstrate and take orders for nationally advertised Ferro Rowboat and Canoe Motor. Sells on sight. Makes rowboat real motorboat in three minutes. Write or wire today for complete proposition. Ferro, 677 Hubbard Ave., Cleveland.

MAGIC Ink Eraser. No blade, no acid. Removes ink like magic. Sells like bread in a famine. Sample 10c. Sells 25c to 35c. S. Mfg. Co., 41X, Warren St., N. Y.

No dull, profitless Summer season for agents selling "Billy Sunday's" authorized, wonderful book, illustrated. Our men earning \$50 to \$100 weekly; little work. Everybody interested in "Sunday" now, book in demand everywhere (unusual proposition to mail dealers). Free circulars. Also other "Big money" makers. Marrello Company, Binghamton, New York.

200% PROFIT. You can't beat it. Sells everywhere. Free pocket sample. Our goods get the orders. Wm. J. Dick, Mgr., Dept. K-4, 20 W. Lake St., Chicago.

SEND thirty cents for two hundred sq. inches of America's daily necessity. Money refunded if not satisfactory. Simmons Co., American Bldg., Hicksville, Ohio.

PORTRAIT Agents: Our goods will make you big profits. Delivery guaranteed. Rejects credited. Prompt shipments. Low prices. Catalog and samples free to workers. Adam J. Kroll & Co., 602 Blue Island Ave., Chicago, Ill.

AGENTS, write for our new plan and samples on Ho-Bo-Co Skin and Scalp Soap. Our agents are coinage money. Rothen, 212 N. 2nd, St. Louis, Mo.

WANTED—Man or woman of good character in each town to take orders and distribute free goods as advertising; experience unnecessary; references required; \$15 a week to start. Address Hudson King & Co., 2 South Clinton Street, Chicago.

AGENTS—To sell the newest electric appliance on the market; sold everywhere there is electricity. In the home and office; liberal profits; sales-driving sample, weighs a pound, no experience or knowledge of electricity required; it shows how to use one light instead of two and get the same results; sells for \$3.50 and saves the purchaser an investment of \$25; write for particulars. The Handy Light Co., 17 Handy Light Block, Cincinnati, Ohio.

AGENTS. Coat, 3c, sell 25c. Gold window letters. Any one can apply. Samples free. Chicago Letter Co., 348 Altgeld St., Chicago.

GET in on this winner! Every man wants it—Slide-Stroke Stropper puts perfect edge on any razor, old-style or safety, with diagonal, heel-to-heel motion — scientifically right! Can't get out of order or cut strop. Sure, quick, steady seller everywhere. Some territory open if you write quick. Don't wait—this is a live one for live ones. If you're dead, don't write for my money—talk offer. S. B. Kanner, 554 Broadway, N. Y.

WE manufacture the most complete assortment of novelties, tricks, and puzzles in the world. Agents, dealers, supply houses and jobbers are making big money with our line. Fast sellers. Low quantity prices. Let us start you in a new money-making mail order business. Imprint catalogues furnished. Oaks Magic Co., Dept. 219, Oakbrook, Wis.

AGENTS Men and Women To Sell Cham-olette Junior Gloves, greatest household necessity on market, repeat orders absolutely certain. We will prove to you this is biggest seller you ever tried or refund your money. Write for our wonderful proposition. Textile Utilities Corp., Sole Mfg's, Dept. G, 112 West 30th St., New York City.

AGENTS—We want some one in this town to give away free samples Rogers Old Reliable Metal Polish with a package Starr's Powdered Enamel that repairs chipped and rusty spots on granite, tubs, bathtubs, closets, sinks, kitchen utensils, milk cans, water tanks, metal roofing, without heat, soldering iron or tools. Simply mix with water as wanted. Table-knife all the tools required. 10c gets sample and particulars. Starr, 1910 Monroe St., Toledo, Ohio.

AGENTS—Men and women, newest invention. Wing Self Heating Flat Iron; guaranteed, sells everywhere. Women delighted. Write for particulars. Wing Mfg. Co., 1608 Fulton St., Chicago.

OWN a Business—1,000% profit manufacturing inks at home, spare time. Capital and experience unnecessary. Enormous commercial demand. Our secret formulas and sure selling plans insure lucrative, steadily increasing business. No canvassing. Investigate immediately. Particulars free. A. Covert, Secretary, 6935-6939 Kenwood Ave., Chicago.

SELL Typewriters in your town. Good profits. Write me for wholesale prices and plan. A. E. Atchison, 1930 South Sawyer Avenue, Chicago.

JUST out, the greatest thing of the age. Sells on sight—wanted in every home. Agents given restricted territory. Write at once for particulars. E. Ruben Co., 914 Bedford Ave., Brooklyn, N. Y., Dept. BH.

AGENTS wanted to handle our self-selling needle cases. 100% profit. Sample, 15c. M. Effner, 371 New St., Newark, N. J.

AGENTS making good money selling tool-makers' clamps, plumbos. Send 75 cts. and we will send you one of each with lowest agents' price. Keep posted on our new line of tools. Wheeler Engine Works, North Main St., Stratford, Conn.

AN exceptional opportunity and first-class proposition introducing Security Rule Holder to carpenters and mechanics. Something new. A winner for hustlers. Write quick. Nippon Novelty Co., Nippon, Calif.

AGENTS—Sell guaranteed electric automobile and motorcycle horns. Prices right. Profit big. John Chadwick, Adrian, Mich.

1,000% PROFIT—"Goldline" Sign Letters. Cooperative interest free. Johnston Co., Quincy, Ill.

AGENTS: Sell Luminous Crucifix, "Shines all Night," to Catholic Institutions and families. Old Paduke Distributing Co., Paducah, Ky.

MANUFACTURER requires general agents for patented demand of centuries. 5-minute demonstration convinces. A financial independence to acceptable parties. Samuel C. Osborn, Masonic Temple, Chicago.

AGENTS—\$200 monthly distributing Newell's needle cases. Sell 135 needles in book for 10c and make 200% profit. Approval Plan envelopes make talking unnecessary. Crew Managers write. Send 10c for sample book and particulars. Newell Company, 5611 Theodosia, St. Louis, Mo.

GET cash for names, information, ideas, formulas. Turn what you see, hear and know into money. Instructive booklet for stamp. Information System, 230, Marietta, Ohio.

QUICK Seller—200% profit for 10 cents. Norman L. Lanz, Norristown, Pa.

AGENTS—Stop and think. Forget war and hard times. Get busy handling my portraits. Deal direct with the artist. Write for prices; address Frank A. Wanderley, Wheaton, Ill.

YOU want a seller. Every housewife wants the star reel and clothesline. Big profits. McKelvey Company, Box 295, Clearfield, Pennsylvania.

PERFECTION Ford Starters for Ford Cars, 8,500 sold. Guaranteed to start any Ford Car that is in running condition. Splendid proposition and inducement for state and county agents. Only \$15. Send \$10 for sample. The Perfection Auto Starter Co., 234 16th St., Denver, Colo.

\$1,000,000 WINNER! 1,000,000 sold and sale just started. Agents coming money: Walters, \$10 first day. O'Connell, \$40. Everybody wants new, scientific shoe scraper on doorstep. One automatic operation removes mud, dust, cleans sole, slides, heel. Get free catalog—great \$1,000 offer. Security Mfg. Co., Dept. 108, Toledo, Ohio.

BULLDOG Sashcord Fasteners grip like gum death. Save 3-5 feet cord. Windows Lung in half the time. Carpenters and contractors will buy in big quantities. Representatives wanted. Sample, 10c. Literature free. Lawton & Co., 5 Cove St., Wickford, Rhode Island.

"HOW to Get Rich" and 29 other books with catalogs postpaid straight to you for 75c. Ward Pub. Co., Box 433, Chicago.

EVERYBODY happy! Show cards take a tumble to boost business. Wake up. Circulars free. Popular Show Card Co., Box 433, Chicago.

USE your spare time to build up a mail order business of your own. We help you start for a share in profits. 27 opportunities. Particulars free. Opportunities Exchange, Buffalo, N. Y.

AGENTS: \$50 weekly. Sell our household inventions. Live, quick sellers. Write now. G. W. Simms, Main Street, Lake, New York.

FOUNTAIN Pens, Self-filling; automatic feed; exactly same as best \$4 kind; guaranteed for life, no fake; retail price, \$2; agents' price, \$1.25; none free. Willard Pen Company, Bayonne, N. J.

AGENTS: You can make money handling our H. O. Sliding Casters. A good proposition and a square deal. Write today. G. K. Wardle & Co., Dickey Bldg., Chicago.

"HYDRO-NOX" positively sheds rain and sleet from automobile wind shields. Every automobilist wants it; sells on sight; exceptionally large profits; workers make \$30 to \$50 weekly; particulars free. Hydronox Company, 1182 Broadway, New York.

AGENTS wanted to sell Non-Alcoholic Food Flavors, Perfumes, Toilet Articles, Soaps, Soft Drink Extracts, Household Necessities. 80% saving to consumer. Big Profits to Agent. Sample free. Credit given. Arthur N. Christy & Co., Dept. 8, Newark, New York.

LIVE wire agents wanted. Did you get your sample of Deposit sharpener, proposition and book on salesmanship, last month, all for a quarter? Get it, and show it and sell a dozen. Does work of a ten dollar article. Can't cut your fingers, litter the floor. No competition. Be first to get agency. Big profits. Big seller in offices. Deposit Co., Majestic Bldg., Detroit, Mich.

DOGS in caricature. Wonderful 6 color (15x20), paintings by celebrated artist. 1/2 million sold. Ideal for wall hanging. Agents and dealers wanted everywhere. Unusual proposition. Premier Art Company, 330 Broadway, New York.

ONE Million Agents Wanted, Exclusive territory. Chicago Art Co., 848 Altgeld St., Chicago.

1915 INVENTION. No Burn Dish and Pie Lifter, practical seller. Agents and church societies make money. Sample and particulars, 25c. Jefferson Manufacturing Co., 10 Syracuse, N. Y.

GENERAL Agents Wanted for only product of its kind in existence. A Metal Veneer eliminates metal polishing. The Wonder of the Century. Big opportunity for Big Men, The Trio Co., Inc., 253 Broadway, New York City.

AGENTS—Big money selling our household specialties; write for catalog. Krenschel Co., 469 Wilbraham Road, Springfield, Mass.

SELL Royal Lawn Mower Sharpener. Attaches instantly to any mower; sharpens perfectly, automatically; can be left attached, making mower self-sharpening forever. Every demonstration pays a profit—and makes a sale, too. Don't wait—now is harvest-time. A sure winner! Get our offer quick! S. B. Kanner, 552 Broadway, N. Y.

AGENTS: A free course in General Salesmanship is given to every man of our Sales Organization. This organization is a body of successful men selling the Handy Light; that unique electrical device which cuts the cost of electric lighting in half. Sells for \$3.50, is used in home, office, store, factory; weighs only one pound. Sold by demonstration. All agents furnished with well-planned methods for gaining interviews. A high-grade business for a man of ability and standing in his community. General Agents preferred. Inquire for our full proposition by addressing The Handy Light Co., 1103 Handy Light Block, Cincinnati, Ohio.

AGENTS: Here are new, quick-selling, Registered and Numbered protection tags. For hat, purse or person, 10c gets pair, reward for articles lost. Friends notified in case of accident. With your order, advise if you will act as agent, then we will include ten extra sets free. You keep the dimes and mail us the names and addresses of parties sold. Ohio Registry Co., Toledo, Ohio.

NEW Household Necessity; Inexpensive Food Jar; keeps solid food hot or cold; sells on sight to rich or poor; saves money for housewives; no more cold lunches for workmen, teachers or scholars; one sold sells others; big, permanent income. Write quick. Bartlett Jar Company, Belleville, N. J.

AGENTS—Big profits—Visiting and Business Cards. Outfit free; 2c postage. Printing Man, 226 So. 52d, Phila.

IN open territory for our Special Value Big 4 line for the coming Fall and Winter Season 1915. Four prices only. Tailored suits to measure at \$15.00, \$20.00, \$25.00 and \$30.00, retail. Fit and workmanship guaranteed. Full assortment to sell at \$15.00. Prominent agents now handling line pronounce it easiest selling and most satisfactory and profitable ever handled. Applications also solicited from representatives of co-operative societies, church organizations and suit clubs formed for mutual benefit. Give full particulars with application. Nelson Tailoring Co., 241-245 West Van Buren Street, Chicago.

NEW 1915 Model—Send no money, just your name on a postal card, and learn to return mail how to get the best Vacuum Cleaner made, without costing you one cent. Shipped direct from factory, guaranteed for 5 years. Reliable, live agents wanted. The Warner Company, Dept. 2, Muncie, Indiana.

AGENTS—Sell the Primus, genuine Swedish wickless, coal-oil stoves. Smokeless, odorless. Twice the heat of gasolene at one-eighth the cost. No danger of explosion. Big profits. James Anderson & Sons, Sidney, Ohio, American distributors.

YOUNG Man, would you accept a tailor-made suit just for showing it to your friends? If you live in a town smaller than 10,000, write Banner Tailoring Co., Dept. 50, Chicago, and get beautiful samples, styles and a wonderful offer.

AGENTS make big money and become sales managers for our goods. Fast office sellers. Fine profits. Particulars and samples free. One Dip Pen Company, Dept. 2, Baltimore, Md.

PERFECTION Pocket Adding Machine. Lightning seller. Agents wanted. Cincinnati Specialty Mfg. Co., Dept. R, Cincinnati, Ohio.

WINDOW Lettering Business. We start you free. Everette Co., Dept. P., Long Island City, New York.

SILVER Plated, Self-Filling Pen. No dropper required. No rubber ink-bag. No "mussy" fingers. Dip pen in ink, reservoir fills instantly. Lasts indefinitely. Agents wanted everywhere. Quick sales, big profits. Sample ten cents, none free. Ed. H. Irwin, Box 1201, Carthage, Mo.

KEROSENE Gas Burners in Cook Stoves or Ranges stop use of wood or coal. Recently patented. Money-maker for agents. The Vapor-Gas Burner Co., Columbus, Ohio.

READ the Agents Magazine and make more money. 2 issues 10c. Agent's Magazine, Chicago.

AGENTS—Air Cell Washing Machine. New, marvelous invention. Excels work of washers costing \$25.00 and up. Sells only \$1.00. No wonder every home buys. Exclusive territory free. Nearly 200% profit. Write today. Air Cell Washer Co., 3837 Detroit Ave., Toledo, Ohio.

AGENTS: \$1,000 to \$5,000 yearly selling over eighty every-day articles to farmers. Pleasant, permanent business. Full instructions. Big chance. Write quick. Duoform Factory, Duoform Company, North Java, N. Y.

RED hot seller. Something new. Sells on sight. \$20 to \$50 weekly. It's a winner. Good repeater. Carl Supply Co., Fairfield, Iowa.

AGENTS—Average \$5 to \$12 daily selling astonishing Astor massage machine. New. Just patented. Different. No electricity or water power required. Nothing complicated. Affords exhilarating massage without cent expense. Lowest priced. Best outfit. Retail \$2.50 allowing you big end of the profit. Particulars and beauty folder free. Astor Remedy Co., Dept. 132, Toledo, Ohio.

AGENTS—Sell rich-looking imported 36x 68 Rugs, \$1 each. Carter, Tenn., sold 115 in 4 days. Profit, \$57. You can do same. Write for sample offer selling plan; exclusive territory. Sample rug by parcel post prepaid, 98c. Condon, Importer, Stonington, Maine.

LOCAL Manager Wanted to Appoint Agents and see trade on D-B Products. We have a new sales plan that means quick, profitable sales. The man that is not afraid to work can make an excellent income. If your record will stand rigid investigation send it today—we will be interested. Donley Bros., 7402 Actna Road, Cleveland.

GUARANTEED Hosiery Manufacturer wants man or woman to establish permanent distributing route in home locality. No capital or experience needed. Liberal inducements for all or part time. D. Parker Mills, 2733 No. 12th St., Phila., Pa.

AGENTS—Brand new specialty Aluminum Triplicate Sauce Pan with detachable handle. Cooks 3 different foods on one burner. Saves gas. Lasts lifetime. \$100 to \$200 per month easy. Send for our catalog of 400 other specialties. American Aluminum Mfg. Co., Div J.10, Lemont, Ill.

\$1,040 PER Man per County. Strange invention startles world—agents amazed. Ten inexperienced men divide \$40,000. Korstad, a farmer, did \$2,200 in 14 days. Schleichner, a minister, \$185 first 12 hours. \$1,200 cold cash made, paid, banked by 8-tomcan in 30 days; \$15,000 to date. A hot or cold running water bath equipment for any home at only \$6.50. Self-heating. No plumbing or waterworks required. Investigate. Exclusive sale. Credit given. Send no money. Write letter or postal today. Allen Mfg. Co., 4009 Allen Bldg., Toledo, Ohio.

MAKE and sell your own goods. Formulas by expert chemists. Manufacturing processes and trade secrets. Formula catalog for stamp. B. Mystic Company, Washington, D. C.

500% PROFIT selling our wonderful sign letters for office windows, store fronts and glass signs; resembles finest gold leaf; easily applied; samples free. Metallic Letter Co., 406 N. Clark St., Chicago.

IDEAL Lamp Filler saves bother filling lamps. Men and women canvassers and agents. Good opportunity to make money. Samples A & B 25c. Harry Otis Mayo, Box A2298, Boston, Mass.

AGENTS—Stamping names on Pocket Key Protectors; sample Check with your name and address, 12c. Stamping Outfits, Emblem Checks, Check Fobs, Name Plates, Hart Mfg. Co., Desk 2, 303 Degraw St., Brooklyn, N. Y.

300 To 400% Profit Agents selling our guaranteed U. S. Fire Extinguishers. Tremendous demand. Orders repeat. Exclusive territory to county and district managers. United Mfg. Co., 1508 Oakwood, Toledo, Ohio.

WE need one active, reliable person in every community to take orders for our popular mechanical books. You don't have to be a book agent. These books do their own talking. Simply show them. They contain just that sort of information about how to do and make things that every mechanically inclined person is looking for. And they are reasonable in price. We allow you a liberal commission for this pleasant work which you can do during spare time without interfering with your regular occupation. Don't neglect this real opportunity, but write now for full details to Manager Book Dept., Popular Mechanics Magazine, 6 N. Michigan Ave., Chicago.

ENDLESS Neckties—Something new, twelve ties in one; costs no more than old style; man made \$70, three days; woman made \$22, week; write for special agents' offer. Endless Necktie Mfg. Co., Dept. 10, Kansas City, Mo., or Universal Products Co., Toronto, Canada.

SELL Our Attractive Brass Easel Poster Frames to picture theatres, also changeable letter signs for every store; big demand; easy sales; liberal commissions. Newman Manufacturing Company, Cincinnati, Ohio.

JUST show them—The new adjustable floor and wall mops, dustless dusters and sanitary brushes sell themselves. Big line. Big profits. Agents write Silver-Chamberlin Co., Dept. M. Clayton, N. J.

SAFETY First! Sell our line of Sanitary Twisted Wire Brushes. Big income assured. Exclusive territory given. Goods sell themselves. Households, Offices. Catalogue free. 3 in 1 Brush Co., 105 Beekman Street, New York.

YOU can be your own boss with our Key Check Outfit. Good for \$5 a day stamping names on pocket key checks, fobs, etc. Sample check with your name and address, 15 cents. Please Die Wajka, Dept. M. Winchester, N. H.

STOP Here! Let me start you in a home business that will bring you money every day. Experience unnecessary. Spare time. No canvassing. I furnish everything. Send for proofs. Voorhes, Desk C. R., Omaha, Neb.

BIG Profits for You! Manufacture Barley Crisp. New Confection, 5c package costs you 1c. Machine, instructions complete \$7.50 prepaid. Send 10c for samples. Barley Crisp Co., 1205 Broadway, San Francisco.

EASY pleasant work for Mechanics, Shop Men, Clerks, during spare hours, will add many dollars to their salaries. Also want persons who can give full time. Big wages assured. Novelty Cutlery Co., 67 Bar St., Canton, Ohio.

AGENTS make \$100 monthly selling our 500 handy household articles. Catalogue free. Scheff Company, Desplaines, Ill.

MEDALLIONS—300% profit. Make up your own goods and be independent. Catalogue free. Resag Co., 1205 Randolph St., Chicago.

MAIL-ORDER Opportunities! 25 new Propositions. No competition! Make 95c profit on dollar order; complete outfit 10c. Mail Dealers Wholesale House, 521 Franklin Bldg., Chicago.

AGENTS make \$5 to \$10 a day on the start. Atkinson writes: "The best proposition I have found in my forty years' canvassing." Permanent work. Household necessity. Saving 80%. Write today for General or Local Agents terms. Free sample. C. H. Stuart & Co., 16 Union St., Newark, New York.

YOU can make \$\$\$\$ as our general or local agent. Household necessity; saves 80 per cent; permanent business; exclusive territory; salary or commission; free sample; credit. J. Pitkin, 115 Reed St., Newark, N. Y.

AGENTS of ability and high character wanted on a new household article. Over 100 per cent profit. Special selling plan that pulls results. Address Merritt & Brock, 59 to 69 Temple Place, Boston, Mass.

AGENCIES WANTED

WANT household articles, exclusive rights. T. Mason, 234 W. Newton St., Boston.

SALESMEN WANTED

WANTED—Live territory representative to sell automatic electric light and power plants for domestic and commercial use. Low cost, no competition, large profit. Exceptional opportunity for right party. Address The Zinke Co., 1326 Michigan Ave., Chicago.

SALESMEN—Make Big Money on our Convex Portraits 38c, Frames 25c, Glass 20c. Largest house in America. Est. 15 years. Samples Free. The Culver Co., Box 104, Westerville, O.

GREAT opportunity for general agents selling new specialty to merchants; retail \$5, \$10, \$15 each. Your profit 200%. No competition. Exclusive territory. Free samples. Sayers Co., 408 Wainwright, St. Louis, Mo.

SALES Manager to sell grocery, drug and auto trade; staple article; \$100 to \$300 monthly; repeats; exclusive territory. Cleanall Co., 505 N. 2nd St., St. Louis.

SALESMEN Wanted for newly patented auto accessory. Box 311, Davenport, Iowa.

SALESMEN to call on Dentists, Doctors, Druggists, Hospitals and Meat Markets, to take orders for our Washable Coats and Summer Suits; a very good side line. 25% commission paid. Sample Outfit weighs 1 lb. Write for particulars with references. M. Weinsfeld Co., 253 Market St., Philadelphia, Pa.

SALESMEN, Agents, everywhere: New auto fuel. Permanent, profitable. Tankli Chemical Sales Co., Cleveland, Ohio.

SALESMEN—We have some excellent territory open to salesmen of ability. This is a proposition that appeals to the best class of concerns. Sales are easy and your profits large. Write us today for catalogue P. M., covering the Schick All-Steel Paper Baler, Davenport Mfg. Company, Davenport, Iowa.

SALESMAN—Specialty—High Grade men only. We start you in business for yourself, in your own town. No capital required. New Tungsten Nitrogen Lamp giving the most brilliant light—cuts electric light bill in half. Write for restricted territory. E. Rubes Co., 914 Bedford Ave., Brooklyn, N. Y. Dept. AA.

\$130 HAS been earned in 3 days by our representatives, some even better, introducing our new advertising method which solves the advertising problem for merchants in smaller cities and towns. If you are or want to be a salesman I will show you how to build up a big profitable repeat business quick. Whole or part time. Big money if you act now. Write Salesmanager, Winslow Cabot Company, 62 Congress Bldg., Boston, Mass.

WANTED—Ideal live-wire salesmen to sell pony contests on a commission basis. Liberal commission. Protected territory. Idlewild Co., Sabina, Ohio.

SALESMEN: G. & G. Patent Chalk Holders for billiard parlors. Proving best specialty ever out. \$10 a day easily made. Endorsed by Brunswick-Balke. Exclusive or side line. Write now. G. & G. Mfg. Co., Coffeyville, Kansas.

STEEL, changeable sign with art easel. Everybody buys; 300% profit. 34 letter sample mailed 12c. Convex Signs, 102 N. Dearborn, Chicago.

SALESMEN—Agents: Competition killed. Electric Flashing sign; over 30 different display arrangements possible with 210 three and six inch letter combinations—in colors. 30-inch model \$10. Sample to producers. Multiflex, 367 Manhattan Bldg., Chicago.

MANUFACTURER of international reputation desires representation in this locality. Five established products. Can be sold to retailers, jobbers and large consumers. Permanent money-making business assured by re-orders. Must be able to finance himself sixty days. Box 190, Station C, Cleveland, Ohio.

SALESMEN: Large Chicago Organization wants Specialty Salesmen. Also Side Line men. Handsome commissions on every sale. Pocket samples. State territory desired and present or past connections. Confidential. Merchants Advertising Service, 716 Madison Bldg., Chicago.

WANTED—Representatives everywhere. Exclusive territory. Gold sign letters for stores and office windows. Any one can put on. Write today for free sample. Metallic Letter Co., 403 N. Clark St., Chicago.

TRAVELING Salesmen Wanted—Experience unnecessary. Earn big pay while you learn by mail during spare time; only eight weeks' time required, one or two hours a day. Steady position, easy work, hundreds of good positions to select from. Write today for free book, "A Knight of the Grip," containing full particulars and testimonials from hundreds of students we have recently placed in good positions and who are earning \$100 to \$200 per month. Address Dept. B-16, National Salesmen Training Association, Chicago, New York, Kansas City, San Francisco.

SALESMEN—Get our plan for Monogramming Automobiles and Motorcycles by transfer method. Very large profits. Motorists' Accessories Co., Ashland, O.

BIG Opportunity for Hustling Salesmen. Selling Sandbo Two-Compression Starters for Fords. \$14. Guaranteed to start. Great demand. Salesmen with Fords preferred. Write Sandbo Starter Co., Desk A, Rock Island, Ill.

HELP WANTED

WANTED—Men to get members and establish lodges on commission basis for the Owls, South Bend, Indiana.

THOUSANDS Government Jobs. Open to Men and Women. \$65.00 to \$150.00 month. Write for list. Franklin Institute, Dept. T-21, Rochester, N. Y.

OWN a business. Co-operate with no evenings at home. Everything furnished. Don't worry about capital. Boyd H. Brown, Dept. K-5, Omaha, Neb.

SPEND summer gathering insects, butterflies. I pay big prices. Many worth \$5.00, \$10.00. All salable. Men. Women. Get instructions, price-list, pictures, descriptions of valuable ones. Send stamp. Sinclair, Box 244, D. 6, Los Angeles, Cal.

WANTED—Men and women to qualify for Government positions. Several thousand appointments to be made next few months. Full information about openings, how to prepare, etc., free. Write immediately for booklet G-29. Earl Hopkins, Washington, D. C.

WRITE Moving-Picture Plays. Good prices. Devote all or spare time. No correspondence school. Details free. Atlas Publishing Co., 2045, Cincinnati.

\$75 MONTH. Railway Mail Clerks. Examinations everywhere. Sample questions free. Franklin Institute, Dept. T-21, Rochester, N. Y.

GET a Government Job! See ad on page 10. Write now—today! Patterson Civil Service School, Rochester, N. Y.

WANTED—Distributors of advertising matter everywhere. Send 10c for application contract, sample magazine (none free). Berkeley's Distributing Agency, (403) Mount Pleasant, Pennsylvania.

RAILWAY Mail Clerks Wanted. \$75.00 month. Full unnecessary. Write immediately for full particulars. Franklin Institute, Dept. T-21, Rochester, N. Y.

BE a Detective. Earn \$25 to \$75 weekly; chance to see the world with all expenses paid. Write for particulars. Loraine Detective System, Incorporated, Dept. 304, Boston, Mass.

MEN—Women, 18 or over—Wanted. Government Jobs. \$45 to \$150 month. List of positions now obtainable free. Write immediately Franklin Institute, Dept. T-21, Rochester, N. Y.

ABLE-BODIED Men, good eyesight, for firemen and brakemen on all railroads. \$120 monthly. Inexperienced men helped to positions free. Railway Association, Dept. 298, Brooklyn, N. Y.

USE your spare time to build up a mail order business of your own. We help you start for a share in profits. 27 opportunities. Particulars free. Opportunities Exchange, Buffalo, N. Y.

WANTED—Men and Women, 18 or over, for Government Jobs. \$75 month. Write immediately for list of positions now obtainable and free sample examination questions. Franklin Institute, Dept. T 21, Rochester, N. Y.

A MONEY Proposition—Co-operate with me in a profit-sharing mail-order business. Will place trial advertisement, furnish printed matter, goods to fill orders and divide the profits. Particulars. Desk 153, Hazen A. Horton, Tekonsha, Mich.

EARN \$20 weekly collecting names and information. What you see, hear and know is worth money. Send stamp for instructive booklet. Information System, 229, Marietta, Ohio.

AT Last I Have Found It! A successful start in the mail-order business on small capital. Particulars free. Industrial Co., Box 15-P, Beechwood Sta., Rochester, N. Y.

BECOME Chauffeurs—\$18 week. Earn while learning. Sample lessons free. Franklin Institute, Dept. T 802, Rochester, N. Y.

DRAFTSMEN—Get a higher salary. Topographic Drafting pays from \$1,200 to \$1,800 and up. Big field. Learn Topographic in short time under our instruction. Get full particulars. Columbia School of Drafting, McLachlen Bldg., Washington.

LEARN automobile repairing, driving, on up-to-date cars; also electricity. Room and board while learning; many positions secured; satisfaction guaranteed; catalog free. National School of Engineering, 2110 W. 7th, Los Angeles. Established 1905.

SILVERING mirrors, Plating tableware, auto-brass. Home booklet plans free. Clarence Sprinkle, Dept. 28, Marion, Ind.

DISTRIBUTORS Wanted—Good pay; steady work; giving away packages. Perfumed Borax Soap Powder with our soaps, etc. No capital or experience needed. S. Ward & Co., 218 Institute Pl., Chicago.

JOIN an Order that pays money instead of charging dues. Solicitors wanted. Chas. Strong, Ward, Colorado.

MEN to refinish lighting fixtures, brass beds, etc. All or spare time. No capital or canvassing. Experience unnecessary. Information free. Gunmetal Co., Dept. G, Decatur, Ill.

BE a Detective—Earn from \$150.00 to \$200.00 per month. Travel over the world. Write C. T. Ludwig, 310 Westover Building, Kansas City, Mo.

BE a Detective. Earn \$150 to \$300 monthly. Travel over the world. Write American School of Criminology, Dept. F, Detroit, Michigan.

STOP Here! Let me start you in a home business that will bring you money every day. Experience unnecessary. Spare time. No canvassing. I furnish everything. Send for proofs. Voorhies, Desk C. R., Omaha, Neb.

WANTED—An Idea! Who can think of some simple thing to patent? Protect your ideas; they may bring you wealth. Write for "Needed Inventions" and "How to Get Your Patent and Your Money." Randolph & Co., Patent Attorneys, Dept. 144, Washington, D. C.

GO on the Stage. Vaudeville career offered you. Experience unnecessary. Managers endorse my method. Instructive vaudeville book free. Write today. Frederic LaBelle, Sta. 10, Jackson, Mich.

GOVERNMENT Examinations. Most thorough preparation, \$5; returned if not appointed; particulars free. American Civil Service School, Washington, D. C.

SITUATIONS WANTED

MANUFACTURERS: Man with patentable ideas (metal) wants position; have ready ideas. Kertusz, Newark, N. J.

WANTED

WANTED—Exclusive control of one or two first-class mail-order articles. Correspondence solicited. Jones Brekes, 319 E. 51st St., New York, N. Y.

ENERGETIC young man desires spare-time work. Business experience. Joseph Trinajstic, 3177 West 11th St., Cleveland, O.

FOR SALE

FOR sale at a great sacrifice. Automobile Engine, 6x6, 4-cylinder; cost new \$1,090. Suitable for speed launch, electric lighting, fire engine, motor truck, or stationary work. J. H. Allen & Co., Allen Square, St. Paul.

FOR Sale Cheap. \$500 Vulcanizing Equipment, guaranteed first-class condition. John K. Bradlock, Rensselaer, Ind.

FOR Sale—Tent 20x30 ft., without poles, \$25. Jas. McCall, Norwich, Conn.

FOR Sale—Almost new 24-in. Valley City double-belted single surfacer. Price \$165. Address Chas. E. Francis Co., Rushville, Ind.

OXY-ACETYLENE welding plant, new, cost \$350, cheap. 46 W. 6th St., Covington, Ky.

TELESCOPE Day and Night, 30-Mile Adjustment; value, \$20; special price, \$5.25. Slightly used field and marine glasses and binoculars. Write for list. Money back if not satisfied. Wells' Curiosity Shop, 20 S. 2nd St., Philada.

RAZOR Blade Sharpening Machine (6 blade) for sale. Chas. E. Fuller, Lima, Ohio.

EDISON Moving Picture Machine. Fine condition guaranteed. A bargain. F. E. Dart, Sturgis, Mich.

SALE OR EXCHANGE

SALE or exchange for Ford '13 parts—portable elec. drill, elec. lat-iron, grinder stand, 1½ Hp. gas engine, repeat shot gun, disc phonograph, I. C. S. structural draft course, patterns for 25' motor boat. S. St. Clair, 9 Russell St., Portland, Me.

WELDING machine self-generator for Ford automobile. J. Thompson, 565 Marshall, Memphis, Tenn.

GUNS, SPORTING GOODS, ETC.

PEERLESS famous combination spring exercisers with patented grip handles. Just the thing for athletes, business men, women, boys or girls. All the gymnasium advantages in your own home. Prices \$4c to \$4.99. Five styles, three tonalons. Send for complete manufacturer's catalogue. Peerless Athletic Supply Co., 383 Pearl St., Brooklyn, N. Y.

FIREARMS—Old-time and modern. Buy, sell, exchange all sorts. Stephen Van Rensselaer, West Orange, New Jersey.

FLOUR & FEED MILLING MACHINERY

SPECIAL bargains in second hand Attrition mills, burr mills, crushers, corn shellers, bran dusters, dust collectors, purifiers, reels, double, single, 2 and 3-pair high roller mills, sieve bolters, receiving separators, scooters, etc. Write for description and prices. Sprout, Waldron & Co., P. O. Box 429, Muncie, Pa.

MACHINERY, TOOLS AND SUPPLIES

THE Clark Metal Band Saw will cut tool and structural steel, iron, mica, slate, bronze, brass and copper, in rounds, flats, sheets and tubings. Has two cutting edges. Cuts faster with less loss of metal than a circular saw. Write for circular. Roy H. Clark, Olean, N. Y.

FOR bargains in Screw-Cutting Engine Lathes, write South Bend Lathe Works, 627 E. Madison St., South Bend, Ind.

BARGAIN Demonstrator Parks. Wood Worker, complete. Box 231, Astoria, Ill.

TEN Lincoln milling machines with vise \$50.00 each. Lucas & Son, Bridgeport, Conn.

FOR Sale—Woodworking Machinery for complete Automobile Body Plant in excellent condition. Practically new. A bargain. A. G. Belda, 2636 S. Michigan Ave., Chicago.

PULLEYS, Gears, Sprockets, Shafting, Hangers; see page 148. W. A. Jones Foundry & Machine Co., Chicago.

BELTING—all kinds—rebuilt and new. Everything in Belt Power Transmission. F. Ransville Co., Grand Rapids, Mich.

VACUUM Pumps and Cleaners, all sizes, complete outfits. Thurman Vacuum Cleaner Co., Manufacturers, Dept. O, St. Louis, U. S. A.

FOR Sale—All sizes new and second-hand Pulleys, Belting, Shafting, Hangers, Couplings, Pillow Blocks, Collars, etc. Passman Bros., 28 and 30 So. Green Street, Chicago, Ill.

HAVE for sale several sizes of lathes, milling machines, drill presses, punch presses, shapers, planers, boilers, steam engines, oil, gas and gasoline engines and wood-working machinery. Plimmer, 122 Water St., New York, N. Y.

ENGINE Lathes, swings 9½ in., takes 2½ in. between centers, complete set gears cutting all size threads 3 in. to 46 in., \$42.50. Grammes & Sons, Allentown, Pa.

JUST Published—Popular Mechanics Shop Notes for 1915—626 Easy Ways to do Hard Things. This is Vol. XI and is similar in style to the other numbers in the series. 224 pages, 517 illustrations. Paper 50 cents. Cloth, \$1, postpaid. Popular Mechanics Book Dept., 6 N. Michigan Ave., Chicago.

ENGINES, MOTORS AND DYNAMOS

ALTERNATING and direct current motors guaranteed for one year. Westinghouse, General Electric, Wagner, Emerson at exceptionally low prices. Satisfaction guaranteed or money refunded. Fan bargains. Send for electrical supply bargain list. Hyre Electric Company, 613K So. Dearborn St., Chicago.

LOT small A. C. Motors—guaranteed new automatic start—1/6 H.P., \$14; ¼ H.P., \$18.50; ½ H.P., \$25—other sizes—all have sliding base. Johnston, Evans Ave., Ingram, Pa.

FOR Sale—32 H. P. Pi. Huron traction engine, double cylinder, 42 in. belt wheel, rigged for plowing and practically new. Would be excellent for portable sawmill. Wm. G. Gage, Owner, Saginaw, Mich.

NEW two-cylinder Marine engine, 13-15, high speed. A dandy; cheap. F. O. Cleland, Carlisle, Pa.

10-HORSE motor for sale. 500 V. D. G., \$100. Fine condition. George Starkweather, Helmetta, N. J.

FOR Sale. Kibridge engine, 27 hp., 3-cylinder, 2-cycle (almost outfit), complete outfit. Stubbs, 818 Granite Building, Rochester, N. Y.

FOR Sale—Small Universal Motor suitable for driving a sewing machine or small buffer. Price, \$5. C. F. Smisor, 4808 Lake Park Ave., Chicago.

FOR Sale—Reversible rowboat motor, first-class condition, with magnets. Will sell cheap. X Y Z, 78 E. Madison St., 9th floor, Chicago.

FOR Sale—20-H.P. White Steam Engine and Generator complete, \$75; 4½-H.P. Locomobile steam engine, \$10; 6-cylinder gasoline engine complete, with Spalding magnets, \$85. 1423 North Ave., Bridgeport, Conn.

STORAGE consignment fans and hat cleaners—all sizes—A. C. and D. C.—9-inch fan—\$0.50; hat cleaners, \$12.50—other sizes—less than half price. Johnston, Evans Ave., Ingram, Pa.

6-H. P. GRAY Engine, almost new, model J, \$93. C. E. Feerch, Clinton, Conn.

JARGER Two-Cylinder Gasoline Engine with magneto, etc. Direct connected to Holtzer-Cabot Generator, 6 K. W., 110 V. (Good as new.) Newark Second Hand Machy. Co., 105 Chestnut Street, Newark, N. J.

SELL 60 H.P. Ohio Stationary Gasoline Engine. Single cylinder, fine order, \$750.00. F. O. B. Boston, Stainforth, Wintthrop, Mass.

FOR Sale—2½ H. P. Horizontal Single Cylinder Air-Cooled Gasoline Engine. Weight 600 lb. New. \$60 cash. Myron C. Kline, Warren, Pa.

FOR Sale—15 hp, 2-cylinder Nash gasoline engine, magneto \$225.00, excellent condition. Lucas & Son, Bridgeport, Conn.

KERMATH—12 hp., 4-cycle, 4-cylinder marine engine, factory overhauled, guaranteed first-class condition in every way, with magneto and carburetor, complete, \$165. Kermath Mfg. Co., Detroit.

FOR Sale—Second-hand 1912 Sterling Engine, 18-25, 4-cylinder, fully equipped, first-class condition. Stubbs, 818 Granite Bldg., Rochester, N. Y.

REBUILT Engines—We have on hand a number of rebuilt "Buffalo" engines, guaranteed, at greatly reduced prices. Write for bargain list. Buffalo Gasoline Motor Co., 1293-1305 Niagara Street, Buffalo, N. Y.

JUST Issued—Amateur Mechanics No. 6. Another great book of 293 articles for those who like to make things. Similar in style to the other numbers in the series. 128 pages, 261 illustrations, paper. Price 25 cents postpaid. Popular Mechanics Book Dept., 6 N. Michigan Ave., Chicago.

ENGINE CASTINGS AND BLUE PRINTS

GASOLINE Engine Castings, with drawings. Cheap. Catalog for stamp. Novelty Manufacturing Co., 853 West 6th St., Cincinnati, Ohio.

NEW marine engines, 10 H.P., \$65. Engine castings for sale. Richards Iron Works, Manitowoc, Wis.

BOATS, LAUNCHES, ACCESSORIES

PALMER Motors and Launches, two to fifty horsepower, two and four cycle. Get our 1915 reduced prices. Catalog free. Palmer Bros., Cos Cob, Conn.

FOR Sale—Semi-speed launch, 27 ft. by 4 ft. 6 in. Trebert, 40 hp., fully equipped, splendid condition, speed twenty-two miles. Stubbs, 818 Granite Bldg., Rochester, N. Y.

MOTORCRAFT Encyclopedia—A 150-page book that tells 1001 things every motor boatman should know. How to overcome engine troubles. Price \$1, postpaid. Popular Mechanics Book Dept., 6 N. Michigan Ave., Chicago.

FOR THE SHOP

FOR That Boy—He will appreciate a copy of the great boy's book "The Boy Mechanic" that tells about 709 different things for boys to do and has 800 pictures. 480 (7x10) pages, cloth, big, handsome book for the price, \$1.50 postpaid. Popular Mechanics Book Dept., 6 N. Michigan Ave., Chicago.

BLACKSMITHS

BLACKSMITHS, get out of the rut; be progressive. Get Toy's modern methods of doing hard jobs easy. Make solid welds. Temper all tools to a standard with Toy's Colored Tempering Charts. Do the job the other smith can't do. All for \$1. Send for free samples. W. M. Toy, Sidney, Ohio.

SHOP Notes—Many valuable hints for blacksmiths are contained in our series of Shop Notes books. 10 volumes, 50c each, postpaid, or \$5 per set prepaid. Popular Mechanics Book Dept., 6 N. Michigan Ave., Chicago.

CEMENT

FOUR pounds guaranteed Rubberlike, Elastic, Stickite Boat and Roof-Leak Putty, Mailed for \$1.50. Insulstine, One Broadway, New York.

CONCRETE Building Block Machines and molds. Free catalogue. 3 Market St., St. Louis, Mo.

IF you want the best information on cement and concrete construction, subscribe for Concrete-Cement Age, leading cement and concrete monthly. Sample copy, 10 cents. Yearly subscription, \$1.50. Concrete-Cement Age, 135 Newberry Bldg., Detroit, Mich.

ELECTRICAL

"AMATEUR Electrician." Make Batteries, Dynamos, Motors, Electric Engine, Telephone, etc. 75 illustrations, 19c. Renew Dry Batteries, 3 guaranteed processes, 20c. Both, 25c. Novelty Shop, 3311-F, Belleplaine Ave., Chicago.

STAMP COLLECTING

25 DIFFERENT British Colonials to applicants for stamps on approval who send 2c postage. Nickles, 122 Florida Ave., Washington, D. C.

FREE packet to applicants for approval selections. Leon Cass, Quakertown, Pa.

10 FOREIGN coins 15c, 10 from Warring Nations 25c, 200 different stamps 15c. Burgess Co., 322H, Beacon, Toledo, Ohio.

STAMPS Free! 50 different, including unused Russian War Charity Stamp. Mention gift F91. Send 4c postage. Bright & Son, 164 Strand, London, England.

LOOKING for Good Stamps cheap? Then try my Net Priced Selections. Roberts Scyces, Quakertown, Pa.

500 OLD mixed U. S. Stamps 10c, 65 Varieties 10c. Charles Peugh, Elma, Wash.

5 DUTCH Indies free to approval applicants. Riverview Stamp Company, Kankakee, Illinois.

STAMPS sent on approval at 70% discount. Reference required. Procrustes at 1/2c each. Emory Renold, Hanover, Penna.

FOREIGN Stamps Free; 52 different foreign, including China and Venezuela, to all who apply for our high grade approval selections. Send two cent stamp for return postage. Edgewood Stamp Co., Dept. H, Milford, Conn.

FREE. Choose one. 50 Sweden, 50 Norway-Denmark, 101 United States, 205 foreign, 60 Japanese, 50 Asiatic. Remit 25c six months' subscription McKee's Stamp Weekly, Boston, Mass.

STAMPS—145 China, etc., stamp dictionary and list, 2c. Ballard, Sta. A, Boston.

STAMPS, 1,000 mixed, 15c. 500 different Foreign, 60c. Western Stamp Co., Omaha, Nebr.

STAMP Album with 538 Genuine Stamps, incl. Old Mexico, Malay (tiger), China (dragon), Tasmania (landscape), Jamaica (waterfalls), etc., 10c. 100 diff. Jap. N. Zid., etc., 5c. Big List, Coupons, etc., Free! We Buy Stamps. Hussman Stamp Co., St. Louis, Mo.

1,000 OLD U. S. stamps and 200 different foreign stamps, 25c. F. L. Toupal Co., Chicago Heights, Ill.

STAMPS, 100, all different, free. Postage 2c. Mention paper. Quaker Stamp Co., Toledo, Ohio.

24 VARIETIES Cuban stamps, 10 cents. List of 6,000 low-priced stamps free. Chambers Stamp Co., 111 P. Nassau St., New York City.

PACKET of 23 stamps; no two countries alike, 500 hinges. Set of \$1 and \$2 U. S. Rev., all for 5c. Mention paper. Miami Stamp Co., Toledo, Ohio.

RARE COINS

1913 BUFFALO Nickels; 25c each paid for them and Lincoln pennies, certain kinds. I pay as high prices for old coins as any dealer in the United States. Send 10c for 1913 Coin Book, giving prices paid for Buffalo Nickels, Lincoln pennies, and hundreds of other old coins. Means \$ to you. Jones, Coin Dealer, Dept. 138, Newton, Ill.

OLD Coins Bought and Sold. Spring catalogue list of coins for sale, free to collectors only. Buying catalogue quoting prices I pay for coins, 10 cents. Wm. Hesslein, 101 Tremont St., Boston, Mass.

COINS—10c each—Jackson Cents, Civil War, Flying Eagle, Large United States, 5 Foreign, 1799 Dollar \$3.25. Coin Book, 15c. Moore Coin Company, Commerce, Texas.

\$50.00 PAID for Dollar 1873 S. Mint; \$2.00 for 1904 Dollar, proof; \$7.00 for 1833 quarter, no arrows, etc. Many valuable coins in circulation. Watch your change. Look up your old money; you may have or get coins of premium value. Don't let a valuable coin slip away from you. Get Posted. Send only 4c. Get our Large Illustrated Coin Circular. It may mean large profits to you. You certainly have nothing to lose. Send Now to Numismatic Bank, Dept. H, Fort Worth, Texas.

10 DIFFERENT old bank notes and catalogue, 25c. F. L. Toupal Co., Chicago Heights, Ill.

TEN different coins from warring nations, 25c. Leo Macdonough, Toledo, Ohio.

\$4.25 EACH Paid for U. S. Flying Eagle Cents dated 1856. We pay cash premiums on hundreds of Old Coins. Send ten cents at once for New Illustrated Coin Value Book 4x7. It may mean your fortune. Clarke & Co., Coin Dealers, Box 15, Le Roy, N. Y.

SAFETY BLADES SHARPENED

SAFETY Razor Blades Honed, stropped, sterilized. 2c each. Stamps accepted. Toledo Sharpening Co., Toledo, O.

ALL makes Honed, Stropped, Sterilized. Keen edge guaranteed. 30c dozen. Established eight years. Koenig Company, Dept. K, Chicago.

SAFETY razors sharpened; two cents each. Guaranteed. Issue box free. Electro Stropping Co., 134 Shelby St., Detroit, Mich.

FOR THE HOME

BEAUTIFUL arts-crafts lamps—Anyone can make them out of paper, cardboard and wood. 16 designs. Inexpensive yet artistic. Complete book of instructions. Price, 50c postpaid. Popular Mechanics Book Dept., 6 N. Michigan Ave., Chicago.

ARTISTIC Lamps and Shades in metal and art glass easily made by the amateur craftsman from instructions given in our book of 18 designs ranging from ordinary reading lamps to pretentious chandeliers. Expense only slight. Price of book 50c postpaid. Popular Mechanics Book Dept., 6 N. Michigan Ave., Chicago.

INVALID FURNITURE

ROLLING Chairs. We make 70 styles. Carrying Chairs, Invalids' Lifts, Beds, Tables, Bed Trays, Back Rests, Commodes, etc. Catalog "B" illustrates—describes free. Send for it. Geo. F. Sargent Co., 244 Fourth Ave., New York.

PIANOS AND MUSICAL INSTRUMENTS

OWN an Arionola Talking Machine. Price with jewel point, \$15. The Arionola is the wonder of the age. It is equipped with a jewel point and will play Edison, Victor, Columbia or any other make of disc records. Its quality of tone and clearness of enunciation has surprised thousands. It is built on scientific principles—no muffled or metallic sounds so commonly heard in other makes. This remarkable machine has all the advantages of the very expensive makes and yet sells for so small a price that anyone can afford one. It is handsomely finished in mahogany, with all metal parts highly nickel plated. You will be proud of it even on the most fastidious occasions. The motor has a strong double spring and will actually play from 2 to 3 records on one winding. It is constructed so lightly that you can easily carry it about the house, out onto the porch, the lawn, your boat or to your summer resort. You cannot afford to be without it even if you now have a phonograph. Send \$15 today and get one of these wonderful machines. Guaranteed for one year, same as any \$250 machine. If not exactly as represented, money refunded. Can you beat it? Lloyd & Weaver—Distributors, 1310-14 E. Jackson Blvd., Chicago, Ill.

MUSIC

TALKING Machine Records. Edison Standard, 5c; Blue Amberol, 25c; Victor, 15c; Permanent Jewel Needle, \$1; Jewel Point Attachment for Victrola or Grafonola to play Edison disc-records, \$2. Wells' Curiosity Shop, 20 S. 2nd St., Philada.

SONG Writers; inside tips? Stamp. L. Berton Wilson, San Diego, Calif.

BUSINESS SERVICE

INCORPORATE in South Dakota. Write us at capital. Western Charter Co., Pierre, South Dakota.

INCORPORATE. Our lawyers do the work, saving you time, annoyance and money in incorporating under the most liberal laws of Arizona. Laws and forms free. Southwestern Securities & Investment Co., Box 1488, Phoenix, Ariz.

ESTIMATING and Contracting by Radford—A 900-page manual of up-to-date methods for rapid, systematic and accurate calculation of costs of all types and details of building construction, with quotations of ordinary prices for labor and materials, standard schedules and forms, labor-saving tables and other data useful to the building trades. Flexible leather illustrated—\$2 per copy postpaid. Popular Mechanics Book Dept., 6 N. Michigan Ave., Chicago.

FORMULAS AND TRADE SECRETS

1,650 FORMULAS 40c, resilver mirrors. Tattoo remover. Renew Dry Batteries. Make Printing Cuts 20c each. All 50c prepaid. Formula Bureau, 3311-F Belleplaine Ave., Chicago.

MAKE your own raisin wine. Easily prepared in a jar right in your own home by anyone. Costs only 8 cents per bottle. Absolutely no fake. Your money refunded if not satisfied with results. Complete detailed instructions, only fifty cents. Send your order now. Julius Godin, Ewart, Manitoba, Canada.

20,000 FORMULAS—Price \$1, postpaid; complete list 4c stamps. Edm. Bromley, Watervliet, N. Y.

A HIGH grade, guaranteed formula for almost any occasion. Prices reasonable. Correspondence confidential. Cole Chemical Company, Chicago.

10,000 SELECTED scientific, chemical technological, and practical recipes and processes, including hundreds of so-called trade secrets for every business, alphabetically arranged in one large volume of 800 pages. Price \$3 prepaid. Popular Mechanics Book Dept., 6 N. Michigan Ave., Chicago.

GAMES AND ENTERTAINMENTS

NEW Magic Tricks! Just out! Cut prices! Lowest on earth! Rising Lady Secret and Great Bargain Catalogue free. Eagle Magical Company, Minneapolis, Minn.

BOYS: Here is your chance. Big money selling our latest flying toy. Retail for 15c. Send 50c in coin for six. Every boy wants one. Racine Metal Specialty Company, Box 235, Racine, Wisconsin.

NEW Bargain Sheet Rare Magic Ready. Send stamp. Fake Money. Our own design. Very excellent. Wholesale and retail. Sample roll 10c. Gilmore, Morgan Park, Chicago.

FREE catalogue tricks, puzzles, novelties, magic goods. Harrie Thornton, New Church, Va.

TRICKS, Puzzles, Jokes, Magic Goods, Ventriloquist Figures, Sensational Escapes and Illusions. Big catalogue free. Oaks Magic Co., Dept. 197, Oshkosh, Wis.

MAGIC Money Box with 4 catalogues, tricks, puzzles, jokes, 10c. Jokin, 1193 Broadway, New York.

MAGICIANS' tricks, Handcuffs, Escapes, Ventriloquist and Punch figures. Prices low. Catalog free. Sample trick, 2c. Magic Parlors, 192 Clifford, Providence, R. I.

P-L-A-Y-S, Speakers, Dialogues, Drills, Joke Books, Wigs and Beards. Catalogue free. Ames Publishing Co., Dept. 40, Clyde, Ohio.

BE a handcuff king. We teach you. Escape from handcuffs, boxes, ropes, etc. Secrets of 20 sensational escapes \$1. Particulars free. The Magcraft Co., Dept. A, Box 251, Detroit, Mich.

MAGIC Catalogue, 100 pages, greatest on earth, ten cents. Learn magic at home. We teach you to do these tricks as good as the great professionals—escape acts, rope ties, mind reading, handcuff secrets. Satisfaction guaranteed. Chicago Magic Co., Dept. B, 72 W. Adams St., Chicago, Ill.

MAILING LISTS

SOUTHERN Rural Names. New and Correct. Alphabetically Arranged. Guaranteed. \$2.50 per thousand. TTY My Lists Quick. E. C. Everly, Island, Ky.

100 HIGH grade agents' names, \$1.00; also Farmers, etc. Thomas Co., Kennett Square, Pa.

5,000 NAMES Oregon Farmers, \$1.50 per thousand, cash advance. C. E. B., Lock Box 2063, Portland, Oregon.

ADDRESSES of ladies recently purchasing through mails, \$1.50 per M. Sample 100, 20c. S. Todd, Mgr., Jacob Ave., Louisville, Ky.

FREE to business men, copy of our comprehensive "Silent Salesman." Contains over 2,000 different classifications of Mailing lists with number and price of each list, and information every business man needs. Accept this free offer. Trade Circular Addressing Co., G 164½ W. Adams, Chicago.

TYPEWRITERS AND SUPPLIES

TYPEWRITERS, all makes, factory-rebuilt by famous "Young Process." Look like new, wear like new, guaranteed like new. Our big business insure "Square Deal" and permits lowest cash prices—\$10 and up. Also, machines rented—or sold on time. No matter what your needs are, we can best serve you. Write and see—now. Young Typewriter Company, Dept. 167, Chicago.

TYPEWRITER, good as new, \$15.00. Adams, 108 S. 15th St., N. C. Kan.

REMINGTONS \$10 and \$12. Other bargains. Mdse Co., Bellevue, O.

TYPEWRITER Ribbons renewed. Material, instructions, 10c. Guaranteed. Henry, Roberts, Calif.

GOOD, serviceable typewriters \$7.50 and up. Post card brings list. First class ribbons any machine, 25c. Hub Typewriter Co., 286 Devonshire St., Boston.

LARGEST Stock of Typewriters in America—All makes: Underwoods, Oliviers, Remingtons, etc., one-fourth to one-half manufacturers' prices, \$15 up, rented anywhere, applying rent on price; free trial; installment payments if desired. Write for catalogue L. Typewriter Emporium (Estab. 1892), 34-56 West Lake Street, Chicago, Illinois.

TYPEWRITERS—Rare bargains from \$3 to \$50; all guaranteed; shipped with privilege of 15 days' free trial; get our proposition before purchasing a writing machine. We can save you dollars. Coast Typewriter Exchange, Atlantic City, N. J.

PRINTING, ENGRAVING AND MULTIGRAPHING

250 BOND Letterheads and 250 Envelopes, printed, \$1.65, prepaid. Samples, W. Kinnler, Box 208, Brooklyn, N. Y.

1,000 LHS. new job type 25c per lb. Lucas & Son, Bridgeport, Conn.

MULTIGRAPHING, 100-50c. Additional hundreds, 10c. Higene's, 2441-S Post, San Francisco.

INCREASE your business through colored gummed labels attached to packages, boxes, etc. Book of 149 suggestions free. G. Edward Harrison, "Printing," Baltimore, Maryland.

500 BUSINESS Cards \$1.25. 125 Bond Letterheads and 125 Envelopes 75c. Wolverine Press, 37 Harrison, Detroit, Mich.

1,000 EXCELLENT Bond envelopes or letterheads, printed \$2.50. 500—\$1.50. Murphy Printery, Morristown, Tenn.

50 CALLING Cards 10c. 25 Envelopes 10c. F. Shepard, Rome, N. Y.

250 LETTERHEADS, 2 colors, \$2.50. Envelopes, good stock, \$1.50. Quality Ptg. Co., St. Paul, Minn.

ENVELOPES, Noteheads, Billheads, \$1.50 per 1,000. 6x9 Circulars, \$2.25. Samples free. Jukes, 129 Fifth, Philadelphia.

"ARISTOCRAT," fine business stationery. Letterheads—1,000, \$2.50; 5,000, \$8.75; 10,000, \$16.50. Sample portfolio free. L. S. Frank Adv. Mfg. Co., 720 Locust Street, St. Louis.

500—6x9 WHITE Wove Envelopes, 90c; 500—20-lb. bond letterheads, \$1.50. C. F. Funk, 6104 Hoeweler St., Pittsburgh, Pa.

1,000 BOND Letterheads, Envelopes, Cards, Circulars, \$1.75 up. Perfect imitation typewritten letters, \$3.50 complete. Quick Delivery. Get Samples, Franklin Press, Waukegan, Ill.

100 CARDS printed, two colors, forty cents prepaid. Maywoodian, Maywood, Ill.

150 BOND letterheads and envelopes, printed to order, \$1 postpaid. Essex Publishing Co., Lynn, Mass.

LITHOGRAPHED letterheads, 5,000 for \$13.75, 20 lb. Bond, high class workmanship, 5,000 printed letterheads, 20 lb. Bond, \$8.25, 5,000 printed 6x9 envelopes, \$8.25. Get samples. Southwestern Engraving Company, Fort Worth, Texas.

WEDDING Announcements or Invitations—100, \$3.50—50, \$2.50—25, \$2, including inside and outside envelopes. Perfection Specialty Co., 4437 Prairie Ave., Chicago.

GUMMED Labels, 3,000, \$1, 38pp. catalogue, 2c. MacFargart, 1235 Arch, Philadelphia, Pennsylvania.

1,000 IMITATION typewritten letters, heading black, body purple, bond paper, \$2.90. C. Funk, 6104 Hoeweler St., Pittsburgh, Pa.

1,000 LETTERHEADS, \$1. P. M. Orris, 209 E. 22nd St., New York.

100 LETTERHEADS (bond, watermarked) 100 Envelopes, 100 Cards, \$1.10, postpaid. Superior work. Printing Man, 226 So. 52d, Philadelphia.

PRINTING Outfits—Presses, type, supplies, type novelties. Send stamp for catalogue. Model Press, York, Penna.

250 EACH—Bond Letterheads and envelopes, \$1.30; 100, 80c. Hoyt Bros., Pittsfield, N. H.

PRINTING—500 either noteheads, envelopes, statements, cards, \$1; 1,000, \$1.50; 1,000 linen finish letterheads or envelopes, \$2.50; 1,000 typewriter letters, \$2. Samples. Model Company, Manchester, Iowa.

125 WHITE Bond Letterheads and 125 Envelopes, printed, \$1, prepaid. R. Lutz Printing Co., York, Pa.

PREPAID, 200 gummed labels 10c; 1,000 circulars 3x6, 85c; 500 bond letterheads and envelopes \$2.85. The Majestic Printing Co., 2044 Leeward Ave., Los Angeles, Calif.

ADVERTISERS—Here's your opportunity. 25 word classified ad inserted in "Cartoons Magazine" for 50c; one inch display ad \$1.25, 30,000 copies guaranteed. Send in your ad for the next issue. Cartoons Classified Dept., 78 E. Madison St., Chicago.

PRINTING Presses, Type and Supplies. Big bargain sheet for stamp. Popular Bargain, Highland, Pa.

GOOD Printing at low prices. 1,000 good letterheads, envelopes, cards, billheads, labels, circulars, \$2.50. Samples free. Catalogues, booklets, and circulars our specialty. Ernest L. Fantus Co., 323 S. Dearborn St., Chicago.

PATENT ATTORNEYS

PATENT your invention. \$10,000 offered for inventions wanted. Booklet and opinion free. Milo B. Stevens & Co., Established 1864, 685 F St., Washington; 353 Monadnock Block, Chicago.

FREE advice given on U. S. and foreign patents. High grade inventions only. We serve inventor's interests and sell patents obtained by us on commission. No humbug; send for booklet. International Bureau of Patents, Inc., 14 Park Row, New York.

PATENTS—Edward Bruce Moore, Former Commissioner of Patents. Patents, Trademarks and copyrights. Sole office Barrister Bldg., Washington, D. C. See advertisement, page 120, this issue.

PATENTS—Trade-Marks. Attorney's fee payable when application granted. Reliable service for reliable people. Money-saving patent advice free; correspondence solicited. Jaynes & Jaynes, 655 Kellogg, Washington, D. C.

"A PATENT." Can you tell me how to secure a patent? What will it cost?—M. F. C., Englewood. If you wish to file an application for a patent, it is advisable to employ the service of a reliable patent attorney, as the value of patents depends largely on the skillful preparation of the specifications and claims. The cost is \$65 or more, according to the case. If you write to Allen & Baggett, Patent Attorneys, 950 Old South Building, Boston, Mass., they will send you full particulars.

PATENTS that protect and pay. Advice and books free. Rates reasonable—highest references; best results. Watson E. Coleman, Patent Lawyer, 624 F St., N. W., Washington, D. C.

PATENTS—Books, 100 mechanical movements and full information free. Expert service. Best terms. Write today. Fred G. Dieterich & Co., patent lawyers, 600 Ouray Bldg., Washington, D. C.

PATENTS Secured through Credit System. Send sketch. Free search. Booklet free. John Louis Waters & Co., Wash., D. C.

EQUITABLE Plan enables you to file application for patent at moderate cost. Particulars on request. Geo. R. Hamlin, 850 H Street, N. W., Washington, D. C.

PATENTS \$50.50, payable by easy installments. Wm. C. Dashiell, 800 H St., Washington, D. C.

THE Patents is free. An education in obtaining patents. Established 1803. Anderson & Son, Attorneys, 707 7th St., Washington, D. C.

"**PATENTS** and Patent Possibilities" is a 72-page treatise which tells all about patents, what to invent and where to sell it. It gives honest advice to inventors, and is full of valuable and interesting information. Write for it today! It is free. H. S. Hill, 905 McLachlin Bldg., Washington, D. C.

PATENT what you invent. It may be valuable. Write me. No attorney's fee until patent is allowed. Estab. 1882. "Inventor's Guide" free. Franklin H. Hough, 323 Loan & Trust Bldg., Washington, D. C.

PATENTS—Herbert Jenner, patent attorney and mechanical expert, 606 F St., Washington, D. C. I report free of charge if a patent can be had and its exact cost. Send for circular.

C. I. PARKER, Ex-member Examining Corps Patent Office, Patent Attorney, 910 G St., Washington, D. C. Inventor's handbook, "Protecting, Exploiting and Selling Inventions," sent free upon request.

PATENTS build fortunes for you. Our free booklets tell how; what to invent, how to choose an attorney. Write today. D. Swift, 317 Seventh St., Washington, D. C. Established 1889.

WANTED—New Ideas. Write for List of Inventions Wanted. \$1,000,000 in prizes offered for inventions. Our Four Books sent free upon request. Victor J. Evans & Co., 155 Ninth St., Washington, D. C.

PATENTS explained in my free books, telling what you should know—what to invent—what not to invent—how to sell your patent, etc. Write today. H. L. Woodward, 992 G St., Washington, D. C.

PATENTS That Pay. Proof given. Two wonderful guide books free. E. E. Yrooman & Co., 871 F St., Washington, D. C.

PATENTS—Send sketch for free search and report. Books on patents and book of reference letters sent free. John S. Duffie & Co., 610 F Street, Washington, D. C.

PATENTS—Trade-Marks. Send for my free book "How To Get Them." It's full of information you should know. Joshua R. H. Post, 8 Dearborn St., Chicago; 929 Chestnut St., Philadelphia; 895 G St., Washington.

PATENTABLE Ideas Wanted—Send for 3 free books. R. B. Owen, 30 Owen Bldg., Wash., D. C.

PATENTS secured or fee returned. Send sketch for free search. Latest and most complete patent book ever published for free distribution. George P. Kimmel, attorney, 212 Barrister Building, Washington, D. C.

C. W. GERARD, formerly Patent Office Examiner, Scarritt Building, Kansas City, Mo.

No Attorney fees until patent allowed. Send sketch for free report. Books free. Frank Fuller, Washington, D. C.

PROTECTIVE patents procured promptly. 112 page blue book on patents sent on request. Trade-marks registered. Rohb & Hobb, 211-215 Southern Bldg., Washington, D. C.

PATENTS Secured—Take advantage of my personal experience; send sketch or model. Get my free book containing 200 mechanical movements. W. N. Roach, Jr., 950 McGill Bldg., Washington, D. C.

FOR INVENTORS

\$6,000 FOR an Idea—Chance for inventors. Address Patent News, Department 73, Washington, D. C.

COMPLETE list of all reliable manufacturers who may be interested in your invention. Sent for 50c. No stamps. Absolutely honest. L. A. Hummel, Waterbury, Conn.

INVENTORS! Send to postage for Handsome Book on Patents and List of Inventions Wanted, Sanders, 7 Webster Building, Chicago.

INVENTIVE ideas that have never been tried or thought of. Clear, concise description. Send stamped envelope for inquiry. Ivan Dabney, 45 E. 133d St., New York, N. Y.

PATENT Application fully prepared, \$10. Why pay more? Particulars free. Patent News, Dept. 72, Washington, D. C.

INVENTIONS Wanted. Cash or royalty paid if available. Adam Fisher Mfg. Co., 1061, St. Louis, Mo.

MECHANICAL, engineer expert on manufacturing methods and designer of special machinery will develop your ideas and inventions into commercially practical form. Albert S. Kux, 105 W. Monroe St., Chicago.

WE desire to purchase meritorious patents or ideas for household or office specialties, either for cash or a royalty basis. Marshall Dobbins & Company, 1423 Marquette Bldg., Chicago, Ill.

INVENTORS: We develop and perfect inventions, make models, dies, tools. Metal stampings and special manufacturing. Gerding Bros., Cincinnati, Ohio.

PATENTS, Trade-Marks and Copyrights. Our handbook on patents will be sent free on request. All patents secured through us are described without cost to the patentee in the Scientific American. Munn & Co., Patent Attorneys, 672 Woolworth Bldg., N. Y. Washington, D. C., office, 625 F St.

WIRE goods all kinds made to order. Cooley, 553 W. Monroe, Chicago.

PATENTS and Patentable Ideas sold on commission. Best location and facilities. Absolutely reliable. Fuller Company, 300 Fifth Ave., New York.

INVENTORS: My patent made a fortune. Particulars free. Let me sell yours. Eugene Pearl, 323 Union Square, New York.

HAVE you a Patent to sell? You'll be interested in my proposition. Write now for free particulars. F. W. Johnson, 6 N. Michigan Ave., Chicago.

IDEAS, Patents, Inventions, developed and perfected. Expert Model and Machinery Building. Scientific experimental work. Regal Model and Tool Works, 122 Clark St., Chicago.

HAVE You an Idea? If so, you should protect it by a patent. Send us a model or sketch for free opinion as to patentability. Write for our Four Books sent free to any address. Victor J. Evans & Co., 157 Ninth St., Washington, D. C.

WANTED—An Idea! Who can think of some simple thing to patent? Protect your ideas; they may bring you wealth. Write for "Needed Inventions" and "How to Get Your Patent and Your Money." Randolph & Co., Patent Attorneys, 620 F St., Washington, D. C.

PATENTS without advance attorney's fees. Send sketch for free report. Books free. Frank Fuller, Washington, D. C.

PATENTS FOR SALE

PATENT 1,114,601—Valuable automobile tool for replacing valves, springs. Saves worry, time, trouble. Automobile owners, chauffeurs, see the merit of the tool. Can be cheaply manufactured. Louis Gerdes, 2032 Chancellor Street, Philadelphia, Pa.

"**POOL** Table pocket signaling device." Electric light shows instantly in what pocket ball entered, and stays light until ball is removed. Every light controlled by switch. Poolroom owners buy quickly. Manufactured cheaply. Fortune for buyer. Henry S. Jestead, Stanhope, Iowa.

PATENT on Non-Refillable Bottle, No. 1,133,225. For particulars inquire E. Metz, Universal City, Los Angeles County, Calif.

WILL sell entire rights on automatic stabilizer for aeroplanes; patent applied for. No gyroscopes or compressed air. Nature's law gravity used. Address, Aeroplane, Box 438, Sapulpa, Oklahoma.

BICYCLE Seat Supporter; new practical device. Outright or royalty. Laurens Krumpelmann, Lyons, Iowa.

FOR Sale—Valuable patent on glue forms and clamps; can be used for all kinds of laminated woodwork of any curve or radius. R. S. Orm, U. S. S. Connecticut, care Postmaster, New York City.

"**GAS** Broiler," very practical. Geo. W. Murray, 210 North South Carolina Ave., Atlantic City, N. J.

RAIL Joint and Chair. Eliminates bolts and nuts. Inexpensive and very practical. Good investment for some one. Make offer. Fred E. Hult, 319 Newland Ave., Jamestown, N. Y.

NO. 1,112,620, Automatic Door Holding Spring, \$200. Geo. Johnson, Pigeon Cove, Mass.

FOR Sale—Good Patent with Dies. Charles Eck, Hammond, Ind.

PATENT applied on combination air and spring mattress, broad claims, good for beds, lounges, shipboard, etc. One-piece mattress; just think how handy. Best offer takes it. Address S. Penka, Glen White, W. Va.

PATENT Bedspring Tightener. Good—cheap, Box 462, Rushville, Neb.

AUTOMATIC Siphon. Glass manufacturer's opportunity. To siphon cream off milk in bottle. Pat. allowed. J. L. Von Gohren, 4977 Baker Ave., Seattle, Wash.

AIR purifying and cooling device. Patent 1,199,171 for sale outright. Cheap to make and operate. Carl P. Lundberg, 36 Willow St., Hartford, Conn.

PATENT Buyers are invited to address our sales department for information on any class of Patents they wish to purchase or lease on a royalty. We have secured a number of valuable patents in all lines of invention. Mail Order, Department Store and Household Novelties a specialty. Victor J. Evans & Co., 169 Ninth St., Washington, D. C.

PATENTABLE Ideas wanted—Send for 3 free books. R. B. Owen, 30 Owen Bldg., Washington, D. C.

CONSULTING ENGINEERS

CONSULTING Engineer—A. M. American Institute Electrical Engineers. Practical advice. Ideas, Inventions perfected. Maximilian M. Well, 2 Rector, New York.

MODELS AND MODEL SUPPLIES

METALS and metal parts of brass, bronze, copper, zinc, iron, steel, German silver, aluminum, etc., in sheets, tubes, wire, and rods cut to size. Minimum order ten cents. Cut Metal Supply Co., 435 Marion St., Brooklyn, N. Y.

PRODUCERS of Results: Inventions developed, Models, Experimental work, anything special in metal to order, novelties, spinning, forging, castings in any material. Electrical Devices, patterns of all kinds, plating, general manufacturing, designing, special tools, punches and dies, stampings. Send drawings or sample. Expert information free. John's Machine & Stamping Works, Dept. C, Cleveland, Ohio.

MODEL making. Inventions developed. Write for estimate. Stearns, Paxton, Ill.

INVENTORS: We manufacture metal articles of all kinds to order. Also, special machinery, tools and dies, punchings, lathes and screw machine work, metal spinning, castings, plating, wood and metal patterns, etc. Send sample for estimate and expert advice, free. The Eagle Mfg. Co., Dept. B., Cincinnati, O.

WE develop and perfect working models for inventors. Light machinery building, scientific experiment work. Dies made and stamping done. Modern Die & Tool Company, 70 Ship St., Providence, R. I.

PATTERN makers! A book devoted to the principles of pattern and core making and molding. Written by G. H. Willard, a practical pattern maker of years' experience. This book, just published, treats the subject in a much more simple, direct and effective manner than most books along this line. 224 pages, 312 illustrations. Price, \$1, postpaid. Popular Mechanics Book Dept., 6 N. Michigan Ave., Chicago.

NEW Lithographic Model of a Monster Mallet Compound Locomotive. All parts shown and numbered. Size 9x19 in. in color. Other models in series are, Atlantic Type Locomotive—Steamship—Automobile—Gas Engine—Steam Engine—Steam Turbine—Dynamo—Wireless Telegraph. Price, 50c each or set of 9 for \$4 prepaid. Popular Mechanics Book Dept., 6 N. Michigan Ave., Chicago.

ELECTRICAL and mechanical inventions developed. Drawings, Models, Special and Automatic Machinery, Tools, Dies and Press work designed and manufactured. Commercial Engineering Co., 142 Market St., Newark, N. J.

MODELS, dies, and manufacturing for inventors, by builders of "Tools That Work." La Croix Tool Co., 214 N. 21st St., St. Louis, Mo.

MODELS made for inventors; general machine work; designing and perfecting; developing automatic devices and machinery. In a position to do all kinds of light tool and machine work. Prices reasonable; estimates cheerfully given. Ideal Machine Works, 62 Ann Street, New York City.

WE make working models for inventors; also dies and stamping of specialties, and carry a complete stock of brass gears and model supplies. Send for catalogue. The Pierce Model Works, 3445 Pierce Ave., Chicago, Ill.

FREE catalogue of model supplies. Castings, metal specialties on contract. North Chicago Tool Works, 15 Grove Ave., North Chicago, Ill.

SPECIAL Electrical and Mechanical devices built to order. Models, Tools, Dies. Benj. Levi, 357 West Broadway, N. Y. City.

MANUFACTURING

METAL Stampings, dies and tools. Special size washers, any metal, leather or fibre. Lock washers "Plain and Positive." "Rearwin" Emery Dresser Cutters. Quadrants Mfg. Co., 213-21 West Grand Ave., Chicago.

SPECIALTIES Manufactured. Tools, Dies, Models. Lyons Machine Works, Lyons, Iowa.

WIRE Goods, all kinds, made to order. Cooley Mfg. Co., 553 W. Monroe St., Chicago.

INVENTIONS perfected and manufactured. Reference your banker. Russell Machine Co., Dallas, Tex.

REAL ESTATE AND FARM LANDS

LAND of fruits, grains, pigs, chickens, cows—an irrigated garden spot: Salt River Valley, Arizona. Moderate cost—easy terms. Served by great Roosevelt Dam, government's gigantic project to make happy homes for thrifty people. Ten to twenty acres plenty for fine living and steady profits. Write for free folder, C. L. Seagraves, Gen. Colonization Agent, AT&SF Bldg., 1850 Ry. Exch., Chicago, or a letter to Chamber of Commerce, Phoenix, Arizona, will bring full information on any of these subjects.

LOTS in new seaport, Texas City, fastest growing city in Southwest. Millions being spent by Government and private interests on Harbor improvements, docks, warehouses, factories, mills. Real estate values increasing enormously. Lots splendid investment. Remarkably easy terms, only \$1 per lot cash, \$2 monthly. Price low as \$100. Only a few yet to sell. Closing out. Write for maps, plans and illustrated literature, C. A. Bryan & Co., Owners, 343 First National Bank Building, Houston, Texas.

MAKE MONEY—Buy choice lots in Beautiful City of Denver; only \$250; ten per cent cash, ten per cent per month. J. D. Whitmore, Denver, Colorado.

IMPROVED and unimproved farms; 80 acres and up; some real bargains. Write R. B. Crippen, Holbrook, Nebraska.

PROFITABLE little farms in valley of Virginia, 5 and 10 acre tracts, \$250 and up. Good fruit and farming country. Send for literature now, P. La Haume, Agr. Agt., N. & W. Bldg., 250 Arcade Bldg., Roanoke, Va.

SOUTHEASTERN Okla. Farming, pasture, oil lands and leases. \$3 to \$15 per acre, cash, J. E. Cavanagh, McAlester, Okla.

120 ACRES, 100 miles Chicago, \$80 acre. Indiana black soil. Arthur Chase, Bee Bldg., Omaha, Nebraska.

REAL Estate Educator—Containing inside information not generally known, "Do's" in Real Estate, "Pointers," Legal Forms, etc. It gives in condensed form the essential knowledge of the Real Estate Business. New revised edition covers Workmen's Compensation Act, Income Tax Law, Employers' Liability Act, Statute of Frauds, How to Sell Real Estate, etc. What you need to know; ought to know and want to know. 256 pages, cloth, \$1 postpaid. Popular Mechanics Book Dept., 6 N. Michigan Ave., Chicago.

I HAVE a successful way of selling farms and farm lands. Write me for free particulars. No obligation whatever. E. J. Zimmer, 925 Tower Bldg., Chicago.

SELL your property quickly for cash, no matter where located. Don't pay big commissions. Particulars free. Real Estate Salesman Co., Desk B, Lincoln, Nebr.

FARMS for sale or exchange anywhere in the U. S. or Canada, direct from the owners. State where you want to locate. Information free. American Investment Association, 37 Palace Bldg., Minneapolis, Minn.

GINSENG

MANY common weeds of great value. Send Thirty Cents for Treatise on Roots, Herbs and Barks. Collecting, Curing, Selling, and best American markets. L. J. Brown & Co., Muskegon, Mich.

GINSENG Culture, giving instruction for 10 cents. Roots and seed for planting. W. N. Long, Florence, Ky.

DOGS, BIRDS, POULTRY AND PETS

AIREDALES—Puppies and grown dogs. We also breed collies. Write for list. W. H. Watson, Box 130, Oakland, Ia.

THOROUGHbred Scotch Collie Pups for sale. Mrs. J. A. Seaman, Albion, Ia.

GOLDFISH—Rare specimens, suitable aquariums, snails, plants. Catalog free. Pioneer Goldfish Hatchery, Racine, Wis.

MISCELLANEOUS

FREE samples and prices of Starr's Mineral Putty Powder to manufacturers, contractors and dealers who use or sell putty and write on their printed letter sheet. All orders sample 10c. Starr, 1910 Monroe St., Toledo, Ohio.

20,000 FORMULAS, recipes, etc., 520 p. volume, alphabetically indexed, \$1 prepaid. Formula Bureau, 3311-P, Belleplaine Ave., Chicago.

BOYS and Girls—Vacation money earned by working one hour a day. Send 10c to cover cost of handling and postage and I will send free sample and full instructions. S. S. Holden, 631 Railway Exchange Bldg., Chicago.

SEND \$1 for sample of rough diamond and descriptive circular of diamond holders. Thomson Tool & Supply Co., Odd Fellow Bldg., Indianapolis, U. S. A.

WORKING Drawings of Art Lamps, 50c. Mission Furniture, \$1 and up. Also Mechanical Drawings made at reasonable rates. Address C. D. Kanouse, 216 Compton St., Brazil, Ind.

ENGINES, smallest manufactured; worn on the run from pocket by air. Complete \$2. Miniature Novelty Co., Cleveland, Ohio.

UNIQUE utensil. Combination egg separator, egg beater and cream whip. Tin plated. Post paid 25 cents. T. A. Burke, 203 S. Pearl St., Galesburg, Ill.

GREENBACKS—Bunch, 10c, 4—25c. Enterprise Co., M-3348, Lowe Ave., Chicago.

IF you want to find oil, invest in a Mansfield's oil finder. Absolutely reliable. Particulars from Edwin Mansfield & Co., New Brighton, Cheshire, England.

SECRET Writing System and pack Secret Compression Cards, 10c. G. Elissa, Owosso, Mich.

"ART of Cut-Making" (New). Guaranteed etching process for making Printing cuts cheaply at home and 150 Formulas, 20c. Formula Service, 3311-P, Belleplaine Ave., Chicago.

CHECK protector \$1.50. Circular free. C. Pancoast, Passaic, N. J.

SPEND summer gathering insects, butterflies. I pay big prices. Many worth \$5.00, \$10.00. All salable. Men, Women. Get instructions, price-list, pictures, descriptions of valuable ones. Send stamp. Sinclair, Box 244, D6, Los Angeles, Cal.

CUTS anybody can make. Simple Etching Process, \$1. Particulars, specimens, for stamp. M. Dag. Windfall, Ind.

HIG Mail Free. Your name listed once, 25,000 circulation and magazine one year 10c. Digest, Grand Rapids, Mich.

"VATUDRIP" absolutely prevents metal from rust. Sample, twenty cents postpaid. American Rust Proof Company, Harrisburg, Pa.

WAR Atlas—Large 20-page (11x15 in.) Atlas of the War in Europe, containing large colored scale maps of the battleground, showing Europe, Austria, Serbia, Germany, England, Belgium, France, Russia, Italy, Greece, The World, etc. Special data showing comparison of armies and Navies involved, pictures of rulers, etc. Price, 25 cents. Postage and packing, 5 cents additional. Address Popular Mechanics Book Dept., 6 N. Michigan Ave., Chicago.

TATTOOING—Machines, Colors and Supplies. Write now for my new catalogue. It's free. J. Barber, 70 Brush St., Detroit, Mich.

GRANDFATHER'S Clock Works, \$5. Slightly shop-worn, quantity limited, others with chimes, all prices; also several nice Grandfather's Clock cases, exceptional bargains. Clock Company, 1673 Ruffner St., Philadelphia, Pa.

RUBBER stamps, photo negative type, steel dies, metal badges, seals, stencils. Catalogue 10c. Buckeye Stamp Works, Market, Dayton, Ohio.

TOO LATE TO CLASSIFY

SURVEYING Instruments bought and sold. Good bargains in transits and levels. Sprengnether Instrument Co., 205 Ozark Bldg., St. Louis, Mo.

Who Can Use This Machine?

Here is a special typewriter offer that will appeal to shrewd buyers. You may choose this Underwood machine, or any other make you prefer, bar none—with complete equipment and latest improvements—and own it without red tape, on the easiest plan you ever heard of, at $\frac{1}{2}$ or $\frac{1}{3}$ manufacturers' prices. Write for particulars and see.

Each machine is relentlessly tested when completed, and guaranteed by our iron-bound guarantee that's all in your favor. You must be satisfied or no deal. Thousands of satisfied customers from coast to coast.

You can't go Wrong You take no Risk You can't Lose
YOUNG TYPEWRITER CO., Dept. 195, CHICAGO, ILL.



A FEW CENTS PER DAY; YOU'LL NEVER MISS IT

Write for Prices—Special Inducements, and the big illustrated book, "The Truth About Typewriters." Well worth reading. Send no money, just your name and address TODAY.

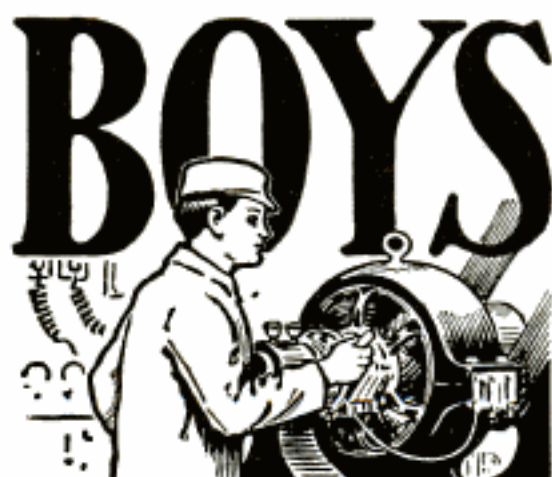

Big Money in Electricity

The electrical field affords a wonderful opportunity to boys with a liking for electrical work. The salaries paid are large—promotion rapid, and, best of all, the profession is not overcrowded.

The International Correspondence Schools of Scranton can make you an expert in the line of electrical work you like best. Hundreds of boys have already won success through I. C. S. help. You can do the same. Everything is made so clear that you can learn in your spare time, regardless of where you live or what you do. No books to buy. See your parents about it—they want you to succeed.

There's big money in electricity. Get after it by marking and mailing the attached coupon to-day. Finding out costs you nothing.

International Correspondence Schools
Box 872B, SCRANTON, PA.

Explain, without further obligation on my part, how I can qualify for the position before which I mark X

Automobile Running
Mine Superintendent
Mine Foreman
Plumbing, Steam Fitting
Concrete Construction
Civil Engineer
Textile Manufacturing
Stationary Engineer
Telephone Expert
Mechanical Engineer
Mechanical Draftsman
Architectural Draftsman
Electrical Engineer
Electric Lighting Supt.

Civil Service
Architect
Chemist
Languages
Commercial English
Building Contractor
Industrial Designing
Commercial Illustrating
Window Trimming
Show Card Writing
Advertising Man
Stenographer
Bookkeeper
Poultry Farming

Name _____

Present Occupation _____

Street and No. _____

City _____ State _____

Please Mention Popular Mechanics

The Most Important Boys' Book in Years THE BOY ELECTRICIAN

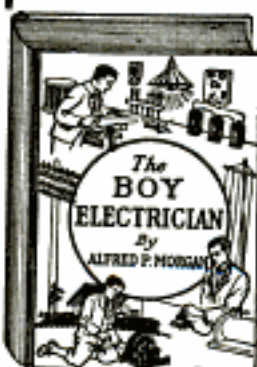

Practical Plans for Electrical Toys and Apparatus, with an Explanation of the Principles of Every-Day Electricity.

By **ALFRED P. MORGAN**

With full-page illustrations, and 324 working drawings and diagrams by the Author. 8vo. Cloth.

Price, Net, \$2.00 Postpaid, \$2.25

This is the most complete, the best illustrated, the most correct and the most entertaining work on the subject of electricity, its uses, and the economical making of home of practically all kinds of electrical appliances that has ever been produced. It also tells very clearly how electrical matters are handled on a large scale.

All all Booksellers. Send for Free Catalog.

LOTHROP, LEE & SHEPARD CO., BOSTON

"How to Install Electric Bells, Annunciators and Alarms" NOW READY



CONTENTS: The principles of an electric bell. Suitable batteries. Bells, gongs and buzzers. Various kinds of pushes. How to wire for bells. Wiring circuits. Faults in bells and wiring. How to locate and remedy faults. Thermostats. Annunciators and annunciator circuits. Low water alarms. Burglar alarms. Fire alarms. Circuits for alarms. Elevator bell wiring. Bell ringing transformers. Combination circuits. Fire alarm circuits. Clock alarm circuits. Three wire return call system. Interphone circuits.

Price, 55c postpaid

Spon & Chamberlain 123 P. M. Liberty St. NEW YORK, U. S. A.

FREE Send for large Catalogue of Practical Mechanical BOOKS FOR HOME STUDY

F. J. Drake & Co., Dept. 8, 1325 Michigan Ave., Chicago



HERE YOU ARE, BOYS

A medallion pin of Foxy Grandpa. Everyone will notice it on the lapel of your coat and try to get a closer look at it. All you have to do is press the bulb.—Foxy Grandpa will finish the job by squirting a fine stream of water over the inquisitive one. Will squirt 20 feet. Greatest joke out. Order one today and fool your friends. Price 15c. Foxy Grandpa and Hooligan both for 25c. 5 for 50c or 1 doz. for \$1.00. A beautiful fountain pen free with every \$1.00 order.

AMERICAN SUPPLY CO., 918 Union St., St. Paul, Minn.



Boy Craftsman

10c Tells how to make all kinds of Toys. New Book just printed. How to make Canoes, Railroad Model, Talking Machine, Telephones, Electric Motor, Bicycle Boat, Pocket Flashlight, and hundreds of other things. Fully Illustrated. Sent postpaid for 10c. 4 for 25c.

NATIONAL CO., 3422 Lyndale Ave., Dept. 38, CHICAGO

123 Place the 9 figures so the 2nd row is twice as much as top row and bottom row as much as top and 2nd row added together. All correct replies will receive 25 cents' worth of our iron puzzles with catalog postpaid. Answers not correct will receive solution. Catalog of 200 puzzles and one of our leading 15c. products. All answers to enclose 10c. in stamps or coin to cover mailing, packing, etc.

WESTERN PUZZLE WORKS, St. Paul, Minn.

THE IRON CROSS 10c
Latest War Novelty. All the rage. Fun for everybody. Wear one. Decorate your friends, at parties, etc. Dull finish as original. Nearly 3-inches in diameter. Order now. Price 10c, 4 for 35c, 12 for 60c, postpaid. Address nearest house.
ANTHONY LEPICK & CO., Dept. 70, KANSAS CITY, MO., or 141-145 West 36th St., NEW YORK CITY

\$2,500⁰⁰ a Year!

Name.....
Address.....

HAVE you the training that is necessary to fill a \$2,500 job? Are your services in demand? Salaries are paid to the man who knows. If you are ambitious to get into the big money class, send the coupon and find out about the opportunities in our profession. We need ambitious men and will give you the proper training right in your own home. Don't miss this wonderful offer. Send the free coupon today—do it right now.

Be a Signal Engineer | More Men Are Needed

Be the man who gets \$2,500 a year. Complete Signal Engineering is one of the most fascinating of professions. As a railroad man you travel from coast to coast. You are the man who tells the other fellow what to do. You can be the man who holds the big job.

Railroads are constantly looking for competent Signal Engineers. Thousands and thousands of miles of track are now being equipped with automatic signals. Many new positions will be open. Men are needed.

Two Big Outfits FREE We give each of our Signal Engineer's outfit and a draftsman's outfit—absolutely free.

Send the Coupon for Big New Book

Put your name and address on the coupon or a letter or a post card and get the big new Signal book absolutely free. No obligations. The book is free. Write today—Now.

Department of Signaling, 1810 Wilson Ave., Room A119, Ravenswood Sta., CHICAGO, ILL.

Department of Signaling,
1810 Wilson Ave., Room A119
Ravenswood Sta., Chicago

Gentlemen: Please send me absolutely free and prepaid your big new Signal book. It is distinctly understood that I assume no obligations of any kind.

TRADE SCHOOL COURSES

Machinist, Automobile Machinist, Chauffeur and Manual Training. Courses with little book study but much shop work

give just the practical training needed to qualify for good paying jobs. Save a year's time. Automobile, Machinist and Manual Training Courses, 48 weeks. Chauffeur Course complete in 12 weeks—general knowledge of the auto—how to drive and locate trouble in car. Special 6 weeks' driving course. Engineering. Low fees and living costs. For catalog address **Geo. P. Magill, Pres., Highland Park College, Des Moines, Ia.**

SHORTHAND IN 30 DAYS

Boyd Syllabic System—written with only nine characters. No "positions"—no "ruled lines"—no "shading"—no "word-signs"—no "cleft notes." Speedy, practical system that can be learned in 30 days of home study, utilizing spare time. For full descriptive matter, free, address—

Chicago Correspondence Schools, 868 Uelby Building, Chicago, Ill.

BE AN ILLUSTRATOR. by mail how to draw for magazines and newspapers. Send for Catalog

Learn to draw. We will teach you School of Illustration 112 Page Bldg. Chicago, Ill.



DON'T TAKE A COURSE IN MACHINE DRAFTING

till you have read my proposition. **Positively the best.** Instruments finished. Rates reasonable. **Pay a part after in position.** For information write **DRAFTSMAN, 252 South Corona Street, Denver, Colorado**

Learn Watchmaking At Home



You can learn by our modern and original system of instruction every part of the Watchmaker's Trade at home as good or better than at a shop. You can earn money while learning and secure a well paying position or start in business after completing our course of instruction. Good watchmakers are always in demand and earn from \$20 to \$35 per week. For particulars apply to the Wisconsin School of Watchmaking, Strub Bldg., Milwaukee, Wis.

WANTED Railway Mail Clerks

there is \$900.00 to \$1,800.00 a year in it for you



Examinations are Held Frequently

Hundreds of Railway Mail Clerks Appointed Yearly

Rapid advancement to higher Government Positions. "No lay-offs" because of STRIKES, WARS, FINANCIAL FLURRIES or the WHIMS OF SOME PETTY BOSS. THE POSITION IS YOURS FOR LIFE.

FRANKLIN INSTITUTE (The Pathway to Plenty), Dept. A-106, ROCHESTER, N. Y. This coupon, filled out as directed, entitles the holder to free specimen questions; a free copy of our book, "Government Positions and How to Obtain Them," a list of Government positions now obtainable, and to consideration for Free Coaching for the examination here checked.

Country residents and city residents stand the same chance for immediate appointment. Common-sense education sufficient. Political influence NOT REQUIRED.

Write immediately for schedule showing the places and dates of ALL COMING Gov't examinations. Don't delay. Every day you lose means the loss of just so much coaching before the rapidly approaching examinations.

FRANKLIN INSTITUTE, Dept. A-106, Rochester, N. Y.

- | | |
|--|--|
| .. Railway Mail Clerk.. (\$900 to \$1800) | .. Customs Positions.. (\$800 to \$1500) |
| .. Bookkeeper..... (\$900 to \$1800) | .. stenographer..... (\$800 to \$1500) |
| .. Postoffice Clerk.... (\$800 to \$1200) | .. Internal Revenue... (\$700 to \$1800) |
| .. Postoffice Carrier... (\$800 to \$1200) | .. Clerk in the Departments at Washington..... (\$800 to \$1500) |
| .. Rural Mail Carrier.. (\$500 to \$1100) | .. Canadian Gov't Positions..... |
| .. Auto Chauffeur..... | |

Name..... Address..... A-106
Use this before you lose it. Write plainly.

Ohio Mechanics Institute, Cincinnati Institute of Applied Arts

Mechanics and Electricity, Architecture, Industrial Art and Design, Chemistry and General Science, Lithographic Art and Printing, Household Arts and Science, Applied Art Trades—Machine Work, Cabinet and Pattern Making, Art Forging, Interior Decorating, Plastic Work.

Special Department for Teachers.



Superior Laboratory and Shop Equipment
Full catalogue mailed on application.
JOHN L. SHEARER
President

ELECTRICAL men with training are always in demand. Having trained over 2000 young men in the past 22 years in the fundamentals of Applied Electricity, **The Illinois Electrical School**, with its well-equipped shops and laboratories, is peculiarly well qualified to give a condensed course in Electrical

ENGINEERING

including Mathematics, Steam and Gas Engines, Mechanical Drawing, Shop Work, and Theoretical and Practical Electricity, in all branches. Students construct dynamos, install wiring and test efficiency of electrical machinery. Course, with diploma, complete

IN ONE YEAR

For practical young men with limited time. 23rd year opens Sept. 22nd. Catalogue on request. **105 Takoma Ave., Washington, D. C.**

EARN \$2,400 A YEAR

Course in SHOW CARD WRITING FREE

If you purchase ALPHA colors to use while practicing. Particulars for stamp. **ALPHA COLOR CO., Inc., Dept. K, 1960 Broadway, NEW YORK**

Boston Garter

Velvet Grip

The FIRST CHOICE
of
Men the World Over
for more than
Thirty Years

Silk 50¢
Lisle 25¢



George Frost Co.
Makers
BOSTON

I will send my 25c book Improve Your Face for 10c, stamps or coin



This book contains a complete course of instructions in Physical Culture for the face

More than 90,000 persons are following these instructions today. They will do more to build beauty than all the paint and powder in the world, for they get right at the root of your facial defects and overcome them.

Not simple or silly, Just Physical Culture applied to facial muscles; common sense, that's all. If you want to improve your looks, send 10c for this book to-day, at once, while it's on your mind.

PROF. ANTHONY BARKER
5640 Barker Bldg., 110 W. 42nd St., N. Y. C.

You should have it

The East A. Early Company
307 Arch St.,
Philadelphia,
U.S.A.

Your dealer should have it



The Drawing Attraction
of the Drawing World

Special Early Celluloid
Line-O-graph

Patented Dec. 13 '04. *Use as you see fit*

Jr. No. 254 Draftsman Sp. No. 142

New York ELECTRICAL School

Gives you a complete training by actual practice. You get the knack of "HOW" together with the theory of "WHY" and the best business methods used in the World of Electrical Activity.

The N. Y. Electrical School is the pioneer and premier school of the "Learn by Doing" method. When you have completed this Course you shall be fully qualified to handle ALL branches of Electrical industry.

The equipment of this School is unequalled and up-to-the-minute. No preparation needed to become a "learner" in this school. You can start to learn on any day of any week throughout the whole year.

Visitors heartily welcomed. Send for catalogue.

44 West 17th St. New York City
N. Y. ELECTRICAL SCHOOL

Be a Draftsman An EXPERT MECHANIC, or An ELECTRICAL ENGINEER

Spend your summer in improving your earning capacity. Our courses in Drawing, Shop Work, and Electrical Engineering are unexcelled. Summer term from June 14th to August 7th. Fees moderate. For further particulars address Dean F. Paul Anderson, College of Mechanical and Electrical Engineering, State University of Kentucky, LEXINGTON, KENTUCKY.

STUDY LAW BY MAIL

University Methods
Theory and practice combined.
Three courses — University,
Business and Banking Law.

McKinley University, 1554 East 53rd Street, Chicago, Ill.

Indorsed by Bench and Bar. Guaranteed to prepare for Bar of any State. Free Public Speaking Course — easy terms. Catalog free.

LEARN WATCHMAKING AND ENGRAVING



Earn while learning. Most practical watch school. Individual instructions. Graduates in great demand. Book free. Chicago School of Watchmaking, 63 E. Van Buren St., Chicago

MUSIC TAUGHT FREE AT YOUR HOME

Write Today for our booklet. It tells how to learn to play Piano, Organ, Violin, Mandolin, etc. Beginners or advanced pupils. AMERICAN SCHOOL OF MUSIC, 50 Lakeside Bldg., Chicago, Ill.

GAGHOO! Make the whole family and all your friends

"just sneeze their heads off" without knowing why, with Gaghoos, the new long distance harmless snuff. Sent anywhere for 10c. 3 for 25c. 1 doz. and special premium for 90c. AMERICAN SUPPLY CO., St. Paul, Minn.



WILLARD - JOHNSON Prize Fight Puzzle



Four even cardboard strips show Willard and Johnson in various absurd fighting postures. When properly put together, the finished picture is Willard, the Champion. Original—and difficult enough to make it unusually interesting. Sent with literature on Magic and Card Tricks for 10c

THE MAGIC SHOP
30 N. 13th St., Philadelphia, Pa.

This 64-Page Free Catalog Saves You 25 to 50% on Furniture

Come-Pack Furniture, sold direct from factory to home on a year's trial, saves you 25 to 50%. Home Furnishing Department helps you make best selections. Money-Back Guarantee. Write for Catalog today.

COME-PACK FURNITURE CO.
601 Fernwood Ave. Toledo, Ohio



DIAMONDS

ON CREDIT

20% DOWN

10% A MONTH

The most beautiful Diamonds are the Blue-white, especially if absolutely perfect. LYON DIAMONDS are 1st Quality, Blue-white. A certificate furnished with every Diamond guaranteeing its value and providing for exchange at full purchase price. Goods sent prepaid for examination and approval. Write for Catalog No. 3.

J. M. LYON & CO., (Incl'd 1942) 71-73 Nassau St., NEW YORK.



LAW BOOK FREE

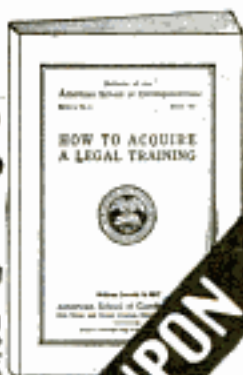

Be Sure to Get This 80-page Free Book Before You Enroll for Any Law Course: No matter which school or which course you may be considering—no matter which method of instruction you may favor—be sure to read "How to Acquire a Legal Training" before you enroll. One of the greatest free books on law ever offered. Tells how to weigh and judge the claims of correspondence schools. Tells just what a law course should contain to give you the training absolutely necessary to succeed in the legal profession. Tells the easiest and best way to become a lawyer by studying at home, and explains all about the American School's simple method of home law instruction. Prepared by 56 of America's greatest legal authorities—23 more subjects and 30 more authors than any other correspondence law course.

FREE 13 Volume Law Library and 60 Text Books

With each course we furnish 60 new pocket size Text Books, 36 Case Books, and our big 13 volume Law Library. Written in plain, simple, easily understood language especially for correspondence instruction. Don't fail to investigate this wonderfully complete and practical course before taking up the study of law—send for your free book today. Just drop us a postal—there is no obligation—it is absolutely free for the coupon.

American School of Correspondence, Chicago, U.S.A.

FREE BOOK COUPON

Pop. Mech. 6-15
A. S. of C.
Gentlemen: Please send me your FREE Law Book, "How To Acquire a Legal Training," and full particulars regarding your wonderful new system of correspondence law instruction.

NAME.....
ADDRESS.....

UNCLE SAM IS BEST EMPLOYER;

pay is high and sure; hours short; places permanent; promotions regular; vacations with pay; thousands of vacancies; all kinds of pleasant work everywhere; no layoffs; no pull needed; common education sufficient. Special money back guarantee if you write today for booklet B900. IT IS FREE.

EARL HOPKINS, WASHINGTON, D. C.

GET A
BETTER
PLACE

"The law trained man"

is a remarkable 128-page book (sent free if you send) showing why more law-trained men are wanted. ONCE. To succeed under modern conditions, you MUST be law-trained. The book tells you WHY, and also explains how men who are unable to leave their home or business can, for the first time, become law-trained in spare time by a method which is prepared by 10 eminent legal authorities and is endorsed by lawyers and judges everywhere. Easy to understand and interesting. Write now for special offer and free book. No obligation.



BLACKSTONE INSTITUTE
20 W. Jackson Boul. 1 PF, CHICAGO, ILL.

Improve your Writing

Controlograph "kills" the finger movement. When in use, fingers cannot bend. Muscular movement becomes easy and natural. Made of metal, adjusts to any hand, and fits any round penholder. A boon to the tired, busy writer. Improves your writing from 50 to 100 per cent at once, by making you use correct principles. With it you can become a good penman. Send 50c today for one, or write for circular. Agents Wanted.

C. W. RANSOM, 325 Essex Bldg., KANSAS CITY, MISSOURI

STRUCTURAL DRAFTSMEN

are paid good salaries. By our correspondence system you CANNOT FAIL. Write for circular and terms.
CANTON TECHNICAL SCHOOL, Canton, Ohio

LONGACRE

NEW YORK CITY HOTEL
Broadway and 47th St.
EXCLUSIVELY BACHELOR
Convenient to Everything. The refined air and good service of a club

RATES PER DAY

50 rooms with lavatory	\$1.00
150 rooms with private bath	1.50
50 rooms with private bath	2.00
Two-room Suites, \$3.00 to \$4.00	
Special Weekly Rates	

Restaurant a la carte. Club Breakfasts
DINING ROOM OPEN TO LADIES
The best value in New York City both in rooms and restaurant.
Phone, 7790 Bryant J. G. BOGGS

SELF MASTERY

Stop and Think

Do you realize what this means to you? It means freedom from physical aches and pains, a strong and healthy body, happiness, success in whatever you may undertake.



Leavitt Science

will show you the way. It accomplishes this result easily and quickly. It gives you courage for despair, strength for fear, direction for aimlessness.

Power of Concentration, Self-Control and Self-Confidence

of influence to attract to you those you desire, those that can help you. It means freedom from servitude and bondage. C. Franklin Leavitt's Wonderful Book, which will show you how to become "Master of Your Fate" and "Captain of Your Soul," will be sent for twelve two-cent stamps. Send for it today and begin to live.

SEND TODAY

C. Franklin Leavitt, M. D.
Suite 948
14 W. Washington St.
Chicago, Ill.

Enclosed find 24c in stamps, for which please send me your wonderful book on How to Become Your Own Master.

Name.....
Address.....

Blue Streak

The Luxurious New
Motorcycle Tire
With the All-Weather Tread

Here, now, is a new-day tire for motorcycles—a tire de luxe that is truly anti-skid. It is big and sturdy. It is over-size and easy-riding. It is safe and secure.

No other motorcycle tire made has this All-Weather tread of big, handsome, sharp-edged blocks—close-set, tough and extra thick.

And no motorcycle tire has an anti-skid tread so wide. It is safe and resistant in turning sharp curves. It gives you the same protection that the famous Goodyear All-Weather tread gives to automobilists.



GOOD YEAR
AKRON, OHIO

**Blue Streak
MOTORCYCLE TIRES**

This beautiful Blue Streak Motorcycle Tire is the outgrowth of the famous Goodyear racing tires. They won all notable records for speed and endurance, as you know.

Those racing tires received the most grueling tests. And those tests taught us how to improve, how to fortify motorcycle tires in ways before unknown.

Hence we attained this new-day Blue Streak Tire. It is the consummation of all that men have learned to date.

There is none that equals it in beauty and durability.

Any dealer can supply you with the new Goodyear Blue Streak Motorcycle Tire. If he hasn't it in stock, he can get it quickly from a near-by Goodyear branch.

**The Goodyear Tire &
Rubber Company
Akron, Ohio
Makers of
Goodyear
Automobile
Tires**

BUTTER-KIST Pop Corn

Its coaxing fragrance is irresistible—its tempting flavor is delightful. Every crisp, crackling, snow-white kernel is evenly buttered, piping hot—the last word in captivating food purity. This quality and delicacy is possible only with the Butter-Kist Corn Popper, that feeds itself, pops the corn, sorts it and butters each kernel evenly.

People everywhere, once they taste Butter-Kist, are satisfied with no other pop corn. They go out of their way to buy it. Try one sack—then you, too, will experience the same delight. Butter-Kist popularity is nation-wide.

\$25 to \$60 Extra Profit Each Week

For hundreds of storekeepers and merchants, the machine is doing this every week—even more for some. Records prove Butter-Kist Pop Corn nets much more profit per square foot than anything else in the store.

One of these machines installed in a store November 13, 1914, took in \$2080.65 the first five months. Seventy cents on every dollar's worth of pop corn you sell is clear, clean profit. Big, constant demand. All-year, spot-cash business. No stock to carry. Butter-Kist is a great trade builder.

Superbly built, beautifies any store or business establishment. Mahogany, Oak or Ivory-White cabinet with plate glass and polished metal.

Pay from Your Sales

A small payment down puts this Butter-Kist Pop Corn machine in your store with all Butter-Kist privileges. Soon pays for itself out of the money it earns.

Get This Book Free

Facts, figures, photographs, proofs of profits, etc., shown in our new book, "The Little Gold Mine." Sent free, postpaid. Every day's delay means lost sales.

Holcomb & Hoke Mfg. Co.
1673 Van Buren St. Indianapolis, Ind.



Come to Detroit
the automobile center
to

LEARN THE AUTOMOBILE BUSINESS

Wonderful opportunities everywhere for Detroit trained men. Every locality needs ambitious men to start garage and repair shops in downtown and residence districts. Detroit is an Automobile center—44 factories—67 out of every 100 cars made in Detroit. Our students begin practical instruction **FIRST DAY**—in construction, repairing and driving standard cars. Can complete course in six weeks—ready for a good position or business of your own. Many work while they learn.

Earn \$75 to \$300 a Month

Get into this business that's growing bigger all the time. Be trained to tackle any auto proposition. You can't beat it—it's the business of the hour—the big money-maker.



P. C. Neilson
Proton, Idaho, took this course, now has garage, repair shop and Maxwell agency; earning around \$3500 a year.

Students Build New Cars From Start to Finish

getting regular factory experience in assembling, testing, etc. Students learn to handle any trouble that may come up. Real work on new cars. Instruction on leading types of self-starters, ignition systems, lighting and starting systems. Block test department has 15 different motors, including 6 cyl. 110 H. P. Lozier. Students get practical experience with all latest equipment.

Students desiring can go thru service department of Detroit Electric—no extra charge. **LEARN IN DETROIT, WORK ANYWHERE.** Always a job for a good man. We have lots of chances to place students in good positions. Opportunity to start good business of your own. **WE GUARANTEE** to qualify you as efficient chauffeur, repair-man, tester, salesman or demonstrator in a short time, or refund your money. It's simply a matter of making a start. Write for full particulars, or jump on the train and come to Detroit and start right in. Classes going all the time. **MICHIGAN STATE AUTO SCHOOL, The Old Reliable School, Dept. P. 6, 11-17 Selden Avenue, Detroit, Michigan.** Write for "Auto School News."

Practical Electrical Education

Our practical course in Electrical Science and Engineering trains you to get and keep the big-pay jobs. Enter at any time, no matter what your education. Advance as fast as you can master the work. Course combines theory with actual practice in all branches of Electrical Science, individual instruction. Only practical training school of its kind in U. S. Endorsed by leading electrical employers past 16 years. Our trained students always in demand and well paid. Write for FREE ILLUSTRATED CATALOG and How to Get Your Summer School FREE.

School of Engineering of Milwaukee, 1975th Edg., Milwaukee, Wis.



Drafting Will Promote You!

These courses will give you the knowledge that means promotion and big salary. Architectural, Mechanical and Structural Drafting and Design, Estimating and Contracting, Builders' Courses and Plan Reading.

STUDY
IT
PAYS

DRAFTING

Complete \$15.00
Outfit and all Blue
Print Plans FREE.

Day, Evening, Home-Study Courses. Write today.

CHICAGO TECHNICAL COLLEGE

1050 Lake View Building CHICAGO, ILL.

Learn by Mail to be a WRESTLER
Great
Farmer Burns, Mr. Frank Gatch, world's champion, will now teach you Physical Culture, Wrestling and Self Defense. Be strong, athletic, healthy. Handle big men with ease. **FREE BOOK** Write today for elegant free book and particulars. Give your age.
Farmer Burns School of Wrestling, 4119 Range Bldg., Omaha

LEARN WATCHMAKING

and become independent. Good-paying positions secured. Easy to learn. Send for FREE CATALOG.
ST. LOUIS WATCHMAKING SCHOOL, Dept. 5, ST. LOUIS, MO.

CHALK-TALK LECTURE ILLUSTRATING COURSE

Would You like to **Make Money?**
In Vaudeville, at Chautauques, or give illustrated talks for Churches, Lodges, or to amuse your friends? Our Chalk-Talk course will teach you how! Not much art ability needed. Complete Course \$15—C. O. D. if desired. Let us tell you about it. **Write TODAY!**
THE LOCKWOOD ART SCHOOL, Dept. 25, Kalamazoo, Mich.

"That's Just What I Need"

COMPLETE COURSE IN ELECTRICITY FREE FOR EXAMINATION

Here is a set of books that no man in the ELECTRICAL FIELD should do without. This is the ELECTRICAL AGE in which we live; ELECTRICITY now controls more trades, directs more men, offers more opportunities than any other power that man has yet discovered. Do you wish to know the underlying principles of MODERN ELECTRICAL PRACTICE?

If so, **HAWKINS ELECTRICAL GUIDES** will give you the information. In reality they are a school within themselves, containing a complete study course with **QUESTIONS, ANSWERS AND ILLUSTRATIONS**, written in plain everyday language so that a practical man can understand the "HOW, WHEN AND WHY" OF ELECTRICITY.

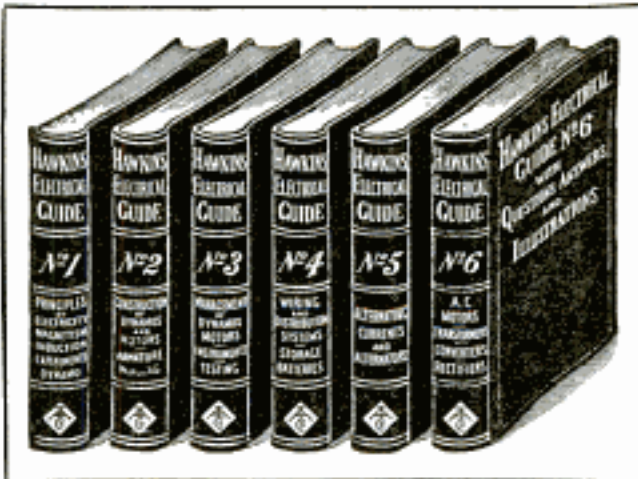

Read over the titles shown on the back of each volume, and note the scope of each book. They are handsomely bound in flexible black leather with gold edges and will readily go in the pocket. **THEY ARE NOT ONLY THE BEST, BUT THE CHEAPEST WORKS PUBLISHED ON ELECTRICITY.**

Each book is complete in itself and will be supplied \$1.00 per copy, but we believe that the complete set is the best bargain.

The books can speak for themselves and a careful examination, page by page, and illustration by illustration, will convince you of their big value.

If you will fill out the following coupon giving all the information requested, **WE WILL SUBMIT THE SIX VOLUMES FOR EXAMINATION ON CONDITIONS NAMED.**

FREE EXAMINATION OFFER

THEO. AUDEL & CO., 72 5th Ave., NEW YORK

Please submit me for examination **HAWKINS ELECTRICAL GUIDES** (Price \$1 each.)

Ship at once, prepaid the 6 numbers; if satisfactory I agree to send you \$1 within seven days and to further mail you \$1 each month until paid.

Signature.....

Occupation.....

Business Address.....

Residence.....

Reference.....

Please Mention Popular Mechanics



Prof. F. W. Foote
Psychologist

Do You Know
the LAWS which
CONTROL Your
Brain?

Concentration
and
Personal
Power Can
Be Obtained as
an Absolute Result
from a Knowledge of
MENTAL LAWS

You know that your Brain plays tricks with you and that you are conscious of **Constant Mental Leakage**; **Constant Loss of Mental Power and Energy**; **Constant Worry, Anxiety and Muddle**.

Now, **Why work in the Dark?** Realize that you can **Train Your Brain to Think**

just as you can train YOUR MUSCLES TO ACT. It is useless for you to attempt any kind of study unless you can so master your Brain so as to obtain instant Obedience. Brain control is the first requisite for Success.

A TRAINED BRAIN

will give you ability to bring all the facts of any problem into the focus of your MENTAL machine when needed. It is not only mental activity, but control and use of that activity so that the greatest results may be obtained. Let me teach you these laws which will give you this **MASTER POWER**. The "systematic study of Mental Laws" which is the

**Science of
Psychology**

will give you
Positive Success.

Your

Personality
will be expressed in all your actions; and you will have the conscious knowledge and use of your own **Trained Will Power**

Nothing will be able to throw you down for you will have a Mental Equipment which will be able to penetrate and **Master every Circumstance**. Your struggles will be opportunities for Success. You will thus **Master Your Destiny**, by using your powers to the full.

My scientific training in the great Universities of the world is at your disposal. It will be my pleasure to personally train you to increase your Mental Powers. My knowledge will enable me to know which is the law for you to use and master. You cannot afford to ignore the opportunity which this course of study offers. It is based on the fact of law. **YOUR SUCCESS is POSITIVE and ASSURED.** You will send for this Free Book and obtain the information which will mean **POWER and MONEY for YOU.**

Send for this **FREE BOOK** at Once



FREE BOOK COUPON

6-15

PROF. FREDERICK W. FOOTE
Principal Chicago Institute of Menti-Culture
30 No. Michigan Blvd., Chicago, Ill.

Send me Free Book "Masters of Destiny" and all particulars of your Mental Training Course.

NAME

ADDRESS



**Oxy-Acetylene
Welding & Cutting
Will Save Money
in YOUR Shop**

Right now, you may be doing work that this process would simplify and cheapen. You owe it to yourself to investigate the actual instances of savings made, and the "on the spot" repairs that have saved money for other manufacturers and shop owners. New uses are being found daily in many different shops.

Cost of necessary equipment is low. We furnish a thoroughly high grade welding apparatus for \$60.00. The average user will also need gas cylinders at an additional cost, and about \$10 worth of welding supplies. Truck and special-equipment for cutting operations at extra cost.

If you are now using the process, by all means secure the added convenience, usefulness, efficiency, portability and simplicity, that is given good welding and cutting equipment, of any make, by

**PREST-O-LITE
Dissolved Acetylene**
(Ready-made carbide gas)

Prest-O-Lite Acetylene Service furnishes the highest grade of Dissolved Acetylene in portable cylinders, used as conveniently as you use cylinders of oxygen. Saves the large initial outlay and heavy depreciation, trouble and inconvenience of making crude Acetylene in carbide generators. Besides, Prest-O-Lite Dissolved Acetylene is perfectly dried, cleaned and purified — makes better welds and is cheaper to use.

Every user of Acetylene should have full details of the liberal "Prest-O-Lite Service Plan," an ideal arrangement assuring maximum quality and quantity.

A Highly Profitable Business in a New Field

Doing Oxy-Acetylene repair work presents wonderful opportunities for profits to enterprising men seeking a business of their own. Immense and growing demand assures profitable operation from the start. Equipment soon pays for itself. Send for particulars.

Put your problems in welding and cutting up to our Oxy-Acetylene experts. Your name and address in the margin of this page will bring folder full of highly instructive literature.

The Prest-O-Lite Co., Inc.
The World's Largest Makers of Dissolved Acetylene
816 Speedway Indianapolis, Ind.

53 direct factory branches and charging plants in principal industrial centers.



EARN \$25 to \$75 A WEEK BE YOUR OWN BOSS

OFFER OPEN TO ONE MAN IN A TOWN

I will start you tomorrow in a permanent, big money making business in your home town or any town without interfering with your present work. You begin making money the first day. A hustler can double his income the first 60 days. I teach you the business, show you how to get trade, give you a

Free Course in Salesmanship

and push you towards success. You don't need capital nor a stock of goods to get a start. Some men I started earn as high as \$5000 a year after a few years. One man writes us

"I Made \$27 in TWO DAYS"

I started thousands the past 22 years. I want to start you in the jewelry business, the first step being to teach you, free of cost, how to repair watches, clocks and jewelry, no simple any man soon learns, a few tools is all you need. This is a remarkable offer. You have everything to gain, so investigate it. Write for Free Offer today before I close up your town.

C. F. ELMORE, Prin., Watchmaking College, 5 So. Wabash Ave., Chicago

Rose Polytechnic Institute

Terre Haute, Indiana

A College of Engineering courses in Mechanical, Electrical, Civil, Chemical and Architectural Engineering. Extensive shops, well-equipped laboratories in all departments, expenses low. 32nd year. For catalogue containing full information and professional register of Alumni, address

C. L. MEES, President

COPY THIS SKETCH

and let me see what you can do with it. You can earn \$20.00 to \$125.00 or more per week, as illustrator or cartoonist. My practical system of personal individual lessons by mail will develop your talent. Fifteen years successful work for newspapers and magazines qualifies me to teach you. Send me your sketch of President Wilson with 6c in stamps and I will send you a test lesson plate, also collection of drawings showing possibilities for you.

The Landon School of Illustrating
and Cartooning
1438 Schottfield Building, CLEVELAND, O.



Taxidermy
Book
FREE

Mount Birds

We teach you by mail to stuff and mount all kinds of Birds, Animals, Game Heads. Also to tan skins and make rugs. Be your own taxidermist. Decorate your home with your beautiful trophies or increase your income selling specimens and mounting for others. Easily, quickly learned in spare time by men and women. Highest endorsements by thousands of students. Write today for our great free book "How to Mount Birds and Animals" Free—write today.

N. W. School of Taxidermy, 4119 Elwood Bldg., OMAHA, NEB.



Furniture On Credit

Write for Mammoth Bargain
Book picturing 4,918 articles

SPIEGEL, MAY, STERN CO.
1089 West 35th Street, Chicago

LEARN TO PITCH

Lessons by "MATTY" ED. WALSH, "DOC" WHITE, WALTER JOHN, SON "NAP" RUCKER, "SMOKY" JOE WOOD. PITCH THE FADE-A-WAY, SPITTER, KNUCKLER, SMOKE BALL, etc. Clearly described and illustrated by 66 Pictures. Entire COURSE OF LESSONS SENT POSTPAID FOR 50 cents.

J. C. DORN, 721 S. Dearborn St., Dept. 108, Chicago, Ill.

New Band Catalog FREE

Your name and address is enough. We'll send you our big new Band Catalog absolutely free. 350 pages, 788 illustrations, 67 art color plates, 2561 musical instruments described.

We supply the WURLITZER Any instrument on Free Trial. U. S. Gov't. 100 years of instrument making

\$200 Brings This Cornet pay the balance at the rate of only a few cents a day. Superb Lyric cornet, triple silver plated. Leather carrying case free. Generous allowance for old instruments. Write for free book today.

Rudolph Wurlitzer Co., Dept. A119
4th St., Cincinnati, O. S. Wabash Ave., Chicago



Big Money

For YOU in LAW

This is the most exceptional opportunity ever offered ambitious men and women everywhere to build a future of power, independence and wealth—to quickly rise out of an ordinary position that pays small wages and offers no future, into a lucrative profession of importance and big income.

\$3,000 to \$10,000 Yearly

That's what Lawyers earn—and more. There is practically no limit to a good Lawyer's income and possibilities. Law offers greater possibilities of success and wealth than most any other profession. Law can fit you for success in almost any other walk of life. The need for Lawyers is now greater than ever. Begin now to qualify for success that awaits you. YOU can

Become a LAWYER

We say YOU, and we MEAN You, no matter who you are or what your present occupation. We make it easy—we guide you right—put you in the footsteps of America's most successful Lawyers.

We Train You by MAIL

at home, in spare time. Ability to read and write intelligently is the only requirement. LaSalle law text is edited in plain language by James Parker Hall, Dean of Univ. of Chicago Law School, and by James DeWitt Andrews, formerly Member Faculty Northwestern Univ. and professors in such Universities as Harvard, Leeland Stanford, Univ. of California, Univ. of Michigan, Univ. of Wisconsin, Tulane Univ., etc.

Become an LL.B.

State of Ill. authorizes us to confer on our graduates degree of Bachelor of Laws (LL.B.). Our Course prepares you to pass all subjects covered by bar examinations. We guarantee to coach free and until successful any LaSalle graduate failing to pass bar examinations. LaSalle Extension University, Dept. F. 626 Chicago, Ill.

Ask about our Special Course for Business Men.

ACT

Mail coupon quick for FREE proof of big opportunities. Send no money—everything FREE to you.

FREE

Complete Course

In PUBLIC SPEAKING

Greatest offer made. Written by Dr. Frederick E. Robinson, A. B., M. A., Ph. D. Complete, authoritative. No other course like it. Everyone should have this course—win fame and power. Learn how we give it free with our Law Course.



LaSalle
Extension University,
Dept. F. 626 Chicago, Ill.

Send at once, free, facts about your Special Law Offer, EXTRA Special FREE Offer of Complete Course in Public Speaking; also send remarkable books "Evidence" and valuable Law Guide. I obligate myself in no way.

Name.....

Address.....

Please Mention Popular Mechanics

Water Pumps Water with a Rife Ram. Plenty of it for every purpose about your farm and country home — day and night, winter and summer, without fuel, labor, freezing or repairs. The



RIFE RAM
is operated by any small stream having a fall of three feet or more and a supply of three or more gallons per minute. Fills high elevated tanks or operates air pressure system. Easy to install. First cost the only cost. Always on the job; over 11,000 in daily use. Tell us your water supply conditions. Ask for free estimate and catalog. Now is the time to install. Write today.

RIFE ENGINE CO., 3131 Trinity Building, NEW YORK

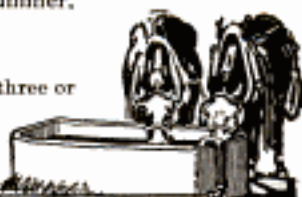

How Much Do You Want

To Act As Our Sales Agent?

Name your price! I'll prove to you that, right in your home county, you can easily make from \$1,500 to \$4,000 a year selling, and appointing sub-agents for the wonderful improved "Jiffy" Washing Machine. Selling price \$1.50. Profit 200 per cent. A clean, dignified, high-class proposition for those who want to make big money.



Note Patented Soap Receptacle. The Original Vacuum Washer

\$10 FOR YOUR FIRST DAY!

The "Jiffy" sells on sight. Every woman wants it. Washes a tub full of clothes spotlessly clean in 3 minutes! New patented feature—the soap receptacle. No one else has it. Vacuum principle, instantly sucks and blows dirt from clothes. Agents are getting rich selling the "Jiffy." Over 107,000 sold, which means profits of \$197,000 for agents. \$1.00 profit on every sale. We need a few more Agents, Managers and General Agents. No experience needed. Write for county rights. A postal will do. Write today.

W. J. FRANK MFG. CO., Dept. 30, ST. LOUIS, MO.

Engines With a Reputation for Superior Quality



Stewart engines are built with an eye to quality first, last and all the time. Strong, sturdy, simple and easy to operate — they deliver the goods right up to the mark all the time.

Made Only in $\frac{1}{2}$, 2, and $3\frac{1}{2}$ H. P. Sizes

but every one a master product of correct design, high grade materials and superior workmanship. If you want an engine in any of the sizes named that will knock the spots off anything else made of the same horse power, get a Stewart. Write for Catalogue.

STEWART LITTLE MAJOR
 $\frac{1}{2}$ h. p. engine with high tension magneto, \$37.50; with battery, \$27.50

CHICAGO FLEXIBLE SHAFT COMPANY
105 N. LaSalle St., Chicago

Try A Skudder Car

The greatest vehicle for fun made. And it's a strengthener and a developer for young, growing muscles. Parents, get your children a

Skudder Car

Help them to grow strong. The Skudder car will aid them. Propelled by the weight of your body. It is ball-bearing and built on the best bicycle standards. Made for children between 5 and 15 years old. Money back if not satisfied. Send for new circular and price.

SKUDDER CO.
521 Straus Bldg., CHICAGO, ILL.



Please Mention Popular Mechanics

If You Are a Shallow Breather

You most certainly are in need of Conscious Evolution to become fully alive and have the benefit of living in full. Why live an inferior life when you can become superior to yourself through Conscious Evolution?

MY NEW BOOK explains the human body as it has never been explained before. It tells of the dangers and after effects of exercise and conscious deep breathing. My free book will prove of great value to you. If you desire to be more successful, to have greater will power and the successful powers, physical, physiological and mental, you cannot afford to be without my free book. Write for it today.

ALOIS P. SWOBODA
1309 Aeolian Hall NEW YORK CITY



Runs on Alcohol

Anywhere at slight expense. No electricity. No wiring. Superb construction. Latest 1915 model. Roller bearing. The original and only **Lake Breeze Motor** manufactured according to the design of the inventor and under his direct and personal supervision.

KEEP COOL

Price in the U. S., \$15, cash with order.

Foreign Price \$20.00 Gold, cash with order, laid down by parcel post at seaport of entry nearest destination.

THE LAKE BREEZE MOTOR, P. O. Box 505, CHICAGO, ILLINOIS



WATCHES On Credit

High Grade **WALTHAM** and **ELGIN MOVEMENTS**

We sell the finest watches made. No matter where you live,

YOUR CREDIT IS GOOD

Better goods at lower prices. Write for the Free Catalog of Watches, Diamonds, Jewelry, Silverware and our Easy Terms of Payment.

MILLER-HOEFER COMPANY
410 Miller Bldg., Detroit, Michigan

SEWS THIS DOLLAR AWL FOR ANYTHING

Makes a perfect lockstitch



1915 Model

Engraving cut to show position of thread in handle

This Automatic Awl is superior to all others. It is of immense value for resewing all kinds of leather, harness, bags, booting, shoes, etc. **THREADED DIRECT FROM THE REEL.** So simple a child can use it. Regular price \$1. For a limited time only we will mail it anywhere, with waxed thread, two Diamond Point Needles (curved and straight), and directions, for **Only 49c** (postpaid 50c). Extra Needles 6c, Thread 10c. **JOHNSON SMITH & CO., Dept. 6, 711 S. Dearborn St., CHICAGO**

49c

Add 6c for postage Agents Wanted

The Library of Original Sources

gives inside, rock-bottom facts on every subject. 10 magnificent vols. Great bargain. Small monthly payments. Send for information.

UNIVERSITY RESEARCH Dept. G, MILWAUKEE, WIS.

When You Build

please bear in mind that there is still plenty of

WHITE PINE

Send for our free booklet, "WHITE PINE IN HOME-BUILDING."

WHITE PINE BUREAU

1626 Merchants' Bank Bldg. ST. PAUL, MINN.

WINNING SUCCESS IN THE NAVY

FOUR years' service in the United States Navy is an education. It is an education of a practical nature, fitting young men for successful careers. In the Navy trade schools are taught such trades as electrician, radio, carpenter, coppersmith, blacksmith, machinist, cook, baker, clerical work, nursing, pharmacy and numerous others. The training stations prepare recruits for the elementary duties of seamanship, and the classes on board ship instruct men in those school branches in which they are deficient, besides preparing them for advancement in rating. It is the aim of the Navy Department to assign every man to the work for which he is best fitted, and to help him strive for promotion.

☐ The pay begins with enlistment, and every recruit is furnished *free* with a complete outfit of uniform valued at \$60. Pay increases with advancement, and with reenlistment. Promotion is open to petty officers, to warrant grades, and for those who work for it, to commissioned rank.

Investigate the Navy's offer. Write for the address of the Navy recruiting station nearest you, and learn all about the work, pay and advantages of naval service.

ADDRESS BOX 67

BUREAU OF NAVIGATION

NAVY DEPARTMENT

WASHINGTON, D. C.



We will send you postpaid
a can of

JOHNSON'S PREPARED WAX

—enough to polish a small floor, a piano, an automobile or several pieces of furniture. **Johnson's Prepared Wax** is a complete finish and polish for all floors, linoleum, woodwork, furniture, pianos, and for the body, hood and fenders of automobiles, limousines and electrics. It is very clean and easy

to use. Gives perfect results over any finish—varnish, shellac, oil, etc. Imparts a perfectly hard, dry, artistic finish of great beauty and durability. It is impervious to water, scratches, heel-marks, finger-prints, dust, etc., and can easily be kept in perfect condition.

JOHNSON'S WOOD DYE

for the artistic coloring of all wood. With it inexpensive soft woods may be finished so they are as beautiful as hard wood. Made in seventeen shades, including *Mahogany, Mission, Early*

English, Fumed etc. **Johnson's Wood Dye** penetrates deeply—is economical—dries quickly and is very easy to use. It has no equal for finishing new furniture, woodwork and floors and for doing over old work of this character—for staining basketry, etc.

S. C. JOHNSON & SON, Racine, Wis.

I enclose 10c for Instruction Book on Home Beautifying and a can of Johnson's Prepared Wax—sufficient for a small floor, an automobile, a piano or several pieces of furniture.

Name.....

Address.....

City and State.....

Free Instruction Book

The new edition of our 25c booklet "The Proper Treatment for Floors, Woodwork and Furniture" is just off the press. This book is the work of famous experts—it is full of valuable ideas on home beautifying—illustrated in nine colors. Use the coupon for a copy.

S. C. JOHNSON & SON
"The Wood Finishing Authorities"
RACINE, WIS.

E. Muller, Jr. P.O. Box 530, New York City

Popular Mechanics Magazine

REGISTERED IN U. S. PATENT OFFICE

WRITTEN SO YOU CAN UNDERSTAND IT

Vol. 23 9669

JUNE, 1915

No. 6

The "Fins" of a Submarine Torpedo Boat

THERE are few persons outside of the navy who have ever seen a submarine's "fins" in action. The modern submersible craft built for the United States Navy are all provided with these lateral rudders, but when the vessels are at the surface or moving in a level plane under water, the fins are folded back into recesses in the sides of the hull.

The purpose of these planes, which are shown clearly in the remarkable photograph on this page, is to aid the submarine to rise or sink on an even keel. "Porpoising," or rising and diving at an angle, is avoided in submarine practice as much as possible.

The lateral fins are attached to the hull by ball-and-socket joints, so that they may be rotated to give a planing effect either upward or downward, at

any angle, and folded away when not in use. Fin planes on different types of submarines are of different shapes, some similar to the fins of a fish, some the shape of tennis rackets, and others rectangular.

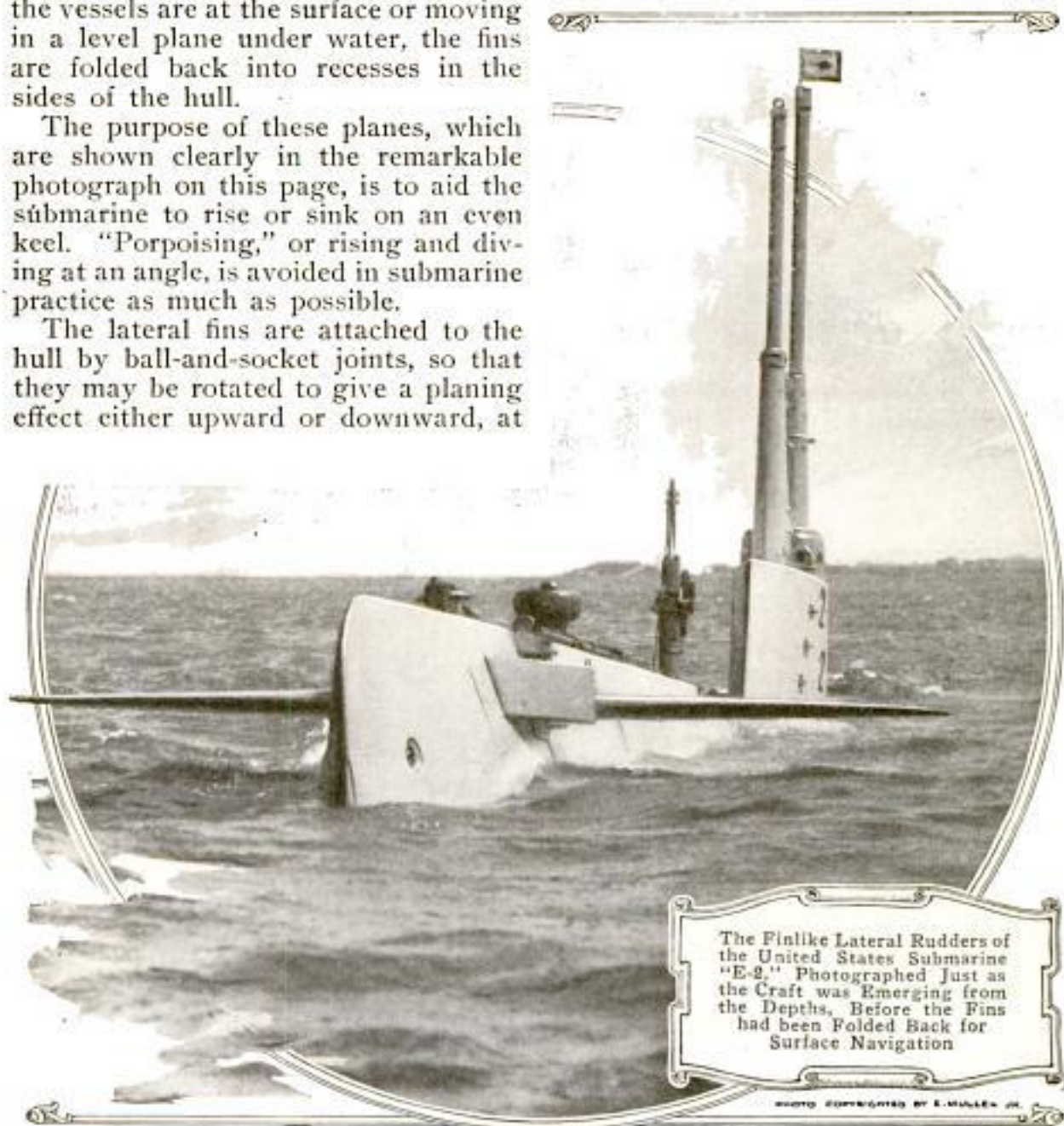

The Finlike Lateral Rudders of the United States Submarine "E-2." Photographed Just as the Craft was Emerging from the Depths, Before the Fins had been Folded Back for Surface Navigation

PHOTO COURTESY OF E. MULLER, JR.

Geo. F. Worts, 627 W. 113 St.
N.Y.C.

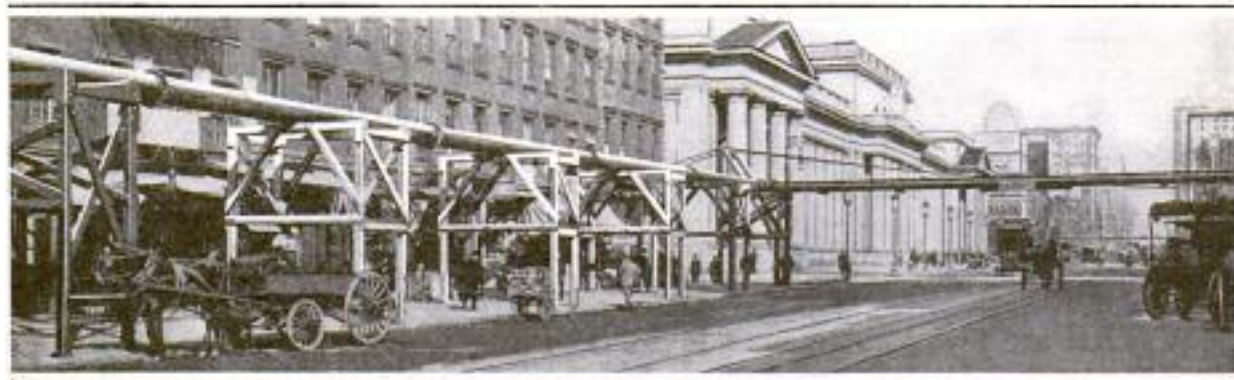

Gas Mains Elevated above a Street in New York during the Construction of a Subway

GAS MAINS ARE ELEVATED 9445 ABOVE CITY STREETS

On streets in New York, where subway-construction work is in progress, the gas mains are elevated on temporary trestles erected above the curb lines at a height sufficient to clear the tops of motor busses and traction cars at the crossings. This is done in order to eliminate the danger of explosions, and in most cases the other utility pipes, such as telephone and other electric conduits, are left beneath the street surface while the excavating is going on. The danger with a gas main in subway work is that there is always a chance for a break to occur and cause a leakage which might easily result in a disastrous explosion.

KNIFE MADE WITH BLADES 9471 THAT MAY BE REPLACED

Broken or worn blades may be readily replaced by new ones in a specially designed pocketknife which has lately been introduced. The blades are fitted with open grooves in their shanks so that they may be removed or inserted quickly, and are so arranged that there is no danger of their falling out accidentally. It is also



possible to have a set of several different styles of blades that may be inserted on occasions when special serv-

*Nagle Reblade Knife Co (Inc)
72 Park Ave.
Longhempire, N.Y.*

ice is required. Thus, blades suited for office purposes may be removed and heavy clip or spear blades set in if a sportsman's knife is wanted, or a pruning blade employed if there is orchard or garden work to be done.

TO ATTACK ZEPPELINS WITH 9521 EXPLOSIVE DARTS

A new weapon that has just been invented in Ireland for use against Zeppelins consists of an explosive dart intended to be dropped from an aeroplane. The dart is made of steel and is fitted at the rear end with projections much like fishhooks. Inside the dart is an explosive charge which burns with a sharp flame. When the dart is dropped on a Zeppelin, or other gas balloon, the hooks catch in the fabric after the point has penetrated it and pull back a detonator that sets off the charge. As the explosion takes place inside the gas bag the effect can hardly be anything but disastrous.

Scientific American

PICTORIAL HISTORY OF 9360 BLACKFEET INDIANS

After months of work a complete pictorial history of their tribe has been worked out by the Blackfeet Indians in the Glacier National Park Reservation in Montana. The story covers approximately a half mile of canvas on which the curious drawings have been executed with hundreds of pounds of bright-colored paints made from mineral materials taken from a near-by mountain.



The history deals at length with the time when the tribe was powerful and ranged the country north of the Missouri River to the Saskatchewan along the slopes of the Rocky Mountains. Some of the incidents which are portrayed are said to have been taken from elk-skin records

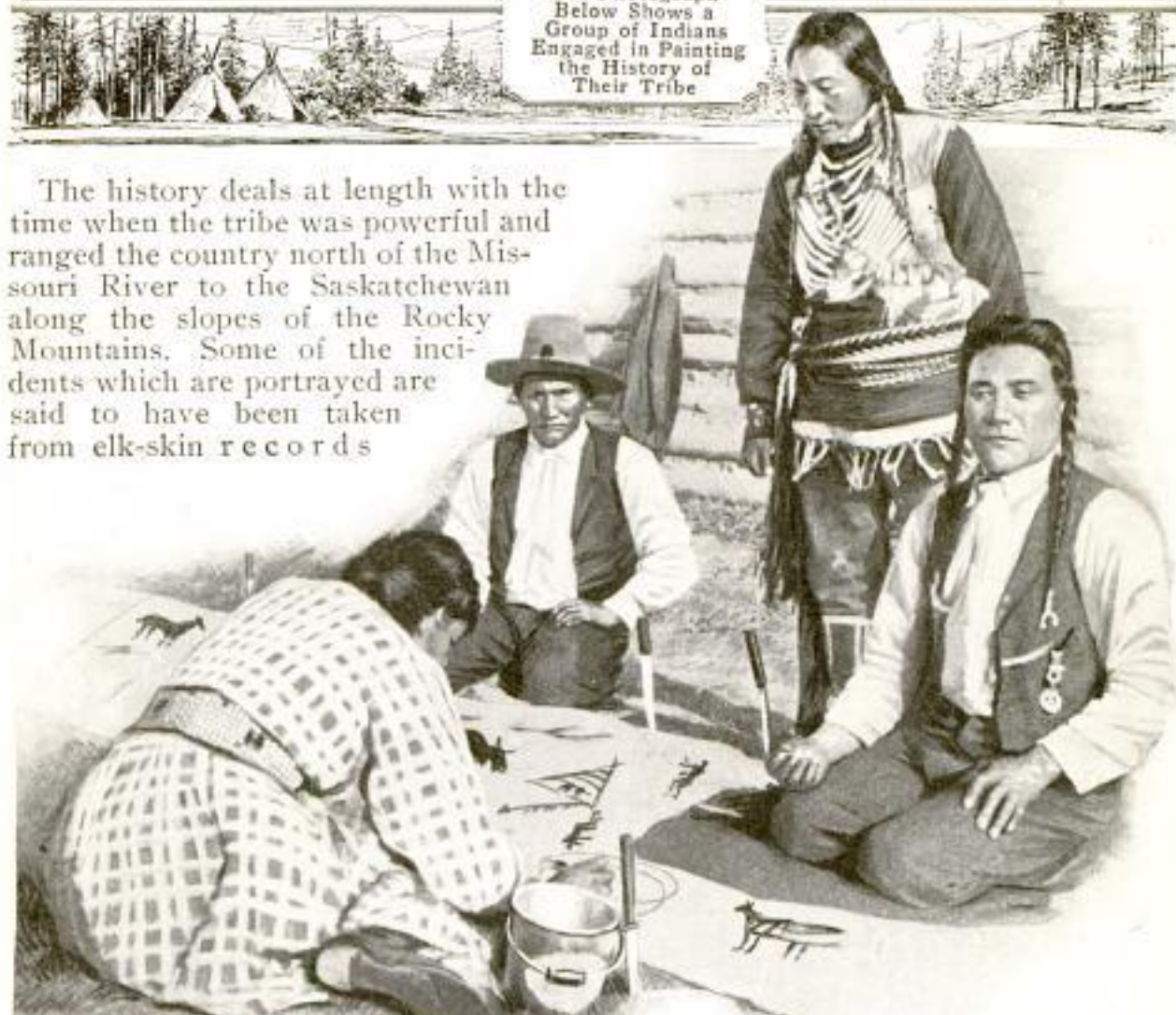

Painted more than 300 years ago. Two hundred and fifty sections make up the complete canvas, which is to be used as a frieze in some of the large log hotels which have been erected for tourists in the national park. These stand on the site of part of the former hunting grounds of the tribe.

taken from patent papers
 Inventor: Geo. R. Guild, U. S. Army,
 assignor to David S. Guild, Jr.,
 804 Kirkwood, Mo. POPULAR MECHANICS

9009 **SIMPLE RANGE FINDER FOR SMALL ARMS**

By using two rifles, each fitted with a sighting bar mounted on the adjustable sight of an army rifle and ope-

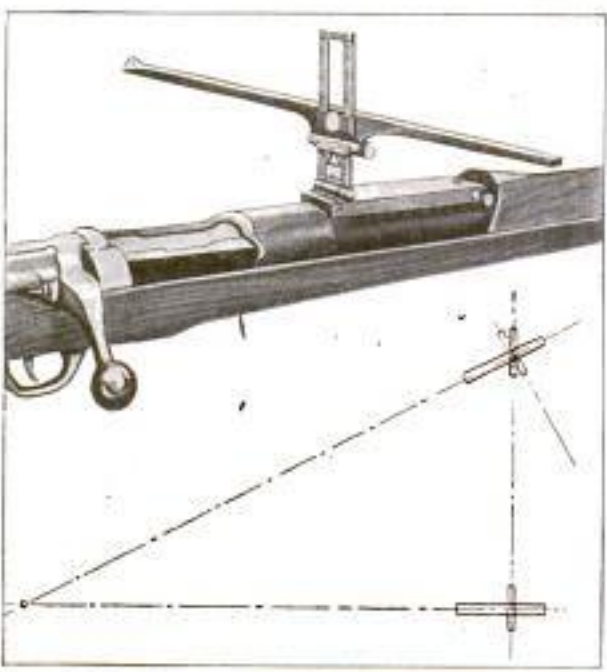

Army Rifle with Range Finder Mounted on Adjustable Sight: The Diagram Shows How Two Rifles are Placed for Finding the Range

rated in connection with the vernier used in allowing for windage, it is now possible to get the range quickly and accurately for any object to be fired at. The sighting bar is mounted on the vertical slide of the rifle sight and ordinarily occupies a position at right angles to the barrel, or the line of fire. The bar has a front sight at one end and a rear sight at the other. In using, one rifle on which the sighting bar is set at right angles to the line of fire is aimed at the object. Along a line at a right angle to the barrel of this rifle,

which is determined by sighting through the sights of the bar, a base line of specified length, usually 100 yd., is laid off. A second rifle held at the end of this base line is then aimed at the object and the sighting bar is turned so that it points to the first rifle, the bar being adjusted by the thumb-screw used in allowing for windage. The vernier on the second rifle then gives the angle between the two lines of fire and the distance from the first rifle to the object to be fired at is determined from a table prepared to correspond to the distance between the two rifles.

9608 **USING CHEESECLOTH TENTS AS MOSQUITO SCREENS**

Along most of the rivers and lakes in the Canadian woods the mosquitoes during the summer months grow to exceptional size and are very aggravating to campers and those on fishing expeditions. Tents are seldom carried on trips through the northern wildernesses, for such equipment is cumbersome, and sleeping bags are much more easily packed for long portage. In order to keep out the mosquitoes so that sleep in these devices is possible, cheesecloth made into the form of miniature tents which completely cover the sleeping bags, is employed. This is of no value as protection from rain, but it keeps out the pests, which are much harder to stand than unpleasant weather.

Cheesecloth Tents are Used in the North Woods to Cover Sleeping Bags and Ward Off Mosquitoes



Francis J. Dickie
 718 Hanover Block,
 Bellamy St. and material
 Edmonton, Canada

8607 NEW HYDROPLANE WITH AERIAL PROPELLER

A new hydroplane that is attracting considerable attention is a skimmer driven by an aerial propeller and capable of making more than 60 miles an hour. The principal feature of this craft is its hull, somewhat like that of a sea sled, with which is used an ingenious means for producing an air cushion between the water and the hull when the skimmer is traveling at a high rate of speed. The air is collected by

air is prevented from escaping from the sides by runners on each side extending 2 in. below the bottom of the hull. The boat is 20 ft. long and 37 in. wide, and

"Fox-Phillips Skimmer"

Fritz Fox

*90 Victoria J. Evans & Co.
Washington D.C.*

*D. B. Phillips
Wash., D.C.*

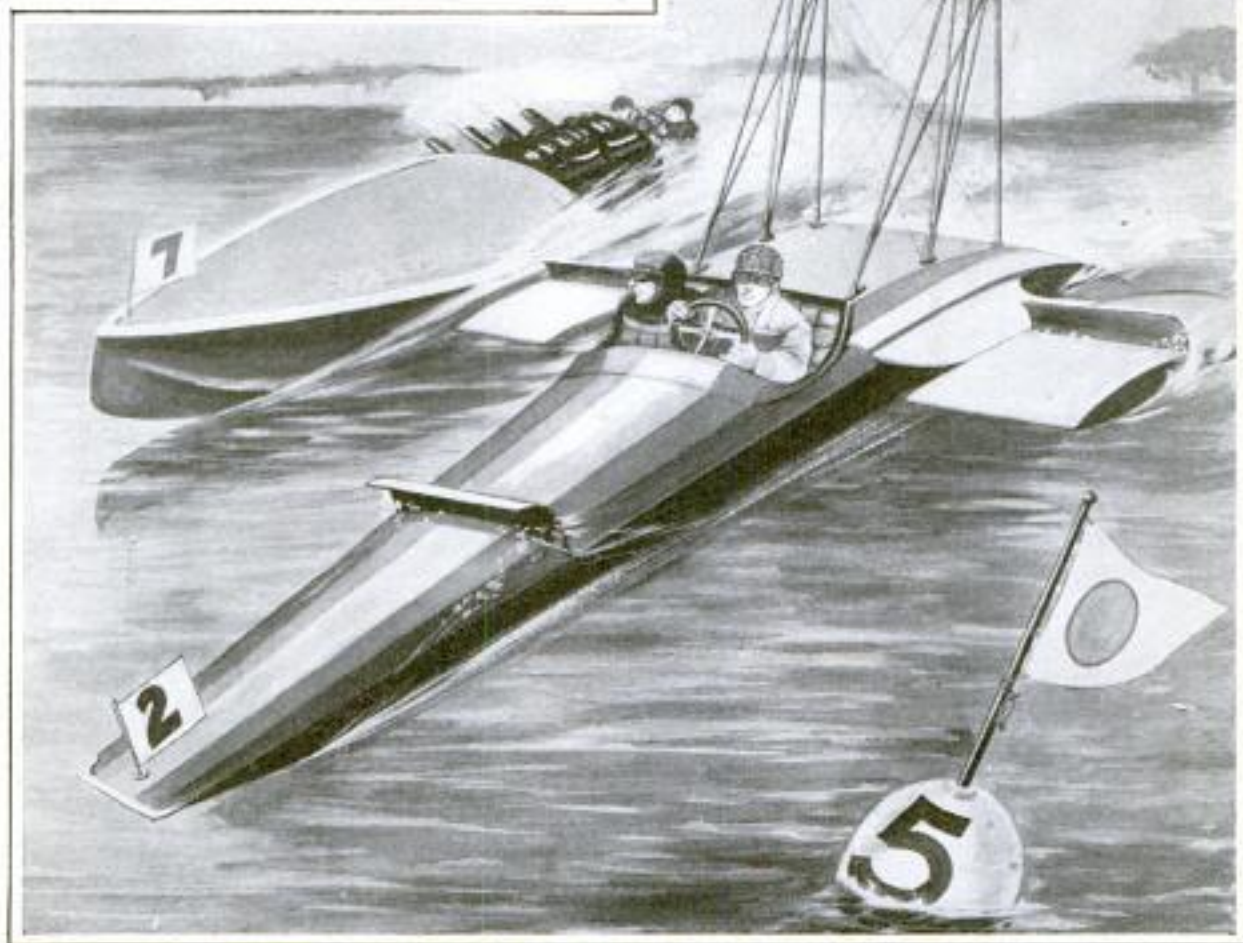

When Going at High Speed This Skimmer Rides on a Cushion of Air and Mist

wide funnels which face toward the bow. Connected with each funnel is a pipe that has its outlet under the hull, the pipe outlets being spaced along the hull from bow to stern. At high speeds the air pressure against the funnels, aided by the suction of the water past the mouths of the tubes, causes a large volume of air to be discharged under the hull, with the result that the hull rides on a cushion of air and mist. The

is equipped with pontoons that prevent it from tipping over when making a turn. It has an 80-hp. motor and has an aerial propeller 8 ft. 3 in. in diameter with a pitch of 5 ft. 2 in. and designed to be run at 1,250 revolutions per minute. The entire weight, including motor, is about 650 lb. When running at 60 miles an hour, the hull draws only about 1 in. of water, and the pontoons are clear of the water surface.

Inventor: Dr. Mathew McVicker
617 S. Yewdell St.,
W. Phila., Pa.

COMBINATION STEPLADDER 9597 AND SCAFFOLD

Suited for either interior or exterior work, a combination ladder and scaffold has been invented which may be

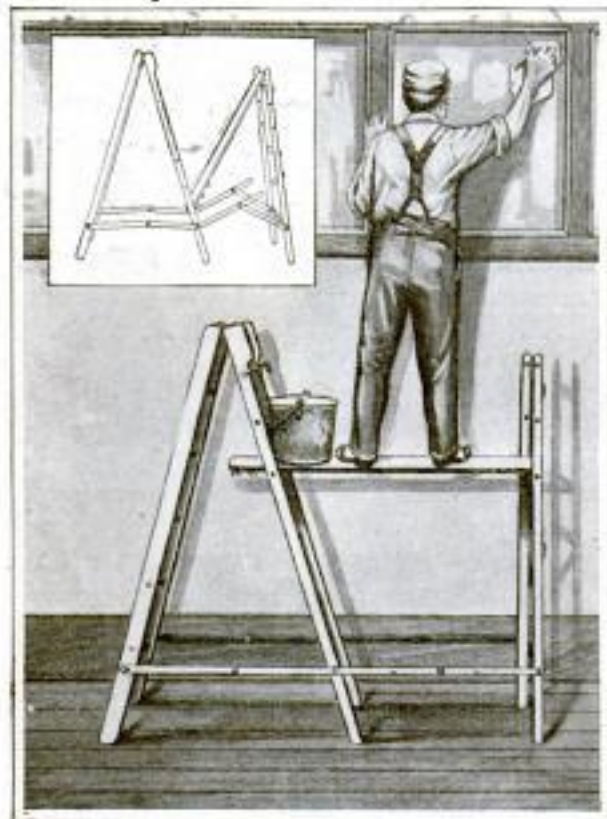

Combination Ladder and Scaffold Which Serves a Practical Purpose in a Household

folded up as compactly as an ordinary stepladder when not in use. While it may be employed by a paper hanger

or painter, it is more particularly designed for various household services. The height of the platform may be adjusted to suit the need, so that it may be used conveniently in washing high easement windows, wiping off the walls of a room, polishing chandeliers, or for similar purposes. When only a stepladder is required the device may be used as such without extending the scaffold.

HEAT-ABSORBING QUALITIES 9607 OF DIFFERENT COLORS

In an attempt to illustrate graphically the relative values for summer wear of different colors in dress materials, an interesting experiment was recently conducted. Four strips of cloth, made of the same material and weight, but of different colors, were placed on a cake of ice and exposed to the sun. The fabrics were white, yellow, red, and black. The result showed in a striking way how white reflects the sun's rays while black absorbs them. The ice covered by the piece of white cloth was not melted to any appreciable degree during the test; that under the yellow strip was slightly depressed; a deep cut was formed beneath the red cloth, and a groove approximately twice as deep as that covered by the latter was melted under the black fabric.



This illustrates, from a point of coolness, comparative values of different colors for summer wear. Above are shown four strips of cloth on a cake of ice presented to the sunlight. Below are to be seen the grooves melted under the red and black fabrics

Hinton Wilmore
Battle Creek, Mich.

Lester L. Sargent, 903 S. St., Wash. D. C.

Inventor: Simon Lake, Lake Torpedo Boat Co.,
Bridgeport, Conn.

9515 THE SUBMARINE FREIGHT TRAIN

America's Newest Contribution to the Art
of Warfare Adds Greatly to the Efficiency
of the Underwater Torpedo Boat as a
Blockading Arm

By FRANK PARKER STOCKBRIDGE

THIS description of the newest of war devices has been prepared from information furnished by its inventor, Mr. Simon Lake, of Bridgeport, Conn., and sketches made especially for this magazine at his shipbuilding yard there. Mr. Lake is a pioneer in the art of submarine-boat construction. His first experimental underwater craft was built in 1894. In 1897, six years before the first naval submarine was commissioned in the United States Navy, he was navigating below the surface of Long Island Sound in the "Argonaut." He has designed and built submarine torpedo boats for the navies of the United States, Russia, Germany, England, and several other powers, and is the originator of many devices now widely used in submarine navigation, including the inclining sideplanes, or fins, to enable a boat to submerge on an even keel instead of diving; the drop keel, which can be instantly detached from within, thus relieving the craft of many tons' weight and enabling it to float after an accident if it has the slightest reserve buoyancy left; the diving compartment and buffer wheels described in this article; the omniscope, an improved periscope giving vision all around the horizon, and many improvements in construction details.



Simon
Lake

—Editor

AN underwater freight train that makes it possible for a submarine torpedo boat to operate in hostile waters for an indefinite period has been devised by Simon Lake, an American inventor, who has designed and constructed submersible fighting craft for the navies of several of the European powers.

Just how many of these novel supply trains are in use, and by what nations, are military secrets. It has been pointed out by naval authorities that the German submarines which have been operating as commerce destroyers in the territorial waters of the British Isles must have some means of replenishing their supplies of fuel oil, fresh water, food, and ammunition without returning to a German naval base. Few, if any, submarines now in existence are known to have a cruising radius of more than 500 miles. German submarines operating in the Irish Sea and off the northwest coast of Scotland are at least 700 miles from the nearest German port.

By means of the submerged supply train, however, it is comparatively easy for a fighting submarine to obtain supplies at regular intervals with almost complete secrecy, for the transfer of stores of all kinds can be made under water. The only way the enemy could

detect what was going on would be by observation from an aeroplane.

Two, three, or more, submersible cars, cigar-shaped, water-tight, and fitted with buoyancy tanks inside and wheels on the lower side, make up a submarine freight train. These cars have no propelling machinery nor quarters for crews, but are towed behind a self-propelling submarine, which may also be equipped for firing torpedoes. Besides the towing line, the trailer cars are connected with the towing vessel by an air tube and an electric cable. The air hose is connected to powerful air pumps on the forward craft and to the water-ballast tanks of the trailers, which are normally filled to a weight that will float the trailers a few feet below the surface. Should the weather be fair and no enemy in sight, the air pumps can expel enough water from the ballast tanks, replacing it with air, to enable the whole tow to rise to the surface and take advantage of the higher speed obtainable in surface cruising, when the towing vessel's oil engines can be used instead of the electric storage batteries that must be depended on for propulsion when submerged. Should an enemy ship be sighted, releasing the air pressure causes all the ballast tanks to fill and the towed cars to sink out of sight,

C. McKnight Smith, 361 Broadway, N. Y. City.

807

Copyrighted material

while the towing vessel descends by the aid of its diving planes.

Each of the towed cars contains compartments for fuel oil and fresh water, each with a hose connection on the outside of the hull, and a space for food supplies and ammunition in water-tight cases. This last-named compartment has a door opening outward, on the bottom of the circular hull near the keel.

Transferring supplies from the towed cars to the towing craft or to an independent fighting submarine is done on the bottom of the sea, in shallow water. Here the value is apparent of the wheels with which nearly all of Mr. Lake's submarines are equipped. On a smooth, hard bottom they enable the submerged craft to travel safely with a minimum of buoyancy, and by holding the hull off the bottom prevent any suction or adhesion of mud that might prove serious. The hydro-pneumatic dashpots to which the wheels are connected by pivoted arms make them act as buffers should the craft sink suddenly or strike an obstacle in traveling along the bottom.

Arrived at the rendezvous, which may be almost under the guns of the en-

emy's coast fortifications and still be unsuspected, the submerged freight train comes to a halt on the bottom in 15 or 20 ft. of water. Under the bow of the towing vessel is a door, opening downward, leading into the sea from a compartment that is cut off from the rest of the craft's interior by air-tight bulkheads. This diving lock is another feature developed by Mr. Lake and used on nearly all his submarines. In shallow water it is not difficult to maintain, inside of this lock, either from compressed-air tanks or by the direct action of a pump, an air pressure that will balance the external water pressure and keep the inside dry even with the door wide open. The diving compartment, in fact, is practically a traveling diving bell. It is large enough to hold two men, one to aid the diver, the other in diving armor, being free to walk along the sea bottom and unload the towboats. Oil and water are transferred to the waiting submarine through pipes. To get at the stores in the air-tight compartment, the diver opens the door from outside. Air pressure from the pumps of the towing vessel keeps the water out, and the interior is lighted by electricity, con-

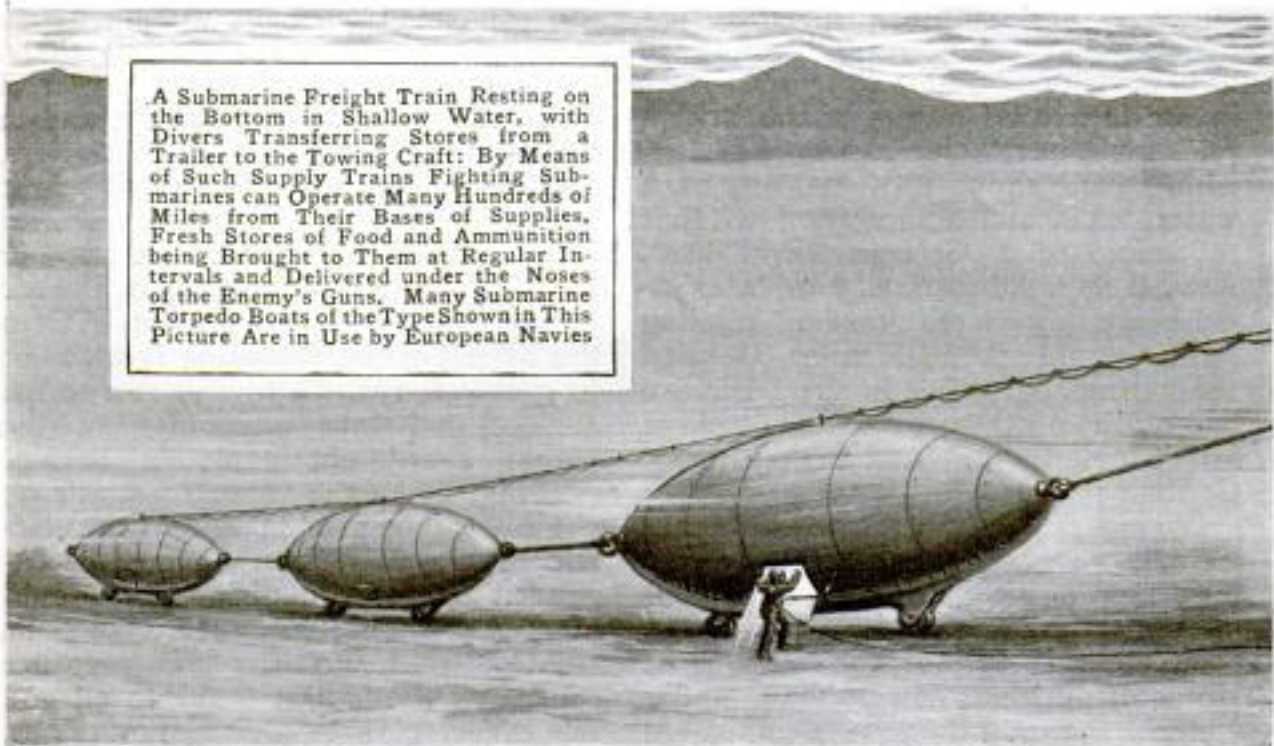

A Submarine Freight Train Resting on the Bottom in Shallow Water, with Divers Transferring Stores from a Trailer to the Towing Craft: By Means of Such Supply Trains Fighting Submarines can Operate Many Hundreds of Miles from Their Bases of Supplies, Fresh Stores of Food and Ammunition being Brought to Them at Regular Intervals and Delivered under the Noses of the Enemy's Guns. Many Submarine Torpedo Boats of the Type Shown in This Picture Are in Use by European Navies

veyed from the storage battery of the main craft. Food in tins, cartridges for rifles and machine guns, even torpedoes, may be transferred in this way from one vessel to another without so much as a ripple on the surface indicating to an observer on shore or on a hostile ship that anything unusual is going on.

When the fighting boat has replenished its stores, the submarine freight train moves on, perhaps to keep a rendezvous with still another underwater craft before returning to the naval base for a fresh cargo.

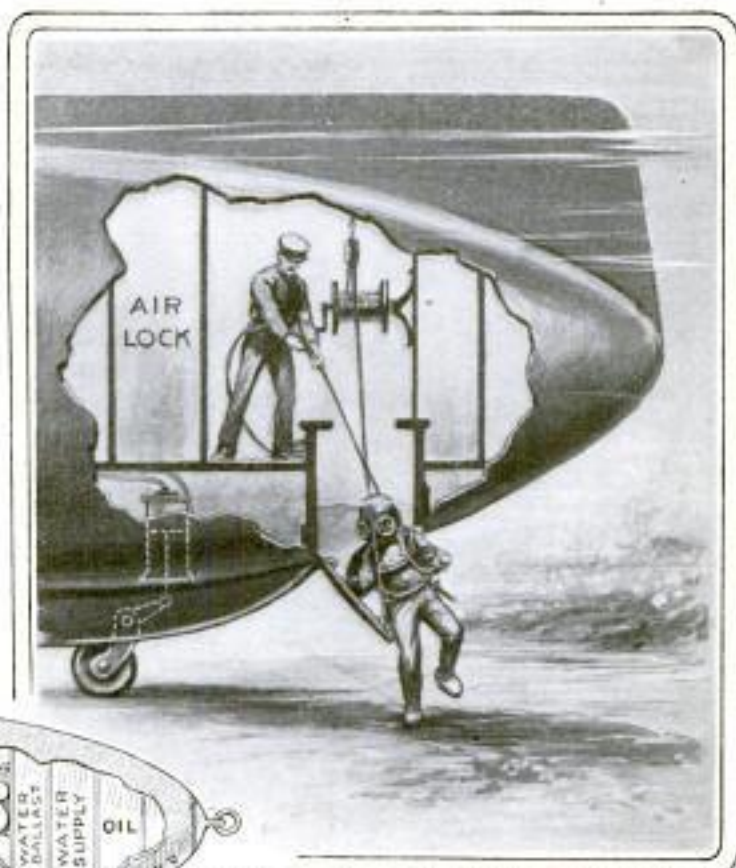

Air Pressure from Within Keeps the Water Out
HOSE CONNECTION

A Trailer of the Submarine Freight Train, Showing How Fuel, Water, Food, and Ammunition are Stored

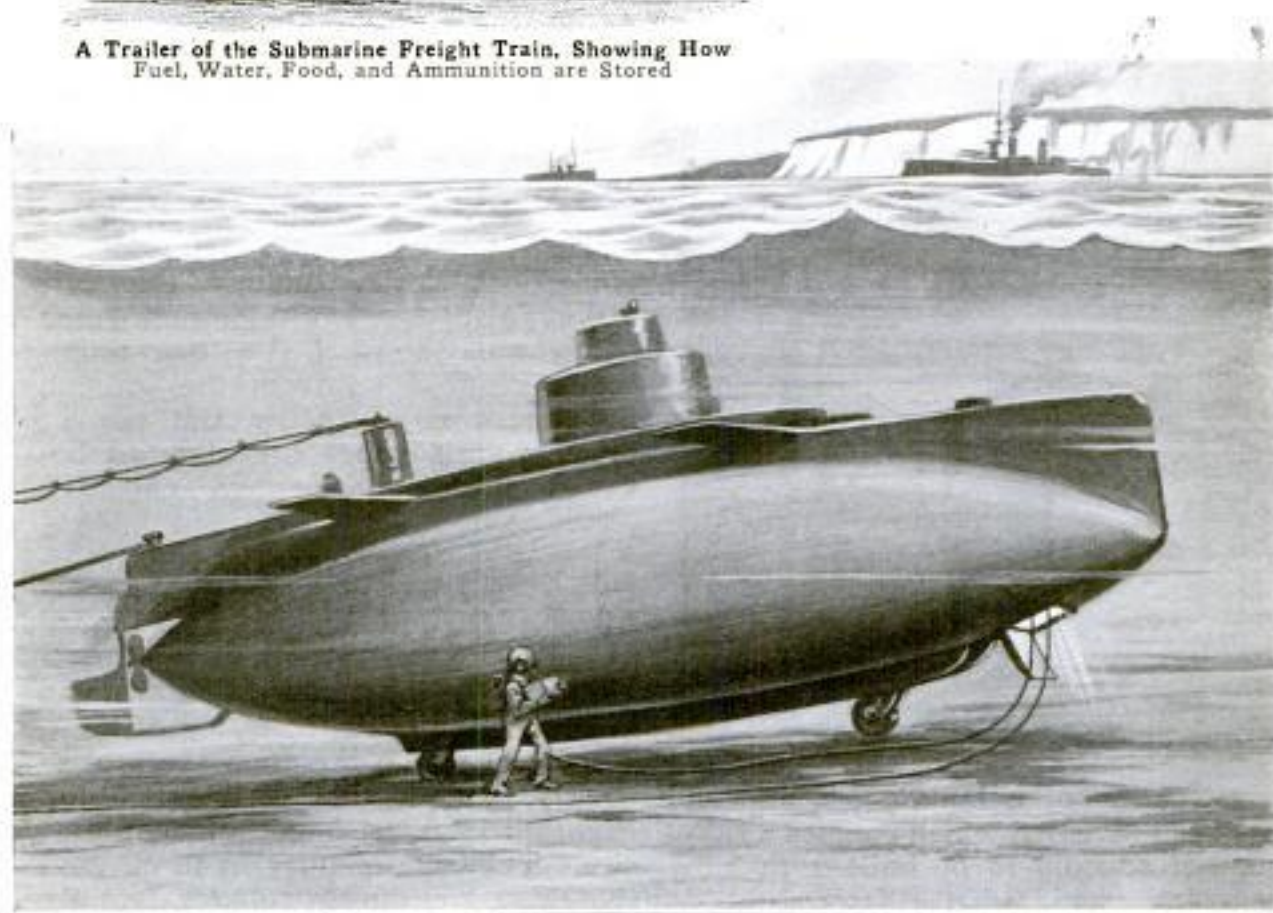

Inventor: J. J. Maclem,
Hoquiam, Wash.

810

POPULAR MECHANICS

Scaffolding

TEMPORARY STAGING BUILT
WITH LADDER BRACKETS

9398

To simplify the work of erecting interior and exterior stagings during the

time. It consists of a casting designed to be clamped to the rungs of a ladder so as to hold out plank arms to support the scaffold flooring, or to allow a plank to be extended between two ladders. Each bracket has two slots for receiving boards, so that they may be projected from both sides of a ladder if a long staging is needed. Or, if an especially heavy one is wanted, the planking may be doubled. When staging is needed for the inside decoration of a church or theater, four ladders and brackets may be used and the square formed by them planked over to suit

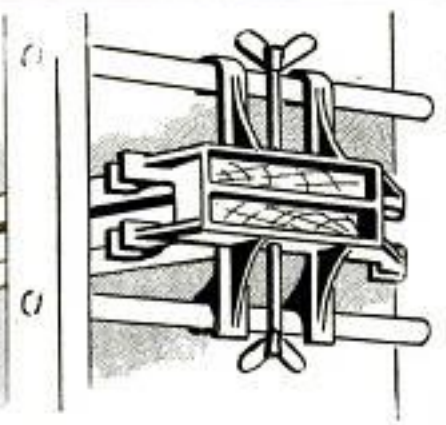
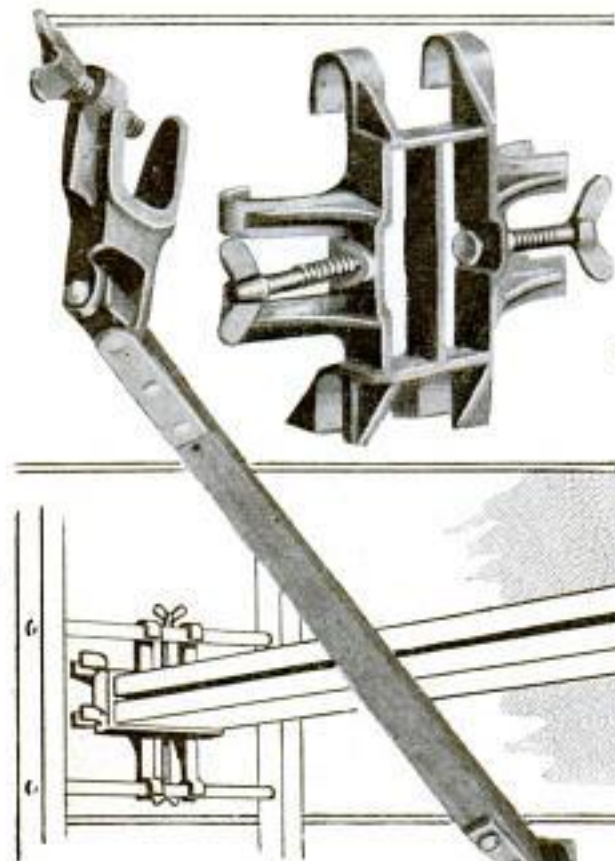

This Shows the Ladder Brackets and Two of the Ways in Which They may be Employed in Erecting Staging



construction of a building, a bracket has been invented which enables a substantial scaffold to be built with ladders and planking in a few minutes'

C. J. Glasier, Daily World,
Aberdeen, Wash.

the needs. Ladders may also be set inside of a building and plank arms extended out of the windows, thus furnishing a support for staging on which cornices may be reached without building a scaffold up from the ground. Steadiness is given by the use of bracing arms which are clamped between the ladder rungs and the planking.

KITE FIGHTING A POPULAR
9104 JAPANESE SPORT

One of the most interesting customs in connection with the flying of kites, a sport of which the Japanese are intensely fond, is that of kite fighting. Fighting kites are made of enormous size. They are circular in form, with the circle inclosing a square, strongly

The Japan Magazine

* # Geo. F. Wörta, 627 W. 113 St.
Designed by: Forest
Dr. Lee Dr. Forest
(Res) River Drive, New York, N.Y. City

POPULAR MECHANICS

811

Confidential - Do not give this name or address - See data

MILITARY RADIO EQUIPMENT
CARRIED ON MOTORCYCLE ^{By 4/15} 9 1/2 1/2

braced diagonally, the woodwork being all of bamboo. The frame is covered with some 1,600 sheets of Japanese paper, which are bound firmly to the frame with hemp strings and on which is painted an emblem for distinguishing the kite when it is in the air. The ropes for handling these kites are made of strong hemp, an inch or more in diameter and more than 2,000 ft. long. Getting one of these enormous kites to take the air is a problem that requires careful preparation and skillful handling. The usual way is to set up a post to which is attached a long chain borne out in the direction that the wind is blowing and carrying 50 or 60 sandbags. To the end of this chain the kite rope is attached. The big kite is set up against timbers driven into the ground, and about 20 men stand by ready to throw it into the air when the word is given. At some distance from the kite the rope is held by about 30 men, and between this group and the chain is a second similar group. These let loose of the rope in succession as the kite ascends, and the final work of controlling the kite falls to a third group stationed at the junction of the rope and chain. The kites are flown in pairs and are played against each other, each party trying to bring the kites into collision in such a way as to destroy the equilibrium of the rival kite and make it fall. The kite that stays up until the wind ceases or until the others are vanquished is victorious. In the vicinity of Muya there are between 20 and 30 kite-flying associations, and each has a fighting kite of its own.

Designed particularly for military purposes in the field, a combination wireless-telephone and telegraph equipment has been developed which is carried in a sidecar compartment attached to a motorcycle. The apparatus is compact, portable, and is claimed to have a telegraphic transmitting radius of ap-



Motorcycle Radio Equipment Which has been Developed for Military Purposes

proximately 100 miles and a telephonic range of about half that distance. Both of the sending instruments are actuated by a high-voltage direct current supplied by a dynamo which is driven by a separate motorcycle engine mounted in the side compartment. Two distinct types of electric waves may be sent out, so that for war purposes, when precautions are needed, a highly damped current may be employed instead of the undamped impulses used for ordinary service. For supporting the antenna a telescopic steel mast is used that may be raised or lowered quickly. For transporting, this mast is strapped securely at one side of the machine.

1391 Development Dr.
New York

Army + Navy Journal
NEW EXPLOSIVE KILLS BY
 9716 **ASPHYXIATION**

The rumor in circulation since the beginning of the war to the effect that the French were in possession of a secret explosive capable of destroying life on a scale not heretofore dreamed of, by the production of deadly asphyxiating gases, has been confirmed by the French military authorities. This explosive is called turpinite and is the discovery of M. Eugene Turpin, the inventor of melinite. It has already been used in a limited way and the statement is now made that preparations have been completed for using it on a large scale in the coming operations against the Germans.

Ever since the war began there has been a vague but general belief that the great conflict might eventually be ended by the discovery by one of the belligerents of some explosive so deadly in its effects that no troops could live in the face of it. If the apparently reliable statements given out in connection with turpinite prove well-founded in actual warfare, that discovery has been made and the world will soon be called upon to witness its effects.

At the opening of the war the effects of exploding turpinite were familiar to the experimenters working with it in the laboratory. It could only be exploded by vibration and at that time there seemed no safe way of firing it from a gun, for the reason that the vibration caused by the discharge of the projectile was likely to explode it before it had got clear of the gun.

With a new fieldpiece invented in December it is possible to fire shells charged with turpinite without danger to the firing party, and it is reported that the French and British arsenals have been busy day and night since then making the shells and the guns for firing them.

When the shell explodes the gases caused by the explosion spread over the ground in a circle having a diameter of about 100 yd. The gases produce paralysis of some of the vital

organs of the body, with the result that every living thing within this circle is killed instantly and painlessly, and so far as is now known there is no defense against nor antidote for the action of these gases. If the turpinite does all that is claimed for it, trenches will furnish practically no defense against it. The gases from a shell exploding within 50 yd. of the trench will simply settle into the trench and kill the men sheltered in it. Shrapnel-proof and bomb-proof covers will be of little use, for the gases in their deadly work will find their way through the smallest opening.

The announcement of the discovery of this explosive apparently confirms several newspaper stories that were too fantastic to be believed at the time they were told. One of these was the report that a French charging party had taken possession of a house in which was found a number of dead German officers and sentries bearing no evidence of wounds of any kind, and in such postures as to indicate that they had been stricken dead instantly. It is now stated that the death of these men was caused by a turpinite shell which had crashed through the wall and exploded within the house.

NOVEL RAILROAD EXHIBIT AT
 9562 **SAN FRANCISCO**

Four western railways have coöperated in building an interesting exhibit in the Transportation Building at the Panama-Pacific Exposition. It consists of a globe, approximately 50 ft. in diameter, which on one face carries a large relief map of North America. Between the points representing San Francisco and St. Louis, miniature trains, which are produced by an ingenious electrical arrangement, flit across the map at frequent intervals. The trip is made in three minutes, and as a train passes through different cities along the line the names of the places are illuminated electrically. Surrounding the globe, and separated by arches leading to its interior, are figures symbolic of transportation, agriculture,



Railway Exhibit in the Transportation Building at the Panama-Pacific Exposition Which Holds Particular Interest Because of Electrical Effects Which are Produced Ingeniously

recreation, and industries. On the inside of the globe are reproductions of many points of interest in the West, such as the Royal Gorge, Denver, Salt Lake City, and other familiar places along the railroads. Overhead a pleasing starlight effect is produced by an ingenious lighting plan which shows several constellations and gives many of the stars a realistic twinkle. Electricity is also used in obtaining effects such as cloud formations, running water, and various moving objects, nearly all of which have required the construction of special apparatus as well as, in most instances, their invention.

Naval guns have a longer range than land guns of the same size because it is easier to reline them, and so heavier charges can be used.

CURBS ON DARKENED STREETS IN BRITAIN WHITEWASHED

9506

Since the exigencies of war have made it necessary largely to eliminate street lighting in British cities, it has been found advisable in certain instances to whitewash the curbs on either side of public thoroughfares so as to make it easier to discern the roadways at night. At Norwich a pneumatic painting machine carried on a steam wagon has been successfully employed for doing this work. The lime solution is forced through a hose under air pressure and directed at the curb. A nozzle especially designed so as to prevent the spreading of the wash beyond certain limits is used. With this equipment the work can be done at a rate of about three miles an hour.

The Engineer, Feb. 19, 1915

Paul Thompson, 10 Spruce St.
N. Y. City

J. A. Lundberg, Arrow Rock,
Idaho.

**9469 SWORD GIVEN KING ALBERT
BY CITIZENS OF PARIS**

As a token of their esteem, the citizens of Paris have presented King Albert of Belgium with a sword which

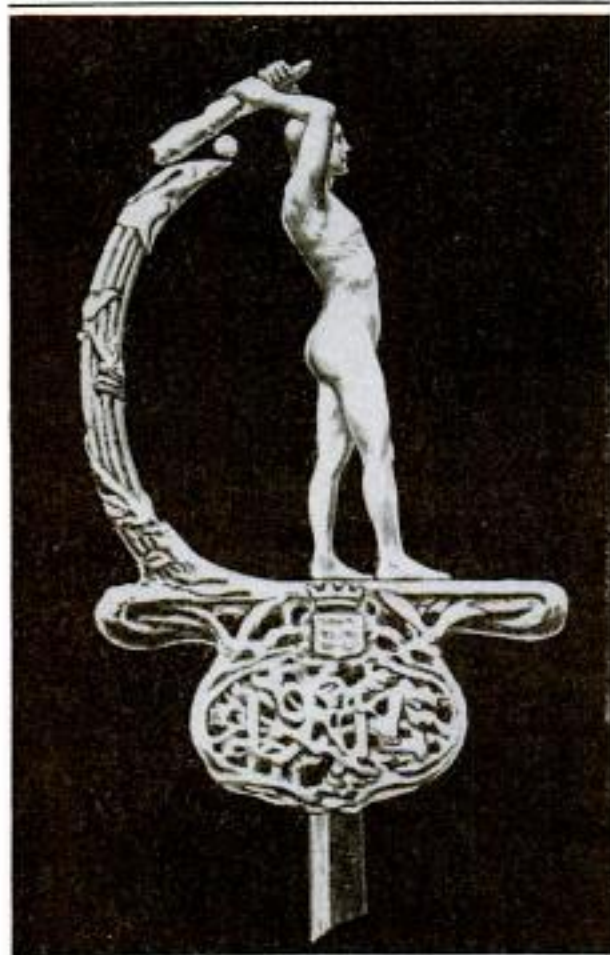

This Sword has been Given to the King of the Belgians by the Citizens of Paris

is in a way emblematic of the struggle now being waged by the ruler and his people. The hilt is made of carved gold. An athletic figure, symbolical of the Belgians, standing on the cross guard and holding back a club in readiness to strike, forms the grip. The guard, which extends from the end of the club to one of the quillons of the cross guard, represents a wreath.

¶To save bandage materials, British and French surgeons at army hospitals on the fields are employing sterilized sawdust as an absorbent for wounds. The particles are finely screened and sewed in bags made of antiseptic gauze.

**9523 ARROWROCK DAM ALMOST
READY FOR USE**

Now that the bulk of the concrete work on the Arrowrock dam in Idaho has been done and the structure needs only the addition of a few minor details to make it ready for service, it is possible to get some adequate appreciation of the magnitude of this, one of the largest dams in the world. The dam is built of reinforced concrete and is nearly 350 ft. high at the highest point. The length of the crest is 1,060 ft.; the thickness at base, 240 ft., and the thickness at the top, 16 ft. As will be seen from the illustration, the face of the dam looks more like the sheer wall of a cañon than a structure raised by human hands.

Something like 600,000 cu. yd. of concrete went into the structure and 250,000 cu. yd. of excavation was necessary to get the foundations down to the solid granite, 80 ft. below the bed of the river. It is built in the form of a curve with the convex side upstream so that the structure does not depend on its own weight alone for stability, but acts as a horizontal arch in resisting the tremendous head of water, transmitting the pressure to abutments that consist of the granite walls of the cañon itself. The gates and accessories alone weigh 1,000 tons, and the spillway, which is capable of discharging 40,000 cu. ft. of water a second, required the excavation of 300,000 cu. yd. of material. The construction of the dam was started in 1911 and it took four years of continuous work to complete it. The reservoir formed by the dam will be about 18 miles long and, when full, will contain enough water to cover an area of 360 square miles to a depth of one foot.

Electricity played an important part in the work of construction. About 15 miles down the river the government built a 3,200-hp. hydroelectric plant, and from this plant power was supplied for operating the crushers, mixing machines, and other equipment used in building the dam. The concrete was mixed in mixing machines placed at the

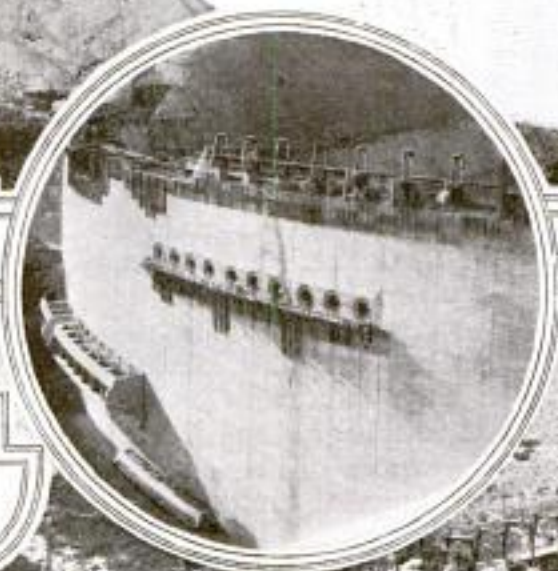

These Views Show the Arrangement of the Outlets and the Way in Which the Dam is Curved Upstream

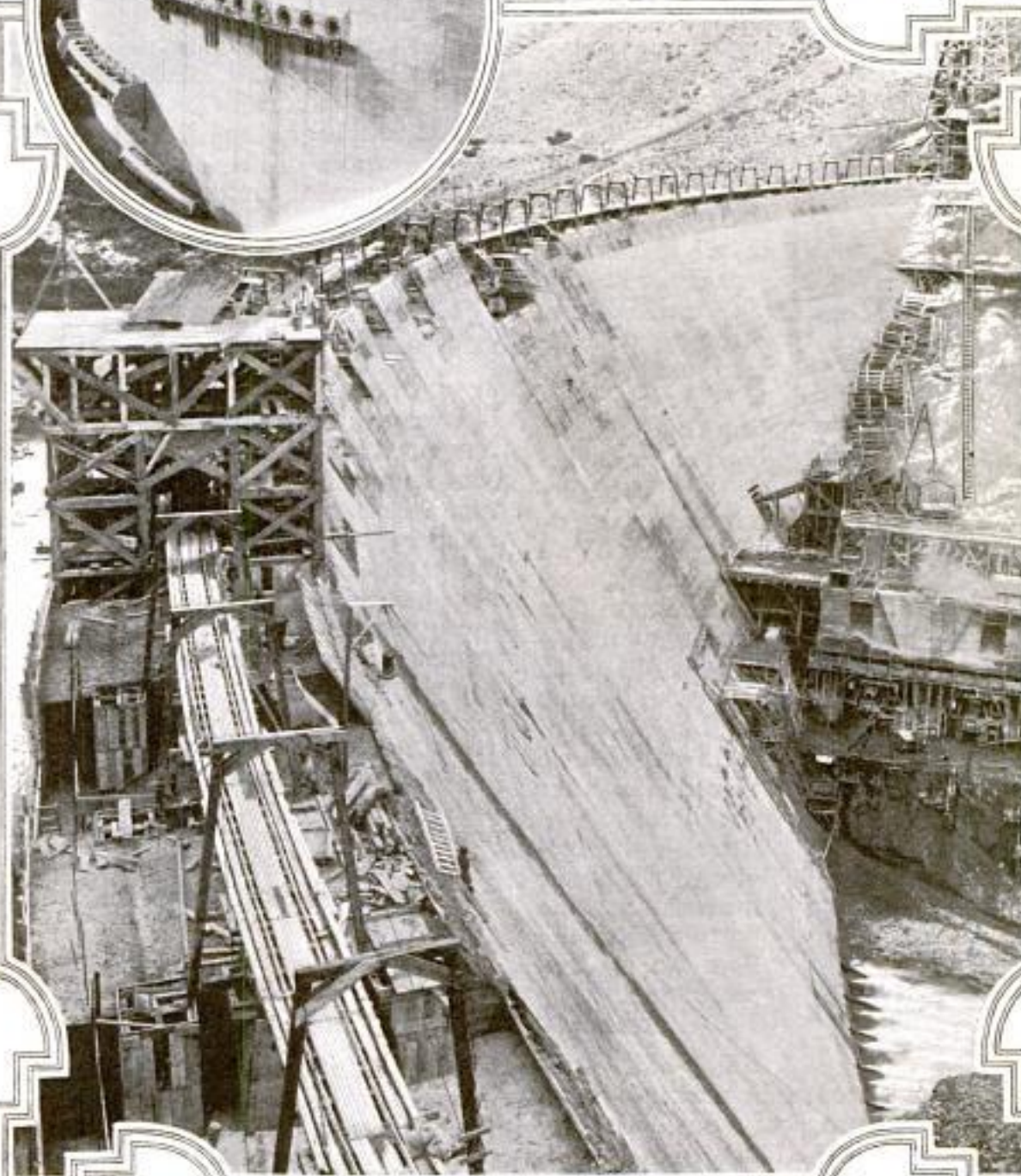

The Downstream Face of the Arrowrock Dam in Idaho, as It Appeared When Built to within 50 Feet of the Top

Inventor: *Chas. F. McKeesson,*
Colorado Springs, Colo.
 Mfg: *The Stearns-Roger Mfg. Co.*
1718 California St.,
Denver, Colo.

sides of the cañon and was conveyed to the dam by cableways, each of which was operated by a 300-hp. electric motor. The concrete was dumped from the cableway buckets into small electric cars which carried it to the particular point required. Each cableway was capable of handling about 15 tons and was used not only in transporting the concrete but in doing much of the heavy lifting and carrying required about the dam during the period of construction.

Radiators
MAKING HEATING FIXTURES

9080 UTILIZE WASTE SPACE

After completing the erection of a factory building at Springfield, Mass.,

it was found that there was no available wall space for heating fixtures. This brought about the adoption of a scheme of placing the radiators vertically on the sides of the interior supporting pillars, which consist of steel I-columns. The radiators used are made with five pipes to each section, seven of which were placed one after the other on two sides of the columns. A heavy bracket at the bottom near the floor holds each set in place.

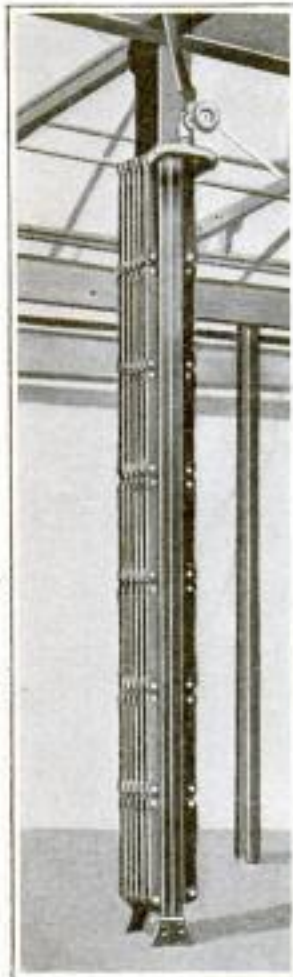

Golf-ball makers have adopted a new paint which does not flake or chip off under repeated blows of the clubs. It is a rubber preparation and is vulcanized to the surface of the ball.

8882 SCREENLESS APPARATUS FOR SIZING COAL

Mechanism
 Sizing coal without screens is made possible by a new sizer that consists simply of a succession of corrugated shaker plates over which the coal is passed. The corrugations run lengthwise of the plates and the plates are inclined sidewise. Lumps of coal that are too large to be held in the corrugations roll off the plate at the side, while those held in the corrugations are shaken forward and deposited on the next plate. The corrugations are largest in the first plate, decreasing with each succeeding plate to correspond to the grading of the coal. The main purpose of this sizer is to diminish breakage of the coal.

AUTOMATIC COMPUTATION

8501 OF SHIPS' SPEED

When battleships are maneuvering or steaming ahead in fleet formation, it is essential that each navigator know the speed his vessel is making, in order that it may be kept in its proper position in relation to the others. Quite recently two new automatic methods for establishing the speed of vessels have been perfected, one in Sweden and the other in this country. The latter system has been adopted by the Navy Department and installed in the latest United States men-o'-war and auxiliary vessels.

The plan takes advantage of the uniform slip of propellers at a given speed, and by means of specially designed instruments, the revolutions of the various propulsion shafts are translated into distance traveled through the water. This eliminates all the calculations heretofore required in computing the speed and distance made by a vessel. With every 100 turns of the propulsion shafts the distance is worked out automatically by the instruments and the revolutions per minute given every 200 turns, and the speed also estimated. The revolutions both ahead and astern are counted.

H. R. Gary, Cummings Ship
Instruments Works,
110 High St. Boston, Mass.

In use in plant of the Wender Mfg. Co., Springfield, Mass.
H. B. Smith Co. of Westfield, Mass. Radiators were used.

mfr: Thomas Bemis,
Indianapolis, Ind.
Industrial Bldg. 817

All of these various functions are performed by devices operated by the vacuum produced in condensers by the action of pumps connected with the various shafts. The direction indicators are worked by means of pressure and vacuum produced by pumps connected with each shaft, a rotation in one direction producing a partial vacuum that turns the indicator hand "ahead," and a movement in the opposite direction causing a pressure which throws the hand "astern." The indicators are placed in the chart house, conning tower, and on the bridge, besides also being at the command of the engineers in both the port and starboard engine rooms.

The new Swedish plan is totally different from this and remarkably simple. Two pipes are placed through the bottom of the vessel; one a Pitot tube, which is a pipe bent at right angles and placed in the water with its mouth open in the direction in which the boat is moving, and the other a straight pipe ending flush with the exterior of the hull. Each of these leads to a separate chamber in a vessel which is separated from the other by a sensitive membrane. The difference in the pressure between the two sides affects the membrane and acts on a lever which, by

HOOP CYCLE NEW VEHICLE
9588 FOR CHILDREN

Something distinctly novel in the way of a pleasure vehicle for boys has recently been invented in the form of



Coasting with a Hoop Cycle, a New Vehicle Which has been Invented for Boys

a hoop cycle. It serves to bridge the gap between the tricycle and bicycle, furnishing an endless amount of fun and stimulus for exercise. The device consists of a 1/2-in. pipe welded into a large hoop, suspended within which on sheave rollers is a yoke carrying a seat. Extending to the rear of this is a two-wheeled balancing gear which is raised from the ground when the rider leans forward. The machine is propelled by the feet, the boy running until he gets up sufficient speed to carry him along, or rolling the cycle by an occasional push with his feet. On small hills the device may be used for coasting, although this is not advisable on steep inclines where there is any possibility of the hoop getting beyond control.



One of the Indicators Used in the Speed-Computing System Installed on American Battleships

means of intervening mechanism, conveys the pressure to a tube of glycerin to which a manometer is attached. The indicators may be extended to any part of the vessel.

☛The government radio station at Cavite, P. I., will have 600-ft. towers.

mfr: *Keppeler Glass Construction, Inc.,*
101 Park Ave., N.Y. City.

Berlin
London
Paris
Vienna
Budapest

PROVIDING ADEQUATE LIGHT
9570 IN MODERN BUILDINGS

Heavy glass partitions which are translucent, substantial, and fireproof are being introduced as a means of dis-

tributing sunlight through large business buildings without lessening the privacy of the various offices. The walls are sound-proof and nontransparent, which gives them essentially the advantages of the ordinary wall, but not the disadvantages. They are built of clear-glass units, 2 in. thick and either 6 or 8 in. square, which are reduced to translucency by impressed de-

signs. The blocks are held together by steel-reinforced cement cores which bind the various rows into panels. These strengthening members are partly hidden by painting the concave edges, or grooves, in the glass, white. When a floor in a building is divided by partitions of this kind the picture moldings, chair rails, surbases, doors, and transoms are made of metal. The installation, although requiring careful, clean work, is not difficult and can be done by any good mason.

BRIDGE SPANS
RAILROADED
INTO PLACE

9711 An unusual method of bridge erection brought about by unusual conditions was used in renewing the Ponnair bridge on the South Indian Railway. The work was done in the dry season, when, in common with other streams of the country, there was little or no water in the river, and it was therefore possible to lay tracks across the river bed for construction purposes. The spans were assembled in a yard near one end of the bridge and were transported to their positions in the

structure by means of trucks running on tracks laid on the river bed. Each span was carried on four six-wheel trucks, two placed under each end of the span and operating on two parallel tracks. Over each pair of trucks was a framework for supporting the span and built to such a height that the span could be slid to the tops of its piers without the necessity of raising or low-

Railway Age Gazette 1-22-15
Data filed with 9857

John O. Rowers Co., 11 W. 25th St., N. York City

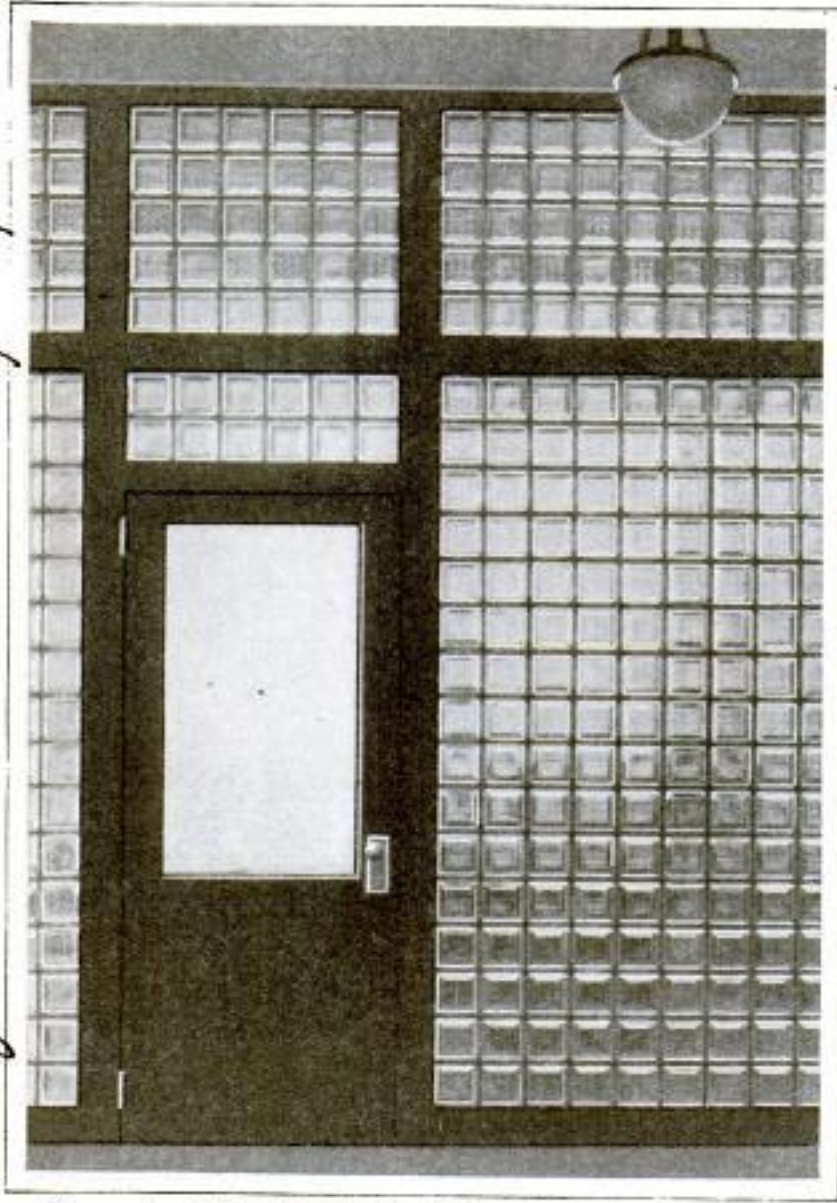

Fireproof and Sound-Deadening Wall Built of Translucent-Glass Blocks So as to Provide Sunlight in Rooms without Windows or Skylights

tributing sunlight through large business buildings without lessening the privacy of the various offices. The walls are sound-proof and nontransparent, which gives them essentially the advantages of the ordinary wall, but not the disadvantages. They are built of clear-glass units, 2 in. thick and either 6 or 8 in. square, which are reduced to translucency by impressed de-

*Invr: C. M. Bowman
The Lebanon Daily Times,
908 Cumberland St.,
Lebanon, Pa. 819*

POPULAR MECHANICS

ering. A ramp, or inclined track, was used for loading the spans on these timber supports, and the same means was used for lowering the old spans from the piers to trucks running on tracks placed on the opposite side of the bridge, by which they were conveyed to the shore for dismantling.

BUNGALOWS BUILT FOR 9196 SCHOOL USE

Following the burning of a 20-room school building in Los Angeles, emergency quarters for the school children of the district were provided within 30 days by the construction of a group of bungalows of the type characteristic of southern California. The embers of the fire were hardly cold when lumber and workmen were on the ground and the construction of the 12 bungalows had been started, the buildings being grouped around a court, as shown in the illustration. The bungalows are of simple but sound construction. Each is built with a double roof, inclosing an air space which helps in keeping the rooms cool during the hot months. Within the 30 days the buildings were not only completed but were ready for use, with all desks, blackboards, and other accessories, in place.

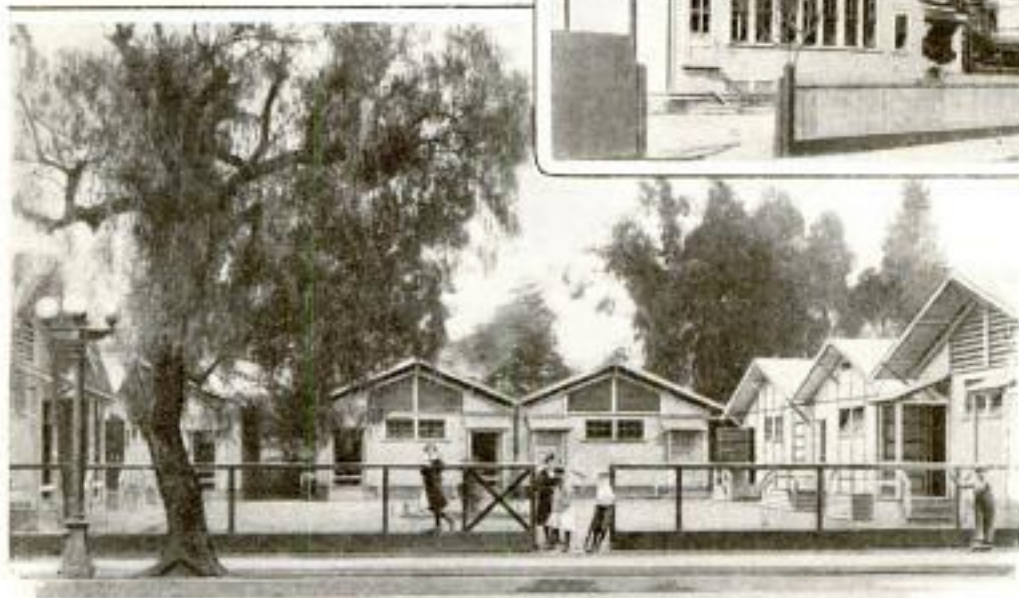

These 12 Bungalows were Built and Fully Equipped for School Use within 30 Days after the Los Angeles School Building Shown Above had been Destroyed by Fire; Each Bungalow Has a Double Roof with Inclosed Air Space for Protection against the Heat of the Sun

OIL RESERVOIR IN HANDLE 8849 OF COAL SHOVEL

A coal shovel with the handle in the form of a cylindrical reservoir for holding oil is being manufactured for factory use. At the lower end of the handle, convenient to the left hand of the user, is a valve which, when pressed by the thumb, permits oil to flow into the shovel. The oily coal ignites more quickly than it otherwise would, producing better combustion and less smoke.



According to the U. S. Department of Agriculture there is more nourishment in 10 cents' worth of potatoes, when these are 60 cents a bushel, than in 10 cents' worth of bread at five cents the pound loaf.

*J. T. Sturgeon, 620 S. Broad St.,
Los Angeles, Cal.*

Miss Maud E. Welsh
336 W. Eaton Ave.,
Triffle Creek, Colo.
820

The Noncarbene Co.
1765 Broadway,
N. Y. City

POPULAR MECHANICS

Access
on

9317 ODD MOTOR-CAR ACCIDENT
WHICH INJURED NO ONE

While being driven across a culvert over a small stream near Rifle, Colo., a light touring car containing four per-



A Nasty Motor-Car Accident Which Ended without Injuring the Occupants

sons ran off the edge of the structure, turned turtle and fell into the water at right angles to the direction in which it was going. The remarkable part of the accident was that although the body of the machine was half submerged in the water and mired in mud, none of the occupants was injured. They escaped in some unaccountable manner and did it so involuntarily that they were unable afterward to give any account of the feat.

8442 STORAGE HOUSE IS BURNED
BY SLAKING OF LIME

Fire destroyed a railroad freight-storage house at Middletown, Conn., some weeks ago when flood water rose in the building and came in contact with a consignment of unslaked lime. Considerable heat is liberated when lime is slaked, and this caused the ignition of surrounding inflammable materials. Fires quite frequently originate from this cause when lump lime is stored in structures with leaky roofs, and for this reason it should always be placed where it will remain dry.

Concrete Cement Age
7/14

9556 SOLUTION FOR PREVENTING
DEPOSIT OF CARBON

A new mineral-oil product that has just been placed on the market is designed to bring about a more complete combustion of the gases in a gasoline engine and at the same time to prevent the formation of carbon deposits in the engine cylinders. The solution is made up of mineral oils of a solvent and cleansing nature and is mixed with the gasoline, so that it acts at each explosion of the gas. The effect of the solution is to cause the carbon to remain in a finely granulated state so that it will either be burned or be blown out of the cylinder at each exhaust stroke of the piston. It is claimed for this solution that it will not only keep the cylinders clear of carbon, but will quickly clean out any carbon deposits that have already been formed.

9158 CALIFORNIA TOWN HAS
"HOBO" HOTEL

A novel experiment of the greatest interest in a social way is being tried at Palo Alto, Cal., the seat of Leland Stanford University, where a "hobo" hotel has been established and is conducted on such a basis that each "guest" is required to work for his board and lodging. This is said to be the only hotel of the kind in the world. Only a small amount of work is required, the idea being to keep away tramps who are too lazy to do any work, and to prevent the town from being overrun with men of this class, attracted to Palo Alto by its mild winter climate. The hotel is a one-story wooden structure, 50 ft. long and 20 ft. wide. The interior consists of one large room the floor of which is covered with tar paper. Arranged around

Milton Abel Hagen.
Stanford University, Cal.
Copyrighted material

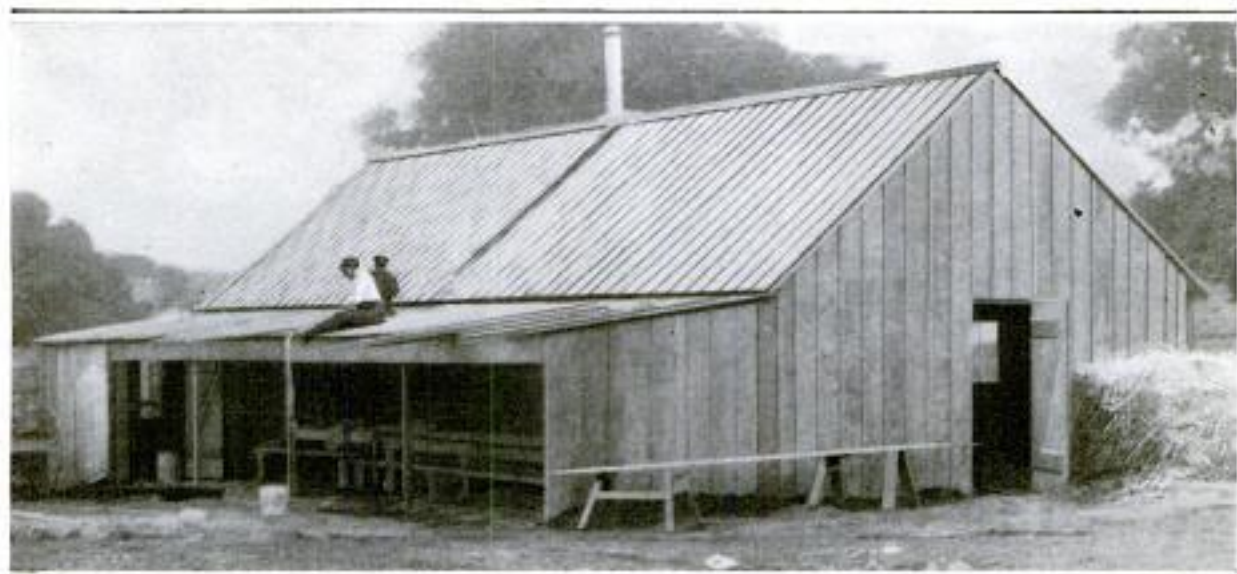

The "Hobo" Hotel Recently Built at Palo Alto, California: Each Guest is Required to Work for His Board and Lodging

the walls are 39 rough bunks covered with straw, and in the center of the room is a stove. This room is used only for sleeping quarters. Cooking facilities and dining table are placed in a porch that runs the full length of the main building. In the inclosed end of this porch is the kitchen in which is a French range, while the dining room consists of the open portion and is equipped with long tables and benches.

MACHINE FOR CLEANSING 9425 WHEAT SEED OF SMUT

It is expected that a big increase will be brought about in the wheat yield of Montana and the Dakotas through the use of seed-treating machines now being introduced and designed to prevent the development of smut in the growing grain. Smut is the wheat grower's greatest handicap and sometimes results in the loss of from 50 to 75 per cent of a crop. There is only one known way of preventing damage from this cause, and that is by giving the seeds a bath in formaldehyde before sowing. This was formerly done laboriously by hand, if at all. The new machine does the work rapidly and thoroughly. It consists essentially of a cylindrical screen that hangs in a tank filled with formaldehyde. With

the screen filled with wheat it is rocked back and forth by a handle until every grain has been thoroughly washed in the liquid. This process also results in washing many of the grass and weed seeds through the holes in the screen into the bottom of the tank, so that the wheat is not only freed of smut but of objectionable seeds of other kinds. A



Machine for Washing Wheat Seed in Formaldehyde to Prevent Formation of Smut in the Growing Grain

bagging device mounted on the side of the machine makes it possible to sack the wheat as fast as it is treated.

During 1914 nearly one billion packages were hauled in the U. S. parcel post.

*mfr: F. B. Connelly Co.,
Billings, Mont.
Miss Florence L. Clark, Bozeman, Mont.*

Underwood & U.
417 Fifth Ave.,
822 N. Y. City

MONUMENT TO BISMARCK
ERECTED AT NURNBERG

9527

In memory of the great Prussian statesman and diplomat, Bismarck,

who brought about the unity of Germany and concluded the triple alliance with the Austrian and Italian governments, a large monument has recently been constructed at Nürnberg, in Bavaria. It is a heavy stone structure built in the form of a tower, surmounting which is a figure, approximately 15 feet in height, of the prince dressed in military attire and mounted on a war horse. Set in long niches which extend far up the sides of the monument are statues symbolical of Justice, Truth, Courage, and Might.

Bismarck's influence in Europe was profound and has had a lasting effect upon the German people. Toward the latter part of his life, after he had gained renown in international affairs, he inaugurated a series of economic reforms in the empire, some of which were intended to benefit the condition of the laboring classes, and also became a strong advocate of a vigorous colonial policy. Subsequently he incurred the displeasure of Wilhelm II and retired from public life, at which time the title of Duke of Lauenburg was conferred upon him.

Since the war began the scarcity of steamships has caused the return of many square-rigged sailing vessels to the transatlantic service. Ships which have been out of service for years are now entering ports in this country.



Monument in Memory of Bismarck Recently Completed at Nürnberg in Bavaria

Submitted by Brooks Mfg. Co., Saginaw, Mich - one of their boats
 Owner of boat shown in picture: O. G. Brendler, Springfield, Mass.



Motorcycle Camping
 Outfit with Boat
 Carried on a Trailer

MAKING CAMPING JUNKETS

9292 **WITH A MOTORCYCLE**

An eastern sportsman who is fond of rowing and fishing, but who lives at some distance from the water, has devised a convenient method of transporting a boat with him on his cross-country excursions with a motorcycle. Attached to the machine is a sidecar which enables him to carry a passenger, while a light, two-wheeled trailer is used for carrying a boat. This is attached to the machine by means of a simple coupling which allows it to take the turns easily and also prevents it from ramming the motorcycle when the brakes are applied. All the provisions and equipment necessary for a short camping junket are carried in the boat, leaving the motorcycle unhampered by paraphernalia. In launching, or drawing, the boat onto the trailer, the running gear is pushed into the water and the craft slid off or on, as the case may be. This enables it to be handled readily by one person.

9075 **ROLLER CONVEYOR DESIGNED FOR HANDLING BRICKS**

To facilitate the work of loading and piling bricks as well as that of distributing them to the different parts of a building during the course of its construction, a conveyor has been invented

which minimizes the consumption of time and loss by damage due to rough handling. It consists of a long chute, the bottom of which is fitted with steel rollers. This may be extended from a wagon so that the unloading and orderly piling of bricks may be materially assisted. It may also be used in



Handling Bricks on a Building Site with the New Conveyor

distributing them from one side of a building to another, or from the outside to the interior.

Prometheus 10/24/14
 maker: Edward Hoering, G. m. b. H. A.
 Droyenstrasse 3, Charlottenburg, Berlin. (B 7/47/15)

Geo. M. Clark & Co.

179 N. Michigan Ave.,
Chicago, Ill.

824

**GLASS FUEL TANK IS USED
ON NEW OIL STOVE**

9148

A departure from the usual form of construction has been introduced in a



new oil stove that has lately been designed. Instead of being fitted with a fixed fuel tank, it has a detachable glass receptacle, of more than a gallon capacity, which is supplied with a bail. This enables a cook to see at a glance exactly how much fuel is at hand, and if necessary, have the container refilled outside of the

kitchen so as to eliminate the odor of kerosene from the room. The stove is also supplied with a removable drip pan, which makes it a simple operation to clean the space beneath the burners.

**MAKING UNCUT CLOTH LOOK
LIKE FINISHED SUIT**

8913

See July 15-63

"INSTANTAILOR"

Making a bolt of cloth look like a finished suit of clothes without cutting or



injuring the cloth is accomplished by a new device invented for the convenience of tailors in showing customers just what effects are produced with different cloths. The device consists of an aluminum, or tin, model about the size of a

man's body, molded in front to the proper shape and made hollow in

E. Leslie Williams, 116 Waverley Place, N. Y. City.

Inventor: S. Lippe, N. York
2011 Morris St. The Bronx, N. Y. C.

the back to receive clamps for holding the cloth in place, with a wire frame that is so mounted that it can be readily pressed over the front of the model. The wire frame carries outlines of the pockets, seams, lapels, collar, and other details, so that a good illusion of a suit of clothes is given when the cloth is in place and the frame pressed back against it. The whole operation requires a minute or less. The model is adjustable for height and girth.

**PHIAL OF IODINE USED BY
SURGEONS IN WAR**

9619

As the war has progressed the use of iodine, for disinfecting the wounds of the soldiers to safeguard against infection,



has come to be one of the chief reliances of the Red Cross surgeons with the French army. Tincture of iodine is now being supplied the field-hospital

corps in small phials containing just enough of the liquid for one average application. The phial is made of glass in the shape of a medicine dropper and is half filled with the antiseptic, the remaining space containing air under pressure of about two atmospheres. It is sealed by a bead at the pointed end, and when this is broken the liquid is sprayed out under sufficient force to penetrate deeply into a wound. One of the first things that is done when a man is hit, providing he is within reach of the surgeons, is to thoroughly coat his wound with iodine.

California has 110 reservoirs for hydroelectric purposes, with storage capacity of 235,780,000,000 gallons.

de nature, June 6, 1915

Laboratoires Dautry
3^{bis} Rue de Dunois
Paris

being supplied the field-hospital

Chas. W. Person, 206 West 105 St., N.Y. City
Lord & Taylors new department store, N.Y. City

See p. 11 - 54 - POPULAR MECHANICS

825

NOVEL SHOW-WINDOW SYSTEM IN NEW YORK STORE

7504 Show windows which are arranged in a distinctly new manner have been installed in one of the Fifth Avenue department stores in New York. They are constructed on hydraulic elevators so that they may be dropped from the street level into the basement, a new display substituted quickly and the windows returned to their normal positions. This enables all the trimming to be done out of sight of the passing shoppers, allows frequent changes, and makes it unnecessary to curtain a window and lose its use during the time it is being redecorated.

This system has made it possible also to utilize the vestibule space during the evenings when the entrance to the building is not needed. When the store is emptied a window is raised to fill the vacant space. This gives an unbroken line of displays along the front of the building. Before opening time in the morning, or after the streets have been cleared at night, the auxiliary window is lowered, its top forming the floor of

the vestibule and giving access to the doors.

The window dressing is all done on specially arranged platforms which may be moved onto, or taken from, the elevators quickly. When it is time to change one of the windows, it is lowered, the platform and its display removed, and another one, on which is a new display, put in its place and the window raised to its proper position.

Two of the windows, one at each side of the entrance, are built on turntables. This enables each of them to be divided into four compartments so that eight distinct displays may be made. The turntables are operated by

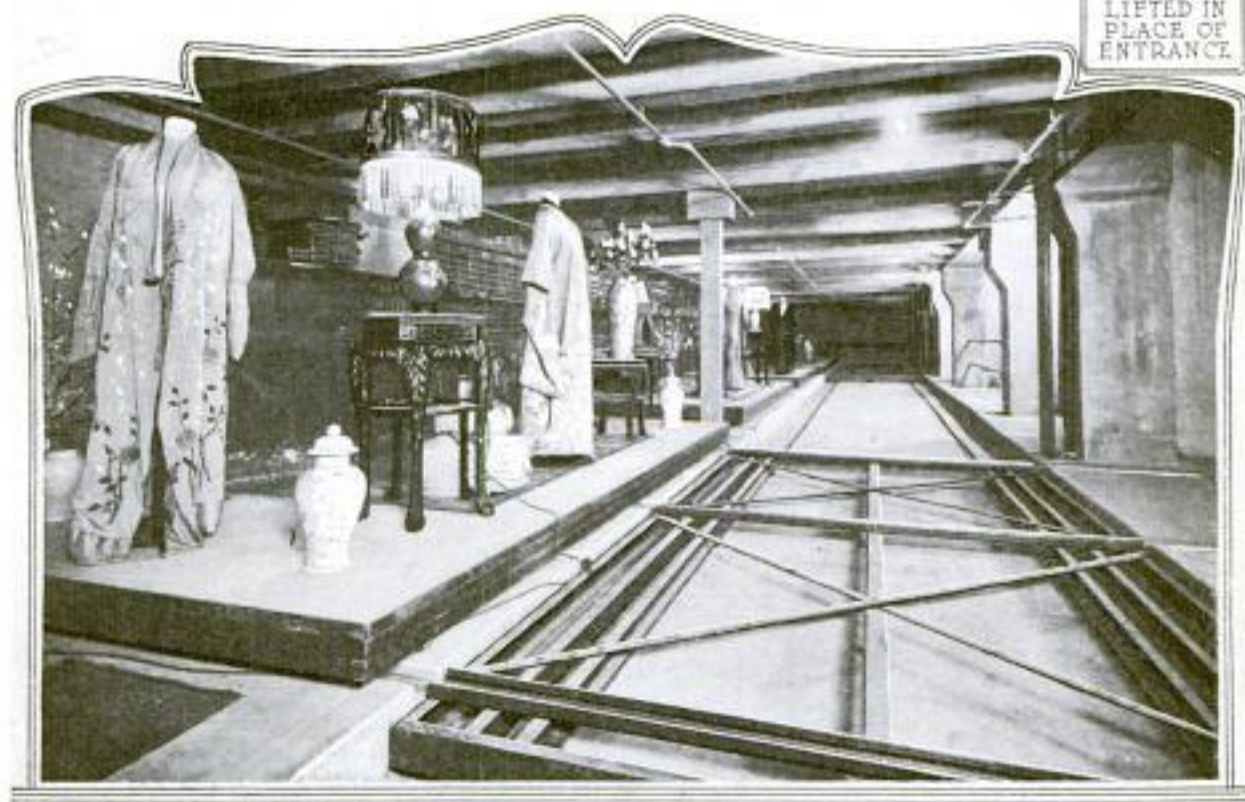
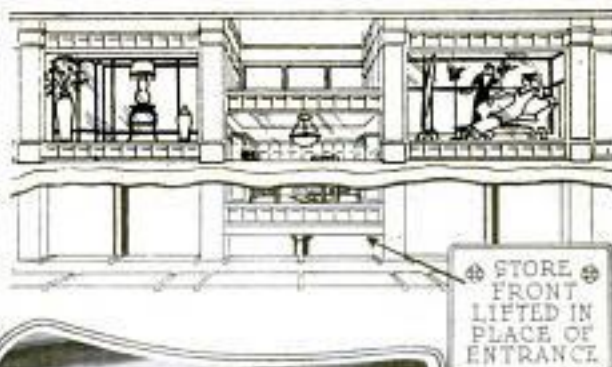

This Shows the Basement beneath the Show Windows Where All of the Displays are First Arranged on Platforms and Then Moved onto the Elevators. The Drawing Indicates How the System is Arranged and Shows a Window being Raised to Fill the Vestibule Space

a mechanism which stops and starts them automatically, so that as each display comes into view it is halted briefly.

MILITARY CROSS IS NEW BRITISH DECORATION

As a reward for bravery and distinguished service in the present war, the British government has issued a new decoration to which only commissioned and warrant officers of the British army, Indian and colonial forces are eligible. It is known as the Military Cross, is an entirely new pattern, $1\frac{5}{8}$ in. square, and is worn suspended on a purple and white ribbon woven with three stripes of equal widths. In



COURTESY ILLUSTRATED LONDON NEWS

the center the cross bears the letters "G. R. I.," the initials of the Latin words meaning "George. King-Emperor," and at the extremity of

each arm the imperial crown. It is awarded only upon the recommendation of the secretary of state for war. An honorary award is allowable to foreign officers associated with the British in the present operations, providing they are of the proper rank. No individual precedence nor right to an addition to a personal description or title is conferred upon the recipient of the decoration.

INEXPENSIVE GARAGE BUILT OF TANK STAVES

One solution of the private-garage problem for the motor-car owner whose residence is temporary, or who desires an inexpensive, portable structure which is also sightly, has been found by a Spokane man who constructed a tank-shaped housing out of tongued-and-grooved staves and iron hoops. The garage is so built that it may be knocked down in less than an hour's time and reassembled by a workman in a slightly longer period. One of its advantages is that it has little waste space and is practically weather-proof, which in moderately cold weather goes far in taking care of the heating, for after a car has been run for a few hours the heat radiated from it is sufficient to warm the garage adequately to keep water from freezing in it during the night. A heavy foundation is not required, as the structure is light in weight. Were it to be used permanently in one place, it might be provided



This Small Garage, Which may be Knocked Down and Reassembled in a Short Time, Represents Only a Small Investment and Serves Very Well for the Man Who Takes Care of His Own Car



Mfr. Mower Portable Garage Co. 1102 Paulson Bldg. Spokane, Wash.

C. L. Edholm 1353 W. 36th Place Los Angeles, Cal.

Francis P. Mann, 12 Boulevard
Arago, Paris, France

Mrs. J. W. Porter, 408 West
B St., Joplin, Mo.
Inventor - Capt. J. E. Moore, Vancouver,
B. C., Canada. 827

POPULAR MECHANICS

Tollens
me Vielle au
Paris

with a concrete flooring, while for ordinary purposes a board, or dirt, floor suffices. The only openings in the garage are a circular window at the rear and wide, double doors at the front, which are provided with glass so as to allow for the entrance of sunlight during the daytime.

"Poulet" Electric
GAS-ANALYSING APPARATUS

9072 FOR FURNACES

For the purpose of analysing the unburned gases given off by industrial furnaces, a French inventor has developed an electric apparatus which makes the tests and automatically records the results. The device is very simple and readily shows the condition of fuel combustion, so that if a furnace is being operated inefficiently the fact is charted immediately. The analyses are made at intervals of five minutes. A motor actuates a pump which draws the gases into a chamber, from which, after the volume reaches approximately 6.1 cu. in., they are passed over pumice stone and caustic potash into a second container. The carbon dioxide is absorbed during this operation and the gases enter the second cylinder minus this content. By



measuring the remaining volume, the percentage of carbon dioxide is apparent. This is recorded by a magnetically controlled pen, which,

at the moment that the last step of the analysis is completed, is drawn against a moving roll of paper. Should only 80 per cent of the 6.1 cu. in. of gas originally taken in be present in the second chamber, the position of the mark made on the recording drum will indicate the fact, which would mean that the proportion of carbon dioxide had been 20 per cent.

NEW LIFE PRESERVER SAVES
VICTIM FROM EXPOSURE

9030 Designed so as to furnish protection against exposure and hunger, a life-saving suit has been invented which



The Victim of a Shipwreck is Given Protection from Exposure in the Water by Wearing This Waterproof Life-Preserving Suit

offers the victim of a shipwreck a fighting chance against death. The ordinary life belt, when placed about the body, prevents drowning, but in a large number of cases there is little hope for the wearer being saved unless he is rescued from the water quickly. The new device, however, partially overcomes this, for its wearer does not come in contact with the water. It consists of a rubberized-canvas suit which protects the entire body. It is fitted with a pneumatic-belt arrangement beneath the arms and prevents drowning, for should the user become unconscious or fall asleep, his head would be held out of the water.

Pockets on the inside of the suit are provided for the storage of sufficient concentrated food to keep a man alive

for a number of days. Access to these pockets is possible by withdrawing an arm from one of the sleeves.

DRIVEWAY ENTRANCE MADE OF COBBLESTONES

8913

An odd but effective triple arch made of cobblestones spans the driveway in front of a Huntington Park, California, residence, serving as an ornamental carriage entrance. The structure is set



Carriage Entrance Made of Cobblestones

at the intersection of the driveway and street sidewalk and is surmounted by a tall flagpole. The uneven stones are set in a cement binder and form a substantial structure, while a rough, low fence of the same material surrounds the grounds.

FLOATING A BIG STEAMSHIP ON A FILM OF AIR

Floating an 11,000-ton liner on a cushion of air was the remarkable feat performed by a wrecking company recently in extricating the steamship "Zeeland" from a mud bank in the St.

Lawrence River. The "Zeeland," running at high speed up the river in a fog, went aground with such force that the mud was 3 ft. above the usual light-load line. The ship was not damaged, but the suction of the soft mud was so great that even when a channel had been dredged and the mud removed from both sides, the power of a fleet of tugs and the "Zeeland's" own 12,000-hp. engines was insufficient to move the ship an inch. As a last resort the use of air was thought of. Fourteen brass drainage plugs in the ship's bottom, close to the keel, were unscrewed from within, and into each hole was threaded a hose connection. Tubes were led from these to an air compressor designed for diving operations, and while the tugs pulled and the ship's twin screws re-

olved, the air was turned into the hose at the rate of 1,000 cu. ft. a minute. In finding its outlet from under the hull the air effectually broke the seal between the ship and the mud, and the vessel was safely afloat in deep water in less than ten minutes.

Fleet Agency, 152 Fleet St., London, E.C. England
 Invented by an Australian

(Evidently new sort of trees, as not listed in any of the books & letters checked 3/20/18)
 329

POPULAR MECHANICS

J.C. Kevelly, 68 W. Madison St. 3rd fl

68 W. Madison St Chicago



Copyright light for Anderson & Brown Dec '08-831
 "Electric Automatic Gun Light"
 "See page 13-508"

The Bullet will Strike Where the Inverted "T" is Emblazoned on the Shoulder of the Beast. At Close Range, This New Method of Aiming a Rifle Quickly at Night Is of Material Value

RIFLE AIMED WITH SHAFT OF BRILLIANT LIGHT

Intended for point-blank firing at close range, a flash-light equipment has been devised for high-power rifles which simplifies the aiming of a weapon when it is used for shooting wild beasts after dark. Unlike other lighting apparatus heretofore introduced for night hunting, the beam of light has the shape of an inverted letter "T." This character is brilliantly emblazoned upon whatever object the shaft of light strikes, as, for instance, the shoulder of a lioness. The hunter in this way is able to point his rifle almost as one would the nozzle of a hose, for upon firing, his bullet will strike the point indicated by the character. Just enough light is diffused outside of the plane of the "T" shaft to dimly illuminate a small field and show the outline of an animal. It is said that use of the device in Australia has shown that a wild beast appears momentarily paralyzed by fear when blinded by the light.

FLASH-LIGHT SIGNAL DEVICE USED BY BRITISH

For communicating after night, the signal corps of the British army is equipped with an electric flash-light apparatus which is easily portable and very efficient for medium ranges. In size, and to a somewhat less degree in appearance, it is similar to an ordinary camera. It is made substantially with the corners reinforced with metal pieces, and is fitted on the top with a telegraph key. A large lens is provided at the front of the box, inside of which the batteries are carried. The light is flashed by means of the telegraph key, enabling code messages to be transmitted rapidly in much the same manner as by wire.



International News Service

Ralph W. Smith, 1463 W. Minnehaha St., St. Paul, Minn.

SCALE REGISTERS WEIGHT

8890 BY BENDING OF BAR

An interesting innovation in scale manufacture is an automatic scale in which the weight is registered by the FLEXURE BAR SCALE

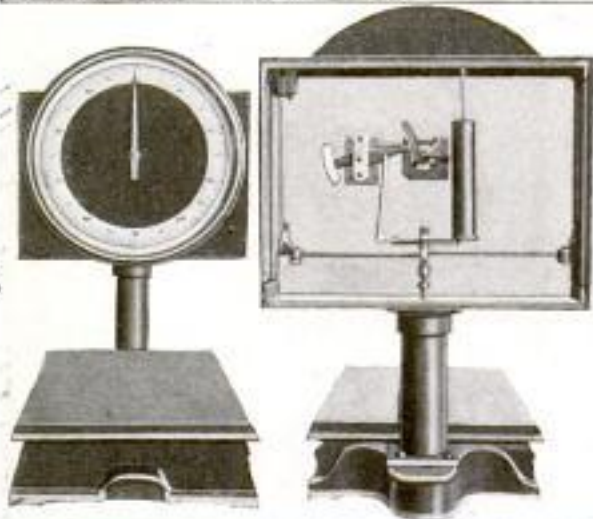

Front and Back View of New Automatic Scale in Which the Weight is Registered by the Bending of a Tempered Steel Bar

bending of a tempered steel bar supported at the ends on knife edges. The middle of the bar is connected by a system of levers with the scale platform and by a rack and pinion with an indicating pointer that works over a dial. When a load is placed on the platform, the bar is bent downward in the middle and the pointer swings to figures on

the dial corresponding to the correct weight. When the load is removed, the bar springs back to its original position and the pointer returns to zero. Excessive vibration of the pointer is checked by a pneumatic dashpot. The principle is being applied to scales of both large and small capacity.

RAILWAY TRACKS COVERED

9518 BY ICE EMBANKMENT

During a spring freshet and ice jam on the Deerfield River in Massachusetts, a solid embankment of ice was formed over the main-line tracks of the Fitchburg division of the Boston and Maine Railway. The barrier was near Buckland where three tracks run parallel along one bank of the stream. The ice covered the roadbed for a distance of more than a quarter of a mile, and in places it was piled to a height of approximately six feet. To clear the road so that trains could pass it was necessary to cut away the embankment with picks. It was formed by large cakes of ice which were pushed out of the river by the high water and frozen together, making an almost rocklike formation. Normally the level of the river is about 12 feet below the tracks at the point where the blockade occurred.



This Shows the East-Bound and Middle Track Cleared of the Ice. The Third Track is Hidden beneath the Ice Embankment

Herbert P. Ashworth
Shelburne Falls, Mass

McFarlane Macfime Co.
3rd Av. So.
Minneapolis, Minn.

When a Fire Alarm is Turned
In from a Street Box, This
Motor Truck's Engine
Automatically Starts Up

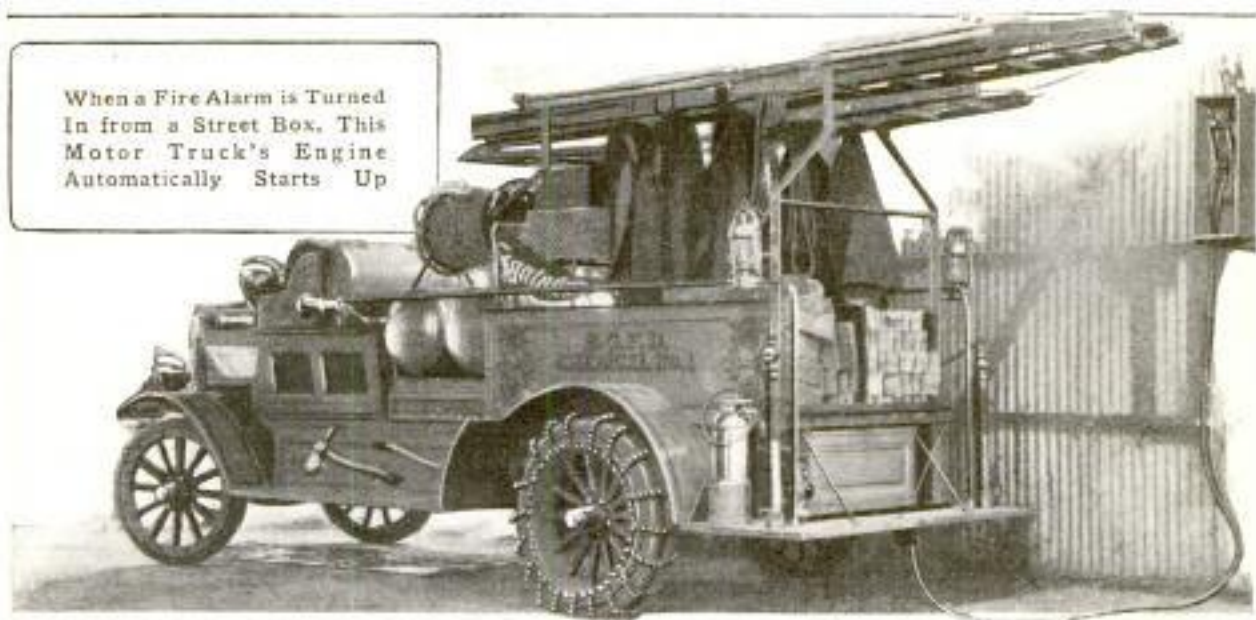

FIRE ALARM STARTS MOTOR- 9007 TRUCK ENGINES

In order to facilitate the quick departure of the equipment from the station when an alarm is turned in, an ingenious electric starting device has been built for the motor trucks of a California fire department. When a call is sent in from one of the fire-alarm boxes, the engines of the motor cars are started automatically, so that there is no delay whatever in leaving after the firemen are once on the machines. A heavy tube carries two wires to a plug connection at the rear of a car, forming a connection between a wall switch and the electric starting mechanism of the motor. When the alarm is turned in this switch is automatically closed, the circuit thus formed actuating the self-starter, which turns over the motor. When the driver jumps into the seat everything is in readiness for him to open up, throw in his clutch and start ahead. The plug is pulled out by the forward movement of the car.

To conserve the supply of rubber, gasoline, and oil in Germany for war purposes, the Federal Council has stopped the use of all motor cars except those employed for commercial purposes.

ELECTRIC ATOMIZER FOR 9241 SCALP TREATMENT

Scalp treatment of an unusual nature is made possible by an electric atomizer recently brought out in which the water, or chemical, is heated by electricity and is delivered through a tube in the form of a vapor instead of being disseminated as a fine spray. Pressure is applied to the vapor by a tube through which the patient blows. The electrical heating device permits a

Electrically Heated
Atomizer for Scalp
Treatment; the
Patient Applies
Pressure by Blowing
through the Tube



quick application of heat to the liquid. The apparatus is designed for applying vapor not only to the scalp but to other parts of the body as well.

*Hinton Gilmore, Battle
Creek, Mich.*

*The Sanitarium Equipment Co.,
Battle Creek, Mich.*

Chimney of the Borough Electric Works,
Wallingford, Conn.
Work done by the Sperry Engineering Co.,
New Haven, Conn.

**REINFORCED CONCRETE USED
TO REPAIR IRON CHIMNEY**

9505

It was found recently that near the base of a 90-ft. iron chimney of a Connecticut electric plant the plates were so seriously corroded that immediate repairs were necessary. Wrinkles had appeared and drill tests showed that the metal, at approximately six feet from the bottom, was only $\frac{1}{32}$ in. thick. The entire load of the plant was being carried at the time by the furnace using this chimney and it was necessary that repairs be made with the pipe in service, in spite of the fact that the gases passing through it showed a temperature of about 600° F. Five-eighths-inch reinforcing steel was placed both vertically and horizontally around the pipe on 8-in. centers. The bars were held about three inches from the chimney and extended up its side for a distance of 25 ft. A very wet mixture of concrete was then poured in the circular forms built around the stack. The repair has proved satisfactory.



**PRODUCING FERTILIZER
FROM PEAT**

9420

The peat deposits of Italy form one of the valuable natural resources of that country, but much of this product is too low in fuel value to compete with imported coal. Plants are now being installed for utilizing this peat in the production of nitrogen on a commercial basis for fertilizing purposes. The nitrogen is practically in an inert

condition in the raw material and to be used successfully for fertilizing must be transformed into a more active compound, such as salts of ammonia. In treating the peat, it is first dried and broken up and then thrown into a turret-shaped oven, 26 to 33 ft. high, which is fed at intervals from the top. The peat burns only in the lower part of the turret, the combustion being regulated by a jet of hot air and steam. The water vapor decomposes on the incandescent mass and its component hydrogen combines with the nitrogen in the peat to form ammonia gas. This gas is then treated with a spray of sulphuric acid which converts it into sulphate of ammonia, the form in which nitrogen is commonly used in fertilizing.

**HOLLOW WALKING CANE USED
AS MEDICINE CASE**

9348

In order to escape the necessity of carrying the customary medicine case when making calls on his patients, a

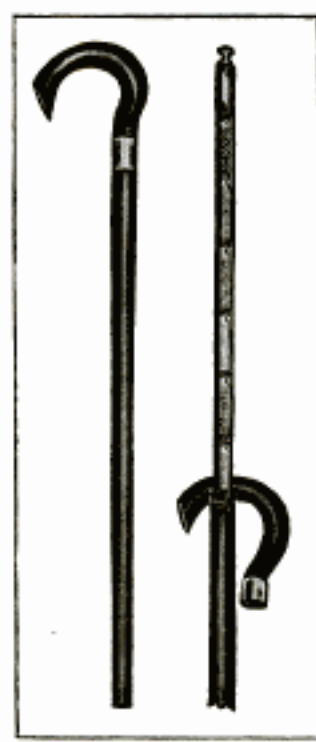

physician, who formerly was United States consul at Vera Cruz, invented a walking stick inside of which he carried whatever bottles of medicine he ordinarily needed on such occasions. The cane is made of a hard-rubber composition and is hollow its full length. Into this space a trough-shaped metal holder for the various bottles is inserted. The handle of the

stick may be detached by unscrewing it, and the holder removed in a moment's time. So far as external appearances are concerned the cane is essentially the same as any other.

Invented by Dr. S. F. Trowbridge, of the U. S. Army & Counsel at Vera Cruz, now deceased.
#D. S. Rockwell, Berkeley, Calif.

Società per l'Utilizzazione dei Combustibili Italiani
 Refer to Bologna, Ferrara, Italy
 * Orientano, Lucca
 (" 1907)

Gas & Oil Power. 2/4/15
Weavers Hall
22 Basinghall St.
London, E. C.

Martin J. B. McDonagh, 124 So. 45th St., Phila., Pa.
Inventor: Jones Wiater, 1819 Walnut St., Phila., Pa.

Photo by ~~Scott~~ Underwood & U.

9640

RIFLE THAT SHOOTS AROUND A CORNER

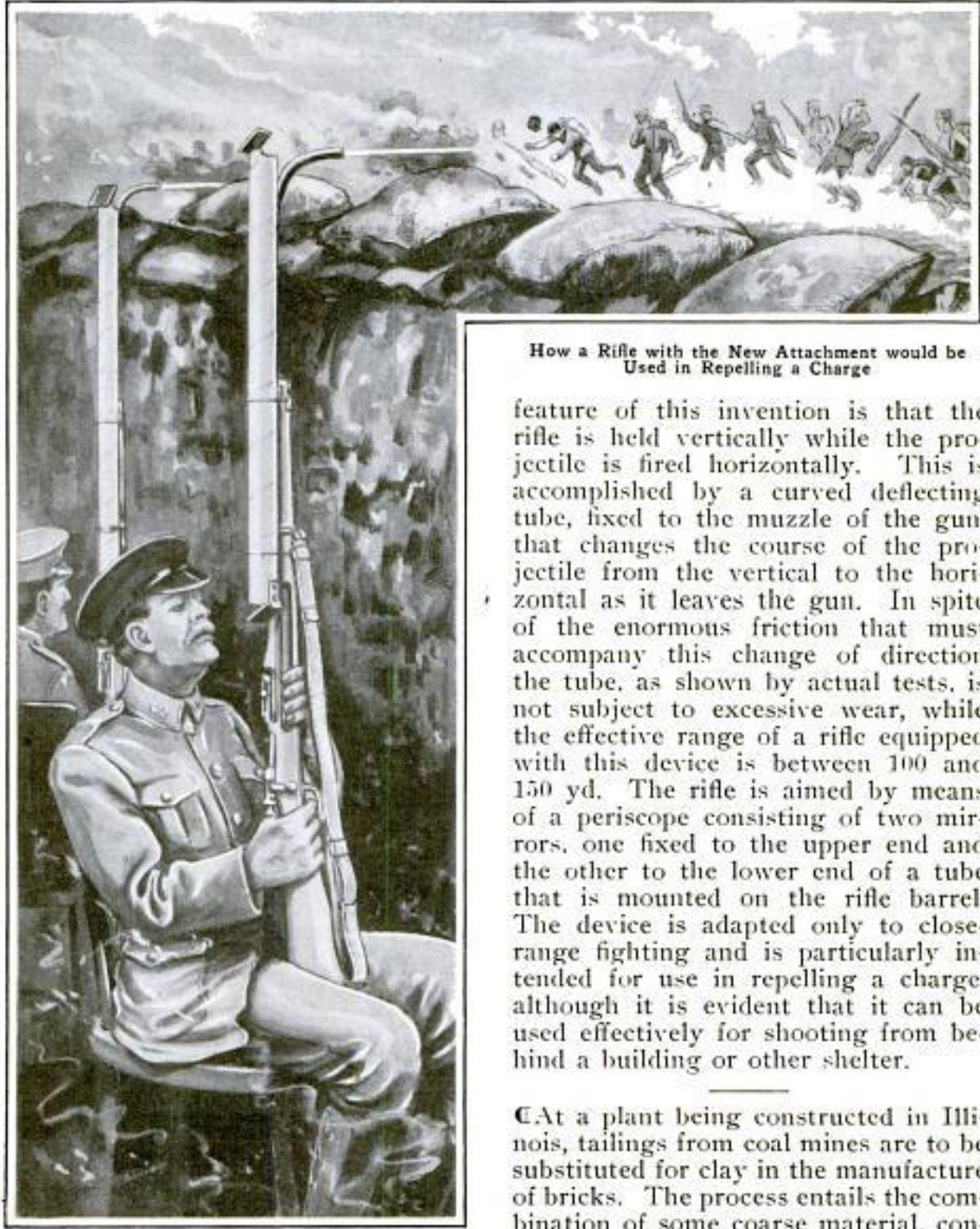

How a Rifle with the New Attachment would be Used in Repelling a Charge

feature of this invention is that the rifle is held vertically while the projectile is fired horizontally. This is accomplished by a curved deflecting tube, fixed to the muzzle of the gun, that changes the course of the projectile from the vertical to the horizontal as it leaves the gun. In spite of the enormous friction that must accompany this change of direction the tube, as shown by actual tests, is not subject to excessive wear, while the effective range of a rifle equipped with this device is between 100 and 150 yd. The rifle is aimed by means of a periscope consisting of two mirrors, one fixed to the upper end and the other to the lower end of a tube that is mounted on the rifle barrel. The device is adapted only to close-range fighting and is particularly intended for use in repelling a charge, although it is evident that it can be used effectively for shooting from behind a building or other shelter.

A rifle that shoots over the parapet while the user sits in comparative safety in the trench without necessity for exposing himself to the fire of the enemy is a late invention brought out by a well-known sportsman and big-game hunter of this country. The

At a plant being constructed in Illinois, tailings from coal mines are to be substituted for clay in the manufacture of bricks. The process entails the combination of some coarse material, containing silica, with a binder of finely divided particles of silica, alumina, potassium, or sodium, in proper proportions. Bricks already made have withstood a temperature of 2,900° F. and a pressure of 20,000 lb. to the square inch, it is claimed.

9789

DIVING FOR THE SUBMARINE "F-4"

THE sinking of the "F-4" of the Hawaiian submarine flotilla, during maneuvers in Honolulu Harbor on March 25, when it failed to rise after diving with 21 members of its crew, is the first fatal disaster that has occurred to an American under-sea craft. In approximately the last 12 years 20 submarines of various navies have been lost during times of peace. Several of these accidents were caused by explosions, some others by collisions, but the greatest number resulted through some inability of the craft to rise after being submerged. In all, 265 lives have been reported lost in these tragedies, which have happened in the French, German, English, Russian, Japanese, Italian, and American navies.

No material anxiety was felt for the "F-4" until several hours had passed following its submersion. A search for the signal buoy, which is always supposed to be raised in the event of difficulties, proved futile. Boats were then put out to drag the harbor in an attempt to locate the vessel, but because of inadequate equipment and deep water this was rendered most difficult. The operations were hurried in the hope that the craft might be located and raised in time to save those within it. At one time the drag lines engaged with what was at first believed to be the submarine, but which later proved to be an anchor, presumably lost several years ago from a Chinese vessel. After this discouraging discovery, hope of rescuing the crew was abandoned. It was not until April 14 that the wreck was definitely located in about 48 fathoms of water.

After the first unsuccessful attempts to find the "F-4," expert divers, and special equipment, from the New York Navy Yard were sent to Honolulu to superintend the operations. Because of the depth at which the boat lay, the workers were confronted with a most perplexing problem. However, in a remarkable dive, which broke the world's record, one of the party went down to a depth of 288 ft., walked about the disabled submarine for 12

minutes and established its position positively. The vessel was lying on its starboard side, its prow shoreward, on a smooth, sandy bottom where there were no coral formations nor growths of vegetation to interfere with the hoisting. Attached to it, also, were two parted lines. Subsequently dives were made to the top of the hull by other members of the party, and through these inspections it was found that the superstructure of the craft had caved in, while the hull was filled with water. Aside from this the boat appeared to be unharmed. The top plates had not given away under the pressure, and no holes were to be found except in the superstructure, which had been fouled by a line used in the early attempts to locate it.

In making the unprecedented dive to the bottom of Honolulu Harbor, the naval operative wore an ordinary diving suit. Altogether he was under the water for about two hours. The descent was made very rapidly, only five minutes being consumed. After inspecting the hull of the submerged vessel and ascertaining how the lines were lying, he commenced to be raised to the surface. An hour and 45 minutes was spent in doing this so as to accustom him slowly to the decreasing pressure and the final change to the normal atmospheric pressure. This procedure is made necessary by the tremendous pressure a diver is subjected to when under a great depth of water. At 300 ft. this amounts to approximately 130 lb. to the square inch, or for a man of average stature, an aggregate load of possibly 140 tons. A quick descent is possible, since an increase in pressure can be readily withstood by the body, up to a certain point, but on ascending every possible care must be taken to allow the body to become accustomed to the lighter load. This is the reason that seven-eighths of the time the diver was in the water was spent in raising him to the surface. Probably the greatest depth before attained by a diver was that of 274 ft., made by another member of the same party some time ago in Long Island Sound.

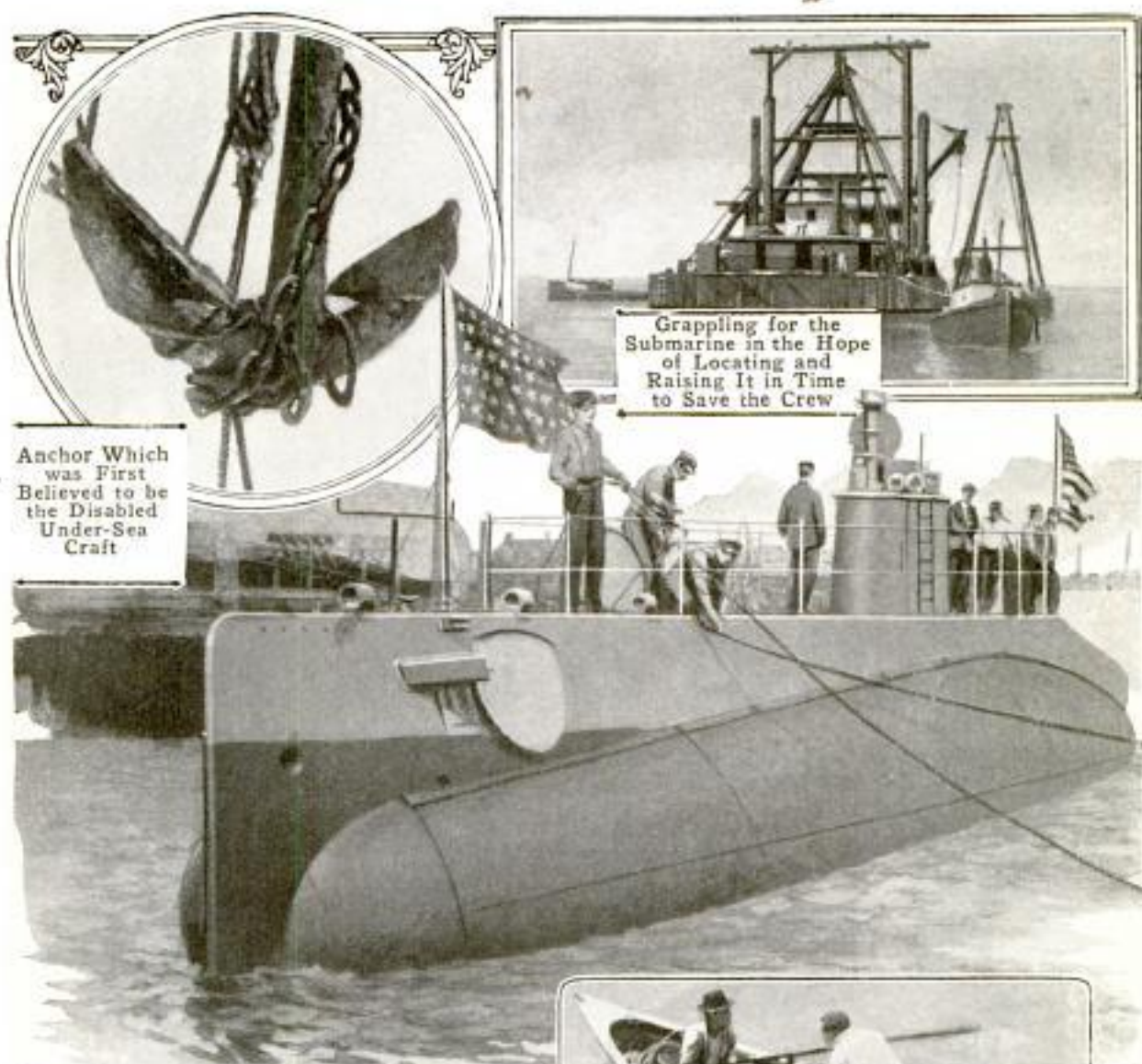

Anchor Which
was First
Believed to be
the Disabled
Under-Sea
Craft

Grappling for the
Submarine in the Hope
of Locating and
Raising It in Time
to Save the Crew

The "F-4" as It Looked When at the Surface.
The Boat Was One of Four Submarines Which
were Towed to Honolulu Some Time Ago
to Form the Hawaiian Flotilla and Guard
the Insular Possession

Using a Water
Glass in the Hope
of Finding
the Position of
the Ill-Fated Craft



Placing a Helmet on a
Diver Preparatory to
Lowering Him to the
Bottom of the Harbor.
The Cables Shown Are
Fast to the Submarine

PHOTO: INTERNATIONAL NEWS SERVICE

mfr: F. Duerr + Sons,
Manchester, S.W.,
England.

POCKET PERISCOPE FOR USE
IN THE TRENCHES

89675

With a new pocket periscope that has just been brought out in England it is possible for a soldier to look over the parapet of the trench without exposing himself to the fire of the enemy. The periscope is simple in construction, consisting only of two mirrors connected by a collapsible framework. Both mirrors are fixed to the framework at an angle of 45°. When the framework is extended and the upper mirror is raised above the trench, the view is reflected by the upper mirror down to the lower one, which reflects the light rays horizontally to the eyes of the observer. When collapsed, the instrument can be packed in a case 4½ in. square and 2 in. thick. It is 2 ft. long when fully extended.



Pocket Periscope Brought Out in England for Use in the Trenches

ARMY & NAVY JOURNAL
AMERICA'S POWERFUL RADIO
SYSTEM HAS GREAT SCOPE

9569

With the completion of the new government wireless station at Panama Canal, the secretary of the navy is now kept constantly in touch with every American naval station and every ship in the Atlantic and Pacific oceans.

The Panama station is equipped with three 600-ft. towers and has a 100-kw. generating plant. Washington is now able to reach Alaska, the Straits of Magellan, all European stations, Honolulu, Manila, China, and Japan. According to the plans of the Navy Department, the Arlington station will be brought up to the standard of the one at Panama, which is of four times its strength, while the same is expected to be done at San Diego, Honolulu, and Manila. If it is found that the plant at Honolulu is able to keep communication open to Manila, only a substation will be maintained at Guam. Otherwise a large plant will be constructed at that point. A system of small stations along the coast lines has been in the course of development for the past year, and before long stations at intervals not greater than 200 miles will be in operation on both sides of the country. The military importance of this powerful system is almost beyond estimation. All official business of the Navy Department will be carried on by radio communication.

"COLOR MUSIC" INTRODUCED
AT NEW YORK CONCERT

9781

During a recent rendition of the Russian composer Scriabine's "Prometheus," which is described as a futuristic tonal poem, by an orchestra in Carnegie Hall at New York, a "color organ" was employed to utilize the author's chromatic score with the orchestration. Various color hues and tints merging and blending with each other appeared in a maze of diaphanous gauze, forming a screen on the stage before the audience. These animated colors appeared simultaneously

George F. Wirtz, 627 W. 113th St., N.Y.

Russian by Scriabine. Orchestra
R. 712 N. West. Alt. by Heller. Conductor
One W. 34th St. and 833 Seventh Av.

For info. See card, 9731 - June '15
 " June 12 - 820
 " Sept '15 - 351

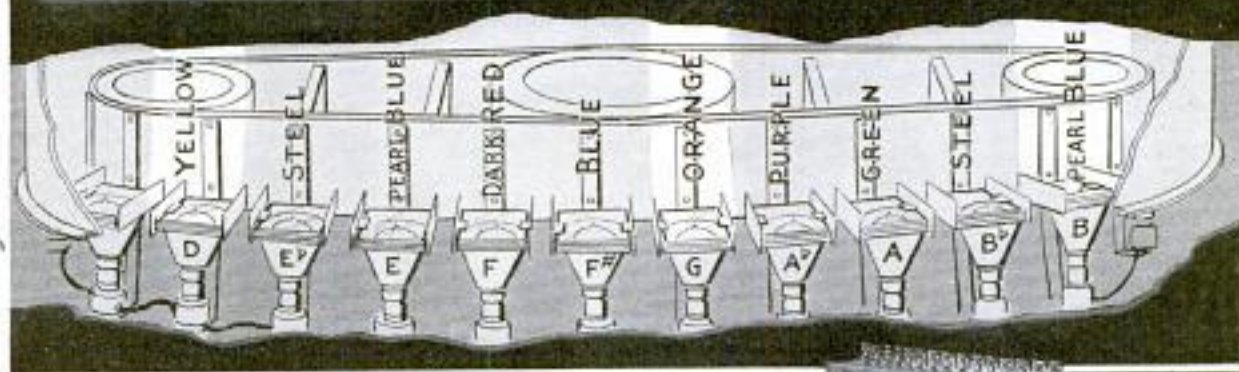

The "Color Organ," Showing the Arrangement of Its Keys, Pedals, the Various Lights, and Their Relation to the Gauze Maze. While from the Front the Screen Appears to Consist of a Single Sheet, Several Strips of Gauze of Different Weights are Placed One Back of the Other

with the orchestral music, varying in intensity, shade and movement in harmony with the combinations and inflections of tones rising from the pit.

The "organ" on which this so-called color music was played was provided with a keyboard like that of a piano, but carrying only 15 keys in addition to pedals, which were used in varying the intensity of the color lamps. The separate light units, which were especially made, high-power tungsten lamps with small globes and fitted with reflectors and color filters, were carried on a horizontal belt arranged in an ellipse. This was moved back and forth by a motor actuating the pulleys on which it was mounted.

Placed above this light source was the screen, which was composed of strips of gauze of different weights, and 8 ft. by 10 ft. in size, mounted vertically. The lightest sheet was placed at the front, each succeeding one back of it being heavier. The rear gauze was sufficiently heavy to reflect the light filtered up against it.

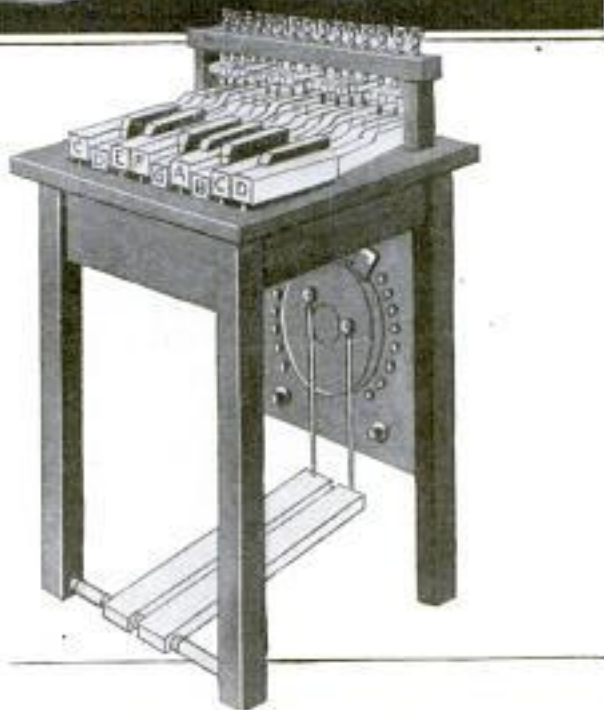

The heavier colors were displayed on the sheets at the back, while the lighter, more delicate ones were thrown on the front gauzes, resulting in delightful combinations of hues, now mellowed and dimmed, now bold, and always moving and changing.

The "color music" was played from a written score using as color equivalents of the tone scale: C, red; D, yellow; E, pearly blue; A, green; B-flat, steely gray, and other "notes" intermediate between these.

Massachusetts
 Patent Attorney
 60 E 4th St., New York

Sears, Roebuck & Co. (V)
Chicago, Ill.

Madden Silent Wheel Corp
1180 Broadway, New York

ELECTRIC SEWING MACHINE

NOISE ELIMINATED BY NEW

9771 CONTROLLED BY BRAKE

STREET-CAR WHEEL

One of the latest developments in electric sewing machines is one in which the motor is built into the ma-

"The Electric King"

King Sewing Machine Co.
Buffalo, N. Y.

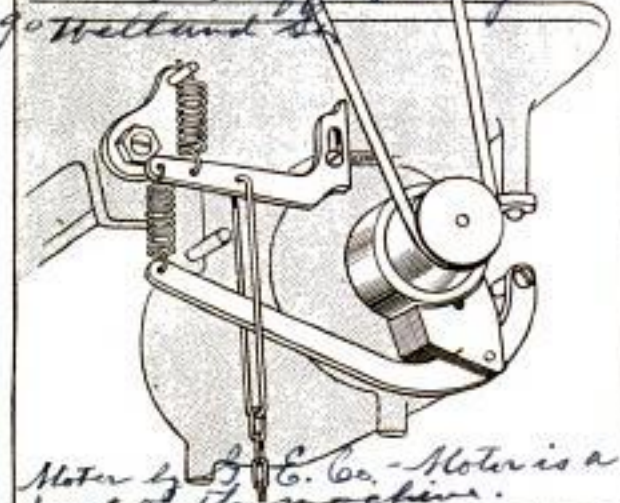

Brake Mechanism with Which the Speed of the Electric Sewing Machine is Controlled

chine and its speed is controlled entirely by a brake working on a drum mounted on the motor shaft. This brake is operated by the pedal. So long as there is no pressure on the pedal the brake prevents the motor from working, even with the current turned on. A slight pressure starts the machine slowly and when the pedal is pushed down as far as it will go, the machine is run at full speed. An additional advantage in this machine is that the needle is placed squarely in front of the operator, eliminating the strained attitude required in running an ordinary machine. Current is supplied through a cord that can be attached to any electric-light socket. In case of failure of electric power, the machine is made ready for operation by foot by disconnecting the motor belt and connecting a belt operated by the pedal.

¶The name of Culebra Cut in Panama Canal has been changed by an order issued by President Wilson, to Gaillard Cut, in honor of Col. D. D. Gaillard, who died of illness contracted in service at the isthmus.

Elimination of the greater part of the noise that now accompanies the operation of street cars and elevated and subway trains is a prospect of the immediate future as the result of a new noiseless wheel that has just been developed to a practical working basis. A street car equipped with wheels of this kind and recently subjected to test runs at Portland, Me., is reported to have run as noiselessly as an automobile. The wheel is made of two sections, and is in effect a wheel within a wheel. The inner section is fixed to the axle while the outer section takes the bearing on the track. Between the two sections is a cushion of rubber of special composition which absorbs the vibrations caused by the grind of the tire on the rail and by irregularities in the track, and it is this that gives the wheel its noiseless qualities. Any possibility of slip between the sections is prevented by the three curved recesses in the inner section into which fit corresponding curved projections on the outer section, there being just enough space left between the two surfaces for the rubber cushion. Two steel

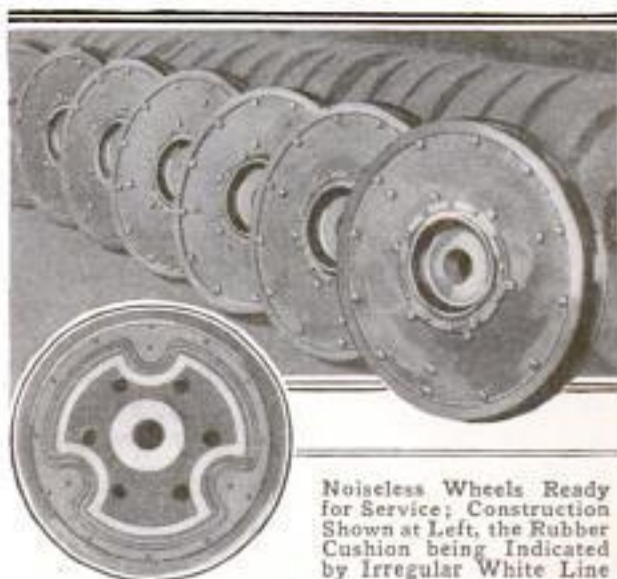

Noiseless Wheels Ready for Service; Construction Shown at Left, the Rubber Cushion being Indicated by Irregular White Line

plates, one on each side of the wheel and forming a part of the outer section, hold the inner section and rubber cushion in place and prevent side slip. A ground wire is used for electrically

Commonwealth Edison Co., Chicago
J. W. Adams, Chicago

Work done by J. L. Cronhardt
11005 N. Payson St.
Baltimore, Md.

connecting the sections. While this type of wheel has only been made so far for street cars, it is believed that the same principle can be successfully used in wheels for the heaviest steam-railroad cars.

HOLE BORED THROUGH HAIR IS THREADED WITH SILK

9790

A Baltimore, Md., watchmaker recently performed the delicate operation of drilling a microscopic hole through a human hair and then threading it with a minute strand of silk. As nearly as it is possible to determine, the hole is approximately $\frac{3}{16}$ inch in diameter. The feat was accomplished in an hour, during which time four hairs were broken in unsuccessful attempts at the work. The hair was stretched taut between two pins and over a white ground covering a working block. It was also pressed to the block with a pair of hairspring tweezers to prevent it from rolling. The point of the finest needle obtainable was ground down until it was a mere nothing and then placed in a jeweler's pin vise to enable its being used. In centering the instrument squarely in the middle of the hair, the man rested his chin on the work-bench, stretched his arms out so that they were practically at rest and then held his breath. This was done to steady the hand holding the instrument sufficiently for the work. After the hole had been cut through the hair the threading operation was performed.

PRIVATE CARS PLACARDED "NOT A JITNEY"

San Francisco has become so thoroughly infested with "jitney busses" that drivers of private cars are continually having to explain to would-be passengers that their machines are not for hire. Hundreds of these cars competing with the traction lines are plying the streets of the city. Several motor-car owners, tiring of being frequently mistaken for "jitney" drivers,

have labeled their machines with signs reading, "NOT a Jitney," the "not" being emphasized by an encircling ring. This placard is placed on



the windshield, or in some other position where it is plainly visible to the jitney-hunting public.

Shoop

COMMERCE RAIDER INTERNED AT AMERICAN PORT

9667

The "Prinz Eitel Friedrich," the German commerce raider that sank the American sailing ship "Wm. P. Frye" and was later interned at the Norfolk Navy Yard, is a steamer of 16,000 tons' displacement built for the Asiatic trade by the North German Lloyd company and taken over by the German government for naval use shortly after the outbreak of the war. This vessel sought refuge at Newport News, Va., after a career at sea during which it sank not only the American ship but seven merchant vessels belonging to nations at war with Germany. It is a 7,000-hp. steamer with a length of 505 ft., a beam of 52½ ft., and a draft of about 27 ft., and is capable of making a speed of 17¼ miles an hour. When the captain of the "Prinz Eitel Friedrich" decided to intern rather than attempt a dash past the

B. Gallagher, 2707 Virginia St., Berkeley, Cal.

E. J. Herbert, 34 Fullerton Parkway, Chicago, Ill.

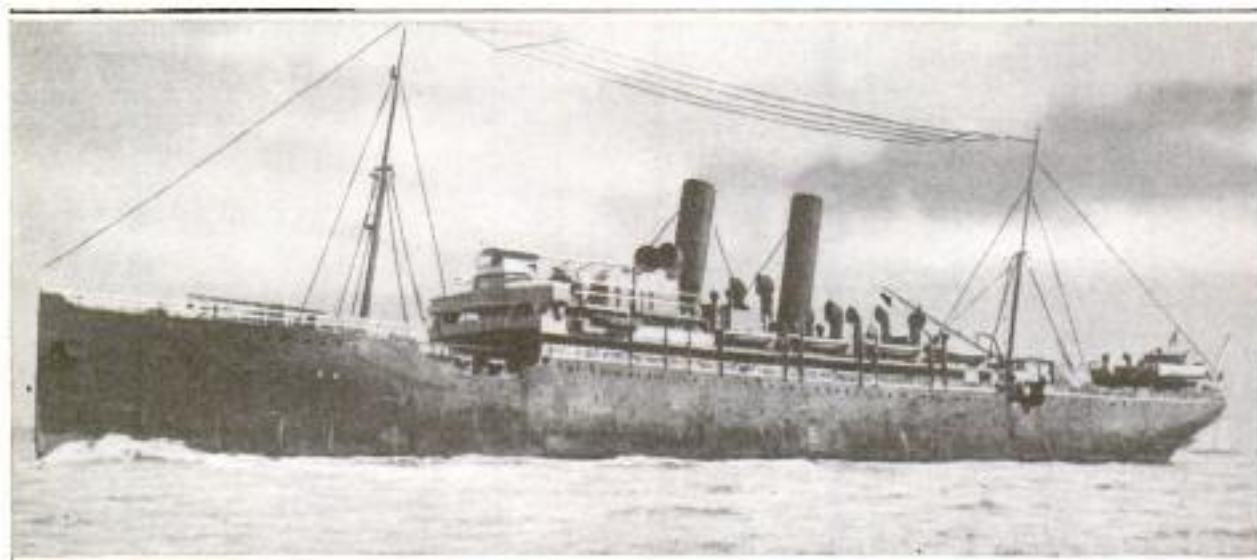

"Prinz Eitel Friedrich," German Commerce Raider, Interned at Norfolk Navy Yard

British and French warships that were believed to be waiting outside the Virginia capes, the ship was taken to the Norfolk Navy Yard, the propelling machinery was dismantled and the wireless apparatus rendered inoperative. The captain was required to give a pledge for himself, officers, and crew not to commit any unneutral act and not to leave, without special permission, the district prescribed in the parole, this district including Norfolk, Portsmouth, Newport News, and Old Point Comfort. Officers and crew will be domiciled on the ship. Under the rules governing internment the ship with its officers and crew will be held until the end of the war.

ELECTRICAL PROCESS FOR 9779 DRYING LUMBER

A simple electrical process for drying lumber now being used successfully in France consists in piling the lumber in layers with electrolytic mats placed at the top and bottom of the pile and between the layers, the mats being connected alternately with the positive and negative pole of any source of electric current. Each mat consists of a sheet of galvanized iron placed between heavy layers of jute that has been soaked in water. Lumber of any thickness and even unbarked logs can be treated by this method, but it has been

found that to get satisfactory results the pile should not be greater than 5 ft. in height. The current may be either direct or indirect and a voltage of 100 is ordinarily used. For treating 35 cu. ft. of lumber about 150 ampere-hours are required. One of the big advantages in the process is that it can be used for treating freshly cut lumber in the woods and at any season of the year. The process causes molecular changes in certain substances contained in the wood and kills all detrimental organisms with which it may be affected.

CAVALRY TENT IS ADOPTED FOR ALL ARMY BRANCHES

9782 Because of the additional comfort which will be afforded the soldiers, the War Department has decided to equip all branches of the United States Army with cavalry tents. The decision was reached recently after a personal inspection, by the secretary of war, of 20 different types of shelter tents which were set up in one of the Washington parks and thoroughly tested. While this tent is 2 lb. heavier than the one heretofore used by the infantry, it is so much larger and more comfortable than the old one that it is considered preferable.

Either two sabers or two rifles may be substituted for the ordinary collapsible poles in setting up one of these

J. C. Mc Carthy, Evening Star
Washington, D.C.
Copyrighted material

All Nov-1911 foot
"A. 6. 620"

Inventor: Albert Nodon, a Frenchman
Industrietidningen Norden,
Stockholm, Mar. 5, 1915

tents. This is considered a distinct advantage, for it makes it possible to cut down the weight of the haversack load on long marches. When rifles are used for this purpose they are stood on end and brass caps are placed over the muzzles to protect the bores from dirt and water.

Considerable complaint has been made in the past regarding the small size of the infantry tent. The cavalry tent, however, is 65 in. in length on the ridge, 61 in. wide at the base, and when supported on the collapsible poles, stands about 43 in. from the ground at the ridge. The canvas, which is of an olive-drab color, is divided into two sections which button together at the ridge and along the slanting end. A wide flap covers the buttons and prevents leakage. Each half has a row of buttons and buttonholes, so that any two sections can be used together. At both ends of the ridge are guy ropes, about 7 ft. 6 in. long, and each of the sections is provided with four foot stops, for holding the tent to the ground. Eight tent pins, 5½ in. long, made of aluminum and weighing approximately 1 oz. each, are provided. The collapsible poles are made in three sections. When the tent is not in use one of these poles and four pins are wrapped in each half of the canvas and become a part of the pack equipment of the individual soldier.

MONUMENT MARKS GRAVE 9586 OF RACE HORSE

In memory of a favorite Colorado race horse which died recently, and to mark its grave near Rocky Ford, a white, Ionic column supporting a bronze figure of the animal has been erected. The pillar is made of concrete, is slightly less than 10 ft. in height and weighs approximately 1,600 lb. It is placed on an elevated place which overlooks the city some three miles away, from which it can be seen on clear days. The horse was buried with its harness and sulky in a large concrete vault beneath the monument, which, because of its character, is attracting the attention of many eastern tourists.

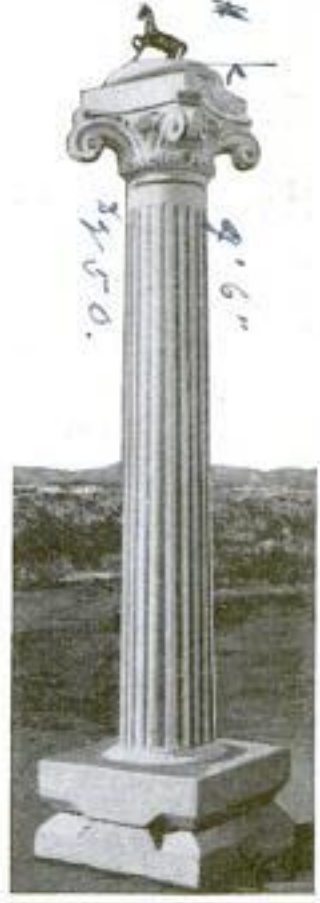

*Horse: Beverly Dillon, died Nov 26, 1914.
Owner: W. R. Dyer, Rocky Ford, Colo.*

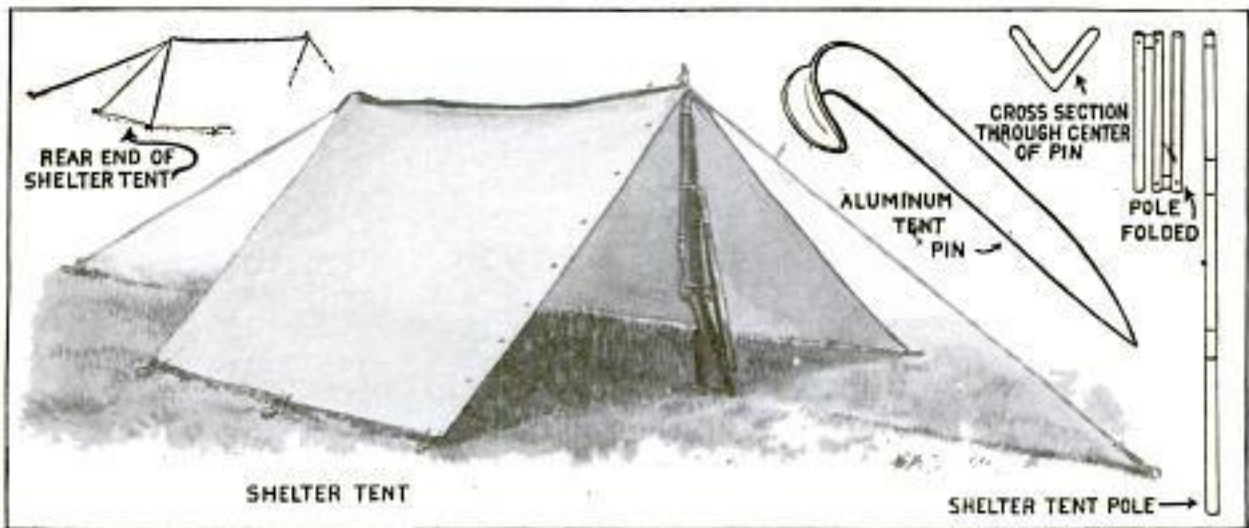

The Cavalry Tent, Recently Adopted for All Branches of the Army, as It Appears When Supported by Rifles in Lieu of the Jointed Poles Ordinarily Used. Only a Moment's Time is Required to Raise It or Take It Down

The Electrical Review - 3/12/15
**AN ELECTRICALLY OPERATED
 9692 SWING BRIDGE**

What is said to be the first swing bridge ever built in which the opening and closing of the bridge as well as the entire work of controlling and safeguarding vehicular and water-borne traffic is performed electrically has recently been placed in service over the Forth and Clyde Canal between Glasgow and Clydebank, Scotland. This is a single swing span carrying a double-track street railway with the usual roadway and sidewalks. Every movement in the operation of the bridge is controlled by a master switch located in the operator's cabin, and so thoroughly is the controlling mechanism interlocked that it is impossible to open or close the bridge without following a prescribed sequence of operations and allowing the time for each operation to be completed. The master switch is housed in a compact metal box and is worked by a handle that is moved in one direction to open the bridge and in the opposite direction to close it. With the bridge closed and the handle moved to the first position, the semaphores at the ends of the bridge are placed at danger and a bell is set ringing, and until the bell has rung for 10 seconds nothing more can be done. In the next position of the

handle, switch points are thrown that prevent a street car from approaching the bridge, and the next movement turns the current from the street-railway wires into the machinery that operates the bridge. Successive movements of the handle close the guard gates, unlock the bridge, and swing it parallel to the stream, the mechanism being arranged to stop the swinging movement automatically at the right point. The handle is then moved back to the central position, and when the bridge is to be closed it is simply moved, one position at a time, in the direction opposite to that followed in opening the bridge.

Industrial
**ELECTRIC TRACTOR IS USED
 FOR WAREHOUSE TRUCKING 9668**

In one of the warehouses at Chicago where many trains of less-than-carload freight are handled daily, a small electric tractor has been adopted for drawing carrier trucks between the various loading and unloading points. The tractor is a three-wheeled machine with a 38-in. wheel base and carries storage batteries capable of operating it continuously throughout one working day. It weighs 1,900 lb., has four forward and two reverse speeds, and may be easily turned around inside of a box car. Ordinarily it



This Shows the Electric Tractor Alone and in Use. It Ordinarily is Employed in Hauling about 10 Trailer Cars

*Mfr: The Mercury Mfg. Co.
 4110 So. Halsted St.
 Chicago, Ill.*

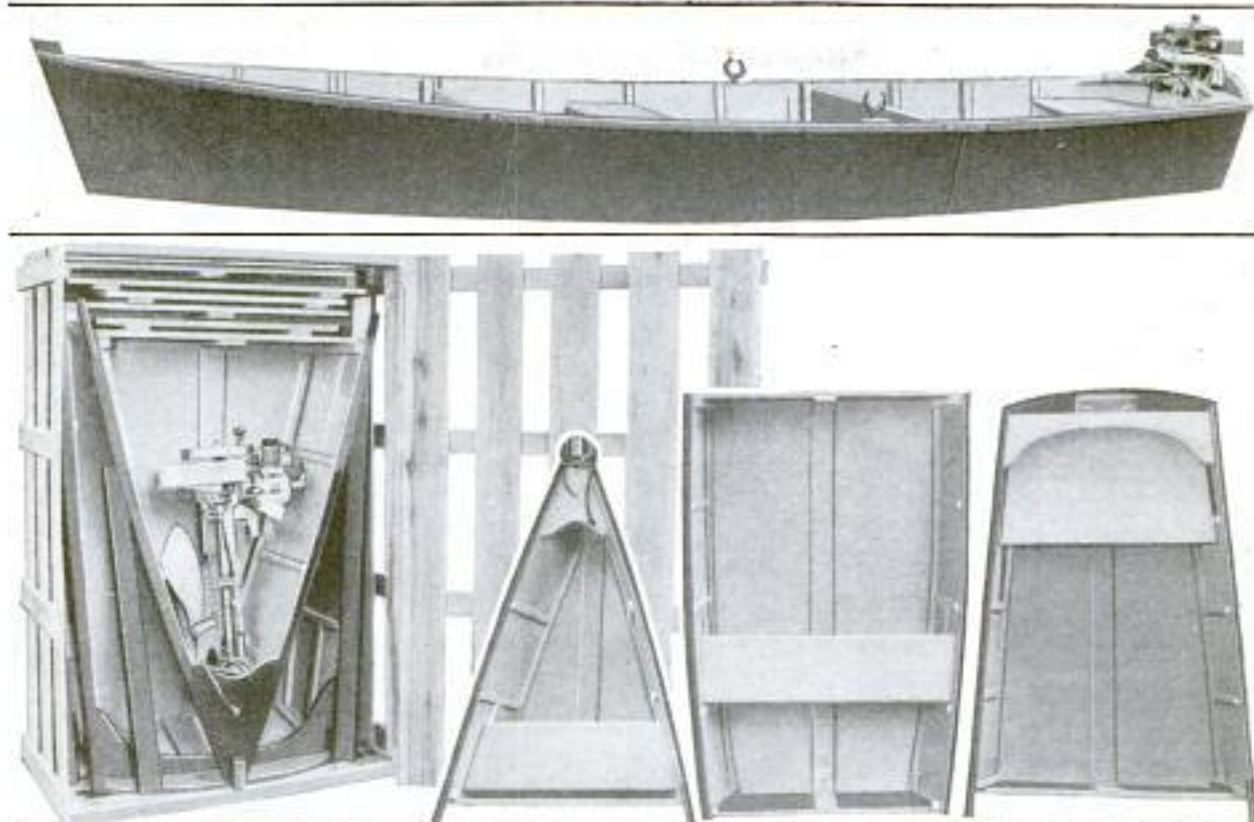

With the Seats Removed the Three Parts Nest Together Compactly and Fit into a Shipping Crate. Above, the Craft is Shown Assembled and Ready for Use

hauls 10 trailer trucks, although in some instances as many as 15 cars are placed in one train. The coupling system is arranged so that the various cars track well and may be drawn in and out about piles of freight, through doors and around 90° angles without any difficulty. In this specific warehouse, where one tractor is in use, it is said that both the cost of trucking and the trucking force have been reduced approximately 25 per cent.

THREE-PIECE POWER BOAT 9708 FOR SPORTSMEN

For the vacationist or sportsman who wants a comfortable power boat for fishing, hunting, or recreation, and needs to transport it to some out-of-the-way camping place where boats are otherwise unavailable, a three-piece craft which may be packed in a small crate and shipped easily, has recently been introduced. It is 16 ft. in length, has a 46-in. beam, and is made of cypress. When the seats are removed, the three sections nest together, leaving sufficient room in the crate for a

pair of "knocked-down" oars, the seats, an outboard motor, and whatever ropes or anchor chains it is wished to carry. It may be assembled or taken apart in a short time and can be ported anywhere that a pack mule can go, or be carried on the running board of a motor car. The segments are adequately braced when coupled together, so that the boat is able to carry a normal load and is safe for ordinary waters, although not intended for weathering heavy seas. If any accident should occur, breaking the boat apart, each compartment could float with an occupant.

BUILDING HIGHWAY ACROSS STORM KING MOUNTAIN 9730

With all surveys completed and a practical route selected, plans are now being made for the construction during the coming summer of the highway across the face of Storm King Mountain, a promontory that rises sheer from the west shore of the Hudson River a short distance north of West Point, N. Y. This will be one of the most interesting and difficult

Photos from Wm. H. Stockbridge
U.S. Military Academy,
West Point, N. Y.

The Caille Perfection Motor Co.,
Detroit Mich.
1523 Caille St.

Engineering
Records



The View Above, Looking North along the Hudson, Shows the Highway as It will be Built along the Face of the Mountain; West Point in the Foreground



At the Left is Shown the Location of the Highway across the Face of Storm King Mountain, Where It Reaches an Elevation of 390 Feet above the River



Map Showing the Location of the New Highway and the Detour Route Inland Used at Present for Passing around Storm King Mountain. The Picture Above Shows How the Promontory Juts into the Hudson, and the One at the Right Shows the Railroad Located on the Narrow Ledge at the Foot of the Cliff



pieces of highway construction ever attempted in this country. Between the foot of the cliff and the river is barely room for the tracks of the West Shore Railroad. To find additional room for a highway it is necessary to go nearly 400 ft. up the face of the mountain and excavate a ledge in the solid rock. The highway will be about $4\frac{1}{2}$ miles long, with a roadway 24 ft. wide, and is estimated to cost close to \$290,000. Starting at Cornwall, at an elevation of 190 ft. above the river, it follows the contour of the cliff to an apex on the face of the mountain 390 ft. above the river, descending from this point to a connection with a state road near West Point, 213 ft. above the river. Near its southerly end the highway passes through West Point Military Reservation, but lies west of the used portions of the grounds. In spite of the nature of the location, the grades are not excessive, varying from 3.2 ft. to 7 ft. in 100 ft. South of the summit it will be necessary to construct a steel truss bridge, 187.6 ft. long, and a rein-

forced-concrete bridge, 72.9 ft. long. Midway between these structures the cut will vary from 35 ft. of ledge rock at the center of the highway to a cut of 83 ft. at the inside. From the face of Storm King Mountain 35,000 cu. yd. of rock must be removed by quarrying methods while traffic is maintained on the railroad below, and part of the construction equipment will consist of a \$10,000 traveling crane and car that will be kept in readiness at all times to remove instantly from the tracks any rock that may fall from above. While the greater part of the work will consist of rock excavation, there will be heavy fills at some points, and at other points a combination of excavation and fill. In the latter case the filled portion will be held in place by massive retaining walls having their footings on ledges cut in the solid rock. This highway will eliminate a 15-mile detour inland over existing routes, and when completed, will constitute one of the finest scenic highways in the world.

9724

TORPEDOING OF MERCHANTMAN PHOTOGRAPHED BY PASSENGER

PHOTOGRAPHS taken by a passenger aboard the British steamship "Falaba," which was torpedoed by a submarine off the Welsh coast on March 28, show in detail, stage by stage, just what happens at sea, under the practices of naval warfare now pursued, when an enemy merchantman is overhauled by a German war vessel.

The pictures tell a connected story which might easily be translated without explanatory notes. They were taken in the sequence in which the different events of the episode occurred, illustrating graphically the reason why 119 noncombatants, one an American citizen, lost their lives.

When overhauled by the submarine, the vessel was steaming near Milford Haven. As the order was given by the captain to man the boats, the amateur photographer, an Englishman, walked coolly about the deck of the boat snap-

ping his camera. The first photograph that was taken shows the passengers and some members of the crew wearing life belts and waiting calmly to enter the boats. It is remarkable in that it is an uncommon picture showing how the passengers look and what they do when ready to forsake a liner and take to lifeboats in an open sea. It indicates also that at the time it was made there was no disorder on board.

The second exposure pictures the lowering of the first lifeboat. This resulted in a tragedy. In the haste of letting the boat down with its little party in order that it get safely away before the ship was blown up, something went wrong with the davit ropes and the craft came down, end first. This threw most of the occupants out, only a few managing to cling to the cross boards, while two or three others fortunately fell into the lower end of

D. N. S. Captions,

*Literary Digest,
Army & Navy Journal*

the boat. Most of those who fell into the water were drowned. When the craft was finally launched it capsized.

The next snapshot was taken an

instant after the ship was torpedoed. The last lifeboat to be lowered—the fourth—had just touched the water when the explosion occurred beneath and to one side of it. As

might be expected, the terrific force of the detonation blew over the small craft. The struggle of the victims, one of whom was a woman, in their attempt to crawl onto the slippery bottom of the boat is to be seen. By inspecting

the picture carefully it may also be noticed how the water was churned by the explosion. The

quartet of life craft, two of them bottom up, and the water about them spotted with men who

were even then only a few feet away from the sinking vessel, is shown in another exposure. A photograph was then

made of the submarine as it rested some 50 yards

off, a gun mounted in front of its conning

tower and a part of its crew watching the ship go down and the 260 per-



The Camera with Which the Photographs were Taken, Showing Its Condition After Its Owner had been Rescued from the Sea



Passengers Aboard the Doomed Vessel Wearing Life Belts and Waiting to Take to the Boats. The Picture was Made a Moment after the "Falaba" was Overhauled by the Submarine



Nearly All Who Crowded the First Lifeboat were Thrown into the Sea Before the Craft Touched the Water. One End Plunged Downward When the Davit Falls Jammed



The German Submarine from Which the Torpedo was Fired. The Boat Remained in the Position Shown Here for Several Minutes. Its Crew Watching the Ship Rapidly Sink

sons, who had been aboard it, fight for their lives.

At the last minute, after the submarine had submerged and disappeared and the "Falaba" was keeling over, its funnels almost level with the water, the photographer placed his camera in a pocket of his mackintosh, slipped into the sea and struck out. It was nearly an hour later that he was picked up from a floating plank by the trawler "Eileen Emma" and taken aboard in a semiconscious condition. When he was revived he felt in his pocket and found the camera still safe, although water-soaked so that the leather had peeled off.

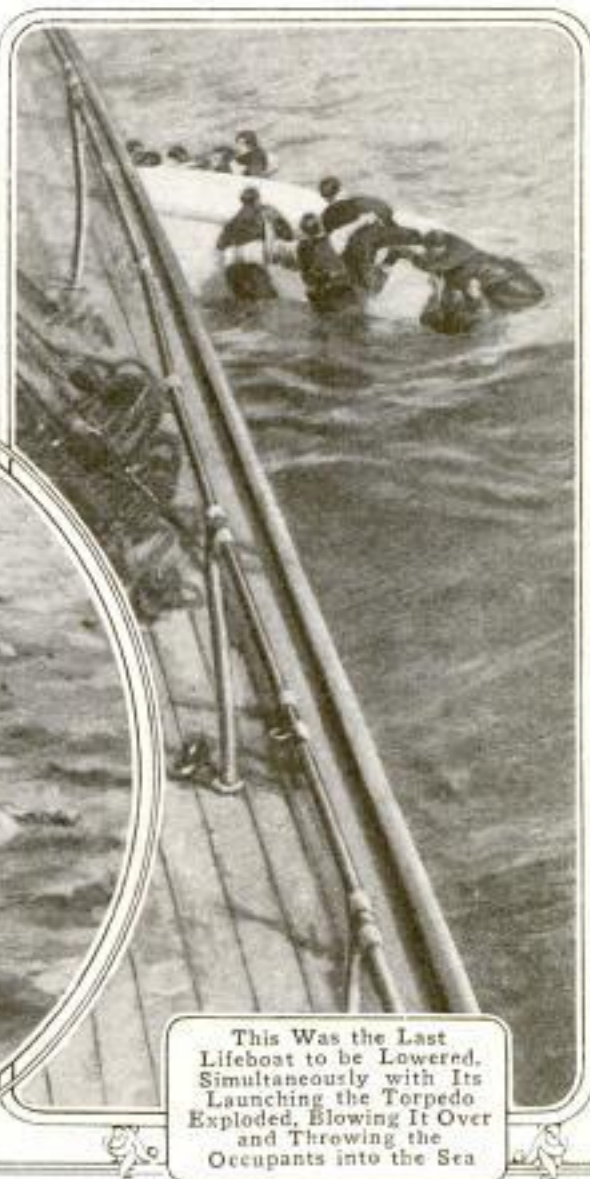

This Was the Last Lifeboat to be Lowered. Simultaneously with Its Launching the Torpedo Exploded, Blowing It Over and Throwing the Occupants into the Sea

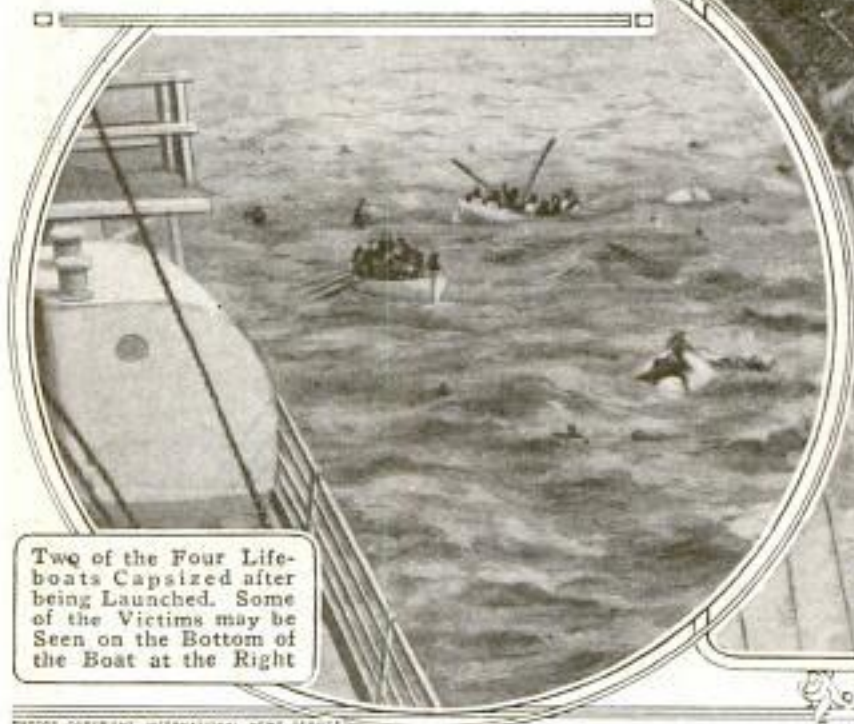

Two of the Four Lifeboats Capsized after being Launched. Some of the Victims may be Seen on the Bottom of the Boat at the Right

ENEMY PLOWS FIELDS IN FRANCE AND BELGIUM



In Some of the Districts Occupied by the Germans in France and Belgium during the Early Spring, the Army Plowed and Planted the Fields for Peasant Farmers Whose Horses had been Commandeered for War Purposes



Girl Workers in the Belgian Coal Mines: Since the Occupation of This Territory by the Germans, Regulations have been Enforced Prohibiting a Large Number of the Women from Doing This Labor

PHOTOGRAPHS BY AP/WIDEWORLD

HEAVY AUSTRIAN SIEGE HOWITZER IN ACTION



One of the Great Austrian Artillery Pieces, Such as has been Used with Pronounced Effect Both by the Germans against the Belgian Fortifications and by Their Ally Operating against the Russians. This Type of Gun is Made in Several Sizes and the Shell Shown Above is Almost an Inch Larger Than That Used in the Battery Below



SCENES FROM THE WAR CAMPS OF THE NORTH



This Shows the Type of British Cavalrymen Who are Pitted against the German Uhlans in the Strategic Movements of the English Forces. Although Cavalry was Not Used to a Great Extent during the Winter Operations, Because of the Close-Quarter Warfare Which was Carried on Chiefly in Bombproof Trenches, It has been Assumed by Military Critics That This Arm of the Service will See Heavy Action When the Allies' Offensive Campaign is Fully Launched

Seventh Regiment of the Belgian Line Infantry Marching along the Coast of the North Sea; This Gives a Good Idea of the Long, Wide, Sandy Beaches for Which Belgium is Noted

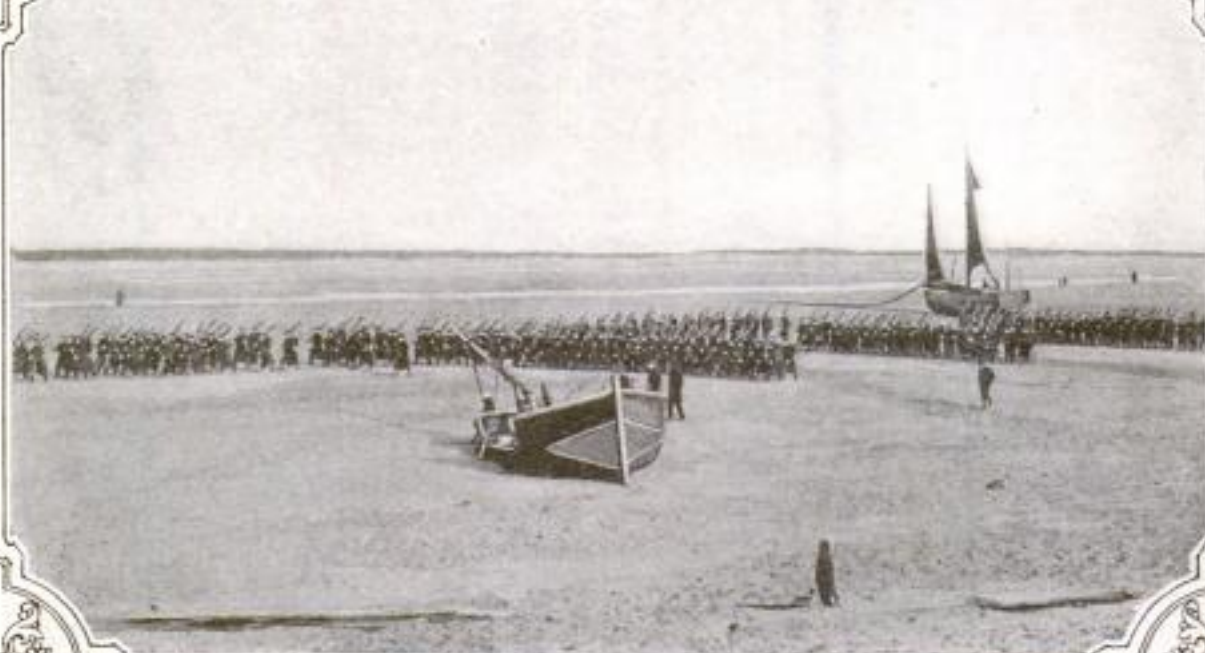

LIGHTER SIDE OF WAR SEEN IN GERMAN CAMPS



A Big Elephant from the Zoo at Hamburg Doing Work at the Rear of the German Lines Which would Otherwise Require the Services of a Dozen Horses
COPYRIGHTED BY BROWN & DAWSON.



Impromptu Orchestra in Camp, Making the Best of Crude Instruments Fashioned during Spare Moments. The Conductor's Baton is a Sword

RIFLEMEN IN THE MAKING AND IN SERVICE



Reservists Going Through Rifle Practice at One of the Military Training Camps in France: Although This Is Only One Phase of the General Course through Which the Men are Put in Drilling and Hardening Them for Active Service, It Is One of Importance

A Method Adopted by Russian Forces of Firing without Exposing Any Part of the Body to View of the Enemy. In This Position There Is Little Danger of being Wounded by Rifle Shot

PHOTO. COPYRIGHT, INTERNATIONAL NEWS SERVICE

MEDIEVAL CHURCH WRECKED BY GERMAN SHELLS

A Shell Striking the Ironwork Supporting a Statue of Notre Dame, Which Formed the Pinnacle of One of the Old French Churches at Albert, Caused the Figure of the Virgin to Fall at Right Angles to the Tower, Where It Remained Suspended in Mid-Air, Producing the Unusual Effect Shown in This Photograph



HOBBYHORSES AND DUMMY CANNON IN THE WAR



Hobbyhorses Such as This are Used in Lieu of Real Animals to Train Volunteers for Service in the British Cavalry. They Are Life-Size and Full of Mechanical Energy, so a Rider Is as Liable to be Thrown as If He Had a Real Mount

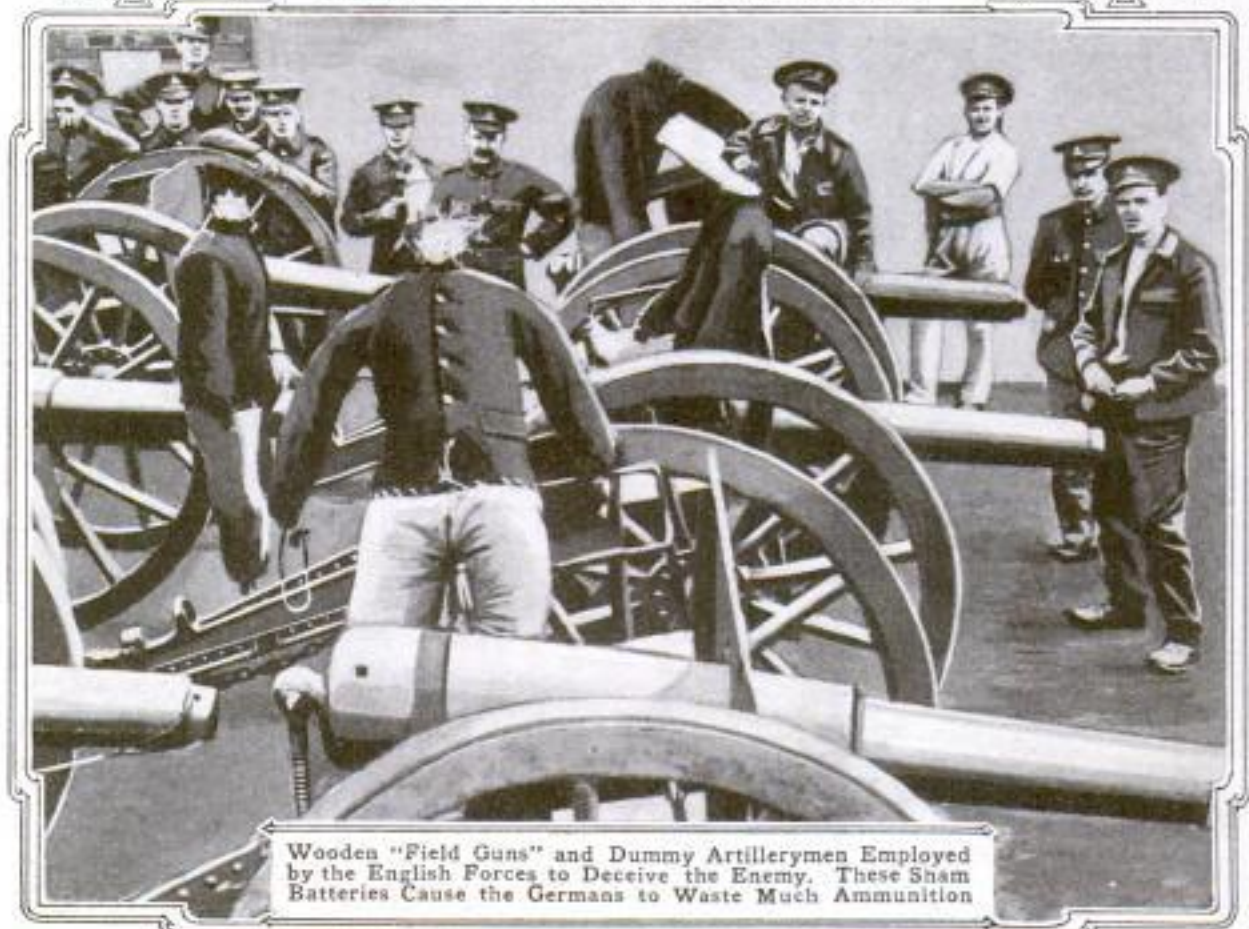

Wooden "Field Guns" and Dummy Artillerymen Employed by the English Forces to Deceive the Enemy. These Sham Batteries Cause the Germans to Waste Much Ammunition

PHASES OF WAR SEEN BY MEN AT THE FRONT

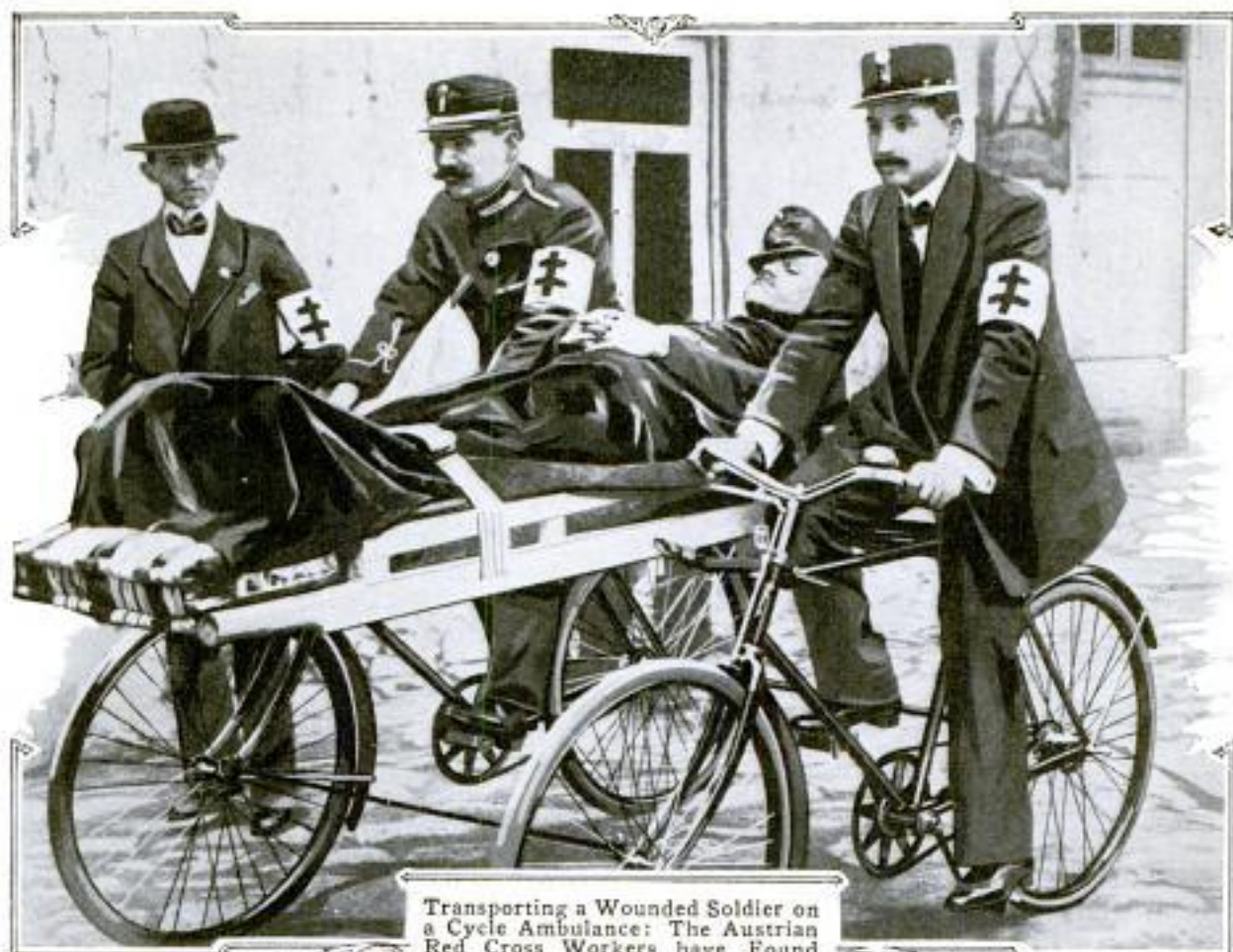

Transporting a Wounded Soldier on a Cycle Ambulance: The Austrian Red Cross Workers have Found These Vehicles Very Serviceable



Glimpse of Barbed-Wire Entanglement before a Russian Position Charged by the German Forces: Often in Night Attacks These Barriers are Not Seen Until Encountered

TOWNS THAT HAVE SERVED AS BATTLE FIELDS



PHOTO COPYRIGHT ENGERWOOD & UNDERWOOD
This Crater, Large as the Cellar of a Small House,
Shows the Explosive Effect of a Projectile
Fired from a German Siege Gun

DURING THE FIGHTING IN NORTHERN FRANCE



One of the Paths before the Germans in Their Assault on Craonne. The Approaches were Planted with Mines and Interwoven with Barbed-Wire Entanglements, Which had to be Leveled Before the Troops could Enter the Barricaded City



Ruins of Baccarat, a Town in Northern France Which Was in the Path of the Enemy. Only a Damaged Church and Two Other Buildings were Left Standing in This Section

STREET CARS PUT TO NOVEL WAR-TIME USES

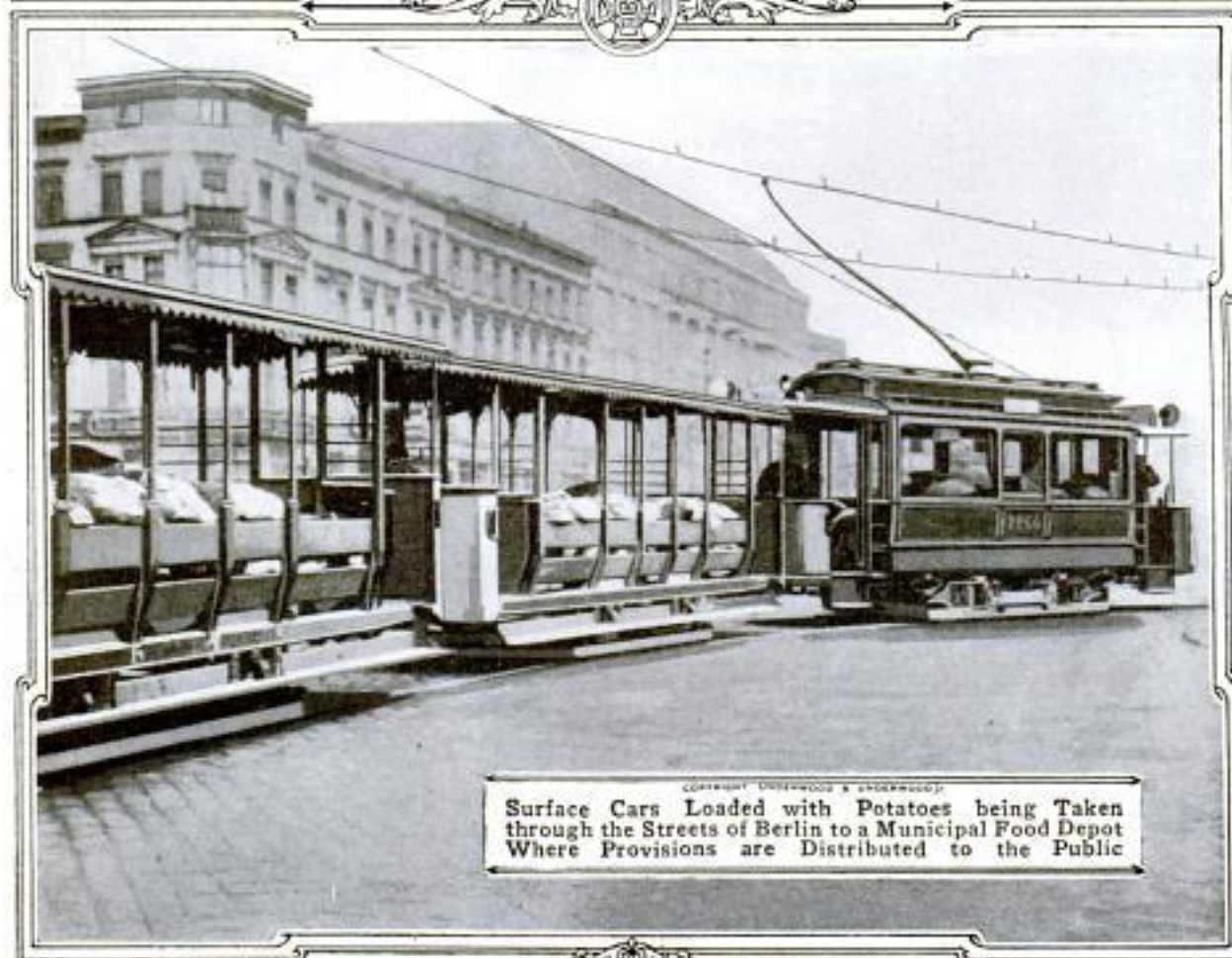
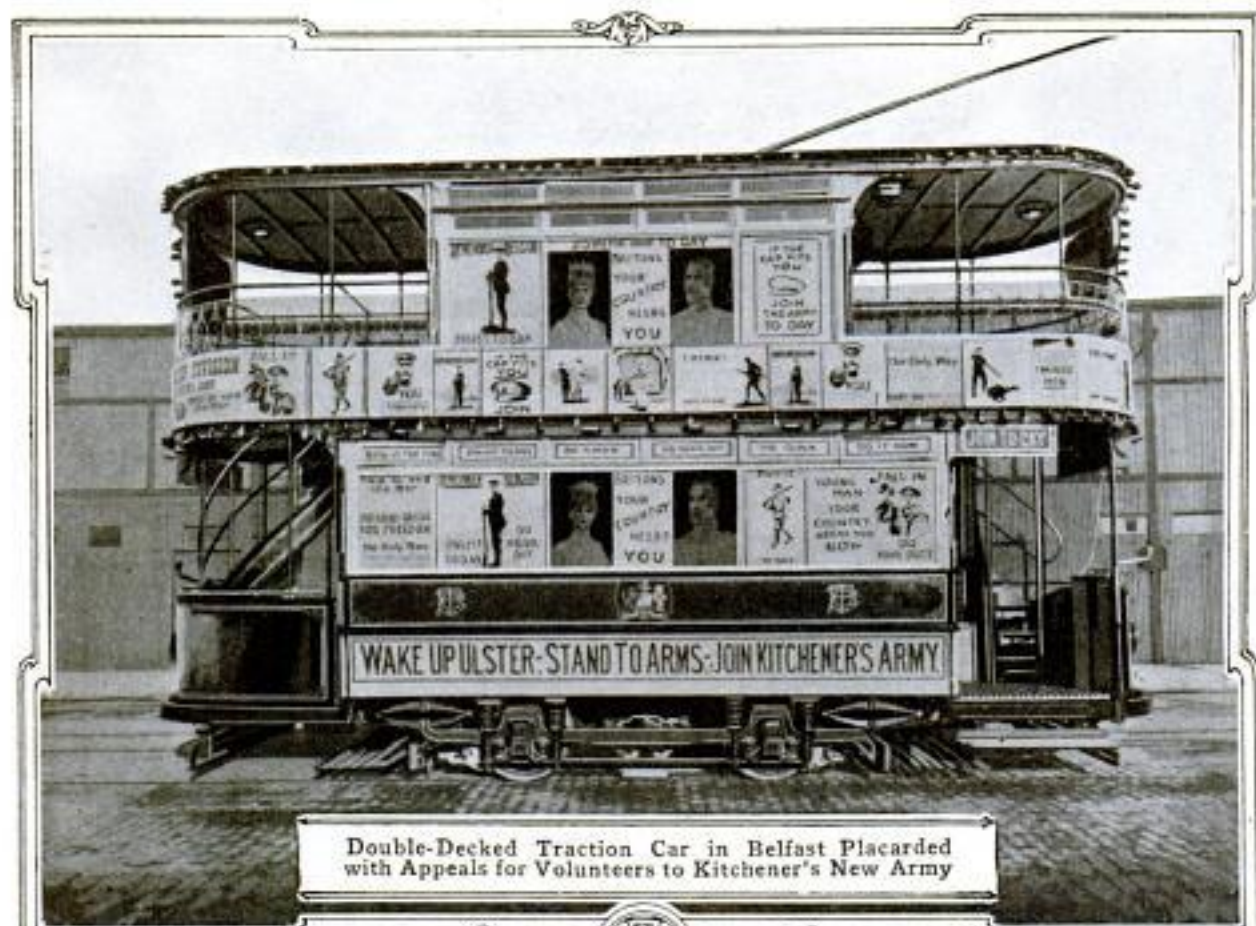

WOOD-FINISHING MACHINE

8904 **LESSENS HANDWORK**

Of late years the demand for better finishing in both interior trimmings and cabinetwork has become general, which from the builder's standpoint means that more time must be spent in sandpapering. To meet this situation, or, in other words, to supply the finish without materially increasing the cost, a machine has been developed which works at high speed while handling almost any kind or shape of material. It is an endless-belt sanding device and, in one form, consists essentially of two uprights carrying pulleys about which the belt passes, its abrasive surface outward. A movable worktable, so arranged that a piece of

material may be held firmly and moved freely as required, fits between the standards and immediately below the lower side of the belt. The sanding is done by the operator applying pressure

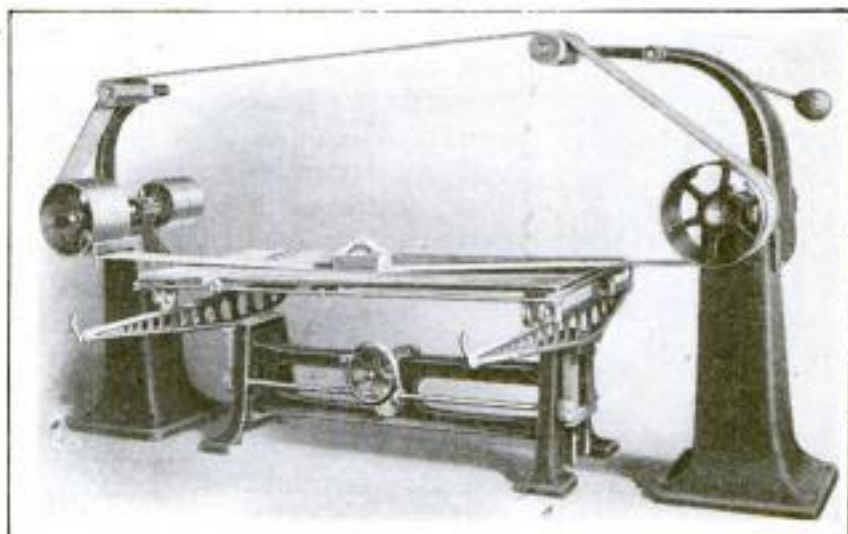

This Sanding Machine is Operated by Placing Pressure on a Hand Block against the Smooth Side of the Belt, Bringing the Abrasive Surface in Contact with the Work

with a block on the smooth side of the belt, pressing the faced side against the work either lightly or heavily as is required.

ELECTRIC GENERATING UNIT

8510 **FOR USE ON YACHT**

Built compactly so that it occupies only a small amount of space when installed, a turbine generator has been designed which is particularly adapted for use on a yacht or tug to supply current for a lighting system. The unit complete is less than a yard in length, approximately 1½ ft. in height, 13 in. broad, weighs 405 lb., and is rated at 1 kw. It is driven at about 4,000 revolutions a minute and is supplied with an automatic valve regulator which controls the intake of steam and prevents the motor from racing. One housing covers the whole

plant and allows easy access to the various parts for inspection or cleaning. The plant may be used wherever there is a boiler to supply a small amount of steam and requires little attention. It

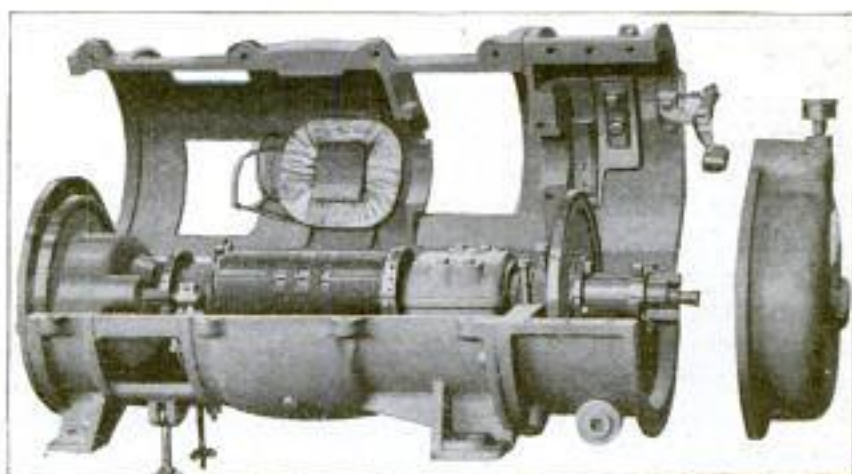

Small Turbine-Generator Unit Which is Particularly Designed for Operating a Lighting System on a Yacht

readily develops sufficient current for about forty 25-watt lamps, which is also adequate for a searchlight.

E. Ellsworth Claspby, Lewistown, Pa.

Built by Westinghouse Machine Co., Pittsburgh, Pa.

J. E. Miller, Fisher Bldg., 2009-111 W. Monroe St., Chicago, Ills.

FOUR ELECTRIC FUSE PLUGS

9401. **IN ONE**

A new electric fuse plug is equipped with four fuse wires that can be brought into service in succession so that the fuse plug cannot be put out of commission until each of the four wires has been blown out, making it equivalent to four ordinary fuse plugs. The porcelain part of the plug is made with four cells and in each cell is a fuse wire that is connected to the common bottom and to connectors at the top. Electric connection through any wire is made by means of a removable screw shell.



Atkinson, Hager & Co., 2210 South Park Ave., Chicago

Ralph C. Bowman, Chicago, Ill. Assignor of 1/2 to Wm. J. Krueger, Chicago, Ill. Filed May 9-12 Serial 696104. Fee: 175-273.

concentrated food and is in no way intended to replace wheat flour or other cereals, and cannot safely be so used. Because an excess of protein is probably as damaging to the human system as a lack of it, not more than approximately three ounces of the flour should be used by one person a day, according to chemists. It is supposed to be mixed with three or four parts of wheat flour and made into bread.

In its chemical composition the product more closely resembles meat than it does wheat flour and actually holds more than twice as much flesh-building material as meat. A pound of the flour contains about four times the quantity of protein and approximately the same amount of fat as an equivalent weight of eggs, or 48.25 per cent protein and 12.16 per cent fat. As a comparison, beef flank holds 19.60 per cent protein and 21.1 per cent fat, and eggs, 13.2 per cent protein and 12 per cent fat. Bread properly made with the new flour contains a maximum of 16.52 per cent digestible protein. Roughly, this may be said to be practically equivalent to either eggs or beef loin.

A man doing moderate work should consume approximately 125 grams (4.41 oz.) of protein daily, according to certain authorities. Some negroes in the South eat as little as 16 to 24 grams of flesh-building material a day, while among the poorer classes in other parts of the country the consumption of protein is also far below normal. In proportion to its food value cottonseed flour is probably the cheapest food known, and it may prove to be of remarkable economic value.

The necessity of using the flour intelligently, however, is imperative. Cottonseed meal has been used as a stock food for some time, but pigs fed large amounts of it daily for several months have frequently died as a result. That the flour is good as a continuous diet for man has not been established. When used moderately, however, it is apparently a very nutritious and beneficial food.

COTTONSEED FLOUR AS FOOD
9598 **FOR HUMANS**

From the results of tests conducted at the Texas Agricultural Experiment Station it has apparently been found that flour made from cotton seed is a valuable food for general consumption. This is a new product which is being manufactured in the South and offered as an inexpensive substitute for meat. It is remarkably high in protein, which is the nutrient, or flesh-producing, substance in meat, and is readily digested by the gastric juices. It is also said to be quite palatable and satisfying.

Cottonseed flour is made from the kernel of the seed after the oil has been pressed from it. It is a highly

*Texas Agricultural Experiment Station
Herbert Quick, Carthage Springs, W. Va.
Prof. H. S. Frazer, Texas Experiment Station, College Station, Texas
Schulenburg Burg Oil Mill, Schulenburg, Texas.*

PACKING A MAN READY FOR SHIPMENT

Stowed away in a box that was barely $3\frac{1}{2}$ ft. long, 3 ft. high, and 3 ft. wide, a lieutenant of the German army, who measures 6 ft. 9 in. from his heels to the crown of his head, nearly succeeded in escaping from England to Holland shortly after the outbreak of the war. The box was part of the bag-

gage and the deception was only discovered as the box was being loaded on the steamer that was to take it to Holland, after it had been dropped down a loading chute and transferred

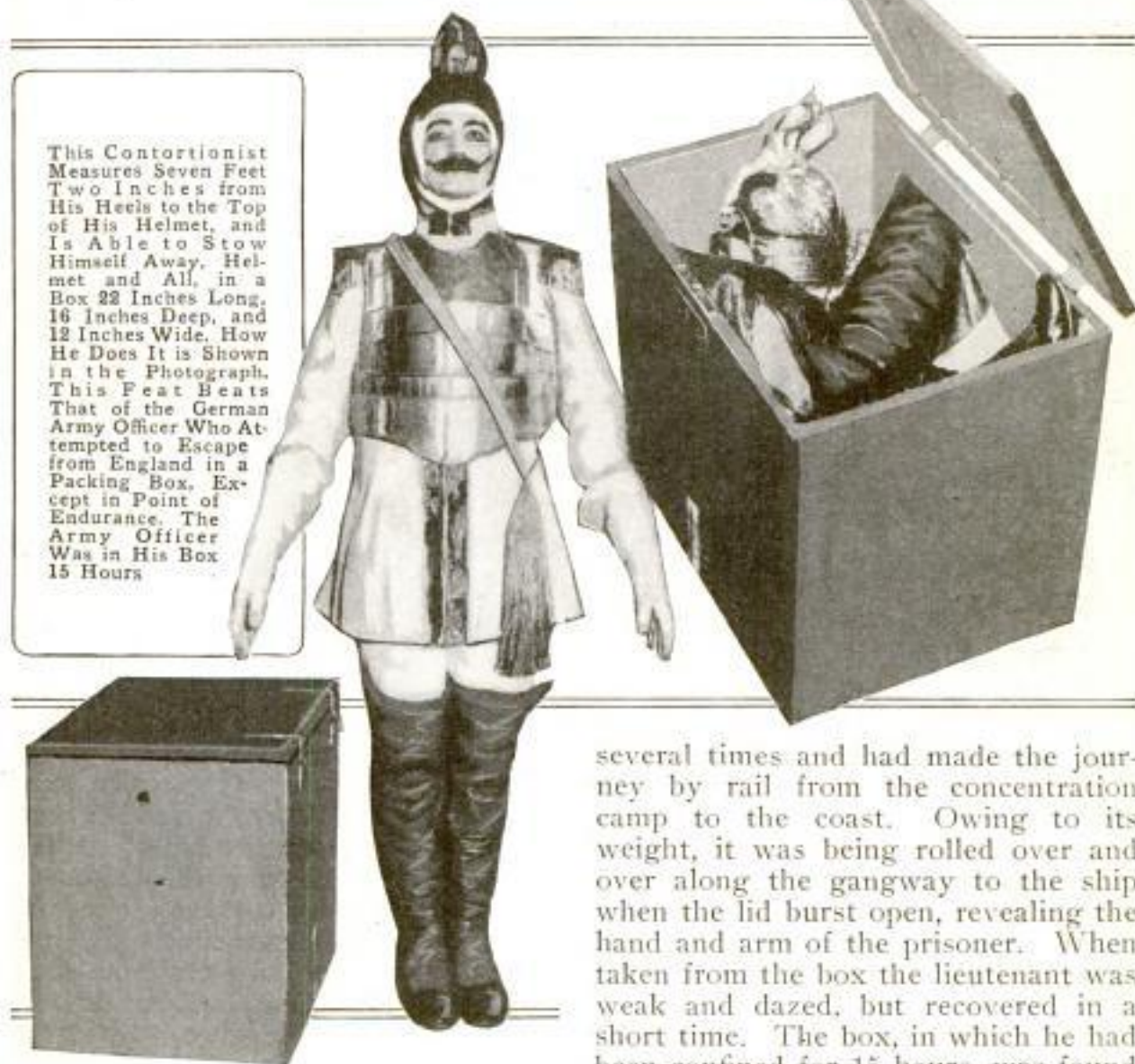

gage that accompanied a party of aliens being sent to Holland from the concentration camp at Dorchester, and had nothing about it to excite suspicion. On the lid were marked the words "Non-Poisonous — Safety Matches," and in addition to this there was a tag giving the destination.

The box was handled like any other

several times and had made the journey by rail from the concentration camp to the coast. Owing to its weight, it was being rolled over and over along the gangway to the ship when the lid burst open, revealing the hand and arm of the prisoner. When taken from the box the lieutenant was weak and dazed, but recovered in a short time. The box, in which he had been confined for 15 hours, was found to contain a blanket, two champagne bottles filled with water, a bottle of meat extract, about a dozen bananas and banana skins, and a rubber pillow filled with oxygen, which was evidently intended to revive the prisoner in case of faintness.

Remarkable as this feat may seem, it is being beaten regularly by the pro-

essional contortionist shown in the illustration. This contortionist measures 7 ft. 2 in. from his heels to the top of his helmet and is able to get into a box 22 in. long, 16 in. deep, and 13 in.

wide. It is to be remembered, however, that the contortionist is not called upon to remain in his cramped position for hours, as was the German lieutenant.

9255 ~~ORNAMENTAL SAFETY ISLAND~~ HAS MULTIPLE USES

At the junction point of two business thoroughfares in Los Angeles, Cal., a safety island has been constructed for pedestrians, beneath which is a public comfort station.

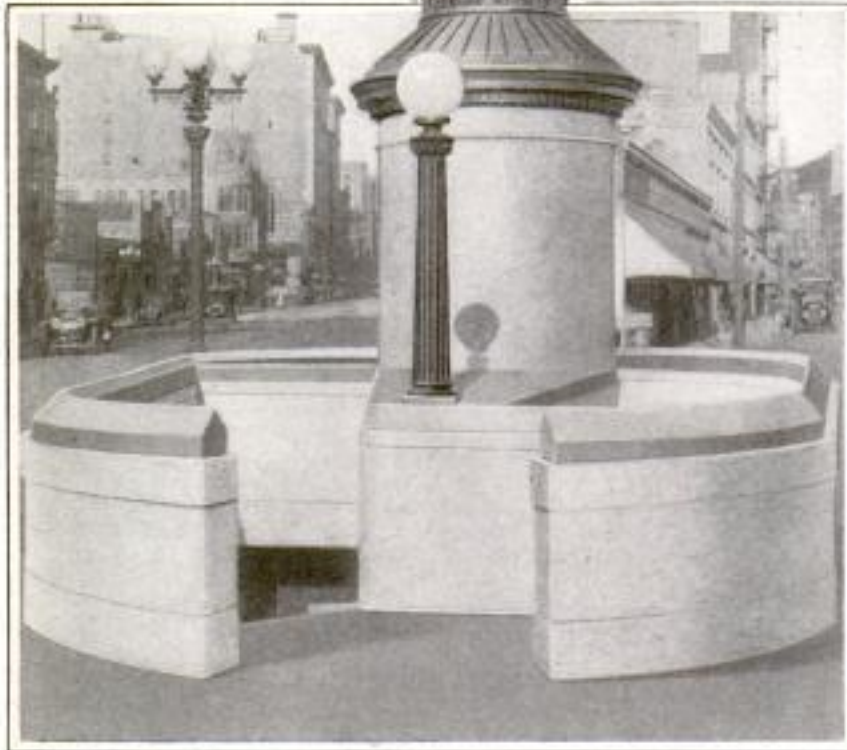

This Safety Island at the Junction of Two Business Streets Forms the Entrance to a Public Comfort Station Built beneath It

placed at a point from which surface traction cars may be entered. At either end of it is a broad, circling stairway leading under the street where there is a vault approximately 30 by 70 ft. in size. This is finished in marble and provided with a ventilating system, the fans for which are placed in the round tower shown in the accompanying photograph. Both hot and cold water are piped to the lavatories.

*J. J. Sturgeon, 620 S. Breed St.,
Los Angeles, Calif.*

9446 ~~SAILOR'S LIFE SAVED BY~~ OXYACETYLENE TORCH

When the salvage ship "Salvor I" turned turtle off the English coast near Yarmouth, all the crew were washed away and drowned except one man who found himself uninjured but imprisoned in the forecastle. The vessel had turned so quickly that there was plenty of air impounded, so he was in no immediate danger of drowning or suffocating. Every time the vessel rose with the swell one of the portholes rose clear of the water, and, stationing himself at the opening, the imprisoned man stuck his arm out and waved his hand each time this occurred. After three hours he heard a slight tapping on the hull, a head was stuck in at the porthole and a voice said "Where shall I cut open the hull?" After showing the rescuers how to keep clear of the stanchions the imprisoned man lost consciousness, but had a

vague realization of being gripped by the neck later and pulled out of the hull. An opening big enough to pull the man through had been cut in the steel hull with an oxyacetylene torch, the rescuers standing neck-deep in water for an hour while doing this work.

CA soldier in service in the trenches wears out a uniform every month, on the average.

*Daily News
3/1/15*

Miss Florence L. Clark, #12 Greenwood Ave,
 Hartford, V. D. ~~Canon City, Colo.~~

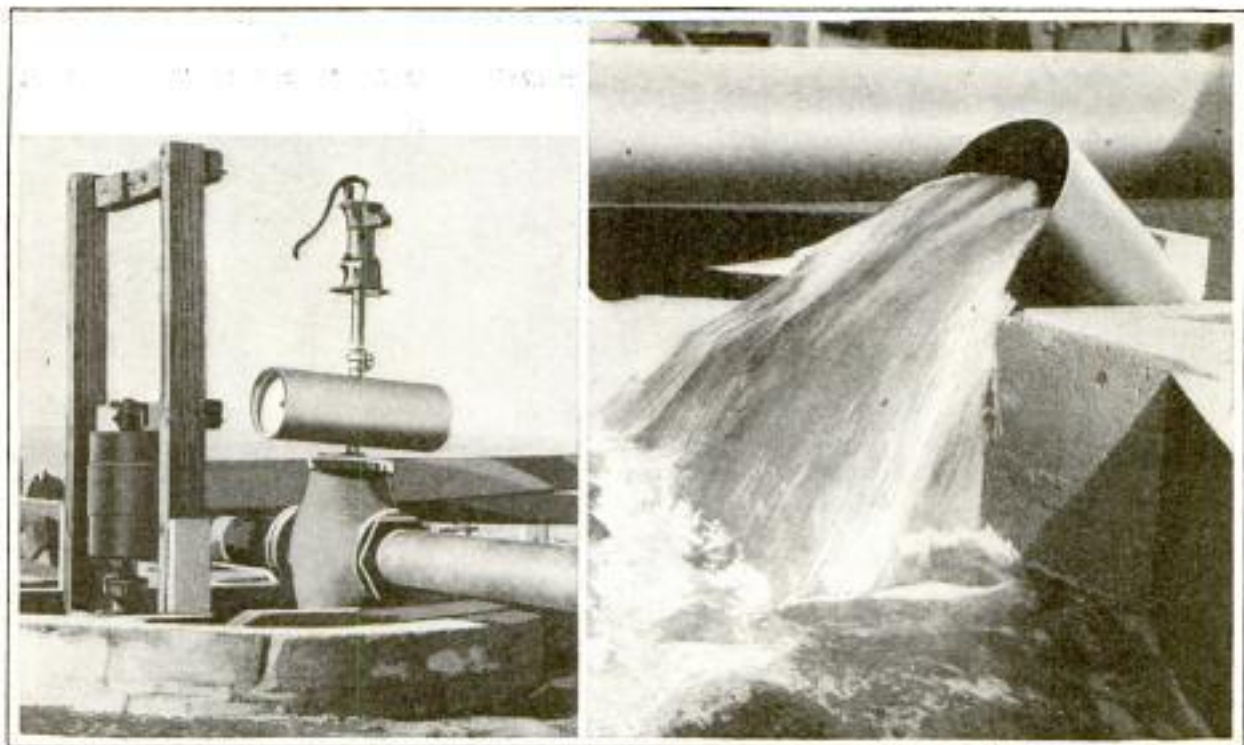

Part of Equipment of Colorado Irrigating Plant: A Hand Pump for Exhausting Air from a Siphon Pipe is Shown at the Left, and at the Right is a 14-Inch Pipe Discharging Water into the Irrigation Flume

SIPHON A FEATURE IN LAND RECLAMATION

9189

Great tracts of land in the arid regions of the West are too remote from any river to be reclaimed under large irrigation projects. With a new system developed for irrigating such tracts water is collected from a series of wells sunk on the land and is conveyed to a central well from which it is raised to the irrigation flume by a single pumping plant. The system for collecting the water is based on the principle of the siphon and is practicable wherever water can be found at depths not beyond the range of siphonic action. The outlying wells are connected with the central well by pipes that run along the surface of the ground and extend down into each well to a point below water level, and mounted on each pipe is a pump for exhausting the air. To start the flow from the outlying wells, the air is exhausted from the pipes and the vacuum thus created automatically fills with water. Then, when the pump is started, there is a siphonic movement of water from all the outlying wells owing to the lowering of the water level in the central well, and this move-

ment continues as long as the pump is in operation. The pumping is done by a submerged centrifugal pump run by gasoline power, which forces the water through a pipe and discharges it into the irrigation flume. On one ranch in Colorado a flow of 2,000 gal. a minute has been made available by this system by connecting 10 wells spaced 50 ft. apart, with the result that a 240-acre tract formerly given over to wild grass now yields something like 1,000 tons of alfalfa annually.

PLAN PREHISTORIC GARDENS FOR PHILADELPHIA PARK

8809

What might be termed a prehistoric zoölogical garden and aquarium is to be built in Fairmount Park at Philadelphia and filled with concrete and stone reproductions of many of the monsters and reptiles which centuries ago inhabited the western part of North America as well as certain parts of Europe. The work is to be modeled after a similarly planned park at Stellingen, near Hamburg, Germany. The various stone animals, many of them of huge proportions, will be placed in surroundings typical of

Wm. H. Watson,
 Morton, Pa.

On ranch of A. Foster
 Foster, Lincoln Co., Colo.

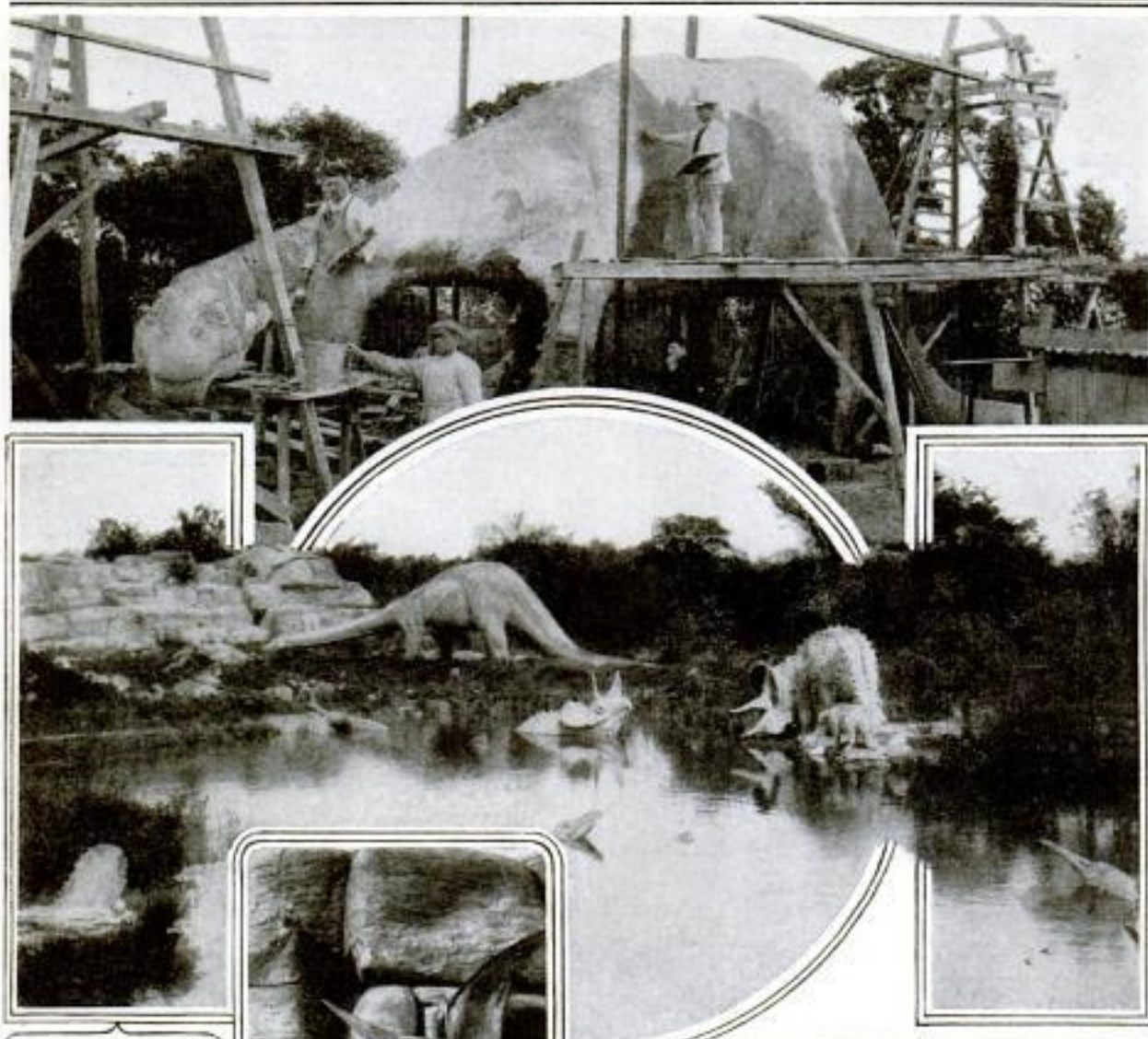

Concrete Reproductions of Prehistoric Monsters Like These are to be Placed in Fairmount Park, Philadelphia



the places in which they dwelt, certain of them being set among large rocks, others on green knolls, and the rest in and about the water.

The animals which will be modeled for Fairmount Park will be made life-size, and some of them will cost \$5,000 each. A Triceratops, an animal which had large horns protruding above its eyes, a horn on its nose and a great bony hood over its neck, will cost approximately \$3,500, while a Stego-

saurus, which was remarkable for its armor, consisting of two rows of bony plates along its back, will cost \$3,750.

RACING YACHT CONVERTED 9508 INTO TRADER

The racing schooner "Rainbow," built in 1898 and famous for many hard-fought races in the Solent and other waters, has been converted into a trading vessel for service around the Cocos Islands, in the Indian Ocean. The "Rainbow" is 132.7 ft. long, has a beam of 23.9 ft., and a depth of about 14 ft. In making the racer into a trader the fine saloon amidships was taken out and the space made into a hold, while the cabins aft were converted into an engine room, steel bulkheads being installed to divide the spaces.

The Engineer, Feb. 19, 1915

8439 MINTS EQUIPPED TO MAKE MORE COINS IN A DAY

To provide ingots for making one-cent and five-cent pieces, which are being coined in larger quantities every year, a new casting machine that turns out ingots weighing more than five times as much as those heretofore used, has been placed in service in the United States mint at Philadelphia. In connection with this machine larger rolls for forming the plates from which the coin "blanks" are cut are also being used, the whole purpose of the improved equipment being to turn out more coins in a day. How important this is, is shown in the fact that each year there is now a demand for approximately 100,000,000 one-cent pieces and 60,000,000 five-cent pieces, or "nickels."

The new ingot-casting machine consists of a turntable mounted on ball bearings, on which are 11 vertical molds, ranged equidistant on a circle 5 ft. in diameter. Each mold is made up of a flat plate fixed vertically to the turntable and a removable channel, the two, when placed together, forming a mold which casts an ingot of the coin metal that weighs about 22 lb. and is 24 in. long, $4\frac{1}{4}$ in. wide, and $\frac{3}{4}$ in. thick. With the removable channels clamped into place, the turntable is rotated and the molds are brought in succession into position for filling from the crucible, which is charged with just enough of the molten metal to fill the 11 molds. The molds are filled by two melters, each equipped with a graphite dipping cup of such size that the two cupfuls fill the mold. The second melter starts his pour just before the first empties his cup. With this arrangement the 11 molds are poured in about five minutes, and in this period of time there is no danger of the molten metal in the crucible becoming chilled. After being cast, the bars are first

passed through "break-down" rolls and then through the finishing rolls, which reduce them to the standard thickness of the coin. The "blanks" for the coins are then cut out of the plates by power cutters at the rate of five or six to each stroke of the cutter, and are annealed and passed to the machines that make them into coins.

In the production of these coins, and, to a smaller degree, in the production of gold and silver coins as well, enormous quantities of copper are used. In

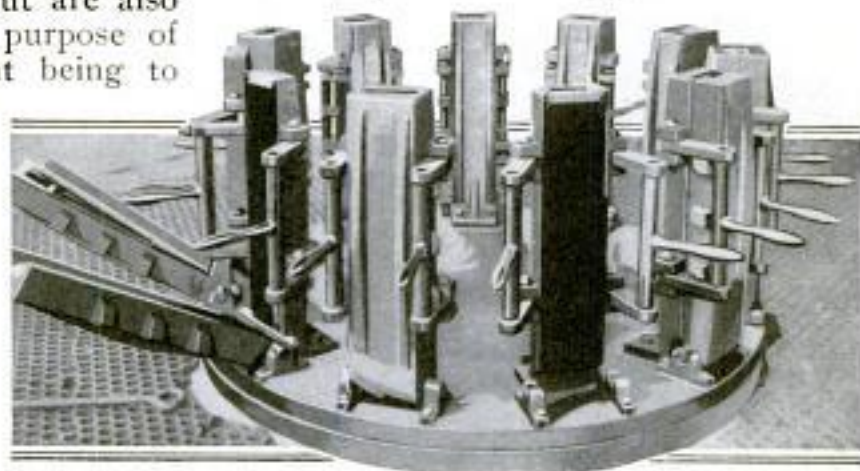

Casting Machine Installed in the Mint at Philadelphia for Casting the Ingots from Which One-Cent and Five-Cent Coins are Made

gold and silver coins there are 900 parts of the precious metal to 100 parts of pure copper. In the one-cent pieces the proportion is 95 parts of copper to five parts tin and zinc, while the so-called "nickel" is made up of 75 parts of copper and only 25 parts of nickel. In the coinage for the fiscal year ended June 30, 1914, the total amount of copper used was about 1,143,000 lb., or nearly 600 tons. Although the making of coins has become a big manufacturing enterprise requiring the most modern and efficient equipment, this kind of money represents only a small part of our total currency. During that fiscal year the coinage of gold amounted to \$26,625,810. At the same time foreign gold coins and refined gold bars stamped with their weight, fineness, and value, and having a total value of nearly \$200,000,000, were being held in storage in the various mints and assay offices as a reserve against gold certificates that had been issued.

Ralph W. Smith
 11463 W. Minnehaha St.,
 St. Paul, Minn.

NEW SCALE COMPENSATOR
8558 GIVES NET WEIGHT

The exact net weight of any commodity stored in a sack, or other container, is given automatically by the aid of a new scale attachment that balances an empty container against the one in which the commodity is stored and thus causes the weight of the



container to be left out of the scale reading. The principle of the device is simple, and consists merely in connecting a pivoted arm to the scale mechanism in such a way that a weight hung at the end of the arm will exactly counterbalance a similar weight placed on the scale platform. In one form of this device, which is installed on scales used in sacking flour, the pivoted arm is placed at the top of the upright and projects horizontally back from the scale. To get the net weight of the

flour all that is necessary is to hang from the arm a sack of the same kind as the one in which the flour is being placed. The scale reading will then give the weight of the flour alone. One advantage of this device over others designed for the same purpose is that the scale is always in balance and ready for use when no weight is suspended from the pivoted arm. This and other compensators of the same class have been developed principally to meet the requirements of the national food and drug law, which provides that all foodstuffs put up in packages for interstate shipment must show the net weight of the contained commodity.

8537 DETAILS OF RETAINING WALL SHOWN BY MODEL

A plan that is coming into favor with municipal and other public authorities when contracts are to be let for ornamental concrete work is the construction of a wooden model of a small part of the structure on the site where it is to be built. The model serves to show how the actual structure will look in connection with other features of the site, and also gives the contractor who contemplates bidding on the work a clearer idea of the general lines and ornamental features than can be given by plans and specifications. A model of this kind erected on the site of a retaining wall that is to be built in Grant Park, Chicago, is shown in the accompanying illustration.

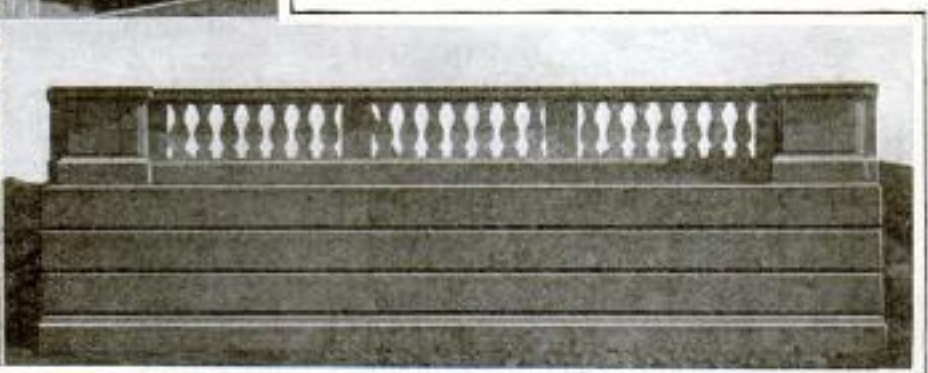
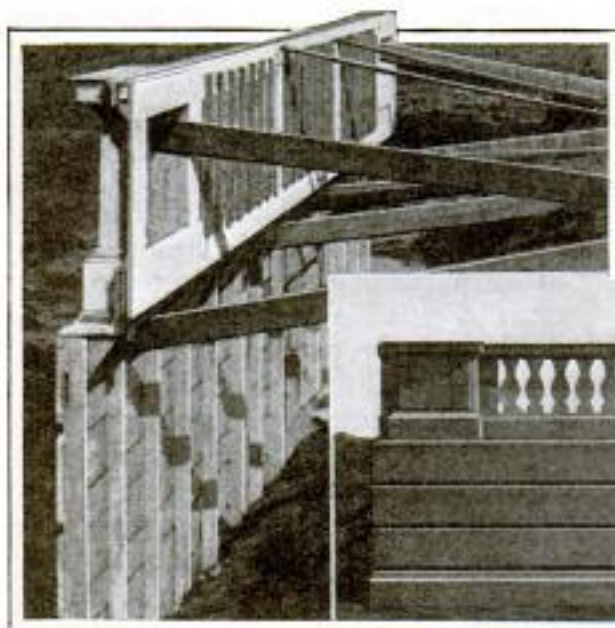

Wooden Model Erected on Site of Concrete Retaining Wall That is to be Built in Grant Park, Chicago

A. S. Jackson
 4316 Armitage Ave.,
 Chicago, Ill.

Data file and "The Oil Conquest of the World" by J. A. Talbot

MORE AND CHEAPER GASOLINE

How New Processes for Extracting the Universal Fuel from Crude Oil have Multiplied the Supply and Cut the Cost

9695

BY JOSEPH E. MURPHY

See Vol '15-516
9436

MORE gasoline is being used in the world today than ever before —yet the price of this fuel, so essential in this era of the internal-combustion engine, is lower than it has been in many years.

The present European war has been termed the gasoline war, and justly so, for if deprived of this fuel the armies engaged in the great conflict would be compelled to suspend operations. For transporting the field and siege guns and for propelling the thousands of motor cars used in the transportation of troops, ammunition, and supplies on the scale required in a war of such magnitude, gasoline is a necessity, and without it the operation of Zeppelins and aeroplanes would be an impossibility. The supreme importance of this feature of the war is shown in the fact that one of the main purposes of the Russians in invading Galicia was to get possession of the oil fields in that country and thus cut off from the Germans one of their few sources of crude oil available under the conditions brought about by the war.

But in spite of the tremendous demand made on the oil supply by reason of the war, gasoline has been getting cheaper. This situation is the result of the development of improved methods of refining by which a greatly increased supply of gasoline can be obtained from a given quantity of crude oil. During the past year the tank-wagon price of gasoline has fallen in the large centers, apparently from this cause, from 16 cents to 9½ cents a gallon. There is little doubt that the price will eventually go still lower with the development of the new process just discovered by Doctor Rittman, chemical engineer of the U. S. Bureau of Mines, which was announced in the ~~May~~ 1915, issue of this magazine. The improved processes now in use are held

as a monopoly by one group of refiners. The new process is to be free to all refiners who will submit to certain government regulations. With it, it will be possible to extract three times as much gasoline as can be extracted by the process of distillation.

Increased production of gasoline is not all that will be accomplished by the new process. It provides a means for obtaining from crude oil the two hydrocarbons toluol and benzol, heretofore obtained from coal tar and produced almost exclusively by German and British manufacturers. Toluol and benzol are of vital importance both in peace and war. They form the "mother" substances from which aniline dyes are made and are at the same time indispensable ingredients of the high explosives used in modern warfare.

To understand just what is done by the new process it is first necessary to know of some of the qualities of that group of substances known as hydrocarbons. A hydrocarbon, as its name indicates, is a combination of the chemical elements hydrogen and carbon. In the combination there is usually nitrogen, oxygen, sulphur, or other chemical elements in small quantities, which are removed in the process of refining. The range of substances produced by different combinations of these two elements is probably the widest to be found in the whole range of natural products. There are about 200 hydrocarbon products, many of them indispensable adjuncts of our everyday life. Crude oil, or petroleum, which is the source from which most of these products are derived, is simply a mixture of many hydrocarbons which may be separated from each other without chemical action by the process of distillation. Gasoline, illuminating oil, and lubricating oil, for

April
p 516

Doctor Walter F. Rittman
U. S. Bureau of Mines

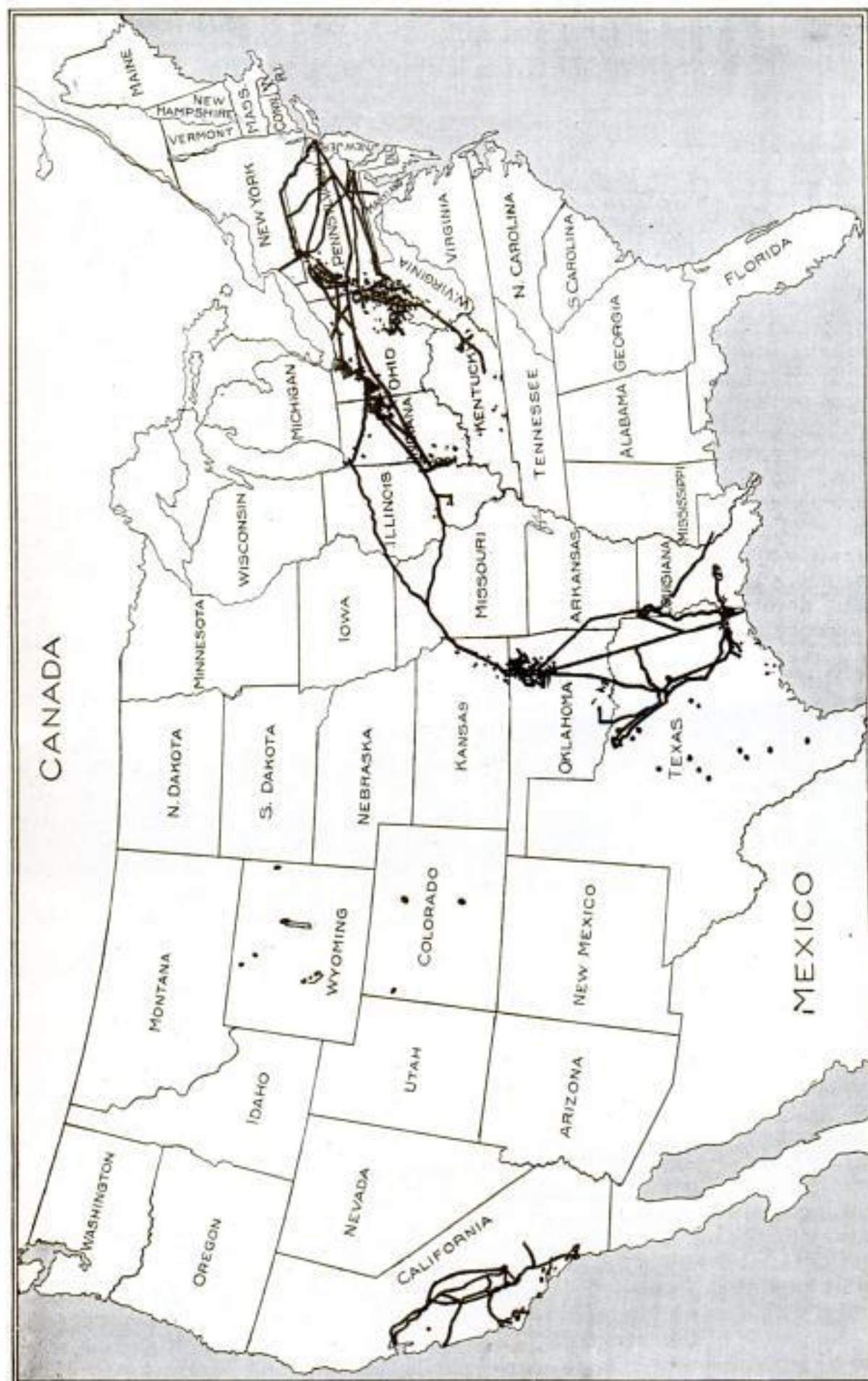

Map Compiled by the U. S. Geological Survey, Showing the Producing Crude-Oil Fields and Pipe Lines of the United States. Extensive as These Fields Are, They are Believed to Form Only a Beginning in the Development of Our Oil Resources. The Pipe-Line Systems for Conveying the Crude Oil Constitute the Biggest Transportation Feature of the Entire Industry

example, are all present in crude oil, being mixed together much as different kinds of grain might be mixed. There are other products, however, that are less obviously present in crude oil, and to produce these it is necessary to resort to chemical action, which consists in breaking up some of the hydrocarbons and rearranging the atoms in molecules of a different kind. This is what is done when oils are "cracked," a process that has been used heretofore mainly for breaking up the heavier oils and forming their components into gasoline molecules. It is one of the peculiarities of hydrocarbons that this breaking up and rearranging can be done repeatedly and to practically an unlimited extent.

Distillation, the process ordinarily used in refining, is made possible through the fact that the different hydrocarbons vaporize at different temperatures. The still is simply a tank equipped with a heating plant for boiling the crude oil. Connected with the top of the tank is a pipe leading to a condenser where the gases produced by the boiling are cooled and reconverted into a liquid. Crude oil contains several ingredients that become gases at from 32° to 62° F., and these pass off to the condenser at the beginning of the process. The real business of distillation, however, begins when the temperature of the oil reaches 140° F. From this temperature to 158° F. the vapor that passes over to the condenser is benzine. As the temperature goes still higher there are produced, in the order given, the lighter gasolines, the heavier gasolines, fuel distillates, kerosene, heavy oils, lubricating oils and paraffin. The residue remaining in the still after the boiling is completed may be almost pure coke or asphalt, depending on the nature of the crude oil, or it may be a mixture of cylinder and fuel oil. Now it has been found that additional quantities of the lighter distillates, such as gasoline, may be produced from this residue by "cracking," which consists essentially in subjecting the oils to extremely high temperature and heavy pressure.

The separation of the condensed distillates is simple, the apparatus consisting of a series of tanks so connected with the condenser that the liquids can be turned into any one of the tanks as

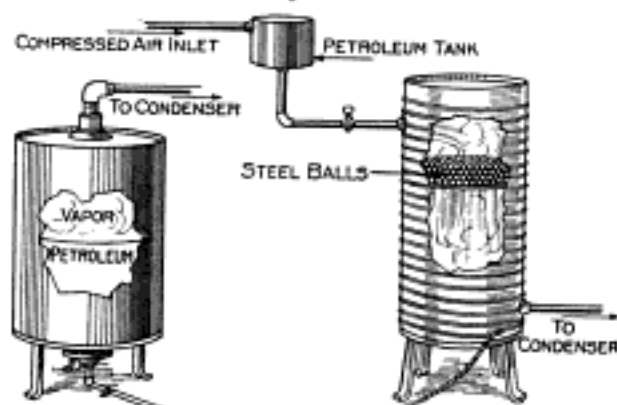

Treatment of Oil by New Process Indicated at Right; Small Model of Ordinary Still at Left

desired. While the benzine is being vaporized all the liquid goes into a tank containing only benzine. The instant the temperature reaches the point where the gasoline begins to come through, a valve is turned and all the gasoline is discharged into a second tank, and the same process is followed with each of the other distillates in turn. Each distillate may contain several products and may have to be subdivided by a second distillation. This is only a general outline of the process, the actual work of distillation varying to suit the methods of the individual refiner and the requirements of the particular crude oil being treated.

The biggest feature of the new process is that practically all the crude oil can be converted into any hydrocarbon desired, so that it provides a means for "cracking" oils on such a scale as has not been thought possible heretofore. Full details of the process have not been made public, but it is reported that the kind of hydrocarbon produced is governed solely by the degree of heat and pressure applied. With a temperature of 932° F., for example, the product obtained is gasoline. If the temperature is raised to about 1,112° F., benzine, toluene, and xylol, with small quantities of methane, creosote oil, and pitch, are obtained. The apparatus is simple and apparently does nothing more than vaporize the

crude oil and subject the vapor to the required temperature and pressure. It consists of a vertical steel cylinder closed at top and bottom and connected at the bottom with a condenser. Near the top are several layers of steel balls that fill the space between the walls of the cylinder. These are kept at the right temperature for vaporizing the crude oil. The oil is admitted through a pipe at the top of the cylinder and drops on the hot steel balls. As it passes the balls the oil is converted into a vapor which is forced to the bottom of the cylinder by the pressure of the new vapor constantly forming. At the bottom of the cylinder the vapor is subjected to the heat and pressure necessary for transforming it into the required product. The heat is supplied electrically by means of resistance coils. The gas formed by the new hydrocarbon molecules is then passed through the condenser and converted into a liquid. This process has already proved successful in the laboratory and is to be immediately subjected to test and development under conditions of commercial manufacture.

Almost simultaneously with the announcement of this process another discovery, so remarkable that it ranks as one of the romances of science, was made public. This consists in a process for taking paraffin, or any other derivative of crude oil, and converting it back into crude oil—in short, in taking one part of a complex product and remaking the whole product from it. The possibility of doing such a thing as this is an illustration of the peculiar qualities possessed by hydrocarbons. This process, like that of "cracking," is simply one of tearing the molecules to pieces and rearranging the hydrogen and carbon atoms into molecules of new kinds, and it must evidently result in a considerable deposit of free carbon that has failed to find its hydrogen under the new arrangement. Distillation of this "synthetic" crude oil results in the production of gasoline, kerosene, and other products, in exactly the same way as the distillation of natural crude oil.

One of the significant things in connection with crude-oil products and the vital part they play in nearly every form of human activity, is the fact that the supply is more than equal to the demand, and is likely to remain so for generations to come. The North American continent is thought to be one vast subterranean oil reservoir. Oil is found from the Atlantic to the Pacific seaboards and from Nome to Central America, and while there are a number of fields from which oil is being drawn in enormous quantities, these vast resources have apparently been touched only in spots. Much the same condition prevails in other parts of the world. The United States is by far the largest producer, the production in this country having been over 248,000,000 bbl. in 1913, or about 65 per cent of the total production of the world. Russia, with its Baku oil fields located on the western shore of the Caspian Sea, ranked next with a production of nearly 61,000,000 bbl., and Mexico third, with over 25,000,000 barrels.

The principal oil fields that have been developed in the United States are those in Pennsylvania, West Virginia, Ohio, Indiana, Oklahoma, Texas, and California, and in connection with these fields the pipe line, the biggest transportation feature of the whole oil industry, is prominent. It is estimated that there are now over 10,000 miles of trunk pipe lines and 80,000 miles of branch or feeder lines, the whole system serving to pick up the oil at the wells and hurry it to the refineries. Before the installation of pipe lines it was necessary to operate small refineries in the oil fields, as crude oil is a weighty, bulky, and awkward article to transport by any other method. Now, instead of taking the refinery to the oil field the oil is brought to the refinery. By this means oil can be transported economically halfway across the continent, and refineries capable of operating with the greatest efficiency because of their size and completeness can be located wherever facilities for marketing and exporting the finished products may dictate.

Inventor:

*Dr. Walter O. Snelling
(Research Chemist) 7440 Finance St.
Formerly of U. S. Bureau of Mins. Pittsburgh, Pa.*

Chas. Alma Byers, #018 Bernice Ave.
Los Angeles, Cal.

Wm. Dillamore Turntable Co.
Pasadena, Cal.

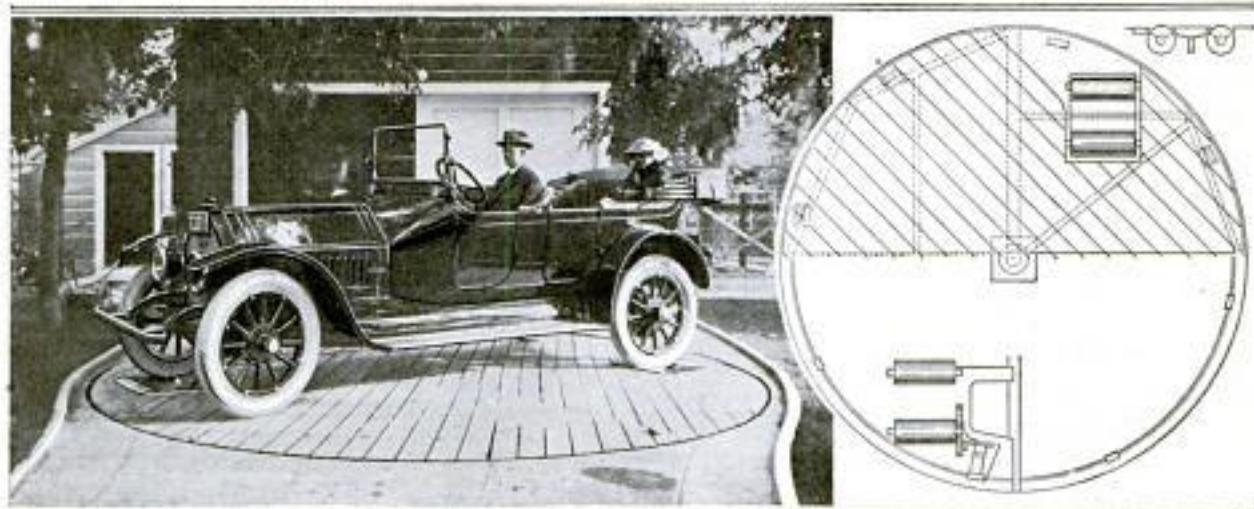

With This Turntable It Is Possible for a Car to be Turned Around without the Driver Leaving His Seat

CAR TURNS SELF AROUND ON NEW TURNTABLE

9272

An automatic turntable for motor cars has been introduced in California which allows a driver to reverse the position of his machine without leaving it. It is designed to be used either inside of a garage, or immediately in front of one, and does away with the trouble occasioned by the necessity of backing in or out. There are two pairs of rollers flush with the platform and so placed that when a car is driven onto it the left rear wheel rests on one set. The transmission is then thrown into reverse, and the car started. The wheel resting on the rollers turns them and the platform is revolved slowly. The turntable operates on a center pivot and turns on roller bearings on a circular steel track.

RINGING CHURCH BELLS BY ELECTRIC POWER

9248

An electrical apparatus with which church bells can either be chimed or rung continuously has been developed and is being installed in some of the leading churches and cathedrals of the country. The bells are operated by means of an electrical keyboard somewhat resembling a piano keyboard and installed in any convenient place. This keyboard operates with small current, but works through a larger keyboard

placed in the basement which applies the full current for ringing the bells. Two keys are provided for each of the bells. One key chimes the bell or causes the clapper to give one stroke, while the other oscillates the bell, or causes it to ring continuously so long as the key is depressed. The chiming is done by means of solenoids and the oscillating by motors. There is practically no limit to the scope of the apparatus, and one person, by manipulating the keys, can easily chime or oscillate a set of bells that formerly required the services of six or eight

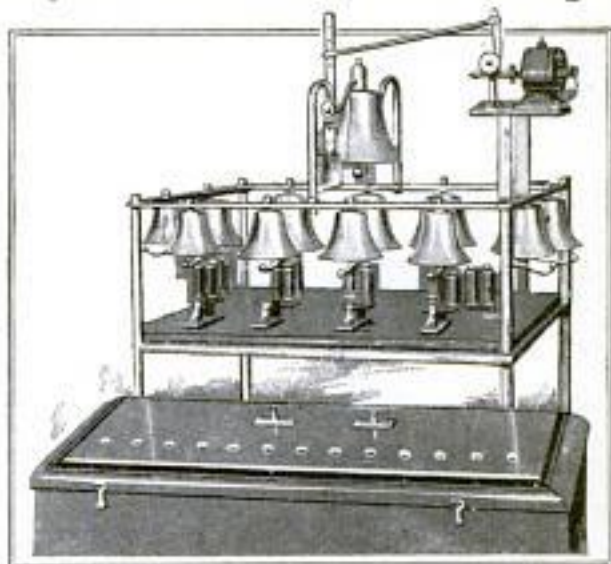

Apparatus Used in Developing System for Chiming and Oscillating Church Bells by Electricity

persons. One important feature of the apparatus is that while one set of bells is being chimed another set can be oscillated.

Inventor + Patentee: W. F. Wacker, Sioux City, Iowa.
Contributed by + installed exclusively by: Murphy Dunham Co.,
216 Davidson Bldg. Sioux City, Iowa.



One of the Latest Uses for Flax Straw Is That of Fuel for Threshing Engines

9022 **FLAX STRAW A VALUABLE BY-PRODUCT**

Many uses are being found for the flax straw produced in the great flax-growing section comprising Montana and North and South Dakota, and this material, formerly regarded as waste and usually burned in the stack, is now recognized as a valuable by-product.

On the prairies of North Dakota, where coal is scarce and expensive, it is being used successfully as a fuel, particularly for firing the threshing engines. The fiber and woody portions of the straw are already extensively employed in the manufacture of insulation materials and building papers, and as a pulp material in making paper of all kinds. The industries of the United States are using about 30,000,000 bu. of flaxseed a year.

9561 **LIGHT-WEIGHT FLYING BOAT USED ON LAKE MICHIGAN**

One of the lightest flying boats ever constructed is a private craft that has recently been flown over Lake Michigan at Chicago. The machine has a wing spread of 27 ft. and a total weight of 400 lb., which is much less than that of any similar aerial vehicle known to be in use. The motor has only two cylinders, weighs 116 lb., is air-cooled and develops approximately 35 hp., which is sufficient to drive the machine through the air at a speed of about 58 miles an hour. The supporting surface amounts to 240 sq. ft. The hull is made of 1/8-in. double-ply pine and has a lining envelope of canvas on the inside.

The exterior of the hull, which is 6 ft. in length, is treated with cellulose acetate in order to render it absolutely waterproof. Under favorable conditions it is possible for the craft to rise off the water in eight seconds from the



This Flying Boat Is One of the Lightest Craft of Its Kind Ever Constructed and Flown

start. It carries only one person, but its weight is so slight that it can be taken from and returned to its hangar single-handedly without difficulty.

Heath Flying Boat, Heath Aerial Vehicle Co.
1227 School St., Chicago, Ill.

*C. L. Edholm
1353 W. 36th Place
Los Angeles, Calif.
873*

POPULAR MECHANICS

Army + Navy Journal
EFFECTIVE FIRING RANGE
9611 OF BIG NAVAL GUNS

During some of the naval engagements in the North Sea and elsewhere, battleships are reported to have been sunk by shells fired from a distance of approximately 15,000 yd. This is another surprise which has been developed by the European war, for heretofore it has been assumed by naval authorities that 12,000 yd. would be the maximum distance at which enemy fleets would attempt bombardment. A range 3,000 yd. greater than this, however, has been taken on different occasions in the present conflict. This means that in target practice hereafter the navies of all powers will undertake firing at greater ranges than has been the custom in the past.

9589 SHOVEL BLOWN FORTY MILES THROUGH PIPE LINE

During a high-pressure test of a new pipe line which has been built into Waco, Tex., from an adjacent gas field, a shovel was blown through the conduit for a distance of nearly 40 miles. During the construction work the tool was evidently dropped in one of the 12-in. pipes and not noticed before the connections were made. The Waco end of the pipe was open when the test was made and faced an embankment at the end of the ditch. The pipe line extends across a nearly level stretch of country and has hardly a rise or depression in the whole 40 miles of its length. When the gas was turned on, the shovel, which weighs 4 lb., was shot with such velocity that it buried itself nearly 18 in. in the earth when it left the opening of the pipe. Several pieces of broken pipe connections and a pair of gloves followed in its wake.

J. E. King, 202 So. Winnetka Ave., Dallas, Texas.

9367 AMERICAN FLAG IS MADE OF COLORED CONCRETE

Concrete is the material which a Kansas farmer has used in making an American flag for his front yard. The

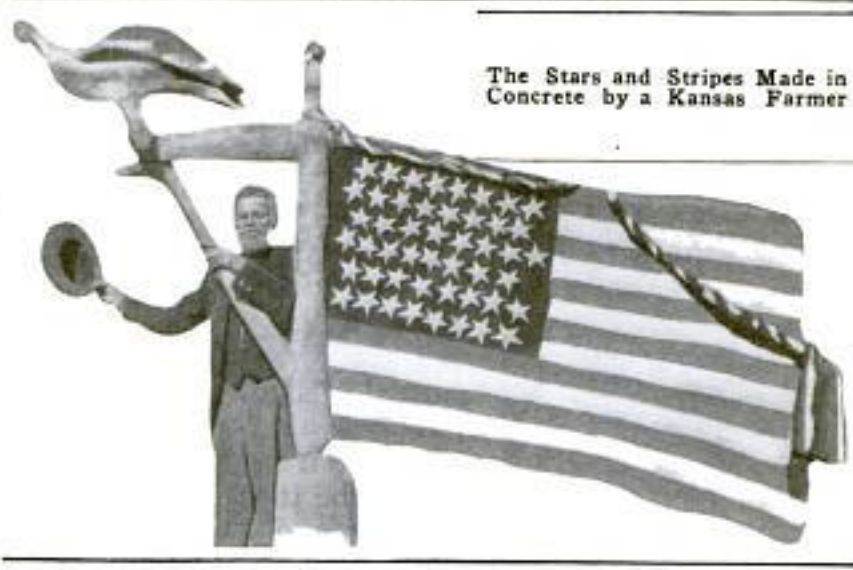

The Stars and Stripes Made in Concrete by a Kansas Farmer

banner was built up, stripe by stripe, while the blue field was painted on instead of being made of colored material, as were the red stripes. In dimensions it is 4 by 6 ft. and is mounted, in flag fashion, 20 ft. from the ground on a "tree" also made of concrete. It is pivoted so that a strong breeze turns it to one side or the other as it would a weather vane.

STEERING WHEEL THAT CAN BE SLID OUT OF WAY 9002

An automobile steering wheel that has just been invented is designed to enable the driver to get into his seat without being compelled to slide into it. The wheel is mounted on a spider so that it can be slid upward and forward on the steering column, and when in this position it gives 9 in. additional space for entering and leaving the car.



*Invented + patented by
O. H. Merrill, of above
company*

*Moroom Steering Wheel Co.
919 Schmulbach Bldg.,
Wheeling, W. Va.*

NEW MACHINE FOR CUTTING SEED POTATOES

To do away with the tedious work of cutting potatoes for planting, a Maine inventor has brought out a machine

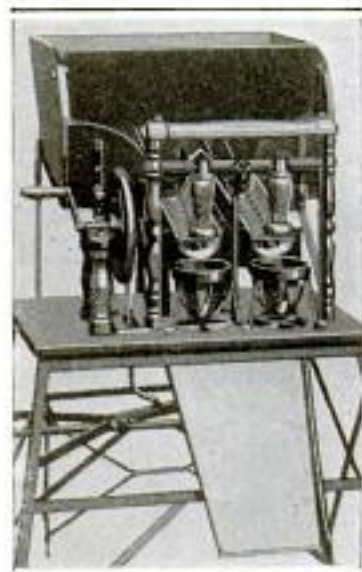

that cuts two potatoes at a time into four pieces each, and does this work with a rapidity that depends only on the speed at which the operating wheel is turned. The potatoes are placed in a bin at the top of the machine. Open-

ing from the base of the bin are two chutes that lead down to the two cutting devices, each of which consists of two intersecting vertical blades and a plunger. When the plunger rises one potato is automatically released into each chute and rolls down to a position on top of the intersecting blades. As the plunger descends, it forces the potato down against the blades and through the spaces between them, so that the potato is cut into four pieces. The plunger makes one up-and-down movement at each revolution of the operating wheel.

NEW INTEREST MANIFESTED IN AMERICAN AVIATION

9520

Fifteen different bidders responded to the Navy Department's request for estimates on armored flying boats for the aviation service. The interest manifested by American manufacturers in this competition gave the navy more encouragement than it has heretofore had in its attempt to stimulate home interests to develop suitable aerial craft for war purposes. As previously announced in this magazine, the department has a fund of approx-

Scientific American

imately \$350,000 available for the purchase and maintenance of flying machines, and contemplates the purchase of 32 American-built craft just as soon as it is possible. The recent bids were submitted in accordance with specifications calling for biplanes of the sea-going class having a carrying capacity of about 600 lb., or capacity for two persons, gun, ammunition, and wireless equipment. The speed of these craft is to range between 50 and 80 miles an hour and their weight between 2,500 and 3,000 lb. The highest bid which was submitted was \$18,000 for one machine, and the lowest, \$6,600. The craft are to be American-built throughout, including the engines.

ELASTIC CHECKREIN MADE FOR GOLF PLAYER

9431

To prevent a golfer from unconsciously turning his head and taking

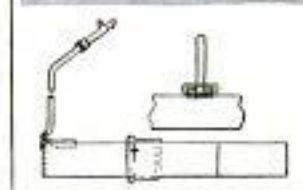

his eye off the ball as he is about to drive it, a checkrein has lately been invented which is intended particularly for the use of beginners, who experience difficulty in mastering this point of the game. The device serves a real purpose, and if used consistently, is an aid in breaking a bad golfing habit. It consists of a belt that is strapped

beneath the arms, attached to which is an elastic cord, or tube, fitted at the end with a soft-rubber mouthpiece which the player grips in his teeth. In this way he is reminded each time by a sudden jerk when he unconsciously starts to turn his head to see where the ball is going.

Patent Office Gazette
Inventor: John F. McWillicuddy
Worcester, Mass.

LOOKING INTO THE MUZZLE OF A BIG GUN

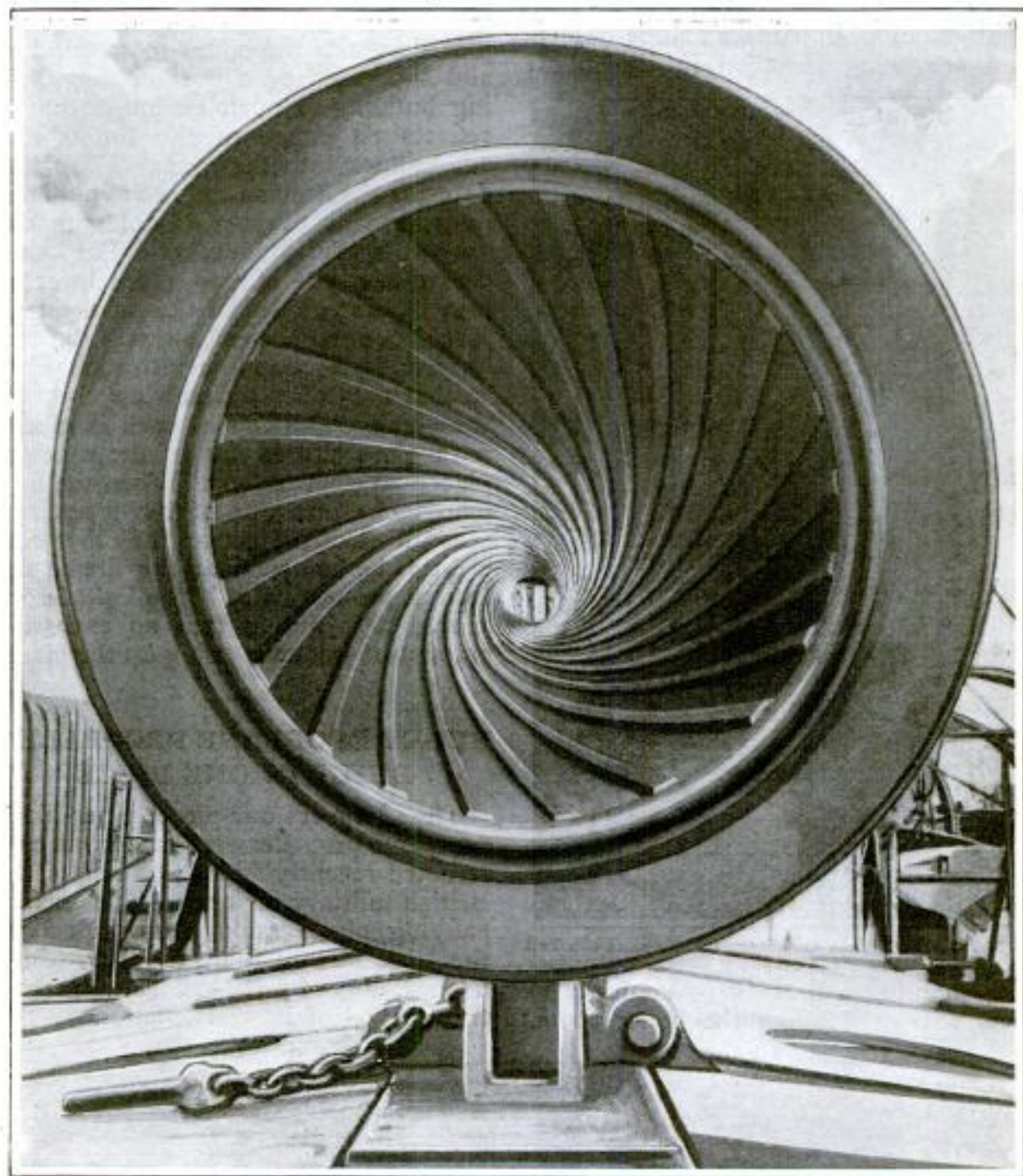

COURTESY OF THE SKETCH

Looking Through a 13-Inch Navy Rifle with the Breech Opened, Giving Clear View of the Length of the Bore

The breech of this 13-in. naval gun is open, giving a clear view of the rifling, which is the most important element in enabling modern artillery to throw projectiles to a great distance. The raised ribs between the spiral grooves are called "lands." Around the shell is a band of soft copper, which is cut into by the lands, thus giving

the projectile a twisting motion that keeps it from tumbling about in the air. Without rifling, an elongated missile would not carry as far as a round one. The average shell is three and one-half times as long as its diameter and needs a twist of one complete turn in a forward movement of 36 times its diameter to keep it steady.

Oscar A. Doob, Times Star,
Cincinnati, Ohio

**SEEING YOUR OWN SMOKE AS
8865 OTHERS SEE IT**

Ingenious but simple smoke detectors are being installed in Cincinnati

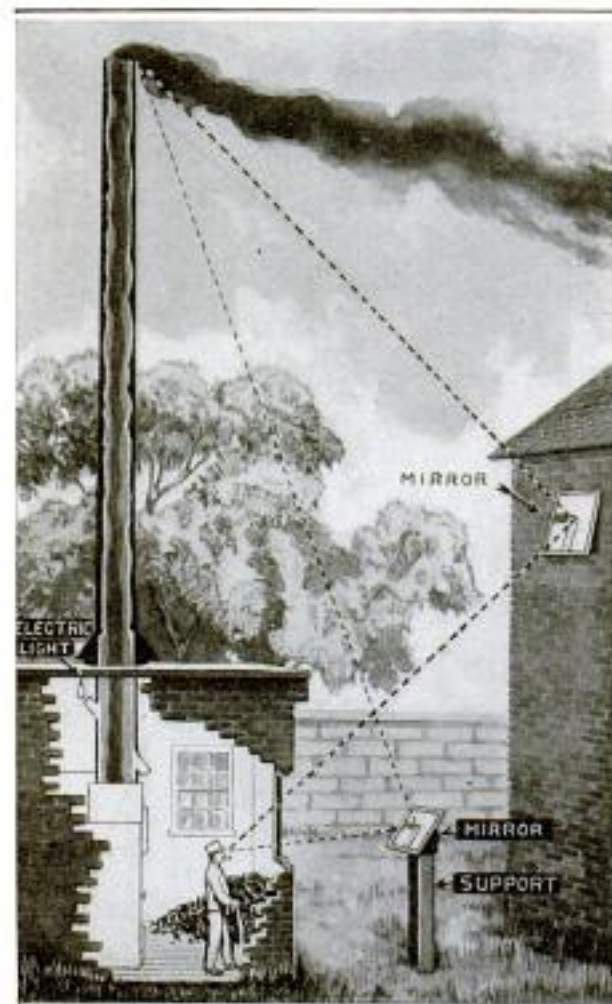

With Either of These Detectors the Fireman can Tell at a Glance How Much Smoke is Going Up the Stack for enabling a fireman or engineer to see, without leaving the boiler room,

whether or not he is violating the smoke ordinance. One of these devices consists of a mirror, about 2 ft. square, placed outside the boiler-room window and supported on a post or neighboring building at such an angle that it reflects an image of the top of the smokestack into the room. With this detector the fireman can see at a glance just what his furnace is doing in the way of smoke production. The other device consists of two pipes inserted into opposite sides of the smokestack just above the connection with the furnace, and placed in line with each other so that they give a clear view through the stack. The end of each is closed with glass and in one of the pipes is placed an electric light. When the fireman looks into one of the pipes and sees the electric light on the other side clearly, he knows that the fire is behaving properly, but if the light is obscured it is a sign that an excessive amount of smoke is going up the stack.

**HUGE AEROPLANE PROPELLER
9315 BUILT IN ONE PIECE**

The largest one-piece, four-blade aeroplane propeller ever made was constructed recently for use on one of the British military air craft. The accompanying photographs show not only the huge size of this propeller, which has a radius of 8 ft., but also illustrate the method of its construction.



How Big Propeller was Built in Laminated Sections



One-Piece Four-Blade Propeller of Eight Feet Radius

Mr. G. J. Gray
The Aeroplane, 166 Piccadilly,
London, Eng.

COURTESY OF THE AEROPLANE

FIRE-ALARM SIREN HEARD 9406 SEVENTEEN MILES

An electric fire-alarm siren recently brought out by a Denver concern proved its efficiency quite remarkably on its first trial in a near-by mountain town. Within a few minutes of the first sounding of the alarm, telephone messages began to come in from outlying points, some of them as far as 17 miles away, demanding to know what was causing the disturbance in town.

The siren consists of a rotor creating a powerful air current which finds exit only through a series of openings in the rotor casing. This sets up air vibrations of great violence and frequency. When the rotor runs at a speed of 3,600 revolutions per minute the vibrations caused by the 12 interruptions in the casing occur at the rate of about 700 per second, giving a piercing note of a pitch nearly two octaves higher than middle C on the musical scale. This pitch was decided upon after experiment as the most penetrating and attention-arresting. A 3-hp. motor, connected to any convenient source of current, operates the siren.

In use, the siren is placed permanently on some high building, being so constructed as to be weather-proof. The actuating switch may be in some other part of town, as, for example, on the switchboard of the telephone ex-

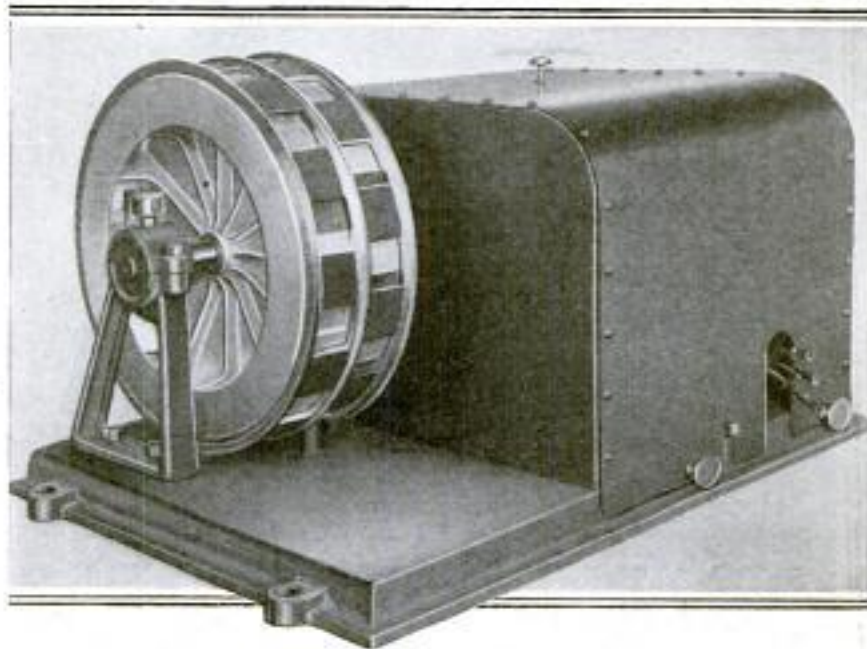

This Electric-Siren Fire Alarm can be Heard 17 Miles Away under Favorable Conditions

change, where the operator can sound the alarm in a fraction of a second after receiving a telephoned announcement of a fire. By throwing the switch off and on at intervals, and so allowing the speed of the motor to die down and accelerate alternately, a wailing rise and fall of pitch is produced, which is practically certain to arouse everyone within hearing distance and which cannot be confused with the sound of a factory or railroad whistle.

MOSQUITO PEST SUPPRESSED BY COLONY OF BATS

7695
The extermination of mosquitoes by means of bats has proved so successful in the vicinity of San Antonio, Tex., that that city has adopted an ordinance forbidding the killing of these little flying animals, and bat colonies are being established in other mosquito-infested sections of the South.

see June 1913
p 812
The beginning of this novel experiment in mosquito control was noted in this magazine two years ago, when the curious artificial bat "cave," erected in

much overestimated see letter at p. 812 June 13
the hope that the bats would make it their permanent headquarters, was illustrated and described. The colony of bats that inhabits this "battery" now numbers many thousands. When leaving their sleeping place in the early evening, a proceeding that takes several hours, the air is so thick with them as to give the impression of a cloud of smoke arising from the wooden structure set on high poles, which constitutes their daytime sleeping place.

E. Leslie Williams 116 Waverly Place, N. Y. City



Ten Thousand Bats Hanging to a Roof, Sleeping

The country around Mitchell Lake, ten miles from San Antonio, where this first bat roost stands, was formerly so thickly infested with mosquitoes that it was almost impossible to remain out of doors at night, and since most of the insects were of the malaria-carrying variety, the section became notorious for the prevalence of "chills and fever." Now it is one of the healthiest spots in Texas, and all due to the efforts of the bats.

A bat will pursue a mosquito as eagerly as a hound chases a rabbit. Combining marvelous powers of nocturnal vision with incredible swiftness in flight, a single bat will pursue and catch from 250 to 400 mosquitoes in a single evening and repeat the performance nightly so long as the supply of insects lasts.

A million bats is not an excessively large number to inhabit a single cave. The bat colony living in one barn in

Texas was found to number more than 10,000. When provided with a dark, dry place, safe from predatory animals, to the ceiling of which they can hang themselves up by the hooks on their wing joints and sleep undisturbed by day, bats will colonize in almost any part of the United States. To induce them to take up their abode in the "battery" a quantity of earth from the floor of a bat cave was placed in it and the interior was sprayed with a chemical having the characteristic bat odor.

HIGH-VELOCITY GUNS FOR THE GERMAN NAVY

A naval gun, believed to be of 15-in. caliber, that fires a 2,000-lb. shell at a muzzle velocity of 3,000 ft. per second, has been developed by the Germans, according to the report of an artillery expert. If this report is true, the Krupps have evidently found a gun

Scientific American

steel and powder superior to anything in use by any other nation, as velocities of 3,000 ft. for big guns have been tried in recent years and abandoned on account of the severe erosion caused by the high powder pressure and the accompanying heat. The general tendency has been to increase the weight of the shell but not the velocity. The 14-in. guns of the United States Navy have a muzzle velocity of 2,600 ft. per second, and the army guns of the same caliber a muzzle velocity of 2,250 ft. per second.

9325 **CURIOUS FREIGHT TRAIN OF WESTERN PRAIRIE**

One of the most curious-looking freight trains to be found any place in the world makes a regular semiweekly trip between Williston and Bonetrail, N. D., a distance of 35 miles. It consists of a 40-hp. gasoline tractor and a string of a half dozen grain wagons, and bears the name of the "Western Limited." Twice each week during the summer months the slow-moving caravan strikes out across the prairie loaded with supplies and various kinds of freight billed for Bonetrail, which is a trading point for a large number of farmers. Williston is the nearest railroad point, so during the harvest season, when freight is heavy, the schedule of the "Limited" is increased to five or six trips a week in order to transport wheat and flax to the railway.



The "Western Limited," a Prairie Freight Train Which Makes Regular Trips between Two Small North Dakota Towns

Glen R. Townsend, P.O. Box 312, Williston, N.D.
 Train owned by Borstad & Wilson, general merchants of Bonetrail

Chicago, Ills.
DEVICE FOR RESHARPENING

9145 **SAFETY-RAZOR BLADES**

For resharpening safety-razor blades a holder has been devised which enables a person to employ one set of blades indefinitely, honing and stropping them as they need attention. It is made to be used with any standard



With This Holder a Safety-Razor Blade may be Honed and Stropped Properly by a Novice

blade and to hold it at the proper angle, so that by following simple instructions an inexperienced user of the device may obtain a keen edge almost in a moment's time. The holder may be used both on a stone and strap.

9284 **COMBINATION WATER TANK AND STORAGE ROOM**

For use on the farm where refrigeration is frequently more or less a problem, a combination water tower and storage room has been designed which may be made to serve adequately the average needs. The structure is built of concrete and in the form of a tower

*A. N. Hoeking, Art Editor
 The Country Gentleman
 Philadelphia, Pa.*

within a tower. The inner of these is formed with a circular wall, 12 in. in thickness, reinforced with wire netting, and by the use of a set of silo forms

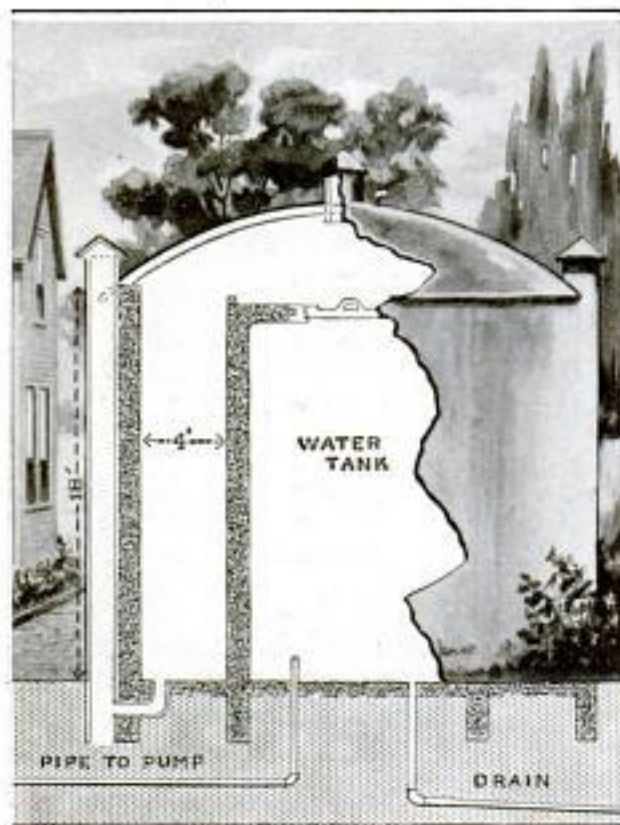

COURTESY OF THE COUNTRY GENTLEMAN
The Structure Consists of One Tower within Another, the Inner One being Used as a Water Tank

made to hold water. The top is sealed and fitted with a cast-iron manhole, while at the bottom are supply and drain pipes. Four feet of space separates the inner from the outer wall, and this is utilized as a storage place by the construction of shelves around both sides. During the summer months the water tank keeps the space sufficiently cool for milk and butter, while during the winter it has the additional advantage of being frost-proof. By using farm labor the structure may be constructed at a very moderate cost.

INTERNATIONAL HORSESHOE 9221 MOTOR ROAD

One of the greatest highway projects of the age is that of an international motor road that will have the form of an enormous horseshoe with its tips in the southern part of the United States, one on the Atlantic

coast and the other on the Pacific, and its outer curve, or toe, extending across southern Canada. This motor road will have an approximate total length of 8,000 miles. Beginning at Miami, Fla., the route will run north through the principal cities of the Atlantic seaboard and then to Montreal. From this point it will run west through Canada to Vancouver, and then south over the Pacific coast highway to San Diego, Cal. A great part of this highway has already been built in sections or is under construction, so that the whole enterprise is now one of building comparatively short connecting links. When completed it will be one of the longest and most interesting highways in the world.

MOVIE CAMERA USES PLATES

8429 IN PLACE OF FILMS

8429 Dec Oct 12 - 469
Modifications have been made to simplify a motion-picture camera and projector developed abroad some time ago, and previously described in this magazine, which is designed to use plates instead of a film. The machine as now constructed is fitted with a large circular disk in which the plates are set so that the exposures come one after the other in a spiral, instead of being arranged in rows extending from left to right across a rectangular plate heretofore. The plate disk, both when used in the camera and in the projector, is revolved by a shaft which moves in a horizontal plane relatively to the lens, which is maintained in a fixed position. *La Science*



Current at a pressure of 150,000 volts is carried on some western transmission lines.

Daily Consular & Trade Reports 1988
Consul Gen. R. E. Mansfield,
Vancouver, B. C., Canada.

J. Crosby Mc Carthy
Evening Star,
Wash. D.C.

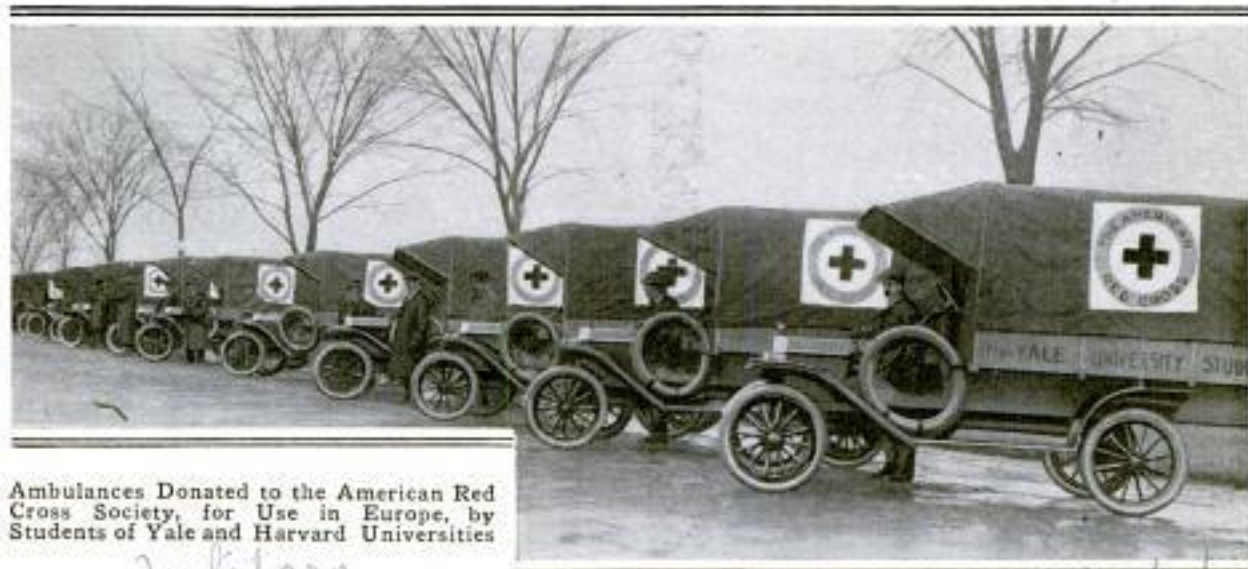

Ambulances Donated to the American Red Cross Society, for Use in Europe, by Students of Yale and Harvard Universities

military

**AMBULANCES FOR EUROPE
DONATED BY STUDENTS**

9298

Seventeen motor-car ambulances, built to be used on the European battle fields, were recently presented at Washington, D. C., to the American Red Cross Society by the students of Yale and Harvard universities. The bodies for the machines are designed to carry three persons on regulation army stretchers. They are covered with khaki, and bear on their sides the society's insignia: the Geneva cross, encircled by the words "The American Red Cross." Each car also bears the name of the university which donated it.

**BIRTHMARKS ARE REMOVED
BY USE OF RADIUM**

9620

Radium has been used successfully during the past year at the Radium Institution in London for the eradication of birthmarks. In a report recently issued it is asserted that blemishes of this kind have been removed readily and without leaving any noticeable trace of the disfigurement following the treatment. Superficial growths of other characters, such as warts which had resisted treatment by acids, have also been removed. In all, 749 cases of different kinds have been treated at the institution, which is supported by popular subscription.

Chicago Journal

**STERILIZING WATER TANKS
ON RAILWAY CARS**

9276

Suppl.

Precautions against accidents in railway travel by the efficient inspection and maintenance of roadbeds and rolling stock are not the only ways in which railroad companies are coming to safeguard the interests of their patrons. One of the large eastern roads has in force a rule that every water cooler in every passenger car on the entire system must be thoroughly sterilized once every week. This is done by passing a hose into the tanks and forcing steam into them and through their drain pipes. This both cleans and purifies the coolers and keeps them free from contamination. After the operation has been performed, each tank is marked so that it shows when sterilized and who did the work.

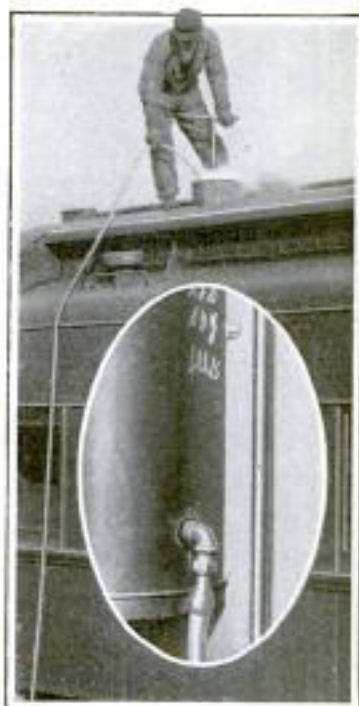

J. S. Lee, Jr. Publicity
Pennsylvania R. R. Co.,
Phila., Pa.

Copyrighted material

Underwood & Co. 417 Fifth Ave. N. Y. City
Ballistics

DREADNAUGHT "WYOMING" STEAMING ON HIGH SEA



PHOTO COPYRIGHT, UNDERWOOD & UNDERWOOD

The United States Dreadnaught "Wyoming" at Sea, Plowing through the Waves: The Long, Curling Comber Which is Seen Breaking over the Bow, Washed the Fore Deck of the Ship

8555 **AIRMAN MAKES RECORD FALL
AND ESCAPES WITH LIFE**

One of the most remarkable falls on record was that of an airman at Lynchburg, Va., who fell 1,800 ft. in his biplane and escaped with no injuries other than bruises and a severe shaking up. The airman was giving an exhibition flight and had started down after ascending to a height of 2,000 ft. He made the first spiral successfully and was starting on another when the elevator of his machine buckled. This rendered the craft unmanageable, and it fell through the remaining 1,800 ft. in a series of skids and somersaults, finally crashing, bottom side up, into a cemetery. The airman was

strapped to his seat and when the machine started to fall he grasped an upright and held on. That he escaped with his life is probably due to the fact that the machine landed upside down, thus protecting him.



Wreckage of an Aeroplane That Fell 1,800 Feet without Killing the Airman

9273 **SWITCH TWO FREIGHT CARS
WITH AUTOMOBILE**

Two cars of freight billed to an Illinois merchant were left recently on a siding in an inconvenient place for unloading them. To wait for the railroad company to reswitch the cars would have consumed considerable time, so a motor car was employed to do the work. The machine which was used is a light, five-passenger touring

car. A cable was attached between it and the lead freight car and the pull successfully made. Although the test was a severe one, because of the comparative lightness of the machine, it was completed without difficulty.

☞ Injurious insects found in seeds may be killed without affecting the germinating qualities of the seed by treatment with hydrocyanic-acid gas in a vacuum chamber.



Employing a Light Automobile to Switch Two Loaded Freight Cars

Wm. H. Watson, Morton, Pa.
Cartecar Co. the auto in question
Pontiac, Mich.

Miss Florence L. Clark
613 S. Grand Ave.,
Bozeman, Mont.

(9517) The Stoltz Appliances Co.
220 W. 42d St.
N.Y. City

**SANDSTONE PILLARS MARK
9328 PART OF MOTOR TRAIL**

Cone-shaped sandstone posts are being used in the vicinity of White Butte, S. D., to mark the Yellowstone trail, which is in the course of construction from St. Paul and Minneapolis to Yellowstone Park. They range from 7 to 9 ft. in height and are approximately 1 ft. in diameter at the base. The words "Yellowstone Trail" are lettered longitudinally on the sides of the pillars to guide motor tourists. The stones are used in their natural shape and are found in the rock-covered hills in that vicinity.



which made that their home port. At that time it was the custom for a watch repairer, upon finishing his work upon an instrument, to place a piece of paper bearing his name and address within the case. It followed that the name of this jeweler was carried by whalers to various seaports over the world, falling into the hands of other watch tinkers. It became noticeable to many of these artisans that the watches last regulated at New Bedford were invariably in good condition and their bearings free from gum. This showed that a lubricant other than sperm oil was used. The subsequent demand for porpoise oil became so great that the watch tinker abandoned his trade in order to fill the demands for porpoise-jaw oil which came to him. This industry is still carried on.

**PORPOISE-JAW OIL MADE
8862 HERE FOR CENTURY**

Practically all the porpoise oil used in this country, even if not in the world, for lubricating watches and other delicate instruments, is made near New Bedford, Mass., which many years ago was important as a whaling port. The product is taken from the jaw, and certain other parts, of the animal, which is caught especially for this purpose. When the industry was in its infancy, whalers were depended upon to supply the porpoise, but now the manufacturers maintain a fishing department which follows the schools of porpoise migrating along the coast, and furnishes a continual supply of them. The history of the New Bedford industry reaches back to the early part of the nineteenth century, to a watch tinker who regulated and cleaned the timepieces and chronometers of the skippers of the whalers

**FRUIT JAR SEALED WITH
9517 AIR SEAL**

A simple canning device recently brought out and particularly adapted to home canning exhausts the air from the jar and then completes the operation by sealing the jar with an air seal. The top of the jar and the rim of the lid are shaped to provide a space in which a rubber band fits, and when the lid is pressed down tightly, as it is by the pressure of the outside air when a vacuum has been created in the jar, the rubber band forms an air-tight seal. The vacuum is created by a hand-operated air pump the base of which is set on the shoulder



Inventor:
Gray Staunton,
Muskegon, Mich.

S. Aronson
1025 E. 102d St.
Brooklyn, N.Y.

See White...
Stoltz Appliances Co.
220 W. 42nd St., New York.

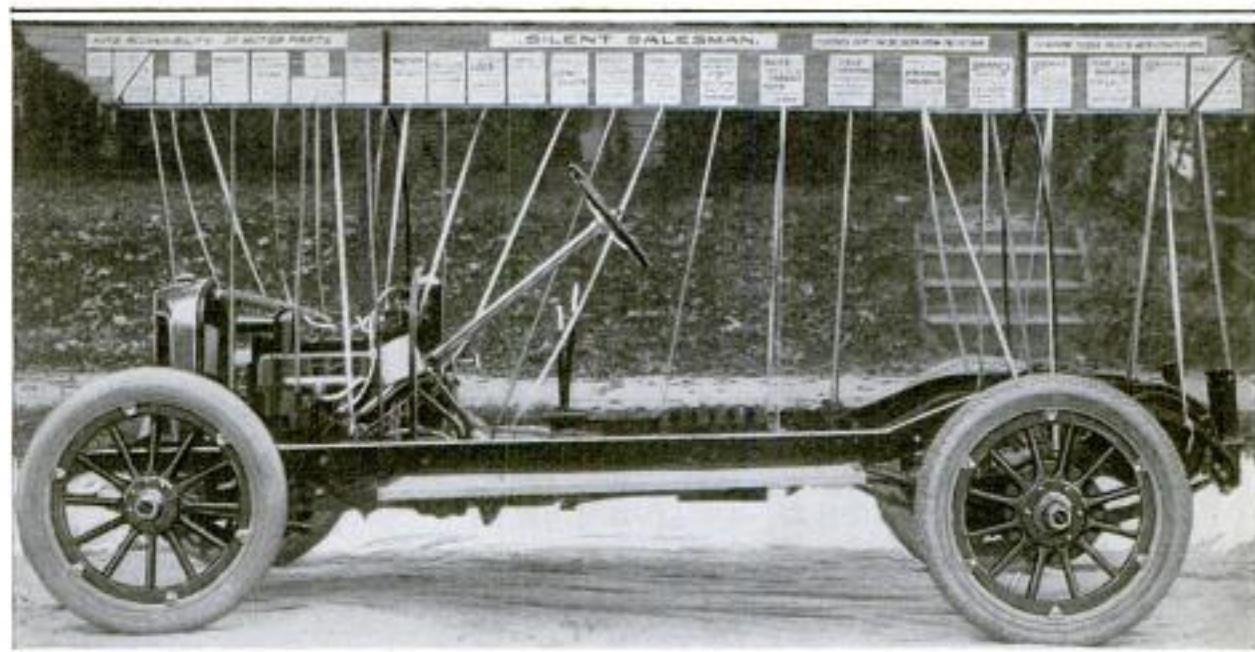

This Car, Used for Advertising Purposes, Carries Placards Each of Which is Connected by a Ribbon with the Part Described

of the jar and incloses the lid. The pump is equipped with a flexible rubber cap that fits over the top of the jar. In using this device it is necessary to boil or cook the food only for the purpose of sterilizing it. With the contents in the jar the lid with the rubber band is placed in position, and over this the pump is placed and the rubber cap drawn down tightly over the jar. A few strokes of the pump create a vacuum and hermetically seal the jar. When the jar is to be opened a pin is inserted through a notch in the lid, pressing the rubber band down so that air enters, breaking the seal. One of the advantages in this device is that a jar can be opened and partially emptied, and then closed and resealed. Aside from canning, there are evidently other uses for this device, such, for example, as the preservation of certain surgical supplies that must be kept in a vacuum.

NEW PLAN FOR ADVERTISING 9209 AUTOMOBILE

An automobile from which the body has been removed, leaving the working parts in plain view, is used by a Philadelphia company for advertising the car and demonstrating its features. Supported on the car and extending

Wm. H. Watson, Morton, Pa.
Oakland Motor Co.,
Phila., Pa.

from end to end is a board carrying placards which give concise information about the different parts, and from each placard there is a ribbon running down to the part described. The placards are big enough to be read as the car passes along the street so that no stops are necessary.

COMBINATION KNIFE AND 8825 FORK

A handy tool for campers and picnickers, as well as for one-armed persons, is a combination knife and fork recently patented and now being placed on the market. It consists simply of a curved blade with the end formed into a four-pronged fork. It is designed to be stowed away in a case that can easily be carried in the coat pocket.



German naval guns are mounted so as to have a possible elevation of 30°, enabling a ship badly listed still to use the guns on the lower side.

Inf. & Contributor: M. S. Hewitt
Georgetown, Texas.

*Mrs. A. H. Vestal
4243 N. Foster Ave.
Chicago, Ill.*

**WEIGHT-COMPUTING CUTTER
8974 FOR BRICK CHEESE**

For use in a grocery store or delicatessen shop, a cutting device for brick cheese has been devised which is made



on the weight-computing plan, and also incloses the cheese so that it is protected from flies and dirt. The knife guard and arch are coated with block tin, are easily kept

in a sanitary condition, and are not injured by contact with the cheese. The body and base of the device are made of steel and finished with heavy enamel.

**FOREST-SERVICE BADGE NEW
8905 NATIONAL INSIGNIA**

A new national badge and uniform button has been designed and added to the already large collection of insignia worn by the personnel attached to the various branches of the government service. They are used on the drab-green uniforms worn by the supervisors and rangers in the Forest Service, which comes under the Department of Agriculture. The badge is small and made of bronze in the shape of a shield. In the middle, between the two

letters "U. S.," is a pine tree, above which are the words "Forest Service." At the bottom appears "Department of Agriculture." The button carries the two words "Forest Service," one word at the top and the other at the bottom, with three stars separating them on each side and a pine tree filling the middle space. They are made in two sizes, large ones for the front of a coat, and small ones for the pockets. At the present time there are approximately 2,000 men in the service who wear uniforms.

**ISOLATED PLACES UNAWARE
9621 OF EUROPEAN WAR**

After nearly a year of fighting in Europe there are still people in the shut-off parts of the world who are ignorant that the greatest war of history is in progress. It was announced in London recently that since the outbreak of hostilities the inhabitants of Tristan da Cunha, a small group of South Atlantic islands, have received no communication from the outside world. South Africa is approximately 1,500 miles from this British possession and frequently a year passes without its residents, who for the most part are the descendants of shipwrecked sailors, hearing anything from civilized points. Iquitos, in eastern Peru, is another place which is supposed to be unaware of the war. It has received no mail since some time last summer.

Stamping or Seal Co. Chicago, Wis.

Chicago Journal. 3/31/15

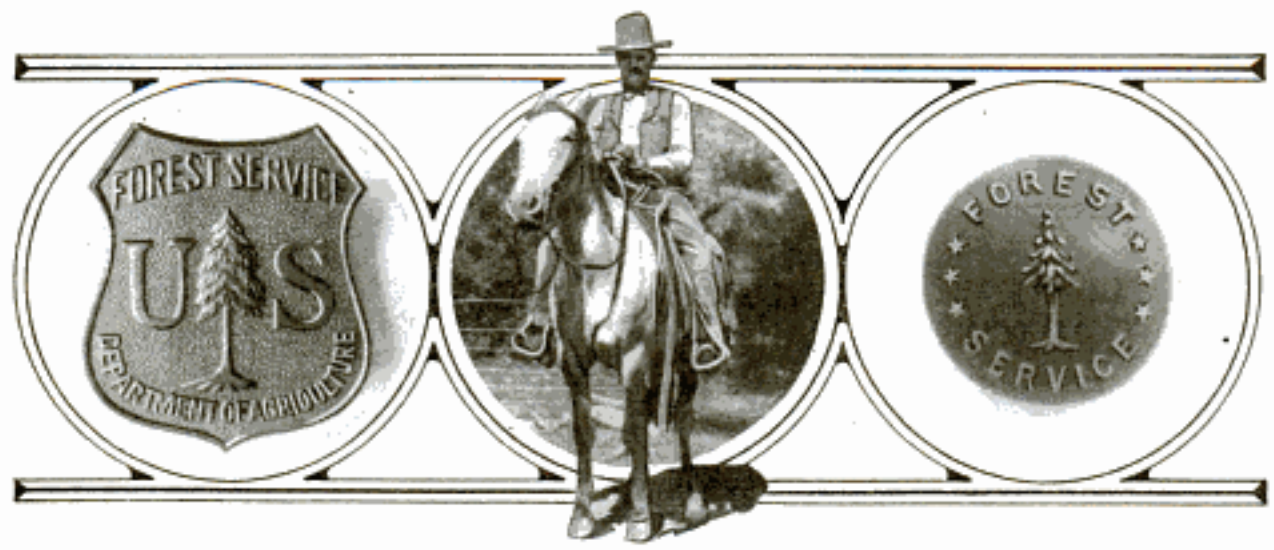

New Badge and Button Issued by the Government for the Forest Service

*Bristow Adams
Forest Service,
Wash. D. C.*

7383 - *The Sphere*
4/11/14

ELEVATOR CONTROL IN THE WOOLWORTH BUILDING

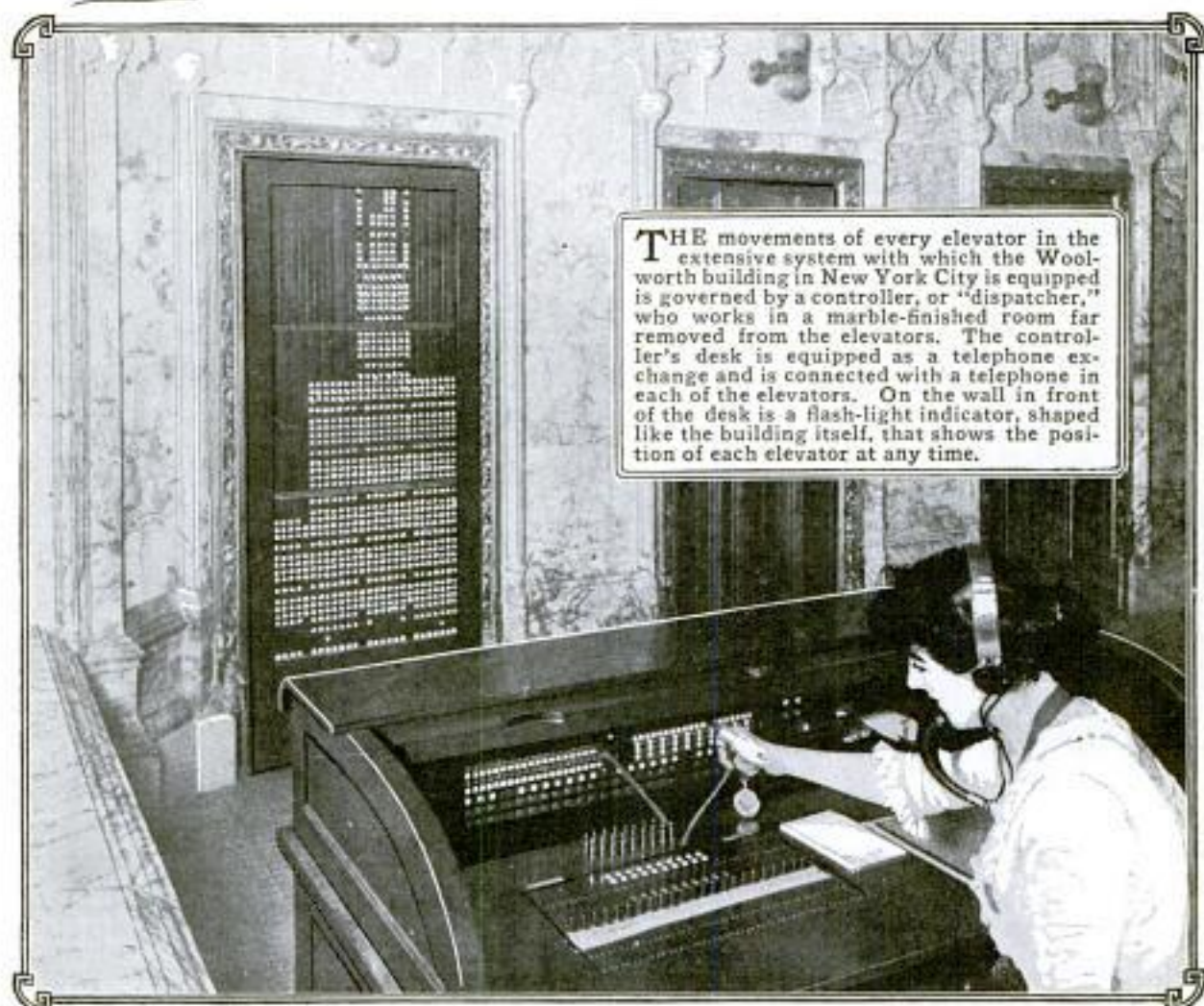

THE movements of every elevator in the extensive system with which the Woolworth building in New York City is equipped is governed by a controller, or "dispatcher," who works in a marble-finished room far removed from the elevators. The controller's desk is equipped as a telephone exchange and is connected with a telephone in each of the elevators. On the wall in front of the desk is a flash-light indicator, shaped like the building itself, that shows the position of each elevator at any time.

9310 SUBMARINE TELEPHONE TO DETECT ICEBERGS

A new method of detecting icebergs, now being investigated by the U. S. Bureau of Standards, involves the use of the submarine telephone for recording the submarine echoes thrown back from the submerged portion of an iceberg when a ship's bell lowered under the water is struck. This method, if it can be worked out successfully, is expected to prove much more reliable than that in which an electric resistance thermometer is used, as it has been found by experience that temperature variations in parts of the ocean far removed from ice are often as great and as sudden as in the immediate vicinity of icebergs.

Jour. of Electricity 1/23/15

9417 ROTARY CUTTER REDUCES STUMP TO SHAVINGS

Stumps are reduced to shavings of uniform thickness and, if desired, are picked up by vacuum and deposited in bags, by a new rotary stump cutter now being introduced. The essential feature of the machine is a rotary cutter head fixed to the lower end of a vertical shaft. The lower face of the cutter head carries eight knives arranged radially around a central drilling point, and cuts the wood away downward in a horizontal circle 36 in. in diameter. The shaft is rotated by a horizontal belt pulley through bevel gears. The machine is transferred from stump to stump and is operated by a traction engine of 30 hp. In operating,

*Moore Rotary Stump Cutter Co.,
213 Hennessey Bldg., (Inc.)
New Orleans, La.*

the traction engine moves the machine until the cutter head is over the stump and the cutter is set to rotating, the

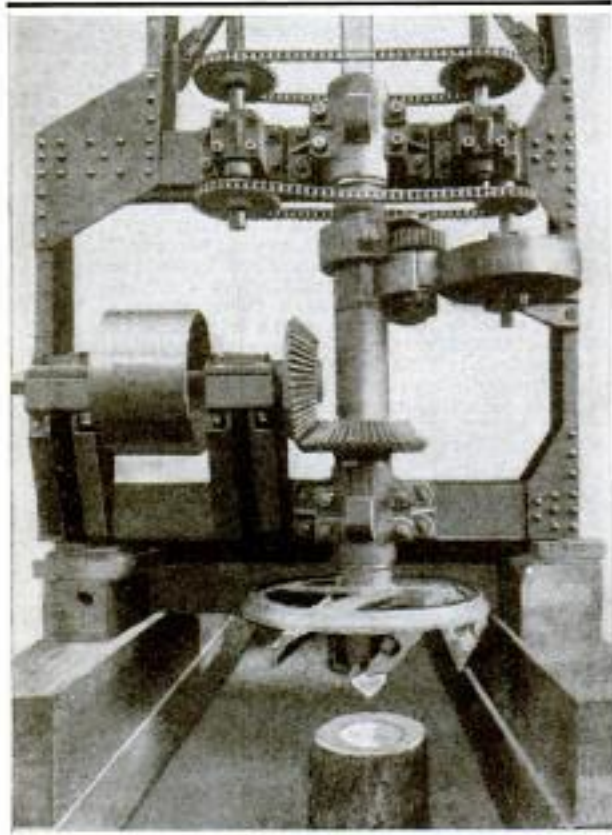

This Rotary Stump Cutter Reduces Stumps to Shavings

machine working down the stump to a depth of about 18 in. below the surface. When cutting pine stumps the shavings are picked up by vacuum and carried through a pipe to sacks, and are afterward conveyed to a mill for the extraction of the resin. The pipe is equipped with a cleaner for removing the dirt and with a cut-off through which the shavings may be deposited on the ground.

BLUE-CROSS WORK SPREADS

9548 AS WAR PROGRESSES

Working side by side with the Red Cross on the battle fields and in the army camps of the allies, is the Blue Cross, a heretofore unknown organization composed of veterinary surgeons and attendants who are taking care of the wounded war horses and dogs, alleviating their suffering and, where it is possible, nursing them back into condition. This service is the latest

The Sphere

addition to military field organizations, and the work is one which is daily becoming more important. While the undertaking is a humanitarian one, it is also a matter of economics, for in this war the loss of a horse is as serious from a military standpoint as the loss of a man.

Hospital bases for the wounded animals have been established in northern France. The sanitation measures which have been carried out at these places are comparable with those instituted at hospitals intended for the soldiers. The premises and stables are kept freshly whitewashed and disinfected, and little has been spared to provide a comfortable housing. Before the horses are admitted to these bases they are inoculated so as to prevent the spread of disease. The hospitals so far established represent the nucleus of those contemplated. Two new institutions are now under construction.

CANOE ATTACHMENT FOR

9594 OUTBOARD MOTOR

For the purpose of converting an ordinary canoe into a power craft, an equipment has been designed which makes it possible to install an outboard motor. Instead of being placed at the stern, which is difficult in a canoe, the motor is set sufficiently far ahead to give the craft better stability. The motor is



mounted on a plank which is bolted to the gunwales of the craft some distance abaft the beam. The shaft sleeve, instead of being led overboard, extends straight down from the motor and through the center line, or keelson. The canoe is steered by changing the driving angle of the propeller, which may be turned halfway around, enabling the craft to be reversed.

*Mfr: Evinrude Motor Co.,
279 Walker St.,
Milwaukee, Wis.
Frank H. Bolles, Adv. Mgr.*

9137 Canal Record 12-30-14

ADMINISTRATION BUILDING OF PANAMA CANAL

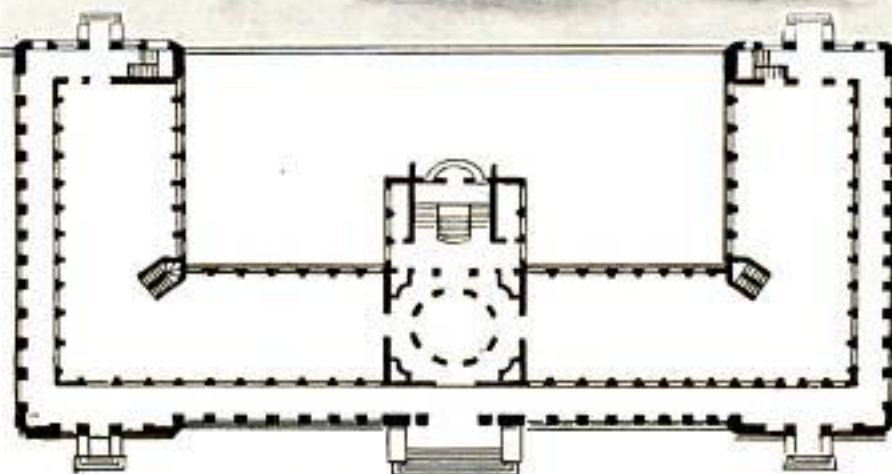
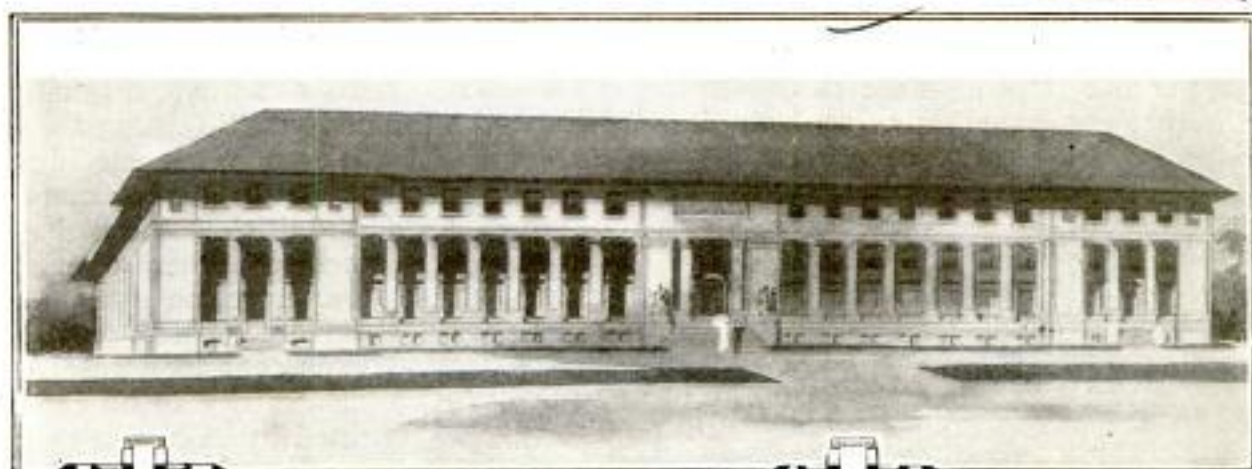

The Administration Building of the Panama Canal, Showing the General Floor Plan

of the sun, so that a gallery is unnecessary. Below, however, a broad balcony extends around the outside, shading the interior and providing communi-

On the toe of the northwest slope of Ancon Hill, overlooking Balboa, the first permanent town of the Zone, the administration building, in which are concentrated the various departmental offices of the Panama Canal, has been erected. It is a low, broad structure, drawn after the plan of the architecture of the Italian Renaissance period and surrounded on all sides by wide concrete terraces flanked by heavy balustrades and broken, at the front, by longitudinal panels of lawn.

In order to compress the building and at the same time provide for adequate light and ventilation, it was designed in the form of the letter "E." It is three stories in height and, unlike other structures erected in the Zone, has a sub-basement. Both its front and the outer wings are lined by a colonnade of square Italian marble columns which support the projected third-story wall and the eaves. The overhanging roof shades the windows of the top floor from the intense rays

of the sun, so that a gallery is unnecessary. Below, however, a broad balcony extends around the outside, shading the interior and providing communi-

cation to the different offices. The building is honeycombed with large windows, which are necessary to provide for an ample circulation of air during the rainy season, when the atmosphere is depressing because of its humidity. Concrete enters largely into the construction of the building. The foundation for the steel framework is made of concrete, as are the floor arches, while the curtain walls are of concrete blocks, and the roof arches, of reinforced sawdust concrete. The spandrels are of poured concrete, and the same material, reinforced, has been used in building all the stairways. In the office portion of the building the floors are made of yellow pine nailed to sleepers laid in cinder concrete. The floors of the balconies and corridors are of tile, and all the outside walls are finished in stucco.

ⒸThe use of glycerin in war has resulted in a great increase in its price.

Iron Age 1/21/15

*# Dr. Wheeler P. Davey,
General Electric, Inc.,
Schenectady, N.Y.*

Individual

9274 FLAWS IN STEEL CASTING SHOWN BY X-RAY

Recent laboratory experiments with the X-ray have proved that by its proper use it is possible to determine whether concealed flaws, such as blow-

holes or cavities, exist in metal, which on the surface appears to be perfectly solid.

holes or cavities, exist in metal, which on the surface appears to be perfectly solid. The discovery is apparently one of material value and importance. The interior of a perfect-looking shafting, or some other vital part of a machine, may always conceal small air inclusions which, if undiscovered, are sources of danger. It has been shown that if such imperfections exist, even at a place where the photographs indicated imperfections might be expected. The result was that the blowholes were discovered. The importance of a discovery of this kind is easily appreciated when it is considered what might eventually happen if such steel unknowingly were used in a marine propulsion shaft or the driving rod of a locomotive.

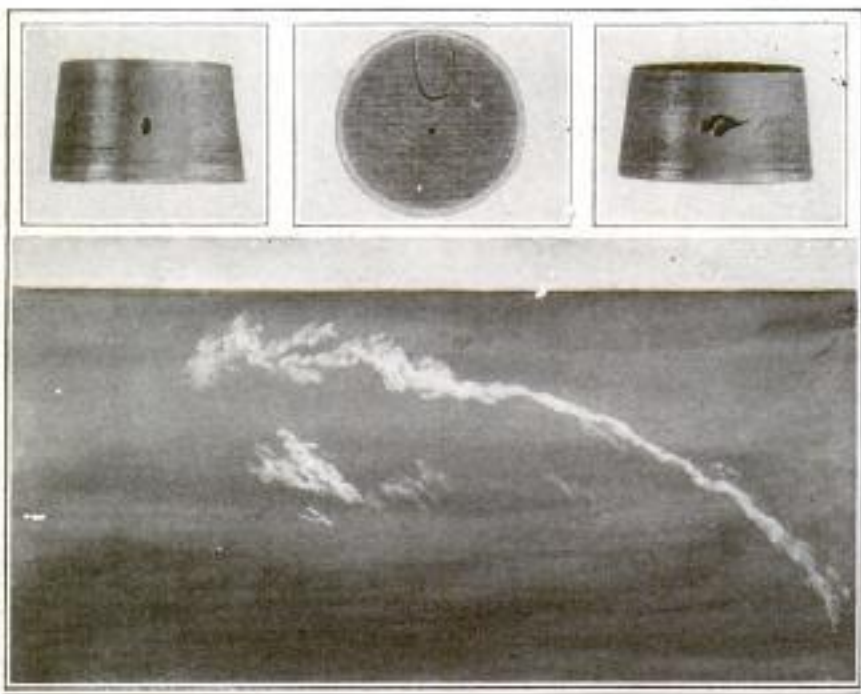

The Lower Photograph is an X-Ray View Revealing a Flaw, the Presence of Which was Proved by Cutting the Circular Plugs Shown Above

holes or cavities, exist in metal, which on the surface appears to be perfectly solid. The discovery is apparently one of material value and importance. The interior of a perfect-looking shafting, or some other vital part of a machine, may always conceal small air inclusions which, if undiscovered, are sources of danger. It has been shown that if such imperfections exist, even

INSTRUMENT FOR LAYING

9234 SHIP'S COURSE

A new invention of interest to all marine men, amateur as well as professional, is an instrument by which the true course for navigating between two points is found and is then converted to a compass course without computation. In using the instrument on a Mercator's projection, which is the kind of map on which the meridians and parallels of latitude are

drawn as straight lines, the direction bar is laid down so that it touches the place of departure and the place of destination. The dial is then slid along the bar and rotated until its north-and-south or east-and-west points coincide with a meridian or a parallel of latitude, as the case may be. The lower pointer, which is always parallel with the edge of the direction bar, then points to figures on the dial giving the true course. This course must next be converted to a compass course. The

*Inventor: Chas. A. Fother
Cawego, N.Y.*

*# 1,108,517 Aug 25-1914
For sale by
John S. Cawego, N.Y.*

L. A. Potter Course Finder & Course Converter

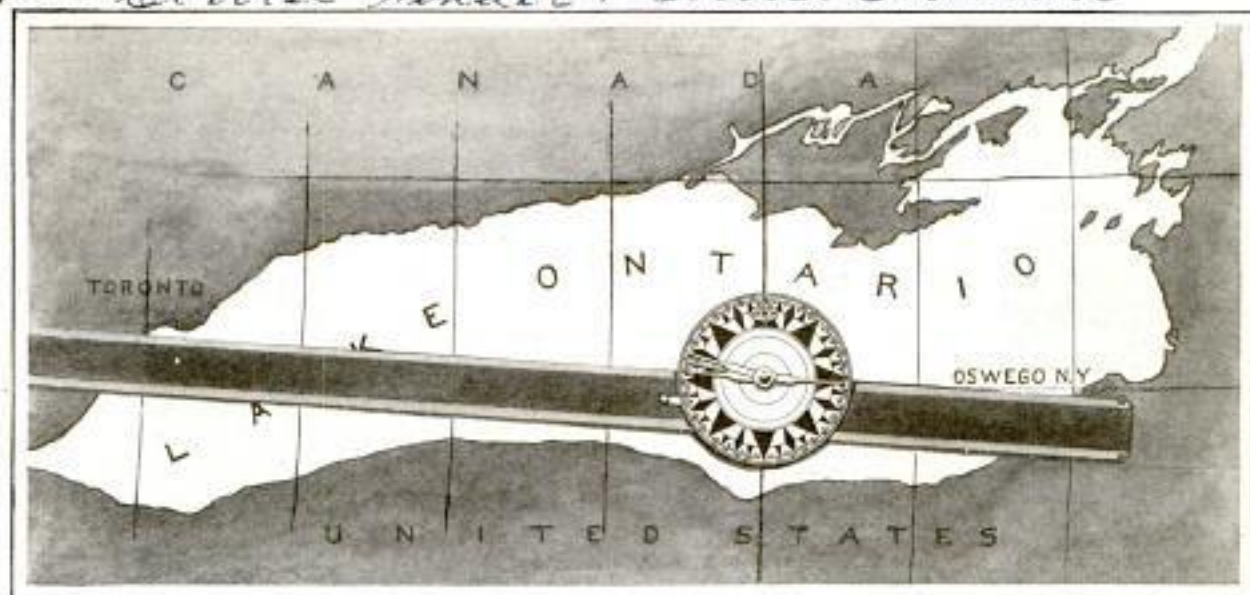

Instrument for Laying the True Course of a Ship and Then Converting It to a Compass Course without Computation

variation at any place is the amount that the magnetic needle points east or west of true north. The average of the variations at the two ends of the course, as given on the map, is then taken, and the next pointer above is set away from the lower pointer by an angle equal to this. The final correction is made for deviation, which is the amount that the ship's compass varies for different headings on account of magnetic influences in the ship or its cargo, and this is taken from a table prepared by the compass adjuster. When the top pointer is set away from the one next below by an angle equal to the deviation, it gives the compass course on which the ship must be steered in order to follow the true course laid down by the direction bar.

MACHINE FOR GATHERING AND CUTTING TURNIPS

8640 A novel machine for picking up and cutting turnips, mangels, and other root crops, has been invented and is being introduced in New Zealand. The main feature of this machine is a large roller equipped with closely set tines which pick up the turnips, or other roots, and deposit them in a hopper at the front of the machine, where they are cut. They are then delivered in rows along the ground by means of a shaker. Where it is desired to cart the crop away, an elevator is provided for loading into a wagon attached to the machine. It is claimed that this ma-

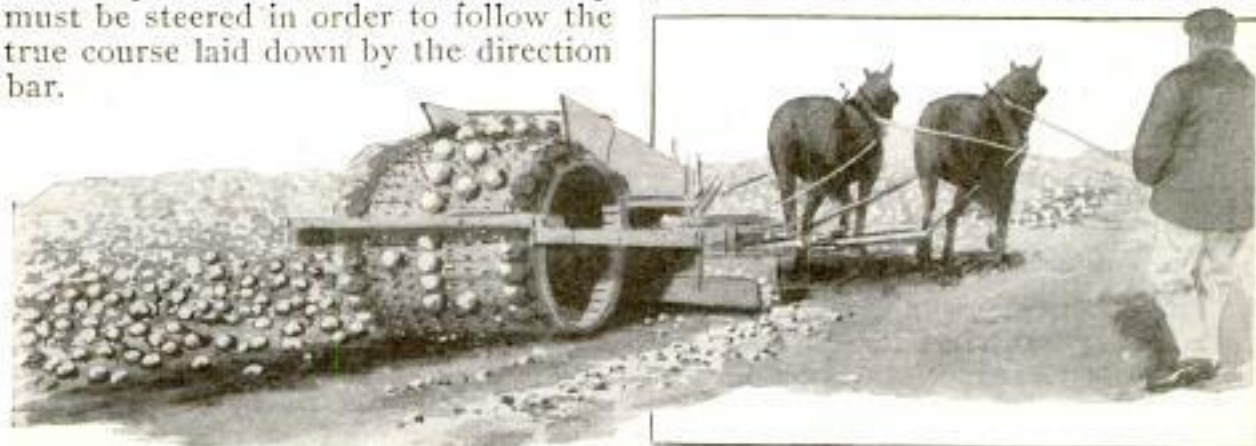

Machine Used in New Zealand for Gathering and Cutting Turnips and Other Root Crops

chine, with one team and one man, will pick up and cut six acres of root crops in a day.

Inventor: J. Thomson, Jr.

Christchurch, N. Z.

Farm Implement News, 6/18/14



This Hay Baler was Constructed by a Canadian Pioneer Who had Never Seen Such a Machine. By Its Use One Man and a Horse can Bale About a Ton of Hay a Day

ADJUSTABLE CRUTCHES USED BY WOUNDED SOLDIERS

9333

At the German hospital bases, where thousands of wounded soldiers are being cared for, adjustable crutches are used which may readily be shortened or lengthened to suit the needs of any patient. Each is made with two grips so that should a man's arms be short and not proportionate with his lower limbs, the crutches would still serve his purpose. Their use saves much time and trouble, making it unnecessary to keep a large assortment of different sizes on hand and also saving the time which otherwise would be consumed in selecting crutches for different patients.



Die Export Woche

Actual rubber has been made from Russian crude oil, which contains chemical elements similar to those in California oil.

HAY BALER MADE OF WIRE AND ROUGH BOARDS

8772

In the accompanying photograph is shown a crude but nevertheless serviceable hay baler which was constructed by a pioneer in one of the interior provinces of Canada a number of years ago, prior to the coming of the railroad to his district. The machine is built entirely of wood and wire, the latter being used in lieu of nails and bolts. The level beam was split down the center and spread so as to form a truss, in order to add to its strength. Its builder, with one horse, is able to bale without other help approximately a ton of hay a day. The machine was built without plans and by a man who had never seen such an implement.

PHOTOGRAPHY LATEST AID IN REPRODUCING SCULPTURE

9089

A new optical method for making reproductions of sculpture consists in photographing the object from two or more points of view and then, with the cameras and lines of sight in exactly the same relative positions, projecting the images to an intersection on the modeling clay or block of marble from which the reproduction is to be made. While somewhat crude in its present state this process is one that ap-

The Illuminating Engineer, Nov. 1914

*Infr: Federal Sign System (Electric)
Lake & Desplaines Sts
Chicago, Ills.*

parently has great possibilities for future development. In making the reproduction the worker simply cuts away the material at any point until the corresponding points as projected from the different cameras coincide on the surface. As most sculptural objects do not have points that are sufficiently prominent for their coincidence to be determined with precision, it is proposed to use an additional apparatus for projecting a series of fine lines and letters on the object while it is being photographed. These lines and letters, of course, appear on the negative made by each of the cameras and are projected with the image. In this way the worker is furnished with a set of artificial points that are sharp and definite, and the coincidence of these is easily determined.

ELECTRIC LANTERN THROWS
9438 **LIGHT DOWNWARD**

An electric lantern that throws an unobstructed light in all directions except upward in the user's face is a new



With This Electric Lantern the Light is Thrown in All Directions Except Upward in the User's Face

NEW ARMOR FOR AUTOMOBILE
9342 **TIRES**

An armor for automobile tires, recently invented, is designed to insure the tire against slipping, skidding, punctures, and blow-outs. This armor is intended to be worn continuously and is made up of small metal-link plates with tongues and recesses, the plates interlocking in such a way as to form a continuous cover for the

1,086,696 Feb. 10, 1914

Ballston Spa, N.Y.

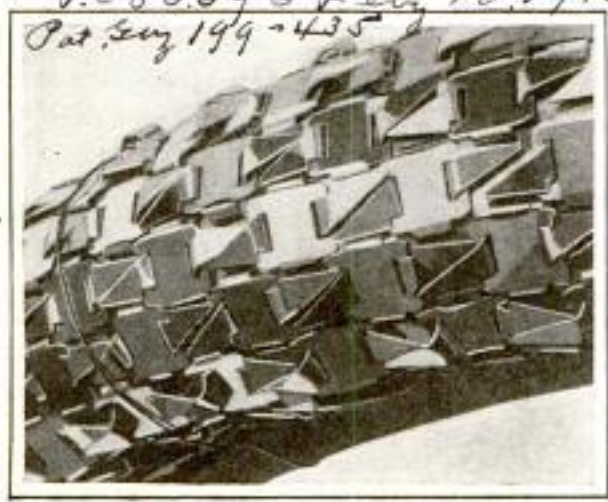

This Armor Forms a Continuous Cover for the Tire and is Intended to Insure It against Slipping, Skidding, Punctures, and Blow-Outs

tire. The plates are interchangeable and any individual plate can be replaced in case of wear or breakage.

invention adapted to general use but particularly suited to the needs of railroad men. Current is supplied by a compact four-cell battery of six volts' capacity carried in the body of the lantern, which consists of a nickelplated casing. Projecting from the bottom of the casing is a small tungsten-filament lamp which is protected by a wire guard. The bottom of the casing, owing to its shape and the fact that it has a polished nickel surface, acts as a mirror that reflects the light outward in a wide circle. The battery, which is easily replaced when worn out, has a life of from 60 to 65 hours. The light is turned on by dropping the bail down as far as it will go on one side, and is turned off by dropping the bail in similar manner on the opposite side. The bail is made to snap into vertical position when being used.

*Inventor: Nelson Anderson, a
jeweler of Ballston Spa, N.Y.
not yet on the market.*

Non-Rewinding Film Reel Co.,
713 Utica St., Toledo, Ohio
By F. J. Hanna, Jr.
894

See Patents (inserted)

POPULAR MECHANICS

FEEDING MOVIE FILMS FROM 9428 CENTER OF REEL

One of the commonest causes of fires in motion-picture operation is the necessary exposure of the film during the process of re-winding after it has been exhibited. Before it can be shown again it must be rolled to another reel so that the beginning of the picture will be on the outside of the roll, and in this handling there often is danger of the accidental ignition of the inflammable celluloid through contact with a spark or flame from some source. Films are often scratched and torn in this re-winding process, while it takes up a great deal of the operator's time.

A new device which can be attached to any standard motion-picture projector draws the film from the center of the roll instead of the outside, making re-winding unnecessary. An electric motor revolves the reel at a speed governed by the speed of the projecting machinery, loosening the innermost coil of the film enough so that it can be pulled through the machine without undue strains or twists. After passing through the projector it is received on a standard reel in the ordinary manner, and from this reel may be fed directly into the machine again without re-winding.

GERMAN WAR CHEST OPENED 9613 AFTER MANY YEARS

London bankers have called attention to the fact that the German government has finally opened up its war chest and placed in circulation the gold which for 43 years has been hoarded

London Times

in the Julius Tower at Spandau. In a report which was made to the government early last summer before the outbreak of hostilities, this imperial treasure was said to amount to 120,000,000 marks, or \$28,560,000. The sum was in gold coins and was originally reserved from the indemnity paid by France at the close of the Franco-Prussian War. A considerable portion of the money was in British sovereigns and these coins are now finding their way back to the London banks for the first time, revealing the fact that the hoard has been broken into.

BUILT-IN IRONING BOARD 9016 FOLDS INTO CABINET

One of the latest conveniences for the laundry or kitchen is a built-in ironing board that is easily extended into position for use, but can be folded back into a cabinet and out of sight when not in use. The wall end of the board is equipped with small knobs that fit into grooves on each side of the cabinet, while the brace is hinged to the bottom of the cabinet and to the under side of the board. The grooves extend from the bottom of the cabinet

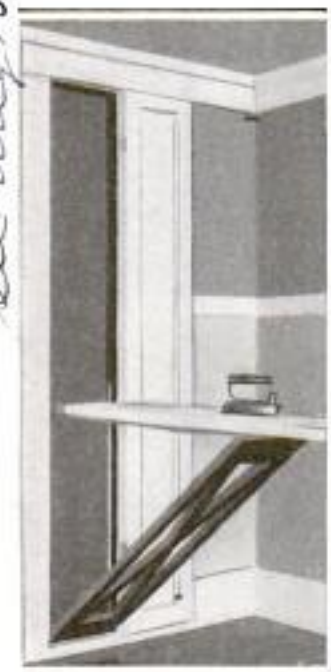

to such a height as to make the board level, and in this position the knobs slip into pockets and hold the board stationary. To close up the board, it is only necessary to press the knobs out of the pockets and lift the outer end of the board, when the knobs slide down in the grooves and the whole device folds vertically into the

cabinet. The cabinet is made with a door so that the board can be concealed.

Mfr: Perfection Concealed Ironing Board Co.
138th + Alameda St.
Los Angeles, Cal.

100 ft. Toledo
Extra Reels \$10.00

See Aug 15 '18

Essex, Alma Myers, 4015 Bonnet Ave., San Angeles, Cal.

dashboard, a sprocket carried shaft, a depending shaft mounted in front of the truck, a larger sprocket wheel on the upper edge of the shaft, a smaller sprocket on the lower edge of the shaft, blocks of insulation secured to the underside of the truck, bars slidably adjustable in the

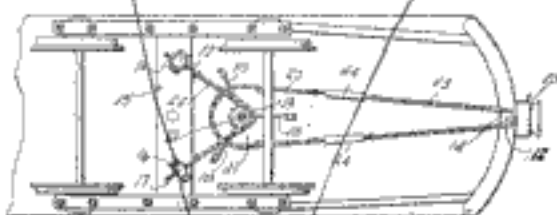

blocks, a chain turned around the first named sprocket and said larger sprocket, adjusting means carried in the chain for taking up slack, and a chain connected at its end to the said adjustable bars and trained around the last named small sprocket.

1,144,692. CONDUIT-MOLD. THOMAS DE LA MARE, Tooele, Utah. Filed May 1, 1914. Serial No. 835,734. (Cl. 25-128.)

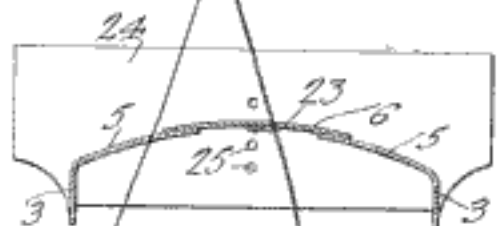

1. In a molding apparatus, a transversely arched cope comprising a pair of side sections, a pair of yoke plates overlapping the said sections adjacent the ends thereof, and means for adjustably clamping the yoke plates and sections together, there being a filling opening between the said sections and yoke plates.

2. In a molding apparatus, a transversely arched cope comprising a pair of side sections adjustably connected and provided with a filling opening therebetween, the said sections having spaced inturned flanges at one end, and flange members adjustably carried by the inturned flanges and having their adjacent ends overlapped.

1,144,693. FILM-REEL. MICHAEL G. DELANEY, Detroit, Mich., assignor, by mesne assignments, to Northern Sales Co., Toledo, Ohio, a Corporation of Ohio. Filed Dec. 12, 1912. Serial No. 736,347. (Cl. 88-18.7.)

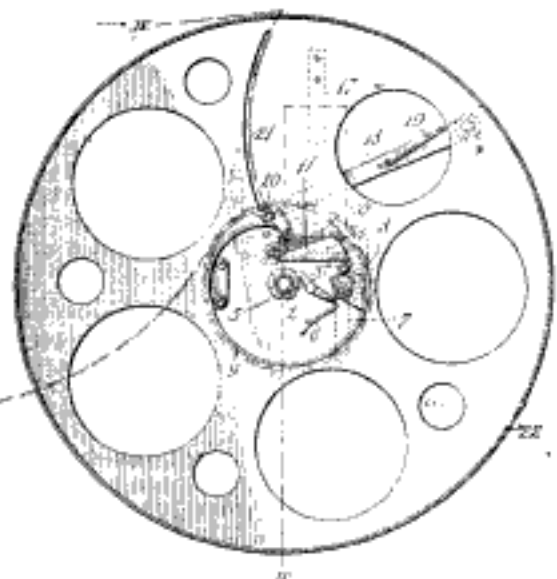

1. A film reel comprising a bearing member with a back plate fixed thereon, a front plate journaled on the bearing member in spaced relation to the back plate and provided with an opening, manually operable means for

locking the plates to turn together, film guiding means extending from an opening through the front plate into concentric relation with the bearing member between the plates, and a cover adapted to be locked on the back plate and to encircle the front plate.

2. A film reel comprising a bearing member with a back plate fixed thereon, a front plate journaled on the bearing member in spaced relation to the back plate and provided with an opening, manually operable means for locking the plates to turn together, film guiding means extending from an opening through the front plate into substantially concentric relation with the bearing member between the plates, a cover adapted to be locked on the back plate and to encircle the front plate, and means yieldingly mounted on one of the plates for maintaining a film applied to the reel in operative position.

3. A film reel comprising a bearing member with a back plate fixed thereon, a front plate journaled on the bearing member in spaced relation to the back plate and provided with an opening, manually operable means for locking the plates to turn together, film guiding means extending from an opening through the front plate into substantially concentric relation with the bearing member between the plates, and a cover adapted to be locked on the back plate to encircle the front plate, the front plate being adapted to detachably engage with the wall of a film magazine or holder.

4. A film reel comprising a bearing member with a back plate fixed thereon, a front plate journaled on the bearing member in spaced relation to the back plate and provided with an opening, manually operable means for locking the plates to turn together, film guiding means extending from an opening through the front plate into substantially concentric relation with the bearing member between the plates, a cover adapted to be locked on the back plate and to encircle the front plate, and means yieldingly mounted on one of the plates for maintaining a film applied to the reel in operative position, the front plate being adapted to detachably engage with the wall of a film magazine or holder.

5. The combination with the wall of a film magazine having a lateral opening and stops thereon, of a film reel comprising a hollow bearing member, a back plate secured on the bearing member, a front plate journaled on the bearing member and provided with an opening, means on the front plate adapted to interlock with the stops of the magazine wall to hold the respective openings of the plate and magazine wall in register, manually operable means for locking the front plate to turn with the bearing member, and a guiding member on the front plate extending from the opening therethrough between the plates to direct an applied film into substantially concentric relation with the bearing member.

(Claims 6 and 7 not printed in the Gazette.)

1,144,694. REGULATOR FOR FILM-MACHINES. MICHAEL G. DELANEY, Detroit, Mich., assignor, by mesne assignments, to Northern Sales Co., Toledo, Ohio, a Corporation of Ohio. Filed Sept. 22, 1913. Serial No. 791,157. (Cl. 88-17.)

1. The combination with a film holder and a projecting machine adapted to draw a film therefrom, of normally disconnected mechanism for positively discharging a film from the holder, and means adapted to be controlled by a film passing to the machine for connecting the mechanism when the tension of the film is abnormal.

2. The combination with a film holder and a projecting machine, adapted to draw a picture film from the holder, of means for rotating the holder, and means for connecting the rotating means to the holder controlled by the tension of a film passing from the holder.

3. The combination with a film holder, and guiding mechanism for a film passing therefrom, and means for passing a film through the guiding means from the holder, of means for positively turning the holder, means for coupling the holder to the turning means, and means controlled by the tension of a film passing over the guiding mechanism for throwing in the coupling means when the

tension of a film engaged by the guiding means varies from normal.

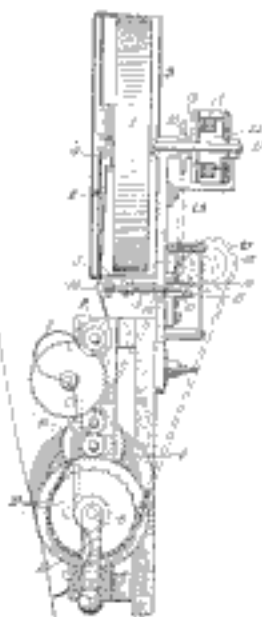

4. The combination with a film holder and guiding mechanism for a film passing therefrom, and means for passing the film through the guiding means from the holder, of normally disconnected mechanism controlled by the tension of a film passing over the guiding means and adapted when thrown in by abnormal tension of the film to turn the holder, and to release the holder to turn independently when the film is under normal tension.

5. The combination with a film magazine, of a film projecting machine, adapted to draw a film therefrom, means for regulating the delivery of the film from the magazine that is normally inert, and means controlled by the tension of a film passing from the magazine to the machine for throwing the regulating means into operation.

[Claims 6 to 11 not printed in the Gazette.]

1,144,695. ADJUSTABLE CASING FOR FILM-REELS. MICHAEL G. DELANEY, Detroit, Mich., assignor to The Northern Sales Co., Toledo, Ohio, a Corporation of Ohio. Filed Feb. 16, 1914. Serial No. 818,911. (Cl. 88-18.7.)

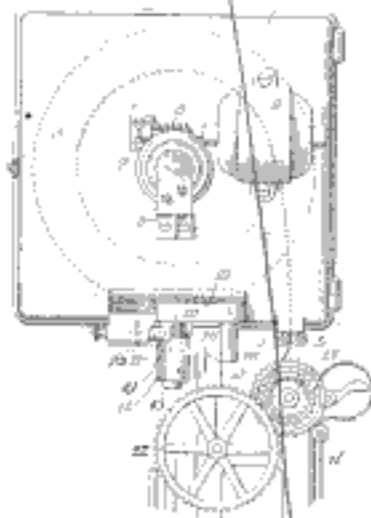

1. In a moving picture machine including a projecting machine with gearing for drawing off a picture film, a casing for film reels provided with means for detachably mounting such reels in the casing and with delivery openings for both center and side delivery reels with means for mounting the casing on the frame in which the casing is adjustable for bringing either opening into operative registration with the gearing.

2. In a moving picture machine including picture projecting mechanism with gearing for drawing a film there-through, a casing for film reels having a delivery opening for side delivery reels and an opening for center delivery reels, and means for supporting the casing in operative relation to the gearing, the casing being adjustable in the supporting means for bringing either opening into proper alignment with the gearing.

3. In a moving picture machine including film operating mechanism, a bracket adjustably supported on the machine, a film reel casing adjustably mounted in the bracket and provided with film delivery openings for both side and center delivery film reels, and means for detachably locking the casing in the supporting bracket with either opening in proper registration with the film operating mechanism.

4. In a moving picture machine, a bracket detachably mounted thereon, a film reel casing, a stem on the casing adapted to detachably interlock with the bracket, film guiding rolls at an opening in the casing that are in operative registration with the mechanism of the machine when the stem is interlocked with the bracket, a film tensioning roller on the casing at a delivery opening thereof, and a stud on the casing that is adapted to cooperate with the stem when engaging the bracket for holding the casing with the tensioning roller in operative relation to the mechanism of the machine.

5. In a picture machine having film feeding gearing, a bracket adjustably supported on the machine, a reel casing, a stem on the casing adapted to interlock with the bracket when the casing is in one position, a stud on the casing adapted to engage the bracket together with the stem for holding the casing in another position, film guiding members at one opening of the casing for drawing a film therefrom by the machine when the stem alone engages the bracket, and a tensioning roller on the casing at another opening thereof adapted to guide a film drawn therefrom by the machine when the casing is held by the engagement of the stud and stem of the bracket.

[Claims 6 to 8 not printed in the Gazette.]

1,144,696. MOVING-PICTURE MACHINE. MICHAEL G. DELANEY, Detroit, Mich., assignor to The Northern Sales Co., Toledo, Ohio, a Corporation of Ohio. Filed Feb. 16, 1914. Serial No. 818,912. (Cl. 88-17.)

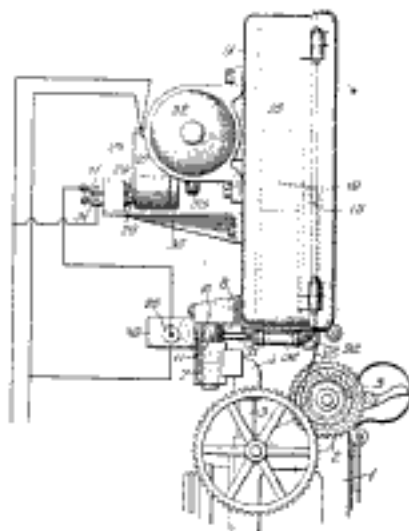

1. A reel container for moving picture machines comprising a casing, means therein for operatively supporting a reel, a pair of guide rolls at one opening in the casing for receiving a film from a side delivery reel, a tension roll at a delivery opening in the casing for a film from a center delivery reel, and means for supporting the casing on a moving picture machine for delivery through an opening.

2. A reel container for moving picture machines comprising a casing, means therein for operatively supporting a reel, a pair of guide rolls at one opening in the casing for receiving a film from a side delivery reel, a tension roll

at a delivery opening in the casing for a film from a center delivery reel, an extension on the casing, a depending stem from the extension, a stud on the extension, and means for interlocking with the stem to support the casing in one position and with the stem and stud to support the casing in the other position.

3. A reel container for moving picture machines comprising a casing, means therein for operatively supporting a reel, a pair of guide rolls at one opening in the casing for receiving a film from a side delivery reel, a tension roll at a delivery opening in the casing, for a film from a center delivery reel, an extension on the casing, a depending stem from the extension, a stud on the extension, a bracket adapted to be adjustably supported on a moving picture machine and to interlock with and support the casing in position for delivery from one opening and to interlock with the stem and stud for supporting the casing for delivery from the other opening.

4. A reel container comprising a casing, a cover therefor, means in the casing for operatively supporting either a side or center delivery film reel, a pair of guide rolls at one opening in the casing for a film from a side delivery reel, a tension roll on the casing at an opening for delivery of a film from a center delivery reel, an extension on the casing, a stem depending from the extension, a supporting bracket having an opening adapted to receive the stem, a member on the bracket for interlocking with the stem to hold the casing in position for delivery past the guide rolls, and a stud on the extension adapted to cooperatively engage the bracket with the stem for supporting the casing to deliver past the tension roll.

5. A reel container for moving picture machines, comprising a casing having a delivery opening for a film, means therein for operatively supporting a reel, a tension roll at the delivery opening adapted to impose a tension on a film after it passes the opening, and means for supporting the casing on a moving picture machine for delivery through said opening.

1,144,697. FILM-REEL. MICHAEL G. DELANEY, Detroit, Mich., assignor to The Northern Sales Co., Toledo, Ohio, a Corporation of Ohio. Original application filed Dec. 12, 1912, Serial No. 736,347. Divided and this application filed Feb. 21, 1914, Serial No. 820,215. Renewed May 8, 1915. Serial No. 26,903. (Cl. 88—18.7.)

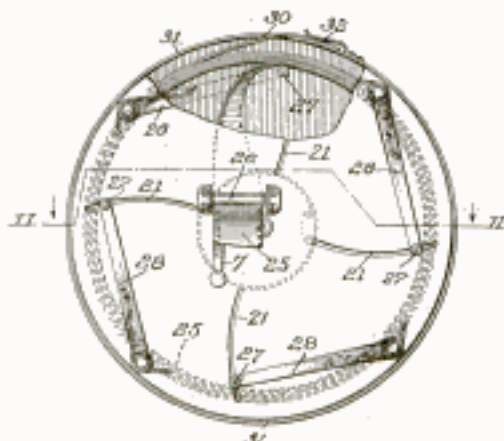

1. The combination with the wall of a film magazine provided with an opening therein, of a film reel comprising a back plate secured on a bearing member, a front plate provided with an opening, and journaled on the bearing member, means for securing the front plate to the wall with the respective openings in register, manually operable means for locking the front plate to the wall to turn

secured to the member, a front plate journaled on the member and provided with an opening means on the front plate adapted to hold a film that passes through the opening in operative relation to the bearing member and plates, a cover removably secured on the back plate and encircling the front plate with a film opening therethrough, and means for locking the plates and member to turn together.

3. A film reel comprising a bearing member adapted to be rotatably mounted on a suitable support, and provided with a fixed side plate, a complementary side plate rotatably mounted on the bearing member in spaced relation to the other plate and provided with a film opening, guiding means between the plates for holding a film that passes through the plate opening in operative relation to the plates and bearing member, a cover detachably secured on the fixed side plate around the other plate and provided with a film opening, and means for locking the rotatable plate to turn with the bearing member.

from the receptacle, and a combustion stack surrounding the flue of greater height than the flue and of substantially greater diameter than the flue above the upper end of the flue, said combustion stack having no communication with the fuel receptacle other than through the flue, and means to controllably admit air to the lower part of the combustion stack around the flue.

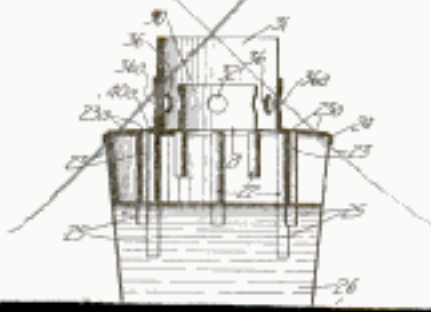

tral orifice that is radially-notched to enable the free passage of the washer over said lugs to snug position beneath said head and to be turned part way for passing said lugs and adapting them to hold the washer on the shank directly beneath said head for manipulation in application for use.

1,144,701. APPARATUS FOR MAKING WHITE LEAD. CARLETON ELLIS, Montclair, N. J., assignor to Ellis-Foster Company, a Corporation of New Jersey. Filed Aug. 25, 1911. Serial No. 645,913. (Cl. 14-68.)

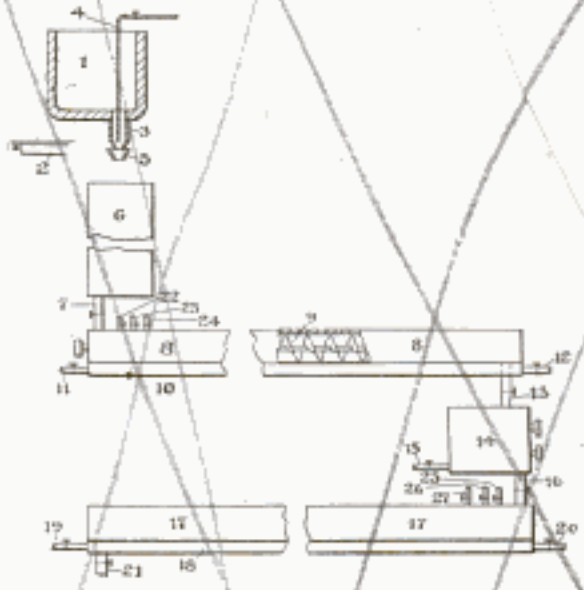

1. An apparatus for making white lead comprising a receptacle for holding molten lead, adjacent thereto a metal atomizer adapted to comminute lead to a product of extreme fineness, a conveyer of great length adapted to propel the comminuted product, a shunt return forming a part of said conveyer, means for contacting said product while in said conveyer with air in the presence of moisture whereby said product is hydrated; a separator connected with said conveyer adapted to free the hydrated material from substantially all metallic particles, a second conveyer adapted to receive and propel the hydrated material from said separator, and means for introducing carbon dioxide into said second conveyer; whereby the hydrated material is carbonated.

2. An apparatus for making white lead comprising a receptacle for holding molten lead, adjacent thereto a metal atomizer adapted to comminute lead to a product of extreme fineness, a conveyer of great length adapted to propel the comminuted product, means for contacting said product while in said conveyer with air in the presence of moisture; whereby said product is hydrated; a separator connected with said conveyer adapted to free the hydrated material from substantially all metallic particles, a second conveyer adapted to receive and propel the hydrated material from said separator, and means for introducing carbon dioxide into said second conveyer; whereby the hydrated material is carbonated.

3. Apparatus for making white lead comprising a receptacle for holding molten lead, adjacent thereto a metal atomizer adapted to comminute molten lead to a finely divided product, a conveyer adapted to propel the comminuted product in contact with moisture and with oxygenating and carbonating gases, and interposed in said conveyer a separator adapted to remove metallic particles from the material.

Underwood & U. 417 Fifth Ave., N.Y. City

9068

CURIOUS FEATURE OF A BURMESE FESTIVAL

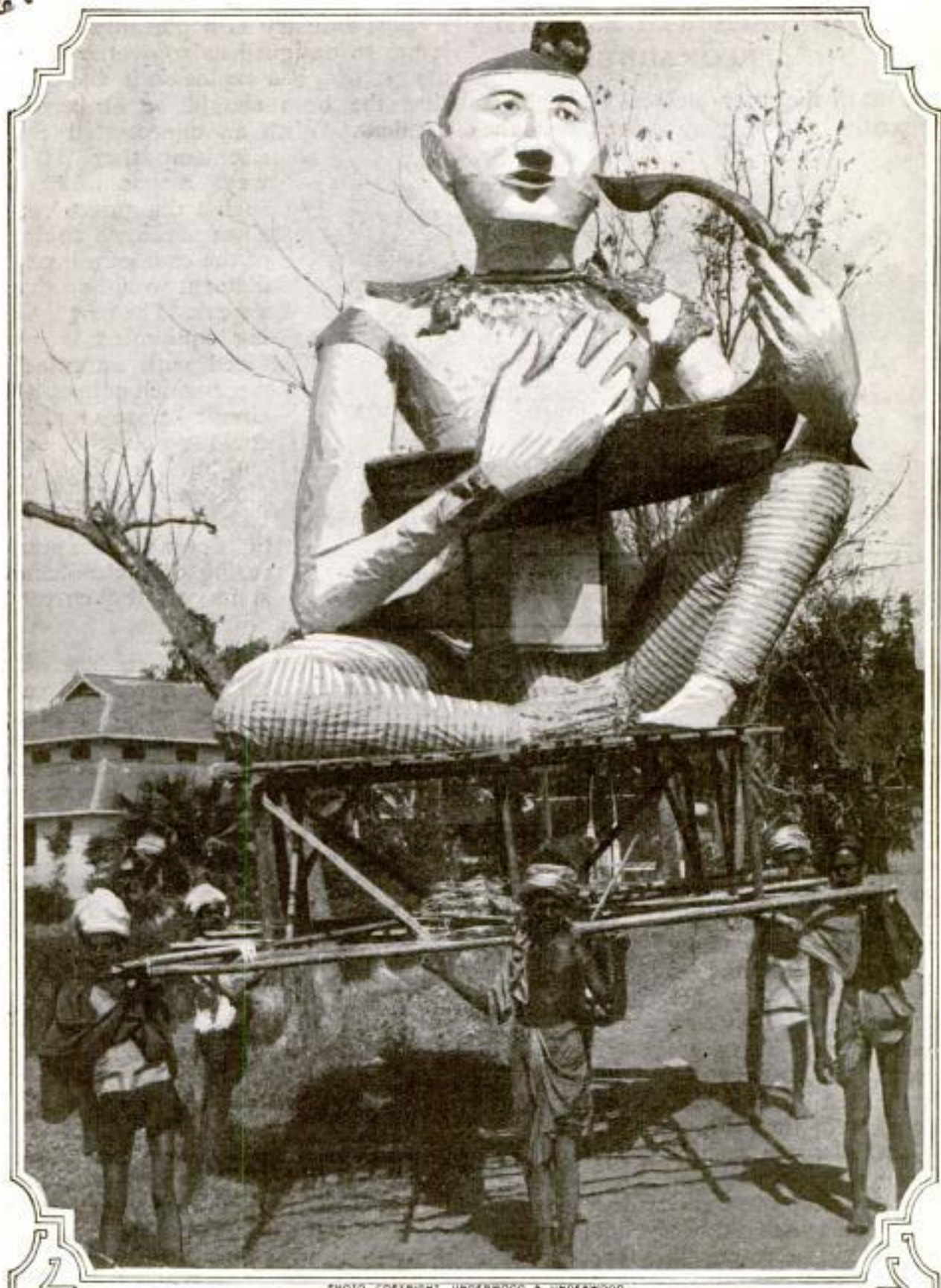
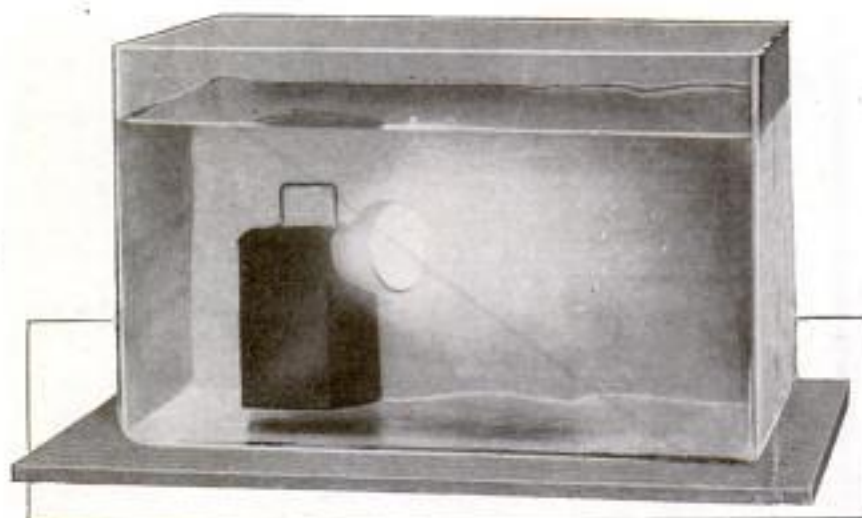

PHOTO COPYRIGHT UNDERWOOD & UNDERWOOD

THIS grotesque figure, carried through the streets of a village in Burma, is an indication of the high esteem in which music and musicians are held in that country. The crude instrument shown is a Burmese harp, shaped like a Burmese boat and dug out of one solid piece of wood. It has 13 strings and a sounding board consisting of calfskin stretched tightly over the "deck." A master of this instrument is called "eintha-dewa," or "celestial musician," and was entitled to a place in the retinue of the king in the days of Burmese royalty.

9409 SAFETY LAMP IS DESIGNED
FOR USE OF MINERS

One of the safety devices which have recently been developed for use in the



The Safety Lamp is Shown Here Burning under Water, Which Illustrates How Tight Its Casing is Made

mining industry is a portable electric lamp, so designed as to overcome the danger of a gas explosion in the event that the bulb should be broken by accident. With an unprotected electric lamp there is always a possibility of such a thing occurring, since a chance contact of the ends of a broken filament would produce a spark. The new lighting equipment is provided with an attachment which cuts off the circuit before anything could reach the bulb and burst it. Both the globe and battery are inclosed in an airtight case and the puncturing of the reflector shuts off the current.

9172

EXAMINING RUBBER GLOVES
FOR ELECTRICAL WORKERS

When electricians are working on high-tension apparatus which is "alive," it is customary for them to wear rubber gloves as a means of protection. These necessarily must have sufficient resistance to prevent a heavy current from jumping through them, and to insure this, they are subjected to severe tests before being accepted. A leakage not to exceed 10 milliamperes is the limit which is set by some eastern power companies. A glove which to all appearances is perfect, one which probably holds water, might still be responsible for the death of its wearer were he to touch a high-voltage wire with it. So to test a glove and make certain that it is suited for this kind of use, it is filled with water and suspended in a metal container which is also filled with water. Elec-

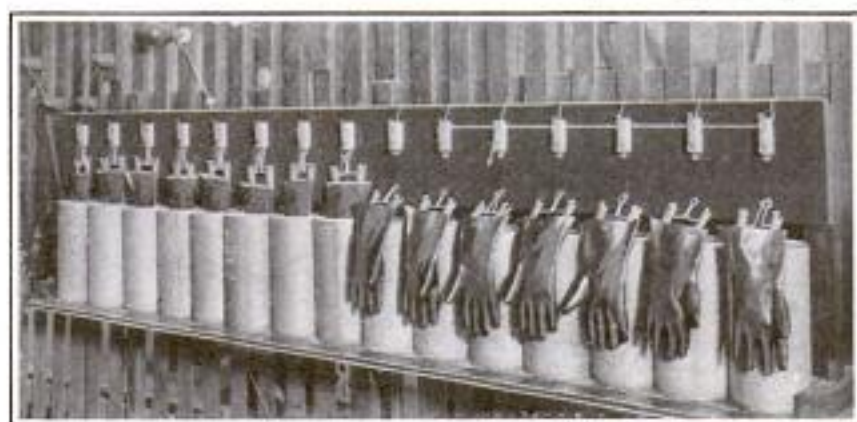

Rubber Gloves being Tested in a Laboratory to Determine Their Fitness for Use by Electrical Workers

trodes are then placed in contact with the water in both the glove and can, and the test current, which runs as high as 10,000 volts, turned on. A glove may be under this test from one to five minutes. By employing an

ammeter it is possible to measure the amount of current which passes through a glove, and if this exceeds 10 milliamperes at 10,000 volts it is rejected.

CA gasoline engine using but $\frac{1}{20}$ of a drop of gasoline for a single charge has been made.

Electrical Testing Laboratories, Inc.,
80th St. + East End Ave.
New York City.

See Card:
Engine smallest base
in the world.
Copyrighted material

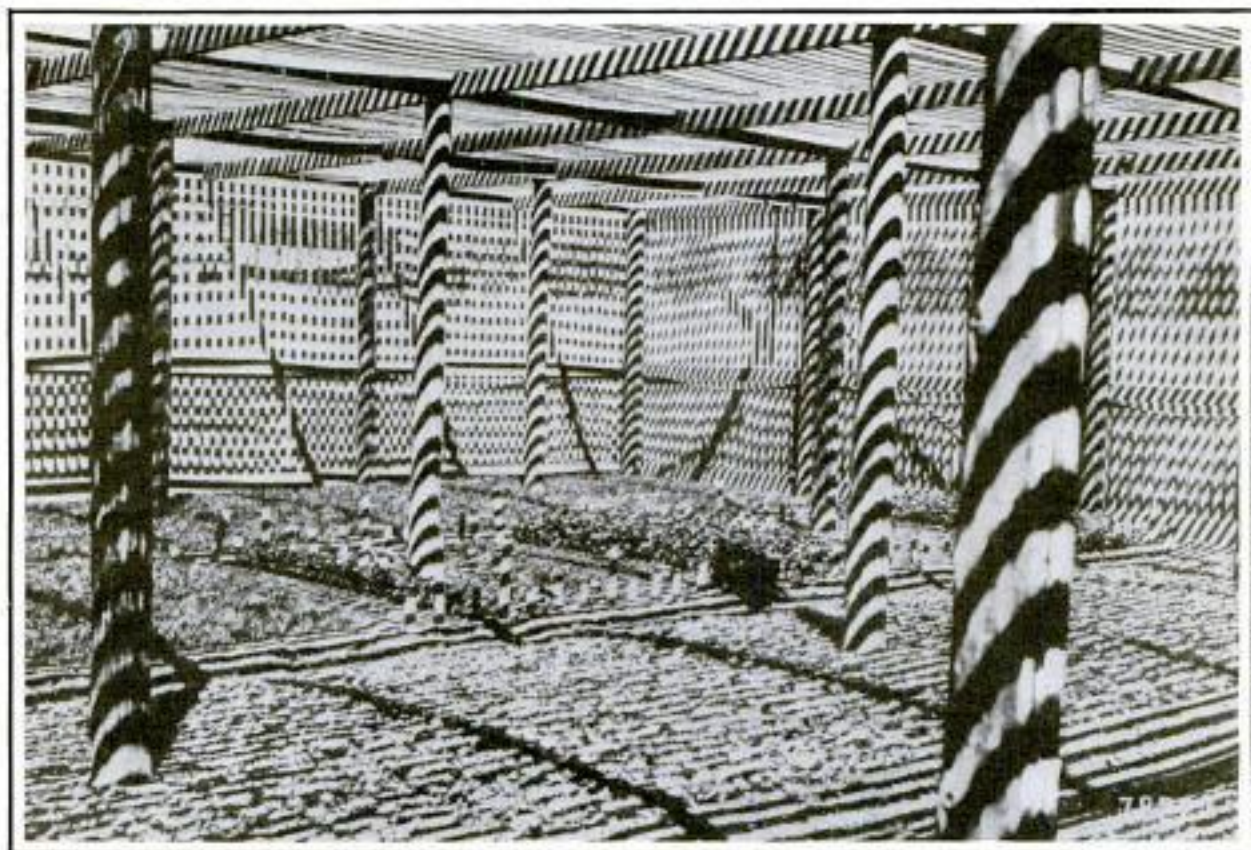

This Photograph Shows the Peculiar Effect of Sunlight and Shadow in the Interior of a Lattice-Inclosed Tree Nursery

8670 LATTICE CAUSES PECULIAR SHADOW EFFECT

A peculiar effect of sunlight and shadow is shown in a photograph of the interior of a lattice-inclosed tree nursery. In this picture the shadows cast by the wooden strips that form the top of the lattice look like stripes painted in black on the sides and supports of the structure and on the young sprouts that have grown to a height of a few inches above the ground.

9395 NOVEL TRAP FOR FLIES AND MOSQUITOES

Catching flies and mosquitoes and humidifying the air at the same time is accomplished by a new apparatus now being introduced. The body of the apparatus consists of a cage covered with fine wire netting for holding the insects. Connected with the cage is an electric suction fan that draws the insects through an opening into the cage. To get the insects to come close enough to the opening to be

caught by the suction two methods are used. At night an electric light and mirror form the necessary attraction, while during the day a metal plate smeared with sirup is placed adjacent to the opening. Within the cage is a

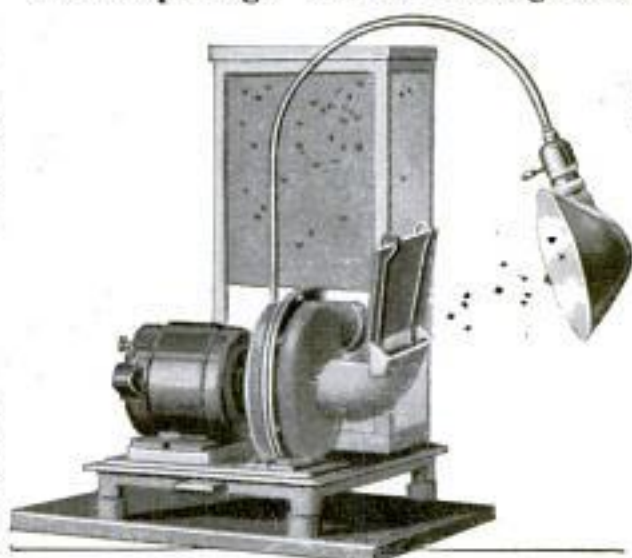

This Fly Trap Lures the Insects by Light and Captures Them by Air Suction

sponge that is kept wet, and the constant circulation of air over this aids in keeping the air in the room at the proper humidity.

Henry Vogel
Vogel Products Co. Mfg. Co.
1616 Chestnut St.
St. Louis, Mo.

Frank C. Perkins
Eric Co. Savings Bank Bldg.
898 Buffalo, N.Y.

POPULAR MECHANICS

HUGE BORING MILL BUILT TO
FINISH GUN TURRETS

8493

At the New York Navy Yard there has recently been completed the in-

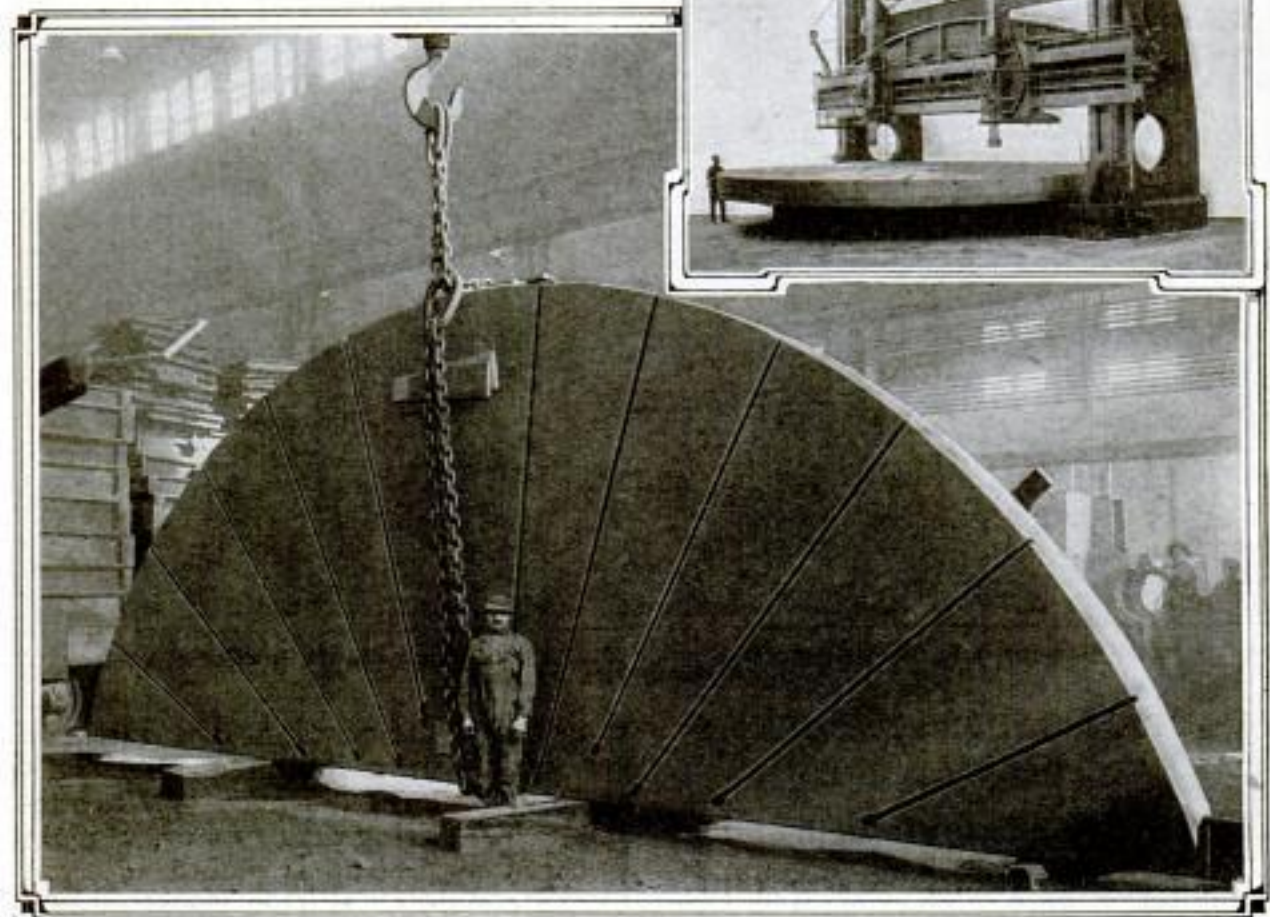

This Boring Mill, the Largest Ever Built in America, Weighs 300 Tons and is Used in Making the Turret Tracks for the New Battleships

stallation of the largest boring mill that has ever been built in this country. This machine was designed for finishing the tracks of the turrets carrying the 14 and 15-in. guns of the new battleships. The mill will also be used for boring cylinders and machining the casings of the steam turbines for war vessels. Some operations previously done on a planer will also be taken care of by it. This mill is not of the "extension" type, but has an actual swing of 36 ft. 2 in. with the housings in a fixed position. The total weight, including motors, is 602,000 lb., or over 300 tons. The maximum height from the table to the under side of the cross rail is 13 ft. The table was designed to carry a weight of over 200,000 lb. The central section

weighed in the rough 83,000 lb., and the side sections each 70,000 lb., making a total weight of 223,000 lb. The table is supported on conical rollers running in a circular track sunk in the bed. A 60-hp. motor provides the driving power.

DEMAND FOR JAPANESE HAIR
NOW EXCEEDS SUPPLY

During the last few years the exportation of human hair from Japan has increased to the point that the demand for it now far exceeds the available supply. Especially when compared with that of the average European, the hair of the Japanese woman is extremely long, elastic, and strong, which gives it superiority for commercial purposes.

The Japan Magazine

The United States and France offer the principal markets for the Oriental dealers. In Europe it is much used for weaving purposes, the hair being bleached by chemical treatment, dyed in different colors, and subsequently woven with silk into ribbon materials and heavy fabrics suitable for draperies and upholstery, some of which command prices of several hundred dollars a yard. Collectors have found that the hair of Tokyo women is inferior to that of country people who pay less attention to dressing it and therefore produce a longer and much better quality.

FAN ATTACHMENT INVENTED FOR SEWING MACHINES

9396

An odd fan attachment for sewing machines has been designed by a Texas inventor. It consists of a me-



With This Attachment a Woman may Fan Herself While Using a Sewing Machine

SHIELD TO CATCH FLYING METAL CHIPS

9338

A simple but effective shield has been adopted by one of the leading steel companies for preventing metal chips from flying when chiseling is being done. It consists of a screen made of ducking, ordinarily 24 in. square, and carried in a frame made of 3/8-in. round steel bars. The frame is mounted on a steel block weighing 21 lb., and the whole device is easily carried from bench to bench and placed in any desired position. For floor use the shield is made larger and is mounted on a heavier base. In some of the



This Shield Catches the Metal Chips When Chiseling is being Done

shields the base is made with a rounded bottom so that it will resume an upright position automatically in case it be upset.

Stephen W. Toner
Maj. Accident & Pension Dept.
Amer. Steel & Wire Co.,
Cleveland, Ohio.

chanical arrangement by which the operator of a machine may be fanned while working. An upright rod is clamped to the sewing-machine table, and pivoted near the top of it is a bar which holds a palm-leaf fan. One end of this is connected to the pedal board by a slender stick, so that the fan is moved rapidly up and down as the machine is operated.

CRUDE CLAY PIPES USED BY INDIAN TROOPS

9287

Those who are unfamiliar with many of the customs of the tribesmen of the East cannot but wonder at some of the curious habits followed by the Hindus and Sikhs now fighting with the allies in the Continental trenches.

Tobacco
Illustrated London News
Jan. 463/1915

*Inventor: John A. Unglaub,
Colorado Springs, Colo.
Taken from patent
specifications*

One of their odd rites is the manner in which they use tobacco. Because the cigarettes supplied the troops are made by "Christian hands," the Hindus and Sikhs abstain from their use, refusing to so defile their lips. Instead they frequently mold a potato-shaped

and then take turns in inhaling the sedative drafts. The pipe is usually placed in a niche cut in one side of the trench at a height which permits them to squat comfortably and smoke. Instead of placing the straw between their lips, they close their fists over the end of it and draw the smoke through them, as shown in the illustration.



COURTESY ILLUSTRATED LONDON NEWS
Taking Turns in the Trenches Smoking through a Straw
a Crude Pipe Made of Clay

pipe bowl out of clay and harden it by baking. Into this they insert a straw

lb. of the product is mixed with a gallon of soft water.

IRON SCENERY FOR THEATER

9200 MADE IN RECORD TIME

Sheet iron is the material which was used recently in constructing scenery for a photoplay house at New York, the managers of which learned a day and a half before the advertised time

for the opening of the theater that municipal fire ordinances prohibited the use of ordinary scenery. In approximately 36 hours the character of the substitute scenery was decided upon, its design drawn, the contract awarded, the work completed, and the theater opened. Just as rapidly as a

*J. S. Feiner, of Feiner Sheet
Metal Works, 335 West 44th St.,
N. Y. City*

MAKING PAINT WEAR LONGER 9058

Patent rights have been granted on a process for increasing the wearing properties of lead paint. This consists of mixing soft water, zinc sulphate, and kerosene with paints composed of linseed oil and lead. It is claimed that this has no deleterious effect upon the color and that the paint will dry with a hard surface which will neither peel nor flake. For use, 2 oz. of a solution of soft water and zinc sulphate are added to a gallon of paint and thoroughly mixed, after which a quart, or more, of soft water is carefully stirred in and a half pint of kerosene finally introduced. In making the sulphate solution, 1

*1127
Serial 727988
John Anton Unglaub.*

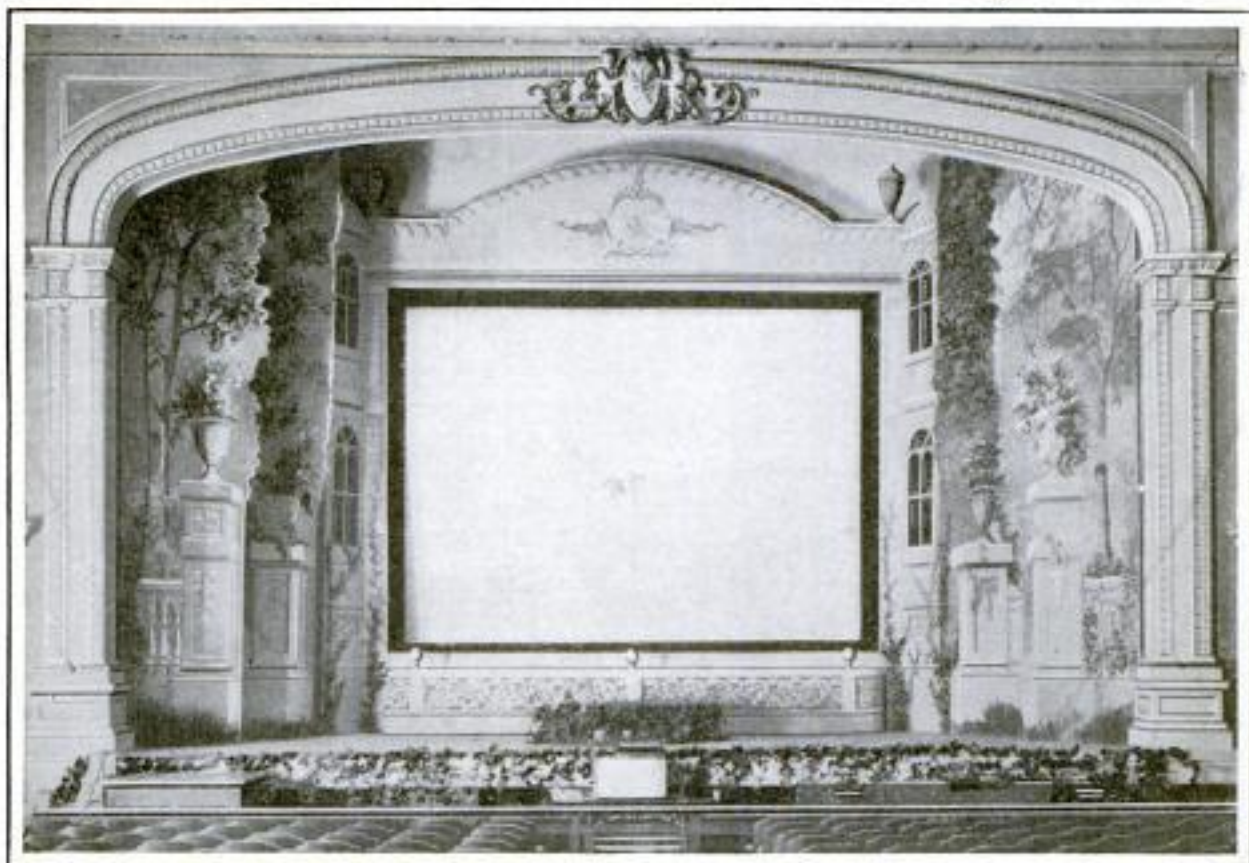

All the Scenery Shown in This Photograph is Made of Sheet Iron and was Designed and Built in 36 Hours

section of the scenery was cut out and fixed to its framework, it was set in place on the stage and turned over to the scene painters. It was only six minutes before seven o'clock, the hour when the doors were to be swung out, that the finishing touches were completed and the stage finally cleared so the audience could be admitted.

HOTEL PROVIDES BUTTONS FOR ITS GUESTS

An assortment of buttons and the means for sewing them on is a convenience for travelers found in every bedroom of a Jacksonville, Fla., hotel. Buttons for coats, waistcoats, trousers, shirts, and underwear, in assorted sizes, are provided, and needles already threaded with white and black thread are stuck in the guest-room pin-cushions.

More than 200,000 tons of copper will have been used for military purposes in the first year of the war.

Reported by Mr. Windsor

WINDOW SHADES ARE TACKED TO ROLLERS BY MACHINE

For tacking window shades to wooden rollers an especially designed machine has been made which does the work quickly and evenly without requiring any hammering. The device is an adaptation of a lately introduced tacker which works on much the same principle as some paper binders used for office purposes. The tacks used are of the staple form, are fed automatically and driven by pressing on a plunger.



A similar machine, the head of which is flat instead of being curved to fit over a roller, is made for tacking tags to packing cases, laying carpets and matting, and doing work of similar nature.

*Refer to Mr. M. S. Cook
259 Broadway, N. Y. City*

*Acme Staple Co. Ltd
Camden N. J. 7 112 No 9th, Phila.
make these machines.*

J. R. Higgins
P.O. Box 422

902 Palatka,
Fla.

POPULAR MECHANICS

9052 CHIP FOUND IN HEART OF CYPRESS TREE

As a cypress tree, cut from a Florida forest, was being sawed into lumber a chip from a tree of another species was



This Photograph Shows How Perfectly the Wood had Grown around a Chip Accidentally Imbedded in a Cypress Tree Over 400 Years Ago

found deeply imbedded in the wood. Estimated from the rings in the wood that had grown over it, this chip had become imbedded in the tree over 400 years ago, or in the time of the Span-

ish explorers, having evidently been thrown by the ax of a woodman of that time and become tightly wedged against the young tree. In growing over it, the tree adjusted itself so perfectly to the ax cuts in the chip that, when the two parts are placed together, the lines of separation are barely perceptible.

ALGERIAN CAMEL CARAVAN CROSSING ARID REGION

74¹⁰ In the desert regions of Africa, camel caravans are seen today just as they were centuries ago. The accompanying photograph was taken when a wealthy Algerian and his suite were starting on a long overland journey from the arid territory east of Ghardaia to Algiers, the capital. Until Ghardaia is reached there are no railroads, and caravans form the only means of transportation. The camels are harnessed in single file, hair ropes often connecting one to another. The leader is usually gayly decorated with colored trappings, while it is not infrequent that a donkey precedes the procession in order that good fortune will be met on the way. In most instances every one is armed for protection against robbers.



A Typical Camel Caravan Pushing through the Sandy Regions of Southern Algeria

Underwood & U.
12-14 W. 37th St. N.Y. City.

Albert B. Niess
Room 230, Treasury Dept.,
Wash. D. C.

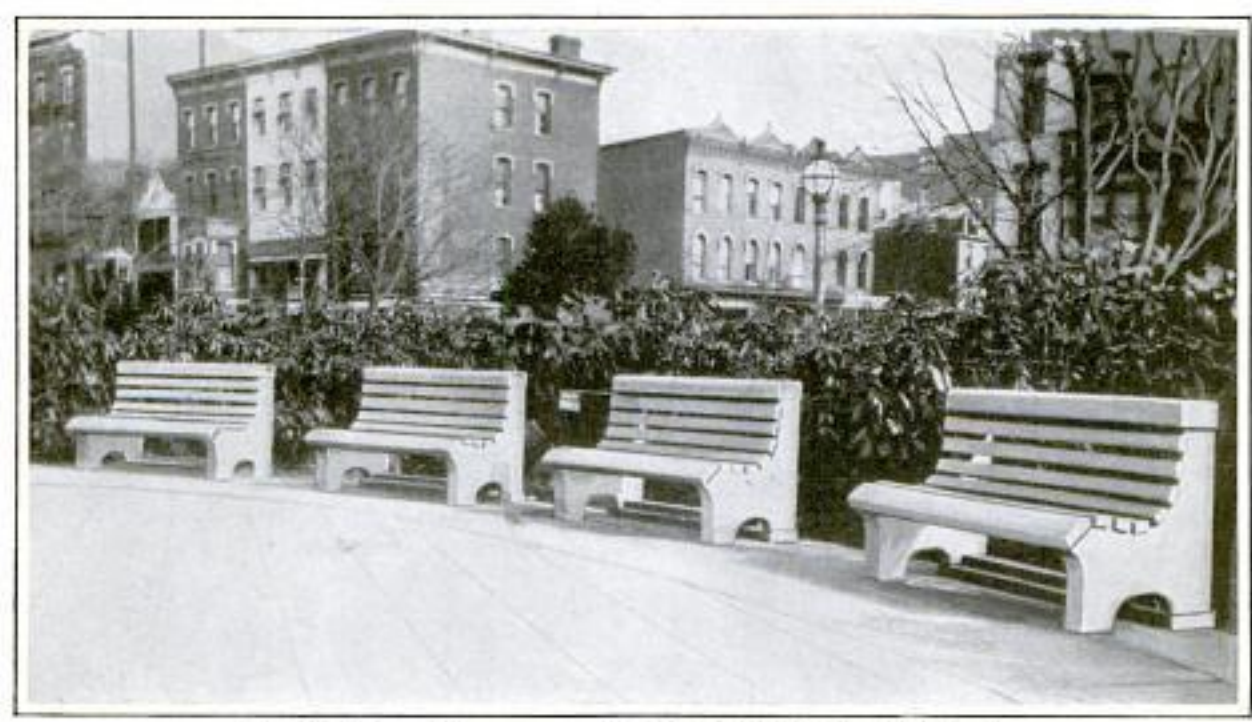

Durable Type of Concrete Benches in a Small Park at Washington

**ARTISTIC CONCRETE BENCH
FOR LAWN OR PARK**

9191

In the small parks about Washington, D. C., a type of concrete bench has been adopted which is not only artistic, but also durable. It is made of heavy, solid construction and so put together that it seldom needs attention other than an occasional painting of the thick wood slats which are bolted in place to form the serpentine seat and back. A number of benches have been made after this pattern, and when once set in place, they are allowed to remain summer and winter in the same spot, not requiring protection from the weather.

**HARDWARE "ZEPPELIN" MADE
FOR WINDOW DISPLAY**

9359

At the time that the fear of a Zeppelin raid was at its height in England, a Manchester household furnisher made use of the opportunity which was afforded for window advertising, and constructed a hardware "Zeppelin" dirigible from various articles selected out of his stock. All of the things which were employed in putting the burlesque craft together were such as are in common use in nearly every

home. An ordinary funnel was used for the front end of the balloon, a roll-bread tin for the body of it, and a jelly mold at the rear. On the top of the dirigible an imitation machine gun was made with a nutmeg grater and a door buffer. Picture hooks were used to hold the chains from which the car, an ordinary bread pan, was suspended. At the front of this was placed an electric

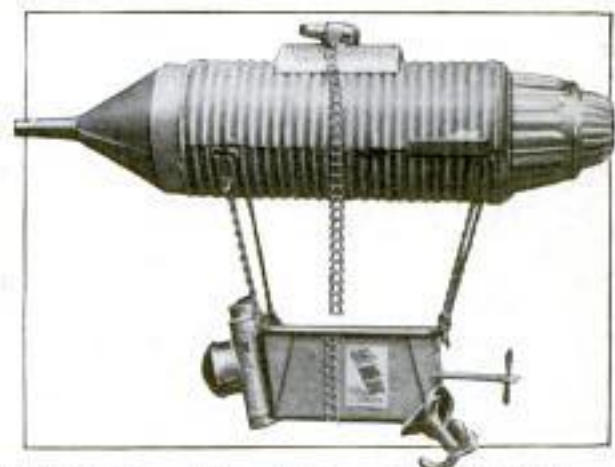

This Hardware "Zeppelin" was Made with Various Household Articles for Window-Advertising Purposes in a Manchester Store

lantern, and at the rear, a revolving wardrobe hook and an egg beater, for the propellers.

ⒸThe U. S. Army has \$50,000 to spend for armored motor cars.

F. M. Rawell
32 Victoria St.,
Manchester, Eng.

Albert Morple
322 Baynton St.,
904 Tropico, Calif.

**WATERING CAN FOR PLANTS
8880 ON HIGH SHELVES**

When potted ferns and other plants are set on high shelves, or in baskets out of easy reach, the daily routine of watering them



is frequently a troublesome one requiring the use of a stepladder or its equivalent. An ingenious device which eliminates this procedure consists of a cylindrical can held in a fork at the end of a long handle. This mounting is similar to that of the

average kerosene torch and allows the can to tip either forward or backward. Near the brim of the receptacle a piece of wire, about an inch long, is soldered. By lifting the can to the edge of a flowerpot and engaging this hook, thus allowing the container to be tipped forward, the water may be poured freely.

**COMPACT GAS ENGINE MADE
FOR USE IN CANOE**

Designed to be used in a canoe, a 2 1/2-hp. gasoline motor has been developed which weighs only 40 lb. and

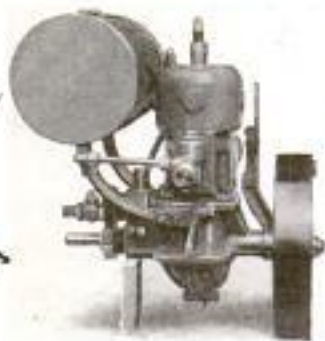

is able to give one of the small craft a speed of approximately 12 miles an hour. The engine is assembled in a fairly compact manner and carries at the back a fuel tank of one-gallon capacity.

It is intended to be mounted in the bottom of a canoe on two short pieces of planking fastened securely to the ribs about 4 1/2 ft. from the stem. The propeller shaft extends through

K. H. Hamilton
1619 Lincoln Place St.
Cincinnati, Ohio.

the keelson, or at one side of it, as best suits the specific canoe to which the power plant is fitted. Sufficient room is left back of the motor for the battery box. The height from the bottom of the flywheel to the top of the gas tank is 18 inches.

**ANTISKID CHAIN INVENTED
FOR MOTOR-TRUCK TIRES**

In Great Britain a new style of non-skid chain has recently been developed for use on the solid tires of motor trucks. It is



made up of several large metal rings linked together by equal segments of a heavy chain. This passes around the circumference of the tire like a necklace. The grips are formed similar to suction cups, and are supposed to prevent skidding in any direction, while it is also said that they are not so destructive to a tire as the flat bars sometimes used, because the size of each ring is such that the strain is spread over a greater area than in the other instance. On bad roads the chain also gives a wheel an excellent purchase.

On bad roads the chain also gives a wheel an excellent purchase.

**TO EXPLORE SEA FOR CARGO
LOST OVER CENTURY AGO**

Preparations are being made to attempt the recovery of a cargo lost in the Pacific Ocean, in 1813, when the Russian sloop "Neva" was wrecked off the coast of Alaska, near Sitka. The vessel was a 375-ton bark and carried 14 brass guns. It was loaded with a cargo composed largely of fixtures for a church at Sitka and this, if obtainable, is thought to be worth approximately \$100,000. The ship is supposed to have gone down in about 75 ft. of water. A list of the things aboard it is still preserved.

Jas. S. McCurdy,
Port Townsend, Wash.

*National Steam Loan Co., Ltd.,
78 Broadwood St., London, E.C. 4.*

*Mfrs: The Blackley Engine Co.,
Maccleson, N. Mich.*

Neva

9053

Walter A. Hillam, 1178 Pender St., W.
Vancouver, B.C.

NEW BRIDGE BRINGS OUT STRIKING CONTRAST



The New Suspension Bridge with Construction Well Started. The Indian Bridge is Shown in the Cañon Just Below

THE new bridge spans the cañon at a height of 250 feet above the water. It is a thoroughly modern structure built to carry foot and vehicular traffic and has a span of 451 feet between towers. The main cables are of steel, two and seven-sixteenths inches in diameter, having their anchorages in massive blocks of concrete. The bridge is nine feet wide and is built to carry a test load of 18,000 pounds distributed over a length of 67 feet.



Close View of Bridge Built by Indians

NO greater contrast between primitive and up-to-date bridge construction can well be found than that brought out by the building of this suspension bridge over the Bulkley Cañon in western Canada within a few hundred feet of an old Indian bridge that is still in serviceable condition. The Indian bridge was constructed 20 years ago of wire and poles abandoned many years before by a telegraph company that started to build a line through Canada and Alaska to connect with the Russian lines in Asia and then stopped work on the project because of the completion of the Atlantic cable. This primitive structure is remarkable in that it embodies correct principles of cantilever construction, although built by untaught Indians. After it was completed, 15 squaws of the tribe were sent to the middle of the bridge to test its strength by doing a dance. The bridge stood the test and has been in service ever since.



Inventor: *Mr. Scott*
2334 Upland Place,
Cincinnati, Ohio.

**SIMPLE WAY FOR MOTORISTS
8564 TO CARRY ROAD MAPS**

For use when touring through unfamiliar districts where it is necessary to depend upon road maps to guide



With the Case Strapped to the Steering Wheel the Motorist Has His Map before Him Constantly

him, an Ohio motorist has devised an ingenious case for his charts which may be strapped to the steering wheel of the car so that the course can be watched as he proceeds. The case is made on essentially the same principle as a roll-film camera, which, if desired, may be used for the purpose. The maps are cut in strips and pasted together so that the entire trip is outlined longitudinally on one long, narrow piece. This is rolled on a spool and the top end attached to a second spool so that the strip may be unwound as the course is traveled. A small pane of glass or sheet of celluloid, placed over the case, serves to keep out the dust.

**SHORT-RANGE TORPEDO USED
9603 IN GERMAN SEA RAIDS**

It has been reported that in its operations against unarmored merchant vessels and transports, the German navy has made use of a small, short-range torpedo which costs much less than the ordinary weapon and may be

Chicago Daily News

made in approximately half the time required in building those of a larger type. Torpedoes are expensive instruments, the German type ranging in cost from \$6,000 to \$12,000 each and demanding much time in construction. The short-range torpedo, which, instead of being capable of shooting through the water for from 4,000 to 10,000 yd. is effective up to about 1,500 yd., costs about \$2,200. In place of carrying an explosive charge of 250 or 300 lb. of guncotton, it uses 100 lb., and also does not require much of the intricate propelling and steering mechanism that is needed in the larger ones. The purpose of the new torpedo is to conserve the supply of the full-sized ones needed in regular naval operations, which would be greatly depleted if used in blowing up merchant ships.

**NEW BAGGAGE RACK FOR
9432 RAILWAY COACHES**

A new type of baggage rack just put in service on a western railway is designed to provide ample storage for hand baggage and, at the same time, eliminate all danger of its falling on the heads of the passengers. The outer side of the rack is made high and consists of two gates sliding on rods at top and bottom. The gates slide independently of each other. In



This Baggage Rack for Railway Coaches is Equipped with Gates for Placing and Removing the Baggage

using, one of the gates is slid to one side, the baggage is placed in position in the rack, and the gate is slid back to close the opening.

W. H. Simpson, Gen'l Adv. Agent
A. T. & S. F. R. R. Co.
80 E. Jackson Blvd., Chicago, Ill.

Felix J. Koch, Heavie Ave., Avondale, Cincinnati, Ohio.

C. L. Edholm, 1353 West 36th Pl. Los Angeles, Cal.

Theo. C. Dodane, Ft. Wayne, Ind.

CYCLECARS BUILT BY BOYS FROM ODDS AND ENDS

8147

In a large number of states the younger brothers of boys who a few years ago were constructing three-

being accomplished at the rear. On good roads the car is able to carry its two occupants along at approximately 15 miles an hour. A Ft. Wayne, Ind., boy is the builder of the other machine shown here, the motive power for which is supplied by an outboard engine previously attached to his rowboat. At the front of the machine is

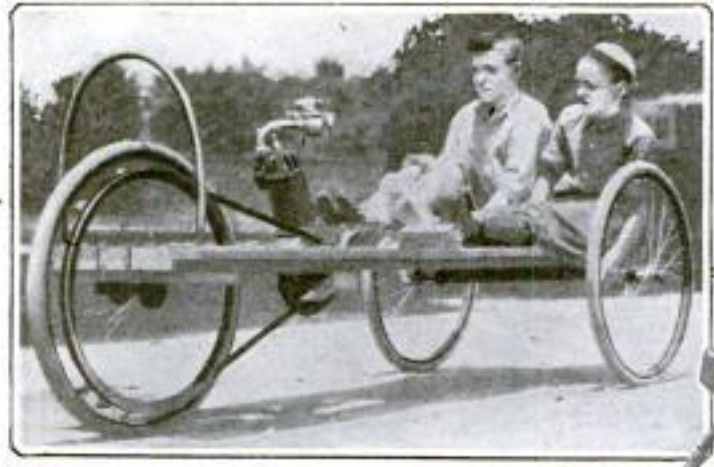

Three-Wheeled Cyclecar Built from Odds and Ends

wheeled coasting devices from bicycle wheels and a few boards, are today constructing motor-driven cyclecars. Many of these are as ingenious as they are simple. One of the accompanying photographs shows a machine built by a Pomona, Cal., boy from a couple of boards, three bicycle wheels, and an old motorcycle engine. The device is driven by belt transmission which is applied to the front wheel, the steering and braking

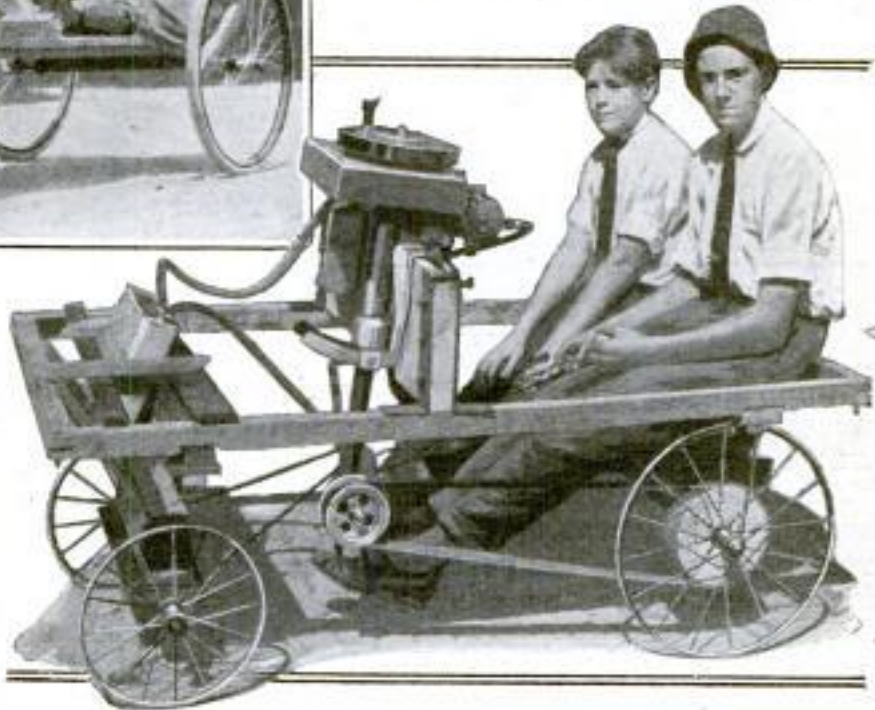

Using an Outboard Marine Engine as Power for a Homemade Cyclecar

placed a large can which is used as a water radiator. By running two pieces of hose from this to the engine, the latter is cooled.

Illustration of a cyclecar built from odds and ends

WRECKED STEAMER RESCUES SELF FROM DESTRUCTION

9485

An odd instance of a wrecked ship saving itself practically without human assistance, occurred on the Alaskan coast a short time ago. The wooden steamship "Delhi," after striking a reef, was abandoned by its owners and left to the underwriters, who rushed the wrecking vessel "Salvor" to the rescue. The wreckers succeeded in installing pumps aboard the disabled craft and

were making good progress when a heavy storm came up, forcing the "Salvor" to put out for its own safety. The breakers were running high and it appeared certain that the "Delhi" would be pounded to pieces in a short time. To the contrary, however, it floated off the reef and commenced aimlessly to drift through the narrows, later being picked up by the power schooner "Takau II" and towed to a place of safety. The vessel is valued at \$125,000 and the pumps and other

Joe. L. McCurdy, Port Townsend, Wash.

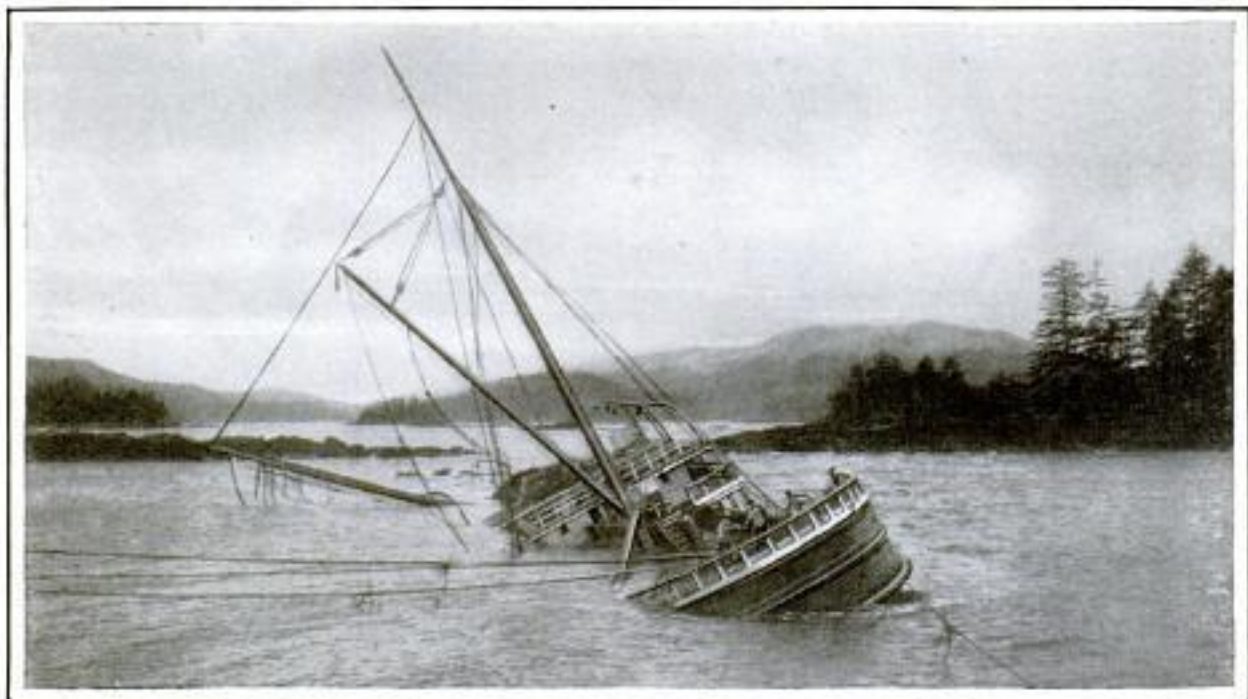

The "Delhi" in Tow After Wandering through the Narrows as a Derelict, Following Its Own Rescue from the Breakers

equipment, placed aboard it by the wrecking crew, at \$12,000. Since it was a derelict when taken in tow, the "Takau II" will receive a salvage award, which means that the wrecking vessel is placed in the position of paying salvage on its own equipment.

MOTOR TRAINS ARE USED

9500 AT SAN FRANCISCO

By constructing motor-car trains, each of which is capable of carrying approximately 40 passengers, adequate transportation facilities have been fur-

nished within the grounds of the Panama-Pacific Exposition at San Francisco. These curious carriers, which were devised especially for this purpose, travel regular routes on a time schedule. The train consists of an especially designed motor-car tractor to which are coupled two or three trailers, each of which is built with long side seats placed back to back, with an aisle between them for the use of a conductor. The cars are provided with automatic steering devices so that they are made to follow immediately in the tracks made by the motor car and take up no unnecessary space

*FADGE-AUTO-TRAIN, Inc., 702 Market St
San Francisco*



One of the Motor-Car Trains Loaded with Passengers on the Way between the Two Terminal Stations

*Hamilton M. Wright, Pan. Pacific Exposition
San Francisco, Cal.*

See Nov '14 663 for full info = 8034

when rounding a curve. They are also fitted with an ingenious self-operating braking system, so that when the speed of the tractor is decreased, the cars behind are checked. Twenty trains of

this kind are in use on the exposition grounds, operating between two terminals, one of which is situated at the Fillmore Street entrance and the other at the Massachusetts building.

8380 CHURCH IN A CAVE A MECCA FOR BRAZILIAN PILGRIMS

In a natural cave on a bank of the São Francisco River at Bom Jesus da Lapa, in Bahia, Brazil, is a subterranean church which is a mecca for the natives of the eastern provinces. A massive limestone rock, nearly 150 ft. broad, rises from the water's edge to a height of about 200 ft. and extends back several hundred yards. Its summit is crowned by slender spires cut by ages of exposure, while the innumerable crevices in the façade beneath are covered by clusters of cactus and the foliage of other growths. Two apertures in the wall form entrances to the church, which has a length of 130 ft., an average width of a little more than 30 ft., and a height of about 25 ft. The altar is placed near one of these openings, which admit just enough sunlight to illuminate the nave dimly. The rock ceiling of the cave has been faced with wooden panels, and hanging from it before the ornate altar, is a large silver lamp. On each side of the auditorium in small recesses are two minor altars surrounded by figures of local saints. Near the central entrance is a wooden balustrade which serves as a choir loft, and with the further exception of a rough brick floor, damp from the continual dripping of water, the cave is as it was found originally. It

is the belief of the worshipers that the dripping water possesses holy virtues. They make long pilgrimages to the church to invoke the favor of the saints or return thanks for blessings received, and no boat ever passes Bom Jesus da



The Interior of the Subterranean Church at Bom Jesus da Lapa, Brazil, Which Is the Mecca for the People of the Eastern Provinces Who Make Long Pilgrimages to Worship before Its Altar

Lapa without leaving an offering at this shrine.

Efforts to drill a hole in a sheet of tantalum, $\frac{1}{25}$ in. thick, with a diamond drill revolving at 5,000 revolutions per minute resulted, after 72 hours' continuous work, in wearing out the diamond and denting the metal.

Robt. H. Becker, Field Museum of Nat. History
Chicago.

J. K. Hamilton, 1231 E. McMullan, Cincinnati, Ohio.

Frank B. Gilbreth, Providence, R.I. has anti-fatigue exhibit

CHAIRS THAT ELIMINATE UNNECESSARY FATIGUE

Elimination of unnecessary fatigue has become recognized as an important element in obtaining efficiency in

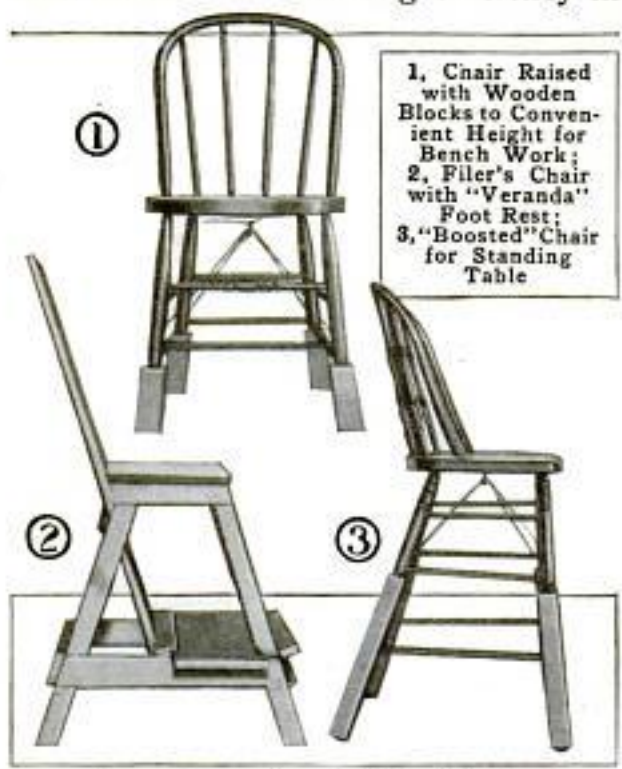

classes of skilled labor. Three of these chairs have already been made, but they are experimental and rough in form. In appearance they are much like ordinary kitchen chairs, but each has been made to fit a certain kind of work. A chair made for the man who formerly stood at his job of filing is known as a "veranda" chair because of the ledge at the bottom. This ledge serves as a brace for the foot and gives the body the necessary rigidity for the work. The other two chairs have simply been made of the right height for the work in hand. One of these, the "boosted" chair, for use at a standing table, is equipped with ball-bearing dome casters, and is easily pushed about as required by the work.

DIGGING BATTLE TRENCHES WITH STEAM PLOWS

any class of work. With this in view, a prominent efficiency engineer has made a beginning in devising chairs that are exactly suited to different

Wherever it is possible to do so, large tractor plows are being used on the different European battle fields to dig intrenchments. In the past this has been a laborious and time-consuming operation, but with modern machinery it has been simplified to the point that an army may make complete preparations for protection in a very

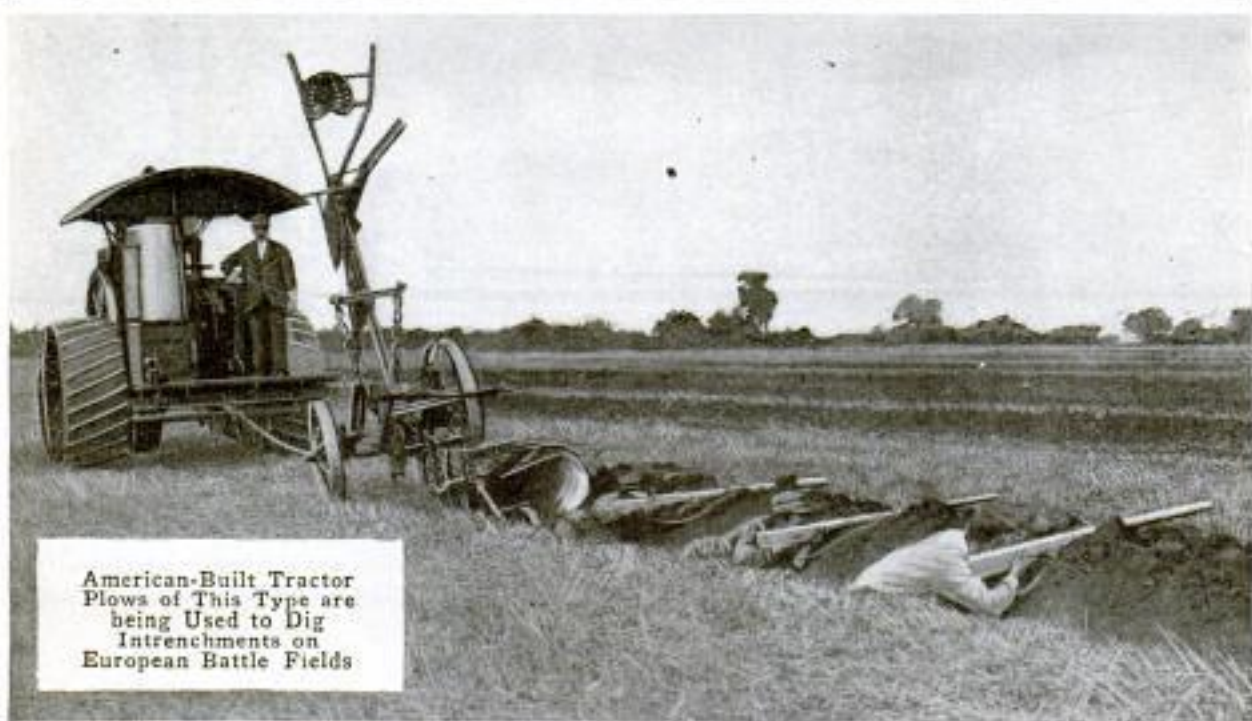

O. P. Seyer, 11429 West 9th St., Des Moines, Iowa.



Funeral of a Native in Northern Siberia near Verkhoyansk, Where the Ground Is Permanently Frozen

short time, a thing of much significance when it is remembered that the introduction of motor cars has greatly lessened the time required for transporting troops from one point to another. The accompanying photograph shows the type of implement which has been supplied to the various countries, by American manufacturers, and is being employed in the war zones. The plow cuts a trench, 20 in. wide and 20 in. deep, and turns the dirt over so that it forms a heavy breastwork for the soldiers. The machine has been especially used in digging trenches before cities in the path of an enemy.

WEIRD FUNERAL OF NATIVES 9320 IN NORTHERN SIBERIA

In the northern part of Siberia, where the ground is permanently frozen to great depths, the funeral rites which are performed when a native dies are quite the antithesis of those with which peoples in moderate climates are familiar. No attempt is ordinarily made to excavate a grave for a deceased person, for such a thing means long and tedious labor. Because of this it is the custom to bind the dead in skins and carry them on reindeer sleds out across the tundra, or plain, to be deposited on the snow in some unfrequented place where they become the prey of arctic wolves. The

Walter L. Beasley
69 W. 108th St.
N. Y. City.

temperature in this district drops to 85° and more below zero. In the past perfectly preserved bodies of the mammoth, thousands of years old, have been discovered in these districts.

SEMIELLIPTICAL SPRINGS 8460 IN SHOCK ABSORBER

In a new shock absorber for automobiles the coiled-spring idea is abandoned and the shock is taken up by a pair of semielliptical springs bolted together at their centers. The casing is made in two parts, the upper part being movable "T.H.R.T.W." up and down and being guided by

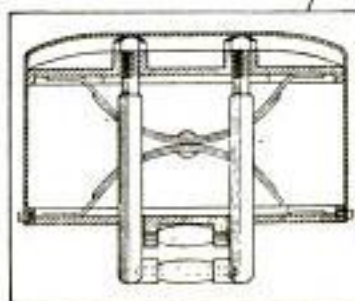

New Type of Shock Absorber Using Semielliptical Springs

posts that slide in sleeves fixed to the lower part. The springs, which have sliding ends, bear against the two parts and keep them spread apart when not subjected to strain, but deflect readily under any shock. The upper part is attached by a link to the automobile spring, while the lower part is supported on the axle.

Inventor: Dr. R. T. Williams
Pat. 1,096,279
May 12, 1914
314 Bowles Bldg.
Detroit, Mich.

*Australasian Hardware & Machinery.
 Invented by S. A. Hogg, of the New South Wales Experimental Farm at Wagga
 Wagga*

912

POPULAR MECHANICS

H. H. Hinds, Ltd., Young & Bridge Sts., Sydney N.S.

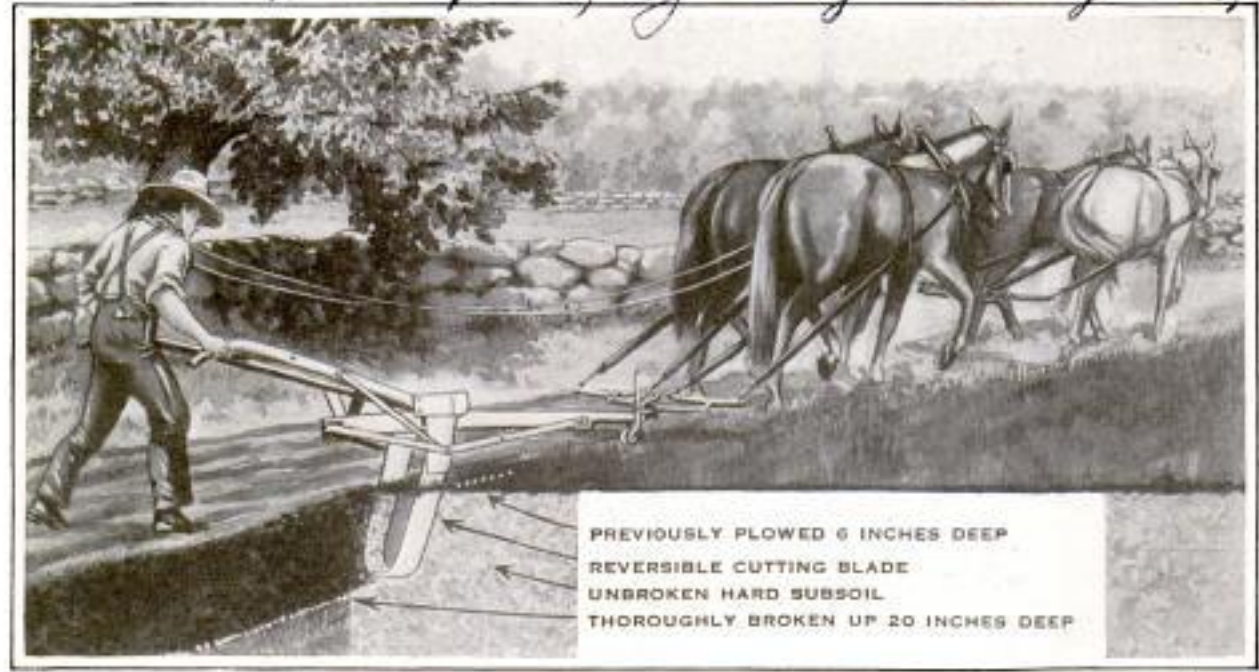

PREVIOUSLY PLOWED 6 INCHES DEEP
 REVERSIBLE CUTTING BLADE
 UNBROKEN HARD SUBSOIL
 THOROUGHLY BROKEN UP 20 INCHES DEEP

This Subsoiling Implement Pulverizes the Soil to a Depth of 20 Inches, and with Certain Modifications is Also Used for Trench Digging

CHECK TUNNEL ALINEMENT

9177

WITH SIGHTING BORE

In projecting the Canadian Northern Pacific Railway through British Columbia a tunnel somewhat more than a half mile in length has been constructed beneath a large bluff on Kamloops Lake. A small patch of light which is admitted at the far end of this passage, to be seen in the accompanying photograph, does not come from the portal, but instead from a sighting hole,



COURTESY ENGINEERING REVIEW

approximately 4 ft. square, which was driven for the purpose of extending a tangent to a point several miles on the opposite side of the water and thus making a check on the alinement of the bore. This procedure was made necessary because the center line of the tunnel curves for a distance of about 300 ft. near its far portal, making it impossible to see from one end of it to the other.

SIMPLE IMPLEMENT MADE

9353

FOR SUBSOILING WORK

Adapted for agricultural purposes, a new subsoiling implement has been invented in Australia which may be used either independently or in conjunction with regular plowing. The device is provided with a U-shaped blade which extends in the ground to a depth of from 12 to 20 in. and makes a cut 14 in. wide, lifting the soil somewhat and breaking it up without turning it to the top. The blade is fixed to a framework which at the front carries a guide wheel and is provided with plow handles. Another type of the same implement is built with a frame which is carried on wheels, allowing the driver either to ride or walk while doing the subsoiling work. The blade may also be used back of the shares of a double-furrow plow. A somewhat different implement, used for draining purposes, is provided with both U and V-shaped blades, and is fitted with a mold board so that the soil instead of merely being pulverized is lifted entirely out of the cut, leaving a trench 14 in. wide and 20 in. deep.

Ⓒ Paper lint for dressing wounds is being used in Europe.

*E. J. Mahren,
 Engineering Record (Photo loaned by)
 1239 W. 39th St.,
 N. Y. City*

Army & Navy Journal
**ARMY AIRMAN MAKES RECORD
CARRYING TWO PASSENGERS**

9569

Lieut. Byron Jones, of the United States Army Signal Corps, during a flight at San Diego, Cal., on March 12, this year, broke the world's record for continuous flying with two passengers in an aeroplane. He succeeded in remaining in the air for 7 hr. 5 min., ascending at 10:02 a. m. and landing at 5:07 p. m. This exceeded by 20 minutes the previous record which was established in November, 1913, by a German airman. The machine used was a modified Burgess tractor.

**PROTECT OLD BUILDINGS
AGAINST DAMP WALLS**

7884

For insulating stone buildings so that they will not absorb dampness from the surrounding ground, a new process has been introduced in Europe which, it is claimed, has proved successful. The method consists in sawing a slot in the foundation a few inches above the ground line and inserting in this lead plates coated with asphalt. To accomplish this, a machine has been constructed which cuts a kerf about an inch in depth in the stone. After the plates are set in place, temporary wooden forms are laid and liquid cement employed to close the crevices.



Insulating the Stone Walls of a Building against Ground Moisture

This plan, it is said, prevents moisture from creeping up a wall, since it is unable to pass the insulation blocks.

*Jack Brooks, 1 Dagen-
ham Road, Romford, Essex,
England*

**INLAND TEXAS CITIES TO
BECOME SEAPORTS**

6764

Two inland cities of Texas are soon to become seaports through the extension inland of the deep-water canal

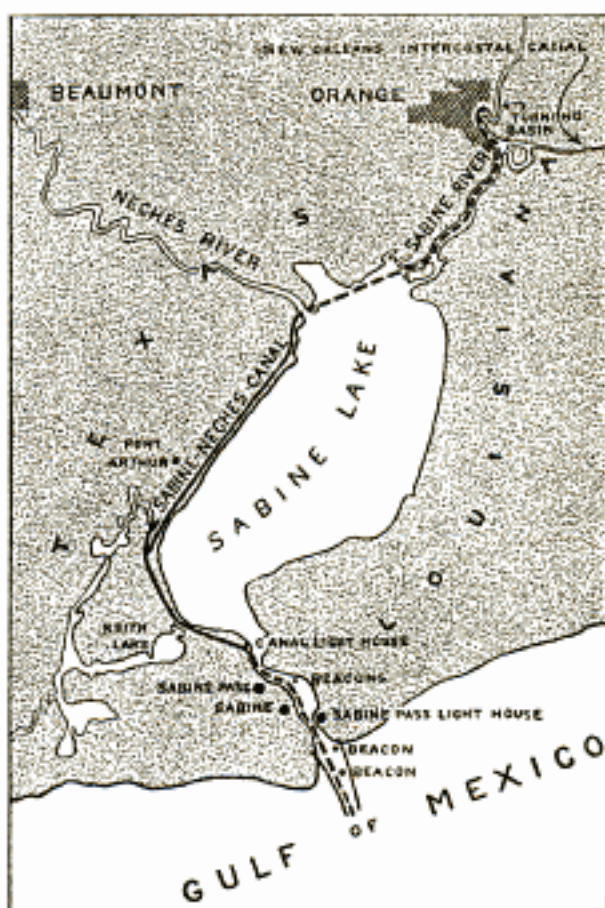

Map Showing Location of Deep-Water Canals That will Give Beaumont and Orange, Texas, Direct Access to the Gulf

that connects Port Arthur with the Gulf of Mexico. The opening of the Port Arthur canal excited interest all over the country for the reason that it was built as a private enterprise and was then presented to the United States government. Work on the new waterways, which is being done under an agreement by which the cost is shared equally by the government and the district benefited, consists in deepening and widening the barge canals that have been in existence for a number of years. The location is along the west shore of Sabine Lake to the mouth of the Neches River, where the canal branches, one branch extending up the Neches River to Beaumont, and the other extending across Sabine Lake and up the Sabine River to Orange.

**NEW CORD ADJUSTER FOR
8511 DROP LAMPS**



A new cord adjuster for use with electric drop lamps is provided with a spring clamp at each end so that the cord is easily inserted or removed without removing the cord from the socket. In inserting the cord it is placed straight across the throat of the clamp at one end, the spring is depressed with the thumb, and the cord is pulled lengthwise until

it slides into place. After forming the required loop, the cord is then inserted in the other end in the same manner. Pressure on the spring permits the cord to be shifted up or down to provide for any adjustment.

**MACHINE LESSENS DANGERS
7966 OF PRAIRIE FIRES**

For establishing fire guards in districts subjected to the dangers of prairie fires, a machine has been built which blazes a strip, 24 ft. in width, or greater, and eliminates the necessity of plowing protection zones, the method usually followed which is both time-consuming and expensive. It consists of a tank wagon, from which side arms extend at right angles carrying large nozzles that project forward in a path of heavy rollers. Back of this wagon and arranged on a trailer is a series of torches. As the machine is driven along, the torches consume the grass immediately beneath them while combustible materials on either side of the path are prevented from being ignited by the streams of water forced out through the nozzles. It is estimated that the expense of establishing fire guards is reduced 75 per cent by this machine. Besides being able to perform its intended function, it also offers a protection in case of emergen-

**PRODUCES HEAT GREATER
8653 THAN THAT OF SUN**

According to a German scientific journal, a German scientist succeeded in producing a temperature of over 13,500° F. while experimenting with liquid carbon under a pressure of 25 atmospheres. This is considerably in excess of the estimated temperature of the sun, which is generally thought to be about 10,000° F. One result of the experiments was the discovery that pure carbon subjected to very high temperatures does not burn unless saturated with a certain salt solution. The purpose of the experiments was the development of a "pressure arc lamp" for lighthouses and signal apparatus.

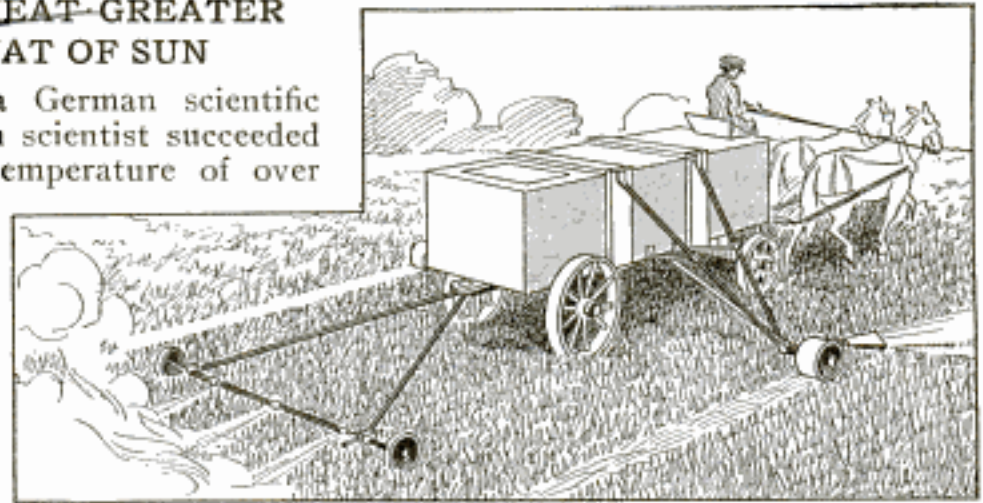

A Machine Which Offers Protection to Settlers in Districts Subjected to the Ravages of Prairie Fires

cies, for since it does its work rapidly it may be used to head off a fire and restrict it to a comparatively limited area in case it leaps previously established guards.

¶ In New York City there are eight church buildings valued, with their grounds, at more than \$2,000,000 each.

Industrietidningen
norden 10/2/14

*Inventor & Contrib: S. A. Aquith
53 Commercial St., Waterloo,
191 Bridge St. Iowa.*

*Fred Telford, 605 S. Douglas
Springfield, Ills.*

NEW SPEEDOMETER USES

7975 AIR FRICTION

An automobile speedometer in which air friction is the essential feature has been patented and is soon to be placed on the market. This instrument is somewhat complicated in detail, but the principle on which it operates is simply that of the friction, with resulting pull, in a film of air contained in a space between two circular plates, one of which is revolving rapidly, five pairs of such plates being used in this instrument. One set of these plates is fixed to a shaft that is driven in the usual way by connection with one of the wheels of the car, while the other set is secured to a casing capable of rotation against the resistance of a light coil spring. The outer face of this casing carries numbers corresponding to the speed of the car in miles per hour. The plates are spaced $\frac{1}{16}$ in. apart, and when the set of plates driven by the car wheel is rotated the friction of the air exerts a pull on the other set of plates, with the result that the latter is rotated to a point where the pull of the air exactly equals the resistance of the spring, and remains at that point so long as the speed of the car, and therefore the rate of rotation of the shaft, remains the same. With an increase in speed this set is drawn farther around, and with a decrease it rotates backward under the action of the spring, until the pull and the resistance are again equal.

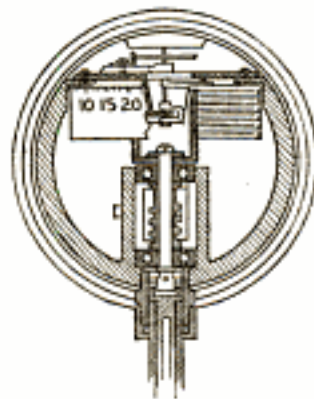

This is all adjusted so that the right number for the speed of the car in miles per hour appears under a glass panel in the outer casing of the speedometer.

Ⓒ Gyroscopic compasses are now in use on 20 battleships, one armored cruiser, and 15 submarines in the U. S. Navy.

MARKER FOR BRANCHES OF
8622 LINCOLN HIGHWAY

An official marker has been adopted for use on the principal branch roads, or "feeders," leading to the Lincoln Highway. This marker consists of a sign having a band of white, 15 in. wide, with a 4-in. band of red at the top and bottom. On the white band are the words "To Lincoln Way," together with an arrow showing the direction, and figures giving the distance to the highway. While this marker is intended principally for the convenience of users of the highway, it is believed that it will have another important effect. It can only be used on feeders officially designated as such, and in this way the official roads will be so definitely pointed out that it is believed local road authorities will find it desirable to develop these roads to the standard of the Lincoln Highway.



Radio
WIRELESS TRANSMISSION
9566 WITHOUT ANTENNAE

A wireless-telegraph outfit that is entirely contained in a box 15 in. long, 6 in. wide, and 8 in. high, and which does not require antennae to operate successfully over fairly long distances, has been tested recently by army authorities. Messages were transmitted from Liberty Island, in New York Harbor, to Fort Totten, 15 miles north, and Fort Hancock, 20 miles south. The inventor claims that this device can be used wherever either direct or alternating current is available and that the current from an ordinary automobile lighting dynamo will suffice to operate it.

*Inventor: Dr. Otto F. Reinhold,
53 Demarest St., Newark, N. J.
Army & Navy Journal*

NOVEL AND PRACTICAL THINGS

FOR DAILY USE



Convenient Window-Locking Device

DESIGNED so that it may be applied to any sash, a window-fastening device has been invented which is convenient for the tourist, as it may be carried in a suitcase and used wherever desired. When an upper sash is lowered and the lock wedged between it and the groove in which the lower sash slides, both parts of the window are fastened against movement.

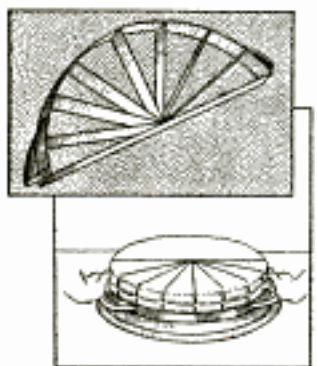

Novel Cake Cutter

A semicircular cake cutter with radiating knives cuts half of a round cake into eight parts in one operation. It is 11 in. in diameter, is provided with two handles, and is finished in silver-plate. The cutting is done on a wooden tray furnished with the device.



Spring Belt for an Apron

Made adjustable to any waist, a spring belt has been introduced to take the place of strings on kitchen and laboratory aprons. It is inserted in a hem at the top of an apron and may be removed quickly, allowing the garment to be washed as a flat piece, which represents a saving in the laundry charge.

Intended for home use instead of the customary seltzer bottle, a siphon that may be applied to a plain flask filled

with carbonated water has been introduced in France. It has a long screw-shaped member which passes through the cork and allows the effervescent water to pass out when a valve is opened by pressure on a plunger.



Siphon for Carbonated-Water Bottles

A fixture for the bathroom has been designed which serves a useful purpose and is also sightly. It is a dispensing apparatus for dentifrice and does away with the use of the usual bottle, which in the hands of a child is in danger of being broken. By passing a brush beneath a small valve it is supplied with the desired amount of tooth powder.



Serviceable Bathroom Fixture

Made in two pieces, a hose clamp which may be applied quickly with a minimum of trouble has been invented. It is provided with either a thumb-screw or machine bolt. Since it is made in two pieces, the hose may be slipped over a pipe or coupling and the clamp then applied. Lips extending over the joints provide a full and tight bearing on the hose.

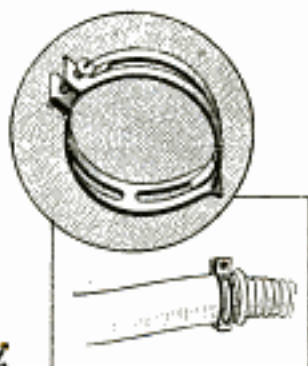

Two-Piece Hose Clamp

Intended for use on a porch, or in a closet, where electric wiring is not provided and where light is frequently needed, an electric lamp has been designed which may be suspended from a ceiling or wall. The equipment consists of a waterproof case carrying a dry battery, a small tungsten bulb, and a reflector. A cord extending from the bottom of the case allows the lamp to be ignited or extinguished as desired.

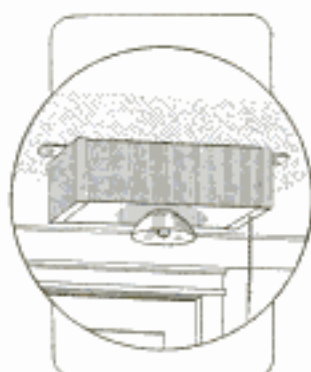

7 Useful Electric Lamp

For serving purposes a fork has been made which is provided with a sliding device that removes a sandwich, for instance, from the of but one hand. The handle is held by three fingers, while the thumb and first finger are used to operate the extending member which moves a shoe piece down the prongs.

The handle is held by three fingers, while the thumb and first finger are used to operate the extending member which moves a shoe piece down the prongs.

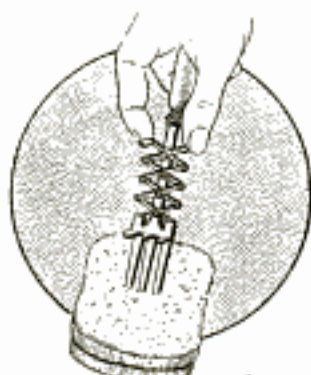

8 Fork for Serving Sandwiches

To simplify the process of removing tarnish from silverware, a metallic tray is

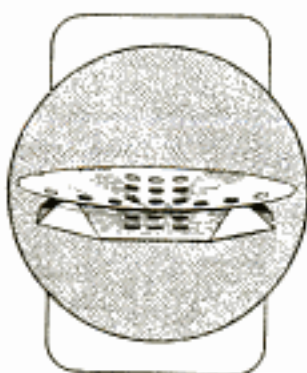

9 Tarnish-Removing Tray

For burning household refuse and waste matter from a kitchen, an incin-

erator is being built which is provided with an ash receiver. This catches the major part of the ashes and half-consumed particles of trash, and prevents a wholesale scattering of the material over a yard. The pan also serves as a base for the burner, and is detachable.

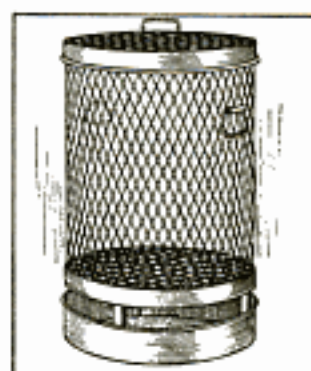

10 Incinerator with Ash Receiver

Patent rights have been granted on a cooking vessel which is so designed that neither steam nor odors escape into a kitchen when food is being boiled in it. It is provided with a vapor flue which opens into the fire box of the stove and allows the fumes to be carried out through the chimney. By taking in cool air at the top of the vessel the steam is also condensed and the resulting water turned back.



11 Odorless Cooking Vessel

For holding fly paper and preventing its sticky surface from coming in contact with and soiling things near it, an adjustable pasteboard form has been patented.

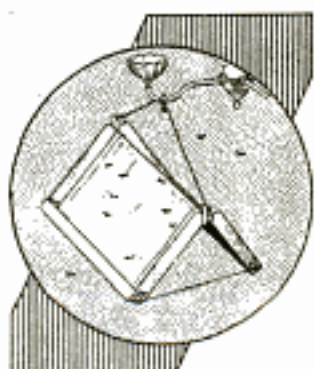

12 Useful Fly-Paper Holder

It is designed so that it holds the paper securely and may be used in any of a number of different positions. It may be folded tentwise and suspended from a wall bracket or chandelier, laid flat and placed on a table, or bent at right angles and used on a shelf without danger of being blown about.

made which, if immersed in a solution of salt and baking soda, will quickly brighten silver articles placed in contact with it. The method is an electrochemical one, economical and rapid, and eliminates all rubbing.

*Wm Trafilog Co.,
see Building, Cleveland, Ohio*

918 *Motor Age* POPULAR MECHANICS
OIL BOX FOR LUBRICATING
7792 AUTOMOBILE SPRINGS

One of the most common and annoying of automobile troubles is squeaky springs. An oil box for sup-

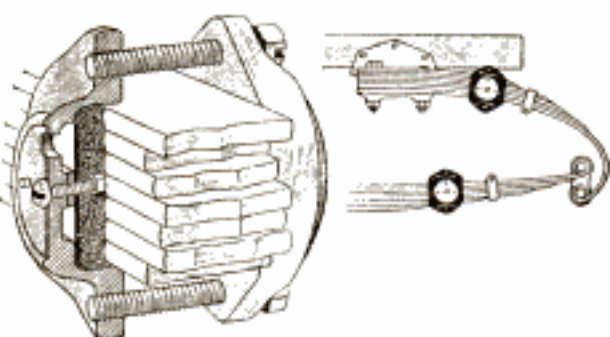

With This Oil Box Clamped to the Spring, the Bearings of the Leaves are Kept Evenly Supplied with Oil

plying the springs with oil constantly and in the right quantity is made in two parts which are clamped against the sides of the spring by means of bolts. The inner, or bearing, face of each half consists of fibrous material. This is kept soaked with oil and in this way a constant and even supply of oil is applied to the side of the spring. The box is supplied with oil through openings in the sides.

7168 **WISE HOLDER THAT FITS IRREGULAR SHAPES**

An ingenious holder for securing irregularly shaped objects in a vise has been invented and placed on the market in Germany.

The frame of this holder consists of two jaws that are pivoted together at the bottom. Between the ends of each jaw is a bar to which is pivoted a series of curved upright steel rods with their upper ends free to slide in and out in a slot at the upper or bearing end of the jaw and thus adjust themselves to the contour of any object, however irregular it may be. After the rods are adjusted to fit they are clamped in that

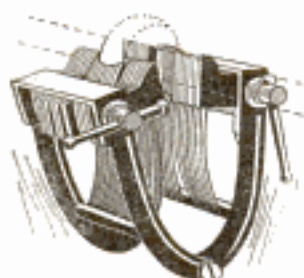

*Reiblatt zum Prometheus 4/14/14
Reinhard Heidfeld & Comp.
Remscheid*

*Office Appliances - Sept. 1914
Dime & Filstead, 508 So. Dearborn
Chicago, Ills.*

*see another → Harton Bros.
21 1/2 Church St. New York*

position by a screw running through the jaw and worked by a lever as shown. The holder, with the object to be worked on in place, is then clamped between the jaws of the vise.

8435 **LINE INDICATOR FOR TYPEWRITERS**

With most of the visible-writing typewriters there is no convenient way of telling how much space is left at the bottom of a sheet when it is nearly filled, and in offices where a large amount of correspondence is handled this often leads to a serious loss of time, owing to the necessity for re-writing letters that have been written too close to the bottom of the sheet. A simple indicator designed to overcome this difficulty and consisting of

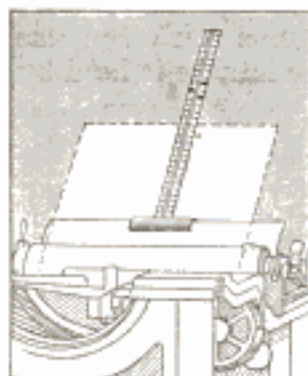

an adjustable scale mounted on the back of the cylinder carriage by means of clips, has just been placed on the market. A gauge on the scale can be set for any size of sheet so that the operator can tell

by the position of the top of the sheet with reference to this gauge just how much space is still available at the bottom of the sheet.

9060 **WOOD VENEERED ON STEEL FOR CAR INTERIORS**

Veneered steel has recently been introduced as an interior finish for railway passenger cars, and from tests which have been made it is considered more satisfactory than anything previously employed. The veneer varies in thickness from 1/8 in. upward, according to the service expected of it. It is applied by gluing thin canton flannel to the sheet of steel, and then in turn gluing wood veneer to the cloth. It has been employed success-

*Railway Age Gazette 12/11/14
Canadian Pac. Ry.*

motorcycle illustrated 3/19/14
 Invented by Elmer S. Reynolds,
 Elmer C. Johnson, & Frank D.
 Warren of Colorado Springs, Colo.

fully in making doors, sleeping-car seat ends and berths, bulkheads, wainscoting, and panels. It is attractive in appearance, costs approximately the same as either steel or wood, eliminates the danger of passengers being injured by the splintering of wood in case of a wreck, serves as a nonconductor of heat and cold, and is durable. A material capable of meeting all these requirements has been sought for some time by builders, especially since the introduction of the steel car.

ried on the deck of the scow, and under the deck is a hold from six to eight feet deep, which is practically waste space. A tram track running



The Material is Dumped into Cars through Trapdoors in the Deck, and the Loaded Cars are Taken Out through a Door in the End of the Hold

NEW MOTORCYCLE PEDAL IS BREAKAGE-PROOF

7317

As a safeguard against casualties, and injury to the machine, a new motorcycle pedal has been introduced which is not easily broken by accident. The ordinary device in present use is often broken or bent in falls or encounters with curbing or ruts in the road. The rider also is endangered by the protruding piece when obstacles are met. Instead of breaking or hurling the rider to the ground, when forced against a heavy object, the latest pedal folds up. Any blow throws it backward and upward, out of danger. Means are provided for tilting the pedal and also for returning the hinged portion to its normal position when deflected.

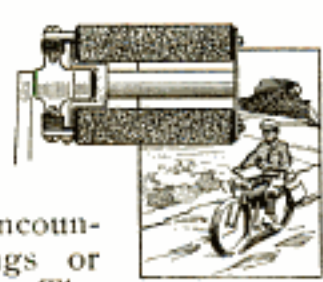

from end to end of the scow was laid along the center of the hold, and doors were cut in the ends of the hold large enough to admit the tram cars. Above the track is a series of trapdoors. Through these the material on the deck is easily dumped into the cars, and the loaded cars are then hauled out through the door to the wharf. The scows have flat bottoms and deep holds, and the plan is made possible through the fact that the scows do not sink more than two or three feet into the water when fully loaded.

MATCH BOX WHICH CARRIES A WINDSHIELD

A windshield match box, designed to form a screen back of which to light matches in the open air, is a simple device made for motorists and sportsmen. The arrangement consists of a metal box with a double side which may be folded back at right angles. Two leaves hinged on the edges are opened up, forming a small inclosure protected from the air. In this a match may be lighted and kept burning in the face of a strong wind.

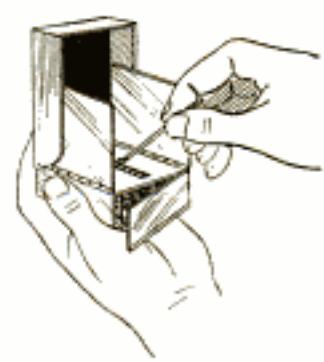

SCOW HAS HOLD EQUIPPED WITH TRAM TRACK

8143

A simple plan by which time and expense are saved in unloading the material has been adopted by a Puget Sound contractor who has considerable quantities of sand and gravel to transport in scows. The loading of the scows by chutes or runways is a simple matter, but until this plan was adopted the unloading was an expensive and troublesome matter. The load is car-

Morse Woolley
 Fort Casey, Island Cos.,
 Washington

J. S. Vickery
 179-184-185 Regent St.,
 London, W. England.

Boys Needle Co.
4343 Rosewood av.
920 Chgo.

J. E. Mc Carthy; Evening Star,
Wash. D. C.

POPULAR MECHANICS

ELASTIC HOLDER FOR PENS
7054 OR PENCILS

A pencil holder made of a spiral band fastened upon a metallic back, affords a safe and convenient method of carrying a pen or pencil, especially as a pair of shaped pins fastened to the back provide for quick attachment to an apron or garment. The spiral band is so flexible that it may be used for carrying scissors, or such small implements, as well as for pencils. Another form is equipped with two or three bands, so that a bookkeeper may have more than one pen or pencil available, and a straight spring may be substituted for the pins if preferred.

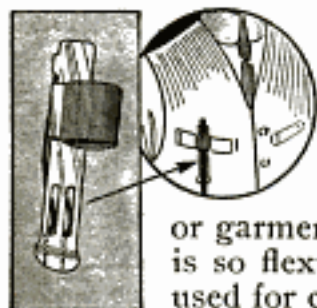

HOLDER FOR CARPENTER'S
7054 RULE

A handy device that has just been brought out and is intended for carpenters and other skilled workmen is a metal holder for the pocket rule. This holder has a tongue spring on each side which serves to hold the rule in place, but permits it to be slid in or out easily, and is equipped with a simple clamp by which it is secured to the trousers.

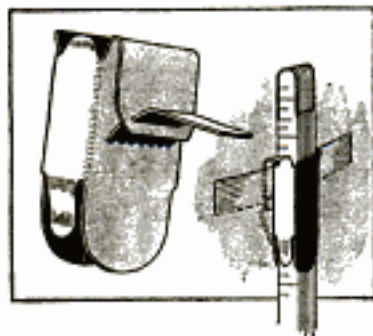

British automobile owners have organized a volunteer association to furnish transportation for wounded soldiers invalided home and for hospital supplies, as well as to provide accommodations in private houses for those injured in war.

UNIFORM STANDARDS FOR
9986 FIRE-HOSE COUPLINGS

The standards for fire-hose couplings established by the United States Bureau of Standards had been adopted, by the end of the year 1914, by 287 towns and cities, and by practically all the engineering, fire-protection and waterworks associations in the country. These standards are designed to make the fire-hose couplings used in every part of the country exactly alike, and to cure a condition that has often prevented the fire departments of adjacent cities from giving aid in cases of bad fires. A striking demonstration of the necessity for uniformity in such couplings was given in the great Baltimore fire of 1904, when fire departments from some other cities were unable to render assistance after they had arrived at the fire, because their engine and hose connections could not be coupled up with the outlets of the local fire hydrants. The couplings that have been standardized are in diameters of 2½ in., 3 in., 3½ in., and 4½ in. The dimensions of couplings and threading vary for the different sizes except that all have the 60° V-threads.

MOTORISTS' CIGAR-HOLDER
7381 CATCHES SPARKS

For the convenience of automobilists, a conical-shaped shield which holds a cigar and protects it from the



A Shield Which Incloses Entire Cigar

wind, and also prevents its hot sparks and ashes from flying into the faces of other occupants of the car, has been conceived. The cigar is placed in a nickelplated screen tube. At one end of this a mouthpiece fits tightly while provision is made at the opposite end for sufficient draft for combustion.

For sale by: Louis S. Warner
Port Clinton, Ohio.
Does not know sup.
See letter 6/7/15-B

© Louis S. Warner Port Clinton, Ohio
Made in Canada -
Does not know sup. for
letter 47/15 add 7054



Shop Notes

An Electric Sign of Unique Construction

The illustration shows a very attractive electric sign that is entirely out of the ordinary, and which can be used for a great number of advertising purposes. It consists of a glass plate on which strips of tin foil are pasted, using shellac as an adhesive; two brass supporting standards; an induction coil, and a battery. The tin-foil strips are placed $\frac{1}{4}$ in. apart in such a manner as to form letters or figures, which are connected by fine copper wires, also pasted to the plate as shown.

The secondary current of the induction coil flows through the wire A, the brass standard and the wire B to the first letter of the sign around which it passes, leaping in blue flames from one tin-foil segment to the next until it reaches the wire C to the next letter; around the next letter, and so on, until it reaches the induction coil, as indicated by the arrow marks. To ob-

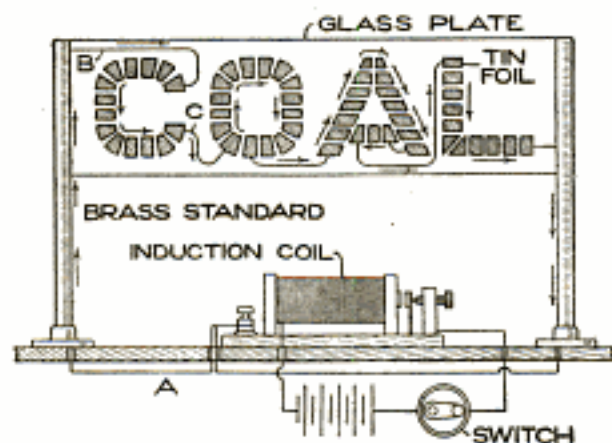

The Flashes of Light Caused by the Jumping of the Current between Strips Illuminate the Letters

tain the best effect the back of the glass plate should be painted black.—Contributed by F. B. Hays, Houston, Texas.

Watering Second-Floor Window-Box Flowers from the Outside

The management of a hotel placed a number of flower boxes on the sills of the second-story windows, and as

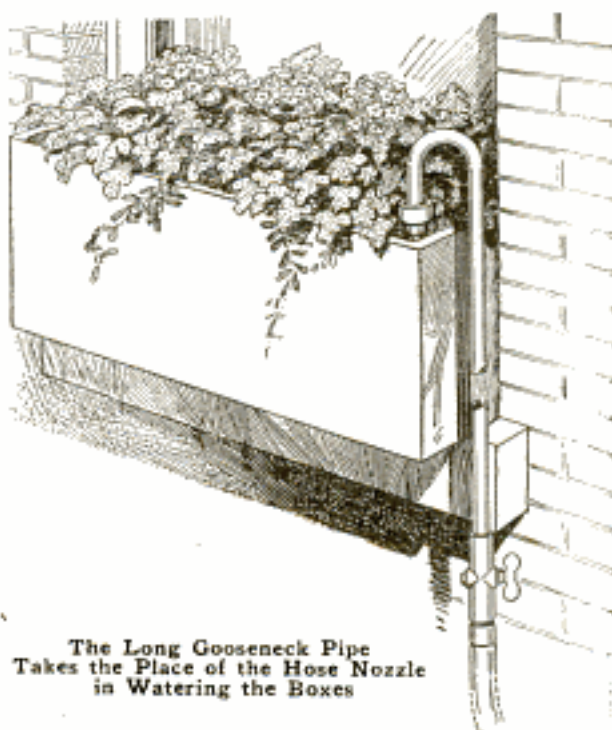

The Long Gooseneck Pipe Takes the Place of the Hose Nozzle in Watering the Boxes

the boxes required watering each day, men had to enter the rooms for doing the work, to which the guests objected. The boxes were changed to a self-watering kind, having a false bottom in which some sponges were fastened so that they pressed against holes in the box that holds the dirt. A 1-in. feed pipe was run down the side of the box to the pan holding the sponges, the surplus water overflowing through a small hole in the side of the box when the pan was full. These boxes required water once a week. The guests still objected to the annoyance of having the boxes watered from the inside, so the chief gardener devised a plan as follows: A 2-in. to $\frac{1}{2}$ -in. reducer was slipped into the top of each

feed pipe to form a sort of funnel into which the water was run with a long gooseneck-shaped pipe attached to the hose.

When the boxes need watering the gardener takes the hose with the gas-pipe connection and inserts the gooseneck end into the reducer and turns on the water, filling each box without annoying the guests.—Contributed by W. F. Held, Chicago.

Grocery-Order Box for Suburbanites

An enterprising groceryman whose store was located on a street traveled by many suburbanites on their way to



the railroad station, devised a plan to further his business by the use of an order box. This box is hung conspicuously in front of his store so that a person coming to work in the morning may deposit his orders without stopping to enter the store, and during the day the groceryman fills them and makes a neat bundle, ready for the customer when he passes in the evening from the station.

It is only necessary for the customer to step in and call his name to get his bundle quickly and without having to wait for it. The box is about 28 in. long and 8 in. square. A sliding door is fitted near the bottom on one side for taking out the orders.

As a safeguard against fire in paint or machine shops prepare bags of sand, marked "Sand for Fire," in several sizes, and have them placed within easy reach.

Restoring Tan Color to Leather

After considerable experimenting, a leather company found that oil of citronella would restore various shades of tan and brown leathers to their original colors. Any shoe shop can adopt the method, as the process is simple. The odor from the oil is strong, which is objectionable to many, but by drying the leather in a current of air much of the perfume evaporates. It is only necessary to rub the leather over with the oil and later polish with a good leather dressing.

Air and Gas Mixer for Gas Engines

By means of the illustrated device, the fuel charge of a gasoline engine can be considerably improved, resulting in additional power. To make the device, an ordinary $\frac{1}{2}$ -in. grease cup must be provided. The inner end of the cup is drilled about $\frac{1}{4}$ in. deep, to tightly fit a $\frac{1}{2}$ -in. piece of thin tubing, 1 in. long. This should be drilled for a row of $\frac{1}{64}$ -in. holes, and securely plugged at one end. The other end is fitted in the grease cup and soldered in place. A circular disk must be made to easily fit inside the large end of the cup. With disk and cap carefully centered, three $\frac{1}{8}$ -in. holes are drilled to serve as air inlets of the device; another hole should be drilled through the center for a disk pin. This pin is provided with a shoulder to fit against the outside of the cap, so that it cannot slip in. The cap hole serves as bearing for the pin which fits through the disk and is riv-

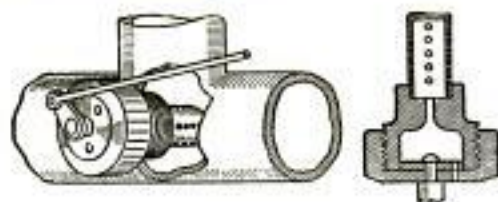

Device Made of an Oil Cup, to Admit Air to the Manifold Inlet of a Gasoline Engine

eted in place to form a close fit against the cap, at the same time permitting a slight movement sufficient to bring the disk holes in or out of alinement with

the corresponding cap holes. To the outside end of the pin is attached a crank arm which connects with a controlling wire, conveniently attached near the throttle control. When attaching the device to an engine, it should be screwed into a threaded hole, provided for it in the engine manifold, between the carburetor and engine cylinder. In using the device, the disk should first be set with its openings closed until the engine is running well, then, by adjusting the disk, additional air may be sprayed in through the small tube holes, thereby finishing up the work of the carburetor and producing a more thorough and better mixture.—Contributed by O. H. Waychoff, Koenig, Colo.

Repairing a Broken Water-Pump Vane

The cost of replacing a broken rotor in the water pump on an automobile engine led the owner to make a repair



as shown in the sketch. The rotor was 1 in. in width. A piece of flat steel stock of suitable length, $\frac{7}{8}$ in. wide and $\frac{1}{8}$ in. thick, was procured and bent to the same shape as the other blades. The bottom was bent over in the shape of the letter "L" to fit into a groove cut in the hub of the rotor. The new blade was held firmly in place with two blind studs riveted over on the outside.

Easily Constructed Concrete Culvert

Our borough construction force builds a very good concrete culvert in the manner shown in the sketch. The sides A are first built, and the forms removed before the concrete is completely set. Benchlike wood forms are then placed at intervals between the sides A, and boards laid on them, then

paper spread over the surface of the boards. The concrete is then put on top of the paper. Short pieces of railroad

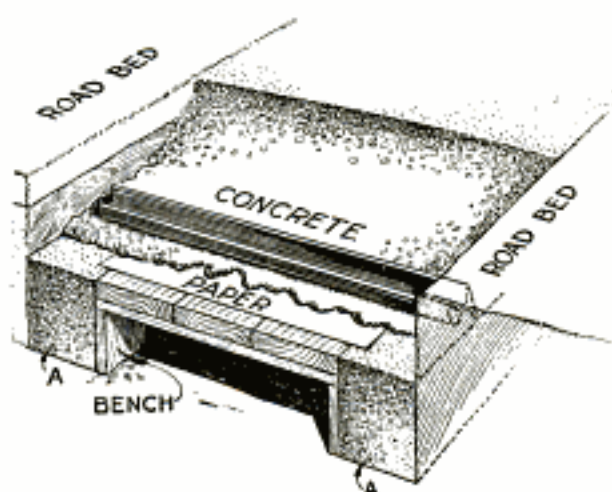

Simple Method of Making a Concrete Culvert by Using Ordinary Construction of the Forms

iron are laid in the concrete to reinforce it.

After the top has properly set, the supports are driven out, or broken down with a long iron rod. The boards are then easily withdrawn. This culvert is strong enough to stand the travel of heavy teams as well as automobile trucks.—Contributed by James M. Kane, Doylestown, Pa.

Support for End of Gear Teeth on a Transmission

One of the gears in the transmission case of an automobile was so designed that its web was placed on one side, as shown in the illustration. The teeth, being supported on one side only, had a tendency to give away on the other, and it was necessary to strengthen the unsupported end. The old gear was damaged and distorted beyond repair, but a new one was purchased, and the flat plate A was riveted to it, as shown, with four rivets. Both the plate and gear were turned down on a lathe.



CA lathe tool will make a smoother and brighter finish with water than when run dry.

Procuring Fresh Water from the Ocean

By the process of distillation fresh water suitable for drinking purposes can be obtained from sea water, but

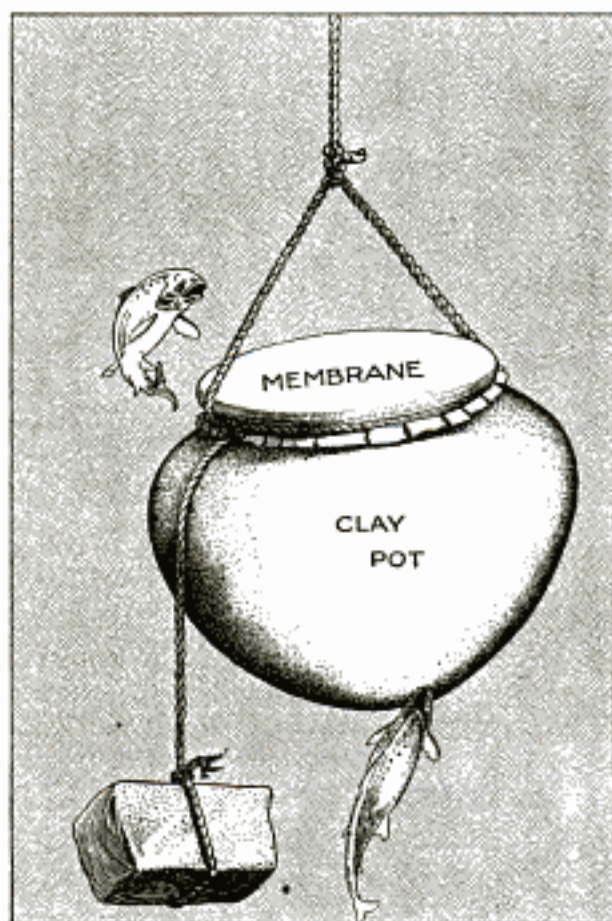

An Unglazed-Clay, or Earthen, Pot Used to Secure Fresh Water from the Sea

this method requires special apparatus and a person trained in laboratory work, conditions which are not easily or cheaply fulfilled. This method, then, is almost out of the question with ordinary seamen. The one illustrated, however, is very simple and inexpensive, and brings good results. The materials necessary are a newly baked earthen pot, a piece of waterproofing material suitable for a covering—a piece of leather or oilcloth will do—and a piece of string or cord with a sinker to hold the pot deeply in the sea. Cover the pot with the waterproofing material, tie on the string, or cord, and sinker, and drop it into the sea. Allow sufficient time for the pressure to force the water through

the porous pot and then haul it in, and clear water will be the result with the salt and dirt on the outside surface.—Contributed by V. M. Apostol, Sorogon, P. I.

Protector Cutter with a Double-Notched Edge

In many places where money is paid for any legal paper, or permit, a receipt, or voucher, is issued, with the correct amount that was paid registered, or marked, by tearing off proper parts from a series of figures indicating dollars and cents on the left side of the receipt, as shown in the illustration. A sharp-edge rule, or a piece of brass with an offset, is used, and this has to be moved a few times before the receipt is properly marked.

The cutter illustrated eliminates many movements by cutting the receipt at one setting. The cutter is made of a flat piece of brass, A, about $\frac{1}{8}$ in. thick, 1 in. wide, and 9 in. long, which has an offset at one end as wide as the left-hand column on the receipt and about 3 in. long. The piece A is beveled at about a 45° angle for the cutting edge B, and it also has a slot, about $\frac{3}{16}$ in. wide, cut in it as shown at C, the edges of which are beveled off to about a 60° angle to form a slide

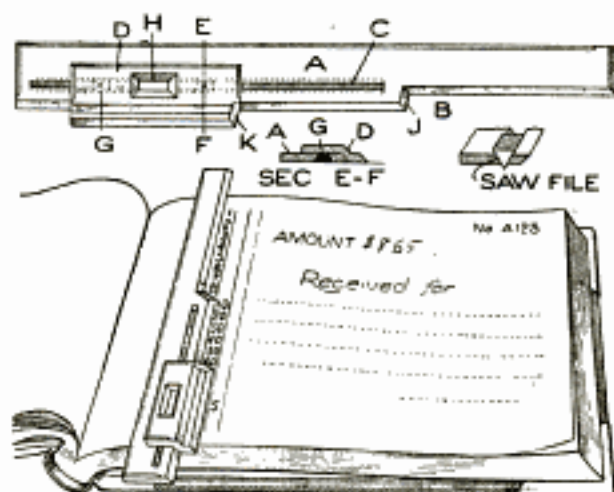

The Piece Forming the Second Offset can be Adjusted for Any Amount of Cents

for the piece D. The slot C is made by drilling a number of holes along the center line of the slot, as close together

as possible, and then filing the slot straight. A piece of triangular saw file is used to file the angle in the slot, as shown.

The piece D is made about $2\frac{1}{2}$ in. long, of the same material as the piece A, and is bent to the shape shown by the section EF, and beveled off on the cutting edge. Two small pieces, G, are made and riveted to the under side of the piece D for sliders in the slot C. A small square hole, H, may be made in the piece D for the finger.

The cutter is set with the offset J to any number of dollars, and the offset K is moved to the number of cents required by sliding the piece D along the slot C, whereupon the receipt is cut off to the registered amount. The forefinger holds the piece A in place, while the thumb moves piece D.—Contributed by Edward Sieja, Chicago.

Goggles to Eliminate Glare of Headlights

To overcome the blinding glare of headlights while driving a car at night, prepare the goggles as follows: Coat the upper portion of each eyepiece down to a line drawn $\frac{1}{4}$ in. above the center with a transparent color, green preferred. In driving, when another car appears ahead with a bright headlight, lower the head a trifle and look through the colored portion of the glasses. This will reduce the glare sufficiently so that a driver will not be confused.

To Prevent Steady-Rest Jaws from Marring Work

To prevent the jaws of a steady rest from scoring the work, wrap a piece of emery cloth around the material to be turned, with the abrasive side out, draw the ends tightly and insert them between the upper and lower part of the steady rest, where they are clamped together with a bolt. The jaws can then be adjusted with safety.—Contributed by F. G. Marbach, Cleveland, Ohio.

A Safe Way to Carry a Watch

Instead of carrying my watch in the lower vest pocket I place it in the upper, and attach the chain as follows: A buttonhole is cut, as shown in the sketch, and the chain run through it and snapped into the watch-stem ring. The other end is fastened to a key ring and slipped into the lower pocket. Any person at a glance would imagine that the watch is in the lower pocket. In addition to the safety for the watch, I have a very convenient way of carrying my keys.—Contributed by L. E. Turner, New York City.



An Eye Magnet

The tool shown in the illustration is a very valuable asset for any mechanic's tool chest. It is designed especially for removing steel or iron chips from the eye. Both ends are turned to form perfect spheres and are tem-



Tool Made of Steel, Highly Tempered and Polished, Then Magnetized for Taking Particles of Steel from the Eye

pered very hard and then given a high polish. It is magnetized as strongly as possible.—Contributed by S. Victor Brook, Hartford, Conn.

ⒸA discarded curtain roller makes a good towel hanger. The ends of the roller can be secured in blocks, or the old roller brackets may be used.

See Aug 15-285

How to Build a Camp House

By E. ARRINGTON

Kearney, N. J.

IF it is desired to have a good camping outfit, one that has a tent beat in a good many ways, build it as shown in the illustration, and the parts forming the floor can be folded into the shape of a box that will inclose all the side walls and the roof, and provide a space for camping utensils and bedding. The house is 9 by 12 ft., and 6 ft. high at the eaves. When ready for shipment, the box will be 3 ft. square and 9 ft. long.

The entire house is made up in sections. The floor is made up in four parts, each 3 ft. wide and 9 ft. long, of flooring boards, well battened on the under side and fastened together with strong hinges at the joints, the hinges being attached on the upper side. The same number of hasps are attached to the edges of the outer sections as the hinges used on each joint. The hasps are fastened to the under side

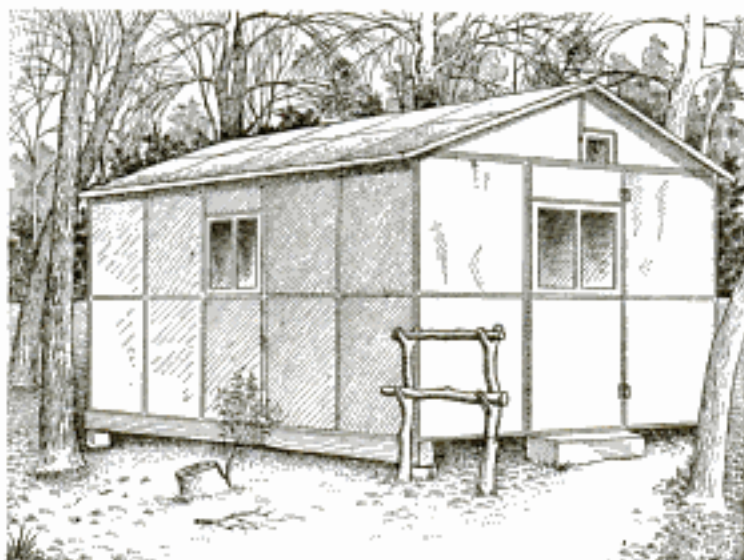

When Set Up, the Building Gives the Appearance of a Well-Made House, and Has the Comforts of One

of the floor. When the sections are folded up with the battens on the outside, the hasps will join the outside sections together in forming the box for shipment. There should be a batten at each end and five spaced between, and two hinges to the section.

The wall and roof sections are made up of furring strips, or pieces of wood, 2 in. wide and $\frac{7}{8}$ in. thick. In construction the sections are all alike, but there is some difference in the size. Each is built somewhat similar to a screen-door frame, the joints being mortised, or halved; whereupon a crosspiece is nailed in the center, and each rectangle thus formed cross-braced. The wall

sections for the sides are 2 ft. 5 in. wide and 6 ft. long; the end sections are 3 ft. wide and 6 ft. long, and the roof parts are 2 ft. 5½ in. wide and 6 ft. long. The dimensions of the gables, of which there are three, one for the center, are made for a little more than what is called a square pitch. The difference of ½ in. in size of the side-wall and roof sections is provided in order to make a little extension of the roof at the ends for an eave.

A $\frac{3}{4}$ -in. strip is nailed on the edge of one side-wall section for each side of the house. This is to make the sides extend over the edge of the end sections at the corners.

The gable parts are hinged together at the joint, and a notch is made in the top to admit the ridge. The ridge is made in halves, each 6½ ft. long, and joined together with a fished scarf joint, the slope being about 4 in.

long, and side plates of metal.

The sections are covered with 8-oz. canvas, stretched tightly, and tacked on like a screen on a door, using half-round molding on the edges of the cloth. This construction is carried out on all parts except for the end gables, and on these the canvas is allowed to extend over the edge of the frame, so that it will lap over the end sections when in place. The canvas on all sections is covered with boiled linseed oil.

All sections are held together with hooks and eyes. In setting the house up, a level place is selected, and the floor is laid on some stones or blocks of wood so that it will rest on the battens.

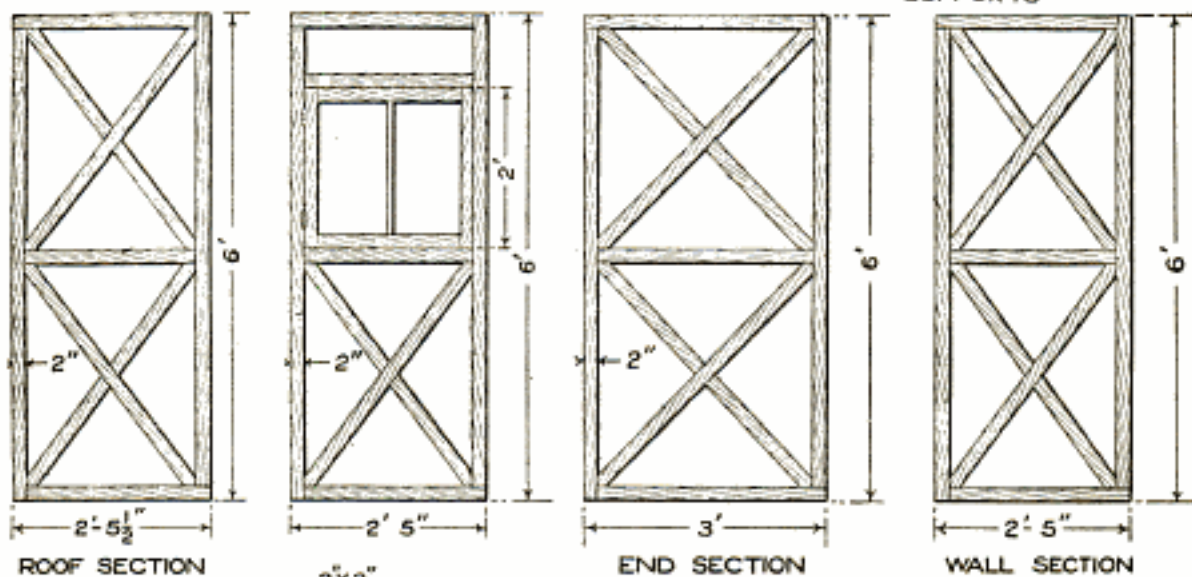
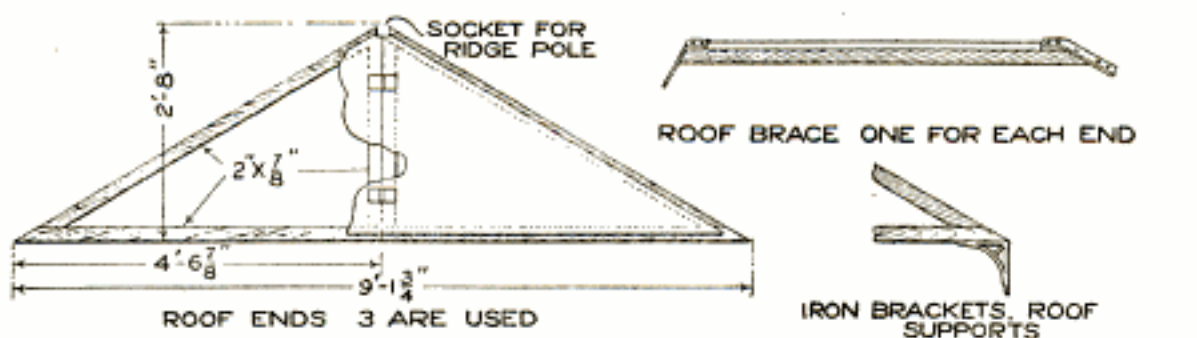

THE FLOOR FORMED INTO BOX

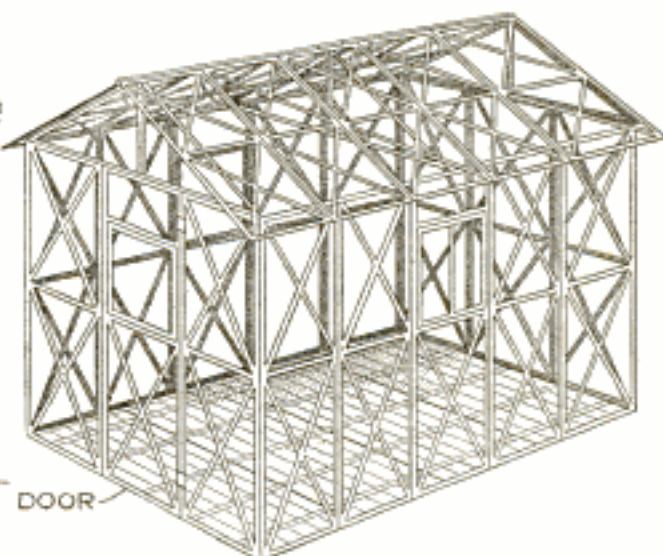
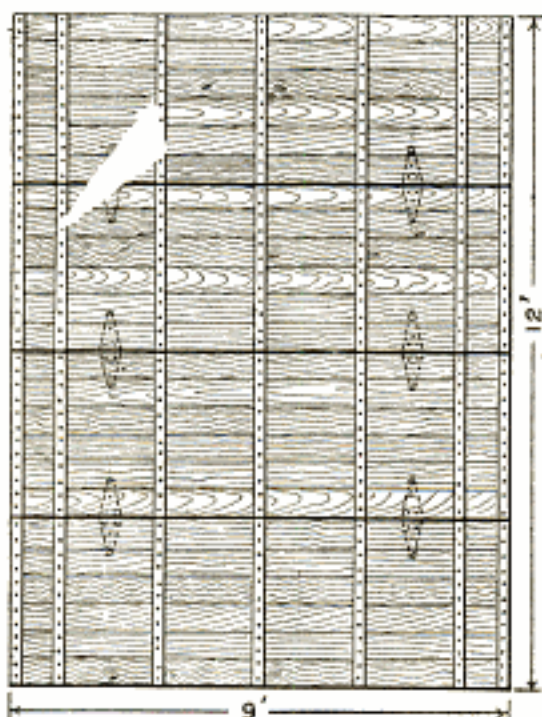

FLOOR FOLDS UP TO MAKE BOX

The House Consists of Sections Made Up of Frames Covered with Canvas, All of Which can be Put in a Box Formed by the Floor Sections, the Box Also Providing Sufficient Space for the Camping Outfit

The wall parts are set up around the outside edge of the floor. To hold these parts firmly in place, two or three long wood screws should be driven through the lower frame piece and into the floor edge. If the sections are numbered, the holes for the screws will always match when set up. The joints of the sections are held with hooks and eyes.

After putting up the walls, set the gables in place and lay the ridge in the notches, then it is ready for the roof

sections. The ridge is braced at each end. One of the end sections is hinged for a door, and two side-wall parts are fitted with a hinged window sash.

In forming a box of the floor, make ends for it to fit the opening snugly. These ends can be fastened temporarily with screws for shipment. The sides and ends of the building being only 6 ft. long, a space of 3 ft. will be left in one end of the box for bedding and camp utensils.

Broaching Staggered Holes in Assembling Machine Parts

It frequently is found in assembling machinery that the bolt holes will not line up properly, and must be gouged out with a chisel, filed, or reamed, before the bolts will enter. Considerable difficulty is experienced if the bottom hole can be gotten at only from above, but by using a broach, a neat fit can be made in shorter time and with far less labor than would otherwise be required.

To make a broaching tool for cutting out staggered holes, it is necessary to obtain a round piece of chisel or tool steel, having a diameter equal to that of the holes and a length depending on the combined thickness of the two drilled parts—8 in. would be suitable for 2 in. of metal. One end is turned or ground tapering up to about the middle of the tool. Cutting edges or teeth may then be cut, or filed, as shown, about $\frac{1}{16}$ in. apart, but only halfway around the circumference. When finished, the broach should be hardened, and its temper drawn to a bluish straw color.

In using the tool, it is driven through the holes, the same as a drift pin. The cutting edges, each projecting a little farther than the preceding one, will

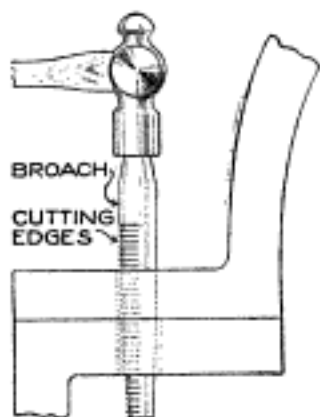

remove the metal in the same way as though a gouge chisel were used. The broaching tool not only acts as a large number of chisels, each taking a small cut, but it also guides itself, and only requires to be driven or forced through the metal.—Contributed by J. V. Romig, Allentown, Pa.

Repairing a Broken Valve-Guide Retainer

One arm of the valve-guide retainer of a gasoline engine broke as shown in the illustration. No doubt the break was caused by overstrain from the stud nut holding the retainer into the engine crank case. It was repaired by filing

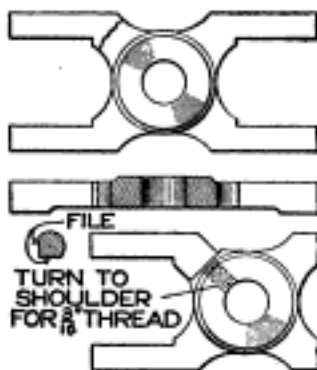

a flat surface at the point of the break, then drilling a hole and tapping it to receive a $\frac{5}{16}$ -in. drill rod. The filing was done at an angle of 45 deg. A piece of drill rod was cut to the proper length and a thread cut on one end. It was then screwed in place and hammered to the proper shape. The end was filed to the shape of the other arms.

It is a good plan to flush out the crank-case oil reservoir of a gasoline engine with kerosene occasionally, then run it idle for a few minutes to clean it out well.

Safety Coupler for Switching Locomotives

The recent movement of railway companies toward a definite and systematic study of safety appliances for the protection of employes, has afforded many wonderful and gratifying results. Comparison, before and after installing the appliances, of statistics of killed and injured necessarily kept by the companies, has proven the time and expense involved in this movement a good investment.

The work of the switchman and the routine of switching service comprise practically the most hazardous duties in railway employment. A study of the occupation by one of the western roads, besides leading to some other vital safety suggestions, resulted in the coupling device for switch engines shown in the illustration. A continuous lifter bar had been in use; that is, one running the entire length of the pilot and footboard beam. This was, of course, to lift the knuckle locker in the coupler head, and when pulled up at one end of the beam, the other end was also raised. This was dangerous when two men were on the footboard, as in raising the lifter by a switchman at one end without informing the other, one of them is apt to be thrown or pushed from the footboard. The new arrangement, as can be seen, provides two separate lifting levers, each of which can be operated independently of the other.

The locker block is raised up from the bottom to free the knuckle, instead of being pulled up from the top as with previous arrangements. The weight of the lifting links and the manner in which the leverage parts are assembled make it impossible for the locker block to jump out, a thing that has caused many accidents. The peculiar shape of the locker block also throws the coupling knuckle out when the hands, or lifting levers, are jerked up, making it necessary for the switchman to go between the car and locomotive to open knuckles in any ordinary switching duty.

The mere disabling, let alone the killing, of an efficient employe, is a loss to the railroad company that

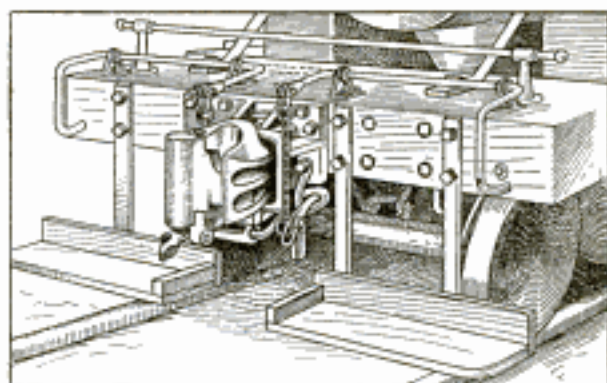

The Locker Block is Raised from the Bottom Instead of being Pulled Up from the Top

many do not realize, and from the standpoint alone of financial loss through claims, setting aside the loss of efficient labor, the companies are realizing the immediate returns from eliminating as much danger as possible.

Hammer for Thin Sheet-Metal Work

An extremely useful tool to have around a garage is a soft-faced hammer. One made up as shown in the illustration is especially adapted for use in straightening bent mudguards, hoods and bodies on automobiles, and for all metal work having enameled surfaces that must not be marred. The hammer is similar to a wood mallet, but the head is provided with a pad

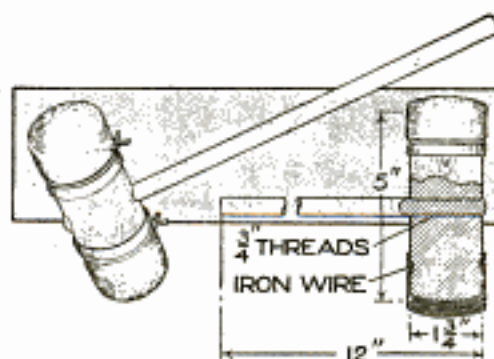

Soft Face on a Hammer Made Up of Felt for Use in Straightening Thin Sheet Metal

of felt, made up of a series of small circular pieces and covered with a larger piece held in place by means of a soft-iron wire wound around in a small groove, as shown.

Electro-Pneumatic Signal and Call Whistle

By F. W. BENTLEY, JR.

IN connection with the boiler-washing system at the terminal roundhouse of a certain railroad company, some difficulty was experienced with the electric-signal arrangement used to notify the engineer at the power house to regulate the pressure of the hot water forced into the water lines used to wash out the boilers in the

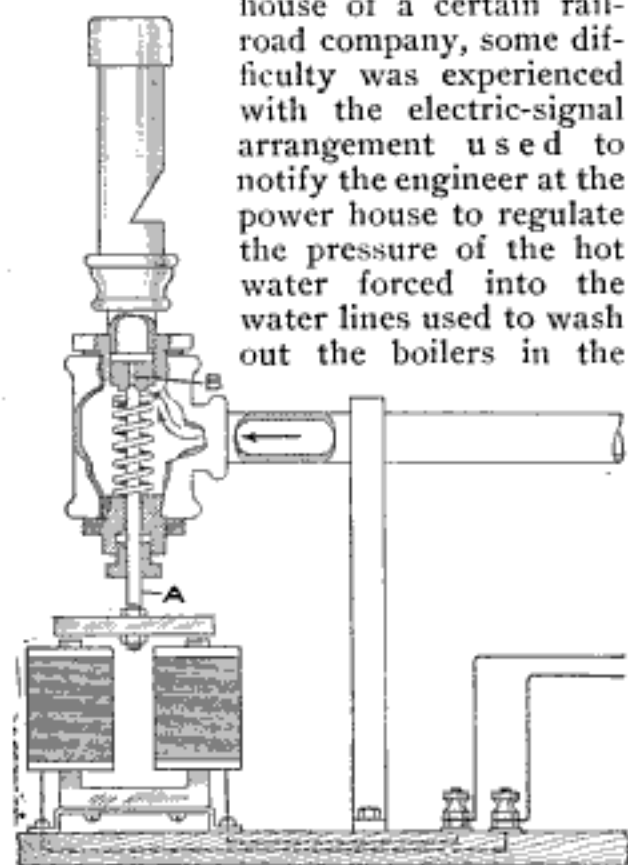

Signal Whistle in Which the Valve Controlling the Air Pressure is Operated by Magnets

roundhouse. At times, when the boiler washers were not using the pump for intervals of 20 to 30 minutes, it could be shut off temporarily to the advantage of the other machinery in the engine room, and also much to the preservation of the pipe lines. The roundhouse was some distance away from the power plant in which the pumps were installed, and an electric call bell was used to notify the engineer when the hot-water force pump was needed. It was impossible to locate the bell in the power plant in such a place that it could be heard distinctly by the engineer wherever he happened to be at various times, and it was also impractical to install a number of large expensive call bells.

The illustration shows an electro-pneumatic whistle which was substi-

tuted for the bell and tried out with a great deal of success. The body of the device consists of a 1-in. tee with a side outlet of $\frac{3}{8}$ in. The air is admitted to the inner portion of the tee through the $\frac{3}{8}$ -in. pipe, where it is controlled by a $\frac{1}{4}$ -in. brass pin valve, A. To the lower end of the stem is fitted a moderate-sized armature bar, which is subject to the control of the magnet poles. When the push button is pressed the bar is attracted by the magnets, pulling the valve away from its seat on the cap that is screwed in an inverted position in the reducing plug at the top of the tee. This allows the air to flow up and cause a blast of the whistle. Release of the pressure allows the spring around the valve spindle to force it up to its seat. On the lower end, to prevent the escape or waste of air that might pass by the valve spindle, a packing-nut arrangement was made for the spindle from a $\frac{1}{4}$ -in. pipe plug. The strength of the magnets is fully utilized, because of the fact that it is necessary to move the spindle only a slight distance from its seat to cause a shrill blast of the whistle, and the armature can be placed very near the core ends of the magnets. In shops of this kind an air compressor with storage tanks is installed, so that a supply of air can always be had for the whistle.

In the case mentioned, a number of whistles were supplied by a $\frac{1}{8}$ -in. pipe from the head of the tee to various places around the power house, making the requests from the distant roundhouse comprehended by the engineer, no matter where the calls around the plant may have taken him. The whole whistle device is made of pipe fittings. The whistles are inexpensively made, from $\frac{1}{2}$ -in. or $\frac{3}{8}$ -in. pipe, and they can be put at almost any place within a reasonable distance by using $\frac{1}{8}$ -in. pipe to connect them to the top of the tee head, the number of whistles depending on the size of the air opening B.

NO.	SIZE OF PIPE	A	B	C	D	E	F	G	H	J	K
1	$\frac{1}{8}$ IN.	$1\frac{1}{2}$ IN.	27	$\frac{5}{32}$ IN.	$2\frac{5}{8}$ IN.	$\frac{3}{4}$ IN.	$\frac{1}{4}$ IN.	SEE NOTE	$2\frac{5}{8}$ IN.	$\frac{3}{32}$ IN.	2 IN.
2	$\frac{1}{4}$ IN. TO $\frac{3}{8}$ IN.	$2\frac{1}{2}$ IN.	18	$\frac{3}{4}$ IN.	$4\frac{1}{2}$ IN.	$1\frac{1}{2}$ IN.	$\frac{1}{2}$ IN.	$\frac{3}{4}$ IN.	$4\frac{1}{2}$ IN.	$\frac{1}{4}$ IN.	2 IN.
3	$\frac{1}{2}$ IN. TO $\frac{3}{4}$ IN.	$3\frac{7}{8}$ IN.	14	$1\frac{5}{16}$ IN.	$5\frac{1}{4}$ IN.	$1\frac{7}{8}$ IN.	$1\frac{5}{16}$ IN.	1 IN.	$5\frac{1}{2}$ IN.	$\frac{1}{2}$ IN.	$3\frac{1}{2}$ IN.
4	1 IN. TO 2 IN.	4 IN.	$11\frac{1}{2}$	$2\frac{1}{4}$ IN.	6 IN.	2 IN.	$1\frac{3}{8}$ IN.	2 IN.	6 IN.	$\frac{13}{16}$ IN.	$3\frac{1}{2}$ IN.
5	$2\frac{1}{2}$ IN. TO 4 IN.	6 IN.	8	$4\frac{1}{2}$ IN.	6 IN.	3 IN.	$2\frac{3}{8}$ IN.	4 IN.	6 IN.	$2\frac{1}{4}$ IN.	4 IN.

NOTE: THIS RADIUS IS OMITTED ON NO. 1 MACHINES, AS THIS NO. IS FOR ONE SIZE PIPE ONLY

Table of Dimensions for the Construction of Five Sets of Bushings and Five Sets of Jaws. Providing a Sufficient Number of Lead Threads to Form All Sizes Used on Pipes Up to Four Inches

A Thread-Forming Tool for Thin Tubing

Tubing, such as rain leaders, stove-pipes, brass and copper pipes having thin walls, cannot be threaded in the usual manner, and therefore the machine illustrated was designed for rolling the threads into the metal. This tool will quickly form a thread sufficiently full to give a good, tight joint. As the thread is formed in the entire thickness of the metal, it serves for either an inside or outside thread.

In Fig. 1 the tool is shown without the chuck jaws, of which five sizes, required to roll threads in the five standard pitches for pipe from $\frac{1}{8}$ in. to 4 in., are given in the table. For example, if it is desired to form a thread on a $\frac{3}{4}$ -in. tube, the table shows that such a pipe is given 14 threads to the inch. The two bushings, L and M, having 14 threads to the inch, are taken from the set, and the tube to be

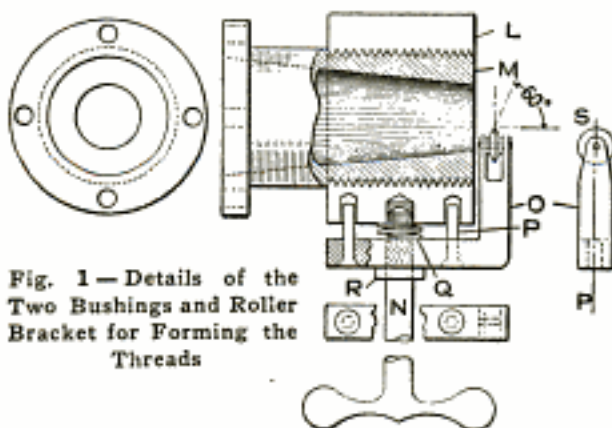

threaded is filled with lead for a distance of about 5 in. This can be accomplished by filling the other part of the tube with clay, or by pushing in

a cork, and pouring the melted metal on top of it. The tube end is placed through the bore in the bushing M, and the four chuck jaws belonging to

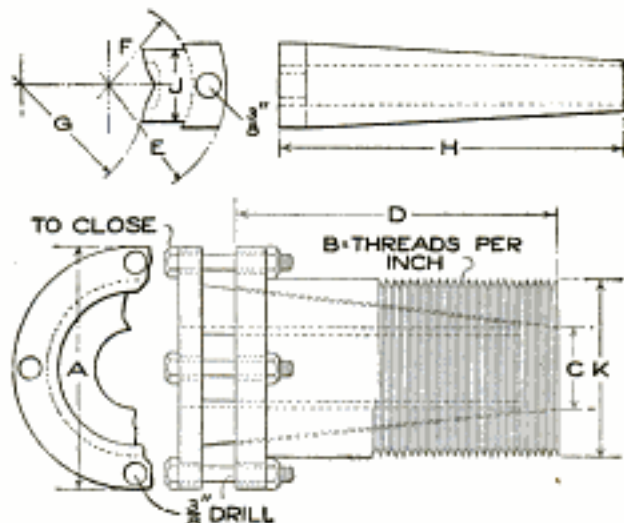

Fig. 2—Four Jaws are Used to Clamp the Pipe in the Inner Bushing of the Machine

this set are placed in the lead-filled pipe. The end of the pipe must project through the bushing M far enough for the thread. Each jaw is located at a point 90 deg. from the other, or where the holes in the flange of the bushing M will meet those in the flange of the jaw, as shown in Fig. 2; then, $\frac{3}{8}$ -in. bolts are placed through the holes and drawn up to cause the jaws to grip the lead-filled pipe. The traveling feed bushing L is then turned on to M for about five threads, and the handle N, having been passed through the clearance hole in the wheel bracket O, is turned a few threads into the tapped hole in the bushing L. The guide pins P are a push fit in the holes drilled in L, and prevent the lateral play in O. The helical spring Q takes up all the backlash.

The handle N is turned down into the hole in L, causing the fixed collar R to force the bracket O so that the desired pressure is obtained on the threading wheel S. The bushing L is revolved for the length of the thread desired, then another run is taken, with the wheel S set a little deeper, until the thread is made. The tube is then removed and the lead taken out. In removing the lead, care must be taken,

if the pipe is plated or finished in any manner. Heat will spoil the finish; therefore the lead must be drilled out as much as possible, and the remaining portion dug out with a sharp-pointed tool.

The tapers in the bushing M and on the jaws should be standard. The torsional strain on the tubing is small, for the reason that the thread is formed with a roller instead of being cut.

Repairing a Broken Steering Lever

Automobiles are as apt to have breakdowns in the country as in the city, but with a few simple tools and

a little skill, repairs can be made on the spot or at a neighboring farmhouse, which will avoid the necessity of abandoning the machine until it can be towed in or a new part secured. A simple roadside repair

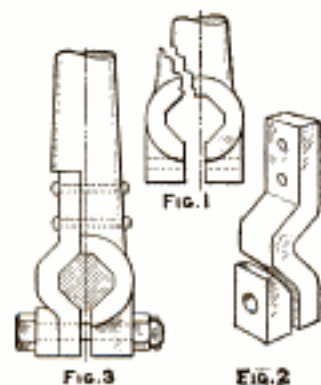

of this nature is shown in the illustration. The steering-gear lever broke, as shown in Fig. 1, preventing further continuation of the journey. The repair was made with the aid of a small vise, clamped on the running board, a breast drill, a piece of steel, several rivets, a nut, and such tools as hammer, chisels, punches, and files, which are found in every well-equipped tool box.

In making the repair, the main piece of the lever was chipped and filed to form a flat surface and square shoulder. A suitable piece of steel was heated in a bonfire, and bent to approximately fit the lever pin, so that but little filing was required to make a close fit. The parts were then assembled, clamped in the vise, and drilled for $\frac{1}{4}$ -in. rivets, which were inserted and riveted in place. In order to use the same clamping bolt and nut, an extra washer was provided. For this purpose a nut was found which slipped over the body of

the bolt, and one corner was chipped off to fit the lever. The completed repair was very rigid, and caused no trouble during the rest of the trip.

Keeping Flies Out of an Ice-Cream Parlor

One owner of a confectionery and ice-cream parlor kept the flies out and away from the entrance in the following manner: The ventilating fan placed in the transom over the door was housed and the draft from it directed so that it passed down in front of the door. This keeps the door free from flies and does not interfere with the ventilation of the room.—Contributed by C. J. Waters, Jackson, Mich.

Tool to Replace Rubber Tires on Velocipedes

The main part of the tool consists of a yoke, A, made of a piece of metal, 8 in. long and 1 in. square, with a notch cut in each end, $\frac{1}{2}$ in. wide and 1 in. deep, into which side pieces, B, 16 in. long and $\frac{1}{2}$ in. thick, are hinged. A toggle joint, C, is made of pieces, $\frac{1}{2}$ in. thick, which is operated with a screw run through the yoke A. The pieces are drilled and

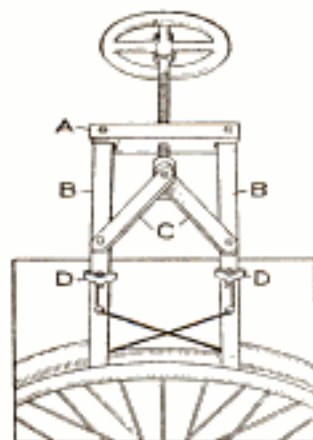

tapped to receive bolts with wing nuts, D.

The wire ends in the tire are fastened under the wing nuts, and the edges of the pieces B are placed against the rubber ends. The screw is turned down to force the pieces B out, thus barring the wire so that it can be tied securely.

Front Sight for a Rifle

File a V-shaped notch in the cross bar of the front sight, about $\frac{3}{32}$ in. deep, with the sides at an angle of 60° for a nine target sight, and about 45° for game. Taper the sides so as to make



a smooth, clean edge on the front of the cross bar. Make a pin, about $\frac{3}{8}$ in. long, from steel, $\frac{5}{32}$ in. in diameter. Cut a thread on one end and drill a $\frac{5}{64}$ -in. hole in the other. Fit in this hole an ivory pin accurately pointed to an angle of 70° . Drill a hole in the bottom plate, and tap it to receive the threads of the pin. Turn the pin in position so that the point of the ivory bead will show exactly in the center at the bottom of the notch in the cross bar. A very little of the white pin showing will give the best results.

This sight combines the two best and oldest known sights in use into one, and eliminates guesswork from aiming.—Contributed by Chas. Carroll, State Soldiers' Home, Ohio.

Locating Empty Theater Seats Electrically

There are but few people who have not experienced the difficulty of going into a movie show, or other place of amusement, and finding a seat in the dark. Having this in mind, a practical electrician has devised a switchboard and electric-light system, similar to a telephone exchange, and when a person sits down on a seat a contact is made which completes the circuit and

a lamp designating the seat row and number lights up. The unoccupied seats remain dark. The contacts are supplied with a spring arranged so

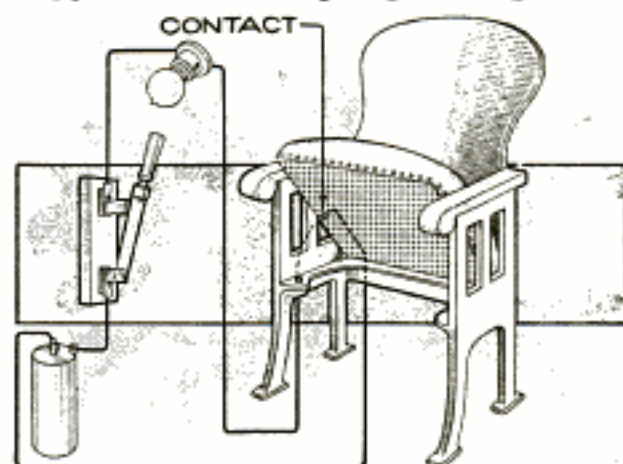

The Switch on Each Seat is Closed When Occupied Which Lights a Globe on the Lamp Board

that they will not meet unless a pressure of 35 lb. is applied. If a chair is vacant or occupied by a child within the free-admission age, the lamp corresponding to that particular seat will remain dark.

It has been found advisable to use a switch in the transmitter circuit so that no current is wasted by keeping the whole number of lamps lit all the time. The lights are small incandescent lamps and are arranged on the switchboard in the relative positions of the seats they represent. With the aid of this device the ushers can seat patrons satisfactorily.—Contributed by M. Ancker, Philadelphia, Pa.

Enlarging Holes in Brass

Several thousand drawn-brass shells, or cups, A, having a hole in them made too small, had to be drilled to enlarge the hole $\frac{1}{64}$ in.

As they were made of soft brass, it was more difficult to enlarge the hole by drilling than if there had been

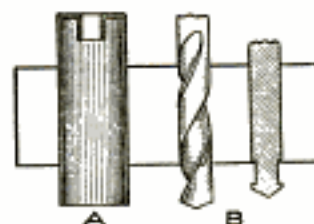

no hole. A drill in good condition passing through metal of this sort will make a hole just a trifle larger than the size of the drill. To take off $\frac{1}{64}$

in. in the diameter would only require the drill to scrape a little from the edges. Various drills were used, also lubricants, but to no avail. The holes were enlarged, however, by the method shown in the illustration. Twist drills have a raised portion, or land, $\frac{1}{32}$ to $\frac{1}{16}$ in. wide, that is the full size of the drill. This forms its cutting edge at its greatest diameter. A part of this raised portion was ground off leaving only a short piece, about $\frac{1}{16}$ in. long, at the point. This cut the hole out to size and the following part did not rub. The removed portion of the raised part is shown at B.

How to Keep a Carving Knife Sharp

It is quite an art to sharpen a carving knife, and there are very few people that know how to do it properly. The secret in caring for the edge of a knife is to sharpen it often, by a few strokes on a good steel. Watching a marketman cut meat, one will notice that he sharpens the knife very

platter, yet the majority of people expect the knife to cut easily without sharpening. In most cases the continued use of the knife without any attempt to sharpen it is due to the individual using the knife not knowing how to sharpen it on the steel. The following suggestions may be a help to those not knowing how to properly use the steel.

Hold the steel in the left hand and apply the knife as shown at A. The blade is drawn across the steel downward and inward, holding the blade at an angle of 15° and starting at the back of the blade and finishing at the point. At B and C are shown two stages in the operation. Repeat, first on one side and then on the other, for at least a dozen strokes, being careful to hold the blade at an angle of 15° to the steel at all times.

Another method of sharpening a knife on a steel, which a great many prefer, as a person is less liable to cut the hand, is illustrated at D, E and F. In this case the steel and knife are

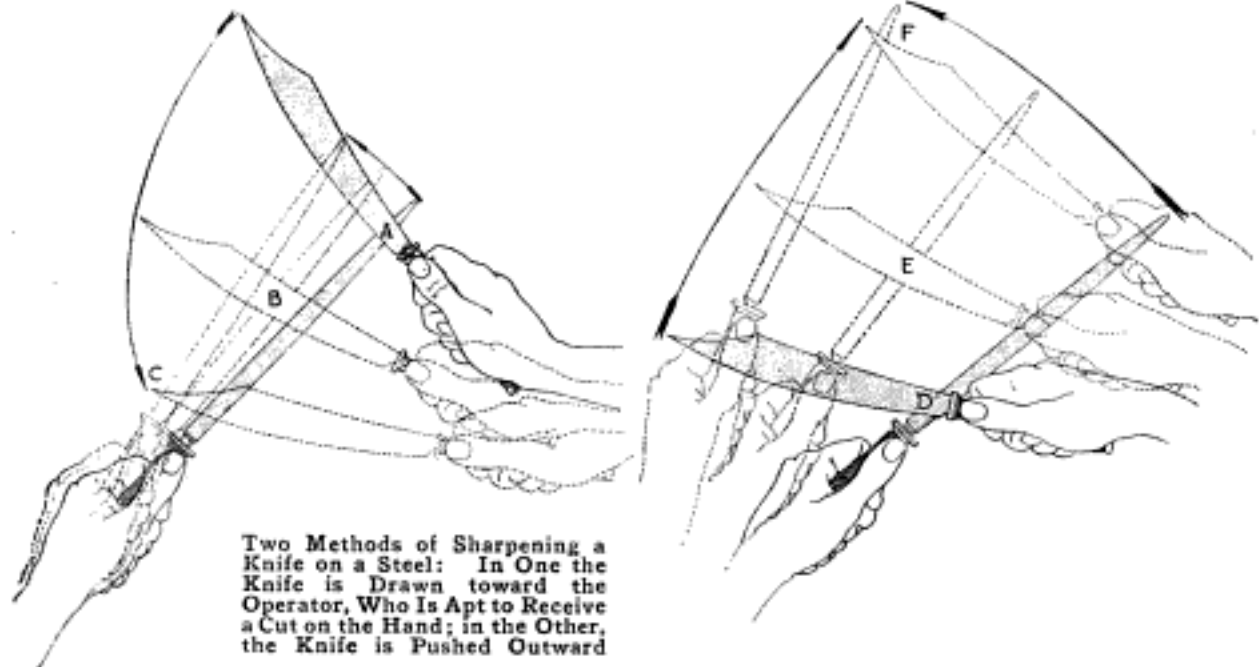

often, only a few rubs on the steel, but every few minutes. A carving knife in the majority of cases has to do much harder work when in use than the knife of the marketman or butcher. Its edge is blunted by contact with the bones in the meat and especially with the bottom of the

held at the same angle to each other, but the stroke begins at the base of the steel and ends at the point, and should be repeated a number of times, first on one side and then on the other. This method is not considered as scientific as the first, but is very effective and much safer.

BUILDING A HOME

By Geo. M. Petersen

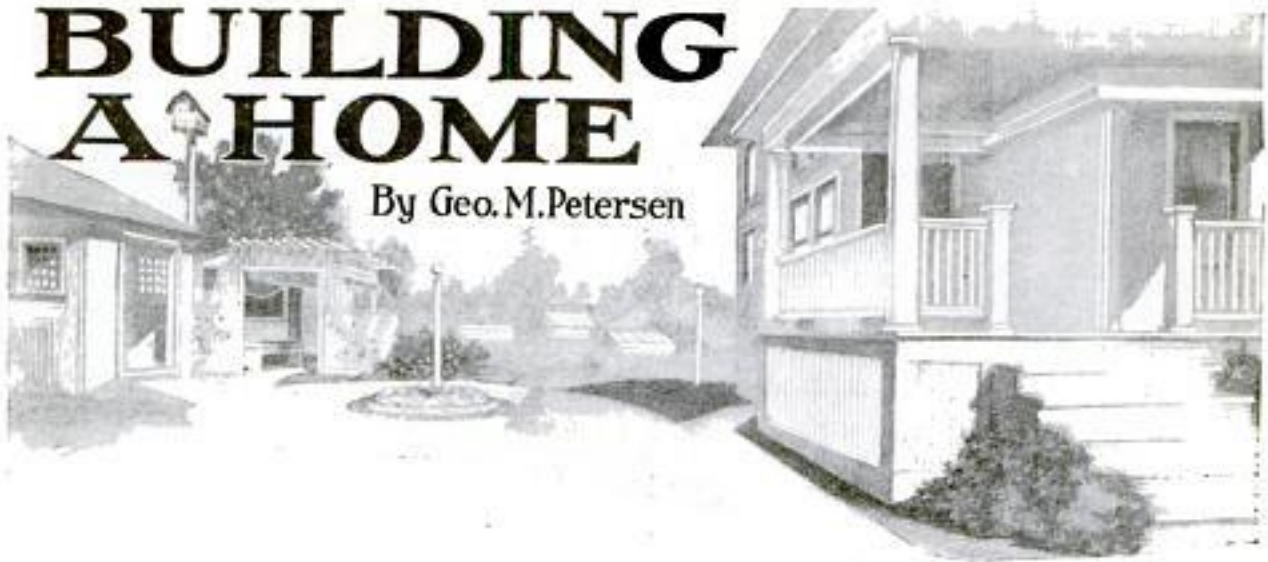

PART III—The Laying of Foundations

BEFORE the work of excavating is begun the foundation lines should be run, as shown in Fig. 1, and a small trench dug with a pick so that the lines may be removed to let the teams work to an advantage. The excavation is usually started by plowing up the surface and then removing the loose dirt with a scraper. When the dirt is not needed for filling in, it is removed in dump wagons. It is always a good plan to leave the top dressing, that is taken from the area to be excavated, near by to be used for grading purposes when the building is completed. Sufficient earth should be left around the edge of the excavation to fill in the space between the bank and the foundation wall, when the latter has been completed, as the excavation should be at least 4 in. larger each way than the finished foundation line, to permit the proper laying up of the wall. When the foundation walls are completed, the space left around them should be filled to at least 3 in. above the finished grade to allow the surface water to drain away from the walls.

Foundation Material

There are six popular classes of foundations, viz., concrete, concrete blocks, flint stone, limestone, brick, and hollow tile. Concrete is made of Portland, or natural, cement and an aggregate usually composed of gravel and sand. Do not accept cement that has become caked from dampness. How-

ever, caking caused by piling will do no harm. The aggregate should be clean and free from loam. A small quantity of clay will do no harm, but never allow loam to be used if a good concrete job is wanted. Concrete is really an artificial rock and when properly mixed in the right proportions—usually one part cement to two parts of clean sharp sand and five parts of

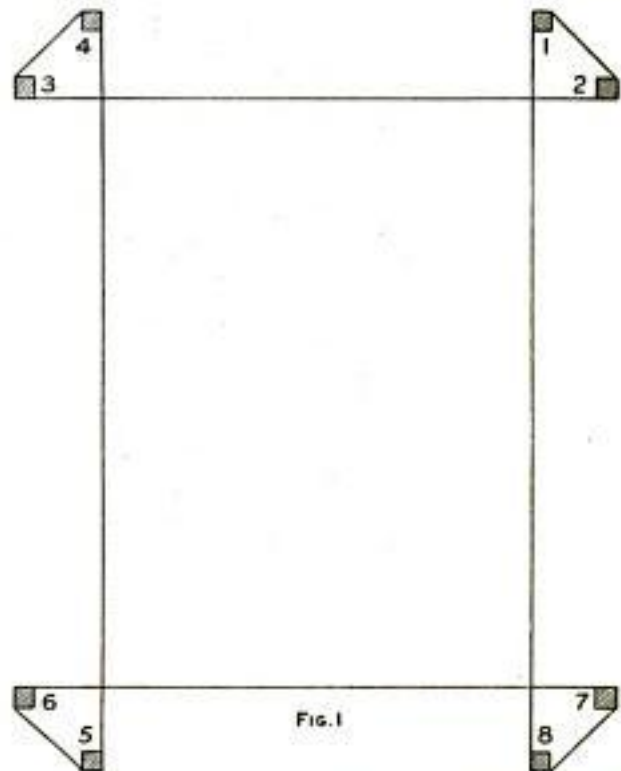

Stakes are Set and the Lines are Run as the Numbers Show, Outlining the Foundation Plan

clean gravel—it becomes so hard and strong that when a piece is broken

off, the small stones in it are often broken along the line of fracture. This fact proves that a proper mixture of concrete makes a first-class building foundation.

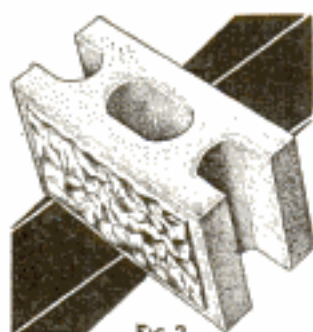

Fig. 2

The two main things to watch closely when pouring a concrete wall is first to see that the mixture is rich enough, and second that the concrete is poured into the forms while it is wet enough to be poured. If the mixture shakes like jelly it is about the right consistency, and when properly tamped after being placed in the forms, a good solid foundation, retarding dampness, will be the result.

A typical concrete block is shown in Fig. 2. The theory of this style of block is that when the wall is laid up and completed the dead-air space is continuous between the inner and outer wall, and this air space, by preventing accumulation, by capillary attraction, of the exterior dampness on the interior wall, will keep the basement from becoming damp. This theory has not worked out in actual practice, but whether its failure is due to the blocks being made of concrete that is too dry to form a really solid block; because the inner and outer walls are too thin, or because, no matter how carefully the blocks are laid up, there is sure to be a certain amount of mortar that will bond the inner and outer wall together, has never been satisfactorily explained. The fact remains, however, that a solid, or poured, concrete wall is a great deal drier and stronger than a block wall of the same size, the only objection to it being the appearance of the smooth concrete wall above grade on the exterior of the building. The only way to overcome this is to pour a solid concrete wall to a point about 2 in. above grade and then build the remainder of the wall with blocks.

The two main things to watch closely when pouring a concrete wall is first to see that the mixture is rich enough, and second that the concrete is poured into the forms while it is wet enough to be poured. If the mixture shakes like jelly it is about the right consistency, and when properly tamped after being placed in the forms, a good solid foundation, retarding dampness, will be the result.



Fig. 3

There are very few foundation materials that are as serviceable, and certainly none that gives a better appearance, than a nice flint stone. The great difficulty with the flint stone is that it "sweats" and keeps the basement damp. A damp basement is not only detrimental to the entire building above it, but also prevents the storing of vegetables and canned fruits in it, as they will decay, or mold.

Limestone is a material that does not sweat, but the appearance is not so good above grade. For this reason it is best to use limestone below grade and then build up on the top four or five courses of the flint stone.

While brick laid in cement mortar will stand a greater strain of compression than concrete, it is seldom used in the construction of foundation walls for dwellings, for two reasons, the cost and the difficulty of making it waterproof. The proper method of damp-proofing a brick foundation wall is by building into it a course of hollow tile, as shown in Fig. 3. This hollow tile has the same effect as the air space is supposed to have in the concrete-block wall.

The two principal kinds of hollow clay tile on the market are the regular book tile, Fig. 4, and the interlocking tile, Fig. 5; and while the former cannot be used for foundation work, the latter is especially well adapted for this work. It can be laid up in an 8,

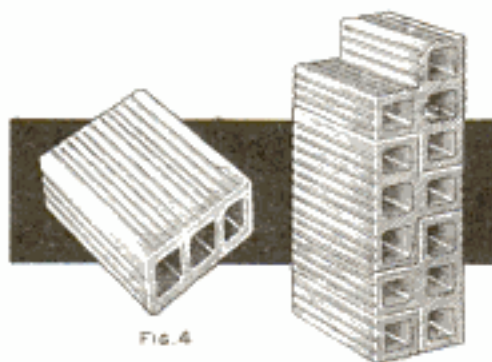

Fig. 4

Fig. 5

Book and Interlocking Tiles, the Latter being Especially Adapted for Building Foundation Walls

12, or 16-in. wall and plastered directly on either or both sides of the tile. The

construction of the interlocking tile makes its uses almost limitless.

Damp-Proofing

The surest way to waterproof a stone or concrete-block wall is to remove the earth at least 12 in., all the way around, and paint the entire outside surface of the wall with hot asphalt after pointing up all the joints. This process is sometimes elaborated upon by first putting on a coat of asphaltum, then laying a layer of three-ply tar paper over the asphaltum, and applying another coat of asphaltum on the tar paper. The inside of the stone wall is then carefully pointed up with mortar and given a coat of patent plaster. The method is the best that can be used, but it is very expensive. The average stone foundation is laid up in a full bed of cement and lime mortar, the lime being used to form the bond between the mortar and the stone, and the cement used to harden the mortar into a stone. If the joints and beds are full, and the wall is plastered on the inside with cement mortar, it will probably make the wall water-tight enough for practical purposes, unless there is an actual water pressure behind it.

The waterproofing compounds composed of powders that must be mixed with the dry cement, and the liquid compounds that must be put into the mixing water, in the majority of cases, should not be used, as they actually prevent the concrete from setting properly, and in many places form a cell around a quantity of aggregate which prevents the contents of the cell from consolidating with the other parts. This naturally forms a detached portion that weakens the whole mass. There are other compounds that are mixed into the face of the wall or into the top coating of the floor. These tend to harden the surface where they are applied and prevent it from bonding

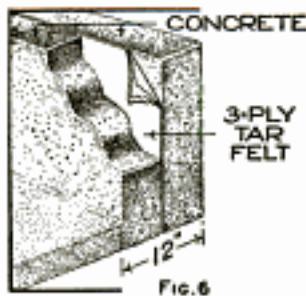

FIG. 6

with the remainder of the mass. It also makes the surface to which it is applied crack and fall off.

The kind of waterproofing material that will give the best results are those put on in paint form. The mixture is

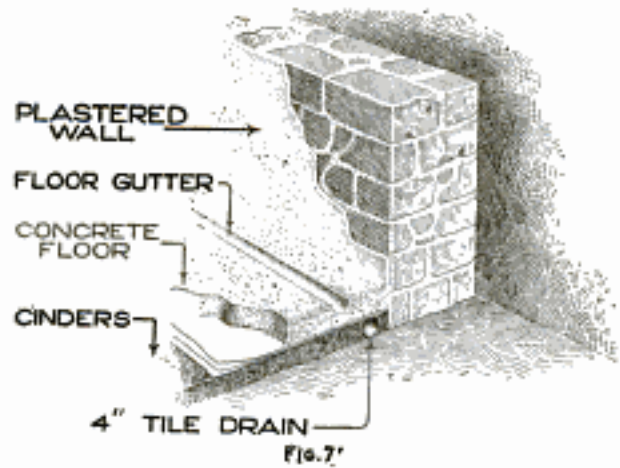

FIG. 7

The Construction of a Basement Floor with Gutter and Curve at Wall Base, and Drain under Floor

thinned with turpentine, is like paint, and may be used on concrete, brick, or stone with satisfactory results. It may be applied when the concrete or brickwork is wet, and will hold in a first-class manner, unless there happens to be a real pressure forcing the water through the pores.

A method of insuring absolute dryness in a foundation wall is illustrated in Fig. 6. This is copied from that used for underground work, such as subways, etc., and consists of building the wall in alternate courses of wet concrete and three-ply tar felt. For ordinary foundation walls one thickness of tar felt, as shown, will prove satisfactory, but care should be taken to give the felt sufficient lap.

Under certain conditions it is desirable to place a tile drain inside the foundation wall and beneath the basement floor to protect the floor from exterior dampness. This is a cheap preventive and can be used in places where there is hardly any call for it. The fact that this drain will work if the water should get under the floor is sufficient excuse for its being placed under every basement floor. This style of construction is shown in Fig. 7.

Waterproofing a concrete-block wall has been a great problem, and it ap-

pears as if this type of construction will never prove popular except in isolated communities, or for an artistic effect above grade. There is also a

the corners, and a gutter should be run to the basement-floor drain, to carry away any water which might come through the foundation walls, or other-

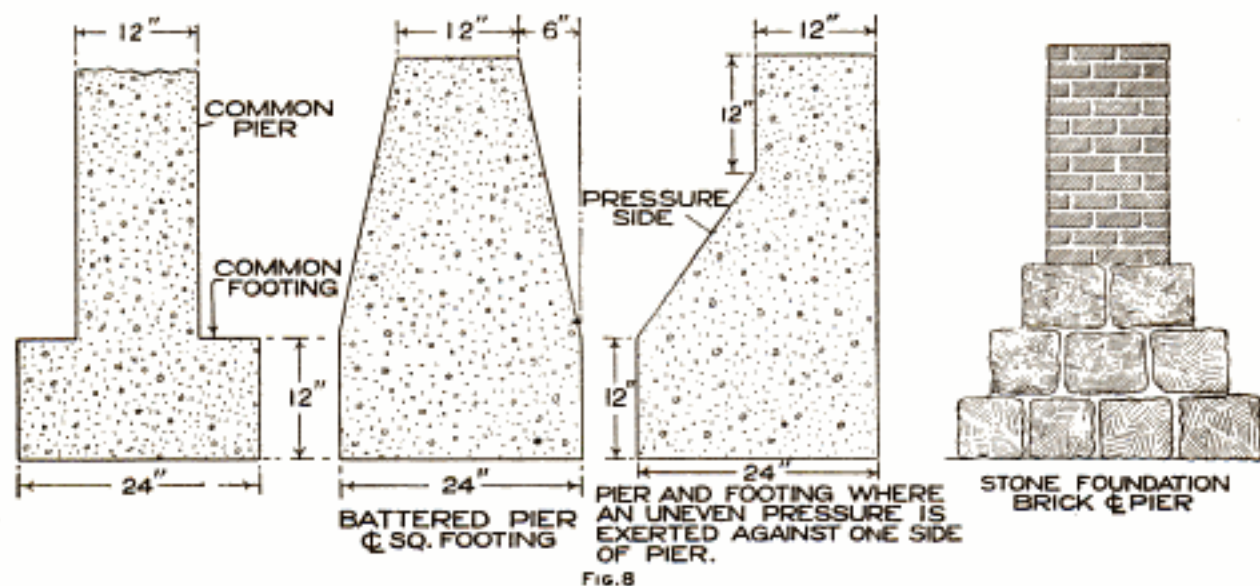

Fig. 8
Piers Are of Many Designs and Types, According to the Conditions under Which They are to be Used, and the Best Material for Shaping Them Properly Is Concrete

strong objection to concrete blocks from the artistic point of view on account of the continual sameness, every block alike. For city use, concrete blocks are almost as expensive as stone and a great deal less desirable in every instance except one, which is that the block wall takes up only 8 in. in width for each wall, while a stone wall takes at least 16 in., or double the floor space of the block.

Basement Floors

The most modern and the most serviceable basement-floor material is concrete, when properly constructed. To secure the best results for a concrete floor, the earth should be well rammed with a heavy tamper to make a firm foundation. A layer of cinders, at least 4 in. thick, should be placed on the earth, and well rammed. The cinders form an insulator between the earth and the concrete work. The concrete for the floor is composed of one part cement and six parts clean gravel, and is floated to a true and even finish. The floor should never be less than 2 in., and preferably 3 in., thick. The edge at the walls is turned up at least 4 in., to prevent dirt from settling in.

wise reach the floor. If the gutters are properly located and graded, and the entire floor graded toward a certain point, usually a floor drain, the basement will always be dry and free from foul air. A properly constructed basement floor is illustrated in Fig. 7.

Probably the greatest trouble with basement floors is due to the foundation not being properly settled; an insufficient quantity of cinders; the use of ashes or broken concrete in the place of cinders; a weak concrete mixture, or a too thin top floor. If the suggestions given above are followed out, the result will be satisfactory.

In extreme cases where dampness or water will come up through the concrete floor the same method of construction may be used as recommended for a waterproof concrete wall. By laying about 1 in. of concrete, covering it with a layer of three-ply tar paper, and covering the paper with 2 in. of concrete, the water will be kept out and the floor dry.

Chimney and Column Footings

When constructing chimney and column footings the first requirement is to excavate down to a solid founda-

tion, if possible. If a natural solid foundation cannot be obtained, then it will become necessary to make one. It may be necessary to consult an engineer, or architect, to find out the proper size to make the foundation sufficiently strong to carry the load. These foundations are usually constructed of concrete reinforced with steel bars, but are sometimes constructed of building stone or brick.

The footings should cover a large area, the size depending on the foundation material and the load to be carried. On these footings are erected the piers which are to extend up to carry the load of the building. Be sure to have the pier cover enough surface of the footing to prevent it from puncturing or breaking through.

Piers

Piers are of many designs and types, according to the conditions under which they are to be used, the size for a residence usually being from 12 in. to 24 in. square. They are sometimes tapered so that their bottoms will cover a larger area than the tops.

A few common shapes of piers are shown in Fig. 8. Although the materials used for piers may be the same as are used for foundation walls, it is safe to say that concrete piers predominate. This is partly due to the adaptability of this material to forms of various kinds. For large piers, over 4 ft. in height above the earth, it is customary to reinforce them with steel, or iron, rods to prevent cracking under side strains, which sometimes occurs.

Hot Spark for Motor with Low Battery Consumption

A motorcycle using a battery will give a much better spark by the following method: Turn the motor so that the cam lifts the spring. Adjust the contact screw to make a firm but light contact. Turn the cam out of the way, and bend the commutator spring so that the break between contacts is about the thickness of a business card. This will give the hottest spark with least battery consumption.—Contributed by F. L. Prescott, Starke, Fla.

An Adjustable Foot Lever for an Automobile

Adjustment of the brakes and of the clutch of an automobile is necessary from time to time, and the relative position of the pedals is changed as the adjustment is made. In quite a few cases the pedal is moved so far inward that the pad almost touches the floor boards, and when this occurs, it is necessary to relieve the brakes, or clutch facings in order to bring the pad back to its original position. The method described and illustrated herewith was applied to make the pedal adjustable and eliminate the relining

job for a greater length of time. Quite a number of cars of recent manufacture are equipped with similar devices, but the car upon which the pedal was

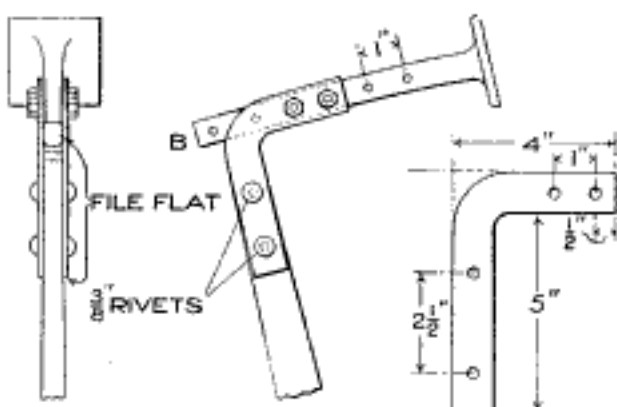

Changes in an Automobile Pedal to Make the Pad Part Adjustable for Length

changed had the type of pedal with the pad forged on the lever end.

The pedal was cut off at a point about 6 in. from the pad, and both portions were straightened and filed flat on both sides. In the upper piece six holes were drilled as shown. An angle piece of cold-rolled steel was forged for each side, and two holes drilled in each end. These pieces were riveted to the sides of the lever end, and the pedal part was fastened with bolts between the upper ends.—Contributed by Adolph Kline, New York City.

Substitute for a Cornet Mute

A new, or discarded, electric globe makes an excellent cornet mute in case of an emergency. Procure a globe of

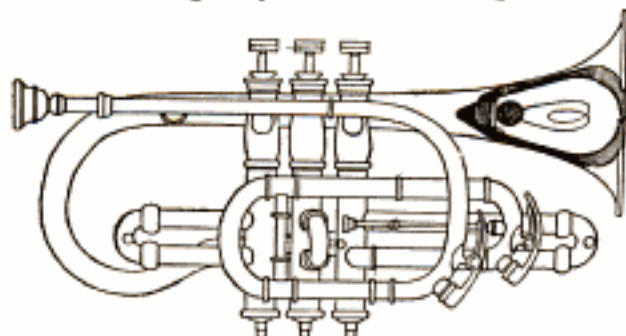

An Electric Globe Taking the Place of a Mute in the Cornet Bell

a size to fit the cornet bell, and paste three felt, or cork, strips on the side of the globe evenly spaced. If possible, use a discarded globe, and remove the metal screw part and grind the glass end smooth. Take out the glass tube and filament. This will produce a better sound, but the entire globe can also be used with good results.—Contributed by George E. Badger, Grays River, Wash.

Extension for a Drawing Board

All draftsmen are familiar with the trouble of removing a drawing from the board in order to draw arcs whose centers are beyond the edge of the paper. This can be avoided by the use of the easily made extension shown in

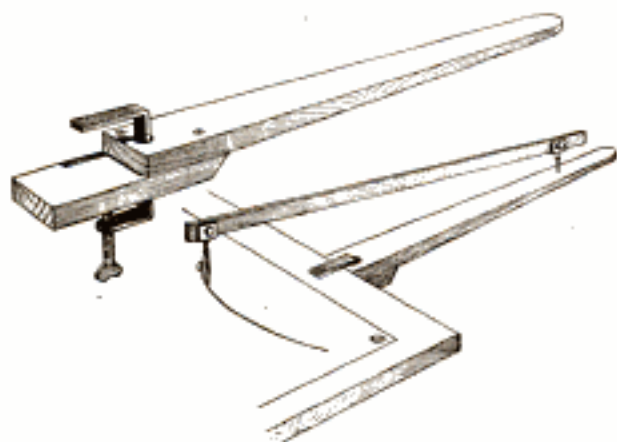

Extension Arm Attached to a Drawing Board for Drawing Arcs with a Long Trammel

the illustration. Two pieces of wood and a small clamp costing a few cents are all that is required. A suitable

width for both pieces is 2 in. The upper piece, which can be made 12 in. long, should be a trifle less in thickness than the drawing board at the base so as to allow the clamp a leverage. From the end of the clamping piece to the tip both edges and under side are tapered to make it lighter and have a better appearance. A hole is bored through both pieces, after they are fastened together, for the clamp to slide in easily. It will be seen that nothing projects above the drawing surface except the upper part of the clamp, and that no difficulty will be experienced in drawing radius lines with a straightedge bearing on a pin stuck in the extension piece at the center of the circle.—Contributed by Morris G. Miller, New Rochelle, N. Y.

Steering-Gear Lever Repair

The steering-gear lever of an automobile broke a short distance above the lower end, and as it was impossible to secure a new one quickly, a repair was made as follows: The portion of the lever at the point of the break was filed off, and a $\frac{3}{4}$ -in. hole drilled in its end to a depth of $2\frac{1}{2}$ in. The ball end was also filed flat, and a $\frac{5}{8}$ -in. hole drilled through it and counter-sunk $\frac{1}{4}$ in. on one end.



A piece of drill rod of the right length was turned down to $\frac{3}{4}$ in. on one end, and to $\frac{5}{8}$ in. on the other. The rod was then bent to the proper shape, after which the ball was riveted to the $\frac{5}{8}$ -in. end. The other end of the rod was inserted in the upper portion of the lever, where it was securely riveted.

In making a repair of this kind, be sure to fit the joints tightly and rivet them well, as the lever is subjected to extreme vibrations.

CA plug tap should never be started in a hole where it is convenient to start the thread with a taper tap.



A Miniature Illuminating-Gas Plant

By MORTON SOUTHARD

VERY few persons realize that the smoke issuing from chimneys is mainly coal gas carrying minute particles of unconsumed carbon that gives it a dark-gray color, containing, besides, some sulphur and sulphuric gases, carbonic-acid gas, and other impurities. It is only necessary to collect this gas and remove the impurities to get a gas that will burn with a bright flame.

The products obtained from a gas plant are gas, ammoniacal liquor, coal tar, and coke. Of 1 ton of coal, 1,500 lb. remains in the retort, or furnace, as coke; 20 gal. of ammoniacal liquor and 140 lb. of coal tar are taken from the cylinders and washers. When distilled, the ammoniacal liquor will yield close to 18 gal. of ammonia, which is used in

the manufacture of artificial ice and cold storage. The coal tar will yield approximately 19 lb. of benzol, which is the base of all true aniline dyes; 6 lb. of naphthalene, commonly known as camphor flakes or moth balls, which also yields some dyes; 4 lb. of toluene, which is valuable as a solvent and is the base of saccharine, and about 2 lb. each of phenol (carbolic acid), pyrene, anthracene, xylenol, cresol, chrysene, and alizarin. The residuum is coal-tar pitch, used extensively as a binder for briquetting coal dust for household consumption, and also for roofing and street paving. From these various coal-tar products, dyes of every tint, shade and color are obtained, as well as other industrial chemicals, from flavoring extracts to perfumes, from volatile oils to high explosives, and from the sweetest of all sweets to the bitterest of bitter.

A model gas plant—one that will be instructive and in no way dangerous if proper precautions are taken—can be

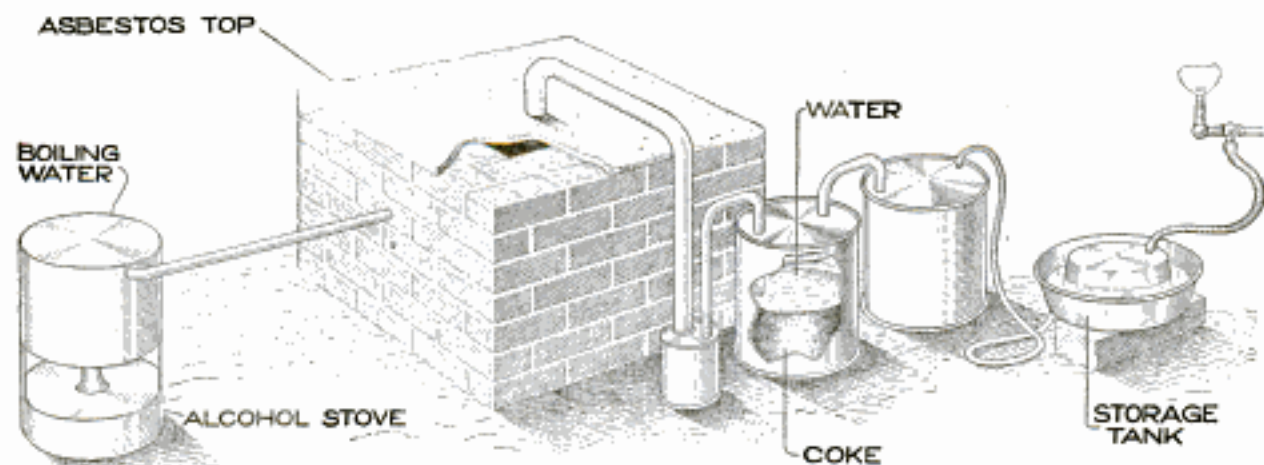

The Furnace Made of Fire Brick is Connected to the Condenser and Washers with Ordinary Iron Pipe through Which the Gases Pass After being Purified Before They Enter the Storage Tank

built from a few fire brick, some pieces of pipe, and a few tin cans. Enough fire brick must be secured to build a furnace 14 in. square by 20 in. high, inside measurements. Build up the four walls on a level surface of the ground, laying the bricks with a cement mortar to seal them perfectly, as coal gas will find any small crevice and escape. For this reason it is best to build a second wall outside of the first and plaster the joint between them as it is built. When the four walls are finished, make a grate of fire brick in the bottom by setting the brick on edge and spacing them about $\frac{1}{4}$ in. After the walls are dry, make ready the material for the fire. Place sufficient kindling on the grate to start a quick fire, then cover it with coal. When this is done, cover the furnace with a heavy piece of asbestos board large enough to reach the outside edge of the furnace walls. The board must be cemented to the top surface of the brick walls. Place the cement mixture on the wall top, then press the board on it, and place a weight on top until the cement becomes dry. The cement mixture should consist of one part cement to two parts of fine sand.

Procure a large can, such as used in canning tomatoes, having a diameter of more than 4 in. and with top and bottom whole; also two other cans, each having a capacity of 2 gal. with closed heads. Connect the first can to the furnace with a piece of 2-in. pipe, as shown in the illustration. The pipe can be bent for convenience, but in case such a piece is not at hand, regular pipe connections can be made with threaded ends, ells, waste nuts, etc. In either case, be sure to make the joints gas-tight. If a bent pipe is used, the ends can be cemented in the asbestos furnace top and the can top. Cut a hole centrally in the asbestos top and at one side in the can top. Fit one end of the pipe in the hole made in the asbestos and seal the connection with asbestos cement, then do likewise with the end that enters the can top.

In connecting the first and second cans, use a piece of 1-in. pipe. This may

be bent or connected with ells to form a U-shaped piece. In either case, one end should be longer than the other, so that one will just pass into the first can, where it is sealed with asbestos cement, while the other end passes through the second-can top, where it is sealed, and extends to the bottom of the can. For the connection to the third can, make a hole in the top of the second can, but do not seal it up to the connection until the can is first filled with water to within 2 or 3 in. of the top. Also put powdered coke into the water, about halfway of the can's height.

The connection from the second and third cans should be made of glass so that the gas can be observed passing through it between the cans. This is not absolutely necessary, however, and a piece of $\frac{1}{2}$ -in. iron pipe can be used instead. This pipe is connected in the same manner as that between the first and second, extending to the bottom of the third can and being sealed where it passes through the tops. The third can is filled with water to within 2 or 3 in. of the top.

The gas coming from the third can, or washer, is ready for use, but as the pressure would not be uniform, a storage tank must be provided. To make a storage tank suitable for the needs of this small plant, procure two pans, from 10 to 12 in. in diameter and from 3 to 4 in. deep. One pan should be a trifle smaller, so that it may be inverted in the larger pan, as shown. Make a connection from the third can with a rubber hose to the bottom of the larger pan, near the center, and use this pan as the bottom part of the storage tank. Pour into this pan enough water to make it 2 in. deep, invert the other pan and set it into the water. Attach a gas hose to the bottom of the inverted pan and fasten a gas jet into the rubber-hose end. This will make the gas plant complete and ready to operate.

To start the furnace, bore a hole in one side of the brick walls, about the size of an ordinary lead pencil, and insert a lighted taper to set fire to the kindling. There may be some diffi-

culty in getting the fire to burn at first, and it may be necessary to force considerable air in; however, when the fire is fairly started, it will burn freely and the gases will soon find their way through the first pipe to the condenser, which is the first can. There they will mingle and deposit some tar and ammonia, then flow out through the second pipe, up through the coke and water in the second can and through the glass tube, where they may be observed passing into the can of water, where some more tar and ammonia will be deposited. After leaving this can the gas will find its way through the rubber tube into the storage tank. It passes from this tank to the burner, where it can be lighted and will burn with a bright flame.

If it is possible to force steam into the furnace when the fire is at its height, a much better quality and a larger volume of gas will be made. This is accomplished by placing a

closed can of water over a fire near the furnace and connecting it to the latter with a piece of 1-in. gas pipe. The water in this can must be boiling hot at the time the fire in the furnace is lighted. The steam entering the furnace is decomposed, the hydrogen being released as a gas. The pipe connecting the boiler with the furnace should be fitted in the furnace wall so that the steam will pass in at the top of the fire; about halfway up the side of the furnace being about right. The steam will start the gases more rapidly and force them through the pipes.

Make sure that all connections are carefully sealed to prevent the escape of gases, as they will always follow the lines of least resistance and pass out through a very small crevice. The only danger with a plant of this size is from fire, wherefore it should be built away from inflammable materials. It will not make sufficient gas to be of injury to any living being.

Webfoot Attachments for Swimmers

In order to make the feet more effective in swimming, webfoot devices are frequently used. A simple arrangement for this purpose is shown in the illustration. It consists of three thin sections of metal, or wood, fastened together on the back side with spring hinges, which tend to remain open, thereby keeping all the sections spread out in one straight surface. The center section should be cut to conform closely to the shape of the foot, or it will produce considerable resistance during the inward stroke of the foot, and tend to stop the forward movement of the swimmer. Straps should be provided for attaching the device to the foot; one to fit across the toes, and the other adjusted around the ankle by a buckle.

When using the device, the upward or forward stroke of the legs will cause the wings to brush against the water, creating sufficient resistance to overcome the slight force of the springs, thereby pushing the wings parallel with the direction of the stroke. Dur-

ing the opposite, or pushing, stroke, the resistance of the water combined

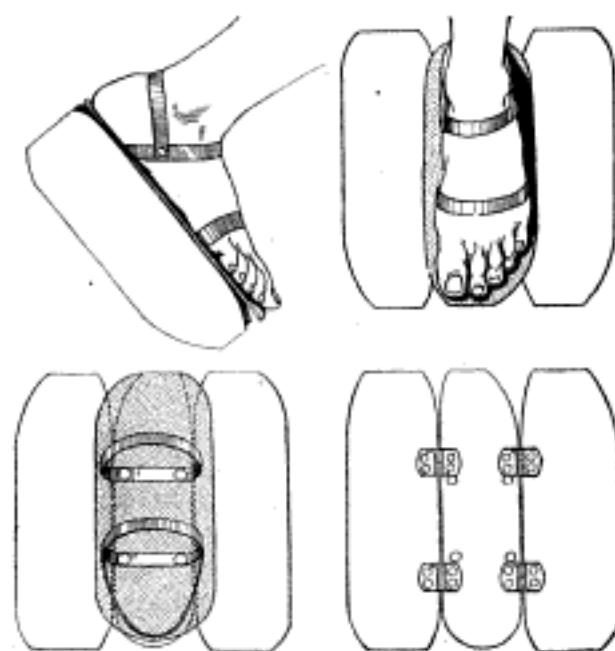

Device for Attaching to the Feet to Work Like Webfeet

with the opening tendency of the hinges will quickly spread the wings out flat, greatly increasing the effectiveness of the feet.—Contributed by J. B. Laplace, New York City.

Grape Arbor Built of Poles

In building outdoor structures, such as grape arbors, pergolas, or arches, it is not necessary to use sawed lumber, as they can be built as substantial, and frequently more artistic and cheap, of poles.

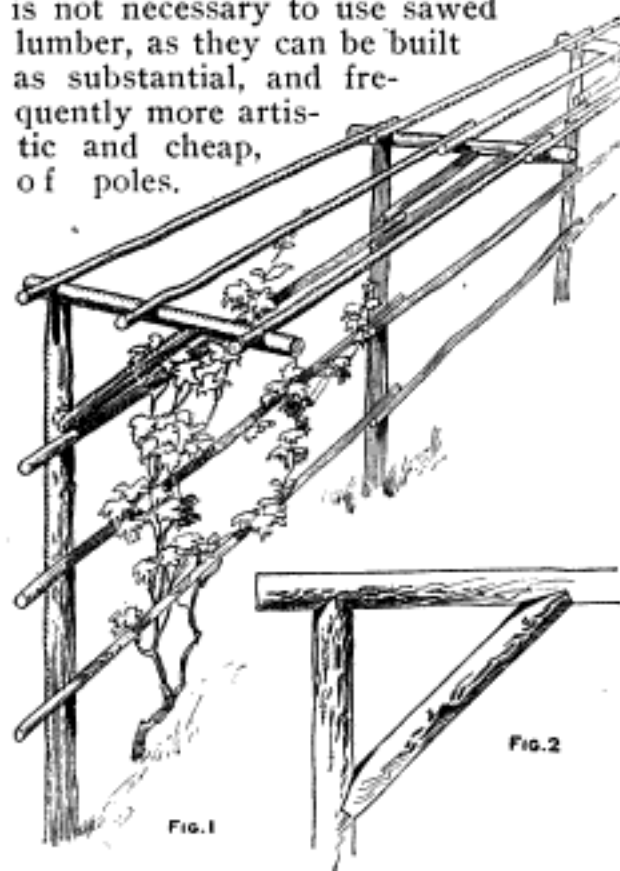

Arbor Made of Poles Which are Supported by One Row of Uprights

These are easily obtained, especially in the country or in the smaller cities where there usually are many trees and gardens.

The illustrated grape arbor consists of but one row of uprights. Across the top of each is placed a horizontal support for the roof poles, as shown in Fig. 1, which is carried near its outer end by an inclined brace. The brace should be connected at each end with a toe joint, as shown in Fig. 2. The upper end of the upright is beveled off on both sides, to form a double-splayed joint with the crosspiece. In order to securely bind the roof of the arbor, the long poles, or roof beams, should be notched near each end to fit over the supports. Similar notches in the poles forming the side of the arbor are to fit the uprights, thereby binding them together and preventing toppling over. Each set of long poles connecting two

uprights should have the end notches the same distance apart, one pole being used as a gauge. All the joints and notches may be cut with a sharp hatchet.

In setting the arbor, the uprights should first be assembled complete with braces and roof supports, and placed in the ground a distance apart corresponding to that of the notches on the long poles. The uprights being set, the long poles are placed and fastened with nails.—Contributed by W. E. Crane, Cleveland, Ohio.

Forcing Fruit Blossoms for Decorations

Twigs trimmed from the fruit trees rather late in the season had quite large buds on them, and we experimented with them in this way: A large box was filled with wet sand, and the twigs were stuck in it and the box set in the warmest corner of the yard. The buds soon swelled and burst into bloom. We then arranged a smaller box of sand and put the blooming twigs into it, and took it into the house where they remained fresh for several days.—Contributed by A. Louise Culver, Oakland, Cal.

Corner Cleaner Attached to a Scrubbing Brush

Dirt will accumulate and harden in the corners of a floor and the base-board just because the end of the scrubbing brush will not enter them. The water gets in with the dirt and leaves a hard crust. This may be easily cleaned out if a metal point is attached to the end of the brush handle, as shown in the illustration. It is used as a scraper to break up the crust and clean it out where the bristles will not enter.—Contributed by L. E. Turner, New York City.



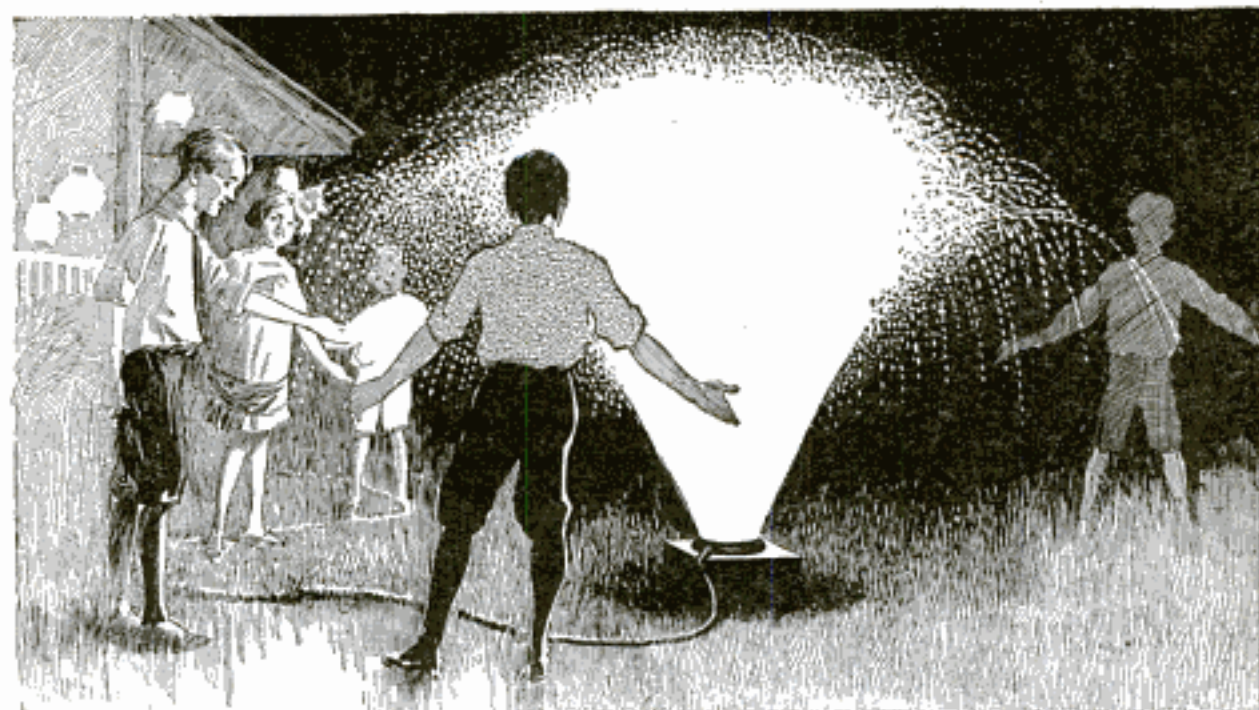

The Electric Globes, as They Light beneath the Spray, Illuminate the Top, and the Light Follows the Streams of Water So That They Appear Like Streams of Light

An Electric Fountain

By WALTER P. BUTLER

To make the grounds as attractive as possible for a lawn party given one night, I constructed an electric fountain which at first appeared to be an expensive proposition, but when completed the desired effect was produced without any expense whatever, as I had the things used in its construction on hand.

A light frame, 9 in. square, was made of $\frac{3}{4}$ -in. material, as shown in Fig. 1, and a grooved pulley was attached exactly in the center on the under side of the crosspiece. A turned stick, A, 2 in. in diameter and $2\frac{1}{2}$ in. long, was fastened to the face of the pulley so that it turned true as the pulley and frame revolved. A hole was then bored centrally through the three parts, the frame crosspiece, the pulley, and the turned stick, of a size to fit a spindle about $\frac{3}{8}$ in. in diameter.

A box was procured, large enough for the frame to turn in freely, and a block of wood was fastened centrally in its bottom, which had a $\frac{3}{8}$ -in. pin set in a hole bored in the center. The pin may be of hard wood, but it is better to use metal. A bolt, or piece of rod, will answer the purpose of a pin very well.

A small battery motor—I had one on hand and did not need to purchase one—was fastened to one side of the box so that its pulley was in line with the pulley on the lower surface of the frame. The batteries to run the motor were placed in the corner of the box, where the revolving frame would not touch them. The motor may be of larger current capacity, however, and run direct on the current used for the lamps.

About $\frac{1}{2}$ in. from the lower end of the turned piece A, a brass strip was fastened around it. This work should be neatly done, and the joint soldered and smoothed, so that the outer surface will not catch on the brush used to make the contact. This ring can be better made by cutting the width from a piece of brass tubing of a size to fit on the turned stick A. About $1\frac{1}{2}$ in. from the lower end four segments of a circle were fastened so as to make a space of about $\frac{1}{4}$ in. between their ends. This construction is clearly shown in Fig. 2. A cross section, showing the wire connections from the brass ring and segments to the lamps and where they lead out on top, is shown at B. The contact brushes

consist of brass strips fastened with bolts to an upright, C, made of wood and attached to one edge of the block in the bottom of the box. Two nuts are used on each bolt, between which are fastened the lead wires from a source of current.

The wiring diagram is shown in Fig. 3. The wire D from the ring is run to the brass base of each lamp, of which there are four. The wires E, from each segment, are connected with solder to each screw ferrule of the lamps, and the ends are left bare and open, as shown, between the lamps.

A lamp is fastened to each corner of the frame on top, as shown in Fig. 4, with a piece of wire wrapped once around the screw ferrule and the extending ends held with staples. The wire used should be heavily insulated or, if it is of iron, a rubber tube slipped over it. A piece of tin, or bright metal, is placed beneath each globe for a reflector.

A glass plate was used to cover the box, and a lawn spray of the fountain type was placed on the glass. The globes, as they light beneath the spray, illuminate the top and the light

A Mystery Coin Box

The effect of this trick is as follows: A small metal box, just large enough to hold a half dollar and about $\frac{1}{2}$ in. high, with a cover that fits snugly over the top, is passed out to be examined, and when handed back to the performer he places it on the finger ends of his left hand, and a half dollar is dropped into it and the cover put on. The box is then shaken to prove that the coin is still there. The performer then taps the box with his fingers and picks it up with the other hand and the coin will appear to have fallen through the bottom. Both the coin and box are then handed out for examination.

This seemingly impossible effect is made when the performer places the cover on the box. The box is resting on the fingers of the left hand and the cover is held between the thumb and forefinger of the right hand, but just before placing the cover on, the box is turned over with the right thumb, and the cover is placed on the bottom instead of the top.

The trick can be done within a foot of the spectators without their seeing

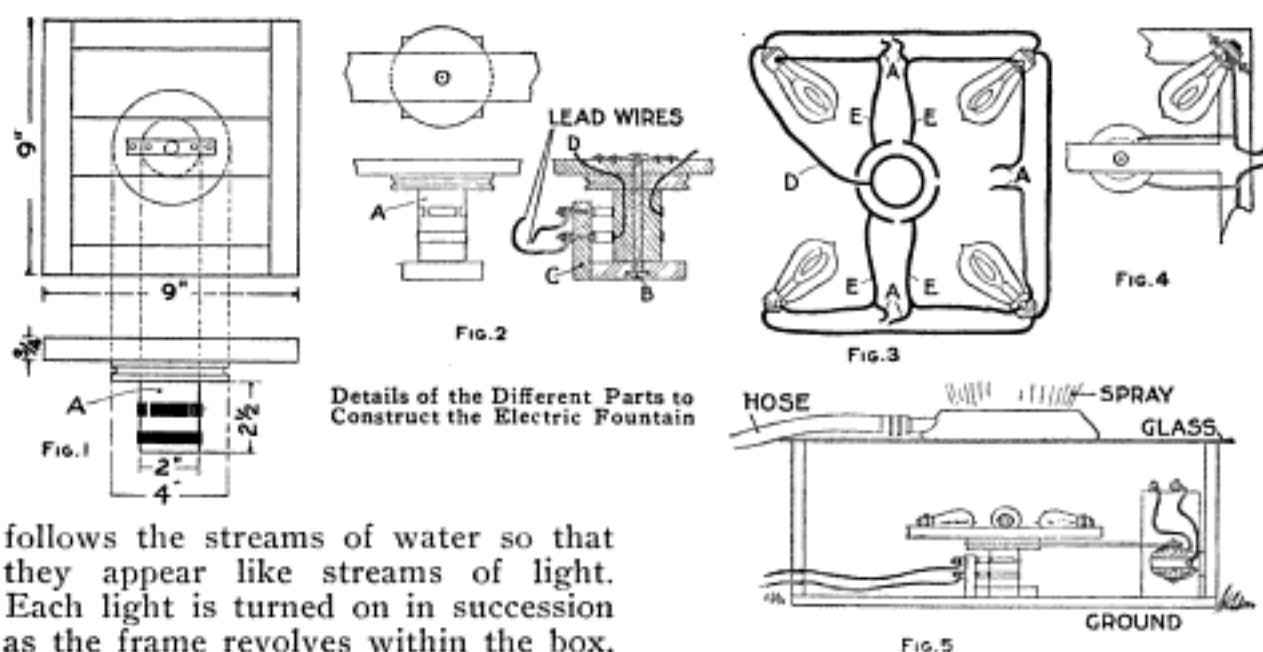

follows the streams of water so that they appear like streams of light. Each light is turned on in succession as the frame revolves within the box, and by using globes of different colors, an exceedingly beautiful effect is obtained. If the bared ends of the wires are twisted together between the globes, these will all glow at once.

the deception. It is a good plan to hide the box with the right hand when placing the cover, although this is not necessary.



As a General Thing, the Veteran Fly Fisherman Prefers to Wade with the Current, and Fishes the Water in Front of Him by Making Diagonal Casts across the Stream

Fishing - Rod Making and Angling

By STILLMAN TAYLOR

Am. N. 8 - 823

PART IV—Trout Fishing with Fly and Bait

How to Cast the Fly

TO be able to cast the artificial fly a distance of 50 ft., or more, and let the feathered lure alight upon the desired bit of water as lightly as a falling leaf is no small accomplishment, for fly casting is an art, and to become an expert, much practice is necessary. The personal assistance of a skillful caster is not often available, but if the angler will follow the suggestions outlined, a beginner will soon grasp the knack of handling the fly rod, and the casting will steadily improve with practice. As the knack of handling a gun is best gained, not in the field, shooting live game, but through shooting at targets, so may the art of fly casting be more quickly acquired by intelligent practice conducted away from the stream, in the back yard, or any other place roomy enough to swing the rod and a moderately long line. By practicing in this way, the angler's attention is focused upon the cast and is not partly occupied with the excitement of fishing. To make a good beginning, let the reel contain about 25 yd. of common, braided, linen line (size E is about right) and instead of a fly, or hook, affix a small split shot to the end of the line. It is well to begin with a cheap rod and save a good outfit, and if the angler learns how to make a fairly long and accurate cast with a common rod, he may feel assured that

he can even do better with a first-rate outfit.

The first point to observe in making the cast is to grip the rod correctly, and this is done by grasping the rod at the right point where it balances best. By shifting the hand about, this point of balance is quickly found, for at no other point will the rod "hang" well in the hand. In casting, the reel is turned to the under side of the rod with the thumb extended along the top of the grip, as shown in Fig. 1. Taking up an easy casting position, with the left foot slightly advanced, pull from the reel



Fig. 1—
The Proper Way
to Take Hold
of the Handle
with the Reel on
the Under Side

about 25 yd. of line and let this slack line fall in coils upon the ground in front; bring the rod up slightly above the horizontal, as shown in Fig. 2, and with a quick snap of the wrist, avoiding shoulder or body movement, throw the tip upward, checking it sharply as

soon as the tip is carried over the shoulder about 25° beyond the vertical plane as in Fig. 3. This snappy upstroke of the rod makes the "back cast," by projecting the line high in the air, and carries it well behind the angler. Before the line has fully straightened out behind, and before it has an opportunity to fall much below the caster's shoulders, the rod is snapped forward with a quick wrist-and-forearm movement, which throws the line forward in front of the fisherman and in the direction he is facing, which finishes the cast with the rod in the position shown in Fig. 4.

Long and accurate fly casting is much more a matter of skill than muscle, and while some fly fishermen cast directly from the shoulder and upper arm, and thus use a considerable amount of muscular force in making the cast, this cannot be regarded as the best method of casting. The great elasticity of the fly rod ought to be taken full advantage of by the caster, and if this is done, casting will be naturally accomplished by the wrist and forearm. To make strenuous efforts to hurl the fly through the air, using an arm or body movement, is extremely tiring after an hour or so of fishing, while if the cast is made from the wrist, aided by the forearm, the snap of the rod may be depended upon to project the fly to greater length of line and allow it to fall close to the desired spot, lightly and without splashing.

Timing the back cast is the most difficult detail of fly casting, because the line is behind the angler and the

eye cannot aid the hand. The novice will soon acquire the knack of casting, however, if he will remember to keep the elbow close to the side, and to keep the line well up in the air when making the back cast, and to begin the forward movement before the line has fully straightened out behind him. After a little practice, the hand will feel the slight tension communicated to the rod as the line begins to straighten out, and this should be taken advantage of to correctly time the forward movement. Counting

"one" for the upstroke, "two and" for the interval required for the line to straighten out in the rear, and "three" for the forward movement, is also a good way to time the cast.

At the beginning the caster should make no attempt to secure distance. Accuracy and delicacy in placing the fly on the water is of much more importance than length of cast in trout fishing, and to attain this end, it is a good plan to place a newspaper about 25 ft.

distant and try to drop the end of the line on this mark. When the caster can drop the line on the target lightly and with reasonable accuracy, he may feel justified in lengthening his cast. Other casts than the overhead cast just described are occasionally used, as the Spey, switch, wind, and flip casts, but the overhead cast is mostly used, although it is much more difficult to master.

To make the Spey cast, the angler requires a rapid stream which will carry the line downstream until it is

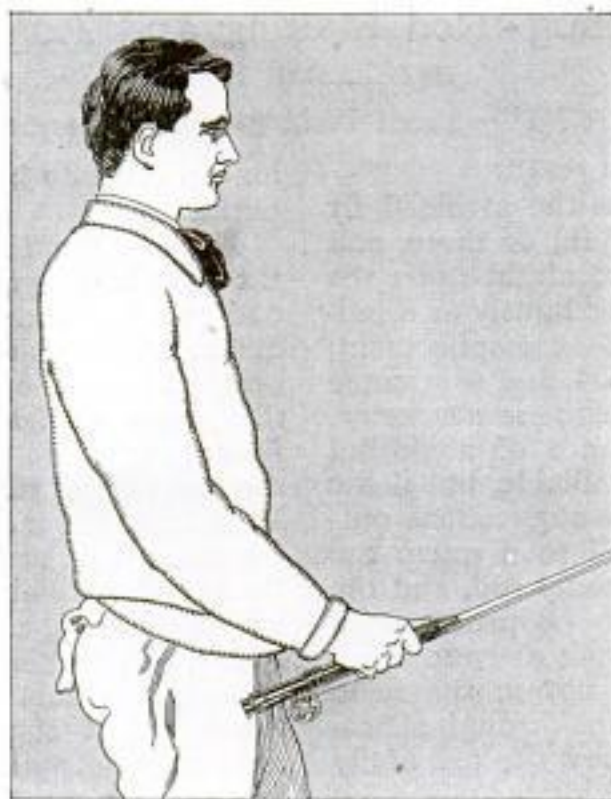

Fig. 2—Begin the Cast with the Rod in a Position Just above the Horizontal Plane

straight and taut, the tip of the rod being held as long as possible to accomplish this end. The rod is then raised high in the air with a quick wrist movement, which lifts the line from the water to the extreme end, then without pausing the rod is carried upstream with just sufficient force to let the fly fall just above the angler. The line is now on the reverse, or upper, side of the fisherman, when with a sweep of the rod the line is projected over the water's surface—not along the surface—in the manner used in making the overhead cast.

The switch cast is sometimes useful when trees or rocks are immediately back of the fisherman, thus preventing the line from extending far enough backward to make the overhead cast. In making this cast the line is not lifted from the water, but merely to the surface by raising the tip of the rod. The line is dragged through the water by carrying the tip in the direction one is standing until it is as far in the rear as the obstructions will permit. By a quick downward sweep of the rod the line is projected with sufficient force to roll it forward in a large coil or loop, much as a wheel rolls on a track.

The wind cast is a modification of the switch cast, but easier to make. The caster brings his line almost to his feet, and with a quick downward motion of the rod the line is thrown

in a long loop against the wind. The underhand and the flip casts are so simple that it seems almost unnecessary to describe them. Both are short casts and are only used when the angler is fishing in an overgrown stream. The underhand cast is really a side cast, inasmuch as the short line is lifted from the water in a loop and propelled in the desired direction by a side sweep of the rod. The flip cast

is made by holding the fly between the thumb and finger and with a few coils of line in the right hand. Bend the rod like a bow, release the fly suddenly, and the snap of the rod will project it in the desired direction and allow it to drop lightly like a fly.

Handling the Flies in the Water

As a general thing the veteran fly fisherman prefers to wade with the current and fishes the water in front of him by making diagonal casts across the stream. A good fisherman will systematically cover every inch of good water and

little will be left to chance. The novice is inclined to fish his flies in a contrary manner, he casts more or less at random, and is as likely to splash the flies recklessly about in the most impossible places as he is to drop them in a favorable riffle or pool. To be able to pick out fishable water, the angler should know something about the habits of the trout, their characteristics at the several seasons of the fishing

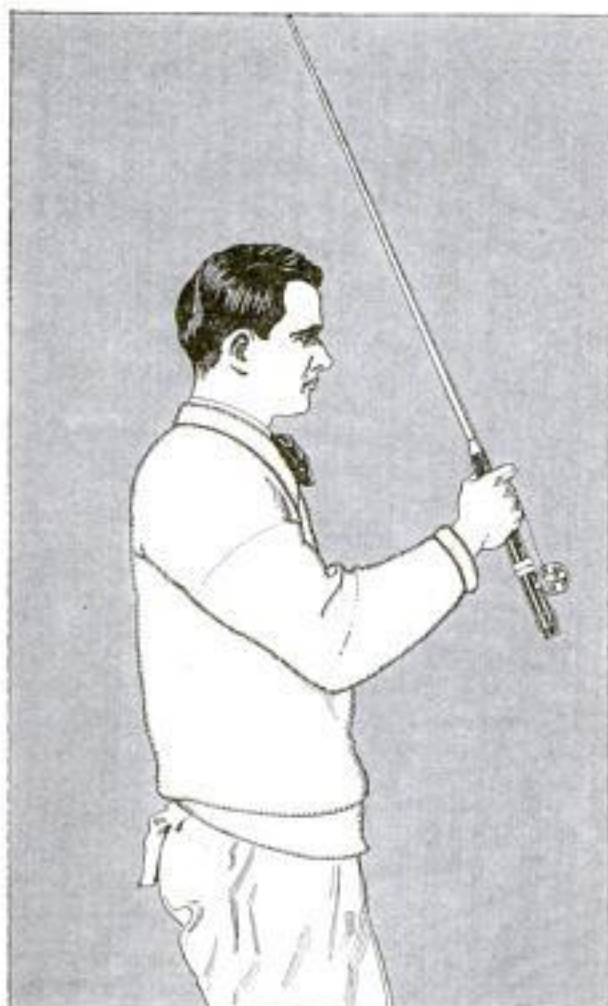

Fig. 3—The Rod is Quickly Checked When It is Carried over the Shoulder About 25 Degrees

year, and their habits, which differ greatly in different streams. A fishing knowledge of the stream to be visited is of much value, but if the angler knows how to make a fair cast and possesses average skill in handling flies on water, there should be no question but that he will creel a fair number of trout even though he casts in strange waters.

To imitate the action of the natural insect is the most successful manner of fishing the flies, and as the natural fly will struggle more or less when borne down with the current, the fisherman endeavors to duplicate this movement by making his artificial fly wriggle about. This motion must not be overdone, for if the flies are twitched and skipped about, or pulled against the current, the wary trout will refuse to fall for any such obvious deceit. A gentle motion of the wrist will cause the fly to move somewhat as the natural insect will struggle.

In making the cast do not cast directly down or upstream, but across the current at an angle. Let the flies fall upon the water as lightly as possible, so that the water will carry them downstream over the likely places where the trout are hiding. Keep the line as taut as possible by drawing the slack in with the left hand. The flies should not be allowed to soak in the water, neither should they be retrieved in haste. The experienced fly caster will invariably fish with a wet line, that is to say, with a slightly submerged fly, and will let the flies drag over as much

water as possible before making a second cast. Owing to the fact that trout lie with their noses pointing upstream awaiting their food carried down by the current, the caster will naturally take pains to float his flies downstream with the leader fairly taut. To neglect this detail and allow the leader to float in a wide loop near or before the flies is slovenly fishing, and few trout will strike a fly presented in this amateurish fashion.

Early in the fishing season, and when the stream is flooded and discolored

after a heavy rain, it is a good plan to fish the flies below the surface. Fishing in this manner makes it more difficult to tell when to strike a fish, and some little practice is needed to determine the opportune moment by feeling the slight tension on the line. Many fish will be pricked to be sure, but some trout will be creeled, and fishing with the submerged fly is sometimes the only way trout can be taken.

On fair days and in smooth

water, better luck may be expected when the fly is kept upon the surface, and this is easily managed by keeping the tip of the rod well in the air. Often the fisherman can take advantage of a bit of floating foam, and if the fly is cast upon it and allowed to float with it downstream, the ruse will often prove effective.

The trout is a hard striker and it is not unusual to have a trout rush ahead of the fly in his attempt to mouth it. In rapid water the savage rush of the fish is sufficient to hook it securely,

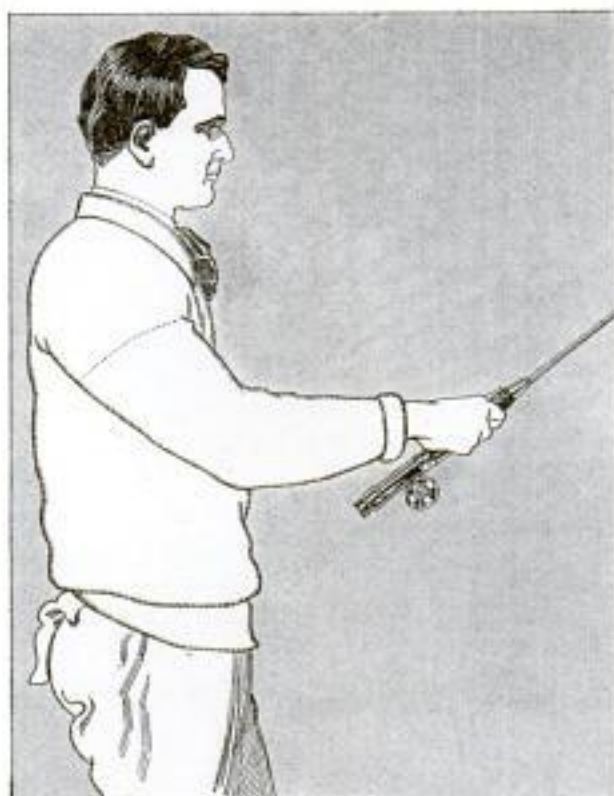

Fig. 4—The Cast is Finished by Throwing the Line Forward with a Quick Wrist-and-Forearm Movement

but when casting in quiet pools, the hook is imbedded by a snap of the wrist. At what exact moment to strike, as well as the amount of force to use, depends upon circumstances. When fishing in small streams and brooks where the trout run small, much less force is necessary to hook the fish, but in quiet water and in larger streams where 2 or 3-lb. trout are not uncommon, the fish may be struck with a smart upward jerk of the forearm and wrist. So far as my experience goes, the matter of striking is governed by the temperament as well as the judgment of the angler. The deliberate thinking man is likely to strike too late, while the nervous individual, striking too early, is apt to prick the trout and roll him over.

The best time to fish for trout is when they are feeding on the surface; and in the early days of spring, when there are few flies about, the warmer part of the day, say, from 10 in the morning to 5 in the afternoon, will prove to be the most successful time. Later on, when flies are numerous, good luck may be expected at an early hour in the morning, and in the hot summer months the cooler hours of the day may be chosen. Of course, there are many exceptions, since there are many cool days in summer, as well as exceptionally warm days in spring, and these changes of weather should be considered. However, extremes are not likely to make good fishing, and the trout will not rise as freely on cold, windy days, nor will they fight as gamely. On hot days, too, not so much luck can be expected during the hours of the greatest heat—12 to 4—but a good basket of trout may be creeled early in the morning or late in the afternoon of summer. A bright, clear day is usually the best for fly fishing, because the sun brings out more flies, but a warm rain, or even a fog, is also considered good fishing weather.

Among the live baits available for trout fishing are the minnow, white grub, cricket, grasshopper, and other insects, and last, but by no means least,

the common angle or earthworm. The minnow is beyond a doubt the most enticing morsel that can be offered to a hungry trout, and a minnow may be reckoned to secure a rise when other baits fail. The inconvenience of transporting this bait is a great drawback, and as minnows are delicate fish, a minnow bucket is necessary for their preservation. This means a lot of trouble, as the water must be frequently changed or aerated, and this labor, together with the difficulty of carrying a bulky pail through the brush, makes this desirable bait almost impossible for stream and brook fishing. The salt-water minnow, known as a "shiner" or "mummychug," is a topnotch trout bait, and being much tougher than the fresh-water minnow, makes a bait often used by anglers residing near the seacoast.

The white grub, or larva of the so-called May beetle, is a good bait available for early-season fishing, and may be obtained in the early spring months by spading up grass land. The grub is about 1 in. long, and of a creamy yellow color with a darker head. It may be kept a month, or more, by putting it in a box with a number of pieces of fresh turf.

Crickets, grasshoppers, and many other insects, make good baits, while the earthworm is a good all-around bait for trout. A supply dug some days before and kept by packing in fresh moss and slightly moistening with milk and water will prove more attractive in appearance and the worms will be tougher and cleaner to handle than when carried in earth.

Other good baits include the fin of a trout, and if this is used in combination with the eye of the same fish, it forms an attractive lure. In using this bait, do not puncture the eyeball, but hook through the thin flexible skin surrounding the eye. A fat piece of salt pork, cut into pieces 1 in. long and $\frac{1}{4}$ in. wide, makes a fairly good bait. Spoons and other spinning baits are presumably attractive, but few sportsmen use them when angling for so fine a fish as trout.

A Table Box for Campers

By GEO. J. EASTER

A very useful combination packing box and camp table may be made from a coffee or other large box. If a box with a three-ply top is available, it makes a neat appearance, but this is not essential. A box, 14 in. deep, 20 in. wide, and 29 in. long, outside meas-

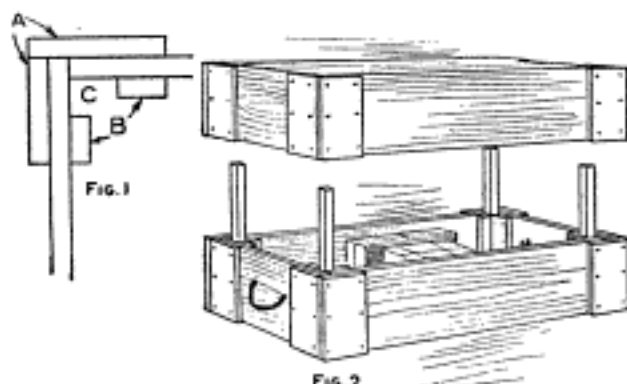

The Strips in the Corners of the Boxes Form Sockets for the Legs

urements, is convenient, as it will slip under the seat of a spring wagon, and is of such a size that a person's knees will pass under it when used as a table.

Saw the box in two on the center line of the narrow way, making two uncovered boxes of the same size and depth. The corners of each box should be well braced on the outside, as shown at A, Fig. 1. The strips B are fastened to the inside of the box to

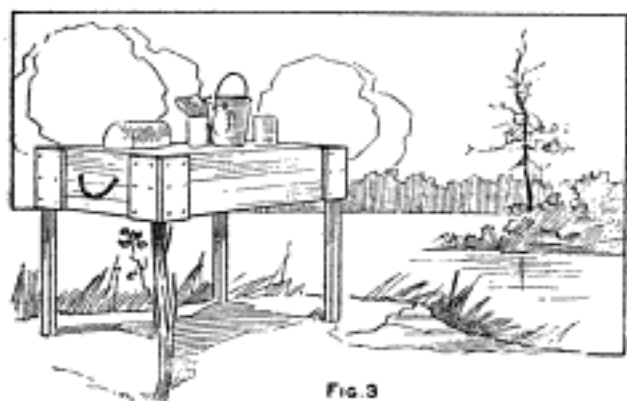

Each Half of the Box Inverted is Used as a Table Top on the Legs

form sockets, C, for the legs. The strips are $\frac{1}{2}$ in. thick, $1\frac{1}{4}$ in. wide, and as long as the box is deep. Four legs, about 12 in. long and of such size

as to fit in the sockets, are used for holding the boxes together in transit. Rope handles are fastened in the ends of each box, and also a hook and eye, which are used to lock them together.

To pack the boxes place one half open side up, and insert the legs, as shown in Fig. 2. Then fill it and extend the packing to the level of the leg ends; slip the other half of the box on the legs, and fasten the two with the hooks. If properly roped, such a box will be taken as baggage. Canvas, and other articles which will be removed at once upon arrival in camp, rather than provisions, should be packed in this box, so that it can be converted into a table with the least possible work.

To make one table, or two, of the box, remove the packing legs and insert long legs in the sockets of each section. A set of eight legs, 30 in. long, take up very little space, and can be carried diagonally in the bottom of the box. A piece of oilcloth can be wrapped around them and used later as a cover for the table. The legs should fit loosely in the sockets to provide for the swelling in damp weather. Ordinarily they can be wedged to make them rigid. The table is shown in Fig. 3.

Novel Homemade Picture Frames

Pictures can be mounted cheaply and artistically on stiff paper, to make them serviceable for decorating the summer home or camp cottage, without having them placed in a wooden frame. For this purpose a "natural-surface" drawing paper should be used, each sheet being sufficiently large to allow a border all around. With the picture properly centered and marked off, the frame can be fixed. Sets of parallel slots can be cut all around in the border, and a suitable ribbon drawn through so that it is held in place only by the narrow strips of paper. On each of the four

corners, a rosette, or similar decoration, can be placed. Ribbons harmonizing with the subject of the picture should be used; for example, a marine scene could have a blue ribbon; fields and brooks, some shade of green; while flowers would probably be best set off by some delicate pink shade.

Another means of decorating the border is to choose some appropriate illustration from a newspaper, or magazine, and carefully trace this outline with carbon paper all around the frame. These figures could then be colored as desired. Profile pictures are best for such work, as they are most easily traced. To be in harmony with the picture, cuts such as captains, sailors, or ships would be suitable for marine

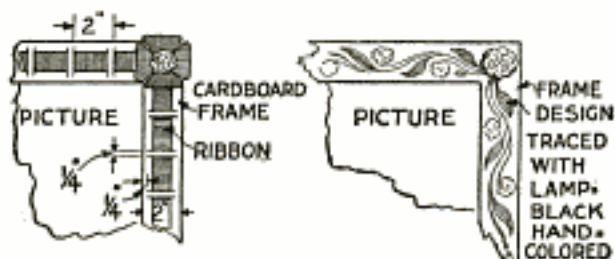

The Edges of Cardboard Extending Out from a Picture Made to Represent a Frame

scenes; soldiers and guns, for war scenes; and trees or flowers, for landscapes.—Contributed by J. B. Murphy, Plainfield, N. J.

Rectangular Opening to Use over Camera View Finder

Ordinary view finders on cameras, having the cut-out in the shape of a Maltese cross, are quite confusing to some camera users. To overcome this difficulty, I cut a piece of celluloid to the shape shown, and in taking a picture, the proper opening is held

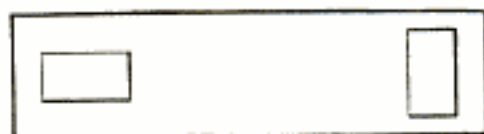

The Rectangular Opening Allows Only That Portion of the View to be Seen Which will Show on the Picture

over the view finder so that only the view that will appear in the picture can be seen.—Contributed by E. Everett Buchanan, Elmira, N. Y.

Clipping File Made of Envelopes

Handy pockets for holding notes, or small articles, may be made by anyone from ordinary envelopes. The



The Flaps Hold All the Envelopes Together, Producing a File of Several Compartments

gummed flaps of the envelopes are stuck together after spacing the envelopes to allow a small margin at the end on which the contents of each separate pocket may be written.—Contributed by H. Goodacre, Wolcott, Ind.

Handle for a Drinking Glass

Measure the bottom part of the glass and make a band of copper that will neatly fit it. The ends of the copper can be riveted, but if a neat job is desired, flatten or file the copper ends on a slant, and braze or solder them together.



Attach to the band an upright copper piece a little longer than the glass is high. To this upright piece a bent piece of copper to form a handle is riveted or soldered. The glass is set in the band and the upper end of the vertical piece is bent over the glass edge.—Contributed by William King, Monessen, Pa.

CA simple and handy pincushion can be made of a large cork fastened to any support or base with a nail or screw.

Repairing a Broken Canoe Paddle

While paddling a rented canoe one day the paddle struck a rock and snapped in two a little below the center of the handle. The

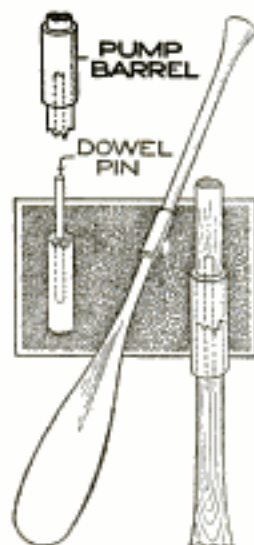

boatman laughed at the idea of trying to fix it, but after paying his price for the paddle I decided to try mending it. The barrel of an old bicycle pump was procured and I found that it fitted over the paddle at the break a trifle loosely. It was pushed on the handle out of the way. Then with a No. 8 bit I bored a hole 8 in. deep in the end of

each broken part. Into these holes, which formed one cavity when the broken ends were brought together, was forced and glued a tight-fitting 16-in. dowel pin. The outside of the handle was then wrapped with tape for about 10 in. each side of the break, and the pump barrel was forced down over this tape until it completely and firmly enveloped the broken ends.—Contributed by Clarence G. Meyers, Waterloo, Iowa.

Tightening Lever for Tennis Nets

Tennis nets are always sagging and to keep them at the proper height requires considerable attention, espe-

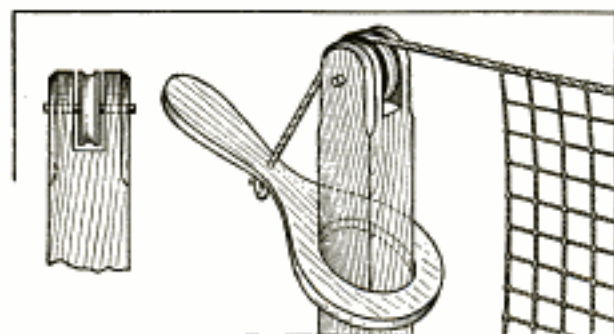

The Upper Rope on a Tennis Net Held Taut with a Lever on the Post

cially so where the posts are not solidly set in the ground. A very effective net

tightener, and one that is easy to make, is the lever shown in the illustration. One end of a piece of hardwood board is shaped into a handle the other end being left large. In the latter a hole is cut to fit loosely over the post for the net. The upper end of the post is notched and a sheave pulley is placed in it so that the groove will be in line with the net. The upper rope on the net is run over the pulley and is attached to the lever handle. A downward pressure on the handle draws the rope taut and locks it on the post. It is easily removed from the post and can be left attached to the rope and rolled up in the net when not in use.

A Desk Watch Holder

A watch holder for the desk is a great convenience for the busy worker, and many calendar devices are sold for



this purpose, yet they are no more efficient than the one illustrated, which can be made from an ordinary spindle desk file. If the wire is too long it can be cut off and the bend made in it to form a hook for the watch ring.

Cleaning Silverware

To clean silverware, or anything made of the precious metals, such as jewelry, etc., is very simple with the following method: Place a piece of zinc in a cup, dish, or any glazed ware; put in the articles to be cleaned, and pour over them a hot solution of water and carbonate of soda—washing soda—in proportions of one tablespoonful of soda to $\frac{1}{2}$ gal. of water. This is a solution and method used by many jewelers for cleaning pins, rings, chains, and many other small articles made in gold and silver.

CA machine should never be stopped in the midst of a fine cut.

How to Make Combined Kites

By C. M. MILLER

PART II—A Festooned Kite

MORE than one kite on the same framework is known as a compound kite. The one illustrated consists of three tailless kites on one long stick, called the spine. The upper one is 3 ft.; the center one, 2 ft., and the lower one, 1 ft. in width. There will be needed for the construction of this kite a stick of light wood—spruce is best, but it may be of pine or bass—7 ft. long by $\frac{1}{4}$ by $\frac{1}{2}$ in. If the wood breaks easily it will be better to increase the width from $\frac{1}{2}$ in. to $\frac{3}{4}$ in., or the stick might be made $\frac{3}{8}$ in. thick without increasing the width, but with a good spruce stick the dimensions first given will be sufficient. The stick should be straight-grained and without a twist. If the spine is twisted, the kites will not lie flat or in a plane with each other, and if one is out of true, it will cause the kite to be un-

by $\frac{1}{4}$ by $\frac{1}{2}$ in.; the center one, 2 ft. long by $\frac{1}{4}$ by $\frac{3}{8}$ in., and the lower one, 1 ft. long by $\frac{1}{4}$ by $\frac{1}{4}$ in. About

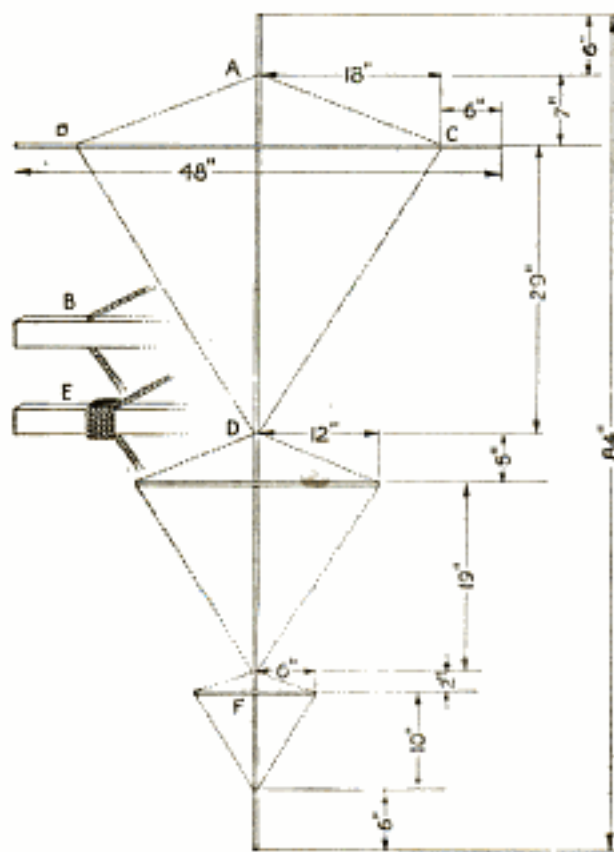

The Spine with the Bow Sticks Properly Spaced as Shown by the Dimensions

steady in the air. The bow sticks are three, the upper one being 4 ft. long

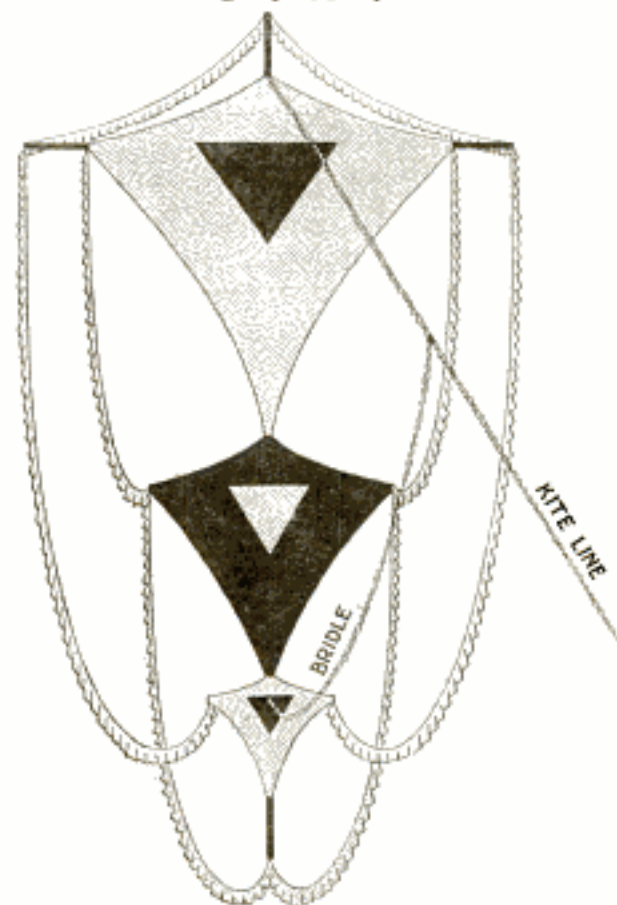

The Kite as It Appears with the Festoons Hung to the Ends of the Sticks

five sheets of tissue paper will be required, but more may be needed for color combinations. The so-called French tissue paper is much better, as it comes in fine colors and is much stronger than the ordinary tissue. It costs a trifle more, but it pays in making a beautiful kite. The Chinese rice paper is the strongest, but it comes only in natural colors.

It will be seen that the kites do not extend to the top and bottom of the spine stick. The first bow stick is placed 13 in. from the top end of the spine, and each of its ends extends 6 in. beyond the kite for fastening the festoons. The bow sticks should be lashed to the spine, not nailed. Wind diagonally around the two sticks, both left and right, then wind between the two,

around the other windings. This draws all windings up tightly to prevent slipping.

To string up the upper kite, drill a small hole through the spine, 6 in. from the top, at A, and also 6 in. from each end of the bow stick, at B and C. If a small drill is not available, notch the stick with a knife or saw to hold the string. Another hole is made in the spine 29 in. from the upper bow stick, or at D. Tie the outline string at A, then pass through the hole at C, then through D, up through B and back to the starting point at A. In tying the last point, draw up the string tightly, but not enough to spring the spine or bow. Measure carefully to see if the distance AC is the same as AB, and if CD is equal to BD. If they are not, shift the string until they are equal and wind at all points, as shown at E, to prevent further slipping. Proceed in the same way with the center and lower kite, and it will be ready for the cover.

The cover tissue should be cut about 1 in. larger all around than the surface to be covered, but turn over about half of this allowance. This will give

plenty of looseness to the cover. For the fringe festoons, cut strips of tissue paper, $2\frac{1}{2}$ in. wide, paste $\frac{1}{2}$ in. of one long edge over a string, and cut slits with scissors at intervals of 1 in. along the loose edge. After the fringe has been made, attach it as shown in the illustration. Do not stretch it tightly, but give sufficient looseness to make each length form a graceful curve and keep the sides well balanced.

To bend the bows of the upper and center kites, attach a string from end to end of each bow on the back side of the kite and spring in short brace sticks in the manner usual for tailless kites.

Attach the upper end of the bridle at A. The length of the bridle string is 87 in. and the kite line is attached to it 30 in. from A, leaving the lower part from this point to F, where it is tied to the spine, 57 in. long.

The kite should fly without a tail, but if it dodges too much, attach extra streamers to the ends of the bow sticks of the lower kite, and to the bottom of the spine.

If good combinations of colors are used a very beautiful kite will be the result, and one that will fly well.

Simple Experiment in Electromagnetism

The following simple experiment, which may be easily performed, will serve to prove the theory that there

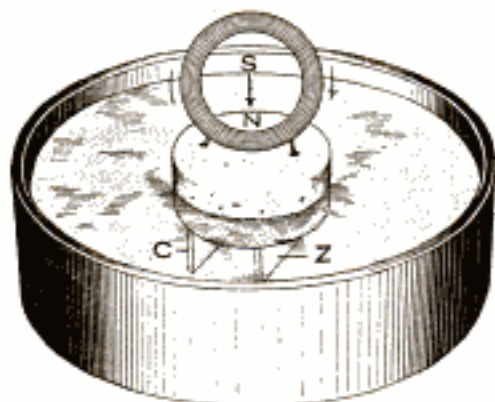

A Small Coil of Wire Mounted on a Cork Floating in Dilute Sulphuric Acid

is a magnetic field produced about a conductor carrying a current, and that there is a definite relation between the

direction of the current in the conductor and the direction, or polarity, of the magnetic field produced by the current. The current in the experiment is to be produced by a battery consisting of a small copper and zinc plate fastened to the under side of a large flat cork, as shown in the sketch, the whole being placed in a glass or rubber vessel partly filled with diluted sulphuric acid. A small coil of wire is formed and mounted on top of the cork, and its terminals are connected to the copper and zinc plates. The electromotive force generated will cause a current to circulate through the coil from the copper plate to the zinc plate. If the poles of a permanent magnet be presented in turn to the same side of the coil it will be found that there is a force of attraction between one pole of the permanent magnet and the coil, and a force of repulsion between the

other pole and the coil. If the same operation be performed on the opposite side of the coil, it will be found that the force between the poles of the magnet and the coil are just the reverse of what they were in the first case; that is, the pole that attracted the coil in the first case will now repel it, and the one that repelled it, will now attract it. Applying one of the fundamental laws of magnetism—like poles attract and unlike repel each other—it can be readily seen that the two sides of the coil are of opposite magnetic polarity.

If the direction of the current around the coil be changed, the action between the coil and the magnet will be opposite to what it was originally, and if the plates be placed in clean water, there will be no current and no attraction or repulsion between the coil and the poles of the magnet.

Double Lock for a Shed

Four boys using the same shed as their workshop wished to lock it so that any one of them could enter alone. Usually only two keys are supplied with a lock, so two locks were purchased and applied to the staples as shown. Each boy was provided with a key and could enter at his pleasure.—Contributed by George Alfred Moore, Versailles, O.



Ferrules for Tool Handles

Discarded metal caps from broken gas-mantle holders should be saved, as they will come in handy for several purposes, such as ferrules on wood handles, and the like. The wire screen is removed from the end, and the cap is fastened to the handle with a nail or screw.—Contributed by James M. Kane, Doylestown, Pa.



Mallet Made from Wagon-Wheel Felly and Spoke

When in need of a mallet and if an old broken and discarded wagon wheel is at hand, one can be made quickly as

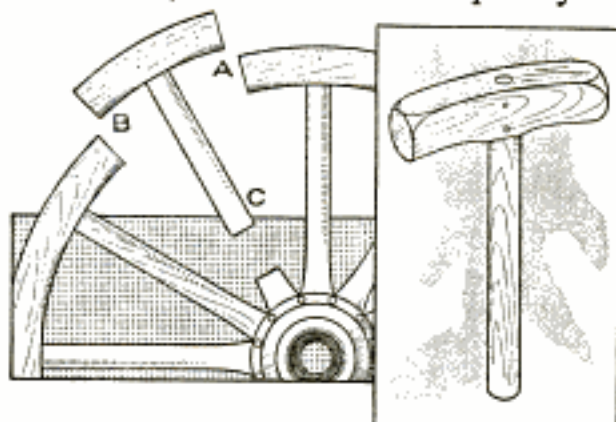

A Well-Shaped Mallet Made from a Section of a Wagon-Wheel Felly and Spoke

follows: Cut through the rim at A and B, and through the spoke at any distance desired, as at C, for instance. The spoke is dressed into the shape of a handle and sandpapered smooth. The section of the felly is used as head and is shaped properly and fastened to the handle with two nails.—Contributed by Mark Gluckman, Jersey City, New Jersey.

A Mystery Sounding Glass

Procure a thin, tapering drinking glass, a piece of thin, black thread, about 2 ft. long, and a long lead pencil. Cut a small groove around the pencil near one end. Make a slip noose in each end of the thread and slip one into the notch and place the thin glass in the other with the thread near the top. When the pencil is revolved slowly the thread will be wound on it slightly and it will slip back with a jerk that produces a ring in the glass. This may be kept up indefinitely. The movement necessary is so small that it is imperceptible. The glass can be made to answer questions by two rings for "yes" and one ring for "no."

CA lighted match held to the outside of a fish-pole joint causes an expansion of the outer ferrule and allows the pole to be readily pulled apart.

INTERESTING NEW PATENTS

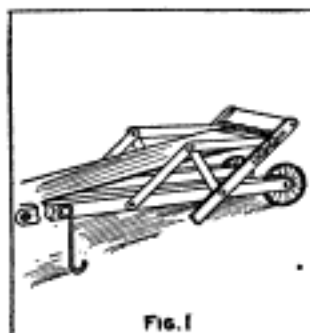

Fig. 1

ADJUSTABLE WHEELED STRETCHER (Fig. 1)—The purpose of this invention is to provide a stretcher that can be trundled about like a wheelbarrow and can be adjusted to the shape of a bed or to that of a reclining chair, or to shapes intermediate between the two. The mattress is supported on springs which are attached to the back of the horizontal beam and to a sliding frame on the diagonal beam at the front. The springs and mattress are stretched tight or made slack by extending or collapsing the diamond frame, the connections at the front and back of the frame being made adjustable for this purpose.

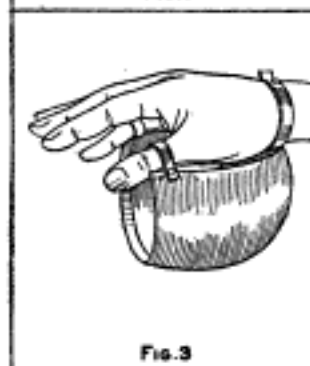

Fig. 3

PARASOL HANDLE WITH VANITY CASE AND COIN HOLDER (Fig. 2)—The parasol handle is provided with a hemispherical lid, on which is carried a hinged mirror, as shown. In the space thus provided in the lid is a receptacle for a powder puff, while the handle portion is hollowed out and equipped with holders for coins of three denominations. With the lid closed and fastened with a spring clasp, the handle has the appearance of an ordinary handle with rounded head.

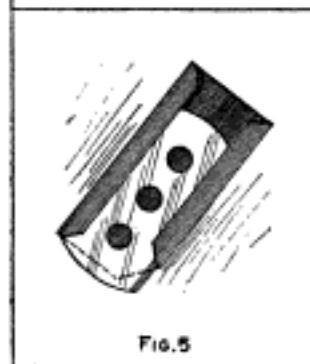

Fig. 5

FRUIT HOLDER (Fig. 3)—This device consists of a hollow receptacle open at the top and front and held to the hand by straps passing around the wrist, thumb and little finger. The purpose of the invention is to provide a holder into which the fruit can be thrust by the fingers as it is picked, the holder being so shaped and attached to the hand as to leave the fingers free.

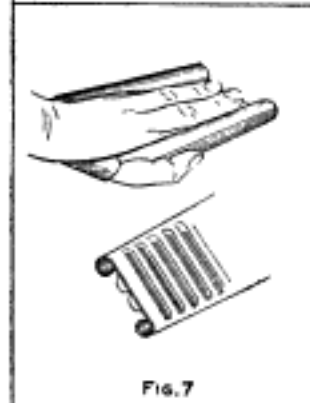

Fig. 7

AIR SYSTEM FOR HOSPITALS (Fig. 4)—This apparatus is designed principally for supplying patients in hospitals with fresh air which may be heated or cooled as required. The outdoor air is led through a pipe into a chamber where it is heated or cooled. From this chamber a pipe system distributes the air to inhaling devices used by the patients. The exhaled air passes through a second pipe system to a vertical air pipe of large cross section, which has its outlet placed higher than the inlet of the fresh-air pipe to induce a natural draft.

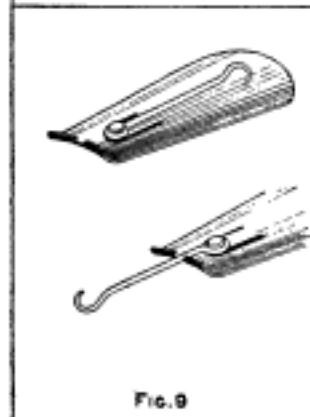

Fig. 9

CUTTER FOR RIPPING SEAMS (Fig. 5)—The blade is held in a metal holder which has one corner rounded to expose the edge of the blade. When the cutter is being used, the blade is slid forward to expose as much of the edge as is required, and is held in position by pressure of the fingers. When not in use, the blade is slid back in the holder, which serves as a shield for protecting the edge.



Fig. 2

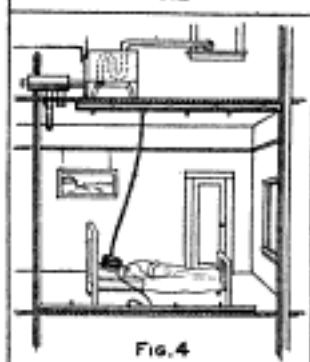

Fig. 4

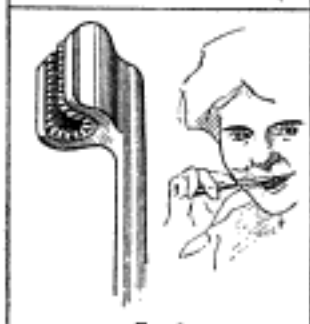

Fig. 6

TOOTHBRUSH (Fig. 6)—This brush is made to fit over the teeth and cleanse the inner and outer sides at one operation. The body of the brush has a channel shape and in this the bristles are arranged as shown.

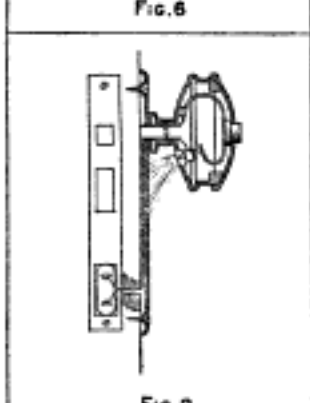

Fig. 8

WASHING DEVICE (Fig. 7)—This device has the form of a mitt with corrugated scrubbing surface, and may be made of metal or rubber. It is held in place by the upturned sides which engage the first and fourth fingers, and by an aperture through which the thumb is passed.

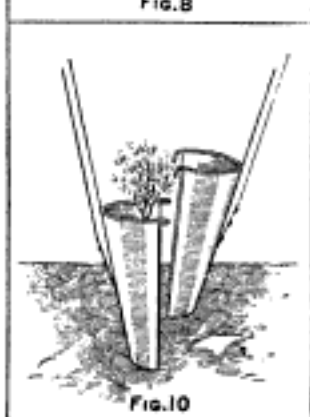

Fig. 10

DOOR KNOB THAT ILLUMINATES KEY-HOLE (Fig. 8)—The door knob is provided with a miniature electric lamp so placed as to illuminate the keyhole, the current being turned on by pressure on a spring push button that projects from the front of the knob. Current is supplied by a small storage battery placed in the door lock.

COMBINED SHOE HORN AND BUTTON-HOOK (Fig. 9)—The buttonhook is pivoted to the convex face of the shoehorn, and when not in use lies flat against it. It is easily swung out on its pivot to an operative position, when the shoehorn serves as a handle.

PLANT-LIFTING DEVICE (Fig. 10)—The bottom of each half is formed to a cutting edge so that it is easily thrust into the ground beside the plant.



Fig. 11

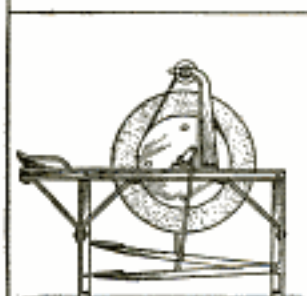

Fig. 13

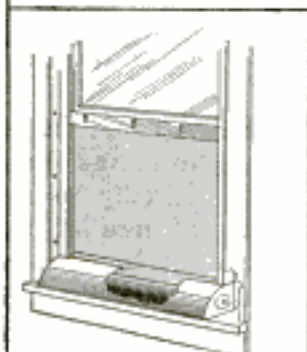

Fig. 15



Fig. 17

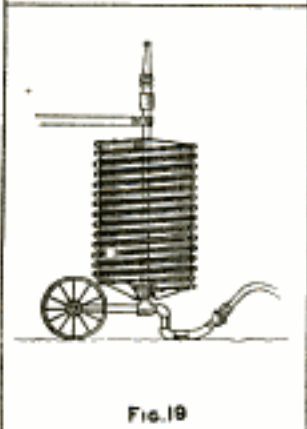

Fig. 19

When the halves are in position they are fastened together by the hook and ring connections, as shown, and the plant is lifted from the ground.

TELESCOPING AND FOLDING TENT (Fig. 11)—The feature of this invention is that the metal frame is made up of telescoping members so that the tent may be varied in size to suit the requirements. The uprights may be equipped with points for driving, or with screws for taking a grip on the ground, the purpose in either case being to connect the frame securely with the ground and make the use of guy ropes unnecessary.

BOW RUDDER (Fig. 12; American patent to a Canadian)—This device is evidently for emergency use when a ship is to be turned in close quarters. The rudder is so made that it can be drawn back out of the way when not in use.

COMBINATION GRINDING MACHINE (Fig. 13)—This machine consists of a grindstone of large diameter, above which is mounted an emery wheel. The two stones are connected by a belt so that they operate together and one serves as a flywheel for the other. Power is applied through pedals that rotate the grindstone.

TREE PROTECTOR (Fig. 14)—The protector consists of a cover that lies in surface contact with the ground, with means for sealing it to the tree trunk. It is made of material that is impenetrable to borers and other insects, and is slitted on one side so that it can be placed around the tree trunk.

WINDOW SCREEN (Fig. 15)—The screen is mounted on a spring roller fixed to the window sill and has its free end attached to the lower edge of the window sash, so that it unwinds or winds as the window is raised or lowered. The free end is equipped with a metal strip having perforations that fit over pins in the sash, and by this means the screen is easily attached or detached as desired.

SATCHEL LATCH (Fig. 16)—The purpose of this invention is to provide a lock that will prevent a handbag from opening accidentally. It consists of a disk carried on one of the frames and provided with lugs that engage perforations in a U-shaped locking bar carried on the other frame. The lugs are so shaped that the grip cannot be forced open unless the disk is turned to the proper position. The whole device is inclosed in a casing, above which projects a knob for operating the disk.

COMBINATION TOILET ARTICLE (Fig. 17)—A comb and brush are mounted on a rectangular case into which they fold when not in use. The brush is pivoted to one end of the case so that it folds over to close the top, while the comb is pivoted so that it folds into a slot in the bottom of the case.

GARMENT HANGER (Fig. 18)—The bar to which the hanger hooks are fixed slides in a rectangular support, as shown, the bottom of the support being slotted to permit movement of the hooks. The device is evidently intended to be placed in a closet, or other restricted space, the sliding bar being drawn out to give easy access to the garments.

SELF-DRAINING HOSE REEL (Fig. 19)—This reel rotates on a vertical axis and consists essentially of a hub provided with wire holders for supporting the hose. When the hose is wound on this reel it has a slope throughout its length so that the water will drain out at the bottom end. The reel is evidently intended to overcome one of the greatest faults in the horizontal reel, the holding of the water in the lower loops of the hose.

TENPIN WITH HOLLOW BODY (Fig. 20)—This tenpin is made with a hollow body, apparently for the purpose of lightness. It consists of a shell of wood reinforced with triangular ribs which project inward from the shell and encircle the interior of the pin. The head of the pin is detachably mounted on the neck.

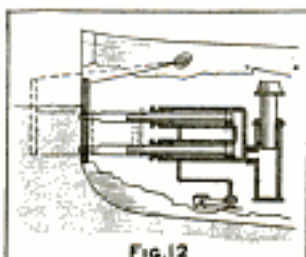

Fig. 12



Fig. 14

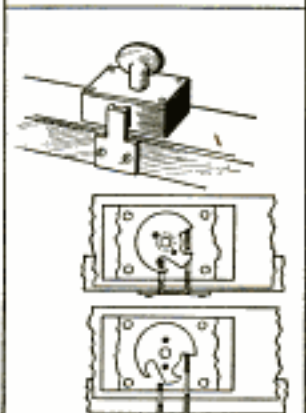

Fig. 16



Fig. 18



Fig. 20

Annie Gordon Vestal

960

4243 N. Kostner, Chicago, Ills.

POPULAR MECHANICS

* AN ATTRACTIVE BUNGALOW WITH RIVER VIEW

Home of Mr. & Mrs. C. L. Vestal, Hamilton, Ill.



* Present address 4243 N. Kostner Av., Chgo.

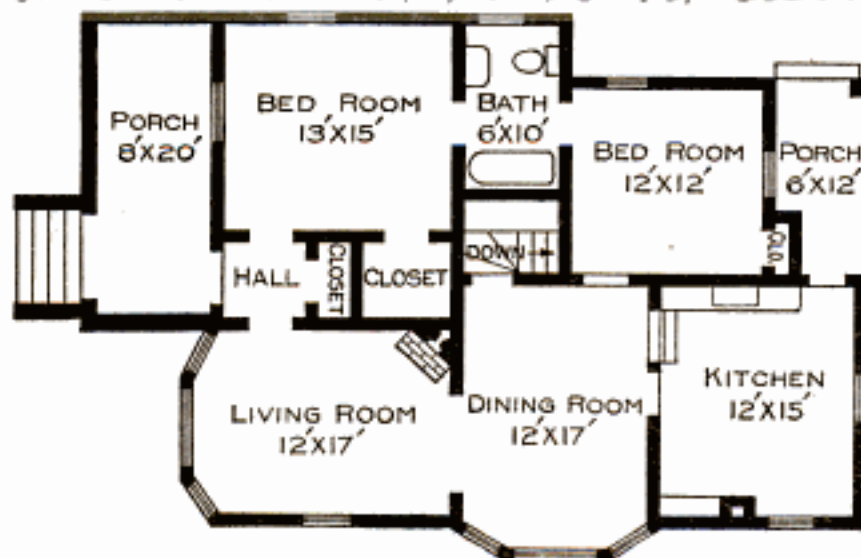

THIS five-room frame bungalow has been designed not only to suit the convenience of the housewife but to suit the surroundings as well. It is located on a high bluff overlooking the Mississippi, and the porch and bay windows were placed as they are to take full advantage of the view up and down the river. To provide a color scheme harmonizing with the sandy bluff on which the building stands, the clapboard exterior is painted in two

shades of tan, with brown trim, and white porch pillars. The roof is of shingle and the foundations of stone. All interior woodwork is stained cypress with the exception of the floors, which are of hard pine. The house is well equipped with conveniences for lessening the burden of housework, among which are three closets of large size, a built-in china and linen closet opening into both dining room and kitchen, and a kitchen sink higher than the standard and located adjacent to the cupboard in which the dishes are placed after being dried. The total cost of the building, including electric wiring and fixtures, hot-air furnace and cemented basement, was \$3,000.

IN accordance with the editorial policy of this magazine never to accept compensation in any form for what appears in our reading pages, and also to avoid all appearance of doing so, we are obliged to omit the name of the maker or the seller of any article described. This information, however, is kept on file and will be furnished free, by addressing Bureau of Information, Popular Mechanics Magazine, Chicago. [Editor]

Build Your Own Summer Cottage

Any Cottage Shown Above For Less Than \$500

Here's Good News for Outdoor Lovers

VACATION days are coming! Let's fill them with the finest of summer pleasures—a cottage on the shore. And best of all, let's build our own cottage, fashion it with our own hands. A week will do it—complete it—a Sovereign Read-Cut Summer Cottage. It's the very best of fun; the work is easy and the cost so small.

Sovereign Summer Cottages

Sovereign Read-Cut Summer Cottages are built on the same system as our famous Aladdin homes. They're built of the same wonderful material, too—the lumber that has made Aladdin famous over the world. The sawing, measuring and fitting are all done in our famous mills—by experts. Your "work" is but to put the material in place and drive the nails. And how fast it grows under your hands! You alone can equal the work of three carpenters—and without any previous experience. We'll guarantee this statement. And you will have the strongest, sturdiest and tightest cottage on the shore—and the handsomest.

Sovereign Cottages from \$100 Up—Complete

Put one year's rental into a Sovereign Cottage and it's yours for all the summers that follow. Send for the big catalog today and see for yourself how cheaply you can own your own summer cottage. You receive it at the station complete. All lumber is shipped cut to fit, together with all doors, windows, glass, shingles, hardware, locks, nails, paint and trim—everything. No delay waiting for materials—and you'll save one-third at least. Hunters' Lodges, \$100; four-room cottages with porch, \$198; seven-room cottages with 36x8 ft. porch, \$443. Whatever price, size or design you want, you'll find in the splendid Sovereign line of cottages. Shall we send you the catalog at once?

Aladdin Read-Cut Houses

The fame of ALADDIN Read-Cut Houses has spread to every hamlet in this broad country. The word ALADDIN has come to mean Quality Homes, Economy Homes—and Happy Homes. Wherever you live, some neighbor is now living happily in his ALADDIN. Let us direct you to him. Talk with him. Ask him how he enjoyed the winter in his ALADDIN—the below zero weather that tests the warmth of construction. Ask him about ALADDIN Golden Rule Service. Ask him about ALADDIN money saving prices. These tests lift ALADDIN out of the experiment class. You are as safe in your dealings with ALADDIN as with your own bank.



Aladdin Read-Cut House



What You Get

ALADDIN houses are complete. You get material absolutely guaranteed to be sufficient for the completion of your house, as follows: Sills, cut to fit; joists, cut to fit; studding, cut to fit; building paper; subfloor, cut to fit; rafters, cut to fit; roof sheathing, cut to fit; siding, cut to fit; outside finish; knotless flooring, cut to fit; lath and plaster or plaster board; knotless inside finish; knotless doors, knotless casings, knotless base board, windows, sash, glass, nails of all sizes, locks, hinges, tin flashing, paints, oils, varnishes, stains, putty and shellac, with complete drawings, illustrations and instructions for erection—The Complete House. The big ALADDIN Catalog No. 180 tells all the interesting facts.

Ask about the Complete 5-room ALADDIN House for **\$298**

Catalog Coupon—Tear Here

North American Construction Co.,
965 Aladdin Avenue, Bay City, Michigan

Please send Catalog No. 180 Dwelling []
Summer Cottage []

Name

Street

Town..... State.....

Famous Dollar-a-Knot Guarantee

The ALADDIN Dollar-a-Knot Guarantee is a clear expression and concrete example of our confidence in our lumber. It is your protection, over our signature, of Highest Quality. ALADDIN prices speak for themselves—and never fail to astonish home builders. ALADDIN customers save as high as \$1000 on their homes.

Send for Catalog.



Mills in Michigan, Florida,
Louisiana and Oregon

NORTH AMERICAN CONSTRUCTION CO.

Home Builders to the Nation

965 Aladdin Avenue

Bay City, Michigan

GRAFLEX CAMERAS



You can make snapshots indoors if you use a Graflex Camera. This picture was made indoors with the shutter set at 1-35 of a second. The negative had plenty of exposure, and the shutter operated fast enough to prevent the movement of the children from spoiling the picture.

No camera equals the Graflex for high speed photography. In this picture both the automobile and biplane were going at a very high rate of speed. This made it necessary to set the shutter at 1-1000 of a second to get a picture that was clear and distinct.

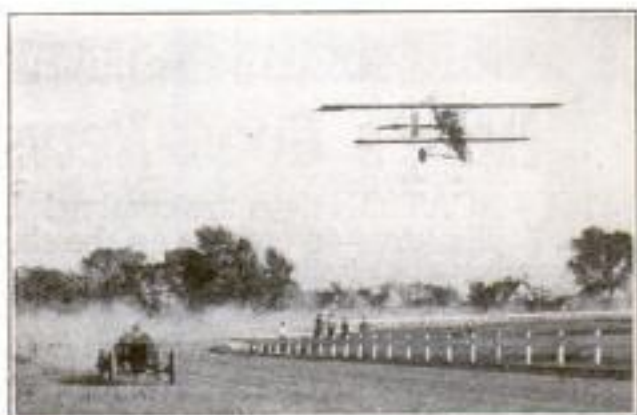

Photographs in the deep woods or in the shade offer many difficulties to those who are not equipped with a Graflex Camera. With the Graflex you can make pictures under light conditions that make photography impossible with cameras of the usual type.

With the Graflex Camera you can make exposures of any duration from "time" to 1-1000 of a second. You see the image on the focusing screen, right side up, the size it will appear in the finished print, up to the instant of exposure.

Our 64-page illustrated catalog tells why the Graflex is the best camera for your work. May we send you a copy?

FOLMER & SCHWING DIVISION
EASTMAN KODAK COMPANY
ROCHESTER, NEW YORK



A New Type

The Pocket Self-Filler

the latest

Waterman's Ideal Fountain Pen

To those who prefer a fountain pen of the self-filling type, this announcement is of special interest. It introduces the most important development in self-filling fountain pens—a new Pocket Self-Filler that is distinctly Waterman's Ideal throughout, possessing all the superior qualities and exclusive features of the Regular type, plus the convenience of automatic filling direct from the ink supply. Simply raise and lower the lever, with the point in the ink, and it fills immediately. The lever snaps down and forms an absolute lock of the ink tube. This is the perfect pen for your vacation equipment. Made in a wide assortment of sizes, including short size for vest pocket or purse.

\$2.50, \$4.00, \$5.00 and up.

The best stores everywhere sell Waterman's Ideals. In addition to the Pocket Self-Filler, ask to see the Regular and Safety types.

Illustrated Folder on Request

Waterman's Ideal Fountain Pen

Secure yourself against substitutes by seeing the Waterman's Ideal Trademark on each pen

L. E. Waterman Company, 173 Broadway, New York

Boston, Chicago, San Francisco, Montreal, London, Paris, Buenos Aires

Please Mention Popular Mechanics



Growing Food

SOME boys actually outgrow their stomachs. Fact—they're growing so fast and playing so hard that they can't keep up with the tax without being "regular little pigs"—as you call them—about their eating.

So they overeat on tired little stomachs—and along comes indigestion, sometimes sore throat ("stomach throat"), loss of appetite, pale cheeks. Doctor says "tonic"—Doctors who've had experience with it say

ANHEUSER-BUSCH'S

Malt-Nutrine

REG. U.S. PAT. OFF.

TRADE MARK

Liquid-Food-Tonic



Give that hard-playing, fast-growing boy or girl of yours this real food tonic. It will be good for them—strengthen and build them up.

All Druggists—Most Grocers

Malt Nutrine declared by U. S. Internal Revenue Department a pure malt product, not an alcoholic beverage. Contains 14½ per cent malt solids—1.9 per cent alcohol.

Interesting Book on Request

ANHEUSER-BUSCH, St. Louis, U. S. A.



Please Mention Popular Mechanics

Copyrighted material

A Check for
\$12,000

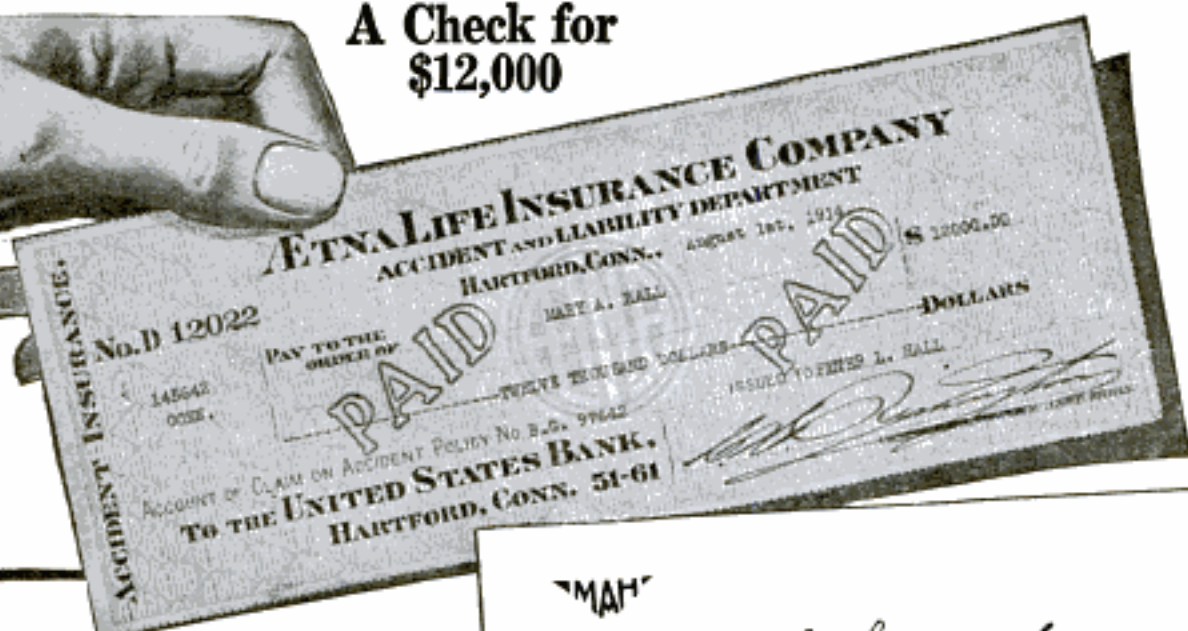

A Big Help in Time of Need

ONE man in seven is accidentally killed or injured each year. You may be the one.

Would your wife then be able to write a letter like this?

This man took out a policy for \$5,000 a little over two years ago. Because it was an Aetna Accumulative Accident policy, it increased \$500 a year in value and his premium stayed the same. He was killed in a railroad accident, so both policy and increase doubled, making the payment \$12,000.

For \$25 a year, in "Preferred" occupations, this policy brings:—

\$5,000 to \$10,000 for accidental death or loss of two limbs or eyes. Add \$500 to \$1,000 to this for every year you renew the insurance up to five years.

Half the above for loss of one hand, foot or eye.

\$50 a week as long as you live if you're disabled from railway, steamship, or burning building accident. \$25 a week for any other accident.

"MAH"

The Aetna Life Insurance Co.

Gentlemen—

I cannot express my astonishment and thanks. The check for \$12,000 came and I am too bewildered even yet to quite understand why you sent me so much.

I did not even know that my dear husband had an accident policy. It is a comfort to know that through his foresight I am provided for. It was like him.

Again thanking you,
I am

Yours sincerely,
Mary A. Hall.



AETNA-IZE



Do you think you are safe from accident? Last year one man in seven was killed or injured by an accident. Take any seven men you know. Any one of them may die or be injured by accident.

Send this coupon. It is the most important thing you have to do. Your wife asks you to do it. Your children ask you to do it. Send it today.

AETNA LIFE INSURANCE COMPANY

Drawer 1341 HARTFORD, CONN.

The largest company in the world writing Life, Accident, Health, and Liability Insurance

Agency opportunities for all Casualty and Bonding lines

Name _____
Occupation _____
Bus. Address _____
AETNA LIFE INSURANCE COMPANY
Drawer 1341 HARTFORD, CONN.
I have marked the kind of insurance
I wish to know about: Acci-
dent Health Disabili-
ty \$250 Life Certifi-
cate \$1 year is
in good health.



Copyright, U. S. A. 1915, by
The B. V. D. Company.

“Now, Now, Cool Off—Get Your B.V.D.’s On!”

“**H**ERE you are, carrying the ‘Worry’ sign, your forehead all wrinkled up like a raisin. Take it easy, Man! Cool off in body and you’ll cool down in mind!

“Go send the boy to the nearest store for a few suits of B.V.D. Underwear. Tell him to look for the B.V. D. *Red Woven Label* and to be sure he gets what he asks for. A few suits of

B.V. D.—you know, loose-fitting and soft-feeling—keep you cool all Summer. And say, they put such good stuff into it, that it wears and washes fine. Take my tip, and don’t let me see you like this to-morrow.”

On every B.V. D. Undergarment is sewed

This Red Woven Label



(Trade Mark Reg. U. S. Pat. Off. and Foreign Countries)

Firmly insist upon seeing the B.V.D. *Red Woven Label*, and firmly refuse to take any Athletic Underwear without it.

B.V.D. Union Suits (Pat. U.S.A. 4-30-07) \$1.00, \$1.50, \$2.00, \$3.00 and \$5.00 the Suit. B.V.D. Coat Cut Undershirts and Knee Length Drawers, 50c, 75c, \$1.00 and \$1.50 the Garment.

The B.V.D. Company, New York.

London Selling Agency: 66, Aldermanbury, E. C.



Copyright U.S.A. 1915 by
The B.V.D. Company



Copyright U.S.A. 1915 by
The B.V.D. Company

Please Mention Popular Mechanics

Something
New



"100 MILES
for 10 cents"

Price
Only **\$125**

Weight Only 110 lbs.

YOU can soon save more than the cost of a Miami Motor Bicycle in the amount of time and travel expense it will save you. The pleasure and satisfaction you get from owning and riding your own motor vehicle costs you practically nothing.

Imagine a self-propelling machine much stronger than a pedal-driven bicycle and almost as easy to operate; much lighter than a motorcycle and without its mechanical complications; as safe to run as a bicycle, but without the exertion required to run either kind of machine—then you have a good idea of

THE MIAMI MOTOR BICYCLE
SAFE · SILENT · CLEAN
WEIGHS 110 Lbs. COSTS \$125.00

Except for high speed, it will do everything that a motorcycle can do—and it costs only a fraction as much. It will take you across country, up and down the hills, and to and from school or work at from four to twenty-five miles an hour—fast enough for business or pleasure with safety.

If you can afford to pay car fare, or know how to manage a bicycle, you cannot afford to be without a Miami Motor Bicycle.

Write us for Free Booklet telling all about the Miami Motor Bicycle.
You can buy one from your Dealer, or direct from our factory.

THE MIAMI CYCLE & MANFG. CO.

"America's Greatest Cycle Makers"

600 Mobile Ave.

MIDDLETOWN, OHIO

Please Mention Popular Mechanics

Copyrighted material

2c a Week Pays Wash Bill!

Write for
FREE Book

Electricity or Water-Power Does the Work

Just a "Twist of the Wrist" Starts or Stops the Machine!

The 1900 Motor Washers are now at work in thousands of homes. They are doing the work formerly done by women, at a cost of 2c a week for power! Saving thousands upon thousands of dollars in wash bills. Saving worlds of wash-day troubles. Leaving the women free to do other work while the machines are doing the washing.

The 1900 Motor Washer

1900 Water Motor Washer
Can be connected with
any water tap instantly

Washes a Tubful in Six Minutes!

Handles Heavy Blankets or Dainty Laces

The outfit consists of the famous 1900 Washer with either Electric Motor or Water Motor. You turn on the power as easily as you turn on the light, and back and forth goes the tub, washing the clothes for dear life. Then, turn a lever, and the washer does the wringing. All so simple and easy that it is mere child's play.

A Self-Working Wringer Sent With Every Washer!

The motor runs Washer and Wringer. We guarantee the perfect working of both. No extra charge for Wringer, which is one of the finest made. Write for FREE BOOK and 30 Days' FREE TRIAL OFFER! Don't doubt! Don't say it can't be done. The free book proves that it can. But we do not ask you to take our word for it. We offer to send a 1900 Motor Washer on absolute Free Trial for an entire month to any responsible person. Not a cent of security—nor a promise to buy. Just your word that you will give it a test. We even agree to pay the freight, and will take it back if it fails to do all we claim for it. A postal card with your name and address sent to us today will bring you the book free by return mail. All correspondence should be addressed to

Doing the wringing with
1900 Electric Motor Washer



1900 WASHER CO., 6187 Court St., BINGHAMTON, N. Y.

OR, IF YOU LIVE IN CANADA, WRITE TO THE CANADIAN WASHER CO., 386 YONGE ST., TORONTO, CANADA.

(23)

BOYS!

Automatic-Repeating Pistol

FIFTEEN-HUNDRED loud reports from one charge. Made of blued gun-metal, 8" long, easy action. Absolutely harmless; no powder or projectile; permitted in any community. Five extra rolls of paper (7500 shots) only 10c.

THE AIRMATIC PISTOL
350 Citizens Building CLEVELAND, OHIO

50c

Postage pre-
paid anywhere
U. S. or Can.



KENNEY INK FONT 50c

Most practical Ink-Well made. Ink held in place by vacuum. No Sludge forms. No dust nor dirt. Pen will not soil. Base and body handsomely nickel-plated. Price 50c Heavy glass container. Worth \$1.00. POSTPAID

Double font for red and black ink, \$1.00

KENNEY SPECIALTY CO. FREE with every font a 233 Fulton Street, NEW YORK



3 YEARS TO PAY

Meister Piano 30 days free trial in your own home
\$1 A WEEK or Price \$175.00
\$5 A MONTH

No cash payment down. No interest—no extras. Piano stool and scarf free.

ROTHSCHILD & COMPANY
Dept. 16F CHICAGO, ILL.

1½ to 18
H. P.

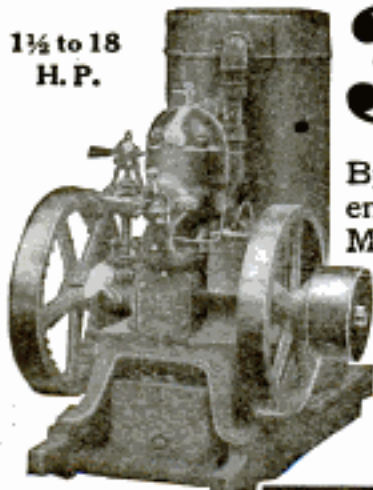

34c

Runs this 6 H. P. Engine for a 10 hour day on KEROSENE

By means of the patent throttle you can run it as a 4 H. P. engine for 23 cents a day, or as a 2 H. P. for 12 cents a day. Many other strong points; force-feed lubrication; uniform speed; sight-feed fuel supply; automobile muffler; no cranking; runs either way; uses any fuel oil satisfactorily. And it's **Guaranteed for 10 Years.** Write for catalogue and 30 days' free trial.

WE PAY THE FREIGHT

ELLIS ENGINE CO., 2871 East Grand Blvd., Detroit, Mich.

Refreshing Breezes Maintain Efficiency

AS the temperature rises, efficiency drops. Keep comfortable, cool and happy this summer; make your office and factory workers cool and comfortable, too—results will show in the output and quality of work when hot weather fatigue is absent. Fresh air searching out the stuffy corners is appreciated by all alike on summer's sultry days. And the cool comfort which a G-E Fan gives, can be enjoyed in the office, factory or home at the trifling cost of

**ONLY A PENNY FOR
TWO OR THREE HOURS**

The twenty years' experience, of which the G-E Fan of 1915 is the result, are evidenced in its silent running, in the even, steady sweep of its oscillation, and in the simplicity of its parts, in the self-lubricating bearings—in the manner of finish even, there being over 50 different finishes from which to choose.

Look for the G-E Trade Mark on the face of the fan—it's a guide and a guarantee to satisfaction. Your nearest dealer or local lighting company will gladly show you one.

GENERAL ELECTRIC COMPANY

General Offices: Schenectady, New York

Sales Offices in
all large cities



Agencies
Everywhere

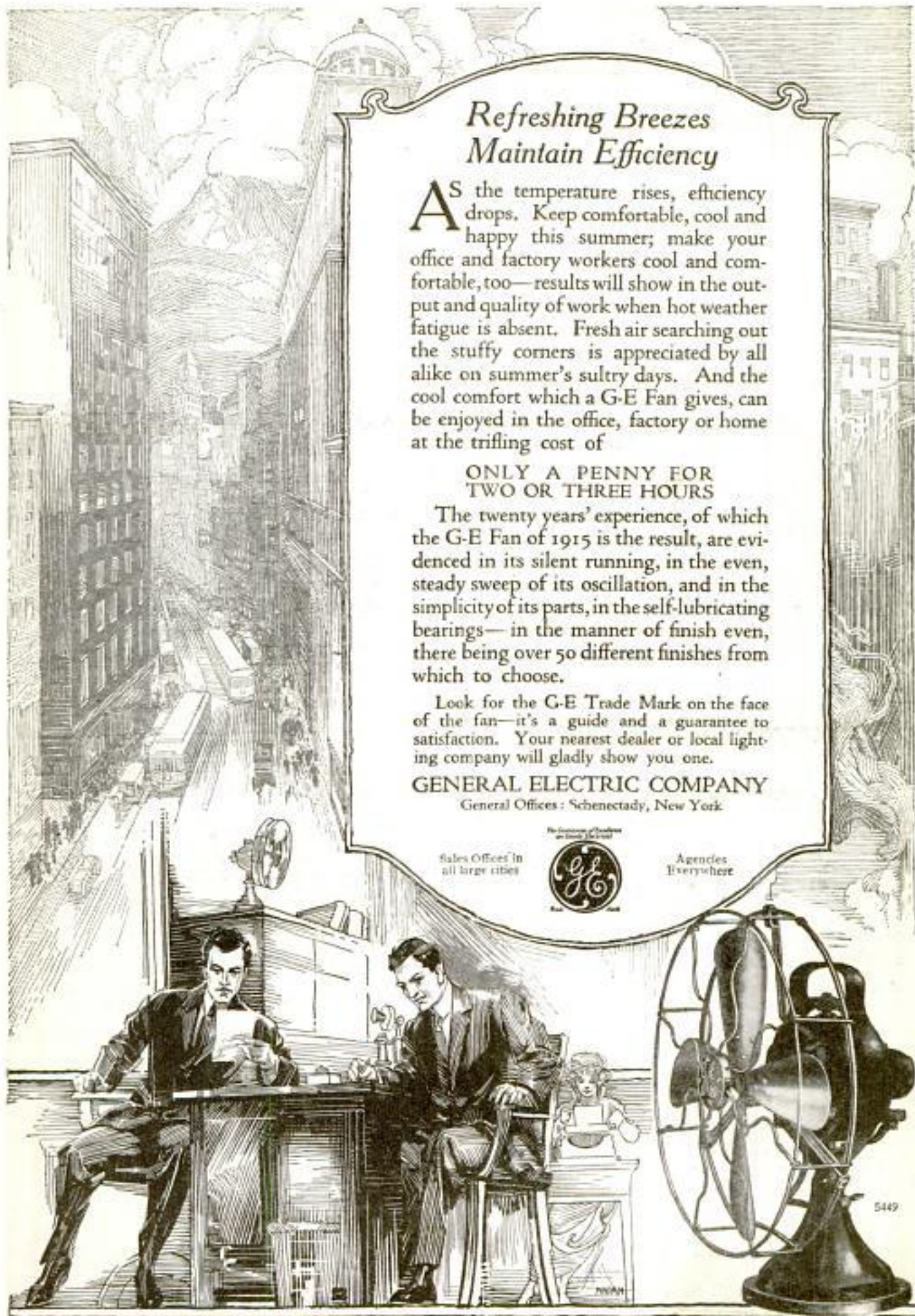

5449

Please Mention Popular Mechanics



Guaranteed roofing — best responsibility!

Why accept a doubtful guarantee on roofing when you can get one signed by the largest manufacturer of roofing and building papers in the world, with a saving in cost in the long run?

Buy materials that last

Certain-teed

Roofing

is guaranteed in writing 5 years for 1-ply, 10 years for 2-ply, and 15 years for 3-ply, and the responsibility of our big mills stands behind this guarantee. Its quality is the highest and its price the most reasonable.

General Roofing Mfg. Company

World's largest manufacturers of Roofing and Building Papers

New York City	Boston	Chicago	Pittsburgh
Philadelphia	Atlanta	Cleveland	Detroit
St. Louis	Cincinnati	Kansas City	Minneapolis
San Francisco	Seattle	London	Hamburg
			Sydney

At each of our big mills we make the following guaranteed products:

Asphalt Roofings (all grades and prices)	Asphalt Cement
Slate Surfaced Shingles	Plastic Roofing Cement
Asphalt Felts	Roof Coating
Deadening Felts	Metal Paints
Tarred Felts	Outdoor Paints
Building Papers	Shingle Stains
Insulating Papers	Tar Coating
Wall Boards	

"Vulcan" Ink Pencils
RED OR BLACK
Inexpensive and Durable. Unequaled for general writing
ONLY Non-Leakable moderate price INK PENCIL made

EXTRA SIZE 8 INC. \$1.25
2 SIZES 4 1/2 & 5 1/2 INC.

ORDER TODAY

AGENTS TERRITORY OPEN
J.C. ULLRICH & CO. 27 THAMES ST. NEW YORK

Buoys of reinforced concrete, each weighing about five tons, are used in the harbor of Kingston, Jamaica. They cost a little less than half as much as steel buoys of the same size.



TYPEWRITERS ALL MAKES

Prices \$15.00 up. SOLD or RENTED ANYWHERE at 1/4 to 1/2 MANUFACTURERS' PRICES, allowing RENTAL TO APPLY ON PRICE. Free Trial. Installment payments if desired. Write for Catalog L.

TYPEWRITER EMPORIUM, 34-36 W. Lake St., Chicago, Ill.

TYPEWRITERS SUMMER PRICES

Look at these bargains! Typewriters Rebuilt in our own Factories, and guaranteed for one year.

Remingtons \$20 to \$35 Smiths \$18 to \$40
Underwoods \$35 to \$50 Royals \$25 to \$45
L. C. Smiths \$30 to \$50 Oliverts \$20 to \$35

We have others, of course. Send for catalog describing them, and address of nearest branch office.

American Writing Machine Co., Inc., 345 Broadway, N. Y.



RIDE a RANGER

bicycle and know you have the best. Buy a machine you can prove before accepting.

DELIVERED FREE ON APPROVAL and 30 days' trial. No expense to you if you do not wish to keep it. LOW FACTORY COST, great improvements and values never before equalled in our 1915 models.

WRITE TODAY for our big catalog showing our complete line of 1915 bicycles, TIRES, sundries and parts, and learn the wonderful new offers and terms we will give you. Auto and Motorcycle Supplies at factory to user prices. Do not buy until you know what we can do for you.

MEAD CYCLE CO. DEPT. F108 CHICAGO

A Bookful of Beautiful Rooms Free

When you build a new home or an addition, remodel one or two rooms, or alter an office or store, try crack-proof BEAVER BOARD instead of lath and plaster.

Write at once for a free sample and this interesting book. All about our free design and decoration service. Absolutely no obligation. Address,

The Beaver Board Companies 160 Beaver Road Buffalo, N. Y.

BRANCH OFFICES in Baltimore, Boston, Chicago, Cleveland, Detroit, Indianapolis, Kansas City, Mo., Minneapolis, New York City, Omaha, Philadelphia, San Francisco

BEAVER BOARD

WALLS & CEILINGS



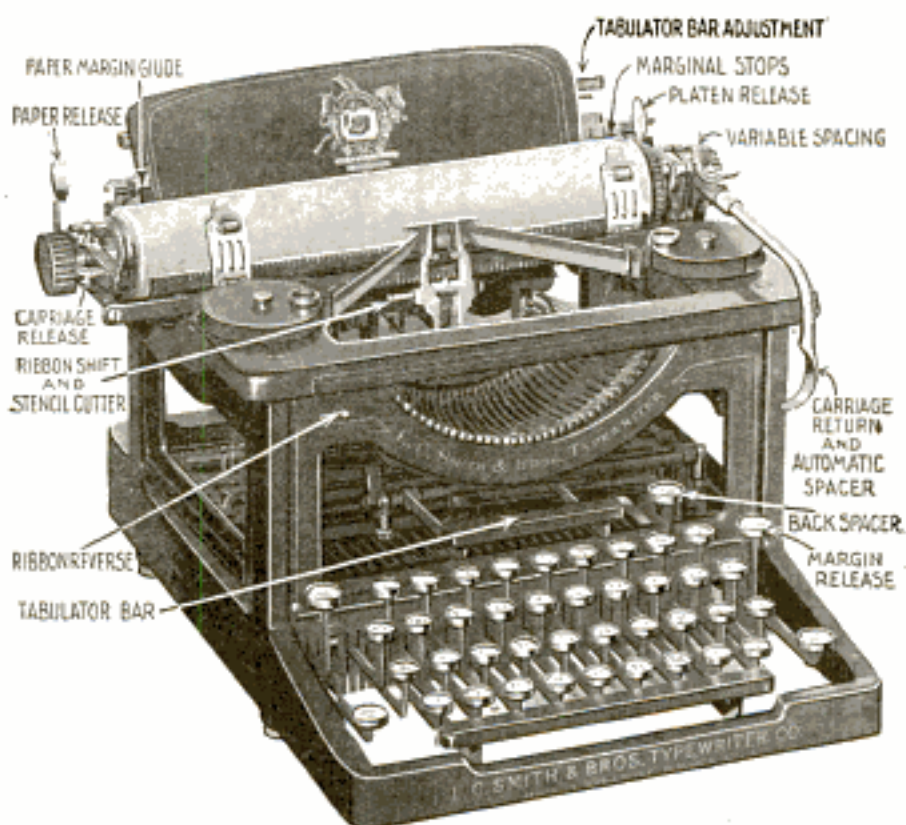

TYPEWRITER SENSATION

Free TRIAL—Use As You Pay
Only \$3.00 a month until the low total price of \$48.30
is paid, and the machine is yours

This is absolutely the most generous typewriter offer ever made. Do not rent a machine when you can pay \$3.00 a month and own one. Think of it—Buying a \$100.00 machine for \$48.30. Cash price, \$45.45. Never before has anything like this been attempted.

Standard Visible L. C. Smith

Perfect machines, Standard size, Keyboard of Standard Universal arrangement writing 76 characters—universally used in teaching the touch system. (Keyboard writing 84 characters \$2.00 extra.) The entire line of writing completely visible at all times, has the tabulator, the two color ribbon with automatic reverse, the **Back Spacer**, in fact every late style feature and modern operating convenience. Comes to you with everything complete, tools, cover, operating book and instructions, ribbon, practise paper—nothing extra to buy. You cannot imagine the perfection of this beautiful typewriter until you have seen it. I will send it to you F. O. B. Chicago for five days' free trial. It will sell itself, but if you are not satisfied that this is the greatest typewriter you ever saw, you can return it at my expense. You won't want to return it after you try it—you cannot equal this wonderful value anywhere.

You Take No Risk—Put In Your Order Now

When the typewriter arrives deposit with the express agent \$9.30 and take the machine for five days' trial. If you are convinced that it is the best typewriter you ever saw, keep it and send me \$3.00 a month until our bargain price of \$48.30 is paid. If you don't want it, return it to the express agent, receive your \$9.30 and return the machine to me. I will pay the return express charges. This machine is guaranteed just as if you paid \$100.00 for it. It is standard. Over one hundred thousand people own and use these typewriters and think them the best ever manufactured.

The supply at this price is very limited, the price will probably be raised when my next advertisement appears, so don't delay. Fill in the coupon today—mail to me—the typewriter will be shipped promptly. There is no red tape. I employ no solicitors—no collectors—no chattel mortgage. It is simply understood that I retain title to the machine until the full \$48.30 is paid. You cannot lose. It is the greatest typewriter opportunity you will ever have. Do not send me one cent. Get the coupon in the mails today—sure.

HARRY A. SMITH, 231 N. Fifth Ave., CHICAGO

H. A. SMITH
 231 N. Fifth Ave.
 CHICAGO, ILL.

Ship me a No. 2 L. C. Smith F. O. B. Chicago, as described in this advertisement. I will pay you the \$39.00 balance of the SPECIAL \$48.30 purchase price, at the rate of \$3.00 per month. The title to remain in you until fully paid for. It is understood that I have five days in which to examine and try the typewriter. If I choose not to keep it I will carefully repack it and return it to the express agent. It is understood that you give the standard guarantee for one year.

Name

Address



WHOLE HIDES are too thick for upholstery, and the under fleshy portion must be split away from the grain side to make it thin enough. The two or three sheets into which the wastage is split, although coated and embossed to look like grain leather, are weak, spongy, and soon crack, peel and rot.



**MOTOR QUALITY
For Automobiles**

**CRAFTSMAN QUALITY
For Furniture**

is a substitute for leather, guaranteed superior to coated splits. Its base is cotton fabric, twice as strong as the fleshy split. It is coated much heavier and embossed in the same way. Two-thirds of all "leather upholstery" is coated splits. Demand superior Fabrikoid on your car, buggy or furniture, and Fabrikoid Rayntite tops, guaranteed one year against leaking.

**Small Sample Craftsman Quality
FREE, or a piece 18" x 35" postpaid, 50c**

It is on sale by John Wanamaker, Philadelphia; McCreery & Co., Pittsburgh; J. & H. Phillips, Pittsburgh; John Shillito Co., Cincinnati; Stix-Baer-Fuller Co., St. Louis; The Palais Royal, Washington, D. C.; Bedell & Co., Washington, D. C.; Stewart & Co., Baltimore, Md.; T. Eaton & Co., Ltd., Toronto and Winnipeg; Du Pont Fabrikoid Co., Equitable Bldg., New York; Davison-Paxon-Stokes Co., Atlanta, Ga.; D. N. & E. Walter & Co., San Francisco, Los Angeles, Seattle, Portland; H. B. Day & Co., Los Angeles, and upholstery dealers generally.

DU PONT FABRIKOID CO.
WILMINGTON, DELAWARE
Canadian Branch: Toronto, Ontario

WILLIAMS' Demountable- Rim Tool

Drop-forged from a strong, tough grade of specially selected steel, each working part tempered especially for its intended use. The hammer and face of the wrench are polished bright; otherwise the tool is black-finished.

It thoroughly replaces and reliably cares for the needs of individual Screw Driver, Special Wrench, Hammer and Tire Tool, for the rapid execution of Demountable Rim and new Tire work — all tools for these purposes in one.

List Showing Size of Nuts on Rims Which Are Usually Fitted to the Cars Mentioned

$\frac{5}{8}$ " Cadillac, Hudson, Hdpmobile, Studebaker.
 $\frac{11}{4}$ " Apperson, Cole, Locomobile, Marion, National, Packard, Pathfinder, Pierce-Arrow, White, Winton.
 $\frac{3}{4}$ " Buick, Chalmers, Dodge, King, Oakland, Oldsmobile.
Specify size when ordering.
Openings — $\frac{5}{8}$ ", $\frac{11}{4}$ " and $\frac{3}{4}$ "; length, each, $9\frac{1}{2}$ "; weight, each, 1 lb. 6 oz. Price each, \$1.00

J. H. WILLIAMS & CO.
47 Richards St., BROOKLYN, N. Y. CITY
Chicago Warehouse, 36 So. Clinton St.
Panama-Pacific Exposition — Block 18, Machinery Palace

The farmers of the United States had 64,618,000 swine at the end of 1914, according to government reports; an increase of 5,685,000 in the year.

Smith & Wesson Automatic

Safe to have around; shoots when you mean to—not before. Booklet on request.

SMITH & WESSON, 814 Stockbridge St., Springfield, Mass.

Make \$98 a Day With this Machine

1000% profit in operating an Empire Candy Floss machine. Practically no cost for materials. Any place there's a crowd there's a harvest. We prove every statement we make. Ask for the proof on a postal.

CATALOG ON REQUEST
EMPIRE CANDY FLOSS MACHINE CO.
1208 Pabst Bldg. Milwaukee, Wisconsin



JENKINS' BRASS BAND AND ORCHESTRA INSTRUMENTS

We save you money and give easy payments

Biggest line of Band and Orchestra Instruments; Cornets, Trombones, Clarionets, Drums, Saxophones, Violins, Guitars and all wind and stringed instruments. Send for free catalog of instruments you want. We give a fifty lesson FREE certificate with each instrument. Tell us the instrument you wish to play.

JENKINS MUSIC CO., 55 Jenkins Bldg., Kansas City, Mo.

OVER 100,000 IN USE

Mostly sold through recommendation. For Personal Desk or General Office. It checks mental calculations. Buy through your stationer.

Write for 10-Day Trial Offer
E. Goucher & A. M. Co., 148 Duane St., New York

Golden Gem PORTABLE Adding Machine



Agents Wanted

Read these two Pages in My New Book

Before you buy any Kind of an Engine

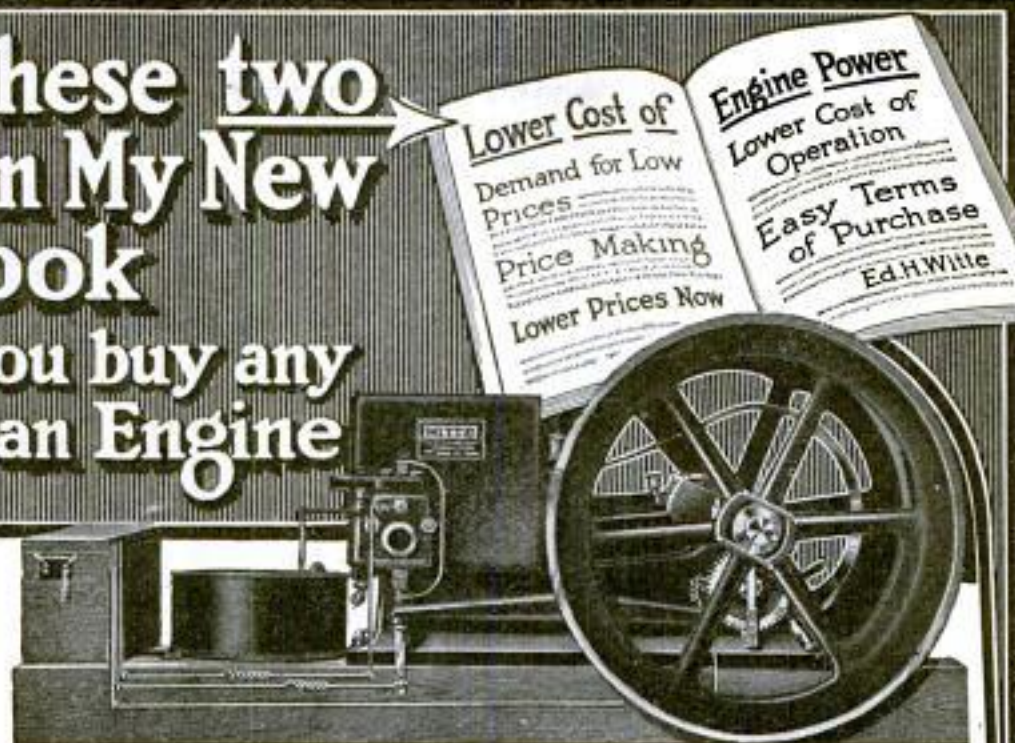

READING these two pages in my New Free Book will save you **dollars** in buying your engine—they will tell you not only how to judge engines and how to make your selection intelligently, but, even more important, what the **cost of operation** should be.

You have the right to expect many years of hard, faithful work from the engine you buy. But the more it costs to operate—fuel consumed and upkeep expense—the less profit you will get from its use. The engine that will do its day's work for **one-fourth to one-half less fuel cost**, and that **keeps on working**, is the one to buy. It means an actual cash saving—a saving that may amount, in a 6 H-P engine, to \$30.00 to \$150.00 per year.

Fuel Saving WITTE Engines

Kerosene, Distillate, Gasoline and Gas

WITTE engines save you money in **first cost**, in **fuel cost**, and in **upkeep cost**. They save in first cost, because I have a natural gas well which furnishes me free light and fuel for power; because my plant is equipped with specially built machinery from my own designs, and because, when you buy a WITTE engine, you deal directly with the maker. They save in fuel cost, because there is no fuel or energy wasted. They save in upkeep cost, because their parts are few and simple; friction and wear are reduced to a minimum, and the material used in their construction is the best.

**Sent Direct From Factory to User—
CASH OR EASY TERMS.**

5-Year Guarantee on Efficiency and Durability.

WITTE engines **cost less** to begin with, and **they quickly pay for themselves in fuel saved**. Ease and safety in starting, delivery of more than rated power, long service, and the backing of a liberal 5-year guarantee—these are other WITTE features that mean much to you.

**Send For My
Free Engine Book**

It will tell you how to know engines—how to find their good points and weak spots—and will explain why I can build WITTE engines for less money than others cost to manufacture, and build them so they give more power and longer service, with less fuel cost.

**ED. H. WITTE,
WITTE ENGINE WORKS,**

1744 Oakland Avenue, Kansas City, Mo.

Please Mention Popular Mechanics



Note
These Latest
PRICES:

WITTE Engines

Easy to Start.
No Cranking.

STATIONARY

2 H-P,	\$34.95
4 H-P,	69.75
6 H-P,	97.75
8 H-P,	139.65
12 H-P,	197.00
16 H-P,	306.80
22 H-P,	389.65

PORTABLE

2 H-P,	\$39.95
4 H-P,	82.75
6 H-P,	127.75
8 H-P,	174.65
12 H-P,	237.00
16 H-P,	358.80
22 H-P,	442.15

SAW-RIG

6 H-P,	152.25
8 H-P,	202.15
12 H-P,	267.00

Ed. H. Witte.

This Book FREE
HOW
TO
JUDGE
ENGINES
Witte

ED. H. WITTE, Witte Engine Works,
1744 Oakland Avenue, Kansas City, Mo.

Without obligation on my part, and with no cost to me, please send a copy of your finest and latest Engine Book, with details of your Liberal Selling Plan.

NAME.....

STREET AND NO.....

CITY.....

STATE.....

W. M. FINCK & COMPANY

DETROIT, MICHIGAN



Who Develop
New and Correct
Features for
**OVERALL
WEARERS**

Manufacturers of High-Grade Working Garments
Union Made—Made in Detroit.

No. 1 Front View New High Vest Back

Retail Price \$1.25

No. 2 Back of New High Vest Back

No. 3 Front of New Combination Suit

Retail Price \$2.00

Cut out this Ad, take it to your retailer and ask him to order these garments for you. If he will not, send us your size and P. O. order for amount and we will Parcel Post at once.

W. M. FINCK & COMPANY, Detroit, Mich.

GENUINE MOGUL \$2.00
DIAMOND 2.

Absolutely the nearest approach to a real diamond. Only experts can tell the difference. Cut like a diamond. Unending in brilliancy. Gold filled diamond mounting. Guaranteed 25 years. 1 karat stone. Rings, pins, studs or earrings, \$1.00 and up. Sent on approval. Mention for lady or gentleman. Write today for complete catalog.

FREY SPECIALTY CO., 106 Frey Building, NEW CASTLE, PA.

A recent report of the Industrial Commission of Wisconsin states that over 70 per cent of all injuries to workmen caused by chips, nails, and other small objects, affect the eyes. Out of a total of 346 cases reported, 32 men lost the sight of one of their eyes entirely, while 217 suffered more or less serious injuries to the organ.



Print Your Own

Cards, circulars, menus, newspaper, book, etc. **PRESS** \$5, larger \$18, Rotary \$30. Save money. Big money printing for others. All easy, rules sent. Write factory for illustrated press catalog. **TYPE**, cards, paper, samples, etc. **THE PRESS CO., Meriden, Conn.**



Large Profits from Small Capital

A Business of your own bearing you an income of at least \$10.00 per day with practically no experience or overhead expense.

THE GREEN AUTOMATIC MACHINE

sharpens, hones and strops all kinds of safety razor blades, all in one operation, at the rate of 150 to 200 blades per hour. You can readily figure your profits. Let us send you our free booklet explaining everything.

Am. Sharpening Machine Co. (Inc.)
Dept. 6 184 Washington St., Chicago

WE TRUST YOU! and start you in this big money-making business. We send the wonderful **Filmless Post Card Camera** at once—you pay us later out of your profits. No films, plates or dark room—a complete studio in itself. Takes 5 sizes of post cards; also photo buttons.

\$50 TO \$100 A WEEK EASY

"snapping" people at Parties, Bathing Beaches, Parks, Carnivals. No experience needed; nets you 50 profit on every dime. Write today for **FREE** particulars and illustrated booklet. **FILMLESS POST CARD CAMERA WORKS**
1107 So. Halsted St. Dept. A5 CHICAGO, ILL.



Repair Tires—Make Money

Many Men are Making \$60 or More a Week

No experience needed. We teach you everything free. Every car owner in your town is a possible customer. Tires blow out every day. Jobs are plentiful—always. The money will come rolling in fast. There's no stopping it once you are known as a tire repair man.

SHALER Vulcanizing Outfits

Anyone with ordinary intelligence can make a perfect repair the first time.

Send No Money Investigate this now before some other wide-awake fellow gets ahead of you. Don't send a penny. Get all the particulars first and find out how the big money is made. Write today—at once. Don't delay—the automobile season will open up big. Tire repairs will soon be needed every hour of the day. Write at once. Learn the facts about this immensely profitable business.

C. A. SHALER CO., 1503 Fourth Street, Waupun, Wis.

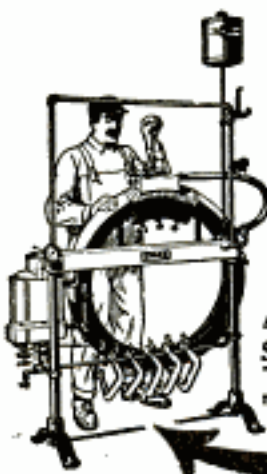



Show Good Form — Make Your Own Cigarettes

Millions of the most critical smokers prefer to roll their favorite tobacco in pure, light, thin, tasteless Riz La Croix "papers." You may use any tobacco that suits your taste — but you must use Riz La Croix "papers" if you want the *best results* and the *greatest satisfaction*.

RIZ LA CROIX

(Pronounced: REE-LAH-KROY)

FAMOUS CIGARETTE PAPERS

By far the easiest papers to roll your cigarettes with — they are so thin, strong, shapable and naturally adhesive.

Purity and perfect combustion make them absolutely tasteless — you enjoy the pure flavor and fragrance of your tobacco.

Riz La Croix are made from the best flax-linen, a pure vegetable product, entirely healthful.



FREE
Two interesting, illustrated Booklets — one about RIZ LA CROIX Cigarette Papers, the other showing how to "Roll Your Own" cigarettes — sent anywhere in U.S. on request. Address The American Tobacco Co., Room 1184, 484 Broome St., N. Y.

Please Mention Popular Mechanics

Manufacturers Calling for Over Two Hundred Inventions

Money Is Waiting to Back the Good Idea

(By a Washington Patent Attorney)

Never was there so good an opportunity for the inventor of something—*anything*—of merit as right now.

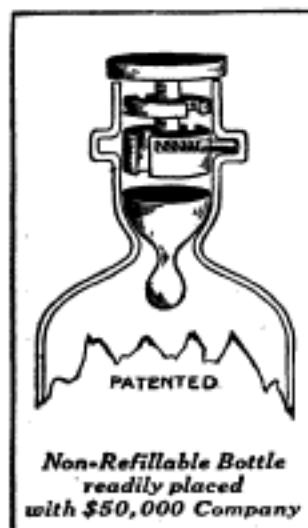

Manufacturers with money and facilities are asking for ideas—*calling* for them. The supply is not nearly equal to demand. Over 200 inventions are asked for in a list just given in a little book "What to Invent." The demand is not for anything extraordinary—just the common everyday things that make work easier or life more pleasant in the household, the shop or the field.

You might think the possibilities of the window screen had been exhausted, but I know of 28 concerns that are looking for a new screen, duly covered by patent, which they can manufacture. I know of 46 manufacturers and others who are ready to manufacture any good, patented household article such as can openers, baking pans, coffee pots, washing machines, carpet sweepers and other devices.

Within the last few weeks I have received forty special requests for a dishwasher and drainer; seventeen others request an improvement in scissors. Manufacturers know that everyone must have a pair of scissors in the house, and they realize that a novelty in them would always sell in place of the old kind, and hence the demand. Among my letters are sixteen requests for a device to turn sheet music on a music stand or piano, and seventeen people are interested in the



purchase of a patent on a device for holding an electric light in any position. Besides these there are hundreds of manufacturers who do not specify any particular device but state that they would be interested in anything of merit

A Chicago man says: "I want something that can be sold to farmers by mail. There is practically no limit to the investment my associates would make in a good proposition." A man in Woodhaven, N.Y., says he is in the market for a small household article, light in weight, which can be sold somewhere around ten cents.

A prominent manufacturing company is interested in something to sell to hardware stores, but would also be interested in other things promising to be money-makers.

A man in Revere, Mass., says: "I am looking for something that can be manufactured, plant equipped, etc., and marketed for an outlay of not over twenty-five thousand dollars."

A big textile machinery company says they are interested in newly patented devices that can be

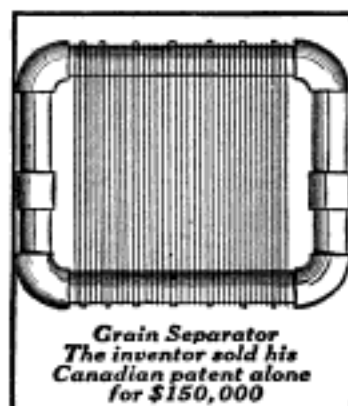

either bought outright or manufactured on royalty. They do not require machinery inventions alone, but anything of merit.

A company in Belvidere, Illinois, wants patents on small tools or metal novelties.

A Dayton, Ohio, concern writes for some machine or device that would have a general sale throughout the land.

The names and addresses of these prospective purchasers are supplied absolutely without charge by Messrs. Chandlee & Chandlee to those who obtain patents through their firm. This firm has been in practice before the Patent Office for over twenty years, and its members are, consequently, familiar with every detail of patent work. They also issue a booklet entitled "How to Obtain a Patent," which tells in simple words just how to go about protecting an invention. The two books, "What to Invent" and "How to Obtain a Patent," are both free. Why don't you write for them and learn what manufacturers are looking for and how to protect your ideas? If you have an invention, send a sketch or model and description of it to Chandlee & Chandlee, 953 F Street, Washington, D.C. They will give you a free opinion as to whether or not it can be patented.

Please Mention Popular Mechanics

1/3 SAVED BUY DIRECT FROM MANUFACTURER

J. HARDIN COMPANY
CHICAGO

GUARANTEED GRADE A FIXTURES

Our Highest Grade Guarantee Label appears on all fixtures

We refund your money if goods are not found as shown and described



No. 67—Zanda Bathtub. Highest grade porcelain enameled. Has our latest designed body and 3 1/4" rolled rim; legs put on with our patented non-come-off attachments; fitted with heavy pattern N. P. Fuller Bathcock, heavy pattern adjustable N. P. Brass Waste and overflow and our N. P. Iron Pipe Supply pipe connections. Width over all 30", height from floor to top of rim 22 1/2", depth inside 17 1/4". Complete as shown and described, 4-ft. \$14.35, 4 1/2-ft. \$14.35, 5-ft. \$15.25, 5 1/2-ft. \$17.45, 6-ft. \$20.75.



No. 68—Modern Siphon Wash-down Closet Outfit. Tank has re-inforced copper lining with heavy trimmings, 2" N. P. connection, Seat re-inforced; heavy brass N. P. Bar Hinges. Highest grade, vitreous china bowl; complete with N. P. supply pipe to floor threaded for iron pipe. Oak or Mahogany, \$9.50.



No. 69—Chicago Bathtub. Highest grade porcelain enameled. Has our latest designed body and 3 1/4" roll rim; on extension base with our patented non-come-off attachments; fitted with heavy pattern china indexed Royal Ideal Waste, heavy N. P. Fuller Bathcock, heavy N. P. Brass tubing supply pipes with iron pipe connections. Width over all 30", height from floor to top of rim 22 1/2", depth inside 17 1/4". Complete as shown and described, 5-ft. \$21.00, 5 1/2-ft. \$24.75.



No. 70—Latest Pattern Vitreous China Closet Outfit with highest grade Roman pattern vitreous china tank fitted with heavy brass trimmings, and 2" N. P. flushing connection. Re-inforced Mahogany seat with heavy brass N. P. bar hinges, highest grade vitreous china siphon wash-down bowl; complete with N. P. brass supply pipe to floor threaded for iron pipe, \$12.00.

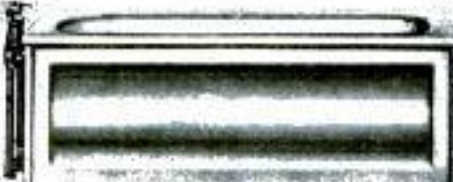

No. 66—New Tiled-in Roman Bathtub. Highest grade porcelain enameled on inside and outside. Latest pattern 3 1/4" flat turned over rim, new Roman body, fitted with heavy china indexed Royal Waste and compression indexed supply faucets. Supplies fitted with iron pipe connections. Water enters through our new bell delivery. Width over all 31", height from floor to top of rim 22 1/2". Complete as shown and described, 5-ft. \$75.00, 5 1/2-ft. \$80.00.



No. 71—New Design Serpentine Vitreous China Closet Outfit. Highest grade vitreous china serpentine tank, with latest heavy pattern trimmings and 2" N. P. flushing connection. Highly polished re-inforced mahogany seat with heavy brass N. P. bar hinges, highest grade vitreous china siphon wash-down bowl. Complete with N. P. brass supply pipe to floor, threaded for iron pipe, \$12.00. With Siphon Jet Bowl, \$15.25.



No. 72—16 1/2" Lavatory. 6" back and D shaped basin, 11x14. Highest grade porcelain enameled one-piece lavatory on concealed wall hanger. Concealed integral overflow, heavy pattern low-down china indexed compression basin faucets, marked hot and cold, 1 1/4" heavy pattern adjustable N. P. brass trap to floor or wall. Adjustable N. P. concealed brass supplies with iron pipe connections. Complete, as shown and described, \$5.85.



No. 74—Colonial Pedestal Lavatory. Highest grade porcelain enameled lavatory and pedestal with concealed integral overflow, heavy N. P. Fuller Basin Faucets, 1 1/4" heavy pattern ad-

justable N. P. brass trap to floor or wall, adjustable N. P. concealed brass supplies with iron pipe connections; size 20x24". D shaped basin 11x15". Complete as shown and described, \$13.90.



No. 73—New Design Serpentine Drop Apron Lavatory. Size 18 x 24. Back 10". D shaped basin 11x15. Highest grade porcelain enameled one piece lavatory on concealed wall hanger; concealed integral overflow; heavy pattern, low down china indexed compression basin faucets, marked hot and cold; 1 1/4" heavy pattern adjustable N. P. brass trap to floor or wall; adjustable N. P. concealed brass supplies with iron pipe connections. Complete as shown and described, \$9.45.



No. 77—Long Drop Apron 1-Pc. Sink. Highest grade porcelain enameled sink combination with drop apron sink, back and drainboard, all cast in one piece, supported on concealed wall hanger; two porcelain enameled adjustable legs so that sink can be set at any height; two 1/2" N. P. flanged faucets; 1 1/4" heavy pattern N. P. brass adjustable trap to floor or wall. Size of sink 20x30", height of back 12". Size of drainboard 20x24", entire length over all 54". Furnished with right or left hand drainboard. Complete as shown and described, \$28.25.



Get Our Free Estimate

on hot water or steam heating plants. We furnish installing plans and specifications and loan you the tools. Any handy man can put in our plants. Send for our complete book on heating plants.



No. 76—Long Roll Rim 1-Pc. Sink. Highest grade porcelain enameled rolled rim sink combination with rolled rim sink long sink back and drainboard, all cast in one piece; supported on concealed wall hanger with two adjustable legs so that sink can be set at any height. Two 1/2" N. P. flanged faucets, 1 1/4" heavy pattern N. P. brass adjustable trap to floor or wall. Size of sink, 20x30; height of back, 12". Length over all, 53". Furnished with right or left hand drainboard. Complete as shown and described, \$17.95.

We Carry Everything in High Grade Guaranteed Plumbing and Heating Supplies Exclusively.

SATISFACTION GUARANTEED

Any handy man can install our goods from plans furnished free.

J. HARDIN CO. 35 Years at 4533-43 Cottage Grove Av. Chicago

J. HARDIN CO. Send me your catalogs, Nos. 63 and 64

NAME

ADDRESS

MA BE A Manufact

OF HAYWOOD RE-

Sounds like a whole lot of money, and it is—looks pretty big from where you stand if you are earning just an ordinary salary at an ordinary job. But why continue the job—why be on that side of the fence? Why not come over on this side—the manufacturing side—where the grass is greener and the picking is better?

Here is a business that gives **big returns, quick returns**, and the demand for your product is ahead of the supply and increases every day in the year. Start a **Haywood Tire Repair Shop**

MAKE \$3,000⁰⁰ A YEAR.

**This Man Did It
So Can You**



\$250 A Month ^{To} **Start**

and more as you get accustomed to the business. The certainty of success in this business is about as sure as anything in this world can be. **Automobile owners increase by the thousands each year and the tires are still the least durable part of the car.** Every owner tries to cut down his tire expense—every owner tries to repair his tires as long as they will hold together. Autos now used the year round. Means big business, big money for you from one year's end to another.

It is not every business that will permit you to start with a very small investment. Most manufacturing business require big capitalization. And rich men take the profits while you, the producer, get a salary and the small end. Why tie yourself down to small wages? Get in business for yourself. Start now. **Mail the Coupon** or send a postal or letter.

**The Haywood Tire &
945 Capitol Avenue**

urer TREADS



Your Wonderful Opportunity

You might just as well be the first to enter this paying business in your town—**open your shop and let the money roll in.** Every automobile sold means more tires to mend. You start with one machine. The business grows fast. You need another and then another. Soon it gets to be a regular business of adding machine—after—machine, until the first thing you know you are running a big shop—you are operating in a big way—you are a real business man and a factor in your community.

Punctures and Blow-Outs Are Common

Tires need retreading and vulcanizing every day—something going wrong all the time—owner after owner forced to buy new tires because they cannot get the old ones fixed. You know that. If you are in the automobile business, operate a tire repair plant as a side line in connection with your present business, garage or salesroom. Any place where there are many automobiles yields a big, steady business, besides the transient work. **Experience is absolutely unnecessary.** You can learn quickly. Anyone with a little mechanical turn, or who can simply follow directions, can learn in a few days on old tires to do the best work. Then business comes fast and easy.

Repair Tires at Home

Young men make money to attend college or start a garage and repair business. Automobile owners—**repair your own tires.** Save money. Pay for your outfit in a short time. We have special outfits for home use. Mr. Any-Man, it's worth while to investigate. There is money in it. It's a field of wonderful possibilities. Make up your mind and send for our catalogue **today.**

**Haywood
Tire &
Equipment Co.
945 Capitol Ave.
Indianapolis, Ind.**

Without any obligation upon my part please send me your complete FREE catalog of tire repair outfits.

Mail This Coupon

Learn of the wonderful money-making possibilities in this fascinating new business. Make something—supply a want—become a manufacturer. This is your chance. Send your name and address only—the coupon—a letter or a postal will do.

Name.....

**Equipment Co.
Indianapolis, Ind.**

Address.....

White Cross Summer Electrical Bargains

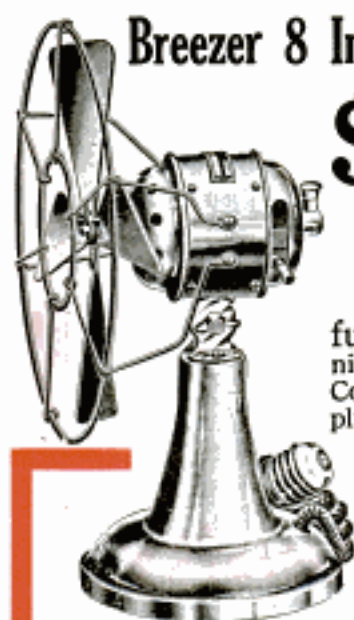

Breezer 8 Inch Electric Fan

\$6⁵⁰

This 8 inch fan furnished either in nickel or oxidized copper. Complete with cord and plug ready to be connected.

Direct or alternating current. 8 to 220 volts. Any cycle. Can also be run on 8-volt storage battery. 3 speeds. Weight 6 pounds. Solidly made and fully guaranteed. May be used either as desk or wall fan. Size 12 in. high, 9 in. wide. Price \$6.50. When ordering specify voltage, cycle and finish wanted.

Table Fan

10¹/₄ in. high; 9¹/₂ in. wide; inverted; shoots air against top with handsome glass bowl which equally distributes it to every one sitting around table or room. A delightfully cooling breeze. Well made. Handsome. Guaranteed. Price, only



\$7⁰⁰



Electric Lantern

Shake it as hard as you want and it won't go out. Made of brass, heavily nickel plated—designed like the Pullman Car Conductor's finest lanterns. Cannot rust or wear out. Will last a life time. Complete with battery. Price

\$3.50

Examination Free

To get this fan or any other article on this page all you need to do is to send the coupon below, with your name and address. See this handsome Breezer Electric fan, table fan, electric lantern, Clearway horn, electric hair dryer or electric stove for yourself before you decide whether you wish to buy or not. Notice the nickel or oxidized finish on the fan—the splendid workmanship on any of the other articles. If you do not think anything you order is the most remarkable value ever offered—send it back at our expense. If you decide to keep it, pay only the net transportation charges and the price shown on this page. If you send cash with coupon we will prepay express charges right to your own home. After you have examined it return it at once if you are dissatisfied and we will refund your money.

Mail This Coupon

Fill out the coupon now and send it to us. Get anything shown on this page for your home—your office or your store. **DO NOT DELAY.** Send coupon today and take advantage of the special rock-bottom summer price made on every item. But whether you order any item shown on this page or not, be sure to ask us to mail free of charge our book of latest electric specialties—hundreds of them. Act immediately. The output is limited.

- Electric Fan
- Electric Table Fan
- Electric Lantern
- Electric Horn
- Electric Hair Dryer
- Electric Stove

LINDSTROM-SMITH CO.
1100-1110 So. Wabash Ave., Dept. A119, Chicago
Please send me the article(s) I have marked X. After I have seen or examined it I will either return it to you or pay the express agent the net transportation charges and the price of \$.....
(state here price of article you want)

NAME.....

ADDRESS.....

VOLTS..... CYCLES.....

My Electrical Dealer's Name is.....

P. S. If you enclose full price for article wanted (of course you retain the privilege of examining it in your own home) we will prepay the express charges. In ordering be sure to state voltage and cycle fan, hair dryer or stove is to be operated on.

Electric Clearway Horn

Simple, compact, light. Made of pressed steel. No heavy castings. 9¹/₂ inches long, 5¹/₂ inches wide. A remarkable value. Operates on 4 to 5 dry cells or 6 volt storage battery. Special, on this sale only

\$3.50

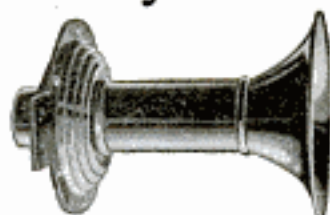

Electric Hair Dryer

Price

\$13⁵⁰



Have your choice of either hot or cold breeze by simply turning the switch. Elegantly finished. Dry your hair in comfort and without danger of taking cold. Complete with cord ready to be connected up.



Electric Stove—4 in 1

A toaster, a griddle, a broiler, and a stove. Prepare a whole meal right on your table or buffet. Handsomely nickel plated. Complete with reinforced silk cord and swivel plug. Dimensions, 12 inches long by 6³/₄ inches wide by 8 inches high. Size of tray is 13³/₄ inches by 10¹/₄ inches. When ordering state volts to be operated on. Price.....

\$5.50

Lindstrom-Smith Company, Mfrs.
1100-1110 So. Wabash Ave., Dept. A119, Chicago



Harley-Davidson Wins International Grand Prize Race

**Breaking Another World's Record
Travels 68½ Miles an Hour for 300 Miles**

Otto Walker, riding a Harley-Davidson, carried off the first money in the 300 mile International Grand Prize Race at Venice, California, April 4th. Next came Leslie "Red" Parkhurst, also on a Harley-Davidson. Both Walker and Parkhurst shattered the world's record and both rode stock 1915 Harley-Davidsons, just like you can buy of any Harley-Davidson dealer.

By finishing 15 3-5 seconds apart these two Harley-Davidsons gave the most remarkable demonstration of consistent performance in the history of the motorcycle industry.

To win the International Grand Prize Race, the greatest motorcycle classic on record, is an achievement worth while, but for the stock Harley-Davidson to win not only first but second also, against special racing machines, built for speed and speed only, is a truly remarkable and convincing performance.

Never before has the Harley-Davidson Motor Company turned out a machine with the speed and power of the 1915 Harley-Davidson. With an eleven horsepower motor and such additional features as three-speed sliding gear transmission, an automatic oil pump, and double clutch control, it is no wonder that this is Harley-Davidson year.

Any Harley-Davidson dealer will explain in detail the many superiorities of the 1915 Harley-Davidson.

Descriptive literature upon request

More Dealers for 1915 Additions to the Harley-Davidson factories enable us to add more dealers for 1915. Dealers, situated where we are not represented who feel qualified to represent the Harley-Davidson in keeping with the Harley-Davidson name and reputation, should get in touch with us at once.

Harley-Davidson Motor Co., ^{425 B} STREET Milwaukee, Wis.
Producers of High Grade Motorcycles for Nearly Fourteen Years

Patents

Trade Marks and
Copyrights Secured
or Fee Returned

Special Offer—Free Search of Patent Office Records

Send us a model or sketch and description of your invention, and we will make a *Free Search* of the *Patent Office Records* to ascertain if it is patentable. If we report the invention patentable, we will guarantee to obtain a patent or return our fee, and furnish a certificate of patentability backed by a bonded contract to that effect. **This Certificate of Patentability will protect the inventor and serve as proof of the invention until the case can be filed in the U. S. Patent Office.**

Obtaining Assistance for Inventors

Our certificate is of great assistance to inventors who require financial aid to obtain patents.

Our Five Books Mailed Free

(SEE COUPON BELOW)

to any address. Send for these books—the finest publications ever issued for free distribution.

How to Obtain a Patent

Our illustrated eighty-page Guide Book is a book of reference for inventors, and contains 100 mechanical movements illustrated and described.

Money in Patents

Tells how to invent for profit, and gives history of successful inventions.

What to Invent

Contains a valuable **LIST OF INVENTIONS WANTED** and suggestions concerning profitable fields of invention; also information regarding prizes offered for inventions, among which is

Prize of One Million Dollars

offered for one invention, and \$10,000 for others.

Patents That Pay

Contains letters from our clients who have built up profitable enterprises founded upon patents procured by us; also endorsements from prominent inventors, manufacturers, Senators, Congressmen, Governors, etc.

We Advertise Our Clients'

Inventions Free

In a list of Sunday newspapers with two million circulation, in manufacturers' journals and in the *World's Progress*. Sample Copy Free. We save you time and money in securing patents. After the patent is granted we assist you **TO SELL YOUR PATENT.**

Foreign Patents

WE HAVE DIRECT AGENCIES IN ALL THE PRINCIPAL FOREIGN COUNTRIES and secure FOREIGN PATENTS in the shortest possible TIME and at the LOWEST COST. Write for our Illustrated Guide Book on Foreign Patents, sent free to any address.



VICTOR BUILDING

Our new \$200,000 building opposite U. S. Patent Office
SPECIALLY ERRECTED by us for OUR own use

WANTED NEW IDEAS

Send for **LIST OF PATENT BUYERS** who consult us when purchasing patents. Contains requests from **MANUFACTURERS, MAIL ORDER HOUSES and PROMOTERS** for patents secured by us, and suggestions as to New Ideas they wish to purchase. We invite manufacturers and promoters to address our Sales Department regarding the purchase or leasing of a number of meritorious patents secured by us.

REFERENCES

Second National Bank, Washington, D. C.; Union Savings Bank, Washington, D. C.; Chamber of Commerce, Washington, D. C.; Pitner Gasoline Lighting Co., Chicago, Ill.; R. G. Dun & Co., Washington, D. C.; Smethport Glass Co., Smethport, Pa.; The Melvin Gauge and Signal Co., Scranton, Pa.; M. Winter Lumber Co., Sheboygan, Wis.; National Savings and Trust Co., Washington, D. C.

FREE COUPON!

VICTOR J. EVANS & CO., Patent Attorneys

NEW YORK OFFICES: 189-191 Broadway

PHILADELPHIA OFFICES: 1429 Chestnut St.

Main Offices: 765 Ninth St., N. W., WASHINGTON, D. C.

GENTLEMEN: Please send me FREE OF CHARGE your FIVE Books as described above.

NAME.....

ADDRESS.....

WANTED IDEAS



Inquiries from Manufacturers and Other Buyers of Patents
Who Are Looking for Good Ideas

Protected by Owen Patents

Are constantly being received. Hundreds of ideas are wanted—a market exists for them to-day. YOURS may be one of them. Send for my free books and see for yourself—read the requests for inventions protected by me. Many are simple. You can help supply this demand.

As soon as my clients' rights are protected I aid in every practicable way, **without charge**, to sell. Their **applications** are advertised free—their patents are called to the attention of the proper prospective buyers—every necessary thing is done. Get my booklets and see.

THESE ARE FREE

You will incur no obligation by writing me. A simple request will bring them to you—the finest, most reliable and instructive patent books published. A postal will do.

"Successful Patents"—a 72 page guide book, tells how to proceed; describes my advantageous business methods; gives references, testimonials, etc.
"Stepping Stones"—gives hundreds of hints of inventions wanted; articles from interviews of noted authorities; tells the truth about prizes for inventions.
"Patent Promotion"—tells you how to sell; why some inventors fail; discusses the value of your idea; how I aid my clients; manufacturing aids furnished you; recent successful patents, etc.

You will also be sent from time to time, as new inventions are wanted, full information concerning them. Only in this way can you keep up to date.

Write for These To-day—Advice costs nothing. All communications confidential. I secure patents or receive no compensation. Your work will receive my personal supervision—but my fees are no higher than others.

Results Speak Loudest—But Here Are Some References

Columbia National Bank,
Washington, D. C.
National Locktile Co.,
Washington, D. C.
The Carnahan Press,
Washington, D. C.
Lightning Gun & Cycle Works,
Oklahoma City, Okla.
Antholene Mfg. Co.,
Hutchinson, Kans.

National Rack Co.,
61 Hannover St.,
Boston, Mass.
The C. J. Loftus Co.,
13 Spring Common,
Youngstown, Ohio
Whitehead Hosiery Mills,
Burlington, N. C.
Dickinson Mfg. Co.,
Des Moines, Iowa.

A LARGE NUMBER OF OTHERS IN MY BOOKLETS.

Search of Records

Send sketch or model of your invention for free search of **Patent Office Records** and report on patentability.



RICHARD B. OWEN 9-303 OWEN BLDG.
WASHINGTON, D. C.

Inventors submitting their inventions to me are protected in a tangible manner until their applications are filed.

PATENTS THAT PROTECT and PAY

Advice free. Terms reasonable. Highest references. Best results.
Send sketch or model for FREE examination and opinion.

BONDED and recommended Patent Lawyer in the Rand-McNally Directory of Bankers and Attorneys Published by Rand-McNally & Co., Chicago, Ill. Recommended Patent Attorney in the Bankers Register and special list of selected lawyers published by the Credit Company, Pontiac Building, Chicago, Sharp & Allen's Directory of Lawyers and Bankers of Philadelphia, Martindale's American Legal Directory of New York City, and the Con. P. Curran Directory of Bankers and Lawyers of St. Louis.

ALL BUSINESS GIVEN PROMPT AND PROPER ATTENTION

A large list of strong recommendations furnished free

WATSON E. COLEMAN, Patent Lawyer, 624 F St., N.W., Washington, D.C.

Money in Patents

Manufacturers are always looking for inventions. All patentable ideas should be protected by a patent. (By a Registered United States Patent Attorney.)

The great majority of money making inventions are thought of by persons, I will term amateur inventors, and nearly always are some very small or simple thing, for the reason that a large invention takes too much time and money for the average person to produce. I have inquiries from all over the country, in which manufacturers and business houses are looking for patents in every line of industry. Owing to these inquiries I am about to put inventors in direct touch with manufacturers who want patents, and thereby find a ready sale for their invention, which, for results, is far more practicable than any other mode of assistance to inventors.

A book "How to get your patent and make your profits thereon," which contains general patent information, is free and I would be very glad to have you write me for a copy of it.

MANSSELL F. MILLS
Registered United States Patent Attorney
244 Commercial National Bank Building, WASHINGTON, D. C.

TRADE MARKS PATENTS COPYRIGHTS
30 YEARS EXPERIENCE IN U.S. PATENT OFFICE

Do not waste your money for patents procured by incompetent solicitors. Such patents are worthless and manufacturers will not buy them, nor do they give absolute protection. Consult an expert who is known throughout the Patent world. **Costs you no more to be safe.** Head of the United States Patent Office and Commissioner of Patents under Presidents Roosevelt, Taft and Wilson and Assistant Commissioner under President McKinley. Thirty years' experience in the U. S. Patent Office qualifies me to give you expert service and to secure you fullest protection. Inquiries solicited.

Sole Offices, 150 Barrister Bldg., Washington, D. C.

EDWARD BRUCE MOORE
PATENT COMMISSIONER UNDER THREE PRESIDENTS



PATENT YOUR IDEAS \$9,000 offered

for certain inventions. Book "How to Obtain a Patent" and "What to Invent" sent free. Send rough sketch for free report as to patentability. Patents advertised for sale at our expense in Manufacturers' Journals.

CHANDLEE & CHANDLEE, Patent Attorneys
Established 46 years.
953 F Street, WASHINGTON, D. C.

PATENTS C. L. PARKER
Formerly Member Examining Corps, U. S. Patent Office
PATENT LAWYER
210 MCGILL BLDG.
WASHINGTON, D. C.

Patents, Trade Marks, Copyrights, Patent Litigation

Handbook for Inventors, "Protecting, Exploiting and Selling Inventions" sent free upon request.

In order to illustrate and make clear its methods of collecting and disseminating information for American merchants, manufacturers and exporters, the U. S. Bureau of Foreign and Domestic Commerce has on exhibition at the Panama-Pacific Exposition, a map of the world, 8 ft. high by 19 ft. wide, one of the largest maps of the world.

Send for **FREE BOOK** { **WHAT TO INVENT**
WHAT NOT TO INVENT
HOW TO SELL YOUR PATENT
Copies of nearest Patents and report in every case without charge
H. L. WOODWARD, 9th and G Sts., WASHINGTON, D. C.

PATENTS THAT PAY. 2 BOOKS **FREE** **1600,000** MADE BY OUR CLIENTS
Protect Your Idea
Send data (model) for Search
E. E. Vrooman & Co., 871 F St., Wash., D.C.

A Fortune to the Inventor

who reads and reads it, is the possible worth of the book we send for 6 cents postage. Write us at once.
B. S. & A. B. LACEY, Dept. T, WASHINGTON, D. C.

I HELP INVENTORS SUCCEED

BY OBTAINING Protecting Patents

My new book "How to Patent Your Invention and 100 Things to Invent" gives a new light on the Patent, Copyright and Trade Mark business. I give a binding guarantee — "No Patent, No Pay." Send sketch of your ideas for free search.

CARL H. CRAWFORD
610 Jenifer Bldg., Washington, D. C.

Please Mention Popular Mechanics

Wanted—Ideas

Inventors! Send for these Remarkable FREE BOOKS, Today

Complete and full information about patents, everything the inventor or manufacturer should know, has been included in these books. Never before has such an inexhaustible fund of valuable information been at the inventor's disposal. Regardless of the fact that the compilation of this information cost us thousands of dollars, we will send to all interested persons, any or all of these books, entirely without charge or obligation.

“Millions In Patents”

This volume, 192 pages, tells the story of the romance of invention. The brain of the inventor is the magician that has made the ancient fairy tales come true. Millions have been paid for a hook, fortunes have come from a toy. Read “Millions in Patents,” and you will realize that this country and all the nations of the world are ready to enrich you beyond your wildest dreams if you can contribute one useful or amusing thing.

“What Is a Trademark?”

It is not an exaggeration to say that billions of dollars have been made out of trademarks, labels and copyrights. He who can fashion a trademark or design a label which will make a product stand out above all similar products, is indisputably a genius for whose brains the world offers almost unlimited money.

“Foreign Patents”

A good invention is bought not by one country but by the world. “Foreign Patents” shows you how the inventor may be paid by other countries and other peoples, as well as by this nation, for his ideas and his inventions. It explains how we, through our representatives in the capitals of the world, maintain for your benefit an endless chain of opportunities which, if you take advantage of them, will girdle the earth and make of your product an agent that may bring back to you rich rewards.

“Inventions Needed”

This book, 256 pages, lays before you a description of the active and profitable field of invention. It tells you the inventions the world needs today, the devices manufacturers are seeking for their business, the ideas for which the public will pay big money. It gives great men's ideas of the most important things needed in inventions now. Science is the key to wealth, and this key can be turned best by the inventor. This book tells you why.

“How to Get Your Patent and Your Money”

The man who invents needs the co-operation of the man who invests. This book, 132 pages, is a guide to the inventor. It describes, according to the teachings of our experience and the lessons of men made rich by patents, how the inventor may secure money; the right amount of money, for the device which his brain has constructed. If you have invented something and desire to learn what it will cost you to get your patent and what you must do to find your market, read this book.

“Special Bulletin of Patent Buyers”

This bulletin, 64 pages, contains copies of hundreds of letters from wealthy men who are seeking to purchase patents. Next to the idea of the invention itself, the most valuable thing to the inventor is a hint of where there is a man ready to buy the invention or to finance the inventor so that his device can be readily marketed. We act as intermediary, without one cent of charge, between the man who invents and the man who invests.

**We Secure Reliable Patents, Trade Marks,
Copyrights, On Most Liberal Terms
Ever Offered**

**Send Model or Sketch and Description of
your invention for Free Search of
the United States Patents**

Rejected and Difficult Cases are Our Specialty

RANDOLPH & CO.
600 F St., N. W., Washington, D.C.

**RANDOLPH & CO.,
WASHINGTON, D. C.**

Gentlemen: Please send me, without obligation on my part, the books indicated on margin of this coupon. (Write on margin of coupon, names of books desired.)

NAME.....

STREET.....

CITY.....

STATE.....

250-A-MONTH



21 Jewels

Standard of the world. Endorsed by Government and Railway Officials. Harris-Gear's enlarged Easy Credit Plan now enables you to own one of these superb Elgin Watches or a beautiful Diamond without missing the money. Write for Free Catalog. Do it today and get this Three Quarter Plate New Model.

GENUINE ELGIN

Here's a real \$40 Watch—one of the finest pieces of mechanism ever turned out by the Elgin factory. Only a few hundred left. They will not last long at this ridiculously low price—about one-half their regular value. Your one chance to own this superb 21 Jewel Elgin that will at once become the pride of yourself and family for a generation. Whether for cash or credit, the price is the same and to make it easy for every reader of this paper to own this marvelous Elgin at the bed-rock factory price of only \$25 (17 Jewels at \$12.75), we make the astounding terms of \$2.50 a Month and

No Money Down—Not a penny. Merely give us your full name and address that we may send you this 21 Jewel on approval. Wear it 30 days in your own pocket and if then you want to keep it, pay us the small sum of \$2.50 a month, or if you don't want to keep it, send it back at our expense.



HARRIS-GOAR
KANSAS CITY, MO.

HARRIS-GOAR CO.

Dept. 1639 Kansas City, Mo.

YOUR CREDIT IS GOOD

Please Mention Popular Mechanics

3 CUSTOM SHIRTS FOR \$5.00

I make shirts that fit you, because I make your shirts from your measurements and guarantee to take them back if they do not satisfy you.

I send you 100 samples to select from.

I send you measurement blank with rules. I send you the finished shirts express prepaid. No ready-made shirts in my shop, but facilities for quick delivery of the highest grade of custom work. Write for my samples. (Higher-priced fabrics, too.) Summer samples now ready. **No agents.**
CLARENCE E. HEAD (Master of Shirtecraft), 110 Cayuga Street, ITHACA, N. Y.

GEARS

SPROCKETS CHAINS

In Stock for immediate shipment

All Kinds sizes and materials made to order.

Send for 48-page New 1915 Catalog
WOBURN GEAR WORKS
 Woburn, Mass.

BRASS GEARS

Cut by an entirely new process. The most accurate made and at prices that cannot be equalled by others. Every gear has a hub, center painted ebony black, edges turned true, highest grade red brass, and much heavier than others. We carry the largest stock in the world and every gear listed is always shipped on date of order.

SEND FOR CATALOGUE
CHICAGO STOCK GEAR WORKS
 16 S. Fifth Av. Chicago

in existence. On it are shown the locations of American representatives abroad including the ambassadors, consuls, and consular agents of the Department of State, and the commercial attachés and traveling commercial agents of the Department of Commerce. These sources of information for American business are connected with

Models and Supplies

We make working models of any description and material, also dies, tools and sheet metal stampings. Send your drawing or sample for estimate. Write for catalog of gears and model supplies.

The Pierce Model Works, 3405 Pierce Ave., Chicago, Ill.

SETS OF CASTINGS OF MODEL ENGINES

SEND FOR FREE CATALOG
 ALL CASTINGS
 ALSO TOOLS
 GEAR WHEELS & PARTS OF MODELS

WILHELM H. WICKHAM & CO.

MECHANICAL SUPPLIES AND MATERIAL

of all kinds.
 EXPERIMENTAL AND
 LIGHT MACHINE WORK
 to order.

132 MILK STREET. BOSTON

Active Powers of Inventive Genius

INVENTORS

Our Brain Belongs to You. Our Ideas Are Free of Charge.

All we want in return is to build your model, special machinery, dies, tools and lugs to manufacture sheet metal goods, etc. We are expert mechanics, over thirty years' experience and have one of the best equipped shops in the country. Ask for Booklet No. 17. Consultation free. Experimental work strictly confidential.

A. Naecke & Son, J. Struman, A. Heidrich, Prop's
 234-242 S. 9th St., Philadelphia, Pa.

140,000 Gears

IN STOCK FOR
 IMMEDIATE SHIPMENT

This does not include our large stock of pinion wire, racks, chains, ball bearings, universal joints and gear gauges. Send for Catalog No. 88.

BOSTON GEAR WORKS
 Norfolk Downs (Quincy), Mass.



Crescent Wood Working **MACHINERY**
will satisfy every particular user who wants the best wood working equipment. Send today for catalog of band saws, jointers, saw tables, planers, planers and matchers, swing cut off saws, disk grinders, shapers, borers, variety wood workers, Universal wood workers.

The Crescent Machine Company
93 Columbia St. Leetonia, Ohio



South Bend Lathes
For the Machine and Repair Shop

11 inch Lathe Complete	\$100.00
12 inch Lathe Complete	125.00
13 inch Lathe Complete	165.00
15 inch Lathe Complete	200.00
16 inch Lathe Complete	250.00
18 inch Lathe Complete	300.00

How to Run a Lathe
A 50 cent book for 10 cents. Postpaid, stamps accepted.

Straight or Gap Beds. Send for free catalog giving prices on entire line.

SOUTH BEND MACHINE TOOL CO.
423 Madison St., South Bend, Ind.



LATHES
9 to 18-inch Swing
List price \$75 and up according to size. When ready to buy send for Lathe Catalog and prices.

W. F. & John Barnes Co.
100 Ruby Street, ROCKFORD, ILL.



Here's A Bargain in a High Grade Lathe
Our price only \$251.00 for this 16-inch Screw Cutting Engine Lathe; 6-foot bed; complete with compound rest, counter-shaft and reverse. Write today for descriptive Machinery Catalog No. 801'209. Copy free.

SEARS, ROEBUCK AND CO., Chicago

Washington by various colored cords. The cities of the United States in which branch offices of the bureau are located are similarly connected with Washington, indicating the manner in which the information is furnished to those interested in foreign trade.



MOTOR DRIVEN BENCH SAW
Saws Wood and Soft Metals
Indispensable and most economical. For shop or private use. Full description and circular on request.

H. G. CRANE Cypress St., Brookline, Mass.

DIAMONDS
ON CREDIT - \$
TERMS AS LOW AS **250**
A MONTH



Diamond Rings
Wonderfully brilliant Genuine Diamonds, any style solid gold mountings; also Diamond La Vallieres, Ear Screws, Brooches, Scarf Pins, Studs, etc., on credit terms as low as \$2.50 a month.

Send for **Jewelry Catalog No. 57**

containing over 2,000 beautiful illustrations of Diamonds, Watches, Artistic Jewelry, Silverware, Cut Glass, etc. Select anything desired, either for personal wear, or for a gift to friend or loved one, then ask us to send the selection for your examination. It will be sent, all charges prepaid by us.

YOU PAY NOTHING—NOT ONE CENT until you see and examine the article right in your own hands. If you like it, pay one-fifth of the purchase price and keep it, balance divided into eight equal amounts, payable monthly. If not entirely satisfactory, return at our expense. You assume no risk; you are under no obligation. Our Catalog tells all about our Easy Credit Plan. Send for it Today. It is FREE.

LOFTIS BROS. & CO., The National Credit Jewelers
Dept. A894, 100 to 108 N. State Street, Chicago, Illinois
(Established 1888) Stores in: Chicago; Pittsburgh; St. Louis; Omaha

DO YOU HAVE KNIVES TO GRIND, SILVER TO POLISH, SMALL TOOLS TO OPERATE, WASHING MACHINES OR WRINGERS TO RUN? LET THE RED DEVIL DO YOUR WORK



Attached to any water faucet will develop up to 3 Horse Power according to size of pipe and water pressure. Only perfect small motor made. Improved bucket wheel construction.

6 in. Motor for Mechanics and Tradesmen. Washing Machine, 1 H. P., on 1/2 in. pipe, 80 lbs. water pressure; 1 H. P., on 3/4 in. pipe, 120 lbs. water pressure. Net price \$55, cash with order.

No. 1492—4 in. Motor for grinding, polishing, fans, sewing machines; for Dusters, Dentists, Druggists, etc., with emery, buffing wheel, silver polish and pulley, \$3.

No. 1490—4 in. Motor and pulley only \$2.50, cash with order.

Money back for any reason. Order your motor from dealer or from us. Send your water pressure and size of supply pipe. Active Agents wanted. Catalog free.

Only Motor to do this work

DIVINE WATER MOTOR CO.
DEPT P. UTICA, N. Y.

SEBASTIAN LATHES HIGH QUALITY LOW PRICES

If you delight in good tools you will delight in Sebastian Lathes. For 25 years we have built lathes, and lathes only, employing skilled labor always, and improving equipment and machinery every year. Sebastian Lathes are **STANDARD FOR QUALITY—LOW IN PRICE**

They are accurate, economical, simple and durable. Many re-orders and voluntary letters from users of Sebastian Lathes prove this. The Sebastian reputation is back of every Sebastian Lathe. You are judge and jury when you buy a lathe. We are not satisfied until you are. Look over the complete line in our new catalog. It shows Lathes for general repair work, garage and automobile work, etc.

When you buy a lathe, say "Sebastian"
ADDRESS (FOR THE CATALOG)
THE SEBASTIAN LATHE COMPANY, 107 Culvert St., Cincinnati, Ohio



Three Refrigerator Improvements Shown in this Book

Write today for this new book by Mr. Leonard. Learn about

- (1) The new method of lining that does away with corners in "hard-to-get-at" places, and makes cleaning easier than ever;
- (2) The new one-piece door lining; and
- (3) The Self-Closing Trigger Lock that automatically shuts the door tight, always, and insures the efficiency of the refrigerator.

Leonard Cleanable

With these three improvements the Leonard is absolutely perfect. Its beautiful, glistening-white, seamless, porcelain lining makes it as sanitary, clean and easy to care for as a Haviland China dish. There is not a nook or crevice in which grease or dirt can collect.

Write for book and sample of porcelain used in the Leonard Cleanable. Compare this lining with any other kind. Put to hard tests. Then you'll understand why the Leonard outlasts ten ordinary refrigerators and is "like a clean china dish." Write today.

GRAND RAPIDS REFRIGERATOR COMPANY
157 Clyde Park Avenue Grand Rapids, Mich.
World's Largest Refrigerator Manufacturers

50 styles
\$15.00 and up.

This style
35 x 21 x 45
in Oak case
\$35.00.

Freight paid to Ohio and Mississippi Rivers.



For sale by good dealers everywhere, or direct from factory with money-back guarantee if not pleased.

Like a clean china dish



Ironing In 1/4 The Time

Try 30 Days FREE



You can do as much ironing as four women ironing by hand and with greater ease if you use

SIMPLEX IRONER

"THE BEST IRONER"

For City and Country Homes

Better results, beautiful finish, straight edges. No fuss and bother or weariness.

Operated by Electric, Gasoline or Hand Power. Heated by gas, gasoline or electricity. Eight sizes—\$25 and up. Easy payments.

Write for FREE Booklet on Ironing, 30 Days Free Trial Offer, and name of local dealer.

AMERICAN IRONING MACHINE CO.

ESTABLISHED 10 YEARS
593-168 N. Michigan Ave. CHICAGO, ILL.

"See our Exhibit at the Panama-Pacific Exposition—San Francisco, Manufacturer's Palace"

"Billiards—The Home Magnet"—FREE!

A handsomely illustrated book showing all Brunswick Home Carom and Pocket Billiard Tables in actual colors, giving easy terms, prices, etc. **Sent Free!** Write for it today. THE BRUNSWICK-BALKE-COLLENDER CO., Dept. 18A, 623-633 So. Wabash Ave., Chicago

Try My Rapid FIRELESS COOKER

30 Days in Your Home At My Risk



A big saving in food bills, fuel, work—and food tastes better. I am making

Special Price on 10,000

to introduce cooker into new neighborhoods quick. Cooker is aluminum lined throughout. Complete outfit aluminum utensils free.

Write for Free Book and Bargain Prices direct from factory.

WM. CAMPBELL CO.
Dept. 64 DETROIT, MICH.

Drink Pure Water

Perfect health demands it. Disease lurks in impure water. Insure purity by installing a

Bohner Self-Cleansing Filter

Gives you constant supply of crystal water, pure as ozone. Inexpensive. Anyone can install without tools. Lasts a lifetime. Full particulars on request.

Bohner Mfg. Co. 10095 So. Wabash Ave. CHICAGO, ILL.



AGENTS WANTED

Guaranteed to give satisfaction or money back if returned in 15 days.

THIS BUNGALOW \$900 CAN BE BUILT FOR

This and many others in my new book, Building Plans for Modern Homes, will save you hundreds of dollars. One of the most complete and comprehensive books of plans ever published by any architect. Fifth edition just off the press. Two hundred and fifty floor plans and photographs of bungalows, etc., costing from \$200 up; gives sizes and cost to build. Sent postpaid for \$1.00



FREDERICK H. GOWING
ARCHITECT

18 Tremont St., BOSTON, MASS.

SEND \$1.00 FOR THIS REAL BUNGALOW BOOK

Design No. 524 by Jud Yoho. Est'd Cost \$2800.
1915 DeLuxe Edition, 112 Pages
The largest exclusive bungalow book published

Shows cream of 1000 practical and distinctive bungalows actually built for \$400 to \$4000, suited to any climate, with exterior and interior views, plans, size of rooms, cost, etc.

Contains valuable suggestions on bungalow building written by experts. Worth many times its cost to any builder. Sent anywhere **\$1.00 Post Paid**
A smaller book 50c. Send check, money order or stamps. Money back if not satisfied.

JUD YOH0, The Bungalow Craftsman, 51 Bungalow Bldg., Seattle, Wash.

Special BUNGALOW Number Newsstands

20¢ KEITH'S MAGAZINE



A BEAUTIFUL BUNGALOW FROM KEITH'S
starts, together with a copy of a new book, "100 Artistic Homes," ALL for \$1.00.
Keith's (established 15 years) 20c a copy. Newsstands—\$2.00 a year
M. L. KEITH, 759 McKnight Building, MINNEAPOLIS, MINN.

GOODELL-PRATT 1500 GOOD TOOLS

This High Speed BREAST DRILL No. 279

is a marvel of mechanical ingenuity and expert workmanship. It is an absolutely new tool different from anything else on the market. By turning the knurled ring between the crank handle and the gear casing the speeds can be changed or the spindle locked for opening and closing the chuck.

Instead of the usual breast drill speeds, the fast speed on this tool is 7 revolutions of the chuck to one turn of the crank, and on the slow speed 2 to one. The gears, which are enclosed in an aluminum casing and packed in grease, are all machine cut like the gears in every other Goodell-Pratt tool. The chuck holds all sizes of round shank drills up to $\frac{1}{2}$ inch in diameter.

The construction of the tool is absolutely up-to-date with every convenience for the operator; the saddle breast plate is much easier on the chest than the old style iron head; the aluminum casing and hollow steel tubes make it as light as possible; the ball bearings make the spindle run easier. All the aluminum parts are polished and the steel parts polished and nickel plated. The list price is \$7.50.

If you are interested in this tool ask any progressive dealer to show you one, or write to us for our new pocket catalog No. 12, which shows over 1500 tools, 80 of them new!

GOODELL-PRATT COMPANY

Toolsmiths

GREENFIELD, MASS., U. S. A.

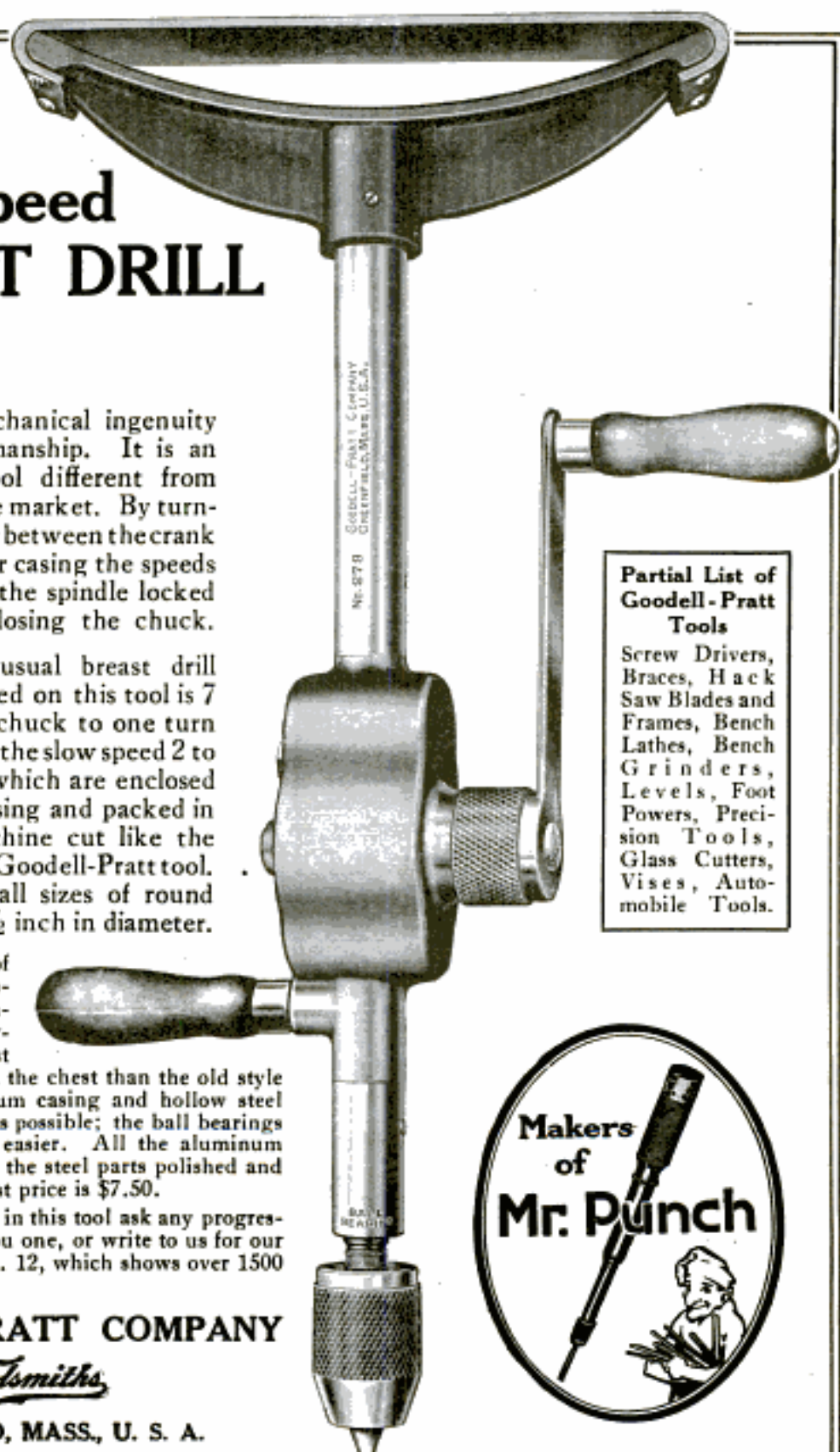

Partial List of Goodell-Pratt Tools

Screw Drivers,
Braces, Hack
Saw Blades and
Frames, Bench
Lathes, Bench
Grinders,
Levels, Foot
Powers, Precision
Tools,
Glass Cutters,
Vises, Auto-
mobile Tools.



Please Mention Popular Mechanics



For Boys Who Like to Build Things

There's a lot of fun and healthful exercise to be had tinkering around the house and yard with tools. But you can't get any fun out of carpentry or turn out good work unless you use the best tools, such as

SIMONDS SAWS

Try a Simonds Saw—see how fast and smooth and straight it cuts and what an easy, comfortable "hang" it has. No tiring out the muscles, no continual filing if you have a Simonds Saw. It holds its edge and cuts true. Simonds Saws are the product of over eighty years' experience in cutting edge tools and are backed by an iron-clad guarantee.

Ask your dealer for Simonds Saws. We will supply you if he can't. Write for our booklet K.

*"If you want saws that cut like diamonds
Ask for saws that are branded SIMONDS."*

Simonds Manufacturing Co.

"The Saw Makers"
FITCHBURG, MASS.

5 Factories

11 Branches



do this. Do this—draw razor blade between thumb and fore-finger moistened with "3 in One." Rub a few drops into strop. Then strop.

The microscopic saw teeth of a razor's cutting edge rust. This dulls the blade. "3 in One" prevents surface rusting. Stropping wipes the edge clean, breaking off all dull rusted steel particles. You get a brand new set of sharp teeth for every shave.

Just try this honestly one week. Write today to
**THREE IN ONE OIL CO. 42CNF. B'way,
NEW YORK CITY, for sample bottle and special circular. Both free.**

TEN COMMANDMENTS FOR SHOP WORKERS— Some rules were posted at a plant for the promotion of efficiency as far as a set of rules and regulations could be expected to go. To make them remembered after they were read, they were put into a form that made a hit because planned on quaint lines, inviting repetition by the readers and occasional good-natured quotation from one workman to another, says Castings. Here they are:

I—Thou shalt have none other thoughts than thy work.
II—Thou shalt take no unnecessary risks, nor try to show off, nor play practical jokes, for by thy carelessness



TOOL CASES

For Up-to-Date TOOLMAKERS and MACHINISTS

We carry the finest and most complete line of mechanics' toolcases and tools in the country. We guarantee to please you or refund money. Write for free catalogue.

J. M. WATERSTON
177 Jefferson Ave., E. Detroit, Mich.

★ STARS MAKE DOLLARS ★



If you're a man of energy and business ability, here's an opening worth consideration. There is a great demand for drilled water wells, and there are large sure profits to the man with a PORTABLE

STAR DRILLING MACHINE

Run by Steam or Gasoline

Best by test. Low in price, high in practical worth. You can make it pay for itself and earn dividends all the time.

Look into this! Sold on payment plan. Our 106-page catalogue describes 21 different Star Outfits. Send 6 cts. to pay postage and we'll mail you this book which will point the way to money making. Write today.

Star Drilling Machine Co.
506 Washington St., AKRON, OHIO

This Grinder Won't Draw Temper from Finest Tools



Takes All the Drudgery Out of Tool Sharpening. The Luther Tool

Grinder gives a perfect edge to any farm or shop tool in a jiffy—saves two-thirds of the time and labor of old methods. Puts a keen edge on the dulllest axe in three minutes or shapes up any plow point in ten minutes. Puts a razor edge on chisel or bit in a jiffy. Fitted with **Dimo-Grit** Wheels, the perfect sharpening substance in the perfect form. Cuts toughest steel as emery cuts copper—will not wear soft, lop-sided or glaze smooth. 25 times faster than grindstone—10 times better than emery. The

LUTHER DIMO-GRIT TOOL GRINDER

can be used without water. The very lightest touch of steel to wheel produces perfect edge. Positively will not draw temper. All metal frame, shaft drive, dust-proof ball-bearings, patent tool rest and 14 different attachments. **Guaranteed 10 years.**

30-Day Free Trial—at our risk—if not the best labor saver you ever saw—return it—trial costs nothing.

Representatives Wanted Everywhere **Small Easy Payments**—so small you can't waste them—enable you to save its cost while paying for it.

How to Get This Grinder FREE We want the good-will of one responsible farmer or mechanic in each locality. No canvassing. Be the first to get full particulars about our remarkable offer. **GET FREE BOOK ON TOOL GRINDING.** If you wish more information send postal for this book and read it carefully.

LUTHER GRINDER MANUFACTURING COMPANY
303 S. Water Street MILWAUKEE, WIS.

thou mayest do injuries which will have effect unto the third and fourth generations to follow.

III—Thou shalt not swear nor lose thy temper when things do not come just right.

IV—Remember that thou art not the only one on the

SOLDERING MADE EASY

GASOLINE SOLDERING IRON BLOW-TORCH
Address Dept. 1, EMMELMANN BROS. MFG. CO., INDIANAPOLIS, IND., U.S.A.

THE AWL YOU WANT

See That Reel



Is the genuine MYERS \$1.00 "Lock Stitch" Sewing Awl with the exclusive feature. See thread reel in front of handle under the finger tip. Natural tension. Sews heavy or light material, diamond point, full grooved needles used to protect the thread when sewing.
C. A. MYERS COMPANY, 6339 University Ave., Chicago, Illinois

The Acetylene Blow Torch

Prest-O-Torch
Costs less to buy than a good gasoline blow torch and costs less to use.

In all soldering and brazing, the Prest-O-Torch avoids the delays and uncertainties of gasoline outfits. Provides a concentrated, intense flame that doesn't blow out even in a high wind. Needs no attention whatever. Used with handy sizes of Prest-O-Lite cylinders—ready-made gas, instantly available.

Style "A" sells for 75c. Used with the small MC size Prest-O-Lite. Will braze up to 3/8 inch round rod. This outfit can be fitted with handle and hook for added convenience in bench and overhead work. Style "C" Prest-O-Torch is recommended for large work. Will braze up to 1/2 inch round rod. Sells for \$2.25. For use with the larger sizes of Prest-O-Lites.

Write for special literature and learn where you can see the Prest-O-Torch in operation.

The Prest-O-Lite Co., Inc. 216 Speedway, Indianapolis, Ind. Exchange Agents: Everywhere



Edges That Cut Clean

The high quality of Keen Kutter steel produces blade edges that cut clean—cut easily—cut quickly.

Keen Kutter pocket-knife blades are firmly pinned and the handles do not loosen or crack.

KEEN KUTTER

Pocket Knives—Razors

Keen Kutter safety-razor blades are made of the finest Swedish cutlery steel. The Keen Kutter Regular Safety Razor and Keen Kutter Junior Safety are set at the correct cutting angle, which enables the most inexperienced man to start shaving right away without practice. The dealer is authorized to refund the price for any Keen Kutter article that doesn't prove satisfactory.

No. K0153
Price \$2.00
Pocket Knife



No. K710
Price \$1.00
Keen Kutter Junior Safety Razor
In neat traveling case

Send for our Cutlery Booklet No. D551.

"The Recollection of Quality Remains Long After the Price is Forgotten."
—K. C. SIMMONS.
Trade Mark Registered.

If not at your dealer's, write us.

Simmons Hardware Company

St. Louis
New York Philadelphia
Toledo Minneapolis
Sioux City Wichita

No. K2551. Price \$0.85
Pocket Knife, 2 blades



Please Mention Popular Mechanics

The Keen Satisfaction of having Keen Tools

CARBORUNDUM Sharpening Stones, in your tool-kit or on your work-bench, insure this satisfaction. The ordinary sharpening stone wears the edge on the tool; a Carborundum stone cuts. It leaves the tool with a smooth, true edge. A favorite stone for general use is the

Carborundum Round Combination Stone

You use every inch of it—no waste stone. It's round so as to allow for circular motion in sharpening chisels, plane bits, etc. There are other shapes and sizes; in fact, there is a Carborundum stone for every sharpening need. **Send 15 cents for handy pocket stone.**

The Carborundum Company
Niagara Falls, N. Y.



Rent This Level 9 Months — Then It's Yours

BUILDERS and CONTRACTORS

High price and cash payments are eliminated. For the first time it is possible to obtain a high grade Level on terms so easy that you can not afford to be without one.

Convertible Level

Besides its use as a Level, it can also be used for running straight lines, getting angles, taking vertical sights, etc., for which ordinarily a Transit is required.



For more than fifty years Aloe's surveying instruments have been recognized as standard instruments. This Level is offered to you with an absolute guarantee that is backed by a ten day free trial offer.

FULL PARTICULARS and details of our extraordinary selling plan will be sent on request.

A. S. Aloe Co., 515 Olive St., St. Louis, Mo.

job and that other lives are just as important as thine own.

V—Honor thy job and thyself, that thy days may be long in employment.

VI—Thou shalt not clean machinery while it is in motion.

VII—Thou shalt not watch thy neighbor's work but attend to thine own.

VIII—Thou shalt not let the sleeves of thy shirt hang loose, nor the flaps of thy coat be unbuttoned, as they may get caught in the machinery.

IX—Thou shalt not throw matches nor greasy waste

BILLINGS & SPENCER

Machinists and Auto

TOOLS

Special Kits
for Ford Cars

Hartford Ct.



Wrenches
Pliers
Sc. Drivers
Hammers
Ratchets
Wrench Kits
Tool Kits



Portable Cases

FOR TOOL MAKERS
AND MACHINISTS

Twelve styles, felt lined drawers, solid brass trimmings, best of material, beautiful finish, low prices, satisfaction guaranteed. Ask for booklet of cases built for service.

The Pilliod Lumber Co.
SWANTON, OHIO

SEARIGHT Compound Lever Mechanics' Snips
cut 16 gauge metal at the point with one hand. The cutting power of these snips is three times that of the common straight snip. They are Drop Forged from Crucible Tool Steel.

No. 7
No. 14

Sizes: 7, 8, 10, 12 & 14 in. long
Prices: \$1.00, \$1.50, \$2.25, \$3.00, \$3.50 Prepaid

BARTLETT MANUFACTURING CO.
20 East Lafayette Ave., DETROIT, MICH.

Vest Pocket "Red Devil" Plier No. 1124



with Prest-o-lite opener. Special thin nose for work in close places. Handsome handles (dentyne milled). Pocket size 5"; tool chest 6½". For long wear, firm yet easy grip, you can't get a better tool. **BUILT FOR EXPERT MECHANICS.**

At dealers or postpaid from us for 60c (one only). Write for booklet

SMITH & HEMENWAY CO., Inc., 161 Chambers St., NEW YORK CITY



For All the Family

EVERYONE needs SKAT, after work or play. Quickly removes all dirt, grime, grease, etc., leaving the hands smooth and white. It "rolls" the dirt out of the pores, loosening it and making it easy to rinse off. You'll find a hundred different uses for SKAT, in the house, garage, office, and shop. Take a can along on your vacation.

If not at dealer's send his name with 10c and we'll see you are supplied. *Salesmen Wanted.*

THE SKAT COMPANY, Hartford, Conn.

NOKORODE SOLDERKIT \$1

With large illustrated instruction sheet never before published, showing how to solder everything. Practical for experts, easy for amateurs, indispensable in home. Approved by "Good Housekeeping" and everyone who has one. Tells how to repair household articles, Automobiles, etc. Includes everything necessary for practical work. Money back if not perfectly satisfied. Sent postpaid in the United States on receipt of \$1.00.

THE M. W. DUNTON COMPANY, 152 Niagara St., PROVIDENCE, R. I., U. S. A.

on the floor, nor scatter oil around the bearings, as a dirty worker is a clumsy worker, and a clumsy worker is a menace to himself and his fellow workers.

X—Thou shalt not interfere with the switches, nor the dynamos, nor the cables, nor the engines, nor anything else that thou art told is dangerous.

The world's annual production of artificial silk is said to be 20,000,000 pounds.

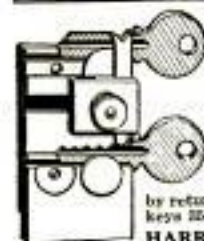

Duplicate Keys for all Pin Tumbler Locks can be made in a minute with The Harrison M. I. P. Key Filing Machine

Invaluable for Machinists, Building Superintendents, Hardware and Repair Shops, Locksmiths, Carpenters, Electricians, Garages, etc. Anyone can make a perfect duplicate key without injuring the original. Every machine unconditionally guaranteed. Money refunded if not entirely satisfactory. Price \$3.00 net. Send us P. O. order or N. Y. draft and receive the complete machine by return Parcel Post. Special diamond shaped files for angular keys 25c each or 4 for \$1.00. Send for circular.

HARRISON & COMPANY, 81 NEW ST., NEW YORK

Braces
Drills

MILLERS FALLS
TOOLS

Hack Saws
Mitre Boxes

Do Better Work and Last Longer

Write for catalog showing complete line
MILLERS FALLS CO., Millers Falls, Mass.



ToolCases for Toolmakers and Machinists

Keep your tools orderly arranged in a Gerstner Portable Tool Case. There's a place for every tool in one of the felt lined drawers. Every up-to-date mechanic needs one and you'll find our Cases the best built, neatest and most practical on the market. We guarantee to please or refund all money. Write for our free booklet.

Gerstner & Sons

Mfrs. of Mechanics' High Grade Tool Cases
808 Columbia St., DAYTON, OHIO



Handy Tools— for the Shop or Home

The name Starrett on these tools for the homeowner and amateur mechanic insures the same quality and service that leads men in the mechanical industries to select for their measuring standards the well-known

Starrett Tools

The tools shown here are "handy" tools for a variety of work. The cabinet scraper is for putting a fine finish on woodwork. The expansion pliers with adjustable jaws combine a small wrench and plier. The small eye-glass screw-driver, insulated handle and patent screw-holding screw-drivers are useful on very small work, electrical work, and odd jobs. The metal-cutting hack saw will cut quicker and last longer than any other.

Starrett Tools are sold at all good hardware stores.

Send for 320 page free catalog No. 20 A. P.

The L. S. Starrett Co.

World's Greatest Toolmakers

Athol, Mass. 01060



Please Mention Popular Mechanics

Brown & Sharpe Micrometers

YOU don't use a micrometer unless the dimension must be accurate, and the surest way to be sure is to use a Brown & Sharpe. Here are four styles out of over 475 in our line.



No. 12

New Style Frame and Graduations

Made thin at anvil to go in small openings. Hub graduations alternately above and below line make reading easy.



The Rex

Our New Low-Priced Micrometer

Drop forged frame with dull nickel finish; new style graduations like No. 12 above. An inexpensive but reliable micrometer.



No. 25

This One Shows the Size in Figures

As easy to read as a clock. Size shows directly in figures to thousandths, through openings in barrel.



No. 102

Made Rugged for Heavy Service

Heavy parts to stand the constant and severe service, water and dirt in grinding rooms and similar places.

Our new catalog No. 26 shows all these and many other tools. Drop a postal for free copy.

BROWN & SHARPE MFG. CO.
PROVIDENCE, R. I.

15 Minutes' Work Saves \$15⁰⁰

Assemble This Beautiful Extension Dining Table Yourself

You can put it together in a jiffy. We ship it in sections—direct from factory. Save 3-4 packing costs, 2-3 freight costs and 1-2 factory floor space usually required. Our original sectional method and direct-to-you dealing give you highest-quality furniture at a remarkably low price. All Brooks' Master-Built furniture is

Shipped in Sections—Direct from Factory

You save almost half. We can give you everything for home, office or club—all selected solid quarter-sawn oak—your choice of best Colonial, Mission or Flanders designs—any finish. We guarantee to satisfy you or return your money. Write today for the Brooks Furniture Book, showing 100 more good ideas like this. Let a few minutes' easy work save many dollars in price.

Brooks
Manufacturing Co.
2708 Brooks Ave., Saginaw, Mich.
Largest Plant of Its Kind
in the World



Our Price
Only
\$19⁷⁵

Dealers'
Price
\$35⁰⁰

Dining Table No. 314

Let Us Send You a Genuine Edison Phonograph on Free Trial



Right to your own home. Entertain your family and your friends. Send it back at our expense if you don't want to keep it. A few dollars a month now pays for a genuine Edison at rock-bottom prices and without even interest on monthly payments. Send today for our beautiful Free Edison Catalog. A postal or letter is enough. But send it at once.

F. K. BABSON

ATFD Edison Block

Edison Phonograph Distributors

Chicago, Ill.

OVER 70 YEARS'
EXPERIENCE

PATENTS

TRADE MARKS
DESIGNS
COPYRIGHTS, &c.

Anyone sending a sketch and description may quickly ascertain our opinion free whether an invention is probably patentable. Communications strictly confidential. HANDBOOK on Patents sent free. Oldest agency for securing patents. Patents taken through Munn & Co. receive special notice, without charge, in the

Scientific American.

A handsomely illustrated weekly. Largest circulation of any scientific journal. Terms, \$3 a year; four months, \$1. Sold by all newsdealers.

MUNN & CO. 672 Woolworth Bldg., NEW YORK

Washington Office, 625 F St., Washington, D. C.

FITS-UR-POT



FITS ANY COFFEE POT

Just out. Going with a rush. Every home a prospect. Converts any pot into percolator. Makes better coffee—saves third to half. Aluminum. Quick sales.

Profits \$24 to \$36 a Week

Most percolators cost \$3 to \$5. FITS-UR-POT sells for \$1. Practical—absolutely new. Our free premiums stimulate sales. Write quick for agency.

Standard Spinning & Stamping Company
106 Smead Ave. Toledo, Ohio

AGENTS WANTED

BIG CHANCE FOR AGENTS



You can earn BIG MONEY

Selling the most complete line of guaranteed transparent handle Knives and Razors with Photo, Name and Lodge Emblem—also full line of cutlery. Write today for catalogue and terms. Golden Rule Cutlery Co., 554 W. Lake St., Dept. 205, Chicago, Ill.

You Can Make Big Money

C. F. Larsen has made over \$1000, selling Matchless Gas Lighters. E. O. Haines made \$17.10 in one day. You too can make big money.



The Matchless Gas Lighter lights gas or gasoline. Safer, cleaner, handier and cheaper than matches. Send 25 cents for agents' sample and big money making offer.

STEEL STAMPING CO., Dept. 22, 143 W. Austin Ave., Chicago

Double Your Income

It's easy and the work is delightful. A trial will convince you. Excuser made \$42.50 in 8 hours with his

DAYDARK POST CARD MACHINE making photos. In a minute and 6 sizes. You can make \$5 to \$50 a day easy without experience. 500 per cent profit. Write for particulars and our FREE TRIAL offer. Daydark Specialty Co., Dept. 2, St. Louis, Mo.

10 days FREE TRIAL

Tomato skins and seeds are used in Italy, the former as stock feed and the latter as a source of oil, suitable for soap making and for lamps.

Make \$15.00 to \$35.00 Per Day

With Our Latest Invention, the Wonderful Ever-Ready Camera. Makes 9 styles single or group pictures direct on postcard or tistypes without film or negative, finished for delivery in less than one minute. **No Experience Necessary.** Get into a good, clean, respectable business of your own and become independent. **Big Money** at fairs, carnivals, parks, picnics, anywhere. Photos cost you from 1 to 25¢; sell at 10, 15 and 25¢ each. Write Today for Free Proposition and Catalogue.

THE NEW YORK FERROTYPE CO.
Dept. 70J, No. 168 Delancey Street, NEW YORK, N.Y.
Dept. 70J, No. 126 S. Halsted Street, CHICAGO, ILL.

Make \$20 to \$40 a Day

with the **VICTOR Plateless Photo Post Card Machine**, which takes 11 styles of pictures direct on post cards, tin types and buttons. The **VICTOR** is the world's biggest money maker, recognized by thousands of successful **VICTOR** operators. Positively no experience necessary. Start in business for yourself with a small investment and be your own boss. 10 year guarantee with every **VICTOR** machine.

Write today to main office and factory of the Ferrotypes and post card machines and supplies.

AMERICAN FERROTYPE CO.
152 Delancey St. Dept. A58 NEW YORK CITY

Regular Price **\$1.25** **THE RAPID VACUUM WASHER**



Sold on 30 days' trial.

The only Washer with Automatic Suction

Washes everything from blankets to fine laces. Tub of clothes washed in 5 to 10 minutes. A child can operate it.

AGENTS WANTED. Special price on sample postpaid. Write for terms and trial offer.

STEWART-SKINNER CO., 26 Cherry St., Worcester, Mass.

Stanley Tools



No 386

Stanley Jointer Gauge

Can be Attached to Any Iron Plane

☐ A tool that will enable you to plane bevels of any angle between 30 and 90 degrees, or to square up the edges of boards with extreme accuracy.

☐ All parts except the knob are of metal—nickel plated and all the joints and bearing surfaces are machined.

PRICE \$1.75 EACH

☐ If you cannot procure this tool from your Hardware Dealer, we will upon receipt of price send same postage prepaid to any part of the United States.

ADDRESS

STANLEY RULE & LEVEL CO.
NEW BRITAIN, CONN. U.S.A.



Pipe-Threading is perfectly simple with a No. 82

Oster

Light, compact, nicely balanced,

Oster die-stock No. 82 is a *satisfying* tool to handle. It's no trick to operate one—any one can thread perfectly these pipe sizes, — ¼ in., ⅜ in., ½ in., and ¾ in. There are no loose, extra parts. No. 82 is a complete working unit in itself with features that distinguish it from all other small stocks. Ask now for the complete Oster catalog. It is free.

Kindly send me by return mail the Oster catalog.

THE OSTER MFG. CO.

2100 E. 61st St. Cleveland Ohio

Name.....
Business.....
Address.....
City..... State..... (2100)

Please Mention Popular Mechanics

"YANKEE" TOOLS

Make Better Mechanics

Speed Up— with "Yankee," No. 50

Quick, on light drilling in metals, wood or tile. Convenient and handy for odd jobs. Drills continuously with forward and backward movements of driver. Exact cutting and careful finish of spiral shaft. Ball bearing in head. Chuck with 3 steel jaws, drop forged and hardened—centers drill points, accurately. Holds drills to 3/16 in. diameter.

"YANKEE" Reciprocating Drill No. 50. Price \$2.50

Length 16 in.—traverse of driver 8 1/2 in. Made with "Yankee" care and precision throughout.

Your Dealer Can Supply You
"Yankee" Tool Book" free; for mechanics and householders. "Yankee" Tools in the Garage" free, for motorists.

North Bros. Mfg. Co.
PHILADELPHIA, U. S. A.



Please Mention Popular Mechanics

WONDER LIGHT OUTFIT



Lots of Fun for Boys!
Big volt. 2 C. P. TUNGSTEN lamp,
switch, socket, 20 ft. insulated
wire and 3 cells of dry battery all
ready to install. May be used to
light a dark closet or hall.

PRICE ONLY 80c. Post. Extra 15c

LITTLE GIANT MOTOR

Is nearly 3 in. high. Runs at high speed on a single cell of battery. Very powerful and may be used to run small toys, etc. Just the motor every boy has been looking for.

Sent postpaid for only 50c

THE SIMPLEX TELEGRAPH OUTFIT

An opportunity for every boy to learn to telegraph and to put up a line with his class. This is a complete telegraph set, consisting of a five-keyed sender, mounted on a polished base. Will work any distance. An excellent Field Telegraph for Boy Scouts.

Price, 98c. Postage Extra. Wt. 2 lbs.



EXPERIMENTERS

THIS IS THE Experimenter's Reference Book

It's the latest edition of the famous Amco Catalogue, contains over 200 pages and is fully illustrated. Complete description and prices of the latest electrical and experimental apparatus—Storage Batteries, Rectifiers, Transformers, Induction Coils, Wireless Apparatus, Lamps, Flashlights, Meters, X-Rays, Books, Tools, Electric Railways, Steam Engines, Water Motors, Dynamos, Motors, Telegraphs, Telephones, Electrical Supplies, Model Aeroplanes and Parts for building your own apparatus. 6c in stamps will bring you this wonderful book. Contains a complete list of Wireless Calls, gives Codes, Wiring Diagrams, tells how to put up an aerial and install apparatus, etc.

Best catalog of Wireless and Electrical Apparatus, etc., published. Send for this catalog right away. Our prices will save you money.

Adams - Morgan Company "The Experimenter's Supply House"
Dept. M UPPER MONTCLAIR, N. J.

THE SPEEDY STITCHER

SEWS LEATHER LIKE A MACHINE

Price \$1.00



Send for terms to Agents

Automatic Awl Co., 26 Hermon St., Worcester, Mass.

ELECTRIC POWER CABLES OF PANAMA CANAL—The electric power distribution for the Panama Canal operation and lighting will require 246 miles of lead-covered cable. These cables will be carried through the lock walls in vitrified-clay ducts. On account of the large amount of cable to be placed in the ducts, a special device using an electrically operated winch was employed.

SO-LUMINUM = ALUMINUM SOLDER

WHY WELD When you can do better work in one-fourth the time—at one-fourth the price—using the latest great discovery

SO-LUMINUM—The Aluminum Solder

It's new with welding. No oxidation. No flux necessary. Runs at a very low temperature. Easily applied. Gasoline torch only thing needed. Used by largest automobile, repairing and manufacturing concerns throughout the country. **Convince Yourself by Trying It.** Price \$4.00 per lb. Tested or used already by Locomobile, Packard, Stanley, Pierce Arrow, Brewster, Demarest, Studebaker, and many other companies. **SEND FOR BOOKLET 1.**

SO-LUMINUM MFG. AND ENGINEERING CO., 1790 Broadway, NEW YORK

"Interlox" SAVES TIME, TEMPER AND TROUBLE

MASTER SLIDE RULE
The Only Interlocking Rule made—and the Only one whereby inside measurements of doors, windows, etc., can be taken rapidly and accurately. Also superior to all others for outside measurements of walls, ceilings, etc. If your hardware dealer hasn't this Rule, send us his name and 15c per foot (in any length from 2 to 8 ft.) and it will be sent prepaid.

Liberal Proposition for Dealers and Agents

DAHL MFG. CO., 51P E. 42nd St., NEW YORK

FREE THIS VALUABLE HAND BOOK

Tells how to help save money and make work easy for you. Just the thing for all Mechanics, Electricians, Plumbers, Steamfitters, Carpenters, Contractors, etc. Write today for this FREE handbook and state your occupation.

VAN EXPANSION BOLT MFG. CO.
1209C Fort Dearborn Bldg. CHICAGO, ILL.





BOYS! Get Your Names in The RECORD BOOK of FLIGHTS

Every boy who owns an "Ideal" aeroplane should send in records of his flights. They will be published in our RECORD BOOK of FLIGHTS which will be distributed everywhere. Record Card Enclosed with Each Flyer.

THE 1915 MODEL

"IDEAL" Three Foot RACER
can be put together in a few minutes and
WILL FLY 500 FEET or MORE. **\$2.50**
Use this ad and save 25c

This Racer is furnished with new patented spring plane fasteners, a patented friction winder and is practically unbreakable.

Cut out this ad and take it to your dealer and he will credit you with 25c., so that you will get this great Racer for only \$2.25. If your dealer cannot supply you, order direct of us.

Other lower priced "Ideal" Flyers ready for instant flight:

BLUE BIRD Racing AEROPLANE . . .	\$1.25
"IDEAL" SPEED-O-FLYER	1.75
"IDEAL" SPEED-O-PLANE85
"IDEAL" LOOP THE LOOP GLIDER25

"Ideal" Scale Drawings are accurate and will enable you to build EASILY exact 1/2 foot duplicates of man-carrying machines. Clearest plans for classrooms, exhibitions and aeronautic students, etc. Price includes building and flying instructions.

PRICE OF (Carlisle Flying Seal) 25c	Wright Biplane 25c
3 FT. SCALE Hispano Monoplane 25c	Carlisle Hydroaeroplane 35c
DRAWINGS (Bristol Monoplane) 15c	Cecil Peel Racer 25c

Complete set of six, \$1.25 postpaid

"IDEAL" MODELS and FLYERS Can Be Had from Your Dealer. Ask Any Toy, Department or Sporting Goods Store or Write to Us.

Some "Ideal" Dealers: Schmelzer Arms Co., Kansas City, Mo.
Spelzer & Harriot, Inc., Seattle, Wash.

Price List of Toys and Models FREE

48 pp. Catalog of "Ideal" Model Aeroplanes and Supplies, 5c.

IDEAL AEROPLANE & SUPPLY CO.
82-88 West Broadway, New York

POULTRY PAPER

44-124 PAGE periodical, up-to-date; tells all you want to know about care and management of poultry for pleasure or profit. Four months for 10 cents. **POULTRY ADVOCATE, Dept. 98, SYRACUSE, N. Y.**

2 1/2 oz. The perfected combination lubricating oil, powder solvent and rust preventative. CANNOT gum. For guns, typewriters, razors, etc. Write for folder. Compounded and guaranteed by Remington Arms-Union Metallic Cartridge Co., New York.

REMINGTON OIL
25c

10 Days Free Trial

Play on the violin of your choice—and test it for 10 days before you decide to buy. Send it back at our expense or pay for it at the rate of only a few cents a day.

Rare Old Violin Circular Free

WURLITZER We supply the U. S. Govt. 400 years of instrument making

The products of the leading violin makers of the world are yours to choose from—Fanny, Hander, Glier, Heberlein, Fiedler, Wurlitzer, etc.

Write Today for Special Circular. No obligations. Get full details of our offer direct to you. Write today.

The Rudolph Wurlitzer Company, Dept. A919
8. Wabash Avenue, Chicago. k. 4th Street, Cincinnati, Ohio

Remoh Gems

Look and wear like diamonds. Brilliance guaranteed forever. Stand fire, acid and fire-like diamonds. Have no paste, foil or backing. Set only in 14 karat solid gold mountings. About 1-80th the price of diamonds. A marvelous synthetic gem—will cut glass. Guaranteed not an imitation and to contain no glass. Sent C. O. D. subject to examination. Write today for our 4-color catalog DeLuxe, it's free.

Remoh Jewelry Co., 622 Washington Ave., St. Louis

No Money In Advance

This Marvelous CAMERA On FREE Trial!

Only 10,000 of these marvelous, instantaneous picture-taking and making cameras to be sent out absolutely on approval without a penny in advance just to prove that it is the most wonderful invention—the camera sensation of the age. So you must send for it quick! Just think of it—the new Mandel-ette

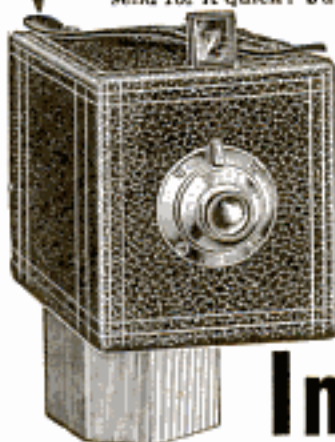

TAKES and MAKES Finished Pictures Instantly

You press the button, drop card in developer and in one minute take out a perfect, finished post card photo 2 1/2 x 3 1/2 inches in size. Camera, itself, is about 4 1/2 x 5 x 7 inches. Loads in daylight 16 to 50 post cards at one time.

No Films, No Plates, No Dark Room

Not a bit of the mess and bother of the ordinary kodak or camera. It is instantaneous photography. Universal focus lens produces sharp pictures at all distances. Pictures develop and print automatically. Can't over-develop; Results simply amazing.

WE TRUST YOU

No difference who you are, where you live or what your age, we will send you the complete Mandel-ette outfit absolutely on approval and give you 10 days to test it. If not satisfactory return at our expense. But when you see what elegant pictures it takes—so quick, so easy, with no trouble at all—if you wish to keep it you simply send us \$1 per month until our special price of only \$5 is paid.

Easy Payments — No References

No red tape of any kind. Monthly payments so small you'll not notice them. Lots of fun and big profits.

No Experience Required

Plain instructions and everything complete with outfit so you can begin taking pictures the moment it arrives. We guarantee that even a child can operate it. Mail coupon right now. No risk or obligation to keep camera.

The Chicago Ferrottype Co.
Desk 27, Ferrottype Bldg., Chicago, Ill.

Send me at once one complete model Mandel-ette Camera outfit including supply of post cards and instructions. I agree to examine and test it thoroughly and if satisfied keep it and pay you \$1 a month until your special price of \$5 is paid. Otherwise I will return it, at the end of 10 days, at your expense.

Name

St. and No.

Town State

MAKE MONEY HERE

AGENTS! DROP DEAD ONES. AWAKE! GRAB THIS NEW INVENTION! AGENTS!

LEARN THE NEW WAY

Get started in an honest, clean, reliable, money-making business. Sold on a money-back guarantee

World's magical gift realized by this new invention. The **BLACKSTONE WATER POWER VACUUM MASSAGE MACHINE** for the home. No cost to operate. Lasts life-time. Price within reach of all. No competition. New field. New business. That's why it's easy. Removes blackheads, wrinkles, rounds out any part of the face or body and brings back Nature's beauty. Endorsed by leading doctors and masseurs. Listen: Parker, Okla., says "8 orders first day." Margwarth, Pa., writes "I am making \$19.00 per day." Shea, "First order 12, second 35, third 72, Schermerhorn, Ia., orders eight dozen machines first month. Shaffer, Va., "selling 4 out of 5 demonstrations." Vaughn, Wash., orders one dozen. Four days later wires "Ship 6 dozen by first express." Spain, Tenn., started with sample. Orders one dozen, then 2 dozen, next 3 dozen. Lewis, Ind., sells 3 machines first hour. Says "Best article he ever saw for merit and money-making." No experience necessary. Territory with protection given free to active workers. Nothing in the world like it. Best agent's article ever invented

We own all U. S. and foreign patents. Big book entitled, "The Power and the Love of Beauty and Health" Free. Investigate now, today. A Postal will do. A big surprise awaits you. Address **BLACKSTONE MFG. CO.** 77 Meredith Bldg. TOLEDO, O.

STOP USING A TRUSS

Do Away With Steel And Rubber Bands

FREE TRIAL

Inner surface is made adhesive to secure the PLAPAO-PAD firmly to the body, keeping the PLAPAO continually applied and the pad from slipping. No straps, buckles or springs attached. Soft as velvet—easy to apply.

It's the Non-Slip- ping, yet Non-Rigid Pad and What is Within it That Counts

PATD
APRIL 6
1909

FREE to 5,000 Truss Sufferers

To the first 5,000 Sufferers who write, I will send, ABSOLUTELY FREE, a sufficient quantity of the Plapao to positively convince them that this is the only logical, common-sense way of treating rupture. Plapao is a highly astringent medication placed within the Plapao-Pad and being absorbed through the skin, creates a wonderful feeling of relief and at the same time tends to strengthen the weakened muscles and thus permanently close the rupture opening. The process of recovery is natural, so you'll have no use for a truss—you can throw it away forever! Old and young have testified under oath that the Plapao-Pads cured their rupture—many of them long-standing, aggravated cases—without delay from work. Patent allowed in U. S. and foreign countries. Awarded Gold Medal at Rome and Grand Prix at Paris.

Send No Money—for a sufficient quantity of the Plapao is sent without charge to enable you to give it a thorough test; you pay nothing for this trial now or ever. Write for it and full information today. Address **Plapao Laboratories, Block 1427 St. Louis, Mo.**

Deafness

Perfect hearing is now being restored in every condition of deafness or defective hearing from causes such as

Relaxed or Sunken Drums, Roaring or Hissing Sounds, Perforated, Partially Destroyed Drums, etc.

Wilson Common-Sense Ear Drums

"Little Wireless Phones for the Ears"—require no medicine but effectively replace what is lacking or defective in the natural drums. They are simple devices, which the wearer easily fits into the ears where they are invisible. Soft, safe and comfortable to wear at all times.

Write today for our 168 page FREE book on DEAFNESS, giving you full particulars and plenty of testimonials.

WILSON EAR DRUM CO., Incorporated
705 Inter-Southern Building LOUISVILLE, KY.

**I will send my 25c Book Strong Arms**

for 10c in stamps or coin

Illustrated with twenty full-page half-tone cuts showing exercises that will quickly develop, beautify and gain great strength in your shoulders, arms and hands, without any apparatus.

PROF. ANTHONY BARKER
645 Barker Building, 110 W. 42nd St., NEW YORK

For
MEN,
WOMEN
and
CHILDREN



When the "boys" spy the trim, dainty figure of alluring little Miss

SEPTEMBER MORN

so handsomely embossed on these WATCH Fobs, they go to them like hungry wolves. **ROSE GOLD FINISH**; twice the size shown here; genuine Leather strap. A smashing big hit!—get this classy fob and **BIG MONEY** agent's offer to-day, **25c. postpaid.**

BUFFALO EMBLEM JEWELRY CO.
411 Morgan Building, Buffalo, N. Y.

An amateur radio station and a ship radio station which meet all the requirements of the law are exhibited by the

Edison Artificial Limb Co., 38 Wash. Av. No., Minneapolis, Minn.
Durable
Does Not Chafe Overheat or Draw End of Stump



Pat. Over 25 Yrs.
Information or Catalog Given

PATENTED

We are
**Under
Govt.
Bond**

**WHITE VALLEY GEMS LOOK LIKE DIAMONDS**

Stand acid and fire diamond test. So hard they easily scratch a file and will cut glass. Brilliance guaranteed 25 years. Mounted in 14k solid gold diamond mountings. See them before paying.

Will send you any style ring, pin or stud for examination—all charges prepaid. **No money in advance. Money refunded if not satisfactory.** Write today for free catalog.

WHITE VALLEY GEM CO., 701 Wulsin Bldg., Indianapolis

NO MORE BALD HEADS

When our **VACUUM CAP** is used a few minutes daily. We accept no pay until you have tried the Cap 60 days and are satisfied. The Vacuum Cap is an appliance that draws the blood to the Hair Roots and starts a new healthy crop of hair. It stops Dandruff, stops the hair from falling out. Bought by Doctors and men who

know that it is the only reasonable **HAIR GROWER** known to science. No Drugs Used. Write for application blank, testimonials, and booklet on "HAIR," sent sealed in plain envelope, FREE.

THE MODERN VACUUM CAP CO.

S. 559 BARCLAY, DENVER, COLO.

Pedal when you want to! Coast and rest when you want to!

The fatigue is taken out of bicycling when you equip your wheel with a

ORBIN Duplex Coaster Brake

Whether you ride a wheel for pleasure or to save car fares to and from work or school, you will find that the Corbin Brake saves your strength and doubles your pleasure.

And it places the wheel under your absolute control—at all times—bringing it to a gradual stop or an instant stop just as occasion demands.

Sold and equipped by dealers everywhere.

Write today for catalog

The Corbin Screw Corporation

The American Hardware Corporation, Successor
NEW BRITAIN, CONN.



U. S. Bureau of Navigation with the assistance and cooperation of the Bureau of Standards at the Panama-



\$40 Motorcycle

We have the largest line of new and used Motorcycles in the country at the lowest prices. We also have a thoroughly equipped repair department and are in position to furnish repairs for any machine. Send us your machine to be overhauled. We pay cash for second hand motorcycles. *Send for Catalog.*
HARRY R. GEER CO., 888 McLaran Ave., ST. LOUIS, MO.

Rider Agents Wanted

in each town to ride and show a new 1915 model "RANGER" bicycle. Write for our liberal terms. **DELIVERED FREE** on approval and **30 days' trial.** Send for big free catalog and particulars of most marvelous offer ever made on a bicycle. You will be astonished at our low prices and remarkable terms. **FACTORY CLEARING SALE**—a limited number of old models of various makes, \$7 to \$12. A few good second-hand wheels \$3 to \$8. Write if you want a bargain. Tires, lamps, wheels, sandries, parts, motorcycle supplies of all kinds at half usual prices. **Write us before buying.**
MEAD CYCLE CO., DEPT. F108 CHICAGO

SOME CAR! BOYS! Send for Booklet Today



The Lad's Car

Send 20c today for Booklet, telling how to build this automobile. Complete instructions and descriptions of parts and sizes, illustrated with diagrams, blue print, cuts made from photographs, and price list of parts.

SPECIAL INDUCEMENT to first boy in your town
Niagara Motor Car Corp'n, Dept. A, Niagara Falls, N. Y.

"Bridgeport"

Bicycle Pumps

—make tire pumping an easy job. You want a strong and durable bike pump.

Be sure your pump is a "Bridgeport." It's the best-made bike pump on the market today: has seamless brass barrel, nickel finished and highly polished. Note wide-grip handle, and comfy foot-piece.

We sell more pumps yearly than any other manufacturer in the country.

Send for our booklet of pumps—it's free.

Bridgeport Brass Co.
BRIDGEPORT CONNECTICUT

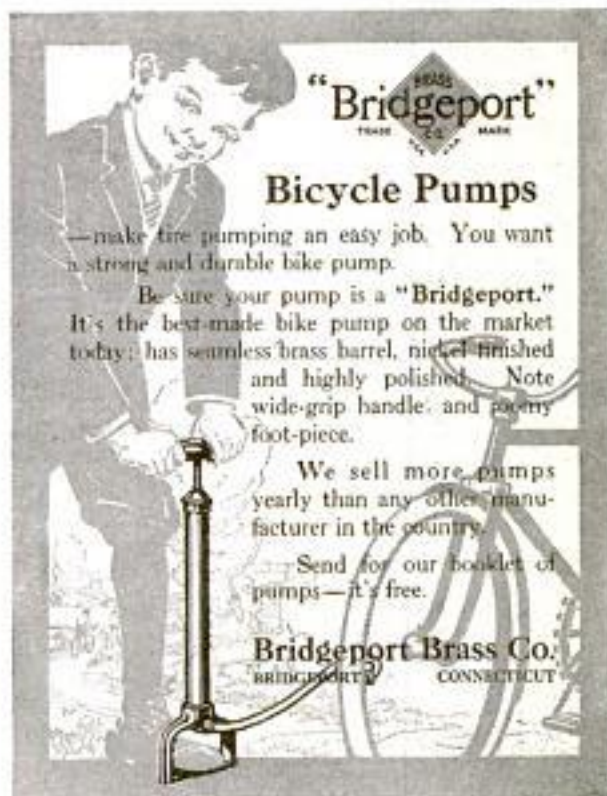

We Save You \$\$\$\$

Buy your Motorcycle accessories from the largest supply house in the United States.

Our 1915 catalog listing 3015 accessories sent **FREE**

You can't be an up-to-date rider without one. It is the one others try to copy. You need it, so send us your name and address today.

MOTORCYCLE EQUIPMENT CO., HAMMONDSPORT, N. Y., LOS ANGELES, CAL.



MAKE YOUR BIKE A MOTORCYCLE

at a small cost, by using our attachable outfit. Fits any Bicycle. Easily attached. No special tools required.

8 Months' Repairs, 30c

Mr. Grabain, of Texas, writes: "I want to write a few lines to you telling you how well pleased I am. Any man or boy can make a good motorcycle with that little 2 1/2 H. P. SHAW motor. It is the simplest and best motor a man can buy for a little money. I ran mine eight months without repairs, and then it was only 30 cents. It uses only half the fuel that other machines use. I can go anywhere with the little SHAW that any other can."

FREE BOOK Write today for bargain list and free booklet, fully describing the SHAW Bicycle Motor Attachment. Motorcycles all makes, new and second-hand, \$35.00 up.

SHAW MANUFACTURING CO.
Dept. 6 GALESBURG, KANSAS





"Cheap Tires Don't Pay!"

It has cost me more in repairs than a good tire would have cost in the first place. Hereafter I buy good tires — or walk."

VITALIC

Bicycle Tires

Have a tread that is good for thousands of miles of hard riding. A fabric so strong it can't blow out. An inner-tube of rubber so heavy and pure that it can't leak air. Send for testing sample and prove these claims.

FREE—Story "The Man who Rode on His Rims"

CONTINENTAL RUBBER WORKS
1964 Liberty Street Erie, Pennsylvania



HENDERSON—

Beauty in outline and general appearance is not a veneer or mask, but is visible evidence of class and quality that affects every part of the motorcycle.

Remember, the maker who is still wrestling with mechanical defects is barred from giving real attention to symmetry and grace.

Our catalog tells of all the distinctive qualities of the HENDERSON "FOUR." Write for it.

HENDERSON MOTORCYCLE CO.
1160 Cass Ave. DETROIT, MICH.



Garage \$69.50

10x12feet "Steelcote" Edwards ready-to-use garage, \$69.50 complete. Factory price. Fireproof. Portable. Quickly set up. All styles and sizes of garages and portable buildings. Send postal for illustrated catalog.

THE EDWARDS MFG. CO.
320-370 Eggleston Ave., Cincinnati, O.



Pacific Exposition, and demonstrations of the use of inspection instruments are made to show the method of determining compliance with the law, serving to illustrate the precautions taken by the government for safety at sea.

5 H. P. 1915 Peerless Motorcycle



with Free Engine, Bosch Magneto, together with the best there is in Motorcycle construction, Power, Speed, Silence, Endurance, and those wearing qualities so essential for low cost of maintenance.
5 MILES FOR ONE CENT
Agents Wanted—Liberal Discount!

PEERLESS MOTORCYCLE CO., 179 Hunting Ave., BOSTON, MASS.

GARGOYLE



Mobiloils

A grade for each type of motor

Don't Throw Away Your Worn Tires



For over three years European motorists have been getting from 10,000 to 15,000 miles out of their tires by "half-soling" them with Steel Studded Treads. In eight months 20,000 American motorists have followed their example and are saving \$50 to \$200 a year in tire expense.

We ship on Approval without a cent deposit, prepay the express and allow you to be the judge.

Durable Treads double the life of your tires and are sold under a signed guarantee for 5,000 miles without puncture. Applied in your own garage in thirty minutes.

Special Discount offered to motorists in new territory on first shipment direct from factory. A postal will get full information and sample within a week. State size of tires. Don't wait—write today. Address nearest factory office.

THE COLORADO TIRE & LEATHER CO.
346 Gutz Bldg., West Austin Ave., CHICAGO, ILL. 108 Tread Bldg., DENVER, COLO.



Convert Your Bicycle into a Motor-Cycle Motor fits any wheel. BEST, MOST RELIABLE. Best hill climber. More STEFFEYS in use than all others. Stamp for circulars. STEFFEY MFG. CO., 5007 Brown Street, PHILA., PA.

The Auto Heel Rest

Used on all cars for the Brake, Clutch and Foot Accelerator Pedals. It brings the foot to just the right height. Takes that strain off the ankle. Saves the floor mat. Locates the heel.

Four Sizes 1/4 in. — 1 in. — 1 1/2 in. — 2 in. Polished Aluminum

PRICE EACH 75c

Agents Wanted Patented April 9, 1912

Made Only by

Lucas & Son, 60 Fox St., Bridgeport, Conn.





EXCELSIOR 4-T-S Two Speed



Model 4-T-S

\$175.00

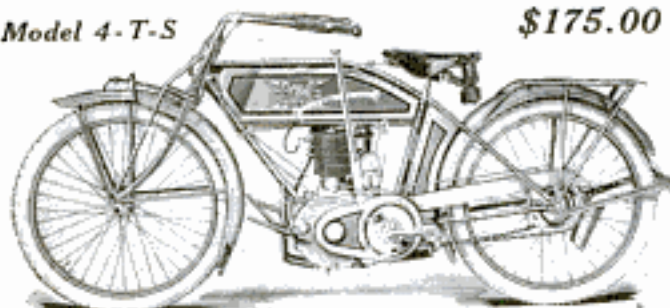

The greatest motorcycle value ever offered.

Every quality of the big twins except the terrific speed at little over one-half the price or cost of maintenance.

A 5 horse power, Two Speed machine that will take you anywhere on any road, at any speed within reason.

The greatest possible combination of Efficiency and Economy.

For the conservative rider who gives cost of upkeep more consideration than excessive speed that is never utilized, the EXCELSIOR 4-T-S meets every possible requirement.

In this machine is combined every feature of EXCELSIOR quality. The motor is the one on which has been built the EXCELSIOR reputation of Absolute Dependability. The Two Speed has been thoroughly tried on thousands of EXCELSIOR Autocycles both Singles and Twins, and has Always Made Good.

Equipment includes Folding Foot Rests, Comfort

Kushion Saddle, Tubular Steel Luggage Carrier, Double Brakes and the EXCELSIOR Grip Control.

For the rational rider who requires comfort and convenience, or for the commercial user to whom cost of operation is an important feature, we offer this machine as the best that could possibly be built for their purpose.

See the dealer or write for our fully illustrated catalog describing this and six other models, Singles and Twins, One, Two and Three Speeds, at prices ranging from \$175.00 to \$315.00, including the machine for your purse and your purpose.

Excelsior Motor Manufacturing & Supply Co.
3702 Cortland St., CHICAGO

PRINCE ALBERT

the national joy smoke

The Electrically Equipped *Indian Motorcycle*
With Cradle-Spring Frame. Send for Free Catalog.
Hendee Manufacturing Co., 316 State St., Springfield, Mass.

YOU CAN EARN AN AUTO

HERE'S YOUR CHANCE TO GET
A NEW FORD TOURING CAR
FOR A FEW WEEKS' WORK



By my new, easy plan, anyone over 16 years old can get a brand new Ford Touring Car for a little cash, respectable work among neighbors. Free Book tells all about it. Postal brings it. Send AUTO TOM, 647-d So. 16th Street, OMAHA, NEB.

AGENTS Wanted

Calling on Ford owners to sell necessities. 50 per cent Profit.

MORGAN MANFG. CO.

Bellevue Street

NEWPORT, R. I.



Amazing Profits In Mushrooms

Anybody can add \$8 to \$40 per week to their income, in spare time, entire year growing mushrooms in cellars, sheds, barns, boxes, etc. I tell you where to sell, at highest prices. Free Illustrated Instruction Booklet

HIRAM BARTON

Desk 2, 329 W. 48th St., New York

—You—



laugh at hills and miles are easy—when you ride a

Columbia Bicycle



Under all conditions you are absolutely sure of your wheel because you ride the best there is.

The COLUMBIA is the finished product of 37 years' successful experience in bicycle-making and has always been recognized as the "Standard of the World."

See Model 512—\$45 at your dealer's. It is a marvel of mechanical perfection—beautiful in design and finish—easy riding—built for years of service and thousands of miles of health-giving exercise.

Pope Bicycles are made in 92 models. Special light and heavy weights and juveniles.

Motor Cycles—6 models. Single cylinder, twins and 2 speeds.

Send for either catalog you wish.

THE POPE MFG. CO.

16 Cycle Street

Westfield, Mass.

Please Mention Popular Mechanics



THOUSANDS OF DOLLARS MADE REPAIRING TIRES

The amount you can make in dollars repairing tires is measured by your own energy. You can make anywhere from \$1500 to \$3000 a year above expenses. Your investment to start in business

is small, returns are quick and your income cash. Profits are large on every job you turn out. The tire repair business is in its infancy. It's growing every year, because more tires are being used every year. In almost every city and town there is a crying need for a good tire repair man. **That means opportunity for you.** Start in your home town if you want to. This is a new **money making business.** Don't delay getting busy. But above all be prepared with an equipment that means satisfactory work for your customers. Buy only an

Akron-Williams Tire Repair Equipment

The better your equipment, the better your work and the greater your volume of business. Let us start you in business right. Use an equipment which is

Endorsed by 30 Leading Tire Manufacturers

It takes you but a short time to become an expert tire repair man. We help you here. We are making an unusual offer to everybody who buys our equipment. You can become an expert by our plan.

SEND FOR OUR 30 DAY SCHOOL PLAN

It means when you start in business, you start right. You are prepared to make money from the jump. No experimenting. No failures. You become a practical, first-class repair man.

WRITE FOR CATALOGUE No. 244

WILLIAMS FOUNDRY & MACHINE CO. Main Street AKRON, OHIO

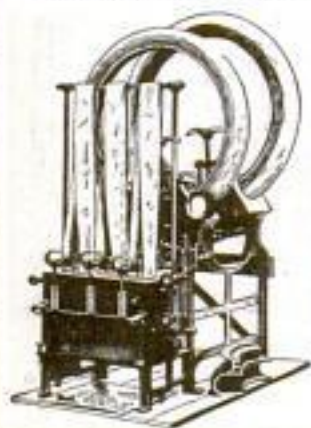

**WARRANTED
CHERRY VALLEY
FLANNEL**

If you wear a flannel shirt

it's worth while to know who made the flannel—there's a difference. See that the shirt you buy has the above hanger in the neck-band, showing that it's made of the celebrated, warranted

Cherry Valley Flannel

Least shrinkage and greatest wearing qualities of any flannel made. Manufactured by a mill that was making flannel in your grandmother's time.

VALLEY WOOLEN MILLS, Cherry Valley, Mass.

That the horse is holding its own on the farm against motors and motor-driven machinery, is indicated by the fact that, according to government reports, at the end of 1914 there were 233,000 more horses on the farms of the United States than at the end of 1913.



FORD RACERS

REBUILD YOUR FORD CAR.
Sketches, Specifications and Instructions.
Information for Two-cent Stamp. T. M. Co.
Dept. A. Box 212, Woodford, Maine.

Used Piano \$95

Other bargains from \$45 to \$195. All standard makes, including Steinway, Knabe, Emerson, Kimball, taken in exchange on Starck Pianos and Player-Pianos. Also used player-pianos \$195 to \$345. 30 days' FREE Trial. Easiest payments. 50 music lessons FREE. Write quick for Bargain List.



P. A. Starck Piano Co., 96 Starck Bldg., Chicago, Ill.



Hurrah for the Unicycle!

Boys run, then sit down and coast inside this single hoop. It's the latest and greatest fun-maker invented. Agents won't know what a real good thing is until they see the Unicycle. Each season, starting April 1, ending Nov. 1, will make live wire agents considerable money. Boys go wild over them. Write at once for Agents' prices.

THOMAS B. BEMIS, INDIANAPOLIS, IND.

Champion Racer



MODEL AEROPLANES

Send 2c postage for Complete handbook of Models and Supplies.

Our set contains this and 9 other drawings, with instructions for building \$1.00

WADING RIVER MFG. CO.
WADING RIVER, N. Y.

DIAMONDS ON CREDIT

20% DOWN 10% MONTHLY

Let us send you any Diamond you may select from our catalogue so you may compare our values with those offered by other dealers; be convinced that our IMPORTER'S PRICES offer you a great saving.

We furnish a guarantee certificate with every Diamond and allow the full purchase price on all exchanges. We will send express prepaid any Diamond or other article, for examination and approval, you to be the sole judge as to whether you keep it or return it at our expense.

Write today for our free catalogue de luxe No. 6, and see how easy it is for you to own and wear a beautiful Diamond. L. W. SWEET & CO., Inc., 2 and 4 MAIDEN LANE, NEW YORK CITY.



Your Motor Wheel Is Waiting—

All ready to attach to your bicycle—any bicycle. The sooner you get it the sooner you can begin to enjoy the greatest outdoor sport in the world with a

*Pedals used only
at starting*

Smith MOTOR
WHEEL

*Just sit still
and steer*

attached to your "bike" (five minutes work) you can travel over all kinds of roads—up hill and down dale—at any speed up to 20 miles an hour. All you do is press a small thumb lever attached to the handle bars of the bicycle to regulate the speed. Thoroughly practical, cleanly, vibrationless, easy to operate, travels 100 to 125 miles on a gallon of gasoline. Write for "Motorwheeling", the big, free catalog and learn where you can see and ride a Smith Motor Wheel.

Motor Wheel Division "72" A. O. SMITH COMPANY, Milwaukee, Wisconsin
Largest Manufacturers of Automobile Parts in the World

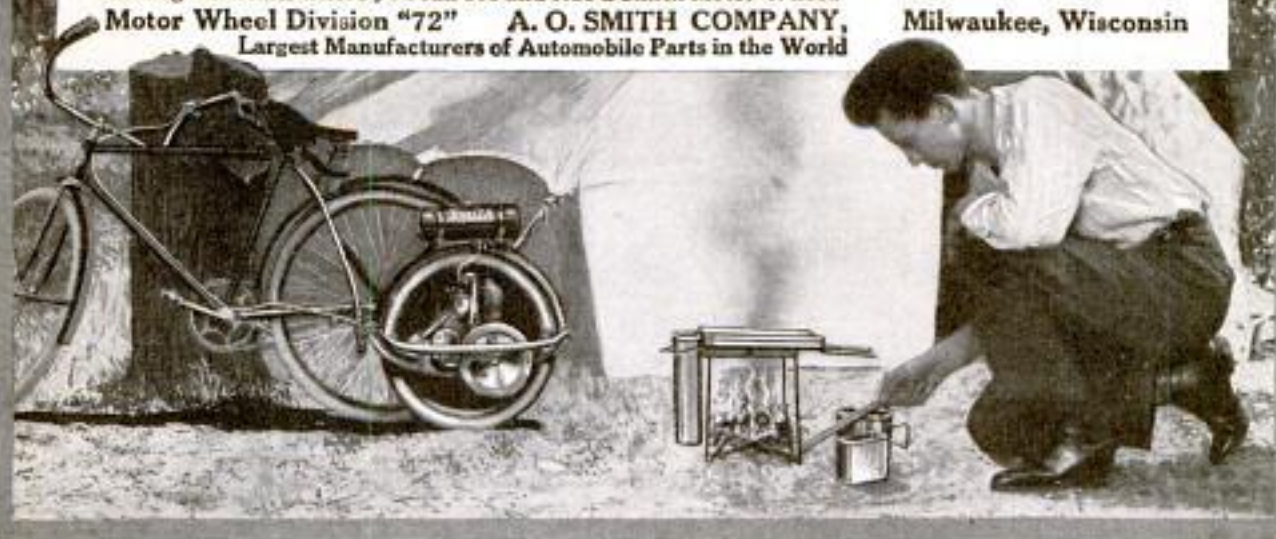

Nothing like a good lather to make the path
of the razor smooth.

Colgate's Shaving Lather

STICK — POWDER — CREAM

Wonderfully softening and soothing in
whichever form you use it. Send 4 cts.
for a trial size of stick, powder or cream.

Colgate & Co., Dept. 81, 199 Fulton St., N. Y.

WILL YOU TAKE ORDERS ?

Many earn \$30 to \$60 every week demonstrating our
1915 Model Steel Automatic Handi-Tool.
Lifting and Pulling Jack, Wire Stretcher, Splicer and
Mender, Post and Stump Puller, Tire Tightener, Cable
Maker, Press, Vise, Hoist, Wrench, etc. Operates auto-
matically. Has power of 40 men. Guaranteed for life.
Spare time or permanent work. Demonstrator
loaned. Credit given. Write for factory agency offer.

Chas. E. Benefield Co., 293F Industrial Bldg., Indianapolis, Ind.

Marlin Guns



Repeating Rifles
in all popular cali-
bers. Repeating
Shotguns, 12 and
16 gauges, hammer
and hammerless.

Free Catalog—128 pages
—full of valuable information
about guns and ammunition.
Send 3 stamps postage to

The MARLIN FIREARMS CO.
65 Willow St., New Haven, Conn.

3 1/3^c a Day

now buys a dazzling Lachmite Gem. Their
brilliance is eternal—they stand fire and acid
tests and cut glass like diamonds. Cost but one-
third as much. Set in solid gold. The newest
designs. Sold on Free Trial. See our new jewelry book.
Write for Big Jewelry Book Your name and
address is enough. No obligations whatever. Write today—now.

HAROLD LACHMAN COMPANY
12 N. Michigan Avenue, Dept. A119 Chicago, Ill.



Rats, Mice, Roaches

—exterminated in one night. No mixing, no
muss, no trouble with Rat Bis-Kit Poison. Place
a little of either kind wherever these pests annoy
you. They quickly seek it, eat it, die outdoors, hunt-
ing water. Results guaranteed or money refunded.

Rat Bis-Kit Poison

Biscuit or Paste

Biscuits (for rats and mice) 15c and 25c packages.
Paste (for roaches, waterbugs, rats and mice) 15c,
25c and \$1.00 tubes. Keeps indefinitely. At any
druggist or direct from us prepaid.

The Rat Biscuit
Company
565 No. Limestone St.,
Springfield, Ohio



Please Mention Popular Mechanics

DUCK'S NEW 325 Page Electrical No. 8 and Wireless Catalog

THE WM. B. DUCK COMPANY
WRITING ELECTRICAL
OR
WIRELESS
TOLEDO OHIO

Mailed for 8c stamps or coin which may be deducted on first purchase amounting to \$1.00. Great cost of catalog and low prices prohibit distribution otherwise. The most elaborate, comprehensive, educational and artistic catalog in its line published. Glance through the contents. Note the amazingly low prices of products representative of the best in the field of electricals. Then you will know why the overwhelming mass of users of electrical and wireless supplies have for so many years adopted the slogan:

"If Duck Sells It, It Must Be Good; If Duck Does Not Sell It, There's a Reason"

WHAT THIS BIG CATALOG CONTAINS

125 pp. Wireless Apparatus for Commercial and Experimental use;
10 pp. Raw Material;
5 pp. Transformers;
8 pp. Storage Batteries;
15 pp. Telegraph Insts.;

42 pp. Motors and Dynamos;
10 pp. Miniature Lamps;
8 pp. Flashlights;
5 pp. Massage Vibrators;
10 pp. Miniature Railways;

5 pp. Lighting Plants;
10 pp. Ammeters and Voltmeters;
25 pp. Electrical and Mechanical Books;

12 pp. Telephone Equipment;
6 pp. Heating Appliances;
10 pp. Auto Accessories;
13 pp. Victrolas, on our Easy Payment Purchase Plan;
30 pp. General Electrical Supplies.

THE WM. B. DUCK CO., Arcade Bldg., Toledo, O.



Send for a Copy of Our New Manual No. 2

Its pages give simple formulas for calculating the natural period of an antenna; capacity of a receiving or transmitting condenser; spark frequency of rotary spark gaps; tables for calculating the correct amount of wire for the construction of magnets and tuning coils; tables for ascertaining the spark lengths of different voltages; the Federal regulations regarding the restrictions of wave lengths for amateur stations; instructions for the installation, maintenance and operation of wireless stations; directions for learning the code, working diagrams and a complete list of up-to-date wireless instruments and accessories, together with other features of interest to the amateur or professional wireless enthusiast.

Containing as it does a fund of valuable information not generally contained in a catalogue, it approaches nearer a text book in the fascinating field of wireless telegraphy. It is printed on good stock with a heavy paper cover in two colors. No expense has been spared to make it accurate and reliable. We make a charge of 10c for it which amount will be allowed on an order amounting to \$1 or more.

No Wireless Experimenter Should be Without the Mescro Wireless Manual

Send for Our Pocket Catalog P.28

It will contain over 200 pages, with over 1,000 illustrations, describing in plain, clear language all about Bells, Push Buttons, Batteries, Telephone and Telegraph Material, Electric Toys, Burglar and Fire Alarm Contrivances, Electric Call Bells, Electric Alarm Clocks, Medical Batteries, Motor Boat Horns, Electrically Heated Apparatus, Battery Gauges, Wireless Telegraph Instruments, Ignition Supplies, Etc.

It Means Money Saved to You to Have Our Manual and Our Catalog When You Want to Buy

Manhattan Electrical Supply Co.

New York 17 Park Place
Chicago 114 So. 5th Av.
St. Louis 1106 Pine St.
San Francisco 604 Mission St.



ELECTRICITY

BOYS—Send today for our new 128-page catalog of everything electrical. Motors, Dynamos, Flashlights, Lamps, Coils, Batteries, Transformers, Magnet and Resistance Wires, Telegraph Outfits, Miniature Electrical Railways and Parts. Catalog with coupon sent only for 6c in stamps or coin. No postals answered.

VOLTAMP ELECTRIC MFG. CO.

Voltamp Block, BALTIMORE, MD.

DYNAMO-MOTOR

As a dynamo it will operate induction coils, light lamps, charge storage batteries, electroplate, etc., makes an ideal machine for experimenting. As a motor they will operate heavy models, steam wheels, and other useful appliances.

18 watt dynamo-motor **\$3.00**
24 " " " **3.85**
40 " " " **5.25**

Send 2 cent stamp for catalog of wireless apparatus, trains, electrical supplies, novelties, tools and books.
LOOMIS ELECTRIC COMPANY
1427 N. Artesian Ave. Chicago, Ill.



250 WATT "WIRELESS" TRANSFORMER \$9.00

CLOSED-CORE TYPE 14000 VOLTS 3 DIFFERENT POWERS
SELF CONTAINED Shipping Weight 30 Lbs.
Send 2c stamp for catalogue of Wireless Supplies, folders, etc. *Winger's Telegraph Code Charts* free with \$2 orders; otherwise 20c, each. Purchased in "station" or "pocket" sizes, Continental or Morse code; please state which, otherwise Continental "pocket" size will be sent. **Wager Electric & Mfg. Co., 111 So. Dearborn St., Chicago, Ill.**



"THE ELECTRICAL EXPERIMENTER"

The big electrical Magazine for those who dabble in electricity and Wireless. Chuck full of experiments. Intensely interesting. Monthly prizes of \$5.00 for best experiments. Amateur Electric, wireless news, Complete Electric Course etc. 50 to 100 illustrations. Only 50c a year in U. S. and Canada. **On all News-stands. Send for free sample.**

Electrical Experimenter 234 Fulton St., N. Y.

USE COUPON

↓ CAT No. 15 OUT

DON'T BUY CATALOGS, FREE WHEN THE BEST IS

In addition to our most complete line of Wireless and Electrical experimental goods, we now offer at the lowest prices in America in our Cyclopedic No. 15: a large line of Sporting goods, comprising Baseball and Tennis material; Footballs and Baseballs, low-priced Printing Presses, students' Microscopes and Telescopes, Photographing goods, Model steam Engines, low-priced Watches, Pocket-knives, **Fretwork Outfits**, Phonographs and Records, Air Rifles, Precision Lathes, Tool Kits, big scientific Book section. **New Electrical Goods:** Rotary and Quenched Spark Gaps, Violet-Ray High Frequency Apparatus, Fans, Generators and Motors. A large Wireless Code Chart; 7 pages Wireless Call letters; Treatise on Wireless and 20 coupons for FREE Wireless Course.



272 Pages.
658 Illustrations.
2000 Articles.
Size, 6 1/2 in. x 5 in.
Weight, 1 1/2 pound.

E.I.Co. N.Y.; Gentlemen:
Send at once big Cyclopedic
Catal. No. 15. I enclose 4c.
for postage. My Name is in
margin below.

THE ELECTRO IMPORTING CO.
"Everything for the Experimenter"
233A FULTON STREET, NEW YORK

YOU FIND IT IN

THE LIVEST CATALOG IN AMERICA



A Storage Battery

The Latest Thing in Lanterns

"YALE" Always in the Lead

The "Yale" Safety-Flex Electric Lantern is now being fitted with a small, non-leakable, guaranteed storage battery good for about 60 hours' service and it can be recharged at a cost of less than 10c in any charging station or recharge it yourself if you want.

Full size, regular shape, just turn the switch and you get a flood of light.

The simplest, safest, handy light for autoists, railroad men, campers, merchants, farmers, sportsmen and the home. Always ready, no matches, no oil, no wick trimming, no smoky chimneys, no danger of fire, no throwing away of dead batteries.

AGENTS write for exclusive territory and our big money making proposition. Start now—be the first.

YALE MANUFACTURING CO.
Dept. C, 30-32 So. Clinton St., Chicago

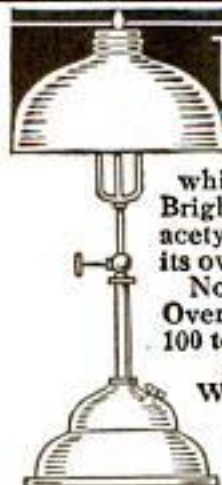

The BEST LIGHT

A soft, luminous light, which casts no shadow. Brighter than electricity or acetylene. Makes and burns its own gas. Costs 2c a week.

No dirt, smoke nor odor. Over 200 styles, ranging from 100 to 2000 candle power.

Absolutely guaranteed.

Write for illustrated catalog.

AGENTS WANTED EVERYWHERE

THE BEST LIGHT CO.

324 E. 5th St., Canton, O.

ELECTRIC LIGHT PLANTS Complete gasoline engine, dynamo, switchboard and storage battery \$240. Agents wanted. American Battery Co., 1129 Fulton St., Chicago (Estab. 1888.)

ELECTRIC HOME, FARM and STORE LIGHT PLANTS. LIGHTS, DYNAMOS, MOTORS, ENGINES. Fan Motors, Storage & Medical Batteries, Rectifiers, Sels, Bells, Bicycle, Carriage & Auto Lights, Massage, Ozone & M. P. Machines. **MOTION PICTURE THEATRE** Permanent and Traveling Equipments. Big Opportunity. Catalog 3 cts. **OHIO ELECTRIC WORKS, CLEVELAND, OHIO**

BRANDES WIRELESS RECEIVERS

You cannot get LONG DISTANCE without an extremely sensitive headset. BRANDES RECEIVERS are made for

LONG DISTANCE READING

SEND STAMP FOR CATALOG "P"

C. BRANDES, Inc., 32 Union Square, New York

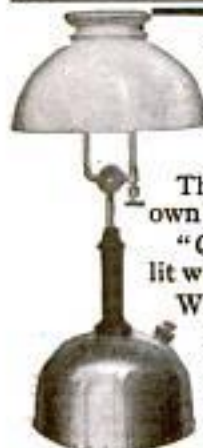

300 Candle Power of Light at a Cost of 1-8c Per Hour

Burns Kerosene

This lamp generates and burns its own gas from ordinary kerosene.

"QUICKLIT" gasoline lamps can be lit with an ordinary match like city gas.

Write today for illustrated catalog of our complete line of kerosene and gasoline lamps, lanterns and lighting systems. **Agents Wanted**

THE NAGEL-CHASE MFG. CO.
174 East Erie St., CHICAGO

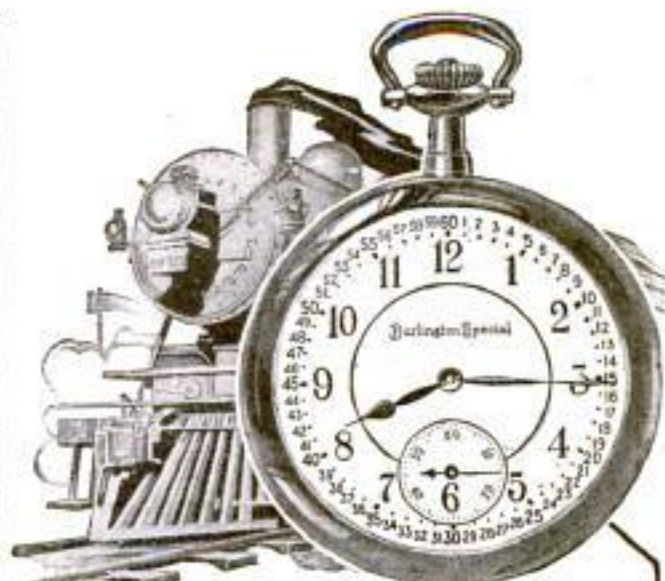

Special Offer!

The *Burlington*—the masterpiece of watch manufacture—19 jewels—yes, 19 full sapphire imported jewels—adjusted to temperature, adjusted to positions, adjusted to isochronism—this superb watch, acknowledged by experts to be the greatest watch ever manufactured—will now be shipped to you direct at the rock-bottom price—the rock-bottom price direct from us—the same price that even the wholesale jeweler must pay.

Superb Inlay Enamel Monogram, in any color you wish

Shipped on Approval

prepaid, not a dollar down—not a cent in advance—all at our risk—and payable either for cash or \$2.50 a month—so you prefer. You must see the superb new Burlington Watch cases—Inlay Enamel Monograms, Block and Ribbon Monograms, Diamond Set, French Art and Dragon Designs, Etc.



Book of Watch Designs FREE

Write while this offer lasts—read this book and learn the reasons for this remarkable offer on the finest watch in the world at the rock-bottom price. Get this booklet now while this offer lasts.

Burlington Watch Co.
19th Street and Marshall Blvd.
Dept. A119 Chicago, Ill.
Please send me (without obligations and prepaid), your free book on watches, with full explanation of your cash or \$2.50 a month offer on the Burlington Watches.

Burlington Watch Co.

Dept. A119

19th Street and
Marshall Blvd.,
CHICAGO,
ILL.

Name.....

Address.....



O-G
"Kick-In"

\$4

"'Tis a long, long way to beat O-G shoes!" And THE PROOF IS IN EVERY PAIR.

Right Over Here!
Is the Hit of the Year!

IT'S four dols. (Money back if wanted after seeing.) Best seller ever. It's a QUALITY shoe if ever there was one.

It's a STYLE shoe or there never was one. It has the HIGH-BALL IN-STEP ball strap (a special). It is nifty. It is honest. It is exclusive. It is a bargain at its very apologetic little price (just to get you started on "O-G shoes and nothing but"). It is made of a fine grade of (black) gun-metal and also of a rich Russia calf. Price the same. We send it prepaid anywhere in the world. Sizes "double A" to "D" and 5½ to 11. YOUR MONEY IS OUR TRUST FUND. Returned if wanted—at our expense.

What have our up-to-date friends to say to this?

O'CONNOR & G
GOLDBERG

mail
order
address

Republic Building,
CHICAGO, U. S. A.

(While you are writing, ask for the latest "Book of the O-G Booteries")

Have Your Own Workshop

Here is a device which will go a long way toward equipping it—

The Stewart Handy Worker Combines, in compact form, several useful tools, including a sturdy anvil, a powerful vise, a sure-grip pipe vise, a carbonandum grinding wheel, a drill press, a metal-cutting wedge, a three-speeds driving mechanism with which you can operate such tools as buffing wheel, scratch brush, small circular saw, etc., etc. Just bolt it to a bench or table and it is ready for business. You can do innumerable odd jobs with it and keep all your tools in fine shape. For house, farm or garage.

Write for **FREE** illustrated booklet telling its many uses, low price, etc.

Chicago Flexible Shaft Company
105 N. LaSalle St.
CHICAGO, ILL.



BUY YOUR FURNACE \$10 DOWN \$10 A MONTH



Our monthly payment plan of selling direct saves you the dealer's profits and charges for installation. The

JAHANT FURNACE

with the patented "Down Draft System" is best for residences, schools, hotels, churches, etc., because it delivers plenty of heat wherever and whenever desired at a saving of ¼ to ½ in fuel bills. Install the Jahant yourself. We send complete outfit, freight prepaid with special plans, detailed instructions and all necessary tools for installation. Satisfaction guaranteed or money refunded.

WRITE FOR FREE ILLUSTRATED BOOK
THE JAHANT HEATING CO.

200 Steiner Avenue

AKRON, OHIO

Save ⅓ to ½ on Fuel Bills

The total foreign trade of the United States for the year 1914 amounted to \$3,900,000,051, of which \$1,780,270,001 were imports, and \$2,119,729,050, exports.

BASEBALL Fits the hand, cannot be seen; can throw Big, Wide curves. Also illustrated booklet How to Play Both for 10c. **CURVER**

(Stamps or coin.) **WARDEA CO., Box 100, STAMFORD, CONN.**

Work for Us at Good Wages

Agents selling American Self-Heating Flatirons make \$10 a day. Demonstration makes sales. Sell in home community or travel. Handsome traveling case. Reserve territory now for summer sales.

AMERICAN GAS MACHINE CO.
564 Clark St., ALBERT LEA, MINN.



Lyon & Healy Band Instruments

Fifty Years the Standard of America

Lyon & Healy American Professional Cornet plays like Sixty—costs only Thirty Dollars. Write for complete catalog with terms, and be sure to tell us what instrument you are interested in.

LYON & HEALY 33-39 Adams St., CHICAGO



ABOUT MUSHROOMS

How to really make big money in mushrooms is fully explained in the wonderful book, "The Truth About Mushrooms," a great revolutionary improvement, things many growers never knew before. Everything explained from A to Z, at first hand, from the greatest practical authority in America. Add \$10 to \$20 a week to your income. Demand exceeds supply. Grow in cellars, sheds, boxes, etc. Small capital to start. Profits bigger and quicker. Anyone can do it. Women and children too.



Now is best time. Send for free book.
BUREAU OF MUSHROOM INDUSTRY, Dept. 111, 1342 N. Clark St., CHICAGO

Only from Basch Can You Get

Genuine Perfect Cut **\$97.50** Per Carat
DIAMONDS



MO1
1/2 Ct. Diamond
Complete \$48.75



MO2 1 Ct. Diamond
Complete \$103.00



MO3 Solid Gold
Diamond Set with
Links. Special Price
per pair. \$1.75



MO4
1/4 Ct. Dia.
Complete
\$21.50

and here's the reason: We import direct from the diamond cutters of Europe — and sell direct to you! We wipe out the middlemen's heavy profits — save you all their expenses! Our tremendous sales justify lowest profits — enable us to save you more than 35% on every diamond — makes your only opportunity to buy at less than jewelers buy at wholesale!

Basch Legal Money-Back Guarantee A written legal contract to refund in cash full

price less 10% should you for any reason wish to return your diamond any time within one year. Also allows full price in exchange at any time. Contains written statement of exact carat weight, quality and value of the diamond — makes dissatisfaction absolutely impossible.

FREE Examination—Send No Money Here's the popular Basch Plan: select any size diamond — choose

any gold or platinum mounting from the thousands we illustrate in our catalogues. We ship entirely at our expense — allow full examination — invite test and comparison. If you don't say it's the greatest value you ever saw return it at our expense!

Buy "by the Carat" Here's a valuable "tip" to the diamond buyer. Always buy diamonds by the carat and yet nearly all refuse to sell on the same honest basis? Simply because they do not want you to know the enormous price per carat they are asking. L. Basch & Co. stand practically alone in selling diamonds by the carat weight.

1915 Basch De Luxe Diamond Book, FREE!

Costly, complete, authoritative! Gives you expert facts about Diamonds needed to buy intelligently. Thousands of illustrations of Diamonds; Watches; Jewelry; solid gold and platinum mountings, etc. Our import and factory prices startlingly low by comparison! Mail coupon or write us a letter for your free copy, NOW!

L. Basch & Co. Dept. F2470 State & Quincy Sts. **Chicago**

L. Basch & Co. Established in 1879. Offices in all European diamond cutting centers. References, UnionBank of Chicago, your banker, any magazine publisher. We number thousands of Popular Mechanics' readers amongst our satisfied patrons.

FREE DIAMOND BOOK COUPON

Please mail me free, to name and address below, 1915 Basch DeLuxe Diamond Book.

Name.....

Address.....

BASCH Dept. F2470 State & Quincy Sts. **CHICAGO, U. S. A.**

BUY PLUMBING and HEATING SUPPLIES



at **WHOLESALE** Will Save You 30%

Don't pay retail prices. Full stock on hand for prompt shipment. Send for free catalog.

B. P. KAROL, 800-802 South Kedzie Ave., CHICAGO

High Grade Violins 30 Days' Free Trial

Your choice from a large and carefully graded stock of representative instruments from the leading foreign violin makers. Strictly hand made and of superior tone, these violins are far superior to the average old violins sold at four times the price.

Write Today. Don't fail to send your name and address today for the superb Lewis catalog sent free and postpaid. Of value to everyone interested in high grade instruments. Learn how you can have your choice of these superb instruments on a free trial in your home. Write today.

Wm. Lewis & Son, Inc. Dept. A119, 225 S. Wabash Ave. Chicago
OUR SPECIALTIES: Imported wood-varnishes and tools for violin makers.

Small Engines

Our 1/2, 1 and 1 1/2 H. P. Gasoline Engines for Farm and Shop are the best small engines.

FORD AUTO SEAT **\$15.00**

Shipped on trial. Send stamp for Booklet and Special Offer
Sieverkropp Engine Co., 1224 18th St., Racine, Wis.



TYPEWRITERS ALL MAKES

Underwoods, Remingtons, Oliviers, Smiths, from \$10 to \$60. Guaranteed 5 years. 500 Typewriters at \$12.50, every one perfect. Write for liberal FREE trial offer at once. All Makes Typewriter Exchange Co., 168 N. Dearborn St., Chicago, Ill.



MAKE BIG INCOME

Men and Women grow mushrooms all the year at home in cellars, stables, sheds, boxes, etc. Sell as high as \$1.00 a lb. Great demand, markets waiting. Start Now. Big Booklet telling how to do it Free. **Nat'l Spawn Co., Oct. 12, Boston, Mass.**

Get This Book FREE

Tells how any member or entire family can now grow mushrooms at home in spare time, in cellar, barn, shed, etc. Costs little to start, big profits. Spawn now produced by scientific methods makes crops certain. We furnish book on growing, fully illustrated. Used in State Agricultural colleges. Secure free information how to start, sell, etc. Demand unlimited, good prices. Remarkable opportunity to add \$5 to \$20 a week to your income.

Address, **A. V. Jackson**
Falmouth Mushroom Cellars, Inc.
355 Gifford Street, Falmouth, Mass.
Only Scientific Mushroom Farm in U. S.



Hand Forged
Razor Steel
Blades. No. 57



This **\$2** KNIFE **83¢** POST PAID
DIRECT AT FACTORY PRICE

Handy shaped blade makes this knife best for mechanics, sportmen and farmers; light but strong; resharpened easily. Stag handle, German silver finish; blades file tested, hand forged from razor steel and warrant-ed. Sample \$5c, 3 for \$2 postpaid. **FREE**

MAHER & GROSH CO., 106 A. St., Toledo, Ohio.

A Real Kerosene Engine

Here's the biggest engine value ever offered in a 1½ H. P. engine. Same cylinder capacity as many 2½ H. P. engines. Throttling governor adjustable while running; crankshaft extends on both sides. Runs either way. Starts without cranking. Equipped with Ellis Patent Fuel Device, guaranteeing successful operation on cheap oils. Beautifully finished in genuine engine enamel.

Runs on 9c a Day

Just the engine for pumping, separating, churning, corn-shelling, sawing, shop work, electric lighting and dozens of other light jobs. Sold on 30 days' trial. Guaranteed for 10 years. We make other sizes from 3 to 18 H. P., vertical and horizontal, single and double cylinders.

Ask for our free book, "ENGINE FACTS," telling how to judge and buy an engine.

ELLIS ENGINE CO., 2873 E. Grand Blvd., Detroit, Mich.

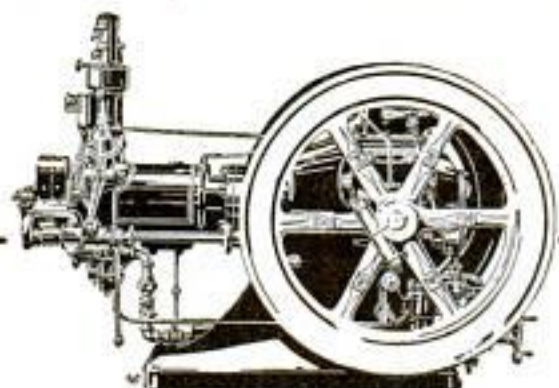
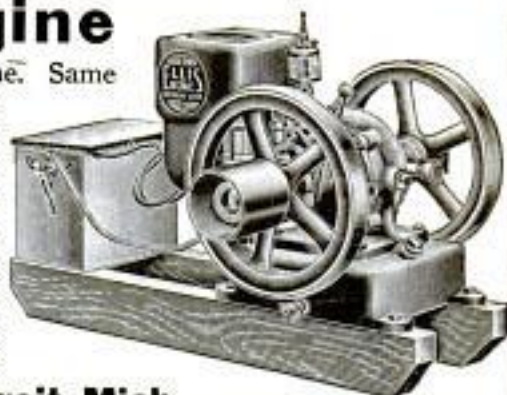

We Say This with Confidence

Knowing the unsurpassable standards that IHC engine makers have set for themselves in manufacturing, and the absolute perfection they have always aimed at, we do not hesitate one moment in saying—whatever difficult qualifications you can possibly demand in a 1915 engine you will find them in the greatest degree on

International Harvester Oil Engines

Care and time and money are not spared in the designing of IHC engines. Elaborate and thorough experimental work is never at an end, and is always resulting in IHC engine improvements. Manufacturing expense and cost of material are not considered whenever a betterment suggests itself. IHC quality is never questioned.

International Harvester oil engines are of all styles, built for all power purposes, in sizes from 1 to 50 H. P. They run on the cheapest or most convenient fuel.

Ask us to do these two things—Send you an interesting catalogue showing the IHC engine features, and tell you the name of the nearest IHC engine dealer.

International Harvester Company of America

(Incorporated)

16 Harvester Building Chicago U S A

Any **ONLY \$5** DOWN—One Year to Pay

\$38 buys the reliable U. S. Engine (size 1½ H. P.) direct from our factory on easy payments of only \$5 down and \$3 a month. Free Catalog Folder shows nine larger sizes all sold at similar low prices and on very easy terms. All guaranteed 5 years and backed by 62 years manufacturing experience; all shipped on 30 days' free trial.

U.S. ENGINES
Burn Gasoline, Kerosene or Distillate
—have double the power of other engines of equal weight—are easiest to move—easy to get at—take up least space—run smoothest—start easy—burn less fuel and last longer. Free Catalog Folder gives 18 reasons for U. S. superiority and quotes low easy-to-pay factory prices. Write now.

(1) U. S. ENGINE WORKS, 3712 Ogden Ave., CHICAGO



"VIM" ENGINE



\$25 COMPLETE

Save money by using a **VIM** 1½ HP. Farm Motor for churning, washing, pumping, separating, spraying, etc. Women operate easily. No valves, cams, gears or complicated parts. Water Cooled, automatic positive lubrication, sensitive governor. Weighs only 25 lbs. Cools ready to run. Fully guaranteed. Get catalog and special agency offer. THE VIM MOTOR CO., 806 Water St., SANDUSKY, OHIO

6 H.P. \$96⁷⁵

1½ H.P. \$24.75 5 H.P. \$ 87.50
2 H.P. 28.75 8 H.P. 135.50
3 H.P. 53.90 10 H.P. 179.90
4 H.P. 68.90 12½ H.P. 214.90

Many other sizes—all sold direct and fully guaranteed. BIG 32-PAGE CATALOG FREE. Write today. **OTTAWA MFG. CO., 252 King St., OTTAWA, KANS.**

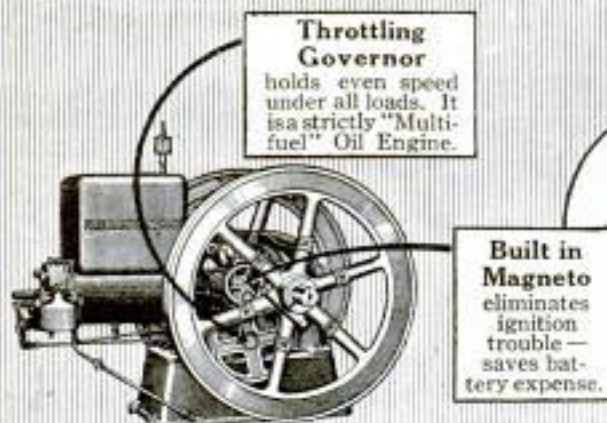
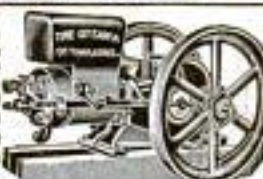

Throttling Governor
holds even speed under all loads. It is a strictly "Multi-fuel" Oil Engine.

Built in Magneto
eliminates ignition trouble—saves battery expense.

Power from Cheaper Oils

Reduce cost of pumping, and running farm machinery, by using the Fairbanks-Morse "Multi-fuel" Oil Engine. It runs perfectly on low-priced oils.

Fairbanks, Morse & Co.

Chicago New York San Francisco
and other leading cities
(449-25P)



Travel to the Fishing Grounds At 7 to 10 Miles an Hour

WHEN you reach the haunts of the big fellows, adjust your Caille Five-Speed Motor at trolling speed. If your line becomes caught in the weeds, you can quickly bring your boat to a standstill and then slowly back, loosen the line and resume your trolling without stopping your

Caille **5** Speed
Motor

Push-Button Controlled

nor altering its speed or reversing its rotation. It gives you five positive speeds—two forward, two backward and a neutral. When set at neutral, the boat stands still, but the motor runs at normal speed. It has a high-tension, waterproof

Magneto in the Flywheel

Can also be furnished with dual ignition system if desired. Propeller is of the woodless type. Silencer on exhaust. Tapes and many other features fully described in free catalog No. 16.

FOR LARGER BOATS. We build motors from 2 to 20 H. P. Special catalog No. 24 on request.

Dealers Wanted

THE CAILLE PERFECTION MOTOR COMPANY
1523 Caille St., Detroit, Mich.



WATKINS' SPECIAL MOTORS

3 H. P. Single Cylinder . . . 30 lbs.
6 H. P. Double Cylinder . . . 40 lbs.
12 H. P. Four Cylinder . . . 100 lbs.

A strictly HIGH GRADE Motor that will give CONSTANT and EFFICIENT service. Especially adapted for CANOES and LIGHT BOATS. Aluminum base, copper water jacket, steel shaft, bronze bearings.

THE WATKINS MOTOR CO.
837-839 West Sixth Street CINCINNATI, OHIO



State of Maine Spinner

For trolling with live minnow for Salmon, Trout, Bass, Pickerel or Perch.

Send for Our Bargain List of Fine Fishing Tackle. Enclose 10c and we will send one of these splendid spinners post free. GOULD & GOULD, Dept. 9, Box 5143, Boston, Mass.

Cushman Light Weight Engines

Easy to move around from job to job, or may be attached to other machines (moving or stationary) to drive all or part of the machinery. 4 H.P. weighs only 190 lbs.; 8 H.P. only 320 lbs. and 20 H.P. only 1200 lbs. No heavy bases or large fly-wheels. Steady and quiet, because of sensitive Throttle Governor and perfect balance.

Forced water cooling system. Run at any speed. Schebler Carburetor and Friction Clutch Pulley. Not a cheap engine, but cheap in the long run.

Ask for Engine Book

Cushman Motor Works
482 N. 21st St., LINCOLN, NEB.



SPECIAL

\$4.75

Size 7 x 7 ft.
Genuine Full Weight
8 oz. Duck



Boys' Special Offer Genuine Wall Tent Complete

JUST THINK OF IT. This 7x7 foot genuine eight-ounce duck wall tent for only \$4.75. Everything complete. Poles, ropes and pins. Big enough for four boys. Strong enough to stand hard wind storms. You can have lots of fun in any season. Don't stay in the house. Take your boy friends out in the tent. You cannot possibly get wet. It's nice and warm too. Great to sleep in. Start to save today. Sign your name to the coupon and tear it off and send it to us. We will mail you at once a beautiful book telling you many things you ought to know about outdoor life. This book is absolutely free and prepaid.

Army Shelter Tents

Commonly Called "Dog Tents" — Made up in 2 Sections, Complete with Poles and Pins

Special White Cloth

Special Khaki Cloth

\$2.25

\$3



Just like the regular soldiers use. Boy Scouts all over the country are using them. Can be set up and taken down in a minute. When not in use can be easily carried on your back. Absolutely waterproof. This tent is 5 ft. 3 in. long by 3 ft. 6 in. wide by 3 ft. 9 in. high. The poles are spliced. Every boy ought to have one of these tents. Send your order in today. They are going like hot cakes.

Send FREE Coupon for New Camp Guide

Just put your name and address on free coupon and mail it at once. We will send you our new 1915 Camp Guide. Gives a hundred pointers on camping boys should know. Tells how, when and where to camp out. We also send a list of supplies you need and where you can get them cheapest. Book is sent free and prepaid. No obligations of any kind. Mail coupon now. Do it now as the supply of these books is limited.

H. Channon
Company

Dept. A-119
150 North
Market Street
Chicago
Illinois

FREE
Camp Guide
Coupon

H. Channon Company
Dept. A-119
150 North

Market St., Chicago
Gentlemen: Please send me, absolutely free and prepaid your new 1915 Camp Guide. Also full particulars of bargains you are offering on tents and other supplies. (Canadians must enclose 10c because of duty.)

Name

Address

Please Mention Popular Mechanics

Will You Trust the Judgment of 60,000 Men?

"Tried and found true" is the verdict that 60,000 present owners of Mullins boats offer for your guidance. Every one of these men banked on the Mullins reputation—and not one was disappointed. It will pay you to buy a boat with a reputation, because you will then know exactly what to expect in the way of lines, speed and general efficiency.

SAFETY AND SERVICE MULLINS BOATS SAFETY AND SERVICE

are designed by well-known Naval Architects like Whittelsey of New York and built by the largest manufacturers of pleasure boats in the world. Powered with 2 or 4-cycle engines selected for their efficiency and adaptability. Every Mullins boat is thoroughly tested in the water, and every fault corrected before it reaches the buyer. *Mullins big, interesting Boat Book should be in the library of every lover of the big outdoors. You may have it for a post card.*

DEALERS:—You will find the Mullins reputation an asset in the selling of boats. Write for proposition.

The W. H. Mullins Company, 487 Franklin St., Salem, O.

Builders of the World's fastest 16 ft., 25 H. P. Hydroplane.



UNMATCHED SPEED EXTRA POWER — NO VIBRATION

"Some speed! Drives a 16 ft. boat 12 miles an hour," writes Mr. Sanders, Madison, Wis. Has power to spare—does not shake the boat.

THE GREAT 2-CYLINDER KOBAN ROWBOAT MOTOR

Fine record—absolutely reliable—easy starter—easy to handle. Reverses by pressing button. Both cylinders fire simultaneously—that's what removes vibration—3 H.P.—speed propeller. Best constructed rowboat motor on the market.



Battery Ignition or Built-in Magneto

Koban Mfg. Co.
291 So. Water
St., Milwaukee,
Wisconsin



Active Agents Wanted

ONE-WAY TRAFFIC PROVES PRACTICAL—Some years ago one-way streets were introduced in Boston to relieve serious traffic congestion on certain narrow ways. Some opposition was encountered at first, but experience has proved the wisdom of the move, as traffic utilizes

Save Dealers' Profits

Why pay a dealer from 30 to 50% more for your marine or outboard motor simply because he writes out your order and sends it to a manufacturer?

Buy Direct

from us. Write out your own order and save nearly half on any American marine motor from 2 to 30 H. P. Also outboard motors. Best materials and workmanship. Every motor guaranteed. Get our prices. Send for free catalog "A" on marine motors or "B" on rowboat motors.

AMERICAN ENGINE COMPANY
605 Boston Street
Detroit, Mich.



\$29.95

"Old Town Canoes"

THE ALL-AROUND CRAFT

Summer camping, fall hunting and spring fishing make an "Old Town Canoe" almost a year-round convenience to sport lovers. It has the strength, stability, speed and light draft to carry heavy loads, sail smoothly and paddle easily.

4000 "Old Town Canoes" ready to ship—dealers everywhere. Send now for interesting catalog giving canoe history and facts.

OLD TOWN CANOE CO., 1466 Middle St., Old Town, Maine, U. S. A.





EVINRUDE

DETACHABLE ROWBOAT & CANOE MOTORS

enable you to instantly convert any kind of craft—rowboat, sailboat, houseboat or canoe—into a power boat. The Evinrude drives an ordinary rowboat 7 to 8 miles an hour—a canoe 10 to 12 miles—and runs four hours on less than a gallon of gasoline.

So light that it can be carried with you anywhere. So strong that it is practically unbreakable. So simple that women and children find no difficulty in operating it the first time they try.

Write today for booklet describing the 1915 model—the last word in portable marine motors.

Evinrude Motor Company
31 Evinrude Bldg., Milwaukee, Wis., U. S. A.

Distributing Branches:
69 Cortlandt St., New York, N. Y.
218 State St., Boston, Mass.
436 Market St., . . . San Francisco, Cal.
182 Morrison St., Portland, Ore.
32427-41201

street surfaces to immeasurably better advantage if it all moves in one direction, and it is now proposed to reserve more streets for this purpose. Those streets upon which one-way traffic is required are marked by inconspicuous signs, the one at the entrance end reading, "Vehicles must go in the direction of the arrow," and the one at the outlet end, "This is a one-way street. Do not enter here."

VIM MOTORS

5 to 27 h. p.
1, 2 and 3 cylinder
Gasoline or Kerosene
Speed, regular, or heavy
duty. Strong, simple,
accessible—absolutely de-
pendable. Built for a life-
time. The boat-builder's
stand-by, the boat-owner's
pride. Double ignition.
Non-backfiring. Heavy
brass fittings.



"Only fault with my Vim is that I did not get it sooner. It runs and sounds like an electric fan. Ran it steady last Sunday on 6 gal. gasoline— that's right good for a 10 H. P. engine. My friend saw his motor in a gasoline color and if he can tell it, a Vim goes in his boat." This from Rex M. Pratt, Warren, Pa.

VIM MOTOR CO.
106 Water St., Sandusky, Ohio



GET THIS CATALOG
FULL OF VALUABLE INFORMATION TO EVERY
BOAT OWNER ON

RACING PROPELLER WHEELS, REVERSE GEARS AND MARINE ACCESSORIES

LARGE CATALOG FREE. SEND TODAY
MICHIGAN WHEEL CO.
1175 MONROE AVE., GRAND RAPIDS, MICH.



KERMATH Marine Engines

"America's Standard 4 Cycle Marine Motor"

4 Cycle, 4 Cylinder, 12 to 20 H.P. Highest quality. Silent operation. No vibration. Controls like the finest Motor Car engine. Extremely economical on fuel. Used as standard equipment by over 80 per cent. of the world's leading boat builders. Catalog on request. \$150 to \$350 depending on equipment.

KERMATH MFG. CO. Dept. P, Detroit, Mich.



Build Your Own Boat and Save $\frac{2}{3}$

It's easy—good exercise—interesting—adds to joys of summer. We send full-sized patterns or knocked-down frame and patterns, or complete knocked-down boat. Fully illustrated instructions always included.

Write for Brooks Boat Book—Mailed Free

See illustrations of beautiful cruisers, launches, motor boats, sailboats, rowboats, canoes, etc., that you can build.

BROOKS MANUFACTURING CO.
8206 Brooks Ave. Saginaw, Mich.

Largest concern of its kind in the world.
Originators of pattern system of boat-building.

ONLY \$37.00
for knocked-down
frame and patterns
for this beautiful 20-
foot motor boat. Write for
Boat Book.



\$3 and up
Buy Boat Patterns



Unheard-of Introductory Price

Wall Tents Heavy Standard, Full Weight Tent Duck, double lap seams, complete with tent poles, ropes, pins, etc. All ready to set up. Wonderful bargains.

5x7.. \$4.00	9 1/2x12.. \$ 9.13
7x7.. 5.32	12x14.. 12.75
7x9.. 6.48	14x16.. 17.10

These Exceptional Bargains

are offered for a short time only. Save money by buying direct from the largest, most reliable manufacturers of Tents, Awnings and Campers' supplies in the country. Supplying the U. S. War Department and Foreign Governments.

Let us tell you about our new Watershed and Mildew-Proof Process. Write at once for free descriptive booklet and price list on everything made of canvas.

Get your letter to us quick before these big bargains are snapped up.

HETRICK BROS. CO.
1217 Fernwood Avenue, Toledo, Ohio



Your Mullins Canoe is ready—

YOU can save yourself a lot of time and worry—and probably some money—if you decide right now that the canoe you buy this season will be a Mullins.

MULLINS CANOES

satisfy. Cedar, canvas covered—beautiful—speedy—light—durable; easily handled. Write today for Mullins big, beautiful Canoe Book and learn where you can see a Mullins canoe.

The W. H. Mullins Company
490 Franklin Street SALEM, OHIO



A complete line of appliances for the transmission of Power. Anything from a bolt to a complete mill or factory outfit. Send for catalogue. Largest Manufacturers of Pulleys in the country.

W. A. Jones Foundry & Machine Co. CHICAGO
1400 W. North Ave.

Toledo MARINE MOTORS NONE BETTER

"Nothing Cheap but the Price"

3 H. P. 1 cyl. complete	\$ 65.00
6 H. P. 1 " "	84.00
8 H. P. 2 " "	125.00
12 H. P. 2 " "	160.00
18 H. P. 3 " "	250.00

Fully guaranteed for a responsible concern. 2 cycle, 2 foot, 3 1/2 x 3 1/2 and 4 1/2 x 4 1/2. Send for free catalog "G."

THE UNIVERSAL MACHINE CO., Pike Ave., Bowling Green, O.

NORTHWESTERN MARINE ENGINES

2 to 18 H. P.

The most compact, powerful and silent running motors for their size in existence. Sold at moderate prices and sent on thirty days trial before buying. Pay if satisfied, otherwise return at our expense. 2 H. P. with complete boat equipment \$60. Other sizes in proportion. Send for 1915 Catalog.

NORTHWESTERN MOTOR COMPANY, 1101 Spring St., Eau Claire, Wis.

Leipzig is the book and music-publishing center of Germany. The total weight of such publications shipped from Leipzig in 1913 amounted to 147,400,000 lb., or considerably more than the giant steamer "Imperator," which, with a displacement of 50,000 metric tons, weighs 110,000,000 pounds.

GRAY MOTORS FOR ALL SIZE BOATS

Boat Builders Catalog the result of the co-operation of 50 Leading Boat Builders, with the Gray Motor Company is yours for the asking. Lists and describes 175 different boats from a \$125 fishing launch to a \$2500 mahogany finished express launch, powered with 6 cylinder self starting 4 cycle Gray Motor. **This Book is Free.** Write for it today. Also Big Gray Marine Engine Catalog showing complete line 2 and 4 cycle marine motors \$35. upwards, 1 to 6 cylinders, 3 to 50 H. P.

GRAY MOTOR CO., 698 Gray Motor Bldg., Detroit, Mich.

FISHERMEN!

Another 5000 "Jim Dandy" (\$1.00 size) Bait at Low Introductory Price **75c**

Put a half and a quarter into a letter now and send it to us for the world's greatest fish lure. No other like it. America's best fishermen swear by it. It gets the fish. Because its motion in the water looks like something in distress and fish grab it—that's the secret. Protected by rigid patents.

MONEY BACK ABSOLUTELY if you don't think it is worth more than you paid for it. Write today and get one of these 5000—\$1.00 size bait at special 75c price. Free literature telling all about "Jim Dandy" on request.

Address: WISE SPORTSMAN'S SUPPLY CO., Dept. B, 20 West Jackson Blvd., CHICAGO

NORTHWESTERN ROWBOAT MOTOR

Strictly high grade—nothing better made at any price. Finished in polished brass and aluminum, nickel-plated fly wheel, Battery or Bosch Magneto. Rudder swings separate from engine, and all other modern improvements. Complete with electrical equipment, \$30. Send for 1915 Catalog.

\$50

Make a racer out of your Row Boat or Canoe

Attach the speedy little Wisconsin Junior to your boat—add a new thrill to your vacation this year. Low priced, dependable. Delivers power to propeller direct, without loss. Has self-locking tiller that holds boat into course you set, by simple turn of wrist—you can get this wonderful convenience only on a

Wisconsin Detachable Row Boat Motor

Backed by 14 years' marine motor experience

All parts standardized—Wisconsin Waterproof Reversible High-Tension Magneto insures hot spark at all speeds; Wisconsin Watercooled Silencers—noiseless running, no loss of power. Patented Adjuster at top enables you to set angle without dabbling in water.

Thousands in use

Fits any sized or shaped boat. Economical, nothing to get out of order. Guaranteed. Whatever type of row boat motor you want—whatever price you want to pay—you'll get more value and service for your money if it's a Wisconsin. Write for catalog Q.

WISCONSIN MACHINERY & MFG. CO.

U. Miner St., MILWAUKEE, WIS.
Makers of marine motors for 14 years
Exhibiting at Panama-Pacific Exposition



Wisconsin Junior 2 H.P. weight 50 lbs.

Row boat motor agents wanted

Hustlers wanted to demonstrate and take orders for Wisconsins. Good profit, easy seller. We help you. Write or wire for agency, as they are being snapped up quick.

ROBERTS The Speed Motor

The Motors That Never Backfire Lightest motor built for power developed.

Cheapest, because of lowest upkeep cost. Simple, only four moving parts. Flexible, responds instantly to your will. Satisfactory, because it's made right. Never backfires. Speedy for speed boats—powerful and strong for boats that work. 3 to 200 h. p. Write today for catalog P. M., pictures of speed boats, owners, testimony and complete descriptions.

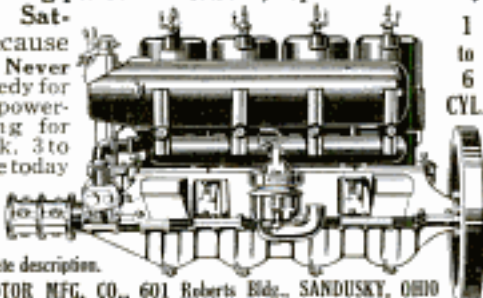

THE ROBERTS MOTOR MFG. CO., 601 Roberts Bldg., SANDUSKY, OHIO

Waterman PORTO

1915 Model has reversing propeller, high tension magneto and unrestricted speed control. 3 H. P. Wt., 65 lbs. Sold direct from factory to you, freight paid. Original outdoor motor—10th year—30,000 in use. Guaranteed for life. Fits any shape stern. Has automobile carburetor, removable bearings, solid bronze slip protecting 10 1/2 x 16 in. propeller. Steers by rudder from any part of the boat. Water cooled exhaust manifold; noiseless underwater exhaust; spun copper water jacket. Demand these essentials if you want your money's worth. Write today for free book showing both outdoor and indoor engines. Our prices will surprise you.

WATERMAN MOTOR CO.
230 Mt. Elliott Ave., Detroit, Mich.



Makes Any Boat

A Motor Boat

Outdoor Sleeping at Its Best

Many believers in healthful fresh-air have not enjoyed outdoor sleeping because of uneven resting places, or damp mattresses. Now you can enjoy it under comfortable conditions with a

"Perfection" Pneumatic Mattress with Sleeping Bag

"Perfection" pneumatic mattresses are evenly soft, and may be used on damp ground with perfect safety—they are non-absorbent. And they are absolutely sanitary, with no place for dust nor vermin to collect.

Easily deflated and inflated—may be rolled into a small light bundle and carried in and out of the house. Last indefinitely. Invaluable for motor, yachting and camping trips. Endorsed by the Federal Government.

Write for illustrated Catalog and endorsements today.



PNEUMATIC MFG. CO. 536 17th Street
BROOKLYN, N. Y.

BESSEMER KEROSENE ENGINE

FREE TRIAL 30 DAYS A Real Kerosene Engine

Bessemer Kerosene Engines are real kerosene engines, not a converted gasoline engine. The use of kerosene or lamp oil is made possible by the Bessemer Universal Fuel Feeder, controlled exclusively by us. Or will use alcohol or gasoline. Sizes 2-4-6-8-10 H. P. Also direct connected to pumps, hoists, air compressors, electric lighting plants, saws, farm machinery, etc.

Owing to low cost of operation it is best economy to have a Bessemer wherever odd power jobs are to be done. The Bessemers are money makers for their owners, because they can be used for so many purposes. Let our free catalogue "K" give you proof and facts. Write for it today.

Bessemer Fuel Oil Engine

Where power from 15 to 165 H. P. is required, Bessemer Fuel Oil Engines are recommended. They burn crude and fuel oil and thus run at about 1/3 to 1/4 the cost of gasoline. Now being used in irrigation, flour mills, factories, lighting plants. This engine is revolutionizing the power question. Get the facts in free catalogue "O."

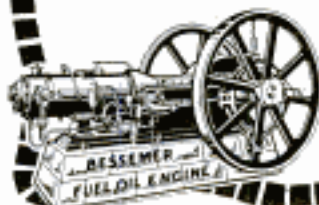

BESSEMER GAS ENGINE CO.

121 Lincoln Ave., GROVE CITY, PA.

D&C Take Your Ocean Trip This Year D&C on America's Great Inland Seas

The most wonderful vacation yet—a thousand mile voyage on the Great Lakes, and an outing in the north country. The historical resorts of Northern Michigan await you with all the enchantments of primeval nature—shady, majestic woods, delightful waters, awe-inspiring scenery. Every pleasure is there—bathing, boating, fishing, golfing, camping, sight-seeing. First-class hotel accommodations and boarding houses at reasonable rates.



The Coast Line to Mackinac—Six Trips Weekly

Four trips weekly from Toledo and Detroit to Mackinac Island and Way Ports. Special steamer, two trips weekly from Cleveland, June 25th to September 10th, direct to Mackinac Island, no stops enroute except at Detroit and Alpena. In addition to above, D. & C. Line operates daily service between Detroit and Cleveland and Detroit and Buffalo. Delightful day trips between Detroit and Cleveland during July and August, four trips weekly. Daily service between Toledo and Put-In-Bay.

Railroad Tickets accepted for transportation on D. & C. Line steamers between Detroit and Buffalo or Detroit and Cleveland, either direction. Send two cent stamp for illustrated pamphlet and Great Lakes Map, containing information regarding routes and rates. Address L. G. Lewis, Gen. Passenger Agent. A set of artistic poster stamps sent on receipt of five cents.



"D. & C. Talisman" Send one dollar cash or money order for D. & C. Good Luck golden frog men's scarf pin or women's brooch pin, set with Mexican rubies and emeralds.

DETROIT & CLEVELAND NAVIGATION COMPANY

25 Wayne Street, DETROIT, MICHIGAN

PHILIP H. McHILLAN, Pres., A. A. SCHANTZ, Vice-Pres. & Gen. Mgr.
All D. & C. Steamers arrive and depart new Third Ave. Wharf, Detroit.

SWEET ROWBOAT MOTORS

You want a Rowboat Motor—the kind that makes any boat a motor boat in five minutes—Best fun you can think of—A regular circus! But you want a **good** one. We have built high quality Rowboat Motors exclusively for years. Our customers say Sweet Motors **beat 'em all**. We sell direct to you—No agents' commissions—That's how we make such low prices. **Two sizes, 2 H. P. and 4 H. P., also canoe sizes — \$38.50 and up.** Flywheel Magneto—Reversible Propellers—all latest and best improvements. Write or wire for particulars—We can save you money. Immediate shipments—Every motor has our full money-back guarantee. **Get our proposition before you buy.**

Sweet Mfg. Co., 601 Griswold St., Detroit, Mich.

\$38.50 AND UP

ROW BOAT MOTOR FERRO

BUILT RIGHT FIRST AND PRICED AFTERWARDS

Easily attached to your own or rented boat. Runs it steadily and quietly from two to ten miles an hour. Consumes but a gallon of gasoline and a quarter-pint of oil in four or five hours. Has own rudder, controlled from any part of boat.

Some Ferro features: Bosch High Tension Magneto; genuine float feed carburetor; quiet muffler (doesn't kill power); wood-proof propeller. One price includes all. Full information in catalog. Write for it.

If interested as dealer, send for prospectus No. 215. Good territory left for men who can qualify as agents. Give references.

The Ferro Machine & Foundry Co.
643 Hubbard Ave. Cleveland, Ohio

\$85 With Bosch Reversible Waterproof Magneto
\$65 With Waterproof Battery Ignition

DON'T GO ROWING—GO FERRROWING

Please Mention Popular Mechanics

KENNEBEC BOOK FREE

Tells how the famous KENNEBEC canoes are built. Interesting facts about design, material, workmanship, draft, describing models for paddling, sailing and motoring. Quotes low prices on highest quality ever built. Now you can enjoy the health and pleasure of canoeing in your own Kennebec. Don't miss our new book—every page interesting and valuable. Send name now on postal. Address **KENNEBEC CANOE CO., 30 R. R. Sq., Waterville, Me.**

"REDEMOTORS"

The simplest, most dependable and only logical small gas or gasoline motors. For every chore, from turning a grindstone or wash machine to driving a pump or railway speeder a "Redemotor" is made that will do the work at a minimum of effort and expense and a maximum of satisfaction. An engine that a woman can install and operate indoors. **Send for Our Booklet J Now.**

ELGIN WHEEL & ENGINE CO., ELGIN, ILLINOIS

POWER

Economical, reliable, steady, satisfactory engine service built into every Galloway gasoline and kerosene engine. Heavy weight, large bore and long stroke low speeded. Compare it with any engine! Then decide! Don't buy an engine of any price until you know all about Galloway engines.

17.95 **ENGINE PRICES LOWER**

Great volume, perfected design and simplicity make Galloway prices possible. Built from best material on modern automatic machinery, all parts standardized. Sold to you at one small profit. No unnecessary parts. Built-in quality steadily increases our volume. All styles and sizes from 1 1/2 h.p. to 16 h.p. at proportionate prices. A postal gets big Galloway engine book free. Engines shipped from Minneapolis, Council Bluffs, Kansas City, Waterloo or Chicago.

WM. GALLOWAY CO., Box 965, Waterloo, Iowa

Joymotor

For Rowboats
and Canoes



Marine
Engine
Dealers
Write for
Agency
Proposition

Joymotor will fit any boat ever made—square stern, pointed stern or decked stern—without additional attachments. Just hook it on or off in a jiffy. No matter where you take Joymotor you know it will fit the boat you have to use. For Canoes Joymotor special bracket sets motor low down—safety first.

REVERSING PROPELLER

The exclusive patented feature of Joymotor that makes it the safest, most convenient, easiest to handle motor in the world. No more danger of accidents. No drifting or paddling to dock or shore. No more awkward, hurried cranking to reverse the motor. Just move the steering tube to right or left and Joymotor almost instantly—**Stops your boat and backs it up without reversing the engine**

"Joymotor is rightly named"—
"A joy to own"—"evidently built
to enjoy"—that's what owners tell us. Easily

portable. Weighs 52 lbs. Runs your boat 7 to 9 miles per hour—canoes 10 to 12. Has real high tension magnets and carburetor, efficient oiling system and does not have slightest tangled up pump hose. Prices: Boat or Canoe Models, Battery Ignition \$65, Magneto Ignition \$75. Write postal now for catalog and life size picture of Joymotor giving full details of the finest, most satisfying portable motor to be had. Write postal now to

JOY ENGINEERING COMPANY
630 Tribune Bldg., CHICAGO



This picture shows how Joymotor steering tiller swings and reverses position of propeller. Compare this position with large picture.

LEARN DRY CLEANING

\$15 DAILY PROFITS



In 20 days' time we will make you an expert dry cleaner. And in five weeks we can have you started in a business of your own, actually making you \$15 a day. Learn at home by mail during spare moments. Write once for free booklet telling all about our wonderful instructions in latest, sure, quickest methods of dry cleaning. Write today.

PARK-BROWN COMPANY, 916 Ford Building, DETROIT, MICH.

Make Big Side Money

Sell our New "Christy" Letter Heads—Blotters—Cards—Samples Free—Beautiful Girl Pictures in color—Sell easy to Advertisers and Printers—50% Profit—WRITE TODAY.

KROHMER COMPANY
Insurance Exchange Bldg. CHICAGO

Do Your Own Printing



You can make good money from the start and build up a profitable business by printing cards, letter-heads, circulars, etc. Requires little money.

Write today for our 96 page catalog. It's free. Contains full printing instructions.

ROWELL PRINTERS SUPPLY CO.
75 Main St. (Est. 1865) Louisville, Ky.

AGENTS CONCENTRATED SOFT DRINKS



Men and Women—make big money—make it fast. Delicious Soft Drinks made in a jiffy—anywhere—any time—every popular flavor—convenient, handy for home, picnics, parties, socials, etc. Guaranteed pure. Make \$30 a week and more. We can show you how. 250 other big money makers—handy sellers—secure territory quick. Outfit furnished. Write today.

American Products Co., Dept. 2506, Cincinnati, O.



On Four Weeks' Trial

YES, we will ship to you—on absolutely free trial for four weeks—a genuine highest grade WING Piano DIRECT from our own factory, freight prepaid. Your choice of 38 styles in any shade of mahogany, walnut or oak—the most generous of all offers on the WING, guaranteed for 49 years. You pay no deposit.

You will be amazed at our rock-bottom, direct from-the-factory proposition on the genuine WING Piano, renowned for its excellence for 47 years.

No Money Down— Freight Prepaid

We ask no money down—nothing on delivery—no freight to pay either way. We ship the instrument, no money down—all freight paid in advance by us. While the piano is in your home use it just as if you owned it. At the end of the 4 weeks' trial, if you wish, you may return the piano at our expense. We pay return freight to New York. Not a penny to pay for the pleasure of using the piano four weeks.

A liberal allowance will be made for your old organ or piano.

Valuable Book—Free

"The Book of Complete Information About Pianos"

The New York World says: "A book of educational interest everyone should own." Tells the secrets of piano making and piano selling. Its 126 pages show you how to judge piano quality and price. Also art catalog of newest wing styles and particulars of our great free shipment offer. Send the coupon now.

WING & SON
(Est. 1862)

Dept. A119
Wing Bldg.,
136 St. and
9th Ave.,
NEW YORK,
N.Y.

Name

Address

Please Mention Popular Mechanics

Wing
& Son

(Est. 1862)

Dept. A119

Wing Bldg., 136 St. and
9th Avenue, New York, N.Y.

Gentlemen:—Without any obligation to purchase or pay for anything, please send me, free and prepaid, "The Book of Complete Information About Pianos." Also send full particulars of your rock-bottom offer on the Wing piano and catalog of latest art styles.

SATIN LINING FREE

In This Handsome Blue Serge Suit

Our system of selling fine tailoring direct—through no stores, agents or dealers, saves you big money and enables you to dress better. We want you to become one of our regular customers—that's why we will make one of our regular all-wool worsted blue serge suits

Tailored-to-Your-Measure (\$25.00) \$15

and line it with guaranteed \$4 satin lining free—also pay shipping charges. Read the guarantee—we take all the risk—you take none. Send for our NEW SPRING CATALOGUE.

BIG BOOK—70 Samples—Mailed FREE Contains generous samples of our plain and fancy suitings (prices \$15 to \$27)—explains our tailoring system—quotes lowest prices on men's furnishings, hats and shoes, also boys' clothes. Send for your copy today to

Desk D26
Bernard-Hewitt Co. 564 W. Monroe St. Chicago



Our Guarantee

We Guarantee to please you in style, fit, fabrics and workmanship or you don't pay us one cent

DIAMONDS

Moderate Prices Easy Terms



Diamonds for June brides and sweet girl graduates. Buy NOW

that diamond for your wife, sweetheart, sister or yourself—Don't wait until you get the money—buy from us now at these startlingly low prices—and pay for it in easy little amounts from time to time. Buy direct from Importers and Save Dealers' Profits. We give **Certified Guarantee with every Diamond**—guaranteeing its weight and quality. A safe way to buy and save money—no inconvenience—and have the Diamond now when you want it. Perfectly cut white Diamonds, gleaming, sparkling, scintillating—genuine high quality. Not a cent to pay until you have carefully examined the Diamond—then if you are perfectly satisfied pay 1/5 down and take the stone on our easy terms plan. We send you free magnifying glass. Any diamond in our

FREE ILLUSTRATED DIAMOND AND WATCH CATALOG

will be sent for examination without obligation. This offer is open to every honest person—open to YOU. Note the wonderful values shown here. Compare these prices with others. We import the rough Diamonds, cut them here, save 31 per cent duty. Give the saving to you. Write today for our **BIG CATALOG** and see our **Special World-Beating Offers**. All diamonds also watches on easy terms. Send for Catalog today.

THE WALKER EDMUND CO.,
DIAMOND IMPORTERS

Dept. C
State and Madison,
CHICAGO,
ILL.



400% to 800% Profit in Popcorn—Crispette and Candy Business

Crowds swarm to buy our Kettle-Popped Popcorn—popped under glass—seasoned while popping!—**GREAT BIG—CRISP—FLUFFY KERNELS!** Corn pops 25 per cent bigger with the **Delicious Crispette** machine and 100 per cent better product. Our delicious **CRISPETTES** melt in your mouth. Wonderful new **Automatic Crispette Press** in a regular money-maker! Big extra money in candy!

Course in Candy Making FREE with Every Outfit Write **AT ONCE** for **FREE** Catalog, new money-making plans, special prices and sensational easy payment offer. **NOW** is the time to start. No experience necessary and very little money. Write

C. E. DELLENBARGER CO., 150 Bissel St., JOLIET, ILL.

A sapphire weighing nine carats, in the collection of the National Museum, incloses a bubble which disappears and reappears with changes in temperature. The theory has been put forth that there is a cavity in the gem containing a quantity of carbonic acid under great pressure; which sometimes becomes fluid, causing the bubble to become visible.

AGENTS—Make \$100 to \$300



per month easy selling our new **Triplicate Sauce Pan**. Cooking utensil for 3 different foods on one burner. **400 Specialties**—all **Whirlwind** sellers. Write quick for exclusive territory and large catalogue.

AMERICAN ALUMINUM MFG. CO.,
Div. 5 61
LEMONT, ILL.



BOYS You can have \$60 worth of fun with this **20-Shot 25c Pistol**

Just out and selling like hot cakes. The **Six Automatic Repeating Pistol** shoots 20 times without reloading. Uses ordinary BB shot. Fine blue steel finish, perfectly made. For indoor or outdoor target practice. Postpaid 25 cents each. Address **STAR CO., 26 Clinton St., CHICAGO, ILL.**



Boys, here's the latest—the dainty figure of alluring little Miss

SEPTEMBER MORN

handsomely embossed on a beautiful **SCARF PIN**, same size as shown here, stem, 3/4 in. long, with **OXIDIZED SILVER OR ROSE GOLD FINISH**. A smashing big hit!—Get this classy pin and **BIG MONEY** agent's offer to-day, 25c. postpaid. **BUFFALO ENAMEL JEWELRY CO.,** 311 Morgan Building, Buffalo, N. Y.

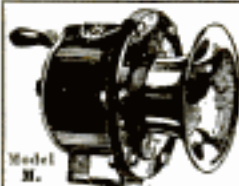

Patented
Mar. 28, '05.
Oct. 6, '14.

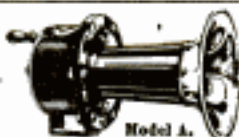

Model M.

Model A.

Model M **\$3.75**

SEISS Model A
Double Acting **HORN \$4.00**

Can be operated either right or left, giving a continuous sound, same as a motor-driven Horn. Bracket furnished for all makes of Autos, Trucks, Boats, Motorcycles, etc. Finished in Black Enamel with Nickel Bell.

SEISS MFG. CO., 439 Dorr St., Toledo, Ohio



Tobacco Habit BANISHED

in 48 to 72 Hours



No Desire After First Dose

Trying to quit the tobacco habit unaided is a losing fight against heavy odds, and means a serious shock to your nervous system. So don't try it! Make the tobacco habit quit you. It will quit you if you will just take Tobacco Redeemer according to directions.

It doesn't make a particle of difference whether you've been a user of tobacco for a single month or for 50 years, or how much you use, or in what form you use it. Whether you smoke cigars, cigarettes, pipe, chew plug or fine cut or use snuff Tobacco Redeemer will positively remove all craving for tobacco in any form in from 48 to 72 hours. Your tobacco craving will begin to decrease after the very first dose—there's no long waiting for results.

Tobacco Redeemer is absolutely harmless and contains no habit-forming drugs of any kind—the most marvelously quick and thoroughly reliable remedy for the tobacco habit the world has ever known.

Not a Substitute

Tobacco Redeemer is in no sense a substitute for tobacco, but is a radical, efficient treatment. After finishing the treatment you have absolutely no desire to use tobacco again or to continue the use of the remedy. It quiets the nerves, and will make you feel better in every way. If you really want to quit the tobacco habit—get rid of it so completely that when you see others using it, it will not awaken the slightest desire in you—you should at once begin a course of Tobacco Redeemer treatment for the habit.

Results Absolutely Guaranteed

A single trial will convince the most skeptical. Our legal, binding, money-back guarantee goes with each full treatment. If Tobacco Redeemer fails to banish the tobacco habit when taken according to the plain and easy directions, your money will be cheerfully refunded upon demand.

Let Us Send You Convincing Proof

If you're a slave of the tobacco habit and want to find a sure, quick way of quitting "for keeps" you owe it to yourself and to your family to mail the coupon below or send your name and address on a postal and receive our free booklet on the deadly effect of tobacco on the human system, and positive proof that Tobacco Redeemer will quickly free you from the habit.

Newell Pharmacal Company
Dept. 300, St. Louis, Mo.



Mail Coupon NOW for FREE Booklet

NEWELL PHARMACAL CO.,
Dept. 300, St. Louis, Mo.

Please send, without obligating me in any way, your free booklet regarding the tobacco habit and proof that Tobacco Redeemer will positively free me from the tobacco habit.

Name

Street and No.

Town..... State.....

Please Mention Popular Mechanics



Runs All Day on 4 Cents Worth of Alcohol

Now you can have a cooling, refreshing breeze, wherever you are—by your bedside, on your desk, on the porch or at the summer camp—without any electric current.

A blessing beside baby's crib on close, hot nights, a real necessity at the office on sweltering days. Take it wherever you wish, set it anywhere, it will give you a refreshing breeze. No wires, batteries or clockwork.



This wonderful fan, 12 inches in diameter, runs by a simple, compact, high-speed thermo engine. Operates anywhere with alcohol or gas. Absolutely safe—noiseless—substantial. Base and standard of iron, handsomely finished in black lacquer. Fan and guard nickel-plated.

To give this wonderful \$15.00 fan a wide introduction, we will send you one on **Ten Days' Free Trial** for \$11.50. Send check or postal or express money order. If fan does not do all we claim for it, return it in 10 days and we return your money.

AL-COOL FAN COMPANY
10601 Corliss Ave. Chicago, Ill.

GENUINE Perfect Cut Blue White DIAMONDS

1/8 C.	\$ 6.25
1/4 C.	15.50
3/8 C.	29.00
1/2 C.	40.25
3/4 C.	64.25



88 Per Carat
\$150 per C. retail value

Small sizes as low as \$50 per carat. Expert comparison proves the value \$150 per carat. Act now, and you'll profit by our direct importing system, big buying power, small profits. All middlemen's tax wiped out by our plan.

NO MONEY IN ADVANCE

Choose any diamond, any mounting, unlimited assortment. We ship for your inspection, without cost to you, or the slightest obligation. Our mail service handy and efficient.

BANKABLE, LEGAL MONEY BACK GUARANTEE

Permits you to return any diamond bought from us, through any Bank in America; and receive promptly **CASH REFUND!** Guarantees also full value in exchange forever! Carat weight, color, value—all legally certified. Here's perfect protection!

1916 De Luxe Book of Diamonds FREE!

First to show 1916 styles. Most complete, authoritative, profusely illustrated book of Diamond facts ever compiled. Tells in simple language how to buy diamonds and get your money's worth. Write today—it's FREE.



References: **ROGERS PARK NATIONAL BANK** of Chicago, your banker, any commercial Agency.

BARNARD & CO.

Dept. 10, N. W. Cor. Michigan Ave. and Adams St.
CHICAGO, U. S. A.

I WANT 200 SALES AGENTS AT \$1200 TO \$3600 A YEAR

To introduce my new **Compress and Vacuum Washing Machine** to every home in the country, I want 200 additional representatives to begin work at once in their home countries. I consider this machine the most brilliant inventive achievement of the age in household necessities. It is selling faster than anything I have ever heard of—going like wildfire.

PROFITS START FIRST DAY

No waiting or guessing. The price of only \$1.50 makes a sale at every house—cash business at 200 per cent profit to you. The biggest opportunity ever offered. I want hustlers—men and women who want to make money quick and fast. No large investment needed—business supplies the capital.

NO EXPERIENCE REQUIRED Just follow instructions. Failure impossible. Success assured. Frank Greene sold 45 first three days—profit \$45. Mrs. L. C. Merrick made \$90 first three weeks in spare time only. J. H. Goddard took 18 orders first three hours. No talking necessary. Just show it—the order is yours right on the spot.



The Wendell Compress and Vacuum Washer
Washes Tub of Clothes in Three Minutes
\$1.50
Selling Price

Every machine sold on money-back guarantee. A child can use it. Abolishes labor of wash day. Women discard \$15 and \$20 machines for it.

MAIL YOUR APPLICATION TODAY

Don't delay. Get your county under contract. No charge for territory. To wait means to lose. Write me a letter or a postal card today. If you are honest and willing to work I will give you the position. Do not let someone else get in ahead of you. I want agents, general agents and managers. Write today—then you will have done your part. Do it right now. Address

H. F. WENDELL, Pres., Wendell Vacuum Washer Co., 861 Oak St., Leipsic, Ohio

Steer Your Ford With Ease and Safety

YOU know how your Ford acts when you go above 10 miles an hour. It means both hands tight on the steering wheel, and the first turn or suggestion of wabbling spells trouble. It means turning the wheel frantically to the right and left to maintain anything like a straight course.

Stop riding with danger every day. Don't steer under this strain. The L-A Steady Steerer actually removes the cause of the trouble—does not merely counteract it. This valuable device is a strut or radius rod so connected between body and axle as to prevent absolutely all side movement between them. It makes impossible the wabbling that is the beginning of the driving trouble. And it assures as precise a course as you could steer with a Packard.

The L-A Steady Steerer is a safety factor of incalculable worth. And it is a positive insurance against unnecessary wear on parts and tires. Can you afford to be without it when so much insurance is provided at so little cost?

Lockwood-Ash Motor Company, 512 Horton St., Jackson, Mich.

\$2.00

Postpaid, with installing directions, if your dealer does not carry it. For use with shock absorbers, \$2.50. Attached by dealer, 50c extra.

Make Your Ford
Walk a Chalk Line

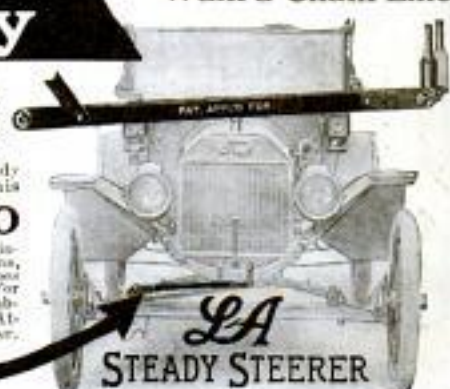

LA
STEADY STEERER



Champion

TOLEDO MADE FOR THE WHOLE WORLD'S TRADE

Spark Plugs

For Stationary Engines

\$1.25 This Two-Piece Heavy Stone Plug is especially designed for use in stationary Engines, Trucks and High Powered Automobiles. Will stand up under heavy punishment.

Over 75% of all gasoline engines, for every purpose, are equipped by their builders with Champion Spark Plugs. To accept a substitute is to disregard this most definite expression of scientifically determined expert opinion. Insist on Champions.

The Champion Guarantee Complete satisfaction to the user—free repair, replacement or money back.

SEE YOUR DEALER OR WRITE DIRECT TO US

Champion Spark Plug Co., 402 Avondale Ave., Toledo, Ohio

For Motorcycles

75c This Motorcycle Mica Plug is of special oil-resisting construction and Mica of course will not break. It will unfailingly deliver the spark of life to your motor.



Champion
Two-Piece
Heavy Stone



Champion
Motorcycle
Mica

Try at Our Risk

Sharpens Knives QUICK!

SWISH! SWISH! A few passes through the slot and your knife is sharp, with a perfect bevel, cutting edge superior to ordinary grinding. Small—attached to wall or table. Has diamond-hard sharpening rolls—adjustable—cannot turn edges—lasts a lifetime. A money and time saver. Price 50c prepaid. Money returned if not satisfied.

AGENTS This knife sharpener sells like hotcakes to housewives. Write for special agent's money-making proposition.

HOLLEY CO., 130 Elm St., Rochester, N. Y.

Agents—Make \$10 a Day

BRAND NEW PURE ALUMINUM
SINK STRAINER

Only one on the market. Will outlast 20 tin ones. Sure sale in every home. Write quick for territory.

AMERICAN ALUMINUM MFG. CO.
Div. Pop., LEMONT, ILL.



MECCO GARAGES

Here is a chance to make money

Write for Proposition
Give References

— ADDRESS —
M. E. Corrugating Co.
COVINGTON,
KENTUCKY

One Man and This Machine Will Earn \$50 to \$100 Daily Profit



\$100 a day can be made with this machine

Not a dream—not a myth—but a reality. If you are honest—earnest, and anxious to go in business for yourself, I will help you. I have helped lots of men to make from \$500.00 to \$1500.00 per month. It's an honorable business—can be started most anywhere, in any town of over 500 population.

A GOOD BUSINESS PROPOSITION

You want a business of your own. Go into the Popcorn Crispette business and make \$2000.00 to \$7000.00 a year. All you need is a machine, a few dollars and a good location. You can learn to make Crispettes in a day. They sell everywhere for a nickel a package. You make almost four cents profit.

SEND FOR FREE BOOK

It tells the whole story—how and where to start, how to succeed, gives experiences of others, etc. It's worth reading, even if you don't start. If you're looking for a good thing, and easy money, write today for the FREE BOOK.

Eskin made \$1500.00 in one month with a Long Crispette Machine, in a store window.

You can do equally as well, or even better.

W. Z. LONG CO.
1056 High St.,
SPRINGFIELD, O.



W. Z. LONG CO.
1056 High St., Springfield, O.

Without any obligation at all, please send me free your book, "Dollars and Sense in the Crispette Business."

Name.....

Address.....

Please Mention Popular Mechanics



Ready for Anything

Keep a Klean-Klad Wear-Over-Suit in the garage, the car or about the house. It will pay for itself over and over in the saving to your clothes. Can be slipped on over ordinary clothes in a minute. Makes you ready for the trip over dusty road—the work about the car or motorcycle—the job in the garden or about the house.

Klean-Klad Wear-Over-Suit

Two-Piece Suit That Saves the Clothes

The ideal protection garment for motorists, or for anyone who don't want to bother to change clothes when they have a few minutes of work to do.

Made of strong, tough khaki cloth. Cool and of light weight. Plenty of pockets for carrying tools. Washable. Send chest and leg measurement taken with your ordinary clothes on. At your dealer's or

By Mail Prepaid \$2.50 per Suit. Don't take chances on ruining a good suit of clothes. Write today.

PANDORA MFG. CO., Pandora, Ohio



PREST-O-LITE For Motorcycle Lighting *The Light that Stands the Jolts*

Is your lighting system as sturdy as your motorcycle?

Every day use, the jolts, vibration, and shocks, the occasional spill or tip-over, that you expect and demand to have no effect on your motorcycle, should not affect your lighting system.

Judging all systems by this stern standard, has resulted in the use of Prest-O-Lite by more experienced riders than all other systems combined.

Yet with these features of absolute reliability, lasting efficiency, freedom from expert repairing, costly replacements, and delicate devices of all kinds—Prest-O-Lite costs less to buy and less to use than any other system of brilliant lighting.

Try It 30 Days

Prest-O-Lite is sold on a money-back basis.

If after 30 Days' Trial you find its equal for brilliant light, economy in upkeep, simplicity in operation; if it doesn't show its superiority in every feature that makes for good motorcycle lighting, the test doesn't cost you a penny.

Get an equal guarantee of satisfaction before spending your money for any lighting system.

Get the FACTS

Send for the whole truth about all motorcycle lighting systems. Prest-O-Lite is ideal for stereopticons, camp lighting and many other purposes. Send for interesting literature—free on request.

The Prest-O-Lite Co., Inc., 265 Speedway
Indianapolis, Ind.
The World's Largest Makers of Dissolved Acetylene
Exchange Agencies Everywhere



Kor-Ker
PUNCTURE CURE

TRADE MARK
Reg. U. S. Patent Office
Formula Patented

District Managers Wanted

We want managers for some open territory. Successful—high-grade—forceful—convincing men who can command good incomes. For a man who can establish a branch business of his own and finance his orders we have an *unusual opportunity*. Write us to-day. This may be the turning point in your career. Territory rapidly being allotted—act quickly.

KOR-KER PUNCTURE CURE
Seals Punctures Instantly

Preserves the Tube, Overcomes Slow Leaks, Increases Tire Mileage. Tubes last longer and can be easily transferred to new casings. Does not interfere with vulcanizing. Guaranteed not to impair tire's resiliency. Always efficient—not a filler—occupies but little space.

Send for Tire Efficiency Booklet and Facsimile Testimonials.

KOR-KER
Puncture Cure
Not a Filler

ALCEMO MFG. CO. NEWARK, N. J.

Alcemo Mfg. Co. Manufacturers and Distributors
14A Bridge Street, Newark, N. J.

What "THEY" say regarding KOR-KER PUNCTURE CURE

"The most satisfactory accessory we have on our vehicles for sale."

Welfare Automobile Co.,
Wilson, N. C.

"Tire troubles from punctures a thing of the past."

Sidney A. Trinch, M. D.,
Newark, N. J.

"It will do everything they claim and possibly more."

H. W. Smook,
Winston-Salem, N. C.

"It effectually does away with the inconvenience and annoyance of punctures."

(Rev.) Wm. H. Laird,
Wilmington, Del.

"A reducer of expense."

J. O. McCall,
Weatherby, Mo.

"We could not afford to be without Kor-Ker."

F. F. Dalton, Inc.,
Sanford, Fla.

"Kor-Ker will do everything claimed for it."

Griffith Implement Co.,
Athens, Ga.

"Winter weather has made no difference with the efficiency of Kor-Ker."

William F. Keim, M. D.,
Newark, N. J.

"I believe in it absolutely."

Haddock-Nixon Tux Co.,
Wilmington, Del.

"Since installing Kor-Ker I have forgotten that I had a tire."

J. J. Thomas,
Raleigh, N. C.

"No trouble with tires whatever."

L. B. Tompkins,
Morristown, N. J.

"Never had to stop on the road for any tire trouble since using."

A. G. Ferris,
Brooklyn, N. Y.

"When my tires are once inflated, they stay inflated."

Henry Wagner,
Newark, N. J.

"Yet to repair first puncture."

E. P. Barrroughs & Son,
Madison, N. J.

"Very satisfactory."

L. W. Quick,
Watertown, N. Y.

"I have not had my tires off once on account of punctures."

R. C. Northwood,
New York City.



SEND A DOLLAR BILL

if you are a motor car owner, chauffeur, repair man, mechanic, carpenter, printer, engineer, butler, chef, store clerk, postal clerk, laboratory man, manual training student, freight and express handler, cartage and baggage-man, or take care of your own house and garden. The

10,000
in
use

JIFFY OVERALL APRON

is made in many sizes to fit small man of 5 feet 3 inches, up to the tall man of 6 feet. There are four styles: (1) Highest quality blue denim; (2) Extra heavy blue and white striped Stetfel; (3) Highest grade waterproofed white duck; (4) Extra quality brown khaki. Each garment has combination tool or watch and pencil swinging pocket. Two large pockets used for tools or other articles. Two elbow-length over-sleeves with each garment. Patented Clip at bottom of each leg—holds garment in place. Union made in Detroit by the highest skilled labor obtainable. Each garment is guaranteed.

Pin a dollar bill to coupon and mail today.

JIFFY APRON COMPANY, 317 Smith Bldg., Detroit, Mich.

Please Mention Popular Mechanics

JIFFY CO.
APRON, Michigan
Detroit, Mich.
Please send me by parcel post, paid, one Jiffy Overall complete with over-sleeves, style No. 1, for which I enclose \$1.00. My height is.....feet.....inches.

Name.....
Address.....
Parcel Post Paid

Drive at Night in Safety

Use the Perrin "No Glare" for Electric Headlights and drive on city streets or country roads without danger. Eliminates all the "glare" and gives a powerful driving light on the road.

Patent Pending

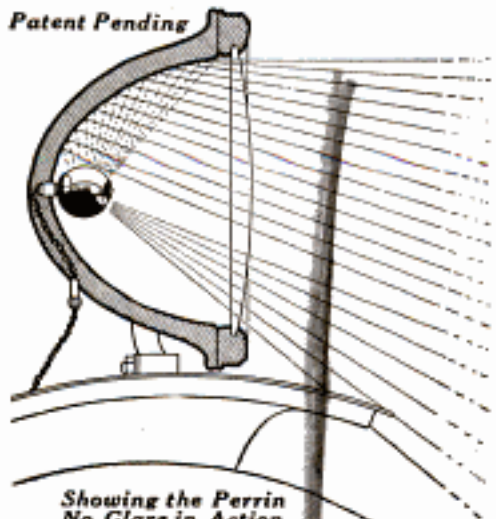

Showing the Perrin
No Glare in Action

Concentrates all the light out and down on the road. Does not blind other drivers or people walking. The beam of light is not over 4 ft. above the level of the road. Made of aluminum — snaps around the light bulb. Takes the place of a dimmer — no levers to turn, no buttons to push. Recommended by Police Departments everywhere. Insist on the

Perrin "No Glare"

Sold only by Dealers and Garages. Price \$1.00 per set (one for each headlight). If your Dealer will not supply you, write direct.

Gibmil Rear Apron

Takes
Away
That
Spindly
Appear-
ance



Price Complete
Only \$1.50

Put a GIBMIL REAR APRON on your Ford and make it look like a high priced car. Easy to put on — will not rattle. Made of heavy steel with baked-on enamel finish. Stand any kind of weather and rough usage.

Get one from your Dealer today.
If he cannot supply you write us.

PERRIN MFG. COMPANY
DETROIT, MICH.

Does
Not
Dim
the
Light

Price
\$1.00
Per
Set

EDWARDS



METAL SHINGLES

Prices of good wood shingles today are higher than the roof. Not only that, but Edwards Metal Shingles last five times as long, and are five times easier to lay. One man can do it all — easily. Edwards Metal Shingles can't blow off. The famous Interlocking Device keeps them on — the wonderful "Tightcote" process makes them weather-proof and water-tight.

Save Every Way

No more roof troubles. No after expense. Edwards Metal Shingles save every way. We can show you an avalanche of letters from Edwards users telling of better protection and money saved.

Lightning Can't Hurt

That's another advantage. A \$10,000 bond is our guarantee to you that your buildings are lightning proof when protected with Edwards Metal Shingles.

Thirty days more and prices must advance because of increasing cost of raw materials. So, NOW is the time to settle that roof question, once and for all. Write today for temporary bargain prices and Catalog 650. Give size of roof. We help you lay it. Act NOW — Prices are surely going up!

THE EDWARDS MANUFACTURING CO.
600-650 Lock St. CINCINNATI, OHIO

Florida Grapefruit Land

In Hillsboro County near Tampa — fastest growing big city in U. S. Highest grade fruit, truck, poultry and dairy lands. Farms 10 to 160 acres — Lowest Prices — Easiest Terms — Best Location — Best cash markets in all Florida. Thousands of acres now being improved right here in Hillsboro County. Satisfied buyers from every State and Canada. Our high reputation and responsibility guarantees you a square deal. Big profits may be made by those who invest now in this most progressive, liveliest and healthiest district in the entire South. Write today for free Florida Book and full information.

North Tampa Land Co., 140 S. Dearborn St., Chicago

Sell Your Patent

We assure sales or profitable realization of a good Patent. Patent secured or our fee returned.

The American European Patent Offices, Inc.
309 Broadway, New York City
Booklet free; English, French and German correspondence.

Hello Boys! BUILD NEW MODELS

MAKE LOTS OF TOYS
Help me get new models. I give 307 Prizes — first an Auto. My

ERECTOR BIG PRIZE CONTEST

is described in big folder. Send for it now. Free.

MYSTO MFG. CO.
253 Foote St.
New Haven, Conn.

Go to it!

TEMCO

Automobile and Garage Necessities

Use

Temco

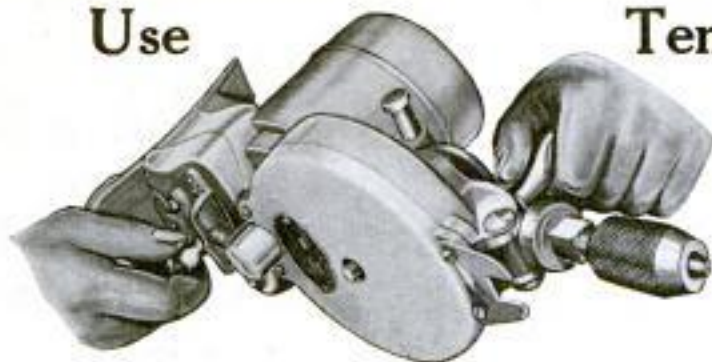

Electric Portable Tools

for drilling in iron, steel or wood, tapping, sharpening tools, reamers, cutters and grinding dies and lathe centers.

Get Quick Results and Double Efficiency

Do away with that tiring hand work. Temco Tools cost but little while operating and stop all expense when not in use. Carry them anywhere in the shop or factory. Connect them to your drop light and you have the most modern equipment—equipment that saves you time and labor and brings quick results.

Compact in Design—Easy to Operate

An operator will appreciate a handy tool like Model B Drill. The weight is so well distributed and it is so compact in design that the drill is well balanced when held in the hands. Easy to operate because the switch is always accessible, right where you want it—near the handle. You do not have to release your hold on the drill to start, stop or reverse the motor.

Reverse the Motor When the Drill Sticks

No matter whether the motor is running at full speed or not—it instantly reverses. The same switch starts, stops and reverses the motor and is always under your thumb when you hold the drill naturally for work. The Motor will not burn out.

Let us show you how a Temco Tool will take care of your needs. We have different models for varied requirements. Ask your dealer for a catalog on Temco Tools. Study the advantages offered. Apply the features to your particular work.

If your dealer cannot supply you with Temco Tools or literature, write direct to the factory and we will see you are supplied.

The Temco Electric Motor Company

Main Office—Factory 115 Sugar Street, LEIPSIC, OHIO



TEMCO Shock Absorbers
For FORD Cars
Complete Set of 4 \$15



TEMCO Improved
Master Vibrator
For FORD Cars \$12.50



TEMCO-ALTA
Universal
Shock Absorber
For All Cars
Complete Rear Set \$12

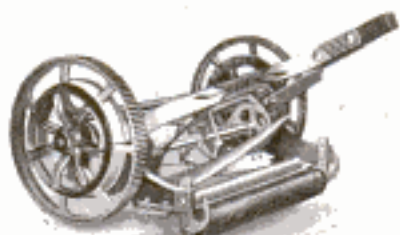

LAWN MOWERS



METAL FURNITURE



TOYS

"Made in
U. S. A."

Strength Lightness Appearance

"Buy
Now"

IF YOU desire to incorporate these qualities in your product, investigate the possibilities of building it of Stanweld Steel Tubing. Stanweld Tubing is light, strong, and has an excellent finishing-surface.

STANWELD TUBING

Stanweld Tubing is furnished in straight lengths or bent to any practicable shape or form. We number among our customers the world's largest manufacturers of automobiles, motorcycles, bicycles, and vacuum cleaners. If you will submit to us your problems they will be given careful consideration by men who have had years of experience in the manufacture of steel tubing and tubular parts. Few jobs are too difficult; no job is too large for our facilities. *Send for Folder "A."*

The Standard Welding Co.
Detroit Ave. CLEVELAND

Branch Offices in
New York Chicago
Indianapolis
Detroit



AUTO PARTS



VACUUM CLEANERS

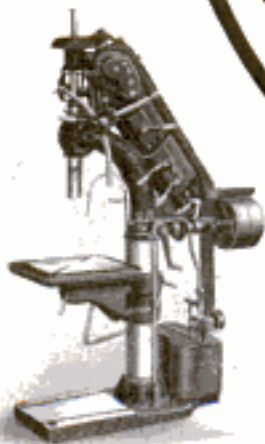

MACHINE TOOLS



MOTOR CYCLES



MUSIC STANDS

Please Mention Popular Mechanics

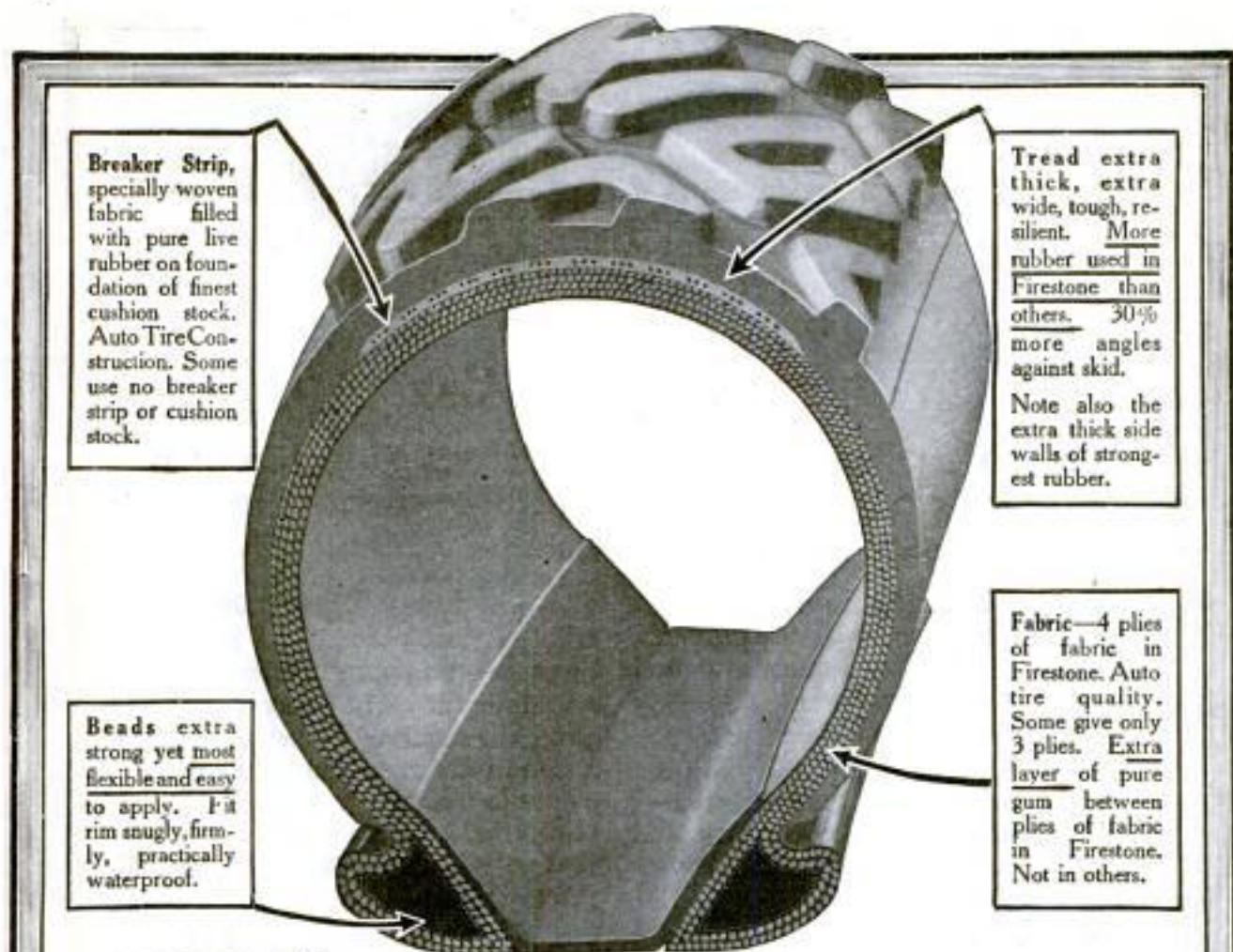

Firestone

Motorcycle Tires

FIRESTONE motorcycle tires are specially designed for the machines of today and tomorrow. Because they are made of the same Firestone quality rubber—the same enduring fabric—by the same scientific methods as the Firestone automobile tires—the Firestone motorcycle tires are making matchless mileage records. They are Firestone Tires in every particular—with ample capacity for the heavily loaded delivery van. This means more load than you will ever put on your machine.

There is more rubber in the broad, resilient treads of these Firestones than in any other cycle tire made. This gives an effective road grip. Lean to your fast turns safely. The Firestone beads with soft rubber core give pliability, make them easy to put on and take off, yet effect a firm, water-tight contact with the rim.

These Low Prices Are Your Benefit

from the Firestone's enormous volume of production and the largest and most effective distributing organization in the world—bringing tires to you at minimum cost.

Firestone Tire and Rubber Co.
"America's Largest Exclusive Tire and Rim Makers"
 Akron, Ohio—Branches and Dealers Everywhere

Firestone Net Prices to Motorcycle Owners

	Case Corr.	Case N. S.	Tube Gray	Tube Red
28x2 1/2" to fit BB rim	\$6.50	\$7.00	\$1.70	\$1.90
29x2 3/4" to fit BB rim	7.50	8.00	1.75	2.00
28x2 3/4" to fit CC rim	7.50	8.00	1.75	2.00
28x3" to fit CC rim	9.25	9.75	2.00	2.25

Please Mention Popular Mechanics

REGAL

Here's Your Car

No matter how exacting your needs—among the Three Regals is a car admirably adapted to your use and also your pocketbook.

The Regal Light Four, is a handsome streamline, five passenger car, unusual in size, appearance and performance—light of weight, economical to operate, at \$650.

Regal Standard Four, is larger, more powerful and luxurious car—the standard in size, beauty and equipment among four cylinder cars, selling at \$1085.

All these models are five passenger capacity—fully equipped, including electric lights and starter—have crown fenders, demountable rims and one man tops. Send for literature and name of nearest dealer.

The De Luxe Eight—Offers the highest development in gasoline motors—the powerful flexible, balanced eight. The smooth vibrationless operation of which makes a ride in it a new and pleasing sensation in motoring. A sensation, once tried, which creates a want that only owning one can supply, price \$1250.

Regal Motor Car Co.

506 Piquette Ave.
DETROIT, MICH.

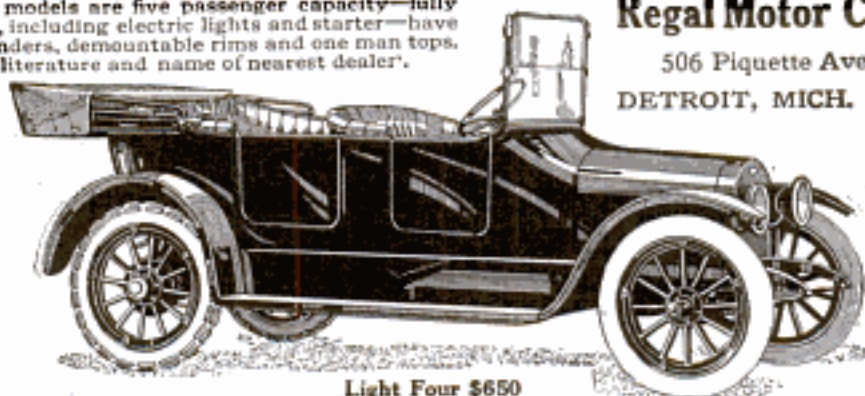

Light Four \$650

FREE SHOE BOOK SAVES \$20



"The Sole of Steel" describes my light, springy, comfortable, economical, waterproof, all-season, general purpose shoe that saves your foot, health and money. 1 pair of "Steels" outwears 2 to 6 pairs leather workshoes. Investigate before buying shoes again. Address, "The Steel Shoe Man."

N. M. RUTHSTEIN, Dept. 132, RACINE, WIS.

BARODA DIAMONDS

FLASH LIKE THE GENUINE—AT 1-50 THE COST

SOLID GOLD MOUNTINGS Stand acid test and expert examination. See them first, then pay. Catalog FREE. Patent Ring Gauge included for 5 two-cent stamps. The Baroda Co., Dept. 15, 1456 Leland Ave., Chicago



THE THREE BEST LIVE MINNOW BAITS

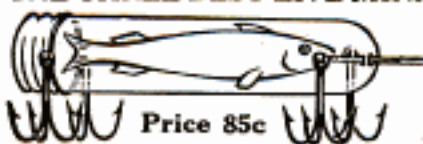

Price 85c

Magnifying Glass Minnow Tube
Minnow will remain alive all day

Live Minnow Hook, held by top fin
Price 25c



Minnow not harassed, hooked nor mutilated—remains alive and active



Live Minnow Cage
Price 50c

Ask your dealer or by mail prepaid from
DETROIT GLASS MINNOW TUBE CO.
73 W. Lafayette Blvd., Detroit, Mich.

The Book That Startled A Nation!



Free To Home Builders

This Book, "The Famous Fifty," has awakened some 78,000 American families to the fact that there is absolutely no use of

paying rent. In the first place, it no longer requires a small fortune to *buy* and *put up* a modern, commodious Home. A few hundred dollars wisely invested will buy a Home that any family can be proud to claim.

In the second place, it is no longer necessary to plank down the full amount. One can now make a reasonable cash payment and pay the balance in small monthly installments which are less than the monthly rent.

This Book has startled the Nation because it explains these facts in detail; and because it pictures the Fifty Famous Home Designs, selected from 2021 house plans. Wherever the U. S. Mail goes, you find this Book—in every community in every state in this great American nation. In a single day 3900 Home Builders often write for this Book.

Surely you want a home of your own—a real, handsome, up-to-date Home. Then this is your chance to gratify that want. Take the first step NOW by writing for the "Famous Fifty Book." It is free.

Building Prices Smashed

With our vast forest holdings and our mammoth MILLS, we have hammered Prices unmercifully. Five room Cottages, trim and neat, now sell at \$296.40; beautiful Bungalows at \$300; palatial two-story residences at \$700 to \$1,000.

These prices include all lumber, all hardware, paint, plaster, etc.—even the nails. Blue prints and Plans free with each Home.

All lumber comes measured and cut to fit. This saves you two-thirds the usual labor cost. (Also saves many days' time in construction.)

Time Payments

Others demand cash in full. We ship on receipt of 50% and accept balance in 24 equal payments, (less than rent). Our materials are so good and our designs so pleasing people always meet their payments gladly.

Write! Don't miss this Book. It offers positively the most remarkable opportunity ever presented to Home Builders. Write to

The International Mill & Timber Co.
BAY CITY, MICHIGAN
Dept. Q6

Be sure to address Dept. Q6



\$187 Brings It

THE "MIRINDALE"—This handsome 5-Room Cottage can be erected in 7 to 9 days. Price and terms: \$187 down and \$5.20 per month. Total cost \$312.



\$414 Brings It

THE "MIRACLE"—One of the most remarkable homes ever designed—Living Room and Dining Room—two large bedrooms—bath—modern, work-saving kitchen. Fine Porch, all complete. Can be erected in 12 to 14 days. \$414 down, balance, \$11.51 per month. Total cost \$609.



\$628⁸⁰ Brings It

THE "SENATOR"—Reverendness rooms, 4 closets, bath. Modern in every detail. Can be erected in 18 to 25 days. Sell for \$628.80 down and \$21.50 per month. Total price \$1,945.

Please Mention Popular Mechanics



Doing Business with a Business Concern

The business man is an important factor in your daily life and happiness.

He may raise wheat or cattle; he may manufacture flour or shoes; he may run a grocery or a drygoods store; he may operate a copper mine or a telephone company. He creates or distributes some commodity to be used by other people.

He is always hard at work to supply the needs of others, and in return he has his own needs supplied.

All of us are doing business with business men so constantly that we accept the benefits of this intercourse without question, as we accept the air we breathe. Most of us have little to do with government, yet we recognize the difference between business methods and government methods.

We know that it is to the interest of the business man to do something for us, while the function of the gov-

ernment man is to see that we do something for ourselves—that is, to control and regulate.

We pay them both, but of the two we naturally find the business man more get-at-able, more human, more democratic.

Because the telephone business has become large and extensive, it requires a high type of organization and must employ the best business methods.

The Bell System is in the business of selling its commodity—telephone service. It must meet the needs of many millions of customers, and teach them to use and appreciate the service which it has provided.

The democratic relation between the customer and the business concern has been indispensable, providing for the United States the best and most universal telephone service of any country in the world.

**AMERICAN TELEPHONE AND TELEGRAPH COMPANY
AND ASSOCIATED COMPANIES**

One Policy

One System

Universal Service

Please Mention Popular Mechanics



No. 5 OLIVER

This Beautiful Oliver on Free Trial Save \$44—No Money Down

\$4 Monthly Payments

What we urge of you is what thousands have done to possess this beautiful typewriter. They write for our unusual Free Trial Offer. Then we quote you a price on this famous Oliver that is amazingly low—about one-half the catalog price.

Note the beautiful finish, the mechanical workmanship of the Oliver. It's the most far-famed typewriter in the business world.

Yet you can try it free in your home or office. Convince yourself this way. It's the only way to buy

No Money Down—Life Guarantee

Did you ever see a more beautiful typewriter? It is easiest to operate. Wonderfully durable. It has visible writing; U-shaped type bar, making possible lightest touch known; built-in tabulator, back spacer, marginal release, universal keyboard with six extra characters. Each machine full standard size, complete with every accessory.

Don't spend a cent for a typewriter till you have seen our offer and low price. Remember, we charge you nothing for the Free Trial. You *must* see this typewriter before buying.

Send this coupon for Free Trial Offer and half price. Send it now, else you may forget.

TYPEWRITERS DISTRIBUTING SYNDICATE
166-81D N. Michigan Blvd., Chicago

a typewriter. The typewriter must sell itself or there is no sale.

Secret of This Remarkable Offer

We have sold 20,000 Olivers by our simple plan. We get these Olivers fresh from the factory. We buy in such tremendous quantities that we can sell at wholesale prices. Then we have no salesmen, no commissions, no branch houses. All this extra saving is yours. We figure our Oliver owners have saved in this way over half a million dollars.

Typewriters Distributing Syndicate
166-81D N. Michigan Blvd., Chicago

Please send me, without obligation on my part, complete information on your famous Free Trial Offer of the No. 5 Oliver Typewriter and your low price.

Name

Address

(300)



A Fresh Morning, a Fresh Mount and a Fresh-Rolled Cigarette

— there's a combination to kindle a man's spirits with the pure joy of living! The delicious *freshness* of "Bull" Durham hand-made cigarettes appeals to the countless thousands of smart, active, sport-loving, health-loving American men — gives added zest and exhilaration to their enjoyment.

GENUINE "BULL" DURHAM SMOKING TOBACCO

To millions of experienced smokers throughout the world "Bull" Durham means much more than a particular brand of smoking tobacco—it stands for a *distinctive form* of tobacco enjoyment, incomparably satisfying. No other tobacco has that wonderful, unique fragrance of "Bull" Durham. No other cigarettes have the delicious freshness and mellow-sweet flavor of "Bull" Durham hand-made cigarettes. You only appreciate this when you "roll your own."

FREE An Illustrated Booklet, showing correct way to "Roll Your Own" Cigarettes, and a package of cigarette papers, will both be mailed, *free*, to any address in U. S. on request. Address "Bull" Durham, Durham, N. C., Room 1124.

THE AMERICAN TOBACCO COMPANY



Ask for **FREE**
package of
"papers" with
each 5c sack