

May

15 Cents

# POPULAR MECHANICS MAGAZINE

WRITTEN SO YOU CAN UNDERSTAND IT

TRADE MARK



Firing on the Clock

Copyrighted material

# \$699

## BUYS THE MATERIAL To Build This Harris Home

### Easily Built — Guaranteed Construction

No Shortage  
No Extras  
No Waste

### Cut-to-Fit that Builds to Stay

# 4

**Big Lumber  
Shipping Points**  
See the 100  
Modern Harris  
Homes in our  
free \$10,000 Book  
of Plans shipped  
"direct to you" from  
our four big ship-  
ping points con-  
veniently located.

No Money Down  
Save 1/3 to 1/2

**Write Today**

We will name you freight prepaid prices on everything — lumber, millwork, hardware, plumbing, heating, etc., that will mean a saving of from 1/4 to 1/2. Upwards of 20,000,000 feet of brand new lumber is in our mammoth stock at all times, and we will ship without one cent down. Get our plan.

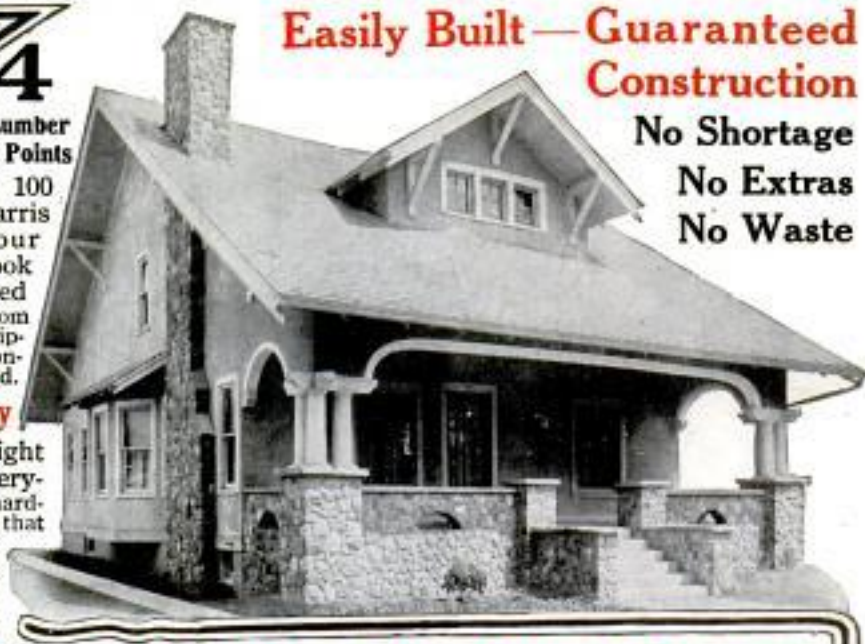

### Build Your Home at the Price You Ought to Pay 23 YEARS OF EXPERT PLANNING

**Our Guarantee  
Protects You**

Greatest of all is this Harris Home Building Plan, a truly wonderful offer — clean and straightforward. The first real helpful home building plan — the opening wedge that made it possible for thousands of satisfied Harris Home owners to realize their dream of years. In dealing with us you reap the benefits of these vital essentials — 23 Years of Expert Planning, Designing and Close Study of Economy in material and labor. Through all these years we have maintained with ease, our lead, never finding it necessary to recognize competition. Make us prove this to your satisfaction. It won't cost you a penny to get our offer now — to-day. Our binding guarantee backed by every cent of our ten million dollar capital stock, gives you an iron clad protection. You can't possibly go wrong, for we take all the risk, you take none.

**THE DESIGN** The Harris Home No. 161, above, is a perfect combination of comfort, convenience and economy; modern in every respect. Six rooms, bath, large closets, pantry and modern stairway. This is but one of the many splendid designs which can be carefully studied from our Free Plan Book in your own home during your leisure hours. Mail the coupon below for your copy of our Plan Book today.

**THE MATERIAL** Knotless lumber for all outside finish, interior finish, Flooring and Cedar Shingles, No. 1 Dimension Lumber. **Ready-Cut the Harris Way:** all glass in and back puttied — saves time and labor. Up-to-date Antique Copper or Lemon Brass Finish Hardware. Harris Homes are architecturally correct in every detail.

**Mail Coupon  
Below Today**

**PLANS FREE** We will send you a complete set of blue print plans, such as would cost you from \$25 to \$100 if drawn up by any reputable architect, upon receipt of the coupon below and \$1. We will also include along with the plans, free of charge, Specifications, Material List and a guaranteed delivered price to your station. If you decide to purchase, you will be credited with this remittance of \$1 on your bill, so you see this service is absolutely free. If the plans did not suit and you are not ready to buy, return them, and 50c will be refunded.

Dept. CF7  
Harris Bros. Co.

Send me your Free  
\$10,000 Plan Book (I  
am also interested in

Name \_\_\_\_\_

Address \_\_\_\_\_

#### Plumbing and Heating

You can easily install your own heating plant and plumbing material with the assistance of our free expert engineering service. We show you how to eliminate much of the biggest expense. Mail the coupon for your copy of our new plumbing and heating book. Complete bathroom outfits, \$37.50, finished bath-tubs as low as \$13. Warm air heating plants, \$67. Steam heating plants, \$85. Hot water heat. plants, \$95.

#### Quality Roofing

Our new roofing book is full of practical information. Tells you the correct grade and style of material adapted to your particular purpose. Everything explained by diagrams. Biggest values ever offered, in ready roofing, metal roofing, siding, ceilings, etc. Prices represent savings of from 1/3 to 1/2 in every instance. Mail coupon for FREE copy today.

#### Building Material

Mail the coupon today for our 200-page building material book, replete with bargains in lumber, doors, windows, millwork, paint, roofing, plumbing, hardware, lighting fixtures, mantles, grates, colonnades — in fact, everything in structural materials for the construction of any building. Substantial savings evident in every instance.

Our every transaction guaranteed and backed  
up by our capital stock of \$10,000,000.00

# HARRIS BROTHERS CO. 35th & Iron Sts. CHICAGO

*"How would  
you like  
to hear  
this record -*

*Loud,  
Soft, or  
Subdued?"*



## **The Victor system of changeable needles enables you to meet every acoustic condition**

It gives you perfect control of the tone volume and enables you to adapt every record to the acoustic limitations of any room.

The different kinds of Victor Needles give you different and distinct gradations of tone. Without this changeable needle system, it would be necessary to have several instruments, each with a different tone, to give such variation.

You can use the full-tone needle, the half-tone needle, or the fibre needle, to suit the individual beauty of each record to its particular acoustic surroundings.

You choose the volume of tone and play each record as loud or soft as *you* personally wish to hear it, without interfering in any way with the artist's interpretation.

Go to any Victor dealer's and hear your favorite music played with the different needles and you will fully appreciate the infinite variety of charm afforded by the Victor system of tone control.

There are Victors and Victrolas in great variety of styles from \$10 to \$250.

**Victor Talking Machine Co., Camden, N. J., U. S. A.**

Berliner Gramophone Co., Montreal, Canadian Distributors



New Victor Records demonstrated at all dealers on the 28th of each month.

**"THE BUNGALOW BUG STILL BUSY" and "NOTHING TO IT BUT CYPRESS"**



for people who want to vaccinate their building investment against the Repair Bill Bugaboo.

Thousands have been writing us for plans for a \$5,000 CYPRESS BUNGALOW — so here it is:

**CYPRESS BUNGALOW "C"**



THIS IS AN EXCEPTIONALLY INTERESTING and ARTISTIC **CYPRESS BUNGALOW** SPECIALLY DESIGNED FOR US BY ONE OF NEW YORK'S ABLEST and BEST KNOWN ARCHITECTS

**WE ADVISE IMMEDIATE APPLICATION**  
for **VOL. 8, CYPRESS POCKET LIBRARY (NEW)**  
*SENT FREE ON REQUEST TO ANY ADDRESS IN THE WORLD.*

SPECIFICATIONS GO WITH WORKING PLANS and are SUFFICIENT for any competent carpenter TO BUILD FROM.

The less you are able to spend in building, the more important it is that you secure the longest possible life for your investment. The *more* you spend, the more important it is that your money represent a *permanent* investment, and not have to be spent over again in exasperating repairs. CYPRESS is "the one best buy" in the entire wood market for those who care what they get for their lumber money. "CYPRESS lasts practically forever." CYPRESS RESISTS THE ROT-INFLUENCES which so soon destroy other woods. CYPRESS does not warp or shrink or swell like most woods—and takes paint or stain perfectly. Whether for MANSION, PASTURE-FENCE OR "LITTLE JOB OF BACK-STEPS"—remember—"IF YOU BUILD with CYPRESS YOU BUILD but ONCE."

Ask our "ALL-ROUND HELPS DEPT." any question about Wood. Our reply will be frank. We recommend CYPRESS *only* where CYPRESS can *prove* itself "the one best wood" for your use.

**SOUTHERN CYPRESS MANUFACTURERS' ASSOCIATION**  
1219 Hibernia Bank Building, NEW ORLEANS, LA. and 1219 Heard Nat'l Bank Bldg., JACKSONVILLE, FLA.

We produce CYPRESS but do not retail it. INSIST ON IT NEAR HOME. Wide awake Local Dealers sell CYPRESS; if yours does not, WRITE US, and we will tell you where you CAN get it.

Please Mention Popular Mechanics

# Popular Mechanics Magazine

6 N. Michigan Avenue, Chicago, U. S. A.

EDITED BY H. H. WINDSOR

England: The International News Co.,  
5 Breams Bldg., Chancery Lane, London, E. C.

Australia:  
The Australasian News Co.

ISSUED MONTHLY

SUBSCRIPTION:

SINGLE COPY, 15 CENTS

In United States, and its possessions, Cuba and Mexico, per year, postpaid - - - \$1.50  
To Canada - - - - - 1.75  
To all other countries in the Postal Union - - - - - 2.50

All subscriptions are discontinued at expiration. Please examine the date printed on your wrapper.

Entered as Second Class Matter Sept. 15, 1903, at the Post Office at Chicago, Illinois, under Act of March 3rd, 1879.

Entered as Second Class Matter at the Post Office Department, Canada.

Published monthly by POPULAR MECHANICS CO.

Copyright, 1915, by H. H. WINDSOR.

Copyright, in France.

## Contents for May, 1915

*Aeroplane Ornament for the Hair*

Advertising Device, Clever .....	644	Drilling, Glory-Hole, Is a Hazardous Job.....	683
Aerators for New York Water Supply.....	672	Electric Lighting, War Causes Extension of.....	681
Air Compressor, Rotary, of a New Type.....	704	Electric Railway, Frozen River Roadbed for....	725
Airman Gerstner's Death Caused by Drowning..	684	Elephants, Begging, of Siam.....	742
Airman's Death Plunge before Movie Camera....	683	Everglades Reclamation a Big Project.....	753
Airship, British, Has Novel Features.....	744	Faucet, Combination Water, with Swinging Spout	723
Ash Tray with Continuous Match Striking Sur-		Fence Post, Steel, Ground Bar Makes Rigid....	763
face.....	709	Fence, Wire, How Much It Costs to Build.....	654
Automobile on Eagle Rock Mountain.....	731	Fireless Cooker Used for Delivering Hot Foods..	644
Automobile Racers, Speaking Tubes are Used by.	651	Fish Trapped by Receding Flood, Rescuing.....	686
Automobile Seat, Adjustable, for Chauffeur....	759	Fisherman, Adjustable Pole Holder for.....	654
Automobile Travels on Land and Water.....	642	Fishing, Electric Minnow New Bait for.....	662
Automobile, Twelve Cylinder, a Possibility....	732	Flask, Stopper Seals Hermetically.....	757
Automobiles, Proper Electric Wiring for.....	738	Flies, Novel Device Traps Mechanically.....	749
Bank, Doors of Stockman's, Picture Ranch Life..	735	Flowerpot Holder, Phonograph Horn Serves as..	744
Baseball Game, Captive, Played Indoors.....	708	Flowerpots Ornamented with Sea Shells.....	729
Battleship, Giant, Launching.....	673	Flying Machine, Miniature, Ornament for the	
Beachey, Lincoln, Monoplane Causes Death of..	678	Hair.....	701
Belt Cutting Instrument Is Time Saving Device..	702	Foghorn, Silent Area of, Now Explained.....	708
Bowling Balls, Weighted, Detected by Scale....	718	Forest Lookout Posts in Montana and Idaho....	670
Bridge, Rope, over River in Ecuador Mountains..	700	Fountain Uses Same Water Over and Over.....	658
Building, Woolworth, Concealed Lights Illu-		Fresh Air Chute Designed for Sleeping Chamber.	
minate.....	716	Fruit, Pyramidal Glass Case for Drying.....	724
Bullets, New Methods of Locating and Removing.	750	Funeral Car of Japanese Emperor.....	734
Canal, Georgian Bay, to Afford Short Cut		Garage Entrance, Automatic Alarm for.....	741
across Canada.....	734	Gas Explosion is Caused by Robbery of Meter...	652
Candles, Birthday Cake, Held on Board.....	706	Gas Lighting Device, Convenient.....	756
Canned Goods, Raising the Standard of.....	655	Gears, Friction, of Paper, Transmit High Powers.	
Cathedral, Salisbury, Flooded.....	645	Glass Roofing, Collapsible, Protects Garden	
Cattle, Albino, To Exhibit at San Francisco....	732	Plants.....	753
Chains, Driving, Testing.....	742	Glass Table Covers, Rubber Pads for.....	757
Chickens, Machine for Killing.....	711	Glider, Homemade, Built from Scrap Material...	671
Chisel Tested by Driving It through Steel Bar..	733	Goldfish Revives Rapidly after Liquid Air Bath..	752
Church, Refrigerated, in a Texas Town.....	740	Gun, Largest Modern, Owned by Italian Gov-	
Cigar with Wooden Peg Inserted in Tip.....	686	ernment.....	710
Coast Guard, New United States, Established....	760	Gunpowder, Exploding with Wireless Waves....	689
Coast Patrol, New Service to Broaden.....	705	Hammock, Couch, Adjustable Headpiece on....	713
Coats, Soldiers', Tell Story of Warfare.....	719	Hearse, Taxicab, is Used for Infants' Funerals...	698
College Colors, Display, in Spectacular Way....	737	Hens, Device Discourages from Sitting.....	755
Comment and Review by H. H. Windsor:		House in Netherlands Has Rooms Three Feet	
Premature Peace Plans.....	681	Wide.....	737
The Medium Sized Man.....	681	House, One Man, a Curious Structure.....	730
Doctors of Mechanics.....	682	Howitzer, New British, Called Coventry Gun...	700
We Learn from Experience.....	682	Ice Boat, Motor Drive, Attains Good Speed....	689
Concrete Pipe, Method for Acid Proofing is		Indian Pupils, Teaching to be Cleanly.....	740
Round.....	746	Kitchen Cabinet, Adjustable Work Table on....	652
Concrete Walls, Spaces for Flowers Made in....	721	Lamp-Post, Artistic, Made from Limb of Tree...	732
Cottage, Seven Room Stucco.....	800	Lenses, New, Give Clear Vision at Any Angle...	755
Crib, Fireproof, is Built of Hollow Tile.....	746	Letter Opener and Paper Cutter.....	756
Crochet Needle, Finger Clamps on.....	750	Level, New, Tells Grades in Terms of Inches...	713
Curtain Rod Which does Not Sag.....	757	Liberty Bell, Sound of, is Preserved.....	676
Dolls, Hot Water Bottle.....	756	Lincoln Highway Building Goes on Rapidly...	712
Dove, Rose Covered Peace, in Flower Pageant..	682	Locomotives Supply Heat for Passenger Station..	752

[Continued on Page 6]

Popular Mechanics offers no premiums; does not join in "clubbing offers," and employs no solicitors to secure subscriptions. It is for sale by nearly every newsdealer in the United States and Canada.

This One



48EB-HQ3-UDW9

## [Contents—Continued]

Manikin, Giant, is Made to Sing and Talk.....	664	War, European:	
Maps, Air, Military Fliers' Success Hinges on...	758	Aerial Raids, Torpedoes and Bombs Used in.....	738
Memorandum Tab Attached to Watch.....	752	Aeroplanes, War, and One of Its Enemies.....	694
Milk Can, Refrigerator, Keeps Milk Sweet.....	758	Ambulance Train, German Ready to Transport	
Money—"Trial of the Pyx" Held at Philadelphia		Wounded.....	690
Mint.....	670	Artillery Pieces, New, Now in Use in Europe..	693
Motor Truck, Six Ton, Used in Handling Gar-		Balloon, Captive, Making Observations from..	688
bage.....	746	Battle Field Strawn with Dead.....	696
Motorcycle, Lightweight, Operates Inexpensively.	646	Churches, French, Destroyed by German Guns..	686
Navies, New, Germany and Britain Both Build-		Curiosities of the War Seen by the Camera.....	698
ing.....	724	Dardanelles, Allied Fleet at Entrance of.....	684
Noodles, Machine Makes in Many Shapes.....	712	Dogs, Parts Played in War by.....	687
Novel and Practical Things for Daily Use.....	756	"Firing on the Clock".....	710
Nutcracker, Grip Strength Not Needed to Work..	759	Incendiary Mediums Used by the Germans in..	743
Oven, Large Gas-Heated for Baking Enamels....	748	Laundries, Motor, Using in.....	701
Oxygen may be Stored without Pressure.....	736	Machine Gun Batteries on the Firing Line.....	689
Panama Canal, Score Board for.....	710	Scouts and Snipers at Work at the Front.....	690
Paper Shirts, Japanese, Russian Soldiers Wear..	740	Ship—"Bluecher," Sinking, Awaiting Death on..	692
Parcel Post, Advertising by Window Display....	650	Trenches, Continental, Striking Scenes in.....	685
Paving Blocks, Cast Iron, for Brooklyn Bridge..	741	Unusual Things Bearing on Europe's War.....	687
Phonograph, Instruct Mexican Laborers with..	670	Watches Designed for Use on Aerial Voyages....	709
Photographic Dark Rooms with Light Locks....	754	Water Draining Apparatus.....	757
Pine Wood, Much, is Used by Pennsylvania.....	738	Water Heater, Electrical.....	756
Pines, Wood Irrigation, Prolonging Life of.....	754	Waterproofing, Lanolin, for French Uniforms..	748
Platform, Suspended, Safety Device to Hold.....	758	Wireless Apparatus Used on Aeroplanes.....	724
Printing, Form Letter and Circular, Made Easy..	723	Wireless between United States and Norway....	702
Quicksand, Man Buried in Kept Alive Until		Wireless, Directing the War by, by Geo. F. Worts	647
Saved.....	706	Wireless Telephoning from Moving Trains.....	685
Radium Cost, New Process Cheapens.....	759		
Radium Fertilizer Gives Increased Crop Yields..	680		
Railroad, Ill Luck Accompanies Opening of.....	748		
Railroad, Quarter Mile, Earns \$1,000,000.....	660		
Railroad Station, New Union Passenger, at			
Kansas City.....	702		
Railroad Tracks, Clearing of Caterpillars.....	730		
Railroad Wrecks—Freight Cars are Buckled in			
Collision.....	704		
Rathole, Poison Button Nailed Over.....	740		
Rice, How Japanese Use Water Power to Hull..	728		
Sack, Paper, Has String Attached Ready to Tie..	758		
Sailboat Used by Store as Advertisement.....	720		
Scott Memorial, Design of, Decided upon.....	672		
Screwdriver, Convenient Pocket.....	757		
Ship—American Bark, Wheat Shipped to Dublin			
in.....	714		
Ship, Big, How Looks After a Fire.....	750		
Ship, Danish, Motor, Broken in Two on Rocks... 646			
Ship, Firing a Fuse to Blow Up.....	641		
Ship—Sailing Craft "John Ena" Passing through			
Panama Canal.....	706		
Ship—Schooner Hotel for New York Poor.....	733		
Ships, Grounded, Apparatus for Releasing.....	745		
Ships—Monitors Operating along the Belgian			
Coast.....	720		
Ships Stranded by Tide in the Bay of Fundy....	701		
Shoe, Arch Support is Attached to Outside of... 650			
Shovel, Folding, Designed for Motor Tourist... 744			
Signal Lamp, Odd, Devised for Railway Crossing.. 725			
Silos, Portable, Used by Missouri Farmers.....	718		
Sled, Sea, Rides at High Speed.....	726		
Soldering Caps on Tin Fruit Cans, Steel for... 694			
Speedway, Great, Projected for Twin Cities.... 662			
Sprinkler, Lawn, That Wets a Large Area.....	728		
Sprinkler System for Cooling Light Court.....	747		
Stamp Vending Machines Used in Canada.....	732		
Steam Systems, Heat Equalizing Device for.... 728			
Steel Cutting, Rapid, with Oxyacetylene Flame.. 672			
Steel Immersed in Sea Water, Cement Coating			
for.....	646		
Street, Important, No Wider Than an Alley.... 751			
Surf Coasters Introduced at California Beaches.. 871			
Swimming Pool, Concrete, of a Country Estate.. 714			
Table, Enamel Top Kitchen.....	757		
Tattooing as Practiced by Japanese.....	722		
Telephone, Small Desk, Operates Efficiently.... 712			
Tetanus Treatment, Respiration Device for.... 642			
Theater, London, Stages Novel War Show..... 712			
Tie, Steel, Designed to be Elastic.....	755		
Time Difference between Washington and Paris.. 753			
Tire, Emergency Motor Car, Made of Wood.... 652			
Tool Sharpening Device for Woodworkers..... 715			
Trade Mark Design, "Made in U. S. A." Selected 680			
Traffic Officer, Shielding from Sun's Rays..... 743			
Traffic Officers, Standing Platforms Used by... 738			
Tree Hurlled upon House in Violent Storm..... 711			
Tree, Pine, Worth Nearly One Hundred Dollars.. 741			
Trees, Growing, Windstorm Leaves Record in.. 644			

## SHOP NOTES

Air at Low Pressures, Tanks for Supplying.....	767
Automobile Crank Handle, To Prevent from Stick-	
ing.....	780
Automobile Engine Manifold, Emergency Repair	
on.....	770
Automobile Starting Crank Handle, Cover for... 766	
Basement Light Circuit, Switch Arm for.....	764
Bearing Caps, Broken, To Prevent.....	775
Bearings, Loose, Doweling.....	769
Boring Bar, Adjustable.....	776
Bottle, Acid, Protection for.....	764
Bracket, Small Broken, Repair for.....	770
Chuck Jaws, Holding Protection Strips on.....	776
Direct Current Dynamos, To Locate and Correct	
Troubles in:	
Part III—Speed and General Suggestions.....	777
Drawing Board Cover.....	769
Fence, Homemade Metal.....	761
Flag, Large, Housing for.....	765
Fuse Plug, Burned Out, Temporary Repair for... 769	
Gasoline Connection, Mucilage Used to Stop Leak	
in.....	765
Gear Shift Lever, To Make Move Easily.....	780
Home, Building a:	
Part II—Planning the House.....	771
Index Cards, Making.....	769
Key, Plain, Removing with a Monkey Wrench... 770	
Lap, Adjustable.....	780
Lathe, Holding Work in, to Cut Taper Threads.. 765	
Magneto Drive, Broken, Repairing.....	768
Metal Planer, Shaping Irregular Surfaces on... 774	
Metals, Acid Test for.....	769
Micrometer Holder.....	767
Reamer, Repairing.....	780
Shaft Coupling, Detachable.....	779
Steam Trap, Easily Made.....	767
Street Lamp Glare Shield.....	766
Tar and Asphalt Spots, Removing.....	767
Thread Cleaning Tool.....	780
Twine Holder.....	769
Valve, Locking a.....	775
Valve Stem, New, Changing to Fit an Old Valve.. 776	
Window Screen, Hinged Molding for.....	766
Wire Straightener, Simple.....	779

## AMATEUR MECHANICS

Battery Circuits, Homemade Fuses for.....	787
Bouquet Holder, Buttonhole, To Keep Flowers	
Fresh.....	785
Dishwasher and Drier.....	788
Doorbell Push Button on Screen Door.....	786

[Contents Continued on Page 8]

# LAW BOOK FREE

**Don't Consider Enrolling in Any Law Course Until You Have Read This Book from Cover to Cover!**

**E**XPLAINS all about wonderful new system of correspondence law instruction. How to eliminate all possibility of failure. Shows exactly how to go about it to get the kind of legal training that leads to **big success**. Worth its weight in gold to any man even remotely considering the study of law as a profession or as an aid to business. Mail coupon **at once** for your free copy.

## New Course — New Text — New Method

60 handy pocket size law volumes yours with this great new law course. The **ONLY** complete series of law text books **EVER PREPARED ESPECIALLY FOR CORRESPONDENCE INSTRUCTION**. Written for the American School of Correspondence by 56 of America's greatest legal authorities, including deans and professors in leading resident university law schools, judges of federal and state courts,

and prominent practicing attorneys. HARVARD, YALE, PENNSYLVANIA, CHICAGO, WISCONSIN, ILLINOIS, MICHIGAN, and other great universities have contributed to this wonderful aggregation of legal talent. No other correspondence school use these remarkable law texts. No other school can supply them. Far superior to studying from a "Law Library" or "Cyclopedia of Law" intended for reference purposes only.

## America's Newest and Best Correspondence Law Course

The last word in American Law and Practice. Everything right down to date. Every branch of the law thoroughly covered. Stripped of all useless technicalities. Written in plain, simple, easily understood language. All legal terms thoroughly explained and made perfectly clear. 100% efficiency in law instruction. Our simple method makes it easy for you to get **ALL** the knowledge contained in the complete course. Not half nor three-quarters, but **ALL**. Handy pocket size text books enable you to study under any and all conditions. You can have your lesson always in your pocket—with you at all times—and take advantage of every spare moment. Saves time and means quicker admission to the bar. Handsome 13 volume "Library of American Law and Practice" and 36 Case Books furnished every student. The most complete and practical correspondence law course ever devised.

## World's Greatest Correspondence School

For seventeen years the American School of Correspondence has stood at the head of all non-resident educational institutions. The only correspondence school in the United States chartered solely as an educational institution for the benefit of its students, not as a commercial enterprise for the benefit of stockholders. Enjoys the proud distinction of having graduated a higher percentage of its students than any other correspondence school in the world. Positively the best school for **YOU**.

### Mail the Coupon Today!

For Special Law Book, "How to Acquire a Legal Training". Send for it today. Get full particulars regarding this great course at once. Be sure of success. Fill in the coupon and mail it today. Better do it **RIGHT NOW!**

**American School**  
of Correspondence, Chicago, U.S.A.



## FREE BOOK COUPON

**American School of Correspondence**  
58th St. and Drexel Ave., Chicago, U. S. A.

Gentlemen:—Please send me your **FREE** Law Book, "How to Acquire a Legal Training", and full particulars regarding your wonderful new system of correspondence law instruction. *Pop. Mech. 5-15*

Name \_\_\_\_\_

Address \_\_\_\_\_

**We Assist Students Getting Actual Driving Experience**



**YOU CAN LEARN the AUTOMOBILE TRADE**

**WITH DYKE'S NEW IDEA WORKING MODEL METHOD**

**IF OTHERS CAN, YOU CAN**

Bert Tippey, De Soto, Ill., writes us that he knew nothing about autos when he started with us, but is now doing repair work, owns his own car, and owes his success to Dyke's Course. In a recent letter he states he began repair work before completing course and paid for course out of first job. He started in a small way, but is now doing general repair work. He grinds valves, cleans carbons, greases cars, times valves, sets magnetos, adjusts carburetors, etc., etc., and sells supplies. We started him. We first taught him the principle of all parts and then helped him get his start, just as we can do for you if you have any hustling ability.

If we prove to you that we have started hundreds of others into the repair business and as chauffeurs—who had no previous experience and who knew no more about an auto than you do right now—you must admit we can do the same for you. Write me today—now—and let me prove it.

A. M. Atkin, Repairing, Overhauling and Supplies, Lone Tree, Iowa, R. D. No. 1, in a recent letter says: "I have a lot of repairing to do; have been called upon several times to inspect second-hand cars. Harry J. Herbin, Jamestown, Kans., was a farmer, but has doubled his income repairing and selling autos. Mr. G. Strickland, Westport, Ont., Canada, writes us: "I am glad I took your course. Have just overhauled a car; timed the valves and set the magnetos. Owner says engine has more power. This is my first job. Thanks to your course." Donald Stewart, Oakland City, Ind., became a chauffeur at \$25 a week. H. M. Fewins and S. T. Slayback, both graduates, are now running a Garage and Repair Shop at Woodbine, Iowa.

And we could continue until we had filled this and several more pages.

CLEAR A CHILD CAN UNDERSTAND



Our book of testimonials, showing photos of students and their shops—free.

**All the Result of the Dyke System**

We can thoroughly train you during spare time. Open a repair shop or drive a car and make many times more than you are making now. Don't forget, we help you get your start with our Employment Plan, if you want it.

**DYKE'S NEW IDEA OF TEACHING BY MAIL WITH WORKING MODELS**

is something new. We use real working models—not just one, but five. On these models you get actual practice, see the actual operation and learn more than you could from the auto itself—it's easy and quick. You don't have to study hard with this system—we teach through the eye—a new idea. We are the originators of the system of teaching by mail with models. We also use charts—268 of them and a 16 page manual. Our 40 instructions and Repairman's Instructions are simplicity itself—simple as A B C.

**Our Employment Plan for Students**

This represents years of work to provide something that no other school had, namely, a way for our students to get started in the practical line of work.

Mr. Dyke has been identified as a pioneer inventor, supply man, etc., with the auto industry since its beginning. He originated the first auto supply co. and published the first book on autos in America. No other man with such experience is to-day teaching others. And all the experience and inside information of the auto business he has thus gained, is embodied in this Employment Plan.

**WRITE TO-DAY FOR THIS FREE BOOK**



It is instructive and interesting—does not cost you a cent and places you under no obligations whatever—You need it for your own sake, not mine. Don't wait—there's no profit in waiting—WRITE NOW and learn how you can obtain all this training for only \$15, if you act immediately.

**DYKE'S CORRESPONDENCE SCHOOL OF MOTORING**  
Box 189, Roe Bldg. ST. LOUIS, MO.

NOTE—Beware of Imitators—Deal with the Originator

**SPECIAL INSTRUCTION on Six and Eight Cylinder Engines**  
1915 Electric Starting and Generating Systems

EXPLANATIONS \$0. SYSTEMS. AND OTHER STARTING AND LIGHTING SYSTEMS.

**(Contents—Continued from page 6)**

Doors, Two Joining, Catch to Hold Open.....	795
Drawing Pictures, Machine for.....	796
Fishing Rod Making and Angling:	
Part III—Trout Fishing with Fly and Bait...	791
Flowers and Leaves, Reproducing in Colors.....	788
Kites, Combined, How to Make.....	781
Marble, Repairing.....	797
Motor, Disk Armature.....	797
Needle, Darning, Threading a.....	789
Photography—Developing Tray, Cooler for.....	788
Popcorn Cakes, How to Make.....	789
Shafting, Preserving from Rust and Corrosion...	790
Stool, Woven Top.....	790
Sunshade and Seat for Garden Workers, Movable.	784
Table, Parlor.....	787
Tennis Courts, To Keep Grass and Weeds Out of.	785
Wood, Working by the Application of Heat.....	786

**PATENTS**

Aeroplane, Multiple Wing.....	798
Awning, Telescoping.....	798
Bottle, Poison.....	798
Filing Cabinet.....	798
Fire Hydrant, Steam Jacketed.....	799
Fruit Picker.....	798
Handsaw, Blower Attachment for.....	799
Ice-cream Operated by Hand.....	799
Mail Box, Rural, Semaphore for.....	798
Pianists, Finger Trainer for.....	799
Scale, Postal, Combined Ruler and.....	799
Sewing Machines, Grinding Attachment for.....	798
Ship, Propeller for Turning.....	798
Shock Absorber.....	799
Steering Gear, Novel, for Motor Vehicle.....	798
Swings, Lawn, Fan Attachment for.....	799
Tree, Fruit Laden, Support for.....	798
Trees, Fruit, Apparatus for Protecting from Frost	799
Watch Fob, Calendar.....	798
Wheel with Flat Treads.....	798

**The Most Important Boys' Book in Years THE BOY ELECTRICIAN**



Practical Plans for Electrical Toys and Apparatus, with an Explanation of the Principles of Every-Day Electricity.

By ALFRED P. MORGAN  
With full-page illustrations, and 324 working drawings and diagrams by the Author. 8vo. Cloth.  
Price, Net, \$2.00 Postpaid, \$2.25

This is the most complete, the best illustrated, the most correct and the most entertaining work on the subject of electricity, its uses, and the economical making at home of practically all kinds of electrical appliances that has ever been produced. It also tells very clearly how electrical matters are handled on a large scale.

At all Booksellers. Send for Free Catalog.  
LOTHROP, LEE & SHEPARD CO., BOSTON



**Every Boy His Own Toymaker**

Greatest boys' book ever written. Tells how to make a Steam Engine, Telephone, Magic Lantern, Bells, kites, balloons, electrical and mechanical toys, traps, fishing tackle, 200 illustrations; also catalog of 150 puzzles, Keller's Magic Ace Trick Card and "DOUBLE THROAT" warbler and bird call all for only 10c. WESTERN PUZZLE CO., ST. PAUL, MINN.



**DOUBLE THROAT 10c New Invention.**

Fits roof of mouth. Greatest thing out. Astonish and mystify your friends. Make dogs or cats talk. Neigh like a horse, sing like a canary. Imitate any Bird or Beast of field or forest. Price 10c; 4 for 25c postpaid National Co., Dept. 31, 3422 Lyndale St., Chicago, Ill.

**RIDE a RANGER**

bicycle and know you have the best. Buy a machine you can prove before accepting. DELIVERED FREE ON APPROVAL and 30 days' trial. No expense to you if you do not wish to keep it. LOW FACTORY COST, great improvements and values never before equalled in our 1915 models. WRITE TODAY for our big catalog showing our complete line of 1915 bicycles, TIRES, sundries and parts, and learn the wonderful new offers and terms we will give you. Auto and Motorcycle Supplies at factory to user prices. Do not buy until you know what we can do for you. MEAD CYCLE CO. DEPT. D108 CHICAGO





# Have YOU These Luxuries?



## The Trained Mind Gets What It Wants

Analyze the biggest single factor responsible for any man's success in life and you will find that he has simply developed his brain to greater power than others in that lies the secret of his achievements. All people have brains—most people start in the race of life on even terms. Those who succeed in getting what they want, in the way of riches, power or happiness merely make greater use of their mind, developing it into wonderful success-building, money-getting power.

### Anyone Can Build a Bigger Brain

Scientists have discovered that the average man fails to make use of nine-tenths of his brain. This means that there lies within the average man the possibility of increasing his brain power to many times its present efficiency.

Anyone can train his brain to be many times as rich in ideas, in creative plans, in new methods, in its ability to think quickly and correctly—in its money-making power, if he will set about it. All that is needed is intelligent exercise—intelligent training.

### Let Professor Haddock Teach You

Frank Channing Haddock, Ph.D., the great scientist, has—after 20 years of research and study—developed a remarkable system of brain training in twenty-eight easy-to-master and intensely interesting lessons. This great work, while really a complete course, is bound in book form under the title "Power of Will." It is not a work of idle essays—it shows the how and why of each step in mental development, and provides easy brain-building exercises which anyone can follow.

### Over 50,000 Students

Over fifty thousand men and women of all ages have been helped by "Power of Will." Many of the most enthusiastic students are big successful men, like Judge Ben B. Lindsey; Supreme Court Justice Parker; Wu Ting Fang, Ex-U. S. Chinese Ambassador; Lieut.-Gov. McKelvie of Nebraska; Assistant Postmaster-General Britt; General Manager Christenson of Wells-Fargo Express Co.; E. St. Elmo Lewis, now Vice-Pres. Art Metal Construction Co., and many others of equal prominence.

### A Battle of Brains

Modern life is a battle of brains. The man with the keenest, most highly trained mind wins in anything he undertakes—and the man who has done nothing to train his brain for the battle, hasn't a chance in the world.

There are thousands of technical books and academic courses in specialized subjects. "Power of Will" is a course in fundamentals—it teaches the secret of how to develop your brain so that you can make the most out of yourself—it shows how to master situations—how to dominate others—how to think "straight"—how to overcome insignificant daily obstacles—how to use that wonderful power which lies in the brain of every man to conquer everything before him and acquire the many comforts and luxuries which are the material evidence of success. The students of "Power of Will" look upon it as a Bible—they feel that it has been the big stepping stone to their success. What it has done for them, it will do for you.

### Send No Money—Examine Book First

We are so sure that you will realize the wonderful brain-building success-achieving power of this great work that we don't ask you to send a single penny in advance. Merely fill out and mail the coupon—without money—enclosing a business card or giving a reference, and your copy of "Power of Will" will reach you by return post—prepaid. Examine it in your own home—then if you don't feel that this big 400-page book will prove the soundest investment you ever made, return it in five days—otherwise send your check for \$3.00. There is no red tape to go through—merely mail the coupon NOW.

**PELTON PUBLISHING CO.**  
55 Pelton Bldg. Meriden, Conn.

### What Readers Say

"I hand you \$3 in payment; from what I have already seen I believe I can get \$300 to \$30,000 worth of good out of it."—C. D. Van Vechten, General Agent, No. West. Life Ins. Co., Cedar Rapids, Ia.

"'Will Power' is a compilation of mighty force. My first week's benefit in dollars is \$900—cost \$3; profit \$897."—J. W. Heistand, 945 Tribune Bldg., Chicago, Ill.

"In my judgment, 'Power of Will' is wonderful."—Owen J. McCaughy, Secy. of Corp. Securities Co., St. Louis, Mo.

"Enclosed find check; send 15 copies to our New York office."—W. M. Taylor, Efficiency Expert, the Overland Auto Co., Toledo.

"The character of 'Power of Will' is such that he who reads and puts forth effort will soon find himself out of the common herd."—F. A. Good, President of Neb. Lumber Dealers' Assn., Cowles, Neb.

"I have carefully gone over 'Power of Will' and find it admirable. I anticipate both pleasure and profit from its practice."—Charles Olin, Editorial Rooms, Boston Evening Transcript, Boston, Mass.

"Here's \$3 for you, 'Power of Will' received. It is the book I've wished for, for years."—J. L. Seawell, Clerk of Supreme Court, State of N. Carolina, Raleigh, N. C.

*It's a fine record of testimonials like these on file.*



**Pelton Pub. Co.**  
55 Pelton Bldg.  
Meriden, Conn.

Gentlemen: Please send me a copy of "Power of Will" on approval. I agree to remit \$3.00 or return the book in 5 days.

Name.....  
Address.....

### Partial Contents

- The Law of Great Thinking.
- The Four Factors on which it depends.
- How to develop analytical power.
- How to think "all around" any subject.
- How to throw the mind into deliberate, controlled, productive thinking.
- Detailed directions for Perfect Mind Concentration.
- How to acquire the power of consecutive Thinking, Reasoning, Analysis.
- How to acquire the skill of Creative Writing.
- How to guard against errors in Thought.
- How to drive from the mind all unwelcome thoughts.
- How to follow any line of thought with keen, concentrated Power.
- How to develop Reasoning Power.
- How to handle the mind in Creative Thinking.
- The secret of Building Mind Power
- How the Will is made to act.
- How to test your Will.
- How a Strong Will is Master of Body.
- What creates Human Power.
- The Six Principles of Will Training
- Definite Methods for developing Will.
- THE NINETY-NINE METHODS for using Will-Power in the Conduct of Life.
- Seven Principles of drill in Mental, Physical, Personal Power.
- FIFTY-ONE MAXIMS for Applied Power of Perception, Memory, Imagination, Self-Analysis, Control.
- How to develop a strong, keen gaze
- How to concentrate the eye upon what is before you—object, person, printed page, work.
- How to become aware of Nerve Action.
- How to keep the body well-poised.
- How to open the Mind and Body for reception of incoming power.
- How to throw off Worry.
- How to overcome the tyranny of the Nervous system.
- How to secure steady nerves.
- How to maintain the Central Factors of Body health.
- Difficulties in Mastering Harmful Habits.

*This is only a partial list—a complete list of contents would almost fill this page.*

# MAKE MONEY THIS WAY



I want to prove entirely at my expense that I can take you out of your small, low wage job and into a profession that always offers you a bigger salary, \$2400 and more yearly, steady employment and an independent future of prosperity. I want to show you how I have helped all kinds of men out of the lowest-paid jobs and into success through training them by my personal method to become Expert Draftsmen.

## Become a DRAFTSMAN \$2,400.00 a Year

If you realized the almost unlimited opportunities of big income and success open every day for competent Draftsmen—if you realized the independence, the influence and the prosperous future afforded in this wonderful profession—I am sure you would lose no time in becoming a Draftsman. Draftsmanship is the profession that means steady employment and prosperity regardless of unsettled conditions. Right now the need for competent Draftsmen is tremendous. Buildings, machines and structural work of all kinds are always planned and Draftsmen are needed everywhere at handsome salaries. Let me prove absolutely that right now is the time for you to begin preparing yourself for the vast opportunities in Draftsmanship.

**I Teach You** No matter who you are or what you work at now, let me prove quick how easy I can train you in your own home in your spare time—how plain and practical my personal instructions are—how I teach you personally everything a successful Draftsman must know. I give you the training the big employers of Draftsmen in this country demand. When you follow my personal instructions you learn under a Draftsman who is successful. You need no previous experience—I train you from the ground up in the shortest time. Keep your present position and earn while you learn.

**YOU ARE NEEDED** Big positions paying \$2400 and more yearly are open right now. These grand opportunities are open to you if you begin at once. Let me prove how competent Draftsmen can advance to big, powerful positions as Chief Draftsman, Chief Engineer or Superintendent at big salaries or open an office and make big money.

**FREE \$1750 DRAFTSMAN'S OUTFIT** Write me now and I will give you absolutely free a magnificent set of Draftsman's Drawing Instruments, valued at \$17.50—same as I use. Every Draftsman needs these—they last a lifetime.

**SMALLEST, EASIEST PAYMENTS**

### SPECIAL TUITION OFFER

To a few more students I offer my personal instruction at such small, easy payments that no matter how small your present salary, you can now become an Expert Draftsman and as an independent for you to enroll at once I make an extra special offer of a free \$25.00 TUITION CREDIT. I am the only Expert Draftsman giving his personal instructions on such small payments. Mail free coupon now for my great proof and fascinating free book. This is your opportunity. Send coupon today—investigate.

**Chief Engineer Cooke**  
Chicago Engineering Works 453 Cass St., Chicago, Ill.



**CHIEF ENGINEER COOKE, 453 Cass St., Chicago**

Without obligation or cost to me send prepaid your free book, "The Road to Success," and particulars of your limited offer.

Name.....  
Address.....

Please Mention Popular Mechanics



## Learn a Paying Profession

that assures you a good income and position for life. For twenty years we have successfully taught

## PHOTOGRAPHY

Photo-Engraving and Three-Color Work

Our graduates earn \$20 to \$50 a week. We assist them to secure these positions. Learn how you can become successful. Terms easy—living inexpensive. Write for catalogue—NOW!  
ILLINOIS COLLEGE OF PHOTOGRAPHY, 999 Wabash Avenue, Effingham, Ill.

## ELECTRICITY

CONDENSED COURSE IN ELECTRICAL ENGINEERING

### Complete in One Year

### Bliss Electrical School

Studies restricted to theoretical and practical electricity, mechanical drawing and necessary engineering work. Teaches simplicity, concentration, hard work. For young men of energy and character. 22 years of greatest success. Graduates hold first-class positions. **Opens Sept. 22nd.** Write for new catalog.

104 Takoma Av., WASHINGTON, D. C.

## The University of Chicago

### HOME STUDY

in addition to resident work, offers also instruction by correspondence.

For detailed information address

23rd Year U. of C. (Div. 20) Chicago, Ill.



## LEARN TELEGRAPH

Morse and Wireless—R. R. Accounting (Station Agency) taught. Splendid opportunities. Positions secured. Marconi Co. takes our wireless graduates. We own and exclusively occupy two large modern buildings equipped with R. R. and Western Union wires and complete \$5,000 Marconi Wireless Station. Largest School—established 40 years. Investment \$25,000. Endorsed by Railroad, Marine and Western Union Officials. Expert practical teachers. Low living expenses; easily earned if desired. Tuition low. Easy payments. Correspondence courses also. Catalogs Free.

Dodge's Telegraph, Ry. & Wireless Institute  
8th Street, Valparaiso, Ind.

## HOME STUDY

Let business experts train you by mail during spare time. Quickest, cheapest, best way. Private Sec'y, Stenog. and Bookkeeper. Advertising Writer-Mgr., Business-Sales Correspondent, Office Manager, Bookkeeper, Accountant, Banking, Civil Service. Name position for which you wish to qualify. We will send free booklet. Very low cost; easy terms now.

CHICAGO UNIVERSITY OF COMMERCE, Dept. 1035, Chicago, Ill.

## DRAWING

Caricature, Cartoon, Comic, Commercial, Fashion, Newspaper and Magazine Illustrating taught by mail. Illustrated book 6c in stamps. **THE BOSTON SCHOOL OF DRAWING, 755M Boylston St. BOSTON, MASS.**



## DON'T TRY TO BE A CHAUFFEUR

GET THIS BOOK FIRST.  
or go to ANY SCHOOL to learn, or part with your hard earned dollars until you have read our valuable guide FIRST. It tells what you should PAY and what you should GET. Do not be deceived by schools which claim everything and give you nothing. **YOU CAN'T AFFORD TO SPEND ONE CENT TILL YOU GET OUR GUIDE.** It costs nothing and may save you many dollars. Write now for this FREE BOOK.  
**PRACTICAL AUTO SCHOOL, 68 Beaver St., New York**

# SENT FREE



# LAW

## COURSE SENT FREE ON APPROVAL

Not one penny down. Get this greatest home-study course in law—consisting of a magnificent fourteen-volume law library, the most complete library of its kind in existence, and the first individual lessons; clear, comprehensive discussions of the law—in your hands positively free of charge, without any obligation whatever. We want you to see this course, examine it critically, put it to every test, compare it with other courses, before you even decide. Mail the coupon now—right now—to get the details of this startling offer—to find how you can, without risking a penny, get started right on your legal education.

### Get Your Degree by Mail

No other school even dares to make an offer of this nature. They don't dare send out their courses in open competition with the LaSalle Extension University Course in Law.

We are authorized by the State of Illinois to confer on our graduates the degree of Bachelor of Laws (LL. B.). Our course prepares you to pass the bar examinations in any state. Should you fail to pass we guarantee to coach you without charge until you are successful.

In a recent Bar Examination at Lansing, Michigan, only six out of fourteen applicants for admission were successful and two of those who passed were LaSalle Students. Not one of the LaSalle students who entered the examination failed. Among the eight rejected, four were graduates of leading resident University Law Schools. These are some of the reasons why it pays us to send out our course on approval, without obligation. Satisfy yourself absolutely that this is the very best home-study law course offered by any school in the country before obligating yourself, before spending a penny.

**\$100.00 Tuition Credit Free** For a short time only, in connection with our free on approval offer, we are giving students the opportunity of saving one hundred dollars. Write at once for full particulars of this unusual opportunity.

### Mail Coupon—Offer Limited

Send no money. Just your name and address on the coupon below, and we will forward by return mail full particulars of our remarkable free on approval offer and our wonderful free book "Guide to the Law" showing how to study law at home. This is the first time in history that a University Home-Study Law Course has been offered on approval; our course is the only one that will stand this acid test. Moreover, if you act promptly we will save you more than half your tuition. We are doing it for advertising purposes only and the offer is subject to withdrawal in a short time, without notice. So act now. Get all the facts in your hands—NOW. Simply sign and mail the coupon.

**LaSALLE EXTENSION UNIVERSITY, Dept. D588, Chicago, Ill.**

### Coupon Brings Details—Tear Off and Mail

**LaSALLE EXTENSION UNIVERSITY, Dept. D588, Chicago, Ill.**

Please send me full particulars of your free on approval, without obligation offer, showing also how I can secure \$100.00 Tuition Credit free, and a copy of your free book "Guide to the Law".

Name \_\_\_\_\_

Address \_\_\_\_\_

# Stop Forgetting!



**Make  
Your  
Mind  
a File  
—not  
a Pile**



**T**HE average person's mind resembles a scrap-pile more than anything—heaped high with a vast miscellany of unrelated, unclassified, unindexed facts. To summon *on the instant* from this disordered pile a needed name, date, fact or circumstance is as uncertain a process as seeking in a big library for an unindexed book. A world of information in the storehouse of your mind is as valueless as undiscovered gold—if this accumulated wealth of thought is not systematically on tap.

**I will make your mind as well-ordered  
as a cross-indexed, classified file**



**Prof.  
Henry  
Dickson**

America's foremost authority on Memory Training, Public Speaking, Self Expression, and Principal of the Dickson Memory School, Auditorium Building, Chicago.

I will make you master of your mind's infinite ramifications instead of a victim of its disordered details. My systematic course of memory training accomplishes this for you. You can grasp its essentials by ten minutes of pleasurable, interesting, concentrated daily study for just a few weeks. As you progress you will surprise yourself continually by the facility of thought and speech which you acquire. The added degree of confidence—

and all loss of self-consciousness—with which you address your colleagues in the business and social world will also be a source of much gratification to you. You will find yourself able to speak on your feet when suddenly called on by your fellowmen at meetings or assemblages of any sort—whereas you probably gurgled foolishly—turned pink—then white—and sat down—before.

## The Key to Success

A good memory is as necessary to success as trained muscles are to the athlete. They are acquired in the same way: That is—through systematic exercise. A good memory means more than mental systematization. It means logical, forceful thinking that is the result of the well-ordered mind. It means positive control of self—and ability to influence others through the medium of mental domination.

Now I have told you of some things that will make or mar your success—and all of these factors are things *within your own control*. A little determination on your part, a little effort, a little scientifically directed training, and you rise way above the mediocre to a position of success and satisfaction.

Don't condemn my method until I can explain it. There is more in it than you think. Thousands have pronounced my training the turning point in their success. Write me personally if you want the details—or if more convenient—signing and mailing the coupon will do. After you get my plan is time to decide it is not meant for you—not before. Will you write me—now?

### This Valuable Book —“How to Remember”—FREE

Simply clip the coupon and mail it—or drop me a letter or postal now—just as it is most convenient for you. You will receive my booklet by return mail. Read this booklet carefully—then let me have your application by an early mail. If I receive it within ten days of the date of this offer I will mail you a de Luxe Edition copy of my handsomely-illustrated, richly-bound volume—free of charge.

**Send the Coupon or  
Postal Today**



**Prof. Henry Dickson, Principal Dickson School of Memory, 705 Auditorium Bldg., Chicago, Ill.**

Send me free Booklet, “How to Remember,” also free trial copyrighted memory test, also full particulars how to obtain a free copy of Dickson’s “How to Speak in Public.”

NAME \_\_\_\_\_

STREET \_\_\_\_\_

CITY \_\_\_\_\_

STATE \_\_\_\_\_

**"That's Just What I Need"**

# COMPLETE COURSE IN ELECTRICITY FREE FOR EXAMINATION

## The Guides Speak for Themselves

### "Alive"

"They are just the books I have been in quest of for some time. I had them right up to date and all dead matter eliminated."

F. A. Welkel, Ft. Caswell, N. C.

### "Practical"

"No one needing practical knowledge on electricity should be without them. I found in them just what I wanted to know."

C. H. Beasecker, Sparta, Mich.

### Worth Their Weight in Gold

"The books arrived in the very best condition. I am surprised at them. They are worth their weight in gold."

I. Peterman, Bessemer, Ala.

### "Ideal for a Beginner"

"Am highly delighted with your books. Everything is so compact and concise, they are the ideal thing for a beginner. Books like that are worth double."

C. A. Haristigh, Montreal, Can.

### "No Better Books"

"I can say for them that they are the best and neatest set of books that I ever saw. No man could ask for a better set of reference works."

W. H. Jennings, Columbus Junction, Iowa.

### "Most Instructive"

"Hawkins' Electrical Guides received. I have inspected them closely and find them the most instructive of any book of their kind."

H. G. Gray, Dundee, Mich.

### "A Good Investment"

"The Hawkins' Electrical Guides remind me a hundredfold."

H. B. Howe, Tipton, Ind.

### "Study Helps"

"In every way they are first class, and of great value to me in my studies, and more than worth the price you charge."

R. G. Wetson,

### "Are A-No. 1"

"My friends all think the books to be A-No. 1. I would not sell mine."

John Vollmers, Milwaukee, Wis.

### "All You Claim"

"The books are all you claim for them; they are better than any I have ever seen. Have had 20 years' experience in the Electrical line."

H. E. Howey, Granite City, Ill.

### "With Time"

"The longer I study the books, the more I think of them."

F. W. Worsley, Farmington, Utah

### "A Long Felt Want"

"From the experimenter's standpoint up to the electrical genius, these books certainly fill a long felt want. My appreciation is extended for so beautiful a volume at such a low price."

W. H. Corbett, Cuyahoga Falls, O.

### "Seen or Heard"

"They are the best of their line that I have ever seen or heard of. I know they will be a great help to me in the future."

C. R. Davidson, Lexington, Ky.

### "Square Deal"

"I for one most highly recommend them to any person wishing to receive knowledge at a very reduced rate."

E. A. Vaupel, Pittsburg, Pa.

HERE is a set of books that no man in the ELECTRICAL FIELD should do without. This is the ELECTRICAL AGE in which we live; ELECTRICITY now controls more trades, directs more men, offers more opportunities than any other power that man has yet discovered. Do you wish to know the underlying principles of MODERN ELECTRICAL PRACTICE?

If so, HAWKINS ELECTRICAL GUIDES will give you the information. In reality they are a school within themselves, containing a complete study course with QUESTIONS, ANSWERS AND ILLUSTRATIONS, written in plain everyday language so that a practical man can understand the "HOW, WHEN AND WHY" OF ELECTRICITY.

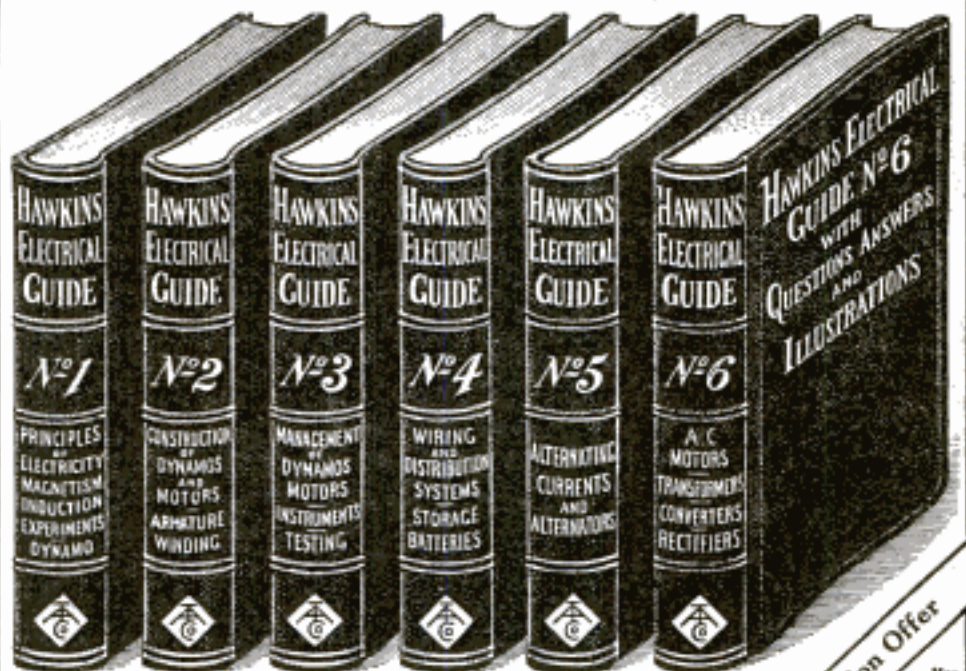

## Makes Electricity Easy to Understand

Read over the titles shown on the back of each volume, and note the scope of each book. They are handsomely bound in flexible black leather with gold edges and will readily go in the pocket. THEY ARE NOT ONLY THE BEST, BUT THE CHEAPEST WORKS PUBLISHED ON ELECTRICITY.

**Each book is complete in itself and will be supplied \$1.00 per copy, but we believe that the complete set is the best bargain.**

The books can speak for themselves and a careful examination, page by page, and illustration by illustration, will convince you of their big value.

If you will fill out the coupon giving all the information requested, we will submit the six volumes for examination on conditions named.

May 15  
Pop. Mech.

Please submit me for examination HAWKINS ELECTRICAL GUIDES (Price \$1 each). Ship at once prepaid the 6 numbers; if satisfactory I agree to send you \$1 within seven days and to further mail you \$1 each month until paid.

THEO. AUDEL CO., 72 5th Ave., New York—Free Examination Offer

SIGNATURE .....

OCCUPATION .....

BUSINESS ADDRESS .....

RESIDENCE .....

REFERENCE .....

**Come to Detroit**  
the automobile center  
and

# LEARN THE AUTOMOBILE BUSINESS

**Big Opportunities Everywhere for Detroit Trained Automobile Men**

Interesting, pleasant, and money making business. Ambitious men needed to start garage and repair shops in down town and residence districts everywhere.

Learn now, be ready for the spring automobile boom—when opportunities are greatest. Chauffeurs, garage and repair men, testers, etc., have more than they can do. Plenty of room for you.

## Earn \$75.00 to \$300.00 Per Month

Get into biggest and best business of the 20th century. The business of big profit and sure progress. We teach you to handle any auto—our equipment is complete. Students actually have experience of building new cars from start to finish—regular factory training in block testing, road testing, etc.—all leading types of starting, lighting and ignition systems in operation. You learn how to read motors, adjust carburetors, valves, bearings, etc. New 6 cyl. Lozier Touring Car used for road instruction. Just purchased—New 8 cyl. King Chassis. Latest thing out. Used solely for students' instruction. Part of our regular equipment.

### 10,000 Square Feet of Floor Space Just Added

The popularity of our school has demanded extensive additions to our equipment. Dormitory space for nearly 75 students on the premises. Large, new, roomy, light, airy lecture and instruction room, study room in connection. Brand new waiting room. Ambitious, cheerful companions.

**Detroit is the Place to Learn** 44 Automobile Factories here. Students can go through any or all of them, including Detroit Electric Service Department. Impossible to get these advantages elsewhere.

**Detroit is the Automobile Center** You make faster progress here, and get practical instruction. Come to Detroit and learn the business right. Our students are successful. W. C. Garden, Tennessee, is Chauffeur, \$25.00 per week and expenses. E. Livingston is head of The Government Garage at Toronto. Owners of offices are holding good positions or running businesses of their own. Remember, ours is the Old Reliable School, in the heart of the Automobile Industry. Anyone can learn by our method. Practical from the ground up. Write us for full particulars. Ask for Copy of "Auto School News." It's free. Or better, jump on the train and come to Detroit. Take Woodward Ave. Car from the Depot and get off at Selden Ave., and our building is right there. **Learn the automobile business in Detroit and learn it right.**

Michigan State Auto School, Department P5, 11-17 Selden Ave., Detroit, Michigan

**Our Guarantee**

We guarantee to qualify you for a position as chauffeur, repair man, tester, salesman or demonstrator in a short time, or we will refund your money.

**And don't forget, we furnish positions, too**

On account of being in the auto center, we can furnish positions that cannot be obtained elsewhere

**UNCLE SAM WANTS YOU**



## Government Examinations for Many Positions Everywhere During the Spring and Summer

Rapid advancement to higher Government Positions. No "Layoffs" because of STRIKES, WARS, FINANCIAL FLURRIES or THE WHIMS OF SOME PETTY BOSS. THE POSITION IS YOURS FOR LIFE. Country residents and city residents stand the same chance for immediate appointment. Common sense education sufficient. Political influence NOT REQUIRED.

### We Will Give 25 Free Scholarships

Write immediately for schedule showing the places of the Spring and Summer examinations. Don't delay. Every day you lose means the loss of just so much coaching before the rapidly approaching examinations.

### FREE COACHING COUPON

FRANKLIN INSTITUTE, Dept. W104, Rochester, N. Y.

The coupon, properly filled out, entitles the holder to free sample questions, full list of positions now obtainable, a free copy of our valuable copyrighted book, "GOVERNMENT POSITIONS AND HOW TO OBTAIN THEM," and to consideration for FREE COACHING for the Civil Service Examination here checked.

... Railway Mail Clerk (\$900 to \$1300)	... Customs Positions (\$900 to \$1500)
... Postoffice Clerk (\$900 to \$1200)	... Internal Revenue (\$700 to \$1300)
... Postoffice Carrier (\$900 to \$1200)	... Stenographer (\$800 to \$1500)
... Rural Mail Carrier (\$600 to \$1300)	... Panama Canal C's (\$1250 to \$1800)

Name.....

Address.....

Use this before you lose it. Write plainly.

Please Mention Popular Mechanics

## Practical Electrical Education

Our practical course in Electrical Science and Engineering trains you to get and keep the big-pay jobs. Enter at any time, no matter what your education. Advance as fast as you can master the work. Course combines theory with actual practice in all branches of Electrical Science, Individual instruction. Only practical training school of its kind in U. S. Endorsed by leading electrical employers past 10 years. Our trained students always in demand and well paid. WRITE FOR FREE ILLUSTRATED CATALOG. Spring Term Now Open—Enter at Any Time.

School of Engineering of Milwaukee, 194 5th St., Milwaukee, Wis.



## BE A SIGNAL ENGINEER \$125-\$300 A MONTH

Write at once. Most wonderful opportunity for the ambitious man. Railroads need hundreds of Signal Engineers—will pay Big Money. We will teach you right at home to be expert. Special offer if you write at once. Two big outfits free. Do practical work while learning. Catalog and full particulars.

DEPARTMENT OF SIGNALING  
Room 1125 1810 Wilson Ave. Ravenswood Station Chicago, Ill.

## IF YOU STAMMER

attend no stammering school till you get my large FREE book and special rate. Largest and best school in the world curing by natural method. Write today. Lee Wells Millard, Pres., North-Western School, Inc. 2317 Grand Avenue Milwaukee, Wis.

## BE A DETECTIVE

Earn from \$150.00 to \$300.00 per month; travel over the world. Write C. T. LUDWIG, 133 Westover Bldg., Kansas City, Mo.

LEARNED BY ALMOST ANYONE AT HOME SMALL COST

**VENTRILOQUISM**

Send today 2c stamp for particulars and proof. O. A. SMITH, Room D 124, 823 Bigelow St., PEORIA, ILL.

# GETTING THE MONEY

## REPAIRING TIRES

The biggest money making field in the Automobile Industry today is in repairing tires. It is an enormous field and growing larger every year. Locations for good tire repair shops are open in every city and town in the country. You can make

**\$1500 TO \$5000 A YEAR**

if you learn by our system of instruction. We teach you every phase of **TIRE REPAIRING and TIRE CONSTRUCTION** by practical demonstration, in a school equipped with every necessary appliance. This is not a correspondence course. You get your training by actually using equipment and repair material. That's the only way.

### WE TEACH YOU BUSINESS METHODS

Instruct you how to open your shop. How to take care of sales. How to retain your trade. How to make your shop pay.

### WHAT OUR STUDENTS SAY

**O. E. Bonnell** writes, "I did a \$15,000 business last season." **A. A. Robinson**, "Have been in business 30 days. More than doubling expenses. Did not know money could be made so easily." **C. E. Kurtz** says, "We are crowded with work." **G. M. Marsh**, "Business coming too strong, and I have not advertised a bit." Hundreds of others tell of similar successes.

### SEND FOR OUR FREE BOOKLET 'A'

It tells all about our school, about our methods of teaching, what our students have accomplished. Be first to enter into this big paying business in your town.

**CLOUSE TIRE REPAIR SCHOOL**  
EUCLID AVENUE AND 90th ST., CLEVELAND, OHIO

## LEARN WATCH REPAIRING

Be a watchmaker—you can learn this profitable trade by correspondence in a few weeks in your own home by the DeSelms Chart System. After you complete the course you will know a watch from A to Z. You will know just what the matter is and how to repair one. When you graduate you will be a practical watchmaker and repairer and competent to fill any position. Positions for our graduates.

Ask for our Free Book. It explains our system and terms.

**THE DeSELMS WATCH SCHOOL**  
23 Perry Street ATTICA, INDIANA



## Learn to PAINT SIGNS and SHOW CARDS

I'll teach you personally by mail. 15 years' successful teaching. Big field for men and women. You can

**Earn \$18.00 to \$45.00 a Week**

Write for particulars today. Brown (Ill.) says, "Wish I had taken instruction years ago."

**DETROIT SCHOOL OF LETTERING**  
Chas. J. Strong, Founder Dept. 205, Detroit, Mich.



## BE A BANKER

Splendid opportunities. Pleasant work, short hours, all holidays off, yearly vacation with pay, good salary. Learn at home. Diploma in six months. Catalog free. **EDGAR G. ALCORN, Pres.**  
**AMERICAN SCHOOL OF BANKING, 119 McLENE Bldg., COLUMBUS, OHIO**

## LEARN JEWELERS' ENGRAVING

A high selected and easily learned trade, taught thoroughly by mail. We will teach the beginner better engraving than he can gain in years of rigid apprenticeship. We will also improve the skill of any engraver. Send for our catalog. **The Engraving School, 112 Page Bldg., Michigan Ave., Chicago, Ill.**

## ARE YOU THINKING?

Mechanical Draftsmen earn Big Wages for short hours. We are creating thousands of openings. Complete course at home 4 MONTHS. Terms low. Instruction simple. Drawing Outfit Free. We are specialists! Teach one subject and teach it right.

Ask for book at "P"—It's free.

**MODERN CORRESPONDENCE SCHOOL, Newark, N. J.**



## "The Power of Law Training"

SEND the coupon now for our new 171-page free book "The Power of Law Training."

It carries a vital and inspiring message

to every ambitious man—to the man who is already successful—to the young man just starting out in life—to the man who has already made his start but has not yet hit his stride—to all men who realize the need of more power.

"The Power of Law Training" will give you a remarkable insight into the vital relation of law to business. Write for your copy today—now. It's FREE.



## If You Know Law—

The power of the man with law training is apparent all about you. Look to the men of your own acquaintance who have achieved the most—look to the men who stand high in the affairs of the nation. Almost without exception you will find them Law trained. The man with the Law training is the man of power—the leader.

## Learn from Masters of the Law!

Through the Course and Service of the American Correspondence School of Law—the oldest and largest institution of its kind in the world, you read law right in your own home—directed by men who stand preeminent in the profession. You may become law trained or prepare for the practice of law. More than 40,000 men have utilized this Course and Service to their advantage and recommend it highly.

With this Course and Service is included a complete and comprehensive cyclopedia of the law without extra charge. Special reduced price offer now being made in many localities.

## Send the Coupon!



Put your name and address in the coupon or on a letter or post card now and get the big 171-page free book, "The Power of Law Training." It's free. No obligations of any kind. Write today.

**American Correspondence School of Law**  
1195 Manhattan Building Chicago

**American Correspondence School of Law**  
1195 Manhattan Bldg., Chicago

Gentlemen:—Please send me free and prepaid your 171-page book, "The Power of Law Training" and particulars of your special reduced price offer.

Name.....

Address.....

Please Mention Popular Mechanics

# Become a TRAFFIC EXPERT

## Learn at Home



### UNLIMITED POSSIBILITIES BIG PAY

Thousands of large shippers and all Railroads need trained Traffic Experts and Managers—newly created positions are open with salaries of \$35 to \$200 weekly. The demand for trained men is greater than the supply. Recently enacted railroad rate laws and interstate commerce regulations have produced new conditions that necessitate trained specialists—men who know how to route shipments, to obtain shortest mileage, quickest deliveries—lowest rates. With such knowledge you can qualify for an important, big-salaried position with a future—quick.

### WE TRAIN YOU BY MAIL

at home, in spare time, without giving up your position or income. The cost is small—we make the payments to suit you. All you need, to get into this powerful, big paying occupation is our training. No matter where you live, what you work at now, how small your pay, how long your hours—no matter what your age or education—if you can read and write intelligently—our Interstate Commerce Course will train you expertly to handle proficiently a big Traffic job—to merit and retain influence, respect, power and puts you in way to earn \$35.00 to \$200.00 weekly.

### MOST THOROUGH METHOD KNOWN

The LaSalle method is simple, practical, logical—anybody can readily master it. It is the work of some of the greatest Traffic Experts in America. It covers thoroughly every feature of the profession you will ever need to know—it is different and more complete than any other method of home-training in Interstate Commerce ever known. This is the largest home-study Extension University in the world—our graduates are recognized as real experts—they are trained to do the kind of work that commands big positions.

### NEW, UNCROWDED OCCUPATION

This is a new, uncrowded occupation—there's room for you if you prepare at once. Let us train you now for a big future, with power, dignity, respect and a big income, with almost unlimited opportunities. Don't remain in a small job that thousands of men are constantly after—let us make you the master—the big man—a successful leader among men.

### FREE—Wonderful Book

Send the coupon below now and receive free copy of our much-talked-of book "10 Years Promotion in One"—learn more about the opportunities afforded Traffic Experts with our training—learn about the big opportunities now open—learn how easy it is for us to make you a traffic specialist. Remember only trained men can secure the big positions now open—remember that big employers are seeking trained and competent office men. Send the coupon—no money.

La Salle Extension University, Chicago

La Salle Extension University, Dept. C589 Chicago, Ill.

Send at once, without expense to me, FREE copy of your famous book "10 Years Promotion in One"; also book telling how I may, without interfering with my present position, prepare myself as Traffic Expert.

Name .....

Address .....

Occupation .....

Please Mention Popular Mechanics

# SHORTHAND IN 30 DAYS

We absolutely guarantee to teach shorthand complete in only thirty days. You can learn in spare time in your own home, no matter where you live. No need to spend months as with old systems. Boyd's Syllable System is easy to learn—easy to write—easy to read. Simple. Practical. Speedy. Sure. No ruled lines—no positions—no shading as in other systems. No long lists of word signs to confuse. Only nine characters to learn and you have the entire English language at your absolute command. The best system for stenographers, private secretaries, newspaper reporters and railroad men. Lawyers, ministers, teachers, physicians, literary folk and business men and women may now learn shorthand for their own use. Does not take continual daily practice as with other systems. Our graduates hold high grade positions everywhere. Send today for booklets, testimonials, etc.

Chicago Correspondence Schools  
969 Unity Bldg., CHICAGO, ILL.

## GOVERNMENT POSITIONS

offer employment for life at a salary ranging from \$800 to \$1800 per year, with short hours under pleasant conditions and no fear of "lay-offs" or strikes. American citizens 18 or over are eligible. Our 64-page booklet contains list of positions, requirements, etc., and tells how you can prepare for "Exams" under the personal supervision of a former U. S. Civil Service Secretary-Examiner. Booklet is FREE, without obligation. Write today.

PATTERSON CIVIL SERVICE SCHOOL  
105 Irving Place ROCHESTER, N. Y.



# HOME STUDY

Let business experts train you by mail during spare time. Quickest, cheapest, best way. Private Sec'y, Stenog. and Bookkeeper, Advertising Writer-Mgr., Business-Sales Correspondent, Office Manager, Bookkeeper, Accountant, Banking, Civil Service. Name position for which you wish to qualify. We will send free booklet. Very low cost; easy terms now. CHICAGO UNIVERSITY OF COMMERCE, Dept. 2035, CHICAGO, ILL.

## LANGUAGES

Quickly Learned AT HOME by the Original Photographic Method

German—French—English—Italian—Spanish or any other language learned quickly and easily by the Cortina Method at home, with Disk Cortina-Records. Write for free booklet today; easy payment plan.

CORTINA ACADEMY of LANGUAGES  
1287 Mecca Bldg., 1090 Broadway,  
Corner 48th Street, New York

CORTINA-PHONE

## EARN \$2400 a YEAR

AS A SHOW CARD WRITER



We will furnish a thorough course absolutely Free to introduce Alpha Colors, if you purchase an assortment of colors to use while practicing. Mynatt (Knoxville) says—"Colors alone, or course alone, worth amount asked for them." Particulars for stamp.

ALPHA COLOR COMPANY, Inc., Dept. E, 1960 B'way, N. Y.

## JEWELRY ENGRAVING

We teach you, by our new and original method of instruction, this clean, fascinating and profitable business right at your home, and furnish you all tools needed absolutely free. Write for free book to the

WISCONSIN SCHOOL OF ENGRAVING, 5th Bldg., MILWAUKEE, WIS.

## MUSIC TAUGHT FREE AT YOUR HOME

Write Today for our booklet. It tells how to learn to play Piano, Organ, Violin, Mandolin, etc. Beginners or advanced pupils.

AMERICAN SCHOOL OF MUSIC, 50 Lakeside Bldg., Chicago, Ill.

## ARITHMETIC SELF-TAUGHT

A plain, easily-understood volume for all who have not had the opportunity of learning this subject thoroughly, or who have forgotten what they once learned. 257 Pages. Requires no teacher. This great little book sent postpaid for 60 CENTS. Stamps accepted.

GEO. A. ZELLER BOOK CO.  
Est. 1874, 4472 W. Belle Place ST. LOUIS, MO.

SPANGENBERG'S  
PRACTICAL  
ARITHMETIC  
Self-Taught





## You can Break the Shackles of Moral Fear!

### What This Book Teaches You

- How to overcome Timidity.
  - How to conquer Bashfulness.
  - How to have "nerve."
  - How to demand "your own."
  - How to face people you have always felt inferior to.
  - How to develop Self-Confidence.
  - How to deal with people on their own level.
  - How to successfully face embarrassing situations.
  - How to "rise to the occasion."
  - How to be Forceful and Dominant.
  - How to eliminate Nervousness in dealing with big men.
  - How to act calmly and naturally on occasions that usually excited you.
  - How to banish Fear, physical as well as mental.
  - How to stop Worry.
  - How to become a Man among men.
  - How to get rid of Superstition.
  - How to face old age calmly.
  - How to maintain poise in public.
  - How to assert yourself in business as well as in the Home.
  - How to develop courage to swing big deals.
  - How to dominate Circumstances.
  - How to defy old time habits of Hesitation.
  - How to insure a healthy, virile, intrepid grade of Brain.
  - How to stir into electrical activity, latent leadership qualities, which Nature has tucked into the make-up of every normal man or woman.
  - How to mass the myriad cell-forces of your Mind into a strong, daring, goal-gaining plan of conduct.
  - How to break open the door to a new world of Thinking—rare in beauty, practical in application.
  - How to blaze the way to unthought-of fields of self-expression.
  - How to add to your physical buoyancy a tingle and zest hitherto missing.
  - How to impress others with your poise, purpose and power.
- A complete list of contents would almost fill this page.*

Do you lack confidence in meeting other people? Are you conscious of another's personality and your own lack of it? Do you feel inferior to others? Are you superstitious about anything? Do you worry about your loved ones or about conditions? Are you afraid of approaching old age? Do you seem to be blinded by petty fears? Are you frightened in public? Are you afraid of your ability to "put things over"? Are you afraid to assert yourself in your home or in business? Do you fear the opinion of others? Have you the courage of your convictions? Do things that other men and women are doing seem impossible of accomplishment by you? Are you afraid to go in business for yourself or afraid to take the risks you used to? Are you able to brush aside all obstacles in order to arrive at your destination? Are you conscious of your power, self-confident and eager, demanding what you want, or do you stand cringing, hat in hand, and whine for it? If any of these subjects even touch on your condition, "Culture of Courage" will prove a godsend!

Fear of self—fear of people—fear of the future—fear of things—fear for others (worry)—are what keep men and women down when they should and could be on top.

But not until the shackles are broken—not until fear is eliminated—not until courage is properly cultivated, can man come into his own.

## "Culture of Courage"

by Frank Channing Haddock, Ph.D.

This great work by the famous author of "Power of Will"—a scientist whose name ranks with James, Royce, and Bergson, is not an inspirational book which merely admonishes you to "Destroy Your Fears" and "Be Courageous." Instead, it is a practical course in how to overcome each particular kind of human fear, physical as well as mental, to which we are all subjected. It contains actual principles, rules, methods, and exercises which any one can easily follow and become ten times bigger—ten times more successful—ten times happier than you had even dared hope.

### A Ghost-Scattering Searchlight

In "Culture of Courage" the author opens up into some of the most important problems of existence; he throws a ghost-scattering searchlight into the shadows that have scared people from rich fields of life; he tears away the straw-and-gossamer entanglement which has held men and women in subjection; he pulls off the imagination-created masks of various fears, superstitions and bugaboos which in all ages have paralyzed the brain's energies and constantly dinned into eager ears the failure slogans: "I'm afraid," "I dare not try," "I haven't the ability," etc.

As you study this new system, you will learn definitely how Reason, Thought, Analysis, and Sanity can scatter to the high heavens the senseless visions of fear that are causing unutterable losses, embarrassments, and failures.

This book will startle you, will awaken strains of thought that may easily change the entire course of your career, just as it has that of thousands of other men and women in all walks of life who have learned its wonderful back-bone building secrets.

**Send No Money** While published in book form, "Culture of Courage" is a comprehensive system of courage-building and contains more material than any \$25 correspondence course. It has 14 main divisions, and fills 460 pages. Beautifully bound in half-leather, gold top leaves, big readable print—yet the price is only \$3.00, and we are offering it for five days' examination without a penny from you in advance.

Send no money—merely mail the coupon enclosing your business card or giving a reference. If, after you have it in your own home, you feel you can afford not to own this wonderful guide to a broader life, to things worth while, send it back. The examination will not have cost you a penny. Tear out, fill in and mail the coupon right now before you turn this page, as this announcement may not appear in this magazine again.



460 pp.  
Half Leather  
Gold Top  
Leaves

**Pelton Pub. Co.** 551 Pelton Bldg.  
Meriden, Conn.

### What Readers Say:

"In it I found rules, principles and regimes which make it worth its weight in gold to me." — District Attorney Goodwin, Oil City, Penn.

"It is a 'wonder.' The more one reads it, the more forceful ideas he can draw from this storehouse." — J. F. Ellis, Pres. Nat. School of Sales'p, Minneapolis, Minn.

"It is simply magnificent; I shall highly recommend it and wish everybody could read it." — L. I. Hall, Rochester, N. Y.

"It stands absolutely at the head of anything I have ever come across; Mr. Haddock is certainly a Master Mind. As a teacher I can say that no greater good could come than the absorption from superstition this book brings about." — James Stratwell, Reynoldsville, Pa.

"These books are a gold mine of 'energizing material' for the progressive mind." — A. A. Martin, M. D., Pierce, Neb.

"Enclosed is my check; send another copy." — W. H. Smith, Pres., Herring Hall, Marvin Sale Corp., New York.

"I have read 'Culture of Courage.' Shall want anything its author may produce. This is the most sincere tribute I can pay the books." — C. A. Drinkwitz, Evanston, Ill.

"'Culture of Courage' is superb. It is clear, forcible, scientific, practical in every form and manner: ALIVE with the rich, the high, the ideal, the sublime. It's an inspiration from beginning to end. IT JUSTIFIES ALL CLAIMS." — F. Stanley Perez, Rex. Master, Wesley College, Colombo, Ceylon.

"Enclosed is check for which send me another copy for one of my friends. Dr. Haddock's works are superior to anything I have ever read for the development of the individual. He is entirely in a class by himself." — Chas. H. Ward, D.C., Houston, Me.

**Pelton Pub. Co.**  
551 Pelton Bldg.  
Meriden, Conn.

Gentlemen: Please send me a copy of "Culture of Courage" on approval. I agree to remit \$3.00 or return the book in 5 days.

Name.....

Address.....



## "Your Salary is Raised 50%"

"THROUGH your knowledge and skill this magnificent structure was made possible. Because your working plans were absolutely accurate in every detail we have finished it successfully. We are proud of you. Your salary is raised 50%."

That is the praise a trained draftsman heard the other day. He had learned drafting and designing in the only practical way and his work was *right*. The president of the big construction company recognized the value and vital importance of the draftsman's work and raised his salary from \$200.00 to \$300.00 a month. Send the coupon for the new book about the drafting profession

### Draftsmen are Needed in All Lines of Business

The draftsman holds a responsible position in almost every line of business. Manufacturing, machinery, construction, designing—choose any line of business that appeals to you and there you will find the man with the draftsman's knowledge holding the position of power—with the high salary. The profession offers almost unlimited opportunities. Skilled men are in demand and always will be. Send the coupon for the book that tells about the achievements that are within your reach.

### Chief Draftsman Will Instruct You Personally

In my position as Chief Draftsman of a large company, I know the kind of training that is necessary for the men who hold the highest paid positions. You can get it. During my spare time I am training ambitious men in their own homes. They are getting practical, thorough training in those departments of the profession that will qualify them to accept responsible positions. Send the coupon for the book that I am sending free.

*Note: To the men that I train personally, I furnish a complete set of fine draftsman's instruments without extra charge. These working tools are the same kind that I use myself—high grade regular working instruments.*

**Chief Draftsman Dobe**  
Engineer's Equipment Co.  
Div. 1195 Chicago, Ill.

Without any obligations to me whatever, please mail your book "Successful Draftsmanship," and full particulars of your liberal "Personal Instruction" offer to a few students. It is understood that I am obligated in no way whatever.



Name.....

Address.....

## Send the Coupon For Big New Book

Put your name and address in coupon or on a letter or a post card now and get the new book on drafting that I'm giving away free. No obligations of any kind. You should read this book carefully. Write for it now. Your copy is waiting for you.

**Chief Draftsman Dobe, Engineer's Equipment Co.**  
Div. 1195 Chicago, Illinois

Please Mention Popular Mechanics

# CLASSIFIED ADVERTISEMENTS

We have records to prove that a classified ad in these columns will find a buyer for almost anything which can be sold. Doubtless you have some article of value to some one else which you no longer need. Why not turn it into money?

Advertisements in this section, 15 cents per word, each insertion, minimum 10 words, payable in advance. To insure ads being inserted under proper classified head in the June issue, copy must reach this office not later than May 1st.

March 13, 1915.

Popular Mechanics Magazine, Chicago, Illinois.

Gentlemen: Your letter of the 8th has been received. We are glad to advise that we have had wonderful returns from the two advertisements which we have been carrying with you during the last five or six months, and consider your classified columns the best advertising medium on the market today. We find very few of the inquiries to be for information only, most of them being deeply interested in the propositions we offer. Our Ford advertisement has brought inquiries from practically all the States in the Union.

Respectfully yours, THE EVARTS MACHINE COMPANY.

## AUTOMOBILES

**VALVE Reseating and Refacing Tools**, from 1 1/2 to 2 1/2 inches. Set complete, \$15. Work equal to 350 outfit, in less time. Private owners, you can do the work yourself and be independent of repair men. Grass agency proposition. J. W. Scott, 37 Warren St., N. Y.

**HOW to operate and repair automobiles.** Book 15c. Richard Desine, M1145 Wells St., Chicago.

**CYLINDER** Regrinding or Rebobing. New oversize pistons and rings fitted. Accuracy guaranteed. Prompt delivery. Worn or broken parts duplicated. Everts Machine Co., 14 Hicks Street, Hartford, Conn.

**REMODELED N. Ford**, guaranteed good order, \$165. C. R. Baum, Kansas City, Mo.

**FORD** cylinders rebored, fitted with 4 oversize pistons, 12 rings, 4 wrist pins, 8 bushings. Cost of complete job \$15. Delivery in 24 hours. Every repair guaranteed. Everts Machine Company, 14 Hicks Street, Hartford, Conn.

**AUTOMOBILE** Instruction—\$35.25. Four weeks' course. Best-equipped school in the country. Men enrolled from all parts of the U. S. Booklet P. M. on request. West Side Y. M. C. A., 318 West 57th Street, New York.

**CURE** Leaky cylinders, use Triple Piston Rings, 90 cents each; Regular rings, 25 cents. Gears, ball bearings and radiators our specialty. Grossman Auto Parts Company, White Plains, N. Y.

**CYLINDER** Regrinding—First-class equipment, fifteen years' experience, and specializing in this work enable us to do high-grade work at lowest prices. We manufacture the "Neverleak" individual cast piston rings. Prices will interest you. Bridgeport Piston Ring Co., 348 Connecticut Ave., Bridgeport, Conn.

**YOU** can earn an auto by my new, easy plan; anyone over 16 years old can get a brand-new Ford Touring Car for a little easy, respectable work among neighbors. Free Book tells all about it. Postal brings it. Send Auto Tom, 647 S. 16th St., Omaha, Neb.

**PAINT** Your Car Yourself—Save \$25 to \$75 by doing the work at home with the Arsenal system. Our big free booklet "The Car Beautiful" tells how. Send for it today. Arsenal Varnish Co., Dept. P, Rock Island, Ill.

**"THE How and Why of the Automobile"**—A 200-page book of practical information for seekers after the fundamental facts regarding the gasoline engine and its application to the motor car. Interesting and instructive to both the beginner and the expert. Bound in full cloth—250 illustrations. Price \$1 postpaid. Popular Mechanics Book Dept., 6 N. Michigan Ave., Chicago.

**THE Last Word in Automobile Literature—New Book.** "The Modern Gasoline Automobile." 700 6x9 in. pages. 500 illustrations, is superior to any treatise heretofore published. Deals with every modern improvement. Price, \$2.50 postpaid. Popular Mechanics Book Dept., 6 N. Michigan Ave., Chicago.

If your car hasn't the compression and power it once had, you'll probably find that your cylinders are worn or scored and need regrinding. We've reground thousands of cylinders in our six years' experience and can refer to pleased customers everywhere. Advise make of car and bore diameter, so we may quote. Do it now before you forget. Waterbury Welding Corporation, Waterbury, Conn.

1914 LITTLE Six touring car. Good condition. New tires; \$900. J. F. Flesner, Golden, Ill.

**COMPLETE** parts for light car. All ready to assemble, at remarkable prices. This is a well known car, but a new selling plan. Tribune Engineering Co., Export Dept., Oswego, N. Y.

## AUTOMOBILE SUPPLIES

**DOUBLE** tires give 6,000 miles and upwards, 30% to 50% saved. Positively guaranteed. Some prices—32x3 1/2 \$9.25, 34x4 \$12.00, 36x4 1/2 \$15.25. Cash Profit-Sharing Coupons, too. Send for list now! State size, Anglo Tire Company, 888 Seventh Ave., New York.

**STOP** that leak in your radiator instantly with ounce of Overton's Water solder. Poured can, parcel post, 50c. Guaranteed. N. L. Overton Co., Dealers, 1109 4th Avenue, Council Bluffs, Iowa.

**FLEXIBLE** Metal Tubing for carburetors, wire covering, exhaust pipes, tire inflating, speedometers and gas. Metal hose better than rubber. Get catalog. Breeze, Newark, N. J.

**RECTIFIERS** for garages. All sizes. Charge one to eight batteries, \$12 upwards. American Battery Company, 1129 Fulton St., Chicago.

**PORTABLE** Automobile Cylinder Grinders. Big Money for Garage or individual in regrinding worn cylinders. Small capital. Boxill-Bruel, 50, Cincinnati.

**60 HP.** Royal Tourist four-cyl. fully equipped, \$125; with clutch, transmission, levers, \$158. Badger Motor Co., Milwaukee, Wis.

**WRITE** for prices on new and used magnets and coils. We repair any magnet. Pellet's Magneto Exchange, 1606 Michigan Avenue, Chicago, Illinois.

**"OXY-ACETYLENE** Welding and Cutting" is the title of a big new text book on welding. Practical men say, "Best ever published." A mine of valuable information explaining in plain language the How and Why of every operation. Elegantly printed on fine enamel paper, profusely illustrated, attractively and durably bound in cloth. Send postpaid for \$1.50. We manufacture a complete line of welding equipment; send for catalogue "P." It's free. Vulcan Process Company, 2434 University Ave., S. E., Minneapolis, Minn.

**TIRES**, tires, tires, tires, tires. Not Seconds, but rebuilt firsts. Double tread, puncture proof. Big mileage for little money. 28x3 plain \$5.95, non-skid \$6.25; 29x3 plain \$6.50, non-skid \$7.45; 30x3 1/2 plain \$8.10, non-skid \$8.80; 32x3 1/2 plain \$9.55, non-skid \$9.80; 34x4 plain \$11.45, non-skid \$12.40; 36x4 plain \$12.10, non-skid \$12.70; 37x4 1/2 plain \$17.60, non-skid \$18.85; 37x5 plain \$19.40, non-skid \$21.35. Terms cash with order. Complete price list free. Welding Apparatus Co., 304 National Union Bldg., Toledo, O.

**ALL** kinds new and slightly used storage batteries and parts. Autoservice, 708 3d St., Milwaukee, Wis.

**AGENTS:** Nothing like this on the market. Automobile Valve Grinder fits any valve. Works at any angle through Universal Joint. Sells at sight. Big profits. Sample \$1. Write for plan. Healy Tool Co., Buffalo, N. Y.

**AUTOMOBILE** Rims—State make and size or describe and we will quote. Shock Absorbers for Ford, \$4.75 set four prepaid. Sandberg Bros. Supply Co., Minneapolis, Minn.

**SHOP** Vulcanizer. Bargain. Tires at cut prices. Vanderpoels, Springfield, Ohio.

**MOUNT** power vacuum cleaner on your auto. Buy parts, assemble, \$50 cost—earn \$15 daily. Vacuum Supply Co., Ann Arbor, Mich.

**USE** an Air-Friction Carburetor, 1915 Improved Model C or D. Increases power and economy of motor one-half. Absolutely impossible to load or choke. Starts easy warm or cold weather. Uses either high or low grade fuels with finest results. We fit all motors and guarantee definite results or refund money if returned within thirty days. Liberal exchange allowance on other carburetors or old model air-frictions. We also make and absolutely guarantee the Air-Friction Spark Plug. Sold in sets of five only at \$3 per set. The Air-Friction Carburetor Co., Dayton, Ohio.

**AUTO** Parts—Build or repair your own car, as we can furnish parts for any make of car at cut prices and discounts. State your wants to Grossman Auto Parts Company, White Plains, N. Y.

## WELDING

**WELDERS**, Attention. Mend those aluminum jobs with my bona fide solder. Makes good. I use it constantly. One dollar money order brings formula. J. Walters, Box 805, Vancouver, B. C.

**WE** weld all metals. Charges reasonable. Work guaranteed. We rebore cylinders and fit pistons. Bertschy Kan-Fix It, Omaha, Nebr.

**WELDING** in all metals. Automobile sheet-metal tanks, hoods and radiators made and repaired. L. & M. Mfg. Co., 319 So. Jefferson St., Chicago, Illinois.

**WELDING** Plants, \$25 to \$250. Liberal terms. Write Bermo Co., Omaha, Nebr., U. S. A.

**"OXY-ACETYLENE** Flame and Its Uses"—The most complete instruction book upon welding shop practice ever published, \$1 prepaid. Admiral Welding Machine Co., Kansas City, Mo.

**OXY-ACETYLENE** Welding and Cutting is the title of a brand new practical instruction book on the methods of doing this work. It includes the operation and care of Acetylene Generating Plants and the Oxygen Process for removal of carbon. 280 pages, 76 illustrations, pocket size, cloth, \$1.60; leather, \$1.50 postpaid. Popular Mechanics Book Dept., 6 N. Michigan Ave., Chicago.

## FORD ACCESSORIES

**STOP** that motor overheating. Buy a Howard cellular type Radiator for \$25. Write for particulars. Steele & Son, Wilkinsburg, Pa.

**CHROME** Nickel Steel pinion gear one dollar for Ford cars, differential drive ring gear three dollars. Special catalogue. Grossman Auto Parts Company, White Plains, N. Y.

## MOTORCYCLES, BICYCLES & SUPPLIES

**MOTORCYCLE** Bargains: Excelsior Single—\$10; Excelsior Twin—\$20; Yale Twin—\$75; Fixing Merkel Twin—\$65; Indian—\$45; Pope Twin—\$85; Flanders—\$35; Harley-Davidson 1913 Twin—\$95; Wagnon—\$25; Iver Johnson—\$60; Detroit—\$55; Curtis—\$33; Emblem 1914 Single—\$70; Henderson 3-Cylinder—\$145. Machines sent anywhere C. O. D., with privilege of examination. Write for our big Bargain Sheet with full description. W. E. Wandersee Co., Largest Motorcycle Dealers in the State of Michigan, 129 Gratiot Ave., Detroit, Mich.

**BARGAINS** in rebuilt Indian Motorcycles. R. E. Haesly, Winona, Minn.

**BIG** bargains in good motorcycles we have taken in exchange on new ones. Send for special bargain list. Shaw Mfg. Co., Galesburg, Kansas.

**REAL** bargains in used machines. Harley single, \$60; Excelsior single, \$60; Flanders single, \$55; Thor single, \$75; Emblem twin, \$80. Guaranteed in serviceable condition. Will ship \$10 cash, balance C. O. D. Vesely Bros., 3859 Ogden Ave., Chicago, Ill.

1911 **EXCELSIOR**, good running order, \$40. Alva Hall, 2205 Fairmont, Atlantic City, N. J.

**FOR** Sale—1914, two-speed, twin Excelsior, fully equipped, \$185. Rogers Side-Car \$40. Run 1,500 miles. First-class condition, guaranteed. Ed Curry, Bemidji, Minn.

**MUST** sell 4-hp. Indian, like new; carries two, fully equipped, \$75. R. Weiss, Haines, Ore.

**SEVERAL** new guaranteed twin and single 1914 Jefferson motorcycles for sale. On account of death of dealer, these must be sacrificed. Make offer. No trouble to get repair parts. Address L. F. McEvoy, 138 Milwaukee St., Milwaukee, Wis.

**BIG** 1914 Eagle twin motorcycle, \$188.00. Geo. Lau, Klemme, Iowa.

**WANT** to sell your motorcycle? I have a method which has sold many. Write me today for free information. F. W. Johnson, Room 900, 78 E. Madison St., Chicago.

**LATE** 1913 Henderson, fully equipped, good as new, \$165. R. Hummel, 1401 Elm St., Cincinnati, Ohio.

**FOR** Sale—Harley-Davidson Motorcycle, \$80. Henry F. Pardon, Owensboro, Ky.

**FOUR** Horse Haverford motorcycle \$35. Walter Robb, Canal Dorer, Ohio.

**FOR** Sale—Indian twin, two speed, electric equipped. Anton Landergotz, Cranston, Wis.

**\$5,000** WORTH of used Motorcycles, all makes; Harley-Davidson, Indians, Excelsiors, Hendersons, etc. Twins, \$75 and up; Singles, \$25 and up. Send for our list at once. C. H. Lang, 1704 Michigan Ave., Chicago.

**HARLEY-DAVIDSON** 1913 Model, good condition, \$125. Raleigh T. Edis, Frederickburg, Ind.

1912 **FLANDERS**, magneto and clutch, \$50. Leslie Cramer, 2522 Atlantic, Atlantic City, N. J.

**40** AND up. Rebuilt Harley-Davidsons, Excelsiors, Indians, etc. Every machine in good running order and with good tires. Write for list 125. Mixx Motor Co., Box 828, Milwaukee, Wis.

**BARGAIN**, Indian twin, clutch, magneto, \$60.00. Clyde Swigert, St. Joseph, Mich.

**MOTORCYCLES:** Indians, Harleys, Thors, Excelsiors, Emblems, Flanders, \$20 up. Many others. Write for list. Hall & Gravat, Atlantic City, N. J.

**FIRST** check for \$45 takes a Thor "4" motorcycle, 1911 model. Recently overhauled. C. M. Anderson, Batavia, Ill.

**PIERCE-ARROW** 4-cylinder motorcycle, new, equipped with luggage-carrier, Steward speedometer, Prest-o-Lite, Oil Sol lamp. Cost \$425. Will accept first reasonable cash offer. W. R. Anderson, 1909 Marshall Ave., St. Paul, Minn.

**\$50 TO \$150** buys the best motorcycles; every make and model in our large stock must be cleared. Half price. Send for list today. Brown Music Co., 9119 Commercial Ave., Chicago, Ill.

**YALE** twin and used sidecars, bargains. Thomas Dunham, Aurora, Ill.

**FLANDERS** Single, 1914, equipped, like new, \$75. Sprauer, Hamilton, Ohio.

1913 **INDIAN** Twin, bargain. Fully equipped, overhauled. H. C. Kelley, Circleville, Ohio.

**WANTED**—Bicycle owners, make your "Never-Leak" formula. Sent on receipt of 5c. S. P. Modlin, Box 31, New Castle, Ind.

**EAGLE**—Two speed—16 horsepower—Dixie Flyer, light weight—rebuilt machines, parts, accessories, clutch, 2-speed equipment for all makes. Live agents wanted. Motorcycle Paris Mfg. Works, 2127 Michigan Blvd., Chicago.

**MOTORCYCLE** Tires, Seconds, Unused, 28x3, \$6.50; 2 1/2, \$5.25; 2 1/4, \$4.75; limited supply; order at once. Anderson's Motorcycle Store, Batavia, Ill.

**INDIAN** racer, \$150. Semi-racing Harley, 1915, \$210. Fast Jefferson, \$85. C. F. Williams, Socorro, N. M.

**LATHE**, Motor, Emery Wheel and Stand, etc., for Motorcycle. Leslie T. Barlight, 2430 Spaulding St., Omaha, Nebr.

**DON'T** buy a Bicycle Motor Attachment until you get our catalogue and prices. Shaver Mfg. Co., Dept. 27, Galesburg, Kansas.

**200** REBUILT Motorcycles, Standard makes, new list, Chicago Motorcycle Works, 2911 Clarendon Ave., Chicago.

**BIG** bargains in second-hand motorcycles, \$25 up. Indians, Harleys, Thors, Excelsiors and Merks. Write for descriptions. Howard A. French & Co., Baltimore, Md.

**SEND** for latest Bulletin of real Motorcycle Bargains, used and slightly used, all makes, models and prices; if you have \$25 and really want a powerful motorcycle, send for this Bulletin; hundreds of machines at all prices, new ones on easy payments; tell us what you want and how much you can pay; we can fix you up. Peerless Motorcycle Co., Dorchester, Mass.

**SUPPLIES**—Our big catalogue with prices lower than usual sent free to motorcycle owners. Meco, Hammondsport, N. Y.

**NEW** Motorcycle Book—Just Published—Motorcycles, Side Cars and Cyclecars, Their Construction, Management and Repair—350 pages, cloth, 250 illustrations. The Dealer, Mechanic and Rider will find this treatise a work of reference without an equal. Price \$1.50 postpaid. Popular Mechanics Book Dept., 6 N. Michigan Ave., Chicago.

**WANTED** at once, fifty young men as factory representatives to travel and place local agencies for Eagle motorcycles. An excellent opportunity paying big profits. Sterling Motor Company, Wholesale Department, Brockton, Mass.

**LOWEST** prices on New and Used Motorcycles. Ask for list M. Prices \$20 up. Rebuilt Motorcycle Dept., 801 Center Street, Brockton, Mass.

**LIVE** agents wanted for the new 1915 Eagle motorcycles. Write quick and make good money as our local representative. Sterling Motor Company, 720 Center Street, Brockton, Mass.

**GET** our list of used motorcycles—Yale, \$55; Excelsior, \$65; Thiem, 2-speed, \$65; Thor, \$85; Indian, \$50 to \$75; H-D Twin, \$145; Yale twins, \$95 to \$185; many others. Horn & Baird, Minneapolis, Minn.

**INDIAN** single; magneto clutch; tandem; \$75. G. E. Thurmond, Custer, Montana.

**FOR** Sale—1912 M. M. Magneto special single cylinder motorcycle, \$75. Good shape. Louis Werth, Burton View, Ill.

**MOTORCYCLISTS**—A small car at the price of a motorcycle. Buy it complete, or build it. We furnish parts ready to assemble. Tribune Engineering Co., Export Dept. Owego, N. Y.

**USED** guaranteed motorcycles at lowest prices, \$25 up. Seeber & Hofheins, Buffalo, N. Y.

#### CYCLECARS

**CYCLECAR** Bargains—Brand new Scripps-Booth—\$200. Demonstrator \$150. Write quick. W. E. Wanderssee Company, 129 Gratiot Ave., Detroit, Mich.

**BARGAIN!** Cyclecar with lots of extra parts. Also all patterns for car, \$160. T. A. Eberhardt, 708 3d St., Milwaukee, Wis.

**PARTS** ready to assemble. 4 cylinder motor, "I" beam axle, rear axle with differential and all other parts up to the minute. A car that is selling in large numbers. Tribune Engineering Co., Export Dept., Owego, N. Y.

#### CYCLECAR MATERIAL

**CYCLECAR** metal bodies for Scripps-Booth \$15. W. E. Wanderssee Company, 129 Gratiot Ave., Detroit, Mich.

**CYCLE** car wheels, All sizes. Send for Bulletin. Heath Aerial Vehicle Co. Chicago.

**CYCLECAR** Friction Transmissions, Aluminum disc, tarred fiber wheel, Roller bearings. Guaranteed. Cogswell Manufacturing Co., Hall St., Springfield, Mass.

#### AERONAUTICS

**GET** world's largest aeronautical catalogue, 6 red stamps, or our aeronautical motor catalogue just off the press, 4 red stamps. Blue prints \$1.75, all standard aeroplanes and aerial driven cycle car. The latest fad. "Heath" Propellers for air, water and land represent the survival of the fittest. Six years propeller production proves perfection. 3 red stamps for propeller catalogue. Heath Aerial Vehicle Co., Chicago.

**FOR** Sale—8 cyl. 70 H. P. Boulevard motor and Curtiss aeroplane, \$600. Box 98, R. No. 2, San Luis Obispo, Cal.

**80-H. P. AERO** motor, 4-cylinder, copper jackets, Bosch magneto, Stromberg carburetor, Tungsten steel valves, turns 8 ft. dia. by 5 1/2 ft. pitch, American propeller; 1208 K. P. M., 4 lbs. per H. P.; guaranteed good as new. Complete with radiator, \$400 cash. Use it in your motorboat. J. L. Cato, Gustine, Cal.

**CHICAGO** Aero Works—Military and Exhibition Tractors—Flying boats. Everything aeronautical.

**BLERIOT** monoplane, 30-H.P. Anzani motor, complete, perfect condition, \$350. Without motor, \$150. Curran, 217 W. 83d St., N. Y. C.

**WILL** sacrifice latest flying boat, \$775. Completely equipped. Heath Aerial Vehicle Co., Chicago.

**ROBERTS** 50 H. P. Motor, complete, almost new. Oscar Solbrig, 707 W. 7th St., Davenport, Iowa.

**YOU** can learn to fly for \$100. Write for particulars now. Aviator, 1402 N. Hickory St., Joliet, Ill.

**WANTED**—Aeroplanes and Motors, on time. Government Contractor, Box 36, Solon, N. Dak.

**WANTED**—Six Curtiss type aeroplanes with or without motors; must be cheap for cash. Aviator, 1402 N. Hickory St., Joliet, Ill.

**WILL** sacrifice fully equipped 30 h.p. water-cooled Curtiss Motor, \$250. Heath Aerial Vehicle Co., Chicago.

**ELDRIDGE-WHITTAKER** hydroplane, 20 feet long, three cylinder Ead engine complete, splendid condition. Sabbs, 818 Granite Bldg., Rochester, N. Y.

**AVIATION** Motors, all makes, up to 150 H.P., \$250 up. Complete aeroplanes, all types, \$500 up. State your needs. Aero Exchange, 38 Park Row, N. Y. C.

**FOR** Sale: 6 cylinder, 75 h.p. Roberts aviation motor in good condition with propeller and radiators, \$475 cash. National Aeroplane Company, Machinery Hall, Chicago.

**BEST** and lowest priced aeroplanes, motors and propellers. Bates, 104 Oak, Chicago.

**MODEL** Aeroplanes—7c brings greatest handbook and catalog. Cheapest supplies. Walter Phipps, 508 5th Ave., New York.

**LIGHT** Weight, Gasoline Engines, 2 1/2 lbs. Guaranteed 3/4 H. P. The Weiss Co., Torrington, Conn.

**COMPLETE** Plan, drawn to scale, with precise instructions for building a Curtiss 3-foot Model Flying Boat, 25c. Other plans: Blériot, 15c; Wright, 25c; Niépport, 25c; Curtiss Hydro, 35c; "Peoli" Racer, 25c. Set of six, \$1.25. 48-pg. Model Supply catalogue, 3c. Ideal Aeroplane Co., 82 1/2 West Broadway, N. Y.

**HOW** to Make a Biplane Glider—Our book "Amateur Mechanics No. 2" contains a complete detailed description of how to make one. Price of book, 25c postpaid. Popular Mechanics Book Dept., 6 N. Michigan Ave., Chicago.

**BUILDING** and Flying an Aeroplane—160-page handbook covering the building of small models and full sized gliders and machines. In both biplane and monoplane models the well-known Curtiss and Blériot types are followed. Fully illustrated with detail drawings. Price, \$1 postpaid. Popular Mechanics Book Dept., 6 N. Michigan Ave., Chicago.

#### BOOKS AND PERIODICALS

**FOR** Sale—One Latin volume, Antiquarium Romanorum Pauli Manutii, published 1582, 3 1/2 x 6 inches, colored parchment; also Plutarch's Lives, 3 volumes, 1716. Lord, Division St., Elkhart, Ind.

**BOOKS** and Art Photos, Sample of either, 10c; both 15c, Globe Co., Box 55, Augusta, Mich.

**LAST** Word in Mathematics—Comparative Cancellation—Solves all problems with ease, accuracy and large saving of figures, 145 pages, \$1.00 postpaid. Money back if dissatisfied. Circulars free. Herrick & Horton, Publishers, Princeton, Ill.

**140** CHOICE After Dinner Stories, together with late song hit—25c. Entertainers' Club, (5)-831 East 163 St., New York.

**BOYS**—10c brings 16 illustrated boys' magazine, one year. (Canada 20c.) Dandy stories, Mechanics, Electric, Stamps, Youths' Magazine, 3853 Ogden Ave., Chicago.

**SPANISH** Books—every kind published—bargains—catalog free. Bernardo Lopez Book Co., Kansas City, Mo.

**BOOKKEEPING**, Expert Auditing, Rapid Arithmetic, 25c. Garfield Commercial School, 1616 Germantown Ave., Philadelphia.

READ these great books about the War: 1. Germany and the Next War, by Gen. F. Von Bernhardi (discloses Germany's war plans for crushing England and France. Price 85 cents). 2. Secrets of the German War Office (by A. K. Graves, for twelve years a spy in the Kaiser's service. Price \$1.60). 3. Germany's Fighting Machine (by E. F. Henderson. Divided into three parts, The War, The Army and The Navy. Price \$1.35). 4. Men Around the Kaiser (by F. W. Wile. Tells about those men who figure most prominently in the affairs of Germany at the present time. Price \$1.35). 5. The Germans (by I. A. R. Wylie. A graphic picture of the German people on the eve of the great conflict. Price \$2.15). 6. The War and America (by Hugo Munsterberg, the great German-American. Price \$1.10). 7. War's Aftermath (a study of the deterioration of the quality of stock occasioned by the lamentable waste of war. Price 85 cents). Popular Mechanics Book Dept., 6 N. Michigan Ave., Chicago.

FROM Dance Hall to White Slavery—Plain wrapper—Special price, 75c postpaid. Free catalog of other specialties. Burkhardt Company, Milbank, S. D.

THE Black Fox Magazine, the trade journal of the Canadian fox industry. Free sample copy. Dr. Randall, Truro, Nova Scotia, Canada.

3,000 SELECTED Cartoons for \$3. A Panorama of World Events. Political, Industrial—Social—Humorous—Tragic—all of intense human interest. A wonderful collection of 3,000 cartoons reproduced from the newspapers of the United States, Canada, Mexico, Cuba and the cities of the Old World, has been made by Cartoons Magazine from more than one hundred and fifty thousand published cartoons, and, bound in an artistic and durable cover, are now ready for your library table. Vol. I, Jan.-June, 1912—\$1. Vol. II, July-Dec., 1912—\$1. Vol. III, Jan.-May, 1913—\$1. Cartoons, 78 E. Madison St., Chicago.

"SOMETHING-TO-DO." Interesting magazine for children who like to draw, paint, read and make small useful articles. You'll like it. Send postal card for free sample copy. Something-To-Do, 120M Boylston St., Boston, Mass.

CORRESPONDENCE Courses and Technical Books. Bought; sold; cut rates. C. A. Bubb, Detroit, Michigan.

BINDER for Popular Mechanics magazines. Best adjustable magazine binder on the market made especially to hold any number from one to six copies of this magazine with name "Popular Mechanics" in gold letters on front cover. No laces or cutting or perforating of pages necessary. Simple, unique adjustment; handsome, durable and neat. We buy in quantities and can offer our readers this regular \$1.50 binder for \$1.25, all shipping charges prepaid. Address Popular Mechanics Book Dept., 6 N. Michigan Avenue., Chicago.

ENGINEERS' questions and answers for license, by Hobson, for twenty-five cents, postpaid. Send stamps. Reilly's Book Store, Philadelphia, Pa.

METAL Work and Etching—A 96-page hand book for art metal workers telling how to make a great variety of useful and ornamental objects, such as desk sets, art-crafts, jewelry, etc. Price, 50c postpaid. Popular Mechanics Book Dept., 6 N. Michigan Ave., Chicago.

"SHE," dandy book, 25c. Catalogue, 2c. Duff, 2712 Mozart, Chicago.

INSTRUCTION Books, Automobile, Inventors' Electricity, Engineers', Jewelers', Machinists', Plumbers' (best published). Lamont Co., Beacon, New York.

SEND stamp for our book "How to Make Patents Profitable." Benjamin & Bassett, 141 S. Dearborn St., Chicago, Ill.

FREE Catalog of Mechanical Books—Our 96-page catalog of 500 books on 100 different subjects will show you where to find that particular information you are in need of on any mechanical subject. Send for it today. Popular Mechanics Book Dept., 6 N. Michigan Ave., Chicago.

#### EDUCATIONAL AND INSTRUCTION

COURSES by mail: Modern Merchandising, Business Letter Writing, Advertising and Mail Order Methods. Worth \$1,500 a year to any progressive person. Complete sample lesson only 25c with full particulars. National Business Instructor, 4432-M, Michigan Ave., Chicago.

WHY go to school to learn shorthand? Complete mail course, \$3. Money back if not satisfied. Almer Agency, Jackson, Michigan.

OPTOMETRY—Art of fitting glasses. Paying and uncrowded profession. Correspondence course fully prepares for diploma and practice. Liberal payment plan. Catalog free. Chicago School of Refraction, Office, 545 Journal Bldg., Chicago.

LOOK! \$10 Drafting, arithmetic, geometry, ornaments, instruction plates, \$1 postpaid. Architect, 51 Elliott Ave., Queens, N. Y.

LEARN Sign Painting, taught by an expert; 35 years' experience in America and abroad. Booklet free. Wansinger School Lettering, Dept. 47, 625 Chestnut, Toledo, Ohio.

THE more you learn the more you earn. We teach you the Real Estate Business by mail. Our course is plain, practical and to the point. Not a single dissatisfied student among the hundreds who have taken our course. Wonderful co-operative selling organization among graduates in all parts of the country. Write for Free Book. Meppen Real Estate School, 312 Palace Bldg., Minneapolis, Minn.

GOOD Opportunities for Veterinarians. Send for catalogue. Grand Rapids Veterinary College, Dep't Z, Grand Rapids, Mich.

ARTIFICIAL Marble, sanitary flooring, ornamental casting, concrete, plaster, papier-mache, interior decorations, garden furniture, statuary, life casting, elastic moulds, electro bronze depositing (immensely profitable work), complete instructions \$1; particulars, 200 illustrations free. Mahler, D-117 Russell St., Brooklyn, N. Y.

MOULDS, models and material sold for working Mahler's marble instructions. Particulars free. Roth, B-45 Frost St., Brooklyn, N. Y.

EIGHTEEN Ways to Make Money! Interesting, isn't it? If you are mechanically or electrically inclined don't fail to write for our free book. Efficiency Company, 104-A, East 16th St., New York.

IT'S the good talker that gets the good job. Improve your vocabulary. The one English authority on vocabulary is Mathew's "Words—their Use and Abuse," "A Command of Good English," "The Secret of Apt Words," "Short Words," "Successful Words," "Words that Convince," "Attention Words," "Persuasive Words," "Climax Words," "Building a Vocabulary," etc. 450 pages. Handsomely Bound. "The meat of all the books on this ambitious subject." Prepaid \$2. We recommend this book. Address The Librarian, Jackson Library, Twelfth and Pine Sts., St. Louis.

BE Successful! Develop Magnetic Force. Send for "Why Men Succeed." It's free. H. M. Otto, 57 E. Vanburen, Chicago.

LEARN Lettering. Best book for home study. Full instructions, 25c stamps. Stevenot Company, 7 Cooper Union, New York City.

EXPERIMENTS. A new 256 page book that gives practical information for building simple, efficient apparatus at small cost, conducting tests and experiments, establishing a laboratory and applying the best experimental methods. Shows you what you can do with your own brains and hands. Both amateur and commercial work is covered. Send for complete description free or book itself sent postpaid upon receipt of price, \$1.50. Popular Mechanics Book Dept., 6 N. Michigan Ave., Chicago, Ill.

FREE Tuition by Mail—Civil Service, Normal, Academic, business, agricultural, English, drawing, engineering, real estate, and law courses thoroughly taught by mail. For "Free Tuition Plan," address Carnegie College, Rogers, Ohio.

SUCCESS! How? Study at home! Fit yourself for a better paying position through one of our 60 courses, including Business, Normal, Kindergarten, Agriculture, Engineering, and Law. Thousands of successful graduates. Chartered 1903. Write for free 30-page catalog, stating instruction wanted. The Modern School of Correspondence, San Francisco, Cal., Dept. 31.

WANT to secure a marine or steam engineers' license? For that great class of ambitious and hard working men, the oilers, coal-passers, water-tenders, firemen or anyone who wants real practical and useful information regarding the every-day operation of the U. S. Revenue Cutter Service has written an engineering story called "McAndrew's Floating School," that makes it possible for those who have not had previous training to absorb the necessary information. Cloth, 250 pages and 37 diagrams. Price \$2. Popular Mechanics Book Dept., 6 N. Michigan Ave., Chicago.

IRREGULAR handwriting changed to a rapid business style by mail. Journal free. F. B. Courtney, Box A 492, Detroit, Mich.

#### TRADE SCHOOLS

ELECTRICITY, Plumbing, Bricklaying, Mechanical and Architectural Drafting taught by practical instruction. This is largest and best equipped practical school in America. Short time required and small expense. Positions secured. Earn expenses while learning. Write for big illustrated book. It's free. Coyne Trade School, Dept. 8195, Chicago.

PAINTING, Decorating, Paper Hanging taught by actual practice. Free catalogue. Chicago School of Painting, 150 West Austin Ave., Chicago.

AUTOMOBILE Instruction. A complete home study course that shows you exactly what you want to know about the automobile. 220-page book, giving definite, thorough, authentic and practical detailed information about every part of the automobile as well as thorough instruction in regard to driving, repairing and general care of the complete car. 190 illustrations, \$1.50 postpaid. Popular Mechanics Book Dept., 6 N. Michigan Ave., Chicago.

#### TELEGRAPHY

LEARN Telegraphy. Young men wanted for Railway Telegraph Service. We teach them and secure for them good paying situations. Address: Oberlin Telegraph School, Oberlin, Ohio.

TELEGRAPHY—Morse and Wireless—also Station Agency taught. R. R. and Western Union wires and complete Marconi Wireless Station in school. Graduates assisted. Marconi Co. employs our wireless graduates. Low living expense—easily earned. Largest school—established 40 years. Investment \$25,000. Correspondence courses also. Catalog Free. Dodge's Institute, 15th St., Valparaiso, Ind.

TELEGRAPHY taught in the shortest possible time. The Omnigraph Automatic Transmitter combined with standard key and sounder. Sends you telegraph messages at any speed just as an expert operator would. Five styles. \$2 up, circular free. Omnigraph Mfg. Co., 41 G, Cortland St., New York.

#### WIRELESS

WIRELESS Set. How to Make—96-page book telling how to construct at small cost an outfit suitable for transmitting four or five miles. Price, 50 cents, postpaid. Popular Mechanics Book Dept., 6 N. Michigan Ave., Chicago.

#### PICTURES, POSTCARDS, PENNANTS

MYSTIC Photos. Pictures made instantaneously "without" using camera. Never before considered possible. Marvellous results. Entertaining and astonishing. Sample outfit 15c, enough for one dozen pictures. Trial satisfies or money back. Alpinia's Studios, 134 Brook Avenue, New York.

ART Studies: Beautiful women in poses from life. Real photos. Classy work for art lovers. Three cabinets, 25 cents; six, with 6 1/2x8 1/2 photo free, 50 cents; two 6 1/2x8 1/2, six cabinets and 50 miniatures for \$1. Money back if not as represented. A. King Co., Andover, Ohio.

PRETTY Girls: Rich samples and catalogue, 4c. Taylor Brothers, M-2159 Clifton Avenue, Chicago.

REAL photos of pretty girls; samples and catalogue, 10c. H. T. Sun Co., Harrison, Mich.

SEE Panama-Pacific Exposition. On receipt of \$1.50 we will mail panoramic photograph of Exposition, four feet long, not enlargement. Satisfaction or money refunded. McFadden Company, 935 Market Street, San Francisco.

"BEWITCHING Female Beauty Poses," rare, imported models, taken from life; beautifully hand-tinted, "true to nature." Send dime for "nifty" samples (genuine pictures, no trash) and illustrated catalogue of "real fascinating" books, pictures, novelties, etc. You'll want more after seeing samples. Williams Publishing Co., 721-C North Dearborn, Chicago.

ART Photos—girls bathing. Splendid samples (postcards)—25c. "Real" goods. G. Olive, Willmar, Minn.

RARE fascinating beauties in "standing" poses. Sent in sealed wrapper. Complete set, 15c. P. Reister, 134 Brook Avenue, New York.

SEPTEMBER Morn and three real photos of feminine beauty posed by models. The three photos and September Morn for 25 cents. Mack Art Company, 609 7th Ave. So., Minneapolis, Minn.

"PANORAMIC view of the Panama-Pacific International Exposition." Size 6x32, suitable for framing, 6 other views, guide, and 6 postcard views of Exposition buildings, all for 25c. Western Novelty Company, Room 418, Monadnock Bldg., San Francisco, California.

BEACH Beauties, class poses, samples and catalogue, 10c. L. Comstock, Springfield, Vt.

EXCHANGE pretty postcards with our members far and near. Best card club. Membership, 10c. Jolly Card Exchange, Box 128, Decatur, Indiana.

JOIN our Post Card Club. You'll get results. Membership 15c. Address R. Hogard, Mgr., Windsor, N. C.

25 FINE postcards, views, sentimental, Dutch, comics, 25 cents. Jenkins, Stationer, New Bedford, Mass.

10 BEAUTIFUL Art Colored Post Cards with your full name in Gold on each, 10c. Veldens & Amlet, 6031 Ridge Avenue, Chicago, Ill.

BETTER than "September Morn!" Two new pictures by same painter. These and "September Morn," silver quarter. Box 522, Minneapolis, Minn.

RECEIVE Post Cards from everywhere. Join our jolly club. Send 10c. H. J. Teeple, Decatur, Indiana.

MEMBERSHIP in press immediately 10c. Pacific Card Exchange, Bryn Mawr, Wash.

15 PHOTOS of Beauties taken from life for 10c. Kay I Co., Box 67, Ottawa, Ill.

12 FINE postcards, copied from any good photograph, 50 cents. Expert copying of all kinds. Good work, low prices. Myland, 2125 N. Front, Philadelphia.

POSTCARDS—Charming Women in attractive poses. Imported; no trash. Catalog and one sample, 10c. Ritz Publishing Co. (Not Inc.), Dept. 53, Chicago.

THREE Cabinet Photographs Sioux Indians, 25c. Jennings Studio, Valentine, Nebraska.

PHOTOS, Handsome Models. Stunning poses. Samples 10c. Box 32-P, Randolph, Mass.

3,000 SELECTED Cartoons for \$3. A Panorama of World Events, Political, Industrial—Social—Humorous—Tragic—all of intense human interest. A wonderful collection of 3,000 cartoons reproduced from the newspapers of the United States, Canada, Mexico, Cuba and the cities of the Old World, has been made by Cartoons Magazine from more than one hundred and fifty thousand published cartoons, and bound in an artistic and durable cover, are now ready for your library table. Vol. I, Jan.-June, 1912—\$1. Vol. II, July-Dec., 1912—\$1. Vol. III, Jan.-May, 1913—\$1. Cartoons, 78 E. Madison St., Chicago.

20 BEAUTIFUL College Pennants, all different, 9x18 1/2, 20 cents. Heyman Supply Co., Box 121, Williamsport, Pa.

ART Poses. Rare Imported Models, samples and catalog, 10c. Girard Novelty Co., Pawtucket, R. I.

If you really want to exchange postcards, try our splendid club. Lists circulate in many countries. Membership, 10c. Halcyon Club, Box 133, Erie, Pa.

PHOTOS—Fascinating subjects, 10 for 25c. Duff, 2713 Mozart, Chicago.

STUNNING Photos of pretty girls. Real "Beauties." Very clear. Set, 25c. Remy-britt, Stone St., Newark, N. J.

CROSS-SECTIONAL view of ocean liner "Britannic," showing interior arrangement of ship in colors, size, 14x20 inches, on heavy plate paper for framing or hanging. Very interesting. Reproduced from front cover design of July issue Popular Mechanics. Will be sent postpaid to any address in the world on receipt of 4 cents in stamps to cover packing and mailing. Popular Mechanics Magazine, 6 N. Michigan Ave., Chicago.

#### CAMERAS AND PHOTO SUPPLIES

LANTERN Slides, Transparencies and Bromide Enlargements. We make pathological and other educational slides to order. Exact coloring guaranteed. Send for price list. F. B. Myrtinger, Lombard, Illinois.

ROLL Films Developed 10c per roll. Printing Post Cards 3c each. 15 years' experience. Give me a trial. You will be pleased. F. C. Hoyt, Sac City, Iowa.

25 FORMULAS for latest fads in photography, 25c. Includes disappearing photos, Phosphorescent photos, Trick pictures; simple enlarging apparatus. Transferring to cloth, chinaware, etc. Satisfaction or money back. P. Benson, Stewartville, Minn.

FILMS developed 5c, prints 3c, all sizes. Johnson's Studio, Oswego, N. Y.

HAVE you a Camera? Write for samples of my magazines, American Photography and Popular Photography, which tell you how to make better pictures and earn money. P. R. Fraprie, 120 Pope Bldg., Boston.

SQUEEGEE glossy prints, no ferrotype plate, no tearing. New scheme. Send 25 cents. A. B. Weeks, Warren, Ohio.

DO you realize that you will never know what good pictures are until you possess Anastigmat Lenses? Why don't you send a two-cent stamp for our free trial offer and valuable exposure meters? Lafbury Co., 305 North Fifth Ave., Chicago.

FOR Sale. 4A Kodak, Tessar lens, Volute shutter, rack and pinion for focusing. Complete outfit cost \$151. Perfect condition, little used, \$85 cash. Dr. Jay Tuttle, Astoria, Ore.

ENLARGEMENTS, 8x10, 25c; 16x20, 75c; films developed free; prints of same 4c. De Vito Co., New Dorp, N. Y.

IVORY Finish Prints. Something new and beautiful. Send your pet film and 4c for sample, together with our free developing coupon. United Publishing Co., 2 Sherman Place, Jersey City, N. J.

TRY us, Roll Film Developed Free. Write "Ensign," Omaha, Neb.

YOUR film receives the personal attention of an expert. Best results, quick returns. Booklet with sample prints and enlargement free. H. Cobb Shaw, 118 Bowdoin St., Boston.

OUR Autotake operates any camera automatically, permitting you to be in all pictures and allows any range of time for posing. Guaranteed. Give model of camera. Price prepaid, \$1 or send for literature. The Autotake Company, M 363, Chicago, Ill.

50c TRIAL offer for 10c. Send one roll of film, any size, 6 or 12 exposure (or film pack); we will develop film or pack and make a total of 6 pictures from best negatives for 10c (stamps). Beautiful 10-inch mounted enlargements, 25c. Price list and sample print free upon request. Roanoke Cycle Company, Roanoke, Va.

ANY film developed, 5c. Prints 3 1/2 x 5 1/2 and smaller, 3c. 24-hour service. National Photo Finishing Co., Dept. M, Omaha, Nebr.

8x10 FOLDING Camera, Zeiss Vitis Lens, B. L. W. A. Lens Series V, in Volute Shutter. C. A. Krabaum, LaCrosse, Wis.

KODAK films developed, 10 cents. Finished paper or Post Cards, 4 cents. Boost, Celina, Ohio.

OPERATE shutter at any distance electrically. Ke-lo Co., Kansas City, Mo.

ANY roll film developed, 10 cents. Prints, 3 to 5 cents each. Unexcelled work. Profit-sharing coupons. Columbine Photo Supply Co., 2147 Lowell, Denver.

SPECIAL trial offer. We will develop and print your next roll of film, any size (six exposures), for 25 cts. Moser & Son, 29 Arcade, Cincinnati, Ohio.

KODAK Finishing. Send Film and Dime for sample work and prices. Square-Deal Photo Shop, 14 Main, West Cairo, Ohio.

MICROSCOPES, Telescopes, Binoculars, Kodaks, bought, sold, exchanged. Enclose stamp. Esasca, 28 John St., New York.

SEND \$1.50 with 4 negatives for 100 finished postcards; each, 4c. Any roll film developed, 10c. Prints 2 1/2 x 3 1/4, 3c each; larger sizes, 4c each. "Kodak Hints" free. 8x10 enlargements, 25c each. Sample Postcard free. This advertisement will appear again in July issue. Caulkins Photo Works, Oneonta, N. Y.

PHOTOGRAPHIC Retouching Taught; cheap course; learn at home. Y. & M. Retouching Co., Dept. M, Marshall, Mich.

FILMS developed 10c, prints 3c to 5c. A reputable incorporated company, conducting largest existing plant. Price list and special offer. Enlargements our specialty. Chicago Photo Finishing Co., 54 W. Lake St., Dept. A, Chicago.

SPOT Cash paid for high-grade Kodaks, Lenses and Cameras. Send full description stating lowest price. Cameras exchanged. In business since 1885. David Stern Co., 1047 W. Madison St., Chicago.

KODAKS, Cameras, all makes, all sizes. Motion picture cameras, hundreds of anastigmat lenses and speed shutters of all makes at about half regular prices at New York's largest photographic store. Send for largest bargain book. Koehler's Camera Exchange, Inc., 7 East 14th Street, New York.

BIG Money Saved on Photographic Lenses and Apparatus—goods exchanged; repairing done. Ralph J. Golsen, 63 East 46th St., Chicago, Department P.

WE buy, sell and exchange. Bargains in Microscopes, Telescopes, Binoculars, Cameras, etc. Bargain list sent. Kahn & Son, Opticians, No. 54 John St., New York. Established 62 years.

FILMS developed 10c, all sizes. Prints 2 1/2 x 3 1/4, 3c; 2 1/2 x 4 1/4, 3 1/2 x 3 1/2, 3 1/2 x 4 1/4, 4c; Post Cards, 50c doz. Work guaranteed and returned 24 hours after receiving. Postpaid. Send negatives for samples. Girard's Commercial Photo Shop, Holyoke, Mass.

SAVE 40% on Photo Paper from factory, prepaid. "Instanto" has a sparkling quality no other gaslight paper possesses, quick printing develops easy. Money back guaranteed. Send 25c for 3 dozen postals or 4x5 size, price list and full directions. Photo Products Co., Dept. J, 6109 La Salle St., Chicago.

ROLL Film developed, 10c a roll. Packs 25c each; Prints, Brownies, 2c; 1a, 3x4, 3x5, and Post Cards, 3c each. Work returned next day. Postage paid. Kodak Film Finishing Co., 112 Merchants Station, St. Louis.

KODAK Films Developed, 10c per roll, any size. Prompt attention given mail orders. Prints, 2 1/2 x 3 1/4 to 3 1/2 x 4 1/4, 3c; 4x5 to 3 1/2 x 5 1/4, 4c. J. M. Manning, Box B, 1062 Third Ave., New York City.

#### MOTION PICTURES

EDISON Motion Picture Machine half price. Bargain list free. National Employment Company, Duluth, Minn.

WRITE Moving-Picture Plays, \$50 each. Correspondence course unnecessary. Details free. Atlas Publishing Co., 394, Cincinnati.

\$35 PROFIT Nightly—Moving Picture Business—small capital starts you, no experience needed. Teach you—furnish everything. Ralph J. Golsen, 65 E. 46th St., Chicago, Dept. M.

MAKE a complete Motion Picture Camera and Projector from instructions given in our book Amateur Mechanics No. 4. Full details given. Not hard to construct. Worlds of enjoyment taking and exhibiting subjects dear to the heart. Price of book only 25c postpaid. Popular Mechanics Book Dept., 6 N. Michigan Ave., Chicago.

MOTION Picture Work—A large 618-page book covering every phase of the moving picture, its production and its theatre. Indispensable for reference and instruction to the thousands of workers in the motion picture field. Price \$3, postpaid. Popular Mechanics Book Dept., 6 N. Michigan Ave., Chicago.

WE can show you how to sell your photographs, stories and ideas. Quick, profitable sales. Model photoplays and criticisms free. No courses or revision. Proof free. Manuscript Sales Co., Box 300, Hazelhurst, Pa.

#### BUSINESS OPPORTUNITIES

START Japsop factory and save freight from us. Five seconds demonstration positively astounding to everybody. Exclusive rights. Immense profits. Write for proposition and samples. Japsop Manufacturing Co., 619 So. Broadway, Los Angeles, Cal.

3,000 FORMULAS, Trade-secrets and money-making plans, 364 page volume, alphabetically indexed, 50c. Formula Bureau, 3311-B, Belleplaine Ave., Chicago.

PLASTOGRAPHY booklet enables you to make from life durable busts of your friends in imitation marble, bronze, etc. Copies statuary, appeals stronger than photos or paintings. Inexpensive, easily learned, profitable; price, \$1. Particulars free. School Plaques made to order. Box P, P. B. Spahr, York, Pa.

OWN a Business—1,000% profit manufacturing Inks at home, spare time. Capital and experience unnecessary. Enormous commercial demand. Our secret formulas and sure selling plans insure lucrative, steadily increasing business. No canvassing. Investigate immediately. Particulars free. A. Covert, Secretary, 6935-6939 Kenwood Ave., Chicago.

I NEED branch managers for my world wide mail-order business. Operate from your own home in spare time. No canvassing or peddling. Experience unnecessary. You should make \$30 weekly. Butler, 407 Factories Bldg., Toledo, O.

IMMENSE profits selling secret writing code. Impossible to read without key. Manufacture yourself. All profit. Sample code with instructions for quarter. Codi-graph, Jeffersonville, Ind.

LEARN to Make Metallic Sign Letters, \$30 to \$50 per week profit. Capital and experience unnecessary. Complete course, \$1. Particulars free. Cushing, 4816 South Vermont, Los Angeles, Cal.

**MAKE Big Money** mailing circulars. Particulars free. Stanford, Canonsburg, Pa.

**MAIL Order Business.** We start you right. Furnish everything. Ideal Novelty Co., Desk 3, Palmyra, Pa.

**USE** your spare time to build up a mail-order business of your own. We help you start for a share in profits. 27 opportunities. Particulars free. Opportunities Exchange, Buffalo, N. Y.

**WRITE Moving-Picture Plays:** \$50 each. Correspondence course unnecessary. Details free. Atlas Publishing Co., 3946, Cincinnati.

**\$30 WEEKLY** manufacturing post cards. Easy to learn. Stamp for particulars. Almer Agency, Jackson, Michigan.

**TWELVE** years ago I started a small mail-order business at home in spare time with a few dollars capital. I wanted to make \$30 or \$40 a month, evenings. The net profits the first year averaged \$300 a week. Five years' work netted me \$50,000. I will show you how to start a small mail-order business. Send today for my proposition. It's interesting. No canvassing. Heacock, Box 867, Lockport, N. Y.

**BEATS 'em all.** I got 30 to 40 letters a day, each contains dime. You can do same. Particulars 10c. Hovey, Perry, Okla.

**FIVE** to 10 dollars per day, sharpening safety razor blades. Automatic machine does all. Experience or big capital unnecessary. Details free. Henderson Machine, 261, Cincinnati.

**READ "Booster"** and make more money! Operate Mail Order business during your spare time. We'll show you how! Sample copy, 10c. Booster Magazine, Northwestern Building, Chicago.

**BECOME Steam Engineer.** Make \$100 monthly. Questions and answers for license, complete—25c. Geo. Olive, Willmar, Minn.

**BIG** income in hard times! I want to start you selling by mail a wonderful little proposition that just fits the times. Intended to sell for two dollars, but owing to tight conditions you sell it by mail for 50 cents and clear 48 cents on every order! I want you to have a sample, but cannot afford to give it away to everybody. Evince your interest with a dime for expenses and I'll send this sample, with the whole story of how I start you selling it, and see you through. I furnish everything. Benj. Burdick, 682, Kalamazoo, Mich.

**"HIRE Yourself as Boss."** Big corporation will back you in Money-Making Mail-Order Business selling Guaranteed Goods. Start spare time. Small capital. No canvassing. Wm. J. Dick, Mgr., Dept. J-10, 20 W. Lake St., Chicago.

**LARGE** Chicago Advertising Organization desires local representation. Investment of \$300 necessary. Fully secured. Chance to establish in permanent and paying business. Merchants Advertising Service, 716 Medinah Bldg., Chicago.

**OWN** a business. Co-operate with me evenings at home. Everything furnished. Don't worry about capital. Boyd H. Brown, Dept. H-5, Omaha, Nebr.

**PROFIT-Sharing Mail-Order Plan;** absolutely new. Goods, literature furnished. DeLute Distributing Co., Station B, Baltimore, Md.

**WE** start you in business, furnishing everything; men and women, \$30.00 to \$200.00 weekly operating our "New System Specialty Candy Factories" home or small room anywhere; no canvassing. Opportunity lifetime; booklet free. W. Ragsdale Co., East Orange, N. J.

**HAND-WROUGHT** Copper Novelty. Full course of instructions, blue prints. Make your own tools. Sale pointers. All for \$1.00 with free 50c sample, by mail prepaid. No fake. L. Llewellyn, 1212 Bonnie Bldg., Los Angeles, Cal.

**BE** Independent; own a Wallpaper-Cleaning Business; whole or spare time; \$150-\$300 a month easy; big profits; no experience required; my booklet shows you how; write today. Miliken Co., Davenport, Iowa.

**BIG** Kansas Company will start ambitious man or woman in fast growing business; any locality; \$3,000 yearly; spare time; no canvassing; no experience. We furnish everything. Write for unique selling plan. C. W. Eyestone, President, 174 E. 5th, Pittsburg, Kansas.

**MAIL** Order Beginners, Agents, Opportunity Seekers. Write for my free literature. H. B. Essex, Box 476, Baltimore, Md.

**INCREASE** income at home. Particulars free. 1116 Monroe, Rochester, N. Y.

**EXCHANGE** factory rights, salable shop tool, no competition. S. Grove, Allensville, Pa.

**"HOW** to Write a Pulling Ad" sent free upon request. Cope Agency, St. Louis, Mo.

**RESILVERING** Mirrors. Renewing Dry Batteries, 150 selected formulas 25c. Formula Service, 3311-E, Belleplaine Ave., Chicago.

**WE** will start you in the cleaning and dyeing business, little capital needed, big profits. Write for booklet. Ben-Vonde System, Dept. C, Charlotte, N. C.

**"DOLLARS"** yearly in your back yard. No ginseng, mushroom dope. New ideas never before published, particulars free. Metz, M. 132 W. 34th St., New York.

**ADVERTISERS, Mail Dealers:** Our 1915 Rate Book lists 2,000 Principal Publications, rates, circulation. Includes 30 Mail-Order Plans. Price 10c. Dearborn Advertising Agency, 210 Franklin Bldg., Chicago.

**OPERATE** profitable mail order book business. 700% profit each sale; small outlay, everything furnished. Spare time. Particulars free. Rejilins, Box 5272, Boston.

**ONLY** \$200.00 required to start profitable money-making business of your own, handling Punch Board Assortments, showing 100% profit. Washington Sales Co., Department P, Chicago.

**\$8.00 PER** day easily made with our plan; write for proof and sworn statement, tells how. Dept. 56, National Distributing Association, Flint, Mich.

**SEND** stamped envelope for information on the biggest mail-order system with the smallest investment. Specialty Co., Box 885, Bridgeport, Conn.

**OPERATE** independent, profitable Post-card Exchange; \$5.00 capital required. My advice with years' experience mailed. \$1.00 Membership, 10c. W. Lee (Pres.), Bryn Mawr, Wash.

**EXCLUSIVE** territory for local manager—selling auto accessory. Big profits. Get our free sample offer. Scientific Products Co., Ashland, Ohio.

**MONEY** in contracting. Spread San-1-tite floors; sanitary; fire-proof. \$150 to \$300 made monthly contracting kitchen floors alone. Instructions telling how to make and spread sold outside this district for \$3. San-1-tite, Washington, Indiana.

**LEARN** Tartaric Mirror Silvering—14 days. Barstow, 513 23rd St., Oakland, Calif.

**MAIL-ORDER** Beginners, postal brings interesting literature. Send for it—Free. L. M. Levin, 13 Vestry St., Haverhill, Mass.

**HERB** Recipe Book and Herb Catalog, 10c. Teaches how to make medicine from herbs for all diseases. Herb Gardens, Dept. 44, Hammond, Ind.

**MAKE** \$50.00 monthly furnishing commercial reports; no canvassing; good opportunity; co-operative offer free. "Cleo," PMC, Peru, Indiana.

**AN UNUSUAL** opportunity for a man with \$2,000 to \$8,000 cash, with a knowledge of machinery, to invest in a combination rice grist, syrup mill and cotton gin, in a live town on the Gulf Coast. Nearly all Northern people. No special knowledge of the above required. Climate very beneficial for Asthma, Catarrh, Hay Fever, Rheumatic and Kidney Troubles. Purest water. No malaria. Attractive surroundings. Foley & Co. 2835-2845 Sheffield Ave., Chicago, Ill.

**CAPITAL** wanted to manufacture an original cushion, non-slip, heel plate for shoes, just patented. File Mail Order and Agent's article. Hugh G. Robinson, Box 205, Oakland, Calif.

**LIVE** men for a lucrative business proposition which requires small investment for exclusive automobile necessity. No experience necessary. Write Peerless Motor Specialty Co., 2 Columbus Circle, New York.

**FIFTY** Dollars weekly easily made. New advertising feature. Send twenty-five cents for proposition. Empire Advertising Company, 87 Plymouth Avenue, Buffalo, N. Y.

**OPPORTUNITY** is knocking at your door. Owing to the war, many common weeds are now of great value. Handellon has doubled. Our treatise on roots, herbs, barks—collecting, curing, selling, thirty cents, postpaid. L. J. Brown & Co., Muskegon, Mich.

**HOW** to Operate a Mail Order Business. 30 Big Profit Plans and year's Mailing service sent for 10c. Mail Dealers' Wholesale House, 521 Franklin Bldg., Chicago.

**\$5 DAILY** easily earned at home, spare time, silvering mirrors; no capital. Free instructive booklet tells how. Patterson & Co., Dept. 8, Brookville, Ky.

**"PROTECTING** Inventions Before Patent Without Cost," next issue Inventor's Advocate, Advocate Building, 14, Washington, D. C., one year, 25c; three months, 10c.

**PATENT** Application fully prepared. \$10. Why pay \$65? Particulars free. Patent News, Dept. 20, Washington, D. C.

**WOOD** Stains, complete instructions, \$1. Mahogany, birch, maple, ebony, mission, early English, walnut, oak, etc., etc. Roth, A-45 Frost St., Brooklyn, N. Y.

**OPERATE** Hahn's Premium Machines, the best seller for cigars and candies. J. Hahn, 1016 Germantown Ave., Philadelphia.

**START** in the Carpet or Clothes Cleaning Business now. Thurman Vacuum Process unequalled for commercial cleaning. We show you how. Easily learned. Only \$125 capital needed to earn good income in towns of 2,000 and over. Write today. Thurman Vacuum Cleaner Co., Manufacturers all types Vacuum Cleaners, Dept. H, St. Louis, U. S. A.

**LEARN** the Real Estate Business. Our complete instruction book teaches: Listing, Appraising, Management, Salesmanship, Insurance, Brokerage, Advertising, Renting Agency, Forms, etc. 121 subjects. Excelsa \$20.00 correspondence course. Buckeye cover, 75c. Silk cloth \$1.00 postpaid. Realty Book Company, 5982 Euclid Ave., Cleveland, Ohio.

**CONDUCT** a "Candy Kitchen." Clear \$5 to \$25 daily. Small capital required. Particulars free. The Kennon School, 142 W. Ontario St., Dept. A, Chicago.

**LET** the parcels post help you. Add (\$15 to \$25 weekly) to your present salary or income. Start during spare time and build up a permanent mail-order business of your own. We show you how and help you make good. No canvassing. Experience unnecessary. The Parcel Post makes success doubly sure. Our new ideas and up-to-date plans bring the money. No so-called "Course of Instruction" to sell. We give that free. Write today. Address Pease Mfg. Co., Inc., Dept. A, 70 Broadway, Buffalo, N. Y.

**BE** Wise. Don't experiment in mail order. I can tell you how to succeed. B. Newnam, Waukegan, Ill.

**MANUFACTURERS, Promoters and Patent Buyers** are invited to write us stating the line of invention in which they are interested, as we can supply their wants in any class of patents. Victor J. Evans & Co., 162 Ninth St., Washington, D. C.

**WOULD** You Like to Own a good-paying mail-order business? We have a line that gets repeat orders all the time. You can start in spare time; invest a dollar or two a week and soon own a nice business of your own. Particulars free. Nadico, 1664 Belmont Ave., Chicago, Ill.

**INDEPENDENCE** and fortune quickly attained in the Manufacturing Mail Order business. I furnish Formulas, Manufacturing Processes and Trade Secrets in all lines. Sold under positive guarantee; 18 years' practical experience. Revision and improvement of Formulas and Processes—reduction of manufacturing cost—utilization of waste materials, etc., a specialty. Booklet, Formula List, and Valuable Information Free. W. L. Cummings, Ph. D., 127 Standard St., Syracuse, N. Y.

**STOP** Here! Let me start you in a home business that will bring you money every day. Experience unnecessary. Spare time. No canvassing. I furnish everything. Send for proofs. Voorhes, Desk C. R., Omaha, Neb.

**PATENTABLE** ideas wanted—Send for 3 free books. R. B. Owen, 30 Owen Bldg., Wash., D. C.

**IF** you want facts instead of fancies about Patents, address Benjamin & Bassett, 140 S. Dearborn St., Chicago.

**LEARN** to collect money. Good income; quick results. Send for free booklet, "Skillful Collecting." Collectors' Association, Long Street, Newark, Ohio.

**I WANT** to send you proof of the wonderful pulling power of Popular Mechanics classified pages. What's your proposition? Write me today. P. W. Johnson, Classified Dept., Popular Mechanics Magazine, 6 N. Michigan Ave., Chicago.

**ONE** beginner makes \$200 per week operating an original mail business we planned. You can. Small capital—spare time—experience unnecessary. No "Outfits" or "Instructors." Proof free. Success Mint, 400 Main, Smethport, Pa.

#### MAIL ORDER SUPPLIES

**INCREASE** your sales. Place your proposition before the readers of "Cartoons Magazine." 50,000 copies guaranteed every month. Classified rate 2c per word. Mail in a trial ad today. Cartoons Classified Dept., 78 E. Madison St., Chicago.

## DUPLICATORS AND DEVICES

\$2.40—THE "Modern" Duplicator. 20 days' free trial—32,846 firms use it to make 50 to 75 duplicate ("Made in U. S. A.") copies of each letter, or anything written with pen, pencil or typewriter. Booklet free. Main office, J. E. Durkin & Reeves Co., 339 Fifth Ave., Pittsburgh, Pa.

A DUPLICATOR \$1.60. Letter size. Make over 50 copies from pen or typewritten original. Send for circulars. Scientific Laboratories, Dept. 1, Madison, Maine.

## TO MANUFACTURERS

WE desire to correspond with manufacturers seeking locations. We have a railroad, about to be constructed through territory where steam coal can be had at 75c a ton; electric power at 1c to 1½c a k.w. hr.; gas, 7c to 8c per M. Road touching or crossing seven systems, offers exceptional opportunities for manufactories of all kinds. Territory rich in pottery, brick and tile clays; fine quality of limestone and cement rock. An exceptional town site, with the above-named fuel and power supplies, with three railroads—32 passenger trains daily. Good factory sites in 39 towns along the line. Address W. B., Room 25, 78 E. Madison St., Chicago.

MANUFACTURER'S Agent wishes to be placed in touch with Manufacturers of high-class Hardware and Woodware Specialties. Cameron Bros., 615 Central National Bank Bldg., St. Louis, Mo.

## FOR ADVERTISERS

ADVERTISE your business, paint all kinds of attractive signs with our stencil letters—one inch up to four feet high. Special 14 inch high 16c apiece. Particulars. Bir Sign Co., Fort Wayne, Ind.

500 ADS, every month. Big list 100 magazines—5c word—\$4.00 incl. Send order now. Magazine, Lists free. Stanford, Canonsburg, Penna.

10,000 BOYS read our 9x12 magazine. Display 6c line; minimum 42c. Classified 1c word, minimum 25c. Two insertions 15% discount. Youths' Magazine, Chicago.

ADVERTISE—In Barkley's Magazine 20 word. Barkley's Magazine, Mount Pleasant, Pennsylvania.

MORE Business at less cost. You want the dollars you put into letters. Follow-ups, ads; circulars, folders, booklets, to accomplish just that. Therefore write Harrmann, No. 1 Sutton Place, New York, for sales help.

ANYBODY can write a sales letter, but everybody will not read it. Only few people can write in such form as to make all people read. Try Martin & Miller, Advertising Counselors. And address their Business Department, 239 Fourth Avenue, New York.

## ADVERTISING SERVICE

FIRST class display advertisements, \$5 each. Circular letters \$5 each. Advertisers' Service, 1809 Lincoln St., Evanston, Illinois.

LETTERS and advertisements written—to accomplish your purpose. Free criticism of your present literature will show my grasp of your individual problem. Dunbar, 1513 Roxana St., Boston.

WANT more orders? My follow-up letters get 'em. Strong, pulling copy that "brings home the bacon." Send your literature for free criticism. I can turn your prospects into customers. C. T. Anderson, 1334 Waverly Ave., Duluth, Minn.

## PERSONAL

FREE—Stop using Tobacco—Free. We will give you free information how to conquer the habit easily and permanently. Results guaranteed. Anti-Tobacco Remedy Co., Dept. G, Omaha, Neb.

USED Tobacco 40 years, a permanent cure in 72 hours; full particulars, \$1. Box 12, Pioche, Nevada.

RECEIVE valuable mail, ten cents, P. Cornish, Schenectady, N. Y.

STAMMERS, Attention! I can cure you at home by my mental training course. Particulars free. R. Arnaud, Keene, N. H.

BROTHER—Accidentally discovered root cause tobacco habit. Gladly send particulars. F. Stokes, Mohawk, Florida.

## AGENTS WANTED

IN open territory for our Special Value Big 4 line for the coming Fall and Winter Season 1915. Four pieces only. Tailored suits to measure at \$15.00, \$20.00, \$25.00 and \$30.00, retail. Fit and workmanship guaranteed. Full assortment to sell at \$15.00. Prominent agents now handling line pronounce it easiest selling and most satisfactory and profitable ever handled. Applications also solicited from representatives of co-operative societies, church organizations and suit clubs formed for mutual benefit. Give full particulars with application. Nelson Tailoring Co., 241-245 West Van Buren Street, Chicago.

AGENTS Wanted—If you know a chance when you see it you'll see this one now. Big money—stylish, nifty clothes—little work—no experience or capital needed—can you beat that? We want agents everywhere to take care of our business in their localities and to advertise our nobby, nifty suits by wearing them. We furnish everything, complete, and charge nothing for agent's outfit. The swiftest dressers everywhere are our agents and all we ask is that you tell people who inquire about your fine clothes where and how they can get them. You make big money—\$10 a day—without trouble. Just a postal brings you full outfit free. Big new sample book of up-to-the-minute suitings sent so you can pick out your first suit; also measuring blanks and everything you need. We pay express on everything—not a penny for you to pay. Send quick before some one else gets the agency there—mail postal today to the American Woolen Mills Co., Dept. 514, Chicago, Ill.

WE are the largest manufacturers of twisted Wire Brushes in America. Highest grade goods, best service, largest profits. Our new Auto Specials are winners. Send for catalog. Fuller Brush Company, Hartford, Conn.; Rock Island, Ill.

GUARANTEED Solid Gold Self-filling Fountain Pen. Fills in 2 seconds, cleans automatically. Not sold in stores. Agents get busy. Sample 75c, sells \$2.00. Money back if you want it. S. Mfg. Co., 41 Warren St., N. Y., Pen Dept. 4

AGENTS: Get particulars of best proposition now on market North Carolina Mfg. Co., Dept. 18, Washington, N. C.

AGENTS—Vacuum Sweeper. New design; big profits; easy to get orders; \$30 to \$60 weekly. Roy Metcalf, General Manager, Penn Yan, N. Y.

AGENTS: Don't fool with trinkets. Sell the Motometer, just patented. Retail \$5. Write today. Steele, Box 1, Wilkinsburg, Pa.

NEW 1915 Model—Send no money, just your name on a postal card, and learn by return mail how to get the best Vacuum Cleaner made, without costing you one cent. Shipped direct from factory, guaranteed for 5 years. Reliable, live agents wanted. The Warner Company, Dept. 2, Muncie, Indiana.

BIG Kansas Company will start ambitious man or woman in fast growing business; any locality; \$3,000 yearly; spare time; no canvassing; no experience. We furnish everything. Write for unique selling plan. C. W. Eveshine, President, 160 E. 5th, Pittsburg, Kansas.

FREE Sample—Nosplash Water Strainers sell themselves—no talking—experience unnecessary. Profits big. Send 2c (mailing cost). F. A. Union Filter Co., New York.

AMBITIOUS Men-Women, 18 or over, wanted. Government Jobs, \$65.00 to \$150.00 month. Full list of positions now obtainable free. Franklin Institute, Dept. 8-22, Rochester, N. Y.

AGENTS wanted for portraits. Deal direct with the artist, Frank Wanderley, Wheaton, Ill.

"MARVELOUS"—Expanding cuff button. Slip your cuffs up or down upon forearm without unbuttoning. Positively stay where you place them. Reduces laundry bills and fills a positive want, practical, guaranteed. Exclusive territory. Fastest selling specialty on market. This is a high-grade proposition. Large money maker. Agents wanted everywhere. Flexo Cuff Links Co., Sheboygan, Wis.

A \$2.50 PREMIUM with every \$1.98 sale and 70 cents profit for you means big daily profits. Free samples. Address Bloom & Black Company, Trenton, New Jersey.

YOU can make big profits selling our Pure Aluminum Kitchen Utensils—Guaranteed for 20 years. Our specialties are not sold in stores, and they get the business for you. \$250,000 firm and liberal credit plan backs you. We have an attractive General Agency offer. Wm. J. Dick, Manager, Dept. 3-21, 20 W. Lake St., Chicago.

AGENTS—Sell the Primus, genuine Swedish wickless, coal-oil stoves, Smokeless, odorless. Twice the heat of gasoline at one-eighth the cost. No danger of explosion. Big profits. James Anderson & Sons, Sidney, Ohio. American distributors.

YOUNG Man, would you accept a tailor-made suit just for showing it to your friends? If you live in a town smaller than 10,000, write Banner Tailoring Co., Dept. 50, Chicago, and get beautiful samples, styles and a wonderful offer.

SIGN Letter Agents and Painters: 500% Profit Gold and Silver Sign Letters for Stores and Office Windows. Anyone can put on. Big demand. Free samples. Metalite Letter Co., 404 N. Clark St., Chicago.

ACTIVE, permanent agents (men and women) to sell Moore Self-Winding Clothes Line and Reel. Only perfected article of its kind. Line keeps clean and dry, never set clothes, never gets tangled; easy to put up and take down, winds up automatically. Every good home a sale at a good profit. Send today for agent's book—"Plenty of Sales and Plenty of Profit." Moore Drop Forging Co., Dept. A, Springfield, Mass.

AGENTS—Drop dead ones. Awake! Grab this new invention. Low-priced, water-proof home massage machine. Magical, marvelous, mysterious. New field. Big profits. Sold on money-back guarantee. "Margwarth sold 5 in 10 minutes; 31 in 2 days." "Parker sells 8 first day; 31 in 2 days." "Vaughn, your machine has merit. Express 5 dozen." Free information. Blackstone Co., 33, Meredith, Toledo, Ohio.

AGENTS make big money and become sales managers for our goods. Fast office sellers. Fine profits. Particulars and samples free. One Dip Pen Company, Dept. 2, Baltimore, Md.

AGENTS—Delicious Soft Drinks in concentrated form. Always ready—just add water—economical—absolutely pure. Every housewife wants them—14 different kinds. Enormous demand. Big summer sellers—money comes easy. 250 other popular priced, fast selling, household necessities. We furnish free outfits. Write today—now. American Products Co., 2229 American Bldg., Cincinnati, O.

PERFECTION Pocket Adding Machine. Lightning seller. Agents wanted. Cincinnati Specialty Mfg. Co., Dept. B, Cincinnati, Ohio.

PHOTO Pillow Tops, Portraits, Frames, Sheet Pictures, Photo Plates, Pennants. Rejects credited. Prompt shipments; samples and Cat. free to agents. 30 days' credit. Jas. C. Bailey Co., Desk A-5, Chicago.

WINDOW Lettering Business. We start you free. Everette Co., Dept. P., Long Island City, New York.

JUST Out. Machine Safety Razor Sharpener. Blades can be used 100 times. No strap to cut, no hook in wall. Saves its cost each few months. Agents go to it. Sample \$1.25, sells \$2.50. Money back if you want it. S. Mfg. Co., 41 Warren St., N. Y. Machine Dept. 4.

AGENTS: Magic Metal Mender, mends Enamel, Tin and Aluminum Ware, Brass, Copper, etc. without soldering irons or acids. Sample 15c. Faam Novelty Co., 295 Mononock Bldg., Chicago.

\$61.50 WEEKLY introducing and selling a new gas light burner for kerosene lamps. Beautiful light, no chimney. No mantle. Perfectly safe. Simple in construction. Nothing to get broken or out of order. Will not burn out. Durable. Will last for years. Low price. Easy to sell. 200 per cent profit. Experience not necessary. Sample free. Why not try one on your lamp? Beware of imitations. No branch offices. Leather Manufacturing Co., Dept. 34, Cincinnati, Ohio.

SELLS like hot cakes. New Ironing Wax, holder and asbestos rest. Perfumes clothes. Nothing like it. Working outfit 5c. MBR Mfrs., 12 Water St., N. Y.

POSTCARDS, 90c thousand. All kinds. Sample 25 assorted 10c, postpaid. Mitchellson, 27 West 139th, New York.

WANTED, Agents—General Agents for Specialty. Sells to every Shoe and Repair Shop, Notion Store, House and Office. Big money for hustler. Gilliam Mfg. Co., Box A, Canton, Ohio.

\$3 TO \$10 daily easily made silvering Mirrors. Wonderful new Tartaric Process opens enormously profitable business. Particulars free. A. Barstow, 514 23rd Street, Oakland, Calif.

THE Add-Phone attached to a telephone makes hearing easy in noisier places. Every telephone user wants one. Wagner Co., 1032 People's Gas Bldg., Chicago.



**AGENTS Wanted**—Right here is the one big chance of your life. If you want to make good money—\$10 a day or more, as easy as rolling off a log, and get your swell clothes free besides, you can do it by acting as our agent. We are the biggest people in the business and want our agents to make big money and be nifty, stylish dressers. Send a postal today for free \$10 outfit, including a big book of nobby suiting samples to select your swell agent's suit from. Then take orders from people who admire your nifty clothes. They come to you—not you to them. This is the way to get rich—the sure, easy way. Remember, you need no money—everything is furnished by us free. We pay express on everything. Just send a postal, but do it today. You can't get started too quick, making this big money and wearing these stylish clothes. Address card to Paragon Tailoring Co., Dept. 514, Chicago, Ill.

"BILLY Sunday's" wonderful sermons and quick-fire sayings take country by storm. Agents now making \$6 to \$15 daily selling "Sunday's" only authorized book; illustrated. Marvellous seller anywhere. (Unusual proposition to mail dealers.) Get next! Marvello Company, Binghamton, New York.

**AGENTS**—Big money selling our household specialties. Write for catalog. Kreimendahl Co., 460 Wilbraham Road, Springfield, Mass.

**AGENTS**—Business your own \$15. Turn capital two or more times a week; 140% on turn; big winner; repeats; sells 25c; Douthaco, 698 Dearborn, Chicago.

**AGENTS**: Make \$100.00 next week. You can. Others do. New invention. Washes while boiling. No rubbing. Generates own power. Forces 29 streams suids through clothes. Outselling everything, \$1.50. Free sample. Geyser Washing Machine Works, Chicago.

**MEXICAN** Diamonds exactly resemble genuine; same rainbow fire; stand tests; sell on sight. We need few more live agents. Profits \$50 weekly and up. Write quick for sample case offer free. Mex. Diamond Importing Co., Box A, Las Cruces, N. Mex.

**EARN \$200.00 to \$500.00** per month co-operating with us, from your home. Address "Ewing Company," Parkersburg, W. Va.

**FOUR** dollars' worth of my goods free. Send red stamp for particulars. Halfstanger, Ridgefield, Conn.

**INTRODUCE** "Jap-Silk Non-Breakable Gas Mantle," new in America, lasts longer, throws greater light, fits standard inverted burners, rapid seller. Exclusive territory given. Particulars upon request. P. Jules, 209 W. 48th St., New York, N. Y.

**SILVER** Plated, Self-Filling Pen. No dropper required. No rubber ink-bag. No "mussy" fingers. Dip pen in ink, reservoir fills instantly. Lasts indefinitely. Agents wanted everywhere. Quick sales, big profits. Sample ten cents, none free. Ed. H. Irwin, Box 1201, Carthage, Mo.

**PORTRAIT** Agents deal direct with the artist. Write for prices. Better work and better service. Geo. Price, 111 W. Erie St., Chicago.

**\$39 WEEKLY** easily selling Ladies' Combination Hand Bag, appealing to every woman. G. C. Coffman, Box 56, Huntingdon, Pa.

**AGENTS**—Earn \$30 to \$50 Every Week selling the New Improved Monitor Self-Heating Flat Iron. Positively the lowest priced and fastest selling iron made. Over 650,000 already sold. Evans, N. Car, sold two dozen on Sat. Mrs. Nixon, Vt., sold eight first half day. Every housewife wants one. Every iron guaranteed. New terms. Exclusive territory. Sample free to workers. Write today. The Monitor Sad Iron Co., 617 Wayne St., Big Prairie, Ohio.

**20% PROFIT.** You can't beat it. Sells everywhere. Free pocket sample. Our goods get the orders. Wm. J. Dick, Mgr., Dept. J-4, 20 W. Lake St., Chicago.

**AGENTS**—Unusual opportunity to earn a steady income and control the sales of the best office and resident necessity on the market; sample fits vest pocket; can sell every telephone subscriber one for each phone; demonstration will make sale. Write for full particulars, selling plan and exclusive territory. Myrophone Company, 1183 Broadway, New York.

**OWN a Business**—1,000% profit manufacturing inks at home, spare time. Capital and experience unnecessary. Enormous commercial demand. Our secret formulas and sure selling plans insure lucrative, steadily increasing business. No canvassing. Investigate immediately. Particulars free. A. Covert, Secretary, 6335-6339 Kenwood Ave., Chicago.

**AGENTS**—If you are making less than \$200 per month—no matter what your locality—you will be interested in our "Sentinel Burglar Alarm" proposition. Brand new invention. Instantly attached any door knob. Impossible turn knob without ringing bell. No batteries, screws or nails. Handsomely nickel-plated. Retail price \$1.00. Provides perfect and cheap burglar insurance. When demonstrated sells on sight to homes, offices. Patented. No competition. Exclusive territory free. For \$1.00 we will send one with full particulars. If not entirely satisfactory, return it and we will refund you \$1.00. You risk nothing and have everything to gain. We know you will be delighted and will exclaim like all others—"Here at last is a real seller and big money maker." Let us prove it. Write today for liberal terms to agents. Marshall Dobbins & Co., 1422 Marquette Bldg., Chicago.

**AGENTS**—\$50 weekly; sell our 15 household inventions; general agents getting rich; every home buys one or more; samples furnished active workers. Offinger & Co., 1309 13th St., Altoona, Pa.

**MAGIC Ink Eraser.** No blade, no acid. Removes ink like magic. Sells like bread in a famine. Sample 10c. Sells 25c to 35c. S. Mfg. Co., 41X, Warren St., N. Y.

**EXCELLENT** proposition selling household specialties. Get busy. Catalogue and particulars free. W. F. Eshelman, Huntingdon, Pa.

**BIG Profits**—H O Sliding Casters. Pocket samples. Easy to attach. Saves floors and carpets. Homes, offices, hotels, buy quantities. 540 Dickey Bldg., Chicago.

**HOUSEHOLD** article sells like lightning. 70% profit to hustlers. Chas. Eads, Valentine, Neb.

**KEROSENE** Gas Burners in Cook Stoves or Ranges stop use of wood or coal. Recently patented. Money-maker for agents. The Vapor-Gas Burner Co., Columbus, Ohio.

**READ** the Agents Magazine and make more money. 2 issues 10c. Agent's Magazine, Chicago.

**AGENTS**—Air Cell Washing Machine. New, marvelous invention. Excels work of washers costing \$25.00 and up. Sells only \$1.00. No wonder every home buys. Exclusive territory free. Nearly 200% profit. Write today. Air Cell Washer Co., 3037 Detroit Ave., Toledo, Ohio.

**NEW** Automatic \$2.50 Adding Machine. Sell 10 a day easy. Big profit. Everyone buys. No competition. Repeat orders. A. Bassett, 5921 Indiana Ave., Chicago.

**"JIPPY"** Ironing Board Cover and Clamps is the biggest red-hot seller ever invented. 150% profit. No competition. Lake Shoe Manufacturing Company, Michigan City, Ind.

**AGENTS**—Snapshoot Household Line on Earth. Red-hot sellers, steady repeaters. Goods guaranteed. Over 100% profit. Write quick—hurry. E. M. Feltman, Sales Mgr., 560 Third St., Cincinnati, O.

**AUTOMATIC** Aluminum Tea Kettle Kover. Latest invention. Self-opening and closing. No scalding hands. Sells when demonstrated. Satisfaction guaranteed. Sample 25c postpaid. Rollins Co., Tremont Row, Boston.

**AGENTS**, step until you get our catalogue! We have a great proposition for men and women agents. Write today. T. H. Snyder Co., 12 E. Third St., Cincinnati, Ohio.

**DISTRICT** Managers, have few openings for live district managers to handle exclusive territory. Staple specialty for hardware and automobile trade, exceptional standing and financial ability to carry stock for retail trade essential. Liberal commissions on jobbing accounts. Junkune Bros., 962 W. 11st St., Chicago.

**AGENTS** Wanted—4 to 10 dollars a day. Address Snyjoco Ventilating Lock Co., East Chicago, Ind.

**GENERAL** Agents and Glassware Jobbers. The greatest 50c article, sells everywhere. Send 30c for sample and particulars. Schoenheit & Pease, East End Pittsburgh, Pa.

**IF** we had your address we'd show you how to earn \$25, not one week, but weekly. Send 10c for samples. Money back if you want it. S. Mfg. Co., 41H Warren St., N. Y.

**ADVERTISE**—20 words in 100 monthlies, \$1. Sample magazine free. Cope Agency, St. Louis, Mo.

**WANTED**—Man or woman of good character in each town to take orders and distribute free goods as advertising; experience unnecessary; references required; \$15 a week to start. Address Hudson King & Co., 2 South Clinton Street, Chicago.

**AGENTS**: \$1,000 to \$3,000 yearly selling over eighty every-day articles to farmers. Pleasant, permanent business. Full instructions. Big chance. Write quick. Duoform Factories, Duoform Company, North Java, N. Y.

**OUT** they go! "How to Get Rich" and 29 other books postpaid straight to you with catalogs for only 25c. Also circulars of war books, show cards, post cards, White Slave books, rare books, songs, joke books, tricks, games, musical instruments, novelties, etc. Ward Publishing Co., Box 433, Chicago.

**AGENTS**—Salary or commission. Greatest seller yet. Every user pen and ink buys on sight. 200 to 500 per cent profit. One agent's sales \$620 in six days; another \$32 in two hours. Monroe Mfg. Co., X 6, La Crosse, Wis.

**PIONEER** Brand Food Flavors; Hygienic Milk Bottle Holders; agents wanted; popular specialties; descriptive circulars free. Weymouth Household Supply Co., Dept. T, Box 387, Springfield, Mass.

**AGENTS**: A free course in General Salesmanship is given to every man of our Sales Organization. This organization is a body of successful men selling the Handy Light; that unique electrical device which cuts the cost of electric lighting in half. Sells for \$3.50, is used in home, office, store, factory; weighs only one pound. Sold by demonstration. All agents furnished with well planned methods for gaining interviews. A high-grade business for a man of ability and standing in his community. General Agents preferred. Inquire for our full proposition by addressing The Handy Light Co., 1102 Handy Light Block, Cincinnati, Ohio.

**AGENTS**—If you make less than \$1 per hour, write us; we manufacture new household necessity; patented; low price; wonderful seller; not sold in stores. Tyler Co., 2210 Main St., Muncie, Indiana.

**AGENTS** are earning money selling our big 10c Packages of 20 Assorted Postal Cards, "5,000 Varieties." "Big Profits." Sell everywhere at sight. Sample Packages 10c. Particulars Free. Sullivan Card Co., 1224 Van Buren St., Chicago, Ill.

**STOP** here and write The Sign Co., Silver Creek, N. Y.

**ALUMINUM** 10-Piece Combination Roaster and Cooking Set, \$1. Sells at \$3. Agents go to it! A winner of winners. S. Mfg. Co., 43 Warren St., N. Y.

**AGENTS**—Average \$5 to \$12 daily selling astonishing Astee massage machine. New. Just patented. Different. No electricity or water power required. Nothing complicated. Affords exhilarating massage without cent expense. Lowest priced, but best outfit. Retail \$2.50 allowing you big end of the profit. Particulars and "beauty" folder free. Astee Remedy Co., Dept. 132, Toledo, Ohio.

**AGENTS**—Make \$30.00 week Selling our Specialties. Send 25c for samples, get wholesale price of Mopex makers. The Electric Appliance Co., Inc. 1891, Burlington, Kansas.

**SIGN** Agents, attention: We have something to offer you that beats selling other people's manufactured letters and signs all to pieces. No previous experience is necessary. Investigate. Address: Ross System, 291 Lincoln Inn Court, Cincinnati, O.

**NICE** income easily earned with quick, sure sellers; permanent position; free samples. Will Sales Company, Syracuse, New York.

**JEWELRY** Scarf Pins, \$1.30 dozen. Money refunded if not satisfied. Classic Jewelry Co., Lynn Street, Providence, R. I.

**LIVE** Agents and Mail-Order Men Wanted to get busy on the latest pencil sharpener on the market. Sells for 15c to everyone; no cut fingers, no shavings on the floor. Stops all yelling at the kids when they dirty the floor. Indestructible, re-sharable blade. Send 25c for sample. Proposition and book on salesmanship with first letter. Get busy, men out of work, and make money. 100 to 150% profit to live ones. Deposit Co., Majestic Bldg., Detroit, Mich.

**AGENTS**—New mighty money-making marvel. World startled. New marvellous clothes-washing crystal. Clothes-washing idea revolutionized; positively abolishes rubbing, washboards, washing machines—women astounded, wild over it; absolutely harmless. \$1,000 guarantee goes with it; make \$50 to \$100 weekly easy. Exclusive territory, no experience necessary; credit granted; own a business, supply customers; pocket big profits; nature's mighty elements do work. Harry! Write today—get overwhelming proof, all free. Equitable Corporation, Dept. 267, 215-217 W. Superior, Chicago.

**PATENTS** granted. Customers all ages wildly enthusiastic. Buy on sight. Agents with ear for music are becoming financially independent. Osborn Mfg. Co., Masonic Temple, Chicago.

**AGENTS:** You can make big money with our summer special. Sample and particulars for ten cents. Henderson Supply Co., 324 M 57th St., Brooklyn, N. Y.

**SOAP** Agents and other canvassers—For profitable side line, fitting into your regular work, write Lefman Mfg. Co., Richmond Hill, N. Y. City.

**AMERICA'S** Daily Necessity. Stamp brings sample. The Simmons Co., Hicksville, Ohio.

**AGENTS—**If you want to receive many desirable propositions to select from, tell us what line you prefer. Canvassing Agents' Registration Bureau, 123 Hart St., Providence, R. I.

**AGENTS—**Here's a winner. The Midget Vest Pocket Garment Hanger—sells on sight. The most attractive proposition ever offered. 150% profit. No competition, as article is fully protected by U. S. and foreign patents. Address: Dept. "M," The Silve Company, 171 Madison Ave., New York.

**SEND 10c** for six household guaranteed formulas for home manufacture. All big sellers. Collyt Laboratories, 575 W. Washington St., Chicago, Ill.

**PORTRAIT** Agents: Our goods will make you big profits. Delivery guaranteed. Referrals credited. Prompt shipments. Low prices. Catalog and samples free to workers. Adam J. Krul & Co., 692 Blue Island Ave., Chicago, Ill.

**AGENTS:** So many lady and gentlemen hustlers have accepted our liberal offer to trust them to \$3.00 worth Starr's Powdered Enamel which repairs chipped and rusty spots on granite, stone, all leaky kitchenware, metal and slate roofs, eavespoets, oil-cans, etc., that we will continue our offer for a short while longer. A household necessity with no dull seasons. Beware of would-be imitators. Prepaid sample with particulars. 10c. Starr, 1919 Monroe St., Toledo, O.

**ICELESS** Milk-Bottle Cooler. Keeps milk and cream from souring. Absolutely new. Retail 50c. Dept. 45 A, Edmund Feeny Co., Muscille, Indiana.

**STOP** here and write The Sign Co., Silver Creek, N. Y.

**U. S. GOVERNMENT** uses Richmond Extinguishers that kill gasoline fires. Four sizes. Three kinds. District Managers make 500% profit. Auto free. Richmond Chemical Co., Room 49, Wheeling, W. Va.

**AGENTS—**\$15 profit, two sales a day. Machine for saloons. Big seller. Free sample, salesmanship course. Write Mohler, Mason Building, Chicago, Ill.

**YOU** can sell our Raincoats. Anyone will buy. We give you one. Outfit free. Temple Raincoat Co., Box 225, Templeton, Mass.

**AGENTS—**Sell rich-looking imported 36x68 Rugs, \$1 each. Carter, Tenn., sold 115 in 4 days. Profit, \$57. You can do same. Write for sample offer selling plan; exclusive territory. Sample rug by parcel post prepaid, 98c. Condon, Importer, Stonington, Maine.

**EASY** money, \$5 to \$10 daily, spare time; double if full time; biggest agent's proposition on market; if you fail to write us you pass up the best thing that has ever come your way. Mitchell, Gen. Mgr., 6036 Kenwood Ave., Chicago.

**\$2.50 PER DAY** salary paid one man or woman in each town to distribute free circulars and take orders for concentrated dandruffs in tubes. Permanent position. I. S. Ziegler Co., 7P East Harrison, Chicago.

**AGENTS.** Cost, 3c, sell 25c. Gold window letters. Any one can apply. Samples free. Chicago Letter Co., 848 Altgeld St., Chicago.

**YOUR** Name on a stencil Transparent Window Display Sign with a chance to make extra money for 10c. F. Murphy Mfg., 257 1/2 York St., Jersey City, N. J.

**USE** your spare time to build up a mail-order business of your own. We help you start for a share in profits, 27 opportunities. Particulars free. Opportunities Exchange, Buffalo, N. Y.

**DOLLAR** an hour, selling gas lighters; lights instantly by thrusting into gas flow. H. & S. Company, Indianapolis, Indiana. Sample 25c.

**READ** this: Never mind; send address, we'll show you the easiest money ever. "King" Mfg. Co., 2 Rector St., N. Y. C.

**AGENTS:** Make \$5 daily selling 20 jandy Post Cards 10c. 100% profit in quantities. Four sample packages 25c. Baker & Co., 2135 Harrison St., Chicago.

**LOCAL** Manager Wanted to Appoint Agents and see trade on D-B Products. We have a new sales plan that means quick, profitable sales. The man that is not afraid to work can make an excellent income. If your record will stand rigid investigation send it today—we will be interested. Donley Bros., 1492 Aetna Road, Cleveland.

**AGENTS** Wanted—Agents make 500 per cent profit selling "Novelty Sign Cards." Merchants buy 10 to 100 on sight. 800 varieties. Catalogue free. Sullivan Co., 1234 Van Buren St., Chicago, Ill.

**DON'T** be an Agent—You take the money; be your own master. Dave Crawford, W. Va., writes: "Made \$42.75 first week." Smith, Pa., writes: "301 in two weeks." Bostwick, N. Y., "Make an average of \$10 a day." We have started hundreds of others. Gray's outfits \$15 and up. Plate Gold, Silver, Nickel, Metal, etc. We furnish recipes, formulas, trade secrets and teach you the art; work easy. Royal new dipping process. Every family, hotel, restaurant, shop has tableware, jewelry, metal goods of all kinds to be replated. Every other business overcrowded, few plating shops. Send postal, free sample plating. Gray & Co., Plating Works, 733 Gray Bldg., Cincinnati, Ohio.

**\$50 PAID** for one day's work. New, wonderful invention, mechanical wonder; scientific marvel. Tremendous sale staggers country. Over 1,000,000 sold, yet just introduced. Agents banking enormous profits daily. Walters \$50 first day. O'Connell \$40. Everybody wants Grab's 10 blade, adjustable, double action shoe scraper on doorstep. Automatically removes mud, snow. Seven new patented features. Territory free, worth fortune. Security Mfg. Co., Dept. 150, Toledo, O.

**STOP** here and write The Sign Co., Silver Creek, N. Y.

**SELL** Meico Chemical Tool Marking Outfits. Non-acid. Marks any metal tool. Big profits. Write for agent's proposition. Meico, Box 101, Eaton, Ohio.

**AGENTS** for Ho-Ho-Co Skin and Scalp Soap, perfumes, toilet articles. Our prices are lower, quality of products better, orders repeat. Rotheo, 212 N. Second, St. Louis, Mo.

**NEW** Electric Novelty. Flashlight, exact size and shape of fountain pen. Sells on sight, \$1. Sample, 75c. Densen lots, 50c. Ludwig, 71 W. Broadway, New York.

**BIGGEST** money-maker out. Newly invented "Linedraper and Copy Holder" for stenographers. Greatest time saver. Exclusive territory. Lineguide Mfg. Co., 140 N. 5th Ave., Chicago.

**GUARANTEED** Hosiery Manufacturer wants man or woman to establish permanent distributing route in home locality. No capital or experience needed. Liberal inducements for all or part time. D. Parker Mills, 2733 No. 12th St., Phila., Pa.

**FROM** Dance Hall to White Slavery. 400 page, cloth book, illustrated, \$1. Immense sale. Experience unnecessary. Liberal terms. Big money quick. Charles C. Thompson Co., Manufacturing Publishers, 1128 Wabash Ave., Chicago.

**RESIDENT** managers wanted for all open territory. Opportunity to establish your own permanent business. Must finance orders for complete Le-Ta-Co. household necessity line. Rapid sellers; big repeaters; large profits. The Mahel Co., Newark, N. J.

**AGENTS—**Now is the season to get quick easy orders for the luxurious, popular-priced "Spray Shower-bath;" it's the real thing, yet sells for \$2 complete; requires only 3-minute demonstration; guaranteed. Get our offer—territorial rights and liberal profit proposition. Smith Co., 12 Broadway, Buffalo, N. Y.

**AGENTS** with a little mechanical ability can make \$20 per week, selling our Ford Auto Starter and Primer at \$15. They are neat, strong and durable. Thousands in use. Good territory for responsible parties. Also other auto accessories. Gahn & McCormick, Box 27892, Streator, Ill.

**AGENTS—**\$50 weekly. We manufacture the best needle case made; a wonderful seller; 200% to 500% profit; talking unnecessary; our "Trust Scheme" envelopes do the work; general agents can make \$100 weekly; particulars free; 25c sample outfit for 10c; buy direct from the factory. Paty Needle Co., 102 Davis St., W. Somerville, Mass.

**RATCHET** Sparkplug Wrench; something new; fits them all; \$3.50; best Automobile Specialty; sell on sight. Unity Wrench Co., Geneva, Ill.

**AGENTS—**200% profit. Wonderful little article. Sells like wildfire. Can be carried in pocket. Write at once for free sample. H. Mathews, 1962 Third St., Dayton, Ohio.

**AGENTS:** For automobile specialties. Man with automobile preferred. Salesman. 639 Woodward Ave., Detroit, Michigan.

**AGENTS** Wanted Everywhere—Men, women, boys or girls make big money selling the chamouis-like duster glove. Nothing like it ever seen before. Sells quickly at sight to homes, offices, stores, hotels, garages. Repeat orders absolutely certain. Send 25c today; get sample salesmanship book, and quantity prices. Recommended by Good Housekeeping Institute. We will prove to you that this is the biggest seller you ever tried or refund your money. Textile Utilities Corporation, Mfgs., 112 West 30th St., New York City.

**PERMANENT** Jewel Needle. No changing needles; improves tone; \$1. Attachment for Playing Edison Disc. Records with Jewel Needle, \$2. Automatic Stop, \$1. Needle Holder, 50c. Cabinets, Record Albums for Victrolas and Grafonolas. Terms and Territory. Wells Curiosity Shop, 20 S. Second St., Philadelphia, Pa.

**SOMETHING** new, Clifton's Vacuum Massager for Beautifier, good seller, get territory. Clifton Specialty Co., Buffalo, N. Y.

**AGENTS—**Brand new specialty Aluminum Triplicate Sauce Pan with detachable handle. Cooks 3 different foods on one burner. Saves gas. Lasts lifetime. \$100 to \$200 per month easy. Send for our catalog of 400 other specialties. American Aluminum Mfg. Co., Div J-10, Lameont, Ill.

**\$20 WEEKLY** and more easily earned taking orders for our guaranteed trees, shrubs and roses; part or full time; no delivering; no collecting. Charlton Nursery Company, Dept. J, Rochester, N. Y.

**\$1,000 PER** Man per County. Strange invention startles world—agents amazed. Ten inexperienced men divide \$40,000. Korstad, a farmer, did \$2,200 in 14 days. Schleicher, a minister, \$195 first 12 hours. \$1,200 cold cash made, paid, banked by stenographer in 30 days; \$15,000 to date. A hot or cold running water bath equipment for any home at only \$45.00. Self-heating. No plumbing or waterworks required. Investigate. Exclusive sale. Credit given. Send no money. Write letter or postal today. Allen Mfg. Co., 4069 Allen Bldg., Toledo, Ohio.

**SURPRISING** Profits: General Agents wanted in every city to handle our sanitary "Sav-ice" Cloth. Reduces ice bills half by preventing useless melting in refrigerators. Exclusive rights. Harsh Mfg. Co., Indianapolis, Ind.

**\$15 MADE** first day by 13-year-old boy with Shomescope. Woman made \$8 first hour. Particulars free. Shomescope Mfg. Co., 523 W. 13th St., Kansas City, Mo.

**AGENTS** make \$10 a day selling rugs at \$1 each; cost agents 55 cents; sizes 36x48; sell from one to six at every house; something every housewife wants; full size rug for sample, 98 cents by parcel post. Commerce Specialty Co., Commerce, Tex.

**YOU** Can Sell Kleenol Sanitary Brushes to every housekeeper. Buy direct from the largest manufacturers of wire frame brushes in America, at lowest prices. Several fine localities still open—exclusive sale granted if you open agency now. We furnish everything—no capital required. Kleenol Brush Co., 71 Taylor St., Springfield, Mass.

**SELL** Dry Goods Remnants. Greatest bargains on earth. Remnant Store Co., Cincinnati, Ohio.

**AGENTS** make big money taking orders for business and calling cards; outfit and agent's instructions free. Wolverine Co., Jackson, Mich.

**"PROTECTING** Inventions Before Patent Without Cost." next issue Inventor's Advocate, Advocate Building, 12, Washington, D. C., one year 25c; three months 10c.

**MAKE** and sell your own goods. Formulas by expert chemists. Manufacturing processes and trade secrets. Formula catalog for stamp. B. Mystic Company, Washington, D. C.

**500% PROFIT** selling our wonderful sign letters for office windows, store fronts and glass signs; resembles finest gold leaf; easily applied; samples free. Metallic Letter Co., 405 N. Clark St., Chicago.

**IDEAL** Lamp Filler saves bother filling lamps. Men and women canvassers and agents. Good opportunity to make money. Samples A & B 25c. Harry Otis Mayo, Box A2998, Boston, Mass.

**AGENTS—**Stamping names on Pocket Key Protectors; sample Check with your name and address, 12c. Stamping Outfits, Emblem Checks, Check Fobs, Name Plates, Hart Mfg. Co., Desk 2, 303 Degraw St., Brooklyn, N. Y.

**300 TO 400% Profit to Agents** selling our guaranteed U. S. Fire Extinguishers. Tremendous demand. Orders repeat. Exclusive territory to county and district managers. United Mfg. Co., 1508 Oakwood, Toledo, Ohio.

**WE need one active, reliable person** in every community to take orders for our popular mechanical books. You don't have to be a book agent. These books do their own talking. Simply show them. They contain just that sort of information about how to do and make things that every mechanically inclined person is looking for. And they are reasonable in price. We allow you a liberal commission for this pleasant work which you can do during spare time without interfering with your regular occupation. Don't neglect this real opportunity, but write now for full details to Manager Book Dept., Popular Mechanics Magazine, 6 N. Michigan Ave., Chicago.

**ENDLESS Neckties**—Something new, twelve ties in one; costs no more than old style; man made \$79, three days; woman made \$92, week; write for special agents' offer. Endless Necktie Mfg. Co., Dept. 10, Kansas City, Mo., or Universal Products Co., Toronto, Canada.

**SELL Our Attractive Brass Easel Poster Frames** to picture theatres, also changeable letter signs for every store; big demand; easy sales; liberal commissions. Newman Manufacturing Company, Cincinnati, Ohio.

**JUST show them**—The new adjustable floor and wall mops, dustless dusters and sanitary brushes sell themselves. Big line. Big profits. Agents write Silver-Chamberlin Co., Dept. M, Clayton, N. J.

**AGENTS:** Here's \$50 a week easy! Brand new device! Every housewife enthusiastic. \$1.25 profit on \$2 sale. Wonderful selling plans. Parvin Mfg. Co., Fondulac, Wis.

**SAFETY First!** Sell our line of Sanitary Twisted Wire Brushes. Big income assured. Exclusive territory given. Goods sell themselves. Households, Offices. Catalogue free. 3 in 1 Brush Co., 165 Beckman Street, New York.

**1,000% PROFIT**—Prepared Sign Letters. Share co-operative business free. Johnston Co., Quincy, Ill.

**YOU can be your own boss** with our Key Check Outfit. Good for \$5 a day stamping names on pocket key checks, fobs, etc. Sample check with your name and address, 15 cents. Pease Die Works, Dept. M, Winchester, N. H.

**STOP Here!** Let me start you in a home business that will bring you money every day. Experience unnecessary. Spare time. No canvassing. I furnish everything. Send for proofs. Voorhies, Desk C. R., Omaha, Neb.

**BIG Profits for You!** Manufacture Barley Crisp. New Confection. 5c package costs you 1c. Machine, instructions complete \$7.50 prepaid. Send 10c for samples. Barley Crisp Co., 1205 Broadway, San Francisco.

**EASY pleasant work** for Mechanics. Shop Men, Clerks, during spare hours, will add many dollars to their salaries. Also want persons who can give full time. Big wages assured. Novelty Cutlery Co., 67 Bar St., Canton, Ohio.

**AGENTS make \$100 monthly** selling our 500 handy household articles. Catalogue free. Scheff Company, Des Moines, Ill.

**OUTFIT Free to Agents.** Best selling Handkerchiefs, Dress Goods and Fancy Goods on the market. Quick sellers, big profits. Deal direct with a large manufacturer. Send stamp for particulars. Freeport Mfg. Co., 59 Main St., Brooklyn, New York.

**MILLIONS—\$60 profit.** Make up your own goods and be independent. Catalogue free. Resag Co., 1205 Randolph St., Chicago.

**MAIL-ORDER Opportunities:** 25 new propositions. No competition! Make 95c profit on dollar order; complete outfit 10c. Mail Dealers Wholesale House, 521 Franklin Bldg., Chicago.

**AGENTS make \$5 to \$10 a day** on the start. Atkinson writes: "The best proposition I have found in my forty years' canvassing." Permanent work. Household necessity. Saving 89%. Write today for General or Local Agents terms. Free sample. C. H. Stuart & Co., 16 Union St., Newark, New York.

**AGENTS—\$5 daily** selling our Handy Tool, 12 articles in one. Lightning seller. Sample free. Thomas Mfg. Company, 442 Third St., Dayton Ohio.

**AGENTS**—Great opportunity to be permanent representative largest manufacturers high-grade soaps and toilet goods. \$25-\$75 weekly. Write for immediate appointment. E. M. Davis Co., R. 64, Davis Bldg., Chicago.

**YOU can make \$448** as our general or local agent. Household necessity; saves 80 per cent; permanent business; exclusive territory; salary or commission; free sample; credit. J. Pitkin, 118 Stead St., Newark, N. Y.

**AGENTS of ability and high character** wanted on a new household article. Over 100 per cent profit. Special selling plan that pulls results. Address Merritt & Brock, 59 to 63 Temple Place, Boston, Mass.

**AGENTS Wanted for a new Duplicate.** Sells to every business man. Fisher Company, 113 Amsterdam Avenue, New York City.

#### SALESMEN WANTED

**SALESMAN** wanted in every county in U. S. to sell Motorade. Will positively remove carbon and if used in gasoline will keep motor free from carbon; also gives 15 to 40% more mileage. Purely an oil product, cannot injure finest mechanism. Absolute necessity for auto owners. Big money for salesman. Good chance for right man as partner. Price prepaid \$2.50 per gallon. Money-back guaranteed. Address, Motorade, Oskaloosa, Iowa.

**MANUFACTURER** of international reputation desires representation in this locality. Five established products. Can be sold to retailers, jobbers and large consumers. Permanent money-making business assured by re-orders. Must be able to finance himself sixty days. Box 190, Station C, Cleveland, Ohio.

**\$150 HAS been earned** in 3 days by our representatives, some even better, introducing our new advertising method which solves the advertising problem for merchants in smaller cities and towns. If you are or want to be a salesman I will show you how to build up a big profitable repeat business quick. Whole or part time. Big money if you act now. Write Salesmanager, Winslow Cabot Company, 61 Congress Bldg., Boston, Mass.

**SALESMEN** are making big money handling our changeable electric flashing window signs. Get our proposition now, with valuable exclusive territory. Telesign Company, 6 North Clark St., Chicago.

**SALESMEN** to sell sliding casters; good side line article; salesmen handling others also write; send 10c covering cost of mailing samples. Weston Co., Arlington, N. J.

**GREAT opportunity** for general agents selling new specialty to merchants; retails \$5, \$10, \$15 each. Your profit 200%. No competition. Exclusive territory. Free samples. Sayers Co., 408 Olive Street, St. Louis, Mo.

**SALESMEN:** Large Chicago Organization wants Specialty Salesmen. Also Side Line men. Handsome commissions on every sale. Pocket samples. State territory desired and present or past connections. Confidential. Merchants Advertising Service, 716 Medinah Bldg., Chicago.

**SALESMEN**—Agents: Competition killed. Electric Flashing sign; over 36 different display arrangements possible with 210 three and six inch letter combinations—in colors. 36-inch model \$10. Sample to producers. Multiform, 367 Manhattan Bldg., Chicago.

**WANTED**—Live salesmen with references, capable of selling Collection Cabinets to business and professional men. Good money proposition. Ye Clark Stationery Shop, Syracuse, N. Y.

**SALESMEN**—We have some excellent territory open to salesmen of ability. This is a proposition that appeals to the best class of concerns. Sales are easy and your profits large. Write us today for catalogue P. M., covering the Schick All-Steel Paper Baler, Davenport Mfg. Company, Davenport, Iowa.

**ENGINEERS, draughtsmen** to sell Winslow direct-reading beam and reinforced concrete calculating Slide-Rules. Fine opportunity for one agent in each city. H. W. Tomlinson, 64 E. Van Buren St., Chicago.

**SALESMEN:** Monarch interchangeable all metal signs, size 1 1/2 x 1 1/2 inch cost you \$1.85; 1 1/2 x 2 1/2 inch at \$3.25; largest supply of all metal letters. Changeable electric flasher sign, 3 1/2 inch model at \$2.75. Monarch Mfg. Company, 416 S. Franklin St., Chicago.

**WANTED**—Representatives everywhere. Exclusive territory. Gold sign letters for stores and office windows. Any one can put on. Write today for free sample. Metallic Letter Co., 483 N. Clark St., Chicago.

**TRAVELING Salesmen Wanted**—Experience unnecessary. Earn big pay while you learn by mail during spare time; only eight weeks' time required, one or two hours a day. Steady position, easy work, hundreds of good positions to select from. Write today for free book, "A Knight of the Grip," containing full particulars and testimonials from hundreds of students, we have recently placed in good positions and who are earning \$100 to \$300 per month. Address Dept. B-16, National Salesmen Training Association, Chicago, New York, Kansas City, San Francisco.

**SALESMEN**—Get our plan for Monogramming Automobiles and Motorcycles by transfer method. Very large profits. Motorists' Accessories Co., Ashland, O.

#### HELP WANTED

**DRAFTSMEN**—Get a higher salary. Topographic Drafting pays from \$1,200 to \$1,800 and up. Big field. Learn Topographic in short time under our instruction. Get full particulars, Columbia School of Drafting, McLeschlen Bldg., Washington.

**LEARN automobile repairing, driving, on up-to-date cars; also electricity.** Room and board while learning; many positions secured; satisfaction guaranteed; catalog free. National School of Engineering, 2110 W. 7th, Los Angeles. Established 1905.

**MEN and Women Over 18 Wanted**—\$65.00 to \$150 month. U. S. Government life jobs. Common education. Write immediately for list of positions open to you, Franklin Institute, Dept. S-21, Rochester, N. Y.

**MEN, 18-40, become Railway Detectives.** Experience unnecessary. Stamp for particulars. Brook, 1321 Ave. A, New York.

**PLEASANT spare-time work; mailing circulars.** Good pay. No scheme. Details free. Home Pub. Society, 46 N. 12th, Philadelphia.

**WANTED**—Distributors of advertising matter everywhere. Send 10c for Application Contract. Sample Magazine (None Free). Barkley's Distributing Agency, (403) Mount Pleasant, Pennsylvania.

**MAKE \$50.00 monthly** furnishing commercial reports; no canvassing, good opportunity; cooperative offer free. "Cico," P. M. C., Peru, Ind.

**SILVERING mirrors, plating tableware, auto-brass.** Home booklet plans free. Clarence Sprinkle, Dept. 28, Marion, Ind.

**DISTRIBUTORS Wanted**—Good pay; steady work; giving away packages Perfumed Boxax Soap Powder with our Soaps, etc. No capital or experience needed. S. Ward & Co., 218 Institute Pl., Chicago.

**SPEND summer gathering insects, butterflies.** I pay big prices. Many worth \$5.00, \$10.00. All salable. Men, Women. Get instructions, price-list, pictures, descriptions of valuable ones. Send stamp. Sinclair, Box 244, D-6, Los Angeles, Cal.

**\$18.00 WEEK.** Become Chauffeurs. Earn while learning. Sample lesson free. Franklin Institute, Dept. S-862, Rochester, N. Y.

**FREE instruction.** Learn Bookkeeping, shorthand, letter writing, rapid calculation, bookkeeping. Our booklet tells how we teach you free and prepare you to get a better position with a higher salary. Make a start today, write for our free booklet. Commercial Correspondence Schools, 303 School Bldg., Rochester, N. Y.

**DETECTIVES** earn from \$25 to \$100 per week and traveling expenses. We show you how. Write National School of Detectives, Room 536, 489 Fifth Avenue, New York.

**RAILWAY Mail Clerks Wanted.** Commence \$75.00 month. Sample examination questions free. Franklin Institute, Dept. S-21, Rochester, N. Y.

**FREE Illustrated Book** tells of about 200,000 protected positions in U. S. service. Thousands of vacancies every year. There is a big chance here for you, sure and generous pay, lifetime employment. Just ask for booklet S-29. No obligation. Earl Hopkins, Washington, D. C.

**OWN a business.** Co-operate with me evenings at home. Everything furnished. Don't worry about capital. Boyd H. Brown, Dept. K-5, Omaha, Neb.

**JOIN an Order** that pays money instead of charging dues. Solicitors wanted. Chas. Strong, Ward, Colorado.

**GET a Government Job!** See ad on page 16. Write now—today! Patterson Civil Service School, Rochester, N. Y.

**MEN—Women—Wanted**—Government Jobs. \$65.00 to \$150.00 month. Write for list positions now obtainable. Franklin Institute, Dept. S-21, Rochester, N. Y.

MEN to refinish lighting fixtures, brass beds, etc. All or spare time. No capital or canvassing. Experience unnecessary. Information free. Gunmetal Co., Dept. G, Decatur, Ill.

WRITE Moving-Picture Plays; \$50 each. Correspondence course unnecessary. Details free. Atlas Publishing Co., 3045, Cincinnati.

THOUSANDS Government Jobs now obtainable. List free. Franklin Institute, Dep't S-21, Rochester, N. Y.

USE your spare time to build up a mail-order business of your own. We help you start for a share in profits. 27 opportunities. Particulars free. Opportunities Exchange, Buffalo, N. Y.

A MONEY Proposition—Co-operate with me in a profit-sharing mail-order business. Will place trial advertisement, furnish printed matter, goods to fill orders and divide the profits. Particulars, Desk 133, Hazen A. Horton, Tokonsha, Mich.

AMBITIOUS Men-Women, 18 or over, wanted. Government Jobs. \$45.00 to \$150.00 month. Full list of positions now obtainable free. Franklin Institute, Dep't S-21, Rochester, N. Y.

SALESMEN, Agents, everywhere; New auto fuel. Permanent, profitable. Tankki Chemical Sales Co., Cleveland, Ohio.

ABLE-BODIED Men for firemen, brakemen, on all railroads, \$120 monthly. Experience unnecessary. Railway Association, Dept. 298, Brooklyn, N. Y.

WANTED—Men. Become Railway Mail Clerks. Commence \$75 month. For particulars write immediately. Franklin Institute, Dep't S-21, Rochester, N. Y.

FIREMEN and Brakemen; \$100 monthly; experience unnecessary; hundreds needed by the best railroads everywhere; particulars free. 810 Railway Bureau, E. St. Louis, Ill.

BOYS and Girls—Vacation money earned by working one hour a day. Send 10c to cover cost of handling and postage and I will send free sample and full instructions. S. S. Holden, 651 Railway Exchange Bldg., Chicago.

TELL Your Boy About This! Boys, you can make big money each month selling The Boys' Magazine. Send no money. Write us today for 10 copies. All unsold copies can be returned. The Boys' Magazine, Dept. A-89, Smetheport, Pa.

HUSTLERS everywhere \$25 week operating Lawn Mower Sharpener. 50% paid. Send four references and 25c with reply. Sharpener and instructions sent prepaid. D. Short Co., Columbus, Ohio.

CANVASSEERS—Make from \$5.00 to \$10.00 a day selling our guaranteed line of Flavors, Soaps, and Toilet Articles. Permanent occupation. J. M. Hampton, S. C. says: "Made repeat sales of \$3.95 to one family, \$3.85 to another; profit \$4.10. Time, 1 hour." Active agents make big money. National Company, Newark, New York.

SALESMEN: Crackerjack, \$5 check protectors; also useful advertising and self-selling specialties; liberal commissions. Irving, 61 Weehawken, N. J.

BE a Detective—Earn from \$150.00 to \$300.00 per month. Travel over the world. Write C. T. Ludwig, 340 Westover Building, Kansas City, Mo.

STOP Here! Let me start you in a home business that will bring you money every day. Experience unnecessary. Spare time. No canvassing. I furnish everything. Send for proofs. Voorhies, Desk C. R., Omaha, Neb.

WANTED—An Idea? Who can think of some simple thing to patent? Protect your ideas; they may bring you wealth. Write for "Needed Inventions" and "How to Get Your Patent and Your Money." Randolph & Co., Patent Attorneys, Dept. 144, Washington, D. C.

GO on the Stage. Vaudeville career offered you. Experience unnecessary. Managers endorse my method. Instructive vaudeville book free. Write today. Frederic LaBelle, Sta. 10, Jackson, Mich.

GOVERNMENT Examinations. Most thorough preparation, \$5; returned if not appointed; particulars free. American Civil Service School, Washington, D. C.

BE a detective. Earn big money. Write John J. Gilles, Licensed and Bonded N. Y. State Detective. Retired Member N. Y. Police Dept., 22 years Experience, 254 Huguenot St., New Rochelle, N. Y. Investigation solicited.

BE a Detective. Earn \$150 to \$300 monthly. Travel over the world. Write American School of Criminology, Dept. F, Detroit, Michigan.

## FOR SALE

WILL sacrifice absolutely high-class violin for \$18, including case and bow. Will send C. O. D. on inspection. Splendid chance to secure valuable violin cheap. Inquire, "Professional, 803 Market Street, McKeesport, Pa."

OLD Coins. Write to Heinz, Numismatic Bank, West Salem, Ohio.

BARGAINS—Gasoline Blowtorch, \$2.00 value, 95c postpaid. Bicycle Gas Lamp, value \$2.25, postpaid 90c. Anything, everything at cut prices. Literature Free. House of Bargains, Box 323, Huntsville, Ala.

TYPEWRITER, good as new, \$15.00. Adams, 108 S. 15th St., K. C. Kan.

MOTORCYCLES, \$20 up. Hall & Gravat, Atlantic City, N. J.

FOR SALE—Case Engine, Reeves Separator. Six Bottom Reeves Plow, nearly new, cheap. E. F. Hink, Farmington, Minn.

3/4-H. P. Commercial Vacuum Cleaner; will sell cheap or exchange for high-speed motorboat. F. Huddy, Ann Arbor, Mich.

FIELD, Marine, Day and Night Glasses with beautiful case, 25-mile adjustment, \$30 value, only \$6.50. Money back if not satisfied. Wells Curiosity Shop, 29 S. Second St., Philadelphia, Pa.

FOR SALE—12 hp. I. H. C. gas tractor. Cost \$1,300. Will take \$700 cash. Elmer Detmers, Hopedale, Ill.

VACUUM cleaner pumps and parts for assembling, save 75%. Vacuum Supply Co., Ann Arbor, Mich.

## SALE OR EXCHANGE

GOOD as new Electric Piano Player, Writterpress, Dictaphone, stamp affixer. Have all kinds machines and personal property to sell or exchange—make offers. Jos. Weller, Olney, Ill.

WRITE for my bargains in typewriters, cameras, guns, books, office supplies, city lots, etc. Hartman, Moline, Illinois.

DRAFTING Instruments wanted; have new krapak, case and complete outfit. Jack Murray, Lewis House, Rockford, Ill.

## GUNS, SPORTING GOODS, ETC.

TWITCHELL'S Gun Paste for polishing old rusty or pitted Guns. Will not injure or scratch the finest barrels. Box with directions, postpaid, 25c. Orris Twitchell, West Milan, N. H.

FIREARMS—Old-time and modern. Buy, sell, exchange all sorts. Stephen Van Benseleer, West Orange, New Jersey.

## FLOUR &amp; FEED MILLING MACHINERY

SPECIAL bargains in second hand Attrition mills, burr mills, crushers, corn shellers, bran dusters, dust collectors, purifiers, reels, double, single, 2 and 3-pair high roller mills, sieve bolters, receiving separators, scourers, etc. Write for description and prices. Sprout, Waldron & Co., P. O. Box 429, Muncy, Pa.

## MACHINERY, TOOLS AND SUPPLIES

BELTING—all kinds—rebuilt and new. Everything in Belt Power Transmission. F. Hanville Co., Grand Rapids, Mich.

16"x8" FORSAITH screw-cutting lathe, power cross feed, chuck, \$150. Western Machinery Co., Cincinnati, Ohio.

REBUILT Lathes, Drill Presses, Milling Machine, Universal Wood-Workers, Saws, Jointers, etc. Vonnegut Machinery Co., Indianapolis, Ind.

HACK Saw and Power Blades, all sizes and points, low prices. Redlo Co., 320-13 West New York, New Jersey.

PULLEYS, Gears, Sprockets, Shafting, Hangers; see page 149. W. A. Jones Foundry & Machine Co., Chicago.

MARK Your Tools. All kinds of steel letter stamps, trade marks, etc., made to order. Your name, \$1; three initial, 50c. Gideon Pike, Attleboro, Mass.

2 BERKSHIRE Molding Machines in fine shape. A bargain. P. O. Box 1323, Columbus, O.

REBUILT Leather Belting, half price—new—equal quality; less stretch, equal service. Less price, cheap, new, better service. All sizes, guaranteed. New leather, rubber, canvas, factory prices. Agents wanted. Frederick Belting Co., Manufacturer, St. Louis, Mo.

5,000 FEET good 2" leather belt, 10c a foot. Lucas & Son, Bridgeport, Ct.

SECOND Hand Lathes, 13 inch and 15 inch for sale. Bargain; both good condition; were taken in exchange. South Bend Machine Co., 627 E. Madison St., South Bend, Ind.

VACUUM Pumps and Cleaners, all sizes, complete outfits. Thurman Vacuum Cleaner Co., Manufacturers, Dept. O, St. Louis, U. S. A.

FOR Sale—All sizes new and second-hand Pulleys, Belting, Shafting, Hangers, Couplings, Pillow Blocks, Collars, etc. Passman Bros., 28 and 30 So. Green Street, Chicago, Ill.

VACUUM cleaner pumps, tools, etc., for stationary house or wagon outfit. Vacuum Supply Co., Ann Arbor, Mich.

FOR Sale—25 Lincoln milling machines, \$25 to \$100 each. Lucas & Son, Bridgeport, Conn.

HAVE for sale several sizes of lathes, milling machines, drill presses, punch presses, shapers, planers, boilers, steam engines, oil, gas and gasoline engines and wood-working machinery. Pinner, 122 Water St., New York, N. Y.

ENGINE Lathes, swings 9 1/2 in., takes 25 in. between centers. Complete set gears cutting all size threads 3 in. to 40 in., \$43.50. Grammes & Sons, Allentown, Pa.

FOR Sale: 5 good Engine lathes, 16" to 32", state size wanted. Lucas & Son, Bridgeport, Conn.

JUST Published—Popular Mechanics Shop Notes for 1915—426 Easy Ways to do Hard Things. This is Vol. XI and is similar in style to the other numbers in the series. 224 pages, 517 illustrations. Paper 50 cents. Cloth, \$1, postpaid. Popular Mechanics Book Dept., 6 N. Michigan Ave., Chicago.

## ENGINES, MOTORS AND DYNAMOS

BARGAINS Gas, Gasoline or Kerosene Engines, Brand New, Never Untraced and with Mfr's. Guarantee on Them. 1 1/2 hp., \$38; 2 1/2 hp., \$52; 5 hp., \$77; 7 hp., \$100; 9 hp., \$147; 12 hp., \$185. Write for price on the lot or any part. Ship from Indiana. H. O. Ewing, Fort Pierce, Fla.

FOR Sale. Elbridge engine, 27 hp., 3-cylinder, 2-cycle (almost outfit), complete outfit. Stubbs, 818 Granite Building, Rochester, N. Y.

FOR Sale—15 hp., 2-cylinder Nash gasoline engine, magneto \$225.00, excellent condition. Lucas & Son, Bridgeport, Conn.

LOW voltage generators. W. W. Stuart, Des Moines, Ia.

ALTERNATING current, single-phase motors, \$6 to \$95. Direct current and three-phase bargains. Motors bought, sold, repaired. Satisfaction guaranteed or money refunded. Send for electrical supply bargain list. Hyre Electric Co., 613-E, So. Dearborn St., Chicago.

FOR Sale—Steam and Gas Engine, Jackson Mfg. Co., Fremont, Ohio.

KERMATH—12 hp., 4-cycle, 4-cylinder marine engine, factory overhauled, guaranteed first-class condition in every way, with magneto and carburetor, complete, \$160. Kermath Mfg. Co., Detroit.

GENERATORS, Batteries, \$9; Lamps, 6-v. up, 25c. Meters, Engines, Compressors, Supplies. List Free. Box 281, Chicago.

MOTORS, New Holtzer-Cabot, Alternating Current, 1/2 hp., \$8.50 each. H. G. Crane, Brookline, Mass.

SMALL A. C. Motors—110 volts—60-cycle—single phase—guaranteed new—automatic start—1-6 H. P., \$14.00; 1/2 H. P., \$18.50; 3/4 H. P., \$25.00. Others smaller. Johnston, 90 Evans Ave., Ingram, Pa.

FOR Sale—Engine, 125 H. P., with direct connected Generator, 75 K. W., 110 volts, perfect condition. R. J. Klittridge & Co., Green and Superior Sts., Chicago, Ill.

FOR Sale—Reversible rowboat motor, first-class condition, with magneto, \$50. X Y Z, 78 E. Madison St., 9th floor, Chicago.

ENGINES and Parts for Sale—45 Hp. Stoddard-Dayton \$100. Studebaker 25 Hp. \$85. Oswald 25 Hp. \$80. Prestos, B size, \$10; Ford Eng. \$100. Studebaker-Garford parts, models 10-F and 14 Buick parts, D. U. 4 Bosch magneto, \$27.50. Auto Salvage Co., 1436 Wabash Ave., Chicago, Ill.

FRANKLIN air-cooled engine, transmission, carburetor, coil, \$40.00. G. French, Metrose Highlands, Mass.

FOR Sale—1/2 H. P. Direct Current Dynamo. 1-10 H. P. Motor. Robert Bestler, Malvern, Penna.

**SPECIAL Sale—Low-voltage generators—**10 lights—110 volts—\$12.50; 30 lights—40 volts—\$32.50; 40 lights—50 volts—\$35.00. Other sizes, different voltages, less than half price. Johnston, Evans Ave., Ingram, Pa.

**ONE 2-cyl. steam auto engine and boiler complete, \$25.** Clare W. Webber, Independence, Iowa.

**MARINE motors—\$97.50** four cylinder, four cycle, high speed. Powerful enough for a thirty-foot boat, a "crackerjack" for a speed boat, 2,500 this year permits price. Tribune Engineering Co., Marine Dept., Oswego, N. Y.

**10 H. P. Alamo Oil Engine.** Never used. A bargain, 15 H. P. Fairbanks & Morse Gas Engine, fine shape. Cheap, P. O. Box 1323, Columbus, O.

**FOR Sale—Second-hand 1912 Sterling Engine, 18-25, 4-cylinder, fully equipped, first-class condition.** Stubbs, 818 Granite Bldg., Rochester, N. Y.

**BARGAINS in Rebuilt Stationary Gasoline Engines.** These are our own engines taken in exchange and rebuilt good as new, 1½ to 12 H. P. \$20 up. Write for description. State size wanted. Sta-Rite Engine Co., La Crosse, Wis.

**FOR Sale—Gasoline engines, automobiles, marine and stationary, also castings.** Second-hand ones taken in exchange and for sale. Apply with stamps. B. W. Richardson, R. No. 36, Peoria, Ill.

**REBUILT Engines—We have on hand a number of rebuilt "Buffalo" engines, guaranteed, at greatly reduced prices.** Write for bargain list. Buffalo Gasoline Motor Co., 1293-1305 Niagara Street, Buffalo, N. Y.

**JUST Issued—Amateur Mechanics No. 6.** Another great book of 293 articles for those who like to make things. Similar in style to the other numbers in the series, 128 pages, 261 illustrations. Paper, Price 25 cents postpaid. Popular Mechanics Book Dept., 6 N. Michigan Ave., Chicago.

#### ENGINE CASTINGS AND BLUE PRINTS

**FOR Sale—Castings for two-cycle engines, 10 H. P. marine engines \$65.00.** Richards Iron Works, Manitowish, Wis.

**CASTINGS for small stationary gasoline engines, with drawings.** R. H. Bowersox, Hanover, Pa.

**GASOLINE Engine Castings, with drawings.** Cheap. Catalog for stamp. Novelty Manufacturing Co., 853 West 6th St., Cincinnati, Ohio.

#### BOATS, LAUNCHES, ACCESSORIES

**PALMER Motors and Launches, two to fifty horsepower, two and four cycle.** Get our 1915 reduced prices. Catalog free. Palmer Bros., Cos Cob, Conn.

**FOR Sale—Semi-speed launch, 27 ft. by 4 ft. 6 in., Trebert, 40 hp., fully equipped, splendid condition, speed twenty-two miles.** Stubbs, 818 Granite Bldg., Rochester, N. Y.

**MOTORCRAFT Encyclopedia—A 150-page book that tells 1081 things every motor boatman should know.** How to overcome engine troubles. Price \$1, postpaid. Popular Mechanics Book Dept., 6 N. Michigan Ave., Chicago.

#### FOR THE SHOP

**FOR That Boy—He will appreciate a copy of the great boy's book "The Boy Mechanic" that tells about 700 different things for boys to do and has 800 pictures.** 480 (7x10) pages, cloth, big, handsome book for the price, \$1.50 postpaid. Popular Mechanics Book Dept., 6 N. Michigan Ave., Chicago.

#### BLACKSMITHS

**BLACKSMITHS, get out of the rut; be progressive.** Get Toy's modern methods of doing hard jobs easy. Make solid welds. Temper all tools to a standard with Toy's Colored Tempering Charts. Do the job the other smith can't do. All for \$1. Send for free samples. W. M. Toy, Sidney, Ohio.

**SHOP Notes—Many valuable kinks for blacksmiths are contained in our series of Shop Notes books, 10 volumes, 50c each, postpaid, or \$5 per set prepaid.** Popular Mechanics Book Dept., 6 N. Michigan Ave., Chicago.

#### CEMENT

**IF you want the best information on cement and concrete construction, subscribe for Concrete-Cement Age, leading cement and concrete monthly.** Sample copy, 10 cents. Yearly subscription, \$1.50. Concrete-Cement Age, 135 Newberry Bldg., Detroit, Mich.

**CONCRETE Building Block Machines and Moulds; free catalogue.** 5 Market St., St. Louis, Mo.

#### ELECTRICAL

**"FOUNTAINLIGHT"—a flashlight resembling a fountain pen.** Useful. Durable. \$1 complete. Sinclair, 190 Mount Prospect Avenue, Newark, N. J.

**ELECTRIC Fans, D. C. \$3, A. C. \$3.50,** with cord and plug. Edgar Philip, 197 Field Ave., Detroit, Mich., for Bargains.

**HOME Electric Candles, with Tungsten Bulb, Nickel finish, postpaid, 65c.** "Fits any standard battery." E-H Electric Co., 146 Hansford Bldg., San Francisco.

**40-WATT Lamps, 25c each.** Any quantity. Genuine drawn wire filament. Other types and sizes at lowest prices. Buy direct from factory. Save 25 per cent. Norwood Lamp Works, Box 20, Cleveland, Ohio.

**"AMATEUR Electrician," Make Batteries, Dynamos, Motors, Electric Engine, Telephone, etc.** 75 illustrations, 10c. Renew Dry Batteries, 3 guaranteed processes, 20c. Both, 25c. Novelty Shop, 3311-E, Belleplaine Ave., Chicago.

**RENEW Old Dry Batteries, Instructions (29c) Guaranteed.** Willamack, Grampian, Pa.

**TESLA Coil, 12-inch spark.** For wireless or X-ray. Good condition. For sale cheap. Ross Whittier, Athorp House, Cambridge, Mass.

#### STAMP COLLECTING

**FOREIGN Stamps Free; 52 different foreign, including China and Venezuela, to all who apply for our high grade approval selections.** Send two-cent stamp for return postage. Edgewood Stamp Co., Dept. H, Milford, Conn.

**OLD Canada packet free—Early issues.** Maps, Jubilees, Tercentenaries, Dues, Maple Leaves, etc. Postage 2c. Superb 50% approvals. Midland Stamp Company, Midland, Ontario.

**FREE—Choose one, 205 foreign, 191 United States, 50 Sweden, 50 Asiatic, 50 Norway-Denmark, all different, with McKee's Stamp Weekly, Boston, Mass., six months. Remit 25c.**

**APPROVALS; desirable stamps on approval at low prices.** Reference required. G. V. Lovering, 2715 Thirteenth St., N. W., Washington, D. C.

**FREE! Fifteen Austrian Jubilee stamps for requesting 1c approvals.** P. Riedell, Schenectady, N. Y.

**STAMPS Free! 50 different, including unused Provisional Swiss (Just Out).** Send 4c postage; mention gift F-76. Bright & Son, 164 Strand, London, England.

**STAMPS—165 China, etc., stamp dictionary and list, 2c.** Bullard, Sta. A, Boston.

**104 DIFFERENT stamps, including United States 1861 Civil War, Japan, Argentine, etc.** Large price list and sample New England Stamp Monthly, only 5c. Finest approval sheets, 50% discount. New England Stamp Company, 19 Washington Bldg., Boston.

**STAMPS, 1,000 mixed, 13c. 500 different Foreign, 60c.** Western Stamp Co., Omaha, Nebr.

**STAMP Album with 538 Genuine Stamps, incl. Old Mexico, Malay (tiger), China (dragon), Tasmania (landscape), Jamaica (waterfalls), etc., 10c. 100 diff. Jap. N. Zid., etc., 5c.** Big List. Coupons, etc. Free! We Buy Stamps. Hussman Stamp Co., St. Louis, Mo.

**STAMP Collectors! Free! Not a cheap packet, but something worth asking for.** Your name and address on post card will do. Wm. Roland, 719 East Decatur St., Decatur, Ill.

**STAMPS—On approval, U. S. postage, revenue, and department.** Business reference necessary. Mrs. L. Kellogg, West Hartford, Conn.

**STAMPS sent on approval at 70% discount.** Foreign Revenues, 5c each. Reference required. Emory Renall, Hanover, Penna.

**HOW to earn a 25c and a 50c California gold coin as token.** Send 2c stamp. Coin Exchange, New Rochelle, N. Y.

**7 VARIETIES Bolivia, 1894, Free to Approval Applicants, enclosing 4c Postage.** Roberts Scyces, Quakertown, Pa.

**1,000 OLD U. S. stamps and 200 different foreign stamps, 25c.** F. L. Toupal Co., Chicago Heights, Ill.

**FREE—100 stamps, including Japan, Queensland, etc.** Head, 502 Park Place, Milwaukee, Wis.

**50 VAR. So. America, 10c.** Weed Stamp Co., Centerville, Mich.

**LOW priced approvals.** Mention paper and receive unused Department Stamp Free. S. E. Colman, 634 Keefer Place, Washington, D. C.

**WATERMARK Detector and fifty different stamps, ten cents.** Bert McCann, Kirksville, Missouri.

**STAMP Collectors—\$2 premium coupon, big 1915 price list, Monthly Bargain Lists, etc., free.** No unsolicited approvals. W. C. Phillips & Co., Glastonbury, Conn.

**1,000 STAMPS from 30 countries, 12c.** Edward Luffery, Wallingford, Conn.

**STAMPS, 100, all different, free.** Postage 2c. Mention paper. Quaker Stamp Co., Toledo, Ohio.

**24 VARIETIES Cuban stamps, 10 cents.** List of 6,000 low-priced stamps free. Chambers Stamp Co., 111 P. Nassau St., New York City.

**PACKET of 23 stamps; no two countries alike, 500 hinges.** Set of \$1 and \$2 U. S. Rev., all for 5c. Mention paper. Miami Stamp Co., Toledo, Ohio.

**25 DIFFERENT British Colonials to applicants for stamps on approval who send 2c postage.** Nickles, 122 Florida Ave., Washington, D. C.

**YOU save money when buying from my 1, 2 and 3c approvals.** References please. Wm. Haase, 971 East 39th St., Los Angeles, Cal.

#### RARE COINS

**\$50.00 PAID for Dollar 1873 S. Mint; \$2.00 for 1904 Dollar, proof; \$7.00 for 1833 quarter, no arrows, etc.** Many valuable coins in circulation. Watch your change. Look up your old money; you may have or get coins of premium value. Don't let a valuable coin slip away from you. Get Posted. Send only 4c. Get our Large Illustrated Coin Circular. It may mean large profits to you. You certainly have nothing to lose. Send Now to Numismatic Bank, Dept. H, Fort Worth, Texas.

**FOR Sale—1853 Half-dime, stars and arrow-heads; good plain condition; send bids.** O. M. Mendenhall, Newton, Ia.

**ALL for 50c—1 old cent, 1 eagle cent, 1 Indian nickel cent, 1 V. B. D. Lincoln cent, 1 2-cent piece, 1 3c nickel, 1 nickel (No cents), 1 Columbia nickel, 1 Jap. coin, 1 Chinese coin and selling list.** C. J. Carey, New Rochelle, N. Y.

**BUFFALO Nickels—25c each paid for them and Lincoln pennies.** Highest prices paid for old coins. We are willing to compare our prices with any dealer in United States. Send 10c at once for our new 1915 Coin Book. Jones, Coin Dealer, Dept. 38, Newton, Ill.

**10 DIFFERENT old bank notes and catalogue, 25c.** F. L. Toupal Co., Chicago Heights, Ill.

**10 FOREIGN coins 15c, 5 old bills 15c, 200 different stamps 15c.** Burgess Co., 522B, Beacon, Toledo, Ohio.

**OLD Coins Bought and Sold.** Spring catalogue list of coins for sale, free to collectors only. Buying catalogue quoting prices I pay for coins, 10 cents. Wm. Heeslein, 101 Tremont St., Boston, Mass.

**COINS, Antique Relics—Five curious, rare coins with catalog, 10c.** Ray Chapin, New Berlin, N. Y.

**TEN different coins from warring nations, 25c.** Leo Macdonough, Toledo, Ohio.

**WE pay big prices for Lincoln Pennies.** Send dime for elegant catalog and information. Independent Coin Brokers, 92, Olney, Illinois.

**\$4.25 EACH Paid for U. S. Flying Eagle Cents dated 1856.** We pay cash premiums on hundreds of Old Coins. Send ten cents at once for New Illustrated Coin Value Book 4x7. It may mean your fortune. Clarke & Co., Coin Dealers, Box 15, Le Roy, N. Y.

## FOR MEN

WHY wear a woman's apron? 35c will buy a man's divided apron. Box 4, North Wayne, Maine.

MANILA cigars. Direct from factory to smoker, at wholesale price, 100 cigars, best grade, \$3 by registered mail, all duties paid. Write for free catalogue. Satisfaction or money returned. Pattinpell, Martin & Co., Luzon, P. I.

SAVE money on shoes! Factory to feet. You save retailer's profit and get better shoes. Fit and entire satisfaction guaranteed or money back. Style book free. Pathfinder Shoe Co., Dept. P, Webster, Mass.

## SAFETY BLADES SHARPENED

SAFETY Razor Blades Resharpended "Keen as new," 24c up. Pay after you try blades. American Tool Co., Springfield, Ohio.

ALL makes Honed, Strooped, Sterilized. Keen edge guaranteed. 30c dozen. Established eight years. Keenedge Company, Dept. K, Chicago.

GRIND—Hone—Any Blade—2c. Razor 25c. Keenedge, Oshkosh, Wis.

SAFETY razors sharpened; two cents each. Guaranteed. Handle box free. Electro Strooping Co., 134 Shelby St., Detroit, Mich.

## FOR THE HOME

NEW Burglar-Proof Lock — Prevents rattling, also raising by burglars or children, even if window partly raised for ventilation. Easily attached, never wear out; no home safe without them. Send 10 cents in stamps for sample lock to try in your own home. The Warner Company, Dept. 30, Muncie, Ind.

DREAMS to be beautiful, come true, using Clifton's Vacuum Massager, get territory. Clifton Specialty Co., Buffalo, N. Y.

BEAUTIFUL arts-crafts lamps—Anyone can make them out of paper, cardboard and wood. 16 designs. Inexpensive yet artistic. Complete book of instructions. Price, 50c postpaid. Popular Mechanics Book Dept., 6 N. Michigan Ave., Chicago.

ARTISTIC Lamps and Shades in metal and art glass easily made by the amateur craftman from instructions given in our book of 18 designs ranging from ordinary reading lamps to pretentious chandeliers. Expense only slight. Price of book 50c postpaid. Popular Mechanics Book Dept., 6 N. Michigan Ave., Chicago.

## INVALID FURNITURE

ROLLING Chairs. We make 70 styles, Carrying Chairs, Invalids' Lifts, Beds, Tables, Bed Trays, Back Rests, Commodes, etc. Catalog "B" illustrates—describes free. Send for it, Geo. F. Sargent Co., 284 Fourth Ave., New York.

## DIAMONDS, WATCHES AND JEWELRY

SPECIALLY priced 16-size thin model 77 Flgin. Guaranteed Watch. 20-yr. gold-filled case. Postpaid \$6.98. Worth \$12.00. Baker & Co., 2126 Harrison, Chicago.

## PIANOS AND MUSICAL INSTRUMENTS

USED talking machines, all makes, \$5 and up. Send for free list. Brown Music Company, 9119 Commercial Ave., Chicago, Ill.

PIANO—A fine new Mahogany Upright Grand Piano, direct from factory, including stool, scarf and 10-year guarantee. Regular \$700.00 value. Price, \$135 cash. Geo. P. Gross, 1324 Main St., Cincinnati, O.

BEAUTIFUL double action harp. 45 strings. Bird's-eye maple, gold-plated metal. Perfect condition. Bargain. Also good viola. Lord, Division St., Elkhart, Indiana.

FINE old violin, music, bow and case for sale. Earl Sanders, Pawnee, Ill.

TALKING Machines with Records, \$5 up, all makes. Edison Standard, 3c; Blue-Amboral, 25c; Victor Records, 15c up; Player Piano Rolls, 58, 65, 88 notes, 15c up. We buy, exchange. Wells Curiosity Shop, 20 S. Second St., Philadelphia, Pa.

## MUSIC

SONG Writers; inside tips? Stamp. L. Berton Wilson, San Diego, Calif.

## BUSINESS SERVICE

INCORPORATE in South Dakota. Write us at capital. Western Charter Co., Pierre, South Dakota.

INCORPORATE. Our lawyers do the work, saving you time, annoyance and money in incorporating under the most liberal laws of Arizona. Laws and forms free. Southwestern Securities & Investment Co., Box 1483, Phoenix, Ariz.

ESTIMATING and Contracting by Radford—A 990-page manual of up-to-date methods for rapid, systematic and accurate calculation of costs of all types and details of building construction, with quotations of ordinary prices for labor and materials, standard schedules and forms, labor-saving tables and other data useful to the building trades. Flexible leather illustrated—\$2 per copy postpaid. Popular Mechanics Book Dept., 6 N. Michigan Ave., Chicago.

## FORMULAS AND TRADE SECRETS

WANTED—Enamel to cover ink on Aluminum, 200 deg. heat limit. Transparent, non-alcoholic. Ajax, 401 Whitlitt, Kansas City, Mo.

1,650 FORMULAS 40c, 100 plans, schemes 20c, 75 manufacturing secrets 10c, restorer mirrors 20c, Tattoo remover 20c. All 50c prepaid. Formula Bureau, 3311-E Belleplaine Ave., Chicago.

20,000 FORMULAS—Price \$1, postpaid; complete list 4c stamps. Edm. Bromley, Watervliet, N. Y.

A HIGH grade, guaranteed formula for almost any occasion. Prices reasonable. Correspondence confidential. Cole Chemical Company, Chicago.

10,000 SELECTED scientific, chemical technological, and practical recipes and processes, including hundreds of so-called trade secrets for every business, alphabetically arranged in one large volume of 800 pages. Price \$3 prepaid. Popular Mechanics Book Dept., 6 N. Michigan Ave., Chicago.

## GAMES AND ENTERTAINMENTS

FREE! Rising Lady Secret and Latest Bargain Catalogue, New Magic Tricks, Lowest prices on earth. Magic Company, 1215 Nicollet, Minneapolis, Minn.

NOVELTIES, Books, Tricks, Games, Etc. Illustrated catalogue free. Sample 25c Card trick, 10c. Auburn Supply Co., Dept. TX3, 7745 Peoria St., Chicago.

CRY Baby Trick Pillow, Funniest of jokes; attractive, useful ornament, \$1.50 prepaid. Stovers, Millersburg, Pa.

800 TRICKS, puzzles, games, jokes, songs, stories, etc., including big illustrated catalog and free offer, 10c. Novelty Shop, 3311-E Belleplaine Ave., Chicago.

MAGICIANS—Amateur and professional, we can save you money in the magic line; send for our illustrated catalogue. Northwestern Supply Co., Minneapolis, Minn.

TRICKS, Puzzles, Jokes, Magic Goods, Ventriloquist Figures, Sensational Escapes and Illusions. Big catalogue free. Oaks Magic Co., Dept. 197, Oshkosh, Wis.

MAGIC—You will find something new on Parlor and Stage Magic, Escapes and Illusions if you get our revised Magic Catalog. Descriptive circular on new tricks, enclosed. Yours for the asking. Ryan & Von Bach, Rochester, N. Y. Dept. 6.

1,100 TRICKS, games, puzzles, jokes, songs, pictures, etc., 10c. E. W. Sun Co., Harrison, Mich.

"MAGICAL BULLETIN," a classy little monthly of exclusive information for magical entertainers. Whole year 25 cents. Sample copy for stamp. F. G. Thayer, 257 S. San Pedro St., Los Angeles, Cal.

WONDERFUL Magic Trick Cards Free! To introduce our catalogue, Walwen Company, 150 Nassau St., New York.

105 MAGIC Tricks, including Houdini's Needle and Thread Swallowing; together with trick card pack—25c. Entertainers' Club, 451-831 East 163 Street, New York.

NEW Pocket Trick, including Professional Catalog, 6c. Magic Supply, 249 West 38th Street, New York.

A NEW One. The latest trick out. Boys, here is the trick that gets the cigars every time. Sent postpaid for 25c. W. W. Fowler, Hesston, Kans.

MAGICIANS' tricks, Handcuffs, Escapes, Ventriloquist and Punch figures. Prices low. Catalog free. Sample trick, 2c. Magic Parlors, 192 Clifford, Providence, R. I.

P-L-A-Y-S, Speakers, Dialogues, Drills, Joke Books, Wigs and Beards. Catalogue free. Ames Publishing Co., Dept. 40, Clyde, Ohio.

BE a handcuff king. We teach you. Escape from handcuffs, boxes, ropes, etc. Secrets of 20 sensational escapes \$1. Particulars free. The Magcraft Co., Dept. A, Box 251, Detroit, Mich.

NEW Bargain Sheet Rare Magic Ready. Send stamp. Fake Money. Our own design. Very excellent. Wholesale and retail. Sample roll 10c. Gilnovco, Morgan Park, Chicago.

PLAYS, Vaudeville Sketches, Monologues, Dialogues, Speakers, Minstrel Material, Jokes, Recitations, Tableaux, Drills, Musical Pieces, Entertainments for all occasions, Make-up Goods. Large Catalog Free. T. S. Denison & Co., Dept. 11, Chicago.

MAGIC Catalogue, 160 pages, greatest on earth, ten cents. Learn magic at home. We teach you to do these tricks as good as the great professionals—escape acts, rope acts, mind reading, handcuff secrets. Satisfaction guaranteed. Chicago Magic Co., Dept. B, 72 W. Adams St., Chicago, Ill.

## MAILING LISTS

5,000 NAMES North Carolina Voters, \$2.00 per thousand. Cash advance. C. C. Broughton, Attorney, Troy, N. C.

50 FIRMS that buy names, 25c. H. A. Lerberg, Portsmouth, O.

FREE to business men, copy of our comprehensive "Silent Salesman." Contains over 2,000 different classifications of mailing lists with number and price of each list, and information every business man needs. Accept this free offer. Trade Circular Addressing Co., G 164½ W. Adams, Chicago.

## CIRCULAR MAILING

I MAIL circulars to live agents' names each month. Will mail yours with mine for \$2.50 per thousand. Honestly guaranteed. Earle Fowler, Clintonville, Conn.

CIRCULARS monthly mailed, 6 by 3 or smaller, 1,000, \$2.00. Universal Syndicate, Moline, Ill.

## TYPEWRITERS AND SUPPLIES

LARGEST Stock of Typewriters in America—All makes: Underwoods, Oliviers, Remingtons, etc., one-fourth to one-half manufacturers' prices, \$15 up, rented anywhere, applying rent on price; free trial; installment payments if desired. Write for catalogue L. Typewriter Emporium (Estab. 1892) 34-36 West Lake Street, Chicago, Illinois.

TYPEWRITER Ribbons, best quality, 50c each; \$5 doz, postpaid. Standard Ribbon Co., Mfgs., Natick, Mass.

\$2 A MONTH for Factory Rebuilt Oliver Visible—Lowest price—free trial—ten-year guarantee. United States Typewriter Exchange, Dept. 303, Federal Life Bldg., Chicago.

WANTED—Used Standard Typewriter. Must be in A1 condition. Write, giving lowest price, etc. O. H. Stivers, 10 East Pearson St., Chicago.

1,000 REMINGTONS, \$10 and \$12. Other bargains. Department F. Mdee. Co., Bellevue, O.

TYPEWRITERS: Any make; direct from factory; \$40 to \$85 discount. Money back guarantee. Write for booklet. Paul C. Malls, Leavenworth, Kansas.

TYPEWRITERS, all makes, factory-rebuilt by famous "Young Process." Look like new, wear like new, guaranteed like new. Our big business insures "Square Deal" and permits lowest cash prices—\$10 and up. Also, machines rented—or sold on time. No matter what your needs are, we can best serve you. Write and see—now. Young Typewriter Company, Dept. 166, Chicago.

ALL standard makes of typewriters, Big saving. Liberal guarantee. Catalogue, bargain list and valuable typewriter information free. The leading mail order typewriter house. A. E. Atchison, 110-112 No. LaSalle St., Chicago.

GOOD, serviceable typewriters \$7.50 and up. Post card brings list. Hub Typewriter Co., 286 Devonshire St., Boston.

TYPEWRITERS—Rare bargains from \$5 to \$50; all guaranteed; shipped with privilege of 15 days' free trial; get our proposition before purchasing a writing machine. We can save you dollars. Coast Typewriter Exchange, Atlantic City, N. J.

TYPEWRITER Ribbons for any Typewriters or color, 45c each; \$4.75 dozen. Postage free. Agents wanted. Wells Curiosity Shop, 20 S. Second St., Philadelphia, Pa.

## PRINTING, ENGRAVING AND MULTI-GRAPHING

"ARISTOCRAT," new size stationery, 1,000 letterheads, \$2.50; 1,000 envelopes, \$2.50 (printed) prepaid. Send for booklet "Letterhead Suggestions." It's Free. L. S. Frank Adv. Mfg. Co., 711 Locust Street, St. Louis.

100 FINE AA White 6% envelopes printed 30c. (Commission.) Printer, Kysertke, N. Y.

LETTERHEADS that advertise. Plates to print. D. Freeburn, Hicksville, Ohio.

RUBBER Stamp; name and address 15c. Dickey, 1174 Stout, Denver, Colo.

PRINT your own envelopes. Outfit 50c. Sample of work free. U. S. A. Art Goods Company, Box 348, San Diego, California.

PRINTING Outfits—Presses, type, supplies, type novelties. Send stamp for catalogue. Model Press, York, Penna.

1,000 COLORED Art Ad. Slips, 3 1/2 x 5 1/2, \$1.00 postpaid. Coin carriers, De Luxe slip, envelopes, letterheads, imitation typewritten letters, 6x9 circulars, \$1.50 up. Elegant samples free. Good's Printery, Harrisonburg, Va.

GUMMED Labels, 5,000—\$1, 1x2 inches, printed to order. Catalogue 2c. Helmers Co., Hoboken, N. J.

HALFTONES, \$1.25; six \$1.10 each; your signature rubber stamp, \$1.00. Interstate Engraving Company, 290 5th Avenue, New York.

THREE hundred Letterheads, Envelopes, and cards printed \$2.50 postpaid. Lincoln Press, 324 Elm Street, Cambridge, Mass.

"SAVE a Dollar—Let Grandon Print It." 1,000 3 1/2 x 5 circulars, \$1; 6x9, \$1.50; 1,000 Bond Letterheads, \$2.25; envelopes, \$1.75 up. Samples, Grandon, Jackson, Mich.

QUALITY Stationery—Attractive Letterheads and Envelopes at usable prices; samples upon request. Clark & Son, North Block, Cohoes, New York.

POSTPAID—1,000 Envelope Slips, 75c; 500 Noteheads, Statements, Cards, 85c; Envelopes, 95c; Bond Letterheads, \$1. Samples, Ryder, Barnerville, N. Y.

IMITATION Typewritten letters, lowest rates. Multigraph Printing Company, Beaver Springs, Pa.

GUMMED Labels with name, 200 for 10c; with address, 15c. Star Press, Clintonville, Conn.

250 EACH—Bond Letterheads and envelopes, \$1.20; 100, 80c. Hoyt Bros., Pittsfield, N. H.

4,000 GUMMED Labels—1x2 inches, printed to order, \$1. Pearl Co., X-10, Clintonville, Conn.

UNITY Bond Letterheads, Embossed in two colors, with envelopes, 250 for \$2. Exclusive work. Satisfaction guaranteed or money refunded. Samples on request on your letterhead. Franklin Art Co., Little Falls, N. Y.

PRINTING—500 either noteheads, envelopes, statements, cards, \$1; 1,000, \$1.50; 1,000 linen finish letterheads or envelopes, \$2.50; 1,000 typewriter letters, \$2. Samples, Model Company, Manchester, Iowa.

125 LETTERHEADS and 125 Envelopes, printed, \$1 postpaid. Patterson, Printer, Beaver Falls, Pa.

125 WHITE Bond Letterheads and 125 Envelopes, printed, \$1, prepaid. B. Lutz Printing Co., York, Pa.

50 CALLING Cards, 10c, prepaid. F. Shepard, Rome, N. Y.

PREPAID, 200 gummed labels 10c; 1,000 circulars 3x6, 85c; 500 bond letterheads and envelopes \$2.85. The Majestic Printing Co., 3844 Leeward Ave., Los Angeles, Calif.

ADVERTISERS—Here's your opportunity. 25 word classified ad inserted in "Cartoons Magazine" for 50c; one inch display ad \$1.25. 30,000 copies guaranteed. Send in your ad for the next issue. Cartoons Classified Dept., 78 E. Madison St., Chicago.

PRINTING Presses, Type and Supplies. Big bargain sheet for stamp. Popular Bargains, Richland, Pa.

PRINTING Presses, type, supplies. Catalog free. L. M. Carroll & Co., 326 Madison St., Chicago.

GOOD Printing at low prices. 1,000 good letterheads, envelopes, cards, billheads, labels, circulars, \$2.50. Samples free. Catalogues, booklets, and circulars our specialty. Ernest L. Fantus Co., 323 S. Dearborn St., Chicago.

## PATENT ATTORNEYS

PATENTS—Edward Bruce Moore, Former Commissioner of Patents—Patents, trademarks and copyrights, Sole offices Barrister Bldg., Washington, D. C. See advertisement Page 120, this issue.

PATENTS secured, on easy terms. Pay a little at a time. I trust you—no references required. Booklet free. W. T. Jones, 894 G St., Washington, D. C.

PATENTS that protect and pay. Advice and books free. Rates reasonable—highest references; best results. Watson E. Coleman, Patent Lawyer, 624 F St., N. W., Washington, D. C.

PATENTS—Books, 100 mechanical movements and full information free. Expert service. Best terms. Write today. Fred G. Dieterich & Co., patent lawyers, 600 Ouray Bldg., Washington, D. C.

PATENTS secured promptly. Trademarks, Designs and Copyrights. Personal attention. Edward W. Kibbey, Patent Attorney, 503 Victor Bldg., Washington, D. C.

PATENTS Secured through Credit System. Send sketch. Free search. Booklet free. John Louis Waters & Co., Wash., D. C.

EQUITABLE Plan enables you to file application for patent at moderate cost. Particulars on request. Geo. R. Hamlin, 800 H Street, N. W., Washington, D. C.

PATENTS \$50.50, payable by easy installments. Wm. C. Dashiell, 809 H St., Washington, D. C.

THE Patentome is free. An education in obtaining patents. Established 1865. Anderson & Son, Attorneys, 707 7th St., Washington, D. C.

"PATENTS and Patent Possibilities" is a 72-page treatise which tells all about patents, what to invent and where to sell it. It gives honest advice to inventors, and is full of valuable and interesting information. Write for it today! It is free. H. S. Hill, 305 McLachlen Bldg., Washington, D. C.

PATENT what you invent. It may be valuable. Write me. No attorney's fee until patent is allowed. Estab. 1882. "Inventor's Guide" free. Franklin H. Hough, 323 Loan & Trust Bldg., Washington, D. C.

FOR dependable advice about Patents, address Benjamin & Bassett, 140 S. Dearborn St., Chicago, Ill.

PATENTS—Herbert Jenner, patent attorney and mechanical expert, 606 F St., Washington, D. C. I report free of charge if a patent can be had and its exact cost. Send for circular.

C. L. PARKER, Ex-member Examining Corps Patent Office, Patent Attorney, 919 G St., Washington, D. C. Inventor's handbook, "Protecting, Exploiting and Selling Inventions," sent free upon request.

PATENTS build fortunes for you. Our free booklets tell how; what to invent, how to choose an attorney. Write today. D. Swift, 317 Seventh St., Washington, D. C. Established 1889.

WANTED—New Ideas. Write for List of Inventions Wanted. \$1,000,000 in prizes offered for inventions. Our Four Books sent free upon request. Victor J. Evans & Co., 166 Ninth St., Washington, D. C.

PATENTS explained in my free books, telling what you should know—what to invent—what not to invent—how to sell your patent, etc. Write today, H. L. Woodward, 302 G St., Washington, D. C.

PATENTS That Pay. Proof given. Two wonderful guide books free. E. E. Vrooman & Co., 811 F St., Washington, D. C.

PATENTS—Send sketch for free search and report. Books on patents and book of reference letters sent free. John S. Duffie & Co., 610 F Street, Washington, D. C.

PATENTS—Trade-Marks. Send for my free book "How To Get Them." It's full of information you should know. Joshua R. H. Potts, 8 Dearborn St., Chicago; 929 Chestnut St., Philadelphia; 805 G St., Washington.

INVENTIONS Worth Thousands—Their value is governed by the strength of the patent. Get the advantage of our 39 years' experience in procuring your patent. Clients in your state. Write and send sketch. Louis Bagger & Co., 609 Barrister Bldg., Washington, D. C.

PATENTABLE Ideas Wanted—Send for 3 free books, R. B. Owen, 30 Owen Bldg., Wash., D. C.

PATENTS secured or fee returned. Send sketch for free search. Latest and most complete patent book ever published for free distribution. George F. Kimmel, attorney, 212 Barrister Building, Washington, D. C.

C. W. GERARD, formerly Patent Office Examiner, Scarritt Building, Kansas City, Mo.

No Attorney fees until patent allowed. Send sketch for free report. Books free. Frank Fuller, Washington, D. C.

PROTECTIVE patents procured promptly. 112 page blue book on patents sent on request. Trade-marks registered. Robb & Robb, 211-215 Southern Bldg., Washington, D. C.

PATENTS Secured—Take advantage of my personal experience; send sketch or model. Get my free book containing 200 mechanical movements. W. N. Bosch, Jr., 950 McGill Bldg., Washington, D. C.

## FOR INVENTORS

PATENTS, Trade-Marks and Copyrights. Our handbook on patents will be sent free on request. All patents secured through us are described without cost to the patentee in the Scientific American. Munn & Co., Patent Attorneys, 672 Woolworth Bldg., N. Y. Washington, D. C., office, 625 F St.

WIRE goods all kinds made to order. Cooley, 553 W. Monroe, Chicago.

WANTED to buy patent on article with merit. State price and particulars. F. C. Desch, 321 St. Paul St., Baltimore, Md.

INVENTORS: Your inventions developed, models made by experts, spare time, half cost. Kasdorf, 51 Mercer St., New York.

MECHANICAL engineer expert on manufacturing methods and designer of special machinery will develop your ideas and inventions into commercially practical form. Albert S. Kux, 105 W. Monroe St., Chicago.

WE desire to purchase meritorious patents or ideas for household or office specialties, either for cash or a royalty basis. Marshall Bobbins & Company, 1422 Marquette Bldg., Chicago, Ill.

BARGAINS—15-word ad, one year's subscription 25c; extra words one cent. 35,000 circulation. Digest, Grand Rapids, Mich.

INVENTORS and manufacturers: We develop patent and market practical inventions. Write Adam Fisher Mfg. Co., 61 Fisher Bldg., St. Louis, Mo.

PATENTS and Patentable Ideas sold on commission. Best location and facilities. Absolutely reliable. Fuller Company, 509 Fifth Ave., New York.

INVENTORS! Send 4c postage for Handsome Book on Patents and List of Inventions Wanted. Sanders, 7 Webster Building, Chicago.

"PROTECTING Inventions Before Patent Without Cost," next issue Inventor's Advocate, Advocate Building, 11, Washington, D. C., one year, 25c; three months, 10c.

PATENT Application fully prepared, \$10. Why pay \$65? Particulars free. Patent News, Dept. 31, Washington, D. C.

INVENTORS: My patent made a fortune. Particulars free. Let me sell yours. Eugene Pearl, M23 Union Square, New York.

WE'LL tell you without charge why your invention is, or is not, worth patenting. Benjamin & Bassett, 143 S. Dearborn St., Chicago, Ill.

HAVE you a Patent to sell? You'll be interested in my proposition. Write now for free particulars. F. W. Johnson, 6 N. Michigan Ave., Chicago.

IDEAS, Patents, Inventions, developed and perfected. Expert Model and Machinery Building. Scientific experimental work. Regal Model and Tool Works, 122 Clark St., Chicago.

HAVE You an Idea? If so, you should protect it by a patent. Send us a model or sketch for free opinion as to patentability. Write for our Four Books sent free to any address. Victor J. Evans & Co., 157 Ninth St., Washington, D. C.

WANTED—An Idea: Who can think of some simple thing to patent? Protect your ideas; they may bring you wealth. Write for "Needed Inventions" and "How to Get Your Patent and Your Money." Randolph & Co., Patent Attorneys, 629 F St., Washington, D. C.

PATENTS without advance attorney's fees. Send sketch for free report. Books free. Frank Fuller, Washington, D. C.

## PATENTS FOR SALE

**GREATEST** Advertiser ever invented. Gun tacks signs on buildings and walls. Proven success. The Sign Gun that Popular Mechanics Magazine gave a full front page writup in October number, 1914. Will sell U. S. and foreign patents. J. F. Burnam, Huntsville, Ala.

**PATENT** for Sale—Bat trap. Sanitary, durable, sure catch. Address, D. H. Clippinger, Perkins, California.

**PATENT** on Self-sealing, Self-cleaning, rotary valve for gasoline motors. Noiseless, simple. E. G. Fisher, 1908 Florida Ave., N. E., Washington, D. C.

**FOR Sale**—Valuable patent. Automatic Safety Stirrup, now selling. Complete set of tools for manufacturing in large quantities. Address, C. W. Stier, American Falls, Idaho.

**SELF-CONTAINED** Taper Turning Tool. Adjustable for different tapers. Wonderful, practical tool for mechanics. Will sell reasonable. C. J. Boyce, 592 Central Ave., New Haven, Conn.

**PATENTED** Hat Pin Guard. Sell cheap; easily manufactured. F. Read, Ireland Island, La Poile, Newfoundland.

**SAFETY** Device for submarines. Insures safety of crew under most severe conditions. Practical and easy to operate. Attached to submarine in few seconds. Works perfectly in 10 or 1,000 feet of water. It's worth investigation. Correspondence invited. Victor J. Martin, Idaville, Ind.

**DIES** and Patent No. 1,128,248 Lawn Hose Holder. W. H. Hetzel, Syracuse, N. Y.

**BASIC** ball-bearing metallic paint mixer. Paralyzed, sell cheap. Hathaway, 135 9th St., Miami, Fla.

**FASCINATING** Novelty for Sale. Patented. For mail order, premiums or advertising. Brand new. H. A. Gould, 4529 McMillan Ave., St. Louis, Mo.

**FOR Sale**—Mechanical Starter for Internal Combustion Engines. U. S. Patent. For automobiles. Revised by hand or engine. Robert Dressmann, Covington, Ky.

**WILL** sell my patent on Automatic Gate. Best offer takes it. Elza R. Hurst, Orient, Ohio.

**HOSPITAL** Bed appliance. Unlike any other. Adapted for numerous purposes. Practical and convenient. A boon to bed-ridden patients. Will sell outright or royalty. Inspection invited. L. Witt, 629 First National Bank Bldg., Oakland, Calif.

**FOR Sale**—Patent 1,124,093. Greenhouse Glass Mender. Chas. W. Woodruff, 62 Washington St., Middletown, N. Y.

**CAR-FENDER**, practical device; easily attached. George Koros, care P. S. S. Hospital, Mont Alto, Pa.

**OUTRIGHT** or royalty, recently patented new tool used everywhere; same as hammer, more efficient, best offer accepted. Particulars from Emerson Currie, Vancouver Heights P. O., B. C., Canada.

**AIRBRAKE** appliance, will connect with triple valve. Straight air, full braking power on every car. T. F. Cain, Montgomery, Missouri.

**PATENT** for Sale—The Postal Department will use 250,000 of these devices annually; publishing houses also. Photo, specifications; price on application. Mrs. Minnie Crafton, Mason City, Ill.

**LEVERLESS** riding corn cultivator; machines built, working in field; only machine of this type on market; can furnish testimonials from farmers using machine; on exhibition. H. Bohlander, Hinsdale, Ill.

**SALE** or Royalty—Patent 991,289 Multiple Plug Sockets—Improvement on Branch Plug fixtures. Make offer. L. H. Figg, 2621 1/2 Huron St., Los Angeles, Cal.

**FOR Sale**—Stream Heater, Patent; Portable. Automatic. Inexpensive. Efficient. Fully perfected, tested. Burns gas, gasoline. F. W. Seiffel, Carlock, Illinois.

**PATENTS** on Sanitary Sink Trap, corset clasp, health refrigerator, auto specialty. W. J. McLean, 554 Broadway, Everett, Mass.

**AIR** purifying and cooling device. Patent 1,189,171 for sale outright. Cheap to make and operate. Carl F. Landberg, 36 Willow St., Hartford, Conn.

**FOR Sale**—Fan for threshing machines. It keeps all the dust away from feeder. First patent in U. S. \$1,000 or less if cash. C. A. Holmquist, St. James, Minn.

**IMPROVED** Oiling Device. U. S. Patent No. 844,149. Canadian Patent No. 105,281. Both for sale. Best offer takes them. Harvey Laidy, Box 47, Cadillac, Sask., Canada.

**ADDING** Machine, entirely new; large capacity; best offer takes. W. J. Brown, Anita, Iowa.

**LOCK** for dental cabinets, desks, etc. Replaces expensive safes. An enemy to thieves. Investigate. Dr. Jordan, Jr., Lexington, Miss.

**VALUABLE** patents, all kinds, recently issued, for sale, reasonable terms. Alexander J. Wedderburn, Patent Attorney, Wedderburn Building, Washington, D. C.

**PATENT** Buyers are invited to address our sales department for information on any class of Patents they wish to purchase or lease on a royalty. We have secured a number of valuable patents in all lines of invention. Mail Order, Department Store and Household Novelties a specialty. Victor J. Evans & Co., 140 Ninth St., Washington, D. C.

**If** you want to know why you cannot sell your patent, write Benjamin & Bassett, 140 S. Dearborn St., Chicago, Ill.

**PATENTABLE** ideas wanted—Send for 3 free books. R. B. Owen, 30 Owen Bldg., Washington, D. C.

## CONSULTING ENGINEERS

**CONSULTING** Engineer—A. M. American Institute Electrical Engineers. Practical advice, Ideas, Inventions perfected. Maximilian M. Weil, 2 Rector, New York.

## MODELS AND MODEL SUPPLIES

**PRODUCERS** of Results: Inventions developed, Models, Experimental work, anything special in metal to order, metal novelties, metal spinning, castings in any material, patterns of all kinds, plating, general manufacturing, designing, special tools, punches and dies, metal stampings. Send drawings or sample. Expert information free. John's Machine & Stamping Works, Dept. C. Cleveland, Ohio.

**METAL** parts for experimenters and model makers. Any metal, all sizes and shapes in sheet, tubing and rods of brass, copper, bronze, zinc, German silver, aluminum, steel, solder, etc. No order too large or too small. Write for quotations. Cut Metal Supply Company, 435 Marion St., Brooklyn, N. Y.

**We** develop and perfect working models for inventors. Light machinery building, scientific experiment work. Dies made and stamping done. Modern Die & Tool Company, 70 Ship St., Providence, R. I.

**EXPERIMENTAL** and Model Work. Write for estimates. Wm. H. Doffert, Tatamy, Pa.

**INVENTORS**, let us make your Model. Dies, Tools, Metal Patterns, Special Machinery, Metal Stamping and Castings. "Patented Specialties." Send sketch. 25 years' experience. Ohio Valley Specialty Company, 2129 Barnard St., Cincinnati, Ohio.

**ELECTRICAL** and mechanical inventions developed. Drawings, Models, Special and Automatic Machinery, Tools, Dies and Press work designed and manufactured. Commercial Engineering Co., 142 Market St., Newark, N. J.

**We** make models of every description. Perfect inventions, electro-mechanical devices, and light machinery built. Experimental work our specialty. Expert workmen; prices reasonable. Aetna App. Co., 2819 Lincoln Ave., Chicago, Ill.

**INVENTORS**: We perfect and manufacture your invention, dies, models, metal patterns, stampings and screw-machine products. Crescent Tool Co., 118 Cincinnati, Ohio.

**MODELS**, dies, and manufacturing for inventors, by builders of "Tools That Work." La Croix Tool Co., 214 N. 21st St., St. Louis, Mo.

**MODELS** made for inventors; general machine work; designing and perfecting; developing automatic devices and machinery. In a position to do all kinds of light tool and machine work. Prices reasonable; estimates cheerfully given. Ideal Machine Works, 62 Ann Street, New York City.

**We** make working models for inventors; also dies and stamping of specialties, and carry a complete stock of brass gears and model supplies. Send for catalogue. The Pierce Model Works, 3465 Pierce Ave., Chicago, Ill.

**FREE** catalogue of model supplies. Castings, metal specialties on contract. North Chicago Tool Works, 15 Grove Ave., North Chicago, Ill.

**SPECIAL** Electrical and Mechanical devices built to order. Models, Tools, Dies. Benj. Levi, 357 West Broadway, N. Y. City.

## MANUFACTURING

**WE** manufacture metal specialties, all kinds; also dies and tools. Light stamping finished complete in steel, copper, brass, or any metal. Drawing a specialty. Difficult work solicited in novelties and patented articles. Write your wants. Loesch Mfg. Co., Enterprise Bldg., Milwaukee, Wis.

**SPECIALTIES** Manufactured. Tools, Dies, Models. Lyons Machine Works, Lyons, Iowa.

**A** MANUFACTURING concern with an efficient sales organization covering the world will take on a patented manufacturing specialty. If you have anything in this line which you want built and marketed, address with full particulars, C. C., 9th floor, 78 E. Madison St., Chicago.

**CLEVELAND** Specialty and Manufacturing Company, Cleveland, Ohio, design or make special articles to order. Inventions developed.

**WIRE** Goods, all kinds, made to order. Cooley Mfg. Co., 553 W. Monroe St., Chicago.

**INVENTIONS** perfected and manufactured. Reference, your banker. Russell Machine Co., Dallas, Tex.

## REAL ESTATE AND FARM LANDS

**KANKAKEE** Valley Farmlands—The great opportunity of the Middle West. River now being dredged to Illinois State line; result—lands will double in value; only eighty miles from Chicago, \$80 per acre. 580 acres, fair buildings, one mile station, \$5,000 cash, balance five years, five per cent interest. Robert D. Peters, Exclusive Agent, Knox, Indiana.

**ARKANSAS** improved farms, \$12 acre and up; healthful; no crop failures; rich soil; grow anything; write for list. J. L. Goodbar, Charleston, Arkansas.

**\$2,500 CASH** Required. 360 acres, 25 cows, tools. Owner has made money, retiring; chance of a lifetime for young man; 100 acres rich fields, big pasture, valuable wood, 1,000 sugar maples; 8-room house, 4 barns, 160-ton silo, near large R. R. town; if taken now you get stock, machinery and crops; price \$3,500, only \$2,500 cash, balance easy terms; full details, traveling directions, page 12, "Strout's Farm Catalogue No. 38," just out; write today for your free copy. E. A. Strout Farm Agency, Station 7343, 47 West 34th St., New York.

**40-ACRE** farm South Tampa, rich black soil, produces best paying crops raised in Florida, ready for market when prices are highest. Box 478, Jacksonville, Florida.

**POULTRY**, Fruit, Truck Farms near Philadelphia. Catalog. W. Stevens, Perkasie, Pa.

**I** HAVE a successful way of selling farms and farm lands. Write me for free particulars. No obligation whatever. E. J. Zimmer, 925 Tower Bldg., Chicago.

**THAT** Dream of yours, about getting the most out of life in "The Land of Sunshine, Fruit and Flowers"—California—will come true, just as soon as you desire, if you let me tell you where you can get excellent land, in large or small tracts, at reasonable prices and on easy terms. So write to me today. Accurate information free for the asking. R. A. Smith, Colonization & Industrial Agent, Union Pacific R. R. Co., Room 4125, Union Pacific Bldg., Omaha, Neb.

**WE** can sell your farm, city real estate, or business, no matter where located. Established 28 years. Write us, Aetna Investment Co., Suite 623, Green Building, Seattle, Wash.

**FOR Sale** cheap, 157 acres near Clinton, Oklahoma; running water, woven-wire fencing, telephone, rural route. Howard Harris, Thane, Alaska.

**320-ACRE** Free Homesteads; choice land open. Fox, Gillette, Wyoming.

**CALIFORNIA** Special—Widow's sacrifice, 86 acres improved; electricity, telephone, alfalfa, unirrigated. Five thousand cash, balance easy payments. Neideffer, 2108 L St., Sacramento, Calif.

**VIRGINIA** Farms, small and large, \$15 an acre and up. Easy payments, mild climate, fertile soil. Ideal for fruit, stock or general farming. On railroad with big markets near-by. Write for list, maps, etc. P. La Basme, Agri. Agt., N. & W. Ry., 250 N. & W. Bldg., Roanoke, Va.

**SELL** your property quickly for cash, no matter where located. Don't pay big commissions. Particulars free. Real Estate Salesman Co., Desk B, Lincoln, Nebr.



**FREE Government Lands**—Million acres now open to homestead entry in 25 states. Official 112 page book describes every acre in every county. How secured free. New laws, lists, etc. Price 25c postpaid. Also maps, soil guides, complete information. **Webb Pub. Co., Dept. 71, St. Paul, Minn.**

**SOUTH Florida Fruit and Trucking Lands.** We are wholesalers of Southern Lands and have choice South Florida lands along the line of the Florida East Coast Railroad which we are offering at attractive prices. These are splendid lands for colonization purposes, being fertile and well located. Write us for particulars. **Albert Fendig & Co., Brunswick, Georgia.**

**"WHERE Opportunity Knocks Twice"** is an interesting book on California, published recently by a well-known author. It tells the remarkable results attained in that great state and the San Joaquin Valley in particular. Facts and figures are given, proving that, in this great valley, opportunity not only knocks twice, but every day in the year. Lands are within reach of the man with average means. Values are lower than in many sections less inviting. The opportunities are worth investigating. Send for our description folders. They are free. **C. L. Seagraves, General Colonization Agent, AT&P Ry., 1841 Railway Exchange, Chicago.**

**120 ACRES** hardwood timber—oak, gum, hickory—Grenada County, Miss. 1 1/4 miles to shipping point—no better investment anywhere. \$180 down, balance \$10 per month. **Jelley, Sheddley Bldg., Kansas City, Mo.**

**LANDOLOGY**, a magazine giving the facts in regard to the land situation. Three months' trial subscription, free. If for a home, or as an investment you are thinking of buying good farm lands, simply write me a letter marking it personal and say, "Mail me Landology and all particulars free." Address **Lloyd M. Skinner, Gen'l Mgr., Skidmore Land Co., 48 Skidmore Bldg., Marinette, Wis.**

**GOVERNMENT State Indian Land.** Booklet, dime. **Joseph Clark, Sacramento, California.**

**160 ACRE Farm**, bargain; best of soil, level, fenced, big crops on adjoining farms, 5 miles from railroad town; price \$15 per acre; will take serviceable auto as part pay. If you don't want to buy, don't write. **A. L. Stone, Texline, Tex.**

**400-ACRE** corn and alfalfa farm. **Neal Pickett, Arkansas City, Kansas.**

**FARMS for Sale or exchange** anywhere in the U. S. or Canada, direct from the owners. State where you want to locate. Information free. **American Investment Association, 37 Palace Bldg., Minneapolis, Minn.**

**\$220 WILL buy 40 acres** good land and four good yearling heifers. We guarantee to take good care of heifers, have them properly bred, for one-half the increase. Title to land and heifers remains in your name. A splendid opportunity to start in live-stock business with small capital. **Wood-Fisher Company, 211 Utah Savings Bldg., Salt Lake, Utah.**

## GINSENG

**GINSENG seeds \$1.00 thousand.** Planting instructions free. **Specialty Farm, Rockford, Minn.**

**GOLDEN Seal**, the golden opportunity. My own experience how to grow. Booklet 10c. **W. N. Long, Florence, Ky.**

## DOGS, BIRDS, POULTRY AND PETS

**RAISE Belgian Hares for us.** We furnish stock and pay you \$1.50 each. Also Skunk, Mink, Squabs, Frogs, etc. Send dime for booklet and contract. Address **The Belgian Hare, Dept. 12, Holmes Park, Mo.**

**THOROUGHBRED Scotch Collie Pups for sale.** **Mrs. J. A. Seaman, Albion, Ia.**

**FOR Sale**—Champion bred Airedale pups, mating, Ch. Gold Heels and Ch. Soudan Sapphire (imported, English name Ch. Springbank Diamond). **Mrs. Fred Alman, Portland, Ind. Almandale Farm and Kennels.**

**LARGEST dog kennel in world.** Dogs of all breeds reasonable. **Philadelphia Kennel, 170 E. Allen Street, Philadelphia.**

**ENGLISH setters**, white and black. Tricked, broken quail and chicken. **W. J. Wetshimer, St. Marys, O.**

**GOLDFISH**—Rare specimens, artistic aquariums, snails, plants. Catalog free. **Pioneer Goldfish Hatchery, Racine, Wis.**

## MISCELLANEOUS

**RADIUM**—Liberal sample crushed ore, containing \$10 worth, free Radium, \$1 prepaid. Splendid chance to experiment! A fortune awaits the man who can extract the metal inexpensively. **Radio-Active, Box 126, Callstoga, Cal.**

**CUTS anybody can make.** Simple Etching Process, \$1. Particulars, specimens, for stamp. **M. Day, Windfall, Ind.**

**SPEND summer gathering insects**, butterflies. I pay big prices. Many worth \$5.00, \$10.00. All salable. Men, Women. Get instructions, price-list, pictures, descriptions of valuable ones. Send stamp. **Sinclair, Box 244, D6, Los Angeles, Cal.**

**METAL stamps last longer than rubber.** Two stamps, name and address, 25c. **U. S. A. Art Goods Company, Box 548, San Diego, California.**

**EMBOSS your own stationery**, books, music, etc.; initials, monogram, name or address—single initial 25 cents; circular for stamp. **R. W. Shoupe, Box 416, Findlay, Ohio.**

**SILVER Mirrors and make money.** Others are doing it. The best formula 25c. **Auburn Supply Co., Dept. R-5, 7745 Peoria St., Chicago.**

**SMALLEST manufactured article.** Perfect machine screw. A thimble holds 50,000. Send 10c for 1/2 dozen. **E. Wood, Chamberlain Terrace, Waltham, Mass.**

**ALASKAN ore samples or views**, 3 for 25c. **Charles Grohman, Thane, Alaska.**

**"ART of Cut-Making" (New).** Guaranteed etching process, and 60 Formulas, 25c. **Formula Service, 3311-E, Belleplaine Ave., Chicago.**

**METAL melts in hot water 175 F.** Fine thing for experimenters, artisans, pattern makers; casts in wet plaster molds; copies accurately. Electro-deposit any metal on it, melt out core in hot water. Make trick teaspoons that melt in hot tea, etc. \$1, 1/2 lb.; \$1.75, 1 lb. **Superior Mfg. Co., 44 Henry St., Buffalo, N. Y.**

**CANDY Making a fine art.** Splendid instructions how to make and sell, 25c. **Auburn Supply Co., Dept. C5, 7745 Peoria St., Chicago.**

**MAKE \$3.00 to \$10.00 a day** refinishing lighting fixtures, brass beds, etc. Experience unnecessary. Free samples showing finishes. **Gunnmetal Co., Dept. H, Decatur, Ill.**

**20,000 FORMULAS**, recipes, etc. 530 p. volume, alphabetically indexed, \$1 prepaid. **Formula Bureau, 3311-E, Belleplaine Ave., Chicago.**

**BE a Handicraft King.** Earn Big Money on Stage. I will teach you how. For particulars address **Box 992, Springfield, Mass.**

**BIG Mail Free.** Your name listed once, 35,000 circulation and magazine one year free. **Digest, Grand Rapids, Mich.**

**WAR Atlas**—Large 29-page (11x15 in.) Atlas of the War in Europe, containing large colored scale maps of the battle-ground, showing Europe, Austria, Serbia, Germany, England, Belgium, France, Russia, Italy, Greece, The World, etc. Special data showing comparison of armies and Navies involved, pictures of rulers, etc. Price, 25 cents. Postage and packing, 5 cents additional. Address **Popular Mechanics Book Dept., 6 N. Michigan Ave., Chicago.**

**VOCOPHONE**—One dime—no toy—sweet music—vocal and instrumental—nothing to learn—produces perfectly popular music. **Jennings Studio, Valentine, Nebr.**

**TATTOOING**—Machines, Colors and Supplies. Write now for my new catalogue. It's free. **J. Barber, 70 Brush St., Detroit, Mich.**

**GENUINE Sioux Indian Beadwork and Curios**, also Elk Teeth, Moccasins, Fobs, Belts, Hatbands, Pouches, Wacclubs, Indian Costumes. Send 10c for price list. **Strong Curio Co., Gordon, Neb.**

**GRANDFATHER'S Clock Works**, \$5. Slightly shop-worn, quantity limited, others with chimes, all prices; also several nice Grandfather's Clock cases, exceptional bargains. **Clock Company, 1673 Buffner St., Philadelphia, Pa.**

**RUBBER stamps**, photo negative type, steel dies, metal badgers, seals, stencils. Catalogue 10c. **Buckeye Stamp Works, Market, Dayton, Ohio.**

**BE AN ILLUSTRATOR.** Learn to draw. We will teach you School of Illustration 112 Page Bldg. Chicago, Ill. Send for Catalog



**LEARN WATCHMAKING** and become independent. Good-paying positions secured. Easy to learn. Send for FREE CATALOG. **ST. LOUIS WATCHMAKING SCHOOL, Dept. 5, ST. LOUIS, MO.**

**LEARN RIGHT AT HOME BY MAIL DRAWING-PAINTING** Home study courses in Drawing, Painting, Illustrating and Cartooning. Learn for profit or pleasure. We can develop your talent. This school has taught thousands. Free Scholarship Award. Write today for full explanation and our handsome illustrated Art Annual. **FINE ARTS INSTITUTE, Studio 755, OMAHA, NEB.**



**WANTED RAILWAY MAIL CLERKS \$75 to \$150 a month for life**

**OVER 230,000 U. S. GOVERNMENT POSITIONS ARE OPEN TO COMPETITORS**

**Many appointments are made each month WAR-PROOF—PANIC-PROOF—SURE-PAY JOBS**

Country residents and city residents stand the same chance for immediate appointment. Common-sense education sufficient.

Write immediately for schedule showing the places and dates of the coming examinations in your neighborhood. Don't delay. Every day you lose means the loss of just so much coaching before the rapidly approaching examinations.

**FRANKLIN INSTITUTE, Dept. W106, Rochester, N. Y.**



**COUPON** This coupon, filled out as directed, entitles the sender to free specimen questions; a free copy of our copyrighted book, "Government Positions and How to Obtain Them," a list of positions now obtainable, and to consideration for Free Coaching for the examination here checked.  
 ... Railway Mail Clerk (\$900 to \$1200)... Customs or Int. Rev. Pos. (\$750 to \$1000)  
 ... Bookkeeper - - - (\$800 to \$1200)... Stenographer - - - (\$500 to \$1500)  
 ... City P. O. C. k or Car. (\$800 to \$1200)... Clerk in the Departments  
 ... Rural Mail Carrier - (\$800 to \$1200) at Washington - - - (\$800 to \$1500)  
 ... Passes Canal Clerk - (\$1200 to \$1500)... Canadian Government Positions.

Name..... Address..... W106

# Typewriter Economy

Pay only \$2.00 a month until the low total price of \$29.80 is paid and the machine is yours. And you

## Use As You Pay

ing a \$100.00 machine for \$29.80. Anything like this been attempted.

This is absolutely the most economical typewriter offer ever made. Do not rent a machine when you can pay \$2.00 a month and own one. Think of it—Buy—Cash price \$28.60. Never before has

Genuine  
Standard  
Model No. 6

# REMINGTON

Typewriter  
Guaranteed  
—Free Trial

Perfect machines only, complete outfit, nothing extra to buy, no strings of any kind to this offer. Just think of buying such a typewriter for \$7.80 down and \$2.00 a month. Cash price \$28.60. Thousands of people have paid \$100.00 cash for Remingtons. This typewriter built the reputation of writing machines in the business world. It's standard; as fast as the fastest operator; so reliable and strong the shrewdest business men choose it; so wonderfully simple a child can operate it with half an hour's practice and rapidly attain speed. Comes to you with two color ribbon, complete operating instructions, tools, waterproof cover, practice paper, carbon paper, universal keyboard arrangement, everything ready. It runs beautifully. Writes as perfect and clean-cut a letter as quickly and easily as any typewriter bought for \$100.00. It's wonderfully simple; it's strongly built and will give you years and years of honest service and complete satisfaction.

### COUPON

HARRY A. SMITH, Dept. P, 231 No. Fifth Ave., Chicago

Ship me a No. 6 Remington, l. o. b. Chicago, as described in this advertisement. I will pay you the \$22.00 balance of the special \$29.80 purchase price, at the rate of \$2.00 per month. The title to remain in you until fully paid for. It is understood that I have three days in which to examine and try the typewriter. If I choose not to keep it I will carefully repack it and return it to the express agent. It is understood that you give the standard guarantee for one year.

Name .....

Address .....

Pop. Mech. May



## You Take No Risk. Put in Your Order NOW

When the typewriter arrives, deposit with the express agent \$7.80 and take the typewriter three days and try it. If you find it to be the best typewriter you ever saw, satisfactory in every respect, keep it and send us \$2.00 each month, until our special price of \$29.80 is paid. If you don't want to keep it, return it to the express agent, and he will give you back your \$7.80, and return the typewriter to us. We will pay the return express charges.

You won't want to send this machine back after you have seen it and tried it. You can't imagine the perfection of these machines till you see one, and the price is \$70.20 less than the catalogue price, and it is guaranteed just as if you paid \$100.

The supply at this price is very limited, the price will probably be raised when next advertisement appears so don't delay. Simply fill in the coupon—mail to me—the typewriter will be shipped promptly. There is no red tape. I employ no solicitors—no collectors—no chattel mortgage. It is simply understood that I retain title to the machine until the full \$29.80 is paid. You cannot lose. It is the most economical typewriter opportunity you will ever have. Without sending any money, let me now ship you this typewriter for free trial.

## Ridpath's History of the World At a Bargain



We will name our price only in direct letters to those sending us the Coupon below. Tear off the Coupon, write name and address plainly, and mail to us now before you forget it. Dr. Ridpath is dead, his work is done, but his widow derives her support from his history, and to print our price broadcast for the sake of quickly selling these few sets would cause great injury to future sales.

### FREE BOOKLET COUPON

WESTERN NEWSPAPER ASSOCIATION 5-15  
140 So. Dearborn St., Chicago, Ill.

Please mail your 46-page free sample booklet of Ridpath's History of the World, containing photogravures of Napoleon, Queen Elizabeth, Socrates, Caesar and Shakespeare, diagram of Panama Canal, etc., and write me full particulars of your special offer to Popular Mechanics readers.

NAME .....

ADDRESS .....

Please Mention Popular Mechanics

## 25c Postpaid PRACTICAL —ELECTRICS—

(MODEL LIBRARY SERIES)

The biggest book bargain ever offered—contains a fund of useful and practical information in convenient form for easy reference. Data covers

Electric Bells, Batteries, Accumulators, Dynamos, Motors, Telephones, Inductive and Intensity Coils, Microphones, Phonographs, Photophones, etc., etc.

135 pps. 126 illustrations.

Spon & Chamberlain 125 P. M. Liberty St.  
New York, U. S. A.

### LEARN WATCHMAKING AND ENGRAVING

Earn while learning. Most practical watch school. Individual instructions. Graduates in great demand. Book free. Chicago School of Watchmaking, 63 E. Van Buren St., Chicago

### LEARN TO WRITE EARN \$25 to \$100 ADVERTISEMENTS A WEEK

We can positively show you by mail How to increase your salary. BOOK MAILED FREE. PAGE-DAVIS CO., 112 Page Building Chicago Ill., or 150 Nassau St., New York

### 30 Days FREE TRIAL

and freight prepaid on the new 1915 "RANGER" bicycle. Write at once and get our big catalog and special offers before buying.

Marvelous improvements. Extraordinary values in our 1915 price offers. You cannot afford to buy without getting our latest proposition. WRITE TODAY.

Boys, be a "Rider Agent" and make big money taking orders for bicycles and supplies. Get our liberal terms on a sample to introduce the new "RANGER."

Tires, equipment, sundries and everything in the bicycle line half usual prices. Auto. and Motorcycle Supplies. MEAD CYCLE CO., DEPT. D108 CHICAGO





# HOW TO RUN AN AUTO

1915 EDITION IS SELF-TAUGHT IN 1915 EDITION

## AUDELS AUTOMOBILE GUIDE, \$1.50



### LATE — CONCISE — PRACTICAL

THE object of this book is to give, in the easiest understood form, the information necessary for the proper operation, care and maintenance of an automobile.

To adapt the book to many needs the subject matter is presented in the form of questions and answers. Technical terms are explained or made clear by the wording of the answer, which is always brief and direct.

Any one of the definite chapters on Carburettors, Ignition, Gas Engine Operation, How to Run an Automobile, Overhauling the Car, Battery Troubles, or Starting and Lighting Systems, are alone worth the price asked for the 30 complete chapters contained in this book of 700 pages, illustrated by 550 illustrations.

The form and size are such that it is convenient to handle and study.

This book is a self-educator, hence: "He who runs may read" and improve his present knowledge of automobile engineering and proficiency.

Handsomely bound in durable Full Leather, Pocket size.

### Audels Automobile Guide, \$1.50

## A BOOK WORTH HAVING

"Understand Your Car" Explained in the following chapters:

1. Ready Reference Index.
2. The Automobile.
3. The Gas Engine.
4. The Cycle of a Gas Engine.
5. Brief Outline of Gas Engine Principles.
6. Cooling Systems.
7. Fuels.
8. Carburettors.
9. Ignition.
10. Timing and Balancing.
11. Gas Engine Operation.
12. Clutches.
13. Transmissions.
14. The Drive.
15. The Differential.
16. The Running Gear.
17. Tires.
18. Brakes.
19. Ball and Roller Bearings.
20. Lubricants and Lubrication.
21. Motor Cycles.
22. Electrics.
23. Electricity.
24. Dynamos and Motors.
25. Storage Batteries.
26. Methods of Circuit Changing.
27. How to Run an Automobile.
28. Overhauling the Car.
29. Starters and Starting Systems.
30. Electric Lighting and Wiring.

## NONE OTHER JUST AS GOOD

### Free Examination

We don't want you to take our word, or anyone else's for it. We are willing to send you the book without deposit. Use it seven days in connection with your car. Then send back the book or remit \$1.50. Could anything be fairer?

Cut out and fill in your name and address plainly at the bottom. Place it in an envelope and mail.

### This Book Will Speak for Itself

Theo. Audel & Co., 72 Fifth Ave., New York

Kindly mail me copy of Audels Answers on Automobiles, and, if found satisfactory, I will immediately remit you \$1.50, or return the book to you.

NAME.....

OCCUPATION.....

ADDRESS..... May P. M.

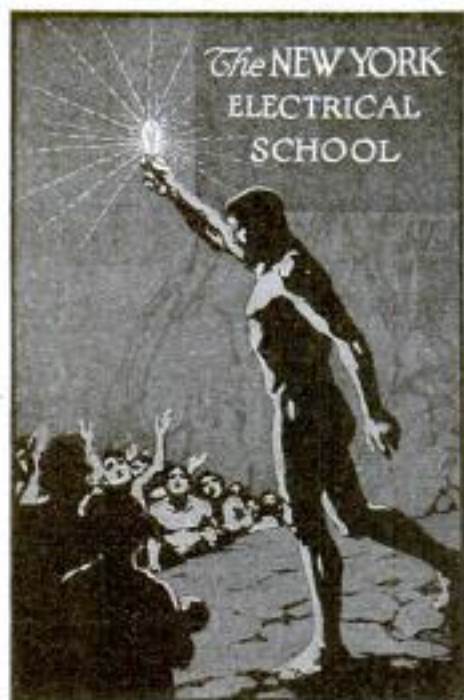

The N. Y. Electrical School is the pioneer and premier school of the "Learn by Doing" method. When you have completed this Course you shall be fully qualified to handle ALL branches of Electrical industry.

The equipment of this School is unequalled and up-to-the-minute. No preparation needed to become a "learner" in this school. You can start to learn on any day of any week throughout the whole year. Send for catalogue.

**New York Electrical School**  
44 West 17th Street New York City



## DO NOT STAMMER

My book, "How to Stop Stammering"—a treatise on "Scientific Talking and Psychic Training." School and circular literature FREE. **M. L. HATFIELD**, Prin. of The Pacific School for Stammerers, 1918 Grove St., OAKLAND, CAL.

## WHY NOT BE AN ARTIST?



STUDY drawing at home under Expert Faculty. We have successful students in every part of the world. Turn your Talent into money. Our Students are filling high salaried positions. 14 years successful teaching. Endorsed by high authorities. 18 Courses in Commercial and Illustrative Drawing, Teachers' Normal and Applied Art, Profit or Culture.

Thoroughly Equipped Residence School  
Artist's Output FREE to Enrolled Students  
SCHOOL OF APPLIED ART, 755 Applied Art Bldg., Battle Creek, Mich.

You should have it

The **Earl J. Early** Company  
307 Arch St.,  
Philadelphia,  
U.S.A.

Your dealer should have it



The Drawing Attraction  
of the Drawing World

The **Earl J. Early** Celluloid  
**Line-O-graph**

Patented Dec. 13 '04. No other equal

No. 754 Draftsman Special 189

*Learn to Write*

BEGIN TODAY  
WRITE FOR MY  
FREE BOOK

I can make a good penman of you at home during spare time. Write for my free book, "How to Become a Good Penman."

It contains specimens and tells how others mastered penmanship by the Tamblin System. Your name will be elegantly written on a card if you enclose stamp to pay postage.

FREE Write for it Today  
BOOK

F. W. Tamblin, 418 Meyer Bldg. Kansas City, Mo.

## Are You a Square Peg in a Round Hole?

Most men in this world are misfits, square pegs in round holes. This is why more do not succeed. You cannot hope to make a success if your whole heart and soul is not in your work. You are wasting your time and energy—dwarfing your personality—giving your ideas and individuality no chance to develop, if you do not love your work. Most men have it in them to be successful if their energies are properly directed—if their work is congenial.

If you are mechanically inclined—if you love machinery you are wasting time and losing money if you are working at anything else—you are a square peg in a round hole. The automobile business offers bigger and broader opportunities for the mechanically inclined men than any other. This is the most rapidly growing industry in the world today. Thousands of new cars are sold every month and an army of experts are required to care for them. The demand for thoroughly trained and competent automobile men is far beyond the supply and you are assured a good position, short hours and good pay. Here you will find success and satisfaction in congenial work. I have shown thousands of men the way to success in the automobile business. My big school is perfectly equipped to make you a thoroughly competent mechanic, chauffeur, demonstrator, repair man, garage manager, salesman, etc.

I want to send you without obligation on your part my big and handsomely illustrated book that fully explains the wonderful opportunities the automobile industry offers ambitious men. It tells why Sweeney Graduates succeed. It explains the inside workings of my great automobile school. It is yours if you will send me your name and address on a post card. Do it today.

**SWEENEY AUTOMOBILE SCHOOL**  
1161 East 15th St. Kansas City, Missouri

## TRADE SCHOOL COURSES

Machinist, Automobile Machinist, Chauffeur and Manual Training. Courses with little

book study but much shop work give just the practical training needed to qualify for good paying jobs. Save a year's time. Automobile, Machinist and Manual Training Courses, 48 weeks. Chauffeur Course complete in 12 weeks—general knowledge of the auto—how to drive and locate trouble in car. Special 6 weeks' driving course, Engineering. Low fees and living costs. For catalog address

**Geo. P. Magill, Pres., Highland Park College, Des Moines, Ia.**



## BE A TRAVELING SALESMAN

Hundreds of good positions now open. No experience required to get one of them. Write today for list of openings offering opportunities to earn Big Money while you learn and travel—earn from hundreds of our students who are earning \$100 to \$500 a month. Address nearest office, Dept. 507 NATIONAL SALESMEN'S TRAINING ASSOCIATION Chicago, New York, San Francisco

## CIVIL SERVICE

positions are in all parts of the country. Good pay steady work, life positions, congenial surroundings, promotions on merit, short hours, annual vacation and sick leave with pay. Many thousands appointed yearly. Both sexes. No political pull. Nearly 300,000 classified positions. Common school education sufficient. Full information and questions used by the Civil Service Commission free.

**COLUMBIAN CORRESP. COLLEGE, Washington, D. C.**

## STRUCTURAL DRAFTSMEN

are paid good salaries. By our correspondence system you CANNOT FAIL. Write for circular and terms.

**CANTON TECHNICAL SCHOOL, Canton, Ohio**



## STAMMER NO MORE

If you stammer, I can cure you. Attend a stammering school until you hear from me. WRITE at ONCE for MY FREE BOOK **ALBERT R. BELLERO, E.** Principal of the Connecticut School for Stammerers 73 Park Street Dept. A MERIDEN, CONN.

## AUTOMOBILE WATCH FOB

The neatest and most novel Fob ever designed. Has a leather strap and nickel buckle. Wheel is made of Rubber and is an exact reproduction of an automobile wheel with a quick detachable tire which can be removed and put on in a "jiffy." We will mail you this novel watch fob

**ABSOLUTELY FREE**

If you will send us 25c in coin or stamps for a three months' trial subscription to the AMERICAN CHAUFFEUR AND AUTOMOBILE DIGEST, the new illustrated technical Automobile magazine, which is full of valuable, interesting, helpful Automobile information.

Send today, as our supply of Watch Fobs is limited. Address

**THE AMERICAN CHAUFFEUR**  
261 Butler Bldg. CINCINNATI, OHIO

## Learn the Auto Business

### Earn a Splendid Salary



By practical experience we train you for a good position as automobile mechanic, salesman or chauffeur. Over 3,000 graduates are earning big salaries. Complete training in 4 weeks, including extensive practice in repairing and driving high powered cars. Tuition and board reasonable.

Send today for free catalog and list of graduates

**Cleveland Automobile School**  
2338 Euclid Ave., CLEVELAND, OHIO

## \$20000 EARNED BY YOUNG ARTIST IN FOUR DAYS

BY MAKING DRAWING FOR NATIONAL ADVERTISER

Our faculty trained him. Millions of dollars spent for Commercial Designs. Com'l Designing mastered at home by our practical Correspondence Method. Takes only part of your time. Increase your Income! Book entitled Your Future and Folio of Com'l Illustrations mailed free.

**FEDERAL SCHOOL OF COMMERCIAL DESIGNING**

603 WARNER BLDG. - MINNEAPOLIS, MINN.

## A GOOD POSITION

with **UNCLE SAM** is most desirable. Life positions, pleasant surroundings, good pay, steady work, short hours, promotions on merit. Both sexes. No political pull. Thousands of appointments yearly. Most thorough preparation \$5. Returned if not appointed. Full information and questions used by the Civil Service Commission free.

**AMERICAN CIVIL SERVICE SCHOOL WASHINGTON, D. C.**

## SPEAK A FOREIGN LANGUAGE !!!

The European war has created a great demand and unlimited opportunities for those who know **Spanish, French, German or Italian.** Now is the time to better your position or increase your business. You can learn quickly and easily, at home, during spare moments, by the

**LANGUAGE-PHONE METHOD**

And **ROSENTHAL'S PRACTICAL LINGUISTRY**

You listen to the living voice of a native professor pronounce the foreign language, over and over, until you know it. Write today for booklet, particulars of Free Trial. Easy payments.

The Language-Phone Method, 981 Pulean Bldg., 2 W. 45th St., N. Y.

## HOME STUDY

Train by mail under experts. Stenographer, Bookkeeper, Advertising Writer, Office Man, Accountant, Banking, Civil Service. Name position—Free book tells how to qualify. Easy terms.

**CHICAGO UNIVERSITY OF COMMERCE, Dept. 4035, Chicago Ill**

## Learn Watchmaking At Home



You can learn by our modern and original system of instruction every part of the Watchmaker's Trade at home as good or better than at a shop. You can earn money while learning and secure a well paying position or start in business after completing our course of instruction. Good watchmakers are always in demand and earn from \$20 to \$35 per week. For particulars apply to the Wisconsin School of Watchmaking, Sixth Bldg., Milwaukee, Wis.

# Learn Electricity

# Learn Plumbing

# Learn Bricklaying

Unlimited possibilities for gaining wealth and future independence in all of these trades. They pay \$5 to \$8 a day right from the start and any one of them offers exceptional opportunities for starting a business of your own on very small capital. The same is true of



## Mechanical Drawing and Moving Picture Operating

Two new, big-paying occupations that are now demanding more and more trained men everywhere and pay salaries of from

**\$100 to \$250 a Month**

We give you thorough, practical training—no needless theory—you learn with actual tools in your own hands under expert instruction instead of from books. No experience and no special adaptability required. Just a willingness to learn and we'll make you an expert in a surprisingly short time.



## MEN WANTED

right now for all of these trades. That's why we are now making special inducements in the way of a very small tuition on easy payments if you like, agree to assist you in earning your way through school and also help to place you in a good paying position when you graduate. At this biggest and most successful of all trade schools everything has been arranged for the benefit and convenience of our students. Day or night classes as you prefer, and we even furnish



**Tools Free** as well as all other necessary equipment for your work

**Mail Coupon NOW!** Don't put it off. This is a matter of vital importance to you. Get full particulars of the wonderful opportunities this remarkable school affords. No obligation—everything free. Mail coupon today while our Special Offer is still open.



**Earn While You Learn**

**WE OCCUPY ENTIRE BUILDING**

**L. L. Cooke, Director, Coyne National Trade Schools**  
39-51 E. Illinois St., Dept. 1195, Chicago, Ill.

GENTLEMEN: Without any obligations on me whatsoever, please send me your school catalog and full particulars of this offer to men—all free.

NAME .....

ADDRESS .....



# BRAIN POWER TELLS

The Story of Success for YOU—

If you will use your Brain-Power correctly you have all that is necessary for success—But—

## How Are You Using Your Brains?

You cannot let your Brain-Power go to waste by allowing it to dictate to you and continue its tricky method of action. Remember, YOUR

### Trained-Power is the Only Power You Can Use

**Prof. F. W. Foote**  
Psychologist

You do not know what power you possess until you train it. Electricity has always been in the world—but its power was not understood until it was trained and directed and controlled. Your mental Power must be brought under direction and control through training. I claim the only scientific method of **Mental Training** in the world is **my method** based on the Psychological laws of your Brain-Machine. You know Psychology is not a theory, nor is it any man's scheme or system. In this study there is no system to remember or forget.

**Psychology is the Positive Success-Science** I will give to you through this science knowledge of the definite mental laws which you will be able to use and thus will your own success. It will be **IMPOSSIBLE FOR YOU TO FAIL**. Through my direction your whole mental life will be developed—Concentration will be gained—Poise will mark your actions.

### Your Whole Personality Concentrated—Your Destiny Mastered

My unique personal method of helping you guarantees your success. The help I have given to hundreds of students and the fact that I have never had a dissatisfied one speaks for itself. The course is written in easy-to-read-and-understand language. I have gained my knowledge of the great positive Science of Psychology at the greatest institutions in the world and from the greatest authorities past and present. I have made a life-study of this science and have trained men and women for years—Trained them for success.

#### FREE BOOK COUPON

**PROF. FREDERICK W. FOOTE** P. M. 5-15  
Principal Chicago Institute of Mental Culture  
30 No. Michigan Blvd., Chicago, Ill.  
Send me Free Book "Masters of Destiny" and all particulars of your Mental Training Course, and special offer of Free Courses and tell me about your easy method of payment.

NAME .....

ADDRESS .....

#### I WANT TO TRAIN YOU Give Me the Opportunity

I want you to send at once for my wonderful Book "Masters of Destiny." It's Free, And I want to tell you about my special Limited Ten Day Offer of Free Courses. I have revised and made my method of payment so easy that you will not notice the cost. You can pay on a Few Cents a week basis without extra charge.

**But you must send at once— Yes! at once—It's necessary!**



#### Do You Like to Draw? Cartoonists Are Well Paid

We will not give you any grand prize if you answer this ad. Nor will we claim to make you rich in a week. But if you are anxious to develop your talent with a successful cartoonist, so you can make money, send a copy of this picture, with 6¢ in stamps for portfolio of cartoons and sample lesson plate, and let us explain.

The W. L. Evans School of Cartooning  
821 Leader Bldg., Cleveland, O.



#### Be an Artist. We Buy Our Students' Drawings

All Branches of Art Taught BY MAIL or Local Classes. Write for illustrated booklet, terms and list of successful pupils. ASSOCIATED ART STUDIOS, 2122 Flatiron Bldg., NEW YORK

**Be an Auctioneer** Travel over the country and make big money. No other profession can be learned so quickly, that will pay as big wages. Write today for big free catalogue of Home Study Course, as well as the Actual Practice School. Missouri Auction School Largest in the world. W. H. Carpenter, Pres. 330 HALL BLDG. KANSAS CITY, MO.

#### DON'T TAKE A COURSE IN MACHINE DRAFTING

till you have read my proposition. **Positively the best.** Instruments furnished. Rates reasonable. **Pay a part after in position.** For information write DRAFTSMAN, 252 South Corona Street, Denver, Colorado

#### EARN \$1200 to \$2000 PER YEAR

TUNING PIANOS. Expertly learned by our thorough, practical course. Taught by experts either at our school or in your own home for mail. Write for information. LUNDBERG SCHOOL OF PIANO TUNING Desk P.M., 140 N. Dearborn Street, CHICAGO, ILL.

#### The Library of Original Sources

gives inside, rock-bottom facts on every subject. 10 magnificent vols. Great bargain. Small monthly payments. Send for information. UNIVERSITY RESEARCH Dept. G, MILWAUKEE, WIS.

**123** Place the 9 figures so the 2nd row is twice as much as top row and bottom row as much as top and 2nd row added together. All correct replies will receive 25 cents' worth of our iron puzzles with catalog postpaid. Answers not correct will receive solution. Catalog of 200 puzzles and one of our leading 15c. products. All answers to enclose 10c. in stamps or coin to cover mailing, packing, etc.  
**456**  
**789**  
WESTERN PUZZLE WORKS, St. Paul, Minn.

**FREE "Linene" COLLAR**  
State size on postal and whether you want collar like cut or low turnover style. REVERSIBLE COLLAR CO., Dept. U, Boston, Mass.

#### Drafting Will Promote You!

These courses will give you the knowledge that means promotion and big salary. Architectural, Mechanical and Structural Drafting and Design, Estimating and Contracting, Builders' Courses and Plan Reading.

**DRAFTING** Complete \$15.00  
Outfit and all Blue Print Plans FREE.  
Day, Evening, Home-Study Courses. Write today.  
CHICAGO TECHNICAL COLLEGE  
1050 Lake View Building CHICAGO, ILL.

#### WRITE 100 WORDS a MINUTE with

**BRIEFHAND** The modern substitute for stenography. Uses longhand letters. Quickly learned. Complete instructions \$1.00. Sample lesson free. PREMIER BRIEFHAND SCHOOL, Dept. B, WASHINGTON, D. C.

#### STUDY LAW BY MAIL

University Methods Theory and practice combined. Three courses — University, Business and Banking Law. McKimley University, 1554 East 53rd Street, Chicago, Ill. (Indorsed by Bosch and Bar. Guaranteed to prepare for Bar of any State. Free Public Speaking Course —easy terms. Catalog free.)

The **BEST** **ART** SCHOOL  
Resident and correspondence courses in  
**Cartooning** DESIGNING, ILLUSTRATING, LETTERING AND CHALK-TALKING. Estab. 1892.  
BEST courses obtainable, guarantee plan. Send at once for catalogue and "The Proof."  
THE LOCKWOOD ART SCHOOL, Dept. 20, Kalamazoo, Mich.

My twenty years experience in the roofing business has convinced me that you take no chances with roofing backed up by J-M Responsibility.

*John E. Myers*  
Sussex, N.J.

*Hundreds of folks in the southern tier of New York State and over the line in northern New Jersey know what John Myers stands for—and a lot of J-M Roofs up that way back him up, too.*

## Your Roof Becomes Our Roof

when you cover your building with J-M Roofing and register that roof with us.

You may have a guarantee if you want one; but no "guarantee" ever printed assures your roofing satisfaction so well as the J-M way of doing business.

Every foot of roofing we ever made was made not merely to sell but to serve. J-M Responsibility is not a policy. It is a principle.

J-M Responsibility gives this roofing service because our

branches cover the country and our representatives are everywhere. Be a J-M registered roof owner and one of our men will take supervisory charge of your roof.

J-M Asbestos Roofings never need painting and last for years practically without repairs. And they are not only weather-proof, they are also fire-retardant. Sparks and flying brands will not ignite them.

**J-M Asbestos Roofings are examined and approved by Underwriters' Laboratories under the direction of the National Board of Fire Underwriters.**

If every J-M roof owner will register his J-M Roof with us, we will see that that roof gives him full roofing service. Tell us what kind of building you have to roof and we will give you, our experience with roofs of that kind.

# J-M ROOFING Responsibility

**H. W. JOHNS-MANVILLE CO.**

Akron	Buffalo	Dayton	Houghton	Louisville	New Orleans	Portland, Ore.	Seattle
Albany	Chicago	Denver	Houston	Memphis	New York	Rochester	Syracuse
Atlanta	Cincinnati	Detroit	Indianapolis	Milwaukee	Omaha	St. Louis	Toledo
Baltimore	Cleveland	Duluth	Kansas City	Minneapolis	Philadelphia	St. Paul	Washington
Birmingham	Columbus	Galveston	Los Angeles	Newark, N.J.	Pittsburg	Salt Lake City	Wilkes-Barre
Boston	Dallas					San Francisco	Youngstown

THE CANADIAN H. W. JOHNS-MANVILLE CO., LTD., Toronto, Winnipeg, Montreal, Vancouver

3057

# 3 POSITIONS You Can Get

Over 400,000 more automobiles will be running next year than at the present time.

The jitney bus service is rapidly spreading all over the country. This means that thousands of new jobs will be created. Men will be required to fill them. This is the coming business with a future of unlimited possibilities.

## Are You Prepared

for the big demand for trained men that's sure to come? For men that can fill the bill as high-class salesmen — men that can manage successfully garages and repair shops — men that can drive and care for a car intelligently. These jobs carrying salaries of from \$75 to \$300 per month carry prestige besides the opportunity they offer for big returns.

GET READY FOR THEM



\$150 TO \$300 A MONTH



\$125 TO \$200 A MONTH

## We train you from the ground up

We put you through the grind of shop and repair work; we give you plenty of actual driving, under all sorts of weather and road conditions. You'll be made to overhaul cars from top to bottom—to adjust carburetors, wire-up ignition systems and self-starters and find the trouble." You'll know every inch of every part of an automobile. And you'll take your own time to learn it.

Dormitory and boarding accommodations for out-of-town men at moderate cost. A full description of our work is contained in our complete, illustrated catalog. Just send us your name and address, and you will receive it by return mail. That little act may be the turning point in your career—**SO DO IT NOW!**



\$75 TO \$150 A MONTH

### WHERE this SCHOOL is BETTER

1. It is a school and not a side-line to a garage or a repair shop. It pays real practical instruction first.
2. It has for use every distinct type of every part found in an automobile—besides the complete cars used for road work.
3. There are no extra charges. Tools and other equipment are furnished free.
4. You take your own time to learn. The average is 4 to 6 weeks.

NATIONAL AUTO SCHOOL 2625 Reading Road CINCINNATI, OHIO

## SELF MASTERY

### Stop and Think

Do you realize what this means to you? It means freedom from physical aches and pains, a strong and healthy body, happiness, success in whatever you may undertake.

### Leavitt Science

will show you the way. It accomplishes this result easily and quickly. It gives you courage for despair, strength for fear, direction for aimlessness.

### Power of Concentration, Self-Control and Self-Confidence

of influence to attract to you those you desire, those that can help you. It means freedom from servitude and bondage. C. Franklin

Leavitt's Wonderful Book, which will show you how to become

"Master of Your Fate" and

"Captain of Your Soul,"

will be sent for twelve

two-cent stamps.

Send for it today

and begin to live.

C. Franklin Leavitt, M. D., Suite 948

14 W. Washington St. Chicago, Ill.

Enclosed find 24c in stamps, for which please send me your wonderful book on How to Become Your Own Master.

Name .....

Address .....

Please Mention Popular Mechanics

## LAW STUDY AT HOME BECOME AN LL.B.

Only recognized resident law school in U. S. Conferring Degree of Bachelor of Laws—LL.B.—by correspondence. Only law school in U. S. conducting standard resident school and giving same instruction, by mail. Over 450 class-room lectures. Faculty of over 30 prominent lawyers. Guarantees to prepare graduates to pass bar examination. Only law school giving Complete Course in Oratory and Public Speaking. School highly endorsed and recommended by Gov. Officials, Business Men, Noted Lawyers and Students. Send today for Large Handsomely Illustrated Prospectus. Special Course for Business Men and Bankers. HAMILTON COLLEGE OF LAW, 405 Aberdeen Bldg., CHICAGO, ILL.

### COPY THIS SKETCH

and let me see what you can do with it. You can earn \$25.00 to \$125.00 or more per week, as illustrator or cartoonist. My practical system of personal individual lessons by mail will develop your talent. Fifteen years successful work for newspapers and magazines qualifies me to teach you. Send me your sketch of President Wilson with five stamps and I will send you a test lesson plus, also collection of drawings showing possibilities for you.

The Landon School of Illustrating and Cartooning  
1438 Schofield Building, CLEVELAND, O.



Learn by Mail to be a **WRESTLER**  
Farmer Burns, Mgr. Frank Gotch, world's champion, will now teach you Physical Culture, Wrestling and Self Defense. Be strong, athletic, healthy. Handle big men with ease. **FREE BOOK** and particulars. Give your name. Farmer Burns School of Wrestling, 1195 Range Bldg., Omaha

## HOME STUDY

Train by mail under experts. Stenographer, Bookkeeper, Advertising Writer, Office Mgr., Accountant, Banking, Civil Service. Name position—Free book tells how to qualify. Easy terms. CHICAGO UNIVERSITY OF COMMERCE, Dept. 3335, Chicago Ill.

## LEARN PIANO TUNING AT HOME

My Patented Tune-a-Phone method makes it easy. Eliminates guess work. Anyone can learn. A. D. Pope, Texas, made \$82 first ten days. Course guaranteed as represented. Diploma granted. Write for free booklet, graduate's records, etc. Miles Bryant School of Piano Tuning, 645 Inst. Bldg. Battle Creek, Michigan





# THE AGE OF SKILLED LABOR

**T**HIS is the age of skilled labor. It becomes more difficult each year for unskilled men to obtain steady work. And when times are dull, the unskilled workmen are the first to be laid off. It is a problem for many young men to acquire the necessary training in a lucrative trade, without incurring expense which is beyond their limited means.

☐ This problem has been solved *in the Navy* for thousands of unskilled youths. The Naval service offers the opportunity for four years steady employment, to obtain practical training, and the chance to learn a useful trade.

☐ The men are paid meanwhile; they get plenty of wholesome food, an outfit of clothing, and they are cared for at Government expense if injured or taken sick. When they have become useful to the Navy they are advanced in rating, and their pay is increased. The Navy needs men of mechanical ability, and a young man who is "handy" with tools will find plenty of opportunities to become skilled in the trade of his choice.

☐ If you are over 17 and under 25, an American citizen of good health and habits, it will pay you to look into the Navy's offer.

Men between 25 and 30 are accepted in certain specified trades, provided they are competent to work at their trades, without preliminary instruction. Write for pamphlets, and for the location of the nearest *Navy Recruiting Station*.

ADDRESS BOX 68

## BUREAU OF NAVIGATION

NAVY DEPARTMENT

WASHINGTON, D. C.



We will send you postpaid  
a can of

## JOHNSON'S PREPARED WAX

—enough for polishing a small floor, a piano,  
several pieces of furniture or an automobile.

Johnson's Prepared Wax is a complete  
finish and polish for all finished surfaces. It  
gives perfect results over varnish, shellac, oil,  
etc. You will find it splendid as a polish for

Floors  
Linoleum  
Woodwork

Pianos  
Furniture  
Automobiles

Johnson's Prepared Wax is clean and easy  
to use and economical. It imparts a perfectly  
hard, dry, artistic finish of great beauty and  
durability.

## JOHNSON'S WOOD DYE

for the artistic coloring of all wood. With it  
inexpensive soft woods may be finished so they  
are as beautiful as hard wood. Made in seven-  
teen shades, including Mahogany, Mission,  
Early English, etc.

Johnson's Wood Dye penetrates deeply—is  
economical—dries quickly and is very easy to  
use. It is unequalled for finishing new furniture,  
woodwork and floors and for doing over old work  
of this character—staining basketry, etc.

### Free Instruction Book

Ask your paint or hardware dealer for a free copy of our 25c color  
book "The Proper Treatment for Floors, Woodwork and Furniture."  
This book is the work of famous experts—it is full of valuable ideas  
on home beautifying—beautifully illustrated in colors.

**S. C. JOHNSON & SON, Racine, Wis.**

"The Wood Finishing Authorities"

**S. C. JOHNSON & SON, Racine, Wis.**

PA5

I enclose 10c for a can of Johnson's Prepared Wax—enough for  
polishing a small floor, an automobile, a piano or several pieces of  
furniture, also Instruction Book on home beautifying.

NAME.....

ADDRESS.....

CITY and STATE.....

# Popular Mechanics Magazine

REGISTERED IN U. S. PATENT OFFICE

WRITTEN SO YOU CAN UNDERSTAND IT

Vol. 23

MAY, 1915

No. 5

## Firing the Fuse to Blow Up a Steamer

**T**HE sinking of British merchant ships by German submarines has not been by means of torpedoes, for the most part, but by bombs or mines placed in the captured vessel's hold and exploded by fuses which are lighted as the last boatload of the crew leaves the ship. Torpedoes are too expensive to waste where not necessary.

When the "Ben Cruachan," a cargo steamer, was halted at sea by a submarine, the crew was given 10 minutes to leave the vessel. An officer from the submarine then went on board with a bomb, leaving the long fuse trailing over the side. After the captain had gathered up the ship's papers and embarked in the boat, the German officer lighted the fuse by firing his automatic pistol, and the boat was rowed

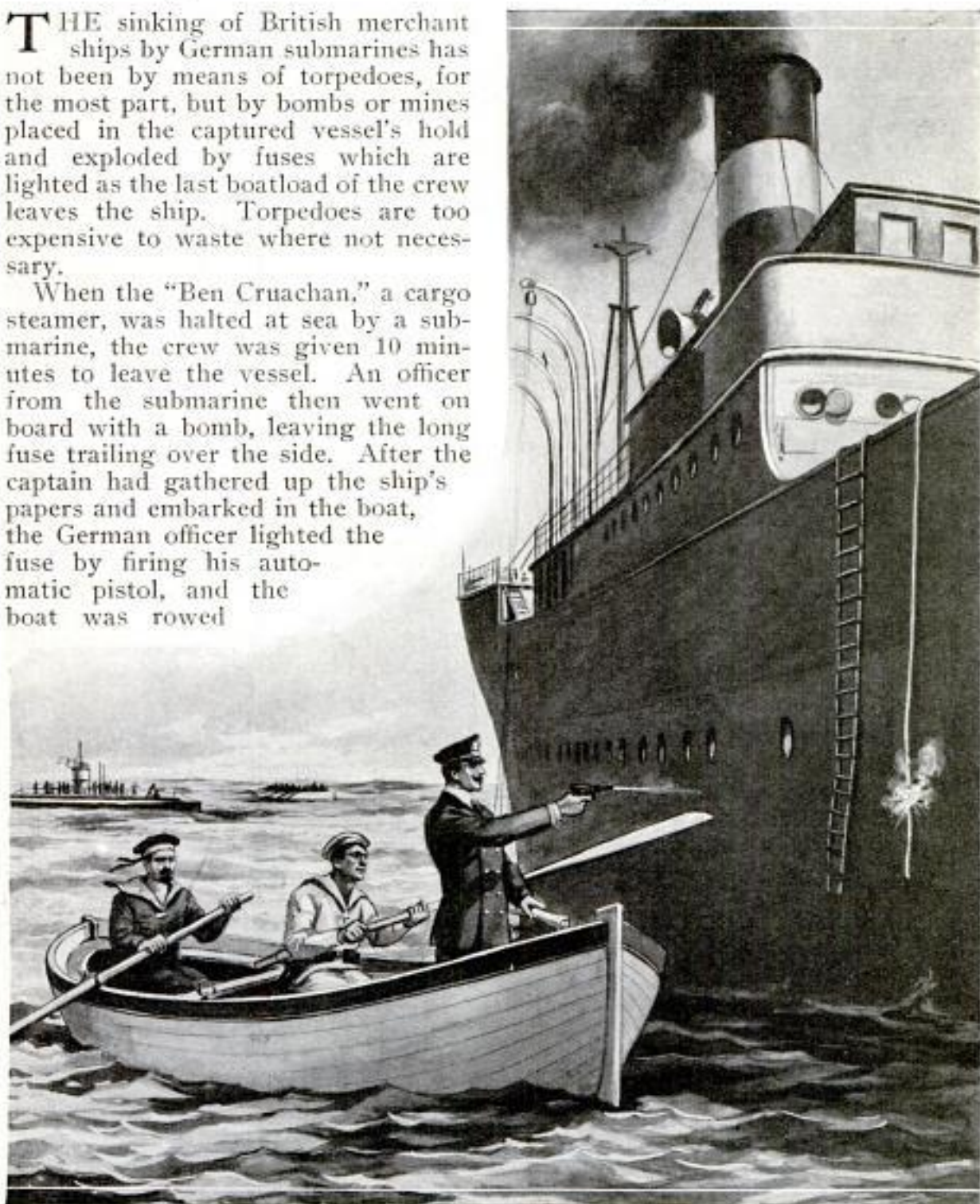

How Merchant Ships are Destroyed in War: Firing the Fuse of a Bomb by the Flash of an Automatic Pistol

quickly away. The officer returned on board the submarine, which disappeared, while the crew of the "Ben Cruachan" rowed toward some fishing craft a few miles distant. The doomed ship blew up and sank in a few minutes.

### AUTOMOBILE TRAVELS ON

### 9457 LAND AND WATER

A curious vehicle that travels both on land and water has been brought into service on the coast of Oregon, for carrying passengers between Marshfield and a railway terminal 65 miles distant. This vehicle, which the inventor calls the "Amphibion," consists of an automobile body mounted on standard wheels and equipped with large pontoons, one fixed to each side of the car. The craft is driven by an aerial propeller, having a diameter of  $7\frac{1}{2}$  ft., and operated by an 80-hp. aeroplane engine. Along the smooth beach sands the "Amphibion" has attained a speed of 75 miles an hour. When the driver comes to a bay or inlet he drives boldly into it. The pontoons float the vehicle, while the aerial propeller drives it across the water at a speed of 15 miles an hour. It is built to carry five passengers besides the driver, and the 65-mile trip is made with ease in  $2\frac{1}{2}$  hours.

This Vehicle, Equipped with Pontoons and Driven by an Aerial Propeller, is Used for Transporting Passengers along the Oregon Coast

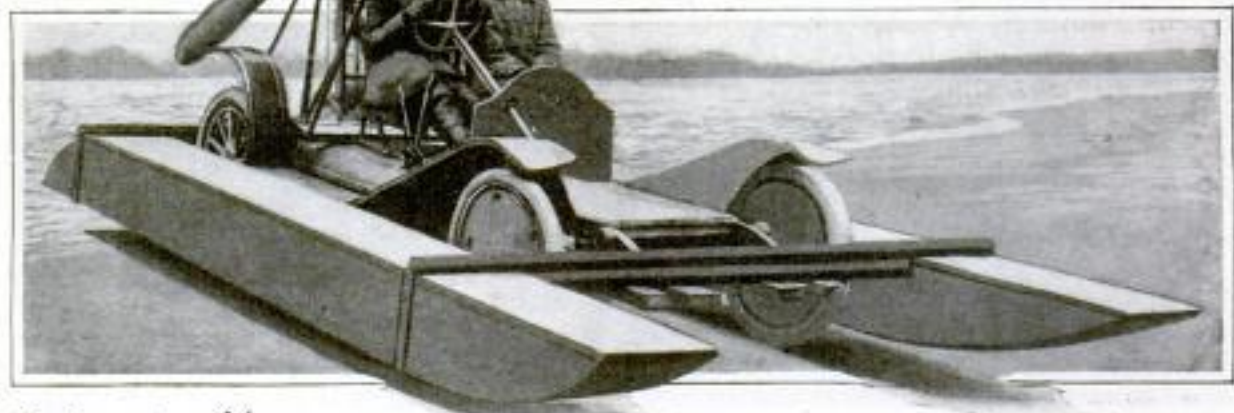

Lair H. Gregory  
 % The Oregonian,  
 Portland, Ore.

### RESPIRATION DEVICE FOR

### 9450 TETANUS TREATMENT

In connection with the treatment of tetanus or lockjaw, a disease that has proved to be the greatest menace of all to soldiers wounded in the European war, an apparatus has been developed which is apparently certain to come into general use in cases where it is necessary to resort to artificial respiration. This apparatus is not used in the treatment of tetanus, but in preventing one of the medicines used in the treatment from proving fatal. Tetanus can only be treated successfully by means of antitetanus serum. It takes this serum several hours to act and in the meantime the victim is in danger of dying from the violent convulsions that accompany the disease. To provide relief from the convulsions and thus keep the victim alive until the serum has time to act, a solution of epsom salts injected under the skin, into a vein, or into the mucous membrane of the spinal column, is used, the latter method being imperative if the disease has reached a violent stage. This simple remedy stops the convulsions, but it also causes so complete a relaxation of the muscles that there is danger that the lung muscles will cease to act and the victim will die of suffocation. The new apparatus is designed to produce and maintain artificial respiration until the muscles begin to act normally, and thus make it possible to give as much of the epsom salts as may be necessary.

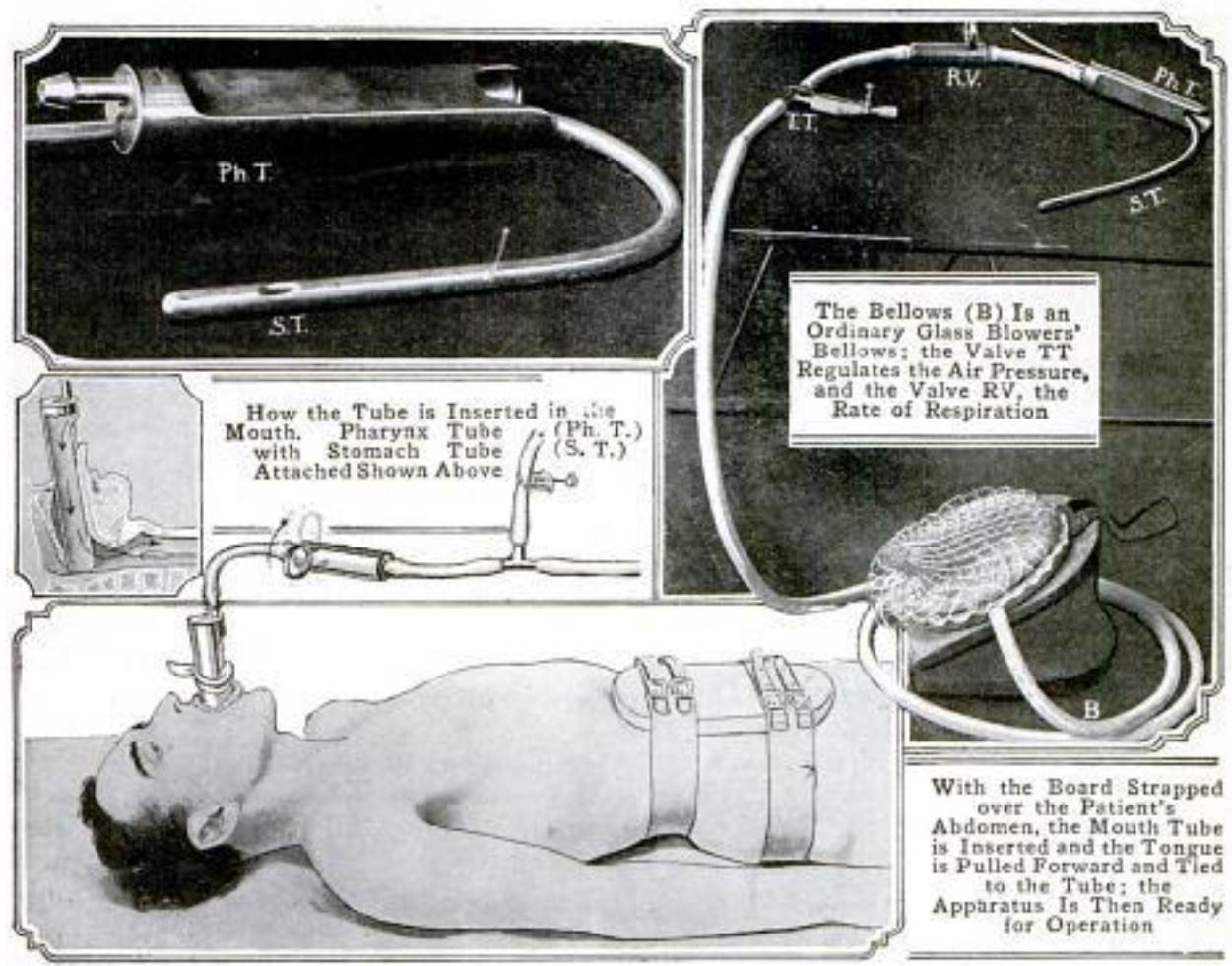

This apparatus works on the principle of insufflation, a process that consists in expanding the lungs with air at regular intervals of about 12 to the minute and depending on the elasticity of the chest walls to expel a portion of the air during each intervening period. In using the apparatus, a board is first strapped tightly over the abdomen to prevent the stomach instead of the lungs from being expanded with the air. The mouth tube attached to the apparatus is then placed in the mouth and pushed as far back as it will go, and the tongue is pulled forward and tied to the tube. The tube pushes the soft palate upward and effectually closes the passageway through the nose so that no air can escape through the nostrils, while an opening in the bottom of the tube permits the air to pass freely down the throat.

For supplying the air, an ordinary glass blower's bellows is used. As

the air goes up the tube it passes a valve which regulates the inspiration and expiration. With watch in hand, the attendant turns the ring that governs this valve alternately to the right and left at regular intervals. When the ring is turned to the right the air is forced into the lungs, and when the ring is turned to the left the pressure is shut off, a small vent is opened and the air escapes from the lungs. Just below this valve is one for regulating the pressure of the air given the patient. At the start the pressure used is very low, but is increased by a gradual closing of the valve. At the end of a minute the patient's breast is usually heaving regularly and the full pressure is applied.

In case the apparatus is hurriedly called into use during an abdominal operation, in which case the abdominal board cannot be strapped on, a small tube is passed through the mouth tube and inserted into the

stomach and the air escapes through this as fast as it is forced into the stomach. An important feature of the apparatus is that it can be operated by one man, who need not be an ex-

pert. The bellows is worked by the feet and the respiratory valve is operated by the right hand, leaving the left hand free for making any adjustments that may be necessary.

**FIRELESS COOKER USED FOR  
8872 DELIVERING HOT FOODS**

Fireless cookers used in connection with a cooperative kitchen in a city in New Jersey are said to contribute more than does any other one feature to the success of the enterprise, since with these it is possible to deliver the food steaming hot to the users of the service. Each of these cookers is equipped with a number of compartments nested together. Each is provided with a bail, and with this the cooker



is carried direct to the dining room of the customer without removing the foods from the compartments in which they have been cooked.

**WINDSTORM LEAVES RECORD  
9397 IN GROWING TREES**

The little diagonal streaks or wrinkles across the grain that indicate weakness in timber are not only caused by rough handling but by wind stresses during the growing period and can sometimes be used to check official records of windstorms, according to a report issued by the United States Department of Agriculture. The marks are caused by "compression failures," which occur when the fibers bend or buckle under a too heavy strain. In cutting up logs at the laboratory it was found that such wrinkles

appeared on the north side of a number of trees coming from the same locality in Florida. By counting the annual rings of the wood it was decided that the wrinkles must have been caused by a severe windstorm from the south about the year 1898. Inquiries made in Florida revealed the fact that a hurricane had swept over the region at the time indicated.

**CLEVER NOVELTY DESIGNED  
9101 FOR ADVERTISING USE**

An ingenious advertising novelty intended for window-display purposes has been invented in France, which, because of the seemingly mysterious manner in which the law of gravity and other physical rules are apparently violated, easily attracts and holds the attention of passers-by. It consists of a hollow metallic cylinder supported on a pedestal and connected by electric wires which are easily hidden from view. Inside the cylinder is a revolving electromagnet. When the device

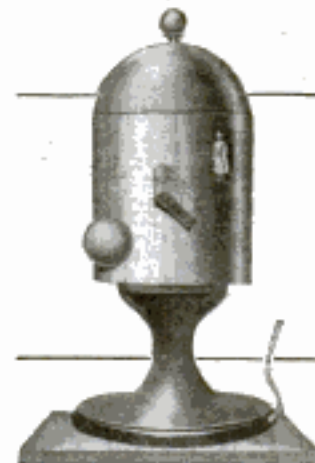

is in operation, such articles as a doll, a cigarette box, and a ball move slowly about its circumference, to all appearances suspended in air without any means of connection. On the interior of each, however, is a soft-iron core which is attracted to the circular wall by the drawing power of the magnet. Since the latter member constantly rotates, the objects clinging to the outside move with it.

Information sheet sent out  
by Forest Service

-Francis P. Mann  
12 Boulevard Arago,  
Paris, France

Inventor: H. J. Varsanyi  
16 H. St. Nicholas Av., N. Y. C.

International News Service  
238 Williams St., N. York City

## WHEN THE WATERS ROSE ON SALISBURY PLAIN

945



Interior of Famous  
Salisbury Cathedral  
Photographed at the  
Height of the Floods  
That Inundated the  
Camps of the Recruits  
for the British Army

9418

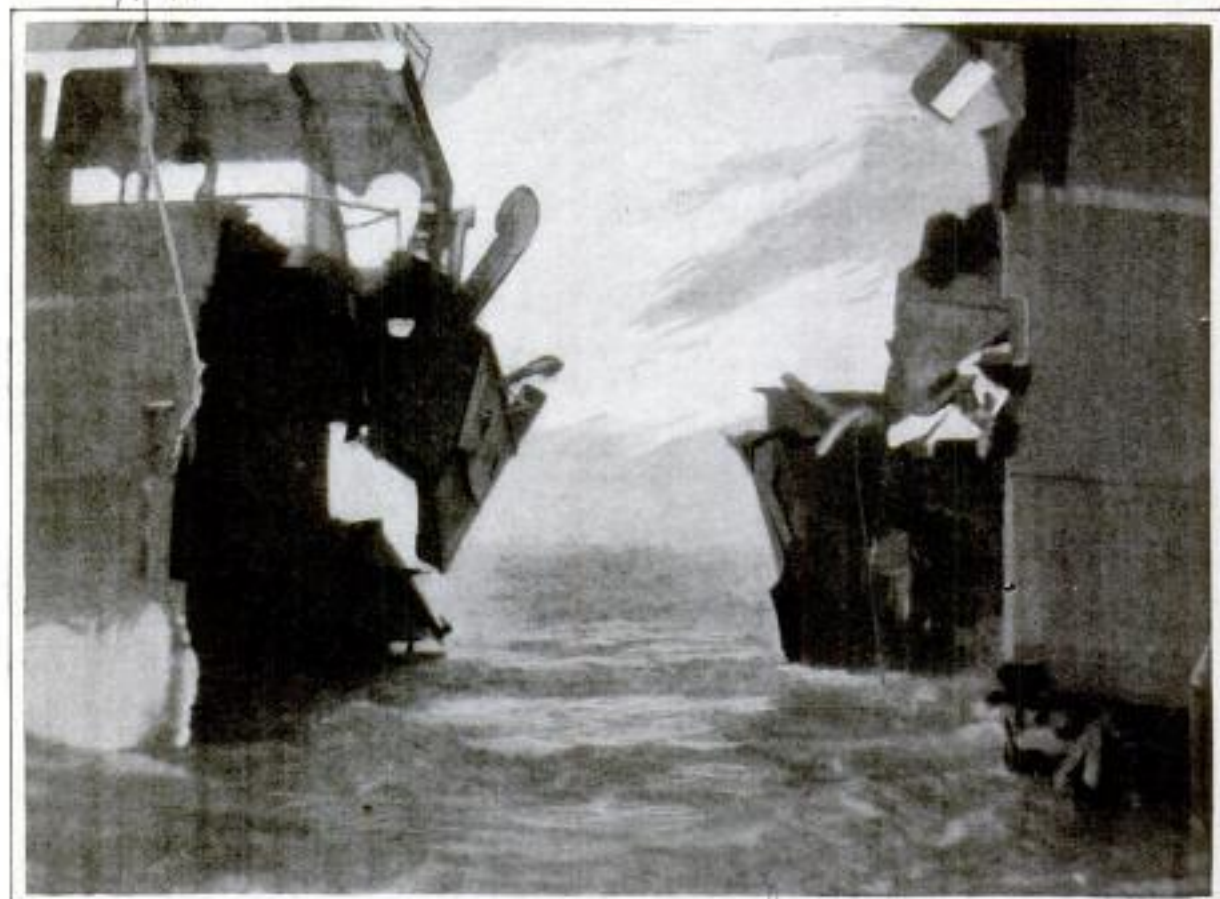

COPYRIGHT, UNDERWOOD & UNDERWOOD

*Wreck*  
**DANISH MOTOR SHIP BROKEN IN TWO ON ROCKS**

WHILE en route from the Pacific coast to Copenhagen, the Danish motor ship "Malakka" was driven during a severe gale onto Red Rock at Cedros Island, off Sebastian Vizcaino Bay, on the coast of Lower California. The breakers pounded the vessel with such force that it broke completely in two amidships, separating far enough for a small-sized boat to pass through the gap and exposing the cargo, consisting of wines, flour, and general freight, to the sea. The vessel was 410 feet in length and had a 52-foot beam and a gross register of 5,150 tons. It was making its maiden voyage in the service of new owners when the wreck occurred.

**LIGHT-WEIGHT MOTORCYCLE OPERATES INEXPENSIVELY**

9239

To bridge the gap between the ordinary bicycle and the modern, high power motorcycle, a light-weight medium - power machine has been developed. It is built with a sturdy frame of the loop type, much lighter than that of the average motorcycle. With its tanks filled the machine weighs

only 110 lb. as compared with the approximate average weight of 260



lb., or more, of the larger cycle. In its design and means of control, there is little difference between it and its predecessor. Because of its lightness, it uses smaller and less expensive tires and may be operated very cheaply.

**CEMENT COATING FOR STEEL IMMERSSED IN SEA WATER**

9403

From tests made to determine the degree of protection against the action of sea water given to steel by coating it with cement, it has been found that the life of steel structures immersed in sea water can be considerably prolonged by such coatings from 1/2 in. to 1 1/2 in. thick, but that the protection is not great enough to dispel all apprehensions as to their permanency under such conditions.

*Canal Record*

*The Miami Cycle & Mfg. Co.,  
600 Middletown, Ohio.  
Mobile Ar.*



# DIRECTING THE WAR BY WIRELESS

By GEO. F. WORTS

*U. S. Licensed Wireless Operator, First Class*

THE European war cloud burst at the psychological moment in the career of wireless telegraphy, for only very recently has the art based on the science of ether waves been reduced to the reliable basis of a sound industry. Five years ago, or even less, wireless could not have responded to the exacting demands which this war is putting upon it.

At the beginning of hostilities cables and telegraph lines were ruthlessly cut. Germany, more than any other belligerent, has been in an exceedingly trying position as regards external telegraphic communication, surrounded as she is by enemies on all sides. Her main cables have been cut or disconnected, so that now her only electrical communication with the outer world is by wireless. At the outbreak of the European war, Germany had 17 government wireless stations, Austria-Hungary, 4; France, 18; Russia, 28; and England, 47.

One of the first tasks of the wireless of the various warring countries was to fill in the gaps caused by severed cables. As later incidents have proved, however, that was only an insignificant portion of the work. Hundreds of miles of roaring battle line, hostile warships roving the remotest wastes of the sea, aeroplanes and Zeppelins soaring high above the earth, even the stealthy submarines, lurking in the depths for victims, are subservient to the invisible hand of the wireless.

The wireless equipment with which General Joffré keeps in touch with the fighting line of the allies has a range of 200 miles, and is portable. Within 15 minutes after the command is given, the station can be erected and put in operation. At the front, smaller and lighter equipments, known as "knapsack" stations, are employed. These are so constructed that one complete set can be divided up and carried by four men, with an average weight to each man of 20 lb. Five minutes after

the command for erection is given, these sets are in operation.

Besides the knapsack stations, a new and ingenious auxiliary equipment has been devised for cavalry scouting duty, called "whisker wireless." This odd name arises from the bristling appearance of the antennae which project like the quills of a porcupine from the horses' flanks.

"Landing stations," having a range of 50 miles and designed for impromptu service, are used by the marines. For example, when a cruiser anchors off shore and sends a detachment of men for scouting duty, they carry with them this very compact equipment which can be set up hurriedly.

Probably the most novel use to which wireless has been put in this war is in aeroplane service. The equipment installed on the French and Belgian fliers weighs about 100 lb., and is exceedingly compact and simple. The metal frame of the aeroplane forms the antennae, while a long trailing wire is used for "ground." This wire is attached so that should it become entangled in a tree or other obstruction, it automatically pulls loose, and another one is substituted.

Wireless communication over a distance of 54 miles has been carried on from an aeroplane to a land station in the U. S. Army, but greater ranges than five to ten miles are not practical or necessary. In service, the wireless-equipped aeroplane is sent on scouting duty over the enemy's lines from a base at which a knapsack station is located. It is rarely necessary for the aeroplane to fly to a greater distance than two or three miles from this base. As he flies over the enemy, the operator telegraphs the condition or maneuvers of the enemy to the knapsack station. Surprises on both sides are constantly being frustrated in this manner. As a matter of incidental interest, it is due principally to this fact that there have been no recorded surprise attacks made by

either side on the Franco-German frontier and that a deadlock exists now.

The wireless telegraph comprises an important part of the equipment of Zeppelins. Much greater transmitting power, due to a larger space allotment, is made possible on the Zeppelins and French dirigibles. A greater range also results from the use of a larger antennae system.

A wireless direction finder, to supplement the aeroplane spying service, has recently been adopted by the British for the purpose of locating wireless stations at German artillery bases. When the approximate location of a battery is thus found, the British and French guns are trained upon it. An English radio engineer, who recently visited this country, made the statement that by means of one of the field direction finders the exact location of the admiral's ship of the "hidden" German fleet had been discovered by an officer.

The secrecy of the interior of submarines is proverbial, but it has been stated on authority that a wireless equipment of short range is in use on the majority of underwater craft. When a submarine is cruising on the surface, a short mast, or the periscope tube, is used for suspending a small antennae system. The equipment closely resembles the aeroplane installations. For an aerial conductor, when the craft is traveling submerged, an insulated jet of water is substituted for the regular antennae.

Practically every move that the British, French, or German fleets make is the result of a radio order from the respective war office. The impotence of Germany's bottled fleet at present rather limits this use of her wireless service, although the British fleet relies upon orders via radio exclusively. England directs the maneuvers of her fleets from the Marconi station at Carnarvon, Wales; Germany, from Nauen, and France, from Paris. Except for one hour each day, Carnarvon transmits the orders of the British Admiralty to the various ships in a very complex secret code, which is changed

daily. To further insure secrecy, the wave length is frequently and suddenly changed. The principal advantage gained in directing fleets wirelessly is that fewer ships can now do the work of the many which were formerly required. Before the days of radiotelegraphy, ships of a fleet clung together, and orders were either semaphored or carried from ship to ship by fast cruisers. A naval battle line, 200 or 300 miles long, is now quite feasible, while in the days before wireless telegraphy one only a fraction of that length was possible.

Except when a warship is actually under fire the wireless room is perhaps the liveliest place on board. Every message caught on the instrument, whether intended for that particular ship or not, is delivered to the captain. Whenever anything suspicious is sighted—smoke on the horizon or a speck in the sky that might be a Zeppelin—it is immediately reported to the rest of the fleet. Aside from messages of a general character, such as this, the operator must be constantly on the alert for battle orders from the admiral. The rôle played by the wireless operator in war time is certainly not a desirable one, at least from the standpoint of personal safety. He is always shut up tightly in his room, fully aware of the dangers of attack by air, sea, and submarine.

The Eiffel Tower station at Paris has a most systematized method of collecting information from all parts of the war zone. By the use of an ingenious recording apparatus, any number of messages, up to ten, can be received simultaneously. An incidental purpose of the Eiffel Tower plant is to transmit news to the soldiers in the trenches. The tremendously high-powered transmitting apparatus, combined with the 900-ft. high tower, makes a 3,000-mile range possible, so that France is kept in constant touch with her fleet.

Perhaps the most romantic use to which wireless has been put in the war was in the case of the "Emden," the German cruiser which, early in the

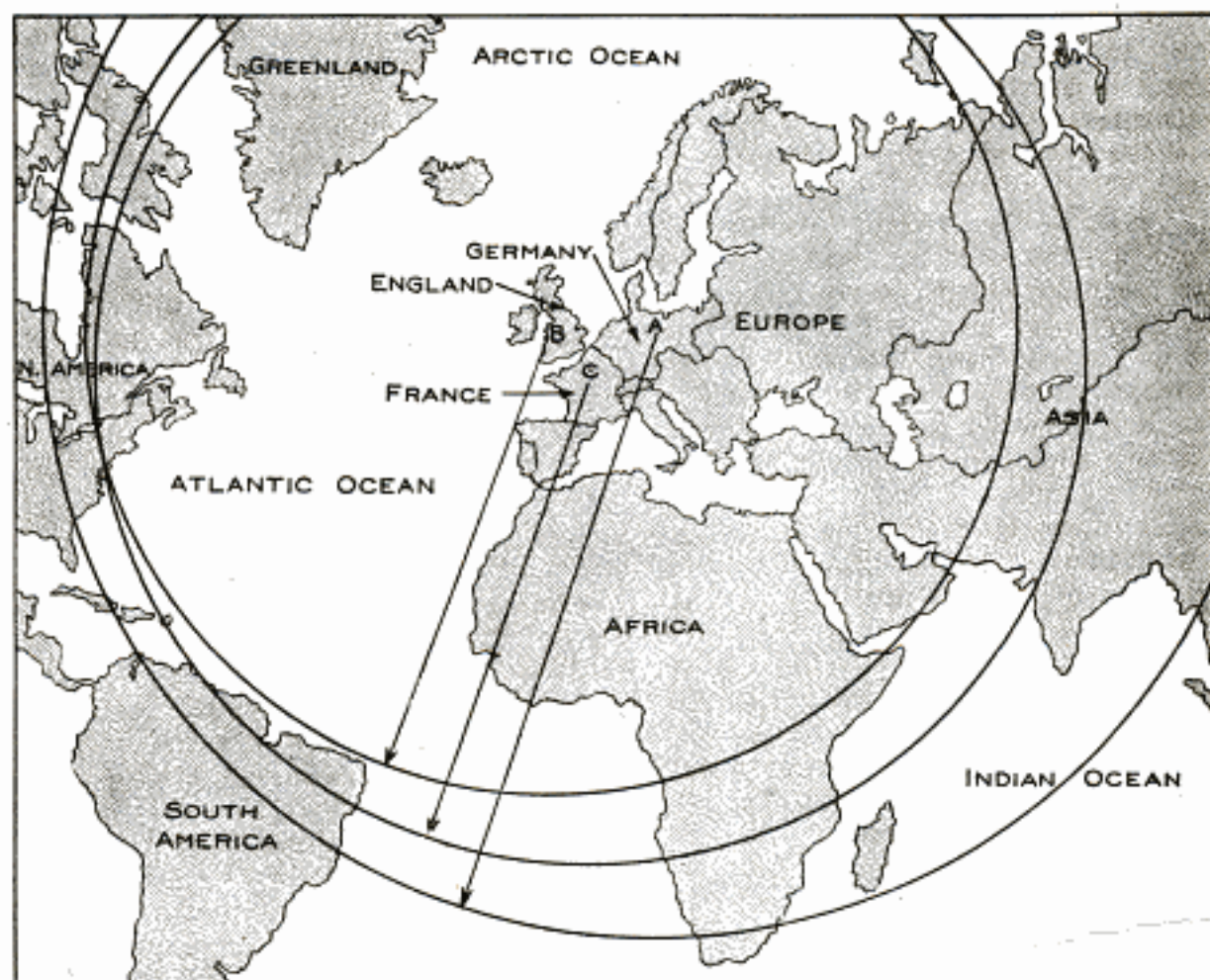

Diagram Showing Range of Wireless from Nauen (A), Carnarvon (B), and Paris (C)

war, sank many British merchant ships in the Indian Ocean. It is stated by those who claim to know that the "Emden" received all its instructions direct from the enormously high-powered station of Nauen, Germany. The signals sent out from Nauen are so powerful that they can very often be heard on amateurs' instruments in the United States—a distance of nearly 4,000 miles. With this exceptional working range, the "Emden," or any other ship for that matter, might receive orders if she were cruising near Greenland, Rio Janeiro, Cape Town, or Singapore. It is quite probable, therefore, that the "Emden" accomplished her work from orders or information she received from Nauen while she was cruising in the Indian Ocean. Strangely, wireless also proved the "Emden's" undoing. Just before she attacked Direction Island and demolished the wireless and

cable stations there, one of the Direction Island wireless operators flashed out an SOS call. This was picked up by the "Sidney," and the engagement shortly followed in which the "Emden" was sunk.

The "Karlsruhe," another German ship, acting with her convoys, adopted an ingenious dragnet method of capturing British vessels. The German cruisers reduced the sending radius of their apparatus to 30 miles, and traveled forward in a circular formation no more than 30 miles in diameter. When an enemy was sighted by one of the circle, the others were notified and the ring closed in on the helpless victim. By thus reducing the transmitting range the possibility of attack by British warships was very slight.

The inevitable command of the Germans upon capturing a ship is "Don't use your wireless!" Usually that or-

der is followed by imperative instructions to cut down the antennae and throw it overboard together with the instruments. For what is so helpless in these days as a ship without wireless?

The British war code is so complicated that it should be insoluble. Once, however, the Germans used it to advantage in a "fake" message. When the war started, the "Breslau" and the "Goeben" were bottled in the Strait of Messina, between Sicily and Italy, by a British squadron. During the morning of August 6, the British commander received a wireless message, apparently from the British Admiralty, ordering the release of the "Breslau" and the "Goeben." Not until long after the two German ships were safely at sea was the falsity of the message discovered.

One of the most interesting phases of the wireless-in-war-time question concerns secretly operated stations. The press, on numerous occasions, has appeared with the announcement of the existence of a hidden wireless station in this country operated by one of the belligerents. This possibility is so remote as to be ridiculous. An amusing example of this occurred recently when various newspapers announced that the "Germans and Japanese were suspected of operating hidden plants in

Lower California and the Maine woods." Whoever was the well-meaning source of this information, the fact remains that the supposed "German station in Lower California" was none other than the new Marconi trans-pacific station at Bolinas, Cal., while the "hidden radio plant" in the Maine woods turned out to be a perfectly harmless commercial station at Wellfleet, Mass. The U. S. Government would have a tremendous task on its hands if an attempt should be made to dismantle all privately owned stations, as more than 100,000 of them exist. Germany, France, and England, however, whose wireless laws have always been much stricter than ours, have ordered every private aerial down and all instruments disconnected.

Numerous "wireless spies" have been discovered in all of the warring countries, and when convicted they have met the customary fate.

Interference with wireless messages as they are now handled by the perfected army and navy equipments is practically impossible. Telegraph wires and cables may be cut, but a wireless wave cannot be stopped. "Jamming," or sending out waves of the same length as a transmitting station to confuse the receiving operator, is averted by making frequent changes of wave length at known intervals.

### ARCH SUPPORT IS ATTACHED TO OUTSIDE OF SHOE

9076

Made of rubber so as to be flexible and yielding, an arch supporter has been introduced which is intended to



be attached on the outside to the shank of a shoe, instead of being worn on the inside next the foot, as has heretofore always been done.

A means of fastening the supporter in place has been devised so that while it is held

securely it may also be detached and applied to another shoe in a moment's time. A pair of clips are tacked to the shoe under the arch of the foot, while two flanges extend from metal pieces anchored in the rubber block. By means of these connecting members the device may be applied quickly.

### ADVERTISING PARCEL POST BY WINDOW DISPLAY

8995

A novel and effective method of advertising the U. S. Parcel Post was devised by the postmaster of Cañon City, Colo. The post-office has a large show window, and in this were placed a great variety of articles that could

*India Rubber World 12/1/14*  
*The Dr. Neal Co., Portsmouth,*  
*N. H.*

*Florence L. Clark, #12 Greenwood Ave. Cañon City, Colo.*



How a Colorado Postmaster Advertised the Advantages of Parcel Post

be or had been shipped by parcel post. The list included boxes of apples, sacks of flour, hams, rocking chairs, shovels, and many other commodities the sending of which by parcel post would not ordinarily occur to most people. Each was properly wrapped, tagged, and addressed, and placards showed the weight and the cost of postage to different points. One result has been a large increase in the parcel-post business at Cañon City.

### WAR CAUSES EXTENSION OF 9403 ELECTRIC LIGHTING

Since both petroleum and copper are essential military supplies, the German people have had to face the problem of finding a substitute for kerosene for lighting purposes that would not involve the construction of additional copper electric-light circuits. The answer was found in a soft-iron wire, insulated with impregnated paper and inclosed in a water-tight metal covering. With this wire, electric lighting is being installed in thousands of houses that had formerly been lighted by oil. Many new gas installations are also being made since the government took over all supplies of copper and petroleum, while alcohol and acetylene lights are being adopted in the country districts.

*Christian Science Monitor*

### 8901 SPEAKING TUBES ARE USED BY MOTOR-CAR RACERS

At a motor race run at Los Angeles recently, the driver of one car and his mechanic wore helmets and masks which were linked with speaking tubes that enabled them to talk freely to each other. When a machine is tearing along a track at high speed, the reports of the explosions in its engine cylinders also producing a loud roar, it is next to impossible for either occupant to make himself heard if he wishes to communicate with the other. In this instance speaking tubes, extending from the mouth of each person to the ears of the other, were used.



Speaking Tubes Joined the Helmets of These Auto Racers, at a Recent Speed Contest, Enabling Them to Talk Freely to Each Other While Driving

*Devised by Eddie Pickenbacher*

*# Class. Anna Bygone, 7018 Bernier Ave. Los Angeles, Calif.*

Inventor: B. R. Bonney 1105 No. 29th St.,  
Omaha, Nebr.

Infr: at 1225 No. 22d St., Omaha, Nebr.

**EMERGENCY MOTOR-CAR TIRE**  
9119 **MADE OF WOOD**

Intended only for emergency use on the road, a wooden motor-car tire has

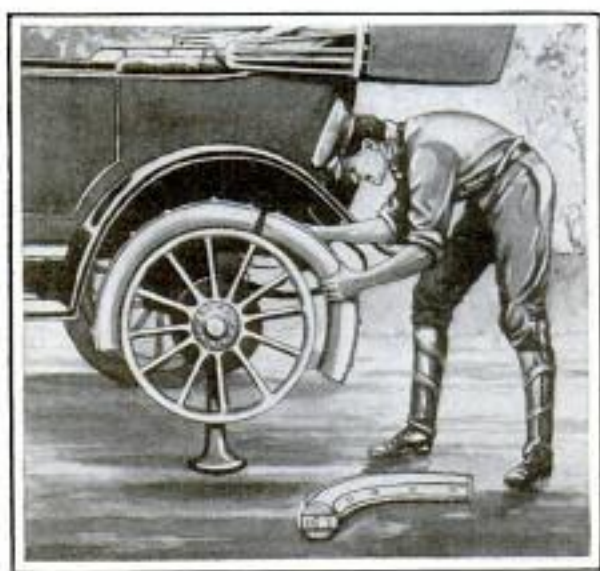

Made of Wood and Divided into Three Sections, This Motor-Car Tire is Held to the Rim by a Single Bolt

been invented to do away with the necessity of carrying extra casings which are expensive and in danger of being stolen when a machine is left unattended. The tire is made in three sections and so designed that it is held fast to the rim by a single bolt, while the operation of fitting it in place is one

which requires only a very few minutes. On the inner side of each section are rubber pads which are intended to absorb the shocks. Except for a thin steel band, encircling the circumference of the tire to lessen the wear on it, no metal is visible. It may be carried set up in a holder, or may be unjointed and placed beneath a seat.

**GAS EXPLOSION IS CAUSED BY ROBBERY OF METER**

9254

An explosion of illuminating gas which completely wrecked a residence at Moline, Ill., recently, was the aftermath of a burglar's breaking into the house and robbing a gas meter of the "quarter-first" type. In order to get the money out of the meter the thief tore it loose from its connections and then broke into it. Later, when the occupants of the house returned after an absence of a few hours, a match was ignited. Instantly there was an explosion which blew out the ceiling of one of the rooms, lifted the roof off one side of the house and broke all the windows. Although half of the house was nearly demolished, the person who ignited the match was uninjured.



The Roof of This House was Blown Off by an Explosion of Illuminating Gas Which did Not Injure Those in the Room in Which It Occurred

Eugene Witlick  
104 - 6th Ave., Moline, Ills.

# A. E. Long, % Omaha Bee, Omaha, Nebr.

## FOUNTAIN USES SAME WATER 9133 OVER AND OVER

The use of fountains in landscape gardening and architectural ornamentation is much less common than formerly, owing to the expense of keeping up a steady flow of water which runs to waste without serving any useful purpose save the decorative one. In some municipalities where the public water supply is pumped at great expense, the use of fountains on private grounds is forbidden by ordinance. Other cities forbid their operation except within stated hours, while in almost every city where fountains are permitted to operate freely the cost of the necessary amount of water to produce the volume of flow requisite for the most attractive effects is almost prohibitive.

An entirely new kind of fountain recently patented by Dr. Nikola Tesla, the famous electrical inventor, is designed to do away with the existing drawbacks to the use of water fountains for ornamental purposes. The device consists of a basin large enough to hold the entire volume of water required; a central pipe rising to any desired height from a point well below the water level, and flaring, or lipped, at the upper end to shape the flow of the falling water; a screw propeller, or turbine, so placed inside the pipe and below the level of the water in the basin as to propel the water up the pipe when rotated, and an electric motor mounted at the upper end of the vertical shaft of the turbine. The wires supplying current for the motor may

be brought down from above or, if it is desired to conceal them, they can be easily led through water-tight tubes along the central pipe.

With a properly designed propeller a very large volume of water can be passed through this fountain in a continuous stream, producing beautiful effects as well as serving to humidify and cool the air when used indoors. Experiments on a large scale have

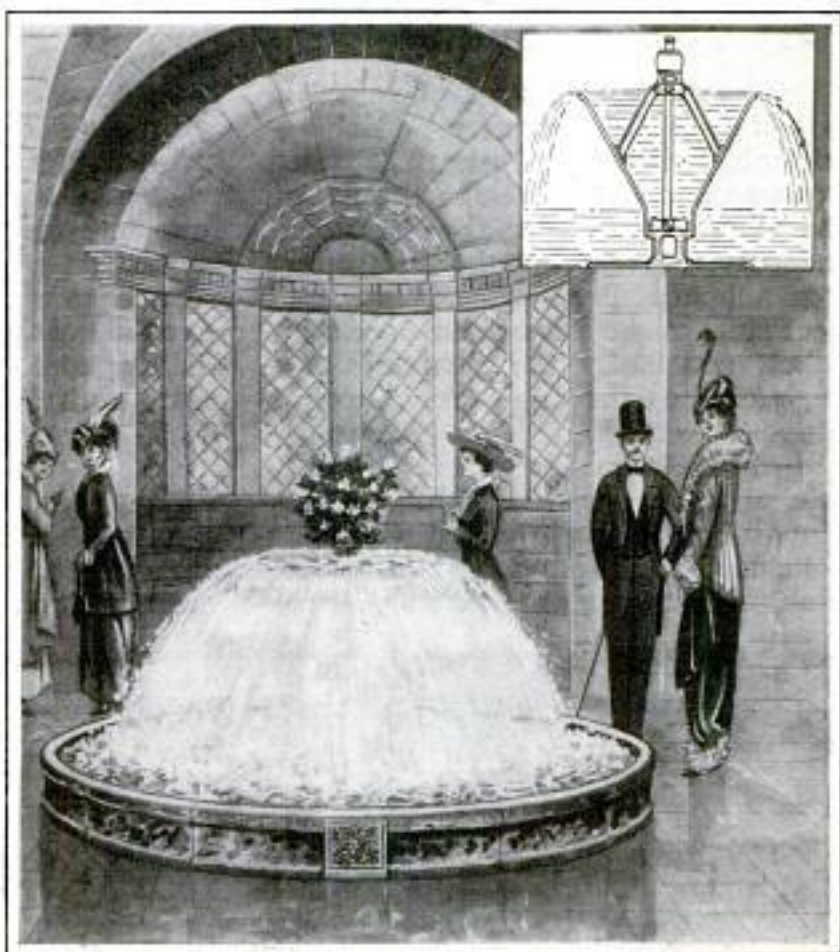

A New Kind of Fountain That Uses the Same Water Over and Over Again. A Diagram of Its Construction is Shown Above

shown that it is not necessary to replenish the water for weeks, when the fountain is operated continuously, for the entire volume is passed through the fountain several times a minute and becomes aerated and purified in the process.

A fountain of this type, requiring no external water connection, may be moved from one place to another easily, and when constructed of small size, serve as a banquet-table decoration.

Overflow basins may be arranged in tiers so as to provide for a series of falls by extending the central pipe upward and providing outlets for the water at different levels. Colored electric lights can be placed behind the falling water to produce gorgeous effects. The cost of electric current to operate this fountain is said to be very small indeed.

### ADJUSTABLE POLE HOLDER

#### 9251 FOR FISHERMAN

Designed so that it may be used in a number of different ways, a fishing-rod holder has been invented which performs a real service for the fisherman who is using several poles simultaneously, especially if he be trolling from a boat. The device is made of sheet steel in the form of an adjustable socket, which, by the changing of a pin, regulates the angle at which the pole may be held. It is possible to use it in almost any place, from the gunwale of a boat to one's trouser belt. A small bell is also provided which fits to the device and sounds an alarm when a fish takes the bait.

### HOW MUCH IT COSTS TO 9455 BUILD WIRE FENCE

An idea of the cost of building barbed-wire fence is given in a circular relating to fence building in North Dakota, recently issued by the United States Department of Agriculture. The costs in North Dakota are high owing to the fact that all material, including posts, must be shipped in, and for this reason the figures are thought to represent practically a maximum for this country. The maximum cost per rod is 36.9 cents, for a three-wire fence with posts spaced one rod apart. A two-wire fence with posts spaced one rod apart costs 32.2 cents per rod; a four-wire fence with posts spaced two rods apart costs 29.7 cents, and a five-wire fence with posts spaced three rods apart, 30 cents. The figures also show the low cost of wire as compared with posts both in construction and in upkeep.

One hundred and thirty-three foreign-built ships with aggregate tonnage of 475,524 had changed to American registry up to March 1, 1915.

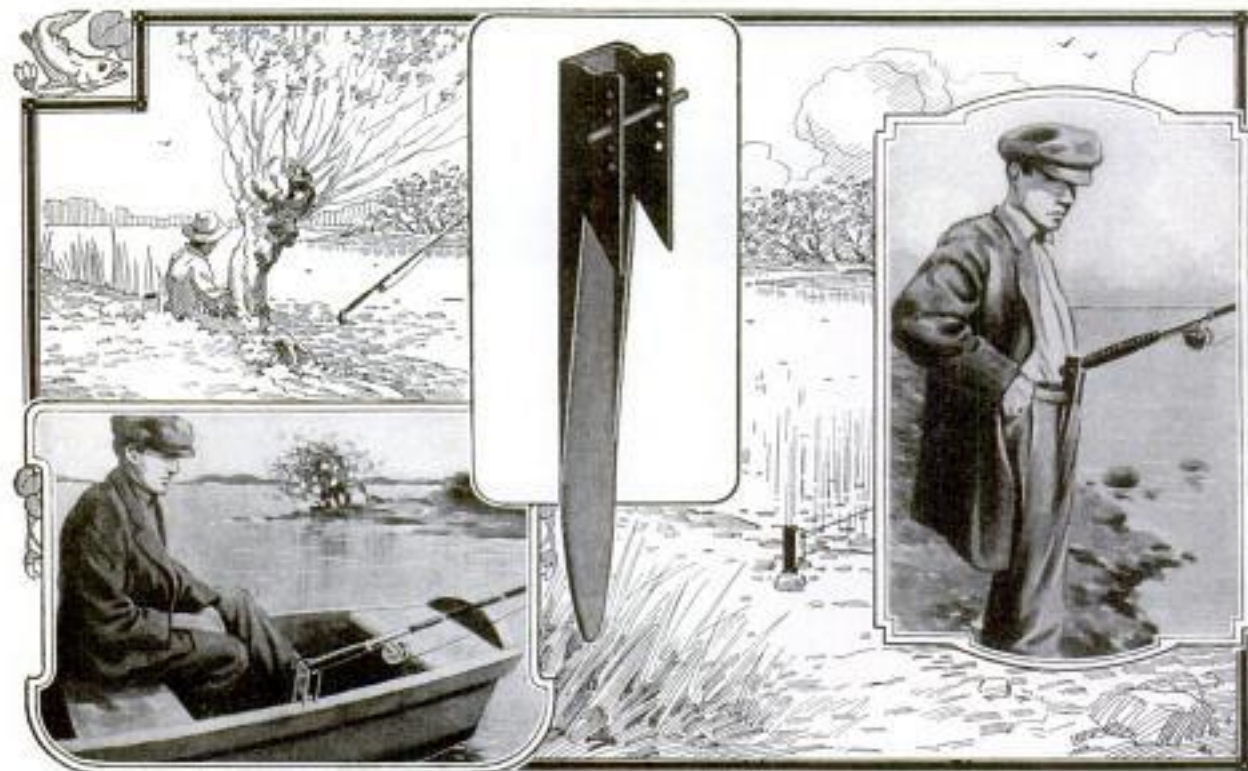

A Convenient Holder for a Fishing Pole Which Is Especially Serviceable When Several Lines are Trolled from a Boat

Inventor & Contributor:  
A. C. Hall, 1605 Second Ave., H.P.,  
Richmond, Va.



## RAISING THE STANDARD OF CANNED GOODS

How the Pure-Food Laws and the Cooperative Efforts of the Canners  
have Revolutionized the Industry

9393

WITH a can opener and a corkscrew as her only kitchen implements, the housewife of the future—or even of today—can feed her family better food and in wider variety than her mother, with a whole armory of pots and pans, could ever dream of doing. The day when wholesome, nourishing, palatable food could be prepared only at home has passed, never to return. Canned goods are no longer regarded in the light of "emergency rations," but have become firmly established as an important part of the domestic economy of almost every American household. Nor is it difficult to understand the reasons for the enormous increase in the consumption of cannery products in the past two or three years.

A universally higher standard of quality, due to the greatly improved methods of canning stimulated by national and state pure-food laws; the extension of this method of preparation to a long list of foodstuffs that a few years ago had to be cooked at home, if at all; and economy, if not actually in dollars and cents, at least of the housewife's time, labor, and nerves—these are the underlying causes of the change.

Foodstuffs can now be obtained in cans, or other containers, in such wide variety that not only a complete dinner, but dozens of kinds of dinners can be served with no labor other than that of opening the containers and heating such foods as are to be served hot. A recent list of canned foods, which had received the approval of one of the pure-food laboratories, named 132 different kinds of edibles. It would be hard to mention any sort of food outside of fresh meats that cannot be obtained in cans or packages of some kind.

The steady improvement in the quality of commercial canned goods, which has almost entirely removed the prejudice that formerly existed, is due in large part to the action of the can-

ners themselves, who, through their national organization, are attempting to see to it that all canned foodstuffs placed on the market shall be canned under sanitary conditions, free from impurities, and honestly labeled. This National Canners' Association is an organization working in close touch with the Department of Agriculture and is made up of the manufacturers of about 75 per cent of all the canned goods produced in the United States. While this organization is neither altruistic nor charitable, it is not commercial, since it has no part in the profits arising from the trade and will not permit its name to be used in connection with the advertising of any canner. In its laboratory, at Washington, D. C., is complete apparatus for testing canned goods of every kind; for experimenting with raw foods to determine the best methods of canning; for making tests to solve the problems of individual members of the association who are having trouble with their processes, and for testing materials for determining the best kinds of containers for different foods. Installed in the basement of the laboratory is a small but complete canning plant for experimental purposes. In addition to its other activities the association takes an active part in the promotion of pure-food laws, and always holds itself in readiness to investigate and remedy, if possible, any abuses in the canning industry that may be reported to it.

A typical example of the kind of service the association gives is the case of a canner who forwarded to the laboratory samples of canned fish which, when opened, were found to be covered with minute black specks. The association chemists found that the specks were due to the salt used in seasoning the fish, and that they were harmless, although they spoiled the looks of the product. The salt had not been dissolved properly and had been made black by coming in

contact with the tin. The chemists instructed the canner as to the best methods of adding the salt, and no further trouble was experienced. A fatal case of poisoning resulting from the eating of canned tomatoes was reported to the association. The chemists found that death had been caused by rat poison placed in the tomatoes and the investigation resulted in the conviction of the murderer. Canners occasionally experience difficulty because of the water which they use, some of the so-called "hard" waters having a marked effect on canned goods, even to the extent of changing their chemical composition. When trouble of this kind is encountered an analysis of the water is made at the laboratory and the canner is told how to avoid the difficulty. Whenever an investigation is of benefit only to the individual canner the cost of the laboratory work is charged to him, but if the findings are of interest to canners generally, it is done free of charge, the work of the association being supported by dues paid in by the members.

Sterilization, which has entirely replaced chemical preservatives, is the most important as well as the most difficult feature of modern canning. Not only do different meats, vegetables and fruits require different treatment, but the same vegetables and fruits raised in different parts of the country require the application of different degrees of heat. Unusual problems in sterilization come up continually in the laboratory work. A Virginia canner used for a part of his product tomatoes grown on a soil heavily fertilized with a commercial fertilizer. These tomatoes alone out of all those canned at the factory could not be sterilized so they would keep after being canned unless they were subjected to a temperature of 235° F. When analyzed, this unusual case of spoilage was found to be caused by a hardy spore-bearing bacterium that had evidently been introduced into the district by the commercial fertilizer.

Spoilage of foods, whether canned or not, is caused by bacteria, yeasts, and molds, and the sole purpose of sterilization is to kill these elementary forms of life. While there are many kinds of bacteria, they may all be divided into two classes so far as the canning industry is concerned—one class comprising all bacteria that can be killed at or below the temperature of boiling water, and the other class comprising all bacteria that require a higher temperature than this. The latter is one of the things that make home canning frequently a failure, since sterilization at temperatures higher than 212° F. cannot be accomplished with ordinary cooking utensils, but requires the use of a closed retort and special apparatus for applying the steam. Experiments made at the laboratory indicate that the hardiest known bacteria, with the spores by which they are propagated, are killed at 250° F., if this degree of heat is applied to them directly for a period of 20 minutes.

A modern cannery is a well-organized and sanitary establishment far different from the rough shed, housing crude machinery and processes, that was formerly thought to be sufficient. The location and surroundings of the typical cannery must be sanitary, away from manufacturing establishments that produce noxious odors or organisms of decomposition. The yards and drives about the establishment are cleaned daily and the drainage of the premises is good. The interior of the cannery is kept clean, and in contrast with the old type of cannery, there is provision for plenty of light and ventilation. In short, the modern canning establishment is not only designed to turn out canned food-stuffs under sanitary conditions, but to provide healthful working conditions for its employes. In most of the process handwork has been superseded by machinery.

The first requirement in all good canning is that the raw material be delivered to the factory in good condition, fresh from the field or orchard, and so packed or crated that it can be

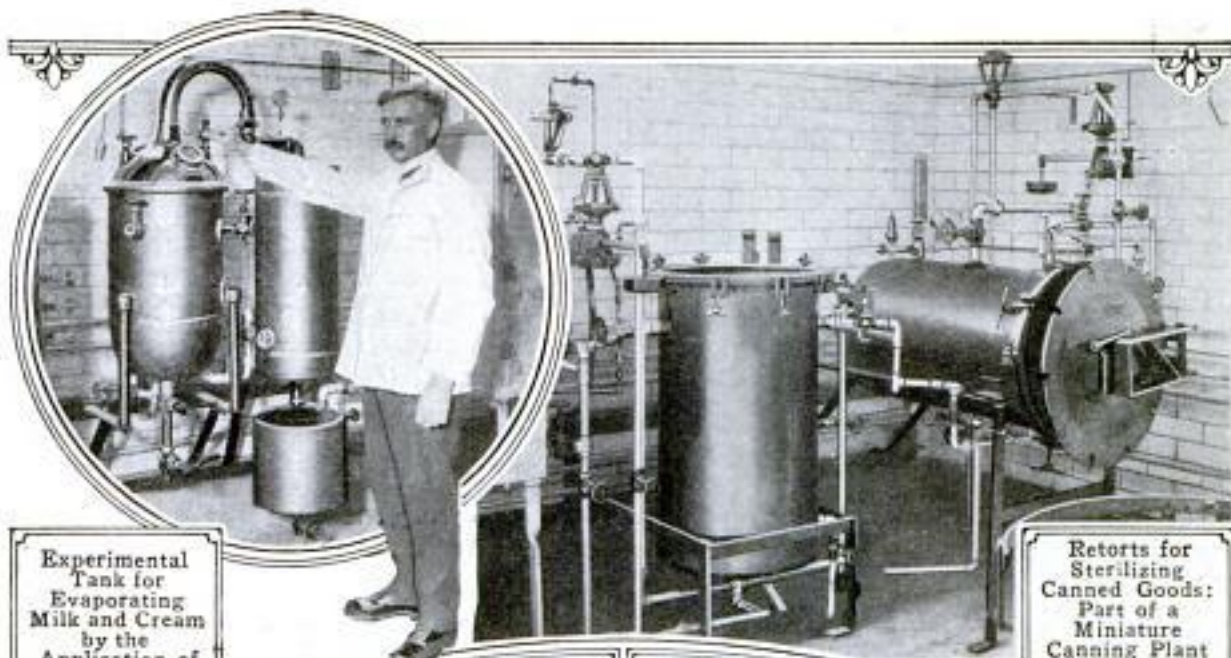

Experimental Tank for Evaporating Milk and Cream by the Application of Heat and Vacuum

Retorts for Sterilizing Canned Goods: Part of a Miniature Canning Plant in the Laboratory at Washington



Chemical Laboratory at Washington, D. C., in Which are Conducted Tests for Determining the Best Methods of Canning, for Analyzing the Different Grades of Tin Plate, and for Solving the Problems of Individual Canners

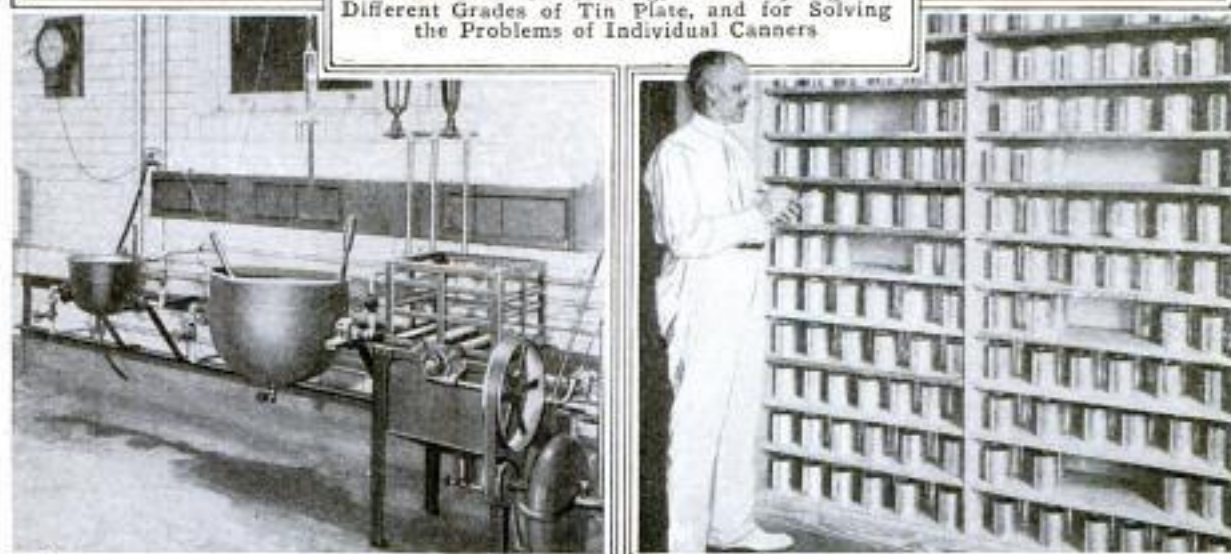

Experimental Sterilizing Device and Steam-Jacketed Kettles for Cooking Jams, Jellies, and Preserves

After being Stored in the Laboratory for a Specified Time the Cans are Opened and the Contents Tested

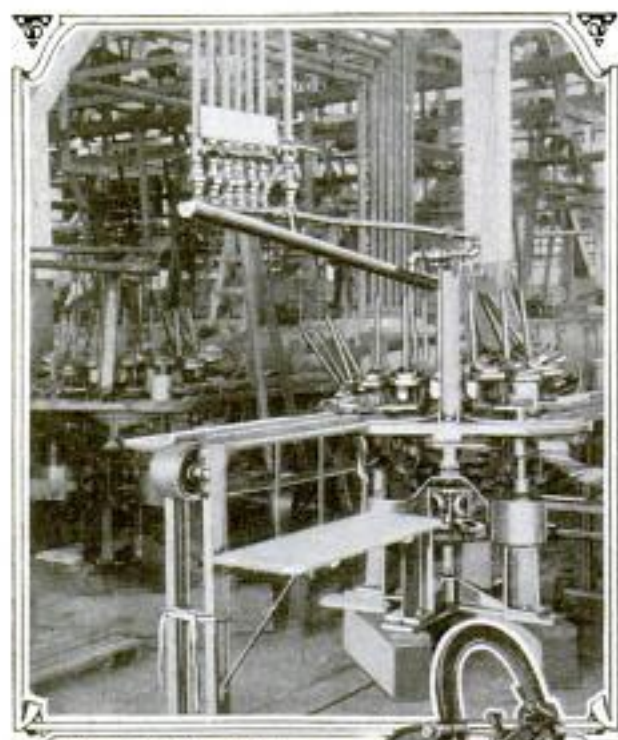

The Machine That  
Seals the Cans

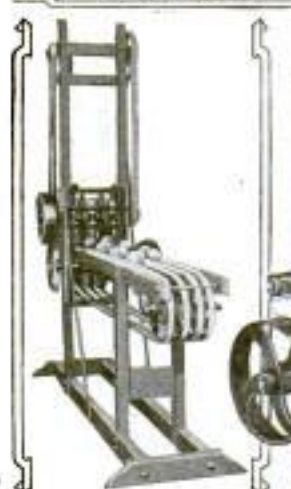

Peach Splitter and  
Machine for Placing  
the Labels on the Cans

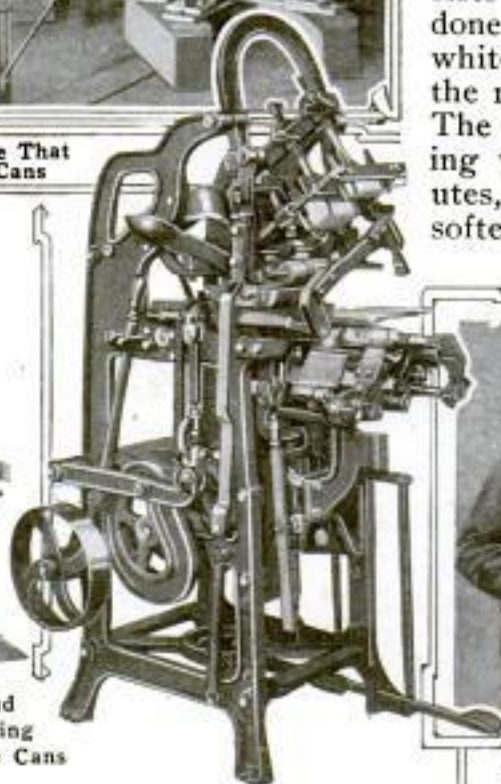

Rotating Disks That Remove  
Pumpkin and Squash from the Rind.  
Below: Battery of Steam-Jacketed  
Sterilizing Kettles

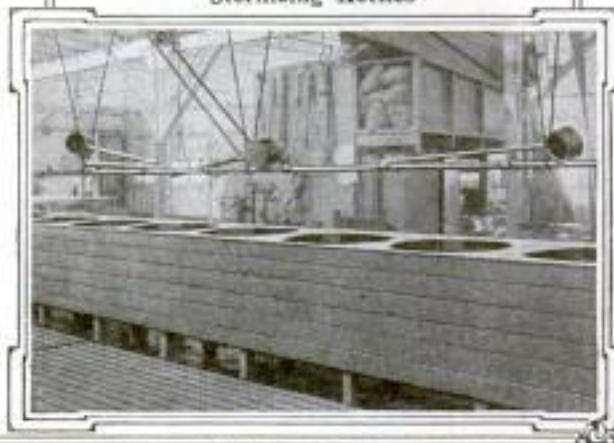

the cans. Such fruits as peaches, apples, and pears must be peeled and cut into pieces of the right size. This operation, formerly done by hand, is now performed by machinery in all well-equipped establishments. Nearly all vegetables require special treatment of some kind. Peas are shelled, graded for size and quality, and washed and blanched by automatic machinery. Corn must be cut, silked, brined, and cooked. Beans must be snapped and strung, graded for size, and blanched. Asparagus must be cut into lengths and blanched, while sweet potatoes and beets must be peeled and graded. Blanching consists simply in parboiling and is not done primarily for the purpose of whitening, as might be supposed from the name, but to improve the quality. The vegetables are dropped into boiling water for from one to five minutes, with the result that they are softened and much of the mucous sub-

handled without injury. The first step is that of grading, which is usually done on belts or special table tops to expedite the work. All fruits and vegetables must be thoroughly cleaned, and this is ordinarily done by washing in a tank and then thoroughly cleansing with a spray. Many of the fruits require no special preparation other than sorting and cleaning, after which they are placed directly in

stance that has formed on the surface is removed. Washing and filling the cans is the next step in the process, and the filling is done by machinery except in the case of products such as some fruits which cannot be handled by machinery because of the danger of crushing. Corn, peas, and other foods that are placed in the cans hot or are covered with a hot sirup, must be subjected to a treatment for exhausting the air, this process consisting in passing the filled cans through a steam box and heating the contents to from 160° to 180° F. Cans that require no solder are sealed by a special machine that crimps the lids into place at the rate of 1,800 an hour. For sealing cans with solder tops a machine is used that wipes the top, places the cap and applies the acid and solder in one series of operation, without the necessity for touching with the hands, at the rate of 5,000 an hour. As the cans pass from the capping machine

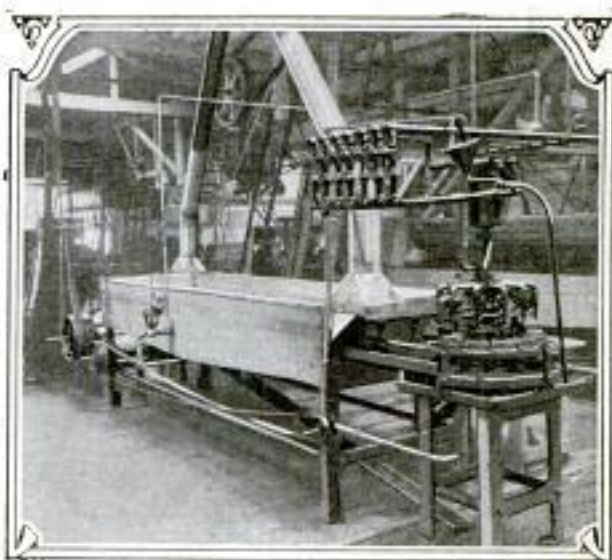

Siruping Cans Filled with Fruit



Machine That Distributes Cans to Filling Machines. Small Machine Shown at Bottom Is a Cabbage Corer

they are dropped into a bath of boiling water to test for leaks. Any imperfections in the can or the sealing will be shown by bubbles issuing from the opening. The final step in the process is that of sterilizing, which is done after the can is sealed, and while this process is one on which the success of the whole work depends, it comes in the end simply to a matter of applying the right amount of heat



Cherry Pitter and Fruit-Washing Machine. Below: Thousands of Cans of Salmon Stored in Factory and Ready for Shipment



for the right length of time. With the product sterilized there is nothing left to do but apply the labels, which are placed on the cans at high speed by a machine. Modern canning standards require that the label shall tell the truth.

The average consumer is getting farther and farther removed from the sources of food supply, and as a rule, can no longer raise his own fruit and vegetables or buy from a neighbor's garden. This is especially true of the great cities, where so-called "fresh" products are often as much as a week old before they reach the consumer. The cannery makes it possible for the consumer to have such products fresh, not only "in season" but at any time of the year. One of the features of the enormous increase in the production and use of canned foodstuffs is its effect as a means of conserving our food supplies. It is becoming increasingly unnecessary to leave fruits and vegetables rotting on the ground for lack of transportation to the great central markets. Practically every district now has its cannery, centrally located so that the products of the garden and orchard can be delivered to it in fresh condition. Owing to the large scale on which canning operations are conducted, with resulting economy and efficiency, waste is largely eliminated, and many canned foodstuffs can now be served in the home at less cost than the fresh article. A can of whole apples weighing 35 oz., for example, usually retails for 10 cents. In a government report it is estimated that apples bought in this way cost less than apples bought by the peck at the rate of \$2 a bushel.

Many vegetables, such as corn and peas, can be bought in fresher condition and more cheaply in cans than in bulk, especially in the cities.

One of the disadvantages heretofore experienced in using canned goods was that the cans were too large or too small, with resulting waste in many cases. This fault is being remedied by the canners themselves through the introduction of cans of intermediate sizes. The attempt is being made, in particular, to provide cans that will hold just enough of different foods to serve for a meal for an average family of three or four without the necessity for any waste.

The biggest thing, after all, in the whole question of canned foodstuffs is its meaning to the housewife. When every kind of food can be obtained in as good and palatable condition in cans as in the fresh state, nine-tenths of the drudgery of the kitchen will have been eliminated. This condition has already been so nearly reached that the whole question is now practically up to the housewife. She must learn to make intelligent selection and to buy in packages of such size as to suit the needs of her own individual family. If the greatest economy is to be secured, she must buy by the dozen or the crate. She must learn costs and acquire the ability to watch the markets and take advantage of favorable cost conditions just as she would if she were conducting a commercial business. From present indications it is the acquisition of skill in these things, rather than skill in cooking, that will constitute the education and determine the efficiency of the bride of the future.

### 9322 QUARTER-MILE RAILROAD EARNS \$1,000,000

The shortest railroad in America and at the same time one of the most profitable is the Grand Island Railway, which constitutes the only rail link in the transcontinental trade route that connects Fort McPherson, on the arctic circle, with settled parts of Canada.

This curious railroad is owned and operated by the Hudson's Bay Company. It is a quarter of a mile long and cost less than \$800 to build, the rails being of wood, with strap-iron facings. The rolling stock consists of two dilapidated flat cars which are pushed

*Francis J. Dickie, 18 Hanover Blk., Bellamy St.,  
Edmonton, Canada.*

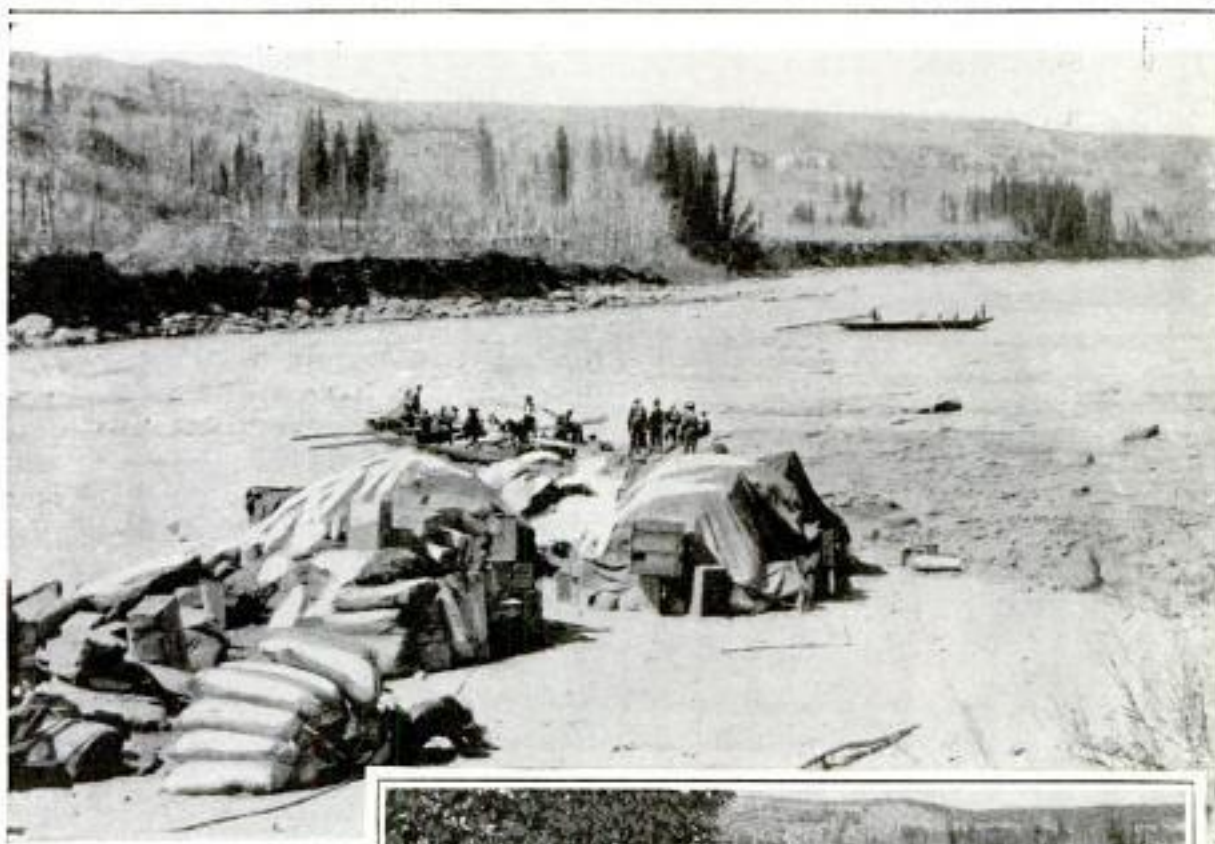

Freight Piled Up at the Lower Terminal of America's Shortest Railroad, Waiting for Scows to be Hauled Up for Loading

At Right:  
The Entire Rolling Stock of the Road that Earned \$1,000,000 on an Investment of \$800, on Grand Island in the Athabasca River



by hand along the rails. The freight rate for all classes of commodities is \$2.50 a ton, and some idea of the volume of traffic can be had from the fact that in its 60 years of operation the Grand Island Railway has earned profits of more than a million dollars.

The secret of the road's commercial importance and success lies in the fact that it is the only means, other than "toting," whereby freight can be taken safely past the Grand Rapids of the Athabasca River. Except for these rapids, the river offers the shortest and safest route for the transport of trade goods into the interior and the bringing out of the furs for which the northbound freight is traded to the Indians. A hundred thousand dollars' worth of furs may be loaded on a single

scow at times, and the risk of loss is too great to justify an attempt to get the boat through without unloading.

The rapids have a fall of 65 ft. in a quarter of a mile, and while they can be "shot" by expert rivermen, few ever attempt it with a loaded scow. The railroad occupies a narrow island in the middle of the river. The scow crews handle all their own freight, running the empty craft down through the rapids after the cargo has been piled on the flat cars. At the lower end of the falls ropes are thrown to the men in the scows, which are hauled up against the current to the island by a winch. Up-bound boats are sometimes towed up the rapids, after discharging their freight, or carried up on the railroad for a fee of \$10.

Inventor: Al. Sampney, Springfield, Mo.  
Has made for only own use and for  
a few friends.  
662

## POPULAR MECHANICS

motor age 4/5/14

### ELECTRIC MINNOW NEW BAIT 9295 FOR GAME FISH

Intended for deep-water trolling for game fish such as bass, muskellunge and pike, as well as for night fishing,



an electric minnow has been made which represents a new kind of artificial bait. The inventor conceived the idea of a luminous bait by the fact that examination of the stomachs of these fish showed that they ate fireflies and other phosphorescent insects. The minnow is made of tin, celluloid, and a couple of pieces of

cedar. Inside it is a miniature electric bulb, which is connected by a fine, insulated wiring that is held in the line. The fisherman carries a small dry battery in one of his pockets to which the

wires are connected. A switch on the pole near the reel allows the light to be flashed intermittently, as a glow-worm, so as to attract the fish. The hooks carried on the sides of the bait are detachable.

### GREAT SPEEDWAY PROJECTED 8922 FOR TWIN CITIES

Financial arrangements have been made for the construction of a two-mile concrete speedway for St. Paul and Minneapolis, Minn., which if built in accordance with the present plans will be the greatest of its kind in America. A half section of land lying  $4\frac{1}{2}$  miles from the courthouses of each of the cities has been purchased for the site, where it is expected to expend \$1,250,000. The track will be 80 ft. in width, with a 50-ft. graveled safety zone on either side, and have a base of 12 in. of rock and 6 in. of concrete, laid in two layers. The grade of the course will run from 2 per cent on the straightaways to 35 per cent at the turns. The grandstand will be 3,225 ft. long and seat 76,450 persons, while the bleachers will accommodate an additional 30,000. Facilities will be provided for more than 50,000 motor cars.

### ROSE-COVERED PEACE DOVE IN FLOWER PAGEANT

9324 One of the spectacular entries in a recent "Tournament of Roses" at Pasadena, Cal., was a "dove of peace,"

which was built over a small motor car. The framework forming the bird was completely covered with white

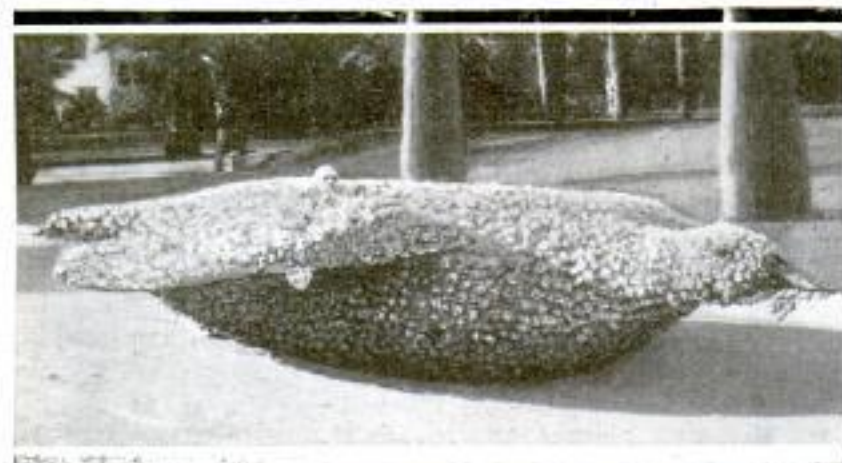

roses and hid from view every part of the car except the two rear wheels. It was made with outstretched wings and held a green olive branch in its beak. The operator of the car was dressed in white and sat in such a concealed place that unless one looked carefully the "bird" seemed to be moving slowly along without human assistance.

The Driver of the Car was So Nearly Hidden from View That the Dove Seemed to Move along the Street Unassisted

C. L. Edholm, 1353 W. 36th Place,  
Los Angeles, Calif.

Marvin M. Collier, 890 Billings St., Springfield, Mo.



*Mining & Engineering World, 6/18/14*  
*Bullwhacker Copper Co., Butte, Mont.*

## GLORY-HOLE DRILLING IS A HAZARDOUS JOB

9312

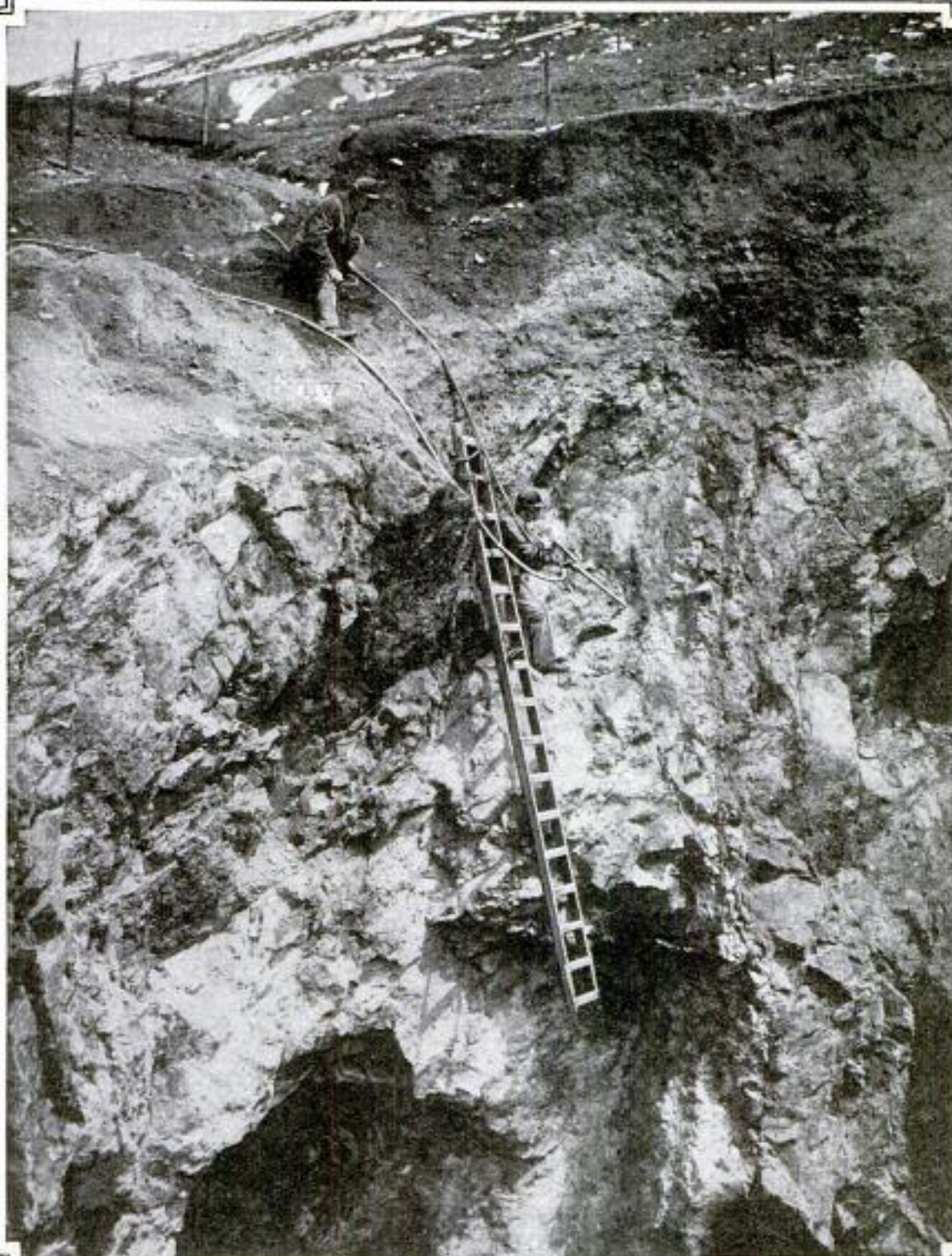

COURTESY OF MINING AND ENGINEERING WORLD

**O**PEN-PIT or "glory-hole" mining, as it is termed, is in some respects even more hazardous than working in underground tunnels. Tripod drills for boring the blast holes in the sides of the cut are out of the question, since there is no base on which to place them, so the miner must use jack-hammer drills held in the hands. The photograph shows a miner drilling a six-foot hole with a jack-hammer drill in the glory hole of a Montana copper mine. The bottom of the hole is 75 feet below the surface and the slightest misstep would be fatal. Hollow drills worked by compressed air are used. The blasted rock falls to the bottom of the open pit.

*A. H. Ross*  
 R. H. Ross, Room 1085, 440 S.  
 Dearborn, Chicago, Ills.  
 664

**GIANT MANIKIN IS MADE  
 9352 TO SING AND TALK**

Having the ability to sing, carry on a monologue, wave her arms and move



her eyes in a circular orbit, a feminine manikin, nine feet in height, has been built by a Chicago decorator. The figure, a burlesque of the prophetic superwoman, is composed chiefly of wood, wire mesh, and wax, over which are added hair, paint, and silk. Concealed within the body is a phonograph and an

ingenious arrangement of wires and cords so strung as to provide for the ready movement of the head, arms, and eyes of the manikin. With perfect facial composure the creature will sing selections from "Aida," or whistle a street song while wildly swinging her arms about her head. Likewise the eyes may be moved soulfully to suit the particular selection which is being rendered.

**AIRMAN GERSTNER'S DEATH  
 9493 CAUSED BY DROWNING**

According to the testimony given by Captain Muller at the investigation of the aeroplane accident in which Lieutenant Gerstner of the U. S. Army lost his life near Oceanside, Cal., on Dec. 22, 1914, death was caused not by the fall of the biplane in which the two were riding, but came about as a re-

*Scientific American*

sult of the latter's attempt to swim ashore after the craft had made a landing on the sea. As the biplane fell Captain Muller, who was acting as pilot, kept sufficient control to bring it to a safe landing on the water, about half a mile from a deserted section of shore, but with the nose pointing seaward. An attempt was made to tear away some parts of the machine that would serve as floats to assist the airmen in swimming ashore. To do this required tools, which could not be obtained, as they were stored in a box securely wired to a submerged part of the craft. Lieutenant Gerstner then attempted to swim ashore unaided. After he had gone about half the distance he disappeared under the water. Captain Muller tied himself to the elevator wires of the biplane and was eventually rescued by boatmen.

**STEEL FOR SOLDERING CAPS  
 9154 ON TIN FRUIT CANS**

For use in small canneries, domestic-science schools, and homes in which a considerable quantity of fruit or vegetables is canned, a small self-heating capping steel has been devised for soldering the covers on tin cans. The ordinary steel requires continual reheating, while the new device, which is made round so that



it applies solder in a circle matching the circumference of the cap, has a small gasoline burner attached above it which keeps it constantly heated. The apparatus is intended to be

clamped to the edge of a table in such a position that a can may be easily slipped beneath the capping steel. The soldering operation requires but a moment's time.

CA metal X-ray tube, provided with a window through which to concentrate the rays, has been invented. mfg  
 mfr: The Home Canner Co.,  
 - Hickory, N. C.  
 mgr: E. L. Flowers

*By Miss Ethel Rogers, 36 W. 42nd St.,  
 Brooklyn, N.Y.*

Dr. F. H. Milliner, Experimental Engineer  
Union Pacific Railroad Co., Omaha, Nebr.

## TELEPHONING BY WIRELESS FROM MOVING TRAINS

9321

Radio

Evans

At Right: Wireless-Telephone Equipment as Installed in the Railroad Station

Station at Binghamton, New York, with Aerials for Wireless Communication with Moving Trains



Sending Wireless-Telephone Message from a Moving Train: To Listen, the "Listening Key" is Depressed, and When Speaking This Key is Released. Power is Supplied by a Generator Carried in the Baggage Car

**C**OMMUNICATION by wireless telephone between moving trains and the stations of a railroad, heretofore considered one of the hardest problems in the whole wireless field, has been brought to practically a working basis on two of the railroads of this country—the Lackawanna and the Union Pacific. One of the interesting things about this latest development in wireless is that while they accomplish practically the same purpose, the systems developed on the two railroads differ radically in most of their essential features.

On the Lackawanna Railroad the

wireless waves are transmitted directly between antennae carried on the train and the aerial at the railroad station, whatever the distance may be, while the system developed on the Union Pacific utilizes for distance transmission two wires strung on the telegraph

poles that parallel the track, so that the wireless waves are only required to bridge the gap between the telegraph line and the antennae carried on the train, a distance that rarely exceeds 75 ft. and is usually less than 50 feet.

That the system used on the Lackawanna is a success has been demonstrated by telephone conversations recently carried on over a distance of 27 miles between a limited train running at high speed and a wireless station at Binghamton, N. Y. The aerial carried by this train consists of four wires stretching over four coaches and running parallel with the roofs. When the train is made up, the wires of the four coaches are connected together so that the entire antennae system is close to 300 ft. in length. The telephone equipment is placed in a small booth at the end of the smoking car, while a small generator that supplies current for the transmitter is installed in the baggage car. This generator is driven by a turbine that takes its steam from the locomotive and exhausts down on the roadbed. Instead of the direct current ordinarily used in wireless-telephone transmission, a 110-volt alternating current at a frequency of 6,000 cycles is employed. The operation of this system is so simple that there is no necessity for the presence of an expert on the train. When the oscillator that sends out the wireless waves is once adjusted it is locked so that it cannot be tampered with. To listen, the "listening key" is depressed, and when speaking this key is released. Conversation at a distance of 27 miles is loud and clear, although somewhat affected by the noise of the train, while the sounds of the voice have been heard at a distance of 52 miles with the train running at 50 miles an hour. It is now planned to use an ingenious device by which conversation from the train can be relayed to the telephone lines of the city in which a wireless station is located. With this device the voice of the person speaking from the moving train will be registered on a phonograph record and instantly reproduced

and relayed over the telephone wire to the local telephones.

The system worked out on the Union Pacific is designed for talking both by wire and by wireless. It is used for communication between the different cars of the train, and it is then operated as an ordinary wire telephone with selective talking and signaling. When the train is stopped at a station, the equipment is connected with the wires of the telegraph line and is operated as a single long-distance telephone system. With the train in motion, the wireless is brought into action simply by starting the generator carried in the baggage car, and it is then possible to talk with a train ahead or behind, or with a fixed wireless station. The wireless waves thrown out by the apparatus are taken up by the two wires strung on the telegraph poles, these wires having been balanced and equipped with condensers. Over the wires the electric impulses are transmitted direct to the telephone equipment of the railroad stations, but at every point wireless impulses that can be picked up by another train are also thrown out by the wires, and it is this that makes communication between trains possible.

For connecting the equipment and making it continuous through the train, a copper wire woven into the air hose and grounded through the wheels at each end is used, the hose couplings being provided with metallic connections that interlock in firm contact when the couplings are made.

### CIGAR WITH WOODEN PEG

9437 INSERTED IN TIP

A cigar manufacturer in Wisconsin equips each cigar with a small wooden shoe peg inserted in the tip and projecting far enough to be easily grasped by the teeth. Instead of biting off the end of the tip the smoker simply takes hold of this peg with his teeth and pulls it out, and in this way opens a good draft through the cigar without loosening or injuring the wrapper.

*Mfgs: R. E. Holcomb, Monroe, Wis.  
Chas. E. Gopen, 4322 Walnut St.,  
Chicago, Ill.*

Red material

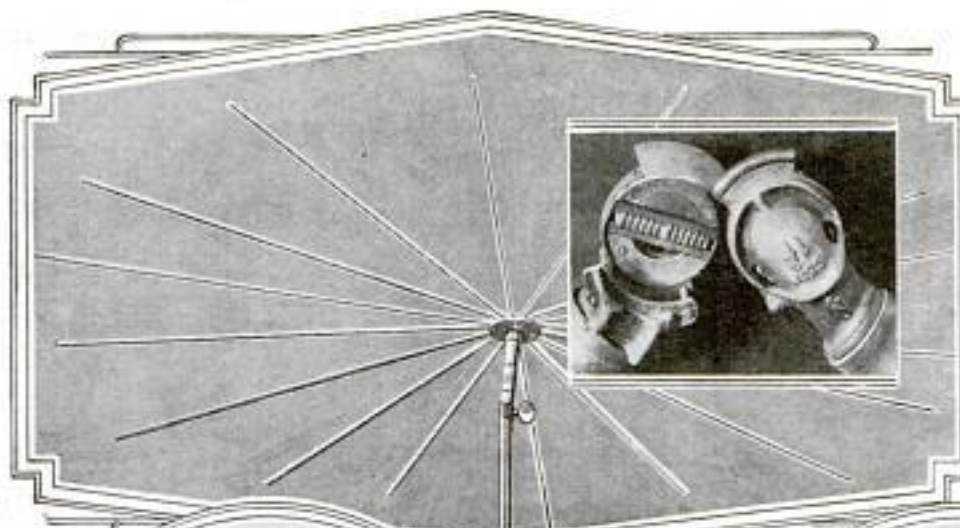

A Copper Wire Woven into the Air Hose Runs through Each Car, and These Wires are Connected by Electrical Contacts in the Couplings. The Umbrellalike Antenna Forms Part of a Wireless-Telephone Apparatus Installed Indoors and Shown in Operation Below



With the Ribs of the Umbrella Acting as Antennae, This Brakeman is Receiving a Wireless Message from a Station Located Several Hundred Feet Away

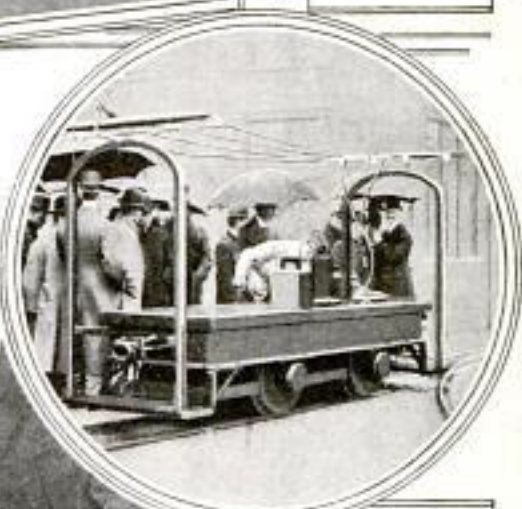

This Electric Truck, Used for Experimental Purposes, was Run Forward and Backward at Varying Speeds by the Manipulation of the Key in the Wireless Station

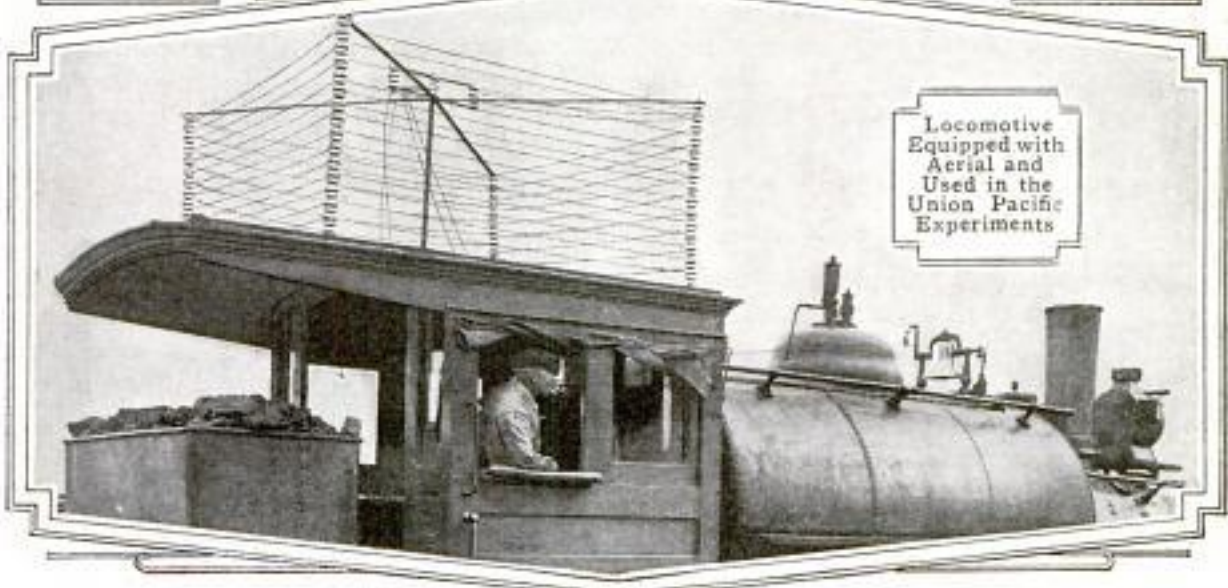

Locomotive Equipped with Aerial and Used in the Union Pacific Experiments

O. G. Geyer,  
1429 West 9th St.,  
668 Des Moines,  
Iowa.



Rescuing Fish Trapped in a Shallow Pool by the Receding Flood Waters of the Mississippi River

### RESCUING FISH TRAPPED BY RECEDING FLOOD

8943 Each year when spring freshets swell the Mississippi River, spreading it out over the lowlands for miles in every direction, millions of fish are carried out of the channel. When the flood waters subside the fish are trapped in shallow bayous and ponds. In order to prevent what was once a tremendous loss, the government has established fishery stations at different points along the river and sends its men into the field annually to rescue

the fish trapped in this manner. The accompanying photograph shows one of the gangs seining in a shallow pool in which the fish would have died within a short time had they not been released. The greater percentage of the fish, the "fingerlings," are returned to the river, while millions of them are carried to the interior rivers which are in need of restocking.

¶ Preliminary surveys are being made for a bridge across the Hudson River from New York City to New Jersey. The cost will be \$42,000,000.

### TAXICAB HEARSE IS USED FOR INFANTS' FUNERALS

8940 Taxicab hearses are the rather uncommon vehicles that have been intro-

duced at Chicago for use at children's funerals. One of these cars is designed so that an infant's casket may be carried in a boxlike receptacle of appropriate appearance, which is constructed at one side of the chauffeur's seat. The mourners ride in the rear the same as they would in an ordinary taxicab. From the driver's side the appearance of the car is no different from that of any ordinary motor vehicle. The vault in which the casket is carried is decorated in white and is similar to the full-sized hearses in style.

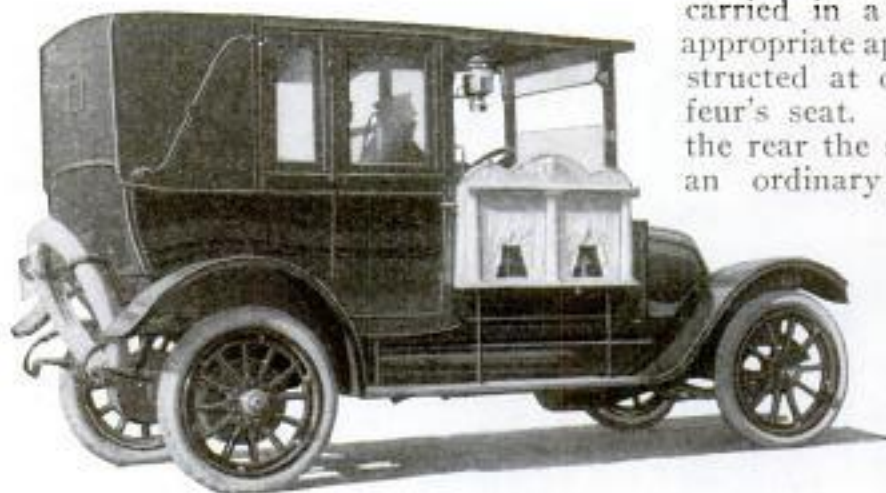

Taxicab Hearse, a Funeral Vehicle Designed to Carry a Child's Coffin

J. S. Reid, 506 Belden Ave.,  
Chicago, Ills.

**EXPLODING GUNPOWDER**

9497 **WITH WIRELESS WAVES**

According to reports coming from Japan a wireless apparatus for exploding gunpowder at a distance proved successful in tests recently conducted at Kumamoto. Nothing is known of the apparatus except that it is intended "for the manipulation of wireless electric waves." For making the tests a double stockade was erected, a pound of explosive inclosed with wire netting was placed in one corner of the stockade and the exploding apparatus in the opposite corner. When all was ready the inventor pressed a key and, according to the reports, the explosion followed instantly. The distance was short, but the inventor claims that using the apparatus at greater distances is only a matter of greater power.

**MOTOR-DRIVE ICE BOAT**

9230 **ATTAINS GOOD SPEED**

On smooth ice a three-runner ice boat which during the winter has been used at Battle Creek, Mich., has attained a speed of 55 miles an hour with a twin-cylinder, 3-hp. motor, driving a 4-ft. 3-in. aerial propeller. The craft is guided by the fore runner, which is turned with an ordinary steering wheel. Beneath the driver's seat is a



Homemade Ice Boat Driven by a Three-Horsepower Motor

steel claw which digs into the ice and serves as a brake when pressure is applied with one foot on a lever at the front.

*Suzuki,  
Battle Creek,  
Mich.*

**ADJUSTABLE WORK TABLE**

9003 **ON KITCHEN CABINET**

A kitchen cabinet with a working table so devised that it may be readily adjusted to any convenient height

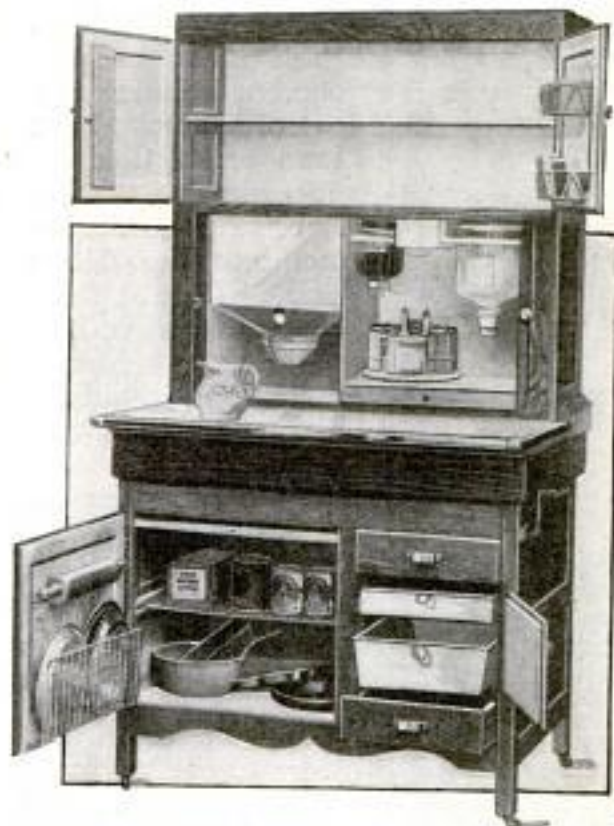

*Greeneville Cabinet Co.,  
Greeneville, Tenn.*

By Turning a Crank This Kitchen Cabinet may be Adjusted So That Its Working Table Is of Proper Height for Its User

has recently been invented. In general appearance it is similar to ordinary cabinets. At one side, however, it has a small crank that operates a ratchet-and-pawl mechanism which controls the working table, allowing it to be raised or lowered to suit its user. In this way a short woman, or a tall one, may have a cabinet which suits her height as satisfactorily as if it had been made to order. The adjustment may be made in a few seconds, and once fixed, the cabinet requires no further attention. It is as substantial as if it were of a fixed height.

CX-ray photographs on metal plates and celluloid films are being used by French military surgeons, being less likely to be broken than the glass plates.

## LOOKOUT POSTS IN FORESTS OF MONTANA AND IDAHO

924+ On many of the mountain peaks throughout the timbered areas of western Montana and northern Idaho,



lookout points connected by telephone to the various permanent stations and patrol camps have been established by government forest rangers in order to facilitate the detection of fires at their inception when it is possible to curb them. In numbers of places where for some reason it has been impossible to construct regular stations, use has been made of the tallest pine trees. On each of these the branches have been stripped from one side, a ladder built up the trunk, and an observation platform constructed at the top. From such a point it is often possible, by the use of binoculars, to view the surrounding

mountains for many miles. In this manner a vigil is kept over many of the most remote sections of the forests.

## INSTRUCT MEXICAN LABORERS WITH THE PHONOGRAPH

9326 The phonograph has been put to a novel use on a western railroad which employs many Mexican laborers who understand no language other than Spanish. To reach these laborers a "safety-first" talk was translated into Spanish, and a phonograph record of it made. A phonograph is carried on an inspection car and each Mexican gang of laborers is made to listen to a

nine-minute talk in their own language. Extra records are carried, and whenever a bunk car is found with a phonograph as part of its equipment, a record is left so that the laborers may hear it repeatedly. In addition to these records the car also carries a number of Mexican musical records. When the car stops for the night at a point where a work train is tied up, a concert lasting for an hour is given for the benefit of the Mexican laborers and their families, and this concert invariably ends with the "safety-first" talk.

## "TRIAL OF THE PYX" HELD AT PHILADELPHIA MINT

9327 Periodically the coinage of all the United States mints is examined by the Federal assay commission, a custom which is also followed in other countries, and in England dates back to the time of Henry II. The procedure is known as the "Trial of the Pyx," a name derived from the sealed box, or "pyx," in which the coins to be examined are kept. In America it is the

custom to preserve two coins out of each shipment amounting to \$1,000, for examination by the commission. This inspection is made to ascertain whether the coins are up to standard in quality and weight, which means that many of



them are subjected to both chemical and filing tests. In the course of this work, some of the coins are cut in half, as is shown in the accompanying photograph taken at the Philadelphia mint recently while the coin jury was undertaking its work.

*Santa Fe Magazine*  
Jan. 1915

*International News Service*  
200 Williams St.,  
New York City.



V. M. Lecher, 693 Fair Hills Ave.,  
Oakwood Village,  
Dayton, O.

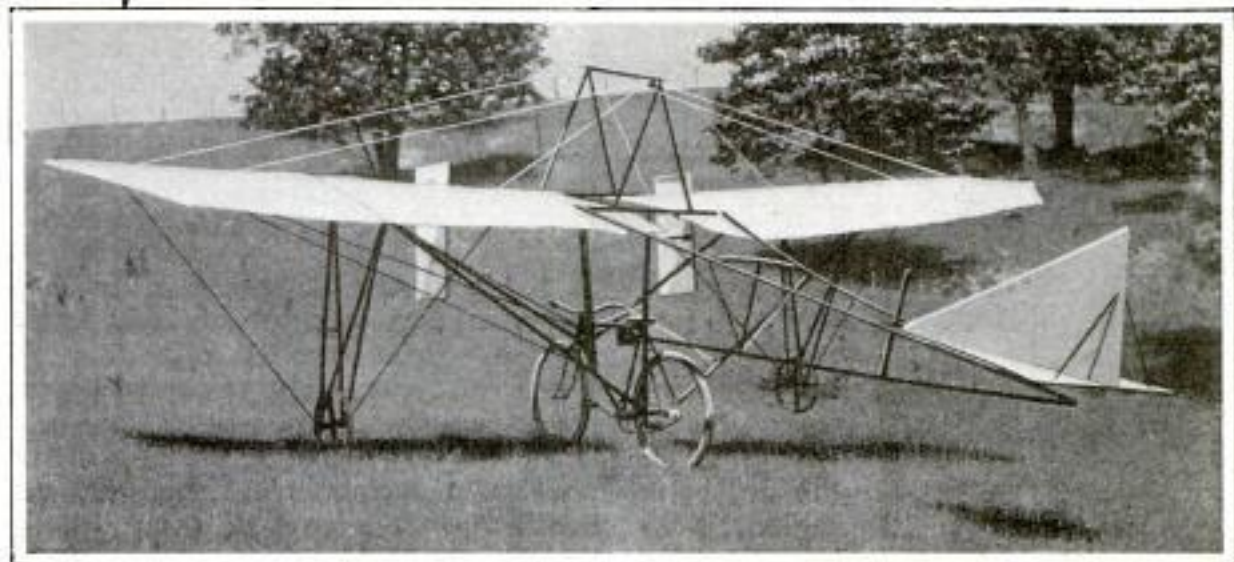

By Pedaling the Bicycle Part of the Way down a Knoll, the Glider may be Shot into the Air so That It Skims Along for Several Rods

9201 **HOMEMADE GLIDER BUILT FROM SCRAP MATERIAL**

From odds and ends of scrap material available for his use, an Ohio farmer boy has constructed a monoplane glider attached to a bicycle which fills quite adequately the purpose for which it is intended. To cover the framework of the wings, which are made principally of laths, its builder made use of pieces of canvas that had been used over tobacco-plant beds. The bracing wires were taken from an old fence, and a few other members were likewise reclaimed from scraps. By pedaling the bicycle rapidly part of the way down one side of a knoll, the rider is able to gain sufficient momentum for the glider to take to the air when its nose is pointed upward. By means of wires extending from the handlebars to the outer tips of the plane, the wings are warped and the craft guided.

coaster is shaped much like a toboggan, curving up at the prow in a generous scroll, and instead of being made from a solid slab of wood, it has a light frame covered with canvas. This furnishes it with a large air compartment, gives it buoyancy and makes it very simple to handle in the water. No skill is required in learning to ride the device, as in the case of the surf board, and for this reason it has gained popularity among winter tourists.

see Oct-13-467



Toboggan-Shaped Coaster Which is Used for Surf Riding at California Beaches

8378 **SURF COASTERS INTRODUCED AT CALIFORNIA BEACHES**

Surf coasters have made their appearance on the beaches of southern California and are being used there by the bathers in much the same way as surf boards are in Hawaii, and some other parts of the world where conditions are favorable for them. The

A. A. Holismith  
544 So Hobart Blvd.,  
Los Angeles, Calif.  
Stanford University

For sale by A. S. Spalding Bros.  
435 So. Spring St. Los Angeles, Cal.  
or all other Hawaiian

*The Sphere 6-25-14*  
**DESIGN OF SCOTT MEMORIAL**

7978 **DECIDED UPON**

As a memorial to Capt. Robert F. Scott, commander of the ill-fated British expedition to the south pole,



COURTESY OF THE SPHERE

a monument symbolizing his patriotism and fortitude, as well as theirs who died with him in the antarctic region, is to be raised in London. The design for this structure was recently selected by a special committee which considered the models submitted by various sculptors. The place of erection probably will be in Waterloo Place, in the heart of the city. The work consists of a granite pylon, at the top of which is a group of figures representing "Courage" supported by "Patriotism," disregarding "Fear" and "Despair." The names of the five explorers who failed to return appear on the front of the pylon, while other inscriptions are engraved elsewhere. A podium at the base carries on each of its four sides a bronze relief of the principal incidents of the expedition, with an inscription reading, "To Strive, to Seek, to Find, and Not to Yield."

*Scientific American*  
**AERATORS FOR NEW YORK**  
 8837 **WATER SUPPLY**

A spectacular feature of the new water-supply system of New York City will be the devices used for aerating the water, one of which is being installed at Ashokan and the other at Kensico. With these the water will

be aerated just before entering the aqueduct and again before being distributed to the city mains. Each aerator consists of a basin covering nearly three acres, measuring 460 ft. in length and 240 ft. in width at the widest point. The floor of the basin is studded with 1,600 nozzles arranged in rows, and when the aerator is in full operation each nozzle will spout a jet of water from 15 to 20 ft. high. From each nozzle the water will issue in a fan-shaped, whirling fountain, and owing to the close spacing of the nozzles, the jets will intersect and break up into a mass of spray, giving the air access to every particle of the water.

*9047*  
**RAPID STEEL CUTTING WITH OXYACETYLENE FLAME**

The oxyacetylene flame was used in cutting down all the steel street-awning frames on the main streets of Baltimore, which had been ordered removed before a specified time to comply with a city ordinance. This method proved to be a great time saver, an average of only about 15 minutes being required to clear away



the frame in front of each establishment. In cutting down a frame, the two compressed-gas tanks, one containing oxygen and the other acetylene, were placed in convenient position on the sidewalk. The operator, armed with a stepladder and a cutting torch, attacked first the

horizontal members and then the upright posts. The posts were cut off flush with the sidewalk, the edge of each cut being melted down so there would be no projection. The average cut was made in less than half a minute.

*Alvin W. King, Payson Ave.,  
 Cantonville, Ind.*

*Scientific American  
 11-21-14*

J. C. Mc Carthy  
Love Star Wash. D. C.

# LAUNCHING A GIANT BATTLESHIP A LONG-PLANNED AND RISKY JOB

9575

By J. CROSBY McCARTHY

WHEN the "Pennsylvania," the biggest warship ever built in America, slid off the ways at Newport News on March 16 and floated safely in the waters of the James River, the huge craft passed successfully through the most critical stage of its construction—the launching.

To slide a steel structure as big as a 30-story office building downhill into the water and have it arrive right side up without damage is a big job, even in these days of big achievements. The builders of the "Pennsylvania" risked nearly \$7,000,000 worth of material and labor when the launching triggers were released. The outcome depended on the correctness of calculations made before the big fighting ship's keel was laid on the blocks, for before the first construction work on a ship is begun the preparations for its launching must be started. It is comparatively easy to build a ship on land, but to get it into the water is another matter, as Robinson Crusoe discovered after working seven years to construct a boat which, when finished, proved so big that he could not launch it. After the "Great Eastern," for 43 years the largest ship in the world, was built in 1858, it took three months to get it afloat.

The larger the vessel, the more ticklish is the job of sliding it safely into the water. Although years of experience and careful study have reduced the methods used to a standard practice, yet there is always a degree of uncertainty about the operation. In spite of the navy's record of an unbroken series of successful launchings, those responsible for each succeeding one experience considerable anxiety until the crisis is safely past. Even though every known precaution has been taken, there is always the chance that some unknown factor may ruin the plan and wreck the ship.

Data compiled from previous launchings of similar ships serve as the basis of calculation. In the case of the "Pennsylvania" the experience with the

"Oklahoma," launched a year before, was the guide. The "Oklahoma" is only 33 ft. shorter and weighs within 4,000 tons as much as the "Pennsylvania."

The construction of the ways, which carry the ship a distance of a little more than its own length into the water, is the most important of the launching preparations. The term "ways" includes both the pair of inclined wooden tracks along which the vessel travels, known as ground ways, and the skids, or runners, that support its weight while moving, called sliding ways. The ground ways for a big battleship are about 5 ft. wide, 70 to 90 ft. longer than the ship, and spaced about a third of the ship's width apart. They are built up of yellow-pine timbers a foot square, bolted together and supported on cribbing. A cross section of the ground ways shows a concave upper surface, the outer edges being about two inches higher than the center, and having wooden plates bolted to them to keep the sliding ways from slipping off.

The sliding ways are about two inches narrower than the ground ways and slightly shorter than the ship. Both the lower surface of the sliding ways and the upper surface of the ground ways are usually sheathed with 3-in. oak planking. Like the ground ways, the sliding ways are of foot-square timbers, bolted firmly, and above these is built up a packing of 4-in. pine planks, conforming to the curves of the ship's body and held in place by heavy iron rods and steel cables extending from the bulwarks completely around the hull. Between the sliding ways and the packing are placed oak wedges, 8 ft. long and 6 in. square at the thick end.

The "Pennsylvania," like most large ships, was launched stern first. This made it necessary to take elaborate precautions to insure against the crushing of the forward part of the hull at the moment when the stern floated, lifting the weight of the middle off the

ways and leaving the whole gigantic mass supported only at the two ends. This is one of the most serious dangers to be guarded against in launching a ship.

To prevent an accident of this kind, cradlelike supports, extending under the hull and known as poppets, are constructed. They consist of steel plates conforming to the curvature of the hull and supported by timbers resting on a curved rocker. Between the plates and the hull concrete is poured in order to insure a more uniform bearing. Between the two parts of the rocker grease is applied so as to lessen the friction when the vessel begins to pivot and pressure is brought on the poppets, which, because of their peculiar construction, serve as an axis when the stern starts to lift from the ways. The pressure brought on the forward part of the hull when the vessel pivots is so great that it is necessary to brace the hull from the inside where the poppets bear against it so that the plates will not be forced out of alignment during the launching. The sliding ways, poppets, and all of the packing, are tied to the vessel by means of ropes and cables, so that when the ship floats out into the stream it carries with it all of the cradle which supported it during the launching. When the ways are placed in position, a layer of stearin and tallow about three-quarters of an inch thick is placed between them. Iron plates, which are removed a few minutes before the launching, are placed between the ways at intervals of every few feet to prevent the lubricant from being forced out by the weight of the timbers.

The day before the launching the shores and braces which have supported the ship during the course of construction are removed. Several hours before the launching a force of 200, or more, men begin to drive in the hundreds of wedges between the sliding ways and the packing. Heavy mauls and hydraulic rams are used for this purpose. This setting of the wedges serves to lift the weight of the vessel from the keel blocks so that it is supported by the ways. The keel

blocks are then removed and the ship is ready for launching.

A few minutes before the time arrives to send the ship gliding down the ways for its initial plunge into the water, dogshores which hold the sliding ways fast are knocked out, and the pressure is transferred to hydraulic triggers fitted in each of the ground ways about amidships. The triggers, which are of heavy steel, project through holes cut in the ground ways, the upper ends engaging iron caps fitted into recesses in the sliding ways. The bearings for the triggers are bolted to the under sides of the ground ways, and the lower ends of the triggers rest against the pistons of hydraulic jacks at a pressure of about 1,700 lb. to the square inch.

At a signal, the safety struts of the hydraulic jacks are swung aside and the escape valve in the pressure pipe is opened. The pistons recede into the cylinders, the triggers release the sliding ways and the vessel is free to slide into the water. Sometimes it is necessary to employ hydraulic jacks at the forward end of the sliding ways in order to start the ship. At first it moves slowly, but the speed rapidly increases until it reaches a maximum of as much as 25 ft. per second. The speed of the ship down the ways must not be too great, otherwise the friction will set fire to the lubricant. If this happens the vessel is liable to come to a standstill before it reaches the end of the ways. In order to retard the speed, rope checks are employed. Temperature is an important factor. If the weather is warm, the lubricant between the ways will be soft and the speed much greater. In extremely cold weather it has been necessary, in some cases, to lay steam pipes along either side of the ways to warm the lubricant.

Motion-picture cameras were used to make observations of the launching of the "Pennsylvania." The pivoting of the vessel is clearly shown on the films and the data obtained will be of great value in future launchings.

Larger than any other fighting ship ever built in America and exceeding

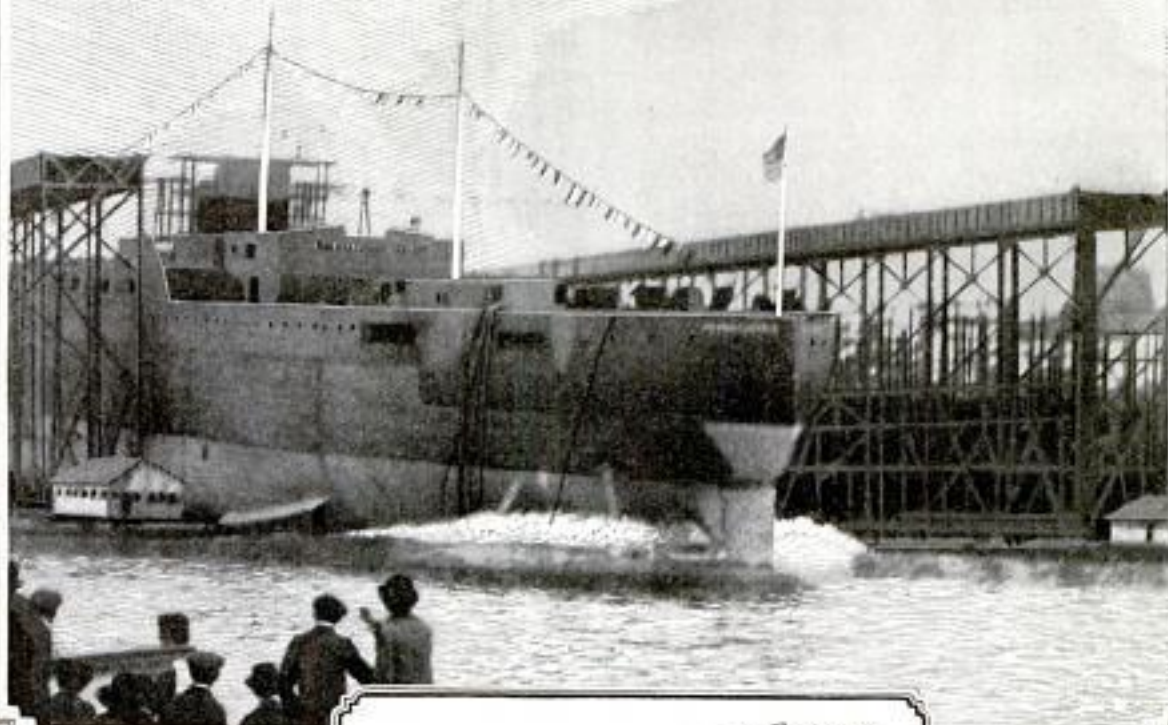

The Battleship "Pennsylvania," Largest Ship Yet Built for American Navy. Sliding into the Water at Newport News

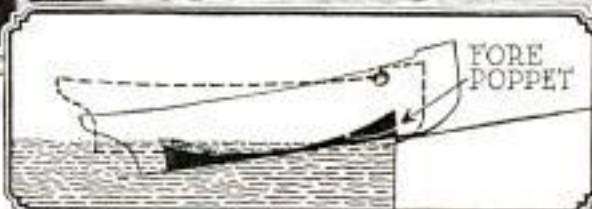
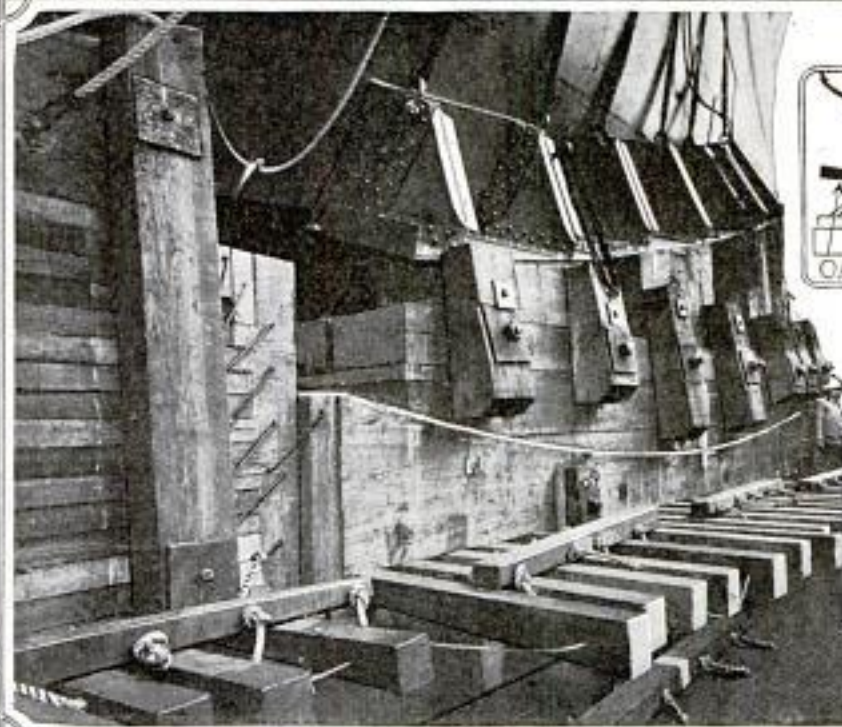
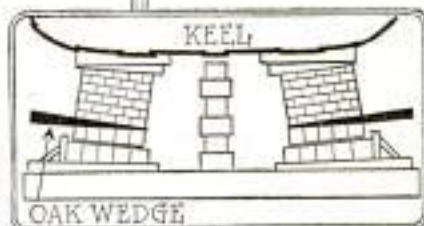

Diagram Showing How the Launching Poppet Serves as a Pivot When the Stern of the Ship Floats and the Angle of the Keel Changes toward the Horizontal



Photograph Showing the Forward Launching Poppet, Which Bears the Ship's Weight and Enables It to Change Its Position from Slanting to Horizontal. Note the Wedges between the Packing and the Sliding Ways



How Wedges between Packing and Sliding Ways Lift the Ship off the Keel Blocks Preparatory to Launching



Steel Launching Trigger Held in Place by Hydraulic Jack. When This is Released the Ship Begins to Slide to the Water

every other ship of any nation in the combined power of its great guns, the "Pennsylvania" was begun on Oct. 27, 1913, and will not be ready for active service until Feb. 28, 1916, so long does it take to construct a modern war craft. The new ship is 608 ft. long over all, 97½ ft. wide, 53 ft. 9 in. deep from keel to upper deck, and will draw 28 ft. 10 in. of water, displacing 31,400 tons. Curtiss steam turbines developing 32,000 hp. will drive its four screws, producing a speed of 24.2 miles an hour. Oil fuel will be used, the tanks in the ship's double bottom having a capacity of 694,830 gal. A band of 11-in. armor, extending nearly the entire length of the ship and 8 ft. below the water line, will furnish the main protection. The four turrets will have 15-in. armor. In each of them will be mounted three 14-

in. guns, 52 ft. 6 in. long. The turrets are so placed that the entire 12 guns of the main battery can be fired in a single broadside, or six can be fired at once dead ahead, and six dead astern. The combined weight of shells thrown at once will be 7½ tons. The secondary battery will include 22 guns of 5-in. caliber and 21 ft. 3 in. long, four 3-pounders for saluting, two 1-pounders for boats, two 3-in. field guns for landing parties, and two standard .30-caliber machine guns for the marines to use in the fighting tops on the two skeleton masts placed fore and aft of the single funnel. When in commission, the "Pennsylvania" will carry a crew of 65 officers, 863 enlisted men, and 74 marines. The hull alone cost \$7,260,000, and the completed ship, fully armed, will cost \$13,000,000.

## 954 SOUND OF LIBERTY BELL IS PRESERVED

WHAT may prove to be the last ringing of the historic Liberty Bell took place in Independence Hall at Philadelphia recently.

Instead of sending the bell to the Panama-Pacific Exposition, it was decided to transmit its tones across the country to San Francisco over the recently completed transcontinental telephone line, partly fulfilling in a literal sense the prophetic words cast on the bell, "Proclaim liberty throughout all the land, unto all the inhabitants thereof." The bell was struck three times with mallets at intervals of five seconds. By an arrangement of three very sensitive transmitters which were suspended beneath it on rubber bands, so as to exclude all foreign vibrations, the tones were caught and clearly heard over the telephone wires on the Pacific coast. At the same time a phonographic record was made of the notes so as to preserve them for posterity.

This is the first time that the great bell has been sounded since it was cracked in 1835 while tolling the death of John Marshall, the first Chief Jus-

tice of the United States Supreme Court. The reason that it may never again be rung is that a new crack, more serious than the old one, has developed in it.

It has been found that the bell is afflicted with the "disease of metals." This is partly responsible for the appearance of the latest fissure and has made it necessary to support the weight on padded props in order to relieve the stress which has gradually been pulling it apart.

The new crack is now plainly visible, while only a short time ago it was microscopic. It begins at the upper part of the original fracture, extending from the letter "P" in the word "Philadelphia," diagonally a quarter of the way around the circumference, to the letter "y" in "Liberty," near the top. It is believed that the new crack might not have occurred had the bell been allowed to remain at rest after it was first broken. It has, however, been shipped on different occasions to New Orleans, Chicago, Atlanta, Charleston, Boston, and St. Louis. That it is actually suffering from a malady known

*The Iron Age - 2/8/15*  
*The Telephone News*

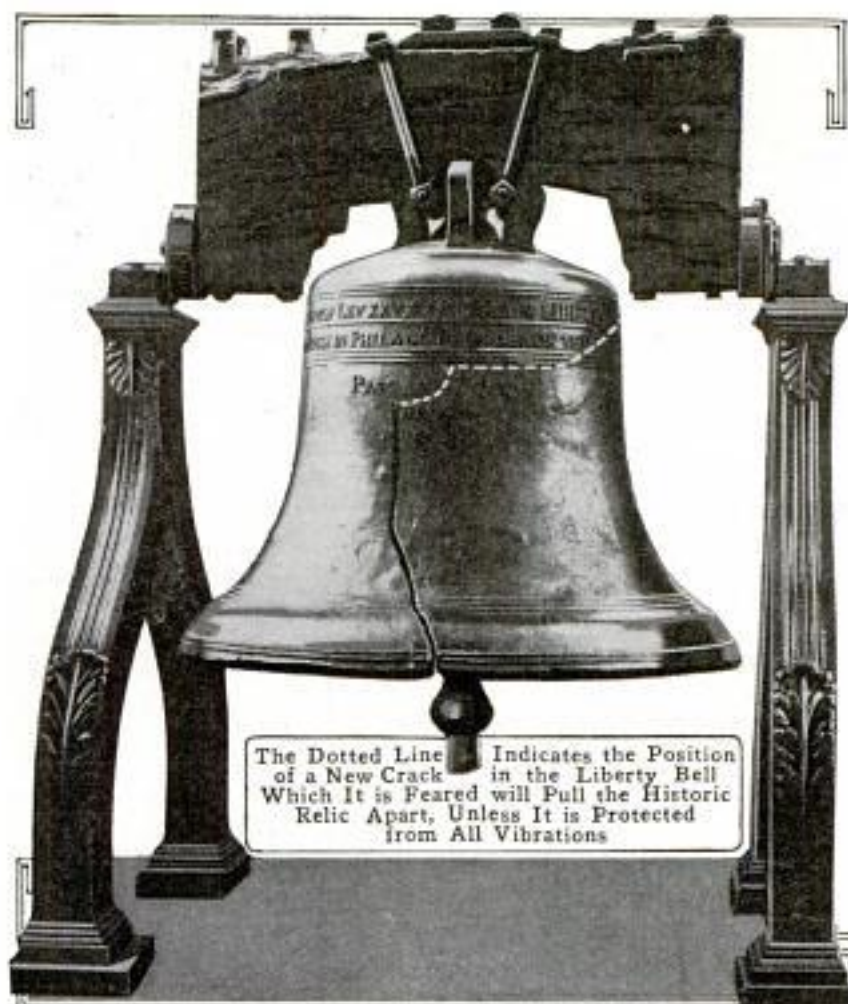

The Dotted Line Indicates the Position of a New Crack in the Liberty Bell Which It is Feared will Pull the Historic Relic Apart, Unless It is Protected from All Vibrations

enced in the art, undertook the recasting in Philadelphia. Obviously the bronze was too brittle, and in order to toughen it, they added approximately 10 per cent of copper to the original metal. When the bell was later rung it was found that too much copper had been used, and, to the chagrin of everyone, the tone was destroyed. The same men again undertook the work, and this time are supposed to have added tin to restore the tone. The third bell was accepted, but too much tin had been used, and the tones were so highly resonant that it was seldom rung.

as the "disease of metals," is the description of its ailment in the technical phraseology of the metallurgist, and is not a popular figure of speech. The reason for this distemper is to be found in the history of the bell's casting.

It was originally made by Thomas Lester at London, in 1752, and shipped to Philadelphia. When it was hung to try the sound it was cracked by the clapper. At first it was intended to return it to England, but subsequently two workmen, Pass and Stow, neither of whom was experi-



Ring the Liberty Bell for the First Time Since It was Cracked Years Ago. Below Are the Transmitters Used in Sending the Tones across the Continent. The Horn at the Left was Employed in Making a Phonographic Record of the Tolling

9557  
**FAULTY CONSTRUCTION OF MONOPLANE  
CAUSE OF LINCOLN BEACHEY'S DEATH**

**W**HEN Lincoln Beachey, the airman, lost his life by a 3,000-ft. plunge into San Francisco Bay a few weeks ago, he proved his theory that the monoplane of today is not the logical machine for looping the loop and making spectacular drops from the clouds. His death resulted from the structural weakness of a new craft of this type, which was too light and poorly braced to withstand the stress of the 2,000-ft. perpendicular dive that he attempted to make in it. One of the wings crumpled while he was diving, head down, at a speed of probably three miles a minute.

The wing spread of the machine was only 26 ft. 6 in. It was not a German Taube, as is popularly thought, but a small tractor monoplane with ailerons extending back from the tips of the wings. The fuselage was short and the body made of aluminum, with an opening at the top just large enough to allow him to climb into the machine. Only the airman's head protruded above the hood when in flight. Beachey's fatal mistake lay in his over-eagerness for a light machine, for he neglected to brace the wings even as substantially as is customary on high-power monoplanes intended merely for speed and straight flying. He relied solely on two sets of bracing wires, or stays; one on top and the other on the bottom—a total of eight wires. Two of these wires extended from the center pylon over the body to the outer part of each wing, while beneath, the wires reached from the same wing points to the running gear. In this connection attention has been called to an additional weakness in the bracing, caused by the crossing of the under stays. This would have a tendency to induce a strain which would bend the wings longitudinally at the spar, instead of holding them against such a pull. In view of French, German, and English plans of monoplane construction, the inadequacy of this system of bracing is glaring. Practically all German single-decked machines have three pylons,

two of them midway of the wings, reaching through to form a similar post on the under side, and each carrying from six to eight wires both at the top and bottom of the plane, in addition to a truss extending nearly the full length under the front spar. And these machines are not intended for Beachey's type of flying.

Exactly what happened will never be known, but there is one theory that is quite plausible. Previously Beachey had performed his feats while seated on a slender outrigger at the front of his biplane where no part of his body was shielded from the air. Just as the marine navigator learns to measure the speed of his vessel by taking into account the effect of a heavy head wind, so did Beachey grow to estimate his speed by the force of the air against his body. When he seated himself in the cockpit of the new monoplane, however, covered his head with a tight-fitting hood and his eyes with goggles, this also for the first time, he was protected from the air in a way he never before had been. Therefore when he started on his long, head-first dive, after successfully looping the loop and flying upside down, he probably failed to realize that he was plunging toward the earth at a rate much greater than was his custom. There is no doubt about this point, for a monoplane meets less resistance than does a biplane and travels at a greater speed. In a few seconds his craft attained a terrific momentum and the stress was greater than it was capable of withstanding. The front spars of the wings were not braced against head resistance, neither were they reinforced with a truss, so, when he was within a thousand feet of earth and ready to straighten out and volplane to the green, the velocity of his craft was out of proportion to its strength and a wing crumpled under a stress heavier than formerly had been borne by the four wings of his biplane.

Chicago has an all-night movie theater.



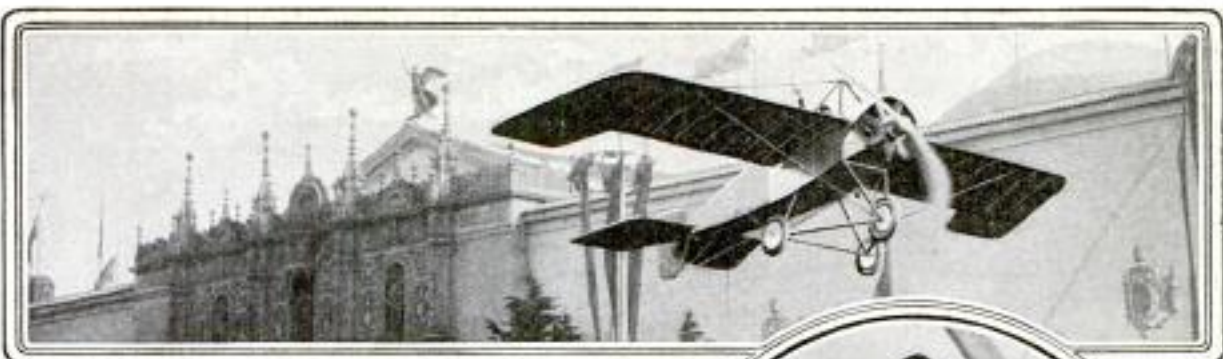

Above,  
Lincoln  
Beachey  
is Shown  
Rising from  
the Ground  
at Start of  
Flight



This Shows the  
Demolished Mono-  
plane being Pulled  
Out of San Francisco  
Bay After a Diver had  
Located It. The  
Body of the Airman  
was Taken from  
the Wreckage

Close View Pic-  
turing Wreckage of  
Air Craft After It had  
been Removed from  
the Water, Which It  
Struck While Falling  
at a Speed of About  
Three Miles a  
Minute

From the book: "Influence of Radio-active Earth in Plant Growth and Crop Production" by H. H. Rusby, of Columbia Univ.

POPULAR MECHANICS

9581 RADIUM FERTILIZER GIVES INCREASED CROP YIELDS

That radium as a fertilizing agent has a wonderful stimulating effect on plant growth and also imparts to vegetables grown under its influence added richness and sweetness of flavor has been demonstrated by Prof. H. H. Rusby of Columbia University. Doctor Rusby conducted two experiments with radium fertilizer, one on 100 acres of farm land at Northfield, Ohio, and the other on a 1½-acre garden plot at Nutley, N. J. In both cases the results were surprising.

The cost was not as great as might have been expected. It takes about 400 tons of radium ore to yield a gram of radium, and this quantity is worth, at the current market quotation, \$120,000, equivalent to a price of more than \$50,000,000 a pound. But the finely powdered residue of ore, remaining after all the radium possible has been extracted, still contains two or three milligrams to the ton, and it was with this waste material, obtained from the Colorado radium mines, that the experiments were made.

The radium-ore tailings were diluted with ordinary fertilizer and applied in the usual way in proportions of 25, 50, 100, and 200 lb. of radioactive substance to the acre. Five plots were made for each crop grown, one for each of the proportions of radioactive fertilizer, and one without fertilizer, as a control.

On the Ohio farm, pumpkins on soil

late corn showed an increase of 105 per cent; oats, potatoes, cucumbers, cabbages, and tomatoes all showed increases of over 50 per cent, and other crops increased from 20 to 50 per cent. In the New Jersey garden, melons showed a gain of 80 per cent; radishes, 70 per cent; turnips, 129 per cent, and nearly all other vegetables gave greatly increased yields.

9528 DESIGN FOR "MADE IN U. S. A." TRADE-MARK SELECTED

A design that is characterized by the judges as being "simple, strong and mechanically perfect" has been selected as the prize winner in the competition held by the Detroit Board of Commerce for obtaining the best "Made in U. S. A." trade-mark. The qualities specified in the specifications governing the competition were that the trade-mark should not only be suited to printing by ordinary processes, but that it should be suitable for reproduction by lithographic or color processes, for printing as a textile label in colors, and for reproduction by zinc or copper processes in one color, and that it should be adapted to use as a stencil, metal stamp, or die. Above all, it was to be thoroughly American in atmosphere, composition, and color scheme. The winning design not only possesses all these qualities but can be reproduced clearly in a width of as little as ¼ in. It is to become the property of the people of the United States, and it

*Chicago Herald 5-10-15*



Prize-Winning Design for National Label, Arranged for Colors



The Prize-Winning Design as Applied with a Stencil



How the Prize-Winning Design will be Woven into Fabrics

treated with 100 lb. of radium fertilizer to the acre produced 135 per cent more by weight than on the untreated plot;

is expected that it will be adopted generally, the names of other cities being substituted.

Designed by: Jasper Harley Nash and Clowdy Chapman. Address of C. C.: 106 Morningside Drive, N. Y. City  
Business add. of C. C.: 17 East 38th St., N. Y. City

Copyrighted Material

# COMMENT AND REVIEW

**J**UST now a lot of well-meaning people, but most inexperienced for the task attempted, are essaying to evolve various plans for a peace pact which shall end the present war. Would-be reformers who

## *Premature Peace Plans*

would not think of going into a county court on a trivial case without a lawyer, profoundly offer their services in the settlement of differences which, when they are adjusted, as some day they must be, will require the master legal and diplomatic minds of the world.

It is commendable in all of us to talk and work and throw our influence in every practical, sensible way in furtherance of permanent and universal peace, but ill-timed and inadvised efforts are merely the getting in the way of the firemen by people who honestly want to see the conflagration extinguished but who have no experience in handling the apparatus.

As terrible as the present conflict is, and regardless of who is right and who wrong, it would be an even greater calamity to hasten a premature settlement, which would be only a temporary abatement of the fever, and not a radical cure and restoration to normal, permanent health.



**W**E are all inclined to look up to the physically big man, not only literally, but there is always a certain presumption in his favor that he must be correspondingly strong mentally. People make room

## *The Medium- Sized Man*

for him; they attach more importance usually to what he says than to the same words uttered by an undersized man. We unconsciously picture in our minds the bayonet charge and storming of the trenches as the work of large men. The boy dreams of having a football physique and little sister worships her big brother.

Other abilities being equal, the large man has a positive advantage over the small man. And yet many, if not the majority, of the great men of the world have been only of medium size, and not a few even undersized.

A certain large city in this country had for years made it a rule not to employ in its fire department any but large men. The result was a small army of athletes which never failed to cause a positive thrill whenever they went on parade. They distinctly represented the day of physical might.

For some years past the inventive mind has been busy, and very successfully, to produce apparatus which never tires, and calculated to transfer to a great extent the hard work from muscle to machine. The evidences of this evolution may be seen in even small towns everywhere, and now the fire engine drawn by volunteers and worked with hand brakes must be looked for in museums of strange mechanics of the past. In its place is the self-propelled gas-engined machine, carrying its own hose and capable of highly effective work with only two men; and ladder trucks by means of which one small man manipulating some short levers can in a few seconds raise great ladders to dizzy heights, or pour a deluge of water into tenth-story windows while standing in the street below. Hence it has come

about that the man small of stature but nimble of body and alert of mind is not only the peer but often the superior of the giant in build. There yet remains some work for the big athletes, but it is growing less each year, and the man whom nature has not endowed with great physical strength is coming into his own.



**S**O many laborious tasks have been taken over by machines, and so far-reaching has been the area of occupation, that it is only by pausing and taking a good look backward we can realize the progress made in this direction. A new and remarkable labor-saving invention is flashed into view, it is the talk and wonder of all for a few days and then retires to give place in the public mind to another which in turn must yield to yet another. Was there ever such an age, and where and when will we reach the limit of human initiative? On the farm, in the household, on land and

*Doctors  
of  
Mechanics*

sea, in shops, and in the air, it is one continuous story of the mastery of mind over matter. Immediately any service assumes large proportions and is difficult, or dangerous, or specially tiresome to perform, just so quickly the laws of mechanics and science, under the direction of brilliant minds and tireless energies, are concentrated on the problem. And like a piece of ice under the focus of a burning glass, no matter how cold the day, the problem melts and yields to a force it cannot resist.

What at first are expensive luxuries, under the pressure of demand soon become daily necessities, to be produced and sold at a price within the reach of thousands. The man who invents and he who by reason of study, experiment, and organization finds the way to manufacture a helpful article for a dollar which otherwise would cost ten to make—these Doctors of Mechanics—are doing a work for humanity in every way no less valuable than anything accomplished by our famous doctors of medicine.

It affords a positive relief to turn our thoughts from the weary depression of war to that helpful, hopeful progress which moves steadily, irresistibly onward and upward.



**A** RESIDENT of Georgia, who is at the head of a very large mercantile business, said to me the other day: "Inability to sell our cotton has worked a great hardship to the South, but in the end it will prove a great benefit. For years our state agricultural colleges have urged the planting of more diversified crops, but their advice fell mostly on deaf ears. We felt secure in that old, comfortable, but now exploded boast, that we could build a stone wall around this country and live on just about the same. An almost total failure of the cotton crop even would not have worked the desired result, because any one staple could not fail every year. And now the flash light is turned on millions of bales of as fine cotton as ever grew, which must remain in storage until

*We Learn  
from  
Experience*

Mr. Demand returns. And so our planters are figuring what they could have made with more corn and oats. It will take two or three, perhaps more, crops before our people learn how to approach the big corn production of the northern corn belt, but that the average production per acre can be doubled, by different planting and more cultivating, is already assured. The planting now determined on includes more food products than ever before, and a good share of this harvest will not be shipped as grain, but will be fed to pork and beef stock. The industrial departments of the railroads have done a splendid work in encouraging boys in the raising of corn, and where the average farmer was satisfied with 15 to 18 bushels per acre the boys have produced as high as 100 to 110 bushels from one acre. This of course was highly intensified production stimulated by the hope of winning some of the handsome prizes offered by the railroads, but nevertheless served as an actual demonstration of possibilities, and when reduced to the practical performance of large tracts shows returns which are highly profitable. The South will remain the cotton field of the world, but from now on it will grow millions of grains and other foods."

March 31, 1915.

H. H. WINDSOR

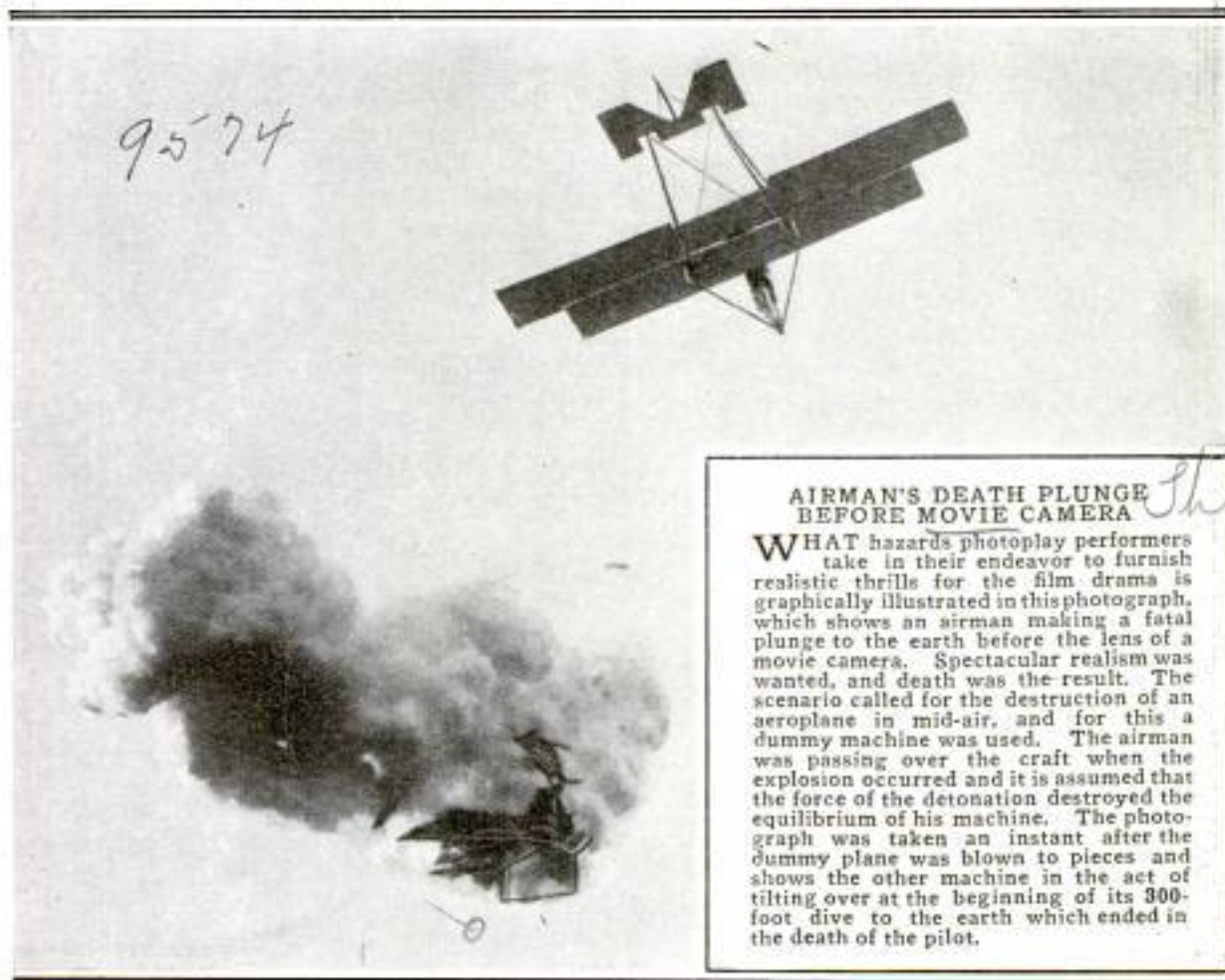
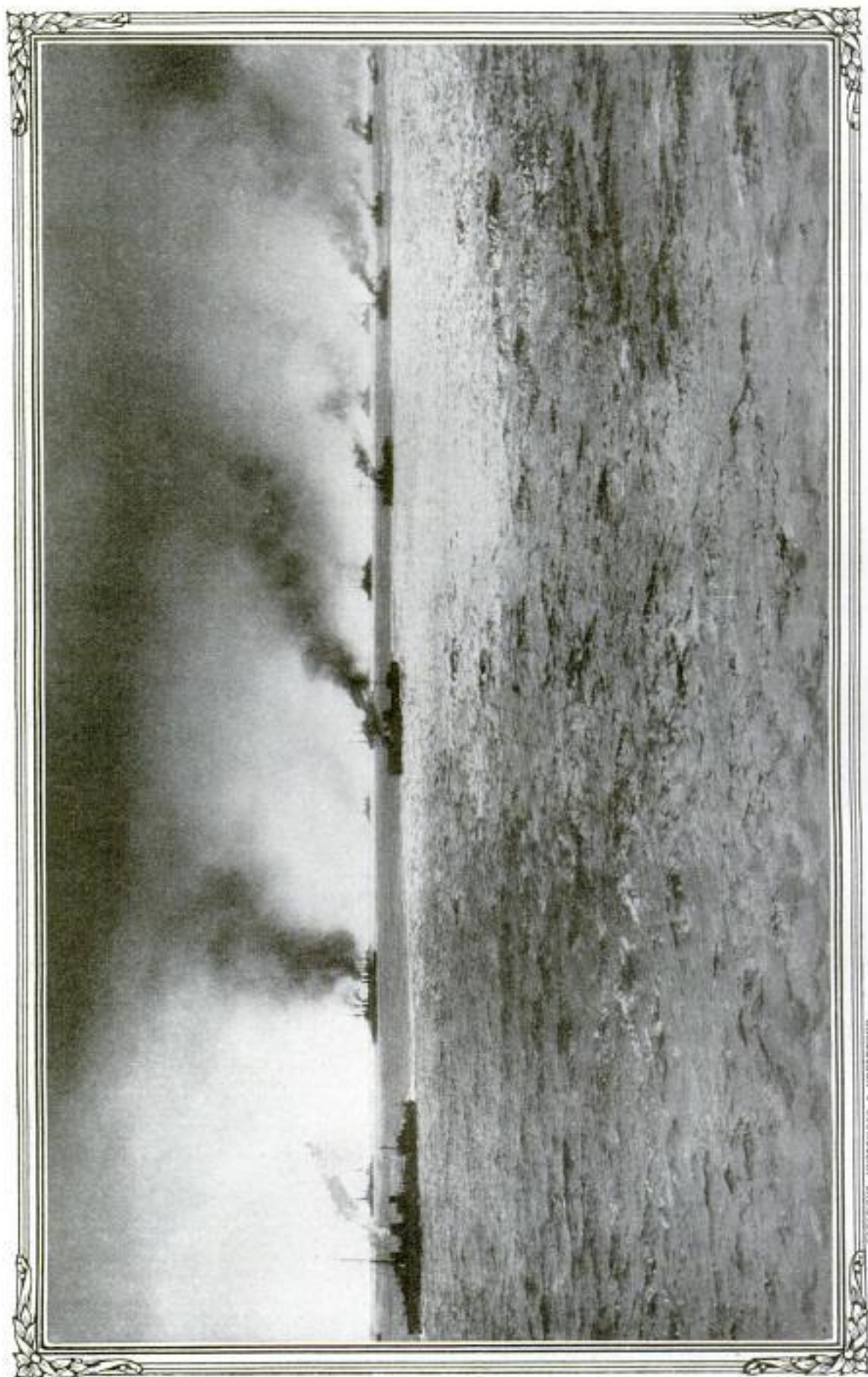

PHOTO BY WHIPPLE

*International News*

## ALLIED FLEET AT ENTRANCE OF DARDANELLES



This Remarkable Photograph Shows Part of the Allied Fleet in Battle Formation at the Entrance of the Dardanelles Shortly before the Bombardment of the Outer Defenses. It was Taken from Aboard the French Battleship "Bouvet," Which was Subsequently Sunk by a Mine during the Engagement before Erenkoi

COPYRIGHT, UNDERWOOD & UNDERWOOD

## STRIKING SCENES IN CONTINENTAL TRENCHES



An Army Dentist  
Extracting a Tooth  
for a German  
Soldier in a Snow-  
Lined Battle Trench  
in Poland

Austrian  
Defenders of  
Przemysl Bury-  
ing Their Dead  
Back of the Lines  
after a Spirited  
Russian Attack

British Soldiers Throwing Hand  
Grenades into German Trenches. The  
Exploding Bomb Scatters Shrapnel

# FRENCH CHURCHES DESTROYED BY GERMAN GUNS

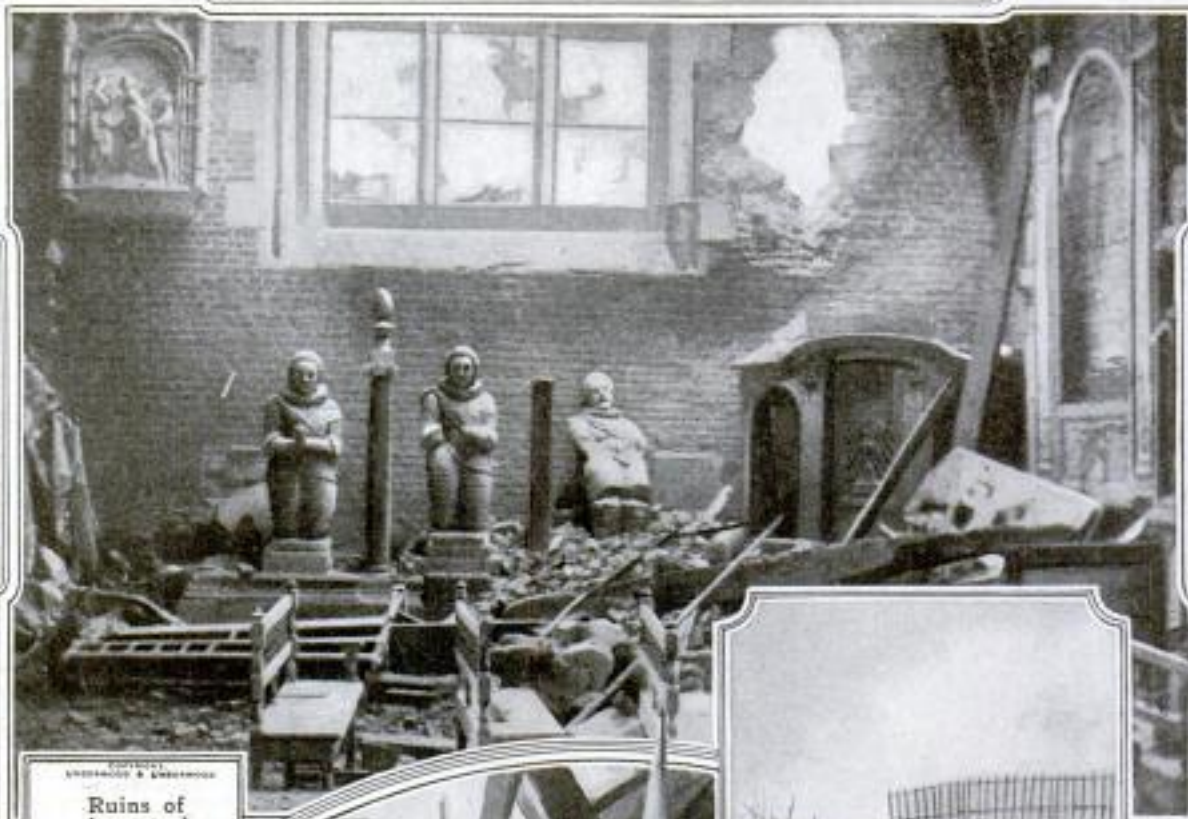

**Ruins of Ancestral Tombstones in a Fourteenth-Century Church at a Small French Village**



**This Trench Allows French to Reach Lines**

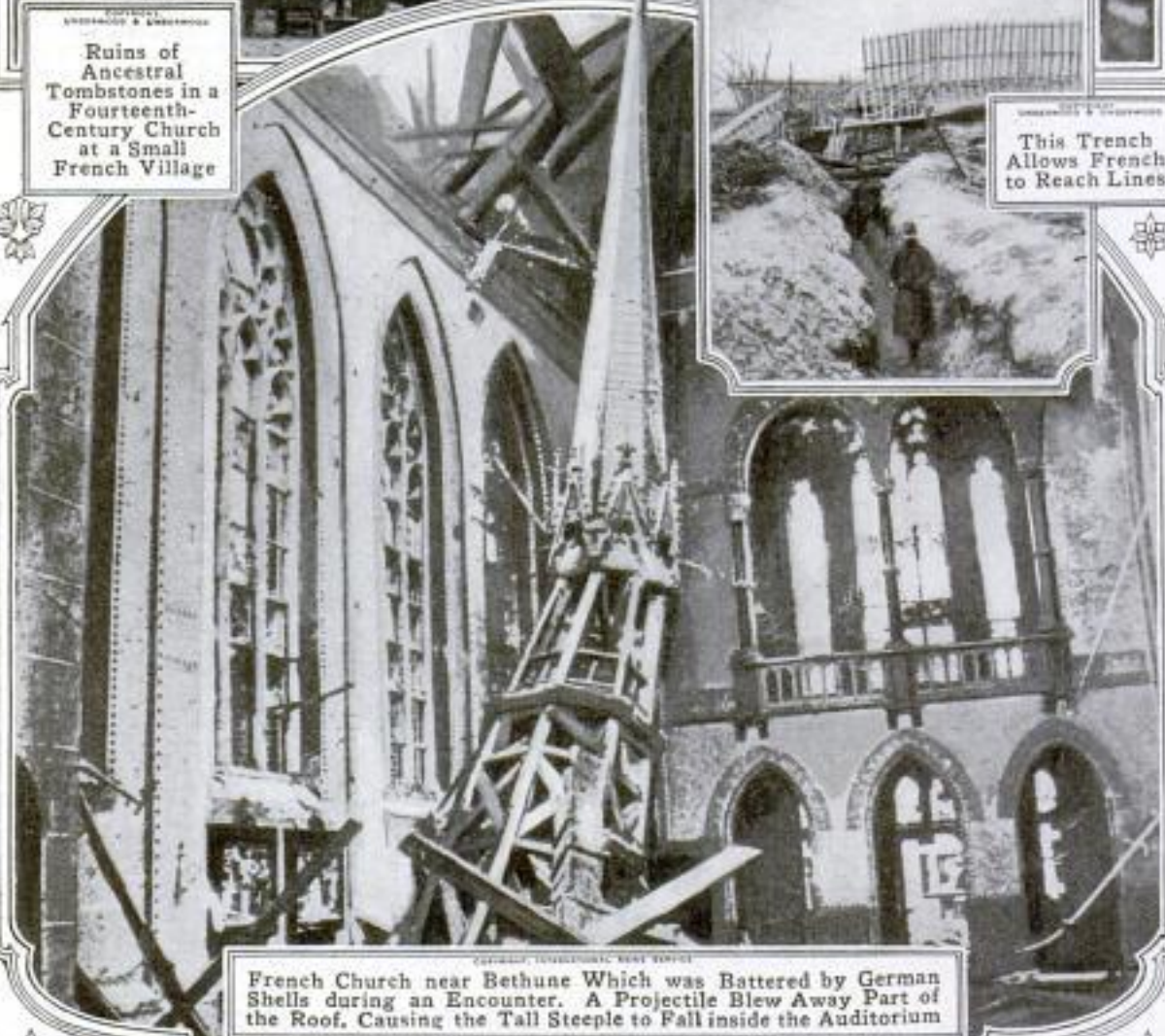

**French Church near Bethune Which was Battered by German Shells during an Encounter. A Projectile Blew Away Part of the Roof, Causing the Tall Steeple to Fall inside the Auditorium**



# PARTS PLAYED IN THE WAR BY BOYS AND DOGS



German Children Bringing to School Copper Utensils Requisitioned from Their Homes by the Government for War Purposes

Dog Decorated with Iron Cross for Saving Germans from Ambuscade

Ten and Twelve-Year-Old Boys in Germany are being Thoroughly Trained in Military Maneuvers and Taught Marksmanship, in Order That They may be Ready to Serve Their Country When Old Enough

## MAKING OBSERVATIONS FROM A CAPTIVE BALLOON

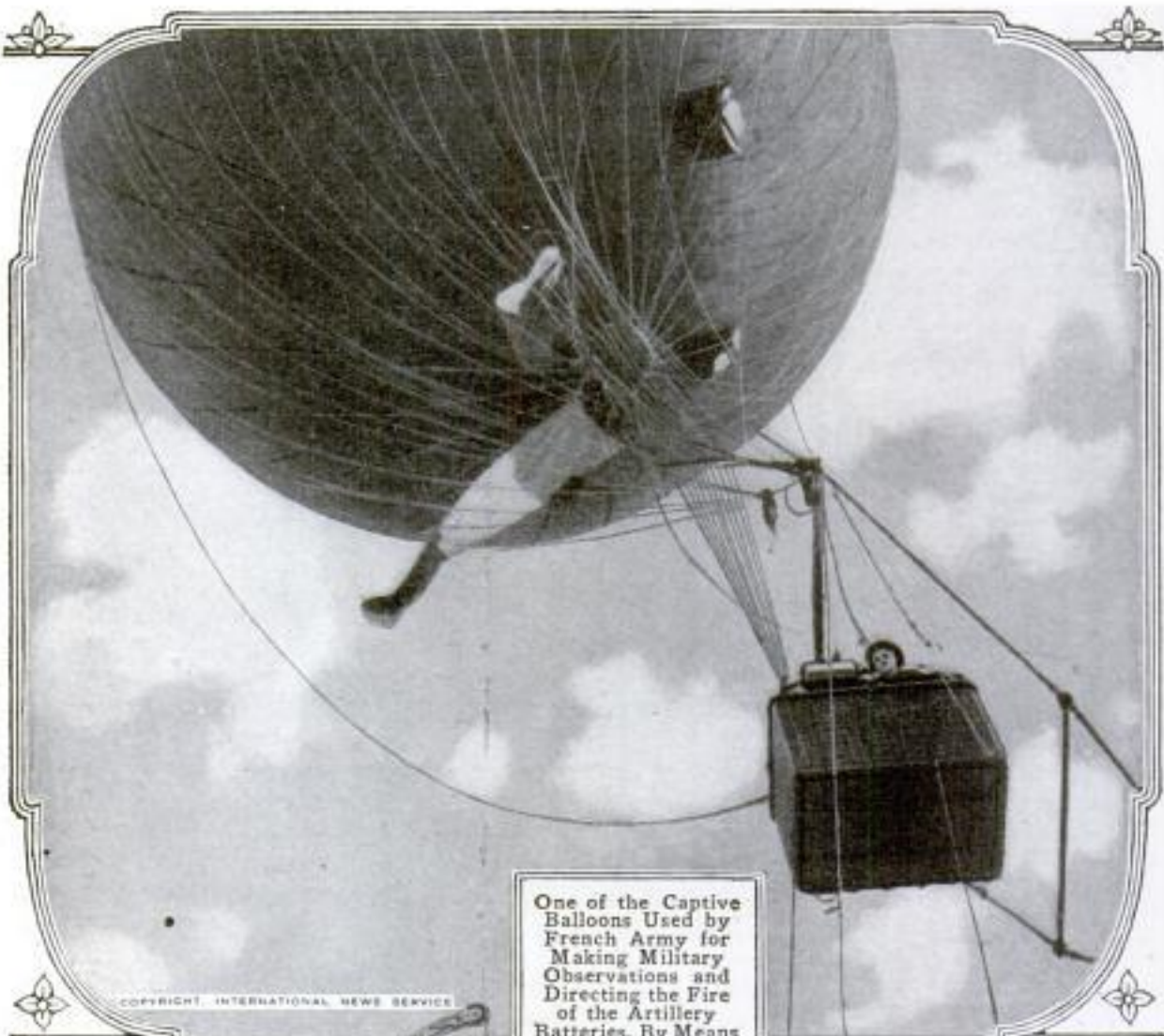

One of the Captive Balloons Used by French Army for Making Military Observations and Directing the Fire of the Artillery Batteries. By Means of a Telephone the Observer is Able to Keep the Gunners Informed as to Where Their Shells are Striking

COPYRIGHT, INTERNATIONAL NEWS SERVICE

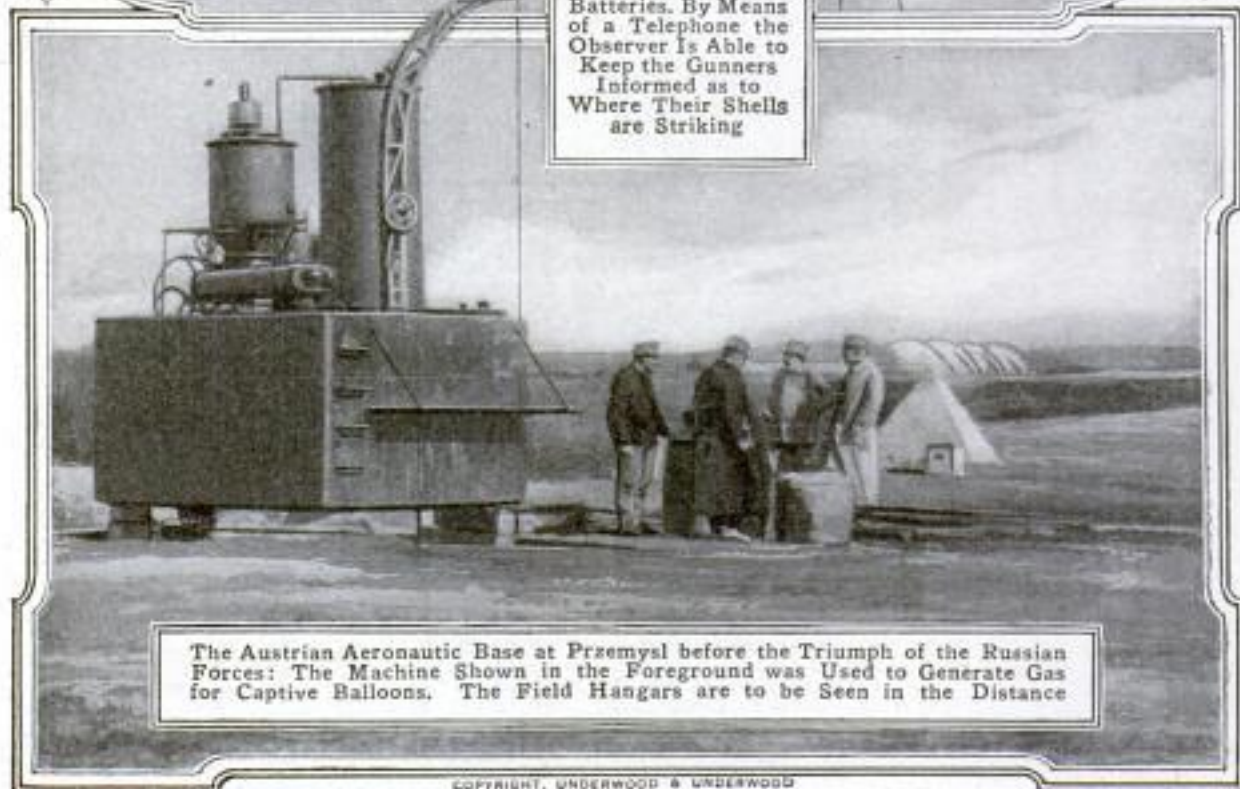

The Austrian Aeronautic Base at Przemyśl before the Triumph of the Russian Forces: The Machine Shown in the Foreground was Used to Generate Gas for Captive Balloons. The Field Hangars are to be Seen in the Distance

COPYRIGHT, UNDERWOOD & UNDERWOOD

## MACHINE-GUN BATTERIES ON THE FIRING LINE



© UNDERWOOD & UNDERWOOD  
This Photograph  
Shows a  
Detachment of Gunners  
Advancing Yard by  
Yard under Fire

Strong Battery of  
German Machine Guns  
Keeping Up an  
Incessant Fire on the  
Russian Forces in the  
Eastern Theater of War



Dugout Concealed  
with Brush and  
Occupied by Some  
of the Kaiser's  
Airmen



## GERMAN AMBULANCE TRAIN READY TO TRANSPORT



German Ambulance Train on Way to Front to Collect Wounded Soldiers from the Field Hospitals and Rush Them to Bases Where They may be Given Proper Attention



This Car is One Which is Provided for Women Nurses While They Are in Transit with the Wounded. It is a Place Where They may Rest and Refresh Themselves

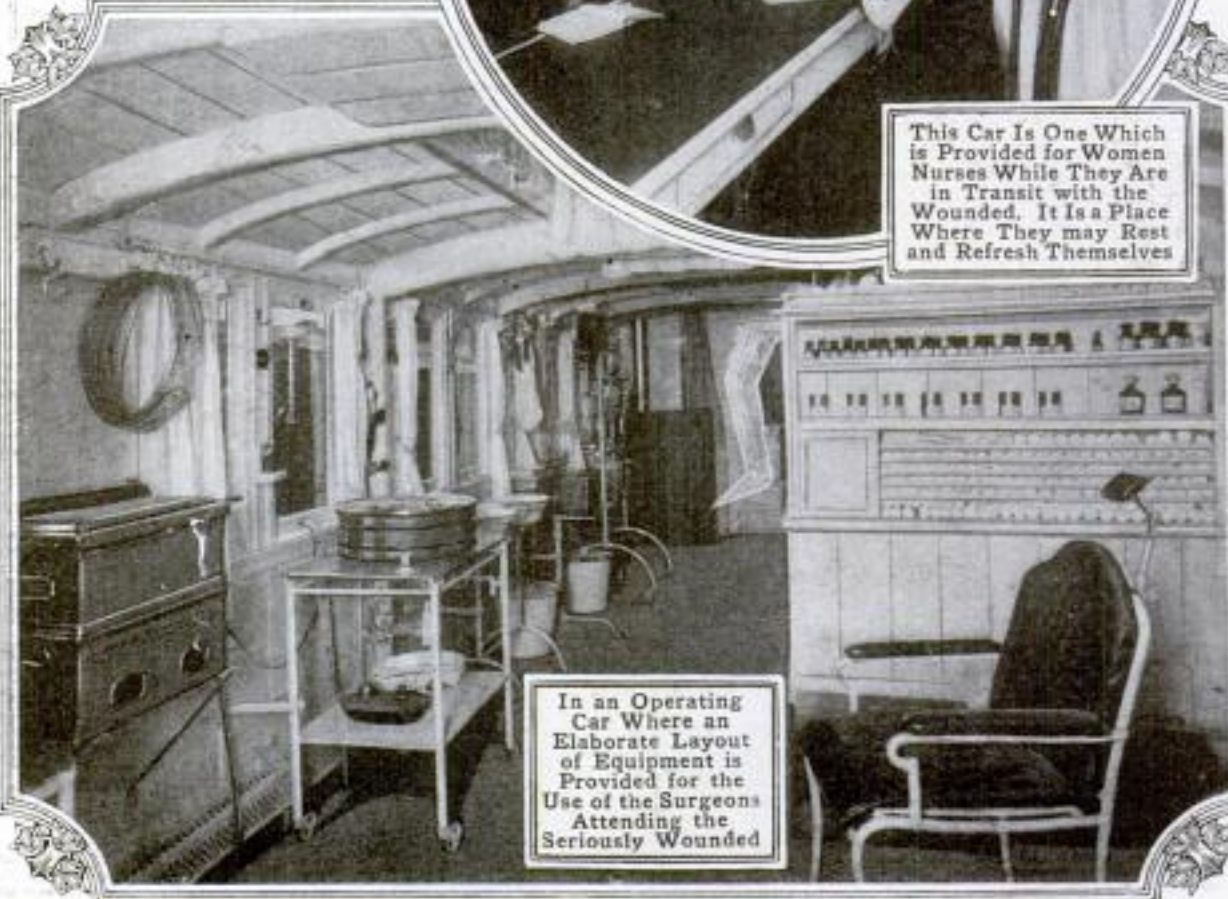

In an Operating Car Where an Elaborate Layout of Equipment is Provided for the Use of the Surgeons Attending the Seriously Wounded

# ARMY OF WOUNDED SOLDIERS TO HOSPITAL BASES



There Is Little Delay in Handling the Men When the Train Arrives at the Hospital. They are Removed on Stretchers as Quickly as Possible



At the Left and Below are Shown the Interiors of Ambulance Cars Where the Wounded are Cared for en Route between Field and Hospital

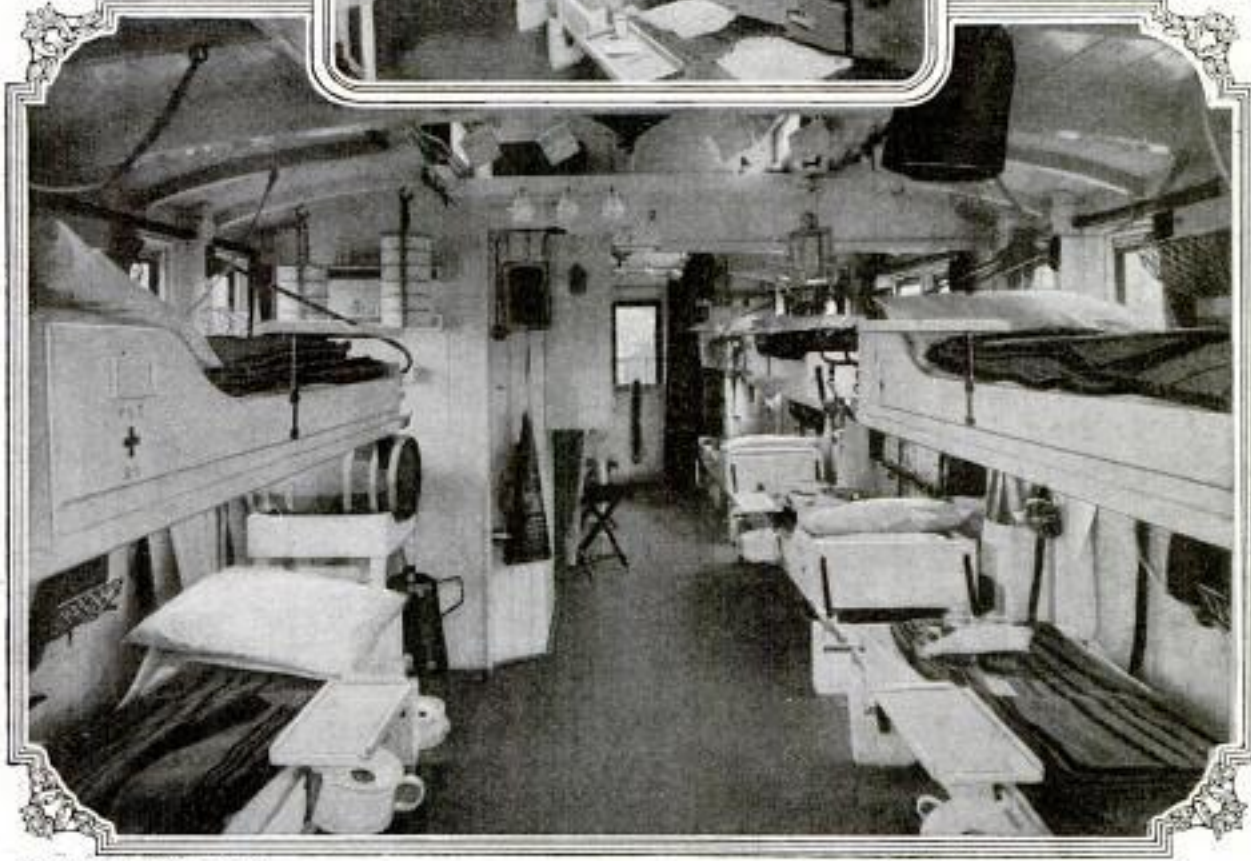

## AWAITING DEATH ON THE SINKING "BLUECHER"

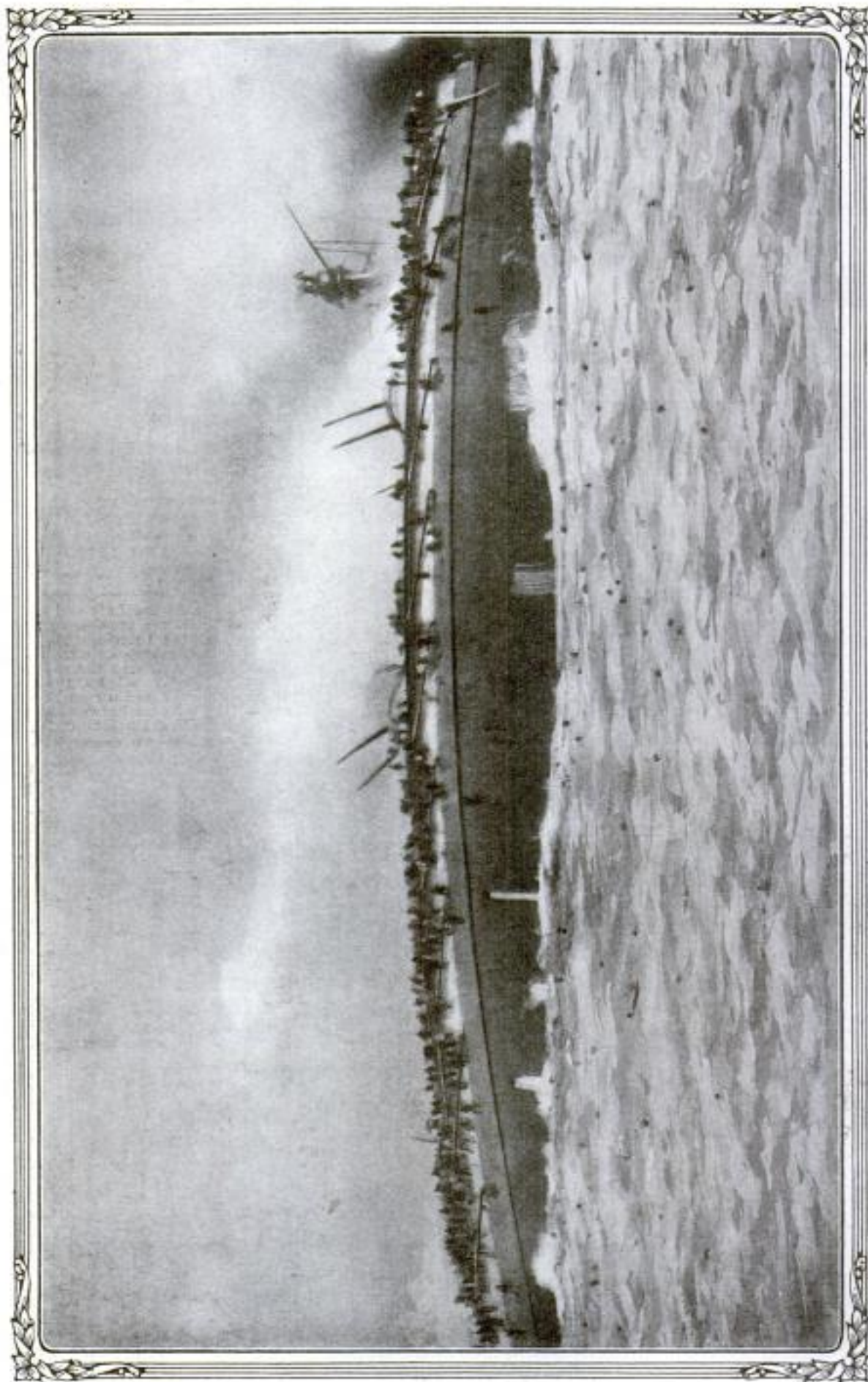

COURTESY, INTERNATIONAL NEWS SERVICE  
The Last Minutes of the German Cruiser "Blucher," a Mass of Flames after being Torpedoed in an Encounter with a British Fleet in the North Sea: Scores of Its Sailors, Still Alive, but Waiting for Death, are Clinging to the Slippery Hull as the Vessel is Gradually Turning Over and Sinking from Sight

## NEW ARTILLERY PIECES NOW IN USE IN EUROPE



These Two Heavy Schneider Guns, Neither of Which has Seen Service, are being Rushed along the Yser to Strengthen One of the French Positions



Muzzle-Loading German Trench Mortar Captured by the Belgians: It is Used Very Effectively at Close Range to Blow Up Breastworks



One of France's New 14-Inch Guns Which are Reputed to be More Mobile and Easily Assembled Than the Big Krupp Pieces

## THE WAR AEROPLANE AND ONE OF ITS ENEMIES

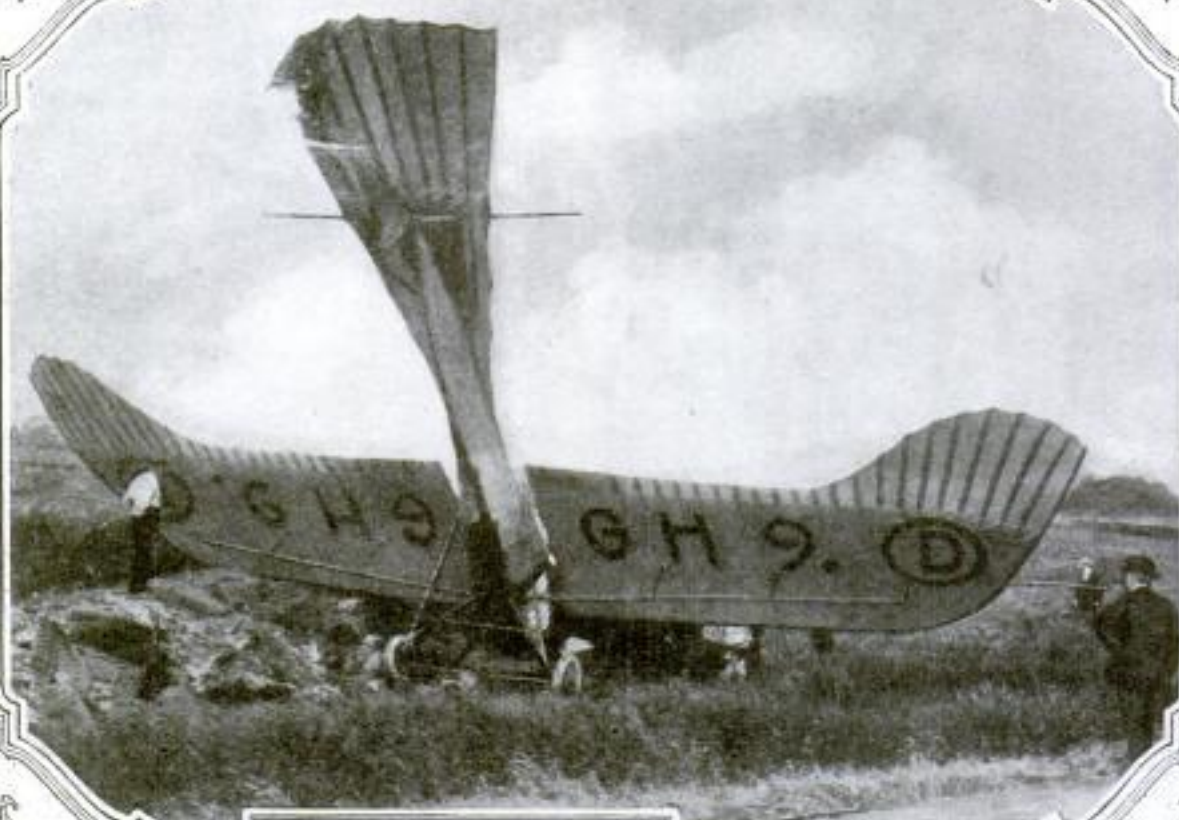

Wreck of a German Taube, One of Several Craft Sent over the French Lines on a Scouting Expedition. The Airman was Struck by a Bullet from a Machine Gun and the Aeroplane Crashed to Earth



Battery of French Armored Motor Cars, One of the Several Enemies of the War Aeroplane, Halted for Consultation of Road and Contour Maps of the District Ahead



## SEEN ON DIFFERENT EUROPEAN BATTLE FIELDS

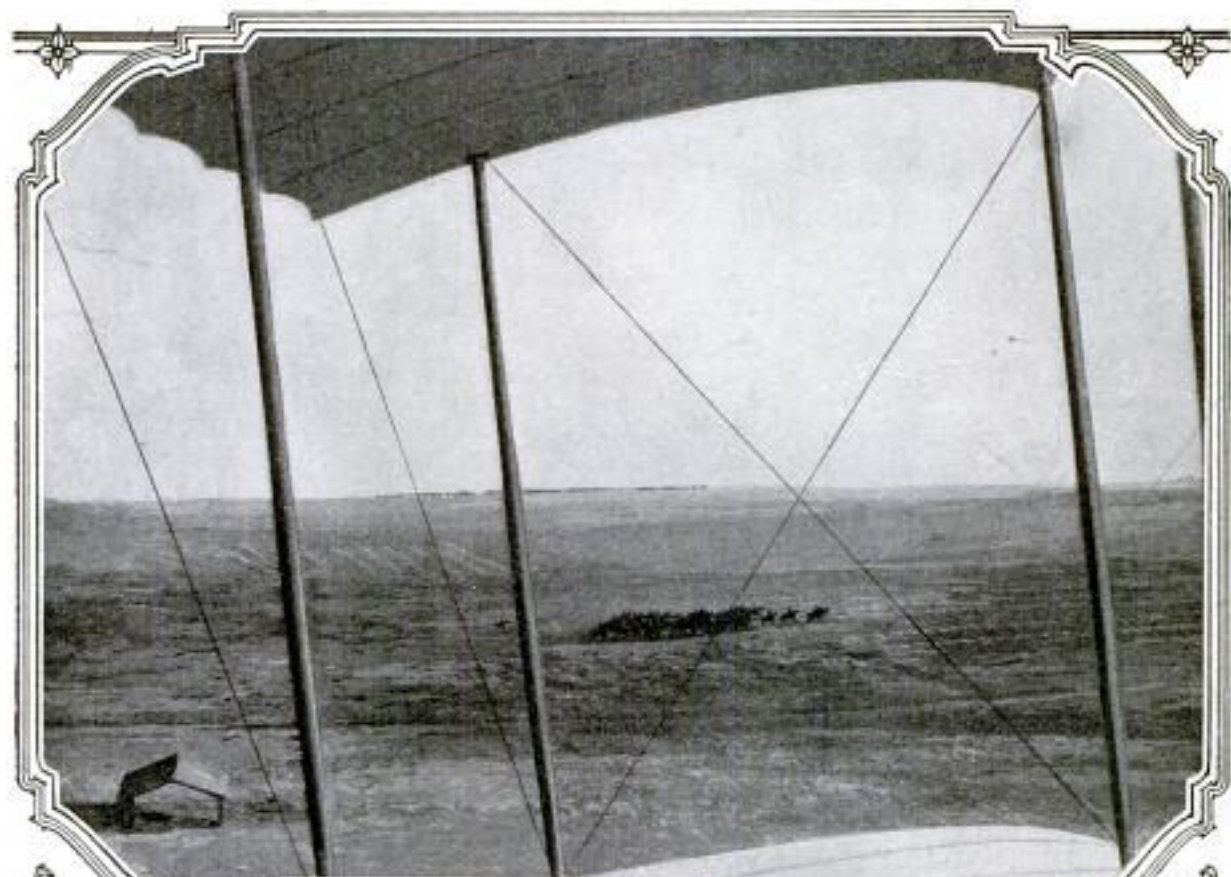

This Shows What an Aerial Scout Sees When He Flies above an Enemy's Lines for Reconnaissance Purposes. Approaching Below Is a Cavalry Squadron in Advance of Heavier Forces in the Background



An Approaching German Taube was Sighted by the Crew of This French Motor Car. A Rain of Bullets was Directed at the Speck in the Sky, but the Flier Escaped

WORLD EDITORIAL UNDERWOOD & GARDNER

# THE "GLORY OF WAR" AS THE SOLDIER SEES IT

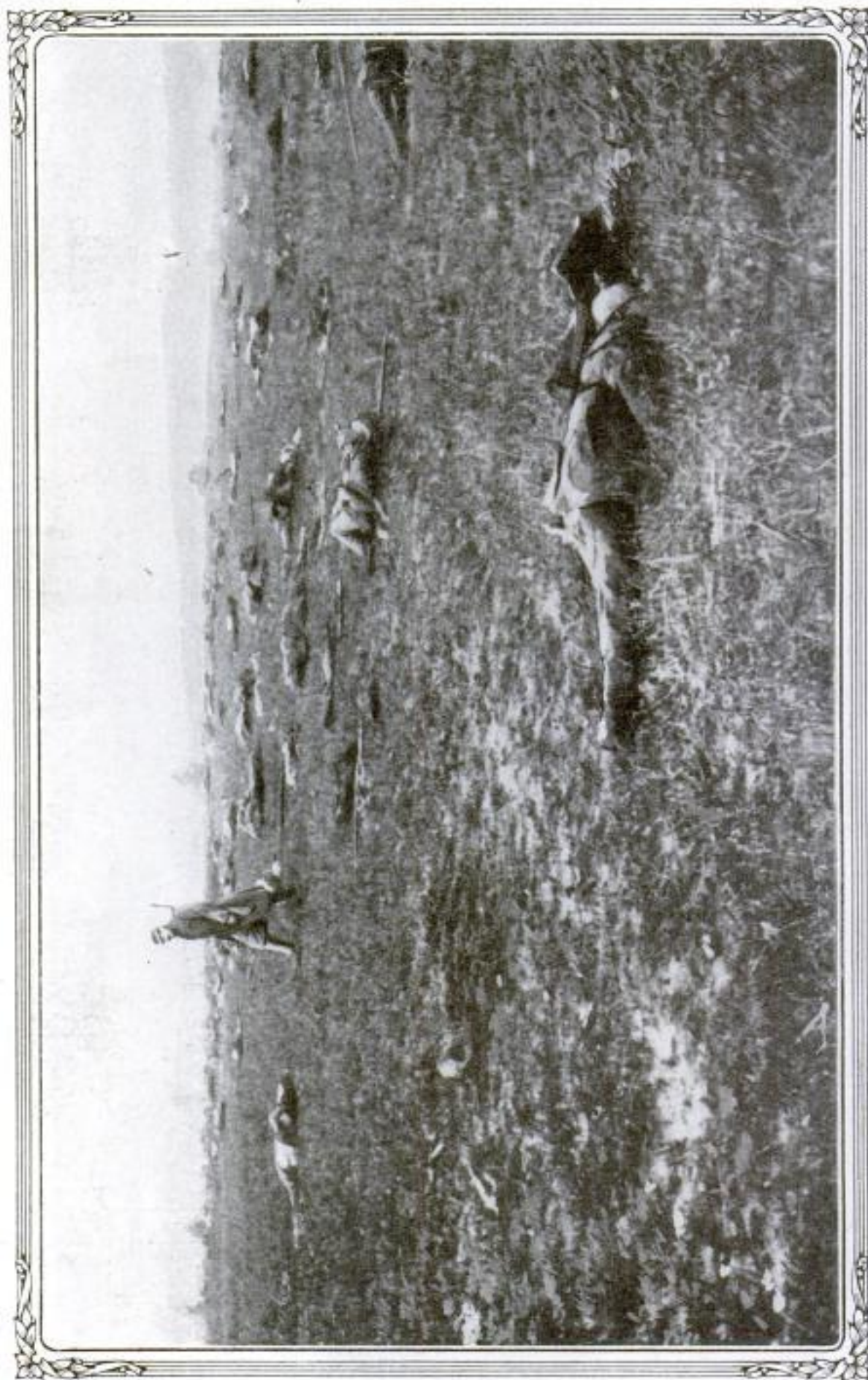

COPYRIGHT, UNDERWOOD & UNDERWOOD  
This Photograph, One of the Most Remarkable Ever Taken on a Battle Field, was Made Following a Charge by German Forces across Open Ground in the Face of French Machine Guns. Dead Litter the Field Farther Than the Eye can Reach. The Scene Shows the "Glory of War" as the Man at the Front Sees It.

## UNUSUAL THINGS BEARING ON EUROPE'S WAR

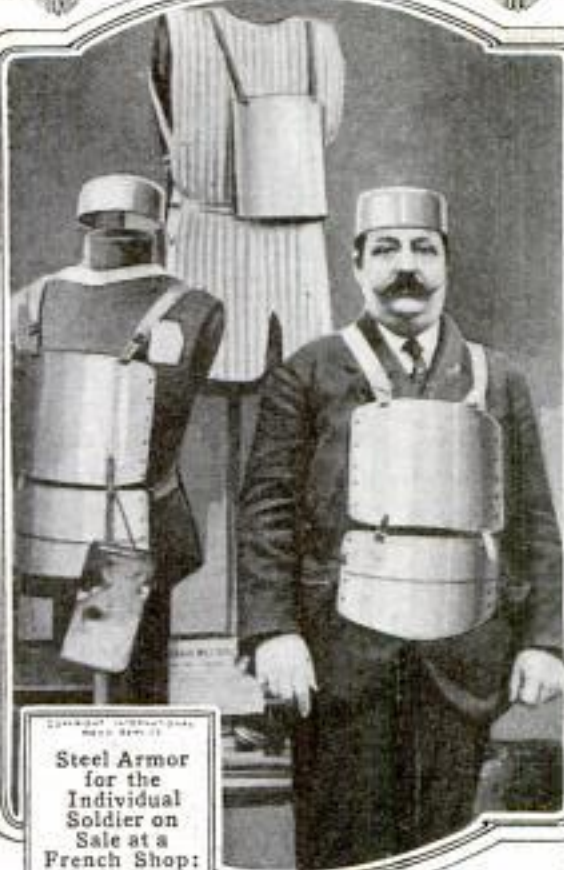

Steel Armor for the Individual Soldier on Sale at a French Shop: The Bullet-Proof Plates are Strapped to the Body



This Shows a Clip of Cartridges, Carried by a British Soldier in His Bandolier, Which was Pierced by a Bullet during an Engagement



An Army Maneuver Ground near Berlin being Plowed Preparatory to Planting Spring Vegetables for the Poor Classes Who are in Need

## CURIOSITIES OF THE WAR SEEN BY THE CAMERA

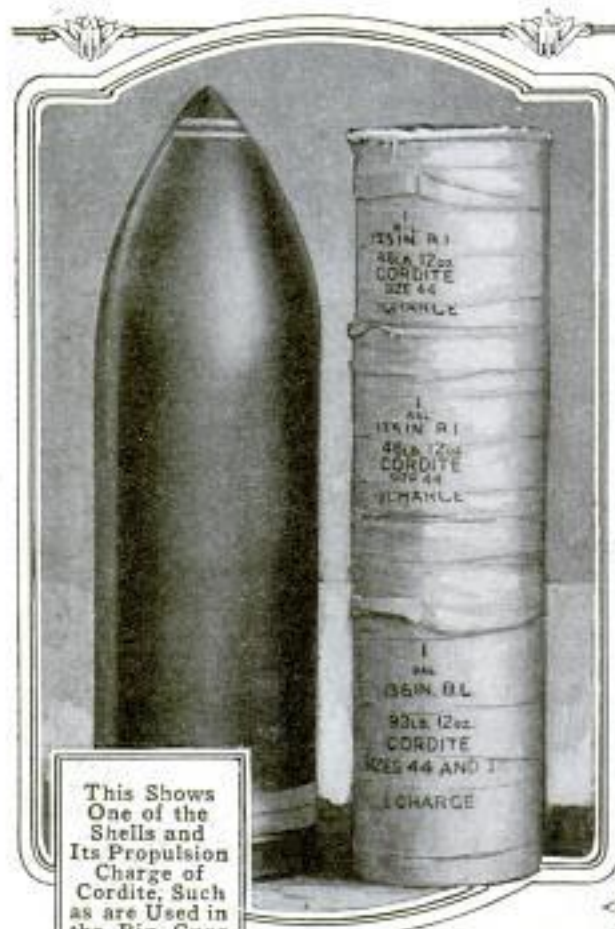

This Shows One of the Shells and Its Propulsion Charge of Cordite, Such as are Used in the Big Guns on British Dreadnaughts



Many Residents of Scarborough and of Other Towns on the East Coast of England have Constructed Private Bombproofs



Remarkable Photograph Showing the Dynamiting of a Bridge by Retreating German Forces in an Attempt to Cut Off Their Pursuers

## SCOUTS AND SNIPERS AT WORK AT THE FRONT



German Scouts in the Enemy's Territory Crossing Small Stream near the Aisne by Climbing along the Trunk of an Overhanging Tree



French Marksman behind Iron Breastwork Waiting Opportunity to Show His Skill



French Scouts in Advance of a Reconnoitering Party Discovered Some German Trenches. Followed by Their Regiment They are Charging the Position

### ROPE BRIDGE OVER RIVER IN ECUADOR MOUNTAINS

9165 Across one of the several rivers in the mountainous province of El Oro, in the western part of Ecuador, is a

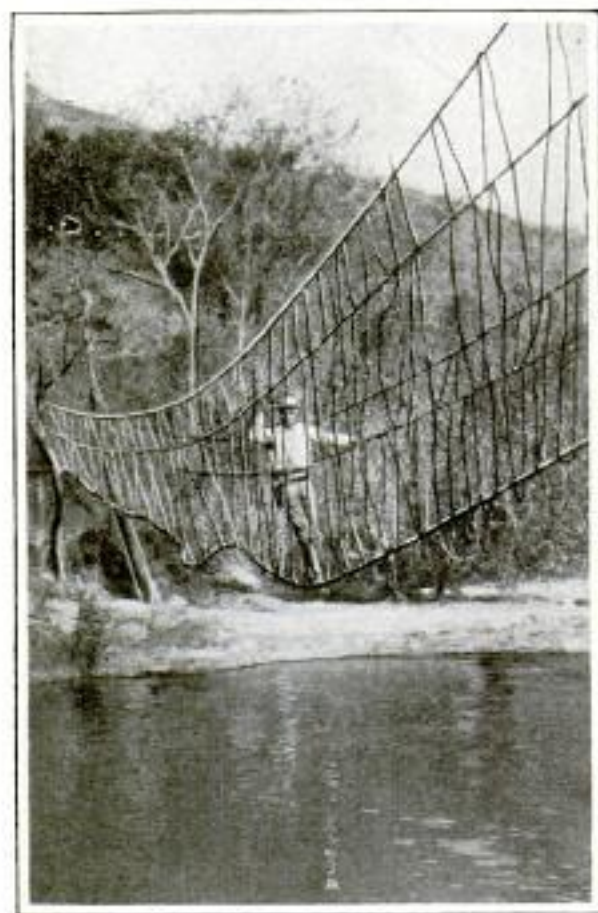

This Hammock Bridge Forms the Only Means of Crossing above the Stream at This Point

hammock bridge constructed entirely of rope. At the point where this swinging structure is stretched between the bluffs on either side of the stream, it forms the only means of crossing above the water. To use it, a person is forced to hold to the guy lines on either side and walk dexterously along a single rope which forms the bottom chord of the V-shaped network. For the uninitiated this requires no little exercise of care, but the mountain people who are accustomed to it climb along the line with great agility and ease.

¶The development of the "jitney bus" has stimulated the market for second-hand automobiles.

### NEW BRITISH HOWITZER IS CALLED "COVENTRY GUN"

9498 Howitzers that compare with the famous 42-centimeter guns of the Germans, which were the big surprise of the beginning of the present war, have been built for the British army and some of them have already been taken to the continental war zone.

The new weapon, known in England as the "Coventry gun" from the place of its manufacture, has a bore of 15 in. as against the 16.5 in. of the big German war tool. It is claimed, however, that it will fire a heavier projectile and has a mile greater range. Its chief advantage, however, lies in its portability. The "Busy Bertha," as the German gun has been nicknamed as a compliment to Frau Bertha Krupp, the owner of the famous gun works, requires an extensive concrete foundation, and except where such emplacements have been prepared in advance, it takes two or three days to get the monster ready to be fired. The Coventry gun, on the other hand, can be completely assembled in five hours and can be placed wherever the ground is firm enough to support a traction engine.

The standard shell for the Coventry gun weighs a trifle over 1,800 lb. Its head is solid, of armor-piercing type like a naval shell. Back of this is the chamber for the lyddite, or other high explosive, constituting the bursting charge, and the rear end of the shell is another solid mass, to give momentum. The whole is so designed that the shell has great penetrating power and will not explode instantly upon impact but an appreciable instant afterward, so that if the shell should penetrate the wall of a fortress the explosion would take place inside.

The expectation of the British authorities is that these new Coventry guns will be used against the German fortified towns in Alsace and Lorraine. Twelve of them have been built. Should they all go into action at once the combined weight of metal thrown in a single broadside would be more than ten tons.



WHERE SHIPS ARE HIGH AND DRY TWICE A DAY

IN the Bay of Fundy, Canada, the daily rise and fall of the tide is as great as 60 feet in some parts of the narrow inlet that penetrates 170 miles inland from the sea.—The harbor of St. John, N. B., at low tide, is shown in this photograph, the water rising every 12 hours to within a few feet of the wharf stringpiece. The hard sandy bottom is a good motor highway at low tide.

*Army*  
**USING MOTOR LAUNDRIES IN EUROPEAN WAR**

9494  
Motor-drawn laundries operated in connection with field hospitals are the latest feature in the European war, the equipment for each laundry being carried on a powerful motor truck and three trailers. The motor truck carries a steam mangle which is removed when the laundry is to be operated. The first trailer carries a complete steam plant with boiler, turbine, drying cabinet, and disinfecting tank, while the second carries the washing machine with centrifugal drying drums and other accessories. Tools and such supplies as soap, soda, coal, and gasoline are carried on the last trailer. When the laundry is in operation the trailers are arranged in the shape of a horseshoe and are usually covered by a tent, while the motor truck, with the steam mangle removed, is used for carrying laundry to and from the hospital. The capacity of the outfit is about 3,000 lb. of assorted laundry per day.

**MINIATURE FLYING MACHINE ORNAMENT FOR HAIR**

9181  
One of the odd styles that have been developed in Europe since the outbreak of the war is a new fashion in head dress which is worn in England with clothing of a military cut. The hair is built high on the head with puffs and surmounted by a miniature aeroplane, which is supported at the end of a slender wire that fastens in the coiffure. Frequently a small flag is also used as an ornament in addition to the flying machine.



*Scientific American*  
Mar. 6, 1915

*International News Service*  
238 William St. N. Y. C.  
Copyrighted material

*Mr. Belt Cutter Co., Georgia, Ills.*  
*Inventor: J. Ellis Dodd, Sales Mgr.*  
*R. Herschel Mfg. Co. Georgia, Ills.*

**BELT-CUTTING INSTRUMENT  
TIME-SAVING DEVICE**

Designed for the purpose of cutting various kinds of belting and squaring the ends without requiring the use of



a try-square, an instrument has been devised which may be used on any size belt not greater than 14 in. in width nor more than 1 in. thick. The device consists of a heavy

drawknife, the top part of which is fitted with a handle while the bottom part extends through a groove into an inclosed case where it is mounted on roller bearings. The case is made of steel in the form of a grooved bar, at one end of which, on either side of the groove, are two upright pieces

which protrude above the surface sufficiently far to hold a belt squarely when it is being cut. The groove serves as a guide for the knife and the top of the bar as a cutting table.

*Radio*

**WIRELESS BETWEEN UNITED STATES AND NORWAY**

9454

*Daily News*

Through the operation of wireless stations now being erected in Massachusetts and on the coast of Norway, commercial wireless communication between the United States and Norway is soon to be established. The two American stations, one located on Cape Cod and the other at Marion, on the west shore of Buzzard's Bay, are now practically completed. The total cost of these two stations is estimated at about \$1,500,000. It is now reported that the stations are to be put in operation as soon as completed to meet the situation arising from the war.

*#1. S. Hall, 322 Cole St., E. Georgia, Ills.*

**MODERN STATION PLANNED TO ELIMINATE CONFUSION**

8896

Facilities for handling complicated passenger traffic on a large scale, without confusion between the different routes or between incoming and outgoing traffic, probably constitute the biggest feature about the new union passenger station at Kansas City, although the station itself is one of the largest and most costly in the world. An average of 260 trains daily, carrying a total of from 25,000 to 28,000 passengers, use this station, and every day there are about 530 tons of mail and 7,000 pieces of baggage handled. The value of the tickets sold annually is something like \$5,000,000.

The most impressive feature about the station is the grand lobby, a spacious room entirely free from columns, 230 ft. long, 100 ft. wide, and 90 ft. high. The ticket office, built of solid bronze and having 24 windows, occupies the space between the two main entrances and projects 48 ft. into this room. Around the walls are grouped dining and lunch rooms, and all other

facilities needed by the traveler. The grand lobby is the only place in the station where incoming and outgoing passengers meet. Outgoing passengers go from this room into the main waiting room, which is a structure 165 ft. wide and 410 ft. long, built out over the 16 tracks that parallel the station. From this room individual stairways lead down to each of the track platforms. Incoming passengers are lifted by elevators to one of the two "midways," which are simply corridors leading to the grand lobby. The midways are located one on each side of the waiting room, are parallel with it and at approximately the same level. The baggage room is the largest in the United States, containing over 74,000 sq. ft. of floor space. All baggage, mail, and express is transferred to and from trains through tunnels passing under the tracks. The station cost about \$5,000,000, while the terminal of which it is a part cost upward of \$50,000,000.

*Kansas City News Service, 205 Corn Belt Bldg. K. City, Mo.*  
*J. H. Morgan, 1002 Main St., Kansas City, Mo.*



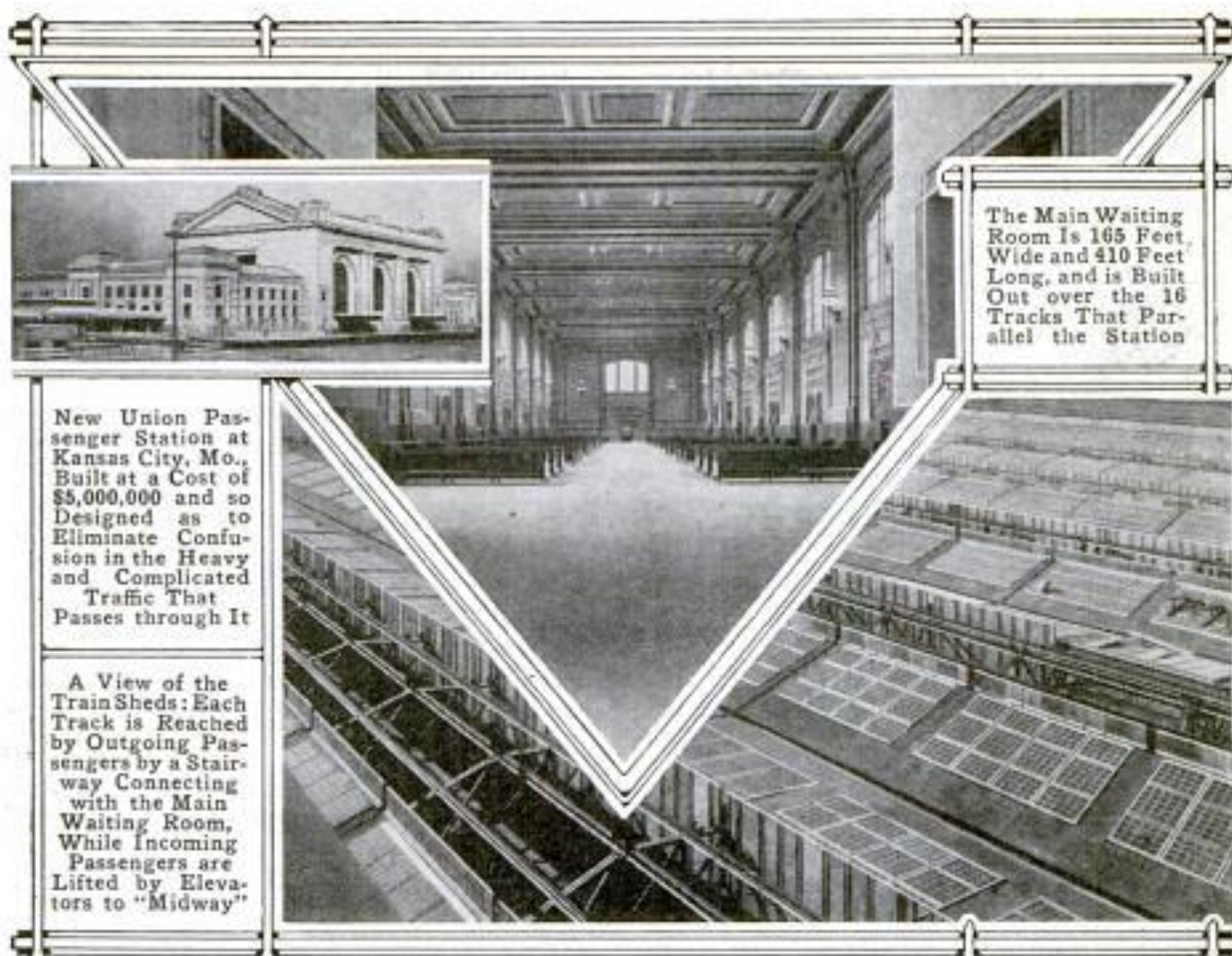

New Union Passenger Station at Kansas City, Mo., Built at a Cost of \$5,000,000 and so Designed as to Eliminate Confusion in the Heavy and Complicated Traffic That Passes through It

A View of the Train Sheds: Each Track is Reached by Outgoing Passengers by a Stairway Connecting with the Main Waiting Room, While Incoming Passengers are Lifted by Elevators to "Midway"

The Main Waiting Room Is 165 Feet Wide and 410 Feet Long, and is Built Out over the 16 Tracks That Parallel the Station



Looking East in the Grand Lobby: At the Right Is the Ticket Office, Built of Solid Bronze, and at the Left Is the Arched Entrance to the Main Waiting Room

MacGrath Faulder  
341 W. Onondaga St.,  
Syracuse, N. Y.  
704

**FREIGHT CARS ARE BUCKLED**  
IN HEAD-ON COLLISION

While running at considerable speed on one of the eastern railways recent-

tating casing and a cylinder that rotates within it, both the casing and the cylinder being made to rotate in the same direction and at the same speed but on offset centers. Owing to the eccen-

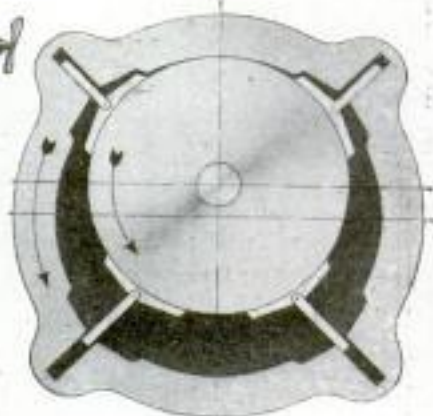
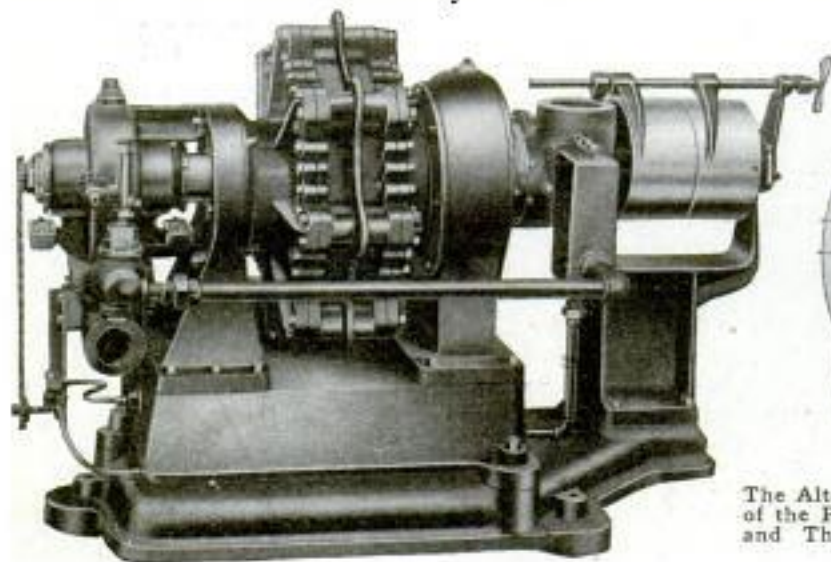

The Alternate Expansion and Contraction of the Pockets Causes Air to be Drawn In and Then Compressed in Each Pocket

ly, a long freight crashed head-on into a heavy work train. The impact of the collision was so great that two of the box cars were buckled by the solid resistance ahead and the momentum behind them. Such behavior is not



Two Cars in the Middle of a Long Freight Train Buckled When a Head-On Collision Occurred

unusual for two engines when coming together, but for cars in the middle of a train is not so common.

**ROTARY AIR COMPRESSOR**  
OF A NEW TYPE

A simple and ingenious rotary air compressor that has just been developed, compresses the air by utilizing the alternate expansion and contraction of pockets formed between a ro-

tric mounting, the casing and cylinder are close together at the top, while the space between them spreads down each side and has its greatest width at the bottom. This space is divided into four pockets by vanes that are hinged to the cylinder and project into slots in the wall of the casing. The shaft of the cylinder is hollow and is mounted within the stationary bearing of the casing. By means of pipes projecting into each pocket air is drawn in through one end of the hollow shaft and discharged through the other end. As a given pocket rotates away from the top it widens at a regular rate, sucking in air until it reaches the bottom. During this process only the inlet pipe is open. When the pocket starts up the other side the inlet pipe closes automatically, and the air is compressed as the space contracts. When the pocket reaches the top, the outlet pipe opens, and the compressed air is discharged into a container through the hollow shaft. Leakage from one pocket to another is prevented in a simple manner. In the case of adjacent pockets that are compressing, the pressure is greatest in the one that is in the lead, and the excess pressure thrusts the vane against the side of the slot, forming an air-tight seal.

Wernicke-Hatcher Pump Co.,  
Grand Rapids, Mich.

## NEW SERVICE TO BROADEN 9318 PATROL OF COASTS

With the creation of the United States Coast Guard a system of coast patrol is to be put into effect which will practically constitute a beginning in the plan of girdling our coasts with a series of wireless stations operated in conjunction with a submarine patrol, as suggested in the January, 1915, number of this magazine. The life-saving service, which has been absorbed by the coast guard, maintains a beach patrol that keeps a lookout for ships in distress and has a system of telephone lines connecting with the life-saving stations. Under the new arrangement this system will be perfected and the life-saving stations will be connected, either by wireless or by telephone, with naval stations along and near the coast. This system is designed to be used in connection with life-saving and revenue-cutter services, but its value in time of war is evident, as the coast patrol would then have a means of giving to the Navy Department immediate notice of the approach of hostile vessels.

## MAN BURIED IN QUICKSAND 9581 KEPT ALIVE UNTIL SAVED

In the course of digging a well shaft on his property near Ware, Mass., a farmer encountered quicksand at a depth of approximately 25 ft. beneath the surface of the ground, and sank in it until his head alone was visible when

*Boston Herald, Boston Globe,  
and Chicago Tribune*

his predicament was finally discovered. Every possible agency was called upon to assist in the rescue work, the fire department included, but despite this he was buried for more than 24 hours before he could be taken from his pre-

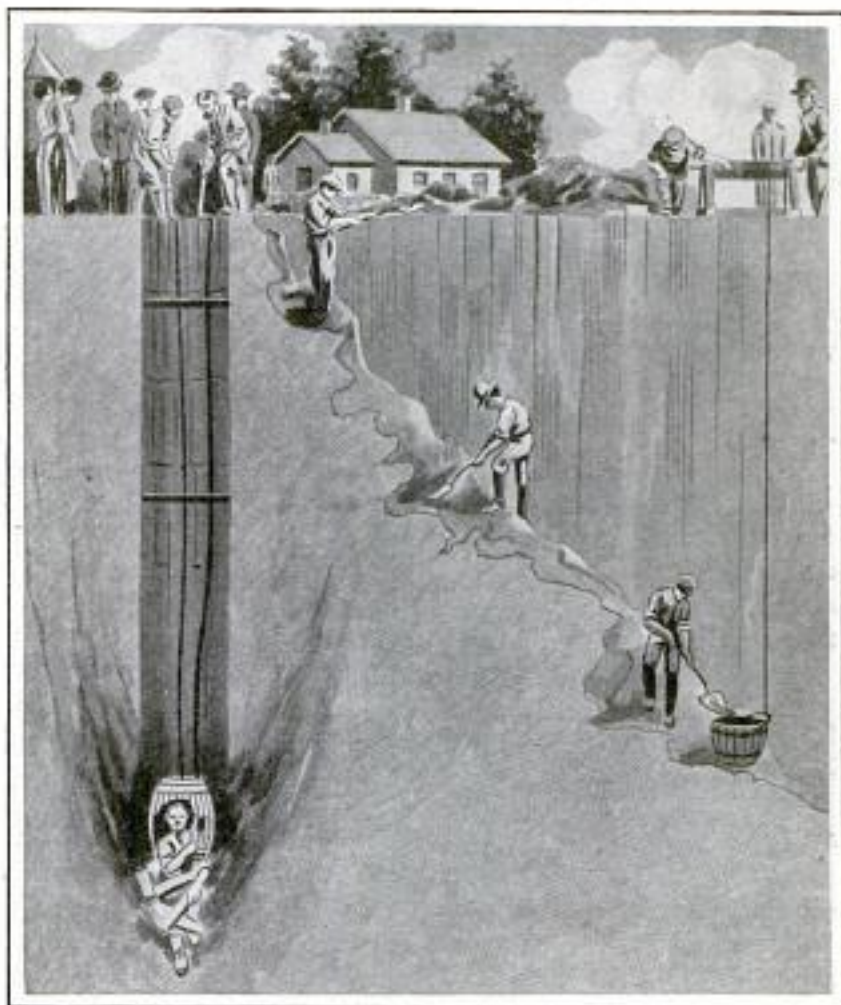

With a Barrel over His Head and Getting Both Air and Nourishment through Tubes, a Man Lived, Buried in Quicksand, Until Rescuers Reached Him after More Than 24 Hours

carious position. The reason for this was that in digging the shaft he had stood on a platform made of planking and when the quicksand sank beneath his weight his feet were caught by the boards, making it necessary to uncover his entire body before he could be saved. This work, at first sight an easy task, was rendered difficult by the continual caving in of the shaft when the rescuers, clinging to a ladder, attempted to dig the man out. This plan had to be abandoned entirely, and to keep the victim alive it was necessary to make an improvised helmet out of

E. Hallen, Balboa Heights  
C. Z.

a barrel and lower it over his head. Reaching from this were two rubber tubes, one of which was used to supply him with air and the other to provide him with nourishment. From a point about 50 ft. away from the well a ditch 30 ft. deep, which was timbered as the work went on, was dug to the shaft and the man finally reached.

**BIRTHDAY-CAKE CANDLES**

**8822 HELD ON BOARD**

Birthday-cake boards arranged to accommodate any number of candles up to 96, are being made of hard wood



Board for Birthday Cake Holds Large Number of Candles

finished in its natural color. These boards are circular in shape, and around the outer margin is provided a series of holes in which the candles are held, while the cake itself is placed in the middle of the tray. When the board is used the practice of placing candles on the cake is not followed.

**SAILING CRAFT ARE USING**

**9418 PANAMA CANAL**

Contrary to the general belief of navigators prior to the opening of the Panama Canal, sailing ships are using the new passage as well as steamers. The expense of tolls and towing, it was assumed, would make it less desirable for such craft, usually carrying cheap bulk freight, to cross the isthmus than to make the longer voyage around the Horn. Experience thus far, however, indicates the contrary.

The largest sailing vessel that has so far used the canal is the four-masted steel barkentine "John Ena," a photograph of which, taken while it was passing through the Culebra Cut at the narrowest point of the canal, is shown on the opposite page. The "John Ena" is 313 ft. long, 48 ft. beam, and 25 ft. deep, and measures 2,609 net tons by canal measurements. The cost of passing through the canal was \$3,130.80 for toll and \$302.15 for tug service. On the vessel's cargo of 4,400 tons of petroleum and wax this makes a charge of 78 cents a ton. The tolls on laden steam vessels have averaged around 75 cents a ton of cargo. These do not require tugs through the canal.

According to the estimates of the canal authorities a sailing vessel should reach the isthmus from New York in about 20 days, or from the English Channel in about 30 days. Besides the "John Ena," four other sailing craft had used the canal up to the middle of February. The largest vessel of any kind to pass through the canal in that time was the passenger steamship "Kroonland" of the Red Star Line, flying the American flag, which went through on February 2. The "Kroonland" is 560 ft. long, 60 ft. beam, and drew over 29 ft. of water when traversing the canal. The canal-toll charge for the passage was \$9,879.60.

CA Pan-American gold coin of the value of \$5, for use as standard currency in all the countries of North and South America, is proposed by a New York bank.

Info: N. W. Bosworth,  
Watertown, N. Y.  
Mrs. Avis Gordon Vestal  
4243 N. Hoarner Ave., Chicago, Ill.

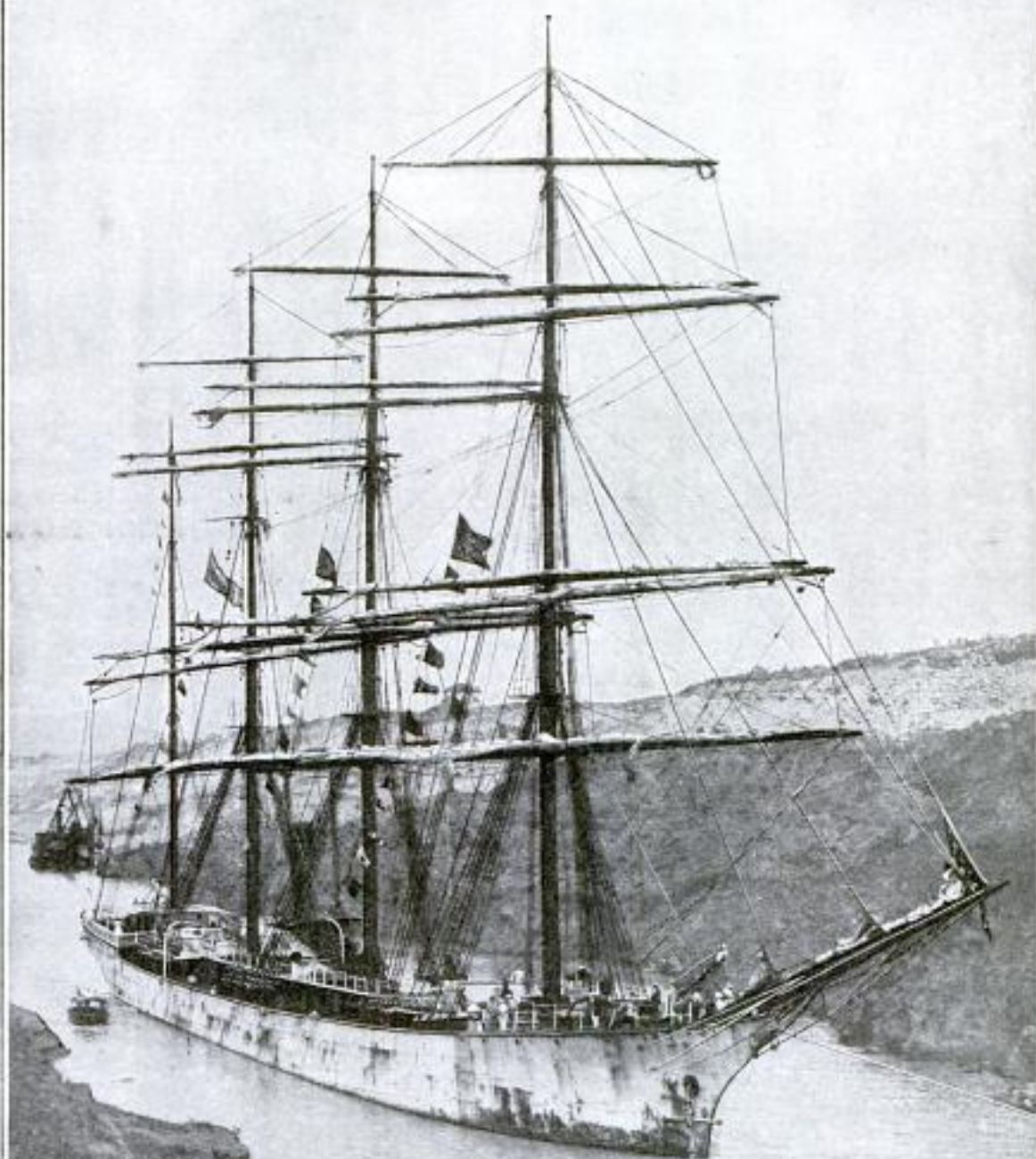

The Four-Masted Steel Barkentine "John Ena" Passing through the Culebra Cut in the Panama Canal. The Photograph was Made as the Vessel Was Opposite the Famous Cucaracha Slide, the Narrowest Point in the Canal

# Lester L. Sargent, 953 2 St., Wash. D. C.

Inventor: Edie Ray Ramsey,  
108 Penn Yan, N.Y.

POPULAR MECHANICS

CAPTIVE-BASEBALL GAME  
9368 PLAYED INDOORS

Captive baseball is a newly devised indoor sport. It is played with an ap-

paratus which is partly electrical, but in principle very like some of the devices used in amusement parks. The chief difference in this game is that the pitching machine is absent. The ball is suspended at the end of a cord hung in front of the batter, who stands before a backstop on which a diamond and the various positions taken by the different players are marked plainly. Placement of the ball is the point of the game. A pull on the line holding the ball starts it swinging, the batter then knocking it against the backstop, or registering board, and his score being shown by the ignition of one of a number of incandescent lamps.

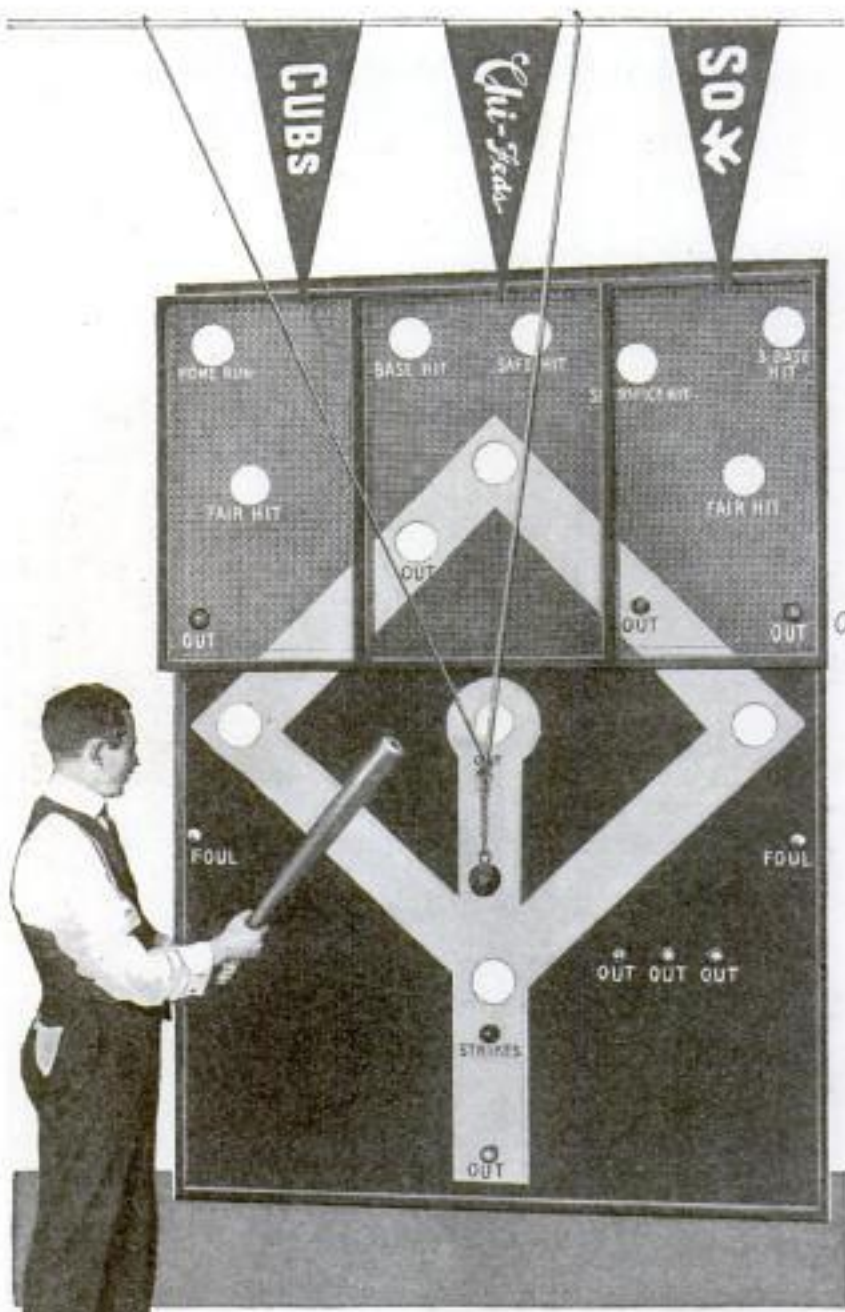

Captive Baseball is a Game Which Gives a Batter an Opportunity to Display His Skill Indoors, for, as in the Regular Sport, It is the Placing of the Ball Which Counts, Rather Than Merely the Amount of Force with Which It is Struck

paratus which is partly electrical, but in principle very like some of the devices used in amusement parks. The chief difference in this game is that the

SILENT AREA OF FOGHORN NOW EXPLAINED

Fog signals, under some conditions, may be audible for a distance of a mile or more from the signal station and again at a distance of three or more miles, while between these areas lies a space within which the signal cannot be heard. Many wrecks that have occurred while near-by fog signals were in full blast are attributed to the fact that the wrecked vessel was in this belt of silence, steaming toward the rocks, and its officers could not hear the foghorn until too late to alter the ship's course or check its momentum. Observations conducted by British authorities, in which the temperatures of fog banks at different heights above sea level were recorded by instruments sent up on kites, indicate that the existence of the silent

*Editor written by Edwin O. Catford, Engineer in Charge of Signal Station, Greenway*

the temperatures of fog banks at different heights above sea level were recorded by instruments sent up on kites, indicate that the existence of the silent

*The Engineer 2-5-15*

Geo. A. Walton, 3 Tenney's Court  
Newbury, Mass.

area is due to temperature variations. The atmospheric temperature was found to rise with the altitude in every fog examined. In some instances, however, a layer of air in which the temperature rose more slowly overlay the fog bank. Such an air layer would refract the rising sound waves more slowly, and these refracted waves would return toward sea level at a much wider angle than those refracted through the lower mass of fog. In such a case, the foghorn would be audible close by and at a distance, but not in the intermediate region.

**WATCHES DESIGNED FOR USE  
ON AERIAL VOYAGES**

Before the outbreak of the European war, when Lieut. John Cyril Porte, of the British navy, was pre-



Aeronautic Watches Carried in Cases Which Strap about the Body of a Pilot

paring for his contemplated transatlantic air voyage in the flying boat "America," which was recently shipped to England for service on the continent, two watches intended to be used in making longitude calculations were constructed especially for him. The instruments are designed to furnish both astronomical and sidereal time, and are carried in a pair of leather cases which may be strapped about the body below the chest. The pockets of these are so made that, should water penetrate into them, it would be discharged immediately through small ducts in the bottom, so that the watches would not be injured or stopped.

Casein, the substance in milk which forms the basis of cheese, is now being used also as the base for so-called "cold cream" for toilet purposes.

**ASH TRAY WITH CONTINUOUS  
MATCH-STRIKING SURFACE**

9156

A new device for the convenience of smokers is designed to do away with the annoyance of trying to get a safety match to light when the striking surface on the box has become moist or worn out. This device consists of a tapelike roll several yards in length, provided with a striking surface, and placed in a circular container so that it can be drawn out as required. It is being applied to match holders, ash trays, and smokers' sets generally. When the exposed surface has been worn out all that is necessary is to pull the roll out to expose a fresh surface



How the Continuous Roll for Striking Safety Matches is Inserted in a Match Holder

and tear off the used part. The end of the roll is held in place by a metal clip. The roll is easily replaced when worn out.

*Wm. A. Deane Co.,  
405 Lexington Ave.,  
N.Y. City*

Paul Thompson  
10 Spruce St.  
N. Y. C.

710

*Army and Navy Journal*  
LARGEST MODERN GUN OWNED

HOW AN ARMY "FIRES ON  
8786 THE CLOCK"

BY ITALIAN GOVERNMENT

An ingenious method, known as "firing on the clock," is much used in the European war for enabling a military officer to concentrate the fire of his command on any particular point. This method consists simply in designating the object to be fired at by its position with reference to an imaginary clockface covering the landscape. The point that forms the center of this imaginary clock must first be understood all around, and a line passing upward and back from this point is, of course, the 12-o'clock line. Then when a command comes down the line to direct the fire at "white house, 10 o'clock," for example, or at "road, 9 o'clock," the rifleman or artilleryman knows definitely which particular white house or road is meant, and is able to direct his fire with the assurance that he is obeying orders.

In view of the accounts of destruction wrought by the remarkable 16.5-in. siege guns of the German artillery, it is interesting to note that the largest modern naval gun has a bore of 17 in. and is owned by Italy. The instrument weighs 104 tons and hurls a projectile of 2,000 lb. Great Britain has a gun which, although slightly less in caliber, exceeds this piece in both muzzle velocity and power of penetration. When a missile leaves this gun it is traveling at a rate greater than 1,380 miles an hour, which enables it to pierce 3 ft. of wrought iron with ease.

SCORE BOARD FOR THE

8766 PANAMA CANAL

A wall board, 12 ft. long and 3 ft. high, on which is painted a map of the Panama Canal and its approaches, has been mounted in the port captain's office at each end of the canal, and push pins, each representing a ship, will be used in connection with this map for showing at a glance the status of traffic at any time. As soon as a vessel enters either end of the canal a report is telephoned to each port captain's office. A pin representing the vessel is then placed on the map, and as the vessel passes the different locks and Culebra Cut the pin is moved to the corresponding positions. The maximum speed at which vessels are allowed to pass through the canal varies from 6.9 miles an hour, in Culebra Cut and Miraflores Lake, to 17 $\frac{1}{4}$  miles an hour over a part of Gatun Lake.

*The Canal Record*

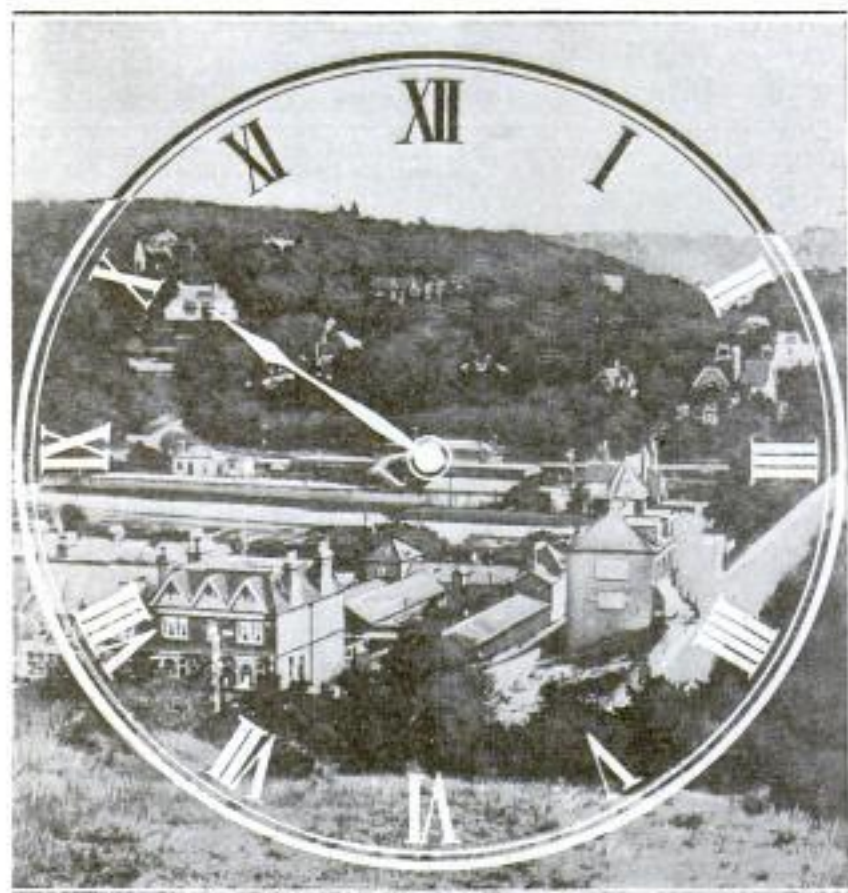

An Imaginary Clock Covering the Landscape Enables a Military Officer to Concentrate the Fire of His Command Quickly and Accurately on Any Desired Point



*Alvin K. Matthews, Stockton Record, Stockton, Cal.*



This Large Tree was Uprooted during a Storm and Hurled against the House, Partly Wrecking It

### TREE HURLED UPON HOUSE 9363 IN VIOLENT STORM

During the course of a heavy storm at Stockton, Cal., a large eucalyptus tree was uprooted and thrown violently against one side of a two-story frame residence. The weight of the tree and its impact crushed in the roof of the house and wrecked one of the bed chambers so completely that had the accident occurred at night when the room was in use, its occupants undoubtedly would have been killed. The tree was more than a half century old, approximately 10 ft. in circumference, and a landmark of the town.

### MACHINE FOR KILLING 9042 CHICKENS

A machine recently invented enables the operator to kill chickens, or other poultry, while they are concealed from view. In using this machine the fowl is placed, head down, in the casing which contains the mechanism, and the side door is closed. The legs of the

fowl are held in a clamping device while the head is gripped by a ringlike device and a V-shaped collar. The mechanism is worked by a lever projecting from the casing. This lever operates a lance within the casing which penetrates the brain of the fowl, causing instant death, and also releases a pendulum device which strikes off the head.

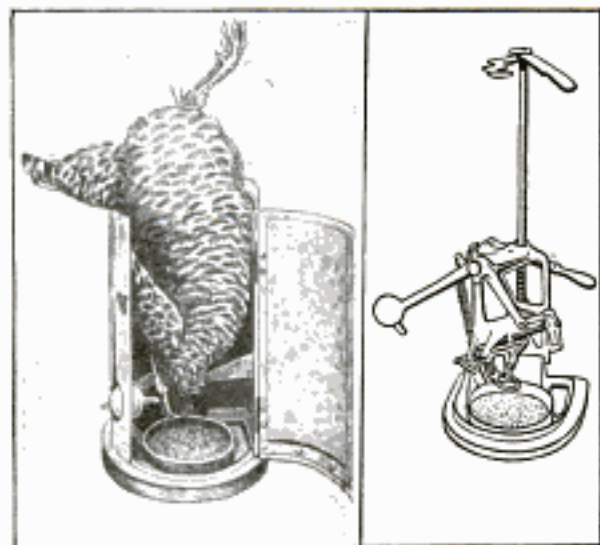

With This Machine the Chicken is Killed While Concealed from View

*Inventor: Vernon Cassard, Stamford, Conn.*

*# Lester L. Sargent, 933 I St., Wash., D. C.*

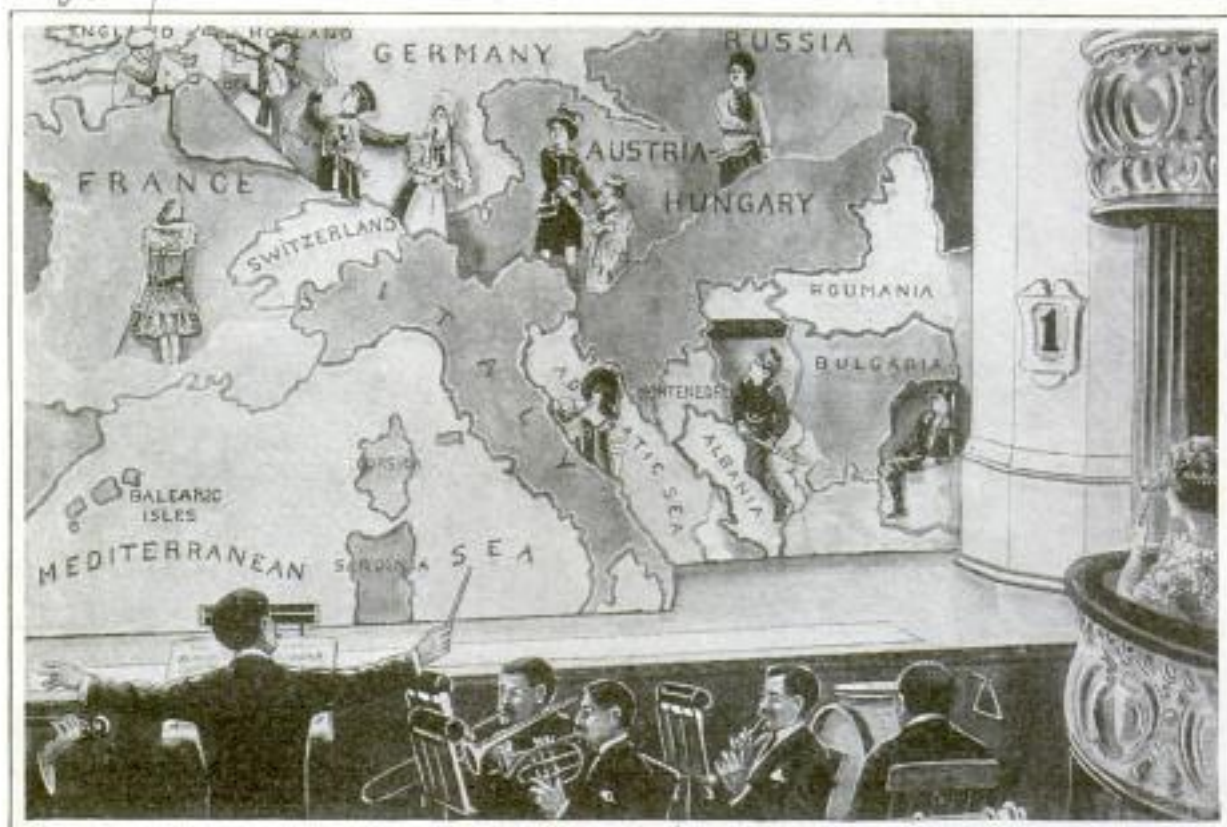

LONDON THEATER TAKES LIGHTER VIEW OF WAR

IN this novel war show, staged in a London theater, singers dressed in the costumes of the countries represented appear at openings in the map, which forms the background of the stage, and sing songs typical of the different countries.

**MACHINE MAKES NOODLES IN MANY SHAPES**

Fifty-two different shapes of noodles may be made on one machine which has recently been imported to this country. The dough is fed through a se-

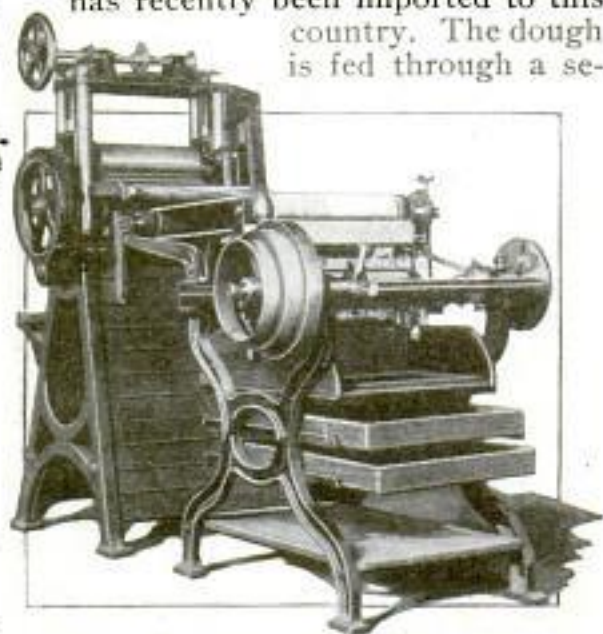

Noodle Machine Having Fifty-Two Different Sets of Dies

W. D. Goodwin, 527 W. 124th St. N. Y. C.

ries of rollers, the pressure of which is regulated according to the thickness it is desired to make the pastry. A broad sheet of the dough is pressed out and run beneath dies which cut out whatever shape is desired, after which operation the noodles are dropped into trays which are placed in racks beneath the knives.

**LINCOLN HIGHWAY BUILDING GOES ON RAPIDLY**

Considerable progress was made during the last year in carrying ahead the work of building the Lincoln Highway, which when completed will reach from New York to San Francisco. The association which is furthering the project marked 2,500 of the 3,400 miles of road, and it is announced that the route is now in such a condition that it would be possible to make a transcontinental trip over it by motor car in less than a month's time. Forty thou-

Engineering News 11-29-14

See that a brand 7807 see letter W. D. N. for further information

The Toledo Indicating Level Co.,  
1341 Nicholas Bldg.,  
Toledo, Ohio. 713

POPULAR MECHANICS

sand dollars' worth of cement was furnished by the promoting organization to different communities for use in road work, approximately three-fourths of the section passing through Ohio was paved, \$350,000 in bonds for improvements, not previously anticipated, was issued by various communities in Indiana, while in Illinois, Nebraska, Colorado, and Wyoming much improvement work was accomplished.

NEW LEVEL TELLS GRADES  
9518 IN TERMS OF INCHES

For the use of carpenters and various mechanics, a new level has been invented which indicates, in terms of

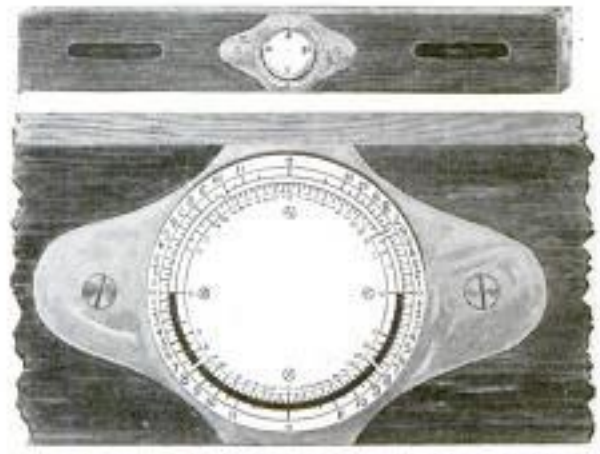

The Number of Inches to the Foot That a Surface Is Out of Plumb or Level is Indicated by This Instrument

ADJUSTABLE HEADPIECE ON  
8958 COUCH HAMMOCK

Intended to be used in a sun parlor or on an open porch, a couch hammock is being made with a headrest which may be adjusted to three different reclining positions. The frame is made of steel and at the head end is provided with a brace, held by a bar and ratchet, which supports the mattress when it is held in a raised position. When it is desired to lift the mattress so that it is in a comfortable position for an afternoon siesta, or braced upright to suit a sitting position, it is only necessary to lift it and allow the bar to engage the proper notch. The hammock is supplied with comfortable springs, while its back and ends are made of a heavy duck. It may be suspended from hooks screwed into the ceiling, or from a collapsible stand which is provided for it.

inches or fractions thereof, to the foot, the deviation of a surface from either the horizontal or perpendicular. The instrument is provided with a pan half filled with red spirits and fitted with a

Comfortable Swinging Couch Which may be Adjusted for Different Lounging Positions



New York Couch Bed Co.,  
418 W. 25th St.,  
N. Y. City.

glass face, over which a dial carrying delicate graduations is fixed. This dial is composed of two scales, one within the other, the outer of which refers to horizontal calculations and the inner to the perpendicular. The graduations and their accompanying figures are etched in glass and traced with blue enamel, which, on account of the contrast with the red liquid, allows the dial to be easily read. The spirits can only be seen in a circular rim extending between the two scales. Since the liquid is necessarily always level it enables a carpenter to determine the pitch of a rafter, a porch-floor beam, or any other structural member, while it is also equally serviceable to a mechanic or mason.

#### WHEAT SHIPPED TO DUBLIN 8655 IN AMERICAN BARK

For the second time in a period of 12 years an American ship has departed from Puget Sound with a cargo of grain billed for an English port. Almost equally as interesting is the fact that this particular craft is a sailing vessel. A few weeks ago a trim, four-masted, square-rigged ship, the "Edward Sew-

all," slipped out into the Pacific laden with 183,475 bu. of wheat bound for Dublin, and commenced the long voyage to Ireland by way of the Straits of Magellan. While it was only a few years ago that practically all of the Pacific-coast grain shipments were consigned in sailing craft, today nearly all of the work is done by tramp steamers of foreign registry. European conditions, however, render it safer to ship in American bottoms than in others at the present.

#### CONCRETE SWIMMING POOL ON A COUNTRY ESTATE

A modern substitute for the "old swimming hole" is the concrete swimming pool, which is now considered a necessary feature of a well-equipped country estate. The pool is usually located in a wooded part of the estate, as is the one shown in the illustration, and is made attractive in every way. This pool is 14 ft. wide and 30 ft. long, and will easily accommodate 15 bathers at one time. At one end are steps leading down into the shallow end of the pool, the bottom of the pool sloping from a depth of 3 ft. at one end to 8 ft.

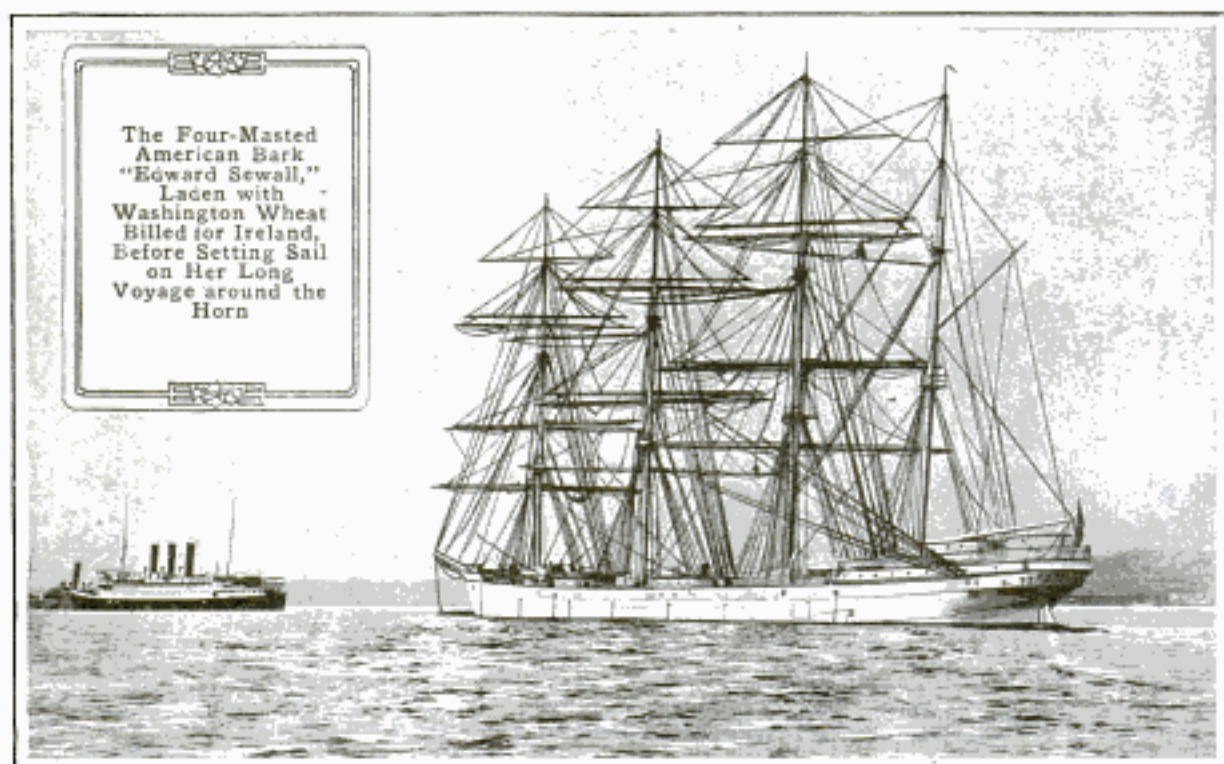

The Four-Masted  
American Bark  
"Edward Sewall,"  
Laden with  
Washington Wheat  
Billed for Ireland,  
Before Setting Sail  
on Her Long  
Voyage around the  
Horn

*The Merchants Exchange  
Seattle Wash.*

Warren D. Schreurs, Highland Park, Ill.

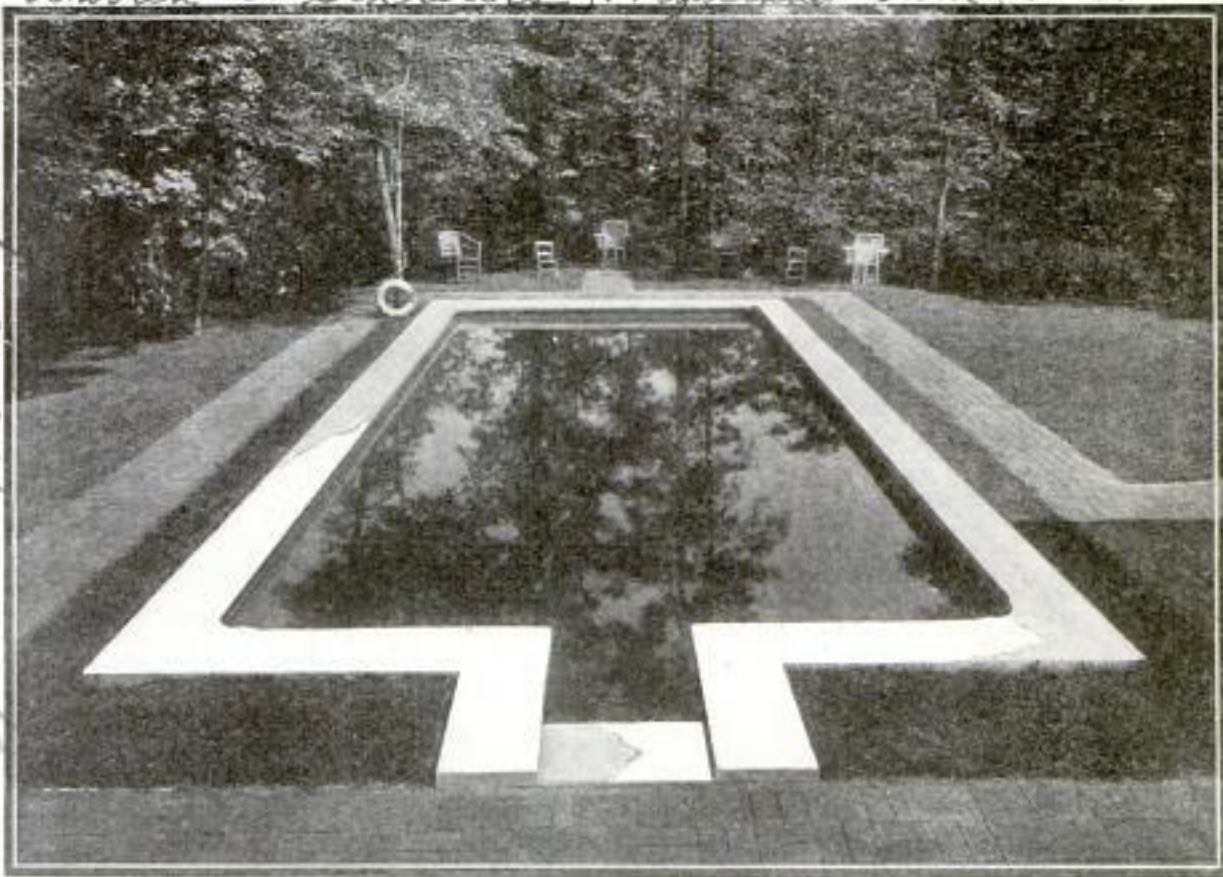

On Well-Equipped Country Estates a Modern Concrete Swimming Pool Takes the Place of the "Old Swimming Hole"

at the other. The concrete walls rest on footings that are 9 ft. across, taper to 14 in. at the top and are capped with copings, while the floor ranges in thickness from 1 ft. at the deep end to 6 in. at the steps. A life preserver is always at hand, while seats are provided for the spectators when a swimming party is given.

to cut through. The new guide is designed with a metal holder for the sharpening stone, and an adjustable angular mounting for the blade, or bit,

**TOOL-SHARPENING DEVICE**

**9235 FOR WOODWORKERS**

For the use of carpenters, and other woodworkers, an instrument has been devised which makes it possible when sharpening a tool, such as a chisel or plane blade, to hold its cutting edge firmly against the surface of a sharpening stone at any angle desired while moving it with a rotary motion. To do this by hand without the aid of a guide is a difficult operation which frequently results in the rounding of an edge, giving the bit later a tendency to "ride" on the surface it is supposed

Guide for Sharpening Chisels and Plane Blades



enabling an angle to be maintained throughout the whole sharpening process.

Info: Luther Grinder Mfg. Co.,  
285 S. Water St. POINT ST.  
Milwaukee, Wis.

See June 1916 - 827

Underwood & Underwood, 417 Fifth Ave., N.Y. City.  
Article and three pictures by Chas. W. Person, 206 W. 105th St.,  
N.Y. Ci

CONCEALED BATTERIES OF ELECTRIC PROJECTORS

9166



Above is shown a cluster of projectors hidden in the ornamentations on a side of one of the Tourelles. While at the right is the Woolworth Building as it now appears at night when its tower is illuminated.



PHOTO COPYRIGHT UNDERWOOD & UNDERWOOD

## ILLUMINATE TOWER OF WOOLWORTH BUILDING

Along the Edge  
Roof Is a  
Electric

of This Penthouse  
Battery of  
Lights

9166

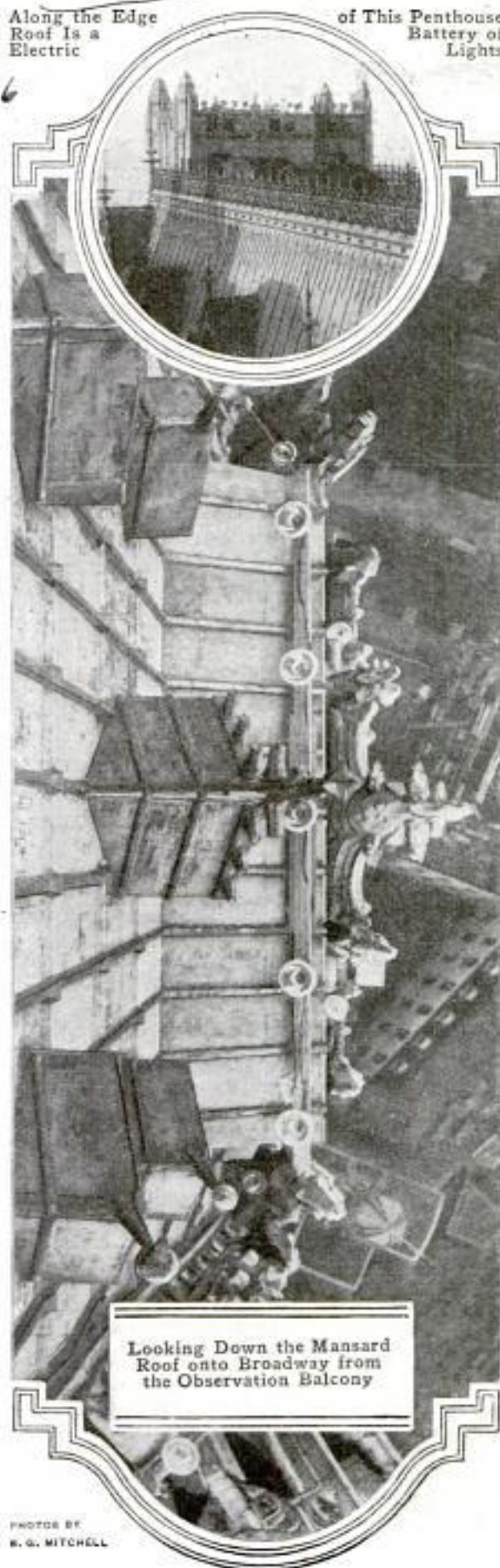

Looking Down the Mansard  
Roof onto Broadway from  
the Observation Balcony

PHOTOS BY  
W. G. MITCHELL

BY a remarkable arrangement of reflectors, screens, and powerful batteries of lights, the tower of the Woolworth building, the highest inclosed structure in the world, now pierces New York City's skyline at night as a great white shaft reaching nearly 800 ft. above Broadway.

In order to make the building stand out in the darkness with the same majesty as it does during the daytime, the tower has been fitted with an elaborate system of hidden lights which illuminate almost every inch of its masonry. The work which has been accomplished represents an unusual example of illuminating-engineering skill, for in bathing every nook and crevice with light, the sources of this light have been hidden from view.

Approximately 600 projectors, each supplied with a 250-watt incandescent lamp, have been placed in various positions on the shaft so as to play their light over its surface. To illuminate the west side of the structure a battery of projectors has been arranged on the north and south sides of the penthouses at the thirtieth story and directed upward at different angles so as to throw the glare as far as the forty-third floor. To light the north and south sides of the tower a similar scheme has been carried out on the gabled roofs at the same floor, while to cover the east side the projectors are placed on a narrow balcony opposite the twenty-seventh story.

At the forty-third floor a set of lamps is placed so that the light is directed downward to cover the spots not illuminated by the lower batteries, while a complicated system of screening is employed to shield them so that they cannot be seen from the street. From the same floor and also from the forty-ninth, other lamps are focused upward to reach the fifty-third story, at which point the mansard roof begins. On the four tourelles opposite this floor there is a series of projectors that play the light upon the observation balcony at the fifty-eighth floor and cover the intervening space.

9118 **PORTABLE SILOS ARE USED BY MISSOURI FARMERS**

Portable silos are being used by a number of farmers in an agricultural

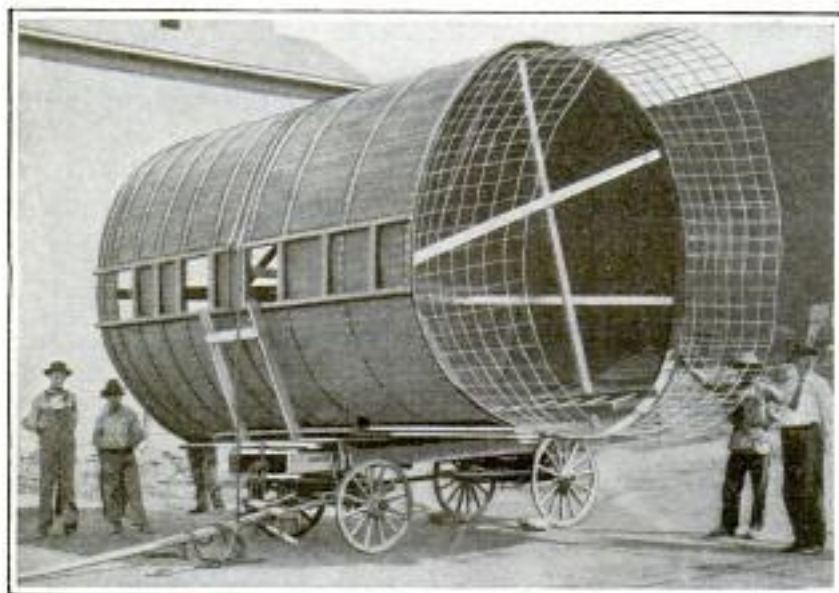

One of the Portable Silos Loaded on a Wagon Ready to be Hauled into a Field

community in Missouri where experience is said to have taught their value. They are so constructed that they may be placed on a wagon and

moved to any part of a farm without difficulty or a material consumption of time. By thus being able to carry the silo into a field, the cost of hauling fodder to it is reduced as well as a considerable amount of time saved. The structure is built with fir flooring held together with wooden hoops, while the inside is reinforced to prevent its collapsing when being transported on a wagon. There is also a certain economical value in the fact that the silo may be moved from one point to another year after year, resulting in a better distribution of fertilizing material than would be true if stock were fed in one place continually. It has

been found that the cost of constructing a silo of this kind amounts to approximately one dollar for each ton of capacity.

9373 **WEIGHTED BOWLING BALLS DETECTED BY SCALE**

Rules of the American Bowling Congress prescribe that the balls used in a game of tenpins shall not be loaded, exceed 16 lb. in weight, nor be manufactured in such a way that one side is purposely made heavier than

another, a variance of three ounces not caused by tampering, however, being allowed. In order to determine certainly whether this specification is adhered to by the contestants in official matches and tournaments, a delicately adjusted balance scale is used for

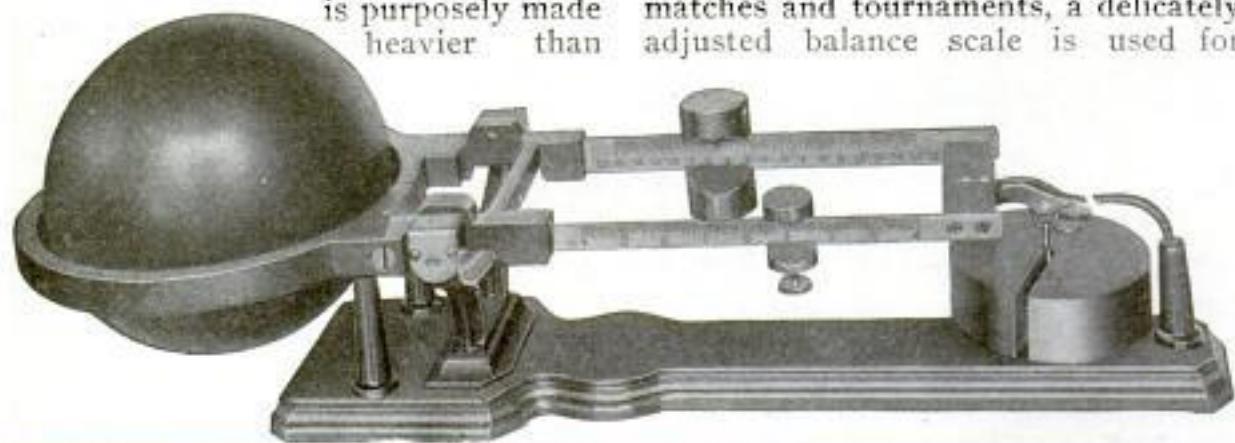

Weighing the Various Sides of a Bowling Ball to Discover Whether It is Loaded

*# Oscar A. Doob, Times Star, Cincinnati, Ohio.  
maker: August Troener, Phila., Pa.*



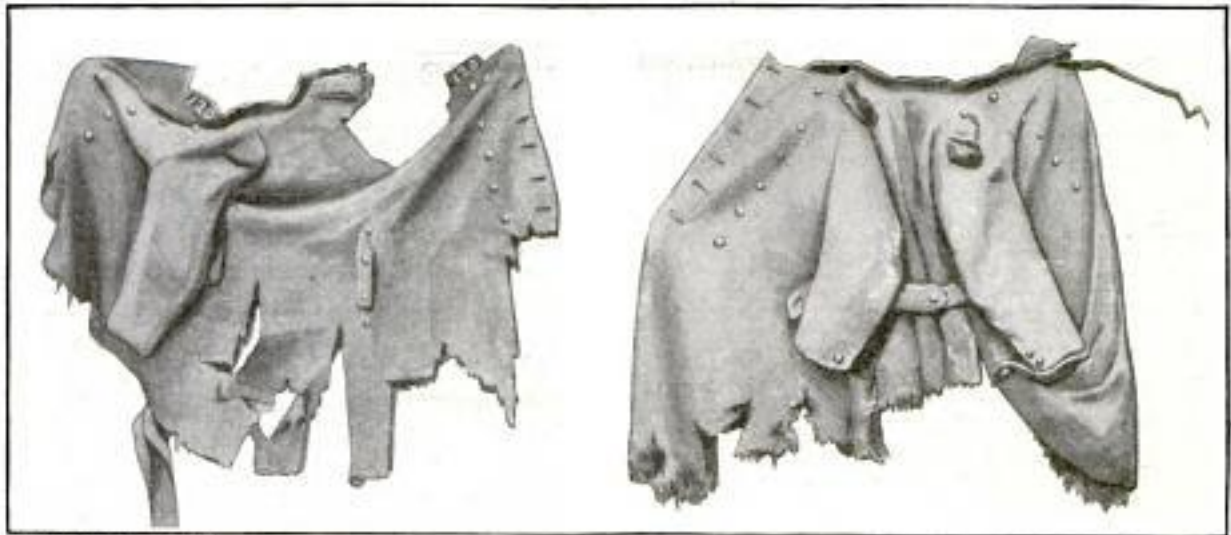

COURTESY ILLUSTRATION

At the Left Is a Coat Torn by a Bursting Shell, and at the Right, One Cut in Two by the Flying Slugs of a Hand Grenade. In Neither Instance was the Wearer Killed

weighing the spheres. One end of this is made with a circular rim in which the ball to be examined is placed. Extending from this are two parallel bars, graduated in fractions of ounces, at the end of which is a balancing weight. By setting the two intermediate weights at zero, a ball weighing exactly 16 lb. will balance the scale. By then turning the ball to different positions and adjusting the weights on the bars, it is possible to readily compute the difference in the weight of opposite sides, as, for instance, the variance in the weight of the front and back, or top and bottom. This makes it impossible for a ball loaded with shot or lead on one side, yet conforming with the rules regarding total weight, to escape detection.

### 9240 TORN COATS OF SOLDIERS TELL REMARKABLE STORY

Every modern war has had its many striking examples of soldiers who were saved from probable death by a prayer book, a uniform button, a watch, a coin, or some other article which broke the force of a bullet and prevented it from penetrating a vital part of the body. The present war has also offered almost unlimited examples of these curious escapes from mortal wounds. In the accompanying photograph are shown coats of two French uniforms,

*L' Illustration*

which are battle-torn to a degree that places their history almost in a category by itself. They were cut to shreds, one by the flying fragments of a bursting shell and the other by the slugs of a hand grenade. And the remarkable part of the story is that although the coats were torn beyond repair, the wearers were not. Both men lived through their experience.

### 9200 SMALL TELEPHONE FOR DESK OPERATES EFFICIENTLY

What is possibly the smallest desk-telephone instrument in use has been made by a South Dakota man. It is shown in the accompanying photograph at the side of a standard instrument, which serves to illustrate its diminutive size. Although only 6½ in. in height and fitted with a transmitter diaphragm 1¾ in. in diameter, it is used for both local and long-distance work with results which are as satisfactory as those attained with ordinary apparatus. The only essential difference in its construction



*C. C. Terhune  
Dakota Central Telephone  
Platte, S. D.*

William Wallace Ferris  
92 Wheeler Ave.  
Providence, R. I.

720

## POPULAR MECHANICS

and that of standard-sized instruments is that it is provided with a button switch instead of the customary receiver-hook switch. When it is being used it is necessary to maintain a pressure with a thumb or finger against the button.

### SAILBOAT USED BY STORE AS ADVERTISEMENT

To advertise a "white sale," a western department-store company made use of the implied pun and displayed



How a Pun in the Concrete was Made Use of for Advertising a "January White Sale"

a fully rigged white sailboat over the entrance of its building. The craft was 25 ft. in length and carried a 30-ft. mast and 25-ft. boom to support the sails, which were made of 10-oz. duck. In order to lessen some of the pressure exerted against the sails and eliminate the danger of the yacht being blown down, holes were cut in the canvas to allow the wind to pass through. Whenever the breeze became too heavy the sails were taken in and everything made secure on deck, as was also done each night.

### *Army and Navy Journal* MONITORS OPERATING ALONG 8944 THE BELGIAN COAST

One of the unexpected developments of the war is the effective work that has been and is being done by modern monitors, not in coast defense, the class of work for which they were designed, but in offensive operations against a foe intrenched along the sea-coast. At the outbreak of the war three monitors, the "Javary," "Madeira," and "Solimões," had just been built in England for the Brazilian government for service on the Amazon River. These vessels were taken over by the British admiralty and placed in service along the Belgian coast. They have since played what is probably the most important part in preventing the advance of the Germans down the coast to Calais and particularly in preventing the establishment of a German naval base at Zeebrugge.

These vessels have little resemblance to the original "Monitor," with its revolving turret, built in 1862 to fight the Confederate ironclad "Merrimac." The superstructure is like that of a gunboat, but each of the vessels has the low freeboard and deck of large area that characterize the monitor type and make in effect simply a steady, floating gun platform. Each monitor is heavily armored, has a displacement of about 1,250 tons and a draft of only 4½ ft. The armament consists of two 6-in. howitzers throwing a 100-lb. projectile at a muzzle velocity of 3,000 ft. per second, two howitzers throwing a 35-lb. projectile at a muzzle velocity of 1,150 ft. per second, four 3-pounders firing 30 rounds per minute, and six machine guns of rifle caliber. With this armament 11½ tons of metal can be discharged every minute. Each vessel has a speed of a little more than 13 miles an hour and can easily carry enough coal for a voyage from England to New York.

The shallow draft of the monitors makes them particularly efficient for work along the Belgian coast, as they can operate in shallow waters and are practically immune against torpedo

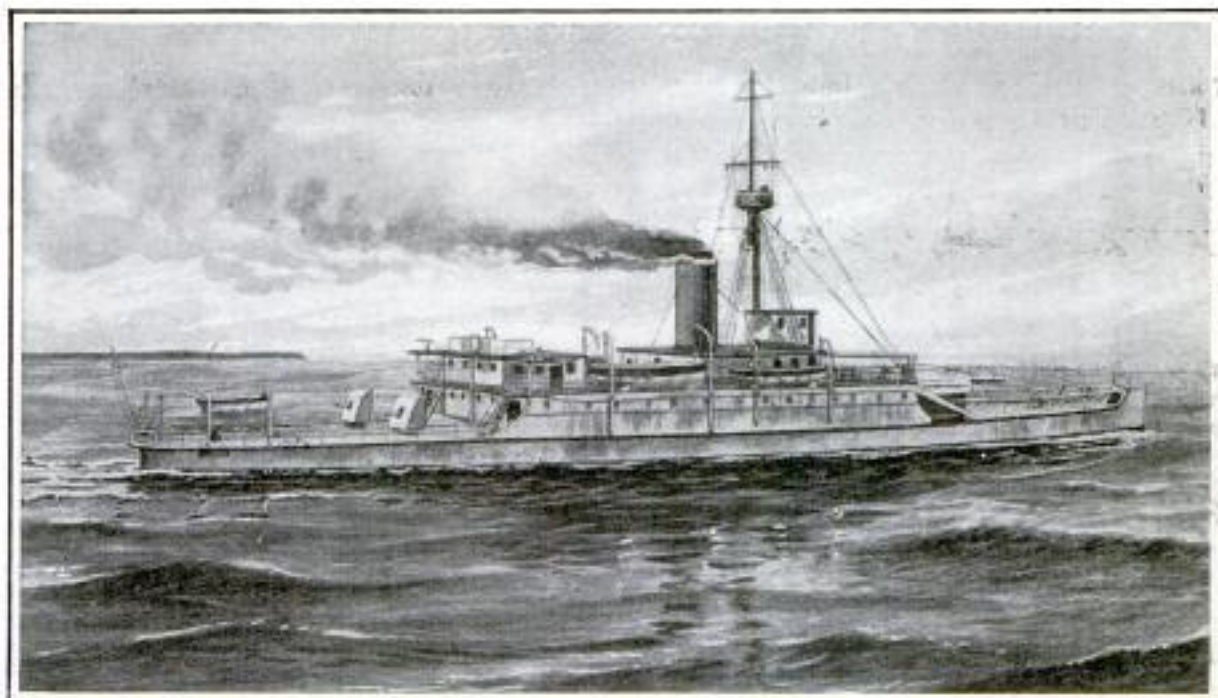

One of the Three Monitors Built in England for the Brazilian Government and Taken Over by the British Admiralty for Service along the Belgian Coast; This Vessel Is Capable of Throwing One and One-Half Tons of Metal a Minute and, Because of Its Shallow Draft, Is Practically Immune from Damage by Torpedoes or Anchored Mines

attack. Torpedoes are ordinarily adjusted to run at a depth of from 12 to 15 ft. below the surface, and unless they are specially adjusted to run almost awash they will pass harmlessly under these monitors, as was demonstrated when a German submarine fired four torpedoes at one of the vessels. For the same reason a vessel of this draft will pass unharmed over an anchored mine. In spite of the fact that the monitors were built for river service, they have proved so seaworthy that they have been able to keep at sea in the rough waters of the English Channel when larger merchant craft were compelled to seek shelter.

Although the monitor originated in this country, vessels of this type are not now regarded as especially useful units of our navy. There are 10 monitors in commission, on the United States Navy list, the latest of these having been built from appropriations made in 1898, but most of them are on reserve duty.

Steel pipe has so far displaced wrought iron that the production of the former is nearly ten times as great as that of the older material.

## SPACES FOR FLOWERS MADE 8915 IN CONCRETE WALLS

In designing a residence driveway which was to be cut through a terrace, a builder avoided the monotony of having two long concrete retaining walls flanking either side by breaking them at intervals with semicircular niches in which plants could be placed. These spaces were made so that they broke what otherwise would have been the straight line of the two copings. Each was made about 3 ft. in depth and 2 ft.



wide and given the same finish as the exterior of the wall. Concrete jardinières were made for the plants which were set in the spaces.

*Albert Marple  
320 Baynton St.  
Tropic, Calif.*

*The Japan Magazine*

## TATTOOING AS PRACTICED

8775 BY JAPANESE

Tattooing, the art of decorating the human body with pictures applied directly to the skin, is one of the most ancient arts. In Japan, where it



In Japan It Is a Matter of No Little Pride with Certain Classes to Possess a Body as Elaborately Decorated as This One

reached its zenith during the first part of the nineteenth century, it is a custom which antedates the earliest records of the people. Although still carried on there, it is done in secrecy, as since the beginning of the reign of the late mikado, Mutsuhito, it has been prohibited by law. Curiously, this

modern edict against the practice corresponds to a similar command in the old Mosaic Law which put an end to it among the Jews centuries ago.

In Nippon this aboriginal custom has always appealed to the esthetic tastes of certain classes. At one time it reached a standing that placed its foremost practitioners in renown. Many of the famous painters of Japan were frequently employed to draw designs to be worked on the human body. Tattooing in Japan comes under three different classifications: the early practice of marking all criminals with characters which enabled the rest of society to identify them; the custom of lovers in their youth to have tattooed upon their forearms the names of their sweethearts in evidence of their undying fidelity; and lastly, "horimono," the practice of decorating practically the entire body with various elaborate designs. In northern Japan this is still persisted in, although the custom is said to be dying out gradually.

Horimono was never practiced among the higher classes of Japanese, but instead among those who on account of their vocations went for the most part unclothed, as was true of the jinrikisha men and many of the tradesmen, such as carpenters, plasterers, and the like. Singularly, the designs in this form of tattooing were influenced by the "irezumi," or the marking of criminals. The brand of the criminal was usually placed above the elbow on the left arm. For this reason the horimono practitioner has rarely decorated his clients' left arms, at least not heavily, beyond a point about two inches above the elbow, for fear that such a decoration might be construed as a covering for the label of the criminal.

Since the process of tattooing, which consists of pricking the skin with a small bundle of needles and allowing the ink to enter the cuticle, is a very irritating operation, a body well covered with an elaborate design is displayed with considerable pride by the youth of certain classes, as it shows that its possessor has endured

Mr. A. Poole, Los Angeles, Cal.  
 40 Potomac St.  
 Dayton, Ohio  
 W. J. Poole, Pres.  
 American Lineograph Co., 223  
 Dayton, Ohio.

**POPULAR MECHANICS**  
**FORM-LETTER AND CIRCULAR**  
**PRINTING MADE SIMPLE**

no little pain. For the most part red and blue inks are used in the work, because neither of the colors fade nor is liable to injure the skin. The designs most frequently used are those in which appear a tiger, a dragon, a famous old warrior or beautiful woman, or even birds and flowers.

Elaborate work is even now an expensive means of decorating the body for the man of Japan who earns only a few sen daily. Frequently a pattern takes months to execute and formerly often represented practically the entire earnings of a person. It is interesting in this connection to note that many of these designs are used by the Japanese today in their outer garments. At one time exhibitions of tattooing were held and largely attended for much the same reason that fashion shows are given in this country at the present time.

**COMBINATION WATER FAUCET WITH SWINGING SPOUT**

Intended to be used over a kitchen sink, a combination water faucet has been designed with a long, swinging spout which may readily be moved from one side to another as desired. In addition to this feature it has the convenient property, characteristic of all similar fixtures, of joining the hot and cold-water pipes so that the water may be mixed to any specific tempera-

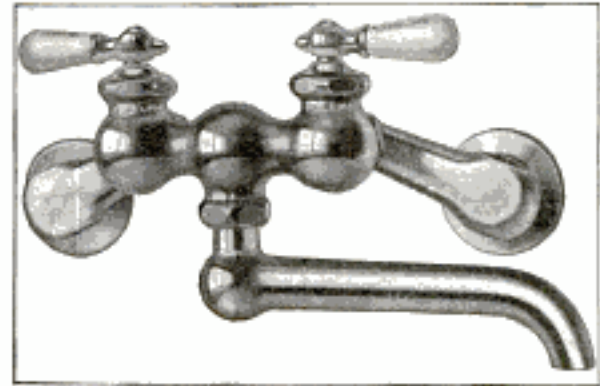

The Spout of This Combination Water Faucet may be Freely Swung from Side to Side

ture as it is drawn. The combined functions make the appliance a very convenient one for kitchen use.

Chicago Faucet Co.,  
 315 So. Clinton St.,  
 Chicago, Ill.

Intended particularly as an office appliance, a typesetting machine has lately been perfected which is operated

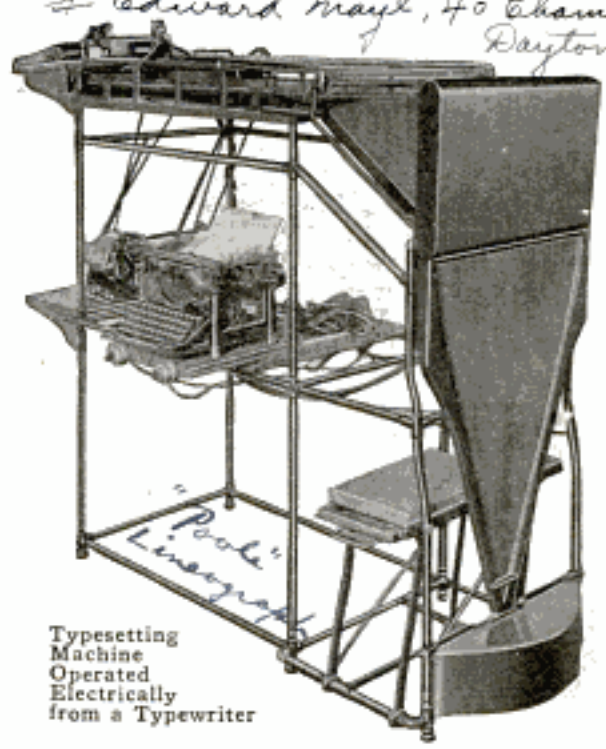

Typesetting Machine Operated Electrically from a Typewriter

by a typewriter, making it possible for a stenographer, wholly unversed in printing, to perform the entire operation of setting type and printing ordinary business circulars and similar matter. This machine occupies a space 22 in. wide, 3 ft. long, and about 4 ft. high. When the typewriter is used it not only performs its ordinary function, but also, through electrical connections made by the movement of its keys, actuates a mechanism which simultaneously sets the type for printing the matter which is being written. Each time one of the typewriter keys is struck an electrical contact is made, causing the corresponding character in type to be set. When once the type is set, which requires no more time than the typing of the copy, the printing is done in much the same way as is multigraphing. A type distributor is also a part of the machine, and this replaces the type in its proper channels after the printing has been run off with a speed of 250 characters a minute. The

Pooler is now at Dayton (40 Potomac St.) 2/6/15 (magl)

Inventor: Chas. Barnard, 373 So. Catalina av., Pasadena, Cal.  
 Mfg: E. E. Dow & Co., Redlands, Calif.

724 Costs about \$12.00 POPULAR MECHANICS

typewritten copy which is made in the beginning is used in reading proof. Corrections are made by rewriting a line in which an error appears and substituting it for the one previously set.

**PYRAMIDAL GLASS CASE FOR DRYING FRUIT**  
 8272

A cheap but efficient fruit drier, now being introduced in California, is designed particularly for the farmer who  
 Costs about \$12.00



This Cheap but Efficient Fruit Drier Exposes the Fruit to the Sun on Three Sides

has only small quantities of fruit to dry. It consists of a table on which three triangular sheets of glass are mounted in the form of a pyramid, with the apex over the back of the table, and supported by a triangular sheet of galvanized iron erected on the back of the table. The inclosed space is exposed to the sun on three sides. The galvanized-iron back is provided with two small ventilators and with a door through which the trays of fruit are handled.

CA new English postal regulation provides for the telephoning of the contents of important letters from the post office to the addressee on Sundays, for a small fee.

*Army & Navy Journal*  
**GERMANY AND BRITAIN BOTH BUILDING NEW NAVIES**

Both England and Germany are building new warships much more rapidly than their navies are being depleted by war. According to an American naval expert who has had an opportunity of observing the activities in British shipyards, 15 new battle cruisers, the newest and heaviest type of dreadnaughts, will be completed for Great Britain in 1915, with a supplementary fleet of light cruisers, destroyers, and submarines enough to make a navy as large as that of the United States. With these new vessels added to England's sea strength and approximately the same proportionate additions to the German fleet, the American navy will be insignificant in comparison.

**WIRELESS APPARATUS USED ON AEROPLANES**  
 8426

Radio communication between aeroplanes in flight and the signal corps of an army on the battle field, embraces a comparatively new phase of wireless telegraphy which is being given a thorough test by military airmen in the European theater of war. The plant consists of three units: a generator and spark discharger, a transmission system, and a portable receiving apparatus, the aggregate weight of which approximates 184 lb. As is shown by the ac-

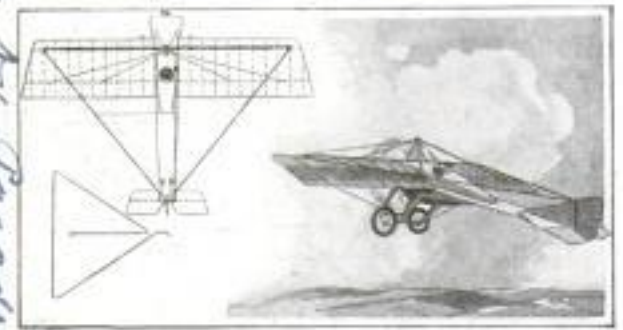

Wireless Equipment for a Monoplane, Showing the Arrangement of the Antenna and Trailing Wire

companying illustration, the antenna is stretched over the upper pylon to the opposite wing tips of a monoplane, and back to the end of the fuselage, from

*Aero and Hydro, 9-26-14*  
*article written by Percy S. B. Morriss*  
 Copyrighted Material

Elizabeth B. Sheer, 220 Grand av., Pasadena, Calif.

Inventor: Chas. Barnard, 373 So. Catalina av., Pasadena, Calif.

Albert Marble, 322  
Boynston St., Tropic, Cal.

which the aerial trailing wire is dropped. This does not necessarily come in contact with the ground, but is extended close to it under ordinary circumstances. It is attached to the transmitting apparatus, but so controlled by a releasing device that should it become entangled in a tree or other fixed object on the ground, a slight jerk would be sufficient to disconnect it from the machine, thereby averting an accident. The entire plant is mounted in the cockpit of the craft, and the generator placed in such a position that it may be driven by a belt running from the monoplane motor.

**FROZEN RIVER ROADBED FOR  
ELECTRIC RAILWAY**

A novel means of transportation is used in Petrograd, Russia, during the winter months for relieving the congestion on the ordinary transportation lines. The river Neva, which flows through the city, freezes at the beginning of the season and remains frozen until the spring break-up. The smooth, solid surface of the frozen river furnishes an excellent location for a temporary but thoroughly practical electric railway, which is installed each year at the beginning of the winter and is kept in service until the ice shows signs of becoming unsafe.



Electric Railway Station on the Ice of the River Neva in Petrograd, Russia; This Railway is Built on the Ice Each Year and is Kept in Service throughout the Winter

**ODD SIGNAL LAMP DEvised  
FOR RAILWAY CROSSINGS**

In different localities in the West a new danger signal is being used as an auxiliary safety device at railway crossings where gongs have been mainly depended upon in the past to warn traffic of approaching trains. The reason is that, while under most conditions a loud bell suffices, there are situations in which it is inadequate, a thing especially true in the case of motorists, who often open up their engines and cut out their mufflers on country roads, with the result that it is frequently diffi-

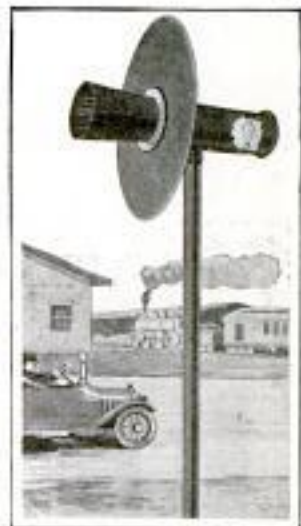

Underwood + U.  
417 Fifth Ave. N.Y. City.

cult for them to hear a bell. The new signal consists of a red light which may be seen either during the daytime or at night. At the top of an iron pipe is mounted horizontally an 8-in. sheet-iron pipe, both the interior and exterior of which are painted black, and about the middle of which is a large red disk. Within the pipe, about 1½ ft. from the open end, is a red lens, and behind this

an incandescent lamp backed by reflectors. When the lamp is ignited the red light may be seen for a half mile or more down a straight road, either at day or night. Its operation is the same as that of the average electric wigwag, the lamp lighting when a train enters a certain block, forming an electric circuit by contact with the rails.

*Wigan Co. Picton Nova Scotia.*  
*Now MURRAY & TREGURTHA Co. SO. BOSTON*  
 9399 **SEA SLED RIDES AT HIGH SPEED**  
**WITHOUT SPRAYING OR SKIDDING** *See Date File*  
*Albert Hickman, designer*

**T**AKING a spin on the water at a speed of 40 miles an hour with all the comforts of automobile riding is made possible by the sea sled, a new kind of high-speed craft that has just been developed. One of the features about this new kind of boat is that it does not throw spray on its occupants, as do most high-speed boats, but gathers the spray under the bow and rides on it. It does not trip or skid. It is not subject to knocks when running over choppy water, and the faster it is driven the more evenly it runs.

Instead of plowing through the water the sea sled rides on top of it, in this respect resembling a hydroplane, although its construction is radically different from that of a hydroplane. Instead of being flat or convex, the bottom of the hull is shaped like an inverted, rounded "V," while the bow, instead of curving to a point, is square and is of the same width as the stern. The original sea sled, shown in the illustration, was wider at the bow than the stern. Extending along each side was a plate having the appearance of a sled runner and serving to gather and hold the air and spray under the hull. With this construction the plates spread outward from stern to bow, resulting in water lines that spread outward instead of converging as in a displacement boat. This construction has been replaced by one in which the body of the boat is rectangular while the bottom is molded to provide the spreading water lines. In

place of the usual submerged screw propellers the sea sled is equipped with "surface" propellers which dip a little less than half their diameters into the water when the craft is running at high speed. The rudders, of which there are two, are metal fins pivoted to the sides of the hull so that they project rearward from the stern. Each fin is carried, not on a vertical pivot, but on one that slopes downward and outward at an angle of about 30° with the vertical. The fins are worked separately by a horizontal rod which is moved back and forth horizontally by a gear at the center, this gear being controlled by a steering wheel of the usual type.

The sea sled is in effect a boat that has the bottom of its hull turned inside out, resulting in placing the keel higher than the sides. At the bow the opening between the hull and the water is made as high as the construction of the boat will permit for the purpose of catching as much air and spray as possible. Aft, the bottom is brought down to such a level as to give the boat a riding surface. With this arrangement there is no necessity for forcing air under the hull through pipes as is usually done with the hydroplane.

One result of this form of construction is that when the boat has a list it will steer of its own accord in the direction of the list and thus right itself automatically. When a displacement boat or hydroplane skids it is the bow that slides, and if the boat is going at high speed the result is almost

Memo to H.H.W. 5/26/15 - Murray & Tregurtha Co. 340 St. South Boston, Mass.



certain to be an upset. Take, for example, the case of a boat starting diagonally up the side of a big wave. If the boat has the usual displacement bow, the extra weight of water on the upper side will force the bow down to-

30 in. This makes it necessary to run the shaft through the bottom of the hull. This shaft with its fittings must be dragged through the water, and above a comparatively moderate speed, the power required for doing this may

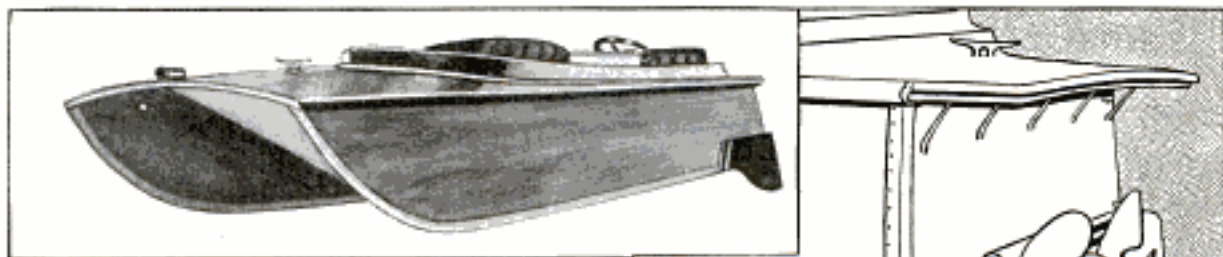

This Picture of the First Type of Sea Sled Shows How the Hull is Shaped to Ride on the Water Instead of Plowing through It

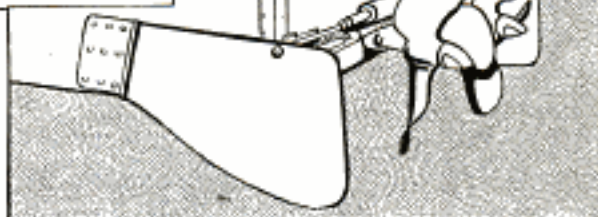

The Arrangement of the Steering Fins and Surface Propellers

ward the trough of the wave, a thing that can be prevented only by prompt and vigorous use of the rudder. A sea sled under the same conditions tries to nose in toward the crest of the wave and will continue to do this until its beam is on a plane parallel with that of the wave. The reason for this is found in the outspreading water lines. As the sides of the hull cut the water each throws a certain amount of water inward under the boat, with the result that there is an outward pressure on each side. The greatest outward pressure will be on the side where there is the greatest mass of water to be thrown inward, or on the side of the boat that is submerged the deepest. Full advantage of this tendency for steering purposes is taken by mounting the rudders on inclined pivots, as explained above. When the boat is to be turned to port, for example, the port rudder acts as an ordinary rudder and undercuts the water at the same time. This depresses the port side of the boat. The port side of the hull is then under the greatest outward pressure from the water so that the bow turns automatically to port, aiding materially in the action of the rudder. For this reason the sea sled is one of the easiest of boats to steer. It also presents the curious spectacle of listing, like a bicycle, in the direction of the turn.

In most racing boats and hydroplanes the propeller is submerged about

be more than that for driving the boat over the water. This resistance is done away with when surface propellers are used. The shafts of the two propellers, geared to revolve in opposite directions, are run straight out through the stern. This places the propellers so that only the portions below the shafts are submerged, but the loss of driving power due to this cause is largely counteracted by making the blades of large area. An incidental advantage in the surface propeller is that the boat can be run in shallow waters, and among weeds and water plants.

The greatest speed yet made by a sea sled is around 43 miles an hour. At higher speeds than this the boat gets to planing so high that it loses its planing surface—that is, the air escapes suddenly from the cavity under the boat and it drops back to the water. It is thought that this restriction in speed may be overcome by further improvements in the shape of the hull. The ordinary hydroplane works satisfactorily at weights not in excess of 45 lb. to the horsepower, while some of the latest sea sleds are capable of running at high speed with weights of as much as 70 lb. to the horsepower.

E. S. Harrington, Weymouth Heights, Mass. Inventor: Samuel R. White, Bloomington, Ill.

Fred Telford, 605 S Douglas Ave., Springfield, Ill.

LAWN SPRINKLER THAT WETS A LARGE AREA

A new lawn sprinkler is designed with the idea of enabling one man to take care of several acres. The sprinkler proper consists of several lengths of pipe joined together, making a string of any desired length. The pipes are perforated and in each perforation a small nozzle is set, while the supports are such that the pipes can rotate back and forth easily. The pipes are supplied with water through a small hydraulic device carried on a two-wheeled truck, and this device swings back and forth under the pressure of the water. The pipe line is rigidly attached to this so that the tiny streams of water are constantly thrown back and forth across a strip 50 or 60 ft. wide. When enough water has been supplied to the strip, the pipes are disconnected and laid across racks on the truck, and the whole is trundled to a new location.

Summer Irrigation Co., Inc., 219 Water St., Troy, O.

HEAT-EQUALIZING DEVICE FOR STEAM SYSTEMS

Designed for use with underground steam systems, such as are employed in serving groups of buildings or apartment houses from a central plant, a new method of heat distribution has been devised which bears essentially the same relation to large heating systems as high-tension feed wires bear to electric-transmission lines. The purpose of the apparatus is to equalize the heat so that buildings situated at a distance from the supply station will be served just as efficiently as those close to it, which is not always the case with a low-pressure system used in this manner. In the new plan a small, high-pressure tube is contained within the ordinary supply pipe and at stated intervals is fitted with automatic valves which operate whenever the pressure in the larger conduit falls below a certain minimum, feeding in a sufficient quantity of steam to equalize the heat at the required points. The system can be installed in old plants.

HOW JAPANESE USE WATER POWER TO HULL RICE

A crude but effective apparatus for utilizing water power in hulling rice is in common use in the rice-growing sections of Japan. It consists simply of a beam that rocks on a pivot and has a bucket at one end and a pounder for hulling the rice at the other. The



A Hydraulic Device on the Truck Rotates the Pipe Back and Forth so That Water is Supplied Evenly to a Strip 50 or 60 Feet Wide

*Geo. F. Worts, 927 Grand Ave., Toledo, Ohio.*

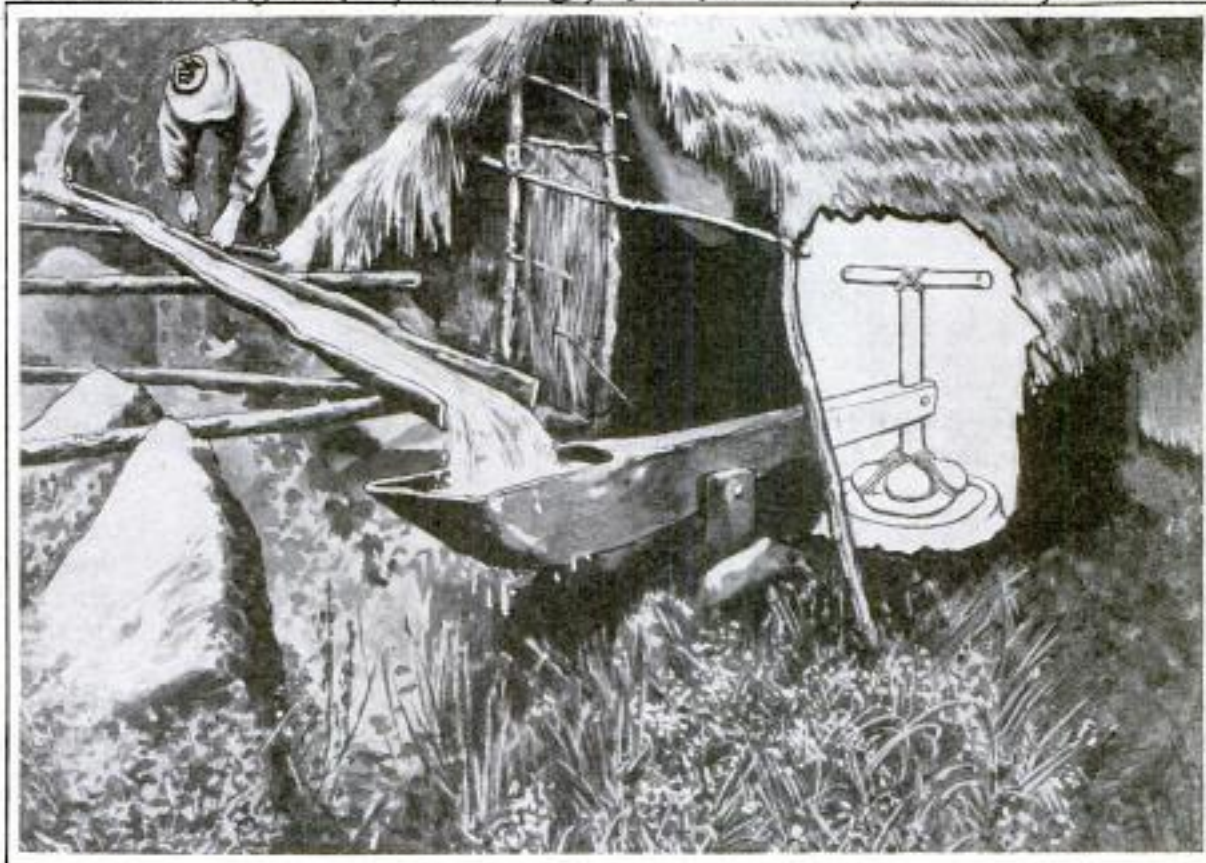

This Crude Water-Power Plant Works Slowly but Needs Practically No Attention

water is supplied through a trough, which empties into the bucket, and no head is required other than that necessary for maintaining the flow. As the bucket fills, the weight of the water forces it down, raising the pounder at the other end of the beam. The bucket is so shaped that when it reaches the low point the water spills out suddenly and the beam flies back to its original position, the pounder falling into the bowl-shaped receptacle with sufficient force to break the hulls from the rice. The apparatus works slowly, but requires practically no attention.

#### FLOWERPOTS ORNAMENTED

#### 8870 WITH SEA SHELLS

The making of flowerpots from sand and cement in which sea shells, picked up along the ocean front, are imbedded is a novel occupation followed by an old man near San Diego, Cal. With the many kinds of shells picked up a great variety of effects are produced.

In some cases the shells are left sticking to the outside of the flowerpot, and in others they are sunk into the composition so that the rims are flush with the surface. Ordinary dishpans are used as molds, and some novel and attractive patterns are worked out for sale to tourists and beach residents.



These Flowerpots are Made of Sand and Cement and are Decorated with Sea Shells Sunk into the Composition While It Is Wet

*Allen Henry Wright  
San Diego, Cal.*

C. L. Edholm, 1353 W. 37th St.,  
Los Angeles, Cal.

**CLEARING RAILWAY TRACKS  
9013 OF CATERPILLARS**

During an almost unprecedented plague of caterpillars in northern Cali-

fornia, railroad tracks were so thickly covered with the small, hairy creatures that in some parts the movement of trains was seriously interfered with and sometimes became dangerous on heavy grades where it was impossible to prevent the wheels from slipping even when the brakes were locked. The problem of clearing the tracks of the pests in advance of a train was solved by extending two pipes ahead of the pilot of the locomotive and directing a high-pressure jet of steam on each rail. The steam was expelled with sufficient force to blow the caterpillars from the track, while its heat was great enough to kill them almost instantly. This simple method put an end to the difficulty and saved the expense

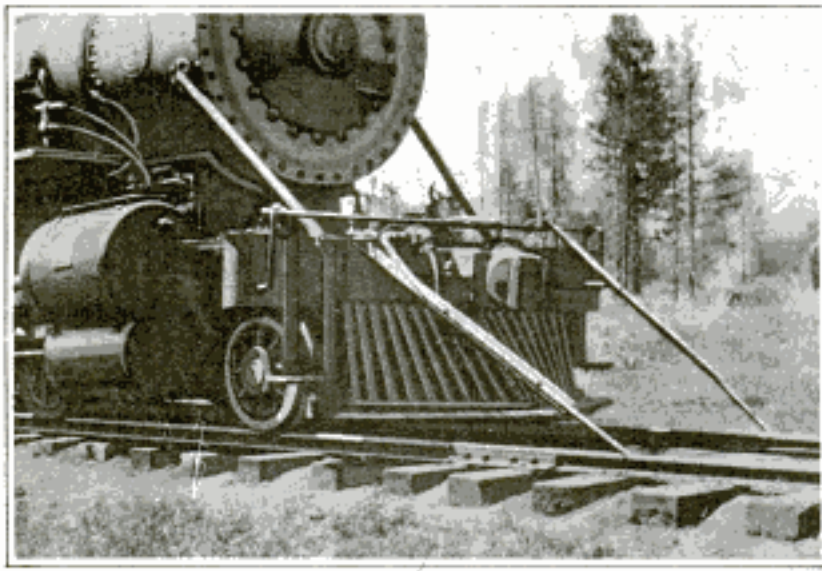

By Blowing Steam through Pipes from the Locomotive Boiler to the Rails, Caterpillars were Cleared from the Railway Tracks without Difficulty

of cutting ditches for miles to prevent grubs from crawling to the rails.

**ONE-MAN HOUSE A CURIOUS  
8777 STRUCTURE**

When the authorities ordered the removal of a partly completed wooden building in a suburb of Cincinnati, a

novel building enterprise on which a civil-war veteran had worked for seven years, and to which he had devoted the most of his pension money, was rudely brought to an end. Every board was cut and every nail was driven by this man working alone. He called it his "White House." When the structure had begun to take definite shape, and its crude lines were seen to follow the contour of the executive mansion in Washington, the reason for this name was apparent. This one-man house was within a few weeks of completion when two inspectors appeared on the scene. The house was found to have been built in violation of the building ordinances, and an order was issued for its removal. The man who built it then proceeded to tear it down, saving the material carefully for use on another location. When only as much of the building as is shown in the illustration remained standing, he quit work.



Corner of "White House" Built by One Man and Then Torn Down by Him When the City Authorities Ordered Its Removal

Oscar A. Doob, Times Star, Cincinnati, Ohio.

Moon Motor Car Co., Main & Cornelia Sts.  
St. Louis, Mo.

Motor Age 11-5-15

### SURE-FOOTED BURRO REPLACED BY MOTOR CAR

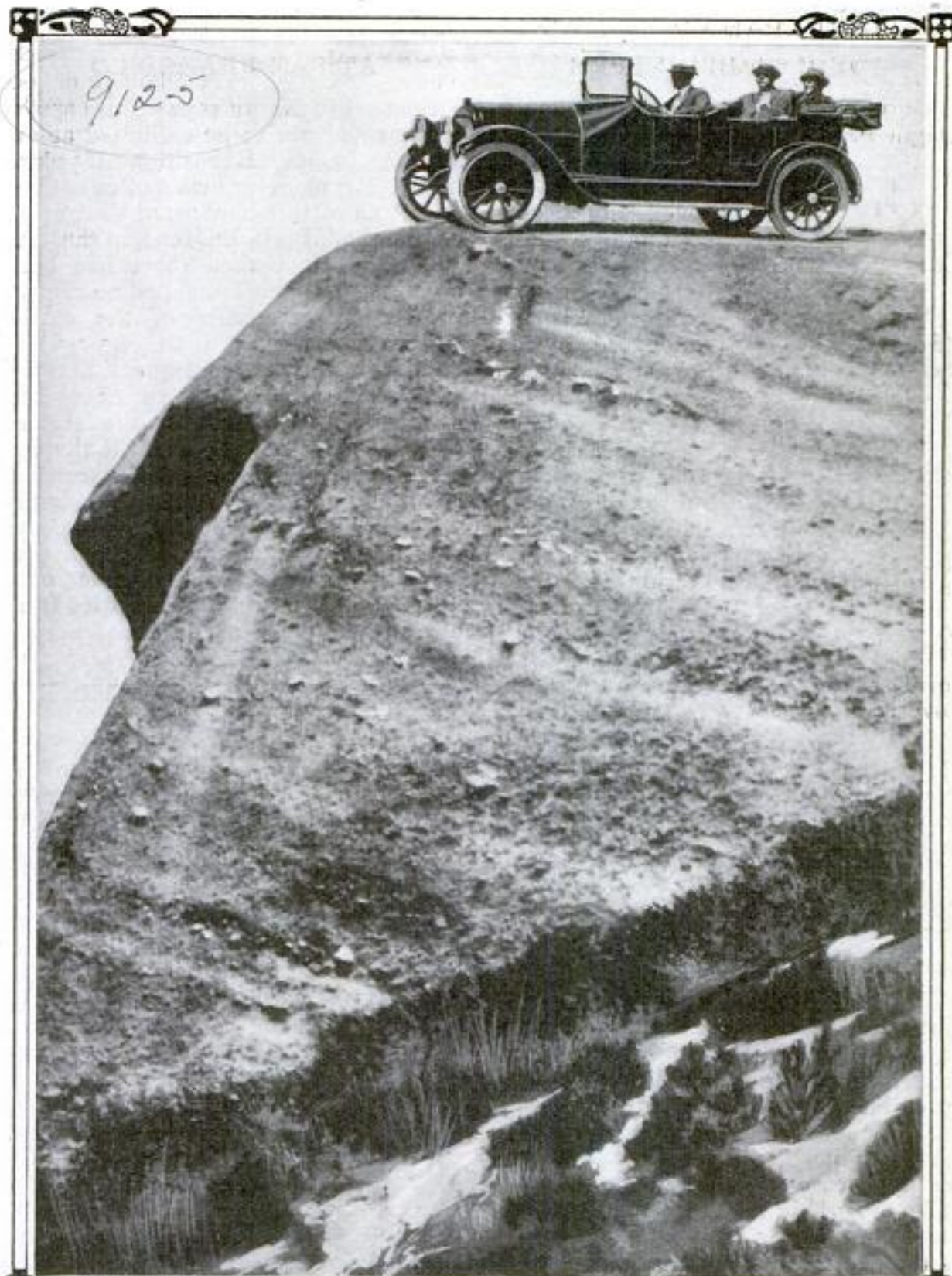

**T**HIS photograph shows a motor car at the apex of Eagle Rock Mountain, a peak with very precipitous sides, near Los Angeles. The feat of climbing it is one which requires not only an engine with power, but also brakes that hold and a driver with a clear head, as may be appreciated by the position in which the machine is standing, one of its wheels being within a hair's breadth of the edge of the cliff. This spectacular piece of hill climbing was accomplished for the purpose of demonstrating the flexibility of a stock car, and also illustrates in a striking manner the tremendous advancement made in gasoline-propelled vehicles.

Albert Marple, 322 Boynton St.,  
Tropico, Cal.

Information sheet sent out by  
Dept. of Agriculture

732

POPULAR MECHANICS

~~Scientific American~~  
ARTISTIC LAMP-POST MADE

9289 FROM LIMB OF TREE

8879 In front of a California bungalow is a rustic lamp-post which is not merely



odd in appearance, but also fits well with its surroundings. It is made from a crooked limb of a tree and is surmounted by an artistic lantern made of brass. The electric wires are run under the ground through a conduit and up through the interior of the post, which has almost the appearance of having grown in its position instead of having been placed there. The novel effect obtained is

not unpleasing, although somewhat startling when first observed.

THE TWELVE-CYLINDER CAR

9289 NOW A POSSIBILITY

With the eight-cylinder car barely introduced, automobile manufacturers are now talking of the 12-cylinder car, one maker having already thrown out the hint that "if the public demanded a 12-cylinder car," his company was prepared to make it. There were 14 eight-cylinder cars exhibited at the automobile show held in Chicago in January, 1915, but so far as is known there is only one 12-cylinder model in existence, and that is a British racing car. Just whether the advantages to be derived from the use of 12-cylinder engines will compensate for the increased complexity of the mechanism is a thing that can be determined only by experience.

Scientific American

TO EXHIBIT ALBINO CATTLE

8679 AT SAN FRANCISCO

Some of the famous Chillingham white cattle are to be exhibited at the Panama-Pacific Exposition if plans now being made are carried out. The ancestors of this herd were shut up in Chillingham Park, England, in the year 1220, and since then there has been no infusion of new blood and no change in the characteristics of the cattle. They are albinos, with snow-white bodies, black noses and horns, and red ears. These cattle are an albino offshoot from the aurochs, the extinct black wild ox from which all the domestic cattle of Europe are descended, and they still show traces of their descent in the colored nose, horns, and ears. The albino trait has been preserved for nearly eight centuries only by keeping them rigidly separated from other cattle.

STAMP-VENDING MACHINES

8671 USED IN CANADA

Combination letter boxes and vending machines that dispense one-cent and two-cent stamps are being introduced by the Canadian government. When a coin is deposited in the machine the stamps are fed forward from a roll and are torn off in a strip by the purchaser. As soon as the supply is exhausted, a metal shield bearing the word "Empty" drops over the coin slot. The machine is operated by electric current, which also furnishes the light for illuminating the advertising placed around the top.



operated by electric current, which also furnishes the light for illuminating the advertising placed around the top.

O. L. Robertson  
44 Riverside Ave.,  
Toronto, Canada.

*W. D. Goodwin, 527 W. 124th St. N. Y. C.*

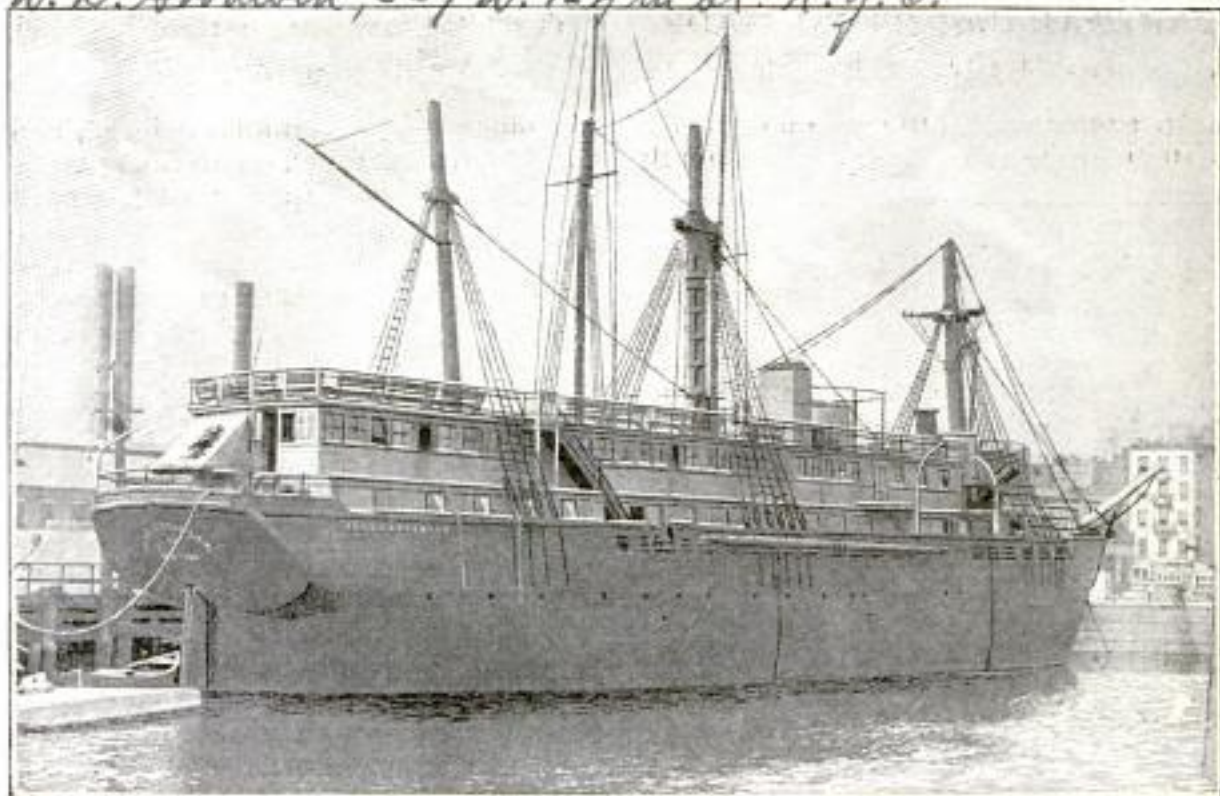

New York's Floating Hotel Which has been Raised and Again Opened as a Home for About 75 Girls and Young Men

*Unusual*  
**SCHOONER HOTEL FOR NEW YORK POOR**

One of America's odd hotels, a five-deck schooner which served as a home for some 75 girls and young men employed in New York, has been raised and again put in service. Several months ago, while taking on a supply of coal, the boat sprung a leak and settled into the mud at its mooring place in the Hudson River at the foot of East Twenty-Third Street. The vessel is an obsolete, timbered craft which has seen more than 50 years of service and is owned by the estate of a famous coffee merchant. It is not operated for profit, but to provide an economical home for worthy young persons. For 12 years the boat has been moored at its present dock, and all that time served as a hotel. It has its own electric-light plant, dining, smoking, and recreation rooms, and is comfortably fitted and heated.

Ⓒ Lightning, campers, locomotives, and incendiaries, in the order named, are the most frequent causes of forest fires.

**CHISEL TESTED BY DRIVING IT THROUGH STEEL BAR**

*9,159* A hand-forged chisel with a tapered point, made from cropped ends of steel such as are used in shrapnel cases, was recently driven through a 2-in. cold steel bar with a sledge. The operation required only 15 minutes and was performed by a blacksmith and his helper, the one holding the chisel with a pair of tongs and the other wielding the sledge. After penetrating the block of steel the chisel was withdrawn and found to be in perfect condition, neither end of the tool showing any marks which would indicate that it had been used.



*Pennsylvania Steel Co.,  
 Steelton, Pa.*

**FUNERAL CAR OF JAPANESE  
9069 EMPEROR**

An ancient and impressive Japanese custom brought to light by the death

bers of one family, in which this duty has been a hereditary honor for generations. The length of the car is always 23½ ft.; the width, 10½ ft., and the height, 12 ft. The wheels are of unusual pattern, each having a rim built in seven sections, with the idea of doing away with all jolting. There are three spokes to each section, and the sections are joined by plates placed on the inner side of the rim. The result is rather curious in one way, since each section has a separate and distinct squeak. The car is drawn by two oxen with three in reserve following the car. The car must be strongly built, as the emperor's coffin weighs between four and five tons, consisting of three caskets placed one within the other. The inner casket is made of Japanese wood, 3 in. thick, and covered with vermilion.

This casket is placed in the second casket, and the intervening spaces are filled with charcoal. These are then placed in the outside casket, and the spaces are filled with granite.

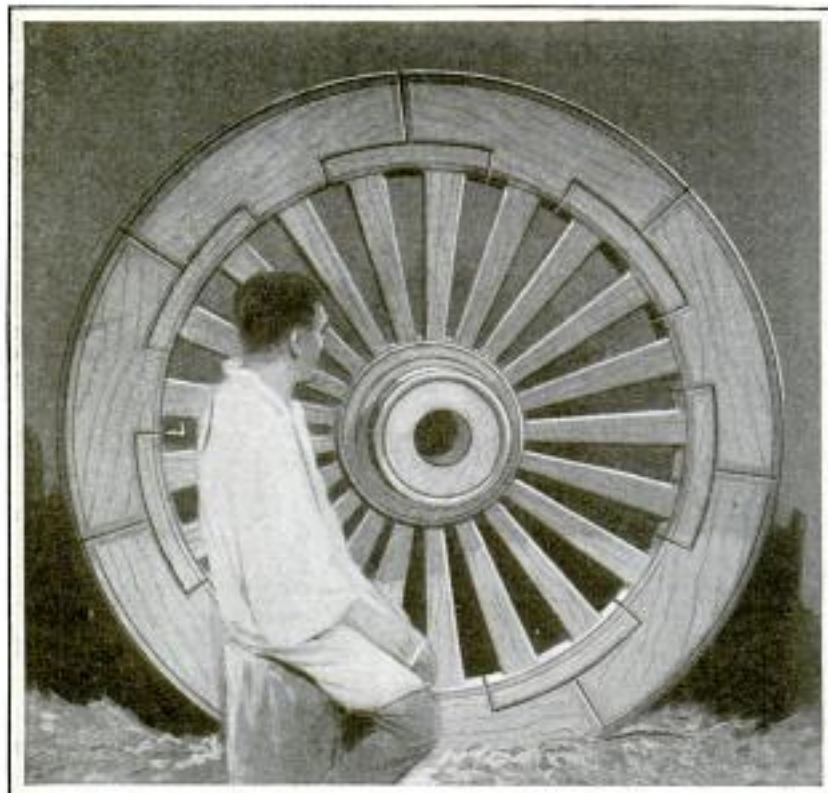

COPYRIGHT, UNDERWOOD & UNDERWOOD

One of the Wheels of a Japanese Imperial Funeral Car: The Rim is Made in Seven Sections with the Result That the Wheel Has Seven Separate and Distinct Squeaks

of the late emperor is that of building the imperial funeral car. When an emperor dies, a new funeral car is always made. It must be built to exacting specifications and only by mem-

bers of one family, in which this duty has been a hereditary honor for generations. The length of the car is always 23½ ft.; the width, 10½ ft., and the height, 12 ft. The wheels are of unusual pattern, each having a rim built in seven sections, with the idea of doing away with all jolting. There are three spokes to each section, and the sections are joined by plates placed on the inner side of the rim. The result is rather curious in one way, since each section has a separate and distinct squeak. The car is drawn by two oxen with three in reserve following the car. The car must be strongly built, as the emperor's coffin weighs between four and five tons, consisting of three caskets placed one within the other. The inner casket is made of Japanese wood, 3 in. thick, and covered with vermilion.

**SHORT CUT ACROSS CANADA FOR SEAGOING VESSELS**

6808

The next great waterway scheme to be carried out, according to present indications, is the Georgian Bay Canal, which is to connect Georgian Bay with the St. Lawrence River at the head of navigation for seagoing vessels near Montreal. This canal will not only give vessels from the Atlantic direct entrance to Lakes Huron, Michigan, and Superior, but will reduce by nearly one-half the distance traveled by water-borne shipping in going from the northern part of Lake Huron to Mont-

real, eliminating the present indirect route by way of Detroit, Lake Erie, the Welland Canal and Lake Ontario. The canal will utilize for the greater part of its length a continuous chain of natural lakes and rivers. The total length is 449 miles, and over only 30 miles of this will it be necessary to construct a new waterway, although much of the existing waterways will require dredging. The total cost of the canal is estimated at less than \$150,000,000.

Engineering Supplement London Times 2-6-14  
The Engineer (London) 2-6-14



The canal begins in Georgian Bay at the mouth of the French River and follows up this river to Lake Nipissing. In this 83-mile stretch there are to be three locks with a total lift of 70 ft.

Lake Nipissing to the St. Lawrence is 633 ft. The canal is to be 200 ft. wide at the bottom and to have a maximum depth of 22 ft., while each of the locks is to be 850 ft. long and 65 ft. wide

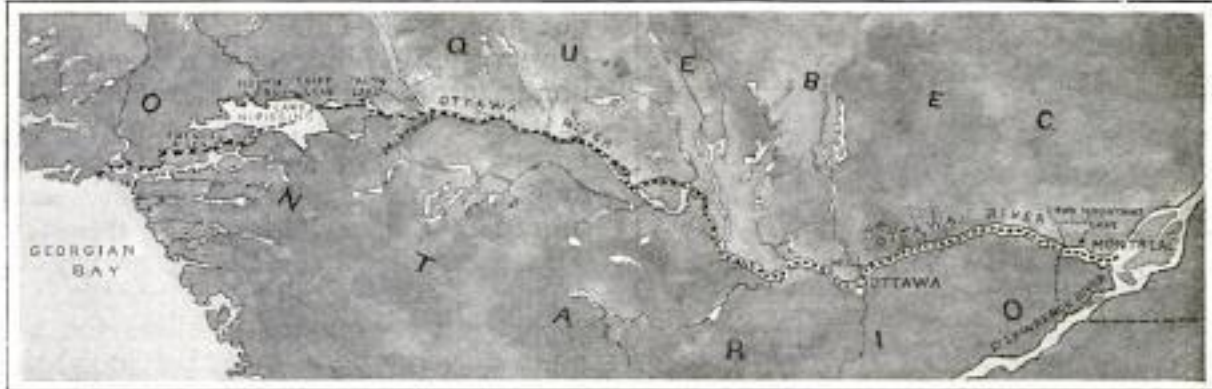

Proposed Georgian Bay Canal, 449 Miles Long, Which is to Connect Lake Huron with the St. Lawrence River and Provide Direct Access for Seagoing Vessels to the Great Lakes Ports

At North Bay, on Lake Nipissing, extensive wharves and grain elevators will be built. A canal connecting the east shore of this lake with the Mattawa River will be excavated. This canal will pass through Turtle, Talon, and Trout lakes and will comprise the heavy portion of the excavation. It is planned to lower these lakes to the level of Lake Nipissing and to make the latter the summit in order to utilize its inexhaustible water supply for lockage purposes in both directions. In the 13 miles of the Mattawa River are two waterfalls, the Paresseux and Les Chines, and these will be passed by a series of five locks. The waterway then follows down the Ottawa River, in which a total of 15 locks will be installed. The last lock is at the lower end of the Lake of Two Mountains, which is the outlet of the Ottawa River into the St. Lawrence River. Leaving this lock, the route follows Back River on the north of Montreal to a junction with the St. Lawrence River at Bout de l'Isle, about 12 miles below Montreal. By using Back River the construction of a new channel and of wharves in front of Montreal sufficient for handling the enormous traffic that will use the new route is avoided, while a new and important commercial frontage will be opened along the north side of the city. The total fall from

and to have a depth of 24 ft. of water over the sills.

The hydroelectric power that can be developed along the canal is estimated at 1,000,000 hp., and it is believed that with the growth of new towns and industries the sale of this power will provide a revenue sufficient to pay most of the interest on the investment for building the canal. About 70 hours will be required for making the journey from Georgian Bay to the St. Lawrence River. It is estimated on good authority that the trade flowing from the Great Lakes to the Atlantic seaboard at present represents 72,000,000 tons a year and that this is doubling itself every six years. About 80 per cent of this shipping is American-owned, and a large part is now diverted at Buffalo and shipped to Atlantic ports by rail.

## DOORS OF STOCKMAN'S BANK PICTURE RANCH LIFE

Each of the doors designed for a recently completed bank building at Austin, Tex., which is owned by a stockman, is divided into three bas-relief panels depicting scenes typical of those on southwestern cattle ranches. Together they weigh approximately 2,600 lb. and represent an expenditure of \$4,000. Photographs were taken on

# H. E. Zimmerman, Int. Morris  
Bank Bldg. owned by Maj. C. W.  
Littlefield, Austin, Texas.

one of the ranches owned by the cattleman, and these were used by the artist in laying out his work. At the



These Bank Doors Picture Scenes Typical of Those to be Seen on Southwestern Cattle Ranches

top of the doors appears a group of cowboys; in the middle, a round-up; and at the bottom, a typical grazing scene. Small bronze heads of steers with lasso nooses about their necks form the knobs for the doors.



The Evolution of a Pipe Bowl from a Slug of Brierwood

## OXYGEN MAY BE STORED WITHOUT PRESSURE

By the use of some of the commercial preparations of fused sodium peroxide, oxygen can now be stored without pressure. This substance has the property of holding oxygen in chemical bonds, from which it is released by the action of water. A pound of the peroxide will hold 2.2 cu. ft. of gas, or enough to supply the breathing requirements of a man for 30 minutes. The application of this discovery to diving and life-saving appliances is said to be entirely practical, since the sodium peroxide, while hard, is not brittle, and can be cast into any convenient shape. When charged with oxygen it may be stored without danger of deterioration if protected from moisture.

## MUCH PIPE WOOD IS USED BY PENNSYLVANIA

Pennsylvania leads all of the states in the consumption of wood for use in the manufacture of pipes. Of the different kinds of material employed, apple wood is in greatest demand, for it is the principal wood used in making the so-called brier pipe. The accompanying photograph shows the evolution of an ordinary pipe bowl from a blank of brierwood, which is purchased at about \$350 a thousand feet. The other woods that are used, aside from this and apple, are red gum, ebony, birch, and olive. The state each year consumes in pipe making the equivalent of approximately 225,000 board feet of timber, the average price of which amounts to about \$65 a thousand feet.

*Bristow Adams*  
*Forest Service, Wash. D. C.*

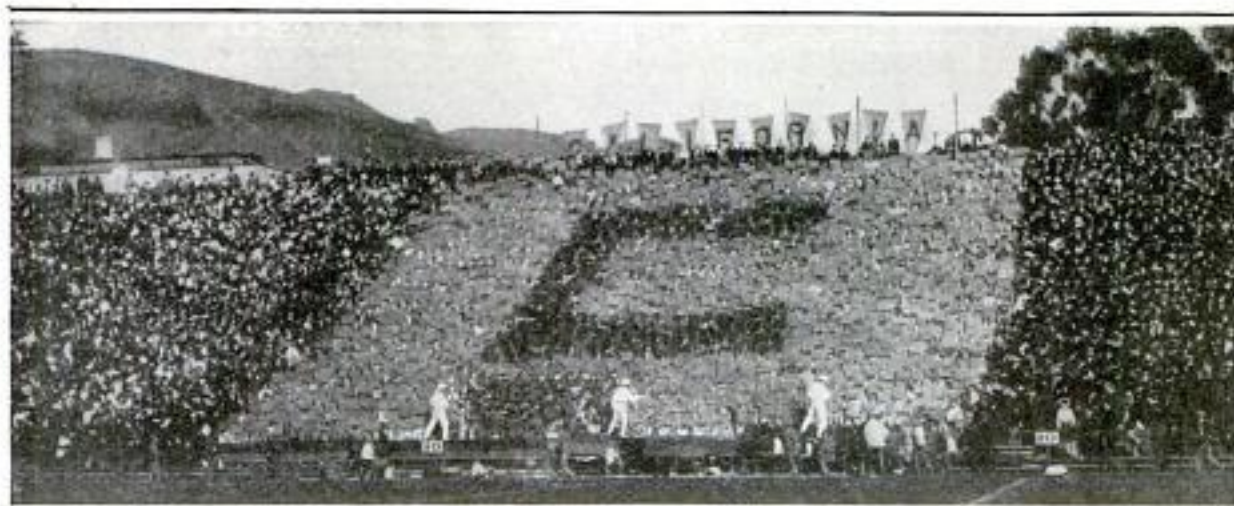

The Great "C" Formed in Blazing Color by University of California Students at a Football Game

8784 **DISPLAY COLLEGE COLORS  
IN SPECTACULAR WAY**

At a hotly contested football game between the University of California and Leland Stanford University, a very striking method of displaying their colors was adopted by the "rooters" of the former institution. The students were seated in a solid block on the bleachers, and each held a rectangular flag which was blue on one side and yellow on the other and held at either end by a stick. In the center of the block a series of the seats had been marked off to form a large "C." In this way the rooters were divided into two groups, those forming the "C" and those constituting the background. Then, by each student holding back his flag so that it covered his head and shoulders, every one in that section of the bleachers was hidden from view beneath a glare of color. When one group of the rooters were displaying the yellow side of their flags, the other would display the blue. So the great "C" in the center appeared one minute in a brilliant yellow and the background in blue, and the next minute in blue with a yellow background. The changes were made in unison, each rooster following the direction of the cheer leaders.

CA metronome watch for gauging the speed of marching troops has been introduced in the Austrian army.

8485 **HOUSE IN NETHERLANDS HAS  
ROOMS THREE FEET WIDE**

So valuable is land in the crowded countries of Europe that even a space, 4 ft. wide, between two buildings in one of the main thoroughfares of Amsterdam, Netherlands, is made to serve as a dwelling. The thickness of the walls eats up a foot of this space, so that this strange house is only 3 ft. wide inside. The front of the lower floor is occupied by the stairway. In the narrow rooms of the upper stories a family lives in comparative comfort.

CA aeroplane recently built for the Italian army has engines of 300 hp., a lifting capacity of 11,000 lb. useful load, a speed of 75 miles an hour, and is capable of sustained flight for 25 hours. Two other giant planes, one of 600 hp. and the other of 1,000 hp., are also being built in Italy.



A. G. Pungler, Western Military Academy  
Alton, Ill.

A. A. Coult  
Republic Bldg.,  
St. Louis, Mo.

738

*Art. 1000*  
*The Motor - November 1914*  
PROPER ELECTRIC WIRING

STANDING PLATFORMS USED

8767 FOR MOTOR CARS

9233 BY TRAFFIC OFFICERS

For the comfort of traffic policemen, who in bad weather are forced to remain for several hours at a time on wet



or frozen pavements unless special provisions are made for them, small standing platforms have been devised by the police board and put in use at some of the street intersections at St. Louis. They are made of slats, an inch in thickness, nailed to crosspieces

that raise them from the pavement so that there is an air space beneath. These platforms are approximately 3 ft. square and are placed in positions from which the policemen may direct the traffic without difficulty.

Attention has lately been drawn to the relative merits of single and double wiring of electric-lighting equipment on motor cars, and the good opportunity afforded by the metal chassis of a machine for grounding has caused the single-wire system to be suggested as possibly preferable to that now in general use. One of the reasons for this is that more substantially insulated connections could be made at the lamps. It is also always possible in double wiring for leaks to occur which are not great enough to blow a fuse, but sufficient to cause a drain on the battery. With the single-wire system the fuse is burned out almost always by a short circuit, and this gives an immediate warning of trouble, enabling it to be looked after before damage is done.

CA cement for fastening metal to marble is made of 30 parts plaster of paris, 10 parts iron filing, and 1/2 part of sal ammoniac, mixed and reduced to a paste with acetic acid.

TORPEDOES AND BOMBS USED IN AERIAL RAIDS

9141

A new instrument of destruction brought to light by the German airship raids on England is a self-propelled aerial torpedo that in many ways resembles a submarine torpedo. It is launched from the gondola of a Zeppelin through a special launching tube that is mounted on a universal joint so that it can be swung at any angle and fired in any direction. The torpedo is launched from this tube by an electrical device operated by a trigger, and, with proper allowance for the speed of the Zeppelin, the shell can be hurled at a given mark with great accuracy. Its great advantage lies in the fact that it can be fired forward, broadside, or astern, and not simply dropped, as is the case with the old-style aerial bomb.

shell, approximately 4 in. in diameter and 20 in. long. In the nose is carried a high explosive, thought to be trinitrotoluol, which is fired by a percussion cap on contact. Back of the explosive is a compartment containing about 4 1/2 lb. of a slow-burning compound which is probably composed of sulphur, saltpeter, charcoal, and a vegetable oil. When ignited, this compound gives off gases which operate the turbine at the rear of the torpedo. The turbine drives the torpedo through the air at high speed and also gives it a rapid rotating motion similar to that of a shell fired from a rifled cannon. The burning compound leaves a trail of smoke behind the torpedo, but produces no flame, so that there is little or no danger to the airship from the firing of the torpedo.

The torpedo consists of a pointed

*The Sphere 7-26-14*  
*12/26/14*

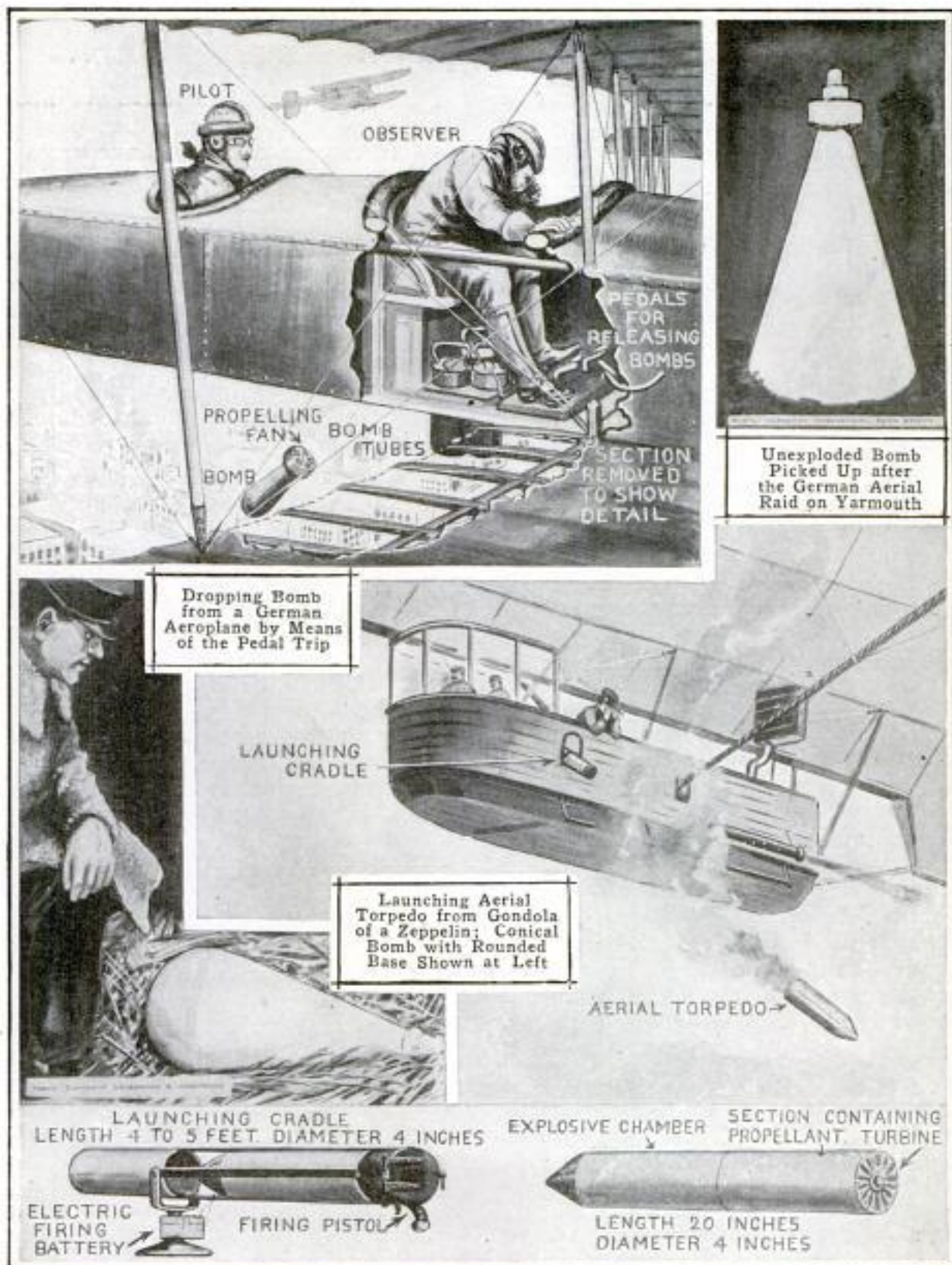

In addition to these, the Zeppelins, as well as the German aeroplanes, carry the ordinary aerial bombs which are simply dropped. Until recently these were thought to be spherical in form. Two unexploded bombs picked up after

the raid on Yarmouth are conical in shape, the base of one being flat and that of the other rounded. The latest aeroplane equipment provides vertical tubes for carrying the bombs, which are released by pressure on pedals.

*ask me Windsor*

*Daily Counselor + Trade Reports*  
*1-22-15*  
*Reported by Consul General Geo. H. Scidmore*

*yokohama, Japan*

**TEACHING INDIAN PUPILS TO BE CLEANLY**

8999

**RUSSIAN SOLDIERS WEAR**

923

**JAPANESE PAPER SHIRTS**

Cleanliness is one of the things upon which particular stress is laid by the instructors in the government's Indian

Paper shirts made in Japan and now being used in large quantities by the Russian army are said to have proved particularly valuable, because of their warmth, in the winter campaigns in Poland and East Prussia. The paper used is the "hashikirazu" paper made from mulberry bark in accordance with a process described in a recent number of this magazine. Paper clothing, known as "kamiko," has long been in use among the Japanese. Such clothing is both cheap and serviceable, its only drawback being that it cannot be washed. The



Combs and Brushes are Provided for All the Pupils at This Government Indian School

schools. At one of these institutions which is maintained for the benefit of the resident Indians in the Salt River Valley of Arizona, a somewhat curious method is followed in drilling the pupils in the practice of brushing their hair regularly. On one side of the school building there is a long, narrow board bearing a series of numerals, beneath each of which is a peg. Suspended from these are a comb and brush for each of the pupils, and their use is a part of the daily routine.

paper is warm and soft, but has little "size" in it, and for this reason a thin layer of silk wadding is placed between two sheets, and the whole is quilted when it is to be used for clothing.

**REFRIGERATED CHURCH IN A TEXAS TOWN**

5970

In Orange, Tex., where the summer temperature often reaches an uncomfortable degree, an enterprising religious organization has devised a way of making its church the most comfortable place in town on a hot Sunday. This is done by means of a refrigerating plant, set up in a small building in the rear of the church edifice. The cold-brine pipes are coiled in the church basement, close to a big ventilating fan. Outside air is sucked in by the fan, passing first through a water spray to cleanse it of dust, then through the refrigerating pipes and on up to registers located in various parts of the auditorium. The temperature averages 20° lower than outside. In winter, steam is used in the pipes instead of brine.

**POISON BUTTON NAILED**

**8484 OVER RAT HOLE**

A new feature in rat poison is a button filled with poison and glued to a tough piece of straw board. This is nailed over the rat hole in such a way that the rat or mouse is compelled to gnaw

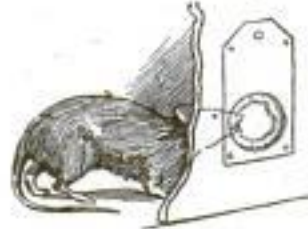

through the button and eat the poison in order to get out.

*American Sanitary Corporation,*  
*Infqrs., Memphis, Tenn.*  
*N. Mitchell, 611 Mission St.,*  
*San Francisco, Cal.*

*L. S. Dennison*  
*1400 River St.*  
*Hyde Park, Mass.*

Information sent out by  
Forest Service

Installed by the Southern Motors Co.,  
Louisville, Ky.  
Electrical World 8/29/14  
741

## POPULAR MECHANICS

### **PINE TREE WORTH NEARLY ONE HUNDRED DOLLARS**

9294

One of the costliest trees on record is a sugar-pine tree cut in trespass from the Stanislaus National Forest in California, for which the government exacted a payment of \$99.40. This tree scaled 18,933 ft. board measure, and contained more than enough lumber to build a good-sized suburban frame house, or to build a 2-ft. board walk nearly two miles long. In spite of its high cost the lumber was valued at only \$5.25 a thousand feet, which is a lower figure than national-forest lumber is often sold for. This is believed to be the first case on record in which a single tree felled in a national forest was valued at anything like \$100 on the stump.

### **CAST-IRON PAVING BLOCKS FOR BROOKLYN BRIDGE**

9006

To provide a roadway that will stand up under the heavy traffic that constantly passes over the narrow roadway of Brooklyn bridge, a new type of paving block consisting of a cast-iron shell, shaped somewhat like a building block and having the openings filled with concrete, has been placed in service. With the best paving material that could be obtained heretofore, ruts have appeared within a few months, necessitating troublesome and expensive repairs. The new blocks have been placed along the edge of the roadway where the rutting

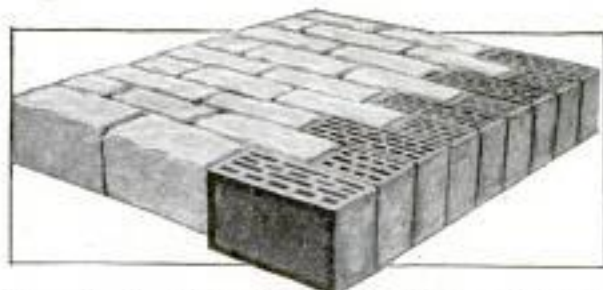

These Paving Blocks, Made of Cast Iron and Filled with Concrete, are being Used on the Roadway of Brooklyn Bridge to Do Away with Wear under the Heavy Team Traffic

was deepest, and although they have been in service for some time, they have not shown indications of wear.

Geo. F. Worts, 405 W. 118th St.,  
N. Y. City

### **AUTOMATIC ALARM FOR GARAGE ENTRANCE**

8441

An automatic alarm for the protection of pedestrians passing the door of the garage, which is flush with the



Red Lamp with Automatic Gong Warns Pedestrians When Car is Coming from Garage

inner line of the sidewalk, has been installed by a motor company in Louisville, Ky. The alarm is carried on a bracket that projects out over the sidewalk and consists of a red lamp that is kept burning at all times during the night, with a gong that rings when a car is coming from the garage. The most interesting feature of the apparatus is the automatic device that sounds the alarm. Placed in the floor of the garage in such a position that the two wheels on one side of any car coming from the garage must pass over it is a contact plate that makes and breaks the circuit controlling the gong. This plate is curved upward at the end so that the circuit is open under ordinary conditions, but a car passing over the plate depresses it and makes a contact.

Lord Rosse's telescope, a 6-ft. reflector, for 70 years the largest in the world, has been relegated to a museum.

THE BEGGING ELEPHANTS OF SIAM

8506

An Elephant on Its Knees Begging for Bananas Is a Common Sight in Siam

Begging elephants are one of the curious features of life in Siam and some portions of India. These elephants make the rounds from house to house regularly, getting down on their knees in a supplicating attitude as they beg for bananas and other fruits.



TESTING DRIVING CHAINS FOR HEAVY MACHINERY

8892

Transmission chains which are to be used for heavy work are tested on a

which they are expected to meet in actual service. Obviously any weakness or flaw is quickly discovered in this manner, but another function is also performed.

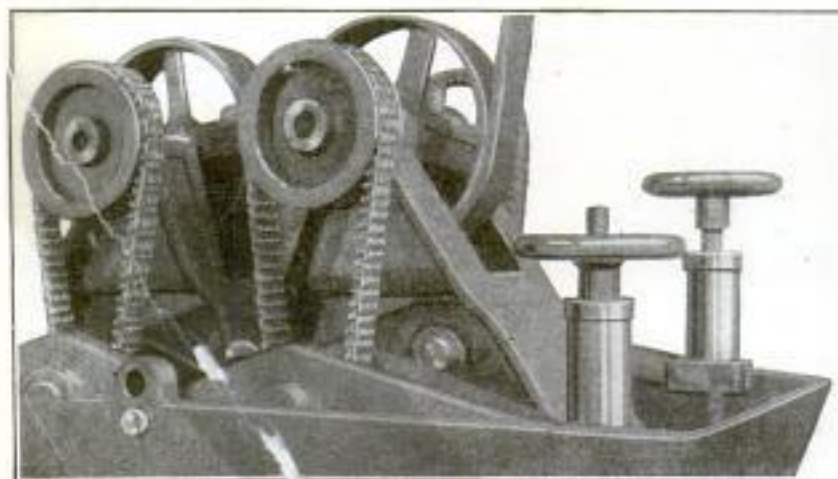

This Machine Removes the Slack from Chain Bearings and Makes a Second Adjustment Unnecessary

By putting them to a high initial tension in this way the slack is taken out of the bearings, which makes an adjustment after a short period of usage unnecessary. In the accompanying photograph the machine is shown in operation. The two chains in the foreground are being

stretching machine which submits them to a greater strain than that stretched, and this is done by adjustment of the screws at the right.

Chas C. Lynde, P.O. Box 468, Pottsville, Pa



Chicago Tribune  
Army & Navy Journal  
a foreign paper

INCENDIARY MEDIUMS USED

ask Mr. Elliott, Art Dept.  
SHIELDING TRAFFIC OFFICER

8828 BY GERMANS IN WAR

7915 FROM SUN'S RAYS

Reports from correspondents in Europe's theaters of war describe some of the equipment with which the German forces are said to have methodically burned villages in Belgium and on the French frontier, and razed buildings standing in the way of their advance. It is claimed that motor tank cars filled with gasoline under pressure have on several occasions been run through the streets of a town, sprinkling the outsides of the houses, which in turn have been fired by means of hand grenades. It is also asserted that in many regiments there is an incendiary corps equipped with gasoline cans, which are strapped to their bodies. These men enter a house which is to be burned and sprinkle the inflammable liquid through its rooms. An American correspondent of standing, in his cable dispatches, has described the firebrand disks which he asserts are carried by many of the German soldiers in Belgium. These consist of small wads, about the size of five-cent pieces and closely resembling charcoal, which are composed of a nitrocellulose material. They are contained in small bags which, when used, are ignited and thrown through windows of the houses which it is wished to burn. The effect is that each disk burns violently and jumps from one place to another much the same as a firecracker, although the combustion causes no noise, and no trace is left of what caused the fire.

An ingenious arrangement for protecting a traffic policeman from the sun's rays during the hot days of sum-

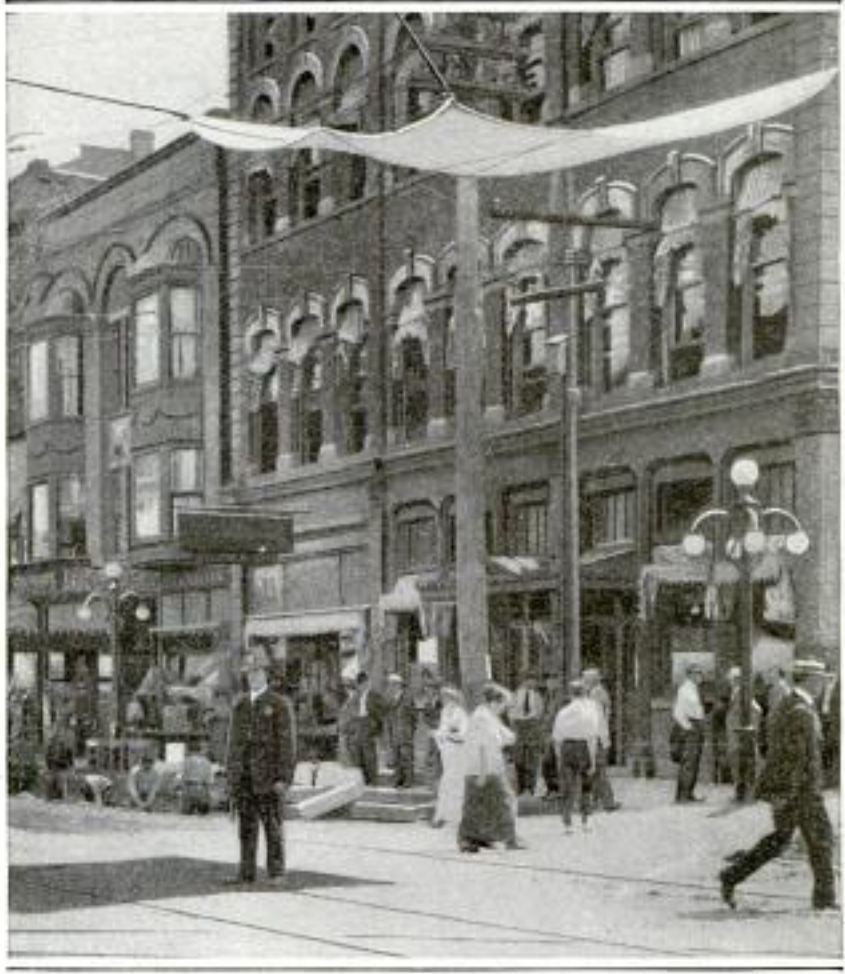

By Changing the Position of This Canvas Shade as the Sun Moves, a Traffic Policeman may be Afforded a Shady Place to Stand during the Heat of a Summer Day

mer, without at the same time obstructing the street with a large umbrella and supporting tripod which at certain hours is valueless, is employed at Aurora, Ill. It consists of a large square of canvas held by ropes which are fastened to pulleys on poles at the four corners of the street intersection. By letting out or drawing in the various lines the shade may be moved as the sun travels its course.

☞The U. S. naval collier "Caesar" was the first ship to proceed direct from Washington, D. C., to San Francisco through the Panama Canal.

*Invr: Dudley Tool Co.,  
Mechanics, Mich.  
Price \$3.00*

*The Rockwood Mfg. Co.,  
1902 English Ave.,  
Indianapolis, Ind.*

**FOLDING SHOVEL DESIGNED FOR MOTOR TOURIST**

*9008*

Intended particularly for the use of motor tourists, a folding shovel has been devised which may be easily carried in a tool box, or under the rear seat. The handle does not unjoint, but when unlocked may be folded back so that the whole implement occupies a space of about 12 by 6 by 2 in. It weighs 4 lb. and is substantial enough for all ordinary work. An additional advantage in having such a tool in the repair kit is found when it is necessary to jack up a car in sand or mud, at which time the shovel may be used as a base for the jack.

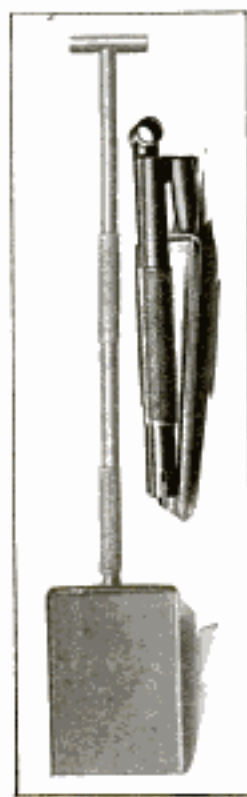

**NEW BRITISH DIRIGIBLE HAS NOVEL FEATURES**

*9009*

A new type of airship recently patented in England, of which several are being built for the British military authorities, according to report, embodies an attempt to combine the advantages of the rigid or Zeppelin type of dirigible with those of the nonrigid type. In this new air craft, the cigar-shaped outer air-tight covering contains a number of gas bags which, when filled with gas, completely fill the envelope, expanding it to its elastic limit and so rendering the whole structure rigid enough to navigate accurately. As the bags become deflated, through leakage or condensation, air is pumped into the outer envelope, thus maintaining the necessary rigidity. The main advantages claimed are simplicity of construction and ease of transportation when deflated.

*The Engineer*

**FRICTION GEARS OF PAPER TRANSMIT HIGH POWERS**

*9010*

Friction transmissions, in which intermeshing toothed gears are replaced by wheels having faces held in rolling contact by spring pressure and transmitting the load from one to the other by surface adhesion alone, are being made in a wide variety of sizes and forms, for many industrial purposes. Very large horsepowers are transmitted in this way in some installations. A recent development is the use of paper-faced cones operating in connection with iron cones to perform the functions of a bevel gear. The wearing qualities of the paper are said to be excellent, and as high as six horsepower per inch of contact width can be transmitted at a speed of 2,000 revolutions per minute.

**PHONOGRAPH HORN SERVES AS FLOWERPOT HOLDER**

*9011*

Using a cast-off phonograph horn as a jardinière is the uncommon service a Californian has made of an article which he redeemed from a scrap heap. The framework to support the funnel is made of strips of iron an inch wide, securely fastened together by rivets. The flower shape of the horn makes it quite a novelty as a container for a blooming plant when used either on a porch or lawn.



Water proof and fireproof paper and noninflammable motion-picture films made from seaweed have been produced by an English inventor.

*Robert Mearns, 322 Baymont St.,  
San Francisco, Cal.*

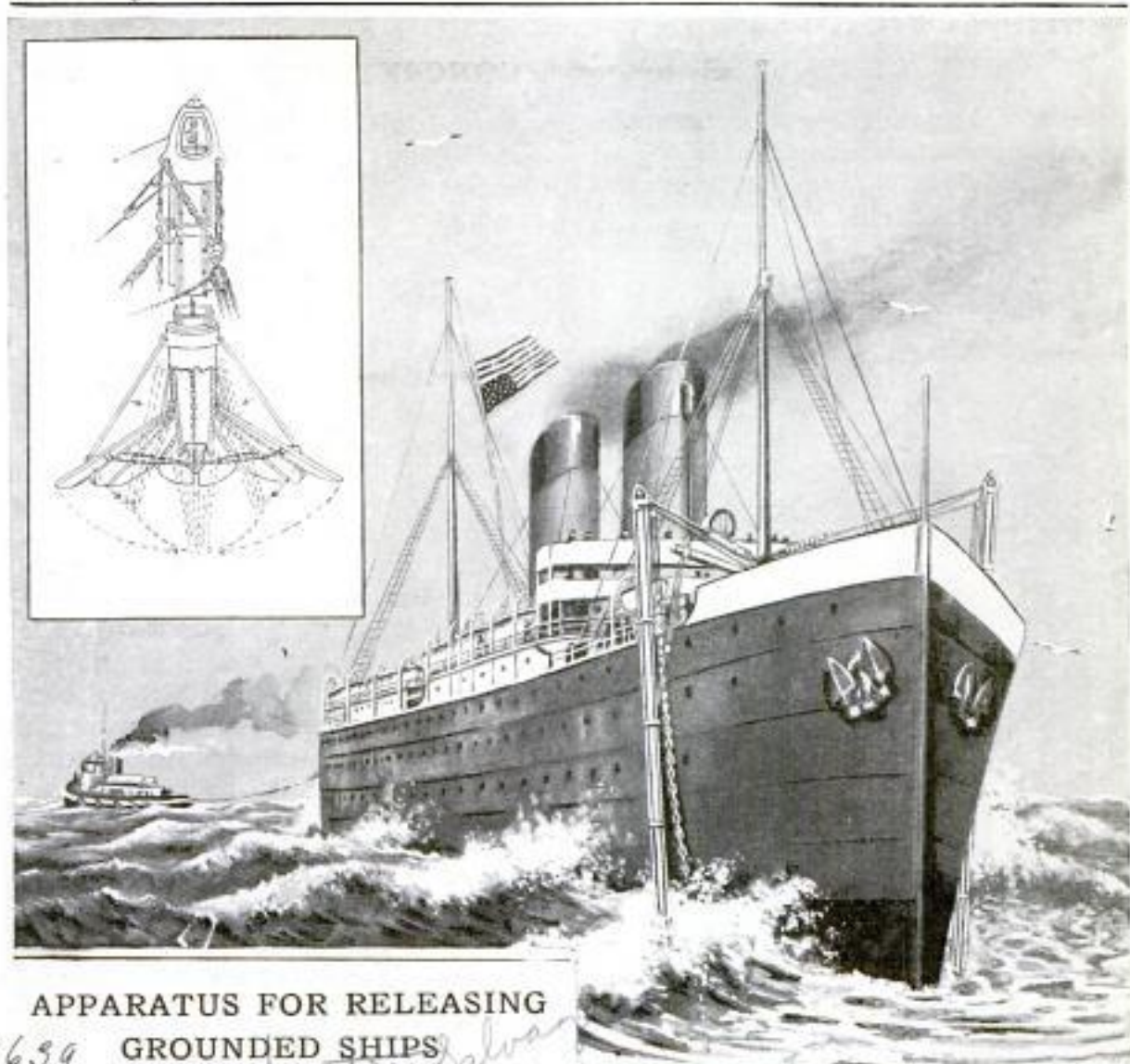

8639 APPARATUS FOR RELEASING  
GROUNDED SHIPS

*Machinery Salvage*  
A new apparatus for releasing grounded ships makes use of much the same principle as that used by a boatman on a small scale when he poles his boat off a beach. Two tubular steel columns that can be built up in sections to suit any height of ship are placed at the sides of the ship with their bases resting on the sea bottom. The bases of the columns may be spread out like an inverted umbrella for working on soft ground. Chains slung under the hull lead through gears at the top of each column to powerful winches on deck. With the winding up of the chains enough of the weight of the ship can be taken off the bottom to enable the ship to back off or be pulled off by tugs. The apparatus can be taken apart and stored on board the ship.



When the Chain Slung under the Hull is Wound Up by the Winches on Deck, Enough of the Weight of the Ship is Transferred to the Columns to Enable It to Back Off or be Pulled Off by the Tug. The Diagram at the Top Shows How the Column Base can be Spread Out Like an Inverted Umbrella When the Footing Is on Soft Ground

Owned by Farmers Cooperative Elevator Co.,  
Rudd, Iowa.

O. R. Geyer, 1429 W. 9th St.,  
Des Moines, Iowa.

## POPULAR MECHANICS

### FIREPROOF CRIB IS BUILT

9110 OF HOLLOW TILE

Built of hollow tile and concrete, a fireproof corner crib, with a capacity of approximately 1,000 bu., has been con-

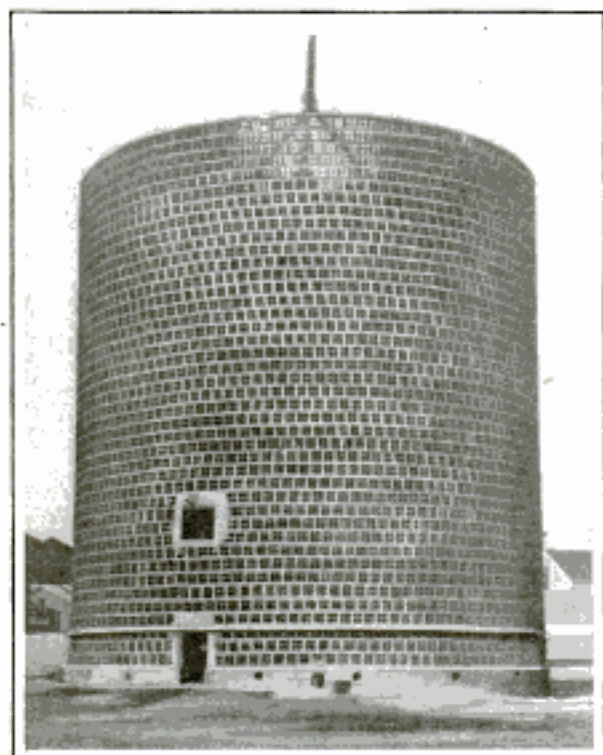

Corncrib Made of Hollow Tile

structed at Rudd, Iowa. The foundation and flooring of the structure is made of concrete, while the latter is supplied with drain pipes so that any water that might be driven in during a rainstorm would be drained out before it could work any injury to the grain. As a protection against rats and mice, galvanized iron and fine wire screening is used about the bottom of the structure. The tile is laid horizontally so that its open ends are exposed. This provides a honeycombed wall with perfect ventilation. In the center of the crib is an elevator which is used in hoisting the corn to the top, while passing along a pit at the bottom is a belt conveyor for carrying corn to a sheller on the outside.

¶ An appropriation of \$90,000 has been set aside by the state of Massachusetts for the reforestation of the denuded areas of Cape Cod.

### METHOD FOR ACID-PROOFING

8924  
Promethews 8/29/14  
CONCRETE PIPE IS FOUND

Patent rights have recently been awarded in Germany on a process for rendering concrete pipes acid-proof. The method consists of coating the interior of the tubing with asphalt, a thing which has previously been attempted but not with satisfactory results for the reason that the material could not be made to adhere permanently. In the new process a certain quantity of asphalt is mixed with the concrete before the pipe is molded. When the cast has been made and the tube dried, the interior is sand-blasted so that the particles of asphalt imbedded in the concrete are laid bare. When hot asphalt is subsequently coated over the inner wall of the pipe it immediately combines with the asphalt particles in the concrete, which serve to securely anchor it in place. There has been much demand for tubing of this kind in industries in which large quantities of materials containing acids must be conveyed through pipe lines.

### SIX-TON MOTOR TRUCK USED 8709 IN HANDLING GARBAGE

The problem of transporting garbage in a way to suit the peculiar conditions prevailing in that city has been solved in Detroit by the use of a six-ton motor truck working in conjunction with garbage-collection wagons. Owing to the long haul from most sections of the city to the substation where the garbage is loaded on railroad cars for transport to the reduction plant located outside the city, it is impracticable to use horse-drawn wagons for this part of the work. The motor truck could not be used in the house-to-house collection, owing to loss of time caused by the numerous stops. The solution was a combination of the two means of transportation. Each wagon is equipped with a box that holds two tons of garbage and can be lifted off the running gear. The motor truck has a flat deck and is equipped with a 2½-ton crane.

Frank C. Perkins  
Erie Co. Savings Bank Bldg.  
Buffalo, N. Y.



This Garbage Truck is Equipped with a Two and One-Half Ton Crane with Which the Loaded Boxes are Lifted from the Garbage-Collection Wagons to the Deck of the Truck

As the truck traverses the route to the substation it is met by the collection wagons, the loaded boxes are lifted to

the deck of the truck, and empty boxes brought back from the substation by the truck are replaced on the wagons.

## 8277 SPRINKLER SYSTEM FOR COOLING LIGHT COURT

In a high office building in which the glass roof of the central light court is near the third-floor level, a sprinkler system has been installed which keeps the upper side of the skylight wet and not only cools the air on hot days for the tiers of offices above, but prevents the accumulation of dust, which has proved an objectionable feature in the offices facing the court. The water pipes are suspended under the top chords of the steel frame and have vertical

risers that project well above the surface of the skylight, and to the tops of these risers sprinkler nozzles are fixed. One riser, located at the center of the skylight, has an ordinary nozzle that shoots the water upward to a height of 50 or 60 ft., and the effect is that of a fountain in the middle of the court. The water flows from the skylight into drains located at the corners of the court. During the summer the water is turned on frequently.

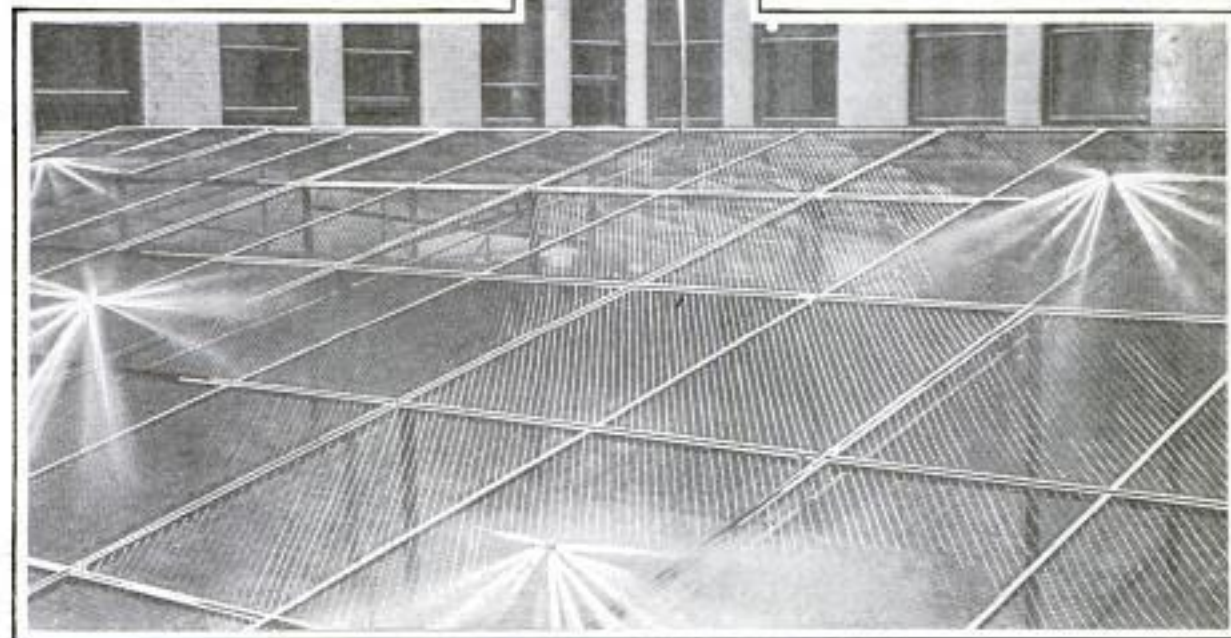

These Sprinklers Keep the Skylight Wet on Hot Days, Washing the Dust into the Drains and Cooling the Air for the Tiers of Offices Above

*J. S. Reid, 506 Belden Ave., Chicago, Ill.*

8410 **LARGE GAS-HEATED OVEN  
FOR BAKING ENAMELS**

One of the largest gas-heated ovens in the world has just been placed in service at Youngstown, Ohio, for baking the enamel on metal furniture. This oven is 30 ft. long, 16 ft. deep, and 11 ft. 6 in. high, and is divided into three compartments. It is of the radiator type, the chamber containing the gas burners being placed under the floor of the oven and made entirely independent of the baking compartments, so that the gas flame cannot come in contact with the fumes from the enamel as it is baked. The heating chamber, which is built under the entire bottom of the oven, is connected with ducts at the top of the oven by a series of flues that run up the sides of the compartments, and in this way the heat is radiated not only from the floor but from the sides as well. The floor plates are perforated and are supported on castings clear of the heating chamber, so that any material to be baked can be placed on the floor without danger of burning. The three baking compartments can be run independently and at different temperatures if desired, and each is provided with doors at both ends, to facilitate the handling of the material. Support is furnished by uprights that have their footings below the heating chamber.

These uprights are hollow and serve to supply the oven with fresh air, which is heated as it passes through the portions of the uprights that are within the heating chamber.

**LANOLIN WATERPROOFING  
FOR FRENCH UNIFORMS**

9392 *Saturday Evening Post*  
Lanolin, the fat extracted from wool in the process of cleaning it for manufacture, is being used by the French authorities for waterproofing the clothing of their soldiers in the field. The wool fat is reduced to a liquid by the use of a suitable solvent, such as chloroform or carbon bisulphide, and then diluted with a volatile hydrocarbon, like benzine, naphtha, or gasoline. Garments soaked for a short time in this liquid dry quickly when hung in the open, leaving the fibers impregnated with lanolin and almost perfectly non-absorbent of water. Neither the color nor the fabric is impaired by the treatment.

9114 **ILL LUCK ACCOMPANIES OPENING OF RAILROAD**

A few days before the opening of a new railroad in northwestern California, a slide came down a mountain slope and not only wrecked a \$10,000 steam shovel, but delayed the opening

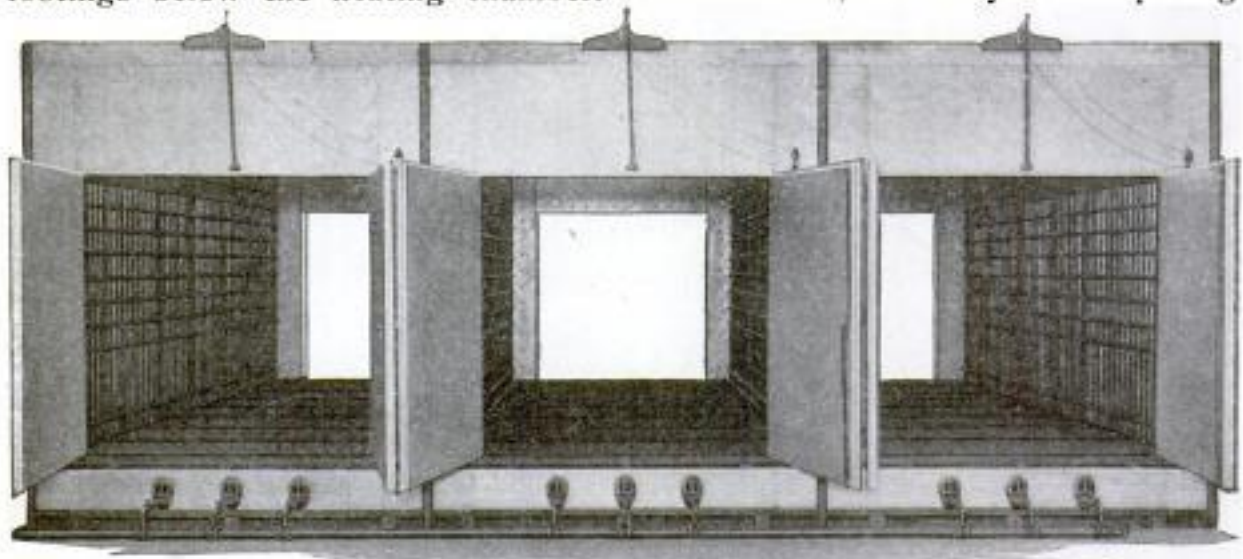

This Gas Oven, Which Is 30 Feet Long, 16 Feet Deep, and 11½ Feet High, is Heated by Radiation through the Floor and from the Flues at the Sides of the Compartments

*Allen W. Dayton, 1539 Franklin St., San Francisco, Cal.*



Cutting Away a Giant Redwood Tree That Fell across a New Railroad in Northwestern California

Upper Right: Steam Shovels Clearing Away the Mass of Loose Rock

Lower Right: What was Left of a \$10,000 Steam Shovel After a Slide Came Down a Mountain Slope



of the line for weeks while two steam shovels were busy clearing away the mass of loose rock. Then at a point where the line passes through a redwood forest, about 40 miles south of Eureka, one of the giant trees fell across the track, and traffic was stopped while a section of the tree was being cut away and the track repaired. The force of the fall was so great that it drove the ties and rails into the gravel roadbed over 3 ft. Some idea of the size of this tree is given in the illustration. It is about 100 ft. from the roots to the point where the tree lies across the track, while the upper branches of the tree are beyond the track and outside the limits of the photograph.

#### NOVEL DEVICE WHICH TRAPS 8478 FLIES MECHANICALLY

An automatic flytrap has been devised which makes use of the tendency characteristic of this insect to seek light when partly enveloped in darkness. The apparatus consists of a fine-meshed screen globe supported above a

revolving bait tray which is mounted above a cylindrical base containing a clockwork mechanism that operates it. Only one-half of the rotating disk, which is provided with a number of depressions in which powdered sugar is placed to attract the flies, is exposed to the light, one side of it being covered. As a fly alights in one of these divisions of the tray it is carried slowly around to the covered side where it is practically in darkness. The only means of immediate exit is through a



small aperture which leads to the interior of the wire ball. The fly instinctively travels toward the light admitted through this orifice and enters the trap. One winding of the clockwork operates the trap for 24 hours.

*U. S. Manufacturers Distributing Co., Inc.,  
101 East 42d St., N. Y. City.*

*# Mrs. Avis Gordon Vestal, 4245 N. Koehler Ave. Chicago, Ill.*

*The Electrical Review 1-8-15*

## NEW METHODS OF LOCATING AND REMOVING BULLETS

9217

Some interesting methods of locating and extracting bullets have been brought to light in connection with the European war. One of the most ingenious of these is that of locating a bullet with the telephone. In applying this method one terminal is attached to a moistened electrode which is applied to the patient's skin, while the other terminal is attached to the probe, or forceps. When the probe touches the bullet a voltaic cell is formed and a grating sound is heard in the telephone, revealing the exact depth at which the bullet is imbedded in the flesh. A method more commonly used is one in which X-ray photographs are taken. Two photographs are taken from different positions and the intersection of the axes of the two views is sufficient for giving the location of the bullet accurately. In the French field hospitals

bullets are being extracted by means of electromagnets, the German bullets with their nickel-steel jackets lending themselves readily to this method of extraction.

## HOW A BIG SHIP LOOKS

8570 AFTER A FIRE

It is not often there is enough left of a burned ship to photograph, but the accompanying illustration shows how a great steel freighter looks after a disastrous fire. The "Santa Catalina," which was destroyed by flames in the Columbia River, was one of the first ships to carry a cargo from an Atlantic port through the Panama Canal. The freight on board was worth \$400,000 and was almost a total loss, while the vessel itself, worth \$700,000, was very badly damaged. The "Santa Catalina" was an oil burner, and several thousand barrels of crude oil from the starboard tank added fuel to the flames. All the 42 members of the crew escaped.

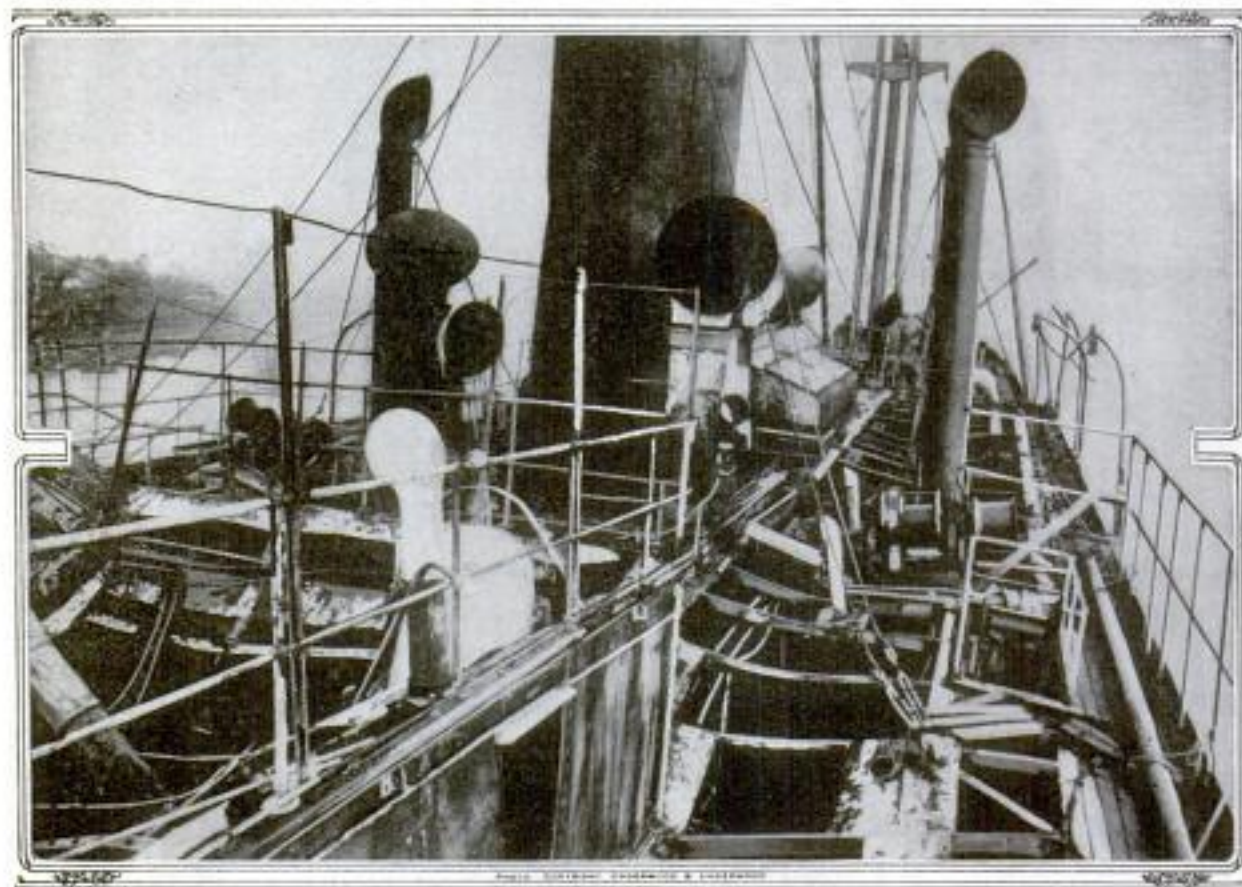

How the "Santa Catalina" Looked after a Disastrous Fire

*Underwood & Co.  
12-14 West 37th St.  
N.Y. City*



*Roy Dugh, Celery City, Pa.*

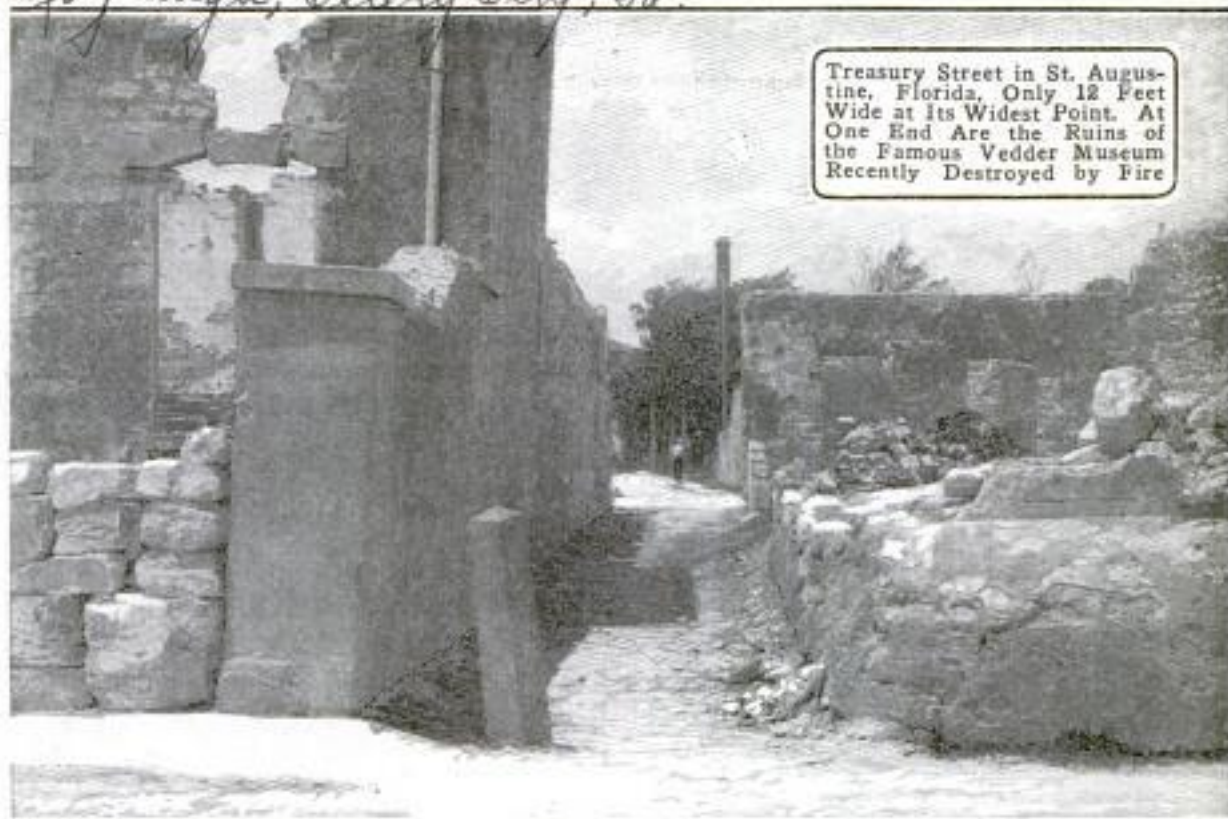

### IMPORTANT STREET NO WIDER 8280 THAN AN ALLEY

What is believed to be the narrowest street in the United States is Treasury Street in St. Augustine, Fla. This street is two and a half blocks long. It is 12 ft. wide at the west end, but narrows at the east end to an alley across which two persons may clasp hands. This thoroughfare is lighted as well as the "regular" streets in the city. Many front doors open on it, and it has its overhanging balconies, high garden walls, and passing crowds. At one end stood the famous Vedder Museum, recently destroyed by fire.

### FRESH-AIR CHUTE DESIGNED 9188 FOR SLEEPING CHAMBER

For those who are desirous of having the benefit of an open window in their bed chamber without the accompanying cold during winter months, an ingenious air chute has been perfected. It consists of a collapsible pipe which is made by stretching canvas, or some other durable cloth, over a framework

composed of wire hoops. One end of this tube is fastened over a circular opening cut in a board which fits between the sash and sill of a raised window, while the other forms a sort of drapery which incloses the sleeper's pillow. A cord extending from the bed to the intake at the mouth of the chute permits control over the volume of air admitted.



Novel Method of Obtaining Fresh Air without Making the Bed Chamber Uncomfortably Cold during Winter Weather

*Mfr: The Sanitarium Equipment Co.,  
Battle Creek, Mich.*

*# Hinton Gilmore, Battle Creek, Mich.*

Park Row Station Chicago.  
Story obtained by J. E. Murphy  
Dec. 31, 1914

752

## POPULAR MECHANICS

### LOCOMOTIVES SUPPLY HEAT FOR PASSENGER STATION

9014 Four locomotives set off on a side-track and connected with the steam main were used by a railroad in Chicago to supply heat for its passenger station and coach yard for a month or more during midwinter, while the boilers in the central heating plant were being replaced. The tenders were first removed, and the locomotives were backed up together in pairs, a space of about 10 ft. being left between the locomotives of each pair. This space was then filled with a platform and shelter for the firemen. Steam was taken from each of the locomotives through a 3-in. pipe, and all four of these pipes were connected with a 6-in. pipe, which led underground to a connection with the permanent steam main. To provide the necessary draft to take the place of that caused by the exhaust from the cylinders when a locomotive is run-

*Die Umschau 8/1/14*  
ning, the smokestacks of these locomotives were replaced by straight stacks, from 8 to 10 ft. in height.

### GOLDFISH REVIVES RAPIDLY AFTER LIQUID-AIR BATH

9092 Organic matter is made more brittle than glass when it is immersed in liquid air, which is responsible for the fact that if a human hand, for instance, were placed in the fluid and left there for several minutes it would upon withdrawal be so fragile that a comparatively light impact would crush it into small particles. A severe "burn" caused by liquid air frequently requires months for healing. In view of these facts it is interesting to note the result attained during an experiment in which a goldfish was placed in a tumbler filled with the liquid. It was frozen hard immediately upon immersion and was later removed and placed in a glass of water, the temperature of which was about the same as that of the atmosphere in a comfortably heated room. After a few seconds the fish showed indications of life and shortly commenced swimming around as lively as if nothing had happened.

Using sawdust from a near-by sawmill to make producer gas, a Swedish electric station produces power at half the cost of water power.

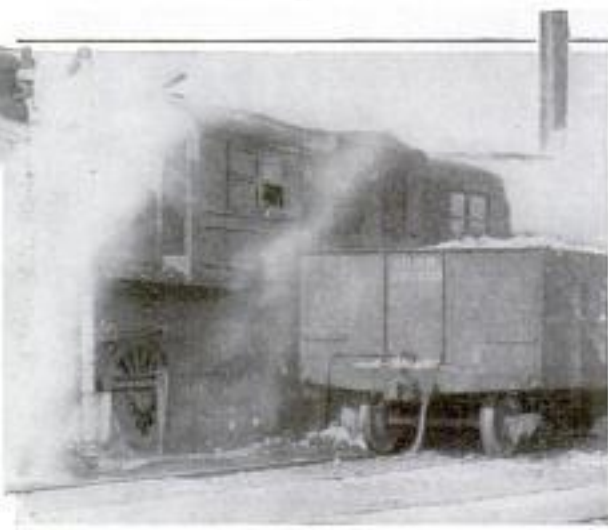
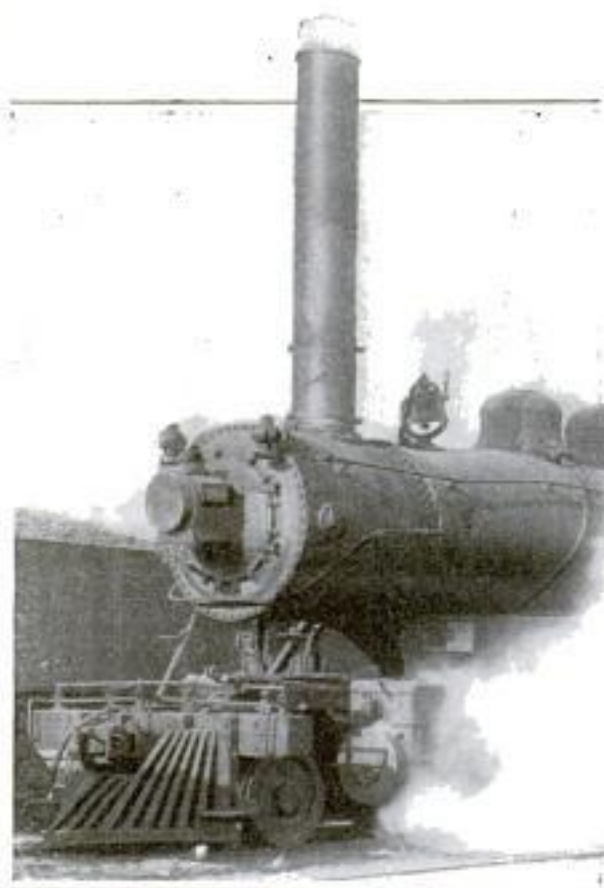

Locomotive Supplying Steam for Heating Chicago Passenger Station While Regular Heating Plant was being Repaired

*The Chase Continuous Caloché, Ltd.,  
11 Queen Victoria St.,  
London, E. C., England*

**POPULAR MECHANICS**

*The Keystone 12/1/14*  
**8908**

**TIME DIFFERENCE BETWEEN WASHINGTON AND PARIS**      **COLLAPSIBLE GLASS ROOFING PROTECTS GARDEN PLANTS**

The first direct observations for determining the difference in time, and therefore in longitude, between Washington, D. C., and Paris, France, were recently completed and give this difference as being 5 hours 17 minutes 36 seconds. Independent observations were made by the United States and French governments, each having two parties, one at the Arlington naval station and the other at the Eiffel tower. The distance between the two points on a great circle was found to be 3,831 miles. One interesting feature of the observations was that of determining the velocity of transmission of wireless signals, which was found to be about 175,000 miles a second:

*782* Furnishing a shelter for tender plants, protecting them from frost,

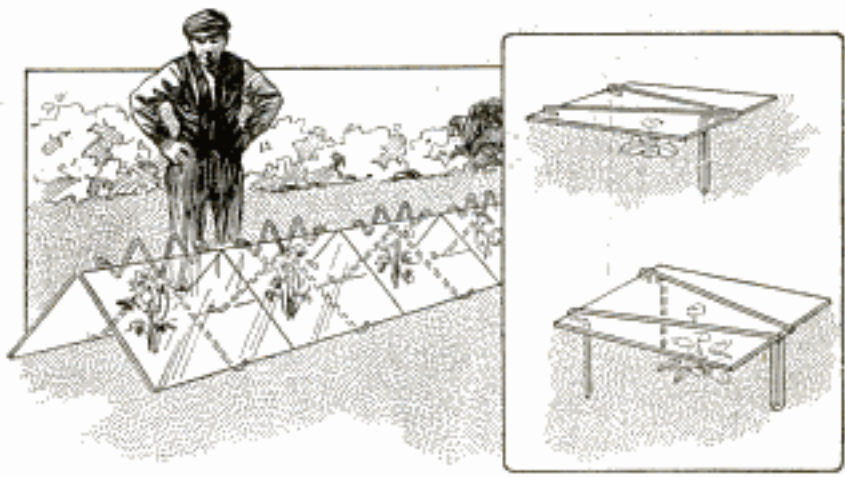

**Tent-Shaped Glass Roofing for the Protection of Rows of Young Plants**

driving rains, and overexposure during the early weeks of spring, a collapsible glass covering is being made in England. It is so arranged that it may be taken apart readily and stored in a small space when not in use. Each unit is composed of panes of glass, held together firmly like a tent by wire fasteners. These are placed end to end over a row of plants, both protecting them and centering the sun's rays upon them. This enables a garden to be set out much earlier than otherwise would be advisable, and insures an early crop.

**GROUND BAR MAKES STEEL FENCE POST RIGID**

Steel fence posts fitted with bar bases, which hold the upright firmly in the earth, are a recent product. An angle head, which allows the post to be driven with an ordinary sledge, saves the time and cost of digging holes and doing the customary tamping. The ground bar has an 8-in. bearing on the soil, and when sunk below the surface, braces the post, which is set 20 in. deep, against side pressure. Any style of fencing may be attached to the posts without difficulty.

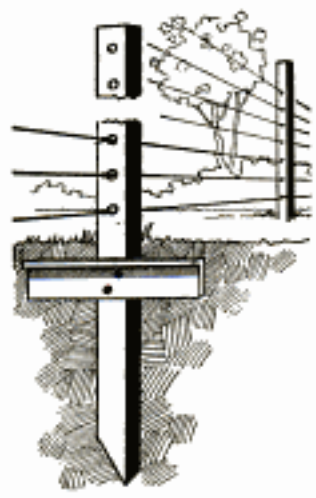

**EVERGLADES RECLAMATION A BIG PROJECT**

The Everglades, those famous swamps of Florida, covering thousands of square miles in a state adapted by climate to the production of luscious fruits and early vegetables, have represented for centuries a direct loss. Careful scientific investigations have demonstrated that water flowing over the edge of Lake Okeechobee seeks an outlet through the low-lying lands between the lake and the sea. Control of the overflow, it is asserted by the engineering commission recently appointed to report on condi-

*Janesville Barb Wire Co.,  
Janesville, Wis.*

*Engineering & Contracting  
1/28/14*

*now selling America: The Caloché Co.,  
131 Hudson St., N.Y. City*

tions there, will eliminate the swamps. Existing canals are to be supplemented by a system which shall divert the water from Lake Okeechobee



Canals Which are Planned to Make Fertile a Great Tract

through the shortest practical route to the Atlantic Ocean. Included in the project is a navigable canal, 12 ft. in depth, from St. Lucie to the lake, and the construction and utilization of waterpower of 5,000 hp. The total cost of the project is estimated in excess of \$18,000,000.

### PROLONGING LIFE OF WOOD 8986 IRRIGATION PIPES

Millions of dollars have been expended in the United States during recent years in the construction of wooden pipes for irrigation purposes, and this has led the Department of Agriculture to study the question of

how they may best be maintained in order to give the greatest number of years of service. It has been found that conduits made of fir or redwood, if fully exposed to the atmosphere and supported free from contact with soil, will, when properly cared for, last approximately 20 years. Contrary to former beliefs, the life of such a pipe depends upon the wood rather than its metal bands. The growth of fungi and possibly the presence of certain bacteria are principally responsible for decay. Fungi grow only under a favorable combination of air, moisture, and heat; the exclusion of any one of which checks the development. Because of this, pipes which are buried in the ground will be preserved longest by either the maintenance of a high internal pressure which saturates the pores of the wood, or by being packed in very fine soil. When under light pressure and in contact with the earth a wood pipe is most prone to deteriorate, while, on the other hand, if it is entirely exposed to the atmosphere its exterior is generally too dry to be conducive to the growth of fungus spores.

### DOORS NOT NEEDED IN DARK ROOMS WITH LIGHT LOCKS

In the construction of laboratories for one of the film companies at Chicago, light locks were devised which eliminate the necessity of employing

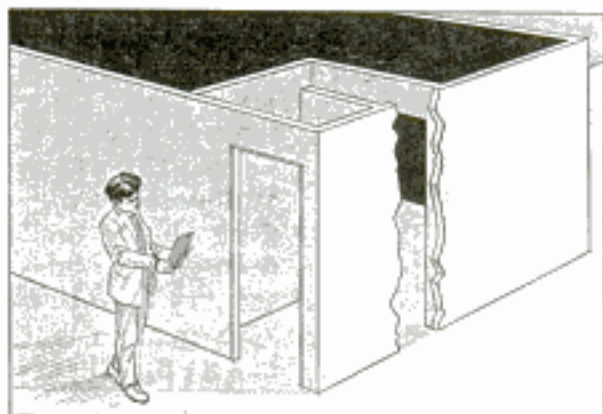

The Arrangement of the Light Locks Which Make Doors Unnecessary in Dark-Room Laboratories

either revolving or swinging doors between the dark rooms and those which are illuminated, while at the same time

Submitted by James T. Woolson  
Wm. D. McJannet Adv. Agency  
35 S. Dearborn Chicago Ill.  
Copyrighted material

Information sheet sent out  
by Dept. of Agriculture

permitting full ventilation. At all the exits the walls are built so that there is a "U"-shaped recess into which another wall protrudes part way, almost the same as if the standard of the letter "T" were partly inserted in the opening of the letter "U," the cross part of the "T" and one side of the "U" representing the regular building walls, and the other parts, the light lock. The surfaces of the lock walls are painted jet-black, to safeguard against reflection. The arrangement is such that while it is possible for a person to walk through the opening without any difficulty, it is not possible for rays of light to penetrate from one room to the next.

*"Patented" Spectacles*  
**NEW LENSES GIVE CLEAR VISION AT ANY ANGLE**

Although developed apparently to the highest point of perfection the best of spectacle lenses heretofore in use have provided the correct refraction only at or near the optical center, or the point directly in front of the pupil

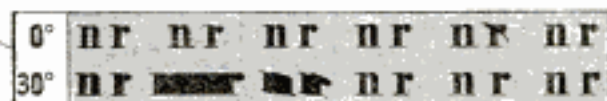

The First Three Columns Show the Distortion Caused at Different Angles by Ordinary Spectacle Lenses, and the Last Three Columns the Effect Produced by Lenses of the New Type

of the eye, and have been subject to a slight distortion when looked through at points near the edge. A new type of lens is designed to do away with this fault and to make the vision as clear through points as much as 30° from the optical center as through the optical center itself. This is accomplished through an exceedingly complex method of grinding the lenses, that necessarily makes them expensive.

**DEVICE DISCOURAGES HENS FROM SITTING**

A device which has been used with some degree of success in discouraging hens from sitting, consists of a screened coop provided with a bottom made of narrow slats which are quite widely

separated. When placed inside of this, a hen finds standing the most comfortable position it can assume. If it at-

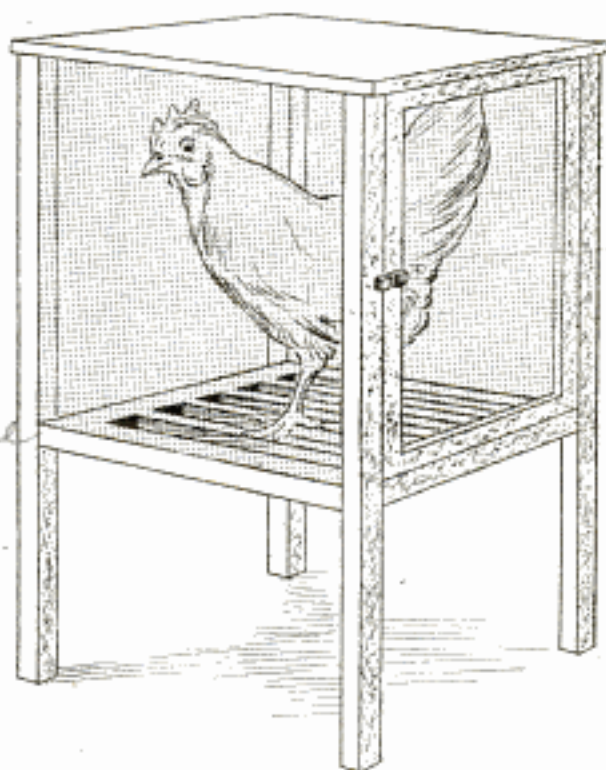

If Placed in This Coop for a Day or Two, a Hen Usually Returns to Egg Laying

tempts to sit, the position is difficult to maintain, and the sensation of feeling air currents instead of eggs, disconcerting. After having been kept in this box for two or three days a hen usually returns to laying eggs.

**STEEL TIE DESIGNED TO BE ELASTIC**

A steel railroad tie brought out by a German inventor is an attempt to combine the advantages of metal with the elasticity of the wooden tie. This tie consists of a steel trough having curved sides and bottom, so that while it has a firm bearing in the roadbed it will yield slightly under the weight of a train. It is attached to the rail by bolts passing through the projecting edges, and is filled with earth or gravel.

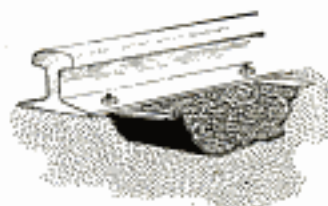

*Prometheus 5/9/14*  
 Inventor: *Edward Ohler*

*Carl Ziss, Temp. Sen. & London  
 Barisch & Hornb. Optical Co., New York, N. Y.  
 The Optical Jour. and General  
 6-4-1914 - p. 168 To see review only*

*Fred Telford, 605 South  
 Douglas Ave., Springfield,  
 Ill.*

## NOVEL AND PRACTICAL THINGS FOR DAILY USE



Convenient Gas-Lighting Device

which eliminates the necessity of using matches when lighting a gas stove or lamp. Inside of a perforated cap, which is at the end of a wooden handle, are



Memorandum Tab Attached to Watch

An ingenious memorandum slip which serves a real purpose for the man who has a tendency to be forgetful, consists of a small piece of celluloid fitted with a clip that may be fastened to the stem of a watch. Notes may be scribbled in pencil on the celluloid and erased at will, while anything written on the tab is sure to be noticed during the day whenever the watch is consulted.

Designed for warming a small quantity of water or milk quickly, an electric heating device has been invented which may be used in a nursery or sick room. The resistance coil is incased

**WORKING** automatically and serving for an indefinite period, a gas-igniting device has recently been introduced

several fine wires made of a metal which becomes incandescent when coming in contact with the gas. Because of this property it is only necessary to turn on the gas and place the stick in the flow in order to ignite it.

in a cylinder less than an inch in diameter and about  $4\frac{1}{2}$  in. long. This is provided with a metal top which serves as a cover for the glass in which the liquid to be heated is contained. It is said to be capable of boiling a glass of water in less than two minutes.



Letter Opener and Paper Cutter

inclosures are not so liable to be cut in two accidentally as when an ordinary paper knife is used. It is fitted with a keen cutting edge which may be removed when desired.



Hot-Water-Bottle Dolls

ers which may be readily filled, making the bodies of the dolls plump, soft, and warm so that they are eagerly accepted as bedfellows. They are made either with indestructible heads, or like rag dolls.

An adjustable clamp for a crochet needle has been devised which enables



Finger Clamp on Crochet Needle

it to be fastened to the first finger so as to relieve the strain of gripping the instrument between the thumb and finger. The device also assists the beginner in learning the correct way to hold a needle, which is not always as easy as it looks.

Intended for emergency purposes, a pocket screwdriver is being made which may be carried as easily as a small coin. The device is about the size of a quarter and is provided with a tapering rim so that it will fit any ordinary-sized screw slot snugly. It is also supplied with a center hole which enables it to be carried on a key ring or hung on a nail.

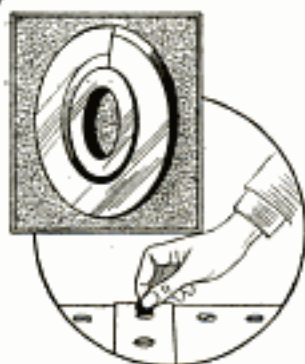

Convenient Pocket Screwdriver

An enamel-topped kitchen table which is easily kept clean and sanitary is a recently introduced household accessory. The top is made of a white, reinforced material that is not only water and acid-proof, but also is resili-



Enamel-Top Kitchen Table

ent enough to eliminate the danger of chipping china by contact with it. It is provided with a seat which may be swung out of the way when not in use.

A convenient water-draining device, for use in private laundries and similar places, is designed to transfer water from a

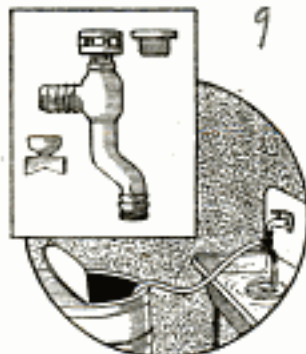

Water-Draining Apparatus

washing machine, or other receptacle, into a sink, or wherever it is wished to conduct it. The apparatus is attached to a faucet, and has a hose connected with a side extension and reaching into the container which is to be emptied. By turning on the water a suction is created in the hose, causing the water to discharge itself.

A bottle stopper which hermetically seals a flask and eliminates the danger of a cork becoming loose, allowing the contents of a receptacle to spill in a bag or suitcase, is designed particularly for the use of travelers. It is fitted with a heavy rubber tube which may be turned down over the lip of a bottle, sealing it air-tight and at the same time holding the cork securely in place.

To eliminate the danger of the polished top of a bureau or desk being marred when plate glass is used to cover it, triangular rubber pads are being made which, when placed under the glass at each of its corners, prevent it from slipping.

Flat, telescoping curtain rods are being made which, although light in weight, have sufficient strength to support heavy valances, or over draperies, without sagging.



Stopper Seals Flask Hermetically



Rubber Pads for Glass Table Covers

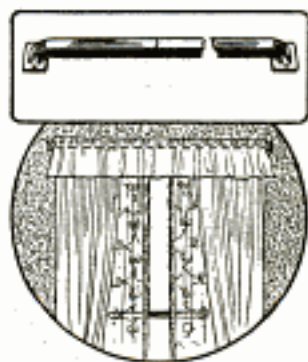

Curtain Rod Which does Not Sag

**7998 PAPER SACK HAS STRING ATTACHED READY TO TIE**

A paper bag carrying, fastened between its folds, a string with which it may be tied, is a recent novelty de-

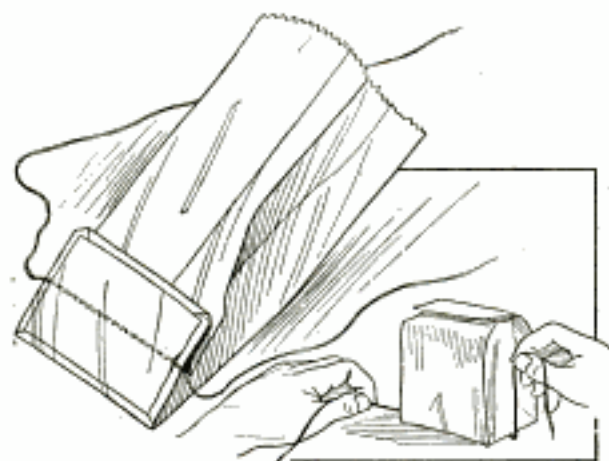

Paper Bag with String Attached

signed to facilitate the wrapping of small packages. Ends of the string extend through channels at both sides of the bottom of the sack. A sufficient length of twine to securely tie the package is contained in a compact space between the folds. When the bag is filled and ready to be wrapped it is only necessary to pull the string about the bag and fasten it.

**7015 SAFETY DEVICE TO HOLD SUSPENDED PLATFORM**

A large percentage of the accidents that happen to painters and other workmen working on platforms that are sus-



How the Safety Device Works in Case a Workman Loses His Hold on the Fall Rope

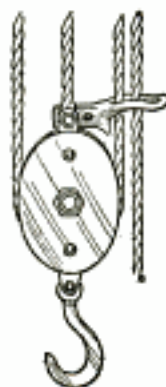

ended by block and tackle occur when the fall rope slips from the hands of one of the workers, and to prevent just such accidents as this a simple and apparently effective device has been invented. It consists of

*Edmond A. Von Kaenel  
312 Wendell St.,  
Inventor Chicago, Ills.*

a steel loop with a solid end through which the bolt at the top of the block passes, forming a pivoted connection, with the loop end free to swing up or down. The fall rope and the adjacent rope pass through the loop. At the inner end the loop is large enough to permit the ropes to work freely, but tapers to a tight fit at the outer end. In case a workman loses his hold on the fall rope, the friction of the rope causes the loop to fly upward, when the fall rope is forced into the small end of the loop and holds the platform securely.

**7197 A REFRIGERATOR MILK CAN KEEPS MILK SWEET**

A new way of shipping milk and cream for long distances during the heated season is offered by the invention of a refrigerator milk can which is simply two cans, one within the other, the space between being filled with baked cork and hair felt. In severe tests, under practical road conditions, milk shipped in these cans showed a rise in temperature of but 18° in 24 hours, when exposed to a continuous temperature of 92°. A special form of neck is provided, the inner portion being a segment of a sphere over which the bowl of the cover fits closely, so that the can is perfectly tight, even if the cover be tilted to one side or the other.



**9028 MILITARY FLIERS' SUCCESS HINGES ON AIR MAPS**

In extensive operations an airman is almost as seriously hampered if he attempts to navigate the air without aeronautical charts, a compass and a barometer, as a seaman would be were he to try to sail the ocean without nautical maps and various instruments

*Flying*



with which to make observations. This is especially true of the military flier who is penetrating into foreign territory. He must know his position accurately, for a forced landing might mean his undoing. And to the aerial chart is due much of the success of European military airmen. This is mounted on rollers, most often, and so arranged in a frame that an aerial navigator may unwind his chart and thus keep a map of the immediate territory over which he is flying constantly before him. When made for military purposes such a chart includes the positions of fortifications, military camps and whatever information is known of the enemy's district. By landmarks indicated on the map he is able to recognize his position. Attached to the frame usually are his compass, barometer and clock, although these oftentimes are provided for in some other manner.

### ADJUSTABLE SEAT FOR

### 7171 MOTOR CHAUFFEUR

While the necessity of an adjustable automobile seat suited for quick adaptation to different drivers long

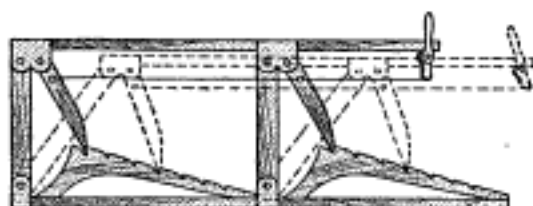

This Automobile Seat Is Adjustable to Suit the Driver



has been felt, the invention of such a device has been made only recently by an Australian. In the case of an ordinary fixed seat, the reach to the clutch and brakes may be comfortable for one chauffeur and exceedingly awkward for another. To overcome this trouble, a frame has been made which may be adjusted speedily to any desired position by moving the seat downward and forward, or upward and backward. This function of the arrangement is made possible by the operation of a single lever. To do this, a series of ratchet bars are employed which are fastened to the seat by link rods. Pivoted to these are locking members which engage and disengage the ratchets.

### GRIP STRENGTH NOT NEEDED

### 7106 TO WORK NEW NUTCRACKER

A new type of nutcracker is worked by placing pressure upon a single lever, instead of gripping two bars as in the case of the ordinary implement. The construction is simple, the device consisting of one lever pivoted into a shorter toothed bar which forms the lower part of the cracker. When in use the instrument is placed on a table, the nut inserted between the two pieces

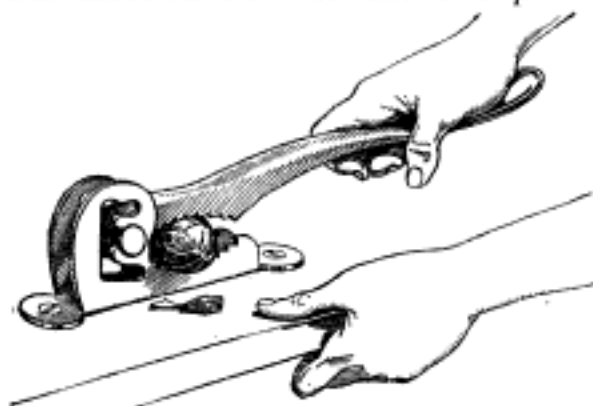

Nutcracker a Child can Use

and pressure exerted upon the lever. In this manner it may be worked with rapidity by a child.

### NEW PROCESS CHEAPENS

### 9502 RADIUM COST

Radium bromide valued at \$11,000, recently turned over to the National Radium Institute for the treatment of cancer cases, is the first radium extracted by the new process developed by the experts of the Bureau of Mines. The work of extracting the metal was done in the laboratory of the bureau at Denver, from Colorado ores. The cost was only \$40,000 a gram (15.43 grains), while the commercial price of radium is about \$120,000 a gram.

Dispatch from Washington in Chicago newspaper and investigated by J. E. Mc Carthy, Col. Stab, Wash. D. C.

Inventor: H. K. Mc Ewan  
Swift Current,  
Sask., Can.

## NEW UNITED STATES COAST GUARD ESTABLISHED

The establishment of the United States Coast Guard, provided for in a recent act of Congress that has been approved by the President, brings about an amalgamation of the revenue-cutter and life-saving services that is expected to result not only in an improvement in the work of these two services but in the provision of an invaluable means of coast patrol and defense in time of war. The coast guard is to have its land and sea forces enrolled like soldiers and sailors, under like discipline, and with parallel emoluments for service and rewards for distinguished deeds, but organized primarily for the saving of human life and property.

At the discretion of the President, the entire service may be transferred to the Navy Department, and will constitute a naval reserve composed of highly trained officers and men thoroughly familiar with the coast and ready at a moment's notice to operate under the Navy Department. In time of war the life-saving branch, now designated as the shore division of the new service, would serve as a beach patrol to give warning of the approach of hostile vessels. The life-saving stations would be used for observation and signaling, while the revenue-cutter branch, now designated as the marine division, would be utilized for scouting and similar duties. The plan of using the life-savers as a coast patrol in time of war is not a new one, and was resorted to during the Spanish-American War. The amalgamation of the two services has created an establishment composed of 4,100 officers and men, 25 ships of the seagoing type, 19 harbor tugs and launches, and 279 coast-guard stations.

Under the regulations, the disadvantages that have heretofore operated to make the life-saving and revenue-cutter services unattractive to ambitious young men have been removed. Provision is made for placing the men on the retired list for age, or after 30

years of service, as is done in the army and navy; for increased pay for reënlistment; for clothing allowances; for medical attention from the United States Public Health Service, and for a sum of money equivalent to two years' pay to the dependents of men who lose their lives in the service. With all the benefits that are expected to accrue from work of the coast guard, it will, in fact, cost the country nothing, as the saving of life and property will at all times be worth more to the people than the cost of maintaining the service. Records of the two services, for the year ended June 30, 1914, show that for each dollar expended there was a saving of \$5.09 worth of property from the perils of the sea. In addition to this, 5,238 lives were saved and 31 derelicts, or obstructions to navigation, were removed or destroyed, during this period, while assistance was rendered to 2,147 vessels having an aggregate value, including cargo, of \$24,386,191. There will be an increase in the cost of operating the service, however, due to the retirement of officers and men and reënlistment and disability increases, all estimated at \$400,000 for the first year, and the payments made to dependents of men who lose their lives in the service, estimated at \$20,000 a year. One of the men to be placed on the retired list at three-quarters pay is Sumner I. Kimball, now 80 years of age, who founded the life-saving service and was its superintendent for many years, and who devoted the best years of his life to its upbuilding. While the work of the coast guard will be confined mainly to the Atlantic, Pacific, and Gulf coasts and to the Great Lakes, the service will be held in readiness to give prompt assistance when lives and property are threatened by floods along the rivers of the country.

---

☞ In one day 15 forest fires in California were started by a single wood-burning locomotive.



## A Homemade Metal Fence

By T. T. STURGEON

**T**HE metal fence shown was constructed by myself, who am only an amateur mechanic, and can be duplicated by any mechanic of average ability who has an accurate eye and a good stock of patience. The tools used to build and erect the fence were a hand drill press, a pipe-fitting outfit, and the ordinary set of bench tools; the jigs, and other appliances, illustrated were made of junk, picked up about the home shop.

The length of the fence is 100 ft.; the height above the wall, 30 in.; space between pickets, 2 in.; distance between rails, 12 in.,

ening the large number of pickets. The smaller things required are four 2-in. ball ornaments; eighteen 1-in. pipe

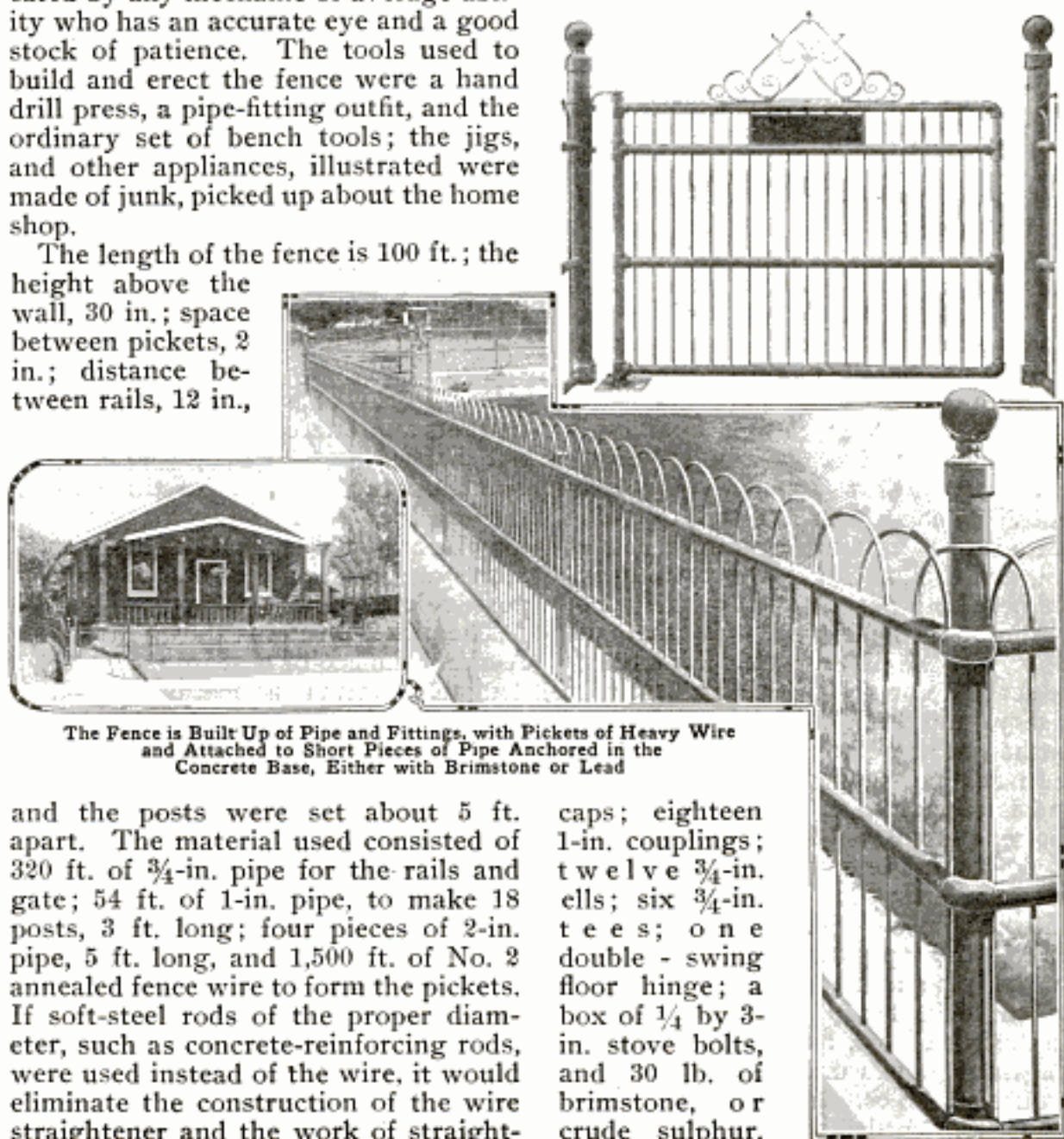

The Fence is Built Up of Pipe and Fittings, with Pickets of Heavy Wire and Attached to Short Pieces of Pipe Anchored in the Concrete Base, Either with Brimstone or Lead

and the posts were set about 5 ft. apart. The material used consisted of 320 ft. of  $\frac{3}{4}$ -in. pipe for the rails and gate; 54 ft. of 1-in. pipe, to make 18 posts, 3 ft. long; four pieces of 2-in. pipe, 5 ft. long, and 1,500 ft. of No. 2 annealed fence wire to form the pickets. If soft-steel rods of the proper diameter, such as concrete-reinforcing rods, were used instead of the wire, it would eliminate the construction of the wire straightener and the work of straight-

caps; eighteen 1-in. couplings; twelve  $\frac{3}{4}$ -in. ells; six  $\frac{3}{4}$ -in. tees; one double-swing floor hinge; a box of  $\frac{1}{4}$  by 3-in. stove bolts, and 30 lb. of brimstone, or crude sulphur.

This completes the list with the exception of the gate ornament, which once adorned a gasoline stove in a different form and was bent to suit its present use. The total cost of the material, including that of the 14-in. wall, was 51 cents per lineal foot.

The first operation in constructing the fence is to build the drill bench, and on it and the drill jig depends the accuracy of the large number of holes to be drilled. The table of the press is swung out of the way and a perfectly straight plank—one without a twist in it is absolutely necessary—12 in. wide, 2 in. thick, and 12 ft. long, is placed at the proper height with the drill about 2 ft. from its right end. The plank is adjusted so that its surface is level and at perfect right angles to the drill spindle, thus taking the place of the drill table.

The construction of the drill jig is clearly shown in Fig. 1. The grooved blocks at each end are hollowed out slightly larger than the diameter of the pipe, thus permitting a slight side play for centering by the screws, as shown at A. The spring clamp is pulled out when placing the pipe in the jig and snaps back to hold it securely against the centering screws, which are ordinary setscrews secured with lock-nuts. The holes in the top, or guide plate, are 2 in. from center to center, and are used to make the pattern rail only. The guide for the drill is half of a motor-car chain and is fastened loosely to the plate so that the jig may be set at an angle with the drill, if necessary, and still guide the drill true to the center without binding.

In drilling the pattern rail the outer end is supported at the proper height, the pipe is entered in the jig from left to right, and the first hole is drilled 1 in. from the end; then the pipe is shifted until the pin will slip through the guide hole in the top plate, through the hole in the pipe and into the base plate, which locks the pipe for the drilling of the next hole, and so on until the length of pipe is drilled, which will be about 125 holes. Extreme care must be used when drilling the pattern rail,

to take up the lost motion around the pin in the following manner: After the pin is in place, twist the pipe from the operator and also shove it to the left. For the next hole the opposite course is pursued, alternating for each hole. If this is not done, the variation of a small fraction of an inch on the same side of all holes will bring the last hole out of true  $\frac{1}{2}$  in. or more.

After the pattern rail is drilled, it is clamped on top of the next pipe, and a center punch of a size to snugly fit the drilled holes, in this case  $\frac{3}{8}$  in. in diameter, is used to mark the next pipe. The operation of drilling the second pipe is the same as for drilling the pattern, except that the sliding jig is used to keep the pipe from turning under the drill, and the punch marks are used for a guide to start the drill. All the pipes are drilled in the same manner, except those intended for the bottom rails, which are drilled through the top only, except where necessary to put the sliding-jig pin through. The drilling operation is shown in Fig. 2.

The wire-straightening apparatus is shown in Fig. 3. There are many different forms of straighteners on the market, and one can be easily worked out that will answer the purpose. The one illustrated consists of three rolls, set in a frame of metal so that one roll may be adjusted against the other two. Gears are used on the rolls to make a positive movement.

The picket former is shown in Fig. 4. A circular piece of cast iron,  $5\frac{1}{2}$  in. in diameter, forms a mandrel around which the pickets are bent. The bending lever consists of a piece of strap iron,  $1\frac{1}{2}$  in. wide and  $\frac{1}{2}$  in. thick, with a sash-weight pulley wheel bolted to it, so that it will clear the mandrel just enough to permit the picket wire to pass in between them. The guide and clamp to hold the wire is made of a piece of angle iron, B, and a short piece of strap iron, C, 1 in. wide and  $\frac{1}{2}$  in. thick, with a notch filed in the lower end in such a manner that, when the wire end is against the stop D and the clamp is pulled to the left, it locks itself, and the wire is held tightly to the

angle iron. The wire is placed in the bender with the bending lever in the downward position. To form the picket, swing the lever to the vertical.

the jig shown in Fig. 5 was used to simplify the operation. The jig is placed on the wall with the clamp directly over the post hole, and the brace

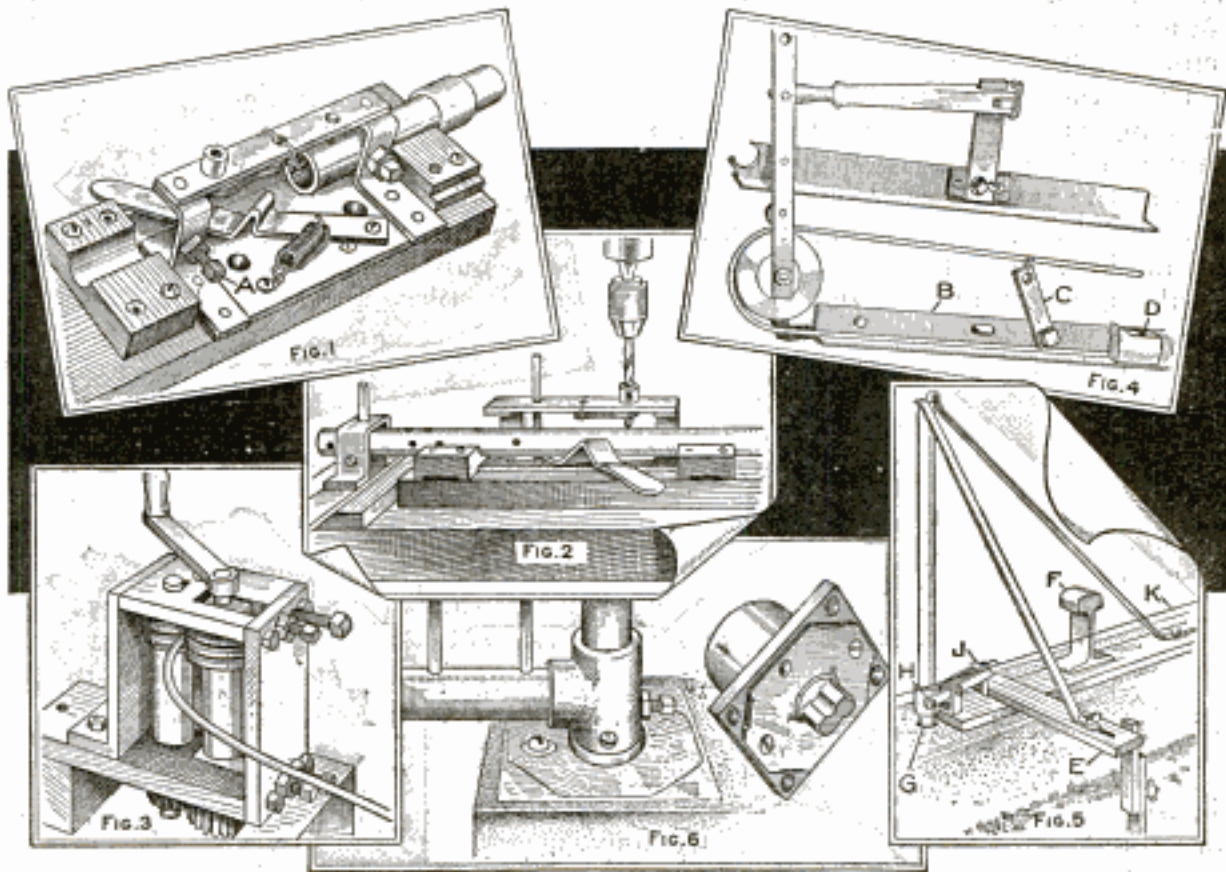

The Jig That Takes the Place of the Drill-Press Table for Drilling the Holes Accurately in the Rails, the Wire-Straightening Machine, the Picket Former, the Post Setter, and the Gate Hinge

As the fence is to be set over a concrete wall, the posts must be prepared in such a manner that the fence can be dismantled at any time by making the posts in two pieces, one 25 in. long and the other 11 in. The short lengths of pipe are set in the concrete base so that the upper end extends above the surface just enough to fit on a coupling. The upper part of the post is screwed into the coupling. The bottom rail is bolted to the coupling, which just clears the surface of the wall; the other holes for the rails are 12 in. apart, thus leaving just enough end to screw a cap on top when the upper rail is in place.

In erecting this fence, the same procedure is followed out as in building a wood fence. When the wall is built, holes about  $\frac{1}{2}$  in. larger than the posts are left at the exact location where the posts are to be set. In setting the posts

E, at the end of the side arm, is adjusted with the ground to hold the arm solid. A weight, F, is placed on the jig to hold it steady. The post G is then dropped into the hole and adjusted in the clamp H, by placing a pin through a hole in the coupling. The post is then raised or lowered by means of the wing nut J in the clamp, until some certain point marked on the coupling is in line with the guide line K. The top braces are then adjusted, and the post plumbed by sliding the lower end of the braces, the bolts holding them sliding in slots, until plumb, then clamped with the thumbscrews. The brimstone is melted and poured in the hole around the post and allowed to cool.

After the posts are all set, the rails are coupled together on the straight run with couplings, and on the corners with ells. They are then clamped to

the posts in their respective positions and drilled for stove bolts by means of a breast drill. The pickets are then driven in and the fence is complete, all but the gate.

The gate is the most difficult part to construct, and the illustration shows better than words can tell its form of construction. The threading of the pipes should be all right threads and has to be done with the utmost accuracy. The two middle rails are run in on one side, and then back into the other side and calked. The pickets are then set, and the top rail put on by means of a run-back of each of the

short nipples on each side. The top bearing is simply a pipe plug screwed into the top tee, the square part being filed round to fit the hole in the supporting bracket.

The hinge used to hang the gate is shown in Fig. 6. This hinge is the type used for double-swing doors, and is countersunk in the cement walk and filled with a very heavy oil. As it is ball-bearing, the gate is absolutely silent in its action. There is no need of a latch on the gate, as the powerful springs of the hinge prevent any of the smaller animals from opening the gate.

### Switch Arm for Use on Basement-Light Circuit

Although it is the usual custom to put a basement-light switch at the head of the steps for convenience, there

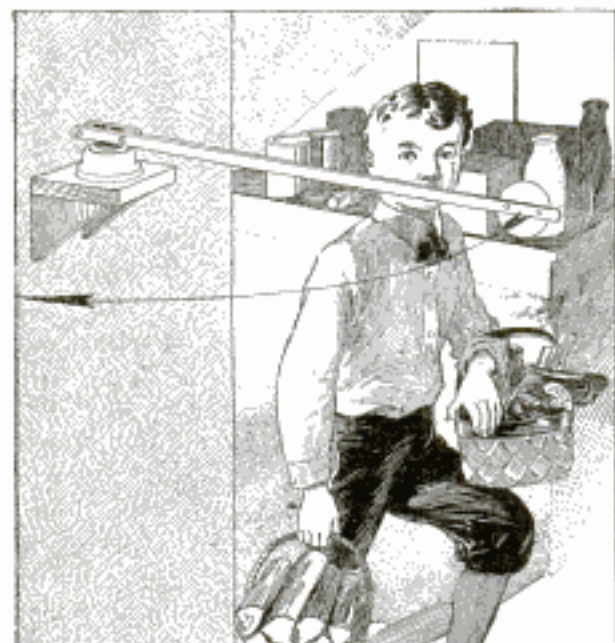

Long Arm Placed on an Electric Switch to Strike the Person Leaving the Basement Steps

is a serious drawback to this position. In a certain basement storeroom it became an annoyingly frequent occurrence to find the light burning hours after the person using it had left, for it was an easy matter to go out into the daylight and forget to turn the switch.

In order to avoid this waste of light, the device shown in the illustration

was adopted. First, the switch was removed and mounted horizontally on a small wood bracket, with the wires leading up through a hole in the center. A light wood arm, 15 in. long, was attached to the switch, as shown, so that the light would be turned off as long as the arm rested against the wall. When the switch is turned to the "on" position, the projecting arm forms a positive means of turning out the light, since it is right in the path of the person leaving the stairs. The card disk at the end makes it easily seen.—Contributed by Morris G. Miller, New Rochelle, New York.

### A Protection for the Acid Bottle

The bottle used as a container for nitric acid, that is kept in a shop for etching steel, is often struck with some piece of metal and broken. As this is a dangerous acid when not confined, it is well to be careful and use all caution possible in handling the liquid. A good safeguard is to glue a cardboard disk to the bottom of the bottle, then coat the outside surface with glue, and when it becomes tacky, roll it in small particles of cork. The cork may be obtained from a fruit dealer selling imported grapes. When the glue hardens to hold the cork, it makes a very satisfactory guard against breakage. Owing to its touch, the bottle can also be used as a poison bottle for the home.

### Mucilage Used to Stop Leak in Gasoline Connection

A leak started in the ground-joint connection between the gasoline-supply pipe and the carburetor on my automobile. It was in a place where it could not be reground easily, although I tried to stop it in this manner. Soap and other lubricants were used to no avail. The thought came to me that some liquid which gasoline would not cut might do, and I used a small portion of old mucilage which had become thick, applying it to the connection and letting it stand to harden, then screwing the joint together. This stopped the leak.—Contributed by Bert H. Stanley, Portage, Wash.

### Holding Work in Lathe to Cut Taper Threads

In cutting an inside taper thread on a lathe, I have found the device illustrated an excellent substitute for a yoke that rocks on the lathe dog.

The device, which is only intended for light work, consists of a bolt, threaded for a nut on one end, and formed to a hook on the other, to engage the setscrew of a lathe dog. The bolt is amply long to receive a rubber washer, between two metal washers, on the threaded end. The rubber washer is made by cutting a 1-in.

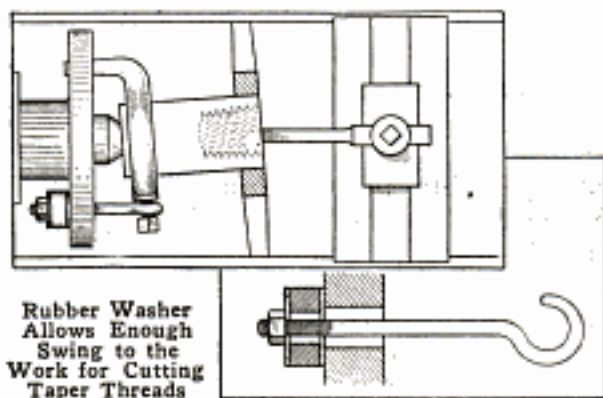

length from a discarded clothes-wringer roll. The application is clearly shown in the sketch.—Contributed by L. Nash, Chesley, Ont.

### Housing for a Large Flag

Many business firms have a flagpole on their buildings so that the national flag can be raised on special occasions. Some times it may be necessary to use the flag for several days, or weeks, and in such cases,

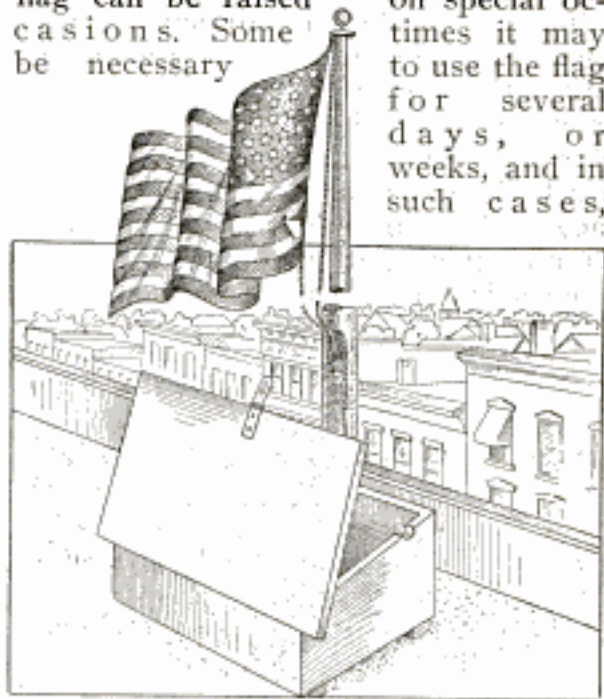

The Box Protects the Flag at Night, without the Need of Taking It from Its Halyards

the flag will be exposed to the weather at night unless it is taken from its halyards and put up again in the morning. One merchant, desiring to protect his flag and keep it as clean as possible, made a box on the roof, as shown in the illustration, to house it when not in use.

The box was made about 18 in. deep, 2 ft. wide, and 3 ft. long, which was large enough to hold two flags of the size used for such purposes. The box was placed on two timbers on the roof at the base of the flagpole. The cover was made slanting, with its edges projecting over on all edges. A notch was cut in the upper edge of one end to admit the halyards when the flag was placed in the box. This made it very easy to haul down the flag and store it for the night. A hasp is provided to lock the flag in with a padlock, and in this case the box was protected from view of the street by a balustrade on top of the building front.—Contributed by John Kohlbecher, San Francisco, California.

### Street-Lamp Glare Shield

Any fixed form of light deflector for a street lamp was strictly forbidden in our city, and the one in front of our house caused considerable annoyance by its glare when we were sitting on the porch in the evening. The light on the porch, during the time it was burning, made an excellent burglar protection.



To overcome all difficulties I designed the deflector shown in the sketch, which can be easily placed on and taken off a lamp, and has given perfect satisfaction. It is in the shape of a shovel, the blade being made of galvanized

iron and the handle constructed from an old broom handle. The position of the hooks by which it is hung, the manner of shaping the sheet metal, and the way in which it is placed on a lamp, are all plainly shown.—Contributed by Irving M. Hayward, Brooklyn, N. Y.

### Hinged Molding for Window Screen

Window screens held in place by special molding strips can be easily removed for cleaning or other purposes, if arranged as shown in the illustration.



In order to do this, the molding on both sides of the window should be sawed in two, so the lower piece will be a little

longer than the height of the screen. If the molding is already fastened in place, the lower pieces should be removed so their upper edges may be rounded off to permit the molding to swing either out or in, as desired, when pinned near its upper edge, as shown. Holes should be drilled and countersunk for loosely fitting wood screws, which are used as

hinge pins, and are fastened in place by being screwed into the window jambs. To lock the hinged strips in their regular upright position, a hole should be drilled near the bottom edge, and continued into the window jamb, to fit a wire nail, or bolt.

In using this arrangement both hinged strips, after being secured at their upper ends, are swung out, and the screen is slipped in place; it can then be swung to its regular upright position. To fasten it in place, the nails, or bolts, are inserted in the lower holes. In order to take out the screen, the molding must first be unlocked by the removal of the nails. The screen can then be swung away from the window and removed.—Contributed by M. Baudier, New Orleans, La.

### Doweling Loose Bearings

In order to stop the turning of loose bearings in connecting rods, a simple method would

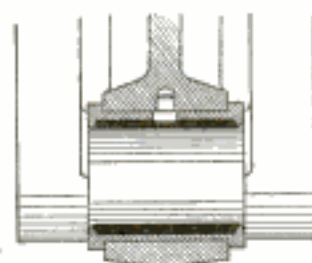

be to provide the rod with a tightly fitting dowel pin, projecting sufficiently far to enter a corresponding hole drilled in the bearing. Care

should be taken that the top of the dowel is always below the surface of the bearing metal.

### Cover for an Automobile Starting-Crank Handle

An extremely handy addition to the starting crank of an automobile in winter is a piece of rubber hose placed over the handle. The usual type of crank is fitted with a metal sleeve of either brass, copper, or steel, and in winter the sleeve becomes more or less slippery, due to the ice and snow, resulting in making it very difficult to crank. The addition of the rubber sleeve over the metal one readily eliminates the trouble.



### Removing Tar and Asphalt Spots

Do not use soap on tar or asphalt spots in cloth first, as this will set it in a way to make the cleaning almost impossible. Rub the spots with soft grease, and set aside until the grease penetrates the tar. Remove the tar and grease with gasoline, or by washing in hot suds. Asphalt should be well wetted with kerosene and left to stand, then washed out in turpentine or alcohol.

### Easily Made Steam Trap

An inexpensive steam trap can be constructed from a piece of 8-in. pipe, 6 or 8 in. long, two flanged heads, and a float. The pipe is threaded for the flanges, which are to hold the heads after they are prepared. One side of the pipe is drilled near one edge, to receive a pipe from the lowest part of the steam system. The other side is fitted with a ball float and lever, hinged near its center. The float lever is fitted with an arm shaped properly to carry a tapered valve on that end which enters the outlet pipe.

The action of the trap is as follows: The water from the condensation in the steam system falls to the lowest part and enters the trap. When the level has risen sufficiently to lift the ball float, the valve is opened and the

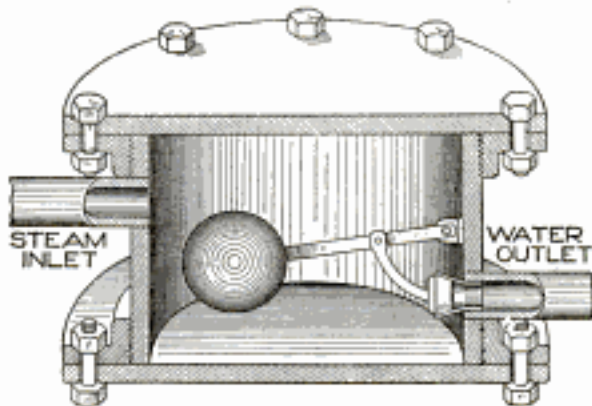

Steam Trap Made of a Large Pipe with a Float to Operate the Outlet Valve

steam pressure forces the water out. The lowering of the water in the trap allows the ball float to close the opening.

### Micrometer Holder

A holder for a micrometer, which fully answers the purpose of an expensive one, is made as follows: A  $\frac{1}{4}$ -in.

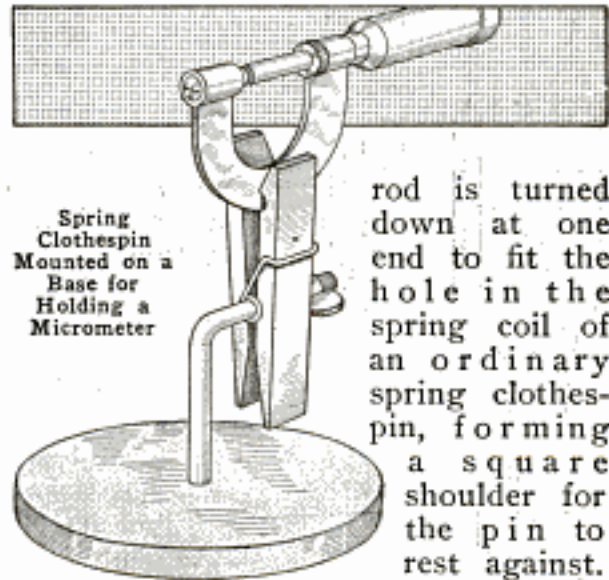

rod is turned down at one end to fit the hole in the spring coil of an ordinary clothespin, forming a square shoulder for the pin to rest against.

About  $\frac{1}{2}$  in. back from the shoulder the rod is bent at right angles, and the end is fastened in a metal base of sufficient weight to hold the micrometer rigidly. The length of the rod is optional. The end of the portion turned down is threaded and fitted with a wing nut. The manner of using the holder, with the clothespin as a vise, is clearly shown.

### Tanks for Supplying Air at Low Pressures

In soldering metals, or melting them in small amounts, compressed air at low pressures can be used to great advantage in connection with gas burners. Power blowers are ordinarily used to obtain the necessary pressure, but a good, cheap substitute for small work can be made of two heavy cans, as shown in the illustration. Two sizes of cans should be obtained, so one may freely pass within the other. They should be open at one end, but otherwise air and water-tight. The larger, or stationary, tank should be provided with four strips of metal placed in sets of two on directly opposite sides and fastened with rivets, or solder. The strips of

metal are formed to fit two wooden strips used as uprights for a frame which is connected at the top by a

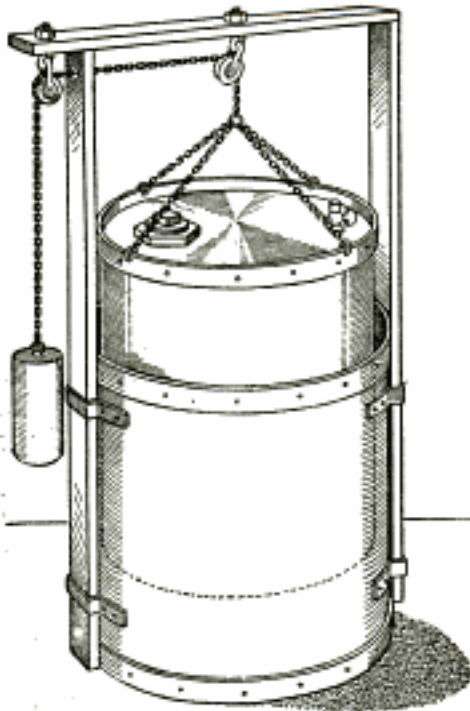

A Low-Pressure Air Tank to Supply Air in Burners for Working Metals Having a Low Melting Temperature

crosspiece provided with two pulleys, one midway between the uprights, and the other suspended from an extension on one side. The upright on this side is drilled for a cable hole in line with the tops of the pulley wheels.

Two openings are made through the closed end of the smaller or movable tank, one to serve as air outlet and the other as an inlet. The outlet is made sufficiently large to fit an ordinary gas cock, which should be soldered in place, and connected to the gas burner with a suitable rubber hose. The inlet opening is cut to fit a suitable pipe flange, which is soldered or riveted in place and fitted with a plug to open or close it. Four chains or cords are evenly spaced and connected to the rim of the movable tank, to hold it in an inverted position. They are fastened at their loose ends to the weight cord, which passes over the pulleys to a regulating weight, used to govern the descent of the movable tank. To get higher pressures than produced by the unbalanced weight of the tank, additional weight may be added on the tank.

To operate the device, the lower tank is filled three-quarters full of water. The movable tank with its outlet open is placed in its upper position, and then closed up with the plug, and connected to the gas burner by a rubber hose. When the gas cock is opened, the excess weight of the tank will cause it to descend, forcing the air through the rubber hose to the burner. When no more air can be forced out of the upper tank, the outlet must again be opened and the tank raised to its upper position. With the outlet again plugged, the operation will proceed as before.—Contributed by J. Koestner, Brooklyn, New York.

### Repairing a Broken Magneto Drive

The combination sprocket and shaft, driving the magneto of an automobile gasoline engine, was fractured at a point marked A. The break may have been caused by defective material, or perhaps the heat treatment was not of the proper kind. The shaft was of such design that the drive sprocket was forged integral with the shaft; then, too, the entire piece was heat-treated and ground. This made it an extremely expensive part if a new one had to be purchased.

To make a repair, a new shaft was turned up, without a sprocket, having the same dimensions as the broken shaft, which was removed from each side of the sprocket and the faces of the latter were ground flat on a grinder. A hole was then bored and reamed

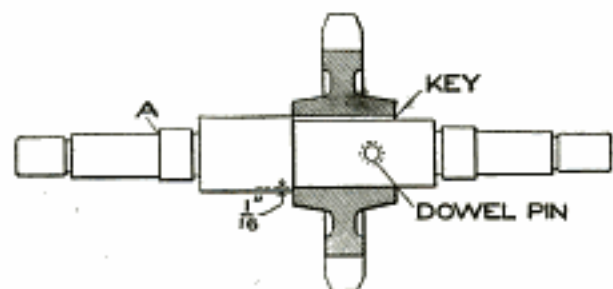

New Shaft Replacing a Broken One Consisting of Shaft and Sprocket in One Piece

centrally in the sprocket, to fit on the new shaft. A keyway was cut in the sprocket and one to match it in the

shaft, and a hole was bored for a dowel. The shaft was then casehardened and ground to a press fit in the sprocket bore, with a shoulder  $\frac{1}{8}$  in. high to provide a stop. When the sprocket was in place a pin was driven into the hole and riveted on both ends.

### Drawing-Board Cover

Having trouble with dust settling on my drawings over night I made a cover, as shown in the illustration, that



can be easily drawn in place and does not interfere with the work on the board. Two pieces of steel, each  $\frac{1}{8}$  in. thick,  $\frac{3}{4}$  in. wide, and about 2 in. long, are secured at the right end of the board, one on the top and the other on the bottom edge. An ordinary window shade with a spring roller of the proper length is fitted between the two pieces of steel. When not in use, the roller with shade hangs under the board as shown by the dotted lines.—Contributed by Lawrence L. Lane, Jackson, Tenn.

### Temporary Repair for a Burned-Out Fuse Plug

When a house fuse plug "blows" out and there is no other at hand, take a bit of tin foil—the covering from a pack of tobacco or chewing gum will do—and fold it once, making the strip about  $\frac{1}{2}$  in. wide, then lay it over the contact points of the plug, as shown, and screw the plug into the receptacle. This will make a connection, and will not produce any more body than if the ordinary fuse wire were used.



CA streaked top lining on an automobile can be made uniform in color by applying a dye of the proper shade while the top is upside down.

### Making Index Cards

Anyone making his own filing systems will find the method illustrated one of the quickest and easiest for constructing index cards. To one of the regular cards in the cabinet attach a piece of cardboard, or any suitable material, cut to the shape shown at A, with a paper clip to keep it in place. The target can be slipped along on the card or it can be placed behind it, as shown at B. Owing to the manner of fastening, any number of cards can be made with targets.

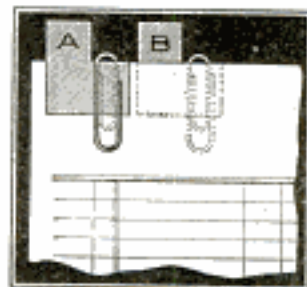

### A Twine Holder

A serviceable twine holder can be made from a wire guard of an electric lamp. The guard is fastened to the wall, or other support, with a single staple over the wire ring at the top. Lift the guard and insert the twine from the back side. The weight of the ball will hold the guard in place. The twine is taken from the small-end opening in the guard.—Contributed by W. H. Sargent, St. Johnsbury, Vt.



### An Acid Test for Metals

File, or grind, the pieces to be tested and polish them smooth, then place them in a dilute nitric or sulphuric-acid solution for a day. Wash and dry the pieces, and if they are of the best steel, the surface will have a frosty appearance. Ordinary steel will have a honeycomb surface, and iron will present a fibrous structure running parallel with the direction in which the metal was worked.

### Repair for a Small Broken Bracket

A simple and cheap repair for a broken automobile-fan bracket, or a similar casting, can be easily made as

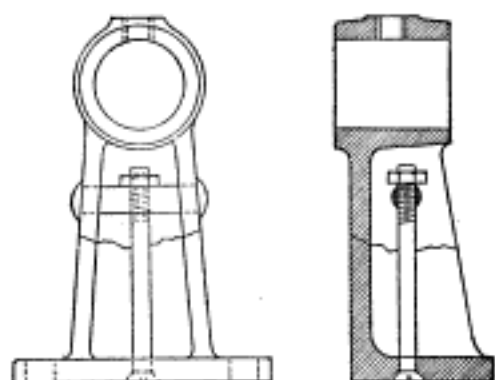

The Parts of the Casting are Held Together with a Screw, or Bolt and Nut

illustrated. A hole is drilled through the sides of the upper, or bearing, portion, and a rivet, or suitable rod, inserted and securely riveted in place. The two parts should then be assembled, and held together with clamps, while a hole is drilled and countersunk through the base and rivet body, to fit a suitable flat-headed machine screw. When assembled, the parts are securely held in place with the screw and nut connecting the base with the rivet.

### Removing a Plain Key with a Monkey Wrench

Considerable skill is frequently required to remove plain keys fitted in places where it is impossible to get at them with a drift. One of the simplest

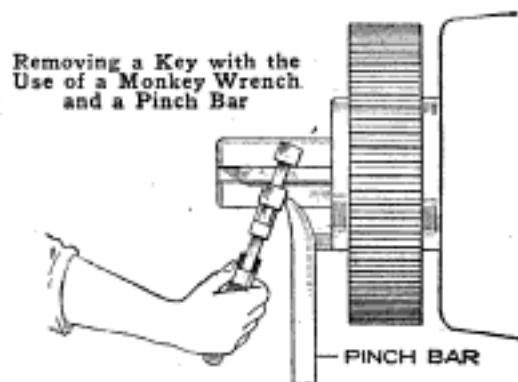

Removing a Key with the Use of a Monkey Wrench and a Pinch Bar

successful methods of obtaining the desired result is the use of a monkey wrench and pinch bar, as shown in the

illustration. For this purpose a wrench should be used that has sharp edges on its jaws, so these can get a good grip on the key. To further improve the method, grooves may be cut on opposite sides of the key, so the jaws will fit better when straddling the key at a slight angle with the face of the keyed machine part. By using a pinch bar against the movable jaw, sufficient force can be applied to remove the key, unless it is so tightly driven, or rusted in place, that it will have to be drilled out before it can be released.—Contributed by J. V. Romig, Allentown, Pa.

### Emergency Repair on Automobile-Engine Manifold

The water-outlet manifold on the gasoline engine of an automobile was very old and corroded, and the pressure of the circulating water fractured the center portion of the pipe and made two pieces of it while out on the road. The repair illustrated was done in a short time and enabled the driver to

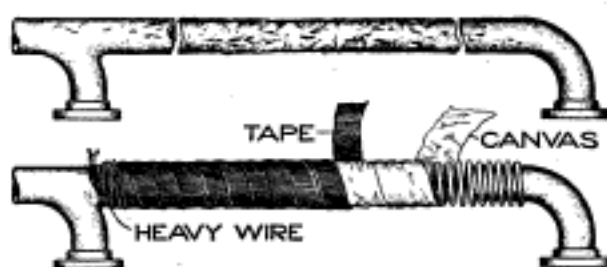

Substitute Manifold Made of Canvas and Electricians' Tape over a Spiral Wire to Form a Hose

reach home, after which it served the purpose until a new manifold could be obtained.

A close-wound spiral spring of ordinary iron wire was wound around the circumference of the hand pump. The spiral ends were fastened to the broken ends of the manifold. Strips 3 in. in width were then cut from an old piece of canvas found in the tool box and wound tightly around the spring for the full length, after which electricians' tape was wound tightly over the canvas. White lead was inserted at both ends to prevent leakage, and the ends were then clamped to the metal with wire.

# Building a Home

By GEO. M. PETERSEN

## PART II—Planning the House

**A**FTER the lot has been selected and the location of the house decided upon, the amount to be used for building purposes should be fixed. It is impossible to set a rule for the value of the building, but the cost should not exceed an amount that can be readily liquidated when the time comes for settlement. It is best to figure the amount of rent a person is paying, or can afford to pay, and see if it will carry the building account. Some of the items which are included in the carrying charges of a property are lost interest on the money invested; interest on the mortgage; fire insurance; city and county taxes; water tax; assessments for repaving the street and building new sewers; repairs, and depreciation. If the rent, which is credited to the house account, will pay 10 per cent gross on the investment, it is reasonably certain that the property will be self-supporting, but be very careful to have the amount come under rather than over the fixed expenditures of the ordinary outlay or that which a person can handle financially.

When the cost is figured and the amount known, it is very easy for an architect to make preliminary sketches and submit them for approval. Upon receipt of the sketches the home builder should carefully look them over with a view of placing the furniture. Many houses have been completed before it was discovered that there was no wall space for the piano, the buffet, or bed. Note the layout for the bathroom and its size, which should never be less than 6 ft. square. A few furniture dimensions are given herein to assist the owner in checking the plans for furniture space.

Single bedsteads are from 3 ft. to 4 ft. wide, the three-quarter bed is from 4 ft. to 4 ft. 6 in. wide, and the double bed is 5 ft. wide. There are also some dormitory beds that are only 2 ft. 8 in. wide. All bedsteads are from 6 ft. 6 in. to 6 ft. 8 in. in length. Headboards

range from 5 ft. to 6 ft. 6 in. in height. Bureaus and dressing tables vary a great deal in size and length, but a space 4 ft. long and 1 ft. 8 in. deep will accommodate them. The average height, exclusive of mirrors, is about 3 ft. Chiffoniers are about 3 ft. long, 1 ft. 8 in. deep, and 4 ft. 6 in. high. Wardrobes come in two general sizes, namely, 4 ft. 6 in. wide, 2 ft. deep, and 8 ft. 2 in. high; and 3 ft. wide, 1 ft. 6 in. deep, and 6 ft. 9 in. high.

Sideboards vary from 4 ft. to 6 ft. in length, and from 1 ft. 8 in. to 2 ft. 4 in. in depth. Upright pianos run from 4 ft. 10 in. to 5 ft. 6 in. in length, 4 ft. to 4 ft. 9 in. high, and 2 ft. 4 in. deep. A space 2 ft. deep and 4 ft. long should be allowed for the kitchen range, but it is better to select this piece of furniture before planning the house, on account of the variation in the size. The illustration shows how the layout for the furniture will appear on the plans.

It is advisable also to check up the closet space shown on the plan and see that no closet is less than 20 in. deep. Stairways should be considered as to the run or tread, which should not be less than 8 in. for basement stairs, 9 in. for inside stairs, and 12 in. for porch steps. The proper proportion of treads and risers can be figured by adding them together, and their sum should be from 17 to 17½ in. The headroom in the basement must not be less than 7 ft. from the top of the concrete floor to the bottom of the girder. Always see to it that plenty of nails are used, as it is better to have too many than not enough. See that each stone in the foundation is laid on a solid bed of lime and cement mortar, and have the plates laid in a bed of mortar. Use a good grade of building paper between the floors and for the oversheathing. The shingles should be put on the roofs with galvanized, cut nails. The most common symbols for designating lighting fixtures, and sundry other equip-

ment, are shown in one of the illustrations. There are many tricks used by dishonest contractors, and a few of them are mentioned here as a warning. Ashes, as well as other refuse, are used in constructing concrete foundations; 2 by 2 in. studs for partitions in the place of 2 by 4-in. material; chestnut, or yellow-pine doors, flooring, and trim, where oak is specified; tile seconds in bathrooms. Tile seconds are slightly discolored, and when laid have a poor appearance. Redwood window frames are used where white pine is specified; a poorer grade of flooring and a smaller furnace than called for in the specifications are often substituted; two registers are connected on one run of pipe; and numerous other fraudulent practices to save on the price of the material going into the house are resorted to.

The hardware is another item where there is opportunity to cheat. It is not uncommon to find plated steel where bronze is specified, as there is no way of distinguishing one from the other except by using a magnet. Naturally the plated steel will attract the magnet and the bronze will not affect it. As bronze hardware costs almost three times as much as steel, it is quite a temptation for the dishonest contractor to use the cheaper grade

nishes, as they will present a high gloss that will not stand in use.

If it is desired at some future time to make additions for more rooms or sleeping porches, or to finish off rooms in the attic, the house should be so arranged that this work may be done without the necessity of remodeling the entire house.

#### Mortgage Loans

If it is necessary to borrow money for building purposes, there are three sources from which it can be obtained by placing a mortgage on the building, namely, a private party, a savings bank, or a building and loan association. A private lender will usually give a larger loan on the property than a savings bank, but the bank, on the other hand, charges a lower rate of interest. The interest on either of these mortgages is payable semiannually while the building and loan association mortgages require a weekly or monthly payment on the principal, together with interest on the unpaid balance. The amounts of these payments vary, but are usually figured out so that the mortgage is fully paid up in from 7 to 13 years. Most building and loan companies require a monthly payment of \$10 for each \$1,000 loaned. The rate of interest is about the same as charged

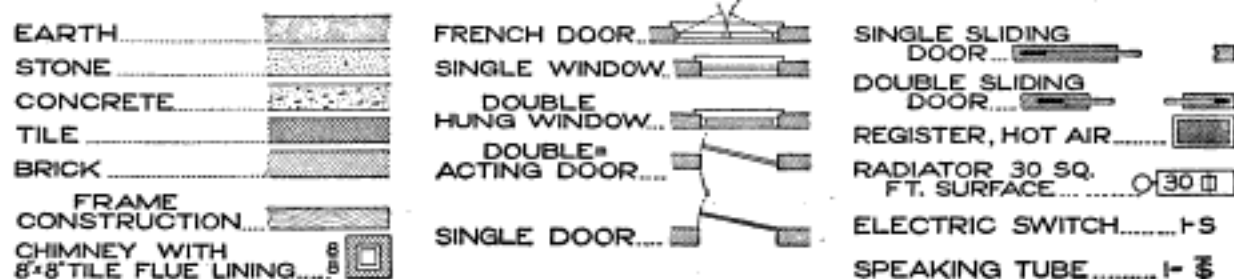

as a substitute. Painting is another thing to be watched closely, and about the only way to know that the proper material is used

is to have the painter open the original packages and to see the colors mixed on the job. Look out for cheap var-

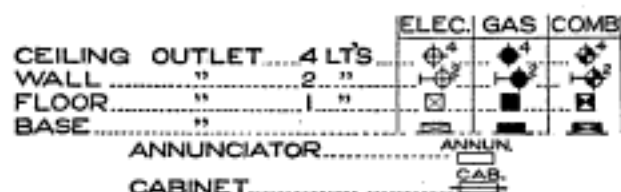

The Novice will Find Many Characters or Symbols on the Plans, and It Is Necessary to Know Them So That the Work may be Checked, as Well as the Kind of Material and the Location of the Fixtures

by the savings bank, perhaps  $\frac{1}{2}$  of 1 per cent higher, and the amount loaned is greater, so that for the average person who really wants

to own a home, the building and loan association proposition is a good one.

There are two regular kinds of

mortgage loans, the straight mortgage and the building-loan agreement. The latter is sometimes called a progressive

the state of New York will be considered. In this state the owner is fully protected so long as the payments are

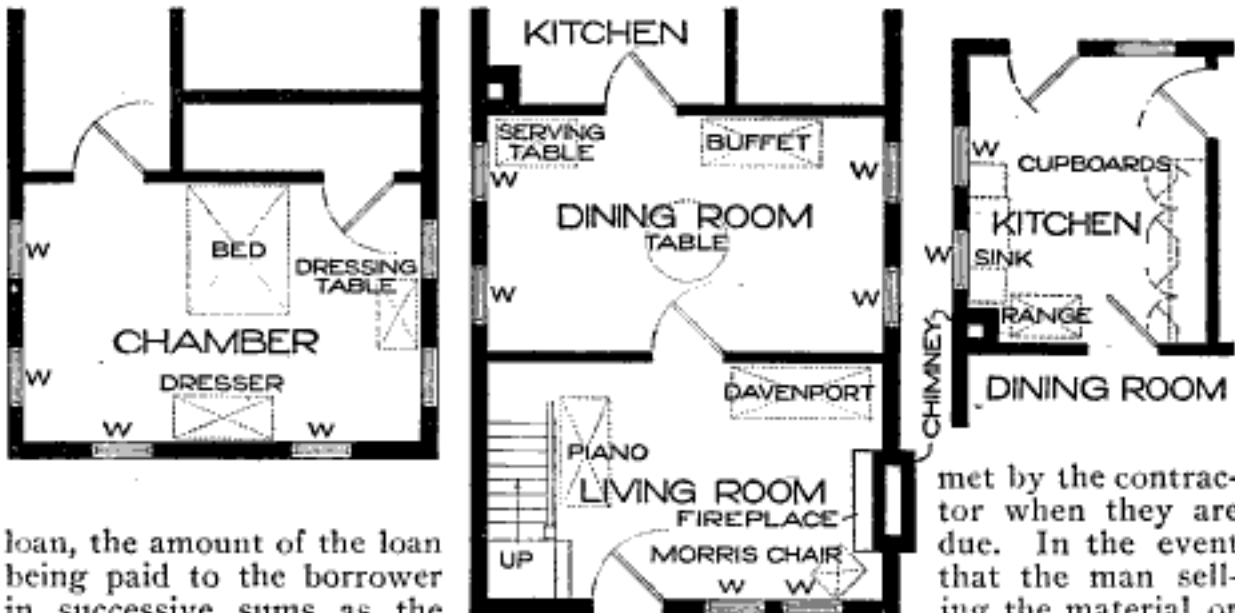

loan, the amount of the loan being paid to the borrower in successive sums as the construction of the building progresses. This kind of a loan is usually obtained from a private party and occasionally from a loan association, but seldom from banks. The building-loan agreement is usually drawn up in legal form similar to a mortgage, but stating when the payments are to be made, such as a certain amount when the foundations are in and the framing commenced; another amount when the building is under roof; another when plastered, and the remaining amount when the house is completed. A copy of this agreement is filed in the office of the clerk for the county where the building is located, which protects the mortgagee's interest. This style of a mortgage is very desirable for the builder, but since the loan is made from the plans and specifications instead of from the completed building, very few mortgagees care to make such loans.

#### Mechanic's-Lien Law

There is another important thing which the owner must watch closely, and that is the mechanic's-lien law. This law differs somewhat in various states so that it would be impossible to give all the laws in this article. As an example, however, the lien law of

Many Houses have been Completed Before It was Discovered That There Was No Wall Space for the Piano, Buffet, or Bed; Consequently These Locations must be Noted on the Plans, and Spaces Arranged for Them

met by the contractor when they are due. In the event that the man selling the material, or the mechanic, is not paid by the contractor, he may file a lien on the property owner and the contractor jointly. If the building is not finished at the time the lien is filed, the owner has the right to finish the building and deduct the amount expended to complete the building from the amount of the contract. Any balance which may be still due the contractor is then paid to the lienor or lienors in the order in which their liens are recorded, and any balance which may remain after all liens are satisfied is turned over to the contractor. If sufficient funds are not due the contractor to satisfy all liens the only redress that may be had by the lienors is a deficiency judgment against the contractor. The liens are all paid in full, when possible, in the order in which they were filed, except that all labor claims are paid before the parties selling the material can collect their claims, and the subcontractor comes last on the list.

If the owner refuses or neglects to pay the contractor, the property may be sold at auction, and the amount so realized is used to pay up the claims against the building. If, however, there

is a mortgage on the property, this must be paid, or assumed, by the party bidding it in, as the first mortgage is a first lien on the property and must be protected.

In some other states it makes no difference whether the contractor has been paid in full or not, the persons who have not received their pay for materials or labor can collect from the owner.

#### Building Contracts

There are three principal kinds of building contracts in use at the present time, viz., straight contract, lump-sum contract, and percentage contract. The first mentioned at one time was the most popular, but the percentage contract is rapidly gaining ground, as it is by far the cheapest and most satisfactory method of doing construction work.

The straight contract is one in which the contractor agrees to do the entire job for a specified sum of money, to be paid in fixed sums at certain times as the construction progresses. This form of contract gives the contractor a chance to use poor material and slight the work to save a few dollars.

A lump-sum contract is one wherein the contractor agrees to perform all labor and furnish all material necessary for the proper completion of the building, for cost, plus a lump sum for his profit. This form of contract leaves the contractor no reason for slighting either the material or the labor, nor can he gain anything by running the expense higher than necessary.

A percentage contract is an agreement whereby the contractor agrees to build the house for cost, plus a certain percentage for profit. This is the proper and most satisfactory method of building, and is rapidly replacing the straight contract among those well informed in building construction. The main thing, however, is not so much the kind of agreement the contractor works under as his reputation for doing the work at a reasonable margin of profit, and well. The better contractors in some places decline a contract job, as they are kept busy on percentage work.

Summed up briefly, the straight contract either forces the owner to pay an unreasonably high price for the house, or else tempts the contractor to substitute poor materials and cheap labor in order to break even, should he have forgotten something when figuring the cost. This means that the owner must supervise the work very closely to avoid substitutions. If the contractor sets out to make up a loss, he will succeed, no matter how close the supervision, and for that reason the work should not always go to the lowest bidder.

With the percentage contract, however, all the tricks of the trade and forgotten costs are eliminated. The owner need not worry about the quality of the materials or labor, as the contractor has nothing to gain by slighting them. The contractor is really put on his honor and works as the owner's agent in getting the best results.

### Shaping Irregular Surfaces on a Metal Planer

Considerable skill and care is required in planing irregular surfaces to a definite outline, but with the aid of the tracing arm and template of the desired shape, as illustrated, the work can be easily and accurately done.

To make the necessary changes, one of the straps on the tool post, for clamping the tool, must be removed—either

the upper or lower can be used, whichever is most convenient. In its place is attached the tracing arm, being a duplicate of the removed tool strap, but having a long, rigid extension on one side terminating in a dull, bent chisel point for following templates. The outline to be planed is marked off and cut out of a hardwood block, or thin metal plate. This is fastened to a suitable block for clamping it to the planer cross rail, so that the template and the



outline of the work, when finished, both have the same position relative to the planer bed. If possible, it is best to mark the desired outline on the work before machining it.

In setting the tool, special care should be taken to see that it will start at the place on the work corresponding to that occupied by the tracing arm with respect to the master template. If this precaution is not taken, the tool may either cut too much, or run off, and the piece will be spoiled. If the desired shape is very irregular, several kinds of tools may have to be used, so that, in setting a new tool, it is best to locate it and the tracing arm on some finished part of the work.

Both the horizontal and vertical feed must be operated by hand, unless the

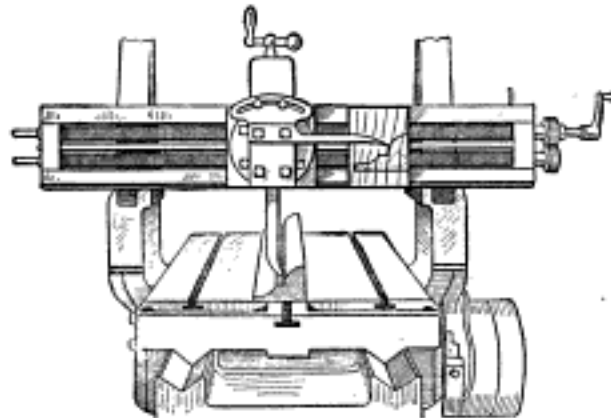

The Pointer Following over the Master Template Guides the Tool in Shaping the Work

outline is very simple. In such cases it might be advisable to remove the horizontal-feed screw in order to secure an automatic side feed, produced by a spring, or cord and weight, attached to the planer head, which tend to keep the tracing point—which should be strengthened for this purpose—pressed against the master template.—Contributed by A. Kerbaugh, Allentown, Pa.

### Locking a Valve

The control valve on a water tank in a shop was almost worn out, and the constant vibration caused the valve to work loose. To eliminate this trouble, a clip was made to hold the handle in position. A piece of  $\frac{1}{8}$ -in. sheet brass was cut to the dimensions shown,

after which it was bent to form the shape of the letter "U." The clip was

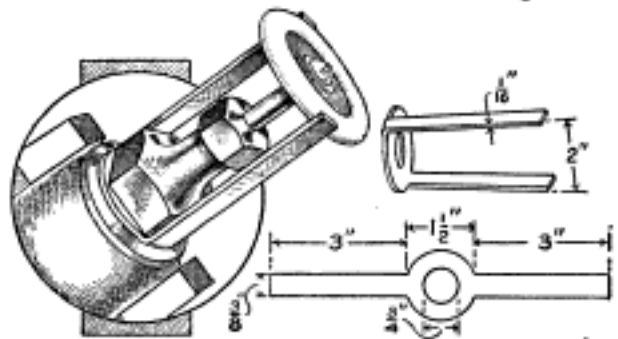

Clip to Fasten on the Valve to Hold the Stem from being Turned by Vibration

then placed in such a position on the valve that the two projecting arms held the valve wheel in place.

### To Prevent Broken Bearing Caps

One of the most frequent gasoline-engine breakdowns is the rupture of a crankshaft-bearing cap. These caps are usually made of aluminum, and the fracture occurs at the point A. The trouble, in most cases, is due to screwing down the bearing studs too tightly, thus causing a strain on the metal in the center.

To eliminate such accidents the following method will be effective. The first operation consists of facing off the lower surface of the cap on a planer, or milling machine. A piece of  $\frac{3}{8}$ -in. cold-rolled steel is then cut to fit the shape of the cap and drilled for the

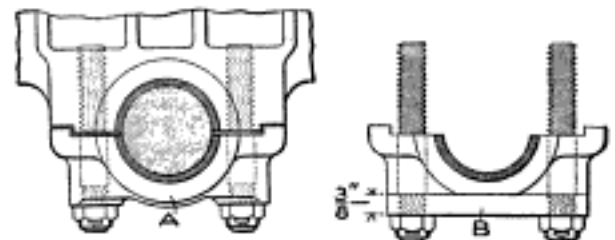

Bearing Cap Planed Off Level, to Receive a Steel Strip to Take the Strain off the Studs

studs, after which it is bolted in position, as shown at B. In this manner the entire strain imposed by the two nuts is carried on the strip of steel.

ⓄThe forward gear on an automobile should never be engaged after reversing until the car is practically standing still.

### Adjustable Boring Bar

Quite frequently a tool in a boring bar is to be adjusted for a deeper cut when the cutter is at the inner end of

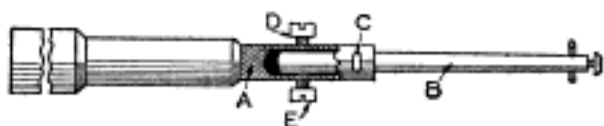

A Boring Bar That can be Adjusted to Make Small Changes without Resetting the Tool

the work. In an ordinary bar, this adjustment can usually be made only after the tool is withdrawn from the work. The illustrated bar overcomes this difficulty. The main bar A is drilled slightly larger than the diameter of the tool holder B, which is held in place in A by means of a taper pin, C. The tool holder B can then be swung back and forth slightly, but is held in any set position by the adjusting screws D and E. When starting an in-cut, the bar B should be held by the screw E only. If it is desired to take a deeper cut when returning, the screw E should be loosened slightly and D turned up tight, again holding B in a rigid position, but at a new setting.—Contributed by Jos. J. Kolar, Maywood, Ill.

### Holding Protection Strips on Chuck Jaws

The rechucking of finished work usually necessitates the insertion of copper or other soft protection strips between the work and the jaws. These strips are not only hard to get in place, but they drop out easily and unexpectedly when the jaws

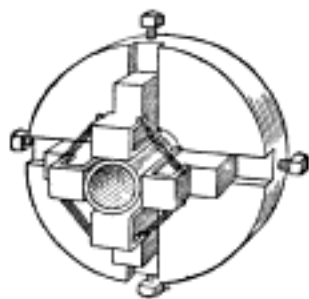

are loosened in centering the job. A simple means of preventing this annoyance is shown in the sketch. Make strips to conform to the shape of the jaws, as shown, but allow for an extra width of about  $\frac{1}{8}$  in. on each side for drilling holes of a diameter to loosely fit the connecting spring

wires as shown. In adjusting the jaws, the protection strips will move with them, being held in place by a spring of the same strength on each side. This scheme will work on any number of jaws, and is particularly valuable when a large number of pieces must be rechucked.

### Changing a New Valve Stem to Fit an Old Valve

In filling an order for a new gate-valve stem of the nonrising type, one

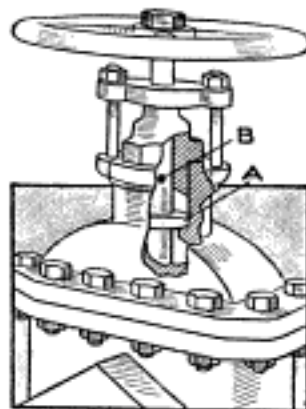

was sent which lacked about  $1\frac{1}{2}$  in. at the inner end, as shown in the sketch, to permit closing the valve. There was sufficient extra length on the outer end of the stem to allow it to occupy a lowered position without causing any interference between the hand-wheel and packing-box gland. A hole was drilled,  $1\frac{1}{2}$  in. above the shoulder A, and a pin, B, corresponding in length and thickness to the diameter and thickness of the shoulder, driven into it. The shoulder was then chipped off, thereby allowing the stem to drop down to the closed position of the valve, and the pin to fit in the place previously occupied by the shoulder. The parts were then reassembled, the only difference being in the location of the stem, and the substitution of the pin for the chipped-off shoulder. All upward and downward movement of the stem was prevented by the pin, just as it would have been by the shoulder, but an increased length of stem was provided, enabling the valve to close tightly.—Contributed by F. S. Johnson, Corona, Cal.

☞ Washing soda, gum arabic, and water make a good writing fluid for fine lines on blueprints.

# To Locate and Correct Troubles in Direct-Current Dynamios

By A. E. ANDREWS

## PART III—Speed and General Suggestions

### Speed Too High

**I**F the governor on the engine fails to respond quickly under a varying load, adjust it to the proper regulation if possible. It should be governed closely from "no load" to "full load" with the proper steam supply. Where a series motor takes too much current for a given load and the motor runs away, put in a shunt, and regulate until the proper current is obtained. If a series motor is run on a constant-current circuit, use the proper regulator for controlling the magnetism of the field for a varying load.

To remedy a motor running at a too high speed on a constant-potential circuit, put in a resistance to cut down the current; use the proper regulator or controlling switch, or change to an automatic speed-regulating motor.

If the regulator, or field rheostat, is not properly set, or the voltage is too high for a shunt motor, the speed will run high. To make the proper change, adjust the regulator, or field rheostat, to control the speed, in the first instance; and use the proper voltage and rheostat, in the latter.

### Speed Too Low

A low speed may result from the same cause as a high speed in respect to the engine governor, and its remedy is the same. An overload of too many lamps on the circuit; a short circuit in the armature; striking or rubbing of the armature on the pole pieces, friction or a weak magnetic field, may also cause low speed, and remedies for these troubles have been described in a previous chapter.

### Motor Stops

If a motor stops, it may be due to excessive voltage on a constant-potential circuit; to excessive amperage on a constant-current circuit; to friction, or too great a load on the pulley. Open the switch, locate the trouble, and remove the cause. Keep

the switch open and the arm of the rheostat on the position "off" while locating and repairing the trouble, then close the switch and move the arm gradually to the position "on," to see if everything is correct. With a

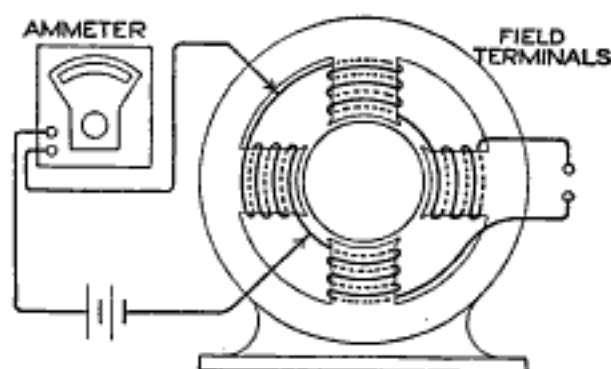

The Manner of Attaching an Ammeter to Test Out the Field Coils for an Open Circuit

series motor no great harm will result from the motor stopping or failing to start. If it is a shunt motor on a constant-potential circuit, the armature may, and probably will, burn out, or the fuse blow.

A motor will stop on an open circuit caused by the melting of the safety fuse; by a broken wire or connection; by brushes in contact; by an open switch, or if the current fails, or is shut off from the station. Open the switch, locate and repair the trouble. If a fuse is out, put in a new one, and in case of a broken line, find it and make the repair. See that the brushes are in close contact. If a switch is open, close it, but before doing so, see that the starting resistance is in the circuit. In case of current failure, open the switch, return the starting lever to the position "off" and wait for the current, testing from time to time by closing the switch and moving the starting lever to the first closed-circuit position.

A complete short circuit of the field will cause a motor to stop. Test out for the fault, and make the repairs if possible. A method for making the

test is shown in the sketch. The ammeter should read the same for all coils if there is no trouble. It will read zero if the coil is open, and a maximum if the coil is completely shorted. Inspect the insulation of the binding posts and the holders. Poor insulation, oil, dirt, or copper dust may cause a short circuit.

The same trouble will result from a short circuit in the armature, or complete short circuit of the switch. The same remedy is applied as in making the repairs for the field.

#### Motor Runs Backward against the Brushes

This trouble will result in making the connections the wrong way. Connect up properly by referring to the diagram sent with the motor. If a proper diagram is not at hand, try reversing the connections to the brush holders. Other changes may be made until the proper connections are found to rotate the armature in the right direction, then connect up permanently.

#### Dynamo Fails to Generate

This will occur from a reversed residual magnetism, caused by reversed current in the field coils. To correct, send a current from another machine, or from a battery, through the field coils in the proper direction. The polarity may be tested with an ordinary compass. If the connections of the windings are not known, try one and test; if not correct, reverse conditions, try again, and test.

Should reversed connections be the trouble, connect up properly for the rotation desired, using the proper diagram of the connections. See that the connections for the series coils, in a compound dynamo, are properly made, as well as those for the shunt coils. In case of the earth's magnetism interfering, use the same method as for reversed residual magnetism, which method also is applicable where another dynamo is in close proximity. If the brushes are not in the proper position, shift them until evidence of improvement is given. The position of the

brushes for the best generating power should be clearly understood, and is generally at, or near, the neutral point. A too weak residual magnetism must be treated in the same manner as reversed residual magnetism. A short circuit will produce the same results, and must be repaired as described in previous paragraphs.

Should a lamp socket, or other part of the line, be short-circuited, or grounded, it may prevent the building up of the shunt, or compound machines. Locate and remedy the fault before closing the switch.

If the field coils should be opposed to each other, reverse the connections of one of the field coils, and make a test. A compass should show the pole pieces of opposite polarity. If, after such a trial, the dynamo does not build up, try sending a current from another machine through the field coils in the proper direction. If the polarity then does not come up in the proper direction, cross the field connections, or re-magnetize them in the opposite direction.

The cause of the trouble may also be an open circuit caused by a broken wire; by a faulty connection; by brushes not being in contact; by a fuse having melted or broken; by an open switch, or by an open external circuit. Repairs are made as described, and in the last-mentioned case make a test with the dynamo switch open and kept open until the repairs are completed.

Where there is too great a load on the dynamo and it fails to generate, reduce the load to the pilot lamps alone, for a shunt, or compound machine. After the dynamo comes up to a full voltage, as shown by the pilot lamps or voltmeter, close the other circuits in succession and regulate the voltage at the same time. Where there is too much resistance in the field regulator, or field rheostat, gradually turn the regulating switch to cut out the resistance, and watch the pilot lamps or voltmeter when the dynamo comes up to the voltage, then regulate, etc.

**General Suggestions and Precautions**

Never use ice water to cool off the bearings, as it may get into the armature and ruin it, unless it has been made waterproof as in the case of street-car motors. Do not shut down because of a hot box resulting from poor oil, dirt or grit in the bearings, tight journals, or too great a load or strain on the belt, until their remedies have been proven useless. If absolutely necessary to shut down, take the belt off the pulley as soon as possible. Do not allow the shaft to "stick" in stopping. Take the boxes, or bearings, out and cool them off naturally as soon as possible, and not in water, as this may ruin them. When cool, scrape, fit, polish, and clean the shaft, and test for free turning by hand, before belting up and starting again.

Cleanliness about a dynamo, or motor, is imperative. Dirt, oil, or copper

dust may prove a source of great annoyance or damage. Small tools, bolts, or pieces of iron must be kept away from a dynamo, as they may be drawn into, or fall upon, the armature and ruin it. Never allow loose articles of any kind to be placed upon any portion of a dynamo.

Brass, or copper, oilcans are the best to use, as they are nonmagnetic. All the connections must be large, clean, and firm. Look over and tighten the loose connections, screws, and bolts daily.

Always keep copper brushes raised from the commutator when the dynamo is at rest. Poor, cheap oil is not economical. Use none but the best of mineral oils, and filter new oils before using them.

Keep cotton waste away from the commutator; use canvas or cloth, and a pine stick makes a good burnisher to keep the bars clean and smooth.

**A Detachable Shaft Coupling**

The simple shaft coupling illustrated was made for a combination water motor and electric-generating outfit. The coupling is inexpensive and has the advantage of being quickly disconnected. The shaft of the dynamo had a  $\frac{3}{8}$ -in. tongue, and that of the water motor an ordinary shoulder. A piece of steel tubing was then cut to the proper length, with the necessary slots on one end to engage the tongue on the dynamo shaft. A standard taper pin held

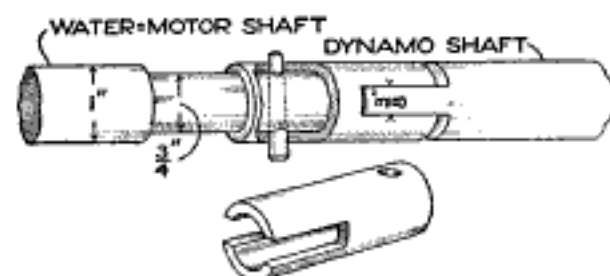

Sleeve Made of Steel Tubing Connecting a Dynamo Shaft with a Water-Motor Shaft

the tubing in position. To disengage, the taper pin is withdrawn, and the bushing is pushed to one side.

**Simple Wire Straightener**

The few parts necessary to make the illustrated wire straightener are as follows: Two pieces of  $\frac{1}{4}$  by 1-in. iron; two flat-head machine screws; one bolt and nut, with a washer to fit, having a thickness approximately equal to the diameter of the wire. The  $\frac{1}{4}$ -in. pieces should be drilled near one end to fit the bolt. In one piece two holes should be drilled and tapped for the machine screws, these being set in so their heads project an amount approximately equal to the diameter of the wire.

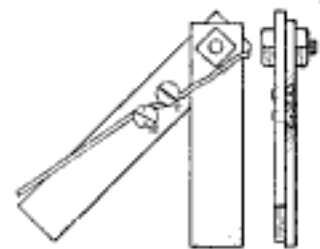

To use the straightener, open out the ends, insert the wire, and close up the parts; then draw the wire back and forth, holding the straightener at an angle with the wire so one screw bears against the top and the other against the bottom of the wire.—Contributed by D. C. Goff, Knoxville, Tenn.

### Repairing a Reamer

A reamer is easily broken on the points of the cutters at the end. As the cost of these reamers is rather high, it



The Cutters are Ground Down and Then Wrapped with Fine Wire and Soldered

is desirable to repair them whenever possible. A very good repair can be made by grinding the end of each cutter down to a level a trifle lower than the break and winding this part with copper or soft-iron wire, then soldering it in place. The solder is then smoothed up with a file.

### To Prevent Automobile Crank Handle from Sticking

Sand and dust collecting in the sleeve of an automobile starting-crank handle



will cause it to stick. To remedy this trouble, remove the handle and turn the pin down in the center about  $\frac{1}{8}$  in. deep for a length of  $2\frac{1}{4}$  in. This groove is then filled with ordinary packing. In this manner the sleeve will be kept well lubricated, and the sleeve will always slide loosely on the shaft pin. If two small grooves are cut lengthwise of the raised end portions, the grease, or oil, can easily reach these bearings.

### An Adjustable Lap

In the ordinary lap, a piece of brass rod of suitable size is slotted in the



A Headless Screw Controls the Adjustment Accurately, and Holds the Parts Rigidly

center for some distance, and a wedge-shaped piece of metal is inserted in the slot. This will not give a fine, or solid, adjustment. An improvement, which

will give a better adjustment, consists of a tapped hole in the portion A, and a headless screw, C, used in it. The screw, when turned in, will force the portion B away to any desired position.

### A Thread-Cleaning Tool

The tool illustrated will be of great help for anyone handling rusted bolts. It is made of a piece of steel of suitable size with a number of holes



Bar with Tapped Holes, and Slotted, for Cleaning Out Rusted Threads on a Bolt.

drilled of sizes necessary to tap with standard taps. After cutting the threads with the taps, the steel bar is slotted as shown. This tool, run over the threads of an old bolt, will clean off the rust and dirt that may have collected, making it an easy matter to start the nut, which otherwise would be a troublesome task.

### To Make Gear-Shift Lever Move Easily

Quite frequently a chauffeur will tug frantically at the shifting lever, in

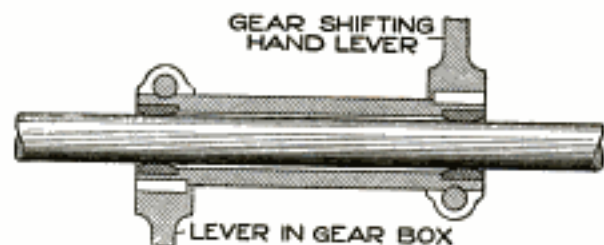

Curved Inner Surfaces of Bushings on a Shifting Lever, to Make It Move Easily

an effort to engage the transmission gears, without success. Trouble of this sort is in many cases caused by the holding of the shaft connected to the shifting lever. To eliminate this trouble insert two bushings, one at each end, having curved surfaces. The clearance between the shaft and bushing should be not less than .005 or more than .01 inch.



## How to Make Combined Kites

BY C. M. MILLER

### PART I—A Dragon Kite

**D**RAGON kites are made as hideous as the maker can possibly conceive, and while the one to be considered is no beauty, it is more droll than fierce-looking. In general appearance the dragon and centipede kites are like huge caterpillars floating about in the air. The kite sometimes twists and the balancer sticks appear to be large hairy spines. Usually the tail end swings higher than the head. It is like so many single kites, pulls hard, and requires a strong cord for the line. The individual circular sections may number 20, and if placed 30 in. apart, would make a kite about 50 ft. in length, or the number of sections may be more or less to make it longer or shorter. The kite will fold

the other sections. There are two principal rings to this sec-

tion, as shown in Fig. 1. The inner ring is the more important, the outer one being added for the protection of the points when alighting. The construction of the framework is shown in Fig. 2. It is made entirely of bamboo. The bamboo is split into strips, about  $\frac{3}{16}$  in. wide, for the ring A. As the bamboo strips will be much too thick, they must be pared down to less than  $\frac{1}{16}$  in. The diameter of the ring A is 12 in., and a strip of bamboo to make this ring should be about 38 in. long, so that there will be some end for making a lap joint. The ends of the strip are held securely together by winding them with linen thread. The Chinese boys use strips of rice paper, about  $\frac{1}{2}$  in. wide and torn lengthwise of the paper. The rice-paper strips are made wet with paste before winding them on the joint, and when they dry out the shrinkage will bind the ends securely.

Two crosspieces, of the same weight as the ring stick, are placed  $3\frac{1}{2}$  in. apart, at equal distances from the center and parallel, as shown at B and C. The ends of these pieces are turned at a sharp angle and lashed to the inside surface of the ring A. To make these bends, heat the bamboo over a candle flame until it will give under pressure, then bend and it will stay in shape after it becomes cold. This method of bending should be remembered, as it is useful in making all kinds of kites. Two

In General Appearance the Dragon Kite Is Like a Huge Caterpillar Floating About in the Air

up into a very small space, for carrying about or for storage, but care should be taken in folding not to entangle the harness.

#### The Head

The head requires much more work than any of



small rings, each  $3\frac{1}{2}$  in. in diameter, are put in between the two parallel pieces, as shown at D and E. These are for the eyes of the dragon. The



FIG. 1

The Kite-Head Section, Having Horns, Ears, and Revolving Eyes, Is Very Hideous

rings are lashed to the two crosspieces B and C. As the eyes revolve in the rings they should be made perfectly true. This can be done by shaping the bamboo about a perfectly round cylinder,  $3\frac{1}{2}$  in. in diameter. To stiffen the whole framework, two pieces of bamboo,  $\frac{1}{16}$  in. thick,  $\frac{1}{8}$  in. wide, and 20 in. long, are lashed to the back as shown by F and G. There is a space of 3 in. between the inner ring A and the outer ring H, giving the latter a diameter of 18 in. It is made of a bamboo strip,  $\frac{1}{8}$  in. wide, and should be less than  $\frac{1}{16}$  in. thick. It may be necessary to make this large ring from two pieces of bamboo, to get the length, and in such case be careful to make a perfect ring with the ends well lashed together. Two short pieces are lashed to the two rings, as shown at J and K. The supports for the horns consist of two pieces,  $\frac{1}{8}$  in. wide and less than  $\frac{1}{16}$  in. thick, and they are lashed to the upper crosspiece and to both rings, so that the parts L and M are exactly halfway between the ends of the pieces F and G and radiate out from the center of the ring A, the other parts, N and O,

pointing to the center of the eye rings, respectively. The ears are unimportant and may be put on if desired. The rings on the horns and the stick ends may be from  $\frac{1}{2}$  to 2 in. in diameter, cut from stiff paper, but if larger, made of bamboo.

Chinese rice paper is the best material for covering, and it should be stretched tightly so that there will be no buckling or bagging places. The only part covered is that inside of the inner ring A, the horns, and the ears, leaving the eye rings open. The shades are put on with a brush and water colors, leaving the face white, or it can be tinted in brilliant colors. Leave the horns white and color the tongue red.

#### The Eyes

The frame for each eye is made of bamboo, pared down to  $\frac{1}{32}$  in. in thickness and formed into a perfect ring,  $3\frac{1}{4}$  in. in diameter. Each ring revolves on an axle made of wire passed through the bamboo exactly on the diameter, as shown at P, Fig. 3. The wire should be long enough to pass through the socket ring D or E, Fig. 2, also, and after the eye ring is in place in the

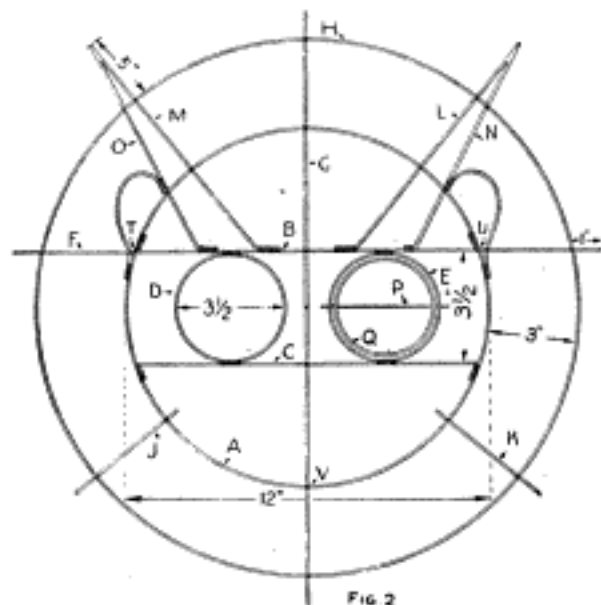

FIG. 2

The Framework for the Head Section is Made Entirely of Bamboo Strips Lashed at the Joints

socket ring and the axle adjusted, the latter is fastened to the eye ring with a strip of paper wrapped tightly around the wire and pasted to the bamboo of



the ring. A glass bead, placed on the wire axle between the socket rings D or E and the eye ring Q on each side, keeps them apart and the revolving one from striking the other.

Each side of the eye ring is covered halfway with rice paper, as shown in Fig. 4. The part R is on the upper front half, and that shown by S is on the back lower half. Placing the two halves in this manner causes an unequal pressure of the wind on the whole eyepiece, and thus causes it to revolve on the axle. The front upper half of the eyepiece is made black, and the smaller dark portion extending below the darkened half is a round piece of paper placed just between the two halves so that half of it will show on both front and back of the eyepiece. When the eyepiece is given a half turn in its socket the back side will come to the front and will appear just the same as the other side. Some kite builders add pieces of mirror glass to the eyes, to reflect the light and cause flashes as the eyes revolve in their sockets.

#### A Section Kite

The ring for the section kite is made the same size as the inner ring of the head kite, or in this case 12 in. in diameter. The bamboo for making this ring should be  $\frac{1}{8}$  in. wide and  $\frac{1}{16}$  in. thick.

be made small, light and well balanced. Small tufts of tissue paper, or feathers, are attached to the tip ends of the balancer sticks, as shown in Fig. 5. The

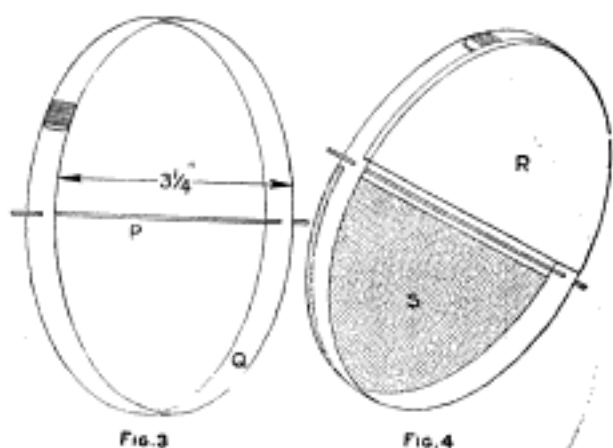

Two Bamboo Rings with Paper Coverings, to Make Them Turn in the Wind, Constitute the Eyes

cover for the section kite is put on tightly, the same as for the head, the colors indicated in the sketch being only suggestions, as the builder can color them as desired. The balancer on the last section should have streamers, as shown in Fig. 6, for a finish. The streamers are made of light cloth.

#### The Harness

As previously stated, 20, more or less, sections can be used, and the number means so many separate kites which are joined together with three long

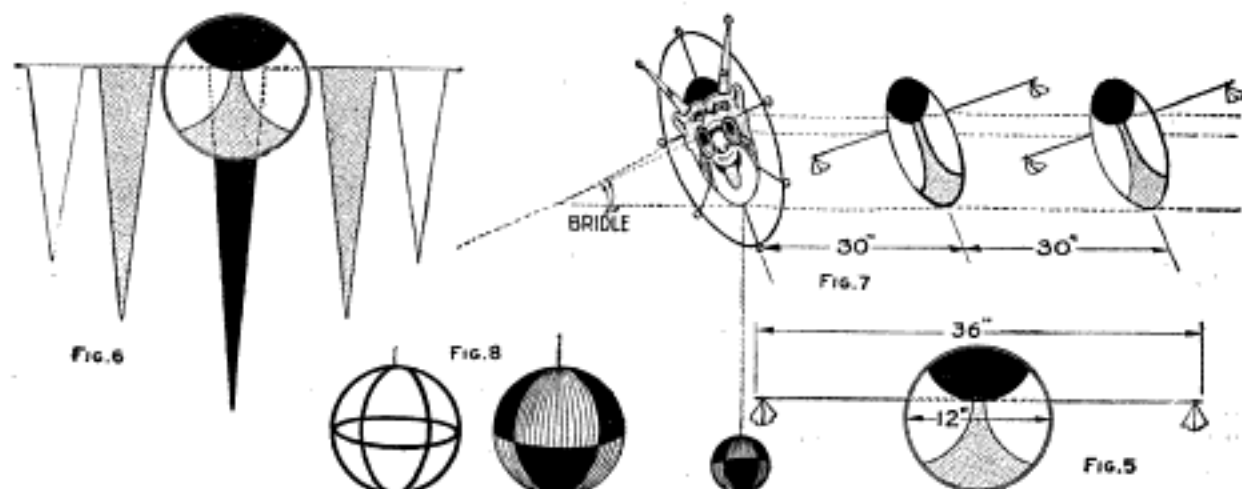

The Section Kites Have Balancers and the Disks are Given Bright Colors So That They will Produce the Effect of a Great Dragon When in the Air, the Head Piece Having a Ball Balancer Hanging from the Under Edge

The balancer stick, 36 in. long, is located about the same place as the cross-stick F, as shown in Fig. 2, and must

be made small, light and well balanced. Small tufts of tissue paper, or feathers, are attached to the tip ends of the balancer sticks, as shown in Fig. 5. The

ficient extra length for the knots. As such a kite will make a hard pull, the cord used should be a six-ply, hard-twisted seine twine. Start by tying the three long cords to the head kite at the points T, U, and V, Fig. 2. Tie the next section at corresponding places just 30 in. from the head kite. The construction will be much easier if the head kite is fastened to a wall so that each cord may be drawn out to its proper length. Continue the tying until all sections are attached just 30 in. apart. Other spacing can be used, but the distance selected must be uniform throughout the length of the kite. The individual kites, or sections, may vary in size, or they can all be 9 in. in diameter, instead of 12 in., and the balancer sticks 30 in. long instead of 36 in., but a kite of uniform sections is much better and is easier to make. The positions of the sections as they will appear in the kite are shown in Fig. 7.

#### The Bridle

The Chinese bridle is usually made of three strings, which are attached to the same points on the head kite as the

harness cords, or at T, U, and V. The lower string is longer than the two upper ones so that the proper inclination will be presented to the breeze. As the head is inclined, all the section kites will also be inclined. Some makers prefer a balancer on the head kite, and in one instance such a balancer was made in the shape of a ball. A ball made of bamboo strips is shown in Fig. 8, and is attached as shown in Fig. 7.

#### Flying the Kite

It will be necessary to have a helper, and perhaps two, in starting the kite up, as the harness might become entangled. Quite a little run will be necessary, but when up the kite will make a steady flier and will pull very hard. If the first attempt is unsuccessful, try re-adjustment of the bridle or a little different position in the breeze, and see that the balancers are not tangled. Quite a number of changes may be worked out on these plans, but it is necessary to bear in mind that the distances between sections must be equal and that the general construction must be maintained.

### A Movable Sunshade and Seat for Garden Workers

Weeding gardens under a hot sun and in a necessarily uncomfortable position is by no means a pleasant occupation, but much of the hardship can

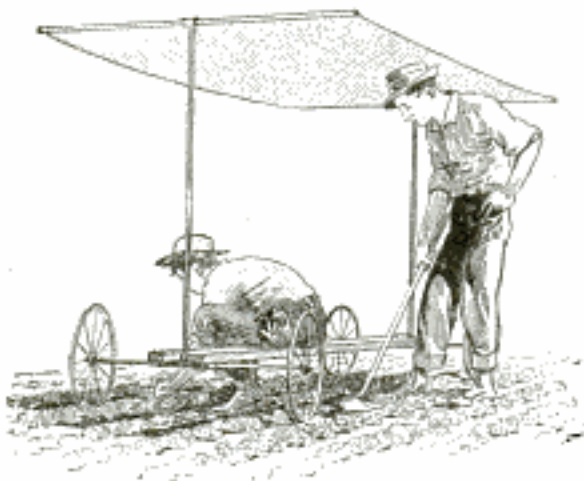

The Sunshade and Seat are Mounted on Wheels So That the Device can be Easily Moved About

be avoided if a combination movable sunshade and seat is made, as shown in the illustration. The framework consists of two end pieces, both made in the same way. Two  $\frac{1}{2}$ -in. tees are required for each. These are connected with a 5-ft. pipe, for the upright, and the crosspiece that supports one end of the canvas consists of two pieces of pipe, each about  $1\frac{1}{2}$  ft. long, screwed into the tee. The axle for the wheels is also formed of two pieces of pipe, but these are only about 1 ft. long.

Four suitable cart wheels should be provided, or solid circular disks cut out of a board or plank, and drilled for a  $\frac{3}{8}$ -in. axle. Ordinary  $\frac{3}{8}$ -in. washers are placed on each side of the wheels, one serving as a shoulder on the pipe end, and the other for the nut. The seat can be made of a 1 by 8-in. board, about 6 ft. 9 in. long, notched at each end to fit the pipe tees and prevented from shifting by means of U-bolts

around the axle on either side of the upright. After covering the top with canvas, fastened at each end around the upper crosspiece, the shaded movable seat is ready for service.—Contributed by W. E. Crane, Cleveland, Ohio.

### To Keep Grass and Weeds Out of Tennis Courts

Tennis courts are very apt to become covered with grass and weeds unless considerable labor is expended on them. The best way to keep a court free from this growth is to put on sheets of tar paper close together when it is not in use. The paper should be cut in strips the proper length, so that they can be rolled up and set aside until the game is over, when they can be laid down again. After the court has been covered a few times, the grass will die out and disappear altogether. The use of salt, acids, and a number of other things, together with hoeing, were tried out, but the paper covering was the most successful of them all.—Contributed by W. D. Mills, Bakersfield, Cal.

### Buttonhole-Bouquet Holder to Keep Cut Flowers Fresh

Being employed near a glass-blowing department I procured a small glass tube and made a buttonhole-bouquet holder. One end of the tube I closed and flared the other, then flattened the whole tube a bit. This tube, inserted in the buttonhole with a few drops of water in it, will keep cut flowers fresh for a whole day. If the upper end is flared just right it will fit the buttonhole and will not be seen, as the tube is hidden beneath the coat lapel.—Contributed by Frank Reid.



see Card:  
Bouquet Holder  
P

### Cooler for a Developing Tray

Regardless of the fact that tank development for photography is the better method under most conditions, there

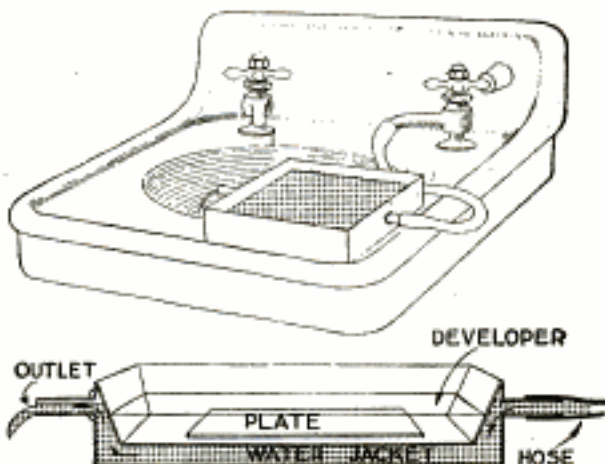

Water-Jacketed Tray for Use in Cooling a Developing Tray with a Flow of Water

are many who take special delight in tray development, because they enjoy seeing the picture as it develops on the plate or film.

There are many of this class of photographers both among amateurs and professionals, and they universally experience much trouble in keeping the solutions cool enough for good work in hot weather or a warm dark room. Many schemes have been used, but there is none simpler than that shown in the illustration. It is certainly better than letting the developing tray float in the bathtub, a common practice among amateurs who are compelled to use the bathroom as a dark room.

Any tinsmith can make a water-jacketed tray of zinc at a nominal price. If one expects to use it for developing films by hand, it should be made relatively deep, or at least shaped so that whatever method is used in manipulating the film will be suited to the size and shape of the tray. I had one made of zinc to accommodate an 8 by 10-in. plate and providing about  $\frac{1}{4}$ -in. space all around the sides and bottom of the inner tray for the circulation of the water.

Two brass gas tips were soldered into the ends of the tray and a rubber tube was attached to one of them, as shown.

By connecting this tray to the bathroom hydrant the developing solution can be kept as cool as desired without slopping water where it is not wanted.—Contributed by T. B. Lambert, Chicago, Ill.

### Doorbell Push Button on Screen Door

Push buttons are frequently put in hallways, or other places, not accessible when the screen doors are hooked

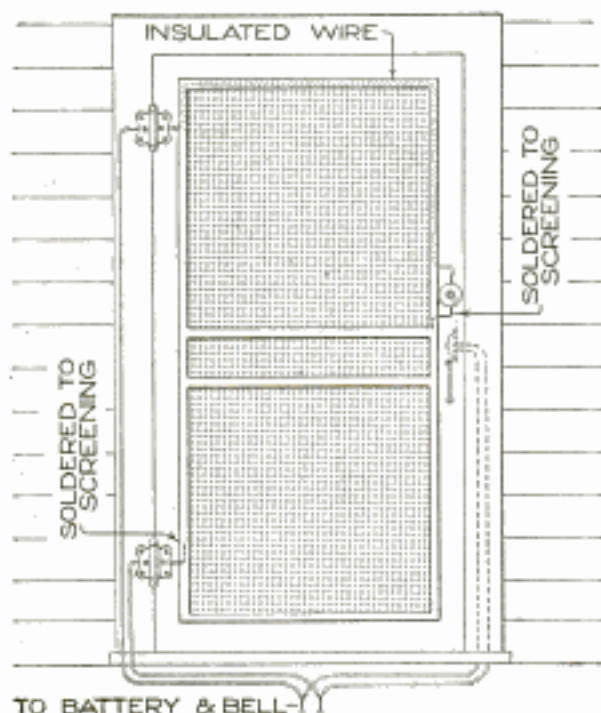

Method of Connecting a Push Button for a Doorbell on a Screen Door

shut. By connecting an extra button on the screen door with the regular doorbell line, the service can be made to go on uninterrupted whether the screen be locked or open.

To do this, one wire, carefully insulated, from the outside button is laid under the upper molding strip of the screen, as shown, coming out through the hinge and passing down to the battery line, being concealed in any suitable manner, by molding or within the door frame. The button circuit is completed by connecting it to the screen with a short wire, the screen then acting as a conductor. If preferred, the line may be run down under the screen-door molding, and out through the bottom hinge same as with

the other wire at the top. If the screen is used as conductor, a piece of wire should be connected to it near the bottom, and led through the hinge as before. In either case, after leaving the hinge, the wire must be led and connected to the battery line, to complete the circuit. It is then possible to operate the bell either from outside of the screen door or at the regular place within.—Contributed by E. M. Davis, Philadelphia, Pa.

### Working Wood by the Application of Heat

It is often desirable to fit a piece of wood into a piece of metal by means of cutting a thread in the metal and screwing the wood therein. This can be accomplished by heating the metal to a little over the boiling point of water and screwing the wood piece into the metal while hot; or, if this is impractical on account of size, to heat the metal, make a screw plate by cutting a thread in a small piece of metal, the size and thread corresponding to the hole into which the wood piece is to be inserted, and heating it to the required temperature, then running the wood with some pressure through the thread. The wood then can be screwed into the larger piece, where it will hold firmly.

The process of heating wood without the aid of steam can be used to advantage in a number of ways; for instance, a hammer handle that is crooked can be straightened by careful heating without burning; also billiard cues, or almost anything of hard wood. It is surprising how easily it is done and how permanent the repair will be. The Indians at one time made their arrows from small hardwood twigs which were almost always crooked to start with, but after being dried they were warmed over a fire and straightened.

Another use for the application of heat is as follows:—When it is desired to place a screw in a fragile piece of wood that is likely to split, if the screw is heated to a blue color and turned

into the wood while hot, there will be scarcely any danger of splitting. In this case do not try to use oil or a lubricant of any kind, as the screw is sure to set before it is in place.—Contributed by James H. Beebee, Rochester, N. Y.

### A Parlor Table

The material required for the parlor table illustrated is as follows:

- 1 table top, 1 by 26 by 41 in.
- 1 bottom shelf, 1 by 15 by 35 in.
- 2 side rails,  $\frac{3}{4}$  by 4 by 33 in.
- 2 end rails,  $\frac{3}{4}$  by 4 by 21 in.
- 2 top cross braces, 1 by 4 by 19 $\frac{1}{2}$  in.
- 4 feet,  $1\frac{3}{4}$  by 4 by 4 in.
- 2 posts, 6 by 6 by 26 in.
- 2 side corner strips, 1 by 1 by 31 $\frac{1}{2}$  in.
- 2 end corner strips, 1 by 1 by 17 $\frac{1}{2}$  in.

The bottom shelf can be made of two pieces of 1-in. material, 8 in. wide, carefully glued together, and reinforced on the under side with two crosspieces, glued and screwed to it. The foot pieces are secured to the bottom shelf so as to project 1 in. on the ends and sides. In case a center support is deemed advisable, another foot piece can be added, but unless the floor is very level, rocking may result. The uprights, or posts, are made from solid 6 by 6-in. lumber, 26 in. long, carefully squared at the ends, and tapered to 4 in. square at the upper end. If desired, the posts can be made of

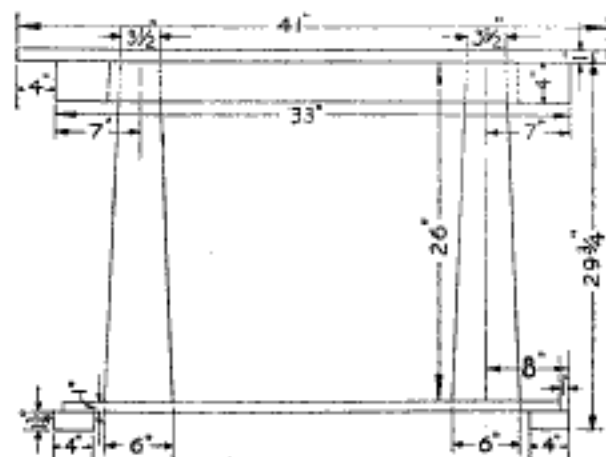

Detail of the Parlor Table, Together with Dimensions of the Pieces

boards, cut and fastened together to form a hollow tapered post. In either case, they should be set in about 4 in.

from each side of the bottom shelf and fastened to it by means of screws.

The rail pieces for the table top

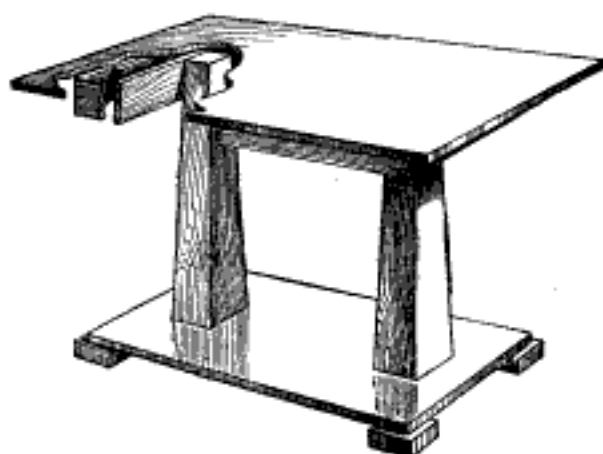

Design of a Table That will Appear Well in the Different Oak Finishes as Well as in Mahogany

should be cut and fitted with mitered joints at the corner to form a rectangular frame, 21 by 33 in. This is glued to the top and may be toenailed to it; but to provide a more secure bracing, a 1-in. square strip of material is fastened all around the inside edge of the rails, flush with their upper edge. The top is screwed to this. In order to prevent tipping when the top is resting on the 4 by 4-in. ends of the posts, two cross braces are provided. These should be screwed to the outer-end sides of the posts, and beveled off on their upper edges to fit the table top. They should be of such length as to have a tight fit between the side rails, and are fastened to these by means of finishing nails driven from the outside. Gluing and toenailing can also be used to secure the top more firmly to the braces; care should be taken that no nails cut through the table top. After thoroughly sandpapering and smoothing off the table, it can be finished to suit.—Contributed by H. J. Blacklidge, San Rafael, Cal.

### Homemade Fuses for Battery Circuits

To carry out the general arrangement of the regular electrical equipment of a large power plant, the battery circuit should have some sort of a fuse block. An excellent way to

make such a block is as follows: Procure a piece of glass tubing, about 1 in. long, and make a mounting for it with four pieces of sheet brass, as

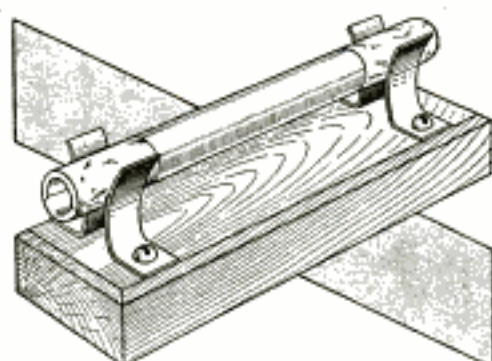

The Fuse is Well Insulated and Protected against Fire the Same as the Large Fuse

shown in the sketch. The brass pieces are shaped and fastened to a wood base so that their upper ends form a clamp to hold the glass tube.

A very thin piece of tinfoil, about  $1\frac{1}{2}$  in. long, is cut  $\frac{1}{8}$  in., or less, in width, the size depending on the amount of current used. This is placed in the glass tube and the ends are bent over the edge. A piece of tinfoil is then wrapped around each end, over the ends of the inclosed piece, and pasted to the tube.

The fuse thus made is pushed into the spring clamps of the block which are connected in the circuit.—Contributed by Charles W. Meinberg, Somerville, Mass.

### Reproducing Flowers and Leaves in Colors

A very cheap, easy, and quick way to make reproductions of flowers, leaves, insects, butterflies, etc., is the following: Purchase 1 oz. of bichromate of potash and dissolve it in water. Spread this fluid over the surface of the paper upon which the picture is to be made, using a soft brush, and place it in a dark room to dry. When dry it will be a light lemon color.

The leaf, or part to be reproduced, is placed upon the yellow side of the paper and the whole exposed to the sunlight. The uncovered portions will gradually turn brown, while the part

covered by the object will remain a lemon color. When the desired shade of brown is attained, remove the paper from the sunlight, and the image of the object will be on the paper.

Go over the outline with crayons or colors, and fill in the print according to the natural colors. Very beautiful pictures may be made in this way, and a butterfly made up in natural colors on a dark-brown ground is very pretty. These prints, uncolored, will keep for some time, if they are not exposed to a strong light.

Washing as ordinary photographic prints are treated will improve them a little. If the instructions are followed, many beautiful objects can be preserved in color.—Contributed by J. B. Murphy, Plainfield, N. J.

### Dishwasher and Drier

Where hot water is available the dishwasher illustrated is especially suitable. It is easily constructed and inexpensive, the only real expense being for the tank, which is 15 in. deep and 20 in. in diameter. A washer of these dimensions will hold the dishes from a table serving six to eight per-

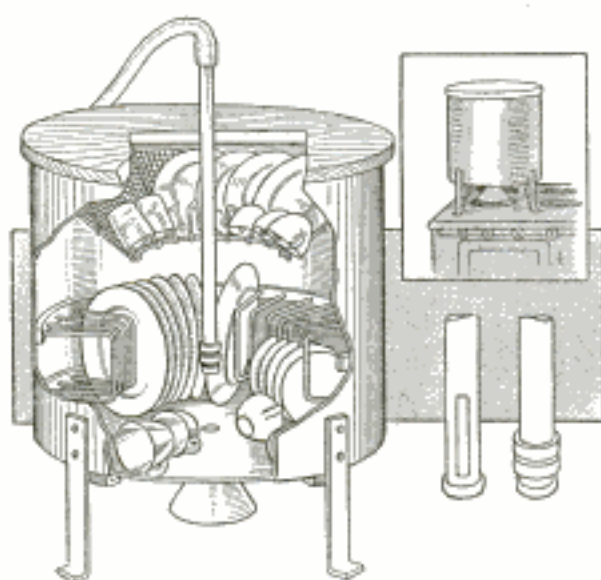

The Hot Water from the Faucet is Forced over the Dishes in a Fine Spray

sons. The tank may be supported on legs if desired.

The supports for holding the dishes

in a vertical position are made of wire in a U-shape, the ends being fastened into two wood hoops that snugly fit the inside of the tank, one near the bottom and the other about 9 in. above the first one. The wires are set about  $1\frac{1}{2}$  in. apart and radiate from the center like wire spokes in a wheel.

A funnel-shaped piece, having a hole 5 in. in diameter in the center, is made of mesh wire and hung in place with several wires running to the upper edge of the tank. Hooks are attached to the edge of the hole on which cups and glasses are hung.

The cover consists of a wood disk, with a hole bored in its center for a  $\frac{1}{2}$ -in. pipe. The piece of pipe used should be 3 or 4 in. longer than the depth of the tank. A long thread is cut on the lower end of the pipe, and two rectangular holes are cut in the pipe end through the threaded part. These holes are made by cutting through the pipe as if making a slot for a key. Two large nuts are run on the threads of the pipe. These nuts should be thick enough to cover the slot in the pipe. A pipe cap is then screwed on the end of the pipe. The upper end of the pipe is attached to a hose connected to the hot-water faucet. By separating the two nuts just a little, a fine spray of water will be forced out of the holes.

When the dishes are in place the spray of hot water can be directed over them by moving the pipe up and down through the hole in the cover.

After the dishes are washed sufficiently the hose is removed and the tank placed over a gas jet so that the heat will pass up through the funnel-shaped attachment in the bottom of the tank. The dishes, already heated by the hot water, soon dry in the heat from the gas jet. If desired, the tank can be allowed to remain over the jet until the next meal is ready to serve, using a very small flame.—Contributed by W. K. Baxter, Massillon, O.

¶To empty a large sack filled with heavy material, turn or roll it over a barrel.

## How to Make Pop-Corn Cakes

It is very difficult to take a bite from a ball of pop corn, and it becomes more difficult as the ball increases in size.

The Pop Corn When Formed into Cakes About One Inch Thick is Easily Handled

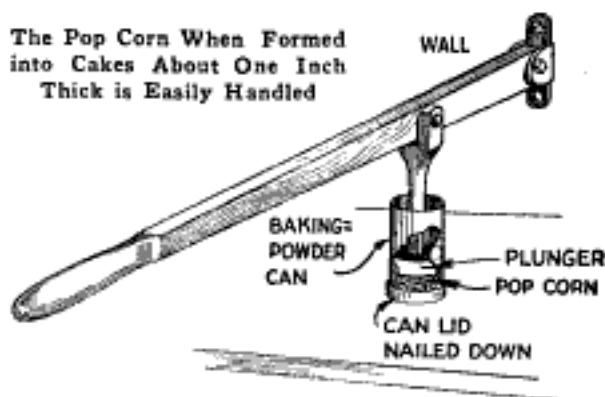

As a large number of balls were required for a church entertainment I decided to make the pop corn into cakes. This was more easily accomplished than first imagined with the use of a cake-forming device as shown in the illustration. The body of the former was made of a baking-powder can with the bottom removed. The cover of the can was nailed to the top of an old table with its flange upward. A plunger of wood was made to fit snugly inside of the can and a lever, about 3 ft. long, attached to it and fulcrumed to the wall.

After the pop corn has been prepared with the sirup, it is placed in the can and compressed. The can is then lifted out of the cover and the pop-corn cake removed. This method offers a much better way to serve pop corn than in balls. In making the cakes, the can, cover, and plunger must be kept well covered with butter.—Contributed by Howard A. Hopkins, Youngstown, New York.

## Threading a Darning Needle

Having occasion to use a darning needle, the eye of which was too small to insert the yarn in the usual manner, I tried the following method with good results. A thread was doubled and passed through the eye, and the loop thus formed was used to pull the yarn through.—Contributed by Joe Henderson, Eldred, Ill.

## Woven-Top Stool

The material necessary for this stool is as follows:

- 4 legs,  $1\frac{3}{4}$  by  $1\frac{3}{4}$  by 16 in.
- 4 bottom rails,  $\frac{3}{8}$  by  $1\frac{3}{4}$  by 16 in.
- 4 top rails,  $\frac{3}{8}$  by 2 by  $16\frac{1}{2}$  in.
- 4 diagonal braces,  $\frac{3}{8}$  by  $1\frac{3}{4}$  by 6 in.



Weaving the Top of the Stool by Using a Wet Weaver of Reed

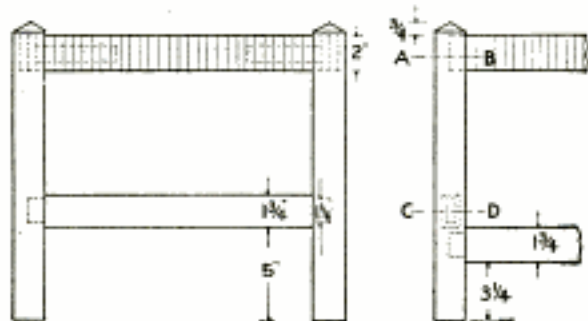
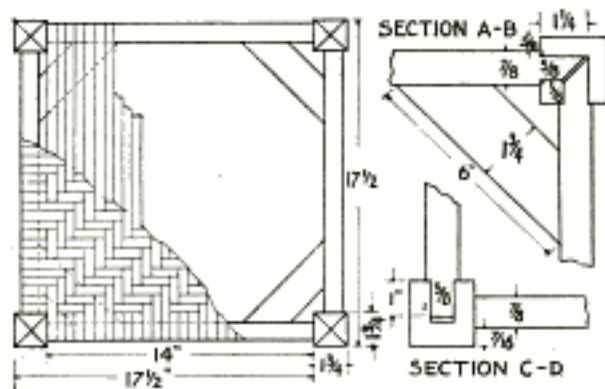

Construction of the Frame and Manner of Laying the Weavers for the Top

The legs are mortised so the top rails come level. The upper rails are tenoned on the sides only and beveled at the ends. For the bottom rails, the mortises are made one above the other, the rails being tenoned on all sides. The braces are cut at  $45^\circ$  on each end and glued into place.

In weaving the top, proceed as follows: Use a wet weaver and wrap one layer over the entire top, the strips being placed close together and tightly wound. Start the second layer at right angles to the first by going under one strip, then over three strips, under three, and so on, by threes, until that strip is finished. Start the second by going under two strips, then over three, under three, and so on, as before. The third strip should start by going under three, then over and under three, etc. Start the fourth by going over one, then under three, and over three, as in the preceding; the fifth, start over two, then under and over three, repeatedly. The sixth, and last of the series, begin over three and then continue, by threes, as before. Having finished one series, the remainder of the top should be completed in similar order. Good white shellac makes the best finish for the seat; the stool itself may be finished to suit.—Contributed by Russel Dodsworth, Erie, Pa.

## Preserving Shafting from Rust and Corrosion

In a laboratory it was very difficult to keep the line shaft and countershafts bright and free from rust, owing to the fumes and gases issuing from the several fume closets within the same room. The following method was tried, and proved very satisfactory. The shafting was covered with two coats of flat white paint and allowed to dry, after which a coat of white enamel was applied, giving it a clean, glossy, and sanitary appearance. This eliminated all the trouble of cleaning it with emery cloth, and it also made it appear in harmony with the other furnishings of the laboratory.—Contributed by Geo. F. Stark, Norwich, N. Y.



# Fishing-Rod Making and Angling

By STILLMAN TAYLOR

## PART III—Trout Fishing with Fly and Bait



If He would Take Full Advantage of Any Sport and Reap the Greatest Pleasure from a Day Spent in the Open, the Sportsman should Get Together a Good Outfit

**T**HE art of angling is generally viewed as one of the world's greatest recreations, and while each and every phase of fishing may be said to possess certain charms of its own, fly fishing for trout is regarded by most well-informed sportsmen as the alpha and omega of the angler's art. This is so because the trout family are uncommonly wary and game fish, and the tackle used for their capture is of finer balance and less clumsy than any employed in angling for the coarser game fishes. If he would take full advantage of any sport and reap the greatest pleasure from a day spent in the open, it is really necessary for the sportsman to get together a good outfit. It is not essential to have a very expensive one, but it should be good of its kind, well proportioned for the purpose for which it is to be used. The beginner, who buys without good knowl-

edge of the articles required, or fails to use careful discrimination, is almost certain to accumulate a varied assortment of junk, attractive enough in appearance, perhaps, but well-nigh useless when it is tested out on the stream. A good representative outfit, then, is of the first importance; it means making a good beginning by initiating the novice in the sport under the most favorable conditions. Let us then consider the selection of a good fishing kit, a well-balanced rod, the kind of a reel to use with it, the right sort of a line, flies, and the other few items found in the kit of the practical and experienced trout fisherman.

### Selecting a Good Fly Rod

The ordinary fishing pole may be bought offhand at almost any hardware store, but a well-balanced rod for fly fishing should be well tested out beforehand. The requirements call for a rod of comparatively light weight, a rod that is elastic and resilient, and yet strong enough to prove durable under the continued strain of much

fishing. If the angler has made his own rod, as suggested in former chapters, he will have a good dependable fly rod, but the large majority of anglers who are about to purchase their first fishing kit should carefully consider the selection of the rod. At the outset it must be understood that good tackle is simply a matter of price, the finest rods and reels are necessarily high in price, and the same thing may be said of lines and flies. Providing the angler has no objection to paying \$15, or more, for a rod, the choice will naturally fall upon the handmade split bamboo. For this amount of money a fair quality fly rod may be purchased, the finer split bamboos costing anywhere up to \$50, but under \$15 it is very doubtful whether the angler can procure a built-up rod that is in every way satisfactory. The question may arise, Is a split-bamboo rod necessary? The writer's own long experience says that it is not, and that a finely made solid-wood rod, of greenheart or dogwood, is quite as satisfactory in the hands of the average angler as the most expensive split bamboo. A good rod of this sort may be had for \$10, and with reasonable care ought to last a lifetime.

The points to look for in a fly rod, whether the material is split bamboo or solid wood, is an even taper from the butt to the tip; that is, the rod should register a uniform curve, or arc, the entire length. For general fly casting 9 ft. is a handy length, and a rod of 6½ oz. weight will prove more durable than a lighter tool. A good elastic rod is wanted for fly casting, but a too willowy or whippy action had best be avoided. However, for small-brook fishing, where the overgrown banks prohibit long casts, a somewhat shorter and stiffer rod will be more useful. For casting in large northern streams, where the current is swift and the trout run to a larger size, a 9½ or 10-ft. rod of 8 oz. weight is often preferred. Of course, the veteran angler can safely use a much lighter rod than the beginner, and one occasionally meets a man on the stream that

uses a 5-oz. rod for pretty heavy fishing. To be on the safe side, the novice will make no mistake in choosing a rod of fair length and conservative weight.

When selecting a rod in the tackle shop, do not rest content with a mere examination of the appearance, but have the dealer affix a reel of the weight and size intended to be used with it. By reeling on a short length of line and reeving it through the guides and then fastening the end to a weight lying upon the floor, a very good idea of the rod's behavior may be gained, since by reeling in the line and putting tension on the rod its elasticity and curve may be seen and felt as well as in actual fishing. To give the utmost satisfaction, the rod should fit its owner, and several rods should be tried until one is found that most fully meets the angler's idea of what a rod should be. If one happens to have a good fly reel, by all means take it along and attach it to the rod while making the tests. It is practically impossible to gauge the balance of a rod without affixing the reel, and many a finely balanced tool will appear badly balanced until the proper-weight reel is affixed to it.

#### The Proper Kind of Reel

For fly fishing nothing is so good as the English style of click reel, which is made with a one-piece revolving side plate and with the handle affixed directly to it. Any kind of a balanced-handle reel is an out-and-out nuisance on the fly rod, because it has no advantage in quickly recovering the line, and the projecting handle is forever catching the line while casting. In fly casting, the length of cast is regulated by the amount of line taken from the reel before the cast is made, and it is while "pumping" this slack line through the guides, in making the actual cast, that the balanced or projecting handle is very apt to foul the line. A good reel that is smooth-running like a watch will cost about \$10, but a very good one may be had for \$5, and cheaper ones, while not so durable, may be

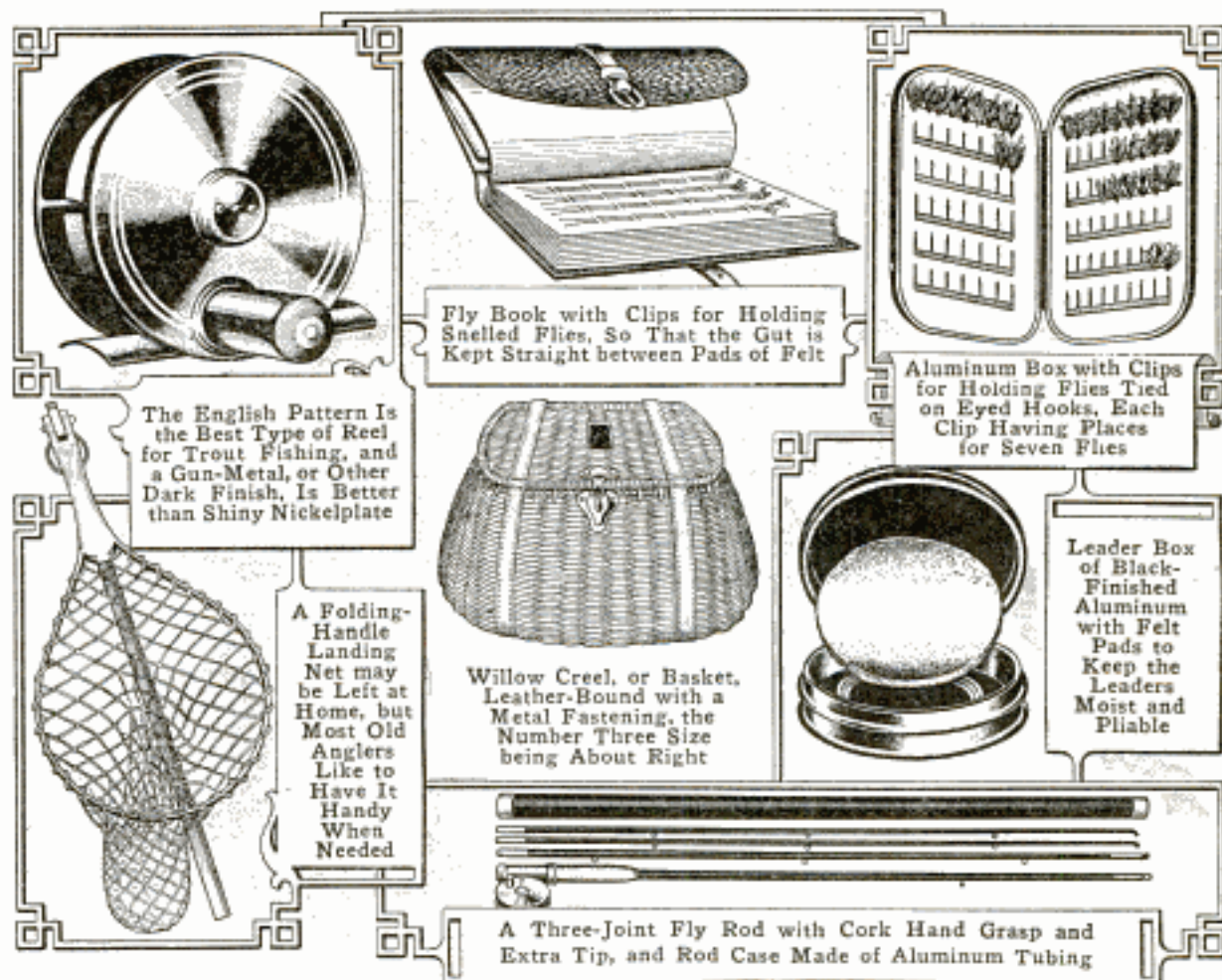

used with fair satisfaction. The heavier multiplying reels, so essential for bait casting from a free reel, are altogether unsuited for the fly rod, being too heavy when placed below the hand, which is the only proper position for the reel when fly casting. The single-action click reel, having a comparatively large diameter, but being quite narrow between the plates, is the one to use, and hard rubber, or vulcanite, is a good material for the side plates, while the trimmings may be of german silver or aluminum. The all-metal reel is of about equal merit, but whatever the material, the most useful size is one holding about 40 yd. of No. E size waterproof line. A reel of this capacity will measure about 3 in. in diameter and have a width of about  $\frac{7}{8}$  in. between plates. A narrow-spoiled reel of this type enables the fisherman to reel in the line plenty fast enough. Owing to the fact that the reel is placed below the grip on fly

rods, a rather light-weight instrument is needed to balance the rod. Of the two extremes, it is better to err on the side of lightness, because a heavy reel makes a butt-heavy rod and, throwing extra weight on the wrist and arm, makes casting increasingly difficult after an hour's fishing. An old hand at the game will appreciate this point better than the novice.

#### The Kind of Line to Use

The fly-casting line used by a veteran is generally of silk, enameled and having a double taper; that is, the line is thickest in the center and gradually tapers to a smaller diameter at each end. Single-tapered lines are likewise extensively used, and while they cost less, they are tapered at one end only and cannot be reversed to equalize the wear caused by casting. The level line, which has the same diameter throughout its entire length, is the line most generally used, but the cast

cannot be so delicately made with it. For the beginner, however, the level line in size No. E is a good choice. For small-brook fishing, No. F is plenty large enough. In choosing the size of line, there is a common-sense rule among fly casters to select a line proportioned to the weight of the rod. For a light rod a light line is the rule, and for the heavier rod a stouter line is the logical choice. If the rod is of a too stiff action, use a comparatively heavy line, and it will limber up considerably; if the rod is extremely "whippy," use the lightest line that can be purchased, and used with safety.

#### A Fine Leader Marks the Expert Caster

The leader for trout is preferably of single gut, and as fine as the angler's skill will allow. The fly caster's rule is to use a leader whose breaking strain is less than the line, then, when the tackle parts, it is simply a question of putting on a new leader and the more expensive line is saved. Ready-made leaders may be purchased, or the angler can tie them up as desired. For length, a 3 or 3½-ft. leader is about right for average fishing. Longer leaders are used, and while they sometimes are of advantage, the 3-ft. length is more useful. A longer leader is awkward to handle because the loop is apt to catch in the top of the rod when reeling in the line to bring the fish close to the landing net. Leaders may be had with a loop at each end, or with loops tied in, for using a cast of two or three flies. For all average casting, the two-fly cast is the best, but the expert angler uses the single-fly very often. For lake fishing, the single large fly is generally preferred. For using two flies, the leader is provided with three loops, one at the top, another at the bottom, and an extra loop tied in about 15 in. from the lower loop. In fly casting, the first, or upper, fly is known as the "dropper," and the lower one as the "tail" fly. For the single-fly cast but two loops are required.

Gut used for leaders should be carefully selected, and only those lengths which are of uniform diameter and

well rounded chosen, the lengths which show flat and rough spots being discarded. Dry gut that is very brittle should be handled very little, and previous to a day's fishing the leaders must be soaked in water over night to make them pliable, then coiled in between felt pads of the leader box to keep them in fishing shape. After use, put the frayed leaders aside and dry them out between the flannel leaves of the fly book.

Gut is the product of the silkworm, and the best quality is imported from Spain. It comes in bundles, or hanks, of 1,000 strands, 10 to 20 in. long and in different thicknesses, or strengths. The heaviest are known as "Royal" and "Imperial," for salmon; "Marana," for extra-heavy bass; "Padron," for bass; "Regular," for heavy trout; "Fina," for light trout, and "Refina," for extra-light trout. The grades "Fina" and "Refina" are well suited for all average fly fishing, while the heavier sizes are useful for heavy large fishing.

To make the leaders, soak the strands of gut in warm water over night until they are soft and pliable. Select the strands for each leader of the desired thickness and length so that the finished leader will have a slight taper to one end only. By using the "Fina" gut for the upper length and tying in two lengths of "Refina" gut, a nicely tapered leader of light weight is obtained. Begin the leader by uniting the strands together to make it the correct length, three 12-in. strands being about right for average casting. The "single water knot" is the strongest and neatest to use. Make it by taking the thick end of the strand and doubling it back enough to tie in a common knot just large enough for the line to pass through and drawing it up tightly. Tie a single loose knot in the other end of the strand, about 1/8 in. in diameter and close to the end; take the next thickest strand of gut, thread the thicker end through the loose knot and tie a second square knot around the strand, as shown at A. By pulling on the two

long ends the loops can be drawn up tightly, and the two knots will slide together and make a neat and very strong knot. Repeat this operation

well-known "angler's knot" is mostly used. This knot is shown at C. The snelled fly is attached by passing the loop over the loop of the leader and

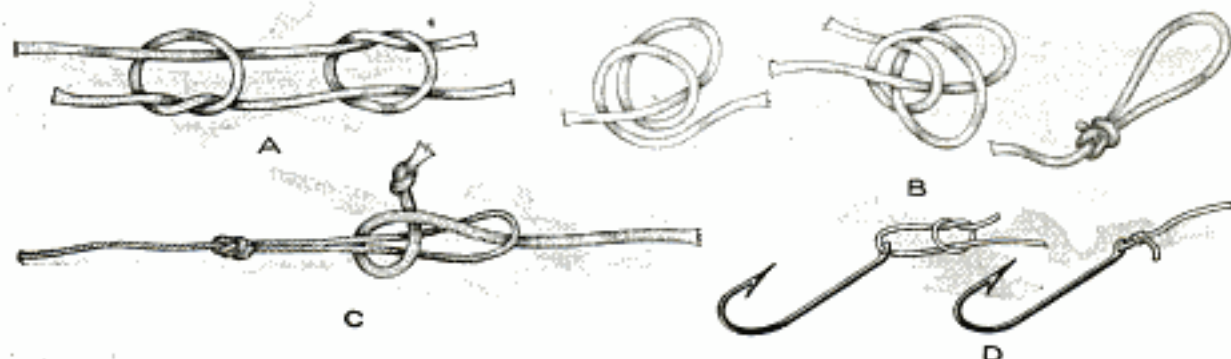

The Single Water Knot Used in Tying Leaders; a Good Knot for Making the Loop at the End of the Leaders; an Angler's Knot Used for Attaching the Line to the Leader, and a Jam Knot for Attaching Eyed Flies, or Hooks, to the Leader or Snell

until as many strands of gut are knotted together as required to make the leader of the desired length. For making the loop at the ends, a double-bight knot, tied as shown at B, is used. If a dropper fly is desired, do not pull the water knot tightly, but first insert a short length of gut with a common knot at the end and a loop in the other, then draw the water knot up tightly, and a short snell will be made for attaching the fly as usually.

#### Flies for Trout Fishing

The standard selection of artificial flies numbers about 60, but the average fisherman will find about 24 selected patterns to answer every need. For making up the most "killing" flies for the trout season, the following can be recommended: Use red ibis, stone fly, cinnamon, red spinner, and parchmencee belle, for April; turkey brown, yellow dun, iron blue, spinner, montreal and red fox, for May; spider, black gnat, silver doctor, gray drake, orange dun, and green drake, for June; July dun, grizzly king, pale evening dun, red ant, and brown palmer, for July; Seth green, coachman, shad, governor, August dun, and royal coachman, for August, and black palmer, willow, whirling dun, queen of the water, and blue bottle, for September.

To attach a line to the leader the

inserting the fly through the leader loop. When eyed flies are used they are often attached direct to the leader, or a looped snell may be used as in the ordinary American-tied fly. To attach the eyed fly direct to the leader, the common "jam knot," shown at D, is mostly used, and when the slipknot is drawn up tightly and the extra end cut off it makes a small, neat knot, not apt to slip.

#### Catch to Hold Two Joining Doors Open

Where two open doors meet, a catch to keep them open can be made of a piece of wire, shaped as shown. The hooks at the ends of the wire are slipped over the shanks of the knobs.—Contributed by W. A. Saul, Lexington, Mass.

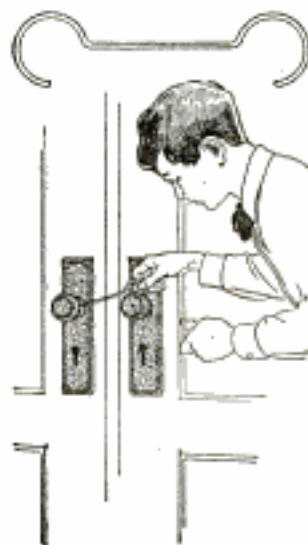

Strips cut from wood dishes used by grocers for butter, thoroughly soaked in warm water, will make excellent repair pieces for market baskets.

### Machine for Sketching Pictures

An ordinary drawing board, with the attachments shown, provides an easy way to sketch pictures, even if

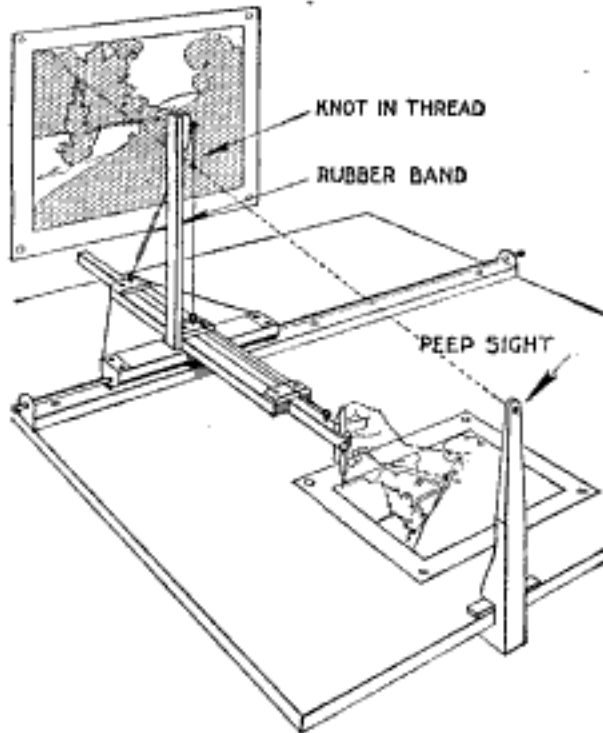

This Machine Aids a Person in Drawing the True Outline of a Picture

one is not proficient in this line of work. It is only necessary to look through the sight and move the pencil about so that the knot in the thread follows the outline of the landscape or object being drawn.

The size of the machine depends on the one building it, but a fair-sized drawing board is sufficient for the beginner. A strip of wood is fastened to the board, near one edge, which has a metal piece on each end, fastened to the under side and bent up over the end to form an extension for the rod to support the moving parts. The strip of wood should be  $\frac{3}{4}$  in. wide and  $\frac{1}{4}$  in. thick, and the sliding arm, holding the pencil,  $\frac{1}{2}$  in. wide and  $\frac{1}{4}$  in. thick. A like strip, but much shorter than the one fastened to the board, is also fitted with metal pieces in an inverted position so the projections will be downward. A  $\frac{1}{8}$ -in. rod is run through holes in the metal pieces of the strips at both ends, and

soldered to those on the strip fastened to the board. This will make a hinged joint, as well as one that will allow the upper strip to slide horizontally.

Centrally located on the upper strip are two more strips, fastened with screws at right angles to the former, with a space between them of  $\frac{1}{2}$  in. for the sliding center piece holding the pencil. These pieces are further braced with a wire at the back, and crosspieces are screwed both on top and under side, to make a rigid guide for the sliding pencil holder. An upright is fastened to the side of one of these pieces over the center of the upper horizontal sliding piece for a screw eye to hold the thread. Another screw eye is turned into the crosspiece just under the one on the support, so that the thread will run perpendicularly between them. Two more screw eyes are fastened, one into the upper surface of the rear crosspiece, and the other in the end of the pencil holder, near the pencil. By connecting these screw eyes, as shown, with a thread, having a rubber band fastened in the rear end and a knot tied in it near the screw eye in the upper end of the vertical stick, a means for following the outlines of the picture is provided.

A vertical stick is fastened to the front edge of the board by means of a notch and wedge. In the upper end of this stick a very small hole is bored for a sight, similar to a peep sight on a rifle.

To use the machine, set the board on a table, or tripod, and level it up in front of the object to be drawn. Look through the sight at the front of the board and move the pencil about to keep the knot of the thread on the outlines of the picture to be drawn.—Contributed by Wm. C. Coppess, Union City, Ind.

CA walnut filler is made of 3 lb. burnt Turkey umber, 1 lb. of burnt Italian sienna, both ground in oil, then mixed to a paste with 1 qt. of turpentine and 1 pt. of japan drier.

### A Disk-Armature Motor

One of the simplest motors to make is the disk motor, its construction requiring a wood base, a brass disk, a 3-in. horseshoe magnet, and some mercury.

in diameter, and a needle, with the eye broken off and pointed, is used for the shaft. The needle shaft can be placed in position by springing the bearings apart at the top.

When the current is applied, the disk

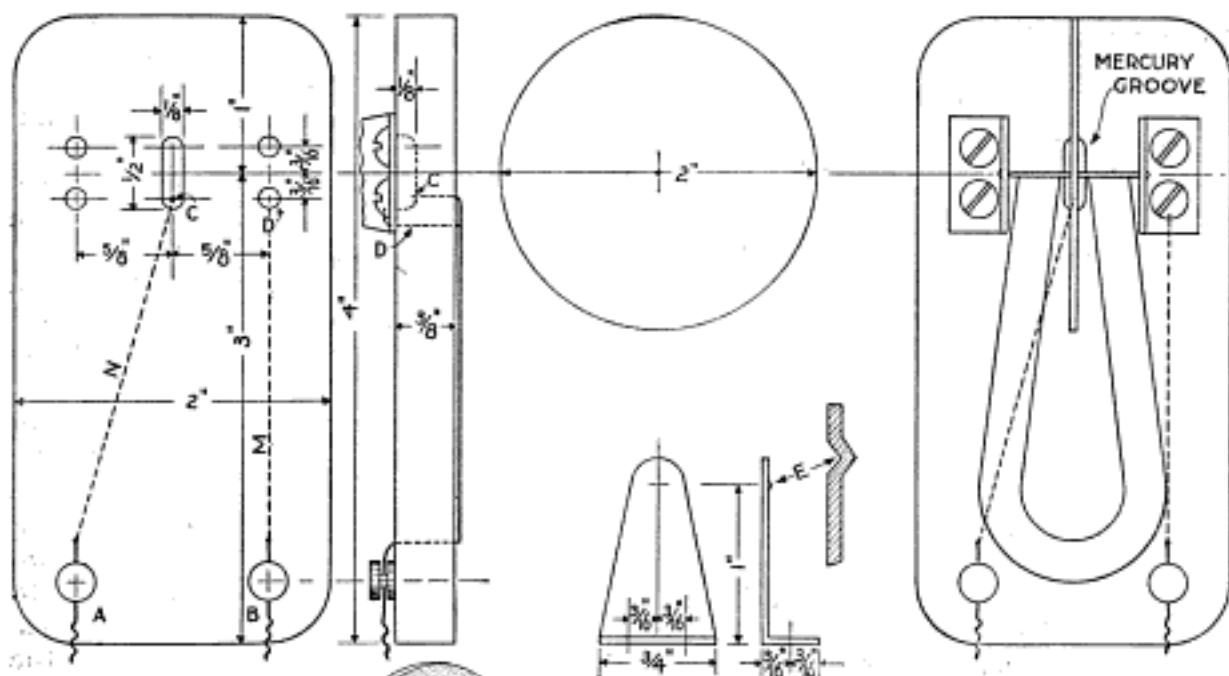

Parts of the Disk Motor Shown in Detail, Also the Location of the Horseshoe Magnet on the Base, Ends of the Poles being Directly under the Center of the Shaft.

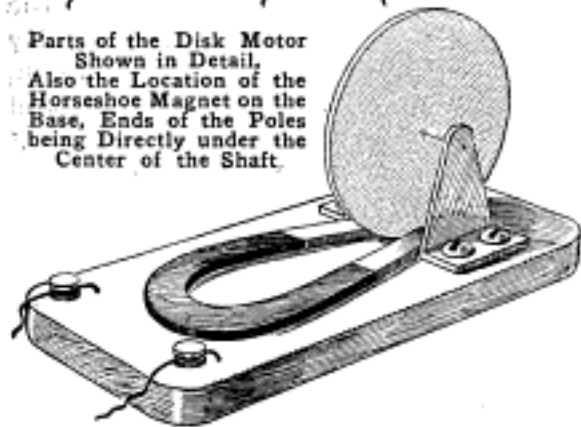

The base is made of hard wood, in the proportions shown in the sketch. The leading-in wires are connected to the binding posts A and B, and from these connections are made, on the bottom of the base, from A to the groove C cut in the upper surface of the base for the mercury, and from B to one screw, D, of one bearing. The end of the former wire must be clean and project into the end of the groove, where it will be surrounded with mercury.

The bearings consist of thin sheet brass, cut to the dimensions shown, the bearing part being made with a well-pointed center punch, as at E. The disk wheel is made of sheet brass, 2 in.

will revolve in a direction relative to the position of the poles on the magnet. The reverse can be made by turning the magnet over.—Contributed by Joseph H. Redshaw, Homestead, Pa.

### Repairing Marble

With a little practice any mechanic can repair holes, cracks or chipped places on marble slabs, so that the patched place cannot be detected from the natural marble. Use the following mixture as a base for the filler: Water glass, 10 parts; calcined magnesite, 2 parts, and powdered marble, 4 parts. These should be mixed thoroughly to a semifluid paste. Fill the crack or hole and smooth off level, then with a camel's-hair brush and colors, made of aniline in alcohol, work out the veins, body colors, etc., as near to the natural marble as possible. It will depend on the application of the colors whether the repair can be seen or not. Artificial-marble slabs can be formed from this mixture.—Contributed by A. E. Soderlund, New York City.

## INTERESTING NEW PATENTS

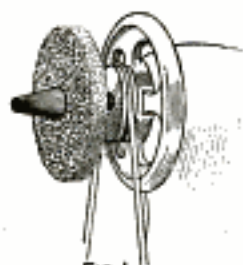

Fig. 1

**GRINDING ATTACHMENT FOR SEWING MACHINES** (Fig. 1)—The grinding disk is mounted on a screw that fits into the screw hole ordinarily occupied by the nut used for locking the flywheel and belt wheel to the shaft. A cone-shaped steel shaft projects outward from the center of the disk, and the taper of the shaft is such that, with the blade of a pair of scissors laid flat on the shaft, the edge is ground to the right angle. The edge of the disk is used for grinding of any kind.

**SEMAPHORE FOR RURAL MAIL BOX** (Fig. 2)—When the semaphore arm is raised to a horizontal position it is a signal that mail has been left in the box. The arm is connected by a series of levers to an inverted-U-shaped trigger which stands upright when the arm is in the lowered position. When the wheel of the carrier's wagon passes over this trigger the arm is raised to the horizontal position and remains in that position until it is reset.

**FILING CABINET** (Fig. 3)—This cabinet has the form of a drum and is mounted on a horizontal shaft. The ends of the drum are closed, while the periphery consists of a series of longitudinal strips on which are mounted filing pockets, as shown. Access to the pockets is through an opening near the top of the casing in which the drum revolves.

**NOVEL STEERING GEAR FOR MOTOR VEHICLE** (Fig. 4)—With this apparatus both the front and rear wheels are turned in steering the vehicle. Steering bars run from the ends of the axles to pivots that slide in slots in a horizontal plate at the middle of the chassis. These pivoted ends are cross-connected by links that are pivoted at their intersection, as shown, while a bell crank controlled by the steering column is pivoted to this intersection. The whole link mechanism is pushed or pulled to one side by the bell crank, and the axles are swung by the sliding of the steering-bar ends along the slots.

**PROPELLER FOR TURNING SHIP** (Fig. 5; British patent)—The propeller is driven by a belt and is carried on a frame that is pivoted to the stem of the ship, so that the propeller can be lowered into the water or raised clear as required. The force is exerted athwartships, the propeller being intended for use in turning the ship.

**MULTIPLE-WING AEROPLANE** (Fig. 6)—Increased sustaining power and stability are evidently the ends sought in this curious arrangement of planes. The planes are flexible and are so connected that they are always warped simultaneously and in the same direction.

**POISON BOTTLE** (Fig. 7; British patent to an American)—An elongated opening passes through the bottle midway between the top and bottom, leaving curved triangular sections at the sides. The purpose is to make the bottle of such distinctive shape that its character will be detected the instant it is picked up.

**SUPPORT FOR FRUIT-LADEN TREE** (Fig. 8)—This support consists simply of a netting of coarse weave drawn around the tree so that it takes the outward thrust of the branches. The netting has a joint extending from top to bottom and is held in place by lacing or clamping the edges together.

**TELESCOPING AWNING** (Fig. 9)—This awning consists of a set of telescoping sections pivoted to a common center in the window frame. When folded back the awning is concealed in the window recess.

**WHEEL WITH FLAT TREADS** (Fig. 10)—The wheel is entirely inclosed by links which are shaped to fit over the rim, and at each of the connections between links a flat tread is pivoted. The whole device is so adjusted that at any time three of the treads will lie flat on the ground under the wheel.



Fig. 2

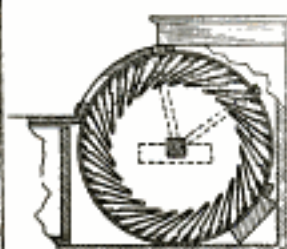

Fig. 3

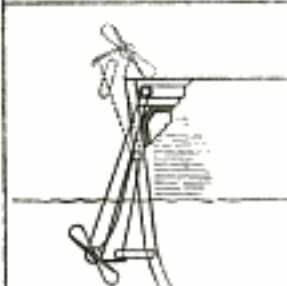

Fig. 5



Fig. 7

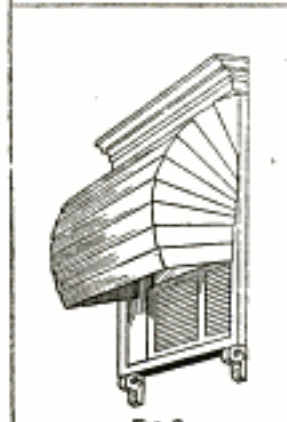

Fig. 9



Fig. 4



Fig. 6



Fig. 8



Fig. 10



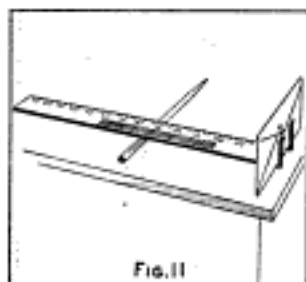

Fig. 11



Fig. 13

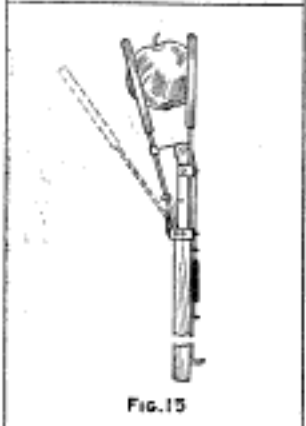

Fig. 15

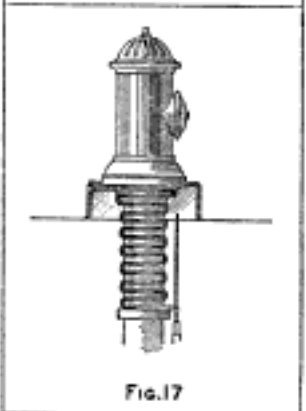

Fig. 17

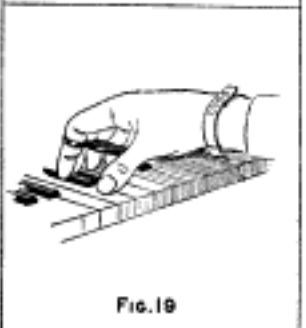

Fig. 19

**COMBINED RULER AND POSTAL SCALE** (Fig. 11)—This simple device is made to be used both as a ruler and as a weighing beam for postal matter. One end is equipped with clips for holding an envelope vertically, and one side is marked with a scale of postal charges. In using, the letter is placed in the clips and the ruler is balanced on a pencil. The scale reading at the point above the pencil gives the amount of postage required.

**APPARATUS FOR PROTECTING FRUIT TREES FROM FROST** (Fig. 12)—The essential feature of this invention is a fabric cover closing a ring that is suspended over the tree and a curtain that is supported by this ring and hangs around and incloses the tree. It can be used in connection with an orchard heater of any type. When not in use the curtain is drawn up and fastened to the ring.

**FAN ATTACHMENT FOR LAWN SWINGS** (Fig. 13)—Fans are fixed to the bottom of a shaft which is journaled in the top of the swinging frame so that the fans hang directly over the seat. The top of the shaft has a crank arm which is connected by a rod with the rigid supporting frame, and as the seat is swung, the fans are also swung and rotated.

**CALENDAR WATCH FOB** (Fig. 14; design patent)—Inside the ornamental cover is a rotatable disk around the edge of which are marked the days of the month. A section of the cover, long enough to expose seven numbers, is cut away, and along the edge of this section the seven days of the week are marked. The disk is set from week to week so that the days of the month and of the week will correspond.

**FRUIT PICKER** (Fig. 15; British patent)—The fixed and movable jaw each consists of a wire loop shaped to engage the fruit. The movable jaw is pulled against the fruit by a cord that extends down the pole and terminates in a handle. When the handle is released the cord is pulled up by a spring and the movable jaw swings outward under its own weight.

**SHOCK ABSORBER** (Fig. 16)—This device consists of a cylinder in which a hollow, elongated piston works, and both the cylinder and the piston contain liquid. In the lower face of the piston is a valve that retards the passage of the liquid in one direction, but permits it to flow freely in the other direction. In the piston are baffles and at the top are air vents. The idea of the invention is to absorb the shock by retarding the flow of the liquid and air and, therefore, the motion of the piston.

**STEAM-JACKETED FIRE HYDRANT** (Fig. 17)—The hydrant is equipped with a system of steam coils passing around the base. In case the hydrant is found to be frozen, the inlet and outlet are connected with the fire engine, and steam is passed through the coils.

**ICE-MOBILE OPERATED BY HAND** (Fig. 18)—At the sides of the sled are toothed wheels that work on one shaft and are set so that they bear against the ice. The sled is propelled by these wheels by means of a handle bar that is connected by a rod with a crank arm on the shaft.

**FINGER TRAINER FOR PIANISTS** (Fig. 19)—This device is designed to hold the fingers in the correct position as they strike the piano keys. It consists of a wrist band to which elastic bands, one for each finger, are attached. The finger bands can be varied for length, and the loops can be adjusted for fitting the fingers.

**BLOWER ATTACHMENT FOR HANDSAW** (Fig. 20; American patent to a Canadian)—This device consists of a bulb attachment designed for blowing the sawdust away from the saw cut. The bulb is of rubber and is placed in a recess in the handle so that it is conveniently pressed by the hand. A tapering stem projects downward from the bulb and the bottom of this stem is curved so that a blast of air will be thrown forward along the line of the saw blade.

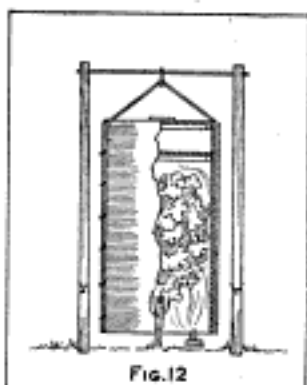

Fig. 12

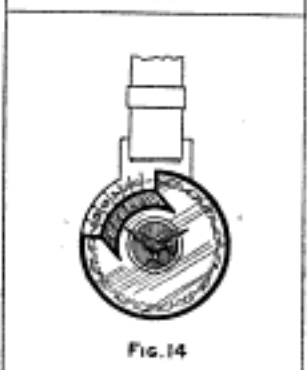

Fig. 14

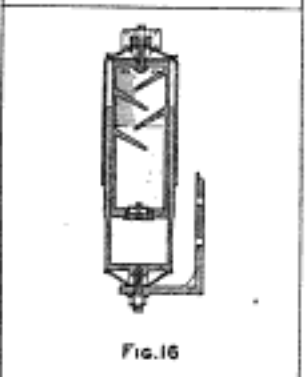

Fig. 16



Fig. 18

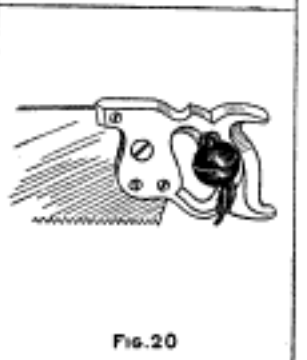
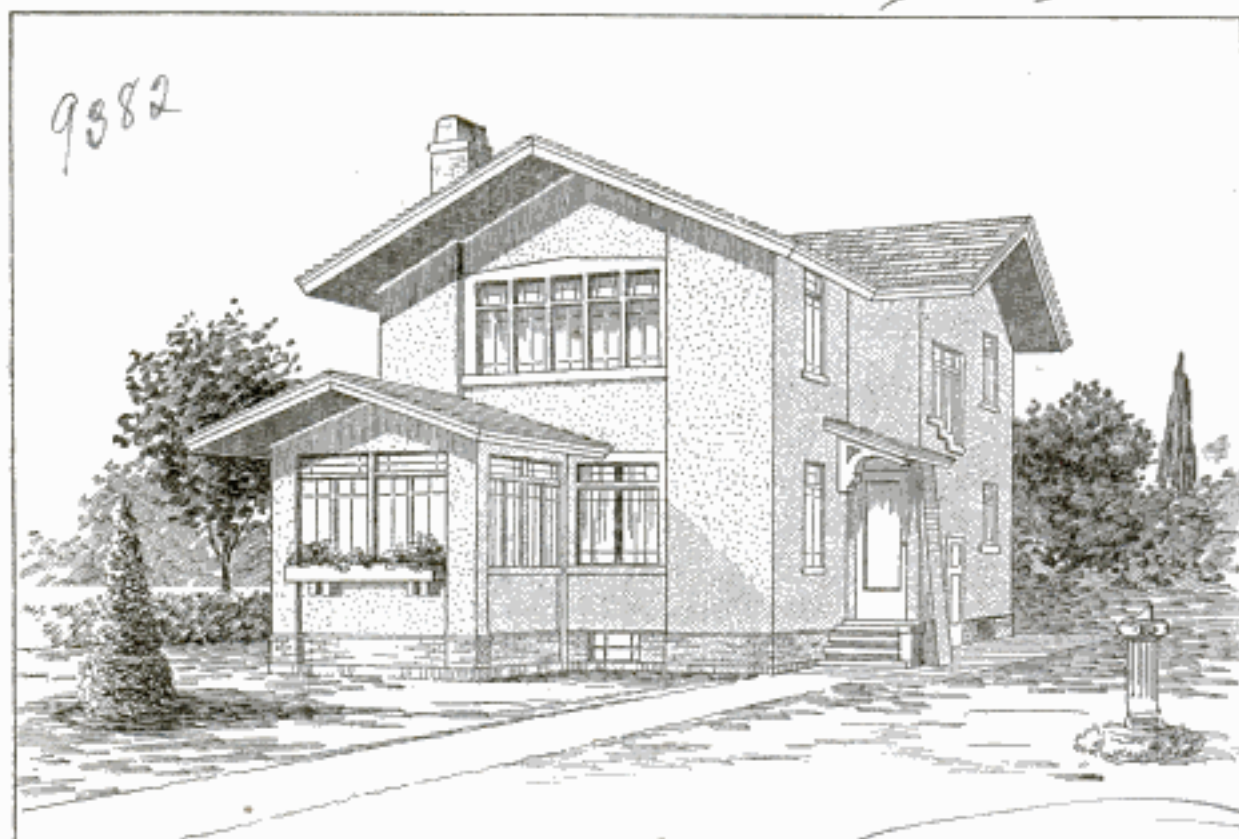
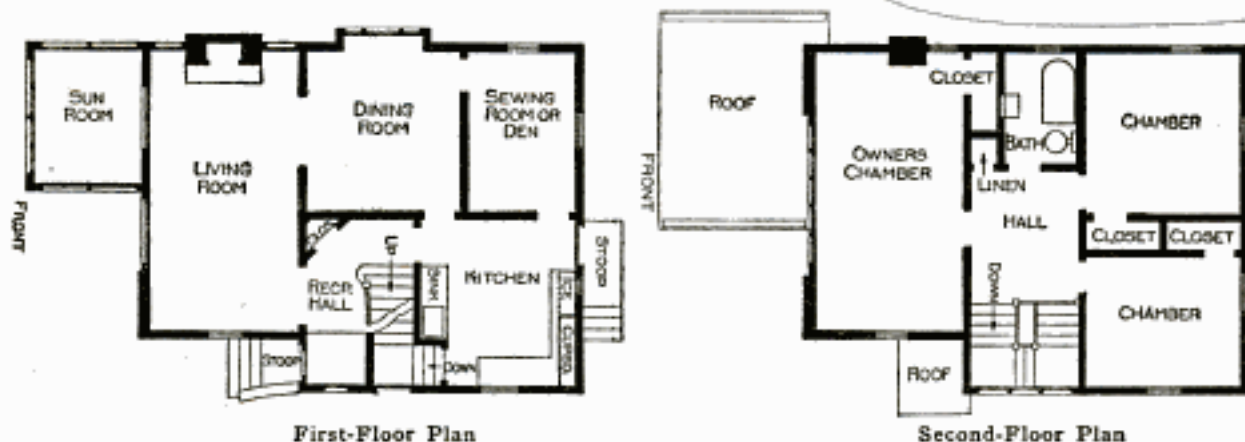

Fig. 20

## AN ATTRACTIVE SEVEN-ROOM STUCCO COTTAGE



M. L. KEITH, ARCHITECT, MINNEAPOLIS, MINN.



**T**HIS stucco cottage is interesting both for the simplicity and effectiveness of the exterior treatment and for the novel way in which the floor space is utilized. The front entrance, which is placed at the side of the building and is given little prominence as an exterior feature, opens into a small reception hall, and from this there is direct access to the living room, kitchen, and second floor. The living room extends entirely across the building and has a massive fireplace at one end. The living room and dining room have beamed ceilings. At the front of the building is the sun room. This is one of the features emphasized in the exterior treatment, which is practically free from ornament. The cottage is a frame structure having exterior walls of cement stucco laid on metal lath. The foundations are of concrete below the grade line, and of brick above this line, while the roof is of stained shingles. The building is estimated to cost about \$3,700 under ordinary market conditions.

**I**N accordance with the editorial policy of this magazine never to accept compensation in any form for what appears in our reading pages, and also to avoid all appearance of doing so, we are obliged to omit the name of the maker or the seller of any article described. This information, however, is kept on file and will be furnished free, by addressing Bureau of Information, Popular Mechanics Magazine, Chicago. [Editor].

# ALADDIN'S TRIUMPH

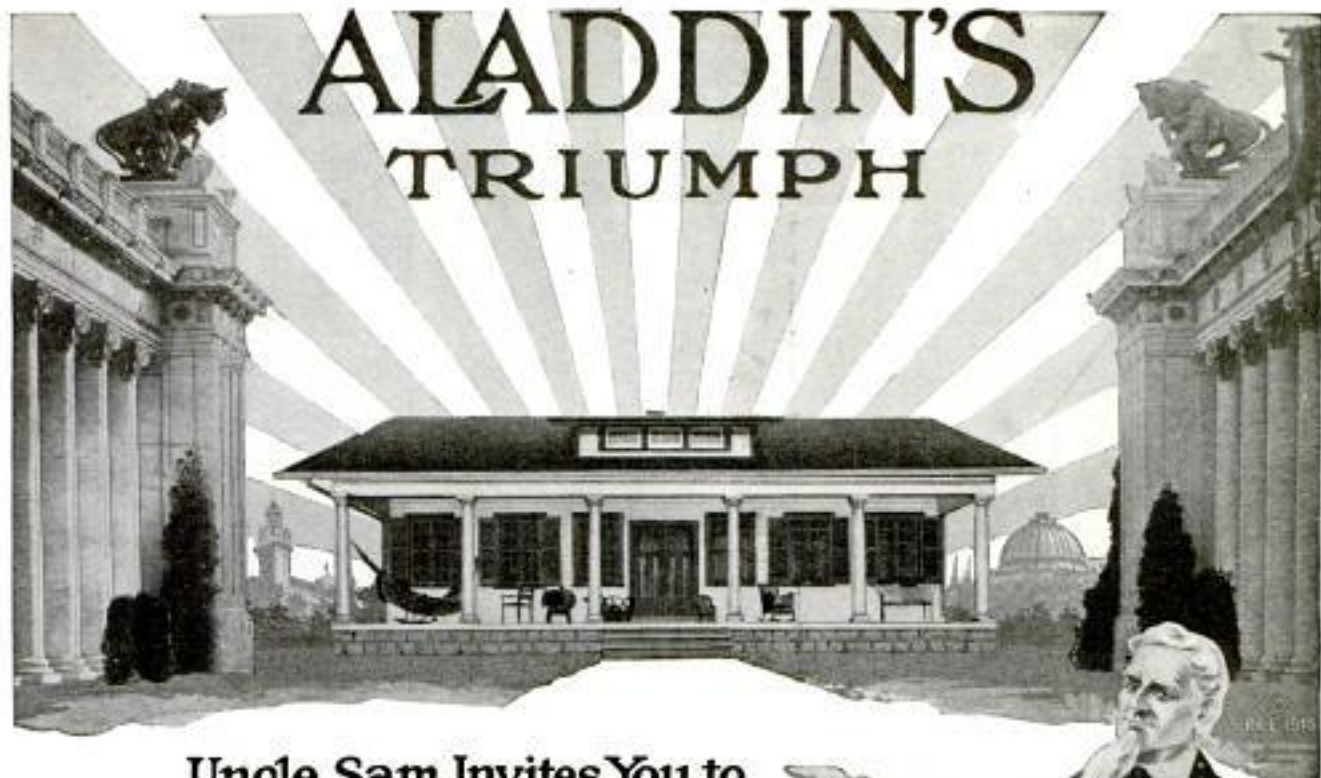

Uncle Sam Invites You to  
See His Idea of a Model  
Home at the Exposition  
— and it's an ALADDIN



Aladdin houses and the Aladdin Read-Cut system of construction have thus scored an imperishable triumph — have taken the leading place in this the greatest exposition of modern scientific, commercial and industrial accomplishments.

Uncle Sam's Department of the Interior chose the Aladdin Company to co-operate in the building of a model home at the Panama-Pacific International Exposition. The result is an Aladdin home which Uncle Sam invites you to inspect if you visit the great exposition. It is built by the Aladdin Read-Cut system of construction, equipped with Aladdin plumbing and lighting fixtures and furnished with Aladdin furniture. It is in charge of one of Uncle Sam's special representatives.

## ALADDIN HOUSES Help Make Happy Homes



You can buy all the material needed to build a cozy, 5-room house complete for \$298. Everything included to finish the house, ready to occupy. Price includes the same high grades of material that are used in the larger Aladdin houses. The Aladdin system makes it possible for you to own your home at a great saving. Houses from \$138 to \$5000 are pictured and described in the Aladdin catalog. Send for your copy today.

## Sovereign Summer Cottages



Enjoy the pleasures and advantages of summer cottage life — spend this summer in a Sovereign summer cottage. Sovereign summer cottages are complete. Price includes all material necessary for completion. All material being cut to fit, you can erect one in a few days, yourself, and save the cost of skilled labor. A number of designs to select from — a complete summer cottage for \$144. Ask about it today.

## Dollar-a-Knot Guaranteed

Aladdin houses are complete. Aladdin prices include sills, joists, studding, cut to fit; building paper; subfloor, rafters, cut to fit; outside finish, flooring, cut to fit; lath and plaster or plaster board; inside finish, doors, windows, glass, nails of all sizes, locks, hinges, paints, oils, with complete drawings, illustrations and instructions for erection — THE COMPLETE HOUSE.

The big Aladdin Catalog No. 180 tells all the interesting facts

## North American Construction Co.

Mills in Michigan, Florida, Louisiana and Oregon

963 Aladdin Avenue

BAY CITY, MICH.





“That’s Your Friend, The B.V.D. Label, Boys!”

“TAKE a mental snapshot of that *Red Woven Label*, Tom, and you won’t be fooled as I’ve been once. Now, they can’t sell *me* anything but B.V.D. Underwear. I’m just as particular about my *underclothes* as I am about my outer clothes.

“I prefer B. V. D. because it feels so soft and fits so good. Take my word for it, it’s certainly cool and comfortable, washes up like new and gives me no end of wear. I don’t buy, if the B. V. D. Red Woven Label is missing.”

*On every B.V.D. Undergarment is sewed This Red Woven Label*

B.V.D. Union Suits (Pat. U.S.A. 4-30-07) \$1.00, \$1.50, \$2.00, \$3.00 and \$5.00 the Suit.



B.V.D. Coat Cut Undershirts and Knee Length Drawers, 50c., 75c., \$1.00 and \$1.50 the Garment.

(Trade Mark Reg. U.S. Pat. Off. and Foreign Countries)

*The B.V.D. Company, New York.*

London Selling Agency: 66, Aldermanbury, E. C.

*Please Mention Popular Mechanics*

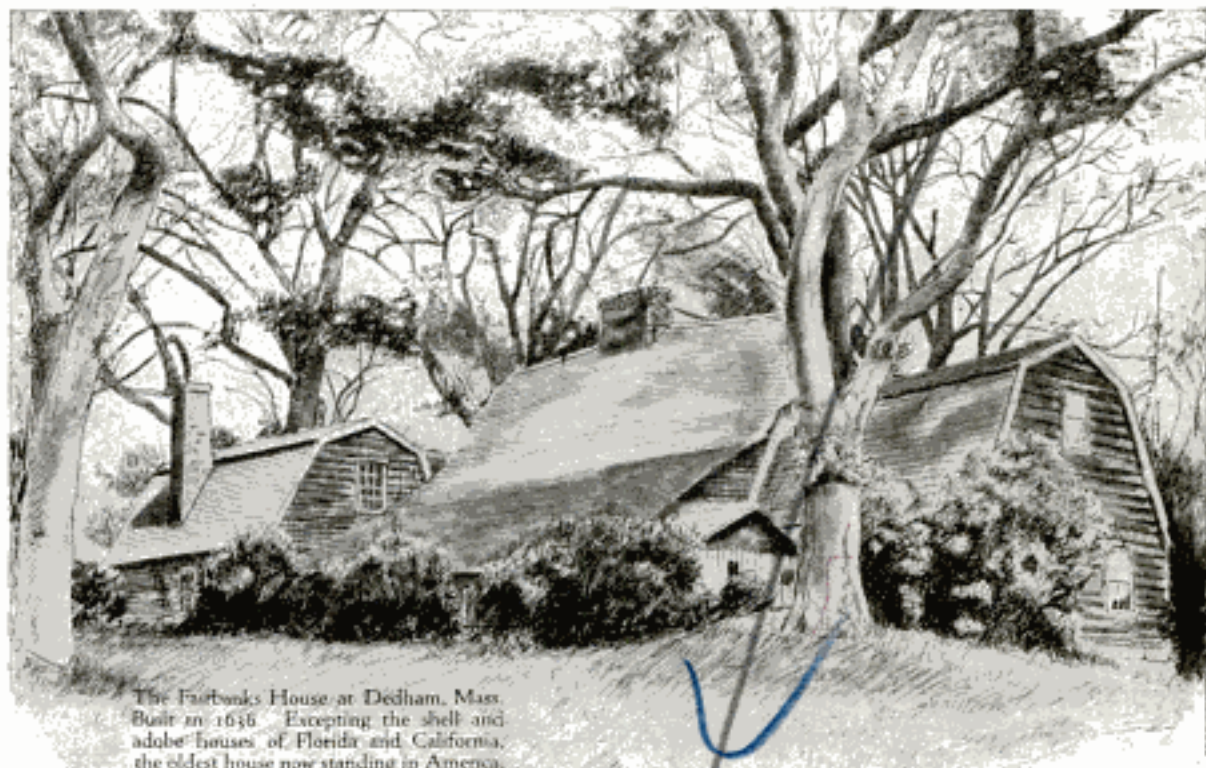

The Fairbanks House at Dedham, Mass.  
Built in 1636. Excepting the shell and  
adobe houses of Florida and California,  
the oldest house now standing in America.

## 279 Years Old—and Still a Comfortable Home

For nearly three centuries this unpainted house has stood exposed to the weather. Continuously occupied and still almost perfectly preserved, it offers the most convincing proof of the enduring qualities of

# WHITE PINE

Ever since the Pilgrims landed, White Pine has been universally recognized as the wood preferred above all others in home-building. And figuring value in terms of service, it is the most economical.

Despite an impression of its scarcity, White Pine is still abundantly available today, as it always has been, in any quantity desired. If your lumber dealer is unable to supply it, we would appreciate the opportunity of being helpful to you in securing it.

Send today for our free booklet, "WHITE PINE IN HOME BUILDING." It is beautifully illustrated, and gives much interesting and practical information regarding this most remarkable wood. If you contemplate building, please send us the name of your lumber dealer when writing for booklet.

Address, *WHITE PINE BUREAU,*  
*1526 Merchants Bank Building, St. Paul, Minn.*

*Representing:*

The Northern Pine Manufacturers Association  
of Minnesota, Wisconsin and Michigan, and The  
Associated White Pine Manufacturers of Idaho



## Neighborhooding the Farmer

One of the most significant facts of our telephone progress is that one-fourth of the 9,000,000 telephones in the Bell System are rural.

In the days when the telephone was merely a "city convenience," the farms of the country were so many separated units, far removed from the centers of population, and isolated by distance and lack of facilities for communication.

But, as the telephone reached out beyond cities and towns, it completely transformed farm life. It created new rural neighborhoods here, there and everywhere.

Stretching to the farthest corners of the states, it brought the remotest villages and isolated places into direct contact with the larger communities.

Today, the American farmer enjoys the same facilities for instant, direct

communication as the city dweller. Though distances between farms are reckoned in miles as the crow flies, the telephone brings every one as close as next door. Though it be half a day's journey to the village, the farmer is but a telephone call away.

Aside from its neighborhood value, the telephone keeps the farmer in touch with the city and abreast of the times.

The Bell System has always recognized rural telephone development as an essential factor of Universal Service. It has co-operated with the farmer to achieve this aim.

The result is that the Bell System reaches more places than there are post offices and includes as many rural telephones as there are telephones of all kinds in Great Britain, France and Germany combined.



**AMERICAN TELEPHONE AND TELEGRAPH COMPANY  
AND ASSOCIATED COMPANIES**

*One Policy*

*One System*

*Universal Service*

# The Next Important Thing for You to do—

## Mail this Coupon Today



**D**ON'T wait for accident or sickness to come to you. One man in seven was killed or injured last year by accident. Many thousands of our policy-holders were laid up by illness. Don't take chances. Look out now while you can. Make things easier for yourself and yours when the accident or sickness does come. Read this letter from a woman in Ohio—"I don't know what I would have done if my husband had not carried your policy. It is all I have to raise the children on while he is sick. I have seven—the oldest only 15." How about *your* wife?



# AETNA-IZE



A sudden attack of typhoid—an ulcerated throat—a quick grippe followed by pneumonia—an operation for appendicitis—you don't know when you are going to be sick. As for accidents, consider the manager of the department store in Atlanta who was so badly hurt by a flying nail—or the girl in Dallas, Texas, whose clothing

caught fire from the exhaust of a motorcycle motor—or the man in Providence, R. I., who was injured by a passing lunatic. These are not exceptions. We note such things every day as the demands for weekly indemnities come in. Things that seem absurd but they may put a man in bed for six months.

### Protect Yourself With An Accumulative Disability Policy

If you are totally disabled by any ordinary accident, we will pay you \$25 a week as long as you live, or \$50 a week if you are disabled by a railway, steamship, elevator or burning building accident. And if you are sick with any illness that confines you to the house we will pay you \$25 a week for a year. If you are killed, your wife will get from \$5,000 to \$15,000. If

you lose two limbs or both eyes we will pay you \$5,000 to \$15,000. Half as much for one hand, foot or eye.

Send the coupon. It costs nothing and brings the whole story.

## AETNA LIFE INSURANCE COMPANY

Drawer 1341

HARTFORD, CONN.

*The largest company in the world writing Life, Accident, Health and Liability Insurance*

Agency opportunities for all Casualty and Bonding lines

Name \_\_\_\_\_  
Occupation \_\_\_\_\_  
Bus. Address \_\_\_\_\_  
AETNA LIFE INSURANCE COMPANY  
Drawer 1341 HARTFORD, CONN.  
I have marked the kinds of insurance  
I wish to know about: Accident  \$250  
Health  Disability  Life Certificate  My age  
is ..... years. I am  
in good health.  F  
PM 5-15

Please Mention Popular Mechanics

EVINRUDE + ROWBOAT = MOTORBOAT

## EVINRUDE

Detachable Rowboat  
and Canoe Motor



### IN THE GOOD OLD SUMMER TIME THE BOY WITH AN EVINRUDE IS "IT"!

Unless you already own one you have no idea of the fun you and your friends can have with an Evinrude Detachable Rowboat Motor.

You start off for a day's outing and take your Evinrude along. Arrived at your destination—lake, river or seashore—you clamp the Evinrude to the stern of *any* rowboat (the work of a moment), give the flywheel a quarter turn and you are off!

The Evinrude drives an ordinary rowboat at the rate of 7 to 8 miles an hour

—a canoe 10 to 12 miles an hour—and runs four hours on less than a gallon of gasoline. If you own an Evinrude all the pleasures of motor boating are yours *without the expense*.

The 1915 model has Waterproof Magneto built into the flywheel (no separate battery required)—Automatic Reverse, enabling you to "back water" instantly by merely giving the tiller handle a twist—and Maxim Silencer, making the motor almost noiseless in operation.

*Illustrated catalog and name of Evinrude dealer in your town on request. Just say:—"Mail me a copy of your catalog and tell me where I can see an Evinrude."*

**EVINRUDE MOTOR CO., 31 Evinrude Block, Milwaukee, Wis., U.S.A.**

Distributing Branches:—69 Cortlandt St., New York, N. Y.—218 State St., Boston, Mass.—  
436 Market St., San Francisco, Cal.—182 Morrison St., Portland, Ore. (1130-7122)

Please Mention Popular Mechanics



• 3000 •  
Home Builders A Day  
Write For This  
Valuable Book



### \$187 Brings It

THE "MIRINDALE"—This handsome 5-Room Cottage can be erected in 7 to 9 days. Price and terms: \$187 down and \$9.25 per month. Total cost \$312.



### \$414 Brings It

THE "MIRACLE"—One of the most remarkable ever designed—Living Room and Dining Room—two large bedrooms—bath—modern, work-saving kitchen. Fine Porch, all complete. Can be erected in 12 to 14 days. \$414 down, balance, \$11.61 per month. Total cost \$591.



### \$441 Brings It

THE "MANOR"—Large, modern 7-room Home with bath. Can be erected in 18 to 19 days. Selling for \$441 down and \$12.23 a month. Our total price \$756.



### \$628<sup>80</sup> Brings It

THE "SENATOR"—8 commodious rooms, 4 closets, bath. Modern in every detail. Can be erected in 13 to 25 days. Sell for \$628.80 down and \$17.93 per month. Total price \$1,048.

GOING to build a home?  
Want to save big *money* and *time*!

Want a *home*, instead of mere "house"? Want one of the "Famous Fifty" chosen as perfect from thousands of master architects' home plans?

Then do as 3000 other alert home builders do daily—write for the "Famous Fifty" book, the sensation of the building world—the most remarkable of its kind ever published. *Absolutely free* to people who contemplate building.

## Sterling System Built Homes

Two Years To Pay!

In addition to astonishingly low prices we offer most liberal credit. We ask but a reasonable cash payment and balance monthly—like rent. Our size and the quality of these homes allows us to do this. Buy your Sterling Home *now* instead of waiting. Simply let your rent money pay for your home.

### Four Big Savings

(1) *Startlingly low prices*, because we own vast forests and mammoth mills and sell direct to consumer. Compare to what you would otherwise be forced to pay—at least 40% more!

(2) *Great labor savings*, because we measure and cut all lumber to fit by amazing power machines. Remember that carpenter cost in ordinary building is the largest item of expense. *We save you two-thirds of this!*

(3) *No cutting waste!* You waste approximately 18% when you buy lumber in bulk and saw it by hand.

(4) *Time saved!* You can be comfortably installed in your sterling Home by the time you would, by the old method, have the frame work sawed and erected.

Our price includes all *Lumber, Plaster, Hardware, Paint, Nails*,—everything from the ground up. Also complete plans, Blueprints, which anybody can readily understand. All materials best selected quality. *Money absolutely refunded if not exactly as represented.* Prompt shipment from our mills and shipping stations in Michigan, Florida, Texas and Washington.

**NOW—The Book!** Over 3000 of these valuable books mailed daily to home builders. *Full of New Ideas. Full of saving suggestions. Full of wonderful homes, planned for comfort and economy by great architects. Send now. A postal or letter will bring book free by return mail.*

International Mill & Timber Co.  
Dept. Q5 Bay City, Michigan

Be sure and address Dept. Q5

Book  
Coupon

International  
Mill & Timber  
Co., Bay City,  
Mich. Dept. Q5

Please send me a  
free copy of "The  
Famous Fifty."

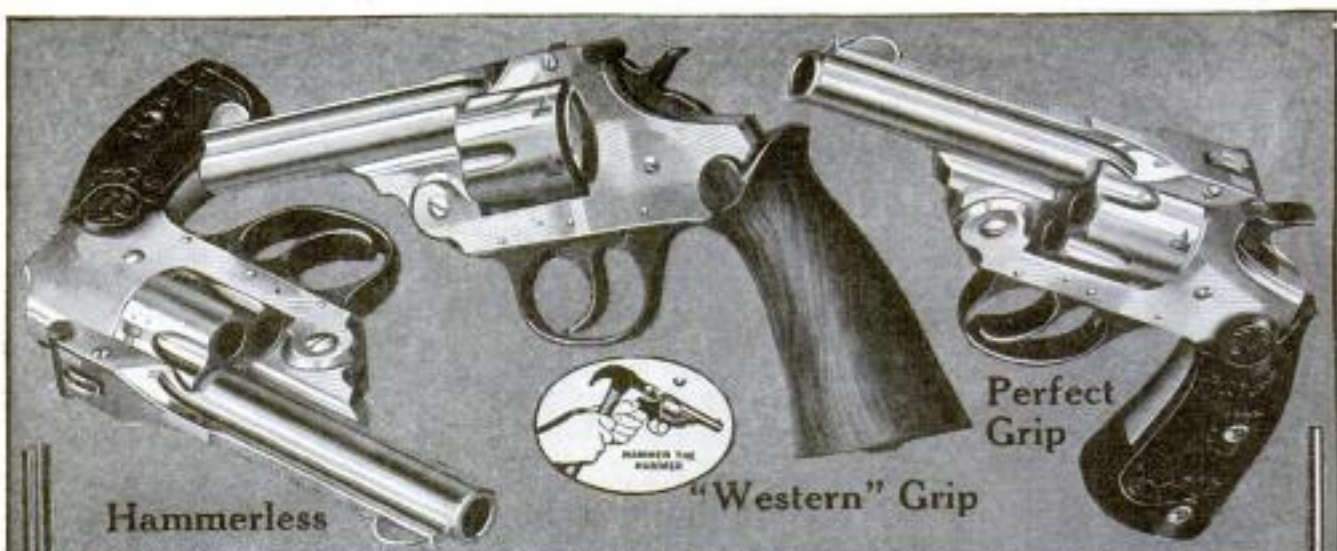

# IVER JOHNSON

**The Boy in you says, "Get the Book"**

It's a pretty tame man that wouldn't enjoy reading and owning this 84-page Book. It tells what quality means in a revolver, what safety means, what accuracy and dependability mean. In other words it describes the Iver Johnson Safety Automatic Revolver.

The Iver Johnson "Champion" Single Barrelled Shot Gun and our new Double Gun are shown and their many good features explained.

After reading the chapter on bicycles, you will understand why most racing men ride the Iver Johnson and why our bicycles have held front rank since



bicycles were invented.

You will be impressed with the talk on the Iver Johnson Motorcycle. It tells of a masterpiece of engineering. It is our belief that no better motorcycle will ever be built. Slight changes may be made, but basically the Iver Johnson Motorcycle is perfect.

**Send for this big Book—  
It is FREE**

**IVER JOHNSON'S ARMS & CYCLE WORKS  
307 River Street, Fitchburg, Mass.**

717 Market Street, San Francisco  
99 Chambers Street, New York

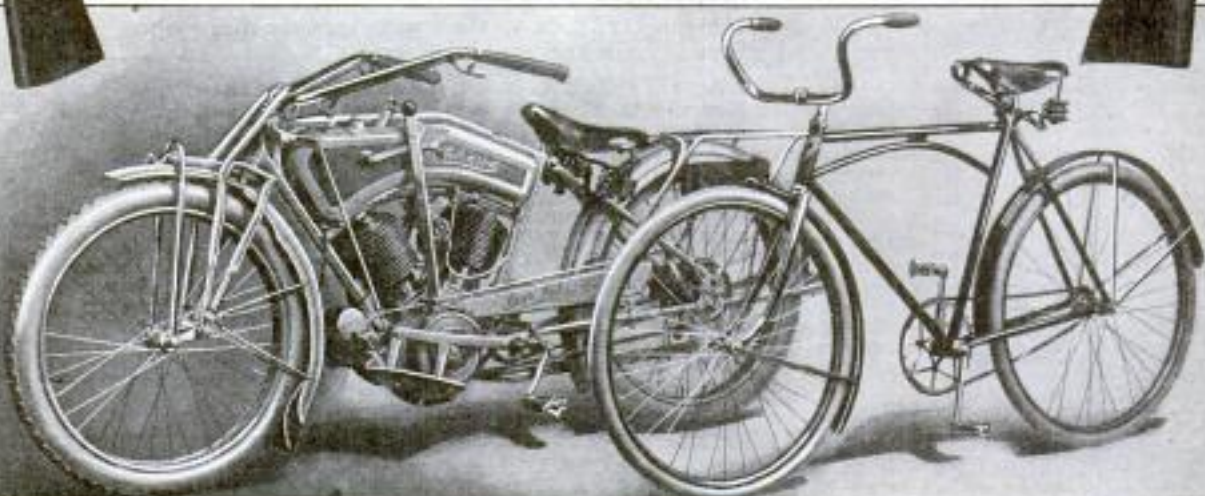

*Please Mention Popular Mechanics*

Copyrighted material



# TYPEWRITER SENSATION

Free TRIAL—Use As You Pay

Only \$3.00 a month until the low total price of \$48.30 is paid, and the machine is yours

This is absolutely the most generous typewriter offer ever made. Do not rent a machine when you can pay \$3.00 a month and own one. Think of it—Buying a \$100.00 machine for \$48.30. Cash price, \$45.45. Never before has anything like this been attempted.

Standard Visible **L. C. Smith**

Perfect machines, Standard size, Keyboard of Standard Universal arrangement writing 76 characters—universally used in teaching the touch system. (Keyboard writing 84 characters \$1.00 extra.) The entire line of writing completely visible at all times, has the tabulator, the two color ribbon with automatic reverse, the Back Spacer, in fact every late style feature and modern operating convenience. Comes to you with everything complete, tools, cover, operating book and instructions, ribbon, practise paper—nothing extra to buy. You cannot imagine the perfection of this beautiful typewriter until you have seen it. I will send it to you F. O. B. Chicago for five days' free trial. It will sell itself, but if you are not satisfied that this is the greatest typewriter you ever saw, you can return it at my expense. You won't want to return it after you try it—you cannot equal this wonderful value anywhere.

**You Take No Risk—Put In Your Order Now**

When the typewriter arrives deposit with the express agent \$9.30 and take the machine for five days' trial. If you are convinced that it is the best typewriter you ever saw, keep it and send me \$3.00 a month until our bargain price of \$48.30 is paid. If you don't want it, return it to the express agent, receive your \$9.30 and return the machine to me. I will pay the return express charges. This machine is guaranteed just as if you paid \$100.00 for it. It is standard. Over one hundred thousand people own and use these typewriters and think them the best ever manufactured.

The supply at this price is very limited, the price will probably be raised when my next advertisement appears, so don't delay. Fill in the coupon today—mail to me—the typewriter will be shipped promptly. There is no red tape. I employ no solicitors—no collectors—no chattel mortgage. It is simply understood that I retain title to the machine until the full \$48.30 is paid. You cannot lose. It is the greatest typewriter opportunity you will ever have. Do not send me one cent. Get the coupon in the mails today—sure.

**HARRY A. SMITH, 231 N. Fifth Ave., CHICAGO**

**H. A. SMITH**  
231 N. Fifth Ave.  
CHICAGO, ILL.

Ship me a No. 2 L. C. Smith F. O. B. Chicago, as described in this advertisement. I will pay you the \$39.00 balance of the SPECIAL \$48.30 purchase price, at the rate of \$3.00 per month. The title to remain in you until fully paid for. It is understood that I have five days in which to examine and try the typewriter. If I choose not to keep it I will carefully re-pack it and return it to the express agent. It is understood that you give the standard guarantee for one year.

Name .....

Address .....

..... Pop. Mech. May

# Be a Manufacturer

## OF



## HAYWOOD RETREADS

### MAKE \$3,000.00 A YEAR TO START

and more as you get accustomed to the business. Sounds like a whole lot of money, and it is—looks pretty big from where you stand if you are earning just an ordinary salary at an ordinary job, but why continue the job—why be on that side of the fence? Why not come over on this side—the manufacturing side—where the grass is greener and the picking is better?

It is not every business that will permit you to start with a very small investment. Most manufacturing business require big capitalization. And rich men take the profits while you, the producer, get a salary and the small end. But here is a business that gives **big returns, quick returns**, and the demand for your product is ahead of the supply and increases every day in the year. Start a **Haywood Tire Repair Shop**

### MAKE \$250.00 A MONTH—\$3000.00 A YEAR

The certainty of success in this business is about as sure as anything in this world can be. **Automobile owners increase by the thousands each year and the tires are still the least durable part of the car.** Every owner tries to cut down his tire expense—every owner tries to repair his tires as long as they will hold together and this brings about

### YOUR WONDERFUL OPPORTUNITY

You might just as well be the first to enter this paying business in your town—**open your shop and let the money roll in.** Every automobile sold means more tires to mend. You start with one machine. The business grows fast. You need another and then another. Soon it gets to be a regular business of adding machine—after—machine until the first thing you know you are running a big shop—you are operating in a big way—you are a real business man and a factor in your community. **You know that punctures and blow-outs are common—tires need retreading and vulcanizing every day—something going wrong all the time—owner after owner forced to buy new tires because they cannot get the old ones fixed.**

If you are in the business, operate a tire repair plant as a side line in connection with your present business, garage or salesroom. Any place where there are many automobiles yields a big steady business, besides the transient work. Experience is absolutely unnecessary.

You can learn quickly. Anyone with a little mechanical turn or who can simply follow directions, can learn in a few days on old tires, to do the best work. Then business comes fast and easy.

### REPAIR TIRES AT HOME

**Young men make money to attend college or start a garage and repair business. Automobile owners—repair your own tires. Save money.**

Pay for your outfit in a short time. We have special outfits for home use. Mr. Any-Man, it's worth while to investigate. There

is money in it. It's a field of wonderful possibilities. Make up your mind and send for our catalogue **today.** Learn of the wonderful money making possibilities in this fascinating new business. Make something—supply a want—become a manufacturer. **This is your chance.**

HAYWOOD TIRE & EQUIPMENT CO.  
897 Capitol Ave.  
Indianapolis, Ind.

Without any obligation upon my part please send me your complete FREE catalog of tire repair outfits.

Name.....

Address.....



THE  
HAYWOOD  
TIRE &  
EQUIPMENT  
CO.

897 Capitol Ave.

INDIANAPOLIS, IND.

Please Mention Popular Mechanics

# Lower Power Cost Proves My Higher Engine Quality

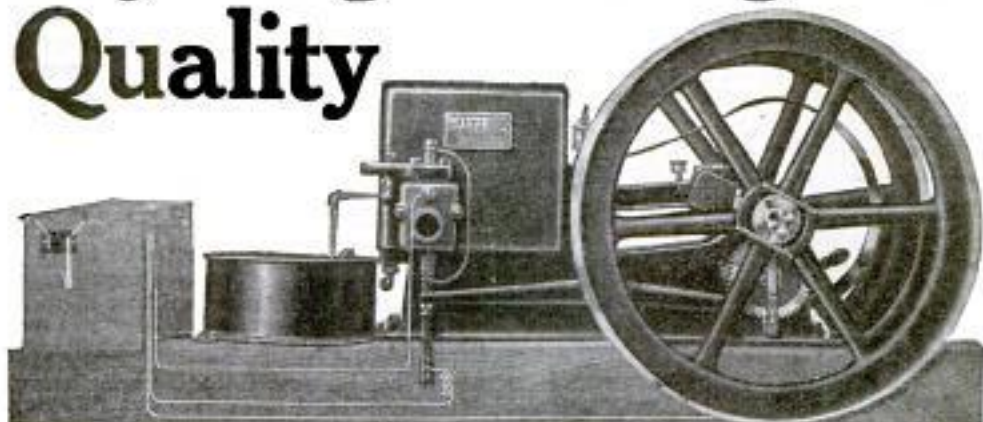

## Latest WITTE Prices

### STATIONARY

2 H-P.	\$34.95
4 H-P.	69.75
6 H-P.	97.75
8 H-P.	139.65
12 H-P.	197.00
16 H-P.	308.80
22 H-P.	389.65

### PORTABLE

2 H-P.	\$39.95
4 H-P.	82.75
6 H-P.	127.75
8 H-P.	174.65
12 H-P.	237.00
16 H-P.	358.80
22 H-P.	442.15

### SAW-RIG

6 H-P.	\$152.25
8 H-P.	202.15
12 H-P.	267.00

My engine H-P ratings have not been raised to make prices look low. My ratings are the same as in previous years—a liberal surplus of power in each size over the regular rating—while my prices are lower than ever.

A WITTE Engine of any size is guaranteed to give its full rated horse-power with a liberal surplus. So, probably, will any other strictly high-grade engine. But the mere ability to deliver its rated horse-power is not all that is needed to prove engine quality. The big question to consider is this: "How much will it cost in fuel, lubricant, and upkeep expense to get that rated horse-power out of an engine?" Real engine quality is measured by the engine's ability to keep that cost down to the lowest possible notch. And, other things being equal—strength, durability, simplicity, ease of operation, smoothness of running—the engine which keeps its operating cost down to the lowest notch is the engine for you to buy.

## WITTE ENGINES

### Kerosene, Distillate, Gasoline and Gas

Thirty years ago when gasoline and other like fuels were cheap almost any type of engine that could pull its rated load, regardless of amount of fuel used, would answer the user's purpose. Those early engines were mostly over-heavy and a large part of their own power was consumed in overcoming excessive friction of their over-heavy parts. Today fuel is a matter of first importance. I foresaw this years ago and began working toward a cheaper power cost. The result is the WITTE Engine of today which, measured by the cost of power put into the drive belt—its actual dollar-earning value—has set a new standard for engine efficiency. A saving of 25% of the fuel used by older type engines amounts, in a year, in many cases to more than enough to pay the entire first cost of a WITTE Engine.

## Sent Direct From My Factory To User CASH OR EASY TERMS

### Five Year Guarantee On Efficiency And Durability

For 28 years the WITTE has maintained its lead in Engine Quality. But it has been hard to keep the cost of manufacturing down to the point where I could also lead in low prices. But I've done it. Compare my prices with others and see how much you save on the first cost of a WITTE—to say nothing of the steady saving on fuel and upkeep.

**FREE ENGINE BOOK.** Tells why I use semi-steel castings, instead of common grey iron; why I make cylinder and bed separable; vertical valves; four-ring pistons; automobile style ignition; safety spark shift for easy starting; and explains other features without which no engine is of high grade quality. Mail coupon today.

ED. H. WITTE, Witte Engine Works  
1747 Oakland Avenue  
Kansas City, Mo.

ED. H. WITTE, Witte Engine Works  
1747 Oakland Ave., Kansas City, Mo.

Without cost to me, and with no obligation on my part, I should like to receive your latest and finest Engine Book, and to investigate your New Liberal Selling Plan.



WITTE Saw-Rig  
Sizes: 6, 8 and 12 H-P. Kerosene and Gasoline engines furnished in this style.

Name .....

Address .....

Please Mention Popular Mechanics

# 2c a Week Pays Wash Bill!

## Electricity or Water-Power Does the Work

Write for  
FREE Book

### Just a "Twist of the Wrist" Starts or Stops the Machine!

The 1900 Motor Washers are now at work in thousands of homes. They are doing the work formerly done by women, at a cost of 2c a week for power! Saving thousands upon thousands of dollars in wash bills. Saving worlds of wash-day troubles. Leaving the women free to do other work while the machines are doing the washing.

## The 1900 Motor Washer

Washes a Tubful in Six Minutes!

1900 Water Motor Washer  
Can be connected with  
any water tap instantly



Handles Heavy Blankets or Dainty Laces

The outfit consists of the famous 1900 Washer with either Electric Motor or Water Motor. You turn on the power as easily as you turn on the light, and back and forth goes the tub, washing the clothes for dear life. Then, turn a lever, and the washer does the wringing. All so simple and easy that it is mere child's play.

### A Self-Working Wringer Sent With Every Washer!

The motor runs Washer and Wringer. We guarantee the perfect working of both. No extra charge for Wringer, which is one of the finest made. Write for FREE BOOK and 30 Days' FREE TRIAL OFFER! Don't doubt! Don't say it can't be done. The free book proves that it can. But we do not ask you to take our word for it. We offer to send a 1900 Motor Washer on absolute Free Trial for an entire month to any responsible person. Not a cent of security—nor a promise to buy. Just your word that you will give it a test. We even agree to pay the freight, and will take it back if it fails to do all we claim for it. A postal card with your name and address sent to us today will bring you the book free by return mail. All correspondence should be addressed to

Doing the wringing with  
1900 Electric Motor Washer



1900 WASHER CO., 6183 Court St., BINGHAMTON, N. Y.

OR, IF YOU LIVE IN CANADA, WRITE TO THE CANADIAN WASHER CO., 225 YONGE ST., TORONTO, CANADA.

(23)



## CLASS PINS

FACTORY TO YOU

FOR COLLEGE, SCHOOL OR SOCIETY

Catalog with attractive prices mailed free upon request. Special offer, either style of pins here illustrated with any three letters and figures, one or two colors of enamel. STERLING SILVER, 30c each; \$3.00 dozen; SILVER PLATE, 15c each; \$1.50 dozen. BASTIAN BROS. CO., 531 BASTIAN BLDG., ROCHESTER, N. Y.



NO. 2479

A FLAT LONG-SPAN CONCRETE ARCH—A very flat concrete arch of long span was built during 1914 over the Aare River at Olten, Switzerland. Its span is 269 ft. and its rise 30.4 ft., giving a ratio of span to rise of 8.8. The bridge is relatively narrow, being only 26 ft. wide between railings. The 16-ft. roadway is designed for a safe load of 77 lb. per square foot, while the sidewalks are figured for 110 lb. per square foot. Load tests under a 16-ton steam roller gave deflections of  $\frac{1}{8}$  inch.

# \$3000 FOR YOU



That's the money you should get this year. I mean it. I want County Sales Managers quick, men or women who believe in the square deal, who will go into partnership with me. No experience needed. My folding Bath Tub has taken the country by storm. Solves the bathing problem. No plumbing, no water works required. Full length bath in any room. Folds in small roll, handy as an umbrella. I tell you it's great! GREAT! Rivals \$100 bath room. Now listen! I want YOU to handle your county. I'll furnish demonstrating tub on liberal plan. I'm positive—absolutely certain—you can get bigger money in a week with me than you ever made in a month before. I KNOW IT!

## TWO SALES A DAY—\$300.00 A MONTH

That's what you should get—every month. Needed in every home, badly wanted, eagerly bought. Modern bathing facilities for all the people. Take the orders right and left. Quick sales, immense profits. Look at these men—Smith, Ohio, got 18 orders first week; Meyers, Wis., \$250 profit first month; Newton, California, \$60 in three days. You should do as well. TWO SALES A DAY MEANS \$300 A MONTH. The work is very easy, pleasant, permanent, fascinating. It means a business of your own.

Little capital needed. I grant credit—Help you out—Back you up—Don't doubt—Don't hesitate—Don't hold back—You cannot lose. My other men are building houses, bank accounts, so can you. Act then, quick, SEND NO MONEY. Just name on penny post card for free tub offer. Hustle!

Exclusive  
Territory.  
100% Profit.



Demonstrating  
Tub Furnished

H. S. Robinson, Pres. 787 Factory Bldg., TOLEDO, OHIO  
Canadian Branch—Walkerville, Ont.



# Tobacco Habit BANISHED

## in 48 to 72 Hours



### No Desire After First Dose

Trying to quit the tobacco habit unaided is a losing fight against heavy odds, and means a serious shock to your nervous system. So don't try it! Make the tobacco habit quit you. It will quit you if you will just take Tobacco Redeemer according to directions.

It doesn't make a particle of difference whether you've been a user of tobacco for a single month or for 50 years, or how much you use, or in what form you use it. Whether you smoke cigars, cigarettes, pipe, chew plug or fine cut or use snuff Tobacco Redeemer will positively remove all craving for tobacco in any form in from 48 to 72 hours. Your tobacco craving will begin to decrease after the very first dose—there's no long waiting for results.

Tobacco Redeemer is absolutely harmless and contains no habit-forming drugs of any kind—the most marvelously quick and thoroughly reliable remedy for the tobacco habit the world has ever known.

### Not a Substitute

Tobacco Redeemer is in no sense a substitute for tobacco, but is a radical, efficient treatment. After finishing the treatment you have absolutely no desire to use tobacco again or to continue the use of the remedy. It quiets the nerves, and will make you feel better in every way. If you really want to quit the tobacco habit—get rid of it so completely that when you see others using it, it will not awaken the slightest desire in you—you should at once begin a course of Tobacco Redeemer treatment for the habit.

### Results Absolutely Guaranteed

A single trial will convince the most skeptical. Our legal, binding, money-back guarantee goes with each full treatment. If Tobacco Redeemer fails to banish the tobacco habit when taken according to the plain and easy directions, your money will be cheerfully refunded upon demand.

### Let Us Send You Convincing Proof

If you're a slave of the tobacco habit and want to find a sure, quick way of quitting "for keeps" you owe it to yourself and to your family to mail the coupon below or send your name and address on a postal and receive our free booklet on the deadly effect of tobacco on the human system, and positive proof that Tobacco Redeemer will quickly free you from the habit.

**Newell Pharmacal Company**  
Dept. 300, St. Louis, Mo.



## Mail Coupon NOW for FREE Booklet

**NEWELL PHARMACAL CO.,**  
Dept. 300, St. Louis, Mo.

Please send, without obligating me in any way, your free booklet regarding the tobacco habit and proof that Tobacco Redeemer will positively free me from the tobacco habit.

Name .....

Street and No. ....

Town ..... State .....

Please Mention Popular Mechanics

## Is Your Refrigerator Poisoning Your Food?

A leading medical authority says: "A poor refrigerator means not only wasted ice, but often wasted lives from spoiled food." Read what physicians and others say about wonderful ice-saving and health protection the Monroe affords.



Approved by Good Housekeeping Institute

**The "Monroe"**  
Established 1868

The Monroe food compartments are Genuine Solid Porcelain ware—in one piece—over an inch thick—every corner rounded. Not cheap porcelain-enamel on metal base—but one piece of white unbreakable porcelain ware which can be easily kept free of germs—no cracks, joints, or corners—nothing to break or chip.

**30 Days' Trial—Cash or Credit**  
Sold direct from factory at factory price. Freight paid and all money back if not absolutely satisfactory.

Monroe Refrigerator Co. (Established 1868), Sta. 28D, Lockland, O.

"Using about one-third the ice the others did."—T. G. Mackie, New Orleans.

"Cut ice bills from \$36 to \$8."—T. W. Williams, Milwaukee

"Reduced ice bills nearly 40 per cent."—Dr. B. H. Wells, Southport, Conn.

"Much more economical than any other of several I have had."—Dr. O. B. Shreve, Salem, Mass.

"Saved about 50 lbs. of ice per day over another make of same size."—W. M. Rieke, Paducah, Ky.

"An ice saver, a germ preventer, hence a health preserver to any family."—Dr. Chas. Hups, Lafayette, Ind.

"Economical in use of ice; and preserving in best manner articles placed in it."—Dr. R. E. Starkweather, Evanston, Ill.

Send a **FREE BOOK** once for **about refrigerators**

It tells you how to select the home refrigerator—how to keep food longer without spoiling—how to cut down ice bills—how to guard against sickness—doctor's bills.

# PATENTS

**IF YOU HAVE AN INVENTION** which you wish to patent you can write fully and freely to Munn & Co. for advice in regard to the best way of obtaining protection. Please send sketches or a model of your invention and a description of the device, explaining its operation.

All communications are strictly confidential. Our vast practice, extending over a period of seventy years, enables us in many cases to advise in regard to patentability without any expense to the client. Our Hand-Book on Patents is sent free on request. This explains our methods, terms, etc., in regard to *Patents, Trade Marks, Foreign Patents, etc.*

All patents secured through us are described without cost to the patentee in the **SCIENTIFIC AMERICAN**.

**MUNN & CO.**  
SOLICITORS OF PATENTS  
672 WOOLWORTH BLDG., NEW YORK  
and 625 F STREET, WASHINGTON, D. C.

Exports from the United States during the month of January, 1915, exceeded the value of imports by \$145,536,000, the largest monthly trade balance in favor of the United States ever recorded.

## FREE SHOE BOOK SAVES \$20

"The Sole of Steel" describes my light, springy, comfortable, economical, waterproof, all-season, general purpose shoe that saves your feet, health and money. 1 pair of "Steels" outwears 3 to 6 pairs leather workshoes. Investigate before buying shoes again. Address, "The Steel Shoe Man,"

N. M. RUTHSTEIN, Dept. 132, RACINE, WIS.

**3 1/3<sup>c</sup> a Day**

now buys a dazzling Lachnite Gem. Their brilliance is eternal—they stand fire and acid tests and cut glass like diamonds. Cost but one-third as much. Get in solid gold. The newest designs. Sold on Free Trial. See our new jewelry book. Write for Big Jewelry Book Your name and address is enough. No obligations whatever. Write today—now.

**HAROLD LACHMAN COMPANY**  
12 N. Michigan Avenue, Dept. 1195, Chicago, Ill.

## You Can Make Big Money

C. F. Larsen has made over \$1000, selling Matchless Gas Lighters. E. C. Haines made \$17.10 in one day. You too can make big money.



The Matchless Gas Lighter lights gas or gasoline. Safer, cleaner, handier and cheaper than matches.

Send 25 cents for agents' sample and big money making offer.

STEEL STAMPING CO., Dept. 21, 143 W. Austin Ave., Chicago

## Furniture On Credit

Write for Mammoth Bargain Book picturing 4,918 articles  
**SPIEGEL, MAY, STERN CO.**  
1089 West 35th Street, Chicago

1 1/2 to 18  
H. P.

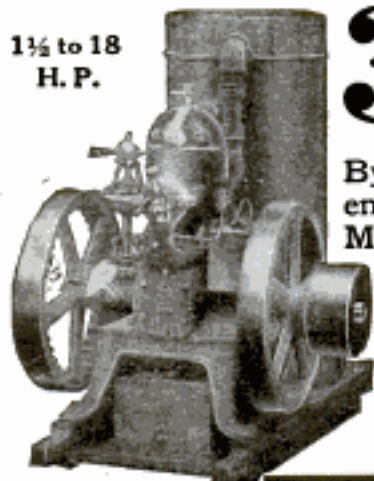

# 34c

**Runs this 6 H. P. Engine for a 10 hour day on KEROSENE**

By means of the patent throttle you can run it as a 4 H. P. engine for 23 cents a day, or as a 2 H. P. for 12 cents a day. Many other strong points; force-feed lubrication; uniform speed; sight-feed fuel supply; automobile muffler; no cranking; runs either way; uses any fuel oil satisfactorily. And it's **Guaranteed for 10 Years**. Write for catalogue and 30 days' free trial.

WE PAY THE FREIGHT

**ELLIS ENGINE CO., 2871 East Grand Blvd., Detroit, Mich.**





# Your Hands Can't Earn the Money You Need

You'll have to work for low wages all your life if you depend upon your hands to make your living. To earn more money you've got to learn how to work with your *head*—you must have *special training* for some particular line of work.

And you can get this training without leaving your home or losing an hour from your work—the International Correspondence Schools can bring it to you right in your *own home* during your *spare time*.

They can train you for the very job you want—where you can earn more than enough money to meet your needs.

If you want to advance in your present occupation, the I. C. S. can train you for promotion. If your present work is not pleasant, the I. C. S. can qualify you for a good position in the kind of work you like best.

Every month more than 400 I. C. S. students of all ages and occupations voluntarily report getting better jobs and bigger pay as a *direct* result of I. C. S. training. What these men did *you* can do.

## Mark the Coupon

What occupation attracts you most or what position do you want? Mark it and mail the coupon now, and learn how the I. C. S. can help *YOU* to earn more money.

### INTERNATIONAL CORRESPONDENCE SCHOOLS

Box 872 F, Scranton, Pa.

Please explain, without further obligation on my part, how I can qualify for a larger salary and advancement to the position, trade, or profession before which I have marked **X**.

Electrical Engineering  
Electric Lighting  
Electric Railways  
Electrician  
Electric Car Running  
Dynamo Foreman  
Wireman  
Mining Engineer  
Tel. and Tel. Engineer  
Surveyor  
Civil Engineer  
Automobile Running  
Agriculture

Mechanical Engineer  
Mechanical Draftsman  
R. R. Construction  
Concrete Construction  
Architect  
Contracting and Build'g  
Architectural Draftsman  
Plumbing and Heating  
Chemist  
Bookkeeper  
Advertising Man  
Civil Service Exams.  
Salesmanship

Name \_\_\_\_\_

St. and No. \_\_\_\_\_

City \_\_\_\_\_ State \_\_\_\_\_

Present Occupation \_\_\_\_\_

Please Mention Popular Mechanics

## FREE Rubber Heels

Trollee instantly adjustable rubber heels; also new illustrated catalog showing many styles and reasonable prices of most serviceable shoes on the market—absolutely free to the readers of this magazine.



**Shoes For Men and Boys**  
Direct From Factory To Buyer

Leather or interchangeable rubber heels. Removed and attached in half a minute. Leather soles replaced without trouble. Shoes made all heights. Water proof. Fit any foot. A postal card brings you special proposition. **Write Today.**

**TROLLEE SHOE COMPANY** 1200 Washington Ave. RACINE, WIS.

Order the Shoe With the Tag

The Work and Wear shoe with the tag attached telling you the exact material used in every part.

Every pair positively guaranteed in every respect or money refunded.

Good to Have "On Hand"



Keep SKAT SOAP on every washstand, to remove dirt, grime, grease from the hands, leaving them white and soft. Can't harm the tenderest skin.

*If not at dealer's, send his name with 10c and we'll see you are supplied. Salesmen Wanted.*

**THE SKAT CO., HARTFORD, CONN.**

## Any WING Upright or Grand On 4 Weeks' Trial

Yes, we will ship you on four weeks' absolutely free trial direct from our own factory your choice of 38 new styles of the highest-grade Wing Piano or Player Piano. No obligations—no C.O.D.—no security.

**No Money Down—Not a Cent of Freight**

Use it and enjoy it four full weeks; then, if you wish, ship it back at our expense. You alone are the judge. You will be amazed at our rock-bottom, direct price on the superb Wing, guaranteed 40 years. Easy monthly payments or cash. Write today.

**Valuable Book—FREE** "The Book of Complete Information About Pianos" sent free and postpaid. Valuable 136-page book. Tells how to judge pianos. Beautiful art catalog also sent and particulars of great Free Shipment Offer. Write today. Wing & Son (Est. 1868), Wing Building, 9th Ave. & 13th St., Dept. 1195, New York



The Wing Uprights, Grands, Player Pianos



## The "BEST" LIGHT

A soft, luminous light, which casts no shadow. Brighter than electricity or acetylene. Makes and burns its own gas. Costs 2c a week.

No dirt, smoke nor odor. Over 200 styles, ranging from 100 to 2000 candle power.

Absolutely guaranteed. Write for illustrated catalog.

AGENTS WANTED EVERYWHERE  
**THE BEST LIGHT CO.**  
324 E. 5th St., Canton, O.

## \$1,000,000 Winner

1,000,000 sold. 1,000,000 unsold! Agents banking enormous profits; O'Connell \$80 first day, Walters \$50. Everybody wants new automatic, ten blade, double action shoe cleaner on door step. **Automatically removes mud, snow.** Has 10 dirt outlets, adjustable brushes on compound springs. Rotates for sweeping. Can't clog. Territory free—worth fortune. Investigate quickly! **SECURITY MFG. CO., Dept. 149, Toledo, Ohio**



## THE MOTOR-BOB

1915 MODEL

BOYS, YOU CAN BUILD A REAL LITTLE AUTO LIKE THIS!



Send 25 cts. for a set of our easy to understand plans, large working drawing and list of parts showing how you can build this simple and practical little car at least possible cost.

**THE IDEA SHOP, Dept. 1, BUFFALO, N. Y.**

# DIAMONDS

ON CREDIT

20% DOWN

10% A MONTH

The most beautiful Diamonds are the Blue-white, especially if absolutely perfect. **LYON DIAMONDS** are 1st Quality, Blue-white. A certificate furnished with every Diamond guaranteeing its value and providing for exchange at full purchase price. Goods sent prepaid for examination and approval. Write for Catalog No. 3.

**J. M. LYON & CO.,** (Est'd 1843), 71-73 Nassau St., NEW YORK.



## Mend Your Health By Fresh Air Sleeping

You can now enjoy outdoor sleeping under best conditions. Sleep comfortably all night on a soft air mattress which is perfectly smooth and dry—the

### Perfection Sleeping Bag With Pneumatic Mattress

Perfection Pneumatic mattresses may be used on damp ground with perfect safety—they are non-absorbent. And they are absolutely sanitary, with no place for dust nor vermin to collect.

Easily deflated and inflated—may be rolled into a small light bundle and easily carried in and out of the house. *Last indefinitely.*

Invaluable for motor, yachting and camping trips. Endorsed by the Federal Government. Write for illustrated Catalog and endorsements—today.



**PNEUMATIC MFG. CO.** 536 17th Street  
BROOKLYN, N.Y.

## LEARN TO PITCH



Lessons by "MATTY," ED. WALSH, "DOC" WHITE, WALTER JOHNSON, "NAP" RUCKER, "SMOKY" JOE WOOD, "PITCH THE FAD-A-WAY, SPITTER, KNUCKLER, SMOKE BALL, etc. Clearly described and illustrated by 56 Pictures. Entire COURSE OF LESSONS SENT POSTPAID for 50 cents.

J. C. DORN, 721 S. Dearborn St., Dept. 108, Chicago, Ill.

**WHITE VALLEY GEMS** LOOK LIKE DIAMONDS

Stand acid and fire diamond test. So hard they easily scratch a file and will cut glass. Brilliance guaranteed 25 years. Mounted in 14k solid gold diamond mountings. See them before paying. Will send you any style ring, pin or stud for examination—all charges prepaid. No money in advance. Money refunded if not satisfactory. Write today for free catalog.

**WHITE VALLEY GEM CO., 701 Wulsin Bldg., Indianapolis**

## Boston Garters

*Never Bind*

**THE NEVERBIND** is a new member of the Boston GARTER family. Like the other 'Bostons' it has the famous *Never Bind* Rubber Button Clasp. And like the others it has its own distinctive individuality. This is in its **NO RUBBER IN LEG BAND** feature which prevents binding and straining and insures long wear. The little tension strip in front makes it fit. The Neverbind weighs less than half an ounce. Sold everywhere at Boston Garter prices.

50cents and 25cents

GEORGE FROST CO. BOSTON

**TYPEWRITERS** ALL MAKES

Underwoods, Remingtons, Oliviers, Smiths, from \$10 to \$60. Guaranteed 5 years. 500 Typewriters at \$12.50, every one perfect. Write for liberal FREE trial offer at once. All Makes Typewriter Exchange Co., 168 N. Dearborn St., Chicago, Ill.

## Let Us Send You a Genuine Edison Phonograph on Free Trial



right to your own home. Entertain your family and your friends. Send it back at our expense if you don't want to keep it. A few dollars a month now pays for a genuine Edison at rock-bottom prices and without even interest on monthly payments. Send today for our beautiful Free Edison Catalog. A postal or letter is enough. But send it at once.

**F. K. BABSON**

Edison Phonograph Distributors

1195 Edison Block

Chicago, Ill.

**SATIN  
LINING  
FREE**

**Our Guarantee**

*We guarantee to please you in style, fit, fabrics and workmanship or you don't pay us one cent.*

## In This Handsome Blue Serge Suit

Our system of selling fine tailoring direct—through no stores, agents or dealers, saves you big money and enables you to dress better. We want you to become one of our regular customers—that's why we will make one of our regular all-wool worsted blue serge suits

**Tailored-to-Your-Measure (\$25.00 VALUE) \$15**

and line it with guaranteed \$4 satin lining free—also pay shipping charges. Read the guarantee—we take all the risk—you take none. Send for our NEW SPRING CATALOGUE.

**BIG BOOK—70 Samples—Mailed FREE** Contains generous samples of our plain and fancy suitings (prices \$15 to \$27)—explains our tailoring system—quotes lowest prices on men's furnishings, hats and shoes, also boys' clothes. Send for your copy today to

**Bernard-Hewitt Co.** Desk D25 504 W. Monroe St. Chicago



# WANTED IDEAS



Inquiries from Manufacturers and Other Buyers of Patents  
Who Are Looking for Good Ideas

## Protected by Owen Patents

Are constantly being received. Hundreds of ideas are wanted—a market exists for them to-day. YOURS may be one of them. Send for my free books and see for yourself—read the requests for inventions protected by me. Many are simple. You can help supply this demand.

As soon as my clients' rights are protected I aid in every practicable way, **without charge**, to sell. Their applications are advertised free—their patents are called to the attention of the proper prospective buyers—every necessary thing is done. Get my booklets and see.

## THESE ARE FREE

You will incur no obligation by writing me. A simple request will bring them to you—the finest, most reliable and instructive patent books published. A postal will do.

**"Successful Patents"**—a 72 page guide book, tells how to proceed; describes my advantageous business methods; gives references, testimonials, etc.

**"Stepping Stones"**—gives hundreds of hints of inventions wanted; articles from interviews of noted authorities; tells the truth about prizes for inventions.

**"Patent Promotion"**—tells you how to sell; why some inventors fail; discusses the value of your idea; how I aid my clients; manufacturing aids furnished you; recent successful patents, etc.

You will also be sent from time to time, as new inventions are wanted, full information concerning them. Only in this way can you keep up to date.

**Write for These To-day**—Advice costs nothing. All communications confidential. I secure patents or receive no compensation. Your work will receive my personal supervision—but my fees are no higher than others.

## Results Speak Loudest—But Here Are Some References

Columbian National Bank,  
Washington, D. C.  
National Locktile Co.,  
Washington, D. C.  
The Carnahan Press,  
Washington, D. C.  
Lightning Gun & Cycle Works,  
Oklahoma City, Okla.  
Antholene Mfg. Co.,  
Hutchinson, Kans.

National Rack Co.,  
61 Hannover St.,  
Boston, Mass.  
The C. J. Loftus Co.,  
13 Spring Common,  
Youngstown, Ohio  
Whitehead Hosiery Mills,  
Burlington, N. C.  
Dickinson Mfg. Co.,  
Des Moines, Iowa.

A LARGE NUMBER OF OTHERS IN MY BOOKLETS.

### Search of Records

Send sketch or model of your invention for free search of Patent Office Records and report on patentability.

**RICHARD B. OWEN** 9-303 OWEN BLDG.  
WASHINGTON, D. C.

Inventors submitting their inventions to me are protected in a tangible manner until their applications are filed.



# Manufacturers Calling for Over Two Hundred Inventions

## Money Is Waiting to Back the Good Idea

(By a Washington Patent Attorney)

Never was there so good an opportunity for the inventor of something—*anything*—of merit as right now.

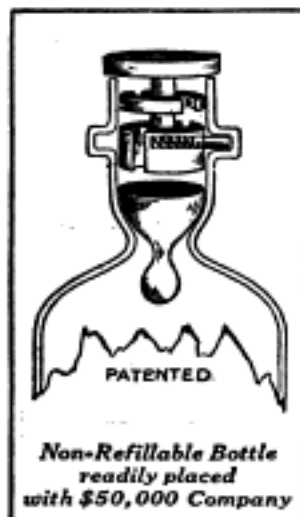

Manufacturers with money and facilities are asking for ideas—*calling* for them. The supply is not nearly equal to demand. Over 200 inventions are asked for in a list just given in a little book "What to Invent." The demand is not for anything extraordinary—just the common everyday things that make work easier or life more pleasant in the household, the shop or the field.

You might think the possibilities of the window screen had been exhausted, but I know of 28 concerns that are looking for a new screen, duly covered by patent, which they can manufacture. I know of 46 manufacturers and others who are ready to manufacture any good, patented household article such as can openers, baking pans, coffee pots, washing machines, carpet sweepers and other devices.

Within the last few weeks I have received forty special requests for a dishwasher and drainer; seventeen others request an improvement in scissors. Manufacturers know that everyone must have a pair of scissors in the house, and they realize that a novelty in them would always sell in place of the old kind, and hence the demand. Among my letters are sixteen requests for a device to turn sheet music on a music stand or piano, and seventeen people are interested in the

purchase of a patent on a device for holding an electric light in any position. Besides these there are hundreds of manufacturers who do not specify any particular device but state that they would be interested in anything of merit



A Chicago man says: "I want something that can be sold to farmers by mail. There is practically no limit to the investment my associates would make in a good proposition." A man in Woodhaven, N.Y., says he is in the market for a small household article, light in weight, which can be sold somewhere around ten cents.

A prominent manufacturing company is interested in something to sell to hardware stores, but would also be interested in other things promising to be money-makers.

A man in Revere, Mass., says: "I am looking for something that can be manufactured, plant equipped, etc., and marketed for an outlay of not over twenty-five thousand dollars."

A big textile machinery company says they are interested in newly patented devices that can be

either bought outright or manufactured on royalty. They do not require machinery inventions alone, but anything of merit.

A company in Belvidere, Illinois, wants patents on small tools or metal novelties.

A Dayton, Ohio, concern writes for some machine or device that would have a general sale throughout the land.

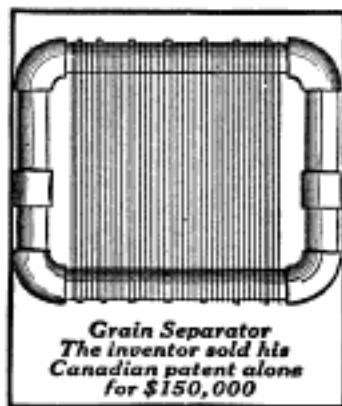

The names and addresses of these prospective purchasers are supplied absolutely without charge by Messrs. Chandlee & Chandlee to those who obtain patents through their firm. This firm has been in practice before the Patent Office for over twenty years, and its members are, consequently, familiar with every detail of patent work. They also issue a booklet entitled "How to Obtain a Patent," which tells in simple words just how to go about protecting an invention. The two books, "What to Invent" and "How to Obtain a Patent," are both free. Why don't you write for them and learn what manufacturers are looking for and how to protect your ideas? If you have an invention, send a sketch or model and description of it to Chandlee & Chandlee, 953 F Street, Washington, D.C. They will give you a free opinion as to whether or not it can be patented.

Please Mention Popular Mechanics

# PATENTS THAT PROTECT and PAY

Advice free. Terms reasonable. Highest references. Best results.  
Send sketch or model for FREE examination and opinion.

BONDED and recommended Patent Lawyer in the Rand-McNally Directory of Bankers and Attorneys Published by Rand-McNally & Co., Chicago, Ill. Recommended Patent Attorney in the Bankers Register and special list of selected lawyers published by the Credit Company, Pontiac Building, Chicago, Sharp & Allen's Directory of Lawyers and Bankers of Philadelphia, Martindale's American Legal Directory of New York City, and the Con. P. Curran Directory of Bankers and Lawyers of St. Louis.

**ALL BUSINESS GIVEN PROMPT AND PROPER ATTENTION**

A large list of strong recommendations furnished free

**WATSON E. COLEMAN, Patent Lawyer, 624 F St., N.W., Washington, D.C.**

## Money in Patents

Manufacturers are always looking for inventions. All patentable ideas should be protected by a patent. (By a Registered United States Patent Attorney.)

The great majority of money making inventions are thought of by persons, I will term amateur inventors, and nearly always are some very small or simple thing, for the reason that a large invention takes too much time and money for the average person to produce. I have inquiries from all over the country, in which manufacturers and business houses are looking for patents in every line of industry. Owing to these inquiries I am about to put inventors in direct touch with manufacturers who want patents, and thereby find a ready sale for their invention, which, for results, is far more practicable than any other mode of assistance to inventors.

A book "How to get your patent and make your profits thereon," which contains general patent information, is free and I would be very glad to have you write me for a copy of it.

**MANSELL F. MILLS**  
Registered United States Patent Attorney  
244 Commercial National Bank Building, WASHINGTON, D. C.

TRADE MARKS **PATENTS** COPYRIGHTS  
30 YEARS EXPERIENCE IN U. S. PATENT OFFICE

Do not waste your money for patents procured by incompetent solicitors. Such patents are worthless and manufacturers will not buy them, nor do they give absolute protection. Consult an expert who is known throughout the Patent world. Costs you no more to be safe. Head of the United States Patent Office and Commissioner of Patents under Presidents Roosevelt, Taft and Wilson and Assistant Commissioner under President McKinley. Thirty years' experience in the U. S. Patent Office qualifies me to give you expert service and to secure you fullest protection. Inquiries solicited. Sole Offices, 150 Barrister Bldg., Washington, D. C.

**EDWARD BRUCE MOORE**  
PATENT COMMISSIONER UNDER THREE PRESIDENTS

Please Mention Popular Mechanics

## PATENTS THAT PAY

OUR TRADE-MARK

OVER \$600,000.00 MADE BY CLIENTS

### PATENTABILITY REPORT

Send sketch or model of your invention for free search of the Patent Office Records and report as to patentability.

### 2 WONDERFUL BOOKS

entitled (1) 146-Page "Inventors Guide" and (2) 127-Page "What and How to Invent - Proof of Fortunes in Patents" which every inventor should have, and can have, FREE.

Highest References, including 100 manufacturers we serve  
Promptness Assured

Across the Street from the U. S. Patent Office.

**E. E. VROOMAN & CO.,** 871 F STREET, N. W., WASHINGTON, D. C.

**PATENTS** secured on square deal fee plan with **FREE** search.  
**MILB H. STEVENS & CO.,** 603 F ST., WASHINGTON  
346 Monadnock Bldg., CHICAGO. Established 1864

Send for **FREE BOOK** { **WHAT TO INVENT**  
**WHAT NOT TO INVENT**  
**HOW TO SELL YOUR PATENT**  
Copies of nearest Patents and report in every case without charge  
**H. L. WOODWARD, 9th and G Sts., WASHINGTON, D. C.**

**I HELP  
INVENTORS  
SUCCEED**

BY OBTAINING  
**Protecting Patents**

My new book "How to Patent Your Invention and 100 Things to Invent" gives a new light on the Patent, Copyright and Trade Mark business. I give a binding guarantee - "No Patent, No Pay." Send sketch of your ideas for free search.

**CARL H. CRAWFORD**  
610 Jenifer Bldg., Washington, D. C.

### A Fortune to the Inventor

who reads and heeds it, is the possible worth of the book we send for 6 cents postage. Write us at once.  
**E. E. & A. B. LACEY, Dept. Y, WASHINGTON, D. C.**

**PATENTS** **C. L. PARKER**  
Formerly Member Examining Corps, U. S. Patent Office  
**PATENT LAWYER**  
210 MCGILL BLDG.  
WASHINGTON, D. C.

Patents, Trade Marks, Copyrights, Patent Litigation  
Handbook for Inventors, "Protecting, Exploiting and Selling Inventions" sent free upon request.

# Patents

Trade Marks and  
Copyrights Secured  
or Fee Returned

## Special Offer—Free Search of Patent Office Records

Send us a model or sketch and description of your invention, and we will make a *Free Search* of the *Patent Office Records* to ascertain if it is patentable. If we report the invention patentable, we will guarantee to obtain a patent or return our fee, and furnish a certificate of patentability backed by a bonded contract to that effect.

**This Certificate of Patentability will protect the inventor and serve as proof of the invention until the case can be filed in the U. S. Patent Office.**

### Obtaining Assistance for Inventors

Our certificate is of great assistance to inventors who require financial aid to obtain patents.

### Our Five Books Mailed Free

(SEE COUPON BELOW)

to any address. Send for these books—the finest publications ever issued for free distribution.

#### How to Obtain a Patent

Our illustrated eighty-page Guide Book is a book of reference for inventors, and contains 100 mechanical movements illustrated and described.

#### Money in Patents

Tells how to invent for profit, and gives history of successful inventions.

#### What to Invent

Contains a valuable **LIST OF INVENTIONS WANTED** and suggestions concerning profitable fields of invention; also information regarding prizes offered for inventions, among which is

#### Prize of One Million Dollars

offered for one invention, and \$10,000 for others.

#### Patents That Pay

Contains letters from our clients who have built up profitable enterprises founded upon patents procured by us; also endorsements from prominent inventors, manufacturers, Senators, Congressmen, Governors, etc.

#### We Advertise Our Clients'

#### Inventions Free

In a list of Sunday newspapers with two million circulation, in manufacturers' journals and in the *World's Progress*. Sample Copy Free. We save you time and money in securing patents. After the patent is granted we assist you **TO SELL YOUR PATENT**.

#### Foreign Patents

WE HAVE DIRECT AGENCIES IN ALL THE PRINCIPAL FOREIGN COUNTRIES and secure FOREIGN PATENTS in the shortest possible TIME and at the LOWEST COST. Write for our Illustrated Guide Book on Foreign Patents, sent free to any address.



VICTOR BUILDING

Our new \$200,000 building opposite U. S. Patent Office  
SPECIALLY ERECTED by us for OUR own use

## WANTED NEW IDEAS

Send for **LIST OF PATENT BUYERS** who consult us when purchasing patents. Contains requests from **MANUFACTURERS, MAIL ORDER HOUSES and PROMOTERS** for patents secured by us, and suggestions as to New Ideas they wish to purchase. We invite manufacturers and promoters to address our Sales Department regarding the purchase or leasing of a number of meritorious patents secured by us.

### REFERENCES

Second National Bank, Washington, D. C.; Union Savings Bank, Washington, D. C.; Chamber of Commerce, Washington, D. C.; Pinner Gasoline Lighting Co., Chicago, Ill.; R. G. Dun & Co., Washington, D. C.; Smethport Glass Co., Smethport, Pa.; The Melvin Gauge and Signal Co., Scranton, Pa.; M. Winter Lumber Co., Sheboygan, Wis.; National Savings and Trust Co., Washington, D. C.

### FREE COUPON!

## VICTOR J. EVANS & CO., Patent Attorneys

NEW YORK OFFICES: 189-191 Broadway

PHILADELPHIA OFFICES: 1429 Chestnut St.

Main Offices: 765 Ninth St., N. W., WASHINGTON, D. C.

GENTLEMEN: Please send me FREE OF CHARGE your FIVE Books as described above.

NAME.....

ADDRESS.....



## Kalamazoo Cabinets \$6 up and Tables

Direct  
From  
Factory

**B**EAUTIFUL, all metal, double white enameled inside and out. Finer cabinet cannot be made. Good for lifetime service. Big, roomy pantry cupboard and kitchen table all in one. Sliding Nickeloid Table Top. *Without extra charge* we include 8-piece crystal set, and white glass rolling pin. **Pay as you use**—a little down, a little each month—money returned if not satisfied.

**30 Days' Trial** We pay freight and guarantee safe delivery. Write today for our big *Free* Cabinet Art Book showing full line of Kalamazoo Cabinets and Tables. Ask for book No. 15

**Kalamazoo Stove Company**

Manufacturers

Kalamazoo,

Michigan

**A Kalamazoo  
Direct to You**

**Pay As You Use**

## KEROSENE AND GASOLINE LANTERNS

Absolutely bug and wind proof and give 300 candle power of light, at a cost of 1/5c per hour. Suitable for use on farms, watchmen, side shows, circuses, street carnivals, garages, livery barns, summer resorts, warehouses, boat landings, etc.

For complete catalog and agency proposition address

**THE NAGEL-CHASE MFG. CO.**  
150 East Erie St. CHICAGO



## Out-Door Lamp 300 Candle Power **FREE**

**To Try at Your Own Home**  
Gives better light than gas, electricity or 15 ordinary lamps at one-tenth the cost. For Lawns, Streets, Barns, Barn Yards, Shops, Dairies, Porches, Alley Ways, etc. Storm Proof, Bug Proof. No wick, no chimney, no smoke. Makes its light from common gasoline. **ABSOLUTELY SAFE.**

**COSTS 1 CENT A NIGHT**

We want one person in each locality to whom we can refer new customers. Take advantage of our **SPECIAL FREE TRIAL OFFER.** Write today. Agents Wanted.  
**SUNSHINE SAFETY LAMP CO.,**  
295 Factory Bldg., Kansas City, Mo.



## BRASS GEARS

Cut by an entirely new process. The most accurate made and at prices that cannot be equalled by others. Every gear has a hub, center painted ebony black, edges turned true, highest grade red brass, and much heavier than others. We carry the largest stock in the world and every gear listed is always shipped on date of order.

SEND FOR CATALOGUE

**CHICAGO STOCK GEAR WORKS**  
16 S. Fifth Av. Chicago



**MECHANICAL SUPPLIES AND MATERIAL**  
of all kinds.  
**EXPERIMENTAL AND LIGHT MACHINE WORK**  
to order.  
132 MILK STREET. BOSTON

## FREE Information given on Ideas and PATENTS

Let us patent your ideas. We sell and promote patents obtained by us without advance fees. Our Booklet explains. Send for it.

**International Bureau of Patents, Inc., 14 Park Row, N.Y.**

## RUNS ON ALCOHOL



anywhere at slight expense. Wonderfully simple mechanism. Finest construction. Improved roller bearing, 1915 model. No electricity, no springs, no wiring. The original and only **Lake Breeze Motor** manufactured according to the design of the inventor and under his direct and personal supervision.

Price in the U. S., \$15, cash with order.  
Foreign Price \$20.00 Gold, cash with order, paid down by parcel post at seaport of entry nearest destination.

**THE LAKE BREEZE MOTOR, P. O. Box 505, CHICAGO, ILLINOIS**

## Jenks Electric Lantern

(No Flash Light with Wire Ball)

Combination House Lamp, Search and Flash Light. Pull wire solid brass, nickel silver plated. **10 Years Guarantee.** Water, wind and fireproof. Can operate on oil, just pick up lantern and the Jenks lantern automatically throws on a light, giving you a flood of light, twice as much as the best. Simple and safe. Just the thing for the home, auto, campers, merchants, farmers and around any place without or garage. No matches, oil, or wick trimming. No smoky chimney or danger of fire. Always on sight. Agents crazy about it.

**AGENTS**

we take the wrinkles out of your pocket book. Send of our agents are carrying as high as \$50 per week. You can do the same. This is our special agents' price, \$3.50. Send us your order and today, accompanied by M. O., and receive our Special Agents' Proposition. If you are alive this is the ad to answer.

**MANUFACTURERS' DISTRIBUTING AGENCY**  
Dept. 1, 901 Lytton Bldg., CHICAGO, ILLS.



Always on the Job

**\$3.50**

## GEARS SPROCKETS CHAINS

In Stock for immediate shipment

All Kinds sizes and materials made to order.

Send for 48-page New 1915 Catalog  
**WOBURN GEAR WORKS**  
Woburn, Mass.



## INVENTORS Our Brain Belongs to You. Our Ideas Are Free of Charge.

All we want in return is to build your model, special machinery, dies, tools and jigs to manufacture sheet metal goods, etc. We are expert mechanics, over thirty years' experience and have one of the best equipped shops in the country. Ask for Booklet No. 17. Consultation free. Experimental work strictly confidential.

**A. Macke & Son, J. Uhrman, A. Hehrlich, Prop's**  
214-242 S. 9th St., Philadelphia, Pa.



## 140,000 Gears IN STOCK FOR IMMEDIATE SHIPMENT

This does not include our large stock of pinion wire, racks, chains, ball bearings, universal joints and gear gauges. Send for Catalog No. **BOSTON GEARWORKS**  
Norfolk Downs (Quincy), Mass.

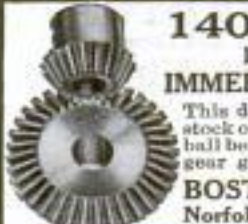



## "IDEAL" Lawn Mower Grinder

Grinds all makes of Mowers perfectly in 15 minutes without removing wheels, ratchets or reel-knife. Ball-bearing; operated by either hand or power. Skate Sharpener Attachment for sharpening skates.



"You Grind It As You Find It"

**Write Today** for full information of this great labor-saver and money-maker. Will do the work so much better, quicker and easier you cannot afford to do without it. The only practical machine for sharpening Lawn Mowers on the market. Over 6000 in use. Fully warranted. Sold on easy-payment terms. Write today. Don't delay.

**THE ROOT-HEATH MFG. CO., Plymouth, O.**

standard period of prediction, according to the press report of the University of Wisconsin, is 36 hours. Madison, Wis., receives a daily report from about 90 outlying points of North America. From this information a weather map is made up with tabulated statements. Within little more than two hours from the time

## INVENTORS! — "Let Us Be Your Factory"



We manufacture Special Machinery, Patented Metal Specialties of all kinds, Electric Articles, Hardware, Contract Manufacturing, Development, Sample Work. You get the advantage of our splendid equipment, up-to-date methods, and wide experience. We Do It All. Tools, Dies, Stampings, Lathes, Screw Machine Work, Milling Machine Work, Metal Spinnings, Metal Drawings, Castings, Plating of all kinds, Enameling, Japanning, Tinning, Galvanizing, Wood and Metal Patterns, Drafting, Designing, Blue-print Work. Send sample for expert advice. Our 25c book free, containing tables and valuable information. Write for it today. Address

**The EAGLE MFG. CO., 1602 Blue Rock St., CINCINNATI, O.**

**DO YOU HAVE KNIVES TO GRIND, SILVER TO POLISH, SMALL TOOLS TO OPERATE, WASHING MACHINES OR WRINGERS TO RUN? LET THE RED DEVIL**

**DO YOUR WORK**

Attached to any water faucet will develop up to 3 Horse Power according to size of pipe and water pressure. Only perfect small motor made. Improved bucket wheel construction.

6 in. Motor for Mechanics and Tradesmen, Washing Machines, 1/2 H. P., on 1/2 in. pipe, 60 lbs. water pressure; 1 H. P., on 3/4 in. pipe, 80 lbs. water pressure. Net price \$5, cash with order.

No. 1492—4 in. Motor for grinding, polishing, lathes, sewing machines; for Doctors, Dentists, Druggists, etc., with easy buffing wheel, silver polish and pulley, \$2.

No. 1493—4 in. Motor and pulley only \$2.50, cash with order.

Money back for any reason. Order your motor from dealer or from us. Send your water pressure and size of supply pipe. Act! No Agents wanted. Catalog free.

Only Motor to do this work



**DIVINE WATER MOTOR CO DEPT P: UTICA, N.Y.**



# His Coal Bill Cut Two-Thirds

Saving of 1/2 to 3/4 Guaranteed the New-Feed UNDERFEED Way!

Stop! Read this. It means money saved to you. It means better, cleaner heat. And please remember that all this comfort and saving is guaranteed—*guaranteed* the Williamson New-Feed UNDERFEED way. It is but one instance among thousands of such others that we can show you.

"The year before my UNDERFEED was installed, my house was heated with an Overfed Furnace of so-called 'standard' make. My coal, year before last, cost me from \$3.00 to \$3.25 a ton; the bill for the winter ran almost \$90.00, and during that winter only about half of my house was heated as a house should be.

"Last winter the same house was heated with one of your UNDERFEED Furnaces. The coal used was 'Slack,' which cost me \$1.50 per ton; the bill for the entire winter ran about \$35.00. The house was comfortably heated every day of the winter, including windy days.

"A comparison of those two years has convinced me of the superiority of your UNDERFEED Furnace."

Yours respectfully, (signed) H. Ernest Hutton,  
401 Baum Bldg., Danville, Ill.

**WILLIAMSON CUT COAL BILLS**  
NEW-FEED UNDERFEED  
Furnaces and Boilers 1/2 to 3/4

### The "Candle" Principle

The New-Feed UNDERFEED operates on the "candle" principle. Coal is fed from below. Hot, clean coals and flame are always on top in direct contact with most effective radiating surfaces. In passing up through the live fire, all smoke, gases and dirt are consumed and utilized in the form of clean heat. They can't go up the chimney and be wasted as in top-fed heaters.

### Burns Cheaper Grades of Coal

And the New-Feed UNDERFEED burns the cheaper grades of coal—a first great tangible saving. And the New-Feed is so simple that a boy of 12 can operate it with as good results as when the fire is in charge of a professional "furnace tender." Adapted to warm air, steam or hot water.

### Learn More About It

Send the attached coupon. Remember the 50% saving in coal bills is guaranteed where the New-Feed is properly installed and operated. The coupon brings you, free, the interesting book "From Overfed to UNDERFEED" which describes the New-Feed's simple operation. Sending the coupon costs you nothing—places you under no obligation. Send it NOW!

**The Williamson Heater Company**

(Formerly The Peck-Williamson Co.)

195 Fifth Avenue, Cincinnati, Ohio

Cut-Out View of Underfeed Furnace



**THE WILLIAMSON HEATER CO.**

195 Fifth Avenue, Cincinnati, Ohio

Tell me how to cut my coal bills from 1/2 to 3/4 with a Williamson New-Feed UNDERFEED.

Warm Air \_\_\_\_\_ Steam or Hot Water \_\_\_\_\_  
(Mark an X after System interested in)

Name \_\_\_\_\_

Address \_\_\_\_\_

My Dealer's Name is \_\_\_\_\_

Please Mention Popular Mechanics



## Smith & Wesson Automatic

*Doubly safe*

Built like a watch  
for accuracy.



Get your dealer to show you the special features of the Smith & Wesson Automatic. Booklet on request.

**SMITH & WESSON**  
814 Stockbridge St., Springfield, Mass.

*Every Smith & Wesson is the Best of its kind*

## ★ Portable Money Makers

★ The Constant, ever-growing demand for sanitary wells offers splendid opportunities for men of integrity and average business ability in practically every community. There's **GOOD, STEADY MONEY** to be earned.

### ★ Star Drilling Machines

low in price; may be secured on payment plan. These machines are regular portable money makers. Thousands in use today, drilling wells and prospecting.

★ If you want to get a good, safe, money making business, send for our catalog (enclose six cents for postage) and learn more about **STAR** Drilling Machines, and the opportunity they offer you.

★ **The Star Drilling Machine Co.**  
506 Washington St., Akron, Ohio



## Crescent Wood-Working Machines

please particular users everywhere and will satisfy you.

Ask today for catalog of band saws, jointers, saw tables, planers, disk grinders, planers and matchers, swing cut off saws, shapers, borers, variety wood-workers, Universal wood-workers.

**THE CRESCENT MACHINE CO.**  
93 Columbia St. LEETONIA, O.



## LATHES

9 to 18-inch Swing

List price \$75 and up according to size. When ready to buy send for Lathe Catalog and prices.

**W. F. & John Barnes Co.**  
100 Ruby Street, ROCKFORD, ILL.



## South Bend Lathes

For the Machine and Repair Shop

11 inch Lathe Complete	\$100.00
12 inch Lathe Complete	125.00
13 inch Lathe Complete	155.00
15 inch Lathe Complete	200.00
16 inch Lathe Complete	250.00
18 inch Lathe Complete	300.00

**Straight or Gap Beds.** Send for free catalog giving prices on entire line.

**SOUTH BEND MACHINE TOOL CO.**  
423 Madison St., South Bend, Ind.

### How to Run a Lathe

A 50 cent book for 10 cents. Postpaid, stamps accepted

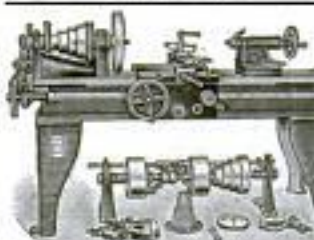

## OUR BIGGEST LATHE VALUE

16-inch Lathe with 6-foot bed, \$252.00; other sizes at proportionately low prices. Every lathe guaranteed. Buy your lathe from us and save \$50.00 or more. Machinery Catalog No. 80P139 sent free on request.

**SEARS, ROEBUCK AND CO.**  
CHICAGO

of observation some 300 of these maps are off the press and in the mail. The forecast alone is sent to a list of about 800. Recently permission has been granted local forecasters to predict for a longer period in case of county fairs, and similar undertakings, if the weather is not in too rapid a state of change.

## Drink Pure Water

Perfect health demands it. Disease lurks in impure water. Insure purity by installing a

### Bohner Self-Cleansing Filter

Gives you constant supply of crystal water, pure as ozone. Inexpensive. Anyone can install without tools. Lasts a lifetime. Full particulars on request.

**Bohner Mfg. Co.** 10098, So. Wabash Av. CHICAGO, ILL.

**AGENTS WANTED**



Guaranteed to give satisfaction or money back if returned in 15 days.

# SEBASTIAN LATHES HIGH QUALITY LOW PRICES

If you delight in good tools you will delight in Sebastian Lathes. For 25 years we have built lathes, and lathes only, employing skilled labor always, and improving equipment and machinery every year. Sebastian Lathes are

## STANDARD FOR QUALITY—LOW IN PRICE

They are accurate, economical, simple and durable. Many re-orders and voluntary letters from users of Sebastian Lathes prove this.

The Sebastian reputation is back of every Sebastian Lathe. You are judge and jury when you buy a lathe. We are not satisfied until you are. Look over the complete line in our new catalog. It shows Lathes for general repair work, garage and automobile work, etc.

*When you buy a lathe, say "Sebastian"*

ADDRESS (FOR THE CATALOG)

**THE SEBASTIAN LATHE COMPANY, 107 Culvert St., Cincinnati, Ohio**

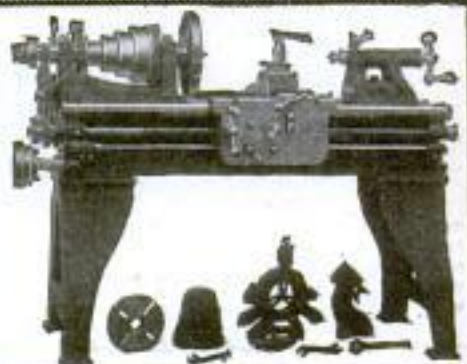



## The New Brown & Sharpe Micrometer Caliper

Here is just the kind of Micrometer you have been looking for so long — a good-looking, reliable one at a moderate price. Because of the constant demand for such a tool, we have just brought out this new style, called the Rex. It is just as dependable in every way as any of the other 475 Micrometers in our line, which have been a standard for accurate measurements for years.

### A High-Grade, Reliable Micrometer at a Popular Price

The improved style of frame is drop-forged and designed to combine maximum strength with lightness. The fine, dull nickel finish of the frame is pleasing and serviceable. Note the new style graduations on the hub, alternately above and below the line, making them easy reading. The measuring screw has a new and simple compensating device and the measuring surfaces are hardened. In every way it is up to the Brown & Sharpe standard, and makes a handsome addition to any mechanic's kit.

**Price \$3.50.** Subject to usual discounts on Micrometers.

*Ask to see this new Micrometer at the leading hardware store or drop us a postal for an illustrated folder.*

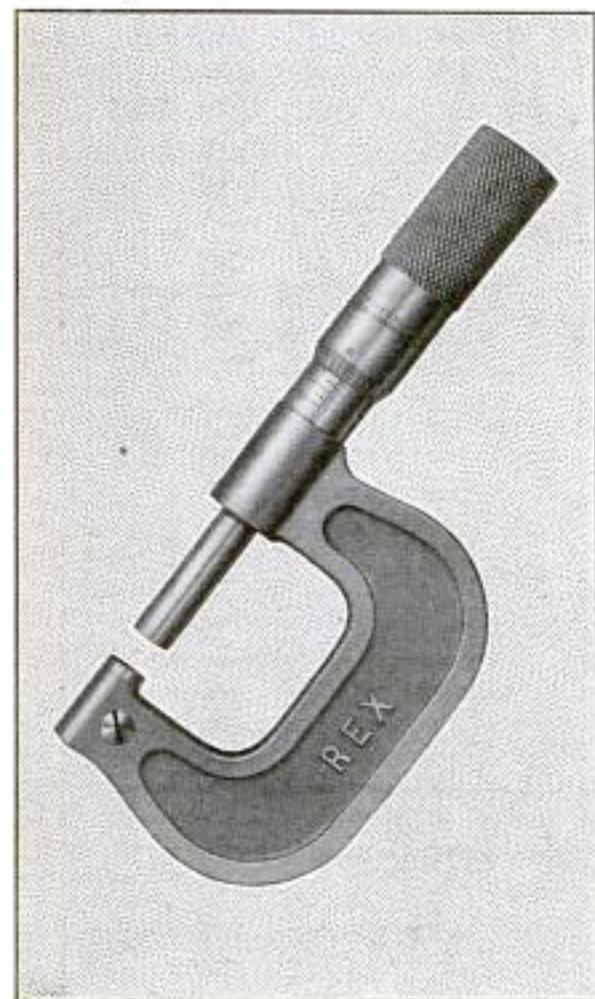

**Brown & Sharpe Mfg. Co.**  
Providence, R. I., U.S.A.

## The Mechanic's Favorite



For years we have been making and selling No. 732. It is a hard brace to beat and the experienced mechanic knows it. When you go to your dealer have him show you

## MILLERS FALLS BIT BRACE No. 732

Head is ball-bearing. Ratchet is protected against injury. Sweep handle is always free acting. Patent cup washer holds chuck to sweep without working loose. Jaw socket of chuck made from bar steel. Chuck shell reinforced at the lip and shaped to fit hand. Jaws hold with bull-dog grip and center with unusual accuracy.

You will recognize many other marks of quality. Millers Falls Tools are made by one of America's oldest and best known tool makers. They are honestly constructed and honestly guaranteed. Every good dealer carries them or will order any tool for you that he has not in stock.

### Other Tools of Millers Falls Make

Ask your dealer to show you Hand Drill 306; Automatic Borer 8, and Hack Saw Gauge 53.

Send for handy pocket catalog describing complete line.

**MILLERS FALLS  
TOOLS**



**Millers Falls Co.**  
Millers Falls, Mass.



## Put a Carborundum Sharpening Stone Under Your Edge Tools

**T**WO or three strokes and you know that you have a stone that is different—a stone that really cuts clean and quick.—Carborundum Stones will not fill or glaze if properly used.

**They Will Last Almost  
as Long as a Tool Itself**

Use Carborundum Stones in your workshop, in the household—wherever tools are to be kept keen and smooth-edged.

Ask your hardware dealer, or send direct for booklet giving details of the Ten Thousand Dollar Prize Business Idea Contest of the Rice Leaders of the World Association, of which the Carborundum Company is a member.

*One of your business ideas may  
win one of the big cash prizes*

**The  
Carborundum  
Company**  
Niagara Falls, N. Y.





## Stanley Bench Bracket No. 203

A new and exceptionally useful article. It simply requires that one or more holes be bored in the front of your bench. The shape of the tool is such that, when the jaw or nose is put through the hole, it is automatically held in place, and by means of the screw clamp the board being worked upon is quickly and firmly secured.

The body of the Bracket is made of iron—japanned—and the clamp screw is strong, well threaded and nickel plated. Special circular, showing several ways in which this handy little tool can be used, furnished upon request.

**Price, 35 Cents Each**

Sent postage prepaid to any part of the United States or Canada upon receipt of price.

ADDRESS

**STANLEY RULE & LEVEL CO.  
NEW BRITAIN, CONN. U.S.A.**

From  $1\frac{1}{2}$  inch  
blade— up to  
30 in.  
long



Handles  
can't work  
loose on  
**"Yankee"**  
Plain Screw  
Drivers

The big line of rigid blade screw drivers includes sizes that fit any job upon which a man wants to use a rigid blade screw driver. "YANKEE" Plain Screw Driver handles won't loosen under the hardest usage. They are fastened to the blades by a "YANKEE" device that makes these drivers practically a one piece tool.

The steel in the blade is specially tempered—it won't chip, bend, twist, break or turn edges—the blades are accurately centered in the handle.

The corrugated handles are made of hard wood—finished in dull black. Of exceptional worth—like all

## "YANKEE" TOOLS

*Make Better Mechanics*

**"Yankee" Plain Screw Drivers**

No. 90—Standard Style—14 sizes—  
2 inch to 30 inch blade.

No. 95—Cabinet Style—11 sizes—2½  
inch to 15½ in. blade.

Your dealer can supply you

Write for "Yankee" Tool Book"  
Free for Mechanics and House-  
holders and "Yankee" Tools  
in the Garage" for Motorists.

**North Bros. Manufacturing Co.  
PHILADELPHIA, U. S. A.**

Please Mention Popular Mechanics

National wealth has increased from \$7,000,000,000 in 1870, to approximately \$140,000,000,000, in 1914; money in circulation from \$279,000,000 to \$3,419,000,000; and New York bank clearings from approximately \$5,000,000,000 to over \$98,000,000,000, while, for the entire



### Tool Cases for Toolmakers and Machinists

Keep your tools orderly arranged in a Gerstner Portable Tool Case. There is a place for every tool in one of the felt lined drawers. Every up-to-date mechanic needs one and you'll find our Cases the best built, neatest and most practical on the market. We guarantee to please or refund all money. Write for our booklet

*Gerstner & Sons*

Mfrs. of Mechanics' High Grade Tool Cases  
808 Columbia St., DAYTON, OHIO

## THE AWL YOU WANT

See That Reel



Is the genuine MYERS \$1.00 "Lock Stitch" Sewing Awl with the exclusive feature. See thread reel in front of handle under the finger tips. Natural tension. Sews heavy or light material, diamond point, full grooved needles used to protect the thread when sewing.  
**C. A. MYERS COMPANY, 6339 University Ave., Chicago, Illinois**

## Large Profits from Small Capital



A Business of your own bringing you an income of at least \$10.00 per day with practically no experience or overhead expense.

### The Green AUTOMATIC MACHINE

sharpens, hones, and stropps all kinds of safety razor blades, all in one operation, at the rate of 150 to 250 blades per hour, you can readily figure your profits. Let us send you our free booklet explaining everything.

**Am. Sharpening Machine Co. (Inc.)  
Dept. 5, 184 W. Washington St., Chicago**



## Are You Interested in Fine Tools?

Most men enjoy working with fine tools—no matter whether they are machinists, carpenters, or electricians who use tools in their daily work or just amateurs who like to do it for the satisfaction of the work itself. Every man who ever uses good tools should learn about the full line of

### Starrett Tools

because there are sure to be some tools out of our 2100 styles and sizes that will just suit some particular job you have. The line includes steel rules, squares, levels, micrometers, calipers and dividers, vernier calipers, gages, hack saws, etc.



#### Combination Squares

Sliding head contains level. Tool includes center head for centering round pieces. Sizes 4 to 24 inches. Popular size 12". Price \$1.50.



#### Hack Saws

Starrett blades cut quicker and last longer. Made of special toughest steel and tempered by a secret process. Starrett frames are sturdy, durable and convenient.



#### Expansion Pliers

These wonderful pliers have adjustable jaws so that work up to 1 1/4" may be held firmly while keeping the handles just right to grip. Quicker than a wrench—easier than common pliers for working about autos, motorcycles, bicycles, motor boats, etc. Price \$2.00.

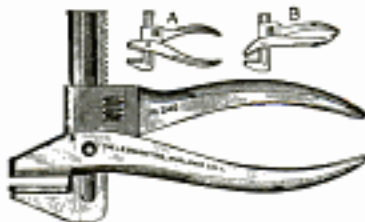

#### Insulated Handle Screwdriver

This class' little screwdriver for electricians has black rubber handle, containing set of four screwdriver blades. Length, with blade in place, 6 1/2". Price \$1.50



### Send For Free Catalog

We want to send our free 320-page catalog describing 2100 styles and sizes of tools to men interested. Ask us for catalog No. 20AP.

Starrett Tools are sold at all good hardware stores.

**The L. S. Starrett Co.**  
World's Greatest Toolmakers  
Athol, Mass. 42-468



REGISTERED  
**3**  
IN

## THIS SIGN-BOYS

is for 3-in-One—the perfect bicycle oil. It oils the bearings exactly right and makes them run about 100 times easier. 3-in-One won't collect dirt, gum and hurt your wheels like inferior greasy oils. 3-in-One cleans and polishes all metal parts, and absolutely prevents rust.

Always use 3-in-One on every part of your gun, just like any sportsman. Every gunner will tell you it's the only oil on earth. Try 3-in-One also on your ice and roller skates, fishing reel, golf clubs, scroll saw, camera, printing press, magic lantern and every tool in your tool chest. A few drops of 3-in-One will preserve and keep pliable your catcher's gloves; also prevent rust on your mask.

**FREE**—Write this very day for a generous free sample and the helpful 3-in-One Dictionary. Both free to live boys. Get yours now!

3-in-One is sold at all drug, grocery and general stores, in three-size bottles: 10c, 25c, 50c. Also in patent Handy Oil Cans, 3 1/2 ozs., 25c.

**THREE-IN-ONE OIL CO.**  
42CNW. BROADWAY, NEW YORK CITY

## Learn How to Solder 10¢

Solder at home—save money. Solder for others—make money. Send 10c in stamps for complete instructions; fully illustrated. Money back if not satisfied. **THE M. W. DUNTON COMPANY, 55, PROVIDENCE, R. I.**

10¢  
IN STAMPS

country, bank clearings have grown from \$52,000,000,000, in 1887, the earliest year for which figures are available, to \$174,000,000,000 in 1913.

## "DON'T BUY BLADES" \$1.00

Our Newly patented Safety Razor Blade Sharpener! It hones and strops all make blades. Make one blade last you the year round. Puts an edge on a blade in 10 seconds. Save 35c on each dozen! Pays for itself in a hurry. Combination Hone and Strop, with blade grip, packed in plush lined case.

Postpaid



**THE ALMORE CO.**  
856 Belmont Chicago, Ill.

Agents Wanted



## Portable Cases

FOR TOOL MAKERS AND MACHINISTS

Twelve styles, left lined drawers, solid brass trimmings, best of material, beautiful finish, low prices, satisfaction guaranteed. Ask for booklet of cases built for service.

**The Pilliod Lumber Co.**  
SWANTON, OHIO



## FASTENINGS

of all kinds of fixtures, apparatus and machinery in Concrete, Brick, Stone, Marble, Tile, etc., made EASY by using the Van Expansion Bolt. Over 100,000 used in the Tower of Jewels at the Panama-Pacific Exposition.

**Trial Offer:** Four Van Expansion Bolts sent POSTPAID for 10c. Will be found as useful as a hammer and nails. Send today, starting your business. Information free.

**VAN EXPANSION BOLT MFG. CO.**  
1209C Fort Dearborn Bldg. CHICAGO, ILL.

# Tools Always Ready For Service



Hammer  
No. K612  
Price  
\$9.70

Equip your home with *needed* tools so that you can make repairs yourself. Such jobs are simple if you have the right tools. Keen Kutter tools are used everywhere by professional mechanics and by the home man. They are incomparable in perfection of steel and balance and hang which make it possible to do a steady day's work without tiring.

## KEEN KUTTER Quality Tools

should be demanded from your dealer. Every one is guaranteed, and it must realize the Keen Kutter standard. Your dealer is authorized to give you a new tool or return your money for any one that doesn't prove satisfactory. You must get absolute satisfaction.

Send for our Home Furniture Design Booklet No. D976.

"The Recollection of Quality Remains Long After the Price is Forgotten."  
Trade Mark Registered.

If not at your dealer's, write us.

**Simmons Hardware Company**

St. Louis, New York, Philadelphia, Toledo,  
Minneapolis, Sioux City, Wichita.

Bit Brace  
No. K212  
Price \$3.25

Draw Knife No. K3—Price \$1.00

Hand Saw  
No. K29, 29-36 in.  
Price \$2.00

Pliers  
No. K956  
Price  
\$1.25

**Duplicate Keys for all Pin Tumbler Locks can be made in a minute with The Harrison M. L. P. Key Filing Machine**

Invaluable for Machinists, Building Superintendents, Hardware and Repair Shops, Locksmiths, Carpenters, Electricians, Garages, etc. Anyone can make a perfect duplicate key without injuring the original. Every machine unconditionally guaranteed. Money refunded if not entirely satisfactory. Price \$3.00 net. Send us P. O. order or N. Y. draft and receive the complete machine by return Parcel Post. Special diamond shaped files for angular keys 35c each or 4 for \$1.00. Send for circular.

HARRISON & COMPANY, 81 NEW ST., NEW YORK

### THE MASTER SLIDE RULE



the only RULE IN THE WORLD whereby inside measurements of doors and windows, etc., can be taken rapidly and accurately. Also superior to any other rule for outside measurements of walls and ceilings, etc., as it can be extended and closed instantly. MECHANICS, BUILDERS, AND ARCHITECTS, TRY ONE TODAY! DON'T WAIT. Ask hardware dealer for it.

On receipt of 15 cents per linear foot, a 4, 5, 6 or 8 foot rule will be sent to you prepaid. Large profits to agents. Write for circulars and particulars.

DAHL MFG. CO. 51-A East 42nd St. NEW YORK CITY

### CUTS PERFECT GLASS CIRCLES

## "RED DEVIL" Circular Glass Cutter No. 263



The only cutter with genuine hand honed steel wheels each selected and tested by an expert. Two extra wheels in the head. Rubber mat on nicked base prevents slipping. Any dealer or postpaid direct from us for \$1.25.

Send for one, also for free booklet of 40 styles

SMITH & HEMENWAY CO., Inc., 161 Chambers St., NEW YORK CITY

## Grinder Pays For Self In 3 Months

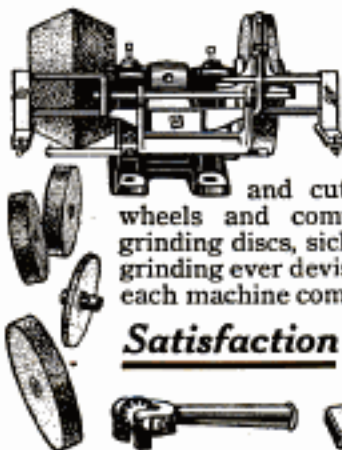

This is the ideal combination grinding outfit you've been looking for—grinds tools, harrow discs, mower sickles, chisels, planes, plow shares, axes and cutlery. A stone for every purpose. Outfit includes buffing and polishing wheels and complete attachments for perfectly grinding discs, sickles, etc. Greatest outfit for power grinding ever devised. Thousands of them sold. With each machine comes a Magic Hone and Magic Scythe Stone. This machine is perfectly made—

**Satisfaction Guaranteed or Money Back** You take no chances. Write for our wonderful 30 day Trial Offer.

MILWAUKEE GRINDER & SPECIALTIES CO.  
Dept. C, MILWAUKEE, WIS.

What  
the  
Carpenter  
Said  
About



**SIMONDS  
SAWS**

He preferred them because he knew they were backed up by over eighty years' experience in cutting edge tools, and were guaranteed.

"Experience," said he, "is a great teacher in tool making. The SIMONDS SAW has the spring and hang that makes cutting easy. You just guide it. The steel is Simonds-made and Simonds-tempered so the set is fast. Teeth hold their sharp, true edge and cut clean. Saw does not bind or scrape and requires little sharpening. Does not tire at the end of the day."

*"If you want saws that cut like diamonds  
Ask for saws that are branded SIMONDS"*

If your dealer can't supply you with a SIMONDS SAW, we will.

Send for our booklet K

**SIMONDS MANUFACTURING CO.**

*"The Saw Makers"*

**Fitchburg, Mass.**

5 Factories

11 Branches

Please Mention Popular Mechanics

## Williams' Junior "Ford" Set "B"

1915  
Catalog

Drop  
Forged  
Tools



Just  
Out

Write  
for  
One

A combination of thoroughly high-class tools and assured great utility. Each tool class tried out for service upon a model T "Ford" Car. Maximum service in a minimum number of Wrenches.

Send for pamphlet or go to your dealer

List prices, \$1.71, \$2.54, \$3.79 per set.  
Roll lists 45c extra.

**J. H. WILLIAMS & CO.**  
47 Richards St., BROOKLYN, N. Y. CITY

Chicago Warehouse, 36 So. Clinton St.

Panama-Pacific Exposition—Block 18, Machinery Palace

## SOLDERING MADE EASY

GASOLINE  
SOLDERING IRON  
BLOW-TORCH



Address Dept. 1, EMMELMANN BROS. MFG. CO., INDIANAPOLIS, IND., U.S.A.

## WILL YOU TAKE ORDERS ?

Many earn \$30 to \$60 every week demonstrating our 1915 Model Steel Automatic Handi-Tool. Lifting and Pulling Jack, Wire Stretcher, Splicer and Mender, Post and Stump Puller, Tire Tightener, Cable Maker, Press, Vise, Hoist, Wrench, etc. Operates automatically. Has power of 40 men. Guaranteed for life. Spare time or permanent work. Demonstrator loaned. Credit given. Write for factory agency offer.

Chas. E. Benefield Co., 293E Industrial Bldg., Indianapolis, Ind.

## THE SPEEDY STITCHER

SEWS LEATHER LIKE A MACHINE

Price \$1.00



Send for terms to Agents

Automatic Awl Co., 26 Bernas St., Worcester, Mass.

## AGENTS \$50 TO \$100 WEEK

SELLING THIS SPLENDID INVENTION—

Any Set  
Wire

"MODEL SPRING WINDER"

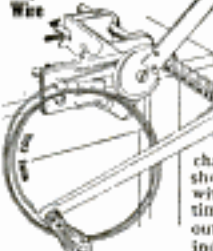

Everybody owning any kind of a machine with a spring on it, buys at sight. No competition. Amazing and wonderfully efficient. Quickly turns out perfect compression or tension springs any size from 1/2 inch to 12 feet long. Uses wire from No. 26 to 3/16 inch thick. Makes all varieties from 1/4 to 1 1/2 inches in diameter. Pitch changed instantly. Indispensable to every factory, shop, garage, repair shop and mechanic. Attaches with thumb screw to any bench or table. Saves time, worry and expense. Works accurately, without waste of wire. Strong and durable, practically indestructible. Only machine of its kind.

Makes Any Kind of Spring Write for full information. Don't hesitate

NATIONAL MFG. & SALES CO., 399 Huron St., TOLEDO, OHIO

12/4/16 915 - 27 Woodruff or  
west copyrighted material



## UNION Tool Chests

Over 15 Different  
Styles and Sizes

Catalog FREE

Made To Last As Long As Any Good Tool

Save many a lost tool—much lost time  
hunting for misplaced tools. You  
check up every night and lock up.

WRITE TODAY FOR CATALOG

UNION TOOL CHEST WORKS  
22 Railroad St. Rochester, N. Y.



## The Acetylene Blow Torch Prest-O-Torch

Costs less to buy than a  
good gasoline blow torch  
and costs less to use.

In all soldering and brazing, the Prest-O-Torch  
avoids the delays and uncertainties of gasoline  
outlets. Provides a concentrated, intense flame  
that doesn't blow out even in a high wind. Needs no  
attention whatever. Used with handy sizes of Prest-O-Lite  
cylinders—ready-made gas, instantly available.

Style "A" sells for 75c. Used with the small MC size  
Prest-O-Lite. Will braze up to  $\frac{1}{8}$  inch round rod. This outfit  
can be fitted with handle and hook for added convenience in  
bench and overhead work. Style "C" Prest-O-Torch is recom-  
mended for large work. Will braze up to  $\frac{1}{2}$  inch round rod. Sells  
for \$2.25. For use with the larger sizes of Prest-O-Lites.

Write for special literature and learn where  
you can see the Prest-O-Torch in operation.  
The Prest-O-Lite Co., Inc. 816 Speedway, Indianapolis, Ind.  
Exchange Agencies Everywhere



**COLD-STORAGE FOOD FOR SILKWORMS**—The  
preservation by cold storage of mulberry leaves for silk-  
worm food is an interesting novelty, and was successfully  
accomplished over a two-month period in some trials in  
Italy. More than a ton of mulberry leaves were dis-  
tributed in boxes made of zinc or wood in various sizes.  
The leaves were eaten with as much relish by the silk-  
worms as fresh leaves and gave equally good results with  
regard to both the worms and the cocoons produced.

## TOOL CASES

For Up-to-Date TOOLMAKERS and MACHINISTS

We carry the finest and most complete  
line of mechanics' toolcases and tools  
in the country. We guarantee to please  
you or refund money. Write for free catalog.

J. M. WATERSTON

177 Jefferson Ave., E. Detroit, Mich.



## Tool Sharpening Made Easy with Luther Hummer Tool Grinder

**Dimo-Grit** (artificial diamond) wheels sharpen  
every tool in jigtime with light touch. No water  
needed. **Won't draw temper.** Steel shaft drive like  
auto. Dust-proof bearings and gears. Patented tool  
rest. Perfect lubrication. Many special attachments.

Shall We Send You Big Free Book?

LUTHER GRINDER MFG. CO., 225 Point St., Milwaukee, Wis.



## SEWS THIS DOLLAR AWL FOR ANYTHING

Makes a perfect lockstitch



1915  
Model

Engraving cut to  
show position of thread in handle

49c

Add 6c for  
postage

The Awl with the thread just where it ought to be  
This Automatic Awl is superior to all others. It is of immense value for repairing  
all kinds of leather, harness, bags, belting, shoes, etc. **THREADED DIRECT  
FROM THE REEL.** So simple a child can use it. Regular price \$1. For a limited  
time only we will send it postpaid anywhere, with waxed thread, two Diamond  
Point Needles (curved and straight), and directions, for ONLY 49c. Extra  
Needles 5c, Thread 10c. Postage 6c extra. **AGENTS WANTED**  
Johnson Smith & Co., Dept. 4, 709 S. Dearborn St., Chicago

## HENDERSON—

The four-cylinder mo-  
torcycle that will race an  
express train or jog con-  
tentedly behind a milk cart.

The motorcycle that  
makes a steep hill ashamed  
of itself.

You will be interested  
in our new short coupled  
model "E." Ask us for  
our latest catalog.

HENDERSON MOTORCYCLE CO.  
1160 Cass Ave. DETROIT, MICH.

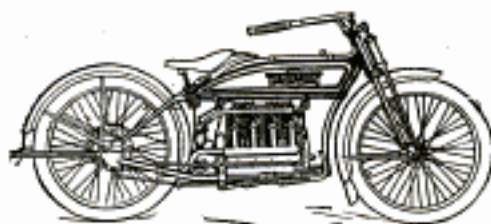

## The "Baby" of a Family of 47

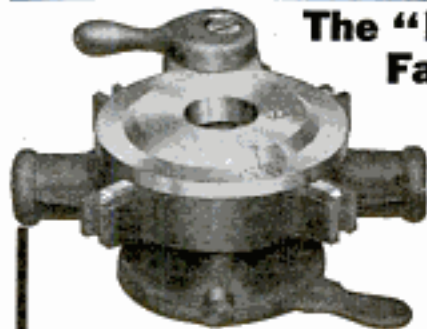

No. 81,  
shown  
here, is the  
little fellow

of the OSTER family of pipe-thread-  
ing tools, capacity  $\frac{1}{8}$ " to  $\frac{3}{4}$ ". No  
matter what size you want or  
whether you thread straight  
pipe, bent pipe, bolts or  
nipples, you will find a  
tool or power ma-  
chine to fit your  
needs in the Oster  
catalog, free on request.

THE OSTER  
MFG. CO.  
2100 E. 61st St.  
Cleveland  
Ohio

Please  
send me  
catalog and  
information  
about  
Die Stocks.....  
Screw Plates.....  
Machines { Belt Driven.....  
              { Molar Driven.....  
Size.....to.....  
Name.....  
Company.....  
Address.....  
City.....State.....(2100)

Please Mention Popular Mechanics

MAKE MONEY HERE

# AGENTS! DROP DEAD ONES, AWAKE! GRAB THIS NEW INVENTION! THE 20th CENTURY WONDER AGENTS!

LEARN the NEW WAY

Get started in an honest, clean, reliable, money-making business. Sold on a money-back guarantee

World's magical gift realized by this new invention. The **BLACKSTONE WATER POWER VACUUM MASSAGE MACHINE** for the home. No cost to operate. Lasts life-time. Price within reach of all. No competition. New field. New business. That's why it's easy. Removes blackheads, wrinkles, rounds out any part of the face or body and brings back Nature's beauty. Endorsed by leading doctors and masseurs. Listen: Parker, Okla., says, "8 orders first day." Margwarth, Pa., writes, "I am making \$19.00 per day." Shea, "First order \$2, second \$5, third \$2." Schermerhorn, Ia., orders eight dozen machines first month. Shaffer, Va., "selling 4 out of 5 demonstrations." Vaughn, Wash., orders one dozen. Four days later wires "Ship 6 dozen by first express." Spain, Tenn., started with sample. Orders one dozen, then 2 dozen, next 3 dozen. Lewis, Ind., sells 3 machines first hour. Says "Best article he ever saw for merit and money-making." No experience necessary. Territory with protection given free to active workers. Nothing in the world like it. Best agent's article ever invented.

We own all U. S. and foreign patents. Big book entitled, "The Power and the Love of Beauty and Health" Free. Investigate now, today. A Postal will do. A big surprise awaits you. Address: **BLACKSTONE MFG. CO.** 59 Meredith Bldg. TOLEDO, O.

## Scientific Device That Does Away With TRUSS-FREE TRIAL



Inner surface is made adhesive to secure the PLAPAO-PAD firmly to the body, keeping the PLAPAO-PAD continually applied and the pad from slipping. No straps, buckles or springs attached. Soft as velvet—easy to apply.

It's the Non-Slipping, Yet Non-Rigid Pad and What is Within It That Counts

### Over 250,000 Now In Use

We have proved to hundreds of thousands of sufferers from hernia (rupture) that to obtain lasting relief and develop a natural process for betterment comes by wearing a Plapao-Pad. This patented **mechanico-chemico** device can do the same for you. The wearing of an improper support aggravates rather than improves the condition. The Plapao-Pad can and does aid the muscles in giving proper support, thereby rendering efficient aid to Nature in restoring strength to the weakened muscles. Being self-adhesive there is no slipping and chafing of pad with resultant irritation and chafing. No discomfort whatsoever—no delay from work. Awarded Gold Medal at Rome and Grand Prix at Paris.

Send No Money. We will send you a trial of Plapao absolutely FREE, you pay nothing for this trial now or later. Write for it today, also full information.

**PLAPAO LABORATORIES, Block 70 St. Louis, Mo.**

## Deafness



Perfect hearing is now being restored in every condition of deafness or defective hearing from causes such as

Relaxed or Sunken Drums, Roaring or Hissing Sounds, Perforated, Partially-Destroyed Drums, etc.

### Wilson Common-Sense Ear Drums

"Little Wireless Phones for the Ears"—require no medicine but effectively replace what is lacking or defective in the natural drums. They are simple devices, which the wearer easily fits into the ears where they are invisible. Soft, safe and comfortable to wear at all times.

Write today for our 168 page FREE book on DEAFNESS, giving you full particulars and plenty of testimonials.

**WILSON EAR DRUM CO., Incorporated** 682 Inter-Southern Building LOUISVILLE, KY.



## Improve Your Eyes For 10c stamps or coin

A high-grade exercise and massage method that quickly strengthens and beautifies the eyes.

Also a most beneficial system of exercises that will improve the muscles of the temples and sides of face, thereby facilitating mastication and vocal pronunciation. Completely illustrated. Entirely without apparatus.

### MUSCLE BUILDER

A steel spring exerciser and chest expander, with complete course of twenty-four selected exercises for developing all the muscles of the body. It is equal to any \$3.00 exerciser. My price for a short time only, \$1.00.

**Prof. ANTHONY BARKER** 4643 Barker Bldg., 110 W. 42d St., N. Y.

**ARTIFICIAL EYES IN ANCIENT EGYPT**—In Egypt in the days of Rameses and the mummies, artificial eyes were worn, but not such glass eyes as are made

**Edison Artificial Limb Co., 38 Wash. Av. No., Minneapolis, Minn.** Does Not Chafe Overheat or Draw End of Stump



**We are Under Govt. Bond**



When the "boys" spy the trim, dainty figure of alluring little Miss

### SEPTEMBER MORN

so handsomely embossed on these WATCH FOBs, they go to them like hungry wolves. **ROSE GOLD FINISH**; twice the size shown here; genuine Leather strap. A smashing big hit! —get this classy fob and **BIG MONEY** agent's offer to-day, 25c. postpaid.

**BUFFALO EMBLEM JEWELRY CO.** 411 Morgan Building, Buffalo, N. Y.

## NO MORE BALD HEADS



When our **VACUUM CAP** is used a few minutes daily. We accept no pay until you have tried the Cap 60 days and are satisfied. The Vacuum Cap is an appliance that draws the blood to the Hair Roots and starts a new healthy crop of hair. It stops Dandruff, stops the hair from falling out. Bought by Doctors and men who

know that it is the only reasonable **HAIR GROWER** known to science. No Drugs Used. Write for application blank, testimonials, and booklet on "HAIR," sent sealed in plain envelope, FREE.

### THE MODERN VACUUM CAP CO.

R. 559 BARCLAY, DENVER, COLO.



### You Would Need Four Hands

with a flat iron in each to accomplish as much ironing by hand as you obtain in the same time with the

# SIMPLEX IRONER

"THE BEST IRONER"

For City and Country Homes

No tired feet or back. No headache. No bother. Ironing will have beautiful finish and straight edges. Irons in 1/2 time. Operated by hand, gasoline or electric power. Heated by gas, gasoline or electricity at average cost of 2 to 4 cents per ironing. 8 sizes—\$25 and up. Easy payments. Soon saves its cost.

American Ironing Machine Co.

Established 10 Years

598-168 N. Michigan Ave., Chicago, Ill.

Write for FREE Booklet on Ironing.

30 Day FREE TRIAL OFFER

and name of our Local Dealer.

See our Exhibit at the Panama-Pacific Exposition, San Francisco



in our days. The Egyptian eyes were made of metal and did not fool anyone. They must have given some feeling of satisfaction to the wearer, but could not have caused any delight to those who had to observe them, for they were made of painted metal and were very much in evidence, says a writer in the Optical Journal and

## I Am Making a Special Factory Price on 10,000 *Rapid* Fireless Cookers



Big bargain to introduce cooker into new neighborhoods quick. Write before price advances.

30 Days' FREE TRIAL

Cooker is aluminum lined, of course.

Complete outfit aluminum utensils free. Write for Free Book

with 150 recipes and Bargain

Prices direct from factory.

WM. CAMPBELL CO., Dept. 64, Detroit, Mich.

## I Will Send You My Valuable Book on HOW to DEVELOP PERFECT HEALTH AND STRENGTH For 10 Cents in Stamps or Coin



Contains valuable information that is worth hundreds of dollars. How to develop and gain great muscular strength, in a very short time, without medicine or apparatus. Also how to gain and govern perfect health. Explaining how to develop and improve your eyes. No other book like it to be had anywhere at this unknown price. Take advantage of this offer today—this minute—and you will never regret doing so. You have nothing to lose, but everything to gain.

PROF. F. BLETZINGER, 607 Marquette Bldg., Chicago, Ill.



## "The stock ain't fed yet, Hiram!"

Played in town or country house—CAROM and POCKET BILLIARDS abound with thrills that crowd right out of mind the weighty cares of the day!

These grand old games are filled with delicious suspense—shots as true as a rifle ball—and unguarded moments when a stroke of strategy can snatch a brilliant victory from almost certain defeat!

No indoor sport can match their merry cross-fire—it caps each climax with a burst of laughter!

Thousands of homes are endowed with Billiards. Mothers, fathers, sons and daughters, and guests—everybody plays these princely games nowadays. And a real Brunswick Table will make your home the center of your social life—win your boys and girls and keep them off the street.

Brunswick Home

# Billiard Tables

## "GRAND" and "BABY GRAND"

Built exactly like our famous regulation tables, for all games of Carom and Pocket Billiards—yet sizes and designs that harmonize with home surroundings.

"GRAND" and "BABY GRAND," superbly made from rare and beautiful mahogany, richly inlaid. Have genuine Vermont slate bed, Monarch cushions—famed for lightning action—fast imported billiard cloth—life, speed and accuracy.

## A Year to Pay—Playing Outfit Free!

Our popular purchase plan lets you try any Brunswick 30 days in your home. And our popular purchase plan lets you pay monthly, if you wish—terms as low as 20 cents a day!

Balls, Hand-Tapered Cues, Rack, Markers, Tips, Cue Clamps, Table Cover, expert rules on "How to Play," etc.—all included without extra cost.

Now get our valuable book, "Billiards—The Home Magnet," that pictures all Brunswick Home Tables in actual colors, gives low factory prices and full details. Sent FREE.

## Mail For Billiard Book FREE

The Brunswick-Balke-Collender Co. (390)

Dept. 15-T, 623-633 S. Wabash Ave., Chicago

Send postpaid, free, your color-illustrated catalog.

"BILLIARDS—THE HOME MAGNET"

with details of your 30-day trial offer.

Name .....

Address .....

Please Mention Popular Mechanics

## Three Refrigerator Improvements Shown in this Book

Write today for this new book by Mr. Leonard. Learn about

- (1) The new method of lining that does away with corners in "hard-to-get-at" places, and makes cleaning easier than ever;
- (2) The new one-piece door lining; and
- (3) The Self-Closing Trigger Lock that automatically shuts the door tight, always, and insures the efficiency of the refrigerator.

### Leonard Cleanable

With these three improvements the Leonard is absolutely perfect. Its beautiful, glistening-white, seamless, porcelain lining makes it as sanitary, clean and easy to care for as a Haviland China dish. There is not a nook or crevice in which grease or dirt can collect.

Write for book and sample of porcelain used in the Leonard Cleanable. Compare this lining with any other kind. Put to hard tests. Then you'll understand why the Leonard outlasts ten ordinary refrigerators and is "like a clean china dish." *Write today.*

**GRAND RAPIDS REFRIGERATOR COMPANY**  
157 Clyde Park Avenue Grand Rapids, Mich.  
*World's Largest Refrigerator Manufacturers*

50 styles  
\$15.00 and up.

This style  
25 x 21 x 45  
in Oak case  
\$35.00.

Freight paid  
to Ohio and  
Mississippi  
Rivers.



For sale by  
good dealers  
everywhere,  
or  
direct from  
factory with  
money-back  
guarantee if  
not pleased.

Like a clean china dish

## Rats, Mice, Roaches

—exterminated in one night. No mixing, no muss, no trouble with Rat Bis-Kit Poison. Place a little of either kind wherever these pests annoy you. They quickly seek it, eat it, die outdoors, hunting water. Results guaranteed or money refunded.

### Rat Bis-Kit Poison Biscuit or Paste

Biscuits (for rats and mice) 15c and 25c packages. Paste (for roaches, waterbugs, rats and mice) 15c, 25c and \$1.00 tubes. Keeps indefinitely. At any druggist or direct from us prepaid.

The Rat Biscuit  
Company  
555 No. Limestone St.,  
Springfield, Ohio



\$48<sup>50</sup>



## The Family Typewriter

When there's a typewriter in the home writing becomes a genuine pleasure—notes, letters, orders, accounts of household expenditures, neat and legible, are dashed off in half the time—correspondence is kept up, instead of put off—interest in schoolwork is stimulated, for the typewriter is a wonderful help in preparing lessons. Everyone wants to write—and everyone can write—and write well with a

### RELIANCE Visible Typewriter

At our price every home can afford to own a standard typewriter—Shoely kind worth owning. We've lowered the price for high-grade typewriters from \$97.00 to \$48.50—a 50% reduction. For only \$48.50 you secure all the typewriter value it is possible to put into a machine—all the best improvements—all the conveniences—all the strength and fine appearance. We guarantee this guarantee positively that the RELIANCE will prove an satisfactory as any standard machine on the market. Be sure that it will, for we use it right here in our offices. Send for Typewriter Catalogue No. 74. Use a RELIANCE for 30 days' free. Save half. Get the best at a price no greater than is asked for second-hand or cheap grade machines made.

MONTGOMERY WARD & CO.  
CHICAGO ILLINOIS

Review. "I wonder sometimes," he adds, "whether the idea of the evil eye was not helped along by the horrible looking false eyes worn by our ancestors of long centuries ago."

**MONEY IN MUSHROOMS**

**MAKE BIG INCOME**

Men and Women grow mushrooms all the year at home in cellars, stables, sheds, boxes, etc. Sell as high as \$1.00 a lb. Great demand, markets waiting. **Start Now. Big Booklet** telling how to do it free. Nat'l Spawn Co., Dept. 12, Boston, Mass.

**Delivered to You Free**

1915 Model

A sample 1915 model "Ranger" bicycle, on approval and 30 DAYS TRIAL and free riding test. Write at once for large illustrated catalog showing complete line of bicycles, tires and supplies, and the most marvelous offer ever made on a bicycle. You will be astonished at our low prices and remarkable terms. **RIDER AGENTS Wanted**—Boys, make money taking orders for Bicycles, Tires and Sundries from our big catalog. Do Business direct with the leading bicycle house in America. Do not buy until you know what we can do for you. WRITE TO US.

**MEAD CYCLE CO., DEPT. D108 CHICAGO**

# LONGACRE

NEW YORK CITY HOTEL  
Broadway and 47th St.

EXCLUSIVELY BACHELOR

Convenient to Everything. The refined air and good service of a club

RATES PER DAY

50 rooms with lavatory	\$1.00
150 rooms with private bath	1.50
50 rooms with private bath	2.00

Two-room Suites, \$3.00 to \$4.00  
Special Weekly Rates

Restaurant a la carte. Club Breakfasts  
DINING ROOM OPEN TO LADIES  
The best value in New York City  
both in rooms and restaurant.  
Phone, 7790 Bryant J. G. BOGGS



**ONLY \$29<sup>75</sup>** **Worth \$60.00**  
in Dealers' Stores

No. 320

## Save Half of Your Furniture Cost

We can help you do it. Our original sectional method of shipping Brooks "Master-Built" Furniture saves ½ packing costs, ½ freight costs and ½ the factory floor space usually needed. We sell direct to you—you save middlemen's profits. We are not a mail-order house—not jobbers or wholesalers. We are straight manufacturers with an economical, 20th Century method of manufacturing and shipping furniture. Hundreds of thousands of people have saved money with our plan. Why don't you, too, have your furniture

### Shipped in Sections Direct from Factory

You can assemble the sections easily and quickly. Just a few minutes' easy work saves many dollars in price. Just think of getting this rich colonial extension dining table for only \$29.75. Write for the Brooks Furniture Book and see 100 more fine offers like it. Everything for home, office and club. All selected quarter-sawed oak—best Colonial, Mission and Flanders designs—any finish. Write today for book.

**BROOKS MANUFACTURING CO.**  
2705 Brooks Ave. SAGINAW, MICH.  
Largest Plant of Its Kind in the World  
We guarantee to satisfy you or return your money

**World's Lowest Prices**

# DIAMONDS

**SEND NO MONEY**  
JUST SEND US YOUR NAME AND ADDRESS, and we will ship to you, on approval, at our risk, an delivery charge, prepaid, the famous No. 1006 Loftis "Perfection" \$50 Diamond Ring.

**You Pay Nothing Not One Cent**

until you see this beautiful Diamond Ring. We want you to examine it right in your own hands. We want you to see it before you say one penny. **IMMEDIATELY ON RECEIPT OF YOUR NAME**, we will select a special Diamond for you, mount it in 14 karat solid gold, case it in a handsome velvet ring box, and send to you prepaid. If you find it to be all that we claim, if it meets your expectations in every way, and if you are absolutely satisfied that it is an unusual bargain, pay \$10 and keep the ring, then 45 a month for eight months, making a total of \$50, and the ring is yours. That's the "Loftis System"—which means a square deal to all.

Write for our Free Catalog containing over 2,500 photographic illustrations of Diamonds, Watches, Jewelry, Silverware, Novelties, etc. It tells all about our easy credit plan. Write today.

**LOFTIS BROS. & CO.**  
The Old Reliable Diamond and Watch Credit House  
Established 1854  
Dept. N894 108 N. State St. Chicago, Ill.  
Stores in: Chicago; Pittsburgh; St. Louis; Omaha

**Our Big Leader**

LOFTIS Perfection Diamond Ring No. H 66  
Special Price \$50  
**CREDIT**  
Terms \$5 Per MONTH



## Print Your Own

Cards, circulars, menus, newspaper, book, etc. PRESS \$5, larger \$18, Rotary \$60. Save money. Big money printing for others. All easy, rules sent. Write factory for illustrated press catalog, TYPE, cards, paper, samples, etc. **THE PRESS CO., Meriden, Conn.**



## 10c a Day

Now Buys This Superb Bader Violin

An exquisite instrument. Made by the great Violin Maker, J. A. Bader. Pay for it at the rate of 10 cents a day. 30 days free trial.

Rare Old Violin Circular Free  
WURLITZER We supply the U. S. Good.  
100 years of instrument making

Thousands of superb instruments to choose from. You get the benefit of our mammoth facilities by buying in large quantities.

**Write Today** for Special Circular. No obligations. See full particulars of our great special offer and handsome illustrations of the superb instruments that you have to choose from. Read our direct money saving offer. Write today.

**THE RUDOLPH WURLITZER COMPANY** Dept. 1195  
E. 4th St., Cincinnati, Ohio So. Wabash Ave., Chicago, Ill.



## ABOUT MUSHROOMS

How to really make big money in mushrooms is fully explained in the wonderful book "The Truth About Mushrooms," a great revolutionary improvement, things many growers never knew before. Everything explained from A to Z, at first hand, from the greatest practical authorities in America. Add \$10 to \$20 a week to your income. Demand exceeds supply. Grow in cellars, sheds, boxes, etc. Small capital to start. Profits bigger and quicker. Anyone can do it. Women and children too.

Now is best time. Send for free book.

**BUREAU OF MUSHROOM INDUSTRY, Dept. 181, 1342 N. Clark St., CHICAGO**

## BUY PLUMBING and HEATING SUPPLIES

at **WHOLESALE** Will Save You 30%

Don't pay retail prices. Full stock on hand for prompt shipment. Send for free catalog.

**B. P. KAROL, 800-802 South Kedzie Ave., CHICAGO**



## We Teach You the Business FREE!

## 400% to 800% Profit in Popcorn-Crispette and Candy Business

Crowds swarm to buy our Kettle-Popped Popcorn—popped under glass—seasoned with popping—**GRAY BIG-CRISP-FLUFFY KERNELS!** Corn pops 25 per cent bigger with the Golden Bagger machine and 100 per cent better product. Our delicious **CRISPETTE** melt in your mouth. We do it all Automatic Crispette Press is a regular money-maker! Big extra money in candy!

**Course in Candy Making FREE with Every Outfit**  
Write AT ONCE for FREE Catalog, new money-making plans, special prices and illustrations, easy payment offer. NOW is the time to start. No experience necessary and very little money. Write

**C. E. DELLENBARGER CO., 77 Bissel St., JOLIET, ILL.**



Hand Forged Razor Steel Blades. No. 57

## This \$2 KNIFE 83¢

**DIRECT AT FACTORY PRICE**

Handy shaped blade makes this knife best for mechanics, sportsmen and farmers; light but strong; resharpened easily. Stag handle, Gorman silver finish; blades file tested, hand forged from razor steel and warranted. Sample \$10, 3 for \$2 postpaid. Cheapest part \$2 each.

Send for our 80 Page List and "How to use a Razor" **FREE**

**MAHER & GROSH CO., 106 A. St., Toledo, Ohio.**

## This Newest Vacuum Sweeper is a BISSELL

At last you can secure a thoroughly practical, reliable vacuum sweeper with sufficient power to really clean thoroughly, yet easily—one that is good enough to bear the Bissell name and guarantee.

This will be all the recommendation needed by the hundreds of thousands of women who use the Bissell's Carpet Sweeper—the women who have been asking our company to make them a BISSELL'S Vacuum Sweeper.

The exclusive features and conveniences embodied in this new BISSELL'S are especially appreciated. Ask your dealer to show you how the dust receptacle comes out with the nozzle in one piece, making emptying sanitary and easy. This is but one of the advantages that characterize the Bissell's. You won't find it on other machines.

Prices, depending on locality, are \$7.50 to \$10.50 for the Vacuum "Cleaner" (without brush) and \$9.00 to \$12.00 for the Vacuum "Sweeper" (with brush). Carpet sweepers \$2.75 to \$5.75. Booklet on request.

The complete BISSELL'S line will be found on sale at dealers everywhere.

**BISSELL CARPET SWEEPER CO.**  
Largest Exclusive Manufacturers of Carpet Sweeping Devices in the World

Department 12  
GRAND RAPIDS, MICH.



Put Your Sweeping Reliance in a BISSELL Appliance

### KEROSENE Gas Lamps

300 to 1000 Candle Power. Guaranteed not to clog, smoke, smell or carbonize. Simplest, safest, most reliable and economical light made for home or business purposes. Nothing complicated. Children can light and operate.

Write for particulars

Brilliant Gas Lamp Company  
1009S So. Wabash Ave., CHICAGO, ILL.

## BEAVER BOARD WALLS AND CEILINGS



### For New Buildings or Remodeling

Saw it like wood—nail panels to studding—then paint—put on decorative strips.

Result—beautiful durable interiors, free from cracks. No more repairs, no wall-paper, easy to decorate. Relief from lath and plaster troubles.

Write at once for free sample and book "BEAVER BOARD and its Uses." All about our free design and decoration service.

The Beaver Board Companies  
159 Beaver Road, Buffalo, N. Y.

Branch Offices in Baltimore, Boston, Chicago, Cleveland, Detroit, Indianapolis, Kansas City, Mo., Minneapolis, New York City, Omaha, Philadelphia, San Francisco.



**PICKING A JOB OUT OF THE AIR**—It does not fall to the lot of many people to literally pick a job out of the air, but that is what happened recently to a licensed wireless-telegraph operator of New York State, says the Michigan Tradesman. He was out of work and was amusing himself by listening to aerial messages

**PAINT \$1 A GAL.** STANDARD GOODS, Varnishes, Stains, Enamels, etc., at greatly reduced prices. Color cards sent on request.  
**FALVEY PAINT WAREHOUSE, 54-56 Pearl St., Boston, Mass.**

### Amazing Profits In Mushrooms

Anybody can add \$8 to \$40 per week to their income, in spare time, entire year growing mushrooms in cellars, sheds, barns, boxes, etc. I tell you where to sell, at highest prices.

Free Illustrated Instruction Booklet

**HIRAM BARTON**  
Desk 2, 329 W. 48th St., New York

### 3 YEARS TO PAY

**Meister Piano** 30 days free trial in your own home

**\$1 A WEEK or Price \$175.00**  
**\$5 A MONTH**

No cash payment down. No interest—no extras. Piano stool and scarf free.

**ROTHSCHILD & COMPANY**  
Dept. 16E CHICAGO, ILL.

## DIAMONDS ON CREDIT

20% DOWN 10% MONTHLY

Let us send you any Diamond you may select from our catalogue so you may compare our values with those offered by other dealers; be convinced that our IMPORTER'S PRICES offer you a great saving.

We furnish a guarantee certificate with every Diamond and allow the full purchase price on all exchanges. We will send express prepaid any Diamond or other article, for examination and approval, you to be the sole judge as to whether you keep it or return it at our expense.

Write today for our free catalogue de luxe No. 6, and see how easy it is for you to own and wear a beautiful Diamond. **L. W. SWEET & CO., Inc., 2 and 4 MAIDEN LANE, NEW YORK CITY.**

## PEARL Screens Are Still New When Others Are Gone—

Does that sound like a pretty strong statement? Let us prove it. First of all, genuine Gilbert & Bennett PEARL Wire Cloth derives its rust-resisting qualities from the coating. This metallic protection is a secret composition, owned and controlled by Gilbert & Bennett. It will not crack, chip or peel off under any conditions whatsoever.

GILBERT & BENNETT  
**Pearl**  
WIRE CLOTH

For Screening Doors,  
Windows and Porches—

Made in Two Weights  
Regular and Extra Heavy

PEARL is handsome—its original bright metallic luster with a short exposure to the weather turns a permanent "invisible gray" and stays that way. The thing that's making PEARL sales bigger every year is the fact that it requires no paint or repairs—it represents true screen economy.

Don't be deceived. There can not be a "just the same" as PEARL. The manufacture and application of the non-crack, no chip coating from which it derives its wonderful rust-resisting qualities is a secret process; the exclusive property of this company.

But to be sure of PEARL, you must get genuine PEARL Wire Cloth—two Copper Wires in the Selvage and the Round Tag bearing the Gilbert & Bennett name on each roll.

Write our nearest office for samples of both Regular and Extra Heavy PEARL, full details regarding same, and the name of the nearest dealer.

The Gilbert & Bennett Mfg. Co.  
(Established 1818)

Dept. L, 277 Broadway, New York  
Dept. L, 38 S. Dearborn St., Chicago  
Georgetown, Conn.  
Kansas City, Mo.



FREE Samples and Booklet  
Write our nearest office.



The Best  
Hardware  
Dealer in Your City Sells "PEARL"

You can shoot better with a Marlin gun—famous for its extreme accuracy—the *thoroughbred* in sporting firearms. Costs no more than less desirable arms. Send 3 stamps postage for 136 page gun book of Marlin repeating rifles and shotguns; helps you select right gun. MARLIN FIREARMS CO., 65 W. St., New Haven, Conn.



Buy Building Materials That Last  
Ask your dealer for *Certain-teed* Roofing and other products made by us—they bear our name.

General Roofing Manufacturing Co., St. Louis, Mo.

### THIS BUNGALOW \$900 CAN BE BUILT FOR

This and many others in my new book, *Building Plans for Modern Homes*, will save you hundreds of dollars. One of the most complete and comprehensive books of plans ever published by any architect. Fifth edition just off the press. Two hundred and fifty floor plans and photographs of bungalows, etc., costing from \$200 up; gives sizes and cost to build. Sent postpaid for \$1.00



FREDERICK H. GOWING  
ARCHITECT

18 Tremont St., BOSTON, MASS.

### Small Engines



Our little guaranteed engines are unequalled for operating small machinery, washing machines, grinders, etc. We make nothing but 1/2, 1 and 1 1/2 h. p. sizes. We are the small engine authorities. We ship on trial. Our book illustrates and describes these wonderful little engines. Send stamp for copy. Our special offer will interest you.

Sieverkropp Engine Co., 1224 18th St., Racine, Wis.

### BUY YOUR FURNACE \$10 DOWN \$10 A MONTH



Our monthly payment plan of selling direct saves you the dealer's profits and charges for installation. The

#### JAHANT FURNACE

with the patented "Down Draft System" is best for residences, schools, hotels, churches, etc., because it delivers plenty of heat wherever and whenever desired at a saving of 1/3 to 1/2 in fuel bills. Install the *Jahant* yourself. We send complete outfit, freight prepaid with special plans, detailed instructions and all necessary tools for installation. Satisfaction guaranteed or money refunded.

WRITE FOR FREE ILLUSTRATED BOOK  
THE JAHANT HEATING CO.

200 Steiner Avenue

AKRON, OHIO

### Save 1/3 to 1/2 on Fuel Bills

### Action Too Fast for the Eye is Clearly "Seen" by Goerz Lenses

Pictures worth money—the kind that show situations the human eye is not quick enough to see are taken with

GOERZ LENSES  
CAMERAS

If you already have some other camera, you can equip it with a Goerz Lens. Universally used by special correspondents and by professional photographers where the first exposure is the last chance for the picture.

Write for  
Our Booklet on "Lenses and Cameras"

C. P. Goerz American Optical Co., 323C East 34th St., New York



ONLY  
\$5<sup>80</sup>



Don't Fail  
to Send for  
Our Big Free Catalog Today  
A Postal Will Do

## Save Your "Hard-earned"—Buy Direct From Maker at Lowest Prices Ever Known

You cannot duplicate Sterling prices anywhere. Remember when you buy Sterling Furniture, you pay approximately the same price that Mail Order Companies pay for their stock. No danger of added cost. We are not a Mail Order House. We have been building Sterling Furniture right in our own factory with best equipment for 30 years under most scientific and efficient organization and system. Finest quality. Best workmanship. Highest grade materials.

Save \$6.70 on this \$12.50 Rocker  
You Pay the Sterling Price of ONLY \$5.80

Shipped the day your order is received. Strong, large, handsome, quarter sawed, solid white-oak easy Rocker. Choice of Golden, Fumed, Weathered or Early English finish. Has deep-cushioned spring seat, upholstered in best quality artificial leather. Lasts for years. On this Rocker alone you save \$6.70 by simply setting a few screws. Shipped "K. D." in four sections. Order now or send for free catalog.

### BIG CATALOG FREE

Surely you want and need some pieces illustrated in our big free Catalog at such rock-bottom figures as these. Surely such quality as Sterling at such prices should cause you to investigate at once. Sterling Satisfaction, Quality and Representation Guaranteed. Write today for the big free Catalog. Postal will do.

The Sterling Furniture Company  
5005 Sterling Bldg. TOLEDO, OHIO

21 Jewels \$3<sup>50</sup> a month  
The REAL Triumph  
of Watch Manufacturing

THE FAMOUS

### Santa Fe Special

A marvel of beauty, dependable to the last degree, accurate to the second. Write today for the story of the "Santa Fe Special." Our beautiful, 52 page, four color watch book shows every feature of this remarkable watch, tells inside facts about the jeweler's trade, explains what a standard watch should be and describes in detail the best watch on earth, the

## Santa Fe Special

The one watch that's guaranteed to last you all your life. Thin model—either 17 or 21 Jewels, adjusted to positions, adjusted to temperature, adjusted to isochronism.

Guaranteed to pass railroad inspection

### EXTRA SPECIAL OFFER

We can prove that our actual wholesale price to you will save one-third of the money usually paid for such high grade watches as the "Santa Fe Special."

Our "Direct to You," easy payment plan is explained fully in the Santa Fe Special catalog. Payments are so small you will not miss the money, only \$1.50 a month and you wear the watch right from the start. Sent by approval without one cent down.

#### NEW CASE DESIGNS

The new watch book shows all the very latest designs of the world's most talented engravers, each case illustrated in beautiful color combinations, showing three color inlay monograms, engraved monograms, fraternity emblems, French art and special designs.

A postal brings the new watch book. Address Dept. M-101

SANTA FE  
WATCH CO.  
Topeka, Kan.



### THE TELL-TALE CARD

If you ever saw a man (he was a REAL salesman) take from his pocket a case containing

#### Peerless Patent Book Form Cards

and detach a beautifully engraved, scrupulously clean, perfectly plain business card, you were amazed at the absolutely smooth edges of the card. There wasn't the slightest indication of its detachment. No man ever witnessed such an act without a stirring of his curiosity. Most men test the credibility of their sense by feeling the edge of the card or ask how such a thing is possible. The card marks the man. It tells the tale you can't tell yourself. Peerless Patent Book Form Card is the best thing in cards. It doesn't appeal to NEAR salesmen. You can differentiate yourself. Send for a sample tab. See for yourself. Send now. Appearance of tab of cards in case.



THE JOHN B. WIGGINS COMPANY  
Engravers, Die Embosers, Plate Printers 62-64 Adams Street, CHICAGO

Please Mention Popular Mechanics

### TYPEWRITERS ALL MAKES \$18 TO \$60

Look at these bargains! Typewriters Rebuilt in our own factories, and guaranteed for one year.

Remingtons \$30 to \$55 Smiths \$18 to \$40  
Underwoods \$35 to \$60 Royals \$25 to \$45  
L. C. Smiths \$30 to \$50 Oliviers \$20 to \$35

We have others, of course. Send for catalog describing them, and address of nearest branch office.

American Writing Machine Co., Inc., 345 Broadway, N. Y.



### JENKINS' BRASS BAND AND ORCHESTRA INSTRUMENTS

We save you money and give easy payments. Biggest line of Band and Orchestra Instruments: Cornets, Trombones, Clarinets, Drums, Saxophones, Violins, Guitars and all wind and stringed instruments. Send for free catalog of instrument you want. We give a fifty lesson FREE certificate with each instrument. Tell us the instrument you wish to play.

JENKINS MUSIC CO. 55 Jenkins Bldg. Kansas City, Mo.

in his own home, where he had a wireless outfit. He heard an appeal made from Scranton to New York for an operator, and cut in with an application for the job. An answer flashed back that his application had been received, that he had been accepted, and that he should report for work immediately.



### TYPEWRITERS ALL MAKES

Prices \$15.00 up. SOLD or RENTED ANYWHERE at 1/2 to 1/3 MANUFACTURERS' PRICES, allowing RENTAL TO APPLY ON PRICE. Free Trial. Installment payments if desired. Write for Catalog L.

TYPEWRITER EMPORIUM, 24-36 W. Lake St., Chicago, Ill.

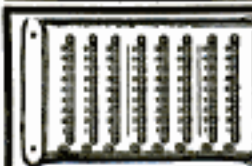

### \$2.50 Adder

Just what you want. Makes adding a snap. It's absolutely accurate, quick as a flash and easy to operate. Small and practical. Latest idea. Everyone pleased. Guaranteed one year. Sent prepaid for \$2.50. Order on today. Address J. H. BASSETT & CO. Dept. 30C, 5921 Indiana Ave., Chicago, Ill.

### "Vulcan" Ink Pencils

RED OR BLACK

Inexpensive and Durable. Unequaled for general writing

ONLY Non-Leakable moderate price INK PENCIL made



AGENTS  
TERRITORY OPEN  
J.C. ULLRICH & CO. NEW YORK

### OVER 100,000 IN USE

Mostly sold through recommendation. For Personal Desk or General Office.

It checks mental calculations. Buy through your stationer.

Write for 10-Day Trial Offer  
E. Gancher & A. M. Co., 148 Duane St., New York

Agents Wanted



### Golden Gem PORTABLE Adding Machine

Multiplies—Subtracts



**AGENTS \$6 A DAY**

Should be easily made selling our Concentrated Non-Alcoholic Food Flavors, Soaps, Perfumes and Toilet Preparations. Over 100 kinds, put up in collapsible tubes. Ten times the strength of bottle extracts. Every home in city or country is a possible customer. Entirely new. Quick sellers. Good repeaters. Not sold in stores. No competition. 100 per cent profit to agents. Little or no capital required. Elegant sample case for workers. Start now while it's new. Write today—a post card will do—for full particulars **FREE**



**AMERICAN PRODUCTS CO., 70 Third St., CINCINNATI, OHIO**

**Big Quick Money For Agents**

**Agents!** We have a lightning seller for every office and home. Everyone needs one. Something new, novel, useful and attractive. Backed by strong 30 day free trial, money back guarantee. You get big profit on first call. Thousands in use. Every interview a quick sale. Write at once for the money making facts. **Men and Women!** Start the money coming your way now. You can do it easily. Address Agents Success Dept.

**A. C. BARLER MFG. CO., 343 E. Ohio St., Chicago**

**Don't Miss This Chance****There is Big Money in Automatic Card Printing**

The Automatic prints while you wait Business and Calling Cards, Tickets, Invitations Announcements & many others. Prints 100 per minute, 6000 per hour. Write today for our free catalog 36.

**S. B. FEUERSTEIN & CO.**  
542 W. Jackson Blvd., CHICAGO



In 1850, depositors in savings banks were 251,000 in number; in 1914, the number was 11,000,000, with deposits aggregating \$4,750,000,000, which is more than 100 times as much as at the middle of the last century.

**10 Days FREE TRIAL**

A few days' trial is all that is necessary to convince you of the big money-making possibilities of taking, finishing and delivering, on the spot, photo post cards the Daydark way. Small investment, big returns. No experience necessary. Write today, now—for FREE TRIAL and full particulars.

**Daydark Specialty Co., Dept. 2, St. Louis, Mo.**

**DAYDARK POST CARD MACHINE****Make \$20 to \$40 a Day**

with the **VICTOR** Plateless Photo Post Card Machine, which takes 11 styles of pictures direct on post cards, tin types and buttons. The **VICTOR** is the world's biggest money maker, recognized by thousands of successful **VICTOR** operators. Positively no experience necessary. Start in business for yourself with a small investment and be your own boss. 10 year guarantee with every **VICTOR** machine.

Write today to main office and factory of the Ferrotypes and post card machines and supplies.

**AMERICAN FERROTYPE CO.**  
152 Delancey St. Dept. A58 NEW YORK CITY

**Make \$15.00 to \$35.00 Per Day**

With Our Latest Invention, the Wonderful Ever-Ready Camera. Makes 9 styles single or group pictures direct on postcard or tints without film or negative, finished for delivery in less than one minute. **No Experience Necessary.** Get into a good, clean, respectable business of your own and become independent. **Big Money** at fairs, carnivals, parks, picnics, anywhere. Photos cost you from 1 to 25¢; sell at 10, 15 and 25¢ each. Write Today for Free Proposition and Catalogue.

**THE NEW YORK FERROTYPE CO.**  
Dept. 70M, No. 168 Delancey Street, NEW YORK, N.Y.  
Dept. 70M, No. 1126 S. Halsted Street, CHICAGO, ILL.

**The Burlington Smashes**

Mail the Coupon TODAY for Free WatchBook

**All Watch Competition Look!**

19 Ruby and Sapphire Jewels—

Adjusted to the second—

Adjusted to temperature—

Adjusted to isochronism—

25-year gold strata case—

Genuine Montgomery Railroad Dial—

New Ideas in Thin Cases.

Every fighting vessel in the U. S. Navy has the Burlington Watch aboard. This includes every torpedo boat—every submarine as well as the big Destroyers.

**\$2.50**

**Only 2.50 A Month**

And all of this for \$2.50—only \$2.50 per month—a great reduction in watch price—direct to you—positively the exact prices the wholesale dealer would have to pay. We do not care to quote these prices here, but write—write before you buy. Think of the high-grade, guaranteed watch we offer here at such a remarkable price. Indeed, the days of exorbitant watch prices have passed.

**See It First!**

You don't pay a cent to anybody until you see the watch. We won't let you buy a Burlington watch without seeing it. Look at the splendid beauty of the watch itself. Thin model, handsomely shaped—aristocratic in every line. Then look at the works! There you see the pinnacle of watch-making. You understand how this wonder timepiece is adjusted to the very second!

**Free Watch Book**

Get the Burlington Watch Book by sending this coupon now. You will know a lot more about watch buying when you read it. You will be able to "steer clear" of the double-priced watches which are no better. Send coupon today for the book and our offer.

**Free Watch Book Coupon**

Burlington Watch Co.  
196 St. and Marshall Blvd.  
Dept. 1195 Chicago, Ill.

Please send me (without obligations and prepaid) your free book on watches with full explanation of your cash or \$2.50 a month offer on the Burlington Watch.

**Burlington Watch Co.**

196 St. & Marshall Blvd., Dept. 1195 Chicago

Name.....

Address.....

Please Mention Popular Mechanics

# DUCK'S NEW 325 Page Electrical No. 8 and Wireless Catalog



Is a TREATISE on ELECTRICITY and WIRELESS. With prices a little lower than the lowest. Bound in imitation leatherette with bronze lettering.

**This unrivalled catalog mailed to anyone upon receipt of 8c in stamps or coin which may be deducted on first dollar purchase. Great cost of catalog and low prices prohibit distribution otherwise.**

## WHY WASTE TIME AND POSTAGE IN SENDING FOR A DOZEN CATALOGS

### ELECTRIC HAND LAMP

For use with the ordinary dry cell battery. Throws a brilliant light over 100 feet. Gives a concentrated light of 65 c. p.



The hand lamp that blazed the way; that initiated many inferior types but no rivals.

In tests conducted in one of the biggest laboratories in America our lantern was found not only to give a greater concentrated light than any other, but an increase of approximately 400 per cent over another widely advertised lamp for which great claims are made. The difference is in the reflector and the lamp. This hand lamp will last sixty hours on continuous burning and longer if used intermittently. Indispensable to plumbers, automobilists, delivery men, switchmen, housekeepers.

Complete, less battery, in burnished brass finish, \$1.90.

Complete, less battery, in pressed rolled steel with hard rubber finish \$1.50. Postage extra. Shipping weight 2 lbs. Postmaster will inform you some rate from Toledo.

when this catalog contains practically everything worth while in wireless and electrical goods, advertised in this and all other magazines, — and in most cases at more attractive prices.

### What This Big Catalog Contains

125 pp. Wireless Apparatus for Commercial and Experimental use;  
10 pp. Raw Material;  
5 pp. Transformers;  
8 pp. Storage Batteries;  
15 pp. Telegraph Insts.;  
42 pp. Motors and Dynamos;  
10 pp. Miniature Lamps;

8 pp. Flashlights;  
5 pp. Massage Vibrators;  
10 pp. Miniature Railways;  
5 pp. Lighting Plants;  
10 pp. Ammeters and Voltmeters;  
25 pp. Electrical and Mechanical Books;

2 pp. Fans;  
12 pp. Telephone Equipment;  
6 pp. Heating Appliances;  
10 pp. Auto Accessories;  
13 pp. Victrolas, on our Easy Payment Purchase Plan; (No Down Payment);  
30 pp. General Electrical Supplies.

## SEND 8c for THIS CATALOG TODAY

(Reasons for requesting 8c mentioned above)

The most elaborate, comprehensive, educational and artistic catalog in its line published. Glance through the contents. Note the amazingly low prices of products representative of the best in the field of electrics. Then you will know why the overwhelming mass of users of electrical and wireless supplies have for so many years adopted the slogan:

**"IF DUCK SELLS IT, IT MUST BE GOOD;  
IF DUCK DOES NOT SELL IT, THERE'S A REASON"**

**THE WM. B. DUCK CO. ARCADE BLDG., TOLEDO, OHIO**  
(Our Former Name "THE J. J. DUCK COMPANY")



### BRANDES WIRELESS RECEIVERS

We make three types of wireless receivers each of which is the best in its class. They are all carefully designed to fulfill the peculiar requirements of wireless work. Send stamp for catalogue to

C. Brandes, Inc. 11 Liberty St. NEW YORK

### DYNAMO-MOTOR

As a dynamo it will operate induction coils, light lamps, charge storage batteries, electroplate, etc., makes an ideal machine for experimenting. As a motor they will operate heavy models, energy wheels, and other useful appliances.

18 watt dynamo-motor \$3.00  
24 " " " 3.85  
40 " " " 5.25

Send 2 cent stamp for catalogue of wireless apparatus, trains, electrical supplies, novelties, tools and books.

LOOMIS ELECTRIC COMPANY  
1427 N. Artesian Ave. Chicago, Ill.



### ELECTRIC LIGHT PLANTS

Complete gasoline engine, dynamo, switchboard and storage battery \$340.

Agents wanted. American Battery Co., 1129 Fulton St. Chicago (Estab. 1889.)

### ELECTRIC HOME, FARM AND STORE LIGHT PLANTS. LIGHTS, DYNAMOS, MOTORS, ENGINES.

Fan Motors, Storage & Medical Batteries, Rectifiers, Bells, Boka, Bicycle, Carriage & Auto Lights, Massage, Ozone & M. P. Rubins, MOTION PICTURE THEATRE Permanent and Traveling Equipments. Big Opportunity. Catalog 3 cts. OHIO ELECTRIC WORKS, CLEVELAND, OHIO



### "THE ELECTRICAL EXPERIMENTER"

The big electrical Magazine for those who dabble in electricity and Wireless. Chuck full of experiments. Intensely interesting. Monthly prizes of \$5.00 for best experiments. Amateur Electric, wireless news, Complete Electric Course etc. 50 to 100 illustrations. Only 50c a year in U. S. and Canada. On all News-stands. Send for free sample.

Electrical Experimenter 234 Fulton St., N. Y.

10¢

Static Machine. Turning crank gives powerful 3 in. spark. No batteries required. Made of steel and hard rubber. Performs 500 experiments. Size 8 x 5 x 10 ins. Weight 6 lbs. Price \$3.70

341B

Hustler Motor. Runs on 1 dry cell. Size 3 x 3 x 4 ins. Weight 1 lb. Price \$0.80

100

Flashlight Lamps. 3 1/2 Volts give brilliant light. Weight 4 oz. Price \$0.09

1043

Dynamo. Very powerful. Gives 6 Volts, 5 Amperes. Lights 12 tungsten lamps, charges storage cells, runs as power motor. NOT A TOY. Size 6 x 6 x 6 ins. Weight 7 lbs. Price \$3.69

1024

Telephone Receiver, 75 Ohms. Hard rubber shell, powerful magnet. With two phones and no batteries, you can talk 500 feet. Size 2 1/2 x 1 1/2 ins. Weight 1 lb. Price \$0.39

9000

Wireless Detector. Guaranteed to receive long distance messages with our \$0.39 telephone receiver, or money back. Our Cyclopedias sent FREE with it. Price PREPAID \$0.10

1331

Static Machine. Turning crank gives powerful 3 in. spark. No batteries required. Made of steel and hard rubber. Performs 500 experiments. Size 8 x 5 x 10 ins. Weight 6 lbs. Price \$3.70

# BOYS

We carry the largest stock of experimental electrical goods in the world, and are the originators of the Wireless experimental Business. ASK YOUR FRIENDS ABOUT US. When ordering above goods enclose postage, else goods must go by express. Shipping weights are given. We ship in 24 hours. Send today 3c. postage for a copy of our famous Electrical Cyclopedias No. 14, containing 400 illustrations, 1,000 articles, "Treatise on Wireless Telegraphy" and 20 coupons for free Wireless Course. With any of above goods, Cyclopedias included FREE. "Everything for the Experimenter" THE ELECTRO IMPORTING CO., 233A, Fulton Street, New York City

**AMUSEMENT MEN, HERE'S THE WINNER!**

The very latest and most novel amusement attraction for Parks, Resorts, Carnivals, etc.

A BIG Money Maker.

**THE CIRCLING WAVE GETS THE CROWD**

and keeps them spending their nickels. The most successful fun and profit-maker ever invented. Some operators have made \$400 in ONE day. More up-to-date and costs 50 per cent less than the old-fashioned Carousel. Easily moved in two wagons. Operated by one man with gasoline or kerosene motor. Can be erected in four hours. Seats 80 people. Price includes complete machine with gasoline motor and either piano or organ. Write for details—a postal will do.

**ARMITAGE & GUINN, 1111 St., SPRINGVILLE, N. Y.**



**\$4 a Month**  
Buys This Visible  
**Oliver Typewriter**

Nothing Down—Free Trial. Less than Agents' Prices. Shipped on approval. If you want to keep it, send us \$4 a month. Send for famous FREE typewriter book. Tells how to save \$48.00. Write today.  
**TYPEWRITERS DISTRIBUTING SYNDICATE**  
166-48C N. Michigan Blvd., Chicago

**Brass Band Instruments, Drums, Uniforms, Supplies**

Write for our big catalog. FREE. Would you like to organize a band? Write for full information and tell us what instrument you are interested in.

**LYON & HEALY**  
33-39 Adams St. CHICAGO

**STRENGTH OF MANILA-ROPE FASTENINGS—**  
By means of tests to destruction of nine ordinary methods of fastening manila rope, made at the U. S. Arsenal, Watertown, Mass., it was found that eye splices are the most satisfactory considering the high strength which they develop. Even with the eye splices the full strength of the rope is not developed. Possibly not more than 95 per cent of the strength is developed in most cases.

**ELECTRICITY**

**BOYS—**Send today for our new 128-page catalog of everything electrical. Motors, Dynamos, Flashlights, Lamps, Coils, Batteries, Transformers, Magnet and Resistance Wires, Telegraph Outfits, Miniature Electrical Railways and Parts. Catalog with coupon sent only for 6c in stamps or coin. No postals answered.  
**VOLTAMP ELECTRIC MFG. CO.** Voltamp Block, BALTIMORE, MD.

**Kor Ker Seals**  
**PUNCTURE CURE**  
**Instantly**

Preserves the tube. Overcomes slow leaks. Increases tire mileage 50%. Tubes last four times as long. Easily transferred to new casings. Tubes can be vulcanized without removing.

**KOR-KER Puncture Cure**  
Lasts forever—always efficient. (Not a filler.) 3 to 3 1/2 in. tires 88 per set, 4 to 4 1/2 inch tires 810.  
Our booklet tells what prominent firms have discovered.

**District Managers Wanted**  
High grade men capable of securing Salesmen and financing orders. Unusual opportunity.

**ALCEMO MFG. CO.**  
214 Bridge St.  
Newark, N. J.

**High Grade Violins 30 Days' Free Trial**

Your choice from a large and carefully graded stock of representative instruments from the leading foreign violin makers. Directly hand made and of superior tone, these violins are far superior to the average old violins sold at four times the price.

**Write Today.** Don't fail to send your name and address today for the superb Lewis catalog sent free and postpaid. Of value to everyone interested in high grade instruments. Learn how you can have your choice of these superb instruments on a free trial in your home. Write today.  
**Wm. Lewis & Son, (Incorporated) Dept. 1195, 225 S. Wabash Ave. Chicago**  
**OUR SPECIALTIES:** Imported wood-varnishes and tools for violin makers.

*Learn to Write*

I can make a good penman of you at home during sparetime. Write for my free book "How to Become a Good Penman." It contains specimens and tells how others mastered penmanship by my method. Your name will be elegantly written on a card if you enclose stamp.

**F. W. TAMBLYN, 418 Meyer Bldg., KANSAS CITY, MO.**

**Send for a Copy of Our New Manual No. 2**

Its pages give simple formulas for calculating the natural period of an antenna; capacity of a receiving or transmitting condenser; spark frequency of rotary spark gaps; tables for calculating the correct amount of wire for the construction of magnets and tuning coils; tables for ascertaining the spark lengths of different voltages; the Federal regulations regarding the restrictions of wave lengths for amateur stations; instructions for the installation, maintenance and operation of wireless stations; directions for learning the code, working diagrams and a complete list of up-to-date wireless instruments and accessories, together with other features of interest to the amateur or professional wireless enthusiast.

Containing as it does a fund of valuable information not generally contained in a catalogue, it approaches nearer a text book in the fascinating field of wireless telegraphy. It is printed on good stock with a heavy paper cover in two colors. No expense has been spared to make it accurate and reliable.

**We make a charge of 10c for it which amount will be allowed on an order amounting to \$1 or more.**

**No Wireless Experimenter Should be Without the Mescro Wireless Manual**

**Send for Our Pocket Catalog P.28** It will contain over 200 pages, with over 1,000 illustrations, describing in plain, clear language all about Bells, Push Buttons, Batteries, Telephone and Telegraph Material, Electric Toys, Burglar and Fire Alarm Contrivances, Electric Call Bells, Electric Alarm Clocks, Medical Batteries, Motor Boat Horns, Electrically Heated Apparatus, Battery Gauges, Wireless Telegraph Instruments, Ignition Supplies, Etc.

*It Means Money Saved to You to Have Our Manual and Our Catalog When You Want to Buy*

**Manhattan Electrical Supply Co.** New York 17 Park Place Chicago 114 So. 5th Av. St. Louis 1106 Pine St. San Francisco 604 Mission St.



# THOUSANDS OF DOLLARS MADE REPAIRING TIRES

The amount you can make in dollars repairing tires is measured by your own energy. You can make anywhere from \$1500 to \$3000 a year above expenses. Your investment to start in business is small, returns are quick and your income cash. Profits are large on every job you turn out. The tire repair business is in its infancy. It's growing every year, because more tires are being used every year. In almost every city and town there is a crying need for a good tire repair man. **That means opportunity for you.** Start in your home town if you want to. This is a new **money making business.** Don't delay getting busy. But above all be prepared with an equipment that means satisfactory work for your customers. Buy only an

## Akron-Williams Tire Repair Equipment

The better your equipment, the better your work and the greater your volume of business. Let us start you in business right. Use an equipment which is

### Endorsed by 30 Leading Tire Manufacturers

It takes you but a short time to become an expert tire repair man. We help you here. We are making an unusual offer to everybody who buys our equipment. You can become an expert by our plan.

### SEND FOR OUR 30 DAY SCHOOL PLAN

It means when you start in business, you start right. You are prepared to make money from the jump. No experimenting. No failures. You become a practical, first-class repair man.

WRITE FOR CATALOGUE No. 244

**WILLIAMS FOUNDRY & MACHINE CO.** Main Street AKRON, OHIO

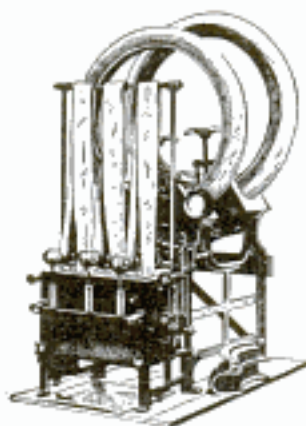
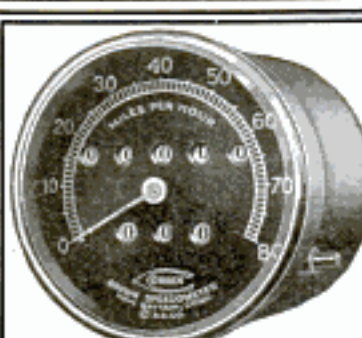
## 2 of every 3 Speedometer Equipped Motorcycles Carry the

### CORBIN-BROWN SPEEDOMETER

*"The Speedometer of Absolute Accuracy"*

Its centrifugal principle makes its accuracy unaffected by heat, cold, altitude or electrical influences. Its simple construction reduces friction to a minimum and thus insures lasting durability. Its specially designed flexible shafting is friction-free. It is also jar-absorbing because, being flexible, it adapts itself to all road conditions.

These are merely a few of the numerous features that have combined in making the Corbin-Brown Speedometer the most popular, accurate and serviceable speedometer sold. Write now for catalog.

*Sold and equipped by dealers everywhere.*

**THE CORBIN SCREW CORPORATION**  
THE AM. HARDWARE CORP., Successor  
NEW BRITAIN, CONN.

Please Mention Popular Mechanics

Twenty-two tests were made on three-strand manila rope with a diameter of about .85 in. in a circumference of 2.68 inches.

**SOME CAR! BOYS! Send for Booklet Today**



**The Lad's Car**

Send 20c today for Booklet, telling how to build this automobile. Complete instructions and descriptions of parts and sizes, illustrated with diagrams, blue print, cuts made from photographs, and price list of parts.

**SPECIAL INDUCEMENT** to first boy in your town  
Niagara Motor Car Corp'n, Dept. A, Niagara Falls, N. Y.

**The New "Arrow" Read! Electrically Lighted!**



Easy motorcycle saddle—New coaster brake—motorcycle mud guards, stand and parcel rack—motorcycle pedals—long rubber grip motorcycle handle bars—re-inforced motorcycle frame. **Flak Red Tread Clincher Tires**—beautiful finish. Write.

## New Motorcycle Type

Write for our new 1915 catalog. Read the wonderful 1915 improvements above. Nothing like this bicycle ever offered before. Other features, too. Send for catalog. The New Arrow—the most wonderful bicycle value ever built. Perfect motorcycle type. All sizes for boys, men and women.

**Pay As You Ride** A small amount down brings you the 1915 Arrow—enjoy riding it right away—pay just a little each month while you ride. Write for rock-bottom direct offer.

**Write Today** Get our new free catalog of this wonderful 1915 Arrow and our rock-bottom offer. No obligations. Don't delay. Your name on a postal will do. Write today—NOW.

Arrow Cycle Co. Dept. 1195 19th St. & California Ave. Chicago

\$150.

Model H-15

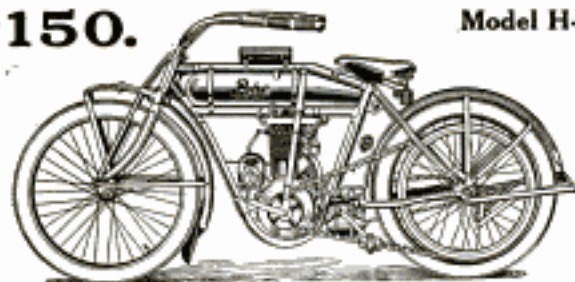

## Pope Motor Cycle

### The Standard Lightweight of America

The only practical, dependable, fully equipped motorcycle sold at so low a price. A highly efficient machine that does more than you expect.

Now in its fifth year, and a great success from the start. Every feature thoroughly tested and proved. Over one hundred less working parts than any other machine of its class—ample road clearance—spring cushion seat post—easy riding—easy control—a wonderful hill climber—lowest operating expense. The product of 37 years' successful experience in making the best. The Pope trade mark is the world's guarantee for quality.

**Motor Cycles**—6 models. Single cylinder—twins, 2 speeds.  
**Bicycles**—92 models. Special light and heavy weights and juveniles.

Send for either catalog you wish.

**THE POPE MFG. CO.**

16 Cycle Street

Westfield, Mass.



### The Auto Heel Rest

Used on all cars for the Brake, Clutch and Foot Accelerator Pedals. It brings the foot to just the right height. Takes that strain off the ankle. Saves the floor mat. Locates the heel.

**Four Sizes** 1/2 in. — 1 in. — 1 1/2 in. — 2 in.

Polished Aluminum

**PRICE EACH 75c**

Agents Wanted Patented April 9, 1912

Made Only by

Lucas & Son, 60 Fox St., Bridgeport, Conn.



### \$40 Motorcycle

We have the largest line of new and used Motorcycles in the country at the lowest prices. We also have a thoroughly equipped repair department and are in position to furnish repairs for any machine. Send us your machine to be overhauled. We pay cash for second hand motorcycles. Send for Catalog.

**HARRY R. GEER CO., 888 McLaren Ave., ST. LOUIS, MO.**

## Speed Without Labor

Boys and girls, do you know that with a Skudder car, experts can go at the rate of ten miles an hour without labor? With a

### Skudder Car

the weight of the rider furnishes the power. No work. Lots of fun. Healthy. This little wonder is ball bearing and made on the best bicycle standards. Sold at a popular price. Suitable for boys and girls 5 to 15 years old. Write for free circular.

**SKUDDER CO.**  
Room 528, Straus Bldg., Chicago



# Now 15% Lower

## New Price Reduction on Goodyear Motorcycle Tires!

We are glad to announce a big 15 per cent reduction on Goodyear 3-inch Motorcycle Tires.

Goodyear policy on price is to give the utmost in a tire at the lowest possible profit. Our reduction is made to that end, without ever reducing the quality.

That always means, with our matchless output, more for the money than any other maker can give.

### The Best We Know

Goodyear Motorcycle Tires offer the best we know. They are built to give you the lowest cost per mile. They minimize tire trouble in seven costly ways, employed by no other maker. And they are always the same, regardless of price reductions.

No reason now, with this new lower cost, why you, too, can't ride on these Goodyear tires.

**GOOD YEAR**  
AKRON, OHIO  
**Motorcycle Tires**

### Note These Features

Goodyears last year won all notable records for speed and endurance. Riders saw these tires were best and they bought them almost 3 to 1. Yet this season, in spite of price reduction, we have added these seven new features. They cost us \$50,000.00 extra.

**Mileage Increased:** (1) by giving a heavier, tougher tread.

**Creeping Prevented:** (2) by stiffer, firmer beads; (3) by equipping the tube with a metal valve spreader. It clutches the casing and rim like a vise.

**Ply-Separation Prevented:** (4) by welding each ply at the splice—the same as in the famous Goodyear automobile tires.

**Fabrics Fortified and Shocks Absorbed:** (5) by adding a breaker strip of heavy rubber-impregnated duck, between the tread and carcass, as in Goodyear automobile tires.

**Chafing Prevented:** (6) by perfecting a feather edge on flap; (7) by giving a 30 per cent heavier inner tube of supreme-quality stock.

You are entitled to these new advances. But you get them in Goodyears only.

Judge these tires yourself. You will see at once their sturdier, extra-mileage construction. Ask your dealer today to show you Goodyears. Any dealer can supply you Goodyears from stock, or can get them at once from a nearby Goodyear branch. (2333)

**The Goodyear Tire & Rubber Co.**  
Akron, Ohio  
Makers of Goodyear Automobile Tires

Please Mention Popular Mechanics



# Have You Seen It?



Model 15-3  
\$275.00



**The Most Complete and Mechanically Perfect Motorcycle Ever Built**

Every up-to-the-minute detail, including Three Speeds; Motor Starter; Mechanical Lubrication; Double Brakes; Non-Splash Fenders; Folding Foot Rests; Luggage Carrier; Excelsior Kum-

fort Kusion Seat Post; and the Most Powerful Engine ever put in a motorcycle.

The Excelsior Grip Control gives absolute safety under all conditions, enabling you to start, stop, control the speed or apply the brakes without removing the hands from the handle bar grips, or in any way interfering with the steering.

**This is one of seven models, all described in our new catalog**

*Write for it today or see the nearest dealer*

**Excelsior Motor Manufacturing & Supply Co.**  
3702 Cortland St., CHICAGO

## We Save You \$\$\$\$

Buy your Motorcycle accessories from the largest supply house in the United States. Our 1915 catalog listing 3015 accessories sent **FREE**

You can't be an up-to-date rider without one. It is the one others try to copy. You need it, so send us your name and address today.

MOTORCYCLE EQUIPMENT CO., HAMMONDSPORT, N. Y., LOS ANGELES, CAL.

**LONGEST RAILWAY TUNNEL IN INDIA**—Piercing the Khojak Range between Quetta and Chaman, near the northwestern frontier, is a 12,870-ft. tunnel, which is the longest in India. Another tunnel, 3,900 ft. long, which is now being driven on a double track cut-off between Thana and Diva, will be the next longest. This pierces the Parsik Hill and reduces the distance between these points 1½ miles.

## 5 H.P. 1915 Peerless Motorcycle



with Free Engine, Bosch Magneto, together with the best there is in Motorcycle construction, Power, Speed, Silence, Endurance, and those wearing qualities so essential for low cost of maintenance.

5 MILES FOR ONE CENT

Agents Wanted—Liberal Discount

PEERLESS MOTORCYCLE CO., 179 Hunting Ave., BOSTON, MASS.

## MAKE YOUR BIKE A MOTORCYCLE

at a small cost, by using our attachable outfit. Fits any Bicycle. Easily attached. No special tools required.

**8 Months' Repairs, 30c**

Mr. Grubbin, of Texas, writes: "I want to write a few lines to you telling you how well pleased I am. Any man or boy can make a good motorcycle with that little 2½ H. P. SHAW motor. It is the simplest and best motor a man can buy for a little money. I ran mine eight months without repairs, and then it was only 30 cents. It uses only half the fuel that other machines use. I can go anywhere with the little SHAW that any other can."

**FREE BOOK** Write today for bargain list and free booklet, fully describing the SHAW Bicycle Motor Attachment. Motorcycles all makes, new and second-hand, \$35.00 up.

**SHAW MANUFACTURING CO.**  
Dept. 6 GALESBURG, KANSAS



## AGENTS Wanted

Calling on Ford owners to sell necessities. **50 per cent Profit.**

**MORGAN MANFG. CO.**  
Bellevue Street NEWPORT, R. I.

## Garage \$69.50

10x12feet "Steelcote" Edwards ready-to-use garage, \$69.50 complete. Factory price. Fireproof. Portable. Quickly set up. All styles and sizes of garages and portable buildings. Send postal for illustrated catalog.

THE EDWARDS MFG. CO.  
320-370 Eggleston Ave., Cincinnati, O.



## Don't Throw Away Your Worn Tires



For over three years European motorists have been getting from 10,000 to 15,000 miles out of their tires by "half-soiling" them with Steel Studded Treads. In eight months 20,000 American motorists have followed their example and are saving \$50 to \$200 a year in tire expense.

**We ship on Approval** without a cent deposit, prepay the express and allow you to be the judge.

**Durable Treads** double the life of your tires and are sold under a signed guarantee for 5,000 miles without puncture. Applied in your own garage in thirty minutes.

**Special Discount** offered to motorists in new territory on first shipment direct from factory. A postal will get full information and sample within a week. Size of tires. Don't wait—write today. Address nearest factory office.

**THE COLORADO TIRE & LEATHER CO.**  
245 Goetz Bldg., West Austin Ave., CHICAGO, ILL. 105 Tread Bldg., DENVER, COLO.



## Mobiloils

A grade for each type of motor

### BIG CHANCE FOR AGENTS



#### You can earn BIG MONEY

Selling the most complete line of guaranteed transparent handle Knives and Razors with Photo, Name and Lodge Emblem—also full line of cutlery. Write today for catalogue and terms. Golden Rule Cutlery Co., 554 W. Lake St., Dept. 204, Chicago, Ill.

The first shipment of early vegetables from California via the Panama Canal to New York was made on Dec. 22, 1914, when six carloads of celery were started for this eastern port.



### FORD RACERS

REBUILD YOUR FORD CAR. Sketches, Specifications and Instructions. Information for Two-cent Stamp. T. M. Co. Dept. A. Box 212, Woodford, Maine.



### \$40 MOTORCYCLES!

New and Rebuilt Motorcycles. Largest stock in the world. Lowest Prices. We guarantee to save you from \$25 to \$50. We repair any make of motorcycle. Send us your motorcycle for repairs. Motorcycle tires \$4, best Belts, \$5. Buy direct; save dealer's profits. Send for Catalogue. DENINGER CYCLE CO., ROCHESTER, N. Y.

## BOYS The best made Bike Pumps are

"Bridgeport"



## Pumps

They're strong and durable. Will out-last any other make on the market.

Send for new booklet on Pumps and "Search-Light" Lantern.

Bridgeport Brass Company  
Bridgeport, Connecticut



"SEARCH-LIGHT"



### Convert Your Bicycle into a Motor-Cycle

Motor fits any wheel. BEST, MOST RELIABLE. Best hill climber. More STEFFEYS in use than all others. Stamp for circulars. STEFFEY MFG. CO., 5007 Brown Street, PHILA., PA.



### Rider Agents Wanted

in each town to ride and show a new 1915 model "RANGER" bicycle. Write for our liberal terms. DELIVERED FREE on approval and 30 days' trial. Send for big free catalog and particulars of most marvellous offer ever made on a bicycle. You will be astonished at our low prices and remarkable terms. FACTORY CLEARING SALE—a limited number of old models of various makes, \$7 to \$12. A few good second-hand wheels \$3 to \$5. Write if you want a bargain. Tires, lamps, wheels, sundries, parts, motorcycle supplies of all kinds at half usual prices. Write us before buying. MEAD CYCLE CO., DEPT. D108 CHICAGO



## "I Can't Afford Cheap Bicycle Tires"

"I used up four cheap tires on my rear wheel in one season. Last year one Vitalic Bicycle Tire went through the season and seems as good as ever this year."

A Vitalic Bicycle Tire wears well because the tread is so tough that only the wearing down of long service affects it; because the motorcycle tire fabric cannot split; because the inner tube is heavy, pure rubber of the finest quality.

CONTINENTAL RUBBER WORKS  
1964 Liberty St. Erie, Pa.

**VITALIC**  
Bicycle  Tires

(Reg. U.S. Pat. Off.)



## Troll With This Motor Without Altering Its Speed

It has five mechanical speed adjustments—a high speed, ideal trolling speed, neutral, slow and fast reverse. Speed adjustments are secured by simply pressing a button without stopping or altering the speed of the motor. When the

**Caille 5 Speed  
Motor**  
Push-Button Controlled

is set at neutral, the boat stands still while the motor remains running. It has a high-tension, waterproof

### Magneto Enclosed in Flywheel

giving a good, hot spark down to practically the last revolution. Motor can be furnished with dual ignition if desired.

### Other Caille Features

Caille Silencer with cut-out. Water-tight gear housing. Double-seamed fuel tank. Reinforced bracket. Non-kinking water tube. Heavy rubber steering handle. Send for catalog No. 10 giving full details.

### DEALERS WANTED

THE CAILLE PERFECTION  
MOTOR CO.  
1523 Caille St.  
Detroit, Mich.

We  
Also  
Build  
Marine  
Motors from  
2 to 30 H. P.  
Send for Catalog  
No. 24.

Develops  
2 H. P.  
Weighs  
About 55 lbs.  
Runs 7 to 10  
Miles an  
Hour.

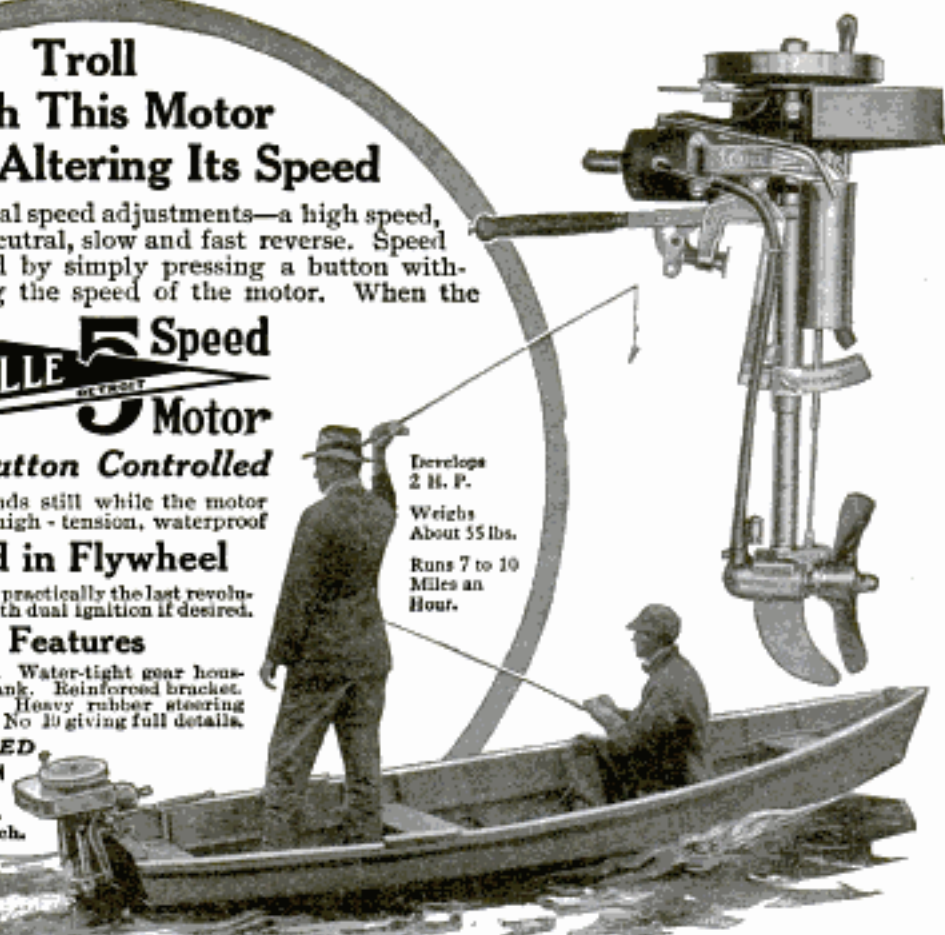

## Unmatched Speed No Vibration

Speed that runs away from all other rowboat motors. Double the power—no vibration. It does not shake the boat.

2-Cylinder  
**KOBAN ROWBOAT MOTOR**

Last season's record proved its mettle. Absolutely dependable—easy to start—reverses by pressing button.

### TROPHY WINNING RACER TYPE

The Koban has 2 opposed cylinders— that's what removes vibration—3 H. P.—nearly double that of other motors—speed propeller. Best constructed rowboat motor on the market. Write for 1915 catalog. Active Agents Wanted. Koban Mfg. Co., 201 So. Water St., Milwaukee, Wis.



Battery  
Ignition  
or  
Built-in  
Magneto

STATEMENT OF THE OWNERSHIP, MANAGEMENT, CIRCULATION, ETC. REQUIRED BY THE ACT OF AUGUST 24, 1912, of Popular Mechanics Magazine, published monthly at Chicago, Illinois, for April 1, 1915. Editor, H. H. Windsor; managing editor, F. P. Stockbridge; business manager, H. H. Windsor; publisher, Popular Mechanics Company; own-

## KERMATH Marine Engines

"America's Standard 4 Cycle Marine Motor"



4 Cycle, 4 Cylinder, 12 to 30 H. P. Highest quality. Silent operation. No vibration. Controls like the finest Motor Car engine. Extremely economical on fuel. Used as standard equipment by over 80 per cent. of the world's leading boat builders. Catalog on request. \$150 to \$300 depending on equipment.

KERMATH MFG. CO. Dept. P, Detroit, Mich.

## Special! 18-ft. Guide's Canoe, \$30

This model "Old Town Canoe" is amazing value at \$30. Built specially for sportsmen, has width for a big load, a flat floor that makes shallow draft and flat ends which give greater stability and speed. Ribs and full length planking of seasoned cedar, other parts of spruce and ash or oak. Altogether an honestly built canoe without ornaments, but guaranteed for wear and satisfaction. You should order at once. 4,000 canoes ready to ship. All models, all prices. Dealers everywhere.

OLD TOWN CANOE CO.

1465 Middle Street, Old Town, Maine, U. S. A.

Send now  
for catalog  
of canoe facts.



# "Old Town Canoes"







## Built His Own Boat

### Just as You Can Build Yours

Mr. J. P. Brittan, of Grenfell, Sask., shown here, writes: "Before I started I could not saw a straight line." But he built his boat. So can you. Write and learn how.

### The Brooks System Makes Boat-Building Easy and Saves 2/3 Price

We send you full-sized patterns, or the knocked-down frame and patterns, or all the parts, cut, shaped and fitted. Fully illustrated instructions always included. Only \$17 buys complete knocked-down frame with patterns for 23-foot power boat. Write for

#### Boat Book FREE

Showing all sizes—small duck boats to big cruisers that you can build. Address

**BROOKS MFG. CO.**

8295 Brooks Ave., Saginaw, Mich.

Largest plant of its kind in the world. Originators of pattern system of boat-building.

**\$3 and up** buys complete set boat patterns. Write for book.



### CANOEES \$18 AND UP ROWBOATS \$18 AND UP

Rowboats and canoes for Detachable Motor. Run-about Launches 16, 18, 20, 22 and 24 ft. Power canoes. SEND FOR FREE CATALOG.

Thompson Bros. Boat Mfg. Co., 29 Ellis Ave., Peshtigo, Wis.



### WATKINS' SPECIAL MOTORS

3 H. P. Single Cylinder . . . 30 lbs.  
4 H. P. Double Cylinder . . . 48 lbs.  
12 H. P. Four Cylinder . . . 100 lbs.

A strictly HIGH GRADE Motor that will give CONSTANT and EFFICIENT service. Especially adapted for CANOES and LIGHT BOATS. Aluminum base, copper water jacket, steel shaft, bronze bearings.

THE WATKINS MOTOR CO.

837-839 West Sixth Street CINCINNATI, OHIO



**BOOK FREE**

Wonderful fun and health in paddling, sailing and motorizing in a Kennebec. Write postal for new book free. Read why "Kennebec" means greatest beauty, strength, speed, lightness, steadiness and carrying capacity. Write today.

**KENNEBEC CANOE COMPANY**  
30 R. R. 54. Waterville, Maine



### GET THIS CATALOG

FULL OF VALUABLE INFORMATION TO EVERY BOAT OWNER ON

RACING PROPELLER WHEELS,  
REVERSE GEARS AND  
MARINE ACCESSORIES

LARGE CATALOG FREE. SEND TODAY

**MICHIGAN WHEEL CO.**  
1139 MONROE AVE. GRAND RAPIDS, MICH.

**Go Camping This Year**

Send Today for Free Camp Guide



**\$4.75** Special Bargain Price on this Splendid Army Style 7 by 7 ft. Wall Tent—Complete

Right now—if you order quick—you can get this splendid wall tent all complete, with poles, ropes, pins, etc., for only \$4.75. Order one now. There never was such a tremendous bargain offer before on a tent of anything like this size and quality. A regular big camping tent. The style the U. S. Government and National Guards have adopted. Made of 8-oz. white duck—a cracker jack of a tent for camping or outing. Go camping this summer. It is the ideal way to spend your vacation. Thousands of people all over the country are now sleeping outdoors in tents to grow healthy and strong. Don't delay. Remember it is a very special offer. If you want one of these tents order direct. But even if you don't order one now, send the coupon today and get a copy of the Free Camp Guide. It's a great book to have. It tells you everything about camps and camping—everything you want to know.

## Special Complete Offer

Send the coupon today and learn about the great special offer being made to readers of this Magazine. Learn how you can get a complete camping outfit. Everything you need—at a remarkably low reduced price. Don't fail to learn about this.

## 1915 Camp Guide Free

Send coupon today for the new 1915 Camp Guide. It will give you all the latest information about camps and camping. Tells you how to prepare for trips. What to take along—also expert advice on hunting and fishing. Send the coupon TODAY — now. (Canadians must inclose 10 cents because of duty.)

**H. Channon Company**

150 N. Market St.

Dept. 1195

Chicago

H. Channon Company  
Chicago



TENTS & CAMP SUPPLIES

## Send This Coupon Today

**H. Channon Company**

Dept. 1195 150 N. Market St., Chicago

Please send me the new 1915 Camp Guide and full details of your tent and camp outfit offers.

Name .....

Address .....

Please Mention Popular Mechanics

# ICY-HOT LUNCH KITS

## Keep Drinks Hot 24 Hours—Lunch Fresh and Moist

Carrying lunch takes on a new meaning to one who possesses an ICY-HOT Lunch Kit. Ideal for outings of any kind, too. Handsome enough for the "boss" to carry— inexpensive enough for the "boy" to own. Made of light weight enameled black, fitted with a leather handle. Upper compartment holds Icy-Hot Bottle, lower one for lunch. Ideal for school children, teachers, clerks, office men, mechanics—for anyone carrying lunch. Order one today and enjoy "carried lunch." Sent on receipt of price—Charges prepaid.



**ICY-HOT BOTTLE** Keeps Liquids Hot 24 Hours, Cold 3 Days. **ICY-HOT JARS**—for solid food and ice cream. Inner glass bottle protected against breakage. Perfectly sanitary—liquid touches only glass. Pints \$1 up, quarts \$2 up. Write today for booklet.



**LUNCH KITS** With this style bottle. Order No. 370. Price, including bottle . . . . . **\$1.75**

**LUNCH KITS** With this style Bottle, Nickel Plated Shoulder and Drinking Cup. Order No. 371. Price, including bottle . . . **\$2**

**ICY-HOT BOTTLE CO.**  
Dept. W. CINCINNATI, OHIO

**Fish Bite** like hungry wolves, fill your bait with **Magic Fish-Lure**. Best bait ever discovered for attracting all kinds of fish. Keeps you busy pulling them out. Write for free booklet and my special offer—one box to help introduce it. **J. F. Gregory**, 3323 Oregon Av., St. Louis, Mo.



**State of Maine Spinner**  
For trolling with live minnow for Salmon, Trout, Bass, Pickerel or Perch.  
**Send for Our Bargain List** of Fine Fishing Tackle. Enclose 10c and we will send one of these splendid spinners post free.  
**GOULD & GOULD**, Dept. 9, Box 5143, Boston, Mass.



## Buy Motors Direct

Why pay excessive dealer prices when we furnish you just as high grade motors and practically **Save Half** 2 H.P.

what the dealers ask? We are manufacturers—not jobbers. We ask but one small profit. Our line embodies the famous American portable and canoe motors as described in catalog "B"; also marine motors from 2 to 30 H. P., one to four cylinders, described in catalog "A." State which book you want. They're free. Get our prices.

**AMERICAN ENGINE COMPANY**  
605 Boston St., Detroit, Michigan **\$29.95**



## NORTHWESTERN MARINE ENGINES

2 to 18 H. P.  
The most compact, powerful and silent running motors for their size in existence. Sold at moderate prices and sent on thirty days trial before buying. Pay if satisfied, otherwise return at our expense. 2 H. P. with complete boat equipment \$50. Other sizes in proportion. Send for 1915 Catalog.



**NORTHWESTERN MOTOR COMPANY**, 1101 Spring St., Eau Claire, Wis.

## Row Boat Motor Agents Wanted

We want a hustler in every town to demonstrate and take orders for the

## Wisconsin Detachable Row Boat Motor

*Backed by 14 years' marine motor experience*

Attach one of the speedy little Wisconsin Juniors to a canoe or row boat—skim through the water. Sales come easy. Every boat owner that sees it in action is interested at once. It's the only motor with the self-locking tiller—a twist of the wrist holds the boat in any course you set. The Wisconsin patented adjustment at top of motor is another exclusive and sales-winning feature.

The Wisconsin Junior is the sturdiest, most compact motor built. It's low in price—high in quality, powerful—simple—easy to operate—starts with a half turn of fly wheel. Equipped with Wisconsin Silencer. Can be easily and quickly attached to any size or shape of boat. Thousands in use.

### Apply now for agency

Wisconsin agencies are being snapped up in a hurry—better write at once and get in on a good profit maker. Sales helps furnished. Write for catalog U.

**Wisconsin Machinery & Mfg. Co.**

Minor St., Milwaukee, Wis.

Makers of marine motors for 14 years  
Exhibiting at Panama-Pacific Exposition



Model J,  
2 H. P.,  
Weight,  
50 lbs.

ers: H. H. Windsor, owner, 6 North Michigan Ave., Chicago. Known bondholders, mortgagees, and other security holders, holding 1 per cent or more of total amount of bonds, mortgages, or other securities: None. (Signed) H. H. WINDSOR, Owner. Sworn to and subscribed before me this 22nd day of March, 1915. (Signed) J. Graham, Notary Public.

## HILDEBRANDT BAITS HOOK AND LAND 'EM

240 sizes and kinds for all kinds of game fish. 3 shapes, 6 finishes, any color fly, reversible blades. Send for

1915 TACKLE CATALOGUE—Colored Insert

J. J. HILDEBRANDT CO., 1325 High St., Lakesport, Ind.



## FISHERMEN!

Another 5000 "Sam Dandy" (\$1.00 size) Bait at Low Introductory Price **75c**

Put a half and a quarter into a letter now and send it to us for the world's greatest fish lure. No other like it. America's best fishermen swear by it. It gets the fish. Because its motion in the water looks like something in distress and fish grab it—that's the secret. Protect this rigid patent.

**MONEY BACK ABSOLUTELY** if you don't think it's worth more than you paid for it. Write today and get one of these 500—\$1.00 size bait at special price.

Address: **Wise Sportsman's Supply Co.**  
Dept. B 20 West Jackson Blvd., Chicago

## NORTHWESTERN ROWBOAT MOTOR

Strictly high grade—nothing better made at any price. Finished in polished brass and aluminum, nickel-plated fly wheel, Battery or Bosch Magneto. Rudder swings separate from engine, and all other modern improvements. Complete with electrical equipment, \$50. Send for 1915 Catalog.

**\$50**





**In the By-ways of the World—**

As you glide over the water in your Mullins Canoe, every dip of the paddle will force the cares of yesterday farther into the background.

**MULLINS CANOES**

are worry-proof. Cedar, canvas-covered—beautiful, speedy, light and durable; easily handled—the kind you can trust. Why take chances when you can be sure? Mullins Indian type canoe is the World's standard. They cost no more than the ordinary kind. Write today for Mullins big, beautiful, Canoe Book. Free on request. Wherever canoes are sold, you'll find a Mullins.

**The W. H. Mullins Company**  
471 Franklin Street SALEM, OHIO  
World's Largest Builders of Pleasure Crafts

**6 H.P. \$96<sup>75</sup>**

- 1 1/2 H.P. \$24.75
- 2 H.P. 28.75
- 3 H.P. 53.90
- 4 H.P. 68.90
- 5 H.P. \$ 87.50
- 8 H.P. 135.50
- 10 H.P. 179.90
- 12 1/2 H.P. 214.90

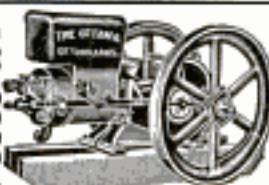

Many other sizes—all sold direct and fully guaranteed. BIG 32-PAGE CATALOG FREE. Write today. OTTAWA MFG. CO., 252 King St., OTTAWA, KANS.

**GRAY MOTORS FOR ALL SIZE BOATS**

Boat Builders Catalog the result of the co-operation of 50 Leading Boat Builders, with the Gray Motor Company is yours for the asking. Lists and describes 175 different Boats from a \$125 fishing launch to a \$2500 mahogany finished express launch, powered with 6 cylinder self starting 4 cycle Gray Motor. This Book is Free. Write for it today. Also Big Gray Marine Engine Catalog showing complete line 2 and 4 cycle marine motors \$35. upwards, 1 to 6 cylinders, 3 to 50 H.P. **GRAY MOTOR CO., 598 Gray Motor Bldg., Detroit, Mich.**

**VIM MOTORS**

5 to 27 h.p. 1, 2 and 3 cylinder Gasoline or Kerosene Speed, popular, or heavy duty. Strong, simple, accessible—absolutely dependable. Built for a lifetime. The boat-builder's standby, the boat-owner's pride. Double ignition. Non-backfiring. Heavy brass fittings. **VIM MOTOR CO., 105 Water St., Sandusky, Ohio**

**Toledo MARINE MOTORS NONE BETTER**

"Nothing Cheap but the Price"  
3 H.P. 1 cyl. complete \$ 65.00  
6 H.P. 1 " " " 84.00  
6 H.P. 2 " " " 125.00  
12 H.P. 2 " " " 180.00  
18 H.P. 3 " " " 250.00  
Fully guaranteed by a responsible concern. 2 cycle, 2 port, 2 1/2 and 4 1/2. Send for free catalog "G."  
**THE UNIVERSAL MACHINE CO., Pike Ave., Bowling Green, O.**



**What You Need to Know About California and the Expositions Told in This FREE Book**

Mail the coupon or drop a postcard for this practical guide book and learn in advance what to see, how to see it, and about how much it will cost. Explains about stopovers and side trips, suggests itineraries. Tells how you can see California and the Expositions and tour the West and Northwest for little more than the price of a single ticket, by traveling via the

**Union Pacific**

**Shortest and Most Direct Route to Panama-Pacific Exposition**

Free stopover privileges at Denver, Colorado Springs and Salt Lake City, together with side trip at slight additional expense to Yellowstone National Park in season, are among the special advantages offered by this route. Special low round-trip fares, special arrangements for the traveler's comfort. All information in the book. Mail coupon or postal today to

**GERRIT FORT, P. T. M., Union Pacific, OMAHA, NEBR.**

Ticket offices in all principal cities, including Philadelphia, Pittsburgh, Detroit, Cleveland, Cincinnati, St. Louis, Boston, New York, Chicago, Birmingham, Milwaukee, Minneapolis.

**MAIL THIS COUPON**

Please send me "California and the Expositions" (Book 161).

Name .....

Address .....

City and State .....

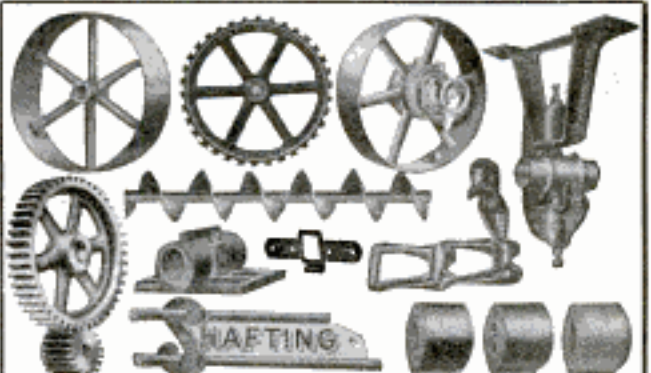

A complete line of appliances for the transmission of Power. Anything from a bolt to a complete mill or factory outfit. Send for catalogue. Largest Manufacturers of Pulleys in the country. **W. A. Jones Foundry & Machine Co. CHICAGO**

Please Mention Popular Mechanics

## WHEN THE THROTTLE'S WIDE OPEN

Hear the rhythmic s-w-i-s-h, s-w-i-s-h of the water—the soft purr of the motor—scent the brisk freshness of the air—see all the beauties of nature spread about you—enchantment! You in your Mullins Boat sweep along, swiftly—forgettingly.



### MULLINS BOATS



are boats of quality. Designed by America's foremost Naval Architects. Planked from garboard to sheerstrake with clear southern cedar—paneled with mahogany—fastened with brass and copper—exquisitely finished. Powered with 2 and 4-cycle motors of the most approved type. Graceful, speedy and ultra-durable. Mullins boats cost no more than very ordinary craft.

*Mullins Catalog of Steel and Wooden Motor Boats, Rowboats and Canoes will be a revelation to you—free on request.*

**The W. H. Mullins Company, 457 Franklin St., Salem, O.**

*World's largest builders of pleasure boats*



## ROBERTS *The Speed Motor*

*The Motors That Never Backfire*

**Cheapest**, because of lowest upkeep cost. **Simple**, only four moving parts. **Flexible**, responds instantly to your will. **Satisfactory**, because it's made right. **Never backfires**. Speedy for speed boats—powerful and strong for boats that work. 3 to 200 h. p. Write today for catalog P. M. pictures of speed boats, owners, testimony and complete description.

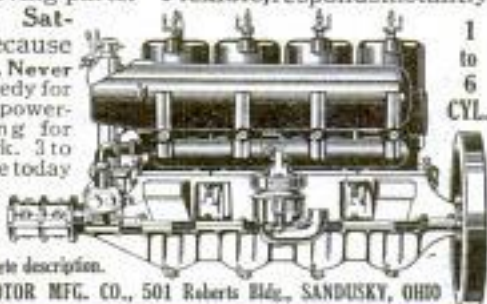

1  
to  
6  
CYL.

THE ROBERTS MOTOR MFG. CO., 501 Roberts Bldg., SANDUSKY, OHIO

## Waterman PORTO

1915 Model has reversing propeller, high tension magneto and unrestricted speed control. 3 H. P. Wt., 65 lbs. **Sold direct from factory to you, freight paid.** Original outboard motor—15th year—30,000 in use. **Guaranteed for life.** Fits any shape stern. Has automobile carburetor, removable bearings, solid bronze skeg protecting 10 1/2 x 16 in. propeller. Steers by rudder from any part of the boat. Water cooled exhaust manifold; noiseless underwater exhaust; spun copper water jacket. **Demand these essentials if you want your money's worth.** Write today for free book showing both outboard and inboard engines. Our prices will surprise you.

**WATERMAN MOTOR CO.**  
330 Mt. Elliott Ave., Detroit, Mich.



**Makes Any Boat A Motor Boat**

## L-A Rowboat Motor

**Play Safe: Try It 30 Days**

in your boat. Test it thoroughly. Be your own salesman: keep the salesman's profit—and it is for you to say when the sale is completed.

Thousands of L-A Rowboat Motors sold and running everywhere. Light weight, detachable, reversible engine; speeds up to 8 miles an hour or slow enough to troll; silent muffler, steers with rudder, bronze underwater parts, can be had with either battery equipment or fly wheel magneto. Take us up on our 30 day free trial offer today; no sale unless you are satisfied. Catalog free—postal today brings it.

**LOCKWOOD-ASH MOTOR CO., 536 Horton St., Jackson, Mich.**

**Buy at the Factory Price**

Direct from Factory to User



**SENT ON THIRTY DAYS FREE TRIAL**

## Cushman Light Weight Engines



**Saves a Team**

4 H. P. Cushman on a binder drives sickle and all machinery. Horses merely pull binder. Same engine may be used on Corn Binders, Sprayers, and other machines. Weighs only 190 lbs., yet runs very quietly and steadily, owing to Thrift Governor and perfect balance. 8 H. P. only 320 lbs. Used on Hay Balers, Corn Pickers, etc. Same engines do all regular as well as special jobs. Cushman engines are not cheap engines, but they are cheap in the long run.

ENGINE BOOK FREE

Cushman Motor Works, 882 N. 21st St., Lincoln, Neb.

Any SIZE **ONLY \$5** DOWN—One Year to Pay

**\$38** buys the reliable U. S. Engine (size 1 1/2 H. P.) direct from our factory on easy payments of only \$5 down and \$3 a month. Free Catalog Folder shows nine larger sizes all sold at similar low prices and on very easy terms. All guaranteed 3 years and backed by 42 years manufacturing experience; all shipped on 30 days free trial.

**U.S. ENGINES**  
Burn Gasoline, Kerosene or Distillate—have double the power of other engines of equal weight—are easiest to move—easy to get at—take up least space—run smoothest—start easy—burn less fuel and last longer. Free Catalog Folder gives 18 reasons for U. S. superiority and quotes low easy-to-pay factory prices. Write now.

(1) U. S. ENGINE WORKS, 3712 Ogden Ave., CHICAGO



**BOYS** You can have \$50. worth of fun with this **20-Shot 25c Pistol**

Just out and selling like hot cakes. The **Star Automatic Repeating Pistol** shoots 20 times without reloading. Uses ordinary BBs. Fine chineston finish, perfectly made. For indoor or outdoor target practice. Postpaid 25 cents each. Address **STAR CO., 36 Clinton St., CHICAGO, ILL.**



**SAFETY FIRST**  
**"Yale Electric" Lantern**

Combination House Lamp, Search and Flash Light. Full size, regular shape. Just turn the switch and get a flood of light, twice as much as the old. The simplest, safest, handy light for autoists, campers, merchants, farmers and the home. No matches, no oil, no wick trimming, no smoky chimneys, no danger of fire. Always ready.

**\$3.50** Sent postpaid on receipt of price, on Money-Back guarantee. Big money for agents. Get our agent's proposition. Start today. Be the first. **YALE MANUFACTURING CO., Dept. 8, 22-30 So. Clinton St., CHICAGO**

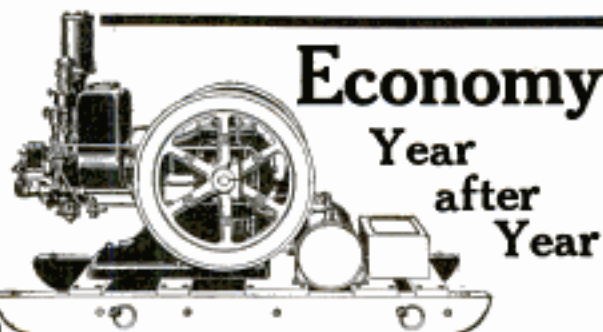

**Economy**  
Year after Year

**E**NGINE buyers who consider the simple, sturdy, efficient construction of I H C engines, and study the great I H C features, know that it is the part of wisdom to buy International Harvester Oil Engines. But not until after several years of steady power delivery will they really appreciate the great economy in I H C quality. They will have spent less than other engine users for fuel and repairs, received steadier power, paid less attention to engine operation—and they will have the soundest engine for future service.

## International Harvester Oil Engines

are furnishing the most economical satisfactory power to thousands of users. The engine for your particular need—whether ordinary or unusual—is in the I H C line. I H C engines range in size from 1 to 50 H. P.; styles—vertical, horizontal, stationary, portable, skidded, hopper and tank cooled. They run on any one of a half dozen fuels.

Local dealers everywhere sell I H C engines. Write and we will direct you to the nearest one. Let us send you one of the interesting illustrated catalogues, explaining I H C engines and special I H C features in detail.

**International Harvester Company of America**  
(Incorporated)  
16 Harvester Building Chicago U S A

## ROW BOAT MOTOR

# FERRO

Don't Go Rowing  
Go FERROWING

The Safest Investment of All

The motor you buy must be powerful, speedy, economical, simple and reliable—it must be so constructed as to give best results in hardest service. The price must be reasonable, too. Send for our literature and see for yourself why the **Ferro** is the motor. State whether interested as dealer or user. Some good territory still open for men who can qualify as Ferro agents. Write at once, giving references.

**The Ferro Machine & Foundry Co.**  
543 Hubbard Ave. Cleveland, Ohio

**\$85** With Bosch Reversible Waterproof Magnets  
**\$65** With Waterproof Battery Ignition



## Supply Electric Current to Light Your Home

Electric light at instant command—current under your own control—is what you secure with the Fairbanks-Morse Electric Plant. Complete—independent—very easy to operate.

## 24 Hour Service with this Electric Plant

Suited to needs of farm, home, store, or wherever lights are wanted. Not necessary to start engine to get light because batteries supply current when engine is not running. Made in sizes from 20 lights up. Write for details.

**Fairbanks, Morse & Co.**

Chicago

New York

San Francisco

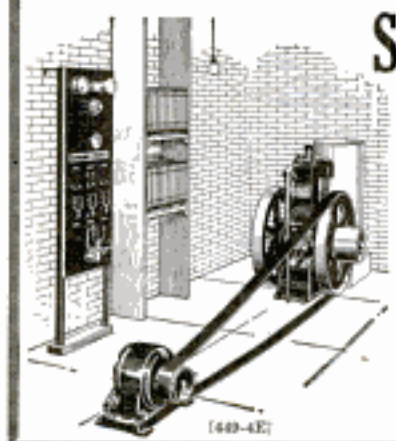

## A Real Kerosene Engine

Here's the biggest engine value ever offered in a 1½ H. P. engine. Same cylinder capacity as many 2½ H. P. engines. Throttling governor adjustable while running; crankshaft extends on both sides. Runs either way. Starts without cranking. Equipped with Ellis Patent Fuel Device, guaranteeing successful operation on cheap oils. Beautifully finished in genuine engine enamel.

### Runs on 9c a Day

Just the engine for pumping, separating, churning, corn-shelling, sawing, shop work, electric lighting and dozens of other light jobs. Sold on 30 days' trial. Guaranteed for 10 years. We make other sizes from 3 to 18 H. P., vertical and horizontal, single and double cylinders.

Ask for our free book, "ENGINE FACTS," telling how to judge and buy an engine.

**ELLIS ENGINE CO., 2873 E. Grand Blvd., Detroit, Mich.**

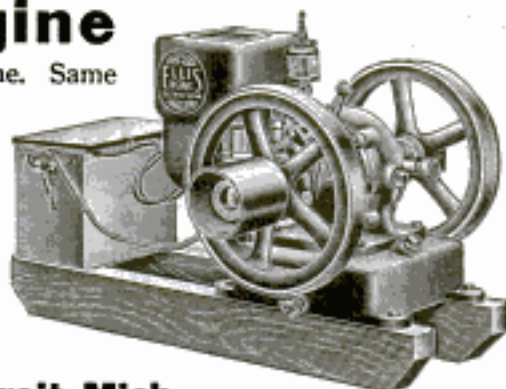

## FREE TRIAL 30 DAYS BESSEMER NON CRANKING KEROSENE ENGINE

"The Masterpiece of the Largest Manufacturers of 2-Cycle Engines in the World"

Every time you hitch a Bessemer Kerosene Engine to a load you know it will pull it. No guesswork, no uncertainty — The Bessemer goes when you start it and goes until you stop it. It will run on less fuel because the wonderful Bessemer Universal Fuel Feeder automatically feeds the right amount to carry the load—no waste. The greatest little workers in the world. Only three moving parts—2 to 10 H. P. — 30 days' free trial — immediate shipment. Write for Catalog "K." If you require a larger engine use the



BEST  
FOR  
MACHINE  
SHOPS

### BESSEMER FUEL OIL ENGINE

Lower picture shows the famous Bessemer Fuel Oil Engine. Widely used in irrigation, flour mills, factories, electric light plants, etc. Runs on cheap fuel and crude oils. No batteries or magnetos required; ignition is automatic after starting. 15 to 165 H. P. Special Catalog "O" free.

**THE BESSEMER GAS ENGINE COMPANY**  
121 Lincoln Ave. GROVE CITY, PA.



## More Power for Less Money 6 H.P. \$98.75

The New Galloway Masterpiece "Six" is the most down-to-the-minute engine that mechanical ingenuity can produce. It is perfectly adapted to furnish power to the shop, the mill, the contractor anywhere and where ready, steady, reliable, efficient and economical power is needed.

### My New 1915 Proposition

is the greatest offer ever made by any manufacturer and is the first time in the history of engine building that an A 1 high-grade engine of this h. p. could be bought for so low a price. Write for particulars and price-reducing sliding scale schedule.

**Wm. Galloway, Pres.**  
**The Wm. Galloway Co.**  
965 Galloway Station, Waterloo, Iowa



**FIRST ANTHRACITE BROUGHT TO PHILADELPHIA USED AS ROAD MATERIAL**—When the first two tons of anthracite coal were brought into Philadelphia, in 1803, the good people of that city, says Power, tried to burn the stuff, but at length, disgusted, they broke it up and made a walk of it. Fourteen years later Col. George Shoemaker sold eight or ten wagon loads of it in the same city, but warrants were soon issued for his arrest for taking money under false pretenses.

## "VIM" ENGINE



**\$25 COMPLETE**

Save money by using a **VIM 1½ HP. Farm Motor** for churning, washing, pumping, separating, spraying, etc. Women operate easily. No valves, cams, gears or complicated parts. Water Cooled, automatic positive lubrication, sensitive governor. Weighs only 75 lbs. Comes ready to run. Fully guaranteed. Get catalog and special agency offer.  
**THE VIM MOTOR CO., 805 Water St., SANDUSKY, OHIO**

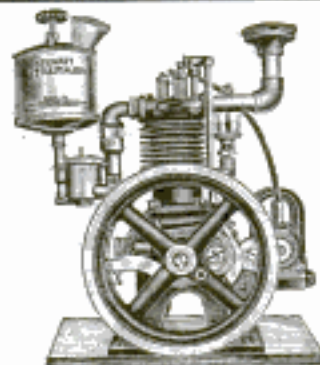

**STEWART LITTLE MAJOR**  
½ h. p. engine with high tension magneto, \$37.50; with battery, \$27.50

## Engines With a Reputation for Superior Quality

**Stewart** engines are built with an eye to quality first, last and all the time. Strong, sturdy, simple and easy to operate—they deliver the goods right up to the mark all the time.

### MADE ONLY IN ½, 2 AND 3½ H. P. SIZES

but every one a master product of correct design, high grade materials and superior workmanship. If you want an engine in any of the sizes named that will knock the spots off anything else made of the same horse power, get a Stewart.

WRITE FOR CATALOGUE

**Chicago Flexible Shaft Company, 105 N. LaSalle St., Chicago**



The solution of accident prevention and industrial safety lies in educating the rank and file of employers and employees out of instinctive recklessness into intuitive caution.

## Universal Safety Standards

by CARL M. HANSEN, M.E., the national text book of safety for Machine Shop and Foundry. Official Publication of the Workmen's Compensation Bureau. Send for descriptive circular.

Safety Engineering, 80 Maiden Lane, New York City, N.Y.

# SAFETY ENGINEERING

## Profitable Reading for All Mechanics

workmen, mill owners, physicians, lawyers, insurance men, firemen, architects, engineers and public service officials. Safety Engineering is of vital interest to every man who is earning his own living.

## We Want to Associate With Us Intelligent Men

who can devote some time in showing Safety Engineering to employers and brother workmen. We allow a substantial profit on every subscription secured.

## Send 25c Today for the Current Issue of Safety Engineering

The yearly subscription is \$3.00. You can secure a year's subscription FREE by taking three subscriptions.

We are offering splendid opportunity for men to advance themselves. Safety Engineering is in great demand. Bring it to the attention of employers and employees. There is a possibility of receiving many subscriptions from one concern alone.

Harry Guilbert, Chief Safety Inspector, American Car & Foundry Co., Chicago, says, "If I am not mistaken, we are subscribing for 28 copies of Safety Engineering. It is our intention to increase this number."

H. W. Forster, Chief Engineer, Independence Inspection Bureau, Philadelphia, says, "We have in our library every copy that has been issued, and we have found it of distinct practical value to us in our professional work. We have taken frequent occasion to recommend Safety Engineering to our clients, especially for the guidance of those men who are actively in touch with fire and accident prevention."

A copy of Safety Engineering is a passport which will take you into any factory, machine shop, mill or other industrial plant.

Mail the coupon, with 25c, and we will send you a copy of Safety Engineering, last issue, with full information how to make your spare time, or all your time, pay. To those who will work diligently, we will show other ways of largely increasing their incomes.

Safety Engineering  
80 Maiden Lane  
New York City, N.Y.

Enclosed find 25c for which send me the current issue of Safety Engineering.

Name.....

Business Address.....

City.....State.....



## MAKE \$10 A DAY

with our wonderful Champion Picture Machine. Takes, develops, finishes photo in half minute; 300 an hour. No Dark Room. Experience Unnecessary. Photo Post Cards and Portraits all the rage! You can make money anywhere. Small investment; big profits. Be your own boss. WRITE FOR FREE BOOK, TESTIMONIALS, ETC. AMERICAN MINUTE PHOTO CO. 2214 Ogden Ave. Dept. X5 CHICAGO, ILL.

## Big Agents Proposition

# ORANGEADE

**PROFITS \$10 to \$50 a day!** Crescent Orangeade comes in powder form. Did you get that? Just add cold water, sweeten with sugar and you will instantly have the richest, most delicious and most refreshing drink imaginable. Guaranteed under the Pure Food Law. Great agent at picnics, fairs, ball games, dances, etc. Vast field for action. Just roll up your sleeves and go to it. Each repeat business. Sell to families, restaurants, parlors, stores, etc. Over 4c profit on every glass. Send 10c for trial package—enough for seventeen glasses. Catalog mailed FREE. No better money maker for the summer. G.M.S. MORRISSEY CO. 4405 Madison St. Dept. a8 CHICAGO, ILL.



# ROOFING

**Why Pay High Prices** for your ready roofing when I will sell you roofing guaranteed for 20 years as low as 65¢ a roll of 108 sq. ft., including nails, cement and full directions for laying. No matter what weight and kind of roofing you want, I can supply you at a big saving, and get the material to you quicker than you can get it from any other house. I sell **Direct from Factory** and if the roofing I send you does not come up to the sample, ship it right back at my expense. I ship from seven big factories so that I can save you freight, which is a big item. If you want to save money, write today for my big roofing catalogue and samples of the roofing I sell—all sent FREE. Free estimates if you send size of roof and mention light, medium or heavy roofing. Write me today. **W. E. McCARRON & CO.** 2261 Dickey Building CHICAGO

**65¢ a Roll**  
**108 Square Feet**

## Special BUNGALOW Number

# 20¢ KEITH'S MAGAZINE

8 numbers, including the special April Bungalow Number of this beautiful 80-page monthly magazine, the recognized authority on planning, building and interior decoration, giving over 60 unique house plans by leading architects, together with a copy of a new book, "100 Artistic Homes," ALL for \$1.00. Keith's (established 15 years) 20c a copy. Newsstands—\$2.00 a year. **M. L. KEITH, 756 McKnight Building, MINNEAPOLIS, MINN.**

## "Let There Be More Light"

Goodbye Old Oil Lantern  
Price only

# METEOR ELECTRIC LANTERN

## COSTS LESS THAN OIL

So Useful This Electric Lantern is designed to take the place of the kerosene lantern wherever used. It costs less to burn and is a hundred times more convenient and safe. **USES ANY NO. 6 DRY BATTERY. ABSOLUTELY SAFE AROUND GAS, OLENE OR HAY. 1 BATTERY LASTS FROM 6 TO 8 MONTHS**

The Meteor Electric Lantern is furnished with new patent altered reflector, high power and improved Tungenen bulb which will stand any jar or rough usage. Simple—Convenient—Safe—Economical. Light is clear, bright and steady. Unaffected by weather—absolutely reliable. Practical—not a toy. Not simply a flashlight, but can be used for continuous burning. Simply turn on the switch with thumb, and you have a most brilliant white light for over 50 feet ahead, which even a hurricane cannot blow out. The ideal light for automobiles, bicycles, and vehicles. So designed that it can be hung on a buggy dashboard and serve as a BRILLIANT HEAD LIGHT. **Don't be without one another day. AGENTS WANTED** Johnson Smith & Co., Dept. 4, 709 S. Dearborn St., Chicago



**75¢**  
Add 10c for postage

Or complete with Battery **\$1.00**  
Add 20c for postage

Extra Batteries 25c



O-G  
"Kick-In"

"'Tis a long, long way to beat O-G shoes!" And THE PROOF IS IN EVERY PAIR.

**Is This One Yours?**

**I**T'S four dols. (Money back if wanted after seeing). It's the very latest. It's a **QUALITY** shoe if ever there was one. It's a **STYLE** shoe or there never was one. It has the **HIGH-BALL IN-STEP** ball strap (a special). It is nifty. It is honest. It is exclusive. It is a bargain at its very apologetic little price (just to get you started on "O-G shoes and nothing but"). It is made of a fine grade of (black) gun-metal and also of a rich Russia calf. Price the same. We send it prepaid anywhere in the world. Sizes "double A" to "D" and 5½ to 11. **YOUR MONEY IS OUR TRUST FUND.** Returned if wanted—at our expense.

What have our up-to-date friends to say to this?

**O'CONNOR & GOLDBERG**

mail  
order  
address

Republic Building  
CHICAGO, U. S. A.

(While you are writing, ask for the latest "Book of the O-G Booteries")



Patented  
Mar. 28, '05,  
Oct. 6, '14.

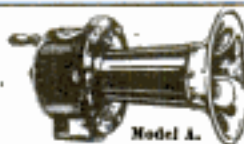

Model A.

Model M.

Model M \$3.75

**SEISS** Model A  
Double Acting **HORN** \$4.00

Can be operated either right or left, giving a continuous sound, same as a motor-driven Horn. Bracket furnished for all makes of Autos, Trucks, Boats, Motorcycles, etc. Finished in Black Enamel with Nickel Bell.

SEISS MFG. CO., 439 Dorr St., Toledo, Ohio

**TWENTY-ONE PINNACLE ROCKS DISCOVERED IN 42-MILE CHANNEL**—During last season one field party of the U. S. Coast and Geodetic Survey discovered, surveyed and charted no less than 21 dangerous pinnacle rocks in the well-known inside passage followed by all steamers going up and down the coast along southeastern Alaska. The rock walls of the channels of this part of Alaska are nearly straight up and down, both above and below the

## Rémoh Gems



Look and wear like diamonds. Brilliance guaranteed forever. Stand fire, acid and fire like diamonds. Have no paste, foil or backing. Set only in 14 karat solid gold mountings. About 1-30th the price of diamonds. A marvelous synthetic gem—will cut glass. Guaranteed not an imitation and to contain no glass. Sent C. O. D. subject to examination. Write today for our 4-color catalog DeLuxe, it's free. Rémoh Jewelry Co., 622 Washington Ave., St. Louis

## Earn a Farm in Florida

We will give you steady work clearing land at \$15.00 to \$25.00 per acre (usual prices paid), which will enable you to quickly pay for 10 or 20 acres of our choice Grapefruit, Orange and truck land near Tampa. All you need is willingness to work and your fare to Tampa. This is hard work and only those physically able to do it can make such contracts. Others can buy land on payments of only \$1.00 per acre monthly.

Write now for our free book on Florida and information as to how you can pay for your farm by work.

**NORTH TAMPA LAND CO., 838 Marquette Bldg., CHICAGO**

## GO INTO THE MOVING PICTURE BUSINESS

Write For  
FREE Catalog



ON our **Easy Payment Plan**  
Make **\$20 to \$50** PER NIGHT

With our moving picture outfit. We sell everything—Films, etc.

**DEARBORN NOVELTY CO.**  
Dept. P, 537 S. Dearborn St., Chicago, Ill.

Southern Office: MONARCH FILM SERVICE, Dept. P, 228 Union Avenue, MEMPHIS, TENN.

Please Mention Popular Mechanics



**WARRANTED**  
**CHERRY VALLEY**  
**FLANNEL**

## If you wear a flannel shirt

it's worth while to know who made the flannel—there's a difference. See that the shirt you buy has the above hanger in the neck-band, showing that it's made of the celebrated warranted

## Cherry Valley Flannel

Least shrinkage and greatest wearing qualities of any flannel made. Manufactured by a mill that was making flannel in your grandmother's time.

VALLEY WOOLEN MILLS, Cherry Valley, Mass.



# LAW BOOK FREE



**Be Sure to Get This Wonderful Free Book Before You Enroll for Any Law Courses**  
No matter which school or which course you may be considering—no matter which method of instruction you may favor—be sure to read "How to Acquire a Legal Training" before you enroll. The greatest free book on law ever offered. Tells how to weigh and judge the claims of a correspondence school. Tells just what a law course should contain to give you the training absolutely necessary to succeed in the legal profession. Points out how you can save both time and money in acquiring your legal education. Tells the easiest and best way to become a lawyer by studying at home. Also explains all about our

**WONDERFUL NEW SYSTEM OF CORRESPONDENCE INSTRUCTION**

## FREE 13 Volume Law Library and 60 Text Books

With each course we furnish 60 new pocket-size Text Books, 36 Case Books, and our big 13 volume Law Library prepared by 56 of America's greatest legal authorities—26 more subjects and 30 more authors than any other correspondence law course. Written in plain, simple, easily understood language. The easiest, best, most complete and practical correspondence course ever devised. Only law course written especially for correspondence instruction. Send for free book today. Just drop us a postal—there is no obligation—it is absolutely free for the coupon.

**American School of Correspondence**  
Chicago  
U. S. A.

**FREE BOOK COUPON**

NAME.....  
ADDRESS.....

P. M.  
5-15

A. S. of C.

Gentlemen: Please send me your FREE Law Book, "How to Acquire a Legal Training," and full particulars regarding your wonderful new system of correspondence law instruction.

This 13-vol. Law Library and 60 Text Books Free with every Course



**Big Profits to Rider Agents**  
**OF THE HOWARD NEW STYLE BICYCLE**  
Men, Women, Boys, Girls, send at once for our free proposition. Learn all about this wonderful bicycle, entirely different from the ordinary sort.  
**HOWARD CYCLE CO., Dept. P. M., TRENTON, N. J.**

### BARODA DIAMONDS

FLASH LIKE THE GENUINE—AT 1-50 THE COST  
**SOLID GOLD MOUNTINGS** Stand acid test and expert examination. See them first, then pay. Catalog FREE. Patent Ring Gauge included for 5 two-cent stamps.  
**The Baroda Co., Dept. X5, 1456 Leland Ave., Chicago**



**AGENTS \$50 to \$90 Per Week**  
**Men or Women**

### New Twentieth Century Youthifier

makes fortune for Agents. Howell makes \$18 first day. Women attracted, interested, fascinated—buy at night. This marvelous new vacuum massage machine, just out, needs no water power or electricity. Live agents don't wait, send today for free particulars and prices. Send no money, simply postal.  
**AZTEC REMEDY CO. Dept. 146 TOLEDO, OHIO**



**Hello Boys!**

**MAKE LOTS OF TOYS**

Help me get new models. I give 307 Prizes—first an Auto. My

**ERECTOR**

**BUILD NEW MODELS**

**BIG PRIZE CONTEST**

is described in big folder. Send for it now. Free.

**MYSTO MFG. CO.**  
253 Feet St.  
New Haven, Conn.

Go to it!

**"The Navajo" \$412**  
**READY CUT**



**LEWIS-BUILT HOMES**

**DIRECT TO YOU CUTS COST IN TWO**

The "Navajo" (above) and the "San Palo" (below) are striking examples of saving by the Lewis Method.

We supply any home **complete** without your bothering with vexatious building problems, getting bids or letting contracts.

### The LEWIS-BUILT READY CUT METHOD

—means preparing the house at the mills, sawing and working the lumber to fit, marking it plainly, detailing full directions for erection, and shipping **direct to you**, with only one small profit to pay. **Saves time, expense, labor, waste and worry.** Insures best grade of lumber, includes accurate plans, hardware, paint, glass, varnish, plaster, roof—everything. Send for free book—"Lewis-Built Homes"—120 bungalows, cottages and houses from \$248 up.

Lewis Mfg. Company, Dept. 578, Bay City, Mich.



**San Palo \$485**

Please Mention Popular Mechanics

## Stewart Motorcycle Speedometer

Double the pleasure of every mile you ride by putting on a Stewart Magnetic Speedometer today. Keeps right before your eyes how fast and how far you ride. Absolutely accurate; dependable and beautiful. Proves your actual speed; often saving arrest. Guards you against recklessness. Trip and season odometers also enable you to figure cost per mile and how to run your machine cheaply. The Stewart Rigid-tube Front-wheel Drive cannot be affected by jarring and bumps from roughest riding. Proved most popular and dependable by thousands. Outlasts your machine. Catalogue free.

**\$12**



Complete

## The Motorcyclist's First Necessities



Protect yourself and warn others with the clear, loud, long, penetrating warning blast of the

### Stewart Motorcycle Warning Signal

Easiest operated. Best and handsomest made and at the lowest price. Outlasts your machine.

**\$4.75** Makes them pay attention.

Special brackets for all makes of motorcycles.

Write for Catalogue of  
Stewart Motorcycle Accessories  
Stewart-Warner Speedometer  
Corporation

1906 Diversy Blvd. CHICAGO, ILL.

**30 Days' Trial**

— money back  
if not satisfied

## EDWARDS



## METAL SHINGLES

Five times easier to lay than wood shingles. Each shingle dipped separately in molten zinc **after** it is cut. The famous Edwards "Tightcote" process and Interlocking Device insure a tight roof and a **tight-on** roof—ALWAYS!

### SAVE ROOF COST

No more wood shingles! Your roof is wear-proof, fire-proof, sun-proof, waterproof, rot-proof. **EXPENSE-PROOF**, when you use Edwards Metal Shingles.

### Free Lightning Insurance

A \$10,000 bond covers you against lightning loss. That's another big EDWARDS advantage.

Prices on all galvanized materials have advanced. Order NOW—at our present low prices. Write today for bargain prices and Catalog 550. Give dimensions of roof. Hammer and nails are all you need the EDWARDS way. Write today—right NOW.

**THE EDWARDS MANUFACTURING CO.**  
500-550 Lock St. CINCINNATI, OHIO

Please Mention Popular Mechanics

level of the water. Depths from 20 to 100 fathoms are within 100 yd. of shore. One of the rocks discovered is of pyramid shape and rises over 600 ft. from the bottom of the channel to within 17 ft. of the surface. It is surrounded by deep water on all sides and is now located on

By my new, easy plan, anyone over 16 years old can earn a brand-new Ford Touring Car for a little easy, respectable work among neighbors. Free Book tells all about it.

AUTO TOM, 647-d S. 17th St., Omaha, Neb.

## Earn an auto

### AGENTS—Make \$100 to \$300



per month easy selling our new Triplicate Sauce Pan. Cooking utensil for 3 different foods on one burner. 400 Specialties—all Whirlwind sellers. Write quick for exclusive territory and large catalogue.

AMERICAN ALUMINUM MFG. CO.  
Div. 5 61 LEMONT, ILL.



### Hurrah for the Unicycle!

Boys run, they fall down and coast inside this single hoop. It's the latest and greatest fun-maker invented. Agents won't know what a real good thing is until they see the Unicycle. Each season starting April 1, ending Nov. 1, will make live agents considerable money. Boys go wild over them. Write at once for Agents' prices.

THOMAS B. BEMIS, INDIANAPOLIS, IND.

A Bass Ball Jersey



### Without a Cent of Cost to You

I give you a very fine pure wool sweater; double collar and cuffs, your choice of color. Just handle for me your club's spring order for baseball goods—at special discount, and this jersey is yours. Send for complete catalogue of my best grade sporting goods at wholesale prices—basketball, baseball, tennis, golf, etc. Write me now.

**JACK SHANNON CO.**  
Dept. 44, 54 E. Monroe St., CHICAGO

## WONDER LIGHT OUTFIT

### Lots of Fun for Boys!

2 1/2 volt, 2 G. P. lamp, switch, socket, 20 ft. insulated wire and 2 coils of dry battery all ready to install. May be used to light a dark closet or hall.

PRICE ONLY 60c. Post. Extra 15c

### LITTLE GIANT MOTOR

Is nearly 3 in. high. Runs at high speed on a single coil of battery. Very powerful and may be used to run small toys, etc. Just the motor every boy has been looking for.

Sent postpaid for only 50c

### THE SIMPLEX TELEGRAPH OUTFIT

An opportunity for every boy to learn to telegraph and to put up a line with his class. This is a full speed telegraph set, consisting of a fine key and sounder, mounted on a polished base. Will work any distance. An excellent Field Telegraph for Boy Scouts.

Price, 98c. Postage Extra. Wt. 2 lbs.

### UPRIGHT STEAM ENGINE

A fine engine of the best materials. 9 in. high. The Right Engine for ANY boy. Runs at high speed. Each engine tested at the factory and fully warranted. Sent postpaid for only 50 cents.

### SIMPLEX WIRELESS OUTFIT

Every boy wants a wireless. Get in this interesting game and read the messages flying around you. This outfit is the simplest bargain ever offered. Consists of a large double slide tuner, a sensitive detector, condenser, telephone receiver and cord. Weight 3 lbs.

Special Price, Complete, \$2.25  
Postage Extra

## EXPERIMENTERS

### THIS IS THE Experimenter's Reference Book

It's the latest edition of the famous Amco Catalogue, contains over 300 pages and is fully illustrated. Complete description and prices of the latest electrical and experimental apparatus—Storage Batteries, Rectifiers, Transformers, Induction Coils, Wireless Apparatus, Lamps, Flashlights, Motors, X-Rays, Books, Tools, Electric Railways, Steam Engines, Water Motors, Dynamos, Motors, Telegraphs, Telephones, Electrical Sirens, Model Aeroplanes and Parts for building your own apparatus. 60 in stamps will bring you this wonderful book. Contains a complete list of Wireless Calls, gives Codes, Wiring Diagrams, tells how to put up an aerial and install apparatus, etc. Best catalog of Wireless Apparatus published.

ADAMS-MORGAN COMPANY "The Experimenter's Supply House."  
Dept. M UPPER MONTCLAIR, N. J.

## PRINCE ALBERT

the national joy smoke

### REDEMOTOR SMALLEST GAS ENGINE

in general use. Runs washing machine, churn, pump, cream separator, dynamo, bench lathe, railway speeder, or any machine requiring light power. Starts easy and gives as reliable service as an electric motor, with same floor space and weight. Run it anywhere, anytime.

Invest in a Redemotor and see how much easier your chores will be. Three sizes, N, M and L E. P. Send for catalog J. Low Prices.

ELGIN WHEEL & ENGINE COMPANY, ELGIN, ILL.

## BOYS!

### Automatic-Repeating Pistol

FIFTEEN-HUNDRED loud reports from one charge. Made of blued gun-metal, 8" long, easy action. Absolutely harmless; no powder or projectile; permitted in any community. Five extra rolls of paper (7500 shots) only 10c.

THE AIRMATIC PISTOL  
350 Citizens Building CLEVELAND, OHIO

# 50c

Postage prepaid anywhere U. S. or Can.

## PREST-O-LITE



## Make your lighting system as sturdy as your motorcycle

You expect your motorcycle to stand up under every day use, to endure a spill or tip over, to suffer jolts, road shocks and vibrations—all without harm. Then choose a lighting system that will meet these same stern requirements—good light is as important as fuel.

Prest-O-Lite does not depend upon complicated, delicate electrical mechanisms, has no fragile wiring. It is absolutely reliable.

Because it gives such superb driving light it is used more by experienced riders than all other systems combined.

Prest-O-Lite costs less to buy and operate than any other system of brilliant light. Never requires extensive repairs or costly replacements of parts.

### Make your own test!

Prove to your entire satisfaction that Prest-O-Lite is all we claim for it by using it on your machine for 30 days. If it doesn't show its superiority in every way, you are not out a cent.

Get the same guarantee of value, safety and satisfaction before you buy any lighting system.

Any motorcycle dealer will include Prest-O-Lite in any "complete equipment" combination if you insist. If he has your interest at heart he will recommend it.

### Know the truth about lighting

Before buying lighting equipment, even before buying a motorcycle, it will pay you to know all the facts about all motorcycle lighting systems. We've prepared this information for you. It's free. Ask for it.

## The Prest-O-Lite Co., Inc.

The World's Largest Makers of Dissolved Acetylene  
265 Speedway, Indianapolis, Ind.  
Prest-O-Lite Exchange Agencies Everywhere

## Choose the Blades You Want

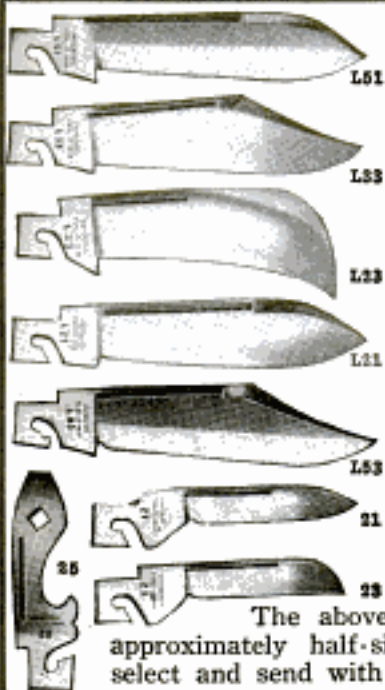

Here is a pocket knife for which you can select the blades yourself according to your individual needs. What's more, when you break a blade you can replace it with a new one instantly without tools. The Nagle ReBlade Knife is a *real* knife. Not a freak or a toy or a tool-kit. Looks like any other well-made knife and is equally strong. Blades can't come out accidentally and cost little to replace. Fully guaranteed.

For a dollar bill (or money order) we will send postpaid this fine two-bladed jack knife with easy-opener handle and an extra blade. Select any one of the five upper blades and any two of the three lower blades.

**\$1.00**  
3 Sheffield Steel blades and handle (actual size 3 1/4 in. long). Additional blades 25c each.

**NAGLE ReBlade KNIFE ©**

72 Parker Ave., Poughkeepsie, N. Y.

### Dealers or Agents Wanted

The above illustrations show blades in approximately half-size. Cut out the blades you select and send with your order.



### The Stag Safety Razor Blade Sharpener

**THE ONLY ONE OF ITS KIND**

Will grind, hone and strove every safety razor blade on the market. Price complete, with hone, strap and holder in durable case, nickel finish, **TWO DOLLARS.** Money back if not as represented. Particulars upon request.

Morris - Kincaid Company  
Box 60  
Grand Central, New York



### Genuine Pearls \$1.00

Average size as illustrated

Beautiful white pearls absolutely and positively guaranteed real pearls. Sounds marvelous, but a positive fact. Just think of it. Average size ordinary pea. Solid gold finished scarf or lace pins. Be real swell and wear a genuine jewel, not cheap imitations that soon break and crack. Mailed to you on receipt only one dollar. Money returned if dissatisfied. Act quickly—supply limited.

AMERICAN PEARL COMPANY, Great Neck, N. Y.

**TO EVERY MAN EVERYWHERE. YOU CAN DRESS ALWAYS for \$10**



**72 SAMPLES AND BOOKLET FREE**

### Good Clothes Always \$10 SUIT OR OVERCOAT

Sounds impossible, doesn't it—smacks of exaggerated advertising—looks like imagination run riot—but IT ISN'T.

We are the largest manufacturers of men's clothing in the world, doing business DIRECT with the wearer. The entire out-put of our factory—just suits, overcoats and top coats—is sold by mail or from our six stores. Price always \$10. We specialize—make clothes at one price only. Everything going into them—the pure wool cloth—the linen canvas—linings—hair cloth—all are of a standard quality bought in immense quantities. We sell thousands of garments, instead of hundreds—make hundreds of a model, instead of a few, all of which reduces the cost on each item and makes possible, always \$10.

**Big Business Men Wear 'Em**—The Men Who Make Money and Keep It—wear these suits. They know Richman Clothes are worth a great deal more than \$10. They prefer several clean suits to one shabby one. In Cleveland, home of our factory and largest store for 35 years, every sixth man of its 650,000 inhabitants buys a suit or overcoat of us once a year. Men in every walk of life are wearing them—they are the clothes for YOU—whenever you are, wherever you are. A ten dollar bill and postage will bring you Richman clothes right to your door—parcel post. Satisfaction guaranteed or money back.

**STYLE BOOK FREE**—Write for spring catalog of latest styles—and 75 newest fabrics.

**THE RICHMAN BROS. CO.** Dept. 27 Cleveland, O.  
Milwaukee, Wis. Cincinnati, O.  
St. Paul, Minn. Minneapolis, Minn. Duluth, Minn.



the chart where a 109-fathom sounding was formerly recorded. The report speaks of this 600-ft. pyramid as a sort of a submerged Washington Monument. It says that if the lead struck it in the old survey it probably slipped off into the deep water alongside. These rocks were located by means of a wire drag more than a mile long, the wire being supported at the desired depths by cables to surface buoys and towed along by power boats.

### ELECTRIC STAPLE DRIVER

Price **50 Cents Pre-paid**

Uses lightest and most economical form of annunciator and bell wiring staple. Drives neatly, accurately and effectively without injury to woodwork, plaster or insulation. Especially effective in dark and difficult places. No more battered fingers or crooked staples. Just the thing for putting up poultry netting, blinds and slat stapling, carpet laying, etc. Agents wanted everywhere.

**KIRKHAM SPECIALTY CO.**  
Washington Bldg. STAMFORD, CONN.

Regular Price **\$1.25** **THE RAPID VACUUM WASHER**

The only Washer with Automatic Suction

Sold on 30 days' trial.

Washes everything from blankets to fine laces. Tub of clothes washed in 5 to 10 minutes. A child can operate it.

**AGENTS WANTED. Special price on sample postpaid.** Write for terms and trial offer.

**STEWART-SKINNER CO., 26 Cherry St., Worcester, Mass.**

### Hartman Will Trust You

#### Rock Bottom Prices

**Furniture, Carpets, Rugs, Etc.**

**Easiest Terms**—Hartman's credit terms custom, most liberal ever offered. No security—no notes—no mortgage. Free from all objections. At the end of a month you may return anything unsatisfactory. **30 Days Approval**—Hartman refunds your money including freight.

**FREE—Big Bargain Book**—Over 5,000 bargains. Write today for FREE copy.

**HARTMAN FURNITURE AND CARPET CO.**  
3945-47 Wentworth Av., Chicago



Please Mention Popular Mechanics



## SEND A DOLLAR BILL

if you are a motor car owner, chauffeur, repair man, mechanic, carpenter, printer, engineer, butler, chef, store clerk, postal clerk, laboratory man, manual training student, freight and express handler, cartage and baggage-man, or take care of your own house and garden. The

10,000  
in  
use

# JIFFY OVERALL APRON

is made in many sizes to fit small man of 5 feet 3 inches, up to the tall man of 6 feet. There are four styles: (1) Highest quality blue denim; (2) Extra heavy blue and white striped Steifel; (3) Highest grade waterproofed white duck; (4) Extra quality brown khaki. Each garment has combination tool or watch and pencil swinging pocket. Two large pockets used for tools or other articles. Two elbow-length over-sleeves with each garment. Patented Clip at bottom of each leg—holds garment in place. Union made in Detroit by the highest skilled labor obtainable. Each garment is guaranteed.

Pin a dollar bill to coupon and mail today.

**JIFFY APRON COMPANY, 305 Smith Bldg., Detroit, Mich.**

Address.....  
Name.....  
Please send me by parcel post paid one Jiffy Overall complete with over-sleeves, style height is.....feet.....inches.  
JIFFY CO.,  
Detroit, Michigan  
Parcel Post Paid



## Make \$5 to \$20 Weekly

Grow Mushrooms in Spare Time  
Spawn now produced by scientific methods. Makes crops certain. Anyone anywhere can now grow mushrooms at home, in basements, barns, sheds, etc. No experience necessary.

I tell you how to grow, sell, etc. Good prices, market unlimited. My instructions based on 20 years' experience. Used in State agricultural colleges. Information free. A remarkable opportunity to increase your income.

Address A. V. JACKSON, Falmouth Mushroom Cellars, Inc.  
354 Gifford St. FALMOUTH, MASS.

Only Scientific Mushroom Farm in U. S.



## DIAMONDS

are the stones nearest a Diamond. Their brilliance is eternal, cut like a Diamond, mounted in gold filled Diamond Mountings. Will send Ring, Pin, Stud or Earrings upon receipt of \$1.00. Illustrated catalogue free upon request.

FREY SPECIALTY CO.  
P.O. Box 379, Dept. 50-P. New Castle, Pa.

## SAFETY FIRST

PRICE \$1.50  
Postpaid



3 IN 1  
Burglar Alarm  
Door Bell  
Door Knob  
COMBINED

Here is the most attractive, practical and up-to-date article ever introduced: it impresses by its neatness, simplicity and accuracy.

## The Kriz Kombination Knob

takes the place of the ordinary door knob; at the same time is a DOOR BELL and BURGLAR ALARM. It requires no wiring, winding or special attention. Simply remove the inside knob and substitute the K. K. K. By the simple pressure of the button it can be set either to ring or be silent, but, when once set to ring, cannot be silenced from the other side of the door. It is better, cheaper and more durable than the electric bell, and will last a lifetime. You cannot afford to be without it.

ORDER ONE TODAY

Agents write for special terms and territory

KRIZ SPECIALTY CO.

Central National Bank Bldg., Dept. A, ST. LOUIS, MO.

\$30 a Week  
EASY

## MEN AND WOMEN WANTED TO SELL PERFECTO Kerosene Irons



No experience necessary. Big profits selling this wonderful self-heating satisfaction guaranteed iron. Easy to operate and demonstrate. Sell itself. Use Kerosene (Coal Oil or Gasoline) with same satisfactory results. Absolutely safe, no smoke or odor. Get facts in detail and let us tell you how to obtain Free Sample and start you in a big paying business. Sample case FREE to Agents.  
PERFECTO SOD IRON FACTORY  
Dept. G, 126 So. Clinton St., CHICAGO, ILL.

# YOU GOING TO BE MARRIED, TOO?



"Take a tip; Alice and I 'looked around' and found our furniture was going to cost more than we expected. A friend told us of the 'Come-Pack' system. We sent for their large catalog and saved around \$150.00. Everybody says our home is the real thing."

"WE SAVED \$25.00 ON THIS DINING ROOM TABLE"

"It's a beauty; 45 inch top; Duo-style look, extends for three leaves without dividing pedestal; all fine quarter sawed white oak, handsomely grained. It has the look and quality of a table costing twice as much. Then we got a lot of other furniture and saved on every piece."

## HOW THE "COME-PACK" WAY SAVES YOU MONEY

"Come-Pack" furniture is not sold in stores—ONLY direct to purchaser, with a money back guarantee. Furniture stores make enormous profits. YOU save that profit for yourself—from 33-3 to 50 per cent. Think of it! It is shipped compact "Come-Pack" and our method of construction insures low freight rates. Free Catalog shows several hundred pieces for the home. Samples of all finishes on quarter sawed white oak, also actual samples of leather and upholstering material, from which to make your selections, will be furnished on request. Buy "Come-Pack" furniture and save money.

THE COME-PACK FURNITURE COMPANY.

501 Dorr Street, TOLEDO, OHIO



Price \$25.25  
Saving \$25.00





**A FEW CENTS PER DAY;  
YOU'LL NEVER MISS IT**

Write for Prices—Special Inducements, and the big illustrated book, "The Truth About Typewriters." Well worth reading. Send no money, just your name and address TODAY.

## Who Can Use This Machine?

Here is a special typewriter offer that will appeal to shrewd buyers. You may choose this Underwood machine, or any other make you prefer, bar none—with complete equipment and latest improvements—and own it without red tape, on the easiest plan you ever heard of, at  $\frac{1}{2}$  or  $\frac{3}{4}$  manufacturers' prices. Write for particulars and see.

Each machine is relentlessly tested when completed, and guaranteed by our iron-bound guarantee that's all in your favor. You must be satisfied or no deal. Thousands of satisfied customers from coast to coast.

**You can't go Wrong You take no Risk You can't Lose**  
**YOUNG TYPEWRITER CO., Dept. 194, CHICAGO, ILL.**

## BOYS!

CUT OUT THIS AD AND  
SAVE 25c ON THE NEW \$2.50

### "Ideal" 1915 Model Racer AEROPLANE

The swiftest, strongest, longest flighted Racer made

**WILL FLY 500 FEET OR MORE**

**Finest Sport on Earth. Safe, Healthful, Scientific**

No Racer like this has ever been sold before for less than \$2.50. It has every point that made our other Models famous—plus many new ideas that make this the swiftest, longest flying Racer made. Made with new unbreakable spring plane holders and multiple winder. So simple it can be put up in 15 minutes, ready for flights of 500 feet or more.

**You want one of these Racers for your vacation  
ABSOLUTELY GUARANTEED PRICE \$2.50**

Cut out this ad and take it to your dealer and he will credit you with 25c., so that you will get this great Racer for only \$2.25. If your dealer cannot supply you, order direct of us.



Other lower priced "Ideal" Flyers ready for instant flights:  
BLUE BIRD Racing AEROPLANE, retails for \$1.25  
"IDEAL" SPEED-O-FLYER, " " " 1.75  
"IDEAL" SPEED-O-PLANE, " " " .65  
"IDEAL" LOOP THE LOOP GLIDER, retails for .25

#### "IDEAL" SCALE DRAWINGS

any accurate and will enable you to EASILY build exact 3 foot duplicates of man-carrying machines. Clearcut plans for class rooms, students, etc. Price for 8 ft. scale drawings includes building and flying instructions:

Curless Flying Boat.....25c Wright Biplane.....25c  
Nieuport Monoplane.....25c Curtiss Hydroaeroplane...35c  
Blériot Monoplane.....15c Coill Peail Racer.....25c

Complete set of six, \$1.25 postpaid

**"IDEAL" MODELS and FLYERS Can Be Had from Your Dealer. Ask Any Toy, Department or Sporting Goods Store or Write to Us.**

Some "Ideal" Dealers: Schmelzer Arms Co., Kansas City, Mo.  
Spiegel & Harbut, Inc., Seattle, Wash.

Price List of Toys and Models FREE

48 pp. Catalog of "Ideal" Model Aeroplanes and Supplies, 5c.

**IDEAL AEROPLANE & SUPPLY CO.**  
82-88 West Broadway New York

## Old Man at 40 Youth at 41

My new copyrighted book is FREE. It explains THE SWOBODA SYSTEM OF CONSCIOUS EVOLUTION and the human body as it has never been explained before. It explains my new theory of the mind and body. It will startle, educate, and enlighten you.

My book is not a dry treatise on anatomy and physiology. It tells in a highly interesting and simple manner just what you have always wanted to know about yourself. You will cherish this book for having given you the first real understanding of your body and mind. It shows how you may be able to obtain a superior life; it explains how you may make use of natural laws for your own advantage.

My book will give you a better understanding of yourself than you could obtain from a college course. The information which it imparts cannot be obtained elsewhere at any price. It shows the unlimited possibilities for you through conscious evolution of your cells; it explains my discoveries and what they are doing for men and women. Thousands have advanced themselves in every way through a better realization and conscious use of the principles which I have discovered and which I disclose in my book. It tells what Conscious Evolution means and what it may do for you. It also explains the DANGERS OF EXERCISE and of EXCESSIVE DEEP BREATHING. I offer my System on a basis which makes it impossible for you to lose a single penny. My guarantee is startling, specific, positive and fraud-proof. Write for my FREE BOOK and full particulars today before it slips your mind. Make up your mind to at least learn the facts concerning the SWOBODA SYSTEM OF CONSCIOUS EVOLUTION for men and women.

**ALOIS P. SWOBODA** 1308  
Apolian Hall New York City, N. Y.

Please Mention Popular Mechanics

## BILLINGS & SPENCER

Machinists and Auto  
**TOOLS**



Your dealer probably has them. If not write us.

Hartford Ct.

Wrenches ✓  
Pliers  
Sc. Drivers  
Hammers  
Ratchets  
Wrench Kits  
Tool Kits



**\$4.50** STARTS YOU  
Towards the  
Big Job

The profession of Meter Engineering needs men. Positions are open. Big Money is being paid. Now—on a great special offer you can start for the big job for only \$4.50. **BE THE BORN**—Be the man who gets the fat pay envelope. Don't miss this offer.

**Write Today for Big New Book** Your name and address is enough. No obligations. Paid out about the great opportunities in our profession. Write today—now. Ft. Wayne Correspondence School, Dep. 1195, Ft. Wayne, Ind.

## MAZDA

Always etched on electric lamps to which MAZDA Service has been applied.

Coffee imported into the United States in the calendar year 1914 exceeded one billion pounds.

## POULTRY PAPER

44-124 PAGE periodical, up-to-date; tells all you want to know about care and management of poultry for pleasure or profit. Four months for 10 cents. **POULTRY ADVOCATE, Dept. 98, SYRACUSE, N. Y.**

2 1/2 oz. The perfected combination lubricating oil, powder solvent and rust preventative. Cannot gum. For guns, typewriters, razors, etc. Write for folder. Com-pounded and guaranteed by Remington Arms-Union Metallic Cartridge Co., New York.



## Mount Birds

We teach you by mail to stuff and mount all kinds of Birds, Animals, Game Heads. Also to tan skins and make rugs. Be your own taxidermist. Decorate your home with your beautiful trophies or increase your income selling specimens and mounting for others. Easily, quickly learned in spare time by men and women. Highest endorsements by thousands of students. Write today for our great free book "How to Mount Birds and Animals" Free—write today.

**N. W. School of Taxidermy, 1195 Elwood Bldg., OMAHA, NEB.**

## 10 Cents a Day

Pays for This Cornet An astounding offer! Only 10c a day buys this superb Triple Silver Plated Lyric Cornet. FREE TRIAL before you decide to buy. Write for our big offer.

**WURLITZER**  
40 years of instrument making

**Free Band Catalog** Write for our big new 250-page Band Catalog.

Carrying Case Free with this superb triple silver-plated Lyric Cornet.

Rock-bottom, direct-from-the-manufacturer's prices on all kinds of instruments. Pay for them at the rate of only a few cents a day. Generous allowance for old instruments. Free Trial. We supply the U.S. Gov't. Write now. **THE RUDOLPH WURLITZER CO., Dept. 9195, 4th St., Cincinnati, Ohio N. Wash. Ave., Uniontown**



**ELGIN**  
WATCHES  
ON-  
CREDIT

**17 Jewel**

25 YEARS

Now, during this Special 30-day Sale, is the time to buy this elegant 17-Jewel Elgin. Factory tested and fitted in a 25-year Gold-Filled Case.

**NO MONEY DOWN—\$2 A MONTH**

Because we want to prove to you that the great volume of our business enables us to save you nearly half on this \$30.00 Elgin. Special **\$12<sup>75</sup>**

**3 Fine Books FREE!** Mr. Harris wants to send you his three latest books free—one the story of "The Diamond," its discovery, where and how mined, cut and marketed; the other, "Facts vs. Fanc," or all about the Watch Business, both at home and abroad, also our Big Free Watch and Diamond Book.

You do not pay a cent until we have placed the Watch or Diamond in your own hands for approval—no security—no interest—no red tape. Big Catalog Free.

**HARRIS-GOAR CO.** Dept. 1631  
KANSAS CITY, MO.

Earn This  
**2 Passenger**  
**\$425 Roadster**  
**EASY**



"Coey Junior"  
4 Cylinder  
Water Cooled  
Shaft Drive  
Fully Equipped

## Get Coey's Big Offer

Write quick for full details of this astonishing automobile offer. Don't miss this chance to get a "COEY JUNIOR"—the classiest little car in America for a few hours' easy work. Let Coey show you how to

**Make \$100 to \$400 a Month**

Be an Auto Expert. We teach you everything about an auto in easy lessons at home. Fit yourself for big paying position as Auto Salesman, Chauffeur, Garage Man, Repair Man, Demonstrator or Mechanic. Thousands getting rich building, selling and repairing autos. Big jobs waiting for Auto Experts. Why not "get in the game?" Write quick!

**Auto Book and Introductory Lesson**

### EXTRA

If you answer this advertisement at once, I will give you a chance to get the agency for the "Coey Junior" in your own town. This means easy money for you. Address me personally. C. A. COEY, President.

**FREE** A postal brings Coey's fascinating Auto Book with introductory Lesson, fully illustrated. It's FREE—not a penny to pay! If you want that \$425 Roadster, rush a postal this minute.

C. A. Coey's School of Motoring  
10 Coey Bldg.

2010-12 S. Wabash Ave., Chicago, Ill.

# Here's Health

AND  
**Power,  
Vim and  
Vigor**

ALL YOURS!

Strength

that is more

than mere muscular strength.

The strength

of perfect

health,

abundant

nerve force,

the strength

of keen relish is now within your reach through vibration! Nine out of ten people are only half alive. How about yourself? Listen! All the joys of life, strength and youth may be returned to you by vibration. Send the free coupon for the big new book that will tell you all about it.

## WHITE CROSS ELECTRIC VIBRATOR

This wonderful instrument gives you three of nature's greatest curative agents—vibration, faradic and galvanic electricity. We will send this wonderful machine to you on free trial. Feel its health-giving vibrations for yourself. Don't be weak. You can be strong and healthy if you will by using the White Cross Electric Vibrator.



White Cross Electric Vibrator and its Attachments.

## Vibration Is Life



It will chase away the years like magic. Every nerve, every fibre, of your whole body will thoroughly tingle with the force of your own awakened power.

All the keen relish, the pleasure of youth, will fairly throb within you. Rich, red blood will be sent coursing through every vein and artery, you will be made over—new from head to foot. You'll sleep the health giving restful sleep like you used to. Your self-respect, even, will be increased a hundredfold.

LINDSTROM-SMITH CO.

Dept. 1195

1100 S. Wabash Av.  
CHICAGO, ILL.

Send the Free Coupon

Just your name and address on the free coupon or a letter or post card is enough. We will send you absolutely free and prepaid, our new book, "Health and Beauty." It's free. No obligations of any kind. Write at once.

Please send me, absolutely free and prepaid, your new book "Health and Beauty," and full particulars about the free trial offer on the White Cross Electric Vibrator. I assume no obligation of any kind.

Lindstrom-Smith Co.

Dept. 1195  
1100 S. Wabash Av.  
CHICAGO

We manufacture White Cross electric irons, hair dressers, stoves. Dealers write.

Name.....

Address.....

My Electrical Dealer's Name is

Any Watch  
You Want  
ON CREDIT



WALTHAM  
ELGIN  
HOWARD  
HAMILTON  
ILLINOIS

Sent on 30 Days Free Trial

No Money Down

Express Prepaid in Advance by Me

You take no chances with me. I am 'Square Deal' Miller and I trust the people. That is why I am doing the greatest Credit Watch, Diamond and Jewelry business in the country. Suppose you want any one of the country's best makes of watches? Name any one. I have it for you. No Money Down, Express Prepaid. A full month to carry it in your pocket and the easiest of Long Time Payments. That's the test that tells. All these watches

Guaranteed 25 Years

I Smash the Terms

No References Demanded

My terms are made to suit you. You get unlimited credit, with no red tape, notes or collectors. All unnecessary detail left out.

An "Open Charge" Account

the same kind of credit you get from your grocer. No matter where you live or what your income is, you can now own the finest watch, a beautiful diamond or any rare jewelry and never miss the money.

Costly Catalog FREE

Send me your name and address so I can mail you, Free and postpaid, the most beautiful catalog of its kind ever printed. I want you to have this book. It's a gem. It illustrates all makes of valuable Watches, Elegant Genuine Diamonds, and a vast assortment of Beautiful Jewelry, all on the easiest and most liberal terms. Write for this book today and get a letter from me that will make you a friend of mine from the start. Take My Word For It.

Square Deal MILLER, Pres.

MILLER-HOEFER CO., 480 Miller Bldg., Detroit, Mich.

# Joymotor

For Rowboats  
and Canoes



Joymotor will fit any boat ever made—square stern, pointed stern or decked stern—without additional attachments. Just hook it on or off in a jiffy. No matter where you take Joymotor you know it will fit the boat you have to use. For Canoes Joymotor special bracket sets motor low down—safety first.

Marine  
Engine  
Dealers  
Write for  
Agency  
Proposition

## REVERSING PROPELLER

The exclusive patented feature of Joymotor that makes it the safest, most convenient, easiest to handle motor in the world. No more danger of accidents. No drifting or paddling to dock or shore. No more awkward, hurried cranking to reverse the motor. Just move the steering tiller to right or left and Joymotor almost instantly—

**Stops your boat and backs it up without reversing the engine**

"Joymotor is rightly named"—  
"A joy to own"—"evidently built to enjoy"—that's what owners tell us. Easily

portable. Weighs 52 lbs. Runs your boat 7 to 9 miles per hour—canoes 10 to 12. Has real high tension magnets and carburetor, efficient oiling system and does not have unsightly, tangled up pump hose. Prices: Boat or Canoe Models, Battery Ignition \$65, Magneto Ignition \$75. Write postal now for catalog and life size picture of Joymotor giving full details of the finest, most satisfying portable motor to be had. Write postal now to

JOY ENGINEERING COMPANY  
530 Tribune Bldg., CHICAGO



This picture shows how Joymotor steering tiller swivels and reverses position of propeller. Compare this position with large picture.

## THE MIAMI MOTOR BICYCLE

SAFE · SILENT · CLEAN  
WEIGHS 110 Lbs. COSTS \$125.00

"ONE HUNDRED MILES FOR TEN CENTS"

SEND FOR CATALOG

The Miami Cycle & Mfg. Co., 600 Noble Ave., Middletown, Ohio

## VENUS PENCILS

Made in 17 degrees (6B softest to 9H hardest) of never varying, uniformly graded quality, also 2 copying. Write on letter-head for free trial sample and booklet.

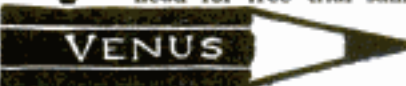

American Lead  
Pencil Company  
210 Fifth Ave., New York



# AL-COOL FAN \$11.50

The wireless breeze builder—runs without electricity. Driven by a self-contained air motor. Operates anywhere with alcohol or gas. More economical and usable than an electric fan. Absolutely safe. Simple—substantial—18 inches high. A new—wonderful—necessity. Price \$11.50. Send for one today. Money back if not satisfied. Dealers and The Al-Cool Fan Co., 10600 Carliss Ave., Chicago, Ill.

## Agents Wanted



**ARGO—\$295****MOTORVIQUE**  
4-cylinder, shaft drive

f. o. b. factory

Top, windshield, headlights and generator attached, \$29 extra.

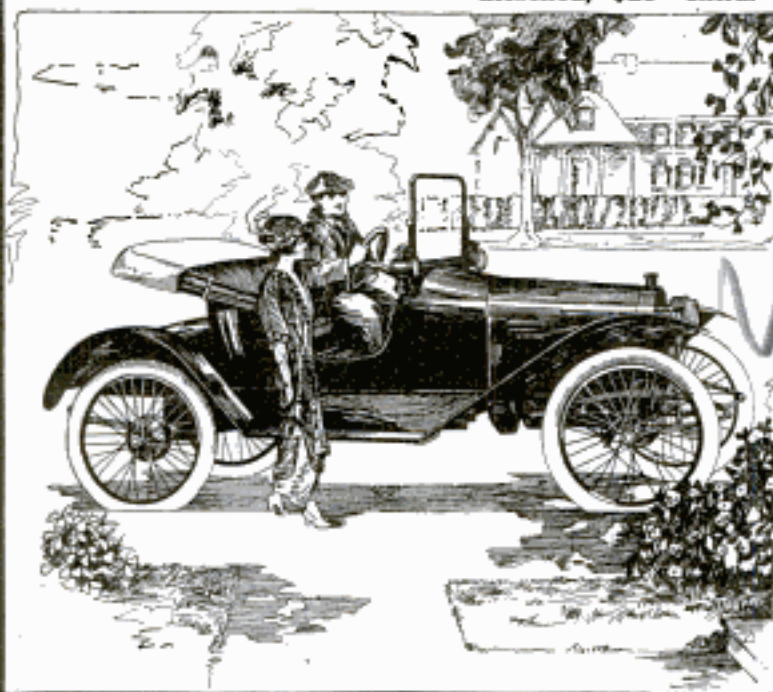

**H**ERE'S efficient, comfortable, motor-transportation at a first cost so low and an upkeep so economical that users say it's "cheaper than carfare."

The Argo Motorvique is not a freak or an untried experiment. It is an easy-riding, good-looking car of sound mechanical design, sponsored by some of the best-known and most successful men in the industry.

The Argo embodies the best European engineering ideas — and the light car has reached its highest success abroad. American manufacturing skill in quantity production at low cost has done the rest.

For pleasure and for business, the Argo offers a greater return than any other investment of a similar amount you can make.

**See the Car, or Write for Descriptive Folder**

Argo dealers are now demonstrating the car in hundreds of localities. If there isn't one near you, write for full descriptive folder of "the motor-vehicle for the millions."

**ARGO MOTOR CO., Inc.**  
614 Main Street, Jackson, Michigan

**Specifications:** Motor: I-head type; 2 3/8" x 4". 4 cylinders cast on block; 5-point suspension. Cooling: Thermo siphon system. Clutch: Internal cone type, leather faced. Transmission: Sliding gear, two speeds forward and reverse. Axle: Front, I-beam; rear, solid alloy steel with bevel gear. Drive: Propeller shaft. Bearings: Full-bearing complete from engine to wheels. Springs: Full elliptic, front and rear. Brakes: External contracting. Lubrication: Self-contained constant-level splash system; sight gauge on dash. Ignition: Tynet distributor of great battery economy. Frame: Pressed steel channel. Wheels: Wire, clincher-rim; 30-inch wheelbase; 4 1/2 inch tread. Tires: 28-inch. Control: Single pedal, spark and throttle on steering column. Body: Dark finish, two passenger; seat 24 x 42 inches; leg room 28 inches. Gasoline: 4-gallon tank, gravity feed; 35 to 40 mi. per gallon; speed 5 to 40 miles per hour. Equipment: Two side oil lamps; oil tail lamp, horn and tools.

The number of farm animals in the United States at the end of 1914 showed a general increase as against 1913, according to government reports, averaging three per cent, while the total value increased only 1.3 per cent.

**250 "WIRELESS" TRANSFORMER \$9.00**  
WATT CLOSED-CORE TYPE SELF CONTAINED 14000 VOLTS 3 DIFFERENT POWERS Shipping Weight 20 Lbs.  
Send 2c stamp for catalogue of Wireless Supplies, folders, etc. Winger's Telegraph Code Charts free with \$2 orders; otherwise 20 cts. each. Purchased in "station" or "pocket" sizes. Continental or Home order; please state which otherwise Continental "pocket" size will be sent. Winger Electric & Mfg. Co., 111 So. Dearborn St., Chicago, Ill.

**We Trust You**

We start you in a business all your own — the minute post card business — nothing like it for big, quick, easy money. You can easily make

**\$50 to \$100 Weekly**

With our wonderful Filless Post Card Camera, takes 5 size post cards, also photo button direct — without use of plates — film or dark room — finished in 1 minute. We sell it on easy terms. There's a fortune in it. Circulars free.

FILLESS POST CARD CAMERA WORKS  
Box 512, 1107 So. Halsted St., Chicago, Ill.

**WORK FOR US—\$50 to \$75 EVERY WEEK START NOW**

Experience not necessary. Honesty and willingness to work is all we ask. Selling **The Easy Wringer** may make \$5000 a year.  
LISTEN: The man's name is...  
orders \$2000 one month—buy in Pa. from...  
commercial problem...  
which may cost...  
Main Street, Toledo, O.

**SWEET ROWBOAT 4 H.P. MOTOR**  
Fastest — most dependable; light built — 4 H.P. — fits any boat. Float feed carburetor — battery or gas. Reversing Propeller. Write for free catalogue and owners' letters. 30 Day Special Price.  
**SWEET MFG. CO.**  
561 Griswold St. Detroit, Mich.

**One Man and This Machine Will Earn****\$50 to \$100****Daily Profit**

\$100 a day can be made with this machine

Not a dream—not a myth—but a reality. If you are honest-earnest, and anxious to go in business for yourself, I will help you. I have helped lots of men to make from \$500.00 to \$1500.00 per month. It's an honorable business—can be started most anywhere, in any town of over 500 population.

**A GOOD BUSINESS PROPOSITION**

You want a business of your own. Go into the Popcorn Crispette business and make \$2000.00 to \$7000.00 a year. All you need is a machine, a few dollars and a good location. You can learn to make Crispettes in a day. They sell everywhere for a nickel a package. You make almost four cents profit.

**SEND FOR FREE BOOK**

It tells the whole story—how and where to start, how to succeed, gives experiences of others, etc. It's worth reading, even if you don't start. If you're looking for a good thing, and easy money, write today for the FREE BOOK.

Eakin made \$1500.00 in one month with a Long Crispette Machine, in a store window.

You can do equally as well, or even better.

**W. Z. LONG CO.**  
1055 High St.,  
SPRINGFIELD, O.



**W. Z. LONG CO.**  
1055 High St., Springfield, O.

Without any obligation at all, please send me free your book, "Dollars and Sense in the Crispette Business."

Name.....  
Address.....

Please Mention Popular Mechanics



## Can't Short Circuit

The ideal plug for motorboat use. Moisture, fog, rain or spray will not interfere with its operation.

Needs no hood.

The porcelain is *baked around* a very fine *platinum* wire with just the *tip* brought flush with the porcelain.

The current driven through so fine a wire is so intensified that it delivers an extremely hot, scouring spark.

The spark is so hot that it actually *consumes* the moisture, oil, soot, carbon, etc., which would collect on any other plug and cause short circuiting.

The Champion Reliance "Spark-in-Water" Plug is self-cleaning and absolutely cannot be short circuited.

## Motorcycle Spark Plugs



**Champion Mica 75c**  
Mica of course will not break, and this Mica Plug is of special oil-resisting construction.

Over 75% of all gasoline engines, for every purpose, are equipped by their builders with Champion Spark Plugs. To accept a substitute is to disregard this most definite expression of scientifically determined expert opinion. Insist on Champions.

See our dealer, or write direct to us.

**CHAMPION SPARK PLUG COMPANY**  
401 Avondale Ave., TOLEDO, OHIO

## An Interesting New Book For Those Who Like to Make Things



## AMATEUR MECHANICS No. 6

293 Articles

261 Illustrations

128 Pages

Price 25c Postpaid

THIS book which is similar to the previous numbers in the Amateur Mechanics series but contains entirely different matter describes how to make the following as well as scores of other interesting and practical things.

Tandem Monoplane Glider—Camp Bed—Sail for Boys' Wagon—Surveyor's Transit—Motion Picture Machine—Small Rheostat—Folding Bookrack—Sunlight Flasher for Garden—Camp Furnishings—Water Motor—Model Steam-Turbine Boat—Hurdle—Pocket Voltmeter—Mechanical Camera—Cyclemobile—Small Series Motor—Cut Press—Heliograph—Electric Heater—Electric Horn—Ski Staff—Monorail Sled—Fire and Burglar Alarm—Blowgun—Pea Shooting Gun—Drill Press—Pushmobile—Ice Racer—Galvanometer—Ellipsograph—Snowball Thrower—Power Windmill—Flymobile—Pantograph—Small Hydro Electric Power Plant.

The other books in this series, Amateur Mechanics Nos. 1, 2, 3, 4 and 5 and Mechanics for Young America, are similar in style but each contains matter entirely different from that in the others.

Price 25 Cents Each, Postpaid

**Popular Mechanics Book Dept.**  
6 N. Michigan Ave., Chicago

## EXPERIMENTS

BY

**PHILIP E. EDELMAN**

256 Pages, 5 1/2 x 8

200 Illustrations

**CLOTH. PRICE \$1.50**

**EXPERIMENTS**  
BY  
PHILIP E. EDELMAN



A new book of practical, up-to-date information for building simple, efficient apparatus at small cost, for conducting tests and experiments, for establishing a laboratory and for applying the best experimental methods.

This is one book for those who wish to make their experimental work count. The facts stated are accurate, the tables and data invaluable and the text reads as interesting and novel.

Practically every question of money that is anticipated. This book will save you the less effort and will place the best of the world's practice at your service. Learn to do things with your brains and hands; to connect the leaders of science with social and economic progress. Here is a great field opened up to you.

Send today for large folder giving complete contents and description of this great book, or book itself will be sent postpaid upon receipt of price by

**POPULAR MECHANICS BOOK DEPT.**  
6 N. Michigan Ave., CHICAGO

# Send Only \$1.00

for this one-minute picture-taking and making machine that has proved the biggest camera sensation of the age and has revolutionized modern photography.

## The MARVELOUS MANDEL-ETTE

Only 10,000 will be sent out on this special limited offer to introduce and advertise this remarkable picture-making invention.

### Takes and Makes Finished Pictures INSTANTLY!

You press the button, drop card in developer and in one minute take out a perfect, finished post card photo  $2\frac{1}{2} \times 3\frac{1}{4}$  inches in size. Camera  $4\frac{1}{2} \times 5 \times 7$  inches. Loads in daylight 16 to 50 post cards at one time. **No Films—No Plates—No Dark Room—No Mess or Bother.** Instantaneous photography. Universal focus lens produces sharp pictures any distance. Pictures develop automatically. Can't over-develop; results simply amazing.

### FOUR MONTHS TO PAY

We will send you complete outfit consisting of camera, supply of post cards, instructions and everything needed to make finished pictures, on receipt of \$1. If it's satisfactory pay only \$1 per month until balance of \$4 is paid. Price is \$5. Money back if not satisfied.

### No Experience Required

You don't have to know a thing about cameras or photography to make dandy pictures with the Mandel-ette. Plain instructions. You begin making pictures moment outfit arrives. So easy and simple a child can operate it. Fun—profits, too, because you can sell these photos for 10c or more each. Remember, only 10,000 on this big special offer. Be sure to get yours by sending \$1.00 today.

CHICAGO FERROTYPE CO., Desk 14, CHICAGO, ILL.



**NEW CANAL-ZONE LIGHTING SYSTEM**—Permanent street-lighting systems are to be installed in the permanent towns of the Canal Zone, namely Cristobal, Gatun, Pedro Miguel, Balboa, and Ancon. The lights will be supported on ornamental cast-iron posts, spaced approximately 175 ft. apart, and each will bear a single lamp of about 200 cp. enclosed in a spherical globe, 14 in. in diameter. The lamps will be of the recently developed nitrogen-filled type, using a concentrated coil of metal filament.

## Do Your Own Printing



You can make good money from the start and build up a profitable business by printing cards, letter-heads, circulars, etc. Requires little money.

Write today for our 96 page catalog. It's free. Contains full printing instructions.

**ROWELL PRINTERS SUPPLY CO.**  
75 Main St. (Est. 1965) Louisville, Ky.

## "Interlox" SAVES TIME, TEMPER AND TROUBLE

### MASTER SLIDE RULE

The Only Interlocking Slide made—and the Only one whereby inside measurements of doors, windows, etc., can be taken rapidly and accurately. Also superior to all others for outside measurements of walls, ceilings, etc. If your hardware dealer hasn't this slide, send us his name and 10c per foot (in any length from 2 to 6 ft.) and it will be sent prepaid.

← Liberal Proposition for Dealers and Agents

DAHL MFG. CO., 51P E. 42nd St., NEW YORK

## FITS-UR-POT FITS ANY COFFEE POT



Just out. Going with a rush. Every home a prospect. Converts any pot into percolator. Makes better coffee—saves third to half. Aluminum. Quick sales.

### Profits \$24 to \$36 a Week

Most percolators cost \$2 to \$5. FITS-UR-POT sells for \$1. Practical—absolutely new. Our free premiums stimulate sales. Write quick for agents.

Standard Spinning & Stamping Company  
105 Smead Ave. Toledo, Ohio

**AGENTS WANTED**

# \$25 to \$60 Weekly Profits

from the famous

## Butter-Kist Corn Popper

All year 'round profits from this remarkable popper. Confectionery, drug and department stores, theatres, restaurants, news stands, etc., all have proved its big earning capacity. People everywhere can't resist delicious Butter-Kist pop-corn.

**H & H BUTTER-KIST POP CORN**

Pays for Itself Quickly

Scores of records prove that Butter-Kist Corn Popper pays five times as much profit per square foot of floor space as anything else in store. Stands anywhere—needs only 26 by 32 inches—move a chair and you have room for it! Soon pays for itself in sales.

Earning capacity instantly variable from 75 cents to \$4.00 per hour in sales. **Runs itself!** People flock around it. They walk blocks for Butter-Kist—none so delicious. They like the big fluffy white flakes, crisp, crackling and clean—untouched by human hands. And they save the valuable prize coupons. Butter-Kist is a great trade winner for the whole store.

## 70 Cents on the Dollar CLEAR PROFIT



One store took in \$679.45 first 28 days. Many average \$25 to \$60 weekly profits—some more than \$100. All year—spot cash business. No stock to carry. A small payment down brings Butter-Kist Corn Popper—all privileges included. Superbly built. Beautiful oak, mahogany or ivory white cabinet; gleaming plate glass sides; metal parts highly polished and nicked.

**FREE—Send Today for "Little Gold Mine"**  
Photographs, sales records, proof of profits and full particulars in our handsome new dealers' book "The Little Gold Mine." **Sent free postpaid.** Write at once—as every day gained may mean \$10 to \$20 more sales for you.

**Holcomb & Hoke Mfg. Co.**  
1653 Van Buren St., Indianapolis, Ind.



700 Miles of Steel Tubing in the Making

## Durable Construction

**M**ANUFACTURERS who are striving to improve their product, and at the same time keep costs at a minimum, will find it worth while to investigate the possibilities of Stanweld Steel Tubing.



Stanweld Steel Tubing is light, strong, and has an exceptionally fine finishing-surface. It is used by the world's largest manufacturers of automobiles, motorcycles, and bicycles—and by hundreds of other concerns making mechanical specialties.

If you are the manufacturer of a product that can possibly be made of steel tubing, write us a letter today. Our service-department may be able to show you ways of improving your product, and reducing its cost of manufacture.

### Articles Made of Stanweld Tubing

Automobiles  
Air - Rifles  
Scabbards  
Go-Carts  
Handles  
Novelties  
Telescopes  
Instruments



Motorcycles  
Furniture  
Registers  
Handles  
Bushings  
Fixtures  
Telephones  
Phonographs

**THE STANDARD WELDING CO.**  
West 75th Street CLEVELAND, O.

*Special Reinforced Stanweld Tube*



## YOUNG MAN! LEARN DRAFTING.

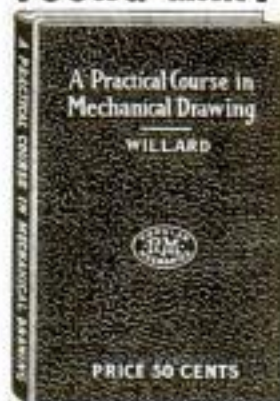

**ONE** of the most practical subjects of study today; an essential in most lines of engineering; indispensable in many occupations and often the secret of successful advancement; of no less importance to the farmer than the mechanic. There is bound to come a time when you will feel the need of the ability to "lay out" something in accordance with the rules and conventions used in the drafting profession.

### Individual Study

may be successfully engaged in with the aid of our new enlarged edition of the book

## A Practical Course in Mechanical Drawing

By **WM. F. WILLARD**

(For several years instructor in Mechanical Drawing at Armour Institute of Technology, Chicago)

**160 PAGES — SIZE 5x7 — 157 DRAWINGS — CLOTH COVER**

### Price 50 Cents, Postpaid

There has been a real need for a book of this kind, as it clinches each problem in the mind of the student by giving the practical application of that problem to every day practice in some phase of the world's work. It meets every modern requirement and is in advance of any other work on the subject. Excellent for use in shop classes, trade or high schools. *A complete detailed description of the contents of this book sent free upon request.*

Order of your Book Dealer or direct from the publishers

**POPULAR MECHANICS BOOK DEPT.**  
6 N. Michigan Ave., CHICAGO

## A BOOK OF NEW MISSION FURNITURE DESIGNS



### Part 3 — Mission Furniture HOW TO MAKE IT

A 128 page collection of 36 excellent new designs that have never before been published and that are entirely different from those in the books Parts One and Two previously issued.

Handsome Cloth Binding

Price 50c Postpaid

This new number has just been published and those already in possession of Parts One and Two will find this an even greater value in variety and excellence of the plans.

### A feature of the New Book is a Complete Set of Dining-Room Furniture

Designed to Harmonize Perfectly

If you are at all handy with tools, you will find that the plainly written directions, dimension drawings and half-tone illustrations will enable you to

### Make Your Own Furniture and Save Two-Thirds

The many who use tools for pleasure will find this book a working guide which will furnish while several of our readers have been able to devote their entire time to this work by disposing of what they have made at a nice profit. One man made and sold \$400 worth of one piece alone.

Parts One and Two in this series are also 50 cents each postpaid

Ask Your Book Dealer or Address the Publishers

**POPULAR MECHANICS BOOK DEPT.**  
6 N. Michigan Ave. CHICAGO

## THIS 21-JEWEL WATCH

Delivered to You for  
**Only \$3<sup>00</sup> MONTHLY PAYMENTS**

We Will Trust You. Wear this Watch while Paying for it. It's that handsome dress size, thin model design, immensely different from the heavy, ordinary, cumbersome R. R. watch. Has 21 jewels, steel escapement, double sunk dial, hand-engraved, gold-filled case, warranted.



Perfect Cut  
White Color

**Genuine  
Diamond Rings**  
**\$250 to \$3**  
Monthly Payments

Guaranteed to Pass Any  
Railroad Inspection  
**20-Yr. GUARANTY**

Just the watch to bring  
pride in ownership.  
It's yours on astonish-  
ingly easy terms.

## DON'T PAY ALL CASH

Keep your money for other uses. Pay only a small amount monthly, on these magnificent, flashing, thousand-colored REAL Diamond bands. Made for Ladies or Gentlemen. Every stone ABSOLUTELY GUARANTEED as represented, or your money refunded. That's our business method. No red tape—no embarrassing inquiries—all dealings in complete confidence. Complete jewelry line for your selection. Everything for gifts. If you buy once you will continue our customers.



Full Value  
or Your  
Money Back

**RICHLI ILLUSTRATED CATALOG FREE**

WRITE FOR IT TODAY TO

**ENGELBRECHT & CO.** 3609 So. Marshfield Ave.  
Dept. 515, CHICAGO, ILL.  
Factory - THREE OAKS, MICH.

## OXY-ACETYLENE

OXY-ACETYLENE  
WELDING  
AND CUTTING  
SWINGLE

## WELDING AND CUTTING

Including the Operation and Care of Acetylene Generating Plants and the Oxygen Process for Removal of Carbon

By **C. F. SWINGLE, M. E.**

200 Pages—76 Illustrations—Pocket Size  
Bound in Cloth, \$1.00

Full Leather—Round Corners—Red Edges  
Stamped in Gold, \$1.50

Here is a brand new practical instruction book on the methods of welding and cutting by the oxy-acetylene process. The thirteen chapters cover the following general subjects:

Welding—Welding Flames—Oxygen Acetylene—Acetylene Gas Purification and Handling—Oxy-Acetylene Torches—Characteristics of Welding Torches—Welding Installations—Preheating and Annealing—Operating a Welding Installation—Metal Welding Practice—Oxy-Acetylene Cutting—Oxygen Carbon Removal—Index.

Sent postpaid upon receipt of price by

**POPULAR MECHANICS BOOK DEPT.**  
6 N. Michigan Ave., CHICAGO

## GOODELL PRATT

1500 GOOD TOOLS

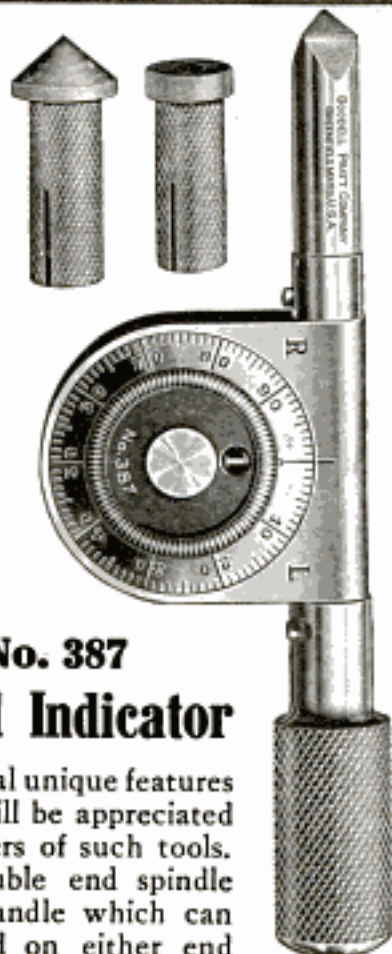

**No. 387**

## Speed Indicator

has several unique features which will be appreciated by all users of such tools. The double end spindle with a handle which can be placed on either end renders the indicator capable of taking the speed of either right or left hand shafts without any confusing double numbers on the dial.

There is a separate dial for counting hundreds which is provided with a friction ratchet mechanism so that it can be instantly turned back to 0. The tool is constructed of steel and a special alloy metal, fully polished and nickel-plated. Two rubber points are furnished with each indicator. **Price \$2.50**

### Partial List of Goodell-Pratt Tools

Hand Drills	Chain Drills	Hack Saws
Brest Drills	Levels	Screw Drivers
Bench Drills	Braces	Precision Tools



**GOODELL-PRATT  
COMPANY**

*Toolsmiths*

Greenfield, Mass., U. S. A.



## Across Lake Erie From Sunset to Sunrise

You leave in the cool of the evening—you arrive before the heat of the day. What better means of travel between Detroit and Buffalo than a slight journey by boat, a delightful evening on the water, a refreshing night's sleep, a fascinating view of sunrise in the morning.

Two of the largest and finest side wheel steamers afloat, City of Detroit III and City of Cleveland III, make the trip across Lake Erie early every evening and arrive at their destination early the next morning—one steamer going from Detroit to Buffalo, the other from Buffalo to Detroit. These two "floating palaces" are equipped with every modern convenience and comfort—beautiful coal parlors, music, telephones in every stateroom, washed air ventilating systems, splendid dining service, perfect attendance—every comfort of a first-class hotel.

"Take a D. & C. Boat when you go afloat." Daily service between Detroit and Cleveland and Detroit and Buffalo; four trips weekly from Toledo and Detroit to Maumee Island and way ports; special day trips between Detroit and Cleveland during July and August—daily service between Toledo and Put-In-Bay. Week-end excursions every Saturday between Detroit and Cleveland and Detroit and Buffalo, returning every Monday morning.

Railroad Tickets Accepted for Transportation on D. and C. Line Steamers between Detroit and Buffalo or Detroit and Cleveland, either direction. Information on rates and time tables upon request. For illustrated pamphlet and Great Lakes map, send two cent stamp to L. G. Lewis, Gen'l Passenger Agent.

**Detroit & Cleveland Navigation Company**  
25 Wayne Street, Detroit, Mich.

PHILIP H. McMILLAN, President. A. A. SCHANTZ, Vice-President & Gen. Mgr.  
All D. & C. steamers arrive and depart from Third Ave. Wharf, Detroit.



Please Mention Popular Mechanics

## Hitch Power to Any Rowboat

Why wear yourself out pulling oars when you can quickly make a good, speedy power-boat out of your rowboat or canoe by attaching the



### Spinaway Detachable Rowboat Motor

Three Big Exclusive Features make it superior to any other of its type:

Disappearing Crankhandle—keeps handle out of the way after starting;

Self-locking Tiller—holds boat true to its course without watching;

Underwater Exhaust—insures quiet, noiseless running.

Engine equipped with famous Bosch High-Tension Magneto. Write today for 1915 price and Free Catalog.

**SPINAWAY BOAT MOTOR CO. 266 Chicago St. FREEPORT, ILL.**



## Ready—Vol. XI SHOP NOTES FOR 1915

626 Easy Ways To Do Hard Things

"Written So You Can Understand It"  
224 Pages 517 Illustrations

Paper, 50 Cents; Cloth, \$1.00 Postpaid

A BOOK that is indispensable to everyone who uses tools, either for pleasure or as an occupation. This is Vol. XI in our remarkable series of Shop Notes Annuals and, in addition to the many hundreds of practical time and labor-saving kinks each of these books gives, this volume contains the following articles which are of special value:

Home Garage—Gate for Stock Farm—Concrete Wall—Lawn Sweeper—Glass Cutter for Circular Work—Segment Work in Pattern Making—Simple Level—Locomotive Parade Float—Paving and Pavements—Concrete Garbage Furnace—Portable Boat Landing—Camper's Sleeping Outfit—Water-Power Vacuum Cleaner—Foot-Power Hammer—Automobile Turntable—Reversed Action of Oars—Hammer Swing—Engineer's Kerosene Torch—Elbow Pattern—Power-Driven Catamaran—Air Circulation in Furnace Heating—Windmill—Open-Air Swinging Bed—Self-Contained Gasoline Soldering Torch—Disk Cutter—Electric Cigar Lighter—Simple Resistance Thermometer—Oxyacetylene Welding Torch—Water-Heating Attachment for Furnace—Basement Hotbed—Heating an Automobile—Portable Cottage—Bed Desk for Invalid.

Complete sets of Shop Notes consisting of 11 volumes and case \$5.50 prepaid, or any of the single volumes sent postpaid at 50c per copy.

**Popular Mechanics Book Dept.**  
6 N. Michigan Ave., Chicago

## Oxy-Acetylene Welding will lower metal repairs and manufacturing costs

Every metal working establishment can employ oxy-acetylene welding and cutting—effects large savings in repair and production costs. New uses and added savings are being discovered daily. No other method of joining metal parts presents such wonderful possibilities for increasing quality and lowering cost. Many repair jobs, impossible heretofore, are now simple, time and labor-saving routine oxy-acetylene welding practice. This low-cost process supplants intricate, wasteful and inefficient methods of manufacture.

### Necessary Equipment is low in cost Operation is simple and easy to learn

Good equipment is necessary to obtain the best results. But good equipment is not necessarily costly. We furnish a thoroughly high-grade welding apparatus for \$60.00. The average user will also need gas cylinders at an additional cost, and about \$10.00 worth of welding supplies. Truck, when desired, and special equipment for cutting operations at extra cost. The welding out-

fit is widely useful—operation extremely simple. Being portable, it can be taken to the job, an important consideration, particularly when heavy, stationary equipment must be repaired with the least possible delay.

If you are now doing Oxy-Acetylene Welding or Cutting, find out why better results are obtained by using

### PREST-O-LITE Dissolved Acetylene (Ready-made carbide gas)

Prest-O-Lite Acetylene Service furnishes the highest grade of Dissolved Acetylene in portable cylinders, used as conveniently as you use cylinders of oxygen. Saves the large initial outlay and heavy depreciation, trouble and inconvenience of making crude Acetylene in carbide generators. Besides, Prest-O-Lite Dissolved Acetylene is perfectly dried, cleaned and purified—makes better welds and is cheaper to use.

#### The Welding Business is Highly Profitable

Ambitious men looking for an opportunity to earn bigger and better profits should investigate the oxy-acetylene welding field. Equipment soon pays for itself. Demand for expert welding work is large and growing. Ask for particulars.

*Write your name and address in the margin of this page and receive our instructive literature on Oxy-Acetylene welding and cutting.*

**The Prest-O-Lite Co., Inc.,**

The World's Largest Makers of Dissolved Acetylene

816 Speedway  
Indianapolis, Ind.

53 direct factory branches and charging plants in principal industrial centers



Outfit weighs less than 300 lbs. on wheels—Easily handled by one man.

## New Lithographic Model of a Monster Mallet Compound Locomotive

IN COLORS Price 50c  
Size 9½ x 19 in.

SHOWS AND NAMES  
EVERY PART

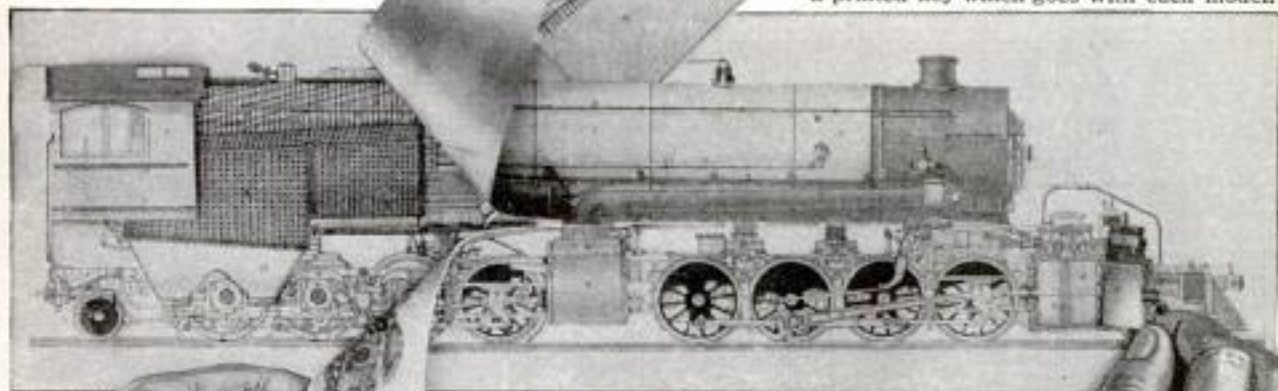

As shown by the photograph, this is a dissected chart, which by an ingenious series of folds or flaps and a careful use of colors, clearly depicts every part of this giant of the rails. This educational contrivance, made at present only in Europe, is the result of the perfecting of a process combining great engineering ability with the lithographer's art. It is a veritable marvel of accurate detail. Every part is numbered to correspond with its name given on a printed key which goes with each model.

#### Other Models of the Same Kind are:

Locomotive (Atlantic Type Passenger)	Automobile (Late Type 6 Cylinder)
Steamship (Large Ocean Liner)	Steam Engine (Stationary—Horizontal)
Steam Turbine	Gas Engine
Dynamo	Wireless Telegraph

Price 50c Each Postpaid or Complete Set of 9 Models Prepaid for \$4.00

POPULAR MECHANICS BOOK DEPT., 6 N. Michigan Ave., CHICAGO

**1/3 SAVED BUY DIRECT FROM MANUFACTURER**  
**J. HARDIN CO. - - Chicago**  
 OUR HIGHEST GRADE LABEL APPEARS ON ALL FIXTURES  
 WE REFUND YOUR MONEY IF GOODS ARE NOT AS SHOWN AND REPRESENTED



**No. 00** — Highest-grade porcelain enameled bathtub, heavy adj. N. P. waste and overflow; heavy Fuller bath cork, N. P. supply cone, for iron pipe. Complete as shown and described ..... **\$14.35**

**No. 11** — Highest-grade porcelain enameled long back one pc. sink on pat. wall hanger and adj. legs, N. P. faucets, N. P. adj. trap to floor or wall. Complete as shown and described, 20 1/2"..... **\$17.95**

**No. 22** — Highest-grade porcelain enameled Serpentine lavatory on pat. wall hanger with heavy adj. N. P. trap; heavy indexed basin cocks; N. P. cone, supplies for iron pipe. Complete as shown and described, 24"..... **\$9.45**

**No. 44** — Highest-grade vitreous closet outfit with vitreous china tank, fitted with heavy trimmings; vitreous china siphon, W. D. closet; reinforced masonry seat. Complete as shown and described, ..... **\$12.00**

**No. 33** — Send for our estimates on steam and hot water heating plants from \$100 up.

WE GUARANTEE EVERYTHING

**WE CARRY ABSOLUTELY EVERYTHING IN HIGHEST GRADE GUARANTEED PLUMBING and HEATING GOODS EXCLUSIVELY**  
**35 YEARS AT 4533-43 Cottage Grove Avenue CHICAGO**  
 SEND FOR COMPLETE CATALOG NO. 61

**JUST PUBLISHED!**

**MOTORCYCLES, Side Cars and Cyclecars**

*Their Construction, Management and Repair*

BY  
**VICTOR W. PAGE, M. E.**

Author of "The Modern Gasoline Automobile"

Contains over 350 specially made illustrations showing the most valuable series of drawings pertaining to motorcycle design and construction ever published.

**550 Pages Price \$1.50 Postpaid 3 Folding Plates**

The only complete work published for the Motorcyclist and Cyclecarist. Describes fully all leading types of Machines, their Design, Construction, Maintenance, Operation and Repair.

This treatise traces the motorcycle from its earliest forms to the approved models of the present day. It outlines fully the operation of two and four cycle power plants and all ignition, carburetion and lubrication systems in detail. Describes all representative types of free engine clutches, variable speed gears and power transmission systems. Gives complete instructions for operating and repairing all types. Considers fully electric self-starting and lighting systems, all types of spring frames and spring forks and shows leading control methods.

The Dealer, Mechanic and Expert Rider will find this treatise a work of reference without an equal.

**POPULAR MECHANICS BOOK DEPT.**  
 6 N. Michigan Ave., CHICAGO

## WE WANT A MAN

to call on the automobile trade in your locality. We will pay \$100.00 per month with traveling expenses and commission. If such a proposition interests you, we will be pleased to consider your application.

Employment Dept. **SALES ENGINEERING CO.**  
 336 West 63rd Street CHICAGO, ILLINOIS

## OWN A BUSINESS

**WE WILL HELP YOU**



"I made \$88.16 first three days," writes Mr. Reed, of Ohio. Mr. Woodward earns \$170 a month. Mr. M. L. Smith turned out \$301 in two weeks. Rev. Crawford made \$7.00 first day. See what they have done, judge what you can do.

**LET US START YOU**

in Gold, Silver, Nickel and metal plating. Prof. Gray's new electromachine plates on watches, jewelry, tableware and metal goods. Prof. Gray's New Royal Immersion Process latest method. Goods come out instantly with fine, brilliant, beautiful thick plate, guaranteed three to ten years. No polishing or grinding. Every family, hotel and restaurant want goods plated.

**PLATERS HAVE ALL THEY CAN DO**

People bring it. You can hire boys to do the plating as we do. Men and women gather work for small per cent. Work is fine—no way to do it better. No experience required, we teach you. Recipes, Formulas, Trade Secrets Free. Outfits ready for work when received. Materials cost about ten cents to do \$1.00 worth of plating. Our new plan, testimonials, circulars and SAMPLE FREE. Don't wait. Send us your Address anyway.

**GRAY & CO., PLATING WORKS**  
 714 Gray Building CINCINNATI, OHIO



**5742**  
 Articles  
**5482**  
 Illustrations  
**2436**  
 Pages

**PRICE**  
**\$5.50**  
 Prepaid in Any Address  
 Any of the single numbers in this series will be sent postpaid at 50c Each

## An Encyclopedia of Easy Ways to Do Hard Things

### Shop Notes Sets—11 Vols.

This great series of books is a veritable "gold mine" of easy ways to do hard things and will make an encyclopedia of priceless value to the owner.

The subjects treated cover every department of mechanics with useful, time and labor-saving kinks for all the trades. Here is the experience of years of hundreds of successful mechanics—"Written so you can understand it"—and of equal value to the professional worker and the amateur.

**Popular Mechanics Book Dept.**  
 6 N. Michigan Ave., CHICAGO



 REGAL

## Power *with* Economy

Unquestionably, if all Regal owners could give expression to their opinion of the dominant feature of Regal cars—the one outstanding fact would be their unlimited power.

They are always hungry for the hills, and at a touch of the throttle leap forward as only an engine with surplus power and perfect balance can. Yet this power is secured with the greatest economy.

Now, there are Three Regals, all of the same rugged design and construction which has characterized Regals for eight years. Surely among them is one suited to your needs—and your pocketbook.

A Light "Four," 106-inch wheel base.....	\$ 650
A Standard "Four" .....	1085
A "V" Type "Eight" .....	1250

All are completely equipped—electric lights, horn and starter—one man top, demountable rims included. All are comfortably roomy, have full streamline bodies, and crown fenders.

### REGAL MOTOR CAR CO.

505 Piquette Avenue  
DETROIT, MICH.

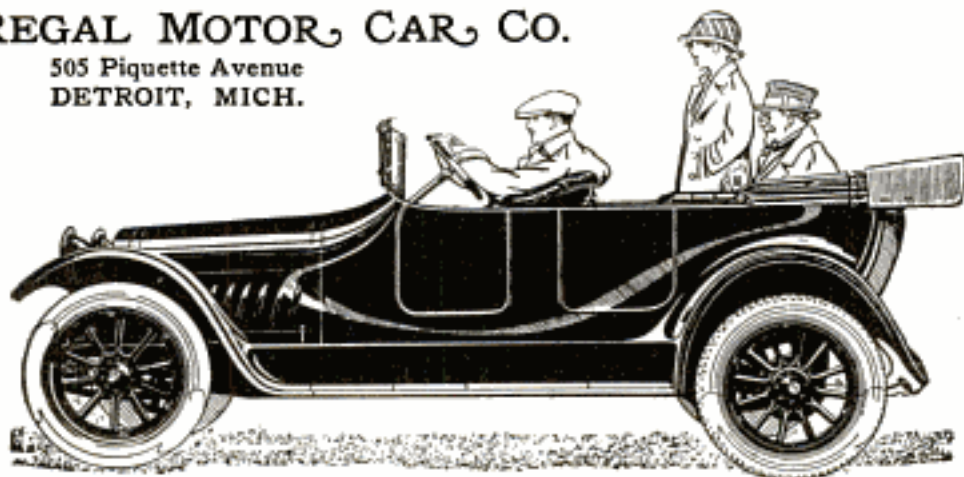

## The Most Fascinating Continued Story in the World

Is now being written in a most fascinating way—in the symbolic literature of Cartoons. The Opening Chapters are still full of interest, making a complete pictorial history of the World War, and may be had in the files of CARTOONS MAGAZINE from October. Hundreds of requests have been received for these back numbers. There are still some left at 25 cents each. 8 numbers, including May, \$1.50.

# CARTOONS MAGAZINE

Address: CARTOONS MAGAZINE, 6 North Michigan Avenue, CHICAGO, ILL.

# DIAMONDS

Moderate Prices  
Easy Terms



Buy NOW That Diamond for Your Wife, Sweetheart, Sister

or yourself now—Don't wait until you get the money—buy from us now at these startlingly low prices—and pay for it in easy little amounts from time to time. Buy direct from importers and Save Dealers' Profits. We give **Certified Guarantee with every Diamond**—guaranteeing its weight and quality. A safe way to buy and save money—no inconvenience—and have the Diamond now when you want it. Perfectly cut white Diamonds, gleaming, sparkling, scintillating—genuine high quality. Not a cent to pay until you have carefully examined the Diamond—then if you are perfectly satisfied pay 1/5 down and take the stone on our easy terms plan. We send you free magnifying glass. Any diamond in our

### FREE ILLUSTRATED

### DIAMOND AND WATCH CATALOG

will be sent for examination without obligation. This offer is open to every honest person—open to YOU. Note the wonderful values shown here. Compare these prices with others. We import the rough Diamonds, cut them here, save 33 per cent duty. Give the saving to you. Write today for our BIG CATALOG and see our **Special World-Beating Offers**. All diamonds, also watches, on easy terms. Send for Catalog today.

THE WALKER EDMUND CO.,  
DIAMOND IMPORTERS

Dept. C

State and Madison,  
CHICAGO,  
ILL.



**HERE YOU ARE, BOYS** A medallion pin of Foxy Grandpa. Everyone will notice it on the lapel of your coat and try to get a closer look at it. All you have to do is press the bulb. Foxy Grandpa will finish the job by squirting a fine stream of water over the inquisitive one. Will squirt 20 feet. Greatest joke out. Order one today and fool your friends. Price 15c. Foxy Grandpa and Hooligan both for 25c. 5 for 50c or 1 doz. for \$1.00. A beautiful fountain pen free with every \$1.00 order.  
AMERICAN SUPPLY CO., 918 Union St., St. Paul, Minn.

**CACHOO!** Make the whole family and all your friends "just sneeze their heads off" without knowing why, with Cachoo, the new long distance harmless snuff. Sent anywhere for 10c. 3 for 25c. 1 doz. and special premium for 90c. AMERICAN SUPPLY CO., St. Paul, Minn.



SEND FOR OUR CATALOG OF

## Mechanical Books—FREE

POPULAR MECHANICS BOOK DEPT., 6 N. Michigan Ave., CHICAGO

## THE DESTRUCTIVE WORK OF A SUBMARINE

can be best understood by studying our Chart of a Modern Submarine, size 14x28 inches; printed on plate paper and showing and naming over 200 parts. This chart is a cross-sectional view (lengthwise) and shows the entire construction and operation; is really an encyclopedia of a submarine; educational and worth many times its cost.

**PRICE 25 CENTS POSTPAID**  
POPULAR MECHANICS BOOK DEPT.  
6 N. Michigan Ave., CHICAGO

## Popular Mechanics Handbooks

PRICE

**50 Cents**  
EACH, POSTPAID

A series of high-class, up-to-date books on mechanical subjects, "Written so you can understand it." Clearly printed on high-grade book paper and durably bound in cloth. Size, 5x7 inches. Each book contains many original illustrations.



**Mission Furniture, How to Make It**  
(In Three Volumes)—Each book gives plain directions and working drawings.

Part 1—30 Designs, 128 Pages—69 Illustrations.

Part 2—32 Designs, 128 Pages—69 Illustrations.

Part 3—36 Designs, 128 Pages—77 Illustrations.

**Wood-Working for Amateur Craftsmen**

Explains every cut, joint and process, proper use and care of tools, working up of material.

128 Pages, 125 Illustrations.

**Arts-Crafts Lamps, How to Make Them**

16 beautiful lamp designs with instructions, working drawings and illustrations.

96 Pages, 50 Illustrations.

**Lamps and Shades in Metal and Art Glass**

19 designs in four different kinds of construction; built up, soldered, etched and sawn shades.

128 Pages, 64 Illustrations.

**Metal Work and Etching**

A complete manual for art metal workers. Tells how to make a variety of articles, such as desk sets, jewelry, hinges, match boxes, pipe racks, etc.

96 Pages, 50 Illustrations.

**Electroplating**

One of the best books ever written on this subject. It is by a practical plater of 30 years' experience.

112 Pages, 62 Illustrations.

**Wireless Set, How to Make**

Explains the construction of an outfit for transmitting four or five miles.

96 Pages, 11 Illustrations.

**Metal Spinning**

A practical working manual on this fascinating art.

80 Pages, 33 Illustrations.

**Heat**

An immensely interesting and instructive book pertaining to heat and its relation to modern mechanics.

128 Pages, 50 Illustrations.

**The Kingdom of Dust**

A remarkable book dealing with a scientific subject in a non-technical manner.

128 Pages, 40 Illustrations.

ADDRESS

Popular Mechanics Book Dept.  
6 N. Michigan Ave., CHICAGO



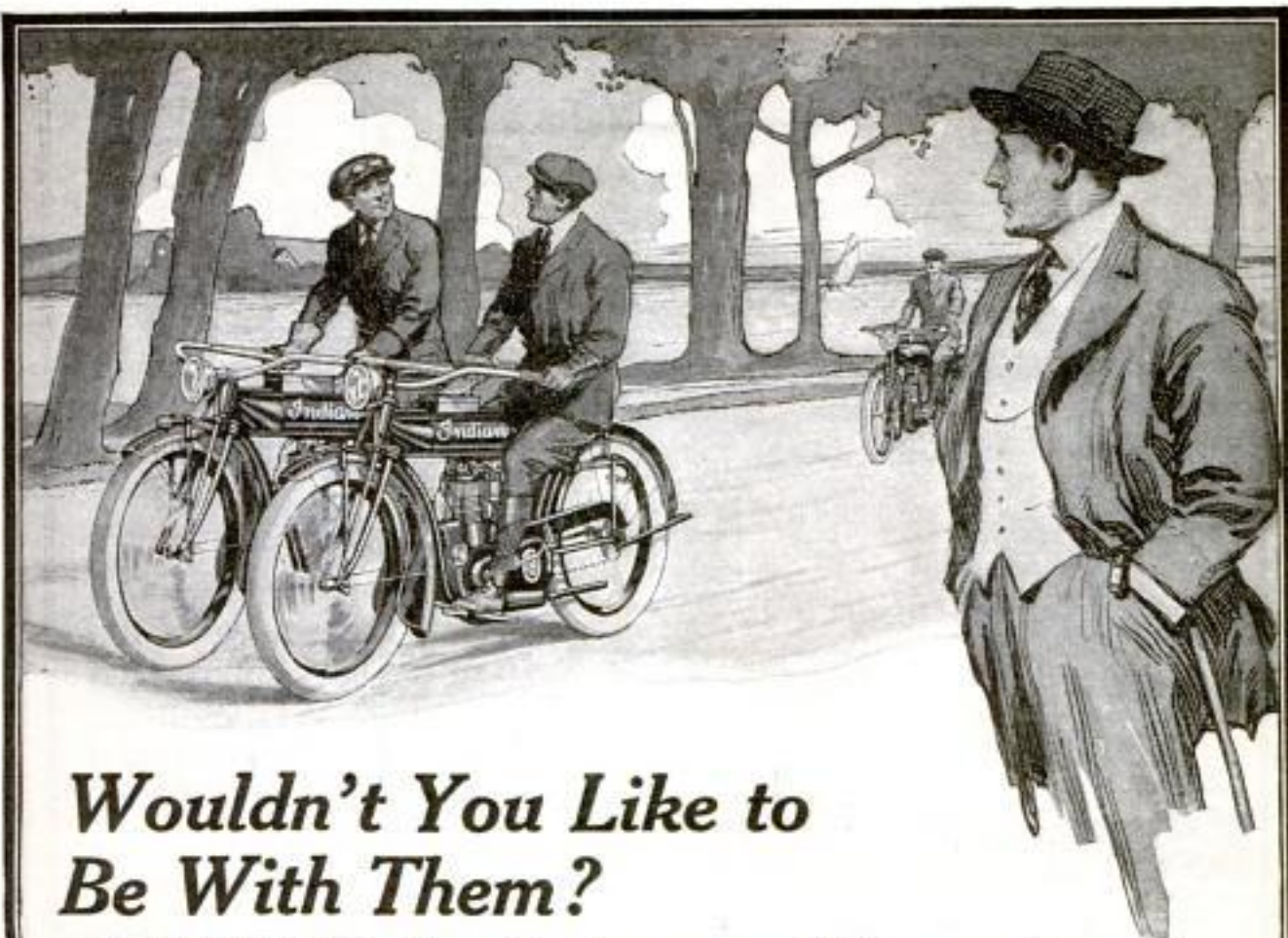

## Wouldn't You Like to Be With Them?

ANYWHERE along the byways and highways, far out into the open country which invites the red-blooded, freedom-seeking man you will find the invigorating, joy-giving 1915

# Indian Motorcycle

Once you own an Indian, the spirit of life tingles in your veins—the exhilaration of power thrills you—the world lies before you to explore—the joys of touring are yours.

Beyond the hills lie the long, sloping valley, the broad plains, the mountain retreats, the winding ribbon of the challenging road. The rhythmic purr of the Indian engine bespeaks unlimited power,

speed, endurance. The gentle resiliency of the famous *Cradle Spring Frame* imparts a comfort, ease, luxury, buoyancy that knows no parallel.

Responding to your every touch, the Indian goes where you will with that mechanical ease and precision that have given it, for over 14 years, *popular international preference*.

One, Two, and Three-Speed Models.

2,800 Indian dealers—everywhere—assure over-night service—anywhere.

Send for Beautiful Indian Catalog showing Nine Big 1915 Indian Innovations.

**HENDEE MANUFACTURING COMPANY, 711 State St., Springfield, Mass.**

*(Largest Motorcycle Manufacturers in the World)*

*Branches and Service Stations:*

Chicago Minneapolis Kansas City San Francisco Atlanta Dallas Toronto London Melbourne

Please Mention Popular Mechanics

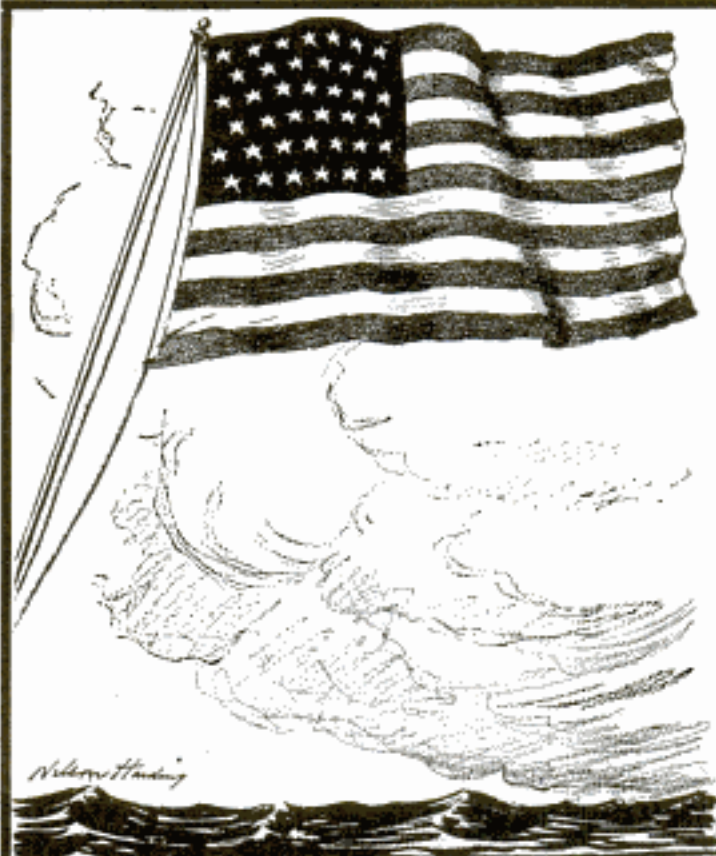

*Handling in Brooklyn Eagle*

**HANDLE WITH CARE**

# America First!

The United States, caught between two fires, has been led to the very water's edge of War. A crisis, possibly the gravest in the nation's history, is impending.

The Cartoonists of the country have interpreted the spirit of the times. At last they have found a subject on which they can turn loose, unhampered by the necessity of remaining neutral.

## Cartoons Magazine

*(Published by H. H. WINDSOR, Publisher of Popular Mechanics Magazine)*

In its May issue will present the cream of this work—a collection of cartoon masterpieces which will become historic. Again the rattlesnake flag has been raised as a warning to the foreign nations to respect our rights. Uncle Sam is seen thoroughly aroused. "America First!" is the call that goes out to the nation.

Other cartoons from foreign journals and newspapers will show why the monarchs of the Old World today are fearing that the Twilight of the Kings is upon them. Here are the cartoons that rock the very thrones of Europe; that have caused King George and Queen Mary to attempt their suppression; that record what is going on under the surface.

These cartoons tell more than editorials. They grasp the situation at a glance. They reflect the opinion of the masses.

***It is the voice of the people themselves that is speaking***

The Grapes of Wrath are being trod in Europe. Swayed by waves of passion, the Cartoonists have begun to show to just what lengths the orgy of hatred and bitterness has been carried. Some of the cartoons will shock you, but they will make you want to get down on your knees and pray to the Almighty that the horror will soon end.

There is no space here to outline other features of the May number.

**FOR SALE AT ALL NEWSSTANDS  
or at 6 N. Michigan Avenue, Chicago**

**SINGLE COPIES 25 Cents. \$3 a Year**

**A dollar bill and the attached coupon will bring you a four months' trial subscription**



**CARTOONS MAGAZINE  
6 N. Michigan Ave., Chicago**

Enclosed find \$1.00 for which please send Cartoons Magazine to my address for four months.

Name .....

Street .....

City .....

**Built for  
Speed and  
Endurance**



**Firestone Net Prices  
to Motorcycle Owners**

	Case Corr.	Case N. S.	Tube Gray	Tube Red
28x2 1/2" to fit BB rim	\$6.50	\$7.00	\$1.70	\$1.90
29x2 3/4" to fit BB rim	7.50	8.00	1.75	2.00
28x2 3/4" to fit CC rim	7.50	8.00	1.75	2.00
28x3" to fit CC rim	9.25	9.75	2.00	2.25

# Firestone

## MOTOR CYCLE TIRES

**A**LL the quality that gives Firestone Automobile Tires their supremacy is built into Firestone Motorcycle Tires.

Motorcyclist and side car owners are proving this Firestone quality on the hardest roads and climbs—in the fastest races—and it is being proved by the heavily loaded delivery cars.

Extra broad, high tread assures effectual road grip. Lean to your fast turns safely. Firestone construction means longest service and freedom from tire troubles.

### Then Why These Low Prices?

Specialized production on enormous scale—these tires are made in America's largest tire and tube factory. The largest tire distributing organization. Big saving in getting tires to you. A

policy of small profit for big volume. These are some of the reasons why you can buy Firestones at the low prices quoted above, and get—

**"Most Miles per Dollar"**

**Firestone Tire & Rubber Co., Akron, Ohio—Branches and Dealers Everywhere**

*"America's Largest Exclusive Tire and Rim Makers"*

Please Mention Popular Mechanics

Copyrighted material



**\$1.00 for this**

The Sonora Multi-Playing Jewel Needle which will save your records and bring out their beauty and harmony in away not possible to the old-fashioned scratchy, constantly-changed steel needle now being rapidly discarded by careful people. You have been told that the steel needle must be used but once because it wears the record. This is very true and it begins to wear the record the minute it starts and keeps on wearing it more and more.

The Sonora Multi-Playing Jewel Needle sells for one dollar and is guaranteed to give perfect satisfaction under daily use for three months.

Send One Dollar at our risk today with the name of your dealer.

**SONORA PHONOGRAPH CORPORATION**  
Makers of the Sonora Phonograph and Sonora Multi-Playing Needle  
Geo. E. Brightson, President  
57 Beale Street, NEW YORK

**\$50 to \$250 PER WEEK** Money's yours; easy; no on to landslide; 12,000,000 want it! Think of it! 12,000,000 homes

in the U. S. and a woman in every home waiting to see, willing to buy this wonderful Easy Wringing mop; easy to operate; keeps woman's hands always dry; she wants it, is eager to buy; Mr. Panschi sold 3 dozen in 12 hours, profit \$20.60; Mr. Munger (Mich.) made \$28 in 3 days; agent's profit 150 per cent; risk a penny to bring a flood of success; send postal for agency, full description; don't wait.

**THE U. S. MOP CO., 306 Main St., TOLEDO, O.**

**THIS \$2 ENGLISH STEEL**

ONLY **69c**

Built for service—best English steel, 2 blades evenly tempered, fine cutting edge—has light heavy bolstered. A beautiful bargain—not sold in stores. Only one of many bargains of all kinds shown in our new 1917 catalog 28, just mailed. Better copy today. Buy frantically and save money.

**CIRCLE H SPECIALTY CO.**  
TOLEDO, OHIO



**FREE Try-On**  
of These Everwearing  
**RACINE**  
Aluminum Shoes

Soles durable aluminum. Lighter than steel and outwear it. Outwear many pairs of leather. Racine Aluminum shoes wear better than any other metal shoe.

**Patent Rocker Bar Helps You Walk**  
Makes walking easy. Comfortable as carpet slippers, yet waterproof, slushproof, puncture-proof. Protect you from Gout, Rheumatism, Lumbago, Pneumonia. Write for Free Book: *Aluminum the Sole of Health*.

**RACINE ALUMINUM SHOE CO., Dept. 73, RACINE, WIS.**



Save Your Shoe Money

**700 Things For Boys To Do**



**700 Things For Boys To Do**

## THE BOY MECHANIC

**The Ideal Book for the Wide-Awake American Boy**

**480 Pages—700 Articles—800 Illustrations—Cloth—Price \$1.50 Prepaid**

All the things described in this volume have actually been built or experimented with by boys. The ideas contained in "The Boy Mechanic" would more than keep a boy occupied until he grows up and also be an incentive to original thinking and achievement.

### The Most Interesting Boys' Book

Unlike so many other books of a somewhat similar nature, it is not confined to only one or a few subjects but describes 700 different things boys can make and do in the fields of mechanics, electricity, sports, arts and crafts work, magic, etc.

An unusually generous book; size 7 by 10 in. and 1 1/4 in. thick; printed from large, clear type on high grade book paper and durably bound in cloth. Attractive four-color cover design.

### Wholesome, Practical, Instructive

Besides telling how to make scores of things useful about the house, full and complete directions are given for constructing the following and hundreds of other things which appeal to the heart of every boy.

Many Electrical Appliances—Steam and Gas Engines—Turbines—Motors—Wireless and Morse Telegraph—Self-Propelled Vehicles—Toboggans—Ice-Boats—Canoes—Paddle Boats—Punts—Camping Outfits—Tents—Fishing Tackle—Magic Lanterns—Searchlights—Cameras—Telescopes—Gliders, Kites and Balloons—Electric Furnaces—Lathes—Pottery Kilns, etc.

Many hours of enjoyment are in store for the boy who becomes possessor of this book.

**PRICE \$1.50, PREPAID TO ANY ADDRESS**

Your book dealer will supply it or you can send direct to the publishers

**Popular Mechanics Book Department**  
6 N. Michigan Ave., CHICAGO

Please Mention Popular Mechanics

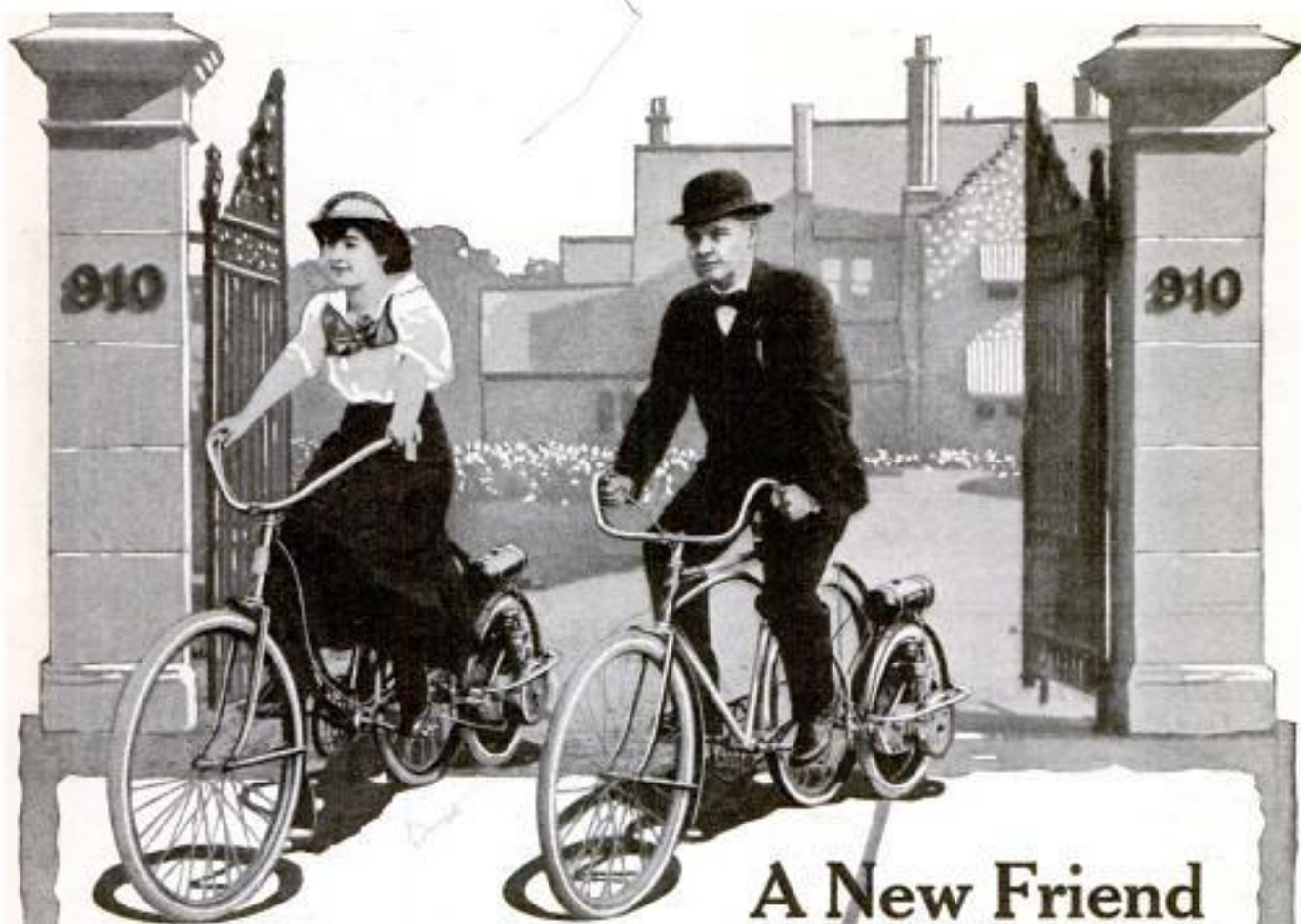

## A New Friend for every Lover of the Big Outdoors

A detachable Bicycle Motor—think what that means! A thoroughly practical, easily operated motor that you can attach to any bicycle in five minutes. It will take you anywhere you want to go at a speed of 4 to 20 miles an hour and will run 100 to 125 miles on a gallon of gasoline. The

**Smith** Motor  
Wheel

travels boulevards or rough roads and climbs hills with ease. Full control from one small thumb lever on handle bars of bicycle. Because the Smith Motor Wheel is so cleanly, simple and vibrationless and affords all the pleasures of bicycling **with the work left out**, "Motorwheeling" is fast becoming the most popular outdoor sport in America.

Write for "Motorwheeling," the big, free catalog and learn where you can see and ride a Smith Motor Wheel.

**A. O. Smith Company,** Motor Wheel  
Division 48 **Milwaukee, Wisconsin**  
*Largest Manufacturers of Automobile Parts in the World*

*Please Mention Popular Mechanics*



*A Few  
Harley-Davidson  
1915 Features*

Three-Speed Sliding Gear  
Transmission.

11 Horsepower Motor.

Enclosed Valves.

Automatic Mechanical  
Oil Pump.

Step-Starter.

Improved All-Steel Muffler.

Harley-Davidson Hubs.

Harley-Davidson Band  
Brake.

Harley-Davidson Clutch.

Double Clutch Control.

Full-Flotation Seat.

Electric Lighting Equipment  
if Desired.



## Why The 1915 Harley-Davidson Won The National Championship

**T**HE winning of the one hour National F. A. M. Championship by a strictly stock Harley-Davidson at Birmingham, Alabama, proved conclusively that the Harley-Davidson was fast—very fast.

But speed alone was not all that was needed. The design, the workmanship, and the materials used, had to be such that the machine could stand the awful grind of mile after mile at terrific speed. And remember this was not a specially made machine but a regular stock model, such as you can buy of any Harley-Davidson dealer.

Here then is proof that the 11 H.P. Harley-Davidson motor (horse power guaranteed) really delivers the power and that the Harley-Davidson automatic oil pump oils as perfectly at 70 miles an hour as at 3. The winning of the National Championship corroborated the experience of thousands of Harley-Davidson rid-

ers and was added proof that the 1915 Harley-Davidson had even more 'staying qualities' than the models of previous years. Add to this such comfort features as Double Clutch Control, a simple efficient Three-Speed and extra long Foot Boards and you have a few of the reasons why this is—Harley-Davidson Year.

Any Harley-Davidson dealer will be glad to explain to you in detail the many superiorities of 1915 Harley-Davidson or if you desire we will gladly send you a catalog on request.

## Harley-Davidson Motor Company

Producers of High Grade Motorcycles for Nearly Fourteen Years  
411 B Street  
Milwaukee, Wis.



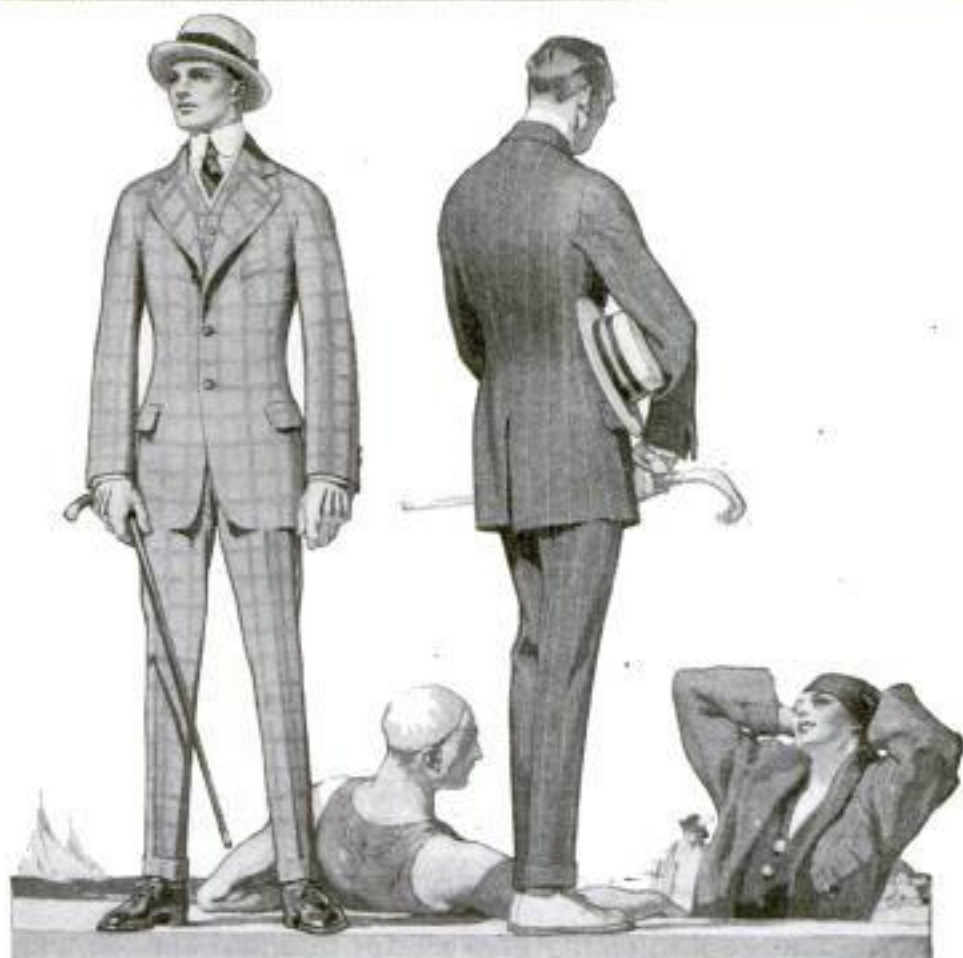

Copyright Hart Schaffner & Marx



## Varsity Fifty Five

You see how it looks front and back; just as many people see you one way as the other.

Young men are showing how much they know about smart style in the way they take to it; what suits young men, suits all men.

Look at the suits at \$25; you'll get fine quality and great value at that price.

Our label in clothes is a small thing to look for, a big thing to find.

### Hart Schaffner & Marx

Chicago

Good Clothes Makers

New York



20 — 35 — 50

**At twenty** Bill thinks he's pretty lucky to be making two or three dollars a day. A husky, hard-working young fellow like himself is always sure of a job, so he isn't worrying about the future.

**At thirty-five** Bill wakes up to the fact that he can't earn a cent more than he could at twenty. There's still plenty of work for him, but the old wage doesn't go very far now that he has a family to support. Still, he's making enough to live on, and is content to let the future take care of itself.

**At fifty**, his usefulness about gone, poor Bill makes way for a younger man. Unfitted to make a living except as a common laborer, he'll have to struggle along on the few odd jobs that come his way. His future looks mighty blue to him now—he wishes he could have seen what was coming.

This is the fate of the untrained man—the man who works with his hands. Assured of steady work while he's young and strong, it doesn't occur to him that old age will rob him of his only means of support—that he'll be discarded like a worn-out machine.

### Your Opportunity Coupon

Mark the position you want  
and mail the coupon now

- |                                 |                             |
|---------------------------------|-----------------------------|
| ..... Electrical Engineer       | ..... Lawyer                |
| ..... Elec. Light & Power Supt. | ..... Business Law          |
| ..... Hydroelectric Engineer    | ..... Business Manager      |
| ..... Telephone Engineer        | ..... Auditor               |
| ..... Architect                 | ..... Accountant            |
| ..... Architectural Draftsman   | ..... Cert'd Public Acctant |
| ..... Building Contractor       | ..... Private Secretary     |
| ..... Building Superintendent   | ..... Stenographer          |
| ..... Structural Engineer       | ..... Bookkeeper            |
| ..... Structural Draftsman      | ..... Fire Ins. Inspector   |
| ..... Mechanical Engineer       | ..... Fire Ins. Adjuster    |
| ..... Mechanical Draftsman      | ..... Fire Ins. Expert      |
| ..... Civil Engineer            | ..... Sanitary Engineer     |
| ..... Steam Engineer            | ..... Plumber               |
| ..... Shop Foreman              | ..... Reclamation Eng.      |
| ..... Shop Superintendent       | ..... Textile Boss          |
| ..... Sheet Metal Draftsman     | ..... College Preparatory   |

We also prepare for civil service examinations in all engineering subjects

NAME .....

ADDRESS .....

Pop. Mech. 5-15

### What about your future?

What will you be at fifty—a broken-down laborer or a prosperous professional man? Will you be walking the streets in search of work, or enjoying a comfortable income? The time to decide is now—before you're a day older. Will you fit yourself for something better than a laborer's job—will you make your future secure?

For over eighteen years the *American School* has been training men everywhere for important posts in life. It has trained thousands for entrance into the big resident colleges. It has trained even more in all branches of *Engineering, Business and Law*. The *American School* will give you the training you need to become a successful, well-to-do man, no matter where you live or what you do. You won't have to give up your work—we train you at home, in your spare time. Not only this, but you can pay for your course as you progress.

Fill in and mail the coupon now—it's the first step toward an independent old age.

# American School

of Correspondence, Chicago, U.S.A.

This school has no connection with any other school using the name "American"

Please Mention Popular Mechanics

# Earn over \$60 a week

## Repairing Auto Tires

### No Experience Necessary— We teach you everything *Free!*

Here's the chance of a lifetime—an opportunity to cash in on the great amount of money spent for automobile repairs, 90% of which goes for tires. Every car owner in your town is a possible customer. Tires blow out every day. Jobs are plentiful—always. The money will come rolling in fast. There's no stopping it once you are known as a tire repair man.

### Make Over \$10 a Day

No other proposition ever laid before you offers such a chance to make money without capital or previous experience. You can start right in making money the day you receive the outfit. No need to solicit trade. Your sign "Tires Vulcanized and Repaired" will bring your customers coming to you. If you have a repair shop—so much the better. This outfit will treble your ordinary profits in no time. Work can be done by your present help.

## **SHALER** Vulcanizing Outfits

are coining money for thousands of enterprising men in every part of the country where automobiles are used. Shaler Vulcanizers are the accepted standard and known everywhere. Remember, they are so simple to operate that no previous experience is required. Instructions are complete and easily understood. Anyone with ordinary intelligence can make a perfect repair the first time they try. Everything is automatic so mistakes are practically impossible.

### Week's Business Pays For the Outfit

Think of that! The expense involved in getting started is so small that just about a fair week's business will pay for the Shaler Outfit. Then what you take in afterwards is all "velvet." And the profits are enormous. You will be surprised how easily the money will keep rolling in—the year round.

**Send the Coupon Now** Write today—at once. Don't delay—the automobile season is just starting to open up big. Tire repairs will soon be needed every hour of the day. You can get all the business in your neighborhood if you want it. *Send the coupon today—now—at once.*

C.A. SHALER CO., 1502 Seventh St., Waupun, Wis.

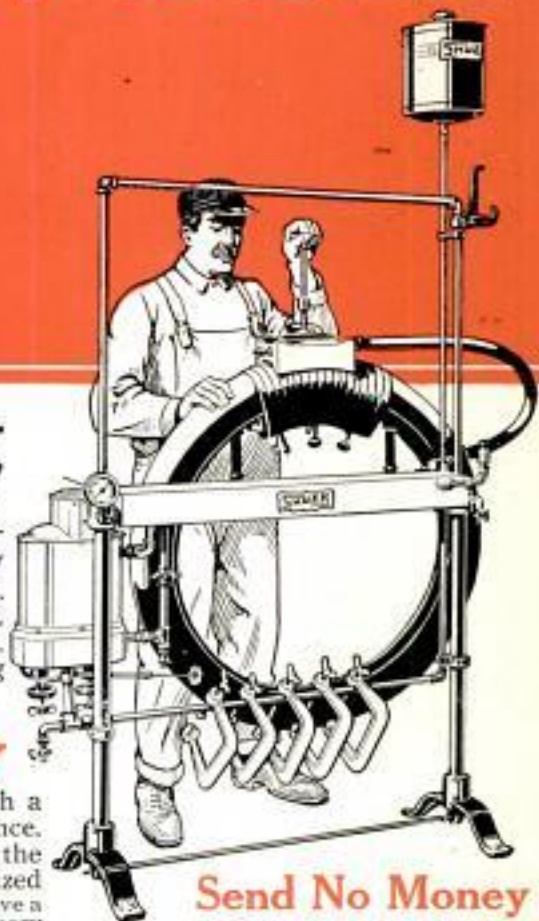

### Send No Money

Investigate this now before some other wide-awake fellow gets ahead of you. Don't send a penny. Get all the particulars first. Learn the big possibilities in the tire repair field.

### Opportunity Coupon

C. A. Shaler Co.  
1502 Seventh St., Waupun, Wis.

Without any obligation on my part, please send me full particulars about the Shaler improved methods of tire repairing, also special offer on tire repairing equipment.

Name .....

Address .....

**If you can find the woman's statement below, clip it and mail it to us with a letter**

We will send you free a trial size of Colgate's Shaving Stick, Powder or Cream—whichever you wish. If you cannot find the woman's statement, send 4c. in stamps for the trial size. In either case you will prove our statement "You cannot be sure you are using the best till you have tried

# COLGATE'S SHAVING LATHER

*Stick*  *Powder*  *Cream* 

"To show that one can get the money's worth from your shaving stick, I enclose what is left of mine.\* I am sending it to show the complete satisfaction of an old customer."

"Its coming marked the beginning of shaving comfort for me. I am delighted with it. My skin is so tender that shaving usually leaves it irritated and sore, but your Rapid-Shave Powder is soothing."

"Your Shaving Cream leaves that smooth, comfortable, velvety feeling and never leaves the skin with the sensation of having been stretched and the hair pulled out."

"Colgate's leaves no smarting sensation." "I sent for a sample of Colgate's and I want nothing better for my use." "Makes the skin smooth and comfortable with a most delightful and cool feeling not obtained with other soaps." "Colgate's superiority is particularly pronounced in the point of *not drying on the face*. My experience is by no means isolated for I have yet to find a man who having tried Colgate's would go back to the soap he formerly used." "Yours has a heavier and firmer lather than any other I have used." "To any man with a wiry beard and tender skin I most heartily commend Colgate's." "Shaving has been a bug-bear to me—but since I used Colgate's, a real pleasure." "In all the time that I have been using Colgate's, I have never had my face smart though I have used dull razors, cold water and all the other drawbacks. I have a very tender skin." "It is so far superior in smoothness, freshness of scent and otherwise, that I wonder how I ever remained a slave to another so long." "Have been troubled with stinging sensation after shaving and blamed my razor. With your soap and the same razor I enjoy a fine, quick shave." "I shaved with Colgate's today and had the first delightful shave

since I began shaving myself." "Have purchased several sticks for friends who are as much pleased with it as I am." "You don't say enough for it." "It is absolutely the best. I know for I have tried them all." "It is the best I ever used and I have been shaving for 40 years." "With its soothing and softening qualities it is now a pleasure to shave." "I find the lather continues moist until I have finished." "I have more than my money's worth." "The handiest, cleanest and best soap I ever used." "You must try it—it makes your skin look wonderful, so clear and alive. I massage with lather and brush about twice a week. Your skin will respond almost at once and you will have people raving about your complexion as they have about mine this winter." "My morning shave is a luxury since using your soap." "It is all and more than you claim for it." "It is a better lather and lasts longer." Colgate's Shaving Stick, Rapid-Shave Powder and Perfected Shaving Cream are sold everywhere. The satisfaction of the users finds frequent expression in such endorsements as those printed here—which are wholly unsolicited. The name of any writer sent on request.

**Colgate's Needs No Mussy "Rubbing In" With the Fingers**

\*Less than 2 grains left. Even this he could have took on a new stick—no waste with Colgate's



**COLGATE & CO.**  
Dept. 81, 199 Fulton St., New York  
Makers of Cashmere Bouquet Soap—  
*luxurious, lasting, refined.*

