

March

15 Cents

# POPULAR MECHANICS MAGAZINE

WRITTEN SO YOU CAN UNDERSTAND IT

TRADE MARK

An illustration depicting a submarine on the left side of the cover. In the center, a long, cylindrical mechanical component, possibly a propeller shaft or a part of a turbine, is shown. To the right, there is a large, cylindrical mechanical part with several sharp spikes protruding from its top. Below these, there are various mechanical components, including what looks like a propeller and other parts, scattered on a surface. The background is a light blue and green wash, suggesting an underwater or industrial setting.

WAR  
UNDER THE  
SEA

# \$699

## BUYS THE MATERIAL To Build This Harris Home

THIS IS OUR WELL KNOWN  
HARRIS HOME No. 161

### Why Pay Rent?

A home is within your reach—no matter how limited your income.

# 4

#### Big Lumber Shipping Points

The material to build this or any of the more than a hundred modern Harris Homes in our free \$10,000 Book of Plans, can be shipped "direct to you" from our main lumber yards at Chicago or St. Louis, also from our stocks at Washington and Mississippi for quick delivery and lowest freight expense.

A true bungalow design easily built under our guaranteed no shortage no extras system, and positive accurate plans.

No Money Down  
Save 1/3 to 1/2

#### Send Us Your Lumber Bill

We will name you freight pre-aid prices on everything—Lumber, Millwork, Hardware, Plumbing, Heating, etc., that will mean a saving of from 1-3 to 1-2. Upwards of 20,000,000 feet of brand new lumber is in our mammoth stock at all times. We would not dare ship this material without one cent down if we were not certain that you would be pleased.



### BUILD THE HOME YOU HAVE BEEN DREAMING OF FOR YEARS—AT THE PRICE YOU OUGHT TO PAY

#### Our Guarantee Protects You

Greatest of all is this Harris Home Building Plan. A truly wonderful offer—clean and straightforward. This was the first real helpful home building plan. We placed the opening wedge and made it possible for the many thousands of satisfied Harris home owners to realize their dream of years. In dealing with us you reap the benefits of these vital essentials—22 years of expert planning, designing and close study of economy in material and labor. Through all these years we have maintained, with ease, our lead, never finding it necessary to recognize competition. Make us prove this to your satisfaction. It won't cost you a penny to get our offer now—today. Our binding guarantee, backed by every cent of our \$10,000,000 capital stock and surplus, gives you an iron clad protection. You can't possibly go wrong for we take all of the risk.

**THE DESIGN** The Harris Home No. 161, above, is a perfect combination of comfort, convenience and economy; modern in every respect. Six rooms, bath, large closets, pantry and modern stairway. This is but one of the many splendid designs which can be carefully studied from our **Free Plan Book** in your own home during your leisure hours. Mail the coupon below for your copy of our Plan Book today.

**THE MATERIAL** The above price includes all first class lumber, Clear Mission Georgia Pine Interior Trim, Clear Flooring and clear Cedar Shingles, No. 1 Dimension Lumber; up-to-date Hardware. **Ready-cut** door and window frames, inside door jambs; outside door and window casings. All glass in and back puttied—saves time and labor. All Harris homes are of sound construction and are architecturally correct in every detail.

#### Mail Coupon Below Today

#### PLANS FREE

We will send you a complete set of blue print plans of above house, such as would cost you from \$25 to \$100 if drawn up by any reputable architect, upon receipt of the coupon below and \$1. We will also include along with the plans, free of charge, Specifications, Material List and a guaranteed delivered price to your station. If you decide to purchase, you will be credited with this remittance of \$1 on your bill, so you see this service is absolutely free. If the plans did not suit and you are not ready to buy, return them, and 50c will be refunded. We also make plans to order after your own ideas—prices way down. Write us.

#### Plumbing and Heating

You can easily install your own heating plant and plumbing material with the assistance of our free expert engineering service. We show you how to eliminate much of the biggest expenses. Mail the coupon for your copy of our new plumbing and heating book. Complete bathroom outfit, \$37.50. Enamelled bath-tubs as low as \$13. Warm air heating plants, \$67. Steam heating plants, \$85. Hot water heat plants, \$95.

#### Quality Roofing

Our new roofing book is full of practical information. Tells you the correct grade and style of material adapted to your particular purpose. Everything explained by diagrams. Biggest values ever offered, in ready roofing, metal roofing, siding, ceilings, etc. Prices represent savings of from 1-3 to 1-2 in every instance. Mail coupon for FREE copy today.

#### Building Material

Mail the coupon today for our 200-page building material book, replete with bargains in lumber, doors, windows, millwork, paint, roofing, plumbing, hardware, lighting fixtures, mantles, grates, colonnades—in fact, everything in structural materials for the construction of any building. Substantial savings evident in every instance.

Dept. E-7  
Harris Bros. Co.

Send me your Free \$10,000 Plan Book if I am also interested in

Name \_\_\_\_\_

Address \_\_\_\_\_

The Chicago House Wrecking Co. has been favorably known to the public everywhere for more than 20 years as "The Great Price Wreckers." The four Harris Brothers who have been the owners and executive officers through all these years have decided that their best interests require more prominent use of the owners' names and will now advertise and sell their goods under the name of

# HARRIS BROTHERS CO. 35th & Iron Sts. CHICAGO

# Tone and Tone Control

*Two Victrola characteristics*

The Victrola tone is a wonderful thing. It is the tone of pure reality—throbbing with life and power. When you hear the world's greatest artists on the Victrola, you hear them just as truly as though they were singing or playing right before you.

Besides this true-to-life tone there is incorporated in the Victrola the important feature of tone-control—the ability to play each individual selection just as *you* personally want to hear it.

These two distinguishing features demonstrate the perfection of every detail in the Victrola. It not only brings you the world's best music in all its beauty, but enables you to enjoy it to the fullest extent.

There are Victrolas in great variety from \$15 to \$250 and any Victor dealer will gladly demonstrate them and play any music you wish to hear.

Always use Victrolas with Victor Records and Victor Needles—the combination. There is no other way to get the unequalled Victrola tone.



The patented Victor "goose-neck" tone-arm in playing position.

"Goose-neck" sound-box tube—the flexible metal connection between the sound-box and tapering tone arm, which enables the Victor Needle to follow the record grooves with unerring accuracy.

Concealed sounding-boards and amplifying compartment of wood—provide the very limit of area of vibrating surface and sound amplifying compartment, so absolutely essential to an exact and pure tone reproduction.

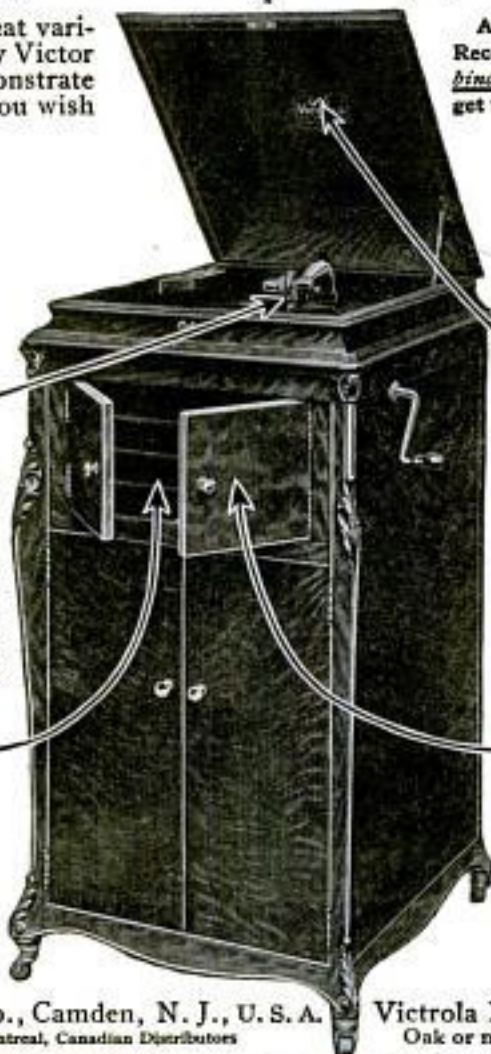

The famous Victor trademark is on every Victrola, Victor, and Victor Record.

Victor system of changeable needles—a perfect reproduction is possible only with a perfect point—therefore a new needle for each record is the only positive assurance of a perfect point. You also have your choice of full tone, half tone or further modification with the fibre needle.

Modifying doors—may be opened wide thereby giving the tone in its fullest volume; or doors may be set at any degree graduating the volume of tone to exactly suit every requirement. Closed tight the volume is reduced to the minimum and when not in use interior is fully protected.

Victor Talking Machine Co., Camden, N. J., U. S. A.  
Berliner Gramophone Co., Montreal, Canadian Distributors

Victrola XVI, \$200  
Oak or mahogany

Here's a "dandy" Free Text  
Book for "Home Carpenters"

12 WORKING DRAWINGS  
 VOL. 36  
**CYPRESS**  
 POCKET LIBRARY  
 "THE WOOD ETHERAL"

"SHORT CUTS" TO  
 GOOD CARPENTRY

BOX SILL CONSTRUCTION  
 JOIST  
 SELF SUPPORTING BARN FRAMING  
 ROOF TRUSS  
 CORNICE DETAIL  
 CYPRESS SHINGLES

"Short Cuts to Good Carpentry"—  
 (Vol. 36, Cypress Pocket Library)  
 48 pages of authoritative instruction (simple, clear and stimulating) fully illustrated and with big Supplement, 24 x 36 in. with detailed Working Drawings that show how to make twelve "hard jobs" easy, safe and economical of both labor and Lumber. Read what "Rural Life," (Rochester, N. Y.) says of

"SHORT CUTS to GOOD CARPENTRY"

"It is a *guide book* for the man or boy who can handle a saw or hammer and wants to know how to use them to the best advantage." Ten topics pertaining to the house and 4 about barns. Sent *free* with our compliments.

**WE TRUST YOUR OWN JUDGMENT** and **SELF-INTEREST** to **INSURE CYPRESS** on **YOUR** job. "The Wood Eternal" keeps values going up by keeping the place from running down.

When planning a Mansion, a Bungalow, a Farm, a Sleeping-Porch or just a Fence, remember—**With CYPRESS you BUILD BUT ONCE. TRY IT.**

Let our "ALL ROUND HELP'S DEPARTMENT" help YOU. Our resources are at your service with Reliable Counsel.  
**SOUTHERN CYPRESS MANUFACTURERS' ASSOCIATION**  
 1219 Heard Nat'l Bank Bldg., Jacksonville, Fla., or 1219 Hibernia Bank Bldg., New Orleans, La.  
 (Please address nearest office)

**INSIST ON CYPRESS AT YOUR LOCAL DEALER'S. IF HE HASN'T IT, LET US KNOW IMMEDIATELY**

# Popular Mechanics Magazine

6 N. Michigan Avenue, Chicago, U. S. A.

EDITED BY H. H. WINDSOR

England: The International News Co.,  
5 Breems Bldg., Chancery Lane, London, E. C.

Australia: The Australasian News Co.,  
126 William St., Melbourne

ISSUED MONTHLY

SUBSCRIPTION:

SINGLE COPY, 15 CENTS

In United States, and its possessions, Cuba and Mexico, per year, postpaid . . . . . \$1.50  
To Canada . . . . . 1.75  
To all other countries in the Postal Union . . . . . 2.50

All subscriptions are discontinued at expiration. Please examine the date printed on your wrapper.

Entered as Second Class Matter Sept. 15, 1905, at the Post Office at Chicago, Illinois, under Act of March 3rd, 1879.

Entered as Second Class Matter at the Post Office Department, Canada.

Published monthly by POPULAR MECHANICS CO.

Copyright, 1915, by H. H. WINDSOR.

Copyright, in France.

## Contents for March, 1915

Acetylene Generator, Gas Consumption Controls . . . . .	339	Dams, Wing, Builds on Ice of Upper Mississippi. 341	
Aeroplane Given Odd Form to Obtain Safety . . . . .	395	Dictating Machine, Moving Parts are Housed on. 391	
Aeroplane Wings, Linen, Better Than Silk . . . . .	409	Dishwasher, New, Works Automatically . . . . .	423
Aero-Sleigh, New, for Use as an Omnibus . . . . .	383	Ditch Digging Eliminated in Laying Cables . . . . .	382
Aluminum Pencils, Using in Glass Etching . . . . .	433	Door, Novel Holder Keeps in Place . . . . .	434
Aluminum Replaces Copper for Transmission Lines . . . . .	366	Drinking Bags, Sanitary, for Horses . . . . .	396
Arrow, Deadly Steel, Used by French Airmen . . . . .	324	Dust Explosions, Cause of, Studied by Government . . . . .	414
Automobile Body, Curious, Cuts Air Resistance. 381		Egg, Serving Cup Keeps Hot . . . . .	436
Automobile Lights, Curtains Eliminate Glare of. 397		Eggs, New Method of Shipping . . . . .	393
Automobile Washer for Garage . . . . .	435	Electric Current, Hat Acts as Conductor of . . . . .	360
Automobiles, Racing with, in Wooden Basin . . . . .	326	Engine, New Rotary, with Horizontal Cylinders. 358	
Bank Vault is Protected by System of Mirrors . . . . .	346	Envelope and Letter in One Piece . . . . .	439
Barber Shop Has Novel System of Fans . . . . .	429	Eye, New Electric Heater for Treatment of . . . . .	410
Bayonets, Training Recruits to Use Skillfully . . . . .	386	Factory Production Efficiency, Machine Shows . . . . .	402
Belts, Thin Steel Ribbons Used for Driving . . . . .	435	Fan Whirled by Simple Device . . . . .	400
Bicycles, Three Speed Hub for Use on . . . . .	426	Fence Post, Concrete, with New Wire Fastening. 438	
Boat Passengers, Landing at Nome, Alaska . . . . .	383	Ferry Which will Bridge Distance to Havana . . . . .	429
Breeches Buoy Line, Anchor Projectile for . . . . .	321	Flagpole, New Kind of, for Large Buildings . . . . .	380
Bridge, Long Truss, Building as Cantilever . . . . .	323	Floors, Dustless Concrete, Method of Making . . . . .	354
Bridge, Peace, is Proposed to Span Niagara River 392		Football Game Signaled by "Human Semaphore" 415	
Bridge, Railroad, over the Snake River . . . . .	417	Fork, Serviceable, for Kitchen . . . . .	436
Bridge, Stone Tree Forms, over Wide Ravine . . . . .	420	Fruit Picking Sack, Simple Form of . . . . .	347
Bucket, Sanitary Delivery, for Ice Cream . . . . .	394	Fuel Combustion Aided by Simple Device . . . . .	435
Building, Explosion of Flour Dust Wrecks . . . . .	390	Fur Bearers, Raising of, Government Experiment 432	
Building, Large, is Moved Eight Miles over Water . . . . .	345	Garage, Automobile, Built on Turntable . . . . .	322
Bunsen Burner, Radial, is Latest Type . . . . .	440	Garbage Pail with Strainer . . . . .	437
Burglar Alarm, Electric, German Invents . . . . .	440	Gas Stove and Fireless Cooker, Automatic . . . . .	345
Burglar Lock and Alarm for Outside Door . . . . .	348	Gear Shifting Indicator for Motor Cars . . . . .	382
Buttons, Pearl, Cutting from Mussel Shells . . . . .	394	Grinding Machine Uses Abrasive Belt . . . . .	341
Canner, New, Required Heat Maintained by . . . . .	420	Gun, Water Cooled Machine, Adopted for U. S. Army . . . . .	340
Capstan, Electric, with Motor Inclosed . . . . .	392	Hammock, New, Has Novel Features . . . . .	412
Car, Gasoline Motor, in Railroad Service . . . . .	381	Handle Worn by Friction of Hands . . . . .	358
Card Holder for Playing the Game of "Kum" . . . . .	355	Heating System, Residence, Dirt and Smoke-Proof 328	
Carts, Beach Sailing, Used by Alaskan Miners . . . . .	324	Hole through Board, Talk during Scientific Test 352	
Cemetery in Open Desert, Typical Mexican . . . . .	380	Hook, Terminal, for Use with Steel Tape . . . . .	438
Church, Ruins of Burned, Encased in Ice . . . . .	356	Horns of Wild Cattle of the Southwest . . . . .	418
Clock, Alarm, Has Mainspring Which is Easily Removed . . . . .	330	Horses, Cost of Raising, and America's Supply . . . . .	421
Clock, Self-Winding, Runs without Attention . . . . .	346	House, Picturesque Twin, of Moderate Cost . . . . .	480
Clock Shows Time around the World . . . . .	428	House with Motto Inlaid in Roof . . . . .	413
Comment and Review, by H. H. Windsor:		Ice Boat Driven by an Aerial Propeller . . . . .	355
Export Trade, Our . . . . .	350	Insulation Material Made from seaweeds . . . . .	324
Safety First Results . . . . .	349	Intrenching Tool, Using as Shield in Battle . . . . .	430
War, European—Harmony Out of Discord . . . . .	349	Ironing Board Cover, Convenient . . . . .	438
Contortionist, Performing, Resembles Frog . . . . .	403	Jack, Base for Adjusting on Sloping Ground . . . . .	421
"Cookie Gun" Uses Dough for Ammunition . . . . .	438	Knife for Cutting Heavy Twine . . . . .	437
Cotton, Archway and Statuary Made of . . . . .	395	Lamp and Mirror, Combined, for Shaving . . . . .	394
Cotton Bales, Searching for Internal Devices . . . . .	342	Lamp, Portable Electric, Serves Many Purposes . . . . .	431
Cotton, Simple Device for Grading . . . . .	360	Lamp Used with Ordinary Dry Cell . . . . .	437
		Leather, American, Effect of Europe's War on . . . . .	434
		Level, Spirit, Determines Degrees of Angulation. 406	

[Continued on Page 6]

Popular Mechanics offers no premiums; does not join in "clubbing offers," and employs no solicitors to secure subscriptions. It is for sale by nearly every newsdealer in the United States and Canada.

This One



QLT8-2ZJ-TL4S

## Contents—Continued

Lumber Rafts, Ocean Going, of the Pacific.....	398
Medals Given to Heroes of Vera Cruz.....	357
Metal Alloy with Valuable Property, Discover... ..	424
Meter Tells Amount of Oil Consumed.....	427
Microscope, Pocket, of High Power.....	400
Mills, German, Use Wind and Steam Power.....	357
Mine Rescue Drills, Fire Drills Replaced by.....	385
Mines, Field, Canadians Drilling with.....	435
Monument to Pioneer in Physical Culture.....	418
Mop with Wringing Device.....	437
Motor Truck, Municipal Service, with Wireless Equipment.....	430
Moving Picture Film, Nonexplosive, Produced in France.....	400
Novel and Practical Things for Daily Use.....	436
Numbers, List of Primes, Compiled in Table.....	416
Nut Bowl with Anvil and Hammer.....	430
Panama Canal, Heavy Grain Shipments through.....	355
Panama Canal, Long Breakwater for.....	439
Panama Canal, Permanent Garrison for.....	338
Panama Canal, Trade Routes through.....	412
Paper and Trash Receiver, Ornamental.....	432
Paper Cap Protects Hat Customer from Infection.....	322
Parcel Post, Household Goods Shipped by.....	356
Parcel Post Rates Shown by Computing Device.....	407
Parcel Post, Shipping Plants by.....	426
Peach Trees, Disappearing, of Colorado Orchards.....	404
Penholder Guide, German Woman Patents.....	435
Photograph, Undersea, An Unusual Kind of.....	359
Plg Casting Machine, Automatic.....	422
Piles, Concrete, Sinking with Water Jets.....	402
Poles, Electric Light, Sand Boxes as Bases for.....	407
Postage Stamps, Machine may Lessen Use of.....	380
Posters, Miniature, Used for Advertising.....	405
"Potato Bug" as Big as a Bungalow.....	326
Projectile Melts Steel by Thermit Process.....	359
Railroad Block Signaling, Beginning of.....	408
Railroad Breaks Record in Handling Troops.....	385
Railroad, Cape-to-Cairo, Runs through Darkest Africa.....	387
Rice Grinding Machine, Siamese.....	428
Rifle, Pneumatic, Carbonic Acid Employed in.....	348
Ring, Adjustable, Fits Any Finger.....	437
Road, Washington-Atlanta, to be Object Lesson.....	398
Roads, Good, from San Diego to Alaska, Over.....	440
Roller Skate, Safety Attachment for.....	433
Ruins, Classical, Made of Concrete.....	384
Saws, Circular, Automatic Guard for.....	424
Sewing Machine, Electric Motor Operates.....	426
Sheep, Persian Fat Tailed, Introduced in Utah.....	403
Shelf, Metal, Easily Attached.....	436
Ship, Apparatus for Steering without Rudder.....	434
Ship—"Britannic," Installing the Equipment of.....	418
Ships, Dummy, Are Targets for British Gunners.....	351
Shoe, New Style Men's, Has Elastic Top.....	344
Shovel, Curious, Made by Boothia Natives.....	352
Sign, Electric, Window Gazers Given Talk by.....	433
Sign, "For Sale," Made of Concrete Letters.....	408
Sign, Restaurant, Appeals to Aerial Tourists.....	414
Signal, Automatic Traffic, for Swinging Bridges.....	409
Silk Output, Increasing by New Culture Method.....	411
Smoke Detector, Electric, Gives Warning.....	393
Snake, Big, Forcibly Fed with Food Gun.....	413
Spring Casing, New, for Flexible Shafts.....	438
Steel Flaws, Discover Valuable Method of Find- ing.....	322
Storm Indicator is Used by Electric Company.....	405
Stovepipe Brace, Simple.....	436
Street Cleaner, Motor, Uses Air Suction.....	427
Submarine Rescue Device of Novel Type.....	411
Submarines—War under the Sea.....	327
Subway Fire, New York, Rescuing Victims of.....	353
Sugar in Show—Valuable Ration for Soldiers.....	386
Telegraph Office, Busy, Distribution System of.....	410
Telephones and Phonographs, Clarifier for.....	325
Telephony—Talking across Continent for First Time.....	357
Tie Rack, Pressing Device Combined with.....	344
Ties, to Grow for Railways of Africa.....	424
Tire, Automobile, with Steel Shoe.....	401
Tire Pumps for Motor Cars Attached to Engine.....	338
Tool, Combination, for Clearing Land.....	407
Tool Guide, Convenient, for Grinding Wheel.....	403
Town of One Street in North Carolina.....	409
Tov, Odd Mechanical, Used as Advertising Novelty.....	339
Tractor, Farm, Costs Less Than Team of Horses.....	417

Transmission, New Magnetic, for Motor Cars.....	354
Trap Gun for Fur Bearing Animals.....	400
Treasure Ship, Search Sea for.....	384
Tree, Fallen Fir, Convert into Long Stairway.....	342
French Digger Driven and Operated by Gasoline.....	344
Umbrella Holder, Compact Metal.....	437
Vehicle, Curious, Made of Odds and Ends.....	425
Vehicles, Curious Land and Water.....	386
Veils, War, the Latest Parisian Fashion.....	421
War, European: British Lines, Curious Glimpses behind.....	377
Curious Glimpses Caught of Europe's War.....	376
Dangers Waiting in the Path of an Army.....	378
Field Artillery Batteries, British and French, Behind-Firing Lines with.....	370
German Stronghold in Far East, Fall of.....	372
Observations, Military, Making under Fire.....	365
Ruin and Devastation Mark Battle Paths in Europe.....	378
Scarborough after the German Naval Raid.....	374
Telephone and Telegraph, Field, in Use.....	362
Tricolor, Beneath, in War Arena.....	369
Troops from Air Fighting in Europe.....	364
Winter Campaign, Hardships Suffered in.....	368
Wreckage along Battle Paths.....	367
Warship "California" to Have Electric Drive.....	438
Warship, "Demologos," First Steam.....	420
Warship, Save, by Blasting Rock from Beneath It.....	412
Washing Machine, Convenient Electrical.....	418
Water, Sulphur Tainted, Treating by Aeration.....	387
Water Wheel, Chinese, of Enormous Size.....	343
Wheel, Automobile, with Resilient Rim.....	432
Windshield to Protect Traffic Policemen.....	352
Wireless Station, Private, of Great Power.....	422
Wooden Thread, Weaving Dress Fabrics from.....	420
Wreck, Mountain Railroad, Has Curious Results.....	348
Wright Patents Valid in England.....	406

## SHOP NOTES

Alarm, Electric Bell, for Passenger Elevator.....	458
Automobile Radiator Cover for Winter.....	460
Automobile Top Holder, Easily Adjusted.....	450
Automobiles, Recoating Worn Plated Parts on.....	457
Barrel, Solid Object in, Kept Away from Opening.....	443
Bath Spray, Pocket.....	433
Brush, Painter's Air.....	442
Can, Gasoline, with Combination Whistle and Vent.....	446
Core Boxes for Square and Rectangular Cores.....	455
Coupling, Simple Flexible, for Transmitting Small Power.....	458
Dog, Safety, for Lathe Work.....	456
Door, Safety Chain for.....	433
Drills, Broken Shank Sockets for.....	458
Dynamos, Direct Current, To Locate and Correct Troubles in—Part I.....	447
Furnaces, To Prevent Dust When Removing Ashes from.....	445
Gun Stock, Recoil on.....	450
Hanger, Coat and Hat, for Shops.....	448
Lock for an Emergency Theater Exit.....	453
Microscopic Cover Glasses, Lifting.....	460
Motorcycle Engine, Starting in Cold Weather.....	446
Motors, Small, Testing with a Magnetic Brake.....	456
Muller Cut-Out Made from Pine Fitting.....	452
Pocket, Clothes, Metal Lining for.....	444
Pulleys, Inexpensive Wood.....	459
Rack for Storing Chain or Rope Tackle.....	453
Rule, Folding, Used as Marking Gauge.....	432
Sign Painter's Palette.....	454
Singletree Used in Orchard.....	455
Soldering Iron Heater, Bench.....	452
Spirit Level Bulb, Broken, Repairing.....	450
Square, Adjustable Precision.....	451
Stamps, Postage, Perforator for.....	451
Steam Trap, Homemade.....	454
Sulphuric Acid, Storing.....	460
Umbrella Equipped with Celluloid Window.....	443
Valve Cap, Bushing to Raise Spark Plug.....	452
Valve Push Rod, To Stop Noise of.....	446
Weed Remover.....	452
Weld, Difficult, by the Chemical Process.....	441
Wheel Spokes, Reducing Traction Power by Fill- ing Space between.....	444
Window Attraction Show.....	451
Window Catches, Pole to Loosen.....	445

[Continued on Page 8]



We will send you postpaid  
a can of

## JOHNSON'S PREPARED WAX

—enough to polish a small floor, a piano, an automobile or several pieces of furniture. **Johnson's Prepared Wax** is a complete finish and polish for all floors, linoleum, woodwork, furniture, pianos, and for the body, hood and fenders of automobiles, limousines and electrics. It is very clean and easy

to use. Gives perfect results over any finish—varnish shellac, oil, etc. Imparts a perfectly hard, dry, artistic finish of great beauty and durability. It is impervious to water, scratches, heel-marks, finger-prints, dust, etc. and can easily be kept in perfect condition.

## JOHNSON'S WOOD DYE

for the artistic coloring of all wood. With it inexpensive soft woods may be finished so they are as beautiful as hard wood. Made in seventeen shades including *Mahogany, Mission, Early English, Fumed, etc.* **Johnson's Wood Dye** penetrates deeply—

is economical—dries quickly and is very easy to use. It has no equal for finishing new furniture, woodwork and floors and for doing over old work of this character—for staining basketry, etc.

### Free Instruction Book

Best paint dealers are supplied with our 25c color booklet "The Proper Treatment for Floors, Woodwork and Furniture." Ask yours for a free copy—if he hasn't one, we will send it free and postpaid upon request. This booklet is the work of famous experts—it is full of valuable ideas on home beautifying, beautifully illustrated in colors.

**S. C. JOHNSON & SON**  
"The Wood Finishing Authorities"  
RACINE, WIS.

S. C. JOHNSON & SON, Racine, Wis.

PA3

I enclose 10c for Instruction Book on Home Beautifying and a can of Johnson's Prepared Wax—sufficient for a small floor, an automobile, a piano or several pieces of furniture.

Name.....

Address.....

City or State.....

We Assist Students Getting Actual Driving Experience



## YOU CAN LEARN the AUTOMOBILE TRADE

### WITH DYKE'S NEW IDEA WORKING MODEL METHOD

#### IF OTHERS CAN, YOU CAN

Bert Tippey, De Soto, Ill., writes us that he knew nothing about autos when he started with us, but is now doing repair work, owns his own car, and owes his success to Dyke's Course.

In a recent letter he states he began repair work before completing course and paid for course out of first job. He started in a small way, but is now doing general repair work. He grinds valves, cleans carbon, greases cars, times valves, sets magnetos, adjusts carburetors, etc., etc., and sells supplies. We started him. We first taught him the principle of all parts and then helped him get his start, just as we can do for you if you have any hustling ability.

Clear a child can understand. If we prove to you that we have started hundreds of others into the repair business and as chauffeurs—who had no previous experience and who knew no more about an auto than you do right now—you must admit we can do the same for you. Write me today—now—and let me prove it.

A. M. Atkin, Repairing, Overhauling and Supplies, Lone Tree, Iowa, R. D. No. 1, in a recent letter says: "I have a lot of repairing to do; have been called upon several times to inspect second-hand cars."

Harry J. Heybin, Jamestown, Kans., was a farmer, but has doubled his income repairing and selling autos.

Mr. G. Strickland, Westport, Ont., Canada, writes us: "I am glad I took your course. Have just overhauled a car; timed the valves and set the magnetos. Owner says engine has more power. This is my first job. Thanks to your course."

Donald Stewart, Oakland City, Ind., became a chauffeur at \$25 a week. H. M. Fawcett and S. T. Slayback, both graduates, are now running a Garage and Repair Shop at Woodbine, Iowa.

And we could continue until we had filled this and several more pages.



Our book of testimonials, showing photos of students and their shops—free.

#### All the Result of the Dyke System

We can thoroughly train you during spare time. Open a repair shop or drive a car and make many times more than you are making now. Don't forget, we help you get your start with our Employment Plan, if you want it.

#### DYKE'S NEW IDEA OF TEACHING BY MAIL WITH WORKING MODELS

is something new. We use real working models—not just one, but five. On these models you get actual practice, see the actual operation and learn more than you could from the auto itself—it's easy and quick. You don't have to study hard with this system—we teach through the eye—a new idea. We are the originators of the system of teaching by mail with models. We also use charts—268 of them and a 16 page manual. Our 40 instructions and Repairman's Instructions are simplicity itself—simple as A B C.

#### Our Employment Plan for Students

This represents years of work to provide something that no other school had, namely, a way for our students to get started in the practical line of work.

Mr. Dyke has been identified as a pioneer inventor, supply man, etc., with the auto industry since its beginning. He originated the first auto supply co., and published the first book on autos in America. No other man with such experience is to-day teaching others. And all the experience and inside information of the auto business he has thus gained, is embodied in this Employment Plan.

#### WRITE TO-DAY FOR THIS FREE BOOK

It is instructive and interesting—does not cost you a cent and places you under no obligations whatever—you need it for your own sake, not mine. Don't wait—there's no profit in waiting—WRITE NOW and learn how you can obtain all this training for only \$15, if you act immediately.



DYKE'S CORRESPONDENCE SCHOOL OF MOTORING  
Box 189, Roe Bldg. ST. LOUIS, MO.

NOTE—Beware of Imitators—Deal with the Originator

Please Mention Popular Mechanics

### (Contents—Continued from page 6)

#### AMATEUR MECHANICS

Bench, Lathe.....	476
Bench with Folding Seats.....	466
Buckle Tongues, Replacing.....	463
Candle, Automatically Extinguishing.....	475
Card, Changing Pip on.....	475
Curtain, Stretching without a Frame.....	466
Doorbell, Musical.....	461
Envelope, Special, To Make.....	475
Fishing Rod Making and Angling: Part I—A One Piece Casting Rod.....	467
Hairpin, Fancy, Lock for.....	464
Lock, Combination Electrically Operated Door.....	464
Photographer's Dark Room, Drying Towels in.....	463
Plots, To Enlarge or Reduce.....	476
Poultry Yards, Automatic Watering System for.....	474
Shaving Cabinet Mounted on an Adjustable Pedestal.....	477
Shoes, Cleaning and Polishing.....	477
Trick Bottles and Glasses.....	465
Wastebasket, Wire, Rim of Wrapped with Felt.....	466
Welding Small Resistance Wire Connections.....	466

#### INTERESTING NEW PATENTS

Air Craft, Steering Apparatus for.....	479
Airship Shelter, Underground.....	478
Camera, Gun.....	478
Corn, Ear, Holder for.....	478
Cup, Collapsible Drinking.....	478
Door Holder and Buffer.....	478
Hedge Trimmer.....	479
Life Preserver, Spherical.....	478
Life Saving Apparatus.....	479
Phonographs, Repeating Device for.....	479
Saw Handle.....	479
Scaffold for Use in Felling Trees.....	479
Ship, Nonsinkable.....	479
Ships, Yielding Fender for.....	479
Shoes, Rubber Oversole for.....	478
Stepladder and Ironing Board, Combination.....	478
Tire Pump Worked by Motion of Wheel.....	479
Washtub and Washboard, Combined.....	478
Wheel, Emergency, for Vehicles.....	479
Windows and Walls, Machine for Cleaning.....	478

### "How to Install Electric Bells, Annunciators and Alarms" NOW READY



**CONTENTS:** The principles of an electric bell. Suitable batteries. Bells, gongs and buzzers. Various kinds of pushes. How to wire for bells. Wiring circuits. Faults in bells and wiring. How to locate and remedy faults. Thermostats. Annunciators and annunciator circuits. Low water alarms. Burglar alarms. Fire alarms. Circuits for alarms. Elevator bell wiring. Bell ringing transformers. Combination circuits. Fire alarm circuits. Clock alarm circuit. Three wire return call system. Interphone circuits.

Price, 55c postpaid

Spon & Chamberlain 123 P. M. Liberty St. NEW YORK, U. S. A.

123 Place the 9 figures so the 2nd row is twice as much as top row and bottom row as much as top and 2nd row added together. All correct replies will receive 25 cents' worth of our iron puzzles with catalog postpaid. Answers not correct will receive solution. Catalog of 200 puzzles and one of our leading 15c products. All answers to enclose 10c. in stamps or coin to cover mailing, packing, etc.

WESTERN PUZZLE WORKS, St. Paul, Minn.

**MAZDA** Always etched on electric lamps to which MAZDA Service has been applied.

**FREE "Linene" COLLAR**  
State size on postal and whether you want collar like cut or low turnover style.  
REVERSIBLE COLLAR CO., Dept. U, Boston, Mass.



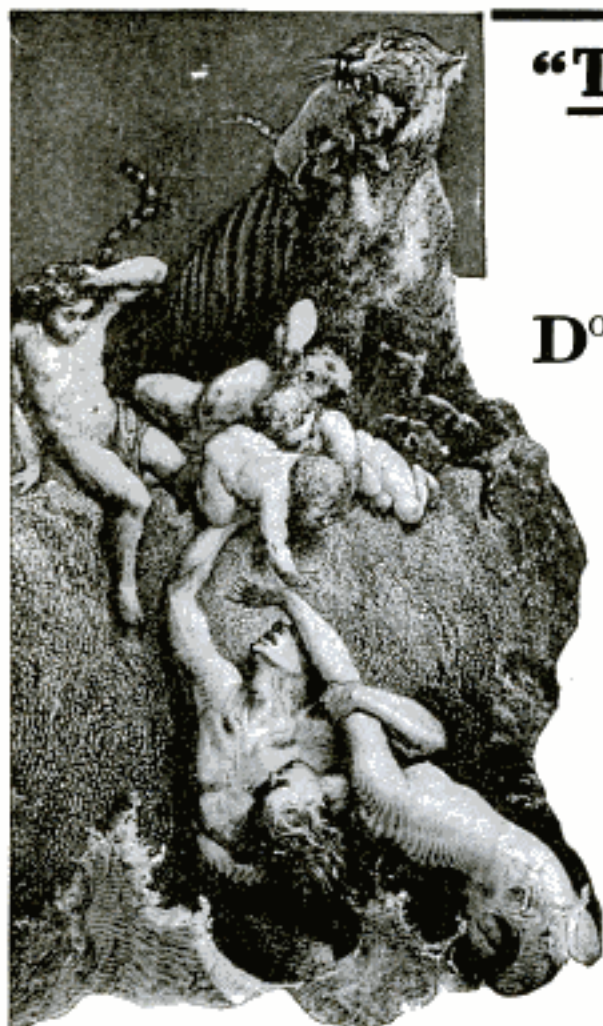

## "The Chaldean Story of the Flood"

### Dug Up From the Ruins of Ancient Chaldea

**D**O YOU KNOW that there has been dug up from the ruins of old Chaldea a complete story of the Flood—the same in every detail as Moses' account in Genesis—and that it was written thousands of years before his version appeared? Hardly one in a million has ever had an opportunity of seeing this startling story—**HAVE YOU?** But it is one of the many thousand curiously interesting accounts in

## The Library of Original Sources

now for the first time available to the general public. Up to the present this remarkable Library has only been sold by subscription, but by taking over the *entire unsold edition* from the publishers we secured it at an *absolutely unheard of bargain*. Therefore we are able to offer the few remaining sets to POPULAR MECHANICS readers at an

## EXTRAORDINARY BARGAIN

Note that the attached coupon specifies that **NO SALESMAN WILL CALL**—no agent's commission to pay. Send the attached coupon **AT ONCE** and we will mail **FREE** a book of rare documents and curious inscriptions and tell of our low price offer **ON EASY MONTHLY PAYMENTS**. Mail the coupon **NOW**. You assume no obligation. No salesman will call. The book is **FREE**.

**THIS MARVELOUS WORK** is revolutionizing modern thought. It's turning upside down old notions and ideas. It gives the authoritative, rock-bottom sources of our knowledge on **ALL SUBJECTS OF HUMAN INTEREST** from the earliest civilization down to today—the inside facts which the average person has never even heard of.

**OVER 100 RESEARCH SPECIALISTS** spent ten years gathering the contents of this great work. Ancient and remote and forgotten civilizations in all parts of the globe were uncovered, and age-buried hieroglyphics on monuments, tablets, sun-baked bricks and palimpsests yielded their secrets; untiring workers ransacked the hidden literature of every age, ancient, mediæval and modern, to find the "original documents" that shaped the civilizations and influenced the thought and life of the world. Nothing like it has ever been attempted or thought of before. You'll be amazed at the wealth of information this unique library contains.

**DO YOU KNOW** that the old Egyptians 5000 years B. C. had a Bible? Do you know the Assyrian literature gives the story of the Creation? Do you know that books and newspapers were printed in Asia thousands of years before printing was invented by Gutenberg? Did YOU ever read Columbus' *personal log* of his great voyage? Do you know that there occurred in Mediæval England the first great Socialist protest? Do you know by what unique process Harvey demonstrated the circulation of the blood? Do you know who Machiavelli was or what world famous treatise he wrote?

**YOU'LL FIND THEM ALL**—and thousands of others equally as curious and important—in The Library of Original Sources. Every document is in the exact words of the original, translated; every contribution is from the actual eye-witness or person who took part; every idea is in the words of the thinker, investigator, discoverer or inventor.

**JACK LONDON SAYS:**—"It is a whole library in itself. I certainly never could spare these books from my shelves."

10 sumptuous, massive volumes, bound in rich, deep red leather; full page illustrations, pure silk headbands, printed in large, clear type on handmade paper, gold tops—a veritable triumph of the bookmaker's art.

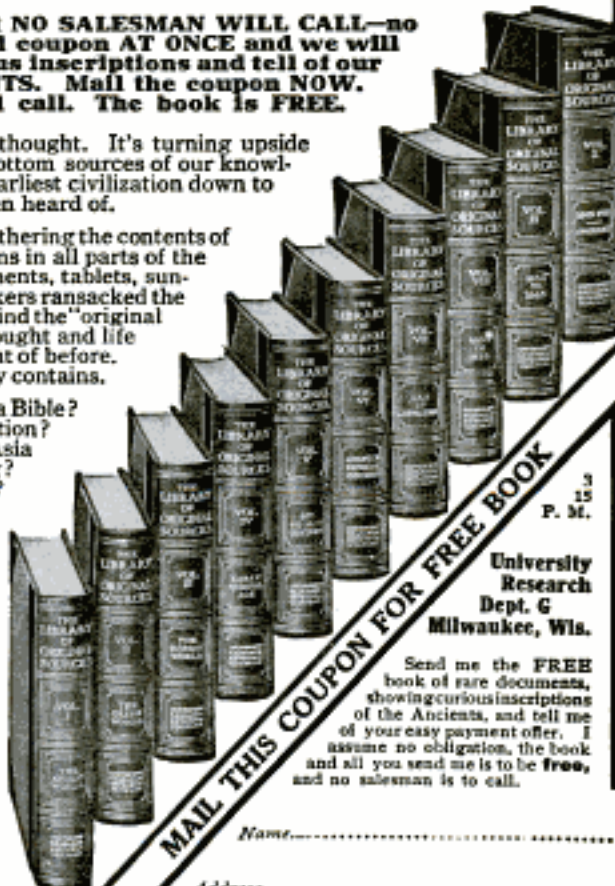

**MAIL THIS COUPON FOR FREE BOOK**

Name.....

Address.....

P. M.

University  
Research  
Dept. G  
Milwaukee, Wis.

Send me the **FREE** book of rare documents, showing curious inscriptions of the Ancients, and tell me of your easy payment offer. I assume no obligation, the book and all you send me is to be **free**, and no salesman is to call.

# THE INTENSE LIFE

How Conscious Energy Makes it Possible for All of Us.

**Become Superior to Your Present Self.** The Swoboda System can make a better human being of you, physically, mentally and in every way. It creates a greater activity of the forces of life which in you are partially dormant, thus compelling them to become more alive and positive, enabling you to grow and evolutionize to a higher state of perfection. The Swoboda System can do more for you than you can imagine. It can so vitalize every organ, tissue and cell of your body as to make the mere act of living a joy. It can give you an intense, thrilling and pulsating nature. It can increase your very life. I not only promise it, I guarantee it.

## WHY BECOME PREMATURELY OLD IN WHOLE OR IN PART?

**Why Take Less Than Your Full Share of Life and Pleasure?** Are you living a full and successful life? Why not always be at your best?—thoroughly well, virile, energetic. Why not invest in yourself and make the most

of your every opportunity? It is easy when you know how. The Swoboda System points the way. It requires no drugs, no appliances, no dieting, no study, no loss of time, no special bathing; there is nothing to worry you. It gives ideal mental and physical conditions without inconvenience or trouble.

**The Swoboda System of Conscious Evolution** is no experiment. I am giving it successfully to pupils all over the world. I have among my pupils hundreds of doctors, judges, senators, members of cabinet, ambassadors, governors, thousands of business and professional men, farmers, mechanics and laborers, and almost an equal number of women



*Pupils are men and women, ranging in age from 14 to 92*

*Originator of  
Conscious Evolution*

*—more than two hundred thousand people have profited through this system.*

**Your Earning Power**, your success depends entirely upon your energy, health, vitality, memory and will power. Without these, all knowledge becomes of small value, for it cannot be put into active use. The Swoboda System can make you tireless, improve your memory, intensify your will power, and make you physically just as you ought to be. I promise it.

# THE BETTER LIFE

## What Others Have to Say:

"Can't describe the satisfaction I feel."

"Worth more than a thousand dollars to me in increased mental and physical capacity."

"I have been enabled by your system to do work of mental character previously impossible for me."

"I was very skeptical, now am pleased with results; have gained 17 pounds."

"The very first lessons began to work magic. In my gratitude I am telling my croaking and complaining friends. Try Swoboda."

"Words cannot explain the new life it imparts both to body and brain."

"It reduced my weight 29 pounds, increased my chest expansion 5 inches, reduced my waist 6 inches."

"I cannot recommend your system too highly, and without flattery believe that its propagation has been of great benefit to the health of the country."

"My reserve force makes me feel that nothing is impossible, my capacity both physically and mentally is increasing daily."

"I have heard your system highly recommended for years, but I did not realize the effectiveness of it until I tried it. I am glad indeed that I am now taking it."

"Your system developed me most wonderfully."

"I think your system is wonderful. I thought I was in the best of physical health before I wrote for your course, but I can now note the greatest improvement even in this short time. I cannot recommend your system too highly. Do not hesitate to refer to me."

"You know more about the human body than any man with whom I have ever come in contact personally or otherwise."

"Your diagnosis and explanation of my brain trouble was a revelation to me. I have had the best physicians of my State, but your grasp of the human body exceeds anything I have ever heard of known. I have read your letters to many people, also to my physicians, who marvel at them."



No woman or man is too weak, old, or too well to profit through the Swoboda personal mail instructions.

**MY NEW COPYRIGHTED BOOK IS FREE.** It explains **THE SWOBODA SYSTEM OF CONSCIOUS EVOLUTION** and the human body as it has never been explained before. It explains my new theory of the mind and body. It will startle, educate, and enlighten you.

My book is not a dry treatise on anatomy and physiology. It tells in a highly interesting and simple manner just what you have always wanted to know about yourself.

You will cherish this book for having given you the first real understanding of your body and mind. It shows how you may be able to obtain a superior life; it explains how you may make use of natural laws for your own advantage.

My book will give you a better understanding of yourself than you could obtain from a college course. The information which it imparts cannot be obtained elsewhere at any price. It shows the unlimited possibilities for you through conscious evolution of your cells; it explains my discoveries and what they are doing for men and women. Thousands have advanced themselves in every way through a better realization and conscious use of the principles which I have discovered and which I disclose in my book. It also explains the **DANGERS OF EXERCISE** and of **EXCESSIVE DEEP BREATHING**.

I offer my System on a basis which makes it impossible for you to lose a single penny. My guarantee is startling, specific, positive and fraud-proof.

Write for my **FREE BOOK** and full particulars today before it slips your mind. Make up your mind to at least learn the facts concerning the **SWOBODA SYSTEM OF CONSCIOUS EVOLUTION** for men and women.

**ALOIS P. SWOBODA**

1249 Aeolian Hall,

New York City, N. Y.



STUDENTS AT LATHE

# YOU CAN MAKE \$25 BY REPLYING TO THIS ANNOUNCEMENT TODAY SWEENEY AUTO SCHOOL

If you ever intend to learn the automobile business here is your chance, and prompt action will make you \$25.00. On April 1st the Sweeney school raises its tuition, as with our magnificent equipment, full enrollment, more teachers, etc., it is costing us \$1600 a month more to teach than it did one year ago. Hence the tuition will be advanced. Write today if you wish to get in under the old terms, and also get a \$50 traction engineering course free. Don't send us any money; we don't take cash reservations; we don't accept one cent until you have seen the school and know what you are getting.

## LEARN IN 6 WEEKS—EARN \$100 A MONTH

We are not a Chauffeur school. We are a mechanical school. We do not guarantee you positions or guarantee to learn you the business. We can teach you, but we cannot make you learn. We guarantee our school to be exactly as we represent it, and if you have a back-bone instead of a wish-bone and come here to school, knowing that you cannot get gold out of a gold mine unless you dig, you can qualify yourself in six weeks' time to earn from \$75.00 to \$150.00 a month, as an automobile repairman, driver, garage manager, salesman, demonstrator, truck driver, Gas Traction Engineer or any branch of the gas engine business that you may wish to follow.

**Free Catalog** We have just issued one of the finest and the largest photographic catalogs ever issued by any automobile school in this country. This valuable book contains 115 illustrations, actual photographs, showing the students here in the school at every phase of repair work on automobiles and traction engines. It is practically a moving picture show, demonstrating the unique advantages of the Sweeney System of Practical Experience. How men are taught in six weeks' time every detail of the automobile business and are fitted to earn \$75.00 to \$150.00 a month as skilled mechanics, garage owners, etc.

It tells you how we teach the business, the opportunities there are for the skilled man and shows hundreds of letters from our graduates who are making good. If you are mechanically inclined you should get this catalog. It costs us 50 cents apiece to publish it, but we will send it to you absolutely free, also one of our papers which gives a full description of the new Cadillac eight-cylinder car. The Sweeney School uses in teaching its students the new eight-cylinder Cadillac car. We have also just purchased 2 more complete Delco systems, making 8 in all.

Simply send name today, if you are interested, and you will receive what hundreds of men have said to be the most complete catalog ever issued and it is absolutely FREE to you. It is the only book we use. When you arrive in school you use tools instead of books.

**Sweeney Auto School, 1169 E. 15th St., Kansas City, Mo.**

### Free Tractor Course

The tractor department offers students what no other school gives. We are building 25 tractors of our own, a tractor that will sweep the country. Men are wanted for building, demonstrating, driving. We also have an International, Case, and Avery. Get **Factory Experience**. We are making a special inducement of giving a \$50 course in Traction Engineering free to any student who enrolls now.

### MAIL COUPON TODAY!

**SWEENEY AUTO SCHOOL**  
1169 E. 15th St., Kansas City, Mo.  
Send catalog and free certificate.

Name.....  
Address.....  
.....  
.....

### WHY NOT BE AN ARTIST?

**STUDY** drawing at home under Expert Faculty. We have successful students in every part of the world. Turn your Talent into money. Our Students are filling high salaried positions. 14 years successful teaching. Endorsed by high authorities. 18 Courses in Commercial and Illustrative Drawing. Teachers' Normal and Applied Art, Profit or Culture. **Thoroughly Equipped Residence School** Artist's Outfit FREE to Enrolled Students **SCHOOL OF APPLIED ART, 755 Applied Art Bldg., Battle Creek, Mich.**

### Learn Watchmaking At Home

You can learn by our modern and original system of instruction every part of the Watchmaker's Trade at home as good or better than at a shop. You can earn money while learning and secure a well paying position or start in business after completing our course of instruction. Good watchmakers are always in demand and earn from \$20 to \$35 per week. For particulars apply to the Wisconsin School of Watchmaking, 508 Bldg., Milwaukee, Wis.

**VIOLIN MANDOLIN GUITAR FREE FINE TONE**

**CORNET** To introduce our wonderful new system of teaching note music by mail, Violin, Guitar, Mandolin, Piano, Organ or Brass Band, will give you a dandy instrument absolutely FREE and guarantee to make you a player or no charge. Complete outfit FREE. Special offer to first pupil. Write at once. **SLINGERLAND'S CORRESPONDENCE SCHOOL OF MUSIC, Dept. 29, Chicago, Ill.**

**IF YOU STAMMER**

attend no stammering school till you get my large FREE book and special rate. Largest and best school in the world curing by natural method. Write today. **Lee Wells Millard, Pres., North-Western School, Inc. 2317 Grand Avenue Milwaukee, Wis.**

**LEARN TO WRITE EARN \$25 to \$100 A WEEK**

**ADVERTISEMENTS** We can positively show you by mail How to increase your salary. BOOK MAILED FREE. **PAGE-DAVIS CO., 112 Page Building, Chicago, Ill., or 150 Nassau St., New York**

# GOV'T JOBS OPEN

**Railway Mail Clerks, City Carriers, Rural Carriers  
City Postal Clerks, Panama Canal Clerks**

**\$300 TO \$2000 A YEAR, FOR LIFE**

Rapid advancement to higher Government Positions. No "lay-offs" because of STRIKES, FINANCIAL FLURRIES or the WHIMS OF SOME PETTY BOSS. THE POSITION IS YOURS FOR LIFE.

Country residents and city residents stand the same chance for immediate appointment. Common-sense education sufficient. Political influence NOT REQUIRED.

Write immediately for schedule showing the places and dates of the Spring examinations. Don't delay. Every day you lose means the loss of just so much coaching before the rapidly approaching examinations.

**FRANKLIN INSTITUTE Dept. S-104, Rochester, N. Y.**

**FRANKLIN INSTITUTE The Pathway to Plenty Dept. S-104, Rochester, N. Y.**

This coupon, filled out as directed, entitles the sender to free sample questions; a free copy of our copyrighted book, "Government Positions and How to Obtain Them," full list of positions now obtainable and to consideration for Free Coaching for examination here checked.

**COUPON**

.. Railway Mail Clerk (\$900 to \$1400)	.. Customs Positions (\$800 to \$1500)
.. Postoffice Clerk (\$900 to \$1200)	.. Internal Revenue (\$700 to \$1800)
.. Postoffice Carrier (\$900 to \$1200)	.. Stenographer (\$800 to \$1500)
.. Rural Mail Carrier (\$900 to \$1100)	.. Clerk in the Departments at Washington (\$800 to \$1600)
.. Bookkeeper (\$900 to \$1800)	.. Canadian Government Positions.

Name.....  
Address..... **\$-104**  
*Use this before you lose it. Write plainly.*

# HOW TO RUN AN AUTO IS SELF-TAUGHT IN AUDELS ANSWERS ON AUTOMOBILES

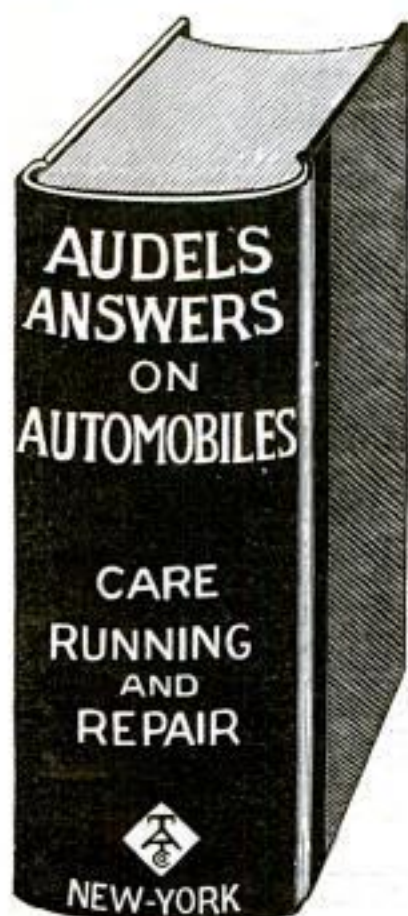

**A New Book from Cover to Cover  
LATEST—PRACTICAL—CONCISE—EXPLICIT—BEST**

**T**HE object of this book is to give, in the easiest understood form, the information necessary for the proper operation, care and maintenance of an automobile.

To adapt the book to many needs the subject matter is presented in the form of **questions and answers**. Technical terms are explained or made clear by the wording of the answer which is always brief and direct.

Any one of the definite chapters on **Carburettors, Ignition, Gas Engine Operation, How to Run an Automobile, and Overhauling the Car, Battery Troubles**, are alone worth the price asked for the 28 complete chapters contained in this book of 512 pages, illustrated by **380 illustrations**.

The form and size are such that it is convenient to handle and study.

This book is a self-educator, hence: "he who runs may read" and improve his present knowledge of automobile engineering and proficiency.

Handsomely bound in durable green cloth and full leather back.

**Audels Answers on Automobiles \$1.50**

## **A BOOK WORTH HAVING**

"Understand Your Car." Explained in the Following Chapters:

1. Ready Reference Index. 2. The Automobile. 3. The Gas Engine. 4. The Cycle of a Gas Engine. 5. Brief Outline of Gas Engine Principles. 6. Cooling Systems. 7. Fuels. 8. Carburettors. 9. Ignition. 10. Timing and Balancing. 11. Gas Engine Operation. 12. Clutches. 13. Transmissions. 14. The Drive. 15. The Differential. 16. The Running Gear. 17. Tires. 18. Brakes. 19. Ball and Roller Bearings. 20. Lubricants and Lubrication. 21. Motor Cycles. 22. Electrics. 23. Electricity. 24. Dynamos and Motors. 25. Storage Batteries. 26. Methods of Circuit Changing. 27. How to Run an Automobile. 28. Overhauling the Car.

## **NONE OTHER JUST AS GOOD**

### **FREE EXAMINATION**

We don't want you to take our word, or anyone else's, for it. We are willing to send you the book without deposit. Use it seven days in connection with your car. Then send back the book or remit \$1.50. Could anything be fairer?

Cut out and fill in your name and address plainly at the bottom. Place it in an envelope and mail.

### **This Book Will Speak for Itself**

Theo. Audel & Co., 63 Fifth Ave., New York

Kindly mail me copy of Audels Answers on Automobiles, and, if found satisfactory, I will immediately remit you \$1.50, or return the book to you.

NAME .....

OCCUPATION .....

ADDRESS.....Mar. 15, P. M.

# STUDY LAW

## AT HOME

### Become an LL.B.

*Only Law School of  
Its Kind in America*

### Special and Exclusive Features

**ONLY** recognized resident law school in the United States conferring Degree of Bachelor of Laws—LL.B.—by correspondence. ONLY law school in U. S. conducting standard resident school and giving same instruction, by mail. ONLY law school giving over 450 class-room lectures to its extension students. ONLY law school giving a full 3-year, University Law Course, by mail, having an actual faculty of over 30 prominent lawyers in active practice. ONLY law school in existence giving Complete Course in Oratory and Public Speaking, in conjunction with its law course.

#### Written Bar Guarantee

We give an absolute written guarantee to prepare our students to pass bar examinations.

The Hamilton College of Law is a regular, thoroughly recognized, bona fide College of Law and NOT an "Institute," "correspondence school," etc. It occupies the entire third floor of the New Advertising Bldg., where its large and commodious resident class-rooms and executive offices are located.



Our Degree Bachelor of Law, LL.B. and executive offices are located. NOT a Diploma or Certificate

#### Direct From Class-Room to Student



From Lecture Room to Student  
No Other Law School Can Do  
This Illustration

is the way we teach law. We are the only school doing this. Our system of teaching is intensely interesting; not dull and dry like the average law course. Our system of conducting examinations is the most thorough, complete and expensive (to us) of any examinations ever given. A student can, if he chooses, take part of our course by mail and finish in our resident school where he will receive full credit for all work done by mail. Our resident school is recognized by all standard law schools in the United States.

The Hamilton College of Law is highly endorsed and recommended by Government Officials, Business Men, Noted Lawyers, Graduates, and Students. We have as students a number of practicing lawyers (not graduates of recognized law schools) who are now earning their degree of LL.B. Many other lawyers are using this course as a review. A probate judge, (one of our active students) says: "I am delighted with the course prescribed and your method of teaching law. It is far in advance of what I expected to receive."

#### Our Law Library

consists of 24 volumes of Student's Standard Text Books, two volumes bound together under one cover, making a total of 12 books. These books were prepared at an enormous cost especially for the students of the Hamilton College of Law, by one of the largest and best law book publishers in America. This is the only set of law text books ever prepared exclusively for student's use. We would be glad to have you submit these books to any lawyer or judge in the country and get his opinion regarding them.



These 12 Volumes are Free to Students

#### Mail Coupon Today

and get our Big, Beautifully Illustrated Prospectus and complete information. Places you under no obligations whatever. This may mean the turning point in your career.

Hamilton College of Law, 327 Advertising Bldg., Chicago, Ill.

Gentlemen: Kindly send me your Illustrated Prospectus and full particulars regarding your method of teaching law by mail

Name.....

Address.....

Write plain and in full

Please Mention Popular Mechanics



#### Learn a Paying Profession

that assures you a good income and position for life. For twenty years we have successfully taught

### PHOTOGRAPHY

Photo-Engraving and Three-Color Work

Our graduates earn \$20 to \$50 a week. We assist them to secure these positions. Learn how you can become successful. Terms easy—living inexpensive. Write for catalogue—NOW!

ILLINOIS COLLEGE OF PHOTOGRAPHY, 999 Wabash Avenue, Effingham, Ill.

## ELECTRICITY

CONDENSED COURSE IN  
ELECTRICAL ENGINEERING

### Complete in One Year Bliss Electrical School

Studies restricted to theoretical and practical electricity, mechanical drawing and necessary engineering work. Teaches simplicity, concentration, hard work. For young men of energy and character. 22 years of greatest success. Graduates hold first-class positions. Opens Sept. 22nd. Write for new catalog.

104 Takoma Av., WASHINGTON, D. C.

#### EARN TELEGRAPH

Morse and Wireless—R. R. Accounting (Station Agency) taught. Splendid opportunities. Positions secured. Marconi Co. takes our wireless graduates. We own and exclusively occupy two large modern buildings equipped with R. R. and Western Union wires and complete \$3,000 Marconi Wireless Station. Largest School—established 41 years. Investment \$25,000. Endorsed by Railroad, Marconi and Western Union Officials. Expert practical teachers. Low living expenses; easily earned if desired. Tuition low. Easy payments. Correspondence courses also. Catalogs Free. Dodge's Telegraph, Ry. & Wireless Institute 8th Street, Valparaiso, Ind.

#### TRADE SCHOOL

### COURSES

give just the practical training needed to qualify for good paying jobs. Save a year's time. Automobile, Machinist and Manual Training Courses, 48 weeks. Chauffeur Course complete in 12 weeks—general knowledge of the auto—how to drive and locate trouble in car. Special 6 weeks' driving course. Engineering. Low fees and living costs. For catalog address

Geo. P. Magill, Pres., Highland Park College, Des Moines, Ia.

#### The University of Chicago

### HOME STUDY

in addition to resident work, offers also instruction by correspondence.

For detailed information address

23rd Year U. of C. (Div. 20) Chicago, Ill.



#### IF YOU STAMMER

I can cure you. Attend no Stammering school until you hear from me. Write at once for information to

ALBERT R. BELLEROSE, Princ. of the Conn. School for Stammerers  
73 Park Street MERIDEN, CONN.



#### DON'T TRY TO BE A CHAUFFEUR

or go to ANY SCHOOL to learn, or part with your hard earned dollars until you have read our valuable guide FIRST. It tells what you should PAY and what you should GET. Do not be deceived by schools which claim everything and give you nothing. YOU CAN'T AFFORD TO SPEND ONE CENT TILL YOU GET OUR GUIDE. It costs nothing and may save you many dollars. Write now for this FREE BOOK.

PRACTICAL AUTO SCHOOL, 68 Beaver St., New York

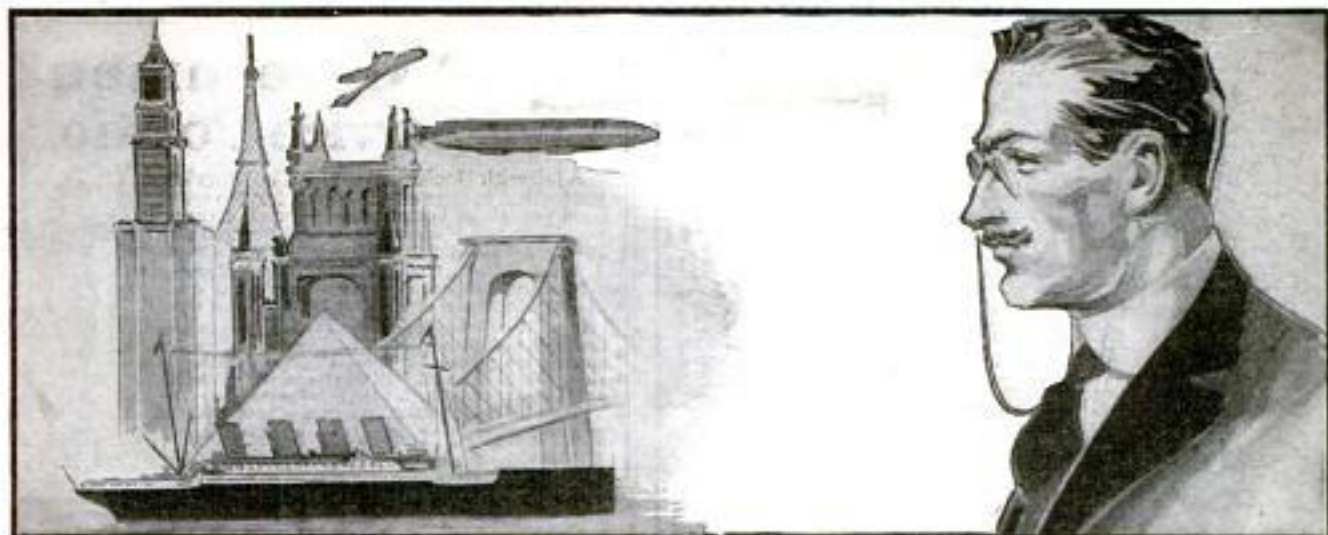

# Power of Will

—the Secret of Every World Achievement  
—of Every Man's Success

**S**TOP and think a minute. What built the pyramids? What developed the modern 40-story skyscraper? What is responsible for every great invention ever conceived? What built Rockefeller's, Morgan's, Carnegie's—every great fortune? What is the keynote of every individual success—of your success?

Three magic words tell the story, "Power of Will." Human will power has been the motive force behind every great accomplishment since the world began. Without trained will power, no man can achieve greatness, yet every man living can have an inflexible will.

## How to Train the Will

Everyone knows what can be accomplished by exercising the brain. Our whole educational system is founded upon the theory that brain can be developed in proportion to the amount of intelligent exercise and use to which it is put.

For years scientists have known that the same is true of the will—that the will can be made indomitable by intelligent exercise and use.

The trouble has been that until now no one has ever devoted their attention to the cultivation of the will. And since we have never been taught to use it, most of us don't know how. We float along carrying out other people's wills simply because our own will has become scotched and dormant from lack of use.

If you should keep your arm in a sling for two years it would become powerless to lift a spoon—the same is true of the will—it becomes powerless to serve its owner simply from lack of use.

## "Power of Will"

by the noted scientist Frank Channing Haddock, Ph.D.—whose name ranks with such leaders of thought as James, Bergson, and Royce—is the first thorough course in will training ever conceived. It is based on a most profound analysis of the will in human beings. Yet every step in the 28 fascinating lessons is written so simply that anyone can understand them and apply the principles, methods and rules set down with noticeable results almost from the very start.

## Over 50,000 Users

"Power of Will" has already helped over 50,000 people—a record equalled by no other single course of any kind in the world. Such men as Judge Ben B. Lindsey; Supreme Court Justice Parker; Wu Ting Fang, ex-U. S. Chinese Ambassador; Lieut. Gov. McKelvie of Nebraska; General Manager Christeson of Wells Fargo Express Co.; Asst. Postmaster-General Britt; E. St. Elmo Lewis, now Vice-Pres. Art Metal Construction Co.; Ernst Knachel, Asst. Atty Gen'l of U. S., and literally thousands of other successful men like them have voiced their praise of this great work.

## A Veritable Godsend

The users of "Power of Will" speak of it as a Bible. It has pulled men out of the gutter and put them on the road to self-respect and success—it has enabled men to overcome drink and other vices, almost overnight—it has helped overcome sickness and nervousness—making thousands of sick people well—it has transformed unhappy, envious, discontented people into dominating personalities suffused with the joy of living—it has enabled people who had sunk deep into the grooves of a rut to pull themselves out and become masters instead of the blind tool of circumstance—it has reawakened ambition in men and women who had been turned from their life purpose and given them the courage and confidence to build anew—it has converted failures in business into spectacular successes—it has enabled successful men to undertake even bigger projects by showing them how to use the power they already possess with even more telling force. Young and old alike, men and women in all walks of life, testify to the almost magical changes in their lives once they undertake Dr. Haddock's simple formula for strengthening the will—once they know how to use this God-given faculty recognized the world over as the greatest weapon of achievement.

## Send No Money—Examine Book First

Although "Power of Will" is a 400-page leather-bound book containing more material than any \$25 correspondence course, the price is only \$3.00. The publishers will gladly send a copy free, for five days' inspection. Send no money now. Merely mail the coupon below, enclosing your business card, or giving a reference. If you decide to keep the book, send the money. If not, mail the book back. Tear out and fill in the coupon now, before you turn this page.

**PELTON PUBLISHING CO.**  
53 Pelton Bldg., Meriden, Conn.

## What Readers Say

"They can achieve wonders if their teachings are closely followed."—Geo. F. H. McVay, Dept. of Finance, City of New York.

"Will-Power is a compilation of mighty forces. My first week's benefit in dollars is \$900—cost \$3—profit \$897.00."—J. W. Hindand, 716 Tribune Bldg., Chicago.

"In my judgment 'Power of Will' is wonderful."—Owen J. McCaughey, Sec'y of Corp. Securities Co., St. Louis, Mo.

We have hundreds of such testimonials on file.

## Partial Contents

The Law of Great-Thinking.  
The Four Factors on which it depends.  
How to develop analytical power.  
How to think "all around" any subject.  
How to throw the mind into deliberate, controlled, productive thinking.  
Detailed directions for Perfect Mind Concentration.  
How to acquire the power of Consecutive Thinking, Reasoning, Analysis.  
How to acquire the skill of Creative Writing.  
How to guard against errors in Thought.  
How to drive from the mind all unwelcome thoughts.  
How to follow any line of thought with keen, concentrated Power.  
How to develop Reasoning Power.  
How to handle the mind in Creative Thinking.  
The secret of Building Mind Power.  
How the Will is made to act.  
How to test your Will.  
How a Strong Will is Master of Body.  
The Six Principles of Will Training.  
Definite Methods for developing Will, etc., etc., etc.

A complete list of contents would almost fill this page.



POWER OF WILL

Pelton Pub. Co.  
53 Pelton Bldg.  
Meriden, Conn.

Gentlemen: Please send me a copy of "Power of Will" without charge. I agree to remit \$3.00 or return the book in 5 days.

Name .....

Address .....



## Be a Signal Engineer

The profession of Signal Engineering is only in its infancy. More men are needed. At the present time, scarcely more than 25% of the railroads are equipped with automatic electric block signals. We must find more Signal Engineers to superintend the installation of the new systems and the maintenance of the ones that are already installed. **Big money is being paid.** You can get just the kind of instruction you need to hold one of the big jobs in your own home—during your spare time. Send the coupon now for the big new book on Signal Engineering. Find out how you can be the boss and the man who gets the fat pay envelope. Write today.

## Earn \$2,500 a Year

Yes, that is what your salary will be when you are a full fledged Signal Engineer, \$2,500 a year to start. Many men making much more than that. Even while you are learning you can hold one of the positions under a Signal Engineer paying you a handsome salary. Here is your opportunity. Be the man who tells the other fellows what to do. Send in the free coupon for full particulars.

## MORE MEN NEEDED

Railroads are constantly looking for competent Signal Engineers. There are not enough men to fill the positions. Thousands and thousands of miles of track are now being equipped with automatic signals. More Signal Engineers are needed to superintend the work. Many new positions will be open. **And there are no men to take them.** Electric Signal Engineering is one of the most fascinating of professions. As a railroad man you travel from coast to coast. You can be the man who knows. You can be the man who tells the other fellow what to do. You can be the man who gets the fat pay envelope and free transportation. Here is your chance.

### TWO BIG FREE OUTFITS

Complete Signal Engineer's Outfit and Complete Draftsman's Outfit given away absolutely free to students. The Engineer's Outfit consists of a miniature railroad system of tracks, locomotive, signals, lights, wires, bell, switches, etc., etc. The Draftsman's outfit is complete, consisting of drawing instruments, T square, drawing board, triangles, etc., etc. Actual working instruments. On this great special offer given away to you absolutely free. Send the coupon.

## Send the FREE Coupon for Big New Book

### FREE BOOK COUPON

Department of Signaling  
Room 1193, 1810 Wilson Ave.  
Ravenswood Station  
Chicago, Ill.

GENTLEMEN: Please send me absolutely free and prepaid your big new Signal book. Also full particulars about your great special free outfit offer. It is distinctly understood that I assume no obligations of any kind.

Name.....

Address.....

Age..... Occupation.....

Just put your name and address on the free coupon and send it in to us at once. Absolutely no obligations of any kind. We will send you the big new Signal book absolutely free. Tells you all about this most fascinating profession. How you can get into the \$2,500 class. The book is free. Get your name and address in at once.

Department of Signaling  
Room 1193  
1810 Wilson Ave.  
Ravenswood Station  
Chicago Ill.

Please Mention Popular Mechanics

## Get A Government Civil Service Position

A job with Uncle Sam under Civil Service protection means employment for life with good pay, short hours, pleasant work, annual vacations and the assurance that you will get your pay regularly in spite of panics or hard times.

Post Office, Railway Mail, Rural Carrier, Custom - Internal Revenue and other examinations are being held all the time.

If you're an American citizen 18 or over, we can help you secure one of these good jobs. Our 64 page booklet tells how you can prepare for "exams" under personal supervision of a former U. S. Civil Service Secretary-Examiner—a man who knows and whose knowledge is at your disposal.

Write today for booklet. It's free, without obligation.

**PATTERSON CIVIL SERVICE SCHOOL**  
103 Irving Place ROCHESTER, N. Y.



## Learn the Auto Business Earn a Splendid Salary



By practical experience we train you for a good position as automobile mechanic, salesman or chauffeur. Over 3,000 graduates are earning big salaries. Complete training in 4 weeks, including extensive practice in repairing and driving high powered cars. Tuition and board reasonable.

Send today for free catalog and list of graduates

**Cleveland Automobile School**  
2338 Euclid Ave., CLEVELAND, OHIO



## LETTERING AND DESIGN

Will pay you a good salary or establish you in the business world. Fit yourself through home study to become a Card or Sign Writer, Letter Artist and Designer in the Lithographic or Printing Fields. Lessons simple, interesting and thorough. My students become competent—no one can you. Personal guidance makes the Course Self-Paying. Prepare now for a better future and send for Free Booklet No. 30 and full information.

The Rising School of Lettering & Design  
The 1900 Euclid Building CLEVELAND, OHIO

## LEARN WATCH REPAIRING

Be a watchmaker—you can learn this profitable trade by correspondence in a few weeks in your own home by the DeSelms Chart System. After you complete the course you will know a watch from A to Z. You will know just what the matter is and how to repair one. When you graduate you will be a practical watchmaker and repairer and competent to fill any position. Positions for our graduates.

Ask for our Free Book. It explains our system and terms.

**The DeSELMS WATCH SCHOOL**  
23 Perry Street ATTICA, INDIANA



## FREE—Increase Your Income

IN AN UNDEVELOPED, PROFITABLE FIELD

Learn Show Card-Writing and Lettering. We furnish a reliable and thorough course, absolutely free, to introduce ALPHA colors, if you purchase an assortment to use while practicing. Particulars for stamp.

Alpha Color Co., Inc., Dept. K, 1960 Broadway, N.Y. City



## DO NOT STAMMER

My book, "How to Stop Stammering"—a treatise on "Scientific Talking and Psychic Training." School and circular literature FREE. **M. L. HATFIELD**, Pres. of The Pacific School for Stammerers, 1918 Grove St., OAKLAND, CAL.

## Be an Auctioneer

Travel over the country and make big money. No other profession can be learned so quickly, that will pay as big wages. Write today for big free catalogue of Home Study Course, as well as the Actual Practice School.

**Missouri Auction School** Largest in the world. **W. B. Carpenter, Pres.**  
330 HALL BLDG. KANSAS CITY, MO.

BE AN ILLUSTRATOR.  
by mail how to draw for magazines and newspapers  
Send for Catalog

Learn to draw. We will teach you School of Illustration  
112 Page Bldg. Chicago, Ill.





# You Can Make This Big Jump!



ANY SMALL JOB  
\$12 to \$18 Weekly



Yes, you! No matter who you are or where you live, we can show you how to quickly rise from an obscure position to power, independence and big salary. Here is without doubt the greatest opportunity ever offered you to enter a vocation with almost unlimited possibilities of future success and prosperity. A new, uncrowded field of opportunities has just been opened to ambitious men everywhere. If you are holding down a small job with small wages and no possibilities of future advancement, don't be discouraged—don't remain in it—

TRAFFIC EXPERT  
\$35 to \$200 Weekly



## Become a TRAFFIC EXPERT

Command a Position of Power and Prosperity!

Recently enacted railroad and interstate commerce regulations have created this great new vocation—have necessitated trained specialists who know how to Route Shipments to obtain Shortest Mileage, Quickest Deliveries, Lowest Rates, Largest Shippers

and railroads now need trained Traffic Experts and Managers—newly created positions are open with salaries of \$35 to \$200 weekly. The Traffic Expert is BOSS—Not Bossed—he can advance to big executive positions of power, wealth, influence and dignity.

## We Train You By MAIL

No matter what your work now—no matter what your age, how long your hours, how small your pay or what your education, if you can read and write intelligently—the LaSalle Interstate Commerce course will train you expertly at home in your spare

time to qualify for a big position as Traffic Manager. The cost is small—payments to suit you.

Our method is simple, practical, thorough—the work of some of America's greatest Traffic Experts. Anyone with intelligence can quickly master it.

## NEW JOBS OPEN

ence, now is the time to let us begin preparing you for this lucrative vocation. Don't think you can't learn—we show you free that you can—prove it by the evidence of others who were in the same position as you are in now. Remember, we are the largest Extension University in America—a powerful, reliable institution. We make no claims we cannot prove.

The need for Traffic Experts is, right now, far greater than the supply. If you are ambitious to increase your income and influence your vocation. Don't think you can't learn—we show you free that you can—prove it by the evidence of others who were in the same position as you are in now. Remember, we are the largest Extension University in America—a powerful, reliable institution. We make no claims we cannot prove.

## 10 Years' Promotion in One

opportunities afforded Traffic Experts with LaSalle training—see how easy it is for us to qualify you for this great vocation with its power, big income and independent future.

Send coupon immediately for free copy of this remarkable book—learn about the wonderful opportunities afforded Traffic Experts with LaSalle training—see how easy it is for us to qualify you for this great vocation with its power, big income and independent future.

## ACT NOW

member we help you—make it easy for you. Send the coupon at once for positive proof. Send no money—everything is free.

Don't put it off—don't be satisfied with a small job. Small jobs pay small salaries—offer no possibilities for success. Make up your mind now to win success. Remember, we are the largest Extension University in America—a powerful, reliable institution. We make no claims we cannot prove.

LaSalle Extension University, Dept. C-470 Chicago, Ill.

Name.....  
Address.....  
City.....State.....

LaSalle  
Extension  
University,  
Dept. C-470  
Chicago, Ill.

Send free proof about  
opportunities now open to  
TRAFFIC EXPERTS with  
LaSalle training; also free copy  
of "10 Years' Promotion in One".

# Free!

## Complete Set of Drawing Instruments

Yes, I will give you this complete set of drawing instruments absolutely free. They are regular working instruments—the kind I use myself and they do not cost you a penny. And besides the instruments in this exquisite plush lined leather case, I will give you absolutely free a 20x25 inch drawing board, a 24 inch T-square, a 12 inch rule, a supply of drawing paper, two triangles and a French curve, pencils, erasers, thumbtacks, etc., etc. A complete draftsman's working outfit. And I give it to the men who get my personal instruction absolutely free.

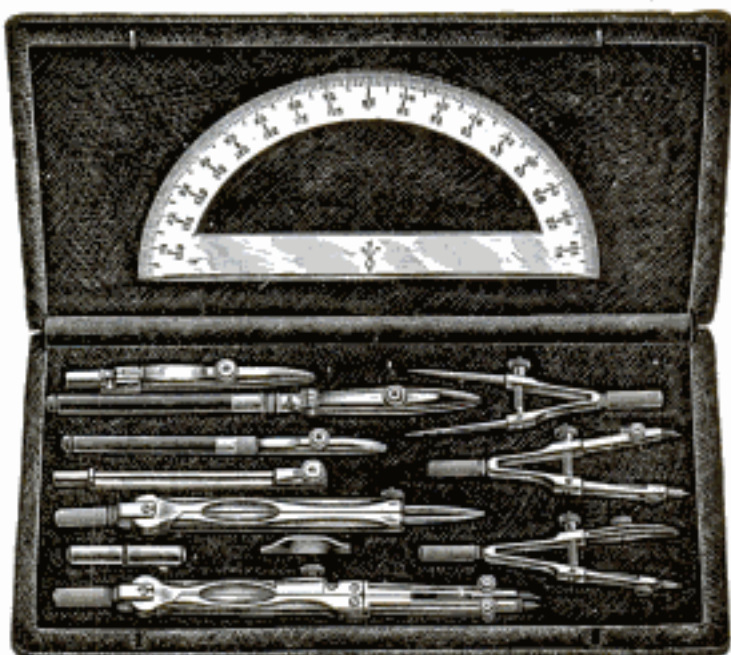

# Be a Draftsman!

## Draw \$125 to \$175 Per Month

There is an urgent demand for skilled draftsmen. Companies are issuing calls every day for men to fill positions paying from \$125.00 to \$175.00 per month. Work is light, pleasant and profitable.

## Chief Draftsman Will Instruct You Personally

I am Chief Draftsman of a large and well known firm. I have been doing the highest paying expert drafting work for a quarter of a century and I know just the kind of training that is demanded from men who get the big salaries. I will give you personal instruction, deal individually with you and give you up-to-date, practical working plans just as your ability and advancement require. I train you by giving you actual work—practical work, the kind that you must be able to do in order to hold permanent, big paying positions. I give you my individual instruction. If your work is right, I will advance you rapidly. If it is wrong, I will show you where, and make you do it right, and do all I can to make you an expert draftsman and designer in a short time. **Write today without fail**

**Pay as You Wish!** What I want is the RIGHT KIND of men. Don't bother about expense. I will give you the working outfit free if you get in at once. I charge a very small fee for training you to be an experienced draftsman. You can pay the small cost as suits you best. My object is to develop experienced draftsmen.

Chief Draftsman Dobe  
Engineer's Equipment Co.  
Div. 1193 Chicago, Ill.

Without any obligation on me whatsoever, please mail your book "Successful Draftsmanship" and full particulars of your liberal "Personal Instruction" offer to a few students. It is understood that I am obligated in no way whatever.



## Send the Coupon for My Big New Book

Put your name and address on the free coupon or a letter or a post card and send it to me today. I will send you absolutely free and postpaid my new book "Successful Draftsmanship," and the great special offer that I am now making on which you get the \$15.00 Draftsman's Working Outfit absolutely free. You assume no obligations of any kind in sending in the coupon. Get in line now for a big paying position. Getting the book and full particulars of the special offer is the first step. Write today—now.

**Chief Draftsman Dobe**

Engineer's Equipment Co., Inc., Div. 1193, CHICAGO, ILL.

NAME.....

ADDRESS.....

# CLASSIFIED ADVERTISEMENTS

We have records to prove that a classified ad in these columns will find a buyer for almost anything which can be sold. Doubtless you have some article of value to some one else which you no longer need. Why not turn it into money?

Advertisements in this section, 15 cents per word, each insertion, minimum 10 words, payable in advance. To insure ads being inserted under proper classified head in the April issue, copy must reach this office not later than March 1st.

Popular Mechanics Magazine, Chicago, Ill.

Gentlemen: Replying to your inquiry of the 5th inst., we are pleased to advise you that Popular Mechanics Magazine is the best medium that we are now using for classified advertising. We keep a very careful tabulation of the returns from all our advertising, and find that 69 per cent of the inquiries received through Popular Mechanics turn into orders. Your readers seem to be of the sincere type of American spending public, and if they are assured of a square deal, they will purchase freely. We are using the classified columns of several hundred publications, and consider Popular Mechanics to be the best, bar none. We say this openly without any intentions to flatter, but we feel that nothing succeeds like success, and that the plain truth is nothing but the truth.

Very truly yours,

THE NATIONAL TYPEWRITER EXCHANGE, Inc.

## AUTOMOBILES

FORD cylinders rebored, fitted with 4 oversize pistons, 12 rings, 4 wrist pins, 8 washers. Cost of complete job, \$15. Delivery in 24 hours. Every job guaranteed. Everts Machine Company, 14 Hicks Street, Hartford, Conn.

YOU can earn an auto by my new, easy plan; anyone over 16 years old can get a brand-new Ford Touring Car for a little easy, respectable work among neighbors. Free Book tells all about it. Postal brings it. Send Auto Tom, 647 S. 16th St., Omaha, Neb.

BARGAIN—1914 Patterson 4-Cylinder; like new. Electric-lighted—starting. Demountable rims, tires new. \$850. Tel. 70, Oak Park, 135 Lake St., Oak Park, Ill.

SOUVENIR Automobile Prestolite Key. Sample postpaid 10 cts. Box 62, Chester, N. J.

VICTOR Truck. High wheels. Double opposed. Friction Transmission. Painted. First \$40 gets it. L. A. Brown & Co., Clay Center, Neb.

MEYER, two-cylinder, good order, \$50. Eli Landy, Berwick, Pa.

FOR Sale—Latest Model White Steam Car, excellent running order. Box 95, Ft. Wayne, Ind.

SPEEDY six-cylinder car with touring and roadster bodies. Fast, large, four-cylinder touring car. Sacrifice for \$298 each. Garrett Poole, Cadiz, Ohio.

CYLINDER Regrinding or Reboring. New oversize pistons and rings fitted. Accuracy guaranteed. Prompt delivery. Worn or broken parts duplicated. Everts Machine Company, 14 Hicks Street, Hartford, Conn.

USED automobiles \$50 to \$350; send for free list. Brown Music Company, 9119 Commercial Ave., Chicago, Ill.

\$1,000 CASH takes a real bargain in my Abbott-Detroit car, including 2 bodies, 5-passenger open body for summer use and 4-passenger coupe for winter use. Easy to change bodies as the season warrants. Car is fully equipped. Late 1913 model or really a 1914 model. No change was made in 1914 or 1915. Electric lighted and electric starter. Just overhauled and running in perfect condition. Continental enclosed valve T head motor. Absolutely noiseless and has never given any trouble. My open body is almost like new, as I had a set of \$85 seat covers made for it last summer, also new carpet for tonneau, Timken axles and Timken bearings. Nickel finish throughout. Tire irons, large storage battery, tool chest on running board and numerous other accessories that would cost you money to buy and that are not included in the standard equipment of a new car. Coupe cost \$800 alone last winter. All steel body. Electric lighted throughout and lined with beautiful green whipcord cloth. Silk window roller curtains and all that goes with a luxurious coupe for winter use. Just the car for a doctor. Original cost for car without coupe, \$1,325. Coupe made to order, \$800. Cost complete without any accessories that I am throwing in, \$2,625, so you can see that it is a bargain at \$1,000. Act quick. Write C. F. Minor, 946 Alnallie St., Chicago.

AUTOMOBILE Flexible Metal Tubing for carburetors, wire covering, exhaust pipe, tire inflating and speedometers. Air, water, gas, steam and oil tubing. Carburetor Hot-Air Outfit, \$1. Get catalog. Breeze Newark, N. J.

HUPMOBILE, excellent condition. Harry Brenneke, 1336 Griswold Street, Burlington, Iowa.

SAVE Cylinder reboring, use Triple rings, 90 cents each; Regular rings, 25 cents; Radiators, \$11; Steering gear complete, \$10; Motor 4 1/2"x5" L-Head, \$150. Grossman Auto Parts Company, White Plains, N. Y.

NICKEL Plate your Automobile Trimmings with Nickel Powder. Prevents brass from tarnishing, steel from rusting, \$1 per can, prepaid. Gunmetal Co., Decatur, Ill.

PAINT Your Car Yourself—Save \$25 to \$75 by doing the work at home with the Arsenal system. Our big free booklet "The Car Beautiful" tells how. Send for it today Arsenal Varnish Co., Dept. P, Rock Island, Ill.

AUTOMOBILE Instruction—\$55.25. Four weeks' course. Best equipped school in the country. Men enrolled from all parts of the U. S. Booklet P. M. on request, West Side Y. M. C. A., 318 West 57th Street, New York.

AUTOMOBILE parts for any car made, tremendous quantity in stock at all times; send description of what you want. Gifford Auto Parts Co., 28 West 33rd St., Bayonne, N. J.

"THE How and Why of the Automobile"—A 200-page book of practical information for seekers after the fundamental facts regarding the gasoline engine and its application to the motor car. Interesting and instructive to both the beginner and the expert. Bound in full cloth—250 illustrations. Price \$1 postpaid. Popular Mechanics Book Dept., 6 N. Michigan Ave., Chicago.

THE Last Word in Automobile Literature—New Book. "The Modern Gasoline Automobile," 760 6x9 in. pages, 500 illustrations, is superior to any treatise heretofore published. Deals with every modern improvement. Price, \$2.50 postpaid. Popular Mechanics Book Dept., 6 N. Michigan Ave., Chicago.

STUDEBAKER 29, late "1912" fore-door touring, looks and runs like new, \$250. Also Studebaker "20" runabout \$150. Others from \$75 up. Automobile Buyers Association, 2107 Walton Ave., New York City.

CYLINDERS scored by piston pin, restored to original shape; use same piston. No welding. Cobb Machine Shop, 2835 Detroit Ave., Cleveland, Ohio.

IF your car hasn't the compression and power it once had, you'll probably find that your cylinders are worn or scored and need regrinding. We've reground thousands of cylinders in our six years' experience and can refer to pleased customers everywhere. Advise make of car and bore diameter, so we may quote. Do it now before you forget. Waterbury Welding Corporation, Waterbury, Conn.

## AUTOMOBILE SUPPLIES

USE an Air-Friction Carburetor, 1915 Improved Model C or D. Increases power and economy of motor one-half. Absolutely impossible to load or choke. Starts easy warm or cold weather. Uses either high or low grade fuels with finest results. We fit all motors and guarantee definite results or refund money if returned within thirty days. Liberal exchange allowance on other carburetors or old model air-frictions. We also make and absolutely guarantee the Air-Friction Spark Plug. Sold in sets of five only at \$3 per set. The Air-Friction Carburetor Co., Dayton, Ohio.

FOUR cyl. 40 hp. Continental motor with equipment at \$95. Badger Motor Co., Milwaukee, Wis.

USED Bosch, Splittdorf, Remy magnetos at cut prices. We repair any make of magnetos or coils. Pellet's Magneto Exchange, 1080 Michigan Avenue, Chicago, Illinois.

AUTO owners: Foredoors for open-front cars, commercial auto bodies, prepared paint for refinishing automobiles. Get our prices before you buy. Economy Service Company, 2714 Boulevard Place, Indianapolis, Ind.

AUTO Parts—Build or repair your own car, as we can furnish parts for any make of car at cut prices and discounts. State your wants to Grossman Auto Parts Company, White Plains, N. Y.

PUNCTURES repaired in one minute. Simple, positive method. Demonstrators coming money. 16c brings complete details. Write, Mountain-Plains, Edgewater, Colo.

66 REO 2-cylinder motor, with trans. Rear axle with 3 speeds, 2 rear and 2 front axles. Cycle car running gear with 2-cyl. motor. Parts for Maxwell 2 cyl. cars, M. Chamberlain, Chester, N. J.

WANT Ford driver every county to sell efficient Ford starter. Price, \$7.50. Retains \$15. What every owner wants. Victor Company, 1724 Welton St., Denver, Colo.

SWISS high-tension magneto, used three hundred miles, \$30; Shelby carburetor, almost new, \$5. Waller & Waggener, Morgantown, Ky.

BANKRUPT stock. Automobile and Cyclecar parts. Prices slaughtered. L. I. Lutes, 361 Lafayette Boulevard, Detroit.

RACING equipments, seats, tanks, cowls, bodies, etc. Latest types, classy designs. On Ford and other chassis. Standard Auto Sheet Metal Works, 332 S. Canal St., Chicago.

USE an Air-Friction 1914 Model "C." Increases power and economy of motor one-half. Absolutely impossible to choke or load. Uses distillate, gasoline or half kerosene with finest results. Starts easily in coldest weather. We fit all motors, guarantee definite results or refund money. Exclusive county rights. Liberal exchange on other carburetors or old-style Air-Frictions. The Air-Friction Carburetor Co., Dayton, Ohio.

FOR Sale—Second-Hand Gasoline Engines, list 29. Lucas & Son, Bridgeport, Conn.

SHOP Vulcanizer, Bargain, Tires at cut prices. Vanderpools, Springfield, Ohio.

AT Bargain Prices—Send for our monthly bargain list on new and used dynamos, lamps and electric equipment for automobiles and boats. The Esterline Co., 254 E. South St., Indianapolis, Indiana.

OXYGEN Decarbonizer—Big money is being made by cleaning cylinders by this new method. Write for descriptive matter. Bateman Bros., Centerville, Ia.

CARBURETOIS, slightly used, Schebler, Stromberg and Rayfield, 1-inch \$6; 1 1/4-inch and 1 3/4 inch \$8 each. Conditions guaranteed. Henry A. Carrier, Auburndale, Mass.

MOUNT power vacuum cleaner on your auto. Buy parts, assemble, \$50 cost—earn \$15 daily. Vacuum Supply Co., Ann Arbor, Mich.

"NEW Touring and Roadster Bodies for most any small or large car. All kinds of Auto parts to build a car." New Ford Touring Tops \$16. Nicholds, Detroit, Mich.

## WELDING

WELD your own castings. Save time, freight charges, and keep the profits yourself. Big profits, small investment. Write today for free 32-page book on welding. Welding Apparatus Co., 211 National Union Bldg., Toledo, O.

SEND your welding to W. T. Shoemaker, Elmira, N. Y. Estimates given.

NEW 3rd edition text book on "Instructions in Oxy-Acetylene Welding and Cutting." Experts say this work best for practical men ever published; 150 pages, cloth bound, over 60 illustrations, price \$1.50. Star welding and carbon cleaning apparatus; complete details include automatic regulators, high and low pressure gauges, welding materials, new instruction book and special process torch, which soon pays for plant by saving in oxygen gas. Best outfit ever sold for less than \$100, now \$75. Write us today. Vulcan Process Co., Minneapolis, Minn.

WE weld all metals. Charges reasonable. Work guaranteed. We re-bore cylinders and fit pistons. Bertachy Kan-Fix It, Omaha, Neb.

EARN \$1000 a month. The Admiral Welding Equipment, with Decarbonizer, Supplies and Instruction Book outfits you for conducting a general welding business. You can't buy a better outfit. Handles any class of work. Many of our customers have earned the cost the first week. We conduct the largest Job Welding Shop in Kansas City, and use this Equipment exclusively. Booklet Free. Admiral Welding Machine Company, 1322 Walnut St., Kansas City, Mo.

WELDING—We can repair that broken part, cast iron, aluminum, etc. Small or large. C. M. Anderson, Batavia, Ill.

WELDING Plants, \$25 to \$250. Liberal terms. Write Bermo Co., Omaha, Neb., U. S. A.

"OXY-ACETYLENE Flame and Its Uses"—The most complete instruction book upon welding shop practice ever published, \$1 prepaid. Admiral Welding Machine Co., Kansas City, Mo.

OXY-ACETYLENE Welding and Cutting is the title of a brand new practical instruction book on the methods of doing this work. It includes the operation and care of Acetylene Generating Plants and the Oxygen Process for removal of carbon. 200 pages, 76 illustrations, pocket size, cloth, \$1.00; leather, \$1.50 postpaid. Popular Mechanics Book Dept., 6 N. Michigan Ave., Chicago.

## FORD ACCESSORIES

CHANGE Ford Tires in Half a Minute. You owners of Ford cars need worry no more about changing those clincher tires. Detroit's oldest department store is now marketing a new tire tool that will positively take off any clincher tire in 30 seconds and it will replace it, too, in just that time. Will remove the worst rusted-on tire as easy as a new one. Quicker than demountable rims. We will send it prepaid for \$1, and after two weeks' use if you do not say it is great, you may return it, and we will send back your dollar. Heyn's Bazaar, Detroit, Michigan.

PISTON Rings for Ford Cars ten cents, pinion gear one dollar, differential drive gear three dollars, set of 14 Model T gaskets thirty-five cents, Grossman Auto Parts Company, White Plains, N. Y.

FORD Racers—Rebuild your Ford car into a racer. Sketches, specifications, instructions. Information two-cent stamp. T. M. Co., Box 212, Woodford, Maine.

## MOTORCYCLES, BICYCLES &amp; SUPPLIES

MOTORCYCLE Buyers: If you want a high-grade, low-priced motorcycle, send for our list. Machines \$25 and up. All machines guaranteed. Western Motor & Supply Co., Lincoln, Neb.

STOP—New and used motorcycles at rare prices, write now. Carl Finske, Michigan City, Ind.

DON'T buy a Bicycle Motor Attachment until you get our catalogue and prices. Shaw Mfg. Co., Dept. 27, Galesburg, Kansas.

FOR Sale—1914 Indian Motorcycle: Twin cylinder, two speed, electric equipped, with Side Car. A Landergott, Crandon, Wis.

FORCED sale on used Motorcycles—Twin 1911 Indian \$60, Single \$40. Twin Excelsior \$135. Thor "4" \$190. Absolutely guaranteed. O. K. Anderson's Motorcycle Garage, Batavia, Ill.

NINETEEN-FOURTEEN twin Indian and Merkel. Both very fast. Hull, Mt. Hope, Pa.

BARGAIN: 1914 Twin Jefferson Motorcycle, \$135, Glenn Bottlesmy, Alden, Ill.

SAVE \$85 on 1915 Thor, any model; sickness; sacrifice \$100 credit for \$65 check. O. S. Haich, 137 W. Lewis St., Ft. Wayne, Ind.

LIVE agents wanted for the new 1915 Eagle motorcycles. Write quick and make good money as our local representative. Sterling Motor Company, 720 Center Street, Brockton, Mass.

BARGAINS in new and slightly used motorcycles. We have just bought from one of the largest motorcycle dealers in Washington, D. C., 52 motorcycles, some new, others demonstration models, and balance in slightly used ones in all well known makes. We now have all told over 100 motorcycles in stock. We own these motorcycles at prices less than 1/2 their value. This month we are going to offer them at prices that will move them quickly. If you intend buying a motorcycle now, or this Spring, get in on this sale, by writing for our list giving description and prices. You will save from 25 to 50%. Gotham Sporting Goods Co., 57 Warren St., New York City.

INDIAN 4 H.P., single magneto, Cradle fork, re-enameled new tires; will take \$60. Box 17, Brookville, Mass.

USED Motorcycles guaranteed in good running condition at lowest possible prices. Best bargains in the country; stock limited; buy now. Secher & Hofheins, Buffalo, N. Y.

1914 TWO Speed Twin Harley, \$150; Pope 5, \$100. Sam Johnson, Westfield, Wis.

\$50 TO \$150 buys the best motorcycles; every make and model in our large stock must be cleared. Half price. Send for list today. Brown Music Co., 9119 Commercial Ave., Chicago, Ill.

1913 EXCELSIOR Single. Run less than 600 miles. Excellent condition. W. Wendell Wildman, Selma, Ohio.

1915 MODEL C-4 Dayton, never uncrated. Have made large payment. Will sell for \$260. Deposit of \$25 required. Newton Barlow, So. Langhorne, Pa.

FOR Sale—Late Henderson, A Qua, Saratoga Spgs., N. Y.

MOTORCYCLES, Second-Hand; get our list. Satisfaction guaranteed or money refunded. W. J. Walker, 74 Huntington Ave., Boston.

\$20 TAKES 3 H. P. Bicycle Motor Attachment. New, King, 307 Wisconsin Street, Chicago.

EXCELSIOR Twin, rated 7 H.P., tests 12, owned by mechanic unfortunate; must sell; \$125. Herbert Beal, Abington, Mass.

MOTORCYCLE Bargains! Indian Twin, clutch, magneto, \$75; Wagner, \$35; Harley-Davidson Twin, \$150. Many others. Carburetors, tires, supplies, half usual prices. Send for price list today. Chapsman Cycle Co., 2018 Irving, Minneapolis, Minn.

1911 HARLEY-DAVIDSON, \$50; 1912 Harley-Davidson, \$65. Both in good condition. 1828 E. 55th Street, Cleveland, Ohio.

\$5,000 WORTH of used Motorcycles, all makes; Harley-Davidsons, Indians, Excelsiors, Hendersons, etc. Twins, \$75 and up; Singles, \$25 and up. Send for our list at once. C. H. Lang, 1704 Michigan Ave., Chicago.

EXCELSIOR Autocycle, \$37.50; Flying-Merkel \$45; Pierce Four-Cylinder, slightly used, \$135; Scripps-Booth Cyclecar, snap, \$165. Leather Leggings, 65c; Spark Plugs, 15c; Grins, 15c. Parts for all motorcycles. Electric Motorcycle Horns, \$1.40. Wandersee Company, 120 Gratiot Ave., Detroit, Mich.

EXCELSIOR Twin, magneto, new tires, fine condition, \$90. Emmott Littler, Skidmore, Mo.

BIG bargains in second-hand motorcycles, \$25 up. Indians, Harleys, Thors, Excelsiors and Merckels. Write for descriptions. Howard A. French & Co., Baltimore, Md.

BULLETIN describes 78 bargains motorcycles. Must sell regardless of cost; need room 1915 stock. Bank handles deposit orders; why take chances? Ludden & Whitten, Brockton, Mass.

SEND for latest Bulletin of real Motorcycle Bargains, used and slightly used, all makes, models and prices; if you have \$25 and really want a powerful Motorcycle, send for this Bulletin; hundreds of machines at all prices, new ones on easy payments; tell us what you want and how much you can pay; we can fix you up. Peerless Motorcycle Co., Dorchester, Mass.

LOWEST prices on New and Used Motorcycles. Ask for list M. Prices \$20 up. Rebuilt Motorcycle Dept., 301 Center Street, Brockton, Mass.

FOR Sale—One 1914 Twin Excelsior. Perfect shape. Price \$160. E. D. Smith, Holly Springs, Miss.

INDIAN Two Speed twin, 1912, new enamel; cost me \$325, ridden 2,500 miles; sacrifice \$135. Treas., People's Savings Bank, Brockton, Mass.

MINNEAPOLIS 4-Horse Power; Indian 5-Horse Power, with free engine clutch. Price of either, \$65. Geo. E. Buss, New Philadelphia, Ohio.

RELIABLE place to buy dependable used motorcycles, all makes, \$25 up. Guaranteed as represented or money refunded. Write for winter lists and terms. Few brand-new 1914 Thor twins, greatly reduced prices. Thor Motorcycle Co., 336 Columbus Ave., Boston, Mass.

BIG bargains in good motorcycles we have taken in exchange on new ones. Send for special bargain list. Shaw Mfg. Co., Galesburg, Kansas.

MOTORCYCLES—your own price, all makes. Write for list. 109 N. 12th Street, St. Louis, Mo.

SUPPLIES—Our big catalogue with prices lower than usual sent free to motorcycle owners. Mecc, Hammondsport, N. Y.

USED Motorcycles, all makes. Send for list. Ward Brothers, 212 Broadway, Camden, N. J.

NEW Motorcycle Book—Just Published—Motorcycles, Side Cars and Cyclecars, Their Construction, Management and Repair—530 pages, cloth, 250 illustrations. The Dealer, Mechanic and Rider will find this treatise a work of reference without an equal. Price \$1.50 postpaid. Popular Mechanics Book Dept., 6 N. Michigan Ave., Chicago.

REBUILT machines, accessories, and parts for every make of motorcycle. Send motors for overhauling. Best work, cheapest prices. Get list 36 of rebuilt machines. Motorcycle Parts Mfg. Works, 4713 Cottage Grove Ave., Chicago.

BICYCLISTS—We'll pay you for using and advertising wonderful Houghton "Nail-Proof" Tires. Drive nails, tacks,—no leaks. Same air pressure. Light weight. Double guarantee. Nothing like it. Get limited offer quick. Houghton, Marion, Ohio.

## CYCLE CAR MATERIAL

ONE pair front wheels 28x2 1/2", with axle and tires, \$21.50. One pair rear wheels 28x 2 1/2", with axle, V Belt drive, \$11.50. Used very little. B. Kietzman, Lakota, N. Dak.

CYCLE Car wheels. All sizes. Send for Bulletin. Heath Aerial Vehicle Co., Chicago.

CYCLECAR Friction Transmissions. Aluminum disc, tarred fiber wheel roller bearings. Guaranteed. Cogswell Manufacturing Co., Hall St., Springfield, Mass.

CYCLECAR parts; busted prices. Write for circular. Act at once. Address Motor-ette, Hartford, Conn., U. S. A.

## AERONAUTICS

GET world's largest aeronautical catalogue, 6 red stamps, or our aeronautical motor catalogue just off the press, 4 red stamps. Blue prints \$1.75, all standard aeroplanes and aerial driven cycle car. The latest fad. "Heath" Propellers for air, water and land represent the survival of the fittest. Six years propeller production proves perfection. 3 red stamps for propeller catalogue. Heath Aerial Vehicle Co., Chicago.

LEARN to fly and become independent. Many of our graduates among America's best pilots, earning \$2,000 to \$5,000 yearly. School and equipment the best. Tuition only \$300. Send for Booklet C. Thomas Bros. Aeroplane Co., Rhaca, N. Y.

FOR Sale—Two Curtiss Biplanes. One Blériot Monoplane. All complete. Bargains. Lorain Hydro and Aero Co., Lorain, Ohio.

BALLOON Men: I give you the formula how to mix balloon varnish; drying the cloth; pattern cutting; sewing the balloon; varnishing the seams; valve in the air-ship; generating the gas; construction of gas plant; precaution with gas; blue print of how to cut your gas bag; blue print to set your gas plant, and the formula to cover your plane—same as used on Deperduain Planes—five full typewritten pages—price \$2. J. F. Bush, Aeronautical Engineer, 1490 State St., Schenectady, N. Y. Note—Postal inspection invited.

**MODEL Aeroplanes**—7c brings greatest handbook and catalog. Cheapest supplies. Walter Phipps, 593 5th Ave., New York.

**BLERIOT-Anzani**, \$350; new 50 Maximator, \$550; 30 Detroit, \$100. Many others. Selling for storage. Curran, 217 W. 83rd St., New York.

**FOR Sale**—50 Horsepower Roberts Motored Tractor Biplane. Excellent condition, good flyer. Genuine bargain. Thos. Timmons, Beloit, Wis.

**WILL** sacrifice latest flying boat, \$775. Completely equipped. Heath Aerial Vehicle Co., Chicago.

**FOR Sale**—Thomas Flying Boat, 75 H. P. Motor, just been overhauled; strong flyer, willing to demonstrate. \$1,500. Thomas Bros., Ithaca, N. Y.

**CHICAGO Aero Works**, 143 North Wabash. Everything aeronautical.

**LIGHT Weight**, Gasoline Engines, 2½ lbs. Guaranteed ½ H. P. The Weiss Co., Torrington, Conn.

**COMPLETE Plan**, drawn to scale, with precise instructions for building a Curtiss 3-foot Model Flying Boat, 25c. Other plans: Blériot, 15c; Wright, 25c; Nieuport, 25c; Curtiss Hydro, 35c; "Peebl" Baeer, 25c. Set of six, \$1.25. 48-pp. Model Supply catalogue, 3c. Ideal Aeroplane Co., 82½ West Broadway, N. Y.

**HOW to Make a Biplane Glider**—Our book "Amateur Mechanics No. 2" contains a complete detailed description of how to make one. Price of book, 25c postpaid. Popular Mechanics Book Dept., 6 N. Michigan Ave., Chicago.

**BUILDING and Flying an Aeroplane**—160-page handbook covering the building of small models and full sized gliders and machines. In both biplane and monoplane models the well-known Curtiss and Blériot types are followed. Fully illustrated with detail drawings. Price, \$1 postpaid. Popular Mechanics Book Dept., 6 N. Michigan Ave., Chicago.

**AVIATION motors up to 150 H.P.**, from \$250 up. Complete aeroplanes from \$500 up. Iceboats, motor-sleighs, from \$500 up. Aero Exchange, 38 Park Row, N. Y. C.

#### BOOKS AND PERIODICALS

**BOYS**—10c brings our 9x12 Illustrated boys' magazine, one year, Canada, 20c. Dandy stories, Mechanics, Electrics, Stamps. Youth's Magazine, 3655 Ogden, Chicago.

**TOY-MAKER**—Greatest book for boys who like to make things. 64 pages. Illustrated, 10c. Electric Shop, 3315-C, Belleplaine Ave., Chicago.

**"THE Future of Electricity"** by Chas. P. Steinmetz, 10c. N. Y. Electrical School, 44 W. 17th, N. Y. City.

**TECHNICAL books** bought, sold; cut rates, easy payments. Accountancy, advertising, chemistry, civil service, drawing, engineering, law, etc. C. A. Bubb, Detroit, Michigan.

**EVERY Herb Collector** should have "Flower Guide," cloth-bound book, 240 pages and 192 colored pictures of wild plants; tells where each is found, when in bloom, etc. Supplement of directions for gathering and preparing, collectors' prices and where to market those used in medicine. Complete postpaid, \$1. Forest Products Co., Box 80, West Milan, N. H.

**RARE Books** and first editions collected and arranged for people who are too busy to attend to the forming of libraries. Address Downing, Box 1330, Boston, Mass.

**WORLD'S Best Self-Educational Books** (Periodicals): Mechanical, Electrical, Agricultural, Engineering, Sciences, Chemistry, Business, Art, Literature, Languages. Any subject. Lists 6c. Explain subject thoroughly. C. Higene Co., 2441-B Post St., San Francisco.

**MATHEMATICAL Revelation**—All Arithmetical and Geometrical Calculations solved with ease, accuracy and great saving of figures by latest method of Comparative Cancellation. 145 pages. \$1 postpaid. Money back if not satisfied. Herrick & Horton, Publishers, Princeton, Ill.

**ENGINEERS' questions** and answers for license, by Hobson, for twenty-five cents, postpaid. Send stamps. Rilly's Book Store, Philadelphia, Pa.

**METAL Work and Etching**—A 96-page hand book for art metal workers telling how to make a great variety of useful and ornamental objects, such as desk sets, aris-crafts, jewelry, etc. Price, 50c postpaid. Popular Mechanics Book Dept., 6 N. Michigan Ave., Chicago.

**"SHE," dandy book**, 25c. Catalogue, 2c. Duff, 2713 Mozart, Chicago.

**INSTRUCTION Books**, Automobile, Inventors' Electricity, Engineers', Jewelers', Machinists', Plumbers' (best published), Lamont Co., Beacon, New York.

**SEND stamp** for our book "How to Make Patents Profitable." Benjamin & Bassett, 141 S. Dearborn St., Chicago, Ill.

**WAR Books**—A careful selection of all the most vital and trustworthy books, on the great European War situation. Send for complete descriptive list free. Popular Mechanics Book Dept., 6 N. Michigan Ave., Chicago.

**FREE Catalog of Mechanical Books**—Our 96-page catalog of 500 books on 100 different subjects will show you where to find that particular information you are in need of on any mechanical subject. Send for it today. Popular Mechanics Book Dept., 6 N. Michigan Ave., Chicago.

**HOBBIES Magazine**; also tools for intensely interesting Antofretwork, Scrollwork and Home occupations. W. R. Price, New York.

**LEARN mouth-organ**. Our complete self-instructor, 12c. G. Elsa, Owosso, Mich.

#### EDUCATIONAL AND INSTRUCTION

**THE more you learn the more you earn.** We teach you the Real Estate Business by mail. Our course is plain, practical and to the point. Not a single dissatisfied student among the hundreds who have taken our course. Wonderful co-operative selling organization among graduates in all parts of the country. Write for Free Book. Modern Real Estate School, 312 Palace Bldg., Minneapolis, Minn.

**ARTIFICIAL marble**, sanitary flooring, ornamental casting, concrete, plaster, papier-mache, interior decorations, garden furniture, statuary, life casting, elastic moulds, galvanne electric plating casts. Complete instructions \$1. Particulars, 200 illustrations, free. Mahler, 117 Russell St., Brooklyn, N. Y.

**FREE Tuition by Mail**—Civil Service, Normal, Academic, business, agricultural, English, drawing, engineering, real estate, and law courses thoroughly taught by mail. For "Free Tuition Plan," address Carnegie College, Rogers, Ohio.

**LEARN photography**. We teach it in one month. Johnson's Studio, Oswego, N. Y.

**LEARN Engineering**—Complete course qualifying you for license sent for 30c. Geo. Olive, Willmar, Minn.

**FOR Sale**—New I. C. S. Electrical Engineering Course; sacrifice; act quick. E. D. Sizer, Sizerville, Pa.

**LEARN to use a slide rule**. The "Gilson Slide Rule" does work equaling a \$10 rule. Results of computations given to five figures. Price with complete instructions, 50c. Clair Gilson, Niles, Mich.

**BE Successful! Develop Magnetic Force.** Send for "Why Men Succeed." It's free. N. Marsden Otto, 57 E. Vanburen, Chicago.

**INCREASE your earning power**. Free booklet, "Magic Story of Achievement," success literature and advice letter; will open your eyes. Write today. Evertz School, P-11, St. Louis.

**PARAGON Shorthand**. Learned in 7 days. Valuable invention by expert—not by mere theorist. Speed capacity beyond reach of hand. Is being used in service of United States Government. Request names of writers and fee. Paragon Institute, 117 Coliseum St., New Orleans, La.

**\$25.00 REALTY Brokerage Course**, \$1.00. Money back unless delighted. Prospectus free. Healy, Box 348-U, Joplin, Mo.

**DO you need help?** Chemical questions answered. Formulas. Technical advice. Frederick Wirthman, Chemist, Kansas City, Mo.

**SUCCESS? How? Study at home; fit yourself for a better paying position** through one of our 60 courses, including Business, Normal, Kindergarten, Agriculture, Engineering, and Law. Thousands of successful graduates. Chartered 1903. Write for free 30-page catalog, stating instruction wanted. The Modern School of Correspondence, San Francisco, Cal., Dept. M.

**EIGHTEEN Ways to Make Money!** Interesting isn't it? If you are mechanically or electrically inclined don't fail to write for our free book. Efficiency Company, 104-A, East 14th St., New York.

**LEARN Mechanical Drafting**. Cost small. Returns large. Individual instruction by expert. Garfield Drafting School, 523 West 134th St., New York City.

**WANT to secure a marine or steam engineers' license?** For that great class of ambitious and hard working men, the oilers, coal-passers, water-tenders, firemen or anyone who wants real practical and useful information regarding the every-day operation of a steam plant, Chief McAllister of the U. S. Revenue Cutter Service has written an engineering story called "McAndrew's Floating School," that makes it possible for those who have not had previous training to absorb the necessary information. Cloth, 250 pages and 87 diagrams. Price, \$1. Popular Mechanics Book Dept., 6 N. Michigan Ave., Chicago.

**IRREGULAR handwriting changed to a rapid business style** by mail. Journal free. F. B. Courtney, Box A 492, Detroit, Mich.

**LEARN to letter attractive show-cards** in six short lessons (by mail). Personal instruction—no failures. Write for information now! M. E. Tice, Frankfort, Ind.

**MECHANICAL, Dentistry**. Enclose \$1, for which I will mail complete instructions. A. Van Wagoner, Osmun Building, Ridgewood, N. J.

**WEST POINT, Annapolis**—Appointments; examinations. Booklet, complete instructions for entering, 25c. Baker Pub. Co., Rochester, N. Y.

#### TRADE SCHOOLS

**BE a watchmaker** at the Stone School of Watchmaking. "Free Book." Earn while you learn. 597 Wabasha, St. Paul, Minn.

**MAKE \$5 to \$8 a day** as skilled Electrician, Plumber, Draftsman, Bricklayer, Moving Picture Operator. We teach you in short time at small expense, profitable trades. Free employment bureau places graduates in good jobs. Special limited offer now. Write at once for catalogue and full particulars—no obligations. Dept. 8193, Coyne National Trade School, 51 E. Illinois St., Chicago, Ill.

**YOUNG MAN**—Learn the plumbing, heating, ventilating trade from practical work on jobs. Good position for students. Write for particulars. Litchfield Trade School, Libertyville, Ill.

**PAINTING, Decorating, Paper Hanging** taught by actual practice. Free catalogue. Chicago School of Painting, 150 West Austin Ave., Chicago.

**AUTOMOBILE Instruction**. A complete home study course that shows you exactly what you want to know about the automobile. 220-page book, giving definite, thorough, authentic and practical detailed information about every part of the automobile as well as thorough instruction in regard to driving, repairing and general care of the complete car. 290 illustrations, \$1.50 postpaid. Popular Mechanics Book Dept., 6 N. Michigan Ave., Chicago.

#### TELEGRAPHY

**NOVEL Telegraph Outfit**—works ¼ mile—Two complete stations, battery, wire, Morse code, instructions, \$1. postpaid. Anyone can learn telegraphy. Boys can have great fun. Electroset Co., 683 Caxton Bldg., Cleveland.

**TELEGRAPHY**—Morse and Wireless—also Station Agency taught. R. H. and Western Union wires and complete Marconi Wireless Station in school. Graduates assisted. Marconi Co. employs our wireless graduates. Low living expense—easily earned. Largest school—established 40 years. Investment \$25.00. Correspondence courses also. Catalog Free. Dodge's Institute, 15th St., Valparaiso, Ind.

**TELEGRAPHY** taught in the shortest possible time. The Omnigraph Automatic Transmitter combined with standard key and sounder. Sends you telegraph messages at any speed just as an expert operator would. Five styles. \$2 up, circular free. Omnigraph Mfg. Co., 41 G. Cortland St., New York.

#### WIRELESS

**500 MILE receiving sets**, \$3. Transformers, 60c. Send stamp for prices. Daniel Russell, 134 Glenwood Ave., Jersey City, N. J.

**WIRELESS Set**. How to Make—96-page book telling how to construct at small cost an outfit suitable for transmitting four or five miles. Price, 50 cents, postpaid. Popular Mechanics Book Dept., 6 N. Michigan Ave., Chicago.

### PICTURES, POSTCARDS, PENNANTS

IF you really want to exchange postcards, try our splendid club. Lists circulate in many countries. Membership, 10c. Halcyon Club, Box 133, Erie, Pa.

EXCHANGE pretty postcards with our members far and near. Best card club. Membership, 10c. Jolly Card Exchange, Box 125, Decatur, Indiana.

EXCHANGE postcards in our splendid club. Large circulating list. Membership 10c. World Wide Card Exchange, Oceanic, N. J.

TEN pretty postcards and catalog fine jewelry. 10c. Dollar Jewelry Co., Chicago.

REAL photos of pretty girls; samples and catalogue, 10c. F. T. Sun Co., Harrison, Mich.

EIGHT photo postcards Panama-California Exposition, 25c. P. S. Daniels, 1268-13th St., San Diego, Cal.

BEAUTIFUL Girls in "Bewitching Poses," hand-tinted photos, "true to nature." Send dime for best samples (full size) and new illustrated catalogue of "real fascinating" books, pictures, novelties, etc. (sent sealed). You'll want more. Satisfaction guaranteed. Williams Publishing Co., 121-C North Dearborn, Chicago.

CARD Exchange, children's, 5c. Parent League, Oceanic, N. J.

BETTER than September Morn. Two new pictures by the same painter; these two and September Morn for silver quarter. Box 592, Minneapolis, Minn.

28 BEAUTY Poses, 10c. Catalogue, 2c. Taylor Brothers, M2129 Clifton, Chicago.

THE old reliable postcard club. Many foreign members, 10c. "Hobbies," Perry, Okla.

FIFTY Art Postcards, 3-10c; 10-25c. Stewart Co., Providence, R. I.

MAN-EATING Shark—Cuba—Beautiful, instructive 5x7 photograph, 20c. Not a print but an actual expensive photograph. A. Butlers, 2818 Ohio, Omaha, Neb.

MEMBERSHIP in press immediately, 10c. Pacific Card Exchange, Bryn Mawr, Wash.

POSTCARDS, 90c per 1,000 up; pennants made to order; fountain pens, safety razors, European War cards, 100 for 50c. Particulars free, or 10c brings a bunch of samples. Gross Co., 2112 Lafontaine Ave., New York.

SEE San Francisco's World's Fair—8 colored postcards, 10c. Hannah, 1344 Jackson Street, San Francisco.

ART Poses, Rare Imported Models, samples and catalogue, 10c. Girard Novelty Co., Pautucket, R. I.

BOOKS and Art Photos, Sample of either, 10c; both, 15c. Globe Co., Box 42, Augusta, Mich.

RECEIVE Post Cards from everywhere. Join our jolly club. Send 10c. H. J. Teeple, Decatur, Indiana.

PHOTOS—Fascinating subjects, 10 for 25c. Duff, 2713 Mozart, Chicago.

ART Photos—Kind everybody wants. Circular free. G. Olive, Willmar, Minn.

JIM: Read my ad under "Games." Something good. Salvino.

25 ASSORTED High Grade Post Cards, 10c. Brown Sales Co., 683 28th, Detroit, Mich.

POSTALS mailed from Frisco Exposition in your name, dime. Dollar dozen. Alan, Poplar, Mont.

25 DIFFERENT Postcards, Holiday, Scenic, etc. Satisfaction guaranteed, 10c. Bay State Supply Co., Dalton, Mass.

STUNNING Photos of pretty girls. Real "Beauties." Very clear. Set, 25c. Renzbritt, Stone St., Newark, N. J.

3,000 SELECTED Pictures for \$3. A Panorama of World Events, Political, Industrial—Social—Humorous—Tragic—all of intense human interest. A wonderful collection of 3,000 cartoons reproduced from the newspapers of the United States, Canada, Mexico, Cuba and the cities of the Old World, has been made by Cartoons Magazine from more than one hundred and fifty thousand published cartoons, and, bound in an artistic and durable cover, are now ready for your library table. Vol. I, Jan.-June, 1912—\$1. Vol. II, July-Dec., 1912—\$1. Vol. III, Jan.-May, 1913—\$1. Cartoons, 6 N. Michigan Ave., Chicago.

POSTCARDS—Showing Female Beauties in attractive poses. Imported; hand-colored; no trash. Catalogue and one sample 10c. Ritz Publishing Co. (Not Inc.), Dept. 43, Chicago.

CROSS-SECTIONAL view of ocean liner "Britannic," showing interior arrangement of ship in colors, size, 14x20 inches, on heavy plate paper for framing or hanging. Very interesting. Reproduced from front cover design of July issue Popular Mechanics. Will be sent postpaid to any address in the world on receipt of 4 cents in stamps to cover packing and mailing. Popular Mechanics Magazine, 6 N. Michigan Ave., Chicago.

JOIN Postcard Exchange; membership 10c. David Cafa, Mancelona, Mich.

20 PHOTOS of beauties taken from life for 10c. Kay I. Co., Box 67, Ottawa, Ill.

EXCHANGE pretty postcards with our members in far-off lands. Membership, 10c. Elite Exchange, R32, 3684 Milwaukee Ave., Chicago.

### CAMERAS AND PHOTO SUPPLIES

25 FORMULAS for latest fada in photography, 25c. Includes disappearing photos, Phosphorescent photos, Trick pictures; simple enlarging apparatus. Transferring to cloth, chinaware, etc. Satisfaction or money back. P. Besset, Stewartville, Minn.

PHOTOCARDS—Many hundred thousand photograph postcards we make in one year for merchants, corporations, battleships, societies and individuals. Send for free sample card, "Kodak Hints," and price list. Send four negatives (4) and \$1.50 for "one hundred" finished postcards. Send 29c and one roll film—we will develop and make you six postcards or prints. Caulkins Photo Works, Oseonta, N. Y.

ARE your spare moments utilized to your advantage? Why not learn Photo-Coloring? The cost is very small. Send for circular. Keil-Barr Company, 56P Pine Street, New York.

LOWEST prices in the United States on Kodak Finishing. Stamp for particulars. National Photo Finishing Co., Dept. X, Omaha, Neb.

TEN 6x8 Enlargements free each month for the ten best films sent to us for developing. Amateur work only. Get into this contest and have your work done by experts. Any roll developed, 10c. Ordinary prints, 3c each. Marquette Studio, 308 Marquette, Minneapolis, Minn.

PRINTING 2 1/2 x 3 1/4, 2c; 3 1/4 x 5 1/4, and postcards, 3c. Developing, 10c. Neat, prompt work. Fay S. Lincoln, Box 310, Greensburg, Pa.

VEST pocket exposure meter and detailed description of the best German genuine Anastigmat Lenses made, and sold at way-down prices—all for a two-cent stamp. Free seven double Anastigmat in 1/250 shutter only \$28. LaBarry Co., 305 North Fifth Ave., Chicago.

FILMS developed 10c; prints 3c to 5c. Take no chances on bathroom finishing; send to a reputable Incorporated Company conducting largest plant in existence. Price list and special offer. Enlarging our specialty. Chicago Photo Finishing Co., 54 W. Lake St., Chicago.

FILMS developed, 10c. Prints, 2c up. Send negative for sample. Schmidt, Dept. A, 2416 Burr, Omaha, Neb.

DRAWINGS and specifications for making electric shutter-trip, forty cents. Ke-lo Company, 4934 Charlotte, Kansas City, Mo.

COLOR Photo Plates developed and finished. Autochrome, Page, Dufay, etc. By pioneer in color photography. "You press the button, I do the rest," even loading your plate holders. Edwin Blake Whiting, 92 Kensington St., New Haven, Conn.

FOR Sale—Victor Studio Flash Cabinet with escape pipe, Aristo Lamp, Eastman Print Dryer fan and gas attachment. Also McFarlin and Spliker moulding cutter, new. Gay's Galleries, Fall River, Mass.

CROSS Photographic Co., 2817 Delmar, St. Louis. Finest equipment in America. Prints 2 1/2 x 3 1/4, 2c each; 3 1/4 x 4 1/4, 3c each. Roll films developed, 10c. Send for prices and free coupon.

ACTINO Cartridge Holder, the best, safest, most convenient means of supporting flashlight cartridges. Will send postpaid with free copy illustrated booklet "Flashlight Photography" for 50c. J. H. Smith & Sons Co., 2548 Cottage Grove Ave., Chicago, Ill.

ENLARGEMENTS, 8x10, 20c; 11x14, 50c; 16x20, 75c; septa 10c extra; films developed, any size, 10c; prints 4x5 or smaller, 4c. Work guaranteed. De Vitto Co., New Deep, N. Y.

FILMS developed, 5c; prints, 3c; any size. Johnson's Studio, Oswego, N. Y.

HAVE You a Camera? Write for Samples of my magazines, American Photography and Popular Photography, which tell you how to make better pictures and earn money. F. R. Fraprie, 690 Pope Bldg., Boston

CAMERAS, Graflex, Plate, Film, new, used, shopworn. Lenses, anastigmat, rectilinear. Wonderful bargains. Get lists. Newark Photo Supply Co., Newark, New Jersey.

FILMS developed free; prints of same 4c; not less than 2 of each; good films bought. Give us a trial. Steffens Photo Co., Bloomfield, Neb.

KODAK rolls developed 10c. Pictures finished 3 1/4 x 4 1/4 or less size, 2c. None cheaper and none better. Lum Fleming, Weatherford, Texas.

WE buy, sell and exchange. Bargains in Microscopes, Telescopes, Binoculars, Cameras, etc. Bargain list sent. Kahn & Son, Opticians, No. 54 John St., New York. Established 62 years.

FILMS developed 10c, all sizes. Prints 2 1/4 x 3 1/4, 3c; 2 1/2 x 4 1/4, 3 1/2 x 3 1/2, 3 3/4 x 4 1/4, 4c; Post Cards, 50c doz. Work guaranteed and returned 24 hours after receiving. Postpaid. Send negatives for samples. Girard's Commercial Photo Shop, Holyoke, Mass.

BIG Money Saved on Photographic Lenses and Apparatus—goods exchanged; repairing done. Ralph J. Golsen, 65 East 46th St., Chicago, Department P.

SAVE 40% on Photo Paper from factory, prepaid. "Instanto" has a sparkling quality no other gaslight paper possesses, quick printing develops easy. Money back guarantee. Send 25c for 5 dozen postals or 4x5 size, price list and full directions. Photo Products Co., Dept. J, 6109 La Salle St., Chicago.

SPOT Cash paid for high-grade Kodaks, Lenses and Cameras. Send full description stating lowest price. Cameras exchanged. In business since 1885. David Stern Co., Dept. M, 1047 W. Madison St., Chicago.

ROLL Film developed, 10c a roll. Packs 20c each; Prints, Brownies, 2c; 1a, 3x4, 3x5, and Post Cards, 3c each. Work returned next day. Postage paid. Kodak Film Finishing Co., 112 Merchants Station, St. Louis.

KODAK Films Developed, 10c per roll, any size. Prompt attention given mail orders. Prints, 2 1/2 x 3 1/4 to 3 1/4 x 4 1/4, 3c; 4x5 to 3 1/2 x 5 1/2, 4c. J. M. Manning, Box B, 1662 Third Ave., New York City.

ANY 6-exposure Roll Film developed and printed for 25c. 12-exposure roll, 50c. 24 hour service. Wolf—3109 N. Grand, St. Louis, Mo.

### MOTION PICTURES

BRAND new 1915 model Motograph picture machine; cost \$250, will sell to quick buyer for \$175. Fred Stelzer, Lincoln, Ill.

BIG Money Writing Moving-Picture Plays, \$75 each. Literary talent or experience unnecessary. Write for free booklet "How to Write Moving-Picture Plays." Lundeen Publishing Company, PM2, Fergus Falls, Minn.

MOTION picture plays wanted. You can write them. We teach you. No experience needed. Big demand and good pay. Details free. As'd M. P. Schools, 601 Sheridan Rd., Chicago.

I GUARANTEE \$10 for first photoplay you write by my method. As former scenario editor, I speak with authority. Send for free booklet, "How to Write Photoplays." Elbert Moore, Box 772 P. O., Chicago.

\$50 TO \$100 weekly writing moving picture plays. Send for free booklet, valuable information and special price offer. Chicago Photoplaywright College, Box 278 T. C. Chicago.

MAKE money writing motion picture plays, \$25 to \$100 each. You can write them. No literary experience necessary. Big demand. Free illustrated booklet tells how. American Authors Ass'n, R 25, 1535 Broadway, New York.

WE accept manuscripts in any form; criticize free; sell on commission. Quick sales; big prices. Don't waste money on "Instructions," etc. Write us. Story Revision Co., Box 33, Smethport, Pa.

"HOW to write and where to sell Photoplays." Contains model scenario. Price 25c. Enterprise Co., PM1102 Morton Bldg., Chicago.

\$35 PROFIT Nightly—Moving Picture Business—small capital starts you, no experience needed. Teach you—furnish everything. Ralph J. Golsen, 65 E. 46th St., Chicago, Dept. M.

**WRITE** Moving Picture Plays. \$50 each. All or spare time. Correspondence course unnecessary. Details free. Atlas Publishing Co., 304, Cincinnati, Ohio.

**MAKE** a complete Motion Picture Camera and Projector from instructions given in our book Amateur Mechanics No. 4. Full details given. Not hard to construct. Worlds of enjoyment taking and exhibiting subjects dear to the heart. Price of book only 25c postpaid. Popular Mechanics Book Dept., 6 N. Michigan Ave., Chicago.

**MOTION** Picture Work—A large 618-page book covering every phase of the moving picture, its production and its theatre. Indispensable for reference and instruction to the thousands of workers in the motion picture field. Price \$3, postpaid. Popular Mechanics Book Dept., 6 N. Michigan Ave., Chicago.

**WRITE** Photoplays. \$50—Easiest Method—Twenty Lessons. Photoplay writing, 25c. "500 Movie Plots." 75c with souvenir. American Filmograph, Syracuse, N. Y.

#### BUSINESS OPPORTUNITIES

**MANUFACTURERS** of high-class, exclusive electrical specialties want man of proven ability and unquestionable standing; familiar with big propositions, for General District Manager in all open territory. May require investment up to \$500. Should net \$3,000 to \$6,000 first year. State age and experience. The Sterling Corporation, 1276 West Third Street, Cleveland, Ohio.

**1,000% PROFIT** manufacturing inks. Start at home during spare time. Capital and experience unnecessary. Enormous and endless demand. Our secret formulas and sure selling plans insure you a lucrative, steadily increasing business. Investigate immediately. Particulars free. A. Covert, Secretary, 6835-6839 Kenwood Ave., Chicago, Ill.

**RESILVERING** mirrors, renewing dry batteries and book filled with formulas and trade secrets, all 25c. Formula Service, 3311-C, Belleplaine Ave., Chicago.

**START** in the Carpet or Clothes Cleaning Business now. Thurman Vacuum Process unequalled for commercial cleaning. We show you how. Easily learned. Only \$125 capital needed to earn good income in towns of 2,000 and over. Write today. Thurman Vacuum Cleaner Co., Manufacturers all types Vacuum Cleaners, Dept. H, St. Louis, U. S. A.

**BIG** Kansas Company will start ambitious man or woman in fast growing business; any locality; \$3,400 yearly; spare time; no canvassing; no experience. We furnish everything. Write for unique selling plan. C. W. Eyestone, President, 174 E. 5th, Pittsburg, Kansas.

**\$130 HAS** been earned in 3 days by our representatives, some even better, introducing our new advertising method which solves the advertising problem for merchants in smaller cities and towns. If you are or want to be a salesman I will show you how to build up a big profitable repeat business quick. Whole or part time. Big money if you act now. Write Salesmanager, Winslow Cabot Company, 60 Congress Bldg., Boston, Mass.

**LEARN** the Real Estate Business. Our complete instruction book teaches: Listing, Appraising, Management, Salesmanship, Insurance, Brokerage, Advertising, Renting Agency, Forms, etc. 121 subjects. Exceeds \$20.00 correspondence course. Buckeye cover, 75c. Silk cloth \$1.00 postpaid. Realty Book Company, 5982 Euclid Ave., Cleveland, Ohio.

**QUIT** working for others. Start a cleaning and dyeing business. No experience necessary. Tremendous money-maker. Greatest re-order business known. Send for free booklet No. 11 today. Full details. White Wonder Co., National Safety Vault Bldg., Denver, Colo.

**WE** start you in business, furnishing everything; men and women. \$30 to \$200 weekly operating our "New System Specialty Candy Factories" home or small room anywhere; no canvassing. Opportunity lifetime; booklet free. W. Ragsdale Co., East Orange, N. J.

**BIG** ready to begin money-making mail-order plans. Little starts you. One plan averaged \$4 per day first thirty days. Send one dollar bill. Satisfaction guaranteed or money back. Descriptive circular free. W. O. McKelvey, Long Beach, Cal.

**START** Candy Shop. Big profits. "Art of Candy Making" tells how, 25c. Service Bureau, 3311-C, Belleplaine Ave., Chicago.

**"DOLLARS"** yearly in your back yard. No ginseng, mushroom dope. New ideas never before published, particulars free. Metz, M., 396 East 85th St., New York.

**OWN** a business. Co-operate with me evenings at home. Everything furnished. Don't worry about capital. Boyd H. Brown, Dept. N-3, Omaha, Nebr.

**START** a Mail-Order Business at Home. I did. Took in \$124,594.03 last year. Free particulars tells how I'll start you. Address Robinson, 181 Woodruff, Toledo, O.

**OPERATE** profitable mail-order book business, 70% profit each sale; small outlay, everything furnished. Spare time. Particulars free. Rollins, Box 5272, Boston.

**WANTED**—General Agent. Exclusive territory. Small capital—secured. Mackinnon-Cobleigh Co., Box 532, Templeton, Mass.

**MAKE** money with your camera, making slides for "movies." Instructions, 50c. Robinson, 514 Baum Bldg., Danville, Ill.

**"FREE"**—Seven best Mail Order Books—with Leading Mail Order Course. "Knowledge is Power"—the money-making winner. Staehlin, Jr., West St., Paterson, N. J.

**CONDUCT** a "Candy Kitchen." Clear \$5 to \$25 daily. Small capital required. Particulars free. The Kennon School, 142 W. Ontario St., Dept. A, Chicago.

**LET** me show you the way to success! Postal brings wonderful opportunities. Thos. Singer, Hancock, Wis.

**WOULD** you like to make Four Dollars in Four Hours? If so, write me. F. A. Holmes, Brewster, N. Y.

**MAKE** Money! Send for guaranteed formula; renewing dry batteries and ink blotter erasing formula, 25c. Battery formula alone worth \$1. Richard Canoe, Ridge-wood, New Jersey.

**MY** Mail-Order Business pays handsome profits. Particulars free. Zerbe, Sacramento, Penn.

**MONEY** in minerals! Many common minerals have market value. List 10c; minerals identified 25c. Mineralogist, 620 Joplin St., Joplin, Mo.

**ADVERTISE** in 133 different magazines, special price 3c word. Send copy now. Lists free. King's Magazine, Box 1370, Little Silver, N. J.

**EARN** \$10.00 daily; particulars and sample 10c. Garfield Supply, 1016 Germantown Ave., Philadelphia.

**WELD** Castings. Enormous profits. Small investment. Write today for free 32 page book on welding. Welding Apparatus Company, 221 National Union Building, Toledo, Ohio.

**OPERATE** profitable mail order business. Literature for red stamp. Dept. A. Box 153 Fort Worth, Texas.

**BE** a contractor for San-i-tite flooring; earn \$150 to \$300 monthly on kitchen floors alone. Will furnish formulas for \$3. San-i-tite, St. Petersburg, Fla.

**INVENTOR'S** best newspaper, three months 10c. Inventor's Advocate, Dept. 43, Washington, D. C.

**RAISE** Frogs—"French Frog Farming" tells how, 50c. Weybret-Lee Co., Monterey, Cal.

**READ** "Booster" and make more money! Operate Mail Order business during your spare time. We'll show you how! Special: Two months trial, 10c. Booster Magazine, Northwestern Building, Chicago.

**PATENT** Application fully prepared \$10. Why pay \$65? Particulars free. Patent News, Dept. 16, Washington, D. C.

**BEATS** 'em all. I get 30 to 40 letters a day, each contains dime. You can do same, no matter where you live. Particulars 10c. Hovey, Perry, Okla.

**RESILVER** Mirrors and make money. Others are doing it. The best formula 25c. Auburn Supply Co., Dept. R-3, 7745 Peoria St., Chicago.

**HERB** Recipe Book and Herb Catalog. 10c. Teaches how to make medicine from herbs for all diseases. Herb Gardens, Dept. 44, Hammond, Ind.

**PROFIT-Sharing** Mail-Order Plan; absolutely new. Goods, literature furnished. DeLoe Distributing Co., Station B, Baltimore, Md.

**START** a business of your own at home; spare time; particulars free; tells how. Thomas Mercantile Co., Box 8373, New Britain, Conn.

**EARN** \$7 daily restoring faded colors in rugs and carpets. No capital. Particulars free. Eldred, D. 75, Detroit, Mich.

**MEN** wanted to manufacture and sell Concrete articles, costs three dollars, sells for eighteen dollars anywhere. Write for particulars. Eureka Concrete Co., Meridian, Miss.

**TWELVE** years ago I started a small mail-order business at home in spare time with a few dollars capital. I wanted to make \$30 or \$40 a month, evenings. The net profits the first year averaged \$200 a week. Five years' work netted me \$50,000. I will show you how to start a small mail-order business. Send today for my proposition. It's interesting. No canvassing. Hancock, Box 887, Lockport, N. Y.

**IT** will pay you to investigate our Mail Dealers' Proposition. \$50.00 Reward offered. Merford Company, Incorporated, Chicago.

**WE** have several openings for establishment of independent mail-order business. Energy, good habits and sound judgment more important than capital. Spare time at first. Particulars free. Opportunities Exchange, Buffalo, N. Y.

**FOURTEEN** Big Circulars describing 800 plans, schemes—for making money—guaranteed formula for Renewing Old Dry Batteries (original price \$1.00), all for 10c. Northern, 154 West Randolph, Chicago.

**\$5 PER** day for laborers and big easy money for you telling them about it, by mail. Fascinating work. Full particulars and sample outfit 10c. Excello Agency, Box 302, Springfield, Ohio.

**LEARN** Dry Cleaning—Profitable, fascinating profession. Complete instructions, 25 cts. The Wiener Co., Madisonville, Ky.

**INSTRUCTIONS** for manufacturing six big sellers and 100 business opportunities, 10c. The Rils Sales Co., New Brunswick, N. J.

**RELIABLE** Man with Small Capital can start a profitable business selling our guaranteed goods. \$200,000 firm and liberal credit plan backs you. Wm. J. Dick, Mgr., Dept. G-10, 20 West Lake, Chicago.

**GET** my letter, "How I made never less than \$50.00 week after week without a cent of capital." C. W. Hagendorf, Elmira, N. Y.

**METLER'S** Compounds make one quart of ink for a dime. Lowest prices; big profits. Samples 4c. A. D. Metler, New Brunswick, N. J.

**HAVE** you lots of friends? If so, we want you; fine proposition for good "mixers." Spare time only. Potter Bros., Dept. 65, So. Bend, Ind.

**BRED** Flying Squirrels for pets or show; profits enormous; small space required. Mated pair and booklet \$2.50; safe delivery guaranteed. E. F. Pope, Colmesneil, Texas.

**MAKE** more money. Operate a mail-order business. Our magazine will show you how. Sample copy free. Publisher, 231 So. Albany, Chicago.

**START** a profitable Mail-Order business. My new instructions insure success. Interesting booklet free. Hayner, 3742 Elmwood, Chicago.

**GET** Wise! Make \$25 weekly. Superior Sign Co., 1839 Linden St., Brooklyn, N. Y.

**BE** a Merchandise Broker. Earn \$2,000 to \$5,000 a year. Our system insures success. Write for free information. National Brokerage Company, Davenport, Iowa.

**FORMULAS** and instructions for manufacturing six big sellers, and 100 business opportunities, for 10c. H. B. Essex, Box 416, Baltimore, Md.

**MANUFACTURE** profitable, fascinating Antofretwork novelties at home. Materials, tools, details. W. R. Price, New York.

**LET** the parcels post help you. Add (\$15 to \$25 weekly) to your present salary or income. Start during spare time and build up a permanent mail-order business of your own. We show you how and help you make good. No canvassing. Experience unnecessary. The Parcels Post makes success doubly sure. Our new ideas and up-to-date plans bring the money. No so-called "Course of Instruction" to sell. We give that free. Write today. Address Pease Mfg. Co., Inc., Dept. A, 70 Broadway, Buffalo, N. Y.

**I GUARANTEE** \$10 for first photoplay you write by my method. As former scenario editor, I speak with authority. Send for free booklet, "How to Write Photoplays." Elbert Moore, Box 772 P.G., Chicago.

**80-PAGE** mail-order advertising rate book—6c exact sealed postage. Kline Advertising Agency, Cleveland, Ohio.

**A BRILLIANT** opportunity awaits you. Manufacture a household necessity in your own home, and make \$8.00 profit on each dollar invested. New England Sales Co., Stamford, Conn.

**BE** Wise. Don't experiment in mail order. I can tell you how to succeed. B. Neunham, Waukegan, Ill.

UTILIZE your spare time. Start a sensible mail business at home. Become your own boss. I'll show you how without advance payment. You pay my fee from profits. No success, no fee. Particulars free. Postage appreciated. Expert, 429 Home Bank, Baltimore, Md.

**MANUFACTURERS, Promoters and Patent Buyers** are invited to write us stating the line of invention in which they are interested, as we can supply their wants in any class of patents. Victor J. Ernie & Co., 162 Ninth St., Washington, D. C.

**WOULD You Like to Own a good-paying mail-order business?** We have a line that gets repeat orders all the time. You can start in spare time; invest a dollar or two a week and soon own a nice business of your own. Particulars free. Nadico, 1664 Belmont Ave., Chicago, Ill.

**INDEPENDENCE and fortune quickly attained in the Manufacturing Mail Order business.** I furnish Formulas, Manufacturing Processes and Trade Secrets in all lines. Sold under positive guarantee; 18 years' practical experience. Revision and improvement of Formulas and Processes—reduction of manufacturing cost—utilization of waste materials, etc., a specialty. Booklet, Formula List, and Valuable Information Free. W. L. Cummings, Ph. D., 127 Standard St., Strouse, N. Y.

**STOP Here!** Let me start you in a home business that will bring you money every day. Experience unnecessary. Spare time. No canvassing. I furnish everything. Send for proofs. Voorhies, Desk C. R., Omaha, Neb.

**HOW to Operate a Mail Order Business.** 39 Big Profit Plans and year's Mailing service sent for 10c. Mail Dealers Wholesale House, 521 Franklin Bldg., Chicago.

**ADVERTISERS, Mail Dealers:** Our 1915 Rate Book lists 2,000 Principal Publications, rates, circulation. Includes 30 Mail-Order Plans. Price 10c. Dearborn Advertising Agency, 219 Franklin Bldg., Chicago.

**THIS beats Illinois.** Charters for stock companies lower than other states. Information free. Philip Lawrence, former assistant secretary of state, Huron, S. D., 101 Dakota Ave.

**START a Stock Food Co.** Be independent. We tell you how. Leslie Cole Stock Food Chemists, Ewing, Mo.

**PATENTABLE Ideas wanted—Send for 3 free books.** R. B. Owen, 30 Owen Bldg., Wash., D. C.

**BUSINESS wanted for cash buyers.** Send description and price. John R. Wright, Real Estate Expert, 1308 Adams Express Building, Chicago, Established 1881.

**IF you want facts instead of fancies about Patents,** address Benjamin & Bassett, 110 S. Dearborn St., Chicago.

**LEARN to collect money.** Good income; quick results. Send for free booklet, "Skillful Collecting." Collectors' Association, Long Street, Newark, Ohio.

**WHITE Moving Picture Plays.** \$50 each. All or spare time. Correspondence course unnecessary. Details free. Atlas Publishing Co., 3046, Cincinnati, Ohio.

**I WANT to send you proof of the wonderful pulling power of Popular Mechanics classified pages.** What's your proposition? Write me today. P. W. Johnson, Classified Dept., Popular Mechanics Magazine, 6 N. Michigan Ave., Chicago.

**BE Independent; own a Wallpaper-Cleaning Business;** whole or spare time; \$150-\$300 a month easy; big profits; no experience required; my booklet shows you how; write today. Milliken Co., Davenport, Iowa.

**WINDOW Lettering Business.** We start you free. Everbrite Co., Dept. P., Long Island City, New York.

**ONE beginner makes \$200 per week operating an original mail business we planned.** You can. Small capital—spare time—experience unnecessary. No "outfits" or "instructions." Proof free. Success Mint, 400 Main, Smithport, Pa.

**INVENTORS:** Let us sell your invention for real money. Investors: Write for particulars of some money-making inventions. Adam Fisher Mfg. Co., Dept. 1, St. Louis, Mo.

**BONDS and stocks bought and sold.** Companies incorporated anywhere. Loans on legacies, inheritances, stocks, bonds, commercial paper and business properties. L. N. Rosenbaum, 80 Wall Street, New York.

**WE will start you in the cleaning and dyeing business;** little capital needed; big profits. Write for booklet. Ben-Vonde System, Dept. C, Charlotte, N. C.

#### BUSINESS FOR SALE

**FOR Sale—Saw Mill and Basket Factory.** Price \$500 for whole machinery. Wm. Reynolds, R. F. D. 2, Mentor, O.

**FOR Sale—Vulcanizing plant in town of 15,000 inhabitants;** no opposition, and 2,400 autos in territory. Vulcanizer, 108 W. Darie St., Raleigh, N. C.

#### MAIL ORDER SUPPLIES

**SELL Joker's Novelties!** 16 samples 10c. Chambers Works, Plainwell, Mich.

**INCREASE your sales.** Place your proposition before the readers of "Cartoons Magazine." 30,000 copies guaranteed every month. Classified rate 2c per word. Mail in a trial ad today. Cartoons Classified Dept., 6 N. Michigan Ave., Chicago.

#### PAN-AMERICAN INVESTMENTS, A. B. C. REPUBLICS, SOUTH AMERICA

**CAPITALISTS** desiring to investigate with the view to investing in Coal, Iron, Petroleum, Nitrate or Borax deposits, etc.; Mining Properties (Copper, Tin, Silver, Gold, etc.); Real Estate (large land tracts, Government or private, all forest, grazing or agricultural), located in the "ABC" and adjoining South American Republics, are invited to write for information, enclosing 20c in stamps, to T. Dennis Locking (Pan-American Real Estate Dealer), P. O. Box 1801, Santiago, Chile.

#### TO INDUSTRIAL ENTERPRISES, MANUFACTURERS, ETC.

**GOVERNMENTAL and Municipal Franchises** solicited in the "ABC" and adjoining South American Republics, water powers, etc.; bids presented for execution of public works, supplying materials, etc.; legal and commercial representation of manufacturers, reports on establishment of industrial enterprises. Ample and satisfactory references offered. Address, T. Dennis Locking (Pan-American Industrial Representative), P. O. Box 1801, Santiago, Chile.

#### DUPLICATORS AND DEVICES

**FORM Letters,** 600 per hour. Genuine ribbon typewritten. Simple roller press anyone can make for 50c. Instructions, drawings, 25c. Money-back guarantee. No postals answered. McFranklin, Diamond, Ohio.

**\$2.40—THE "Modern" Duplicator.** 30 days' free trial—32,846 firms use it to make 50 to 75 duplicate ("Made in U. S. A.") copies of each letter, or anything written with pen, pencil or typewriter. Booklet free. Main office, J. E. Durkin & Reeves Co., 239 Fifth Ave., Pittsburgh, Pa.

**A DUPLICATOR \$1.00.** Letter size. Make over 50 copies from pen or typewritten original. Send for circulars. Schenck Laboratories, Dept. 1, Madison, Maine.

#### FOR ADVERTISERS

**10,000 BOYS** read our large 9x12 magazine. Display 6c line. Minimum 7 lines. Classified, 1c word. Minimum, 25c. Two insertions 15% discount. Youths' Magazine, Chicago.

**20 WORD advertisement one insertion and one year subscription 25c.** Extra words 1c. Circulation 35,000. Digest, Grand Rapids, Mich.

**ADVERTISE in 133 different magazines,** special price 5c word. Send copy now. Lists free. King's magazine, Box 13-P, Little Silver, N. J.

**AERIAL "Ads"** are top notches for publicity. Big money. Get in the game. Coty-Kite, 3508 McLean Ave., Chicago.

**DON'T** pick your own pocket by using poor sales letters. As professional business writers we give your field and your business exhaustive study, then construct letters and booklets that must bring you orders. Martin & Miller, Advertising Counselors, Business Department, 239 Fourth Avenue, New York.

**ADVERTISE in Barkley's Magazine,** 2c word (Display Inch, \$2.00). Send copy today. Sample copy, 10c. Barkley's Magazine (412), Blairsville, Pennsylvania.

**YOUR 50-word ad in our big postcard magazine,** 25c. Inch display, 50c. Elite Exchange, 3684 Milwaukee Ave., Chicago.

**ADVERTISERS—Here's your opportunity.** Your proposition placed before the readers of "Cartoons Magazine" for only 2c per word. Circulation 30,000 copies guaranteed. Send a trial ad for our next issue. Cartoons Classified Dept., 6 N. Michigan Ave., Chicago, Ill.

#### PERSONAL

**GET Success—Read "H. E." Thousands helped.** Marvelous results. Particulars free. Winslow D. Chase, Washington, D. C.

**STAMMERING and Stuttering cured in your own home by my mental training course.** Particulars free. R. Arnaud, Keene, N. H.

**If you like "Real Fascinating" books,** pictures, novelties, etc., send dime for "nifty" samples and new illustrated catalogue (sealed). You'll want more. Williams Publishing Co., 721-B North Dearborn, Chicago.

**"QUIT Tobacco" my harmless way.** Quick—Secret—Pleasant—Inexpensive. Interesting Booklet Free. J. Bradford, Asheville, N. C.

**BROTHER—Accidentally discovered root cures tobacco habit.** Gladly send particulars. P. Stokes, Mohawk, Florida.

#### AGENTS WANTED

**AGENTS—Would \$35 to \$90 per week in practically any locality interest you?** In more populous sections, hustling agents easily make \$75 to \$175 per week, selling our Sentinel Burglar Alarm. Actual sales tests prove this. Amazing new invention—just out—retail price one dollar. Sells quickly at sight to homes, offices, stores, hotels. Handsomely nickel plated—mechanically perfect—weight, 7 ounces. It provides perfect and cheap burglar insurance. Every home needs and wants one or more. Instantly attached to any door knob. Impossible to turn knob or open door without ringing bell. No batteries, wires, screws or nails are used. Just turn thumb screw and it is ready for instant action. Patented. No competition. For one dollar we will send one postpaid with our descriptive circular. If not entirely satisfactory, return it and we cheerfully refund your dollar. Write for our most liberal terms to agents. We want only live, aggressive workers who will actively push sales. Marshall Dobbins & Company, Manufacturers Household and Office Specialties, 1422 Marquette Bldg., Chicago, Illinois.

**OUR Agents are raking money selling the cutest household specialty just out.** The Star clothes line Reel, 70 feet of line. Fully guaranteed. Sells at sight. Every lady wants one. Big demand. Make \$15 to \$25 daily. Write for proposition. Utility Mfg. Co., Riverside, Iowa.

**AGENTS Wanted—Right here is the one big chance of your life.** If you want to make good money—\$10 a day or more, as easy as rolling off a log, and get your swell clothes free besides, you can do it by acting as our agent. We are the biggest people in the business and want our agents to make big money and be nifty, stylish dressers. Send a postal today for free \$10 outfit, including a big book of nobby selling samples to select your swell agent's suit from. Then take orders from people who admire your nifty clothes. They come to you—not you to them. This is the way to get rich—the sure, easy way. Remember, you need no money—everything is furnished by us free. We pay express on everything. Just send a postal, but do it today. You can't get started too quick, making this big money and wearing these stylish clothes. Address card to Paragon Tailoring Co., Dept. 314, Chicago, Ill.

**GENERAL Agents—Capable of calling on the big trade themselves and handling canvassers for the house to house and office to office business,** to sell the newest electric specialty on the market; sold everywhere there is electricity, in the home, office, factory, store, hotel; liberal profits; sales-driving sample, weighs a pound, no experience or knowledge of electricity required; shows how to use one light instead of two and get the same results; sells for \$2.50, \$3.50, \$5.00, and saves the purchaser an investment of \$25.00. Write for particulars. The Handy Light Co., 152 Handy Light Block, Cincinnati, Ohio.

**YOUNG Man,** would you accept a tailor-made suit just for showing it to your friends? If you live in a town smaller than 10,000, write Banner Tailoring Co., Dept. 975, Chicago, and get beautiful samples, styles and a wonderful offer.

**WANTED—Agents,** sell Roark's Auto Diary. 2,000,000 auto owners. Big opportunity. Big profit. Roark & Co., Gardner, Mass.

**THE Addi-Phone attached to a telephone makes hearing easy in noisiest places.** Every telephone user wants one. Wagner Co., 1652 Peoples Gas Bldg., Chicago.



**AGENTS Wanted**—If you know a chance when you see it you'll see this one now. Big money—stylish, nifty clothes—little work—no experience or capital needed—can you beat that? We want agents everywhere to take care of our business in their localities and to advertise our nifty suits by wearing them. We furnish everything complete and charge nothing for agents' outfit. The sweetest dressers everywhere are our agents and all we ask is that you tell people who inquire about your fine clothes where and how they can get them. You make big money—\$10 a day—without trouble. Just a postal brings you full outfit free. Big, new sample book of up-to-the-minute suitings sent so you can pick out your first suit; also measuring blanks and everything you need. We pay express on everything—not a penny for you to pay. Send quick before some one else gets the agency there—mail postal today to the American Woolen Mills Co., Dept. 314, Chicago, Ill.

**YOU can make big profits** selling our order getting line of guaranteed goods. \$290,000 firm and liberal credit plan backs you. We have an attractive general agency offer. Valuable premiums. Wm. J. Dick, Mgr., Dept. 721, 20 W. Lake St., Chicago.

**\$1,000 PER Man per County.** Strange invention startles world—agents amazed. Ten inexperienced men divide \$49,000. Koestel, a farmer, did \$2,200 in 14 days. Schlicher, a minister, \$195 first 12 hours. \$1,200 cold cash made, paid, banked by Stoneham in 30 days; \$15,000 to date. A hot or cold running water bath equipment for any home at only \$6.50. Self-heating. No plumbing or waterworks required. Investigate. Exclusive sale. Credit given. Send no money. Write letter or postal today. Allen Mfg. Co., 4016 Allen Bldg., Toledo, Ohio.

**KEROSENE Gas Burners** in cook stoves or ranges stop use of wood or coal. Recently patented. Money-maker for agents. The Vapor-Gas Burner Co., Desk 5, Columbus, Ohio.

**PROFITABLE Business;** new discovery. Guaranteed harmless fluid, sells direct to motorists. Increases mileage 50%. Has wonderful merit. Quick demonstration proves claims. Agents wanted everywhere western hemisphere. Manufacturer, 18 Natoma, San Francisco.

**AGENTS.** Cost, 3c, sell 25c. Gold window letters. Any one can apply. Samples free. Chicago Letter Co., 2513 Lincoln Ave., Chicago.

**MEN, hurry, get exclusive territory** for our new live household article. Write today. Keystone Products Co., 13623 Blenheim Rd., Cleveland, O.

**AGENTS, \$6 to \$12 a day easy.** 250 light weight, fast selling, popular priced necessities, food flavors, perfumes, soaps, toilet preparations, etc. Agents' outfit free. Write today—quick—now. E. M. Feltman, Sales Mgr., 562 Third St., Cincinnati, O.

**AGENTS:** Right goods at right prices. Winning money-making line. Ufert, 238 West 41st Street, New York.

**BIG Profits—New safety razor.** Sample 25c. Agents wanted. Virginia Sales Co., Fredericksburg, Va.

**AGENTS—Salary or commission.** Greatest seller yet. Every user pen and ink buys on sight. 200 to 500 per cent profit. One agent's sales \$620 in six days; another \$52 in two hours. Monroe Mfg. Co., X 6, La Crosse, Wis.

**\$15.00 MADE first day** by 13-year-old boy with Shonescope. Woman made \$8.00 first hour. Particulars free. Shonescope Mfg. Co., 523 W. 13th St., Kansas City, Mo.

**YOU can make big money** selling electrical diamonds. Send 10 cents for samples of scarf pin or ring. Our catalog is a winner. Send for it. Leon Wilder & Sons, 83 Bowery, New York.

**GOODLUCK** booklet containing your name and address on 120 gummed labels, 25 cents postpaid. Big profit for agents. Riley Publishing Co., Kansas City, Mo.

**SOAP Agents.** Make more money selling Lairo Products. Coffee, flavorings, spices, soaps, perfumes—135 other items. Big commission. Exclusive territory. Freight allowed. Extra free premiums besides cash given. Free sample case. No deposit required. Particulars cost nothing. Write today. Lairo Company, 13 Lairo Bldg., St. Louis, Mo.

**\$150 PER month and expenses—Salary** ce Commission—Introducing our King Butter Separator. Produces best grade of butter from cream or milk, sweet or sour, in less than 5 minutes. Retail \$5 up. Write for free sample and salary proposition. De King Mfg. Co., Dept. 147, Chicago, Ill.

**AGENTS—New, mighty money making** marvel. World startled. New marvelous clothes washing crystal. Clothes washing ideas revolutionized; positively abolishes rubbing, washboards, washing machines—women astounded, wild over it; absolutely harmless; \$1,000 guarantee goes with it; make \$50 to \$100 weekly easy. Exclusive territory, no experience necessary; credit granted; own a business, supply customers; pocket big profits; nature's mighty elements do work. Hurry! Write today—get overwhelming proof, all free. Equitable Corporation, Dept. B, 215-217 W. Superior, Chicago.

**QUICKERNIGHTNING,** cleans the hands quickernightning; agents wanted. Joliet Novelty Company, Joliet, Ill.

**AGENTS—Drop dead ones. Awake!** Grab this new invention. Low-priced waterpower home massage machine. Magical, marvelous, mysterious. New field. Big profits. Sold on money-back guarantee. "Margwarth sold 5 in 10 minutes; 31 in 2 days." "Parker sells 8 first day." Vaughn, "your machine has merit. Express 6 dozen." Free information. Blackstone, Co., 39 Meredith, Toledo, O.

**GREATEST opportunity** for a good man or woman in each county to make big money selling our grand new authorized book, "Billy Sunday—The Man and His Message." Write for special offer. Star Publishing Co., 1130 Wabash Ave., Chicago.

**STAR Clothes Line Reels** sell fast. Unquestionably the best. 70 feet strongest line. Every housewife wants one. Lowest prices—big profits. Feeny Mfg. Co., B-142, Muskegon, Ind.

**AGENTS—Spare or all time.** Big profits. Complete line diamonds, watches, jewelry. No capital. Sell cash or installments. A. B. Englebrecht & Co., Three Oaks, Mich.

**500% PROFIT** selling our wonderful sign letters for office windows, store fronts and glass signs; resembles finest gold leaf; easily applied; samples free. Metallic Letter Co., 406 N. Clark St., Chicago.

**IDEAL Lamp Filler** saves bother filling lamps. Men and women canvassers and agents. Good opportunity to make money. Samples A & B 25c. Harry Otis Mayo, Box A2298, Boston, Mass.

**AGENTS—Stamping names** on Pocket Key Protectors; sample check with your name and address, 12c. Stamping Outfit, Emblem Checks, Check Pobs, Name Plates, Hart Mfg. Co., Desk 2, 393 Degraw St., Brooklyn, N. Y.

**AGENTS—200% profit.** Wonderful little article. Sells like wildfire. Can be carried in pocket. Write at once for free sample. H. Mathews, 1962 Third St., Dayton, Ohio.

**300 TO 400% Profit** to Agents selling our guaranteed U. S. Fire Extinguishers. Tremendous demand. Orders repeat. Exclusive territory to county and district managers. United Mfg. Co., 1508 Oakwood, Toledo, Ohio.

**NOVELTY—Tip your hat** without touching it. Sample and prices 10c cents silver. E. M. Plummer, Dept. "A," 926 Fullerton Ave., Chicago.

**AGENTS, biggest line, biggest profit,** extracts, perfumes, medicines, spices, jelly powders. Premiums for your customers. Western Laboratories, 1839 Van Buren St., Chicago.

**TWO cents buys big ideas.** We tell you how to make money; capital of \$10 is plenty; your spare time completes the investment. Send stamp to Business Textbook Co., Jewelers' Building, Philadelphia, Pa.

**ENERGETIC Agents** calling on factories and building owners of every kind can earn \$25.00 to \$75.00 weekly handling our high-class building specialties. Write today for territory. The Colorcraft Company, 1249 Colorcraft Bldg., Cleveland, Ohio.

**LIBERAL commissions.** High-class toilet and household articles, repeat orders. Dept. B, The Hamilton Company, Mfgs., Wash. D. C.

**I MANUFACTURE** patented novelty which may be sold in 5 and 10c stores. Would like to arrange with salesmen to handle the same on commission basis. C. E. Beals, 5 Hawden Lane, Worcester, Mass.

**AGENTS—Sell Fibersilk specialties—ties,** jabots, scarfs and shawls. Made by new process on patented machines in many rich, beautiful colors. Brilliant silky lustre—washable. Ties sell quickly at 25c and 50c—and sell for 25c and still net you 100% profit. Scarfs and shawls sell for \$1 each. Exceptional proposition for spare time and agents. Send 15c for sample tie (guaranteed). Fisher Knitting Company, Oak St., Utica, N. Y.

**AGENTS—To sell the newest electric appliance** on the market; sold everywhere there is electricity, in the home and office; liberal profits; sales-driving sample, weights a pound, no experience or knowledge of electricity required; it shows how to use one light instead of two and get the same results; sells for \$3.50 and saves the purchaser an investment of \$25; write for particulars. The Handy Light Co., 14 Handy Light Block, Cincinnati, Ohio.

**AMERICA'S daily necessity.**—Free sample. Wm. E. Simmons Co., Hicksville, Ohio.

**MAKE and sell your own goods.** Our Information Bureau tells how. Fine Formula Catalog for stamp. B. Mystic Company, National Union Building, Washington, D. C.

**AGENTS—Let us show you how to earn \$15 daily** calling on automobile owners. Send for free particulars. Amos Rudy, 69 Locust Street, Detroit, Mich.

**WE need one active, reliable person** in every community to take orders for our popular mechanical books. You don't have to be a book agent. These books do their own talking. Simply show them. They contain just that sort of information about how to do and make things that every mechanically inclined person is looking for. And they are reasonable in price. We allow you a liberal commission for this pleasant work which you can do during spare time without interfering with your regular occupation. Don't neglect this real opportunity, but write now for full details to Manager Book Dept., Popular Mechanics Magazine, 6 N. Michigan Ave., Chicago.

**AGENTS—Something new—fastest sellers** and quickest repeaters on earth. Permanent, profitable business. Good for \$50 to \$75 a week. Address American Products Co., 509 Third St., Cincinnati, O.

**"JIFFY" Ironing Board Cover and Clamps** is the biggest red-hot seller ever invented. 150% profit. No competition. Lake Shore Manufacturing Company, Michigan City, Ind.

**IT will pay you to write me before you** take an Agency for Guaranteed Aluminum Utensils. I have an attractive general agency offer. Wm. J. Dick, Mgr., Dept. G-12, 20 W. Lake St., Chicago.

**AGENTS Wanted—To advertise our goods** by distributing free sample to consumer, 30 cents an hour. Write for full particulars. The Favor Company, 1662 West St., Dayton, O.

**FITS-UP-POT** aluminum coffee percolator fits any coffee pot. Agents wanted quick. Big profits. Write today for circulars. Standard Spinning & Stamping Co., 2240 Smead Ave., Toledo, O.

**WE have several openings** for establishment of independent mail-order business. Energy, good habits and sound judgment more important than capital. Spare time at first. Particulars free. Opportunities Exchange, Buffalo, N. Y.

**NEW Inventions:** City and country agents wanted. Samples twenty-five cents, silver! Hurry! Royal Sales Company, Columbus, Ohio.

**AGENTS, office men, employes—Biggest** money maker out. Every office buys one or more. Newly invented. Linebinder for stenographers. Marvellous, ingenious. Placed on trial, 100% profit. Exclusive territory. Write quick. Lanequide Mfg. Co., 160 No. 5th Ave., Chicago.

**I WANT an agent** in every town, to sell my wonderful Wrench. 10 Reasons why every Auto or Cycle owner, every Carpenter, Farmer, Plumber, Machinist and Mechanic buys at a glance. Best 1915 Agents Proposition. Big profit maker. Sample only \$2. Satisfaction guaranteed, or money refunded. Paum Novelty Co., 265 Monadnock Bldg., Chicago.

**AGENTS are coining money** selling our big 10c Packages of 20 Assorted Postal Cards. "5,000 Varieties." "Big Profits." Sell everywhere at sight. Sample Packages 10c. Particulars Free. Sullivan Card Co., 1234 Van Buren St., Chicago, Ill.

**WE Pay \$30 a month salary** and furnish rig and all expenses to introduce our guaranteed poultry and stock powders. Address Bigler Company, X398, Springfield, Illinois.

**AGENTS for Ho-Bo-Co Skin and Scald Soap, perfumes, toilet articles.** Our prices are lower, quality of products better, orders repeat. Rotheo, 212 N. Second, St. Louis, Mo.

**AGENTS make 100% to 200% on article** of universal use. Earn \$5 to \$15 daily. Direct Supply Association, 509 Belmont House, Victoria, B. C.

**AGENTS:** War Book, show cards, post cards, tricks and novelties. Catalog free. Write right away. Ward Publishing Co., Box 435-P, Chicago.

**AGENTS—Vacuum sweeper, new design, everybody buys, big profits, \$5 to \$10 daily.** Jeffrey K. Sullivan, 215 Bedford St., Fall River, Mass.

**AGENTS—Good side line, New. Hub Specialty Mfg. Co., Boston.**

**AGENTS—Graham's Self-Gartered Socks, Patented. Price no higher. Guaranteed never creep down. Don't pinch leg. Fine gauge, wear-forever quality. Send 25c for samples. State size. Graham Company, 536-P Forest Ave., Oak Park, Ill.**

**1,000% PROFIT manufacturing inks.** Start at home during spare time. Capital and experience unnecessary. Enormous and endless demand. Our secret formulas and sure selling plans insure you a lucrative, steadily increasing business. Investigate immediately. Particulars free. A. Covert, Secretary, 6935-6939 Kenwood Ave., Chicago, Ill.

**BIG Kansas Company will start ambitious man or woman in fast growing business; any locality; \$3,000 yearly; spare time; no canvassing; no experience. We furnish everything. Write for unique selling plan. C. W. Keston, President, 160 E. 5th, Pittsburg, Kansas.**

**400% PROFIT—Evergrip Gliders—No rollers; pocket samples free; anyone can attach; cost 3c, sell 15c; homes buy dozens, hotels hundreds; save floors and carpets. S. Mfg. Co., 41H, Warren St., N. Y.**

**AGENTS—Share in the profits. Every person handling our line from now on, will receive on June 30th a bonus of 10% on the total amount of his orders in addition to regular commission. Write today for new catalog. Oestreich Sales Co., Dept. 59, Two Rivers, Wis.**

**INVENTOR'S best newspaper, three months, 10c. Inventor's Advocate, Dept. 47, Washington, D. C.**

**AGENTS—Earn \$30 weekly selling my household and office specialty. R. F. Maddox, Brownsville, Tenn.**

**SALESMEN; agents; everywhere. New auto fuel. Permanent. Profitable. Tankill Chemical Sales Co., Cleveland, Ohio.**

**\$61.50 WEEKLY** introducing and selling a new gas light burner for kerosene lamps. Beautiful light. No chimney. No mantle. Perfectly safe. Simple in construction. Nothing to get broken or out of order. Will not burn out. Durable. Will last for years. Low price. Easy to sell. 200 per cent profit. Experience not necessary. Sample free. Why not try one on your lamp? Beware of imitations. No branch offices. Luther Manufacturing Co., Dept. 439, Cincinnati, Ohio.

**AGENTS—Sell rich-looking imported 35x 68 Rugs, \$1 each. Carter, Tenn., sold 115 in 4 days. Profit, \$57. You can do same. Write for sample offer selling plan; exclusive territory. Sample rug by parcel post prepaid, 98c. Condon, Importer, Stonington, Maine.**

**NEW 1915 Model—Send no money. Just your name written plainly on a postal card and learn by return mail how to get the best Vacuum Cleaner on the market, without costing you one cent! We are putting them out for demonstrating purposes. Guaranteed 5 years. Reliable live agents wanted everywhere. Write today to The Warner Company, Dept. Z, Muncie, Ind.**

**YOU double your money on the popular Hygienic Milk Bottle Holder, Sample, 15 cts. prepaid. Catalog free. Weymouth Household Supply Co., Box 387, Springfield, Massachusetts.**

**BARNES electric vacuum cleaners offer high grade agents an opportunity to average \$40 weekly. Details at \$18.75. An easy seller. You have exclusive territory. Write today for full information. Advance Mfg. Co., 16 Willard Street, Kalamazoo, Mich.**

**AGENTS sell "a repeater," quick sales, big profits; great labor saver, needed and used regularly every week; first trial makes a steady customer; descriptive circular tells why; free sample proves. Utility Co., Chipewah Falls, Wis.**

**"STOP Smoking"—Kilobac will stop the inveterate bend in three to five days. Price \$1. Guaranteed. Circular free. Agents wanted. Anti-Tobacco Remedy Co., Department B, Omaha, Neb.**

**\$5 TO \$10 Daily Profit selling Guaranteed Household articles, \$2.50 premium with each \$1.98 sale. Kansas Supply Co., Florence, Kans.**

**JUST out—450% profit. Large changeable sign with 240 letters. 50c complete. Every merchant buys. Changeable Sign Co., 589 E. 102nd St., Cleveland.**

**AGENTS:** To sell new, patented can opener; sells on sight; something new. Wanted in every home. High-grade article. Send 25c for sample. Money back if not satisfied. The Stevenson Sales Co., 3111 East 92nd Street, Chicago.

**NEED money? I make \$5 day, mail-order business; spare time. 80 can you. 25c brings complete plan and sample. Satisfaction guaranteed. W. P. King, Little Silver, N. J.**

**AGENTS Wanted—Greatest selling novelty. German silver tie forms. Sample sent for 10c. Fenton Novelty Co., 1984 Amsterdam Avenue, New York.**

**AGENTS—Big profits. Manufacture—sell Picture Hooks; tools unnecessary. Sample and instructions, 50c. Household Specialties Co., Wilmette, Ill.**

**AGENTS: Most necessary salable article ever marketed. Over 100% profit. Absolutely new. Demonstration sells. 24c brings sample and particulars. Hayes Company, 4152 Kenmore, Chicago.**

**STOP wearing rubbers and send 25c for sample of our water-proofing for shoes. Something new. A live proposition for live, hustling agents. Seal Products Co., 1144 W. Kinzie St., Chicago, Ill.**

**ENDLESS Neckties—Something new, twelve ties in one; costs no more than old style; man made \$70, three days; woman made \$32, week; write for special agents' offer. Endless Necktie Mfg. Co., Dept. 19, Kansas City, Mo., or Universal Products Co., Toronto, Canada.**

**AGENTS wanted to represent an entirely new, low-priced article for automobiles; experience unnecessary. F. Angeles, Seattle, Wash.**

**AGENTS—\$1 to \$6 daily. 200% profit selling Joy-O. Something new for mechanics, chauffeurs, auto owners, women in the home—everybody. Sure repeater. Establish permanent business. Get free details. Large sample 15c. Write Joy-O Chemical Company, Dept. B, Toledo, Ohio.**

**AGENTS—Either sex, decent commissions. Toilet articles of merit. Address McCanna, 129 1/2 East King Street, Lancaster, Penna.**

**AGENTS: Don't spend your own money. We trust you to \$3.60 worth. Starr's Powdered Enamel repairs chipped and rusty spots on granite. Stops all leaky metal-ware without heat, soldering iron or tools. An old case-knife does the trick. Never hardens in the box. Very hard 24 hours after mixing with soft water. Ladies doing as well as gentlemen. Everybody making repeat sales, a reason why agents are doubling up their orders. 10c gets sample and particulars. Starr, 1910 Monroe St., Toledo, Ohio.**

**BE a Demonstrator—Learn this wonderful new profession. Earn \$1,500 to \$2,500 a year. We place you in position free, that pays from \$3 to \$10 a day while you are learning. Complete instructions so you can start in a few days for 10c to pay postage. Madam Bendit, 2204 Orchard St., Chicago, Ill.**

**AGENTS—Quit hard-work-no-pay-canvassing. Wonderful French Process opens enormously profitable business. No capital; no selling; no stock to buy. Start anywhere. Barlow, 514 23rd Street, Oakland, Calif.**

**PORTRAIT Men, Attention—Write at once for new catalogue. John E. Trubee Mfg. Co., 2411 W. 23rd Street, Chicago, Ill.**

**AGENTS to take orders for Visiting and Business Cards. Large profits; outfit free; 2c postage required. Forman Printery, Waterbury, Conn.**

**AGENTS—We've got the whole drug trade in the United States talking—our eight big, new combination offers in Toilet Articles to sell at 50c up to \$1.39 are wonders. Elegant five-colored circulars free. Write today. Pierce Company, 922 Lake St., Chicago.**

**YOU can make from \$25 to \$100 per week operating Aerial "Ads" in big cities. Don't delay. Get on the job. Conyne-Kite, 3508 McLean Ave., Chicago.**

**AGENTS: The "Never-Slip" Clothes Line Fastener is the biggest seller on market today. Over 100,000 sold first month. Be first in your territory to get this money maker. Send 25c for sample set of 6, and agents' prices. Standard Wire Co., Dept. F, Saginaw, Mich.**

**A LIVE, ambitious man, well acquainted with railroad men or in large factory, to sell town lots on monthly payments in new, fast-growing railroad shop town in sunny South Texas. Experience not necessary. Good commissions. Earnings should run \$50 to \$250 per week. Townsite Company, North Pleasanton, Texas.**

**AGENTS Wanted to sell our Gasoline Flat Irons, Table Lamps, and Lighting Systems. Use a sample 30 days and, if no sales result, return it and we will refund your money. Grand Rapids Novelty Co., Grand Rapids, Mich.**

**DON'T answer this advertisement unless you mean business; \$1.50 sample free; carried in vest pocket; 300% profit. Fountain Pen Searchlight Co., Hartford, Conn.**

**200% PROFIT. You can't beat it. Sells everywhere. Free pocket sample. Our goods get the orders. Wm. J. Dick, Mgr., Dept. T-4, 20 W. Lake St., Chicago.**

**AGENTS Wanted—See Trick cigarette case on page 130. Send for sample.**

**JAP Fibre, the tough gas mantle, latest thing out, guaranteed 3 months, sample and terms, 20c. Jap Mantle Co., Beverly, Mass.**

**AGENTS Wanted to sell Non-alcoholic food flavors, perfumes, toilet articles, household necessities; 80% saving to consumer. Big profits to agent, premiums to customers; Free sample. Apply immediately. Dept. S, Arthur N. Christy & Co., Newark, New York.**

**AGENTS—A free course in General Salesmanship is given to every man of our Sales Organization. This organization is a body of successful men selling the Handy Light; that unique electrical device which cuts the cost of electric lighting in half. Sells for \$3.50, is used in home, office, store, factory; weighs only one pound. Sold by demonstration. All agents furnished with well planned methods for gaining interviews. A high-grade business for a man of ability and standing in his community. General Agents preferred. Inquire for our full proposition by addressing The Handy Light Co., 1109 Handy Light Block, Cincinnati, Ohio.**

**BIG Money for Agents selling Perfection Fuel Savers for stoves, furnaces, heating plants. Easily installed without letting fire go out. Saves 20% fuel. Guaranteed. Illustrated. Folder sent free. Minneapolis Fuel Saving Co., Plymouth Building, Minneapolis.**

**READ the Agents Magazine and make more money. 2 issues 10c. Agent's Magazine, Chicago.**

**"YANKEE" Tie Forms: Tremendous seller—Enormous profit. Made of pure German silver, \$2.50 per gr. (144), including circulars. 81k braid Ties, 75 cts. per dz.—\$6 per hd. Sample Form and Tie, with full particulars, and best "Spel" ever written, sent postpaid for 10 cts. in stamps or coin. The Yankee Novelty Co., 94 E. 10th St., N. Y.**

**WANTED—Men and women canvassers to handle new kitchen article. Easy seller, never been seen before. Exclusive sale to hustlers in outside towns. Experience unnecessary. Satisfaction guaranteed. Write Kobbelt Mfg. Co., Box 308, Central Station, Toledo, O.**

**NEW Automatic \$2.50 Adding Machine. Sell 10 a day easy. Big profit. Everyone buys. No competition. Repeat orders. R. Bassett, 5921 Indiana Ave., Chicago.**

**START a Mail-Order Business at Home. I did. Took in \$124,594.03 last year. Free particulars tell how I'll start you. Address: Robinson, 189 Woodruff, Toledo, O.**

**BIG Textile Mills will employ everywhere reliable people to take orders for dress fabrics, hosiery, underwear and neckwear from samples. Factory prices. Spare of all time. No experience. Permanent. Many making over \$30 weekly. Steadfast Mills, 20 Hensen St., Cohoes, N. Y.**

**MAKE money operating profitable Mail Order Book business. 100% profit; everything furnished. Small outlay; particulars free. Rollins, Tremont Row, Boston.**

**AGENTS Wanted—Agents make 500 per cent profit selling "Novelty Sign Cards." Merchants buy 10 to 100 on sight. 800 varieties. Catalogue free. Sullivan Co., 1234 Van Buren St., Chicago, Ill.**

**SELL Our Attractive Brass Ensel Poster Frames to picture theatres, also changeable letter signs for every store; big demand; easy sales; liberal commissions. Newman Manufacturing Company, Cincinnati, Ohio.**

**JUST show them—The new adjustable floor and wall mops, dustless dusters and sanitary brushes sell themselves. Big line. Big profits. Agents write Silver-Chamberlin Co., Dept. M, Clayton, N. J.**

**AGENTS: Here's \$50 a week easy! Brand new device! Every housewife enthusiastic. \$1.25 profit on \$2 sale. Wonderful selling plans. Parvin Mfg. Co., Fondulac, Wis.**

**\$15 WEEK salary and commission paid one person each town selling non-alcoholic flavorings. Linton Co., Kansas City, Mo.**

**CHRISTY Mathewson's Invention.** Exciting home baseball game sells in offices or homes like wild fire. Big profits. Details free. Mathewson Game Co., Dept. 36, Cincinnati, Ohio.

**MAGIC Ink Eraser.** No blade, no acid. Removes ink like magic. Sells like bread in a famine. Sample 10c. Sells 25c to 35c. S. Mfg. Co., 41X, Warren St., N. Y.

**ONE Hundred Formulas and Manufacturing Receipts,** together with one complete \$5 working plan, for a dime. United Publishing Co., 2 Sherman Place, Jersey City, N. J.

**AGENTS Wanted—\$20 weekly** and more easily earned taking orders for our guaranteed trees, shrubs and roses; part or full time; no delivering; no collecting. Charlton Nursery Company, Dept. J, Rochester, N. Y.

**WANTED—Names and commercial information.** Demand increasing. Steady income at home, spare time. Booklet for stamp. Information System, 227, Marietta, Ohio.

**PHOTO Pillow Tops, Portraits, Frames, Sheet Pictures, Photo Plates, Pennants.** Subjects credited. Prompt shipments; samples and Cat. free to agents. 30 days' credit. Jas. C. Bailey Co., Desk A-3, Chicago.

**SIGN Agents, attention:** We have something to offer you that beats selling other people's manufactured letters and signs all to pieces. No previous experience is necessary. Investigate. Address: Ross System, 261 Lincoln Inn Court, Cincinnati, O.

**ADVERTISE—20 words in 100 monthlies,** \$1; 3 months, \$2. Sample magazine free. Ugo Agency, St. Louis.

**\$50 WEEKLY!** All or part time; dignified, permanent business; free advertising matter; protected territory; no competition. Rudolf, Northwestern Building, Chicago.

**AGENTS make \$5 profit daily.** Name Plates, House Numbers, Signs, Particulars free. Roscoe Lynch, Baseman, Pa., Dept. B.

**YOU can sell our Raincoats.** Anyone will buy. We give you one. Outfit free. Temple Raincoat Co., Box 181, Templeton, Mass.

**STOP here and write The Sign Co.,** Silver Creek, N. Y.

**AGENTS! Billy Sunday's wonderful book,** illustrated, all the rage now; also European War Books; sell on sight everywhere. Earn \$6 to \$15 per day, little work. Outfit free. Write at once, Martello Company, Binghamton, New York.

**GENERAL agent in every city and county;** splendid paying business. Legitimate, new. Our canvassers make up to \$6 a day. You can get exclusive territory and make big money. Crystella Co., 325 Washington St., Brooklyn, N. Y.

**AGENTS. Article costs 3c;** sells quick in homes everywhere for 15c. Free sample. Belmont Specialty Co., Dept. 11, Cincinnati, Ohio.

**SAFETY First!** Sell our line of Sanitary Twisted Wire Brushes. Big income assured. Exclusive territory given. Goods sell themselves. Households, Offices. Catalogue free. 3 in 1 Brush Co., 145 Beekman Street, New York.

**LET me start you Manufacturing and Selling Extracts.** H. Lake Co., Adair, Ill.

**DISTRICT Managers,** have few openings for live district managers to handle exclusive territory. Staple specialty for hardware and automobile trade, exceptional standing and financial ability to carry stock essential. Junkunc Bros., 962 W. 71st St., Chicago.

**AGENTS—Fifteen Whirlwind Sellers,** new in your territory; pay you steady income \$5 a day or better if you are a worker. Liberal credit. Sample case and outfit free to workers; control of your territory and other advantages. Write quickly for proposition. E. E. Briley, Box No. C-732, Linton, Indiana.

**1,000% PROFIT—Prepared Sign Letters.** Share co-operative business free. Johnston Co., Guiney, Ill.

**AGENTS—Average \$5 to \$12 daily** selling astonishing Artec massage machine. New. Just patented. Different. No electricity or water power required. Nothing complicated. Affected exhilarating massage without cent expense. Lowest priced, but best outfit. Retail \$2.50 allowing you big end of the profit. Particulars and "beauty" folder free. Aztec Remedy Co., Dept. 132, Toledo, Ohio.

**AGENTS—500% profit, free sample** Gold and Silver Sign Letters for store fronts and office windows. Anyone can put on. Big demand everywhere. Write today for liberal offer to agents. Metallic Letter Co., 496 N. Clark, Chicago, U. S. A.

**YOU can be your own boss with our Key Check Outfit.** Good for \$5 a day stamping names on pocket key checks, fobs, etc. Sample check with your name and address, 15 cents. Pease Die Works, Dept. M, Winchester, N. H.

**WE manufacture the largest line of Aluminum Utensils and Specialties in the world.** Sales course free. \$50 a week easy to hustlers. Answer quick. American Aluminum Mfg. Co., Div. P.M., Lemont, Ill.

**OUR national advertising helps you sell Fuller Sanitary Brushes and Dustless Mops and Dusters—full line—easy sellers.** We tell you how. Biggest factory for twisted wire brushes in U. S.—reliable, strong concern. Your territory is valuable. Write at once. Fuller Brush Co., 33 Hoadley Place, Hartford, Conn. Western Branch, Rock Island, Ill.

**STOP Here!** Let me start you in a home business that will bring you money every day. Experience unnecessary. Spare time. No canvassing. I furnish everything. Send for proofs. Voorhies, Desk C. R., Omaha, Neb.

**BIG Profits for You!** Manufacture Barley Crisp. New Confection. 5c package costs you 1c. Machine, instructions complete \$7.50 prepaid. Send 10c for samples. Barley Crisp Co., 1205 Broadway, San Francisco.

**EASY pleasant work for Mechanics, Shop Men, Clerks,** during spare hours, will add many dollars to their salaries. Also want persons who can give full time. Big wages assured. Novelty Cutlery Co., 67 Bar St., Canton, Ohio.

**AGENTS make big money and become sales managers for our goods.** Fast office sellers. Fine profits. Particulars and samples free. One Dip Pen Company, Dept. 2, Baltimore, Md.

**AGENTS make \$100 monthly** selling our 500 handy household articles. Catalogue free. Scheff Company, Des Moines, Ill.

**OUTFIT Free to Agents.** Best selling Handkerchiefs, Dress Goods and Fancy Goods on the market. Quick sellers, big profits. Deal direct with a large manufacturer. Send stamp for particulars. Freeport Mfg. Co., 59 Main St., Brooklyn, New York.

**MEDALLIONS—300% profit.** Make up your own goods and be independent. Catalogue free. Besag Co., 1205 Randolph St., Chicago.

**MAIL-ORDER Opportunities:** 25 new Propositions. No competition! Make 95c profit on dollar order; complete outfit 10c. Mail Dealers Wholesale House, 521 Franklin Bldg., Chicago.

**AGENTS make \$5 to \$10 a day on the spot.** Atkinson writes: "The best proposition I have found in my forty years' canvassing." Permanent work. Household necessity. Saving 80%. Write today for General or Local Agents terms. Free sample. C. H. Stuart & Co., 16 Union St., Newark, New York.

**FROM Dance Hall to White Slavery,** 400-page, cloth book, illustrated, \$1. Immense sale. Experience unnecessary. Outfit free. Big money quick. Charles C. Thompson Co., Manufacturing Publishers, 1128 Wabash Ave., Chicago.

**AGENTS—Great opportunity to be permanent representative largest manufacturers high-grade soaps and toilet goods.** \$25-\$75 weekly. Write for immediate appointment. E. M. Davis Co., R. 61, Davis Bldg., Chicago.

**AGENTS—\$5 daily** selling our Handy Tool, 12 articles in one. Lightning seller. Sample free. Thomas Mfg. Company, 462 Third St., Dayton Ohio.

**AGENTS—\$50 weekly.** We manufacture the best needle case made; a wonderful seller; 200% to 500% profit; talking unnecessary; our "Trust Scheme" envelopes do the work; general agents can make \$100 weekly; particulars free; 25c sample outfit for 10c; buy direct from the factory. Paty Needle Co., 102 Davis Sq., W. Somerville, Mass.

**YOU can make \$448 as our general or local agent.** Household necessity; saves 80 per cent; permanent business; exclusive territory; salary or commission; free sample; credit. J. Pitkin, 113 Rodd St., Newark, N. Y.

**AGENTS of ability and high character** wanted on a new household article. Over 100 per cent profit. Special selling plan that pulls results. Address Merritt & Brock, 59 to 69 Temple Place, Boston, Mass.

**AGENTS—Send 10c for terms and sample** of staple 25c article. Large profits. C. Lutz Manufacturing Co., York, Pa.

**AGENTS: \$1,000 to \$3,000 yearly** selling over eighty everyday articles to farmers. Pleasant, permanent business. Full instructions. Big chance. Write quick. Duoform Factories, Neeth Java, N. Y.

**PORTRAIT Agents make big money** selling our goods. Our quality is right. Prices low. Delivery guaranteed. Credit for rejects. Ask for our latest catalog. Adam J. Kroll & Co., 602 Blue Island Ave., Chicago, Ill.

**AGENTS Wanted for a new Duplicator.** Sells to every business man. Fisher Company, 113 Amsterdam Avenue, New York City.

**STEADY business, liberal profits, quick** reports with our Sanitary Wire Frame Brushes and Cleaning Specialties. Household necessities. No capital required. Exclusive sale if you write today. Kleanco Co., 71 Taylor St., Springfield, Mass.

**STOP here and write The Sign Co.,** Silver Creek, N. Y.

**NEW—Practical—Durable.** The L. S. Self-Threading Sewing Machine Needle sells like "Hot Cakes." The only one of its kind sold with a guarantee. Made to fit all machines. Send 10c at once for sample and territory. The Roeti Specialty Co., Putnam, Conn.

**SELL Dry Goods Remnants.** Greatest bargains on earth. Remnant Store Co., Cincinnati, Ohio.

**WANTED—Distributors, Men and Women—to** give away free pkgs. Perfumed Borax Soap Powders; no money or experience needed; good pay. S. Ward & Company, 218 Institute, Chicago.

**MANUFACTURER requires general agents** for patented demand of centuries. Three minute demonstration convinces. A financial independence to acceptable parties. Samuel C. Osborn, Masonic Temple, Chicago.

**WRITE for our free offer.** Good reliable hustling agents wanted for a real live money making proposition. Only hustlers need answer this ad. American Sales Agency Co., 901 Lytton Bldg., Chicago, Ill.

**STOP here and write The Sign Co.,** Silver Creek, N. Y.

**AGENTS—Earn \$30 to \$50 Every Week** selling the New Improved Monitor Self-Heating Flat Iron. Positively the lowest priced and fastest selling iron made. Over 50,000 already sold. Evans, N. Car., sold two dozen on Sat. Mrs. Nixon, Va., sold eight first half day. Every housewife wants one. Every iron guaranteed. New terms. Exclusive territory. Sample free to workers. Write today. The Monitor Sad Iron Co., 677 Wayne St., Big Prairie, Ohio.

#### AGENCIES WANTED

**CANADIAN Agency Wanted.** Patented article, suitable for canvassers. Steacy, 14 Grenville St., Toronto, Canada.

#### SALESMEN WANTED

**SALESMEN—We have some excellent** territory open to salesmen of ability. This is a proposition that appeals to the best class of concerns. Sales are easy and your profits large. Write us today for catalogue F. M., covering the Schick All-Steel Paper Baler. Davenport Mfg. Company, Davenport, Iowa.

**GREAT opportunity for general agents** selling new specialty to merchants. Retail \$3, \$10, \$15 each. Your profit 200%. No competition. Exclusive territory. Free samples. Sayers Co., 408 Olive St., St. Louis, Mo.

**SALESMEN: Crackerjack \$5 check** protector; also excellent advertising specialties; liberal commissions. E. N. Doring, Weehauken, N. J.

**HAVE position for salesman:** good salary and expenses for a man of ability and good character; investment of about \$1,000 required. Stoltz Appliances Corporation, 220 West 42nd St., New York.

**\$1,200.00 to \$1,500.00 in six months** can be made placing our Premium Punch Board Deals, provided you have \$200.00 to \$500.00 to invest. Washington Sales Co., Dept. P.M. Chicago.

**WIDEAWAKE salesmen can earn \$100** weekly, carrying small side line. Popular floor covering and rug border. Liberal commission, mill to merchant. J. C. Dunn & Co., Camden, N. J.

**USEFUL advertising novelty for** clothiers and tailors. Would arrange with salesmen on commission basis to handle this novelty as a side line. Something sure to sell. Worcester Novelty Supply, 5 Hadwen Lane, Worcester, Mass.

**SALESMAN**—Experienced traveling salesman. State experience and references first letter. Well advertised line. Satisfactory commissions. The Lamoges China Co., Sebring, Ohio.

**AUTOMOBILE** Appliance Demonstrators wanted on straight salary basis. No selling. P. O. Box 1068, New York City.

**SALESMEN**—Get our plan for Monogramming Automobiles and Motorcycles by transfer method. Very large profits. Motorists' Accessories Co., Ashland, O.

**WANTED**—Hustlers to take orders for made-to-measure, high grade men's tailored suits from \$9.00 to \$22.00. Make \$25.00 to \$50.00 weekly. Elegant large book outfit free. Experience unnecessary. No pocket folder affair. Splendid opportunity to make money. Handy Dandy Line, Dept. 8, Sangamon St., Chicago.

**TRAVELING Salesmen Wanted**—Experience unnecessary. Earn big pay while you learn by mail during spare time; only eight weeks' time required, one or two hours a day. Steady position, easy work, hundreds of good positions to select from. Write today for free book, "A Knight of the Grip," containing full particulars and testimonials from hundreds of students we have recently placed in good positions and who are earning \$100 to \$500 per month. Address Dept. B-16, National Salesmen Training Association, Chicago, New York, Kansas City, San Francisco.

**WANTED**—Distributors. Men and Women —to give away free pgs. Perfumed Borax Soap Powders; no money or experience needed; good pay. S. Ward & Company, 218 Institute, Chicago.

#### HELP WANTED

**WANTED**, Men and Women, 18 or over, for Government jobs. \$75 month. Common education sufficient. Write immediately for Spring examination dates and free sample questions. Franklin Institute, Dept. P-21, Rochester, N. Y.

WE have several openings for establishment of independent mail-order business. Energy, good habits and sound judgment more important than capital. Spare time at first. Particulars free. Opportunities Exchange, Buffalo, N. Y.

**WANTED**—Railway Mail Clerks. \$75 month. Examinations soon. Sample questions free. Franklin Institute, Dept. P-21, Rochester, N. Y.

**LEARN** Tartaric Mirror Silvering—New process. Barstow, 513 23rd Street, Oakland, Calif.

**INVENTOR'S** best newspaper, three months, 10c. Inventor's Advocate, Dept. 46, Washington, D. C.

**FIREMEN**, brakemen, good wages, promotion on all railroads. Experience unnecessary. State age, necessary. Railway Association, Dept. 298, Brooklyn, N. Y.

**A MONEY** Proposition—Co-operate with me in a profit-sharing mail-order business. Will place trial advertisement, furnish printed matter, goods to fill orders and divide the profits. Particulars, Desk 153, Hazen A. Horton, Tekonsha, Mich.

**OWN** a business. Co-operate with me evenings at home. Everything furnished. Don't worry about capital. Boyd H. Brown, Dept. N-3, Omaha, Neb.

**THOUSANDS** Government Jobs now obtainable. List free. Franklin Institute, Dept. P-21, Rochester, N. Y.

**START** a Mail-Order Business at Home. I did. Took in \$124,594.03 last year. Free particulars tell how I'll start you. Address: Robinson, 288 Woodruff, Toledo, O.

**CASH** paid for butterflies, insects. Summer work. Men. Women. Instruction book. Send stamp. Sinclair, D-6, Los Angeles, Cal.

**COLLECT** names and commercial information. Demand increasing. Steady income at home, spare time. Booklet for stamp. Information System, 226 Marietta, Ohio.

**MAIL** Order Aspirants. See Stachlin's irresistible advertisement under "Business Opportunities."

**WE** want young men everywhere with some natural mechanical ability to take up a new and rapid method of doing an old established line of work always in demand. Average pay, \$1.00 for every hour's work. Address, Ross System, 201 Lincoln Inn Court, Cincinnati, O.

**MEN** to refinish lighting fixtures, brass beds, etc. All or spare time. No capital or canvassing. Experience unnecessary. Write for information, Gunmetal Co., Decatur, Ill.

**15,000 GOVERNMENT** Jobs open to men and women, \$65.00 to \$150.00 month. Write for list. Franklin Institute, Dept. P-21, Rochester, N. Y.

**RAILWAY** Mail Clerks Wanted, \$75 month. Write immediately for spring examination dates. Franklin Institute, Dept. P-21, Rochester, N. Y.

**COMMERCIAL** Information Wanted; Spare time; cooperative plan; good money; no canvassing; exceptional opportunity for stamp. "Cico," PMC, Peru, Indiana.

**WANTED**—Distributors of Advertising Matter everywhere; send 10c for application contract (Sample Magazine—None free), Barkley's Distributing Agency, (403) Hairsville, Pennsylvania.

**GET** a Government Job! See ad on page 16. Write now—today! Patterson Civil Service School, Rochester, N. Y.

**WANTED**—Men. Become chauffeurs, Earn while learning. Sample lessons free. Franklin Institute, Dept. P-862, Rochester, N. Y.

**FREE** Illustrated Book tells of about 500,000 protected positions in U. S. service. Thousands of vacancies every year. There is a big chance here for you, sure and generous pay, lifetime employment. Just ask for booklet S. 29. No obligations. Earl Hopkins, Washington, D. C.

**DETECTIVES**, earn from \$25 to \$100 per week and traveling expenses. We show you how. Write National School of Detectives, 489 Fifth Avenue, New York, Room 536.

**MACHINISTS** Wanted. Bright, ambitious young men for repair shop openings in different towns and cities of the United States. No charge. Box 48, Chicago, Ill.

**INTELLIGENT** Men, 18 to 35 years, wanted, Railway Mail Clerks. \$75 Month. Pull unnecessary. Write immediately for spring examination dates. Franklin Institute, Dept. P-21, Rochester, N. Y.

**LEARN** Automobile Repairing, driving on up-to-date cars; electrical, civil engineering; surveying; methods most practical; room and board while learning; many positions secured; satisfaction guaranteed; catalog free. National School of Engineering, 2110 W. 7th, Los Angeles.

**BECOME** detectives—Large salaries; nice work; experience unnecessary; write Superintendent Wagner, 1243 Lexington Avenue, New York.

**I GUARANTEE** \$10 for first photoplay you write by my method. As former scenario editor, I speak with authority. Send for free booklet, "How to Write Photoplays." Elbert Moore, Box 772, P. F., Chicago.

**BE** a Detective—Earn from \$150.00 to \$300.00 per month. Travel over the world. Write C. T. Ludwig, 340 Westover Building, Kansas City, Mo.

**SILVERING** Mirrors and Auto-trimmings. Plating tableware home. Plans free. Clarence Sprinkle, East Grant, Marion, Ind.

**WRITE** Moving-Picture Plays, \$50 each. All or spare time. Correspondence course unnecessary. Details free. Atlas Publishing Co., 3045 Cincinnati, Ohio.

**STOP** Here! Let me start you in a home business that will bring you money every day. Experience unnecessary. Spare time. No canvassing. I furnish everything. Send for proofs. Voorhies, Desk C. R., Omaha, Neb.

**WANTED**—An Idea! Who can think of some simple thing to patent? Protect your ideas; they may bring you wealth. Write for "Needed Inventions" and "How to Get Your Patent and Your Money." Randolph & Co., Patent Attorneys, Dept. 144, Washington, D. C.

**GOVERNMENT** Examinations. Most thorough preparation, \$5; returned if not appointed; particulars free. American Civil Service School, Washington, D. C.

**GO** on the Stage. Vaudeville career offered you. Experience unnecessary. Managers endorse my method. Instructive vaudeville book free. Write today. Frederic LaDelle, Sta. 10, Jackson, Mich.

**BE** a detective. Earn big money. Write John J. Gilles, Licensed and Bonded N. Y. State Detective. Retired Member N. Y. Police Dept. 22 years Experience. 254 Huguenot St., New Rochelle, N. Y. Investigation solicited.

**YOUNG Men!** Learn Drafting—one of the most practical subjects of study today—indispensable in many occupations—engage in individual study successfully with the aid of our new book, "A Practical Course in Mechanical Drawing," 160 pages, 157 drawings, cloth, 50 cents, postpaid. Popular Mechanics Book Dept., 6 N. Michigan Ave., Chicago.

**POSITIONS**—High as \$1,500 and \$1,800 open to persons trained by us in special Lettering and Map Drafting; real opportunity. Particulars and booklet, "Topographic Drafting," on request. Columbia School of Drafting, Tenth and G, Washington.

**WANTED**—Distributors. Men and Women —to give away free pgs. Perfumed Borax Soap Powders; no money or experience needed; good pay. S. Ward & Company, 218 Institute, Chicago.

**BE** a Detective. Earn \$150 to \$300 monthly. Travel over the world. Write American School of Criminology, Dept. F, Detroit, Michigan.

**BE** Prosperous. Win success and wealth. Free booklet "How to Win." Address Mental Efficiency League, San Francisco.

#### FOR SALE

**FOR Sale**—Two small battery motors, gasoline engine mixer, graining outfit, portable house tent, Standard boring machine for wood, wickless blue flame kerosene stove—3 burner, Zimmerman autoharp, violin. Jenner A. Jones, 1915 Hampden Street, Holyoke, Mass.

**FOR Sale**—25 H. P. I. H. C. Tractor in good shape. Clyde Bradley, Litchfield, O.

**FIELD** Marine Day and Night Glasses with beautiful case, 25 mile adjustment. \$30.00 value, only \$6.50. Money back if not satisfied. The Well Curiosity Shop, 20 S. Second St., Philadelphia, Pa.

**VACUUM** cleaner pumps and parts for assembling, save 75%. Vacuum Supply Co., Ann Arbor, Mich.

**MULTIGRAPH** drums, type, like new. Cheap. Norton Wagner, Scranton, Pa.

#### SALE OR EXCHANGE

**TO Buy, Sell or Exchange**, Farm, Business, Patent, etc., anywhere. Write, Black's Business Agency, Desk D, Chippewa Falls, Wis.

**FIVE** Passenger White Steamer for Gasoline Engines, Machine Shop Tools. F. W. Cole, Toulon, Ill.

#### GUNS, SPORTING GOODS, ETC.

**FIREARMS**—Old-time and modern. Buy, sell, exchange all sorts. Stephen Van Rensselaer, West Orange, New Jersey.

#### FLOUR & FEED MILLING MACHINERY

**SPECIAL** bargains in second hand Attrition mills, burr mills, crushers, corn shellers, bran dusters, dust collectors, purifiers, reels, double, single, 2 and 3-pair high roller mills, sieve bolters, receiving separators, scavengers, etc. Write for description and prices. Sprout, Waldron & Co., P. O. Box 429, Muncy, Pa.

#### MACHINERY, TOOLS AND SUPPLIES

**VACUUM** Pumps and Cleaners, all sizes, complete outfits. Thurman Vacuum Cleaner Co., Manufacturers, Dept. O, St. Louis, U. S. A.

**REBUILT** Leather Belting. Half the price, equal new in service, excellent appearance, all sizes, satisfaction guaranteed. Also new, 25% under dealers' prices. Canvas and rubber Belting. Fredrich Belting Co., Manufacturer, St. Louis, Mo.

**HAND** Planer or Jointer cutter heads for wood tables, which are simple and easily made. W. L. Sherwood, Kirksville, Mo.

**MARK** your tools. Your name on a steel stamp \$1. Three initials 50c. Gideon Pike, Attleboro, Mass.

**5,000 FEET** good 2" leather belt, 10c a foot. Leuss & Son, Bridgeport, Ct.

**PULLEYS**, Gears, Sprockets, Shafting, Hangers; see page 122. W. A. Jones Foundry & Machine Co., Chicago.

**FOR Sale**—All sizes new and second-hand Pulleys, Belting, Shafting, Hangers, Couplings, Pillow Blocks, Collars, etc. Passman Bros., 28 and 30 So. Green Street, Chicago, Ill.

**VACUUM** cleaner pumps, tools, etc., for stationary house or wagon outfit. Vacuum Supply Co., Ann Arbor, Mich.

**FOR Sale**—25 Lincoln milling machines, \$25 to \$100 each. Lucas & Son, Bridgeport, Conn.

**HAVE** for sale several sizes of lathes, milling machines, drill presses, punch presses, shapers, planers, boilers, steam engines, oil, gas and gasoline engines and wood-working machinery. Pinner, 122 Water St., New York, N. Y.

ENGINE Lathe, swings 9 1/2 in., takes 25 in. between centers. Complete set gears cutting all size threads 3 in. to 40 in., \$43.50. Grammes & Sons, Allentown, Pa.

FOR Sale: 5 good Engine lathes, 16" to 32"; state size wanted. Lucas & Son, Bridgeport, Conn.

JUST Published—Popular Mechanics Shop Notes for 1915—626 Easy Ways to do Hard Things. This is Vol. XI and is similar in style to the other numbers in the series. 224 pages, 517 illustrations. Paper 50 cents. Cloth, \$1, postpaid. Popular Mechanics Book Dept., 6 N. Michigan Ave., Chicago.

DRUMMOND "Precision" self-acting, sliding, boring, screw cutting and milling guaranteed lathes, swinging eight inches; forty-two dollars. Book "Lathe Work" free. See page 144. W. B. Price, New York.

### ENGINES AND MOTORS

SIXTY Horsepower, six-cylinder, or forty horsepower, four-cylinder, Gasoline Engines, water-cooled, in A1 condition. Built originally for motor car service. Suitable for farm stationary, portable engine, or marine work. Will deliver full sixty and forty horsepower to belt. A bargain at \$150 and \$125 respectively, while they last. F. A. Cornell, 40 9th St., Racine, Wisconsin.

ALTERNATING current, single-phase motors, 1/20 H.P. to 5 H.P. Bargains in direct current and three phase motors, all sizes. Motors bought, sold, repaired. Satisfaction guaranteed or money refunded. Send for new bargain list electrical supplies. Hyre Electric Co., 613-G, So. Dearborn St., Chicago.

WATER Motor, 6-inch, 3/4 horsepower. Attach to any faucet. Runs lathes, printing presses, grinders, drills, dynamos, washing machines, etc. The ideal power plant. \$3 cash with order. Admiral Welding Co., Kansas City, Mo.

SINGLE cylinder motor and transmission. Salmerville Model Machine Works, Salmerville, O.

BARGAINS in Rebuilt Stationary Gasoline Engines. These are our own engines taken in exchange and rebuilt good as new. 1 1/2 to 12 H. P. \$20 up. Write for description. State size wanted. Sta-Rite Engine Co., La Crosse, Wis.

BARGAIN. New one-horse gasoline motor, water-cooled. Box 128, Astoria, Ill.

BRAND new Holtzer Cabot A. C. motors, 1/4 hp. \$8.50 each. Small saw tables \$13. H. G. Crane, Brookline, Mass.

FOR Sale Cheap—7 1/2 and 5 H. P. General Electric A. C. Motors, Form K. T. 3 phase, 60-cycle, like new. John P. Hunt, Lynn, Mass.

8-CYLINDER 70-hp. Boulevard motor, \$390. Box 99, R. F. D., No. 2, San Luis Obispo, Calif.

FOR Sale—Gasoline engines, automobiles, marine and stationary, also castings. Second-hand ones taken in exchange and for sale. Apply with stamps. B. W. Richardson, R. No. 36, Peoria, Ill.

TWO-cylinder motor, \$20. New, Salmerville Model & Machine Works, Salmerville, Ohio.

2 CYL. 6 h.p. Upright Motor, complete, like new, \$25. Box 275, Burlington, Wis.

FOR Sale—24x36-in., 100 revolutions, 125-lb. automatic cutoff Conway engine, right hand, shaft 18 ft. 6 in. long with two wheels 12 ft. 2 in. by 26-in. face and 11 ft. 10 in. by 20-in. face. In good condition and can be seen in storage at this point. Built by Filer & Stowell Co., Milwaukee. Is as economical as a Corliss. Worcester Lumber Co., Ltd., Chassell, Mich.

REBUILT Engines—We have on hand a number of rebuilt "Buffalo" engines, guaranteed, at greatly reduced prices. Write for bargain list. Buffalo Gasoline Motor Co., 1293-1305 Niagara Street, Buffalo, N. Y.

CASTINGS for small stationary gasoline engines, with drawings. H. H. Bowersox, Hanover, Pa.

JUST Issued—Amateur Mechanics No. 6. Another great book of 293 articles for those who like to make things. Similar in style to the other numbers in the series. 128 pages, 261 illustrations. Paper. Price 25 cents postpaid. Popular Mechanics Book Dept., 6 N. Michigan Ave., Chicago.

GILES 2 H. P. 2 cycle Stationary Motor in best condition. Complete \$25. 2 1/2"x2 1/2" steam engine of strong construction \$12. A. G. Albrecht, 505 Capitol Bldg., St. Paul, Minnesota.

MAGNALIUM pistons are one-third the weight of iron pistons. They give greater horse-power, speed, acceleration, less vibration and wear on connecting rods. Many thousands in use. Lerrett Co., 464 Tenth Avenue, New York.

LOT small motors and generators. All 110 volts, 1/2 A. C., \$11.50; 6-light generator, \$8.50; 10-light generator, \$12. Several larger and low voltage machines. Johnston, Evans Ave., Ingram, Pa.

### BOATS, LAUNCHES, ACCESSORIES

EQUIP your boat with safety device; photo specifications one dollar. Box 122, Lumberton, Miss.

MOTORCRAFT Encyclopedia—A 150-page book that tells 1001 things every motor boatman should know. How to overcome engine troubles. Price \$1, postpaid. Popular Mechanics Book Dept., 6 N. Michigan Ave., Chicago.

### FOR THE SHOP

YOU need a lathe. Write now for easy plan to own one. Not prices for selling. Send four cents postage. Roberts, 157 East 47th, New York.

FOR That Boy—He will appreciate a copy of the great boy's book "The Boy Mechanic" that tells about 700 different things for boys to do and has 800 pictures, 459 (7x10) pages, cloth, big, handsome book for the price, \$1.50 postpaid. Popular Mechanics Book Dept., 6 N. Michigan Ave., Chicago.

### BLACKSMITHS

WELD Castings. Enormous profits. Small investment. Write today for free 32 page book on welding. Welding Apparatus Company, 222 National Union Building, Toledo, Ohio.

BLACKSMITHS, get out of the rut; be progressive. Get Toy's modern methods of doing hard jobs easy. Make solid welds. Temper all tools to a standard with Toy's Colored Tempering Charts. Do the job the other smith can't do. All for \$1. Send for free samples. W. M. Toy, Sidney, Ohio.

SHOP Notes—Many valuable links for blacksmiths are contained in our series of Shop Notes books. 10 volumes, 50c each, postpaid, or \$5 per set prepaid. Popular Mechanics Book Dept., 6 N. Michigan Ave., Chicago.

FORMULA—Braze cast iron. 25c. F. W. Stevens, Burrton, Kans.

BLACKSMITHS — Learn hand-wrought ornamental ironwork. Our 200-page book "Hand Forging" points out clearly all the guiding principles and methods which underlie all forge work. Written by a practical authority. 122 illustrations, cloth, \$1 postpaid. Popular Mechanics Book Dept., 6 N. Michigan Ave., Chicago.

### CEMENT

CONCRETE Building Block Machines and moulds. Free catalogue, 5 Market St., St. Louis, Mo.

If you want the best information on cement and concrete construction, subscribe for Concrete-Cement Age, leading cement and concrete monthly. Sample copy, 10 cents. Yearly subscription, \$1.50. Concrete-Cement Age, 135 Newberry Bldg., Detroit, Mich.

### ELECTRICAL

ARLO Commutator Compound supplies a long-felt need for a reliable commutator preparation. Its use will result in perfect motor and generator performance and will keep a commutator from being cut by dirt or dust and will stop injurious action of chemical gases. It is a cooling agent and will not lose consistency on the hottest commutator. Full directions with each stick. Price per stick, 50 cents. Mail all orders to the Arlo Commutator Compound Co., Terre Haute, Ind.

LOCAL battery telephone transmitters, standard makes, 30c each sent postpaid. 1/8 H.P. alternating current motors, \$12. Other bargains. Queen City Electric Co., 1718 W. Adams St., Chicago.

"AMATEUR Electrician." Make Batteries, Dynamos, Motors, Electric Engine, Telephones, etc. 75 illustrations, 10c. Renew Dry Batteries, 3 guaranteed processes, 25c. Both, 35c. Novelty Shop, 3311-C, Belleplaine Ave., Chicago.

SEND for bargain list electrical supplies, flashlights. Hyre Electric Co., 613-G, So. Dearborn St., Chicago.

FOR Sale: 25 K. W. 125 V 200 A. D. C. generator, \$250.00; 4 H. P. D. C. motor direct connected to 3 K. W. 50 V. generator. This is a storage battery booster, price \$160.00. Lucas & Son, Bridgeport, Conn.

115 V. 3 K.W.D.C. GENERATOR and 6 H.P. Automatic engine combined. Price \$250. Lucas & Son, Bridgeport, Conn.

EIGHT inch electric fans \$3. Magneto-Generators \$2. Edgar Philip, 197 Field Ave., Detroit, Mich., for Bargains.

50 LIGHT Dynamos and 2 Horse Electric Motors. Highest quality. Lowest price. Easiest terms. Write Hobart Bros. Co., Troy, Ohio.

### ENGINE CASTINGS AND BLUE PRINTS

FOR Sale—Castings for two cycle engines. Richards Iron Works, Manitowoc, Wis.

GASOLINE Engine Castings, with drawings. Cheap. Catalog for stamp. Novelty Manufacturing Co., 853 West 6th St., Cincinnati, Ohio.

### RARE COINS

ALL for 50c: 1 old cent, 1 eagle cent, 1 Indian cent, 1 two-cent piece; 1 nickel 3c piece; 1 silver 3c piece; 1 silver 1/2 dime; 1 premium catalog; 1 selling list; 1 Columbia nickel. Coin Exchange, New Rochelle, N. Y.

OLD Coins Bought and Sold. Spring catalogue list of coins for sale, free to collectors only. Buying catalogue quoting prices I pay for coins, 10 cents. Wm. Henstein, 101 Tremont St., Boston, Mass.

1913—BUFFALO Nickels—25c each paid for them and Lincoln pennies, certain kinds. Highest prices paid for old coins. Send 10c for coin catalog and particulars. Jones, Coin Dealer, Dept. 38, Newton, Ill.

\$50 PAID for Half Dol. 1853, no arrows; \$5 for 1878 Half, 8c Mint, \$100 for 1894 Dime, 8c Mint. Many valuable coins circulating. Get posted. Send 4c. Get our illus. Coin Circular. It may mean large profits to you. Send now. You have nothing to lose. Numismatic Bank, Dept. 8, Fort Worth, Texas.

\$4.25 EACH Paid for U. S. Flying Eagle Cents dated 1856. We pay cash premiums on hundreds of Old Coins. Send ten cents at once for New Illustrated Coin Value Book 4x7. It may mean your fortune. Clarke & Co., Coin Dealers, Box 15, Le Roy, N. Y.

COINS, Antique Belies—Five curious, rare coins with catalog, 10c. Ray Chapin, New Berlin, N. Y.

ALL for 30c. A 25c California gold piece, a Premium Coin Catalog, a selling list, a Columbia nickel and a lucky seed. C. J. Carey, New Rochelle, N. Y.

### STAMP COLLECTING

STAMP Bargains (all different), 100 United States Postage, 58c; 200 Salvador, \$3.95; 30 Nicaragua, 17c; 10 Soudan, 32c; 125 Nicaragua, \$2.35; 10 Nyassa (camel), 22c. Rare stamp bargain lists, big 1915 list, \$2; premium coupon free to each new customer. W. C. Phillips & Co., Glastonbury, Conn.

50 DIFFERENT South American Stamps, 10c. Weed Stamp Co., Centerville, Michigan.

STAMPS—On approval, U. S. and foreign. Condition fine. Prices fair. Premium—3 new revenues. Reference necessary. Mrs. L. Kellogg, West Hartford, Conn.

10 FOREIGN Coins, 15c; 10 from warring nations, 25c, 150 different stamps, 10c. Burgess Co., 322B Beacon, Toledo, Ohio.

BOYS! Stamps 66% discount and premiums. M. D. Place, Wrentham, Mass.

STAMPS, 1,000 mixed 12c, 500 var. Foreign 60c. Approvals. Western Stamp Co., Omaha, Neb.

104 DIFFERENT stamps, including United States 1861 Civil War, Japan, Argentine, etc. Large price list and sample New England Stamp Monthly, only 5c. Finest approval sheets, 50% discount. New England Stamp Company, 19 Washington Bldg., Boston.

WHY buy cheap packets when you can get stamps on approval at 1, 2 and 5c each? Wm. Haase, 571 East 34th St., Los Angeles, Cal.

8 ROUMANIA free with Sawyer's Moneyworth approvals. References. Sawyer Stamp Co., Onset, Mass.

**FREE**—Fine Animal Packet; 2c stamp postage. Lighttown Stamp Co., Palmerston Road, Southsea, England.

**FREE**: 205 different foreign, 101 United States, 60 Japanese, 50 Asiatic—choose one. Remit 25c, six months' subscription McKee's Stamp Weekly, Boston, Mass.

**DISCRIMINATING Collectors**: Superb 50% approvals. Immense stock and large variety. Free—large packet, catalogue, hinges, gauge, scarce stamps, 2c postage. Midland Stamp Company, Midland, Ontario.

**FINE** low-priced approvals. Mention paper and receive good premium free. S. E. Colman, 634 Keefer Place, Washington, D. C.

**STAMPS**—70 varieties—new issue, 12c. Approval sheets, sets. Big discounts, valuable premiums. Agents wanted. Rex Stamp Co., 5 Beekman St., New York City.

**BRITISH** South Africans, forty kinds, twenty cents. Pierce Company, Manchester, Michigan.

**FOUR** different Chili free to approval applicants. Helwig, Hanover, Ontario.

**FREE!** Six unused Switzerland for my 50% approvals. Maitland Milliken, Denver, Colorado.

**STAMPS**, 100, all different, free. Postage 2c. Mention paper. Quaker Stamp Co., Toledo, Ohio.

**STAMPS**—12 different from warring nations, 10c; 10 different foreign coins, 15c; 20 Belgium stamps, 10c. Lists free. Toledo Stamp Co., Toledo, Ohio.

**STAMP** Album with 338 Genuine Stamps, incl. Rhodesia, Congo (tiger), China (dragon), Tasmania (landscape), Jamaica (waterfalls), etc., 10c. 100 dif. Jap., N. Zld., etc., 5c. Big list; coupons, etc. Free. We buy stamps. Hussman Stamp Co., St. Louis, Mo.

**STAMPS** sent on approval at 70% discount. Reference required. 1900 Peckable Hinges 8c. Emory Renoll, Hanover, Pa.

**24 VARIETIES** Cuban stamps, 10 cents. List of 6,000 low-priced stamps free. Chambers Stamp Co., 111 P. Nassau St., New York City.

**STAMPS**—105 China, etc., stamp dictionary and list, 2c. Bullard, Sta. A, Boston.

**PACKET** of 23 stamps; no two countries alike, 500 hinges. Set of \$1 and \$2 U. S. Rev., all for 5c. Mention paper. Miami Stamp Co., Toledo, Ohio.

**25 DIFFERENT** British Colonials to applicants for stamps on approval who send 2c postage. Nickles, 122 Florida Ave., Washington, D. C.

**FINEST** 1 and 2c net approvals obtainable. Satisfaction guaranteed. Personal attention. Hinges furnished customers free. P. Riedell, Schenectady, N. Y.

**100 STAMPS** Free. I'll pay postage. Smith Hamill, Keokuk, Iowa.

**FOREIGN** Stamps Free: 52 different foreign, including China and Venezuela, to all who apply for our high grade approval selections. Send two cent stamp for return postage. Edgewood Stamp Co., Dept. H, Milford, Conn.

#### FOR MEN

**MANILA** cigars. Direct from factory to smoker, at wholesale price. 100 cigars, best grade, \$1 by registered mail, all duties paid. Write for free catalogue. Satisfaction or money returned. Patingell, Martin & Co., Luzon, P. I.

**MEN'S** Hats, from our factory to your head. Save money. Send for catalogue. Orange Hat Mfg. Co., Dept. E, Orange, N. J.

**SOFT** and Panama hats cleaned and blocked. Gluck Hat Co., Birmingham, Ala.

**SAVE** money on shoes! Factory to feet. You save retailer's profit and get better shoes. Fit and entire satisfaction guaranteed or money back. Style book free. Pathfinder Shoe Co., Dept. P, Webster, Mass.

#### FOR WOMEN

**LADIES!** Make your own toilet preparations and save money. Five invaluable formulas, 50c. Superbaine Supply Co., Box 478, Williamstown, Mass.

#### INVALID FURNITURE

**ROLLING** Chairs. We make 70 styles. Carrying Chairs, Invalids' Lifts, Beds, Tables, Bed Trays, Back Rests, Commodes, etc. Catalog "B" illustrates—describes free. Send for it, Geo. F. Sargent Co., 284 Fourth Ave., New York.

#### FOR THE HOME

**HAND** Painted China. For \$1 I will send you by parcel post one 7½ inch hand-painted plate; fruit or flower decoration. Address The Boulevard Studio, 349 South Blvd., Oak Park, Ill.

**INSTALL** in your home a Phonograph burglar device (patented). Particulars free. A. Stahl, 1700 Hurling St., Chicago.

**SAVES** one-third coal. New idea in steam radiator attachment. Guaranteed as represented. 35c by mail. Box 1544. W. J. McCollom, Paterson, N. J.

**SASSAFRAS** Tea—Two pounds fresh roots, 50c postpaid. S. B. Collins, Fannett, Texas.

**HOME** Furnishings and Decorations; easy with Hobbies designs, tools, materials. W. R. Price, New York.

**BEAUTIFUL** arts-crafts lamps—Anyone can make them out of paper, cardboard and wood. 18 designs. Inexpensive yet artistic. Complete book of instructions. Price, 50c postpaid. Popular Mechanics Book Dept., 6 N. Michigan Ave., Chicago.

**MAKE** your own mission furniture at the minimum of expense. Our 3 books "Mission Furniture. How to Make It." Parts 1, 2 and 3, tell in plain, simple language just how to make 98 different pieces. Full dimensions, working drawings and half tones of finished articles. Price, 50 cents each or \$1.50 for the three volumes, postpaid. Popular Mechanics Book Dept., 6 N. Michigan Ave., Chicago.

**ARTISTIC** Lamps and Shades in metal and art glass easily made by the amateur craftsman from instructions given in our book of 18 designs ranging from ordinary reading lamps to pretentious chandeliers. Expense only slight. Price of book 50c postpaid. Popular Mechanics Book Dept., 6 N. Michigan Ave., Chicago.

#### SAFETY BLADES SHARPENED

**ANY** blade ground, honed, 2c. Keenedge, Oshkosh, Wis.

**SAFETY** razors sharpened; two cents each. Guaranteed. Blade box free. Electro Stropping Co., 131 Shelby St., Detroit, Mich.

#### DIAMONDS, WATCHES AND JEWELRY

**SPECIAL** Offer. \$12 Waltham watch, gold filled, guaranteed 20 years, for \$7.95. Sent by Parcel Post C.O.D. Money refunded if not satisfied. Schnitzer Jewelry Co., Unity Bldg., Chicago.

**WATCH** Bargains—7 Jewel Elgin in Silver case \$4.50; 17 Jewel Waltham in 20-year, gold-filled case \$11. Can you beat it? Shelman Co., Jewelers and Bankers, Irvington, Ky.

**EXTRA** Special Elgin Sale! The greatest ever known in the United States. You know Elgin Quality. The Ideal Thin Models are marvels of beauty, accuracy and durability. Inspect before paying if desired. Absolute satisfaction or money back. Take advantage of this great opportunity. Our prices will be a revelation to you. Write now. Sutton Watch Co., 297 Keller Building, Louisville, Ky.

**NUGGET** Scarf Pins, Siwash gold. Sample prepaid 50 cents. Money back if you want it. Admiral Co., 1331 Walnut, Kansas City, Mo.

#### MUSIC

**LARGEST** collection of slightly used disc and cylinder records in the world, for Victor, Columbia and Edison, 15c up. Edison Standard and Amberol, 9c up. Piano-player rolls, 58-65-88 notes, 15c up. We buy and exchange. The Well Curiosity Shop, 20 S. Second St., Philadelphia, Pa.

**173 LATEST** Popular Songs, many with words and music, 10c. C. Boyer Co., Penns Creek, Pa.

**PLAY** Piano instantly—first trial. World's greatest invention. Musician Self-Maker, 2812 Lake, Chicago.

**"HIKE** to 'Frisco Fair." Souvenir Song with Historical Sketch of Panama Canal. Mailed fifteen cents. James P. Doyle, Buffalo, New York.

**CATCHY** Cowboy Song. "Trail of Lonesome Girl," with two others, 25c. Neale Music Company, Rocky Ford, Colorado.

**"DREAMS,"** the greatest waltz ballad in years. For sale everywhere or direct from us, 10 cents. Marks-Goldsmith Co., Dept. 91, Washington, D. C.

#### PIANOS AND MUSICAL INSTRUMENTS

**WONDERFUL** Value—Latest model disc talking machine, enclosed case, mahogany finish, with twelve double-face records; regular price \$90, our price only \$39. If not satisfactory, money back. The Well Curiosity Shop, 20 S. Second St., Philadelphia, Pa.

**USED** talking machines, all makes, \$5 and up. Send for free list. Brown Music Company, 9119 Commercial Ave., Chicago, Ill.

#### BUSINESS SERVICE

**ESTIMATING** and Contracting by Radford—A 900-page manual of up-to-date methods for rapid, systematic and accurate calculation of costs of all types and details of building construction, with quotations of ordinary prices for labor and materials, standard schedules and forms, labor-saving tables and other data useful to the building trades. Flexible leather illustrated—\$2 per copy postpaid. Popular Mechanics Book Dept., 6 N. Michigan Ave., Chicago.

#### FORMULAS AND TRADE SECRETS

**FORMULAS** and Trade Secrets for every purpose, guaranteed analytically accurate. Write for free particulars and special "get acquainted" offer. Raymond, Chemist, Scranton, Pa.

**1,000** TRADE Secrets and formulas, 25c; 500 selected formulas, 20c. Resilver mirrors, guaranteed process, 20c. Sneezing Powder, Itch Powder, 10c each. Entire lot 50c. Service Bureau, 3311-C, Belleplaine Ave., Chicago.

**895** SELECTED formulas in book form, 20c (coin or stamps). The Bronx Supply Co., 575P East 137th St., New York.

**ANY** formula, 13c. Satisfaction guaranteed. Keystone Supply Co., Toledo, O.

**10** MOST Wonderful Formulas. All new. All have been tried and tested. Preparations can be made at home at small cost. Profitable for home use or mail-order specialties, 10 cents (coin). Wagner Specialty Co., 219 Bailey Ave., Buffalo, N. Y.

**80-PAGE** booklet containing valuable recipes and secrets, worth dollars, will be sent with list of bargains for 10c. The Hils Sales Co., New Brunswick, N. J.

**A** HIGH grade, guaranteed formula for almost any occasion. Prices reasonable. Correspondence confidential. Cole Chemical Company, Chicago.

**FORMULAS**, Six good ones, 25c. Any formula wanted, 10c and stamp. Rodgers, Box 362E, Fall River, Mass.

**20,000** FORMULAS—Price, \$1, postpaid; complete list 4c stamps. Edm. Bromley, Watervliet, N. Y.

**10,000** SELECTED scientific, chemical technological, and practical recipes and processes, including hundreds of so-called trade secrets for every business, alphabetically arranged in one large volume of 800 pages. Price \$3 prepaid. Popular Mechanics Book Dept., 6 N. Michigan Ave., Chicago.

#### GAMES AND ENTERTAINMENTS

**"MAGICAL BULLETIN,"** a classy little monthly of exclusive information for magical entertainers. Whole year 25 cents. Sample copy for stamp. F. G. Thayer, 237 S. San Pedro St., Los Angeles, Cal.

**67** TRICKS, 250 jokes, riddles, 73 toasts, 8 Fortune Telling secrets, 52 money-making secrets, 22 funny readings and big catalog 10c. Novelty Shop, 3311-C, Belleplaine Ave., Chicago.

**\$1,000** WORTH second-hand tricks for sale cheap. Immense Magic Bargain Sheet, Catalogue, Free Samples, 10c. Fake Money, closest imitation possible. Flashy Roll with joke catalogue, 10c. Gilsovo, Morgan Park, Illinois.

**MAGICIANS**, Amateur and Professional, you need our new book "Bits of Patter," 25c. Illustrated catalogue included. Northwestern Supply Co., 2215 4th Ave. N., Minneapolis, Minn.

**MAGICIANS!** Let us help you save money! \$2 Floating Ball, \$1; \$1 Multicoloring Billiard Balls, 60c; 35c Magician's Trick Cards, 25c; New Book on Patter, 25c; Bargain Catalogue Free. Order from nearest place. Eagle Magic Company, Minneapolis, Minn.; New Bedford, Mass.; Kiowa, Okla.; Blackfoot, Idaho.

**SENSATIONAL** magic tricks. Souvenir and catalog free. Rex, Oshkosh, Wisconsin.

**SEND** 6c to Home of Magic, Albany, N. Y. Get trick complete and two catalogues.

HAVE your name drawn in the mysterious letter Puzzle; interesting; delights everybody, 10c. Hoxie, P-3844 Calumet Ave., Chicago.

NOVELTIES, Books, Tricks, Games, Etc. Illustrated catalogue free. Sample 25c Card trick, 10c. Asburn Supply Co. Specialty Dept., 7745 Peoria St., Chicago.

CACHOO "Snuff," "Itching Powder," "Spit-Fire," each 10c; any 4—25c. Classy Den Photos, set 25c. T. Sullivan, Abbott Ave., Fitchburg, Mass.

MAGICIANS' tricks, Handcuffs, Escapes, Ventriloquist and Punch figures. Prices low. Catalog free. Sample trick, 2c. Magic Parlors, 192 Clifford, Providence, R. I.

RUBBER Daggers, Rubber Silletos—great sport, very useful. Cut your throat, stab yourself, stab your friends. Can be used in theatrical performances or to scare off intruders. Only 25c secures this great imitation. H. Latz, Atlantic City, N. J.

FREE Magic Pocket Trick, Worth 25c. Illustrated catalog included. Send 6c stamps. Everything for stage and parlor entertainment. Buy direct from a professional manufacturer, Magic Co., Sta. 10, 249 West 38th Street, New York.

P-L-A-Y-S. Speakers, Dialogues, Drills, Joke Books, Wigs and Beards. Catalogue free. Ames Publishing Co., Dept. 49, Clyde, Ohio.

I WILL teach you for a dime a pretty after-dinner trick with a handkerchief, and a startling card trick, one that you won't forget soon. Have also splendid proposition for you. Salvo, 1335 Early Ave., Chicago.

BE a handcuff king. We teach you. Escape from handcuffs, boxes, ropes, etc. Secrets of 20 sensational escapes \$1. Particulars free. The Magicraft Co., Dept. A, Box 251, Detroit, Mich.

PLAYS, Vaudeville Sketches, Monologues, Dialogues, Speakers, Minstrel Material, Jokes, Recitations, Tableaux, Drills, Musical Pieces, Entertainments for all occasions. Make-up Goods. Large Catalog Free. T. S. Denison & Co., Dept. 11, Chicago.

MAGIC Catalogue, 100 pages, greatest on earth, ten cents. Learn magic at home. We teach you to do these tricks as good as the great professionals—escape acts, rope ties, mind reading, handcuff secrets. Satisfaction guaranteed. Chicago Magic Co., Dept. B, 72 W. Adams St., Chicago, Ill.

TRICKS, Puzzles, Jokes, Magic Goods, Ventriloquist Figures, Sensational Escapes and Illusions. Big catalogue free. Oaks Medical Co., Dept. 158, Oshkosh, Wis.

NIFTY Joke. September Morn squirt ring, 10c. Stovers, Millersburg, Pa.

#### MAILING LISTS

3,000 OHIO Bookkeepers—\$4 per thousand. Compiled from latest source. Printed alphabetically and neatly bound. American Commercial Co., 421 New First Nat'l Bank Bldg., Columbus, O.

FREE to business men, copy of our comprehensive "Silent Salesman." Contains over 2,000 different classifications of mailing lists with number and price of each list, and information every business man needs. Accept this free offer. Trade Circular Addressing Co., G 164 1/2 W. Adams, Chicago.

#### TYPEWRITERS AND SUPPLIES

WRITE for free trial and cut rate prices. Remingtons \$10. Oliviers \$15. Smiths \$12. 500 Machines \$5 to \$35. Everyone perfect; guaranteed 5 years. Typewriter Exchange, 162 North Dearborn, Chicago.

TYPEWRITERS, all makes, factory-rebuilt by famous "Young Process." Look like new, wear like new, guaranteed like new. Our big business insures "Square Deal" and permits lowest cash prices—\$10 and up. Also, machines rented—or sold on time. No matter what your needs are, we can best serve you. Write and see—now. Young Typewriter Company, Dept. 164, Chicago.

1,000 REMINGTONS \$10. Other bargains. Department F. Mide. Co., Bellevue, Ohio.

100 SHEETS Guaranteed Standard Weight Typewriter Carbon, 8 1/2 x 13, mailed postpaid in United States for \$1.25. Chas. W. Sines Co., 3757 W. Division Street, Chicago.

FOR Sale—Almost new Smith Premier No. 2 typewriter, \$20 cash. Chas. F. Smbser, 4898 Lake Park Ave., Chicago.

WANTED—Used Corona Typewriter. Must be in A1 condition. Write, giving lowest price, etc. O. H. Stivers, 10 East Pearson St., Chicago.

GOOD, serviceable typewriters \$7.50 and up. Post card brings list. Hub Typewriter Co., 286 Devonshire St., Boston.

ALL standard makes of typewriters. Big saving. Liberal guarantee. Catalogue, bargain list and valuable typewriter information free. The leading mail order typewriter house. A. E. Atchison, 110-112 No. LaSalle St., Chicago.

TYPEWRITERS—Rare bargains from \$5 to \$50; all guaranteed; shipped with privilege of 15 days' free trial; got our proposition before purchasing a writing machine. We can save you dollars. Coast Typewriter Exchange, Atlantic City, N. J.

BUY direct: Typewriters of every description. Underwoods, Remingtons, Oliviers, Foxes, etc. Tremendous savings, \$10 up; guaranteed 2 years. 15 days' free trial. Money refunded if unsatisfactory. Bank references. Catalogue free. Agents wanted. National Typewriter Exchange, 357 Broadway, New York.

TYPEWRITERS \$10 up. On approval. Guaranteed. A. Bassett Typewriter Company, 180 N. Dearborn St., Chicago, Ill.

#### CIRCULAR MAILING

CIRCULARS honestly mailed, 6x9 or smaller, 1,000, \$2. Earle Fowler, Clintonville, Conn.

#### PRINTING, ENGRAVING AND MULTI-GRAPHING

\$2.00 FOR 250 either linen finish or plain bond letterheads and 250 envelopes, 5,000 No. 20 bond letterheads for \$1.50. Multigraphed letters of quality. Direct Advertising Co., Akron, Ohio.

"FRANK'S Aristocrat," the new stationery adopted by leading concerns. Most beautiful and practical size. High-grade printing, 1,000 each letterheads and envelopes, complete, \$5.00, prepaid; samples for stamp, L. S. Frank Adv. Mfg. Co., 702 Locust Street, St. Louis.

500 EACH Radan linen letterheads, envelopes, \$3.25, white, blue; 10,000 white envelopes \$12.50. H-T Sales Co., 1413 E. 80th, Cleveland.

50 VISITING cards imitate engraving. 25c cash. Ruth, 6122 Torredale Ave., Phila., Pa.

200 GUMMED stickers name and address 15c. 500 Parcel shipping stickers, 50c. Starr Press, Clintonville, Conn.

ADVERTISERS—Here's your opportunity, 25 word classified ad inserted in "Cartoons Magazine" for 50c; one inch display ad \$1.25. 20,000 copies guaranteed. Send in your ad for the next issue. Cartoons Classified Dept. 6 N. Michigan Ave., Chicago.

1,000 3 1/2 x 5 1/2 CIRCULARS, \$1.00 prepaid. Bond paper—150 words—Samples. Wilson-Grandon, Jackson, Mich.

ENVELOPES, Statements, Billheads, Cards printed \$1.30 per thousand. Other printing low. Samples free. J. M. Hunt, Lambertville, N. J.

100 FINE AA White 6 1/2 envelopes printed 30c (Commission.) Printer, Kyserville, N. Y.

100 CARDS printed with name and address and 2-pocket cardcase for 25c, postpaid. R. De Stefano, 2446 Fillmore St., Chicago.

10,000 3x6 BOND add-slips \$3.50, 1,000, \$1. Monarch Printers, Nora Springs, Iowa.

BUSINESS-Boosting Stationery. 100 Linen Letterheads and 100 Envelopes, \$1 postpaid. De May Printing Co., Jackson, Mich.

50 LETTERHEADS and 50 Envelopes, printed, 50c, prepaid, 1,000 3x5 1/2 Envelope Slips, 150 words, \$1. Patterson, Printer, Beaver Falls, Pa.

150 LETTERHEADS, 150 Envelopes, \$1, postpaid. Art Press, Norton, Mass.

EMBOSSED Letterheads and Envelopes very low price. Samples. Turner & Dunlap, Wilkes-Barre, Pa.

LETTERHEADS; Envelopes; \$2 thousand, 5,000, \$7. Asp. Co., Fairmount, Indiana.

1,000 3x6 BOND Circulars, 150 words, postpaid 98c. Kelmscott Press, Hatfield, Minn.

PRINTING Presses, Type and Supplies. Big bargain sheet for stamp. Popular Bargains, Richland, Pa.

PRINTING Outfits—Presses, type, supplies. Catalogue free. The Model Press, York, Pa.

PRINTING Presses, type, supplies, Catalogue free. L. M. Carroll & Co., 326 Madison St., Chicago.

GUMMED labels, 3,000, \$1; bond letterheads, 1,000, \$2; 5,000, \$7.50. Catalogue, samples 2c. MacTaggart, 1235 Arch, Philadelphia, Pa.

PRINTING—500 either noteheads, envelopes, statements, cards, \$1; 1,000, \$1.50; 1,000 linen finish letterheads or envelopes, \$2.50; 1,000 typewriter letters, \$2. Samples, Model Company, Manchester, Iowa.

100 BOND Envelopes printed to order, 50c, postpaid. Write for samples, Francis M. Bauer, 23 Seventh St., Rochester, N. Y.

50 CALLING Cards, 10c, prepaid. F. Shepard, Rome, N. Y.

GUMMED Labels, 3,000—\$1, 1x3 inches, printed to order. Catalogue 2c. Helmers Co., Hoboken, N. J.

GOOD Printing at low prices. 1,000 good letterheads, envelopes, cards, billheads, labels, circulars, \$2.50. Samples free. Catalogues, booklets, and circulars our specialty. Ernest L. Pantus Co., 523 S. Dearborn St., Chicago.

1,000 IMITATION typewritten letters, 7x8 1/2, \$2.00. Cleaver, Harrison, Michigan.

#### PAN-AM. PATENTS AND TRADE MARKS

T. DENNIS LOCKING, C. E. (Pan-American Patent Attorney), P. O. Box 1801, Santiago, Chile. Patent and trademark protection procured in the "ABC" and adjoining South American Republics; workings effected; prosecution of legal defenses; industrial representation; reports, translations; charges and powers forwarded patent attorneys on request.

#### PATENT ATTORNEYS

PATENTS secured promptly. Trademarks, Designs and Copyrights. Personal attention. Edward W. Kibbey, Patent Attorney, 543 Victor Bldg., Washington, D. C.

PATENTS Procured and Trade-Marks Registered before paying attorney fees; this method guarantees promptness and efficiency. Inventors, request free money-saving advice. Jaynes & Jaynes, Kellogg Building, Washington, D. C.

PATENTS—Books, 100 mechanical movements and full information free. Expert service. Best terms. Write today, Fred G. Dieterich & Co., patent lawyers, 600 Ouray Bldg., Washington, D. C.

INVENTOR'S best newspaper, three months 10c. Inventor's Advocate, Dept. 44, Washington, D. C.

EQUITABLE Plan enables you to file application for patent at moderate cost. Particulars on request. Geo. R. Hamlin, 800 H Street, N. W., Washington, D. C.

INTERNATIONAL Bureau of Patents, Inc., serves inventors' interests. Send for booklet, Park Row Building, New York.

PATENTS \$35.50, payable by easy installments. Wm. C. Dashiell, 806 H St., Washington, D. C.

PATENT Application fully prepared \$10. Why pay \$65? Particulars free. Patent News, Dept. 15, Washington, D. C.

INVENTORS: We can save you \$20 on each patent. We explain how to make money in a few weeks' time. Fuller & Shalton, Engineers and Patent Attorneys, 500 Fifth Avenue, New York.

VALUABLE protective patents secured. Service confidential. "Big Prizes for Inventors," 15c copy. Lester Sargent, 700 9th St., Washington, D. C.

MAKE Patents Pay. I can show you how. Write for my free book. Learn what my services mean to you. Carl H. Crawford, Janifer Bldg., Washington, D. C.

PATENT your invention, \$10,000 offered for inventions wanted. Booklet and opinion free. Milo B. Stevens & Co., established 1864, 685 F St., Washington; 253 Monadnock Block, Chicago.

THE Patents is free. An education in obtaining patents. Established 1885. Anderson & Son, Attorneys, 707 7th St., Washington, D. C.

PATENTS obtained for you without the excessive attorney's profit. Write for particulars. American Patent Agency, Established 1874, Chicago, Ill.

"PATENTS and Patent Possibilities" is a 72-page treatise which tells all about patents, what to invent and where to sell it. It gives honest advice to inventors, and is full of valuable and interesting information. Write for it today! It is free. H. S. Hill, 905 McLachlen Bldg., Washington, D. C.

PATENT what you invent. It may be valuable. Write me. No attorney's fee until patent is allowed. Estab. 1882. "Inventor's Guide" free. Franklin H. Hough, 522 Loan & Trust Bldg., Washington, D. C.

FOR dependable advice about Patents, address Benjamin & Bassett, 140 S. Dearborn St., Chicago, Ill.

**PATENTS**—Herbert Jenner, patent attorney and mechanical expert, 406 F St., Washington, D. C. I report free of charge if a patent can be had and its exact cost. Send for circular.

**C. L. PARKER**, Ex-member Examining Corps Patent Office, Patent Attorney, 910 G St., Washington, D. C. Inventor's handbook, "Protecting, Exploiting and Selling Inventions," sent free upon request.

**PATENTS** build fortunes for you. Our free booklets tell how; what to invent, how to choose an attorney. Write today, D. Swift, 317 Seventh St., Washington, D. C. Established 1889.

**WANTED**—New Ideas. Write for List of Inventions Wanted. \$1,000,000 in prizes offered for inventions. Our Four Books sent free upon request. Victor J. Evans & Co., 166 Ninth St., Washington, D. C.

**PATENTS** explained in my free books, telling what you should know—what to invent—what not to invent—how to sell your patent, etc. Write today, H. L. Woodward, 902 G St., Washington, D. C.

**PATENTS** that protect and pay. Advice and books free. Rates reasonable—highest references; best results. Watson E. Coleman, Patent Lawyer, 622 F St., N. W., Washington, D. C.

**PATENTS** That Pay. Proof given. Two wonderful guide books free. E. E. Vrooman & Co., 871 F St., Washington, D. C.

**PATENTS**—Send sketch for free search and report. Books on patents and book of reference letters sent free. John S. Duffie & Co., 610 F Street, Washington, D. C.

**PATENTS**—Trade-Marks. Send for my free book "How To Get Them." It's full of information you should know. Joshua R. H. Peita, 3 Dearborn St., Chicago; 929 Chestnut St., Philadelphia; 805 G St., Washington.

**INVENTIONS** Worth Thousands—Their value is governed by the strength of the patent. Get the advantage of our 39 years' experience in procuring your patent. Clients in your state. Write and send sketch. Louis Bagger & Co., 699 Barrister Bldg., Washington, D. C.

**PATENTABLE** Ideas Wanted—Send for 3 free books, R. B. Owen, 39 Owen Bldg., Wash., D. C.

**PATENTS** secured or fee returned. Send sketch for free search. Latest and most complete patent book ever published for free distribution. George P. Kimmel, attorney, 212 Barrister Building, Washington, D. C.

**C. W. GERARD**, formerly Patent Office Examiner, Scarritt Building, Kansas City, Mo.

**NO** Attorney fees until patent allowed. Send sketch for free report. Books free. Frank Fuller, Washington, D. C.

**PATENTS** secured through credit system. Patentability search free. Booklet free. John Louis Waters & Co., Hutchins Bldg., Washington, D. C.

**OFFICIAL** Drawings Free. Patents procured or fee refunded. Expert services. Send sketch for Free search. The Patent Exchange, Washington, D. C.

**PROTECTIVE** patents procured promptly. 112 page blue book on patents sent on request. Trade-marks registered. Robb & Robb, 211-215 Southern Bldg., Washington, D. C.

**PATENTS** secured—Take advantage of my personal experience; send sketch or model. Get my free book containing 200 mechanical movements. W. N. Roach, Jr., 950 McGill Bldg., Washington, D. C.

#### FOR INVENTORS

**PATENT** Drafting. Save Money on Patent and Working Drawings. Your Ideas developed from rough sketches by experts. 15 years' experience. Perfected drawings will interest Capital. Edwin R. Lusby, 313 McGill Building, Washington, D. C.

**DRAWINGS** by mail. Same personal service as residents. Machine designing, inventions developed, working drawings. Practical expert, established ten years. Economy, results, satisfaction guaranteed. Inquiries solicited. W. F. Moody, 909 17th St., Denver, Colo.

**PROFITS** on your patent should come to you and not to some capitalist. Therefore, in place of capital, we offer you brains. Our selling plans will instruct you how to market your article with small funds. Write us. Describe your patent. Then we will help you. Martin & Miller, Advertising Counselors, 239 Fourth Ave., New York.

**PATENT** Specifications and drawing. \$15.00. Grover C. Hill, Patent Engineer, Owensboro, Ky.

**INVENTOR'S** best newspaper, three months, 10c. Inventor's Advocate, Dept. 45, Washington, D. C.

**IF** you want to sell your patent quick, good, and without risk, write to The American European Patent offices, New York, Broadway 206A.

**INVENTORS:** My patent made a fortune. Particulars free. Toys and games wanted. Eugene Pearl, 23 Union Square, New York.

**PATENTS** and Patentable Ideas sold on commission basis. Fuller, 509 Fifth Avenue, New York.

**YOUR** Ideas and Inventions designed, developed and perfected into commercially practical shape. Advice given free by expert mechanical engineer, Albert S. Kux, 145 W. Monroe St., Chicago.

**CORRESPONDENCE** invited with inventors or patentees of high-class games or toys. O. M. Palmer, 25 Broad St., New York City.

**WE'LL** tell you without charge why your invention is, or is not, worth patenting. Benjamin & Bassett, 143 S. Dearborn St., Chicago, Ill.

**HAVE** you a Patent to sell? You'll be interested in my proposition. Write now for free particulars. F. W. Johnson, 6 N. Michigan Ave., Chicago.

**IDEAS**, Patents, Inventions, developed and perfected. Expert Model and Machinery Building. Scientific experimental work. Regal Model and Tool Works, 122 Clark St., Chicago.

**HAVE** You an Idea? If so, you should protect it by a patent. Send us a model or sketch for free opinion as to patentability. Write for our Four Books sent free to any address. Victor J. Evans & Co., 157 Ninth St., Washington, D. C.

**PATENTS**, Trade-Marks and Copyrights. Our handbook on patents will be sent free on request. All patents secured through us are described without cost to the patentee in the Scientific American. Munn & Co., Patent Attorneys, 359 Broadway, New York. Washington, D. C. office, 383 F Street.

**PATENTS** Wanted—Will purchase or handle on royalty good Automobile Accessories. Box 124, Sta. B, Cleveland, O.

**WANTED** to buy patent on article with merit. State price and particulars. F. C. Besch, 321 St. Paul St., Baltimore, Md.

**WANTED**—An Idea! Who can think of some simple thing to patent? Protect your ideas; they may bring you wealth. Write for "Needed Inventions" and "How to Get Your Patent and Your Money." Randolph & Co., Patent Attorneys, 629 F St., Washington, D. C.

**WE** contract with inventors to manufacture most all kinds of patented wire goods. Cooler, 533 W. Monroe St., Chicago, Ill.

**PATENTS** Sold; we do the business, not merely collecting advance fees. If you own a patent send for free booklet "How We Get Cash for Your Invention." No charge for listing. Patent Sales Co., Frankford, Philadelphia.

**INVENTORS!** Write for List of Inventions Wanted; handsome new book 4c post-age. Sanders, 7 Webster Building, Chicago, Ill.

**INVENTORS:** We develop and perfect inventions, make models, dies, tools. Metal stampings and special manufacturing. Gerding Bros., Cincinnati, Ohio.

**PATENTS** without advance attorney's fees. Send sketch for free report. Books free. Frank Fuller, Washington, D. C.

#### PATENTS FOR SALE

**WINDOW** Shade Adjuster, saves shades—automatic feature affords great convenience—one to six needed in every home. Cost about 15c to make, retails for \$1. Splendid mail order or agent's seller. U. S. Patent just allowed; have broad protection. Owing to other business connections will sell patent and dies at sacrifice. Investigate this now. Luxie, Waco, Texas.

**UNITED** States patent on valve-grinding tool. Adjustable to all automobile valves, works at any angle, thoroughly tested and proven in large garage. Size and shape particularly adapted to mechanic's kit. Tobias Johnson, Lethbridge, Alberta, Canada.

**MAILBOX**, locks automatically. No keys. Contents readily seen. Worth investigation. Write, S. H. Peters, 166 So. 13th St., Allentown, Pa.

**FOR** Sale—Latest, most efficient, and simplest of all practical nut locks. Patent granted but not issued. A. A. King, Paonia, Colo.

**ELECTRIC** Crossing Iron, for men's clothing, on or off, while you wait, in ten minutes. Just a little ahead of the times; does perfect work. Used at home, traveling, barber shops, shine parlors. Manufactured for \$1.50, retail for \$3.00. Light and attractive. Good for straight sale work or agency. Two good patents, sell for \$10,000. Write me, Business, H. W. Pogue, 1745 N. Church St., Decatur, Ill.

**AUTOMATIC** electric winding clock. Very simple and practicable invention. Never pay attention to winding clock. Please investigate important features. My rights are for sale. Ucal Kreider, Arcanum, Ohio, Route 2.

**PATENT** No. 1,121,317, on adjustable hayrack brake. Royalty basis. Model furnished. Guy Wooten, Ford, Kans.

**MANUFACTURERS**, attention: Valuable patented Burglar Alarm, operating 4 ways before door opens, for sale. James Lesko, 5227 So. Winchester Ave., Chicago.

**\$3,000** PERPETUED self-cleaning filter-faucet combined. Big Mail-Order fortune. Guillemet, 3529 Mission, San Francisco.

**To** arrange for manufacture and sale of a new sheet metal household article necessary in every home. A good proposition for the right parties. Thomas H. Tarn, 534 Oliver Building, Pittsburgh, Pa.

**"AIR-TIGHT"** Dust-cap prevents entirely air leakage through valve stem. Saves worry, time, trouble, expense. Automobile owners see the merit of this Dust-cap on sight. Can be cheaply and substantially manufactured. Will sell on royalty basis. (Patent Pending.) J. C. McCall, 1535 Pruitt St., Ft. Worth, Tex.

**EMERGENCY** Tire Shoe for automobiles. This shoe is used when car loses traction in mud, sand or snow. Easily attached, and the results are always satisfactory. Can be readily sold to tourists. Entirely different from other articles used for this purpose. Can be manufactured substantially at low cost. (Patent pending.) J. C. McCall, 1535 Pruitt St., Ft. Worth, Texas.

**GOOSEBERRY** Cleaner tested with entire satisfaction. Simple in construction. Cleans 3 gal. gooseberries in 5 minutes perfectly. Capacity almost unlimited. Will sell outright. Particulars free. Robt. Pebley, La Fayette, Ore.

**HEATING** device for Table Service. Inspection invited. Sarah Anderson, 133 Broad St., Higgewood, N. J.

**PATENT** 1,054,600 Metallic Railway Tie. L. W. Abbott, Box 60, Delaware, Ohio.

**WILL** sell my patent 1,044,225 for \$250. Guaranteed the most practical screendoor bumper patented. A. E. Molin, care of Standard Garage, 4th Ave., Rockford, Ill.

**SELF-BALANCING** motorcycle, 2 speed ahead and reverse. Automobile seats, cosee clutch. No need of dismounting when standing still. Patent granted July, 1914. Has complete model. R. Hansen, 322 Lindsay St., Stockton, Cal.

**U. S. PATENT** 1,089,003, 1914, a great advertising device; revolving discs that can be attached over letters on electric signs, outdoor signs or window display advertising. The revolving discs can be constantly kept in motion by outdoor air current, in windows by electric fan, making the signs the most attractive day and night. Price, \$1,900. George Mayeric, Optician, 969 Market St., San Francisco.

**FOR** Sale: A Tin Toy, "He Haw Whistle," patent pending. Earl R. Simpson, 488 S. 17th, Salem, Ore.

**OUTRIGHT**—Ford Self-Starter. Can be manufactured for \$2.45 in thousand lots. Geo. B. Ehrig, Nazareth, Pa.

**PATENT** 1,123,046, just granted. Music leaf turner; attach to music stand, piano or organ. Will turn music both directions. For sale. Roy L. Warren, Oxford, Ohio.

**PATENT** No. 1,116,109, a device that will stop land waste, control ditches, gullies, etc. (a good stock yard fence), for sale or royalty. Gottlieb-Muehleisen, Alma, Wis.

**MOP** Squeezer, late patent, outright or royalty. William Menahan, 727 Aldrich, North, Minneapolis, Minn.

**FOR** Sale—Newly patented lock nut. Orley B. Caster, Glenmore, N. Y.

**PATENT** on necessary office article. Address M. Donker, Chicago, Ill.

**PATENT** Buyers are invited to address our sales department for information on any class of Patents they wish to purchase or lease on a royalty. We have secured a number of valuable patents in all lines of invention. Mail Order, Department Store and Household Novelties a specialty. Victor J. Evans & Co., 160 Ninth St., Washington, D. C.



CANADIAN Patent. Warm Air Furnace, new improved features. Write Frank Moll, 449 Baldwin Street, Portland Oregon.

If you want to know why you cannot sell your patent, write Benjamin & Bassett, 110 S. Dearborn St., Chicago, Ill.

PATENTABLE Ideas wanted—Send for 3 free books. R. B. Owen, 39 Owea Bldg., Washington, D. C.

AIR purifying and cooling device, of simple construction. Fixed or portable. Cheaply manufactured. Materials inexpensive. Quickly attachable. Air mild and invigorating. Carl F. Lundberg, 36 Willow St., Hartford, Conn.

FOR Sale—Canadian patent No. 154,797 moisture control for incubators, a great success and a money maker. D. O. Lager, 643 North Rodney, Helena, Mont.

MAKE an offer on Patent No. 1,043,317. This patent is for a meat slicer for use in slicing dried beef, boiled ham, bacon, etc. It is a very meritorious article and the sales for same are unlimited. H. A. Conger, 102 First Street, Portland, Oregon.

GEOGRAPHICAL Globe, flexible material. Readily folds into small compass when not in use. Supported by folding stand. Detailed information free. Herbert H. Van Keuren, c/o Cleveland Stone Co., Amherst, Ohio.

PATENT dirt collector on rotary street sweeper for sale. J. Suszycki, Reedsburg, Wis.

PATENT lock for steering wheel of automobiles, \$3,000. (No. 1,055,923.) L. Landes, 3525 Manito Ave., Los Angeles, Calif.

U. S. PATENT For Sale. Expect to receive Canadian patent in the course of a short while. Automatic Wrench. Cheap to manufacture. P. O. Box 742, South Manchester, Conn.

#### CONSULTING ENGINEERS

CONSULTING Engineer—A. M. American Institute Electrical Engineers. Practical advice. Ideas, Inventions perfected. Maximilian M. Weil, 2 Rector, New York.

#### MODELS AND MODEL SUPPLIES

MODELS, dies, and manufacturing for inventors, by builders of "Tools That Work." La Croix Tool Co., 214 N. 21st St., St. Louis, Mo.

WE develop and perfect working models for inventors. Light machinery building, scientific experiment work. Dies made and stamping done. Modern Die & Tool Company, 70 Ship St., Providence, R. I.

MODEL Making. Inventions developed. Write for estimate. Stearns, Paxton, Illinois.

PRODUCERS of Results; Inventions Developed, Light Mfg., Models, Experimental Work, Tools, Dies and Stampings, Johns Machine & Stamping Works, Middle Bldg., Dept. C, Cleveland, Ohio.

INVENTORS: We manufacture metal articles of all kinds to order. Also, special machinery, tools and dies, punchings, lathe and screw machine work, metal spinings, castings, plating, wood and metal patterns, etc. Send sample for estimate and expert advice, free. The Eagle Mfg. Co., Dept. B, Cincinnati, O.

MODELS made for inventors; general machine work; designing and perfecting; developing automatic devices and machinery. In a position to do all kinds of light tool and machine work. Prices reasonable; estimates cheerfully given. Ideal Machine Works, 62 Ann Street, New York City.

WE make working models for inventors; also dies and stamping of specialties, and carry a complete stock of brass gears and model supplies. Send for catalogue. The Pierce Model Works, 3405 Pierce Ave., Chicago, Ill.

PATTERN makers! A book devoted to the principles of pattern and core making and molding. Written by G. H. Willard, a practical pattern maker of years' experience. This book, just published, treats the subject in a much more simple, direct and effective manner than most books along this line. 224 pages, 312 illustrations. Price, \$1, postpaid. Popular Mechanics Book Dept., 6 N. Michigan Ave., Chicago.

NEW Lithographic Model of a Monster Mallet Compound Locomotive. All parts shown and numbered. Size 9x13 in. in colors. Other models in series are, Atlantic Type Locomotive—Steamship—Automobile—Gas Engine—Steam Engine—Steam Turbine—Dynamo—Wireless Telegraph. Price, 50c each or set of 9 for \$4 prepaid. Popular Mechanics Book Dept., 6 N. Michigan Ave., Chicago.

MAKE models yourself. Why not? Drummond lathe illustrated page 144. W. R. Price, New York.

FREE catalogue of model supplies. Castings, metal specialties on contract. North Chicago Tool Works, 15 Grove Ave., North Chicago, Ill.

SPECIAL Electrical and Mechanical devices built to order. Models, Tools, Dies. Bend, Levi, 357 West Broadway, N. Y. City.

#### HOBBIES

ANTOPLETWORK. Scrollwork; interesting, profitable home occupation. Catalogue and magazine free. W. H. Price, New York.

#### MANUFACTURING

WE manufacture metal specialties, all kinds; also dies and tools. Light stampings finished complete in steel, copper, brass, or any metal. Drawing a specialty. Difficult work solicited in novelties and patented articles. Write your wants. Loeck Mfg. Co., Enterprise Bldg., Milwaukee, Wis.

METAL Specialties manufactured for Inventors. Lyons Machine Works, Lyons, Iowa.

FACTORY prices quoted—Manufacture anything in Iron, Steel or Brass. Our foundry can handle large tonnage of Gray Iron, Brass or Aluminum Castings. Practical Iron Works, North Chicago, Illinois.

WELD Castings. Enormous profits. Small investment. Write today for free 32 page book on welding. Welding Apparatus Company, 220 National Union Building, Toledo, Ohio.

WIRE Wiregoods Springs. Thomas Hamilton, 458 N. Broad St., Philadelphia, Pa.

DIES, special Machinery. Get estimates. Western Manufacturing Co., Fulton, Ill.

WIRE Goods, all kinds, made to order. Cooley Mfg. Co., 533 W. Monroe St., Chicago.

INVENTIONS perfected and manufactured. Reference, your banker. Russell Machine Co., Dallas, Tex.

WE manufacture light stampings and dies from blue prints. Also plate, tin, galvanize and finish goods according to samples submitted. Two Rivers Plating Works, Two Rivers, Wis.

GAS for power is taking the place of steam for reasons of economy. Learn all about this great change by reading our new non-technical book on this subject, written by a first-class authority for the practical man. 192 pages, profusely illustrated, cloth binding. Price, \$1, postpaid. Popular Mechanics Book Dept., 6 N. Michigan Ave., Chicago.

#### REAL ESTATE AND FARM LANDS

THAT Dream of yours, about getting the most out of life in "The Land of Sunshine, Fruit and Flowers"—California—will come true, just as soon as you desire, if you let me tell you where you can get excellent land, in large or small tracts, at reasonable prices and on easy terms. So write to me today. Accurate information free for the asking. H. A. Smith, Colonization & Industrial Agent, Union Pacific R. R. Co., Room 4123 Union Pacific Bldg., Omaha, Neb.

SAN Joaquin Valley—What a woman did: She farms 75 acres in Stanislaus County, California. 35 acres are in peaches, 8 in apricots, 2 in prunes, 20 in almonds, 5 in olives, and the remainder in alfalfa. She sold 350 tons of fresh peaches and dried 55 tons of peaches and 8 tons of prunes. The olives will bring \$1,000. Apricots and almonds did well, too. Her profit for the season is \$10,000, above all expenses. What others are doing is told in our free San Joaquin Valley books. Write for them today and learn of the money-making opportunities here. C. L. Seagraves, Gen. Colonization Agent, AT&SF Bldg., 1818 Ry. Exchange, Chicago.

SPECIAL sale Texas City lots, New Seaport, fastest growing city in Southwest. Millions being spent by Government and private interests on Harbor improvements, docks, warehouses, factories, mills. Real estate values increasing enormously. Lots splendid investment. Remarkably easy terms, only \$1 per lot cash, \$2 monthly. Price low as \$109. Only a few yet to sell. Closing out. Write now for maps, plats and illustrated literature. C. A. Bryan & Co., owners, 230 First National Bank Building, Houston, Texas.

CHICAGO income property is best; small investment; sure returns. Vielsen, Webster Building, Chicago.

FOR Exchange—Lands in Minnesota and South Dakota. All splendid propositions. Will bear inspection. Prefer merchandise. W. J. Taylor, Crookston, Minnesota.

\$500 DOWN, balance your own terms, interest at 5%, buys superior 160-acre farm, Morton County, North Dakota. Situated five miles from town with schools, stores, grain elevators, bank and all facilities. Price right. If you are looking for legitimate bargain direct with owner, write Mrs. Elizabeth Bart, Apartment E, 839 West End Ave., New York City.

8.11 ACRES—4 cultivable, near gold camp; small log house, spring, chicken house, fences, terraced. Fine for truck garden, oat, hay, chickens. House furnished. \$160. J. G. H., Goldfield, Colorado.

80 ACRES \$9,000; terms. Partly improved; adjoining famous Hood River Valley. Box 6, Mossier, Oregon.

CO-OPERATIVE Colony locating here. Co-operators invited. Edward Miller, Crystal Springs, Fla.

TAYLOR County, Wisconsin, Land; 10,000 acres to choose a home from on easy terms. Oscar Nystrum, Medford, Wis.

CALIFORNIA Homeseekers Protective Bureau (Registered), Long Beach, California, is engaged exclusively in furnishing prospective homeseekers with reliable, conservative information on California. No land to sell. Booklet. Write Dept. M.

FOR SALE—100-acre timber tract. Will accept good Roadster Auto as part pay. U. S. G. Peifer, Watsontown, Pa.

FOUR lots near Los Angeles, \$250; four Sonoma County, \$200. Louthain, Olman, 1443 St. Charles, Alameda, California.

CENTRAL Michigan farms, fruit, grain or stock. Write for free list. Philip Lappert, Stanton, Mich.

VIRGINIA Farms, small and large, \$15 an acre and up. Easy payments, mild climate, fertile soil. Ideal for fruit, stock or general farming. On railroad with big markets near-by. Write for list, maps, etc. F. La Baume, Agri. Agt., N. & W. Bx., 250 N. & W. Bldg., Roanoke, Va.

FOR Sale—Kansas Farm and Ranch land at bargain prices. Terms. Wm. Works, Humboldt, Kan.

MOBILE County, Alabama, Farm Land. 40 to 40,000 acres, 20 miles west of City of Mobile. Direct from owners, \$12.50 to \$15 per acre. C. N. Pooley, 1016 Springhill Ave., Mobile, Ala.

FERTILE Farms near Philadelphia; fruit, poultry, truck, dairy; catalog. W. Stevens, Pottsville, Pa.

SARASOTA Bay District in famous Manatee County, Florida. Own ten acres where there are no tree killing frosts. Raise oranges, grapefruit, strawberries, vegetables and chickens under a warm winter sun. Flowing wells. Involving salt air. Pine woodland breezes. \$60 per acre. Terms, \$3 per acre first payment, balance \$3 per acre quarterly. Write for Free Booklet. West Coast Realty Company, Sarasota, Fla., Dept. D.

THE South offers unequalled opportunities for farmers, with its mild climate, ample rainfall, two to four crops a year, great possibilities in live stock, dairying and food crops, low cost lands and good markets. Let me send you information. M. V. Richards, Ind. & Agri. Commissioner, Room 64, Southern Railway, Washington, D. C.

REAL Estate Educator—Containing inside information not generally known. "Don't's" in Real Estate, "Pointers," Legal Forms, etc. It gives in condensed form the essential knowledge of the Real Estate Business. What you need to know; what you ought to know; what you want to know. 254 pages, cloth, \$1.00, postpaid. Popular Mechanics Book Dept., 6 N. Michigan Ave., Chicago.

FARMS for Sale or exchange anywhere in the U. S. or Canada, direct from the owners. State where you want to locate. Information free. American Investment Association, 37 Palace Bldg., Minneapolis, Minn.

SELL your property quickly for cash, no matter where located. Don't pay big commissions. Particulars free. Real Estate Salesman Co., Desk B, Lincoln, Neb.

LANDLOGY, a magazine giving the facts in regard to the land situation. Three months' trial subscription, Free. If for a home, or as an investment you are thinking of buying good farm lands, simply write me a letter marking it personal and say, "Mail me Landology and all particulars Free." Address Lloyd M. Skinner, Gen'l Mgr., Skidmore Land Co., 40 Skidmore Bldg., Marinette, Wis.

FOR Sale—Michigan Fruit and Chicken Ranches. Five and Ten acre Happy Home Tracts. Terms, \$10 down, \$4 monthly. Write for description. Frank P. Cleveland, owner, Fallmouth, Missaukee County, Michigan.

WRITE me if you want to buy or sell a farm or business. Established 1881. John B. Wright, 1208 Adams Express Building, Chicago, Ill.

CITRUS Land, Arcadia, Fla. Uncumbered, good title, dry, 25c per acre per month, interest 6%. Ten acres up. Ford Howell, Des Moines, Ia.

#### GINSENG

GINSENG seeds \$1.00 thousand, planting instructions free. Specialty Farm, Rockford, Minn.

#### DOGS, BIRDS, POULTRY AND PETS

REGISTERED Russian Wolfhounds; catalogue ten cents. Arkansas Valley Kennels, Cimarron, Kansas.

POULTRY raisers succeed with Mandy Lee Incubators, Lee's Lice Killer, Germozone, and Lee's Egg Maker. Sold by dealers or direct. Send for Catalogs and Lee's Poultry Book, Free. Geo. H. Lee Co., Mfrs., Dept. 36, Omaha, Nebr.

GOLDFISH—Rare specimens, artistic aquariums, snails, plants. Catalog free. Pioneer Goldfish Hatchery, Racine, Wis.

WRITE your name on a postal for our new 112-page 1915 book on Poultry Raising—just out. Nothing published like it—better than last year. Full of practical help—how to breed, feed and rear. Tells how leaders succeed—which breeds lay and pay best—gives plans for poultry houses—how to build brooder out of old piano box, etc. Describes the famous Prairie State Incubators and Brooders. Worth Dollars—free for writing. Prairie State Incubator Company, 621 Main St., Homer City, Pa.

RAISE Belgian Hares for us. We pay \$1.50 each. Also mink, skunk, squabs, frogs, etc. Big profits. For particulars address The Belgian Hare, Box D, Holmes Park, Mo.

#### MISCELLANEOUS

GENUINE Sioux Indian Beadwork and Curios, also Elk Teeth, Moccasins, Fobs, Belts, Hatbands, Pouches, Wapitans, Indian Costumes. Send 10c for price list. Strong Curio Co., Gordon, Neb.

CASH paid for butterflies, insects. Summer work. Men, women. Instruction book. Send stamp. Sinclair, D. 6, Los Angeles, Cal.

HOW to make Printing cuts cheaply and 150 high-grade selected formulas 20c. Service Bureau, 3311-C, Belleplaine Ave., Chicago.

CUTS anybody can make. Simple Etching Process, \$1. Particulars, specimens, for stamp. M. Day, Windfall, Ind.

"MIND-READING" exposed. How to read sealed letters; instantly, name articles touched by another, find concealed articles, etc. Particulars free. "88" Agency, Box 737, Shreveport, La.

CANDY Making a fine art. Splendid instructions how to make and sell, 50c. Auburn Supply Co., Dept. C3, 7745 Peoria St., Chicago.

MARK TWAIN Gummed Scrap Book; best way to keep newspaper clippings; 50c. Garbe Co., 846 E. 136 St., New York.

PENNANTS—20 Beautiful College Pennants, all different, 9x18 1/2, 3 dimes. Heilmann Supply Co., Box 121, Williamsport, Pa.

GLASS bending, bevelling, etching, holes drilled. Furniture tops, shelves and lamp glass. Low prices. Alpha Glass Co., 125 Church St., New York.

TWENTY cents brings complete instructions "How to Make Practical Printing Cuts," at two cents each; instructions formerly sold for dollar. F. S. Co., P. O. Box 456, Seattle, Wash.

SKELETON Keys open most common door locks; set, prepaid, 15c. Secret of opening Pin Tumbler Cylinders without picks or keys, \$1.00. Any key duplicated. Lorenzo Stettler, Stamford, Ct.

DID you ever know that your handwriting reveals your characteristics? I will analyze your writing for twenty-five cents in stamps. Money returned if unsatisfactory. K. E. Golt, 5126 University Ave., Chicago.

GET the time, weather and news by wireless. Complete receiving set, \$2.95. Outdoor aerial not necessary. Circulars free. Imperial Electric Co., 89 Wallabout St., Brooklyn, N. Y.

INTELLIGENT Men, 18 to 35 years, wanted. Railway Mail Clerks, \$75 month. Full unnecessary. Write immediately for spring examination dates. Franklin Institute, Dept. P-22, Rochester, N. Y.

COLLECTION of war medals for sale. Wilson, 245 Jarvis St., Toronto, Canada.

THE Mansfield Water Finder is a reliable electrical instrument for locating underground waters. Mansfield, New Brighton, England.

GASOLINE Torches and Furnaces. Ask your dealer for Bernz' make, or send \$2.75 for quart torch or one gallon furnace, prepaid. Otto Bernz, Newark, N. J. Established since 1876.

HOW to open any lock pin-tumbler cylinder without keys, picks or tools. Wonderful secret. Copyrighted instructions. \$1. E. L. Dodd, Rome, Ga.

GRANDFATHER'S Clock Works, \$5. Slightly shop-worn, quantity limited, others with chimes, all prices; also several nice Grandfather's Clock cases, exceptional bargains. Clock Company, 1673 Ruffner St., Philadelphia, Pa.

BIG Mail Free. Your name listed once, 35,000 circulation and magazine one year 10c. Digest, Grand Rapids, Mich.

FIRST book out on Automobile Design, also treats Construction and Repair. By Victor Page, a good authority. Book has 600 (6x9) Pages, 350 illustrations. Right up-to-date. Price, \$1.50 postpaid. Popular Mechanics Book Dept., 6 N. Michigan Ave., Chicago.

GERMANY'S Submarines! What can they do to England's Navy? Learn all about the construction and operation of a submarine of the latest type from our chart, a lengthwise cross-sectional view showing and naming over 200 parts. Size 14x28 inches, on plate paper, mailed in a tube, for 25 cents. Popular Mechanics Book Dept., 6 N. Michigan Ave., Chicago.

RUBBER stamps, photo negative type, steel dies, metal badges, seals, stencils. Catalogue 10c. Buckeye Stamp Works, Market, Dayton, Ohio.

AUTOMOBILE model. Every part shown and named. You can to all intents and purposes take off the wheels, raise the hood and remove the body, exposing to view the vital parts. The only practical method of studying the automobile. Price 50 cents postpaid. Popular Mechanics Book Dept., 6 N. Michigan Ave., Chicago.

WOOD-WORKING for Amateur Craftsmen—128-page book, profusely illustrated, giving every essential step in wood-working. Valuable for either self-instruction or for use in manual training courses. Cloth, 50 cents, postpaid. Popular Mechanics Book Dept., 6 N. Michigan Ave., Chicago.

WAR Atlas—Large 20-page (11x15 in.) Atlas of the War in Europe, containing large colored scale maps of the battle-ground, showing Europe, Austria, Serbia, Germany, England, Belgium, France, Russia, Italy, Greece, The World, etc. Special data showing comparison of armies and Navies involved, pictures of rulers, etc. Price, 25 cents. Postage and packing, 5 cents additional. Address Popular Mechanics Book Dept., 6 N. Michigan Ave., Chicago.

20,000 FORMULAS, recipes, etc. 550 2-volume, alphabetically indexed, \$1 prepaid. Formula Bureau, 3311-C, Belleplaine Ave., Chicago.

"CURIOSITY" Photographs—Cabinet size, glossy, 25c each, 2c stamp brings list. John G. Dickson, 32 West Main, North, Gall, Ontario.

48 HOT Air, joker, acquaintance and other interesting cards, 10c. F. V. Sun Co., Harrison, Mich.

LOCKSMITHS (only) 50 expert lock picks, \$5. McDougald, 5322 Windsor Ave., Chicago.



## BE A BANKER

Splendid opportunities. Pleasant work, short hours, all holidays off, yearly vacation with pay, good salary. Learn at home. Diploma in six months. Catalog free. EDGAR G. ALCOBORN, Pres. AMERICAN SCHOOL OF BANKING, 119 McLENE Bldg., COLUMBUS, OHIO

# 3 Months 25¢

The "AMERICAN CHAUFFEUR" is the liveliest, most helpful, technical magazine in the automobile field. It is the only one published for the interest of the beginner, the man who drives his own car and the chauffeur. Every issue is crammed with valuable articles that will teach you how to operate and care for automobiles economically.

It is edited by Mr. C. T. Schaefer, M. E., America's foremost automobile consulting engineer, assisted by a staff of experts.

A year's subscription lasts the best mail order course. The "AMERICAN CHAUFFEUR" is the last word in automobile education and construction.

Send 25 cents in stamps or coin for three month's trial subscription and be convinced what a valuable magazine this is; or better still, if you will send us \$1.00 in cash, money order or check, we will enter your name for a full year's subscription and send you absolutely FREE a novel automobile watch fob with a real detachable tire which can be put on or taken off in a jiffy. Send today, your money back if not satisfied.

THE AMERICAN CHAUFFEUR,  
251 Butler Bldg., Cincinnati, Ohio



Please Mention Popular Mechanics

Would You Like to Write 100 Words a Minute Without Knowing Shorthand? If So, Learn

## BRIEFHAND

The modern substitute for stenography, using longhand characters. Easy to learn, write and read. Invaluable to business and professional men and women, ministers, teachers, secretaries, clerks, students, boys, girls—EVERYBODY. Recommended by many responsible persons. Complete self-teaching Manual, containing full instructions, 2900 illustrations and numerous "short cuts," \$1. PREMIER BRIEFHAND SCHOOL, Dept. B, WASHINGTON, D. C.

## WE WANT REPRESENTATIVES

buying and selling Real Estate, Mortgages, Bonds, Stocks, etc. Salary and commission. Hustlers make \$3,000 to \$10,000 per year. We furnish a course of instruction which will fully qualify you.

INTERNATIONAL REALTY CORPORATION  
3436 Otis Building 10 South La Salle Street, CHICAGO

## SPEAK A FOREIGN LANGUAGE !!!

The European war has created a great demand and unlimited opportunities for those who know Spanish, French, German or Italian. Now is the time to better your position or increase your business. You can learn quickly and easily, at home, during spare moments, by the

### LANGUAGE-PHONE METHOD

And ROSENTHAL'S PRACTICAL LINGUISTRY You listen to the living voice of a native professor pronounce the foreign language, over and over, until you know it. Write today for Booklet, particulars of Free Trial. Easy payments.

The Language-Phone Method, 861 Peoria Bldg., 2 W 45th St., N. Y.





## What Clarkson is Doing for the Book Buyer

**I**N several hundred thousand Libraries in the homes of people in every walk of life—from the day laborer to the college professor and high government official, from the persons who buy a few books of popular fiction to the persons who pride themselves on having the complete works of all the standard authors in De Luxe Editions art.ically printed and bound—almost every book was bought from me. **WHY?** Because, I have no agents and sell you just the books you want—all new—many at a saving of from 50 to 90 per cent—you examine the books in your own home for five days before paying for them. If not satisfied, return them at my expense—and owe me nothing.

### Sample Prices:

The Eyes of the World, 90c

Their Yesterdays, 35c

Winning of Barbara Worth, 35c

Calling of Dan Matthews, 35c

Library of Oratory, 15 vols., publisher's price \$15—my price \$4.75

Shakespeare, 40 vol. full flexible Morocco, large and true, best notes of a NY Shakespeare published, publisher's price \$35, my price \$24

Messages and Papers of the Southern Confederacy, 3-4 Morocco, publisher's price \$15—my price \$5c

Home Library, 8 vols. cloth, publisher's price \$4—my price 50c

Wild Animals of North America, publisher's price \$5—my price 45c

Orations, Addresses and Club Essays, publisher's price \$1.50—my price 42c

Here are De Luxe Editions, Morocco bound, complete works, many of them at less than 25 cents on the dollar. Hugo, Kipling, Poe, Eliot, Dickens, Thackeray, Scott and scores of others.

### Get My Big, New Catalogue

My new catalog, sent free for the asking, tells you how to save 50 to 90 per cent on thousands of books. It is a course in literature, giving nationalities, date of birth and death of authors, the author's life and standing in literature, etc. Hundreds of sets and thousands of single volumes listed.

I sell more books direct to the booklover—the individual reader—the rich man who insists upon his dollar's worth—the man who wishes his pennies—and sell them for less money—than any other man in America. Every book new and fresh, and guaranteed to please you—you to be the judge. I do not quibble, and would rather have a book or set of books returned at my expense than to have a dissatisfied customer.

**David B. Clarkson, The Book Broker**  
344 Clarkson Building Chicago, Illinois

## EARN WHILE YOU LEARN



**Plumbing  
Electricity  
Bricklaying  
Mechanical  
Drawing**



**MAKE  
\$5 to \$8 A  
DAY**

Mail the coupon below and we'll tell you how you can become an expert in any of these trades in a surprisingly short time. There are unlimited possi-



bilities in all of them—Plumbers, Electricians and Bricklayers get \$5 to \$8 per day; draftsmen, \$150 a month and up. Work is steady—and the demand for trained experts in all these trades is **always** greater than the supply. Or you can go in business for yourself on small capital, and make from \$3,000 to \$5,000 a year.

## We Need You Now

We have calls for more trained men than we can supply. Therefore right now we are making especially attractive inducements in the way of only a very small tuition charge and easy payments when desired. Moreover, we have a plan whereby we help you to earn your tuition and expenses while learning the trade you wish. Many of our students take advantage of this plan. Let us tell you about it. Mail coupon for particulars.

### Free Tools

We furnish all tools and equipment necessary for your instruction **absolutely free**. You are taught by **actual work** under expert instructors—no text books—no dry theory. No previous experience necessary. Day or night classes as you prefer. Courses are **thorough, practical, short, direct**. Not a day of your valuable time wasted. We assist you in finding big paying position **free** after your graduation. Investigate at once this biggest and most successful of all trade schools where you get the **practical, thorough** training that means your success and future independence.

### Mail Coupon Today

and get full particulars. Everything free—no obligation at all on your part. This is your chance to break away from a small-pay job and **get somewhere!** A good-paying trade is the **surest** foundation for **Success**—remember that! Don't put it off—mail this coupon **right now** while you're thinking about it, and get our interesting free book and all the facts.

**L. L. COOKE, Director**  
**COYNE NATIONAL**  
**TRADE SCHOOLS**  
39-51 E. Illinois St.  
Dept. 9193  
CHICAGO, ILL.

**L. L. COOKE, Director**  
**COYNE NATIONAL**  
**TRADE SCHOOLS**  
39-51 E. Illinois St., Dept. 9193  
CHICAGO, ILL.

**GENTLEMEN:** Without any obligations on me whatsoever, please send me your school catalog and full particulars of this offer to men—all free.

Name.....

Address.....

## Learn to be An Auto Expert

Six weeks from the day you commence your studies at this great practical school you will be able to repair any make of automobile and drive any car on the market.

### Earn \$75 to \$200 a Month

Many of our graduates make even more than this. Big demand for competent repairmen, demonstrators, garage managers and chauffeurs. All practical work. No books used. No tools to buy. Write today for big illustrated free book. Address,

AUTOMOBILE TRAINING SCHOOL, 1168 Loerst St., Kansas City, Mo.



**RAG-TIME** Learn to play Rag-time on the Piano. We teach you quickly by mail. BOOKLET SENT FREE.  
**CHRISTENSEN SCHOOL OF MUSIC**  
918 Christensen Building CHICAGO

## DO YOU LIKE TO DRAW?

That's all we want to know

Now we will not give you any grand prize—or a lot of free stuff if you answer this ad. Nor do we claim to make you rich in a week. But if you are anxious to develop your talent with a successful cartoonist, so you can **make money**, send a copy of this picture with 5c. in stamps for portfolio of cartoons and sample lesson plate, and let us explain.

The W. L. Evans School of Cartooning  
821 Leader Bldg., Cleveland, O.



## LAW LEARN AT HOME

SPARE TIME ONLY

Graduate correspondence students most successful at bar examinations. Our method of instruction same as HARVARD, MICHIGAN and other big Law Schools. **GUARANTEE** to coach FREE graduates failing to pass Bar Examinations. Write today for special offer and catalog. **Send FREE**. Offer limited—WRITE IMMEDIATELY.

AMERICAN CORRESPONDENCE SCHOOL OF LAW, Dept. 1155, Manhattan Bldg., Chicago



## Don't Let This Stool Be as High as You Rise!

Don't waste your time in a small job with no prospects of future success. Begin now to prepare yourself for a position of power and big money. No matter what you work at now, here is a big, powerful, prosperous position for you.

Let Us Make You An  
**EXPERT  
ACCOUNTANT**

Right now big concerns, corporations and railroads need Expert Accountants at big salaries.

The need is greater than the supply. Now is the time to let us prepare you for this lucrative vocation—the vocation that offers you remarkable possibilities of advancement into big, powerful executive positions.

We Train  
You By **MAIL**

at home, in spare time, tuition very low—terms to suit your needs. No matter what your work now you can qualify for this big paying position. You do not need to even understand bookkeeping. We have a course that prepares you in bookkeeping from the ground up for more advanced work in Higher Accountancy. Prepared by noted experts—covers Theory of Accounts, Practical Accounting, Cost Accounting, Auditing, Business Law, etc. Prepares you for C. P. A. examinations in any state. Under personal supervision of William Arthur Chase, nationally recognized leader—Ex-President American Association of C. P. A. Examiners and Ex-Secretary Illinois Board of Examiners in Accountancy.

**ACT!** Write now for remarkable free book on How to Become an Expert Accountant. It explains studies, examinations, state regulations, salaries and positions to be had. Become a big factor in business—prepare yourself for power and prosperity. We make it easy. Send no money—everything is FREE. Send now before offer expires.

LaSalle  
Extension  
University,  
Dept. H-469  
Chicago,  
Ill.

Name \_\_\_\_\_

Street No. \_\_\_\_\_

City \_\_\_\_\_

\$3,000 to  
\$10,000  
Yearly

**Special  
Reduced  
Rate**

**SCHOLARSHIP**  
Write quick and learn how, for a limited time you can secure special reduced rate scholarship. Do not miss this Special Offer.

**MAIL  
COUPON  
NOW**

LaSalle  
Extension  
University,  
Dept. H-469 Chicago,

Send at once, your free book, How to Become An Expert Accountant, and full details of your course in Higher Accountancy; also advise me about Special Limited Reduced Rates. I am obligated in no way.

Please Mention Popular Mechanics

## SHORTHAND IN 30 DAYS

We absolutely guarantee to teach shorthand complete in only thirty days. You can learn in spare time in your own home, no matter where you live. No need to spend months as with old systems. Boyd's Syllabic System is easy to learn—easy to write—easy to read. Simple. Practical. Speedy. Sure. No ruled lines—no positions—no shading as in other systems. No long lists of word signs to confuse. Only nine characters to learn and you have the entire English language at your absolute command. The best system for stenographers, private secretaries, newspaper reporters and railroad men. Lawyers, ministers, teachers, physicians, literary folk and business men and women may now learn shorthand for their own use. Does not take continual daily practice as with other systems. Our graduates hold high grade positions everywhere. Send today for booklets, testimonials, etc.

**Chicago Correspondence Schools**  
969 Advertising Bldg., CHICAGO, ILL.

## MUSIC TAUGHT FREE

By the Oldest and Most Reliable School of Music  
in America—Established 1805

**Piano, Organ, Violin, Mandolin, Guitar, Banjo, etc.**  
Beginners or advanced players. One lesson weekly. Illustrations make everything plain. Only expense about 2c per day to cover cost of postage and music used. Write for FREE booklet which explains everything in full.

**AMERICAN SCHOOL OF MUSIC, 51 Lakeside Building, CHICAGO**

## Learn to PAINT SIGNS and SHOW CARDS

I'll teach you personally by mail, 16 years' successful teaching. Big field for men and women. You can Earn \$18.00 to \$45.00 a Week. Scherer (Chicago) writes us: "Your instruction is great. Highly pleased." Complete details promptly on request.

**DETROIT SCHOOL OF LETTERING**  
Chas. J. Strass, Founder Dept. 303, Detroit, Mich.



## Big Money for You!

### BUILDING, SELLING AND REPAIRING AUTOMOBILES

We train you by mail in few easy lessons, and give you exclusive agency for "Cozy Junior" World's Champion Light Car. Write immediately and learn how you can get one of these speedy little roadsters.



Cozy Junior

OFFER STRICTLY LIMITED. HURRY! A POSTAL WILL DO.  
**C. A. Coey's School of Motoring, 312 Coey Bldg., Chicago**

## DRAWING

Learn by mail. Cartooning, Newspaper, Magazine and Commercial Illustrating, Water Color and Oil Painting. Free Scholarship Award. Write for Illustrated Art Annual.

**FINE ARTS INSTITUTE, Studio 753 Omaha, Neb.**



## JEWELRY ENGRAVING

We teach you, by our new and original method of instruction, this clean, fascinating and profitable business right at your home, and furnish you all tools needed absolutely free. Write for free book to the  
**WISCONSIN SCHOOL OF ENGRAVING, Strub Bldg., MILWAUKEE, WIS.**

## VENTRILOQUISM

LEARNED BY  
ALMOST  
ANYONE  
AT HOME  
SMALL COST

Send today 2c stamp for particulars and proof.  
**O. A. SMITH, Room D 122, 823 Bigelow St., PEORIA, ILL.**

## ARITHMETIC SELF-TAUGHT

A plain, easily-understood volume for all who have not had the opportunity of learning this subject thoroughly, or who have forgotten what they once learned. 257 Pages. Requires no teacher. This great little book sent postpaid for 60 CENTS. Stamps accepted.

**GEO. A. ZELLER BOOK CO.**  
Est. 1878, 4472 W. Belle Place ST. LOUIS, MO.

SPANGENBERG'S  
PRACTICAL  
ARITHMETIC  
Self-Taught

# I Put Them There

**Give Me Ten Minutes a Day and I Will Do the Same for You**

Thousands of men and women have acquired an accurate, unailing memory through my system of Memory Training. I have letters from men in nearly all professions and trades thanking me for being of great assistance to them. *Hundreds of them attribute their success and prosperity directly to my training.* These whom I quote below are but a few of them. I want to send you others.

You, young man in college, or you, ambitious worker taking a correspondence course—what good is your study doing you? *Be square with yourself. Are you able to remember what you learn?* If not, you owe it to yourself to train your mind so you can profit by what you learn. No education in the world can help you unless you have a memory—a well ordered mind instead of one that plays you tricks.

Take inventory of yourself. You feel that others do not give you credit for your real worth. There must be a reason. Can you think and talk connectedly or are you always saying things that leap out before you give them serious reflection? *Do You Know How To Think? If not, Learn Now!*



**Prof. Henry Dickson**

America's foremost authority on Memory Training, Public Speaking, Self Expression, and Principal of the Dickson Memory School, Auditorium Building, Chicago.

## A Perfect Memory Means More Money

*Yes, it means money to you every day of your life.* My training will mean promotions, ability to see new opportunities, a real capacity to think out big problems.

There never was a big executive or great man in any line who did not have an excellent memory. If he did not have a perfect memory he would be taking orders—not giving them. Size up these big men. Why are they superior to you? Only in this—that they can think—they have perfect memories.



J. T. M., Stafford Springs, Conn., wrote: *"It has always been hard for me to get up before an audience and speak, but since practicing your exercises I feel quite at home."*

P. H. B., Alaska, wrote: *"I have been using the principles taught, during my selling and am surprised at the results, and I often smile when I have pulled off a sale I had not been sure of."*

## STOP

## Forgetting



A business man wrote: *"Since commencing I can endure the grind of a ten-hour business day and come home feeling tiptop—not brain dusty and all in, as heretofore."*

The curator of entomology in a Public Museum wrote: *"The exercises are most excellent and have brought instantaneous results. Within the past week I have been able to memorize a goodly number of scientific names."*



## I Can Train You To Remember Don't Overlook This Opportunity

By modern scientific methods the memory, like any other function, can be trained and developed. All successful men have well developed minds and memories. *I have made thousands of them successful.*

If you want to win in the fearful competition of today *you must train.* The sooner you realize this the sooner you start to advance.

When you start with my wonderful system you will be astonished at your progress—at your ability to think and remember. *You can have a perfect memory.* It will be a revelation to you, and your friends will also notice it. It will increase your value to yourself and to your employer. The man with a perfect memory becomes a dominant personality—a man to reckon with.

## FREE—This Valuable Book "How To Remember"

Simply clip the coupon—and mail it—or drop me a letter or postal *now.* You will receive my booklet by return mail.

## How To Get Free Copy of this Valuable Book—"How to Speak in Public"

De luxe edition, handsomely illustrated, richly bound. Is exactly suited to meet the needs of the man or woman who de-

sires to be a successful public speaker. The price of this 1915 de luxe edition is \$2. I will, however, present a copy absolutely free to every student, who enrolls for my course of memory training within ten days after reading this offer.



**Prof. Henry Dickson**  
Principal  
Dickson School of Memory  
705 Auditorium Bldg., Chicago, Ill.

Send me Free Trial Copy-righted Memory Test. Also Booklet, "How to Remember;" also full particulars how to obtain a free copy of Dickson's "How to Speak in Public."

Mail Coupon Today

NAME.....

Street.....

City..... State.....

Please Mention Popular Mechanics

# BECOME A DRAFTSMAN



Big buildings, machines and structural work are being planned everywhere and high-salaried positions are open for Draftsmen always. Let us prove free that if you become a Draftsman you need never be out of a good paying position.

## \$2400 a Year

If you could see the great possibilities offered Draftsmen I know that you would make up your

mind to make Draftsmanship your life's work. How would you like to step into a position at \$2,400.00 a year or more? How would you like to build a future of independence and prosperity? You can! Let me prove how I take men out of the lowest paying positions and personally train them to become Expert Draftsmen.

## MEN WANTED

Draftsmen are needed now—positions must be filled. This is your opportunity. There is much work to be done—many of my students are making big money on the side long before graduating. Let me prove quick how my students succeed—how Draftsmen can advance to big positions as Chief Draftsmen, Chief Engineer or Superintendent at handsome salaries.

## I SHOW YOU

I give you my personal training by mail in your own home, in spare time—I teach you all you must know about Draftsmanship—I know what big American employers of Draftsmen demand. I give you the benefit of my years of practical experience as Expert Draftsman and Designer. My students are successful because I train them personally until they secure a good paying position. Let me send you free the most complete book ever published on Draftsmanship. No previous experience is needed. I show you everything from the ground up.

**FREE \$1750 DRAFTSMAN'S OUTFIT** Enroll now and I will give you absolutely free

a magnificent set of Draftsman's Drawing Instruments, valued at \$17.50—same as I use. Every Draftsman needs these—they last a lifetime.

**Smallest Easiest Payments**

## SPECIAL TUITION OFFER

To a few more students I offer my personal instruction at such small, easy payments that no matter how small your present salary you can now become a Draftsman. I can give my personal attention to only a few more students and as an inducement for you to enroll at once I make an extra special offer of a free \$25.00 TUITION CREDIT. I am the only Draftsman giving personal instruction on such small payments. Send free coupon now. Now is the time to start—you are now needed.

**Chief Engineer**

Chicago Engineering Works 444 Cass St., Chicago, Ill.



**CHIEF ENGINEER, 444 Cass St., CHICAGO**

Without obligation or cost to me send prepaid your free book, "The Road to Success," and particulars of your limited offer.

Name.....

Address.....

Please Mention Popular Mechanics

Learn to Write

## I Teach by Mail

I CAN make a good penman of you at your home during spare time, no matter where you live or how poorly you now write. My simplified system has shown thousands of others the way to good penmanship during the past twenty years—it can and will do the same for YOU!

Beautifully Illustrated Book  
"How to Become  
a Good Penman"

It contains general information, with testimonials and beautiful specimens of penmanship showing what others have accomplished by the Tamblin System. **FREE!**  
*Your name signally written on a card if you enclose stamp for postage.* WRITE TODAY. Address

F. W. TAMBLIN  
418 Meyer Bldg., Kansas City, Mo., U. S. A.



## LEARN WATCHMAKING

and become independent. Good-paying positions secured. Easy to learn. Send for FREE CATALOG.

ST. LOUIS WATCHMAKING SCHOOL, Dept. 5, ST. LOUIS, MO.

## BE AN EXPERT STENOGRAPHER

Earn \$900 to \$3000 yearly as a Private Secretary or as a Court or Government stenographer. Our System, used by the world's fastest writers and by over 85% of the U. S. Government stenographers, trains you to pass over the \$10 a week period and speedily places you in the big money class. Easier to learn, write and read than any other system. You can learn at home in your spare time. Hundreds of excellent positions now open. We help you get one. Our course is unconditionally guaranteed—results from it are certain. If you want to make good quickly, write for booklet today—it shows how.

MODERN CORRESPONDENCE SCHOOL  
335 INTERNATIONAL LIFE BLDG. ST. LOUIS, MO.

## A GOOD POSITION

with UNCLE SAM is most desirable. Life positions, pleasant surroundings, good pay, steady work, short hours, promotions on merit. Both sexes. No political pull. Thousands of appointments yearly. Most thorough preparation \$5. Returned if not appointed. Full information and questions used by the Civil Service Commission free.

AMERICAN CIVIL SERVICE SCHOOL WASHINGTON, D. C.

## The Best Art School



Correspondence and Resident Instruction in Designing, Illustrating, Cartooning, Chalk-talking and Lettering. Established 1892—oldest school, most thorough, practical and BEST courses obtainable. WE CAN PROVE IT. Send at once for fine illustrated catalog

THE LOCKWOOD ART SCHOOL, KALAMAZOO, MICH., Dept. 16



# Cash in on Your Spare Moments

**Carry Your Electrical Education in Your Pocket**

Sign the coupon at the bottom of this page and start right away to turn your spare minutes into dollars. Hawkins Electrical Guide is a work of Education, Explanation and Encouragement. It is the royal road to a practical knowledge of Electricity. Each of the six volumes is beautifully bound in durable leather and made to slip easily into your pocket. All important points are fully illustrated, adding greatly to the clearness and value of the work. It covers thoroughly the element-

ary principles as well as the most approved practice. It gives complete explanation on Electrical Construction. It is a practical authoritative, comprehensive guide for all desiring a working knowledge of electricity. O. A. Armfield, Mulberry, Fla., writes, "I wish to say that I have been doing Electrical work for fifteen years and have upwards of \$100 worth of electrical books, but I consider the Hawkins Electrical Guides the 'best ever' for the practical electrician." Our files are filled with endorsements of satisfied users. If you or your friends are looking for a practical education in Electricity, the answer is—

## HAWKINS LIBRARY OF ELECTRICITY

**Sent Free for Examination**

**H**ERE is a set of books that no man in the ELECTRICAL FIELD should do without. This is the ELECTRICAL AGE in which we live; ELECTRICITY now controls more trades, directs more men, offers more opportunities than any other power that man has yet discovered. Do you wish to know the underlying principles of Modern Electrical Practice? If so, HAWKINS ELECTRICAL GUIDES will give you the information. In reality they are a school within themselves, containing a complete study course with QUESTIONS, ANSWERS AND ILLUSTRATIONS, written in plain everyday language so that a practical man can understand.

### The How, When and Why of Electricity

Read over the titles shown on the back of each volume, and note the scope of each book. They are handsomely bound in flexible black leather with gold edges and will readily go in the pocket. They are not only the best, but the cheapest works published on Electricity.

Each book is complete in itself and will be supplied \$1.00 per copy, but we believe that the complete set is the best bargain. The books can speak for themselves and a careful examination, page by page, and illustration by illustration, will convince you of their big value. If you will fill out the following coupon giving all the information requested, we will submit the six volumes for examination on conditions named.



**\$1 Per Volume—  
Pocket Size  
Leather  
Bound**

**Theo. Audel Co., 72 5th Ave., New York—Free Examination Offer**

Mar. 15  
Pop. Mech.

Please submit me for examination HAWKINS ELECTRICAL GUIDES (Price \$1 each).  
Ship at once prepaid the 6 numbers; if satisfactory I agree to send you \$1 within seven days and to further mail you \$1 each month until paid.

SIGNATURE .....

OCCUPATION .....

BUSINESS ADDRESS .....

RESIDENCE .....

REFERENCE .....

# DIAMONDS

ON **EASY TERMS**

1926 \$25  
1927 \$50  
1928 \$75  
1929 \$100

**Better Than a Savings Bank!**

Start Right. Start Now. Buy a Diamond. Beats a Savings Bank four to one, besides daily dividends in pleasure while wearing it.

## Big Special Sale!

Greatest Diamond values ever offered in \$25, \$50, \$75 and \$100 sizes. Pure white, perfectly cut, sent on approval, **no money down.**

**FREE CATALOG.** Write for it quick. Make your selection and when the diamond comes, if you like it and want to keep it, pay for it on our Liberal Club Plan—payments so easy, you'll never miss the money. No red tape, no security—just common honesty among men. Postal will do.

Dept. 1547  
**HARRIS-GOAR CO.** Kansas City, Mo.

## Become Your Own

### Master

### Leavitt Science

will show you the way. It accomplishes this result easily and quickly. It gives you courage for despair, strength for fear, direction for aimlessness.

### Stop and Think

Do you realize what this means to you? It means freedom from physical aches and pains, a strong and healthy body, happiness, success in whatever you may undertake.



### Power of Concentration, Self-Control and Self-Confidence

is what you want. The power of influence to attract to you those you desire, those that can help you. It means freedom from servitude and bondage. C. Franklin Leavitt's Wonderful Book, which will show you how to become

"Master of Your Fate" and "Captain of Your Soul," will be sent for twelve two-cent stamps. Send for it today and begin to live.

C. Franklin Leavitt, M. D., Suite 346, 14 W. Washington St., Chicago, Ill.

Enclosed find 24c in stamps, for which please send me your wonderful book on How to Become Your Own Master.

Name .....

Address .....

Please Mention Popular Mechanics

## New York ELECTRICAL School

Gives you a complete training by actual practice. You get the knack of "HOW" together with the theory of "WHY" and the best business methods used in the World of Electrical Activity.

The N. Y. Electrical School is the pioneer and premier school of the "Learn by Doing" method. When you have completed this Course you shall be fully qualified to handle ALL branches of Electrical industry.

The equipment of this School is unequalled and up-to-the-minute. No preparation needed to become a "learner" in this school. You can start to learn on any day of any week throughout the whole year.

Visitors heartily welcomed. Send for catalogue.

44 West 17th St. New York City  
**N. Y. ELECTRICAL SCHOOL**

## Develop a STRONG PERSONALITY



You can be trained to be one of the men who dominate and control the business **PERSONAL POWER** world. You can develop a

that will enable you to dominate others in such a subtle manner that they are not conscious of your control. You have the power—develop it. Theron Q. Dumont, Founder of the Art & Science Institute of Paris, has prepared a most practical course on Personal Magnetism or Personal Power. He found that all prominent men of strong personality had similar habits, and acted according to certain rules and laws. He formulated these into a course of study and training, which explains the subtle, irresistible, fascinating charm which attracts one mind to another.



**SPECIAL OFFER:** Write now for full particulars how to secure this course at very low price.  
ADVANCED THOUGHT PUB. CO., 312 Federal Life Bldg., CHICAGO

## Big Profits IN THE Auto Business

400,000 more cars this year than last. Thousands of new jobs as drivers, repair men, garage managers, etc.

### NATIONAL AUTO SCHOOL

prepares for these jobs. Splendidly equipped workshops. Teaches its students everything about the automobile. For complete information and catalogue address

**NATIONAL AUTO SCHOOL**  
2625 Reading Rd. Cincinnati, Ohio



## STUDY LAW At HOME

University Methods:

Theory and Practice; Our Course most complete, practical, easiest of any by mail. Endorsed by Bench and Bar. LL. B. Degree conferred. Faculty Prominent Attorneys. Free Public Speaking Course. Catalog and Evidence of Results FREE.

**McKinley University, 1554 E. 55th St., Chicago, Ill.**

Guaranteed Preparation for Bar of Any State



## I Will Teach YOU THE AUTOMOBILE BUSINESS OR HOW TO BE AN AVIATOR

in 60 days with my practical correspondence course.

**CAPT. JOHN BERRY, Licensed Pilot 24, National Aviator of America, Dept. 12, ST. LOUIS, MO.**

**EARN \$1200 to \$2000 PER YEAR**

TUNING PIANOS. Easily learned by our thorough, practical course. Taught by experts either at our school or in your own home by mail. Write for information.

**LUNDBERG SCHOOL OF PIANO TUNING**  
Desk P M, 140 N. Dearborn Street, CHICAGO, ILL.

## BE A DETECTIVE

Earn from \$150.00 to \$300.00 per month; travel over the world. Write

**C. T. LUDWIG, 133 Westover Bldg., Kansas City, Mo.**

## MAKE \$50 TO \$100 A WEEK AT THE PANAMA PACIFIC EXPOSITION

Snapping the crowds with a famous **Diamond Post Card Gun** It will pay all your expenses there and back and a big daily profit besides.

Takes photo post cards and buttons, finished on the spot, in less than a minute. Circulars free.

**INTERNATIONAL METAL & FERRO CO., D123, Chicago**







# A Great Technical Library

## In Simple Language

Out of a world-wide experience in teaching the engineering trades and professions by correspondence the International Correspondence Schools have perfected the greatest system of textbooks in existence. More than \$2,000,000 has been expended in their preparation and \$100,000 is spent annually to keep them up to date.

Prompted by many requests for these textbooks without the correspondence instruction the publishers have issued a special edition from which the very elementary subjects and examination questions have been omitted. These volumes are now being offered for sale to the general public in lots of five or more on easy monthly payments.

### Choose the Books You Need

The 119 volumes included in this Library cover nearly every phase of mechanical and electrical work, mining, architecture, advertising, business, commercial law, etc. Being designed for home study, these textbooks are written in the very simplest terms so that men with only an ordinary education can easily understand them. And each volume is indexed and cross-indexed so completely that any desired information can easily be located on a moment's notice. The following is a partial list of the different lines of work covered by this Library:

Civil Engineering	Business
Concrete Engineering	Chemistry
Electrical Engineering	Automobile
Mechanical Engineering	Architecture
Telep. and Teleg. Engineering	Shop Practice

Just indicate on the attached coupon the subject in which you are interested and mail the coupon to us. This will not obligate you in the least but will bring you a complete table of contents of the volumes on this particular subject, together with our plan of easy monthly payments.

**International Textbook Company**

Box 872-L, Scranton, Pa.

### Exclusive Features

They are more profusely illustrated than any other technical books.

They are written in a simpler style and more easily understood terms than any other technical books.

They are used as textbooks by more than 200 of the leading colleges and universities.

They are kept thoroughly revised and up to date

**I. T. Co.**  
Box 872-L,  
Scranton, Pa.

Without obligating me in any way you may send me catalog and description of volumes on the subjects before which I have placed an X.

<input type="checkbox"/> Civil Engineering	<input type="checkbox"/> Business
<input type="checkbox"/> Concrete Engineering	<input type="checkbox"/> Chemistry
<input type="checkbox"/> Electrical Engineering	<input type="checkbox"/> Automobile
<input type="checkbox"/> Mechanical Engineering	<input type="checkbox"/> Architecture
<input type="checkbox"/> Telep. & Teleg. Engineering	<input type="checkbox"/> Shop Practice

Name \_\_\_\_\_

St. and No. \_\_\_\_\_

City \_\_\_\_\_ State \_\_\_\_\_

Please Mention Popular Mechanics

# Become An Expert Private Secretary, Correspondent, Bookkeeper or Advertising Man

## SPECIAL LIMITED OFFER

Fill in the coupon below and get particulars at once. This offer may never appear again. Write today and find out all about our remarkable

This is one of the Remington models we place in the hands of each student

# FREE

## TUITION HOME STUDY SCHOLARSHIPS

If you are willing to pay a nominal fee to cover text-books, lessons, pamphlets, printed matter, supplies, etc., needed in the course, we will make no charge for tuition and will GUARANTEE TO TRAIN YOU UNTIL QUALIFIED to hold any of the positions named in the coupon. Everybody should have a business training. Everybody today should know how to operate a typewriter. All our graduates are proficient typists. We send you a high-grade, fully guaranteed typewriter as soon as you are enrolled. Each student granted one of these FREE TUITION SCHOLARSHIPS is taught everything there is to know about the expert, all-finger (touch) method of typewriter operation.



Each machine warranted perfect and fully guaranteed. Dust cover and supplies included

We Train You By Mail

And Supply Choice of Fully Guaranteed Standard Typewriters

The Remington shown in this advertisement is only one of the several models supplied our students. If you act promptly we can send you practically any machine you wish—Remington, Oliver, Monarch, Underwood, L. C. Smith. Remember, there is no charge for tuition no matter how long a time you may require to complete the course. A few cents a day will pay for your text books and supplies. If you cannot pay cash in full we will trust you; we will allow you to make easy monthly payments. Can you ever say now that you never had an opportunity to get a good business training and be independent? If you are honest, if you are ambitious, if you are able to lay aside a

few pennies a day to meet a small monthly payment for books and materials needed, then MAIL THE COUPON RIGHT AWAY. We will send full and complete information. You can be started upon the training of your choice without further delay. Our handsome illustrated catalog is free and will give you full information regarding the position for which you wish to qualify. In a few short months you should be ready for a good salary. We assist graduates to desirable positions. The use of our employment department will be free to you. Positions are open everywhere—many paying \$25 to \$50 a week. The demand for well-trained employees always exceeds the supply. The competent always have employment and good pay.

### FREE TUITION COUPON

1033

Chicago Univ. of C.

I wish to qualify for position I have marked with an X, also become an expert typist. Please send particulars of your offer to give me tuition free and accept small payments for texts, typewriter supplies, etc. (Write name of machine you prefer in margin of coupon.)

- Business Correspondent and Office Manager
- Stenographer and Private Secretary
- Bookkeeper and Office Manager
- Stenographer and Bookkeeper
- Advertising Writer, Manager, Solicitor

Name .....

Address .....

## Act Quickly—Send the Coupon NOW

Don't wait until to-morrow, next week, or next month. Send the coupon right now. Investigate this startling scholarship offer. Get that training, that position, that salary you so long have wanted. This is your opportunity—grasp it. If you want one of these scholarships you must hurry. Only a limited number will be given out. When these scholarships are gone there will be no more. We are making this great offer to advertise our courses and learn which typewriter is in greatest demand. No matter where you live we can train you thoroughly and quickly by mail. We have trained hundreds. We can train you.

**CHICAGO UNIVERSITY OF COMMERCE**  
Dept. 1033, 800 North Clark St., Chicago, Illinois

# Make Good or Get Out



Prof.  
F. W. Foote,  
Psychologist

"Making Good" is not so much a question of Brains as it is "How do you use the Brains which you have?" Many an individual has to "Get out" because he did not know how to use his Brains. He possibly knew his job better than the other man, but he could not get his Brains to obey his Will—and the mighty power of

## CONCENTRATION

which always means victory and success—he could not use.

NOW I WANT TO TEACH YOU HOW TO

## TRAIN YOUR BRAIN POWER

Have you ever thought of Training your brain? Do you know that your brain control is governed by absolute law just as surely as control of electricity is? Let electricity run wild and you have no concentrated power. Learn its laws and bring it into subjection and you have concentrated light and concentrated power. So is it with your brain; let it run wild and it will cause you trouble and ultimate failure. Learn the laws which govern its working and concentrate the power and you will reap your desired success. Nothing can stop you, no matter how high you have set your goal. Know that you possess the brain power. Let me teach you how to use the laws through the

## Science of Psychology WHICH IS Success Science

Psychology is the systematic study of mental laws and is now recognized as one of the greatest sciences of our day. Everybody who desires to succeed must know the fundamental laws, or else work in the Dark and let the Brain play continual tricks, which means loss of valuable mental power and Energy. You cannot afford to drag out a mere existence and let others leave you behind. You may possess even a GREATER PERSONALITY than the other man—but you must develop it. Here is your opportunity. It is the only Method by which scientific Mental Training can be accomplished, just as it is the only Scientific **Trained Will Power** method that will give you

A knowledge of this science will give you power of Self-Control; You will have Poise; You will have Concentration and Personal Power. You will have every mental faculty alive and responsive, and your own PERSONALITY will be expressed in all your actions. Give this scientific system of mental training a few minutes each day and the sense of MASTERY will be yours in the consciousness of knowing you can

## MASTER YOUR DESTINY

I have a personal and individual method of Teaching and Training every student. My scientific training in the great Universities of the world is at your disposal. It will be my pleasure to personally train you to increase your Mental Powers. My knowledge will enable me to know which is the law for you to use and master. You cannot afford to ignore the opportunity which this course of study offers. It is based on the fact of law. YOUR SUCCESS is POSITIVE and ASSURED. You will send for my free book now, and please remember that you must act at once if you wish to avail yourself of these two Vocational Courses without charge. Your registration must be received within ten days, so write me at once, this will mean greater Power and more money for you.



**FREE!**

Two Complete Courses

1. The Psychology of Salesmanship
2. The Psychology of Public Speaking

**FREE!**



**OFFER LIMITED!**

You will want to act at once; so just your name and address on the coupon below will bring you particulars of my offer of Two Complete Courses in Psychology Free. These courses mean dollars of investment and deal with subjects you need to have efficient knowledge on—in fact Psychology has entered every department of commercial and professional life, and you must not be ignorant, especially when I send you the Courses Free of Charge. This offer is limited and may be withdrawn any day without notice. You will write me at once.

**PROF. FREDERICK W. FOOTE** 8-15  
Principal Chicago Institute of Menti-Culture  
(A School of Applied Psychology)  
30 No. Michigan Blvd., Chicago, Ill.

Send me Free Book "Masters of Destiny" and all particulars of your Mental Training Course.

Name .....

Address .....



# Come to Detroit the automobile center and

# LEARN THE AUTOMOBILE BUSINESS

## Big Opportunities Everywhere for Detroit Trained Automobile Men

Interesting, pleasant, and money making business. Ambitious men needed to start garage and repair shops in down town and residence districts everywhere. Learn now, be ready for the spring automobile boom—when opportunities are greatest. Chauffeurs, garage and repair men, testers, etc., have more than they can do. Plenty of room for you.

## Earn \$75.00 to \$300.00 Per Month

Get into biggest and best business of the 20th century. The business of big profit and sure progress. We teach you to handle any auto—our equipment is complete. Students actually have experience of building new cars from start to finish—regular factory training in block testing, road testing, etc.—all leading types of starting, lighting and ignition systems in operation. You learn how to read motors, adjust carburetors, valves, bearings, etc. New 6 cyl. Lozier Touring Car used for road instruction. Just purchased—New 8 cyl. King Chassis. Latest thing out. Used solely for students' instruction. Part of our regular equipment.

### 10,000 Square Feet of Floor Space Just Added

The popularity of our school has demanded extensive additions to our equipment. Dormitory space for nearly 75 students on the premises. Large, new, roomy, light, airy lecture and instruction room, study room in connection. Brand new lounge room. Ambitious, cheerful companions.

**Detroit is the Place to Learn** Detroit Electric Service Department. Impossible to get these advantages elsewhere.

**Detroit is the Automobile Center** You make faster progress here, and get practical instruction. Come to Detroit and learn the business right. Our students are successful. W. C. Garden, Tennessee, is Chauffeur, \$25.00 per week and expenses. E. Livingston is head of The Government Garage at Toronto. Dozens of others are holding good positions or running businesses of their own. Remember, ours is the Old Reliable School, in the heart of the Automobile Industry. Anyone can learn by our method. Practical from the ground up. Write us for full particulars. Ask for Copy of "Auto School News." It's free. Or better, jump on the train and come to Detroit. Take Woodward Ave. Car from the Depot and get off at Selden Ave., and our building is right there. Learn the automobile business in Detroit and learn it right.

Michigan State Auto School, Department P3, 11-17 Selden Ave., Detroit, Michigan

### Our Guarantee

We guarantee to qualify you for a position as chauffeur, repair man, tester, salesman or demonstrator in a short time, or we will refund your money.

**And don't forget, we furnish positions, too**

On account of being in the auto center, we can furnish positions that cannot be obtained elsewhere

## "Good Job" Coupon

From.....

To.....

**Send the Coupon**

### It's the First Step Toward a \$3,000 Job

Absolutely no obligations. Put your name and address in the "Good Job" coupon and send it to us at once. We will send you absolutely free and prepaid full particulars of a great special offer that we are now making in order to induce men to start the study of Meter Engineering. There are thousands of positions open now. During the coming year over 500,000 new meters are going to be installed. Big money is being paid. Send the coupon now.

## Be a Meter Engineer

Get into the \$1,000 class. Be the man who is looked up to by everyone in the plant. The profession of Meter Engineering is in its infancy. Few men have the training that qualifies them to hold the big jobs. But you can get it—right in your own home—during your spare time.

**More Men Needed** Over 500,000 new meters are going to be installed this year. A vast army of men will be needed. Large salaries are offered. You can get one of the big jobs.

Fill out the "Good Job" Coupon or a letter or a post card and send it to us at once. No obligations. It's just a request for the big new book on Meter Engineering. Act today. Opportunity waits for no man. Send the coupon now.

Ft. Wayne Correspondence School      Dept. 1193      Ft. Wayne, Indiana



## Wanted—Railway Mail Clerks

there is \$900.00 to \$1,800.00 a year in it for you

**Examinations are Held Frequently**

Rapid advancement to higher Government Positions. "No lay-offs" because of STRIKES, WARS, FINANCIAL FLURRIES or the WHIMS OF SOME PETTY BOSS. THIS POSITION IS YOURS FOR LIFE.

Country residents and city residents stand the same chance for immediate appointment. Common-sense education sufficient. Political influence NOT REQUIRED.

Write immediately for schedule showing the places and dates of ALL SPRING examinations. Don't delay. Every day you lose means the loss of just so much coaching before the rapidly approaching examinations.

FRANKLIN INSTITUTE, Dept. S-106, Rochester, N. Y.



Hundreds of Railway Mail Clerks Appointed Yearly

FRANKLIN INSTITUTE (The Pathway to Plenty), Dept. S-106, ROCHESTER, N. Y.

This coupon, filled out as directed, entitles the sender to free specimen questions; a free copy of our book, "Government Positions and How to Obtain Them," a list of Government positions now obtainable, and to consideration for Free Coaching for the examination here checked.

COUPON	
.. Railway Mail Clerk.. (\$900 to \$1800)	.. Customs Positions.. (\$900 to \$1500)
.. Bookkeeper..... (\$900 to \$1800)	.. Stenographer..... (\$900 to \$1500)
.. Postoffice Clerk... (\$900 to \$1500)	.. Internal Revenue.. (\$700 to \$1800)
.. Postoffice Carrier.. (\$900 to \$1500)	.. Clerk in the Departments
.. Rural Mail Carrier.. (\$500 to \$1100)	at Washington..... (\$900 to \$1500)
.. Auto Chauffeur.....	.. Canadian Gov't Positions.....

Name..... Address..... S-106

Use this before you lose it. Write plainly.

## Prosperity and Power For YOU

**LAW**LEARN  
AT HOMEBecome a Law-  
yer—success  
awaits you—power,  
dignity and inde-  
pendence—\$5,000 to

\$10,000 yearly. Hundreds of big salary positions now open with big firms. You can master Law—our simplified method trains you at home in spare time by mail. Course written in plain language by greatest professors. Endorsed by legal experts. Our method like that used in big Universities. Degree of LL. B. conferred. Course prepares you to pass all subjects required in bar examinations—we guarantee to coach you free until successful. Complete Law Library Furnished if you enroll now.

**COMPLETE COURSE** Written by Dr.  
**IN PUBLIC SPEAKING FREE** Frederick B.

Robinson, Pro-  
fessor Public Speaking in the College of the City of New York, Editor  
Public Speaking Review, Public Lecturer for New York Board of  
Education, etc. Greatest course written—greatest offer out—absolutely  
FREE to you. Write quick for facts. Everything sent Free.

LaSalle Extension University, Dept. F-471, Chicago, Ill.

Make Money  
in the

**MAIL ORDER BUSINESS**

I'll teach you personally by mail—give you the secrets that have made me successful—tell you the things that took me 20 years and cost thousands to learn. Think of the fortunes made in the mail order business.

**MAKE \$5,000 THIS YEAR**

It's great to open a big store of mail each morning and sort out the checks and money orders. Start with small sum. Hold your job—work evenings at the start. No risk. No bookkeeping. You get cash with order. My course tells all—shows all. Invest today. Address  
H.S. Robinson, Pres. Robinson-Buller Co., 11 Woodruff Ave., Toledo, Oh 16

**CIVIL SERVICE**

positions are in all parts of the country. Good pay steady work, life positions, congenial surroundings, promotions on merit, short hours, annual vacation and sick leave with pay. Many thousands appointed yearly. Both sexes. No political pull. Nearly 300,000 classified positions. Common school education sufficient. Full information and questions used by the Civil Service Commission free.

COLUMBIAN CORRESP. COLLEGE, Washington, D. C.

**MEN WANTED**

Prepare as Firemen, Brakemen, Electric Motormen, and colored Train Porters. First Class Standard Roads. Hundreds put to work—\$65 to \$150 a month without any experience. 500 more wanted. Uniforms and passes arranged for when necessary. Enclose stamp for Application Blank. Name position you want.

I. RAILWAY C. I., Dept. 35, Indianapolis, Ind.

**Be a Traveling Man**

Hundreds of good positions now open. No experience required to get one of them. Write today for list of openings offering opportunities to earn Big Money selling goods while you learn and testimonials from hundreds of our students who are earning \$100 to \$500 a month. Address nearest office. Dept. 507

NATIONAL SALESMEN'S TRAINING ASSOCIATION  
Chicago, New York, Kansas City, San Francisco

**LEARN PIANO TUNING AT HOME**

My Patented Tune-a-Phone method makes it easy. Eliminates guess work. Anyone can learn. A. D. Pope, Texas, made \$92 first ten days. Course guaranteed as represented. Diploma granted. Write for free booklet, graduate's records, etc.

Hiles Bryant School of Piano Tuning, 443 East 81st, Battle Creek, Michigan

**DRAWING**

Cartooning, Cartoon, Comic, Commercial, Fashion, Newspaper and Magazine Illustrating taught by mail. Illustrated book 5c in stamps. THE BOSTON SCHOOL OF DRAWING, 755M Boylston St. BOSTON, MASS.

**LEARN WATCHMAKING AND ENGRAVING**

Earn while learning. Most practical watch school. Individual instructions. Graduates in great demand. Book free. Chicago School of Watchmaking, 63 E. Van Buren St., Chicago

**Learn Electricity!**

Earn \$150<sup>00</sup>  
TO  
\$300<sup>00</sup>  
a Month

Electricity is today the great motive power of the world. Its use has extended to every phase of life and industry.

Thos. A. Edison says that the field of electricity is in its infancy—that electrical workers of the future will discover uses for this great force now undreamed of.

Right now there are not enough electrical engineers to fill the big paying positions open. Every month our Free Employment Bureau has calls for Electrical Engineers greater than we can fill. Therefore, we are making a very special offer to students.

Write today! Send the free coupon for our catalog and free information.

**We Teach You in a Short Time — at Small Expense**

In order to supply more electrical engineers we are charging a small tuition fee. Your tools and equipment of all kinds are furnished FREE by the School. You may have easy payments if desired. Our course of instruction is clear, simple and thorough. Our Graduates demand handsome salaries. Don't pass up this opportunity.

**FREE TOOLS**

We will furnish all the material and tools you use in taking our course — ABSOLUTELY FREE. All we charge is a very small amount for tuition. Many of our students earn their expenses while taking the course.

**Men Wanted**  
for These Trades  
Electricity Plumbing  
Bricklaying  
Moving Picture Operating  
Mechanical Drawing

We also teach the trades mentioned above. There are unlimited possibilities in any one of these trades. When you have completed our course you will be in a position to demand from \$5.00 to \$8.00 a day right at the start. Or go in business for yourself and make from \$3,000 to \$7,500 a year.

**Send the FREE COUPON for Catalog and Particulars**

No obligations on you at all. Just fill out the coupon and mail it today. Take this step toward success. Let us tell you how you can master electricity or any other profitable trade in a short time—make a bigger success than you ever dreamed of making. Fill out the coupon and mail it at once.

L. L. COOKE, Director

Coyne National

Trade Schools

39-51 E. Illinois St.

Dept. 1193

Chicago, Ill.

**FREE COUPON**

L. L. COOKE,  
Director

Coyne National

Trade Schools

39-51 E. Illinois St.

Dept. 1193, CHICAGO, ILL.

GENTLEMEN: Without any obligations on me whatsoever, please send me your school catalog and full particulars of this offer to men—ALL FREE

NAME.....

ADDRESS.....

Please Mention Popular Mechanics

# The Library of Valuable Knowledge

25 Splendid Volumes

VOL. CONTENTS

1. The Story of the Stars
2. The Story of the Solar System
3. The Story of Eclipses
4. The Story of the Earth
5. The Story of the Atmosphere
6. The Story of Germ Life
7. The Story of Plants
8. The Story of Sea Life
9. The Story of Animal Life
10. The Story of Man
11. The Story of a Piece of Coal
12. The Story of a Grain of Wheat
13. The Story of the Cotton Plant
14. The Story of Primitive Man
15. The Story of Eastern Civilization
16. The Story of Western Civilization
17. The Story of the Alphabet
18. The Story of Discovery
19. The Story of Architecture
20. The Story of Music
21. The Story of Books
22. The Story of Photography
23. The Story of Electricity
24. The Story of Rapid Transit
25. The Story of the Mind

## Facts Better Than Fiction

In these 25 truthful stories, you will find the very essence and substance of human knowledge, sifted, sorted, arranged, and told in the most charming, entertaining, and instructive manner by the world's eminent scientists and scholars. These books are as interesting as the best fiction. You cannot find a more lasting and profitable investment.

## The Story of the Stars

is told just as though Professor Chambers should go out with you some starlight night, and, looking into the limitless space, tell you the great truths he has learned; reveal to you the wonders of the heavens, the magnitude, the distance, the motion of the stars, so that ever after you will enjoy the scene a hundredfold. Each volume is equally interesting.

## Shipped on Approval

Here is a set of books that will sell itself. Send no money, just fill out and mail coupon. Pay \$1 within 5 days after books are received, and only \$2 monthly for 12 months. This is our Annual Clearance Sale and a great bargain. Satisfaction guaranteed. Books returnable if not satisfactory.

### EXAMINATION COUPON

THE RIVERSIDE PUBLISHING CO.  
Marquette Building, Chicago

Send me, on approval, the Library of Valuable Knowledge, 25 splendid volumes, Half Leather binding. If satisfactory will send you \$1 in 5 days after receipt of books, and \$2 monthly thereafter for 12 months. If not satisfactory will return as soon as I receive shipping instructions. Pop. Mech. 3-15

Name.....

Address.....

Enclose letter head, business card or give references

## The Most Important Boys' Book in Years THE BOY ELECTRICIAN



Practical Plans for Electrical Toys and Apparatus, with an Explanation of the Principles of Every-Day Electricity.

By ALFRED P. MORGAN

With full-page illustrations, and 324 working drawings and diagrams by the Author, 8vo, Cloth.

Price, net, \$2.00 Postpaid, \$2.25

This is the most complete, the best illustrated, the most correct and the most entertaining work on the subject of electricity, its uses, and the economical making of electrical appliances that has ever been produced. It also tells very clearly how electrical matters are handled on a large scale.

At all bookstores. Send for Free Catalog.

LOTHROP, LEE & SHEPARD CO., BOSTON

## Practical Electrical Education

Our practical course in Electrical Science and Engineering trains you to get and keep the big-pay jobs. Enter at any time, no matter what your education. Advance as fast as you can master the work. Course combines theory with actual practice in all branches of Electrical Science. Individual instruction. Only practical training school of its kind in U. S. Endorsed by leading electrical employers past 18 years. Our trained students always in demand and well paid. WRITE FOR FREE ILLUSTRATED CATALOG. Spring Term Now Open.

SCHOOL OF ENGINEERING OF MILWAUKEE, 188 Third Bldg., MILWAUKEE, WIS.



## Ideas Wanted

**For Photoplays At \$10 to \$500 Each**  
Your "happy thoughts" are as good as anybody's and may bring you \$10 to \$500 each, according to merit, for a few hours work in spare time at home. Special education not necessary. I show you how and

**I Guarantee You \$10 For Your First Photoplay**

This means you. Tremendous demand caused by 30,000 movie theatres changing program daily accounts for this unusual offer. It costs nothing to investigate. Send post card or letter at once, while this offer lasts, for free booklet "How to Write Photoplays." Elbert Moore, Box 772PH, Chicago.

## COPY THIS SKETCH

and let me see what you can do with it. You can earn \$20.00 to \$125.00 or more per week, as illustrator or cartoonist. My practical system of personal individual lessons by mail will develop your talent. Fifteen years successful work for newspapers and magazines qualifies me to teach you. Send me your sketch of President Wilson with 6c in stamps and I will send you a test lesson plate, also collection of drawings showing possibilities for you.

The Landon School of Illustrating and Cartooning  
1438 Schofield Building, CLEVELAND, O.



## LANGUAGES

Quickly Learned AT HOME by the Original Phonographic Method

German—French—English—Italian—Spanish

or any other language learned quickly and easily by the Cortina Method at home with Disk Cortina-Records. Write for free booklet today; easy payment plan.

CORTINA ACADEMY OF LANGUAGES

1285 Heena Bldg., 1000 Broadway,  
Corner 48th Street, New York

CORTINA-PHONE

## Make Photo-Pillow Tops, Post Cards

and the Wonderful New

## Photo-Wood-Novelties

yourself by easy process, learned quickly by anyone, no talent required. Big profits. Low cost. Write quick.

VALLANCE, 115 Lincolnway, ELKHART, IND.



## LEARN JEWELERS' ENGRAVING

A high skilled and easily learned trade, taught thoroughly by mail. We will teach the beginner better engraving than he can gain in years of rigid apprenticeship. We will also improve the skill of any engraver. Send for our catalog. The Engraving School, 112 Page Bldg., Michigan Ave., Chicago, Ill.



## Every Boy His Own Toymaker

Greatest boys' book ever written. Tells how to make a Steam Engine, Telephone, Magic Lantern, Boats, Kites, balloons, electrical and mechanical toys, traps, fishing tackle, 200 illustrations; also catalog of 150 puzzles, Keller's Magic Ace Trick Card and "DOUBLE THROAT" warbler and bird call all for only 10c. WESTERN PUZZLE CO., ST. PAUL, MINN.

Please Mention Popular Mechanics

Copyrighted material

"I tell my customers that J-M Responsibility goes with J-M Roofing long after I'm gone"

(Signed) Charles H. Wheelock  
Battle Creek, Mich.

"J-M Service," says this J-M dealer, "makes J-M Roofs practically good as new when other roofs are gone. I have been putting them on steadily for years and they are all still good."

## Your Roof is our Responsibility

—because a J-M Roof, when registered with us, is permanently in our care—backed up by over half a century of recognized business integrity.

No matter what kind of roof—factory, house, barn or shed—J-M Responsibility stands under it to the last. We won't let you be dissatisfied with J-M Roofing. It *must* be right.

J-M Responsibility means a way of doing business—stronger than the guarantee of materials we give you—better than any "scrap of paper" ever signed.

J-M Roofing on your roof makes it our roof, too. We see to it that it makes good to you—that its service to you serves our reputation.

J-M Asbestos Roofings are examined by Underwriters' Laboratories (under the direction of the National Board of Fire Underwriters.)

J-M Roofing Registration is a new and additional feature of J-M enterprise that gives J-M Roofing buyers a positive guarantee of roofing service.

We want every buyer of J-M Roofing to register his roof with us. Then we can see that you get J-M roofing service rendered from your roof as thousands of other J-M roof owners are getting it from their roofs.

Why worry about how your roof will last when you can leave that to

# J-M ROOFING

## Responsibility

Write us About YOUR Roof

Akron	Buffalo	H. W. JOHNS-MANVILLE CO.				Portland, Ore.	Seattle	
Albany	Chicago					Rockchester	Syracuse	
Atlanta	Cincinnati	Dayton	Galveston	Kansas City	Milwaukee	New York	St. Louis	TeleGo
Baltimore	Cleveland	Denver	Houghton	Los Angeles	Minneapolis	Omaha	St. Paul	Washington
Birmingham	Columbus	Detroit	Houston	Louisville	Newark, N. J.	Philadelphia	Salt Lake City	Wilkes-Barre
Boston	Dallas	Duluth	Indianapolis	Memphis	New Orleans	Pittsburg	San Francisco	Youngstown
THE CANADIAN H. W. JOHNS-MANVILLE CO., LTD., Toronto, Winnipeg, Montreal, Vancouver								

Please Mention Popular Mechanics

Copyrighted material



## Will the Boss Send for YOU

### When that Better Job is Open?

Will he offer *YOU* the job that means better pay in the kind of work you'd *rather do*?

To every earnest, ambitious man the opportunity for advancement is *sure* to come.

Are you **READY** for the better job and the bigger responsibilities that go with it? Could you **HOLD** the new job with credit after you **GOT** it? Do you **KNOW** enough?

For more than 23 years the International Correspondence Schools have been training men to *get* and *hold* better jobs.

Thousands of men of all ages and occupations have profited by I. C. S. courses in spare hour study. Without loss of time or wages and at small expense, they have obtained the *special training* that has enabled them to make good in the job that was worth while.

*Why not let the I. C. S. help you, too? You can succeed. Mark and mail the coupon. Do it to-day.*

### INTERNATIONAL CORRESPONDENCE SCHOOLS

Box 872-Y, SCRANTON, PA.

Please explain, without further obligation on my part, how I can qualify for a larger salary and advancement to the position, trade, or profession before which I have marked X.

Electrical Engineering  
Electric Lighting  
Electric Railways  
Electrician  
Electric Car Running  
Dynamo Foreman  
Wireman  
Mining Engineer  
Tel. and Tel. Engineer  
Surveyor  
Civil Engineer  
Automobile Running  
Agriculture

Mechanical Engineer  
Mechanical Draftsman  
R. R. Construction  
Concrete Construction  
Architect  
Contracting & Build'g  
Architect'al Draftsman  
Plumbing and Heating  
Chemist  
Bookkeeper  
Advertising Man  
Civil Service Exams.  
Salesmanship

Name \_\_\_\_\_

St. and No. \_\_\_\_\_

City \_\_\_\_\_

State \_\_\_\_\_

Present Occupation \_\_\_\_\_

## 3000 PRICELESS RECIPES

Hundreds of Profitable Trade Secrets  
Money-Making Wrinkles About Every Trade and Manufacture  
Valuable Formulae for Many  
Processes Hitherto Jealously Withheld

Establish yourself in business. Become independent. Whether you are a man, woman, boy or girl, you may secure a **Constant Income** and a **Respectable Business**, without hard work or worry. Make at your own home in spare time some of the hundreds of articles which find ready sale everywhere, the manufacture of which is clearly described in this valuable book. A single recipe properly employed may be the foundation of a fortune. Pear's Soap, Beecham's Pills, Halloway's Ointment, hundreds of similar things, from which huge incomes are derived, may be equalled or even surpassed by some of the articles described among the **3000 Priceless Recipes**. This valuable work of 368 pages is the result of the life-work of the famous Scientist, Dr. N. T. Oliver, who has selected and published only the best of the many formulae submitted to him, having thoroughly tested every recipe, many of which cost large sums to acquire. Not a cookery book. It is a book of **RECIPES**, of incalculable value to Farmers, Housekeepers, Mechanics, Manufacturers, Chemists, Confectioners, Metal Workers, to Everybody. Write at once for this valuable book. Sent by post to any address for only 35 cents.

Nearly 400 pages **Only 35 Cents**



Johnston Smith & Co., Dept. 2, 711 S. Dearborn St., Chicago



\$2.00 and You Get This  
= Superb Cornet

WURLITZER  
80 years of instrument making

Free Carrying Case with this Superb Triple Silver Plated Lyric cornet, genuine leather. Write today.

Send your name and address and get our 250-page Band Catalog. Buy direct from the manufacturer. Rock-bottom prices on all kinds of instruments—easy payments. Generous allowance for old instruments. We supply the U. S. Gov't. Write to-day.

The Rudolph Wurlitzer Co. Dept. 1193 Cincinnati, Ohio Chicago, Illinois

## 3 1/3 c a Day

now buys a dazzling Lachnite Gem. Their brilliance is eternal—they stand fire and acid tests and cut glass like diamonds. Cost but one-third as much. Set in solid gold. The newest design. Sold on Free Trial. See our new jewelry book.

Write for Big Jewelry Book Your name and address is enough. No obligations whatever. Write today—now.

HAROLD LACHMAN COMPANY  
12 N. Michigan Avenue, Dept. 1193, Chicago, Ill.



### BOY ELECTRICIAN

with 75 illustrations for making Batteries, Dynamos, Motors, Telegraph Apparatus, Telephone, Lights, Bells, Alarms, Coils, "Wireless" Current Reverser, Electric Engine, etc. By Electrical Experts, so that anyone can understand it. With Cat. **All 10c Postpaid.** NATIONAL CO., Dept. 24, 3422 Lyndale St., CHICAGO

### JUST OUT Mechanical World Pocket Diary and Year Book for 1915

Brimsful of valuable data, notes, rules, tables you need every day. 440 pages, cloth bound—pocket size. Price 50c postpaid  
THE NORMAN REMINGTON COMPANY  
304 North Charles Street BALTIMORE, MD.



### ARIDE a RANGER

bicycle and know you have the best. Buy a machine you can prove before accepting.

DELIVERED FREE ON APPROVAL and 30 days' trial. No expense to you if you do not wish to keep it. **LOW FACTORY COST**, great improvements and values never before equalled in our 1915 models.

WRITE TODAY for our big catalog showing our complete line of 1915 bicycles, TIRES, sundries and parts, and learn the wonderful new offers and terms we will give you. Auto and Motorcycle Supplies at factory to user prices. Do not buy until you know what we can do for you.

MEAD CYCLE CO. DEPT. D-108, CHICAGO

Please Mention Popular Mechanics



## What the Navy Has Done for Others It Can Do for You

**T**HE NAVY can help **you** win success as it has helped thousands of others. Many a man in civil life owes his success to the training he received in the Navy. The opportunities it offers are steadily broadening. Each year has brought increased advantages to the enlisted men. The last naval legislation authorized the appointment each year of fifteen enlisted men to the Naval Academy under competitive examination.

¶ Another door to the commissioned ranks has been opened to enlisted men by restricting appointment to the pay corps to candidates from the enlisted personnel.

¶ These are unusual opportunities and call for exceptional young men. But opportunity awaits **every** young man who strives to win. The chance to learn one of the many trades used on board ship is open to all who are competent to learn. Advancement in rating comes when it is earned, and carries with it increased pay. And remember, that in the navy your pay is nearly all clear. The advantages of travel and of acquiring a liberal education are unequalled.

If you are an American citizen of good health and character, it will pay you to investigate the Navy's opportunities. Send for the pamphlets, which will tell you all you want to know about the sailor's life in the U. S. Navy.

ADDRESS BOX 69

## BUREAU OF NAVIGATION

NAVY DEPARTMENT

WASHINGTON, D. C.



## “That coupon gave me my start”

“It’s only a little while ago that I was just where you are now. My work was unpleasant; my pay was small. I had my mother to take care of, and it was tough sledging trying to make ends meet. I hadn’t had much schooling. I didn’t *know enough* to fill any better job than the one I had.

“One day I saw an advertisement of the *American School*. It told how other men got better positions and bigger salaries by taking their courses. I didn’t see how a correspondence school could benefit me, but as long as it didn’t *cost* anything to mark the coupon I thought it was worth investigating at least. I marked the coupon and sent it in on the next mail.

“That was two years ago, and *now I’m drawing more money every week than I used to get in a month.*”

If you want a *better job*, if you want more *congenial work*, if you want a salary that *will put you in the class where you belong*—

**SIGN AND MAIL THE COUPON NOW**

# American School

of Correspondence, Chicago, U.S.A.

### Your Opportunity Coupon

Mark the position you want and mail the coupon now

- |                                |                            |
|--------------------------------|----------------------------|
| .... Electrical Engineer       | .... Lawyer                |
| .... Elec. Light & Power Supt. | .... Bookkeeper            |
| .... Electrical Wireman        | .... Scenographer          |
| .... Telephone Expert          | .... Private Secretary     |
| .... Architect                 | .... Accountant            |
| .... Building Contractor       | .... Cost Accountant       |
| .... Architectural Draftsman   | .... Cert’f’d Public Acc’t |
| .... Structural Draftsman      | .... Auditor               |
| .... Structural Engineer       | .... Business Manager      |
| .... Concrete Engineer         | .... Fire Ins. Inspector   |
| .... Civil Engineer            | .... Fire Ins. Adjuster    |
| .... Surveyor                  | .... Fire Ins. Expert      |
| .... Mechanical Engineer       | .... Moving Picture Op’r   |
| .... Mechanical Draftsman      | .... Sanitary Engineer     |
| .... Steam Engineer            | .... Irrigation Engineer   |
| .... Municipal Engineer        | .... Textile Boss          |
| .... Gas Engine Engineer       | .... College Preparatory   |
| .... Gas Tractor Engineer      | .... Auto. Mechanic        |

NAME .....

ADDRESS .....

Pop. Mech. 3-15

*This school has no connection with any other school using the name “American”*

Please Mention Popular Mechanics

Miss Alice Eccles, 775 - 35th St., Oakland, Calif.  
Inventor: - Frank N. Rogers, 876 - 35th St., Oakland, Calif.

# Popular Mechanics Magazine

REGISTERED IN U. S. PATENT OFFICE

WRITTEN SO YOU CAN UNDERSTAND IT

Vol. 23

8738

MARCH, 1915

No. 3

## Anchor Projectile for Breeches-Buoy Line

ONE of the latest of inventions for saving life at sea is a breeches-buoy apparatus designed for use when a ship has been wrecked near shore. The line is fired from a mortar of the usual type, carried on board the ship, and the new feature is in the line-carrying projectile, which is so made that it anchors itself automatically. This projectile consists of a grappling hook, or anchor, fixed to a solid-steel cylinder, the weight of the cylinder being such as to cause the prongs to wedge themselves securely among the rocks on shore. The line attached to the projectile is a steel rope having a tensile strength of 5,000 pounds.

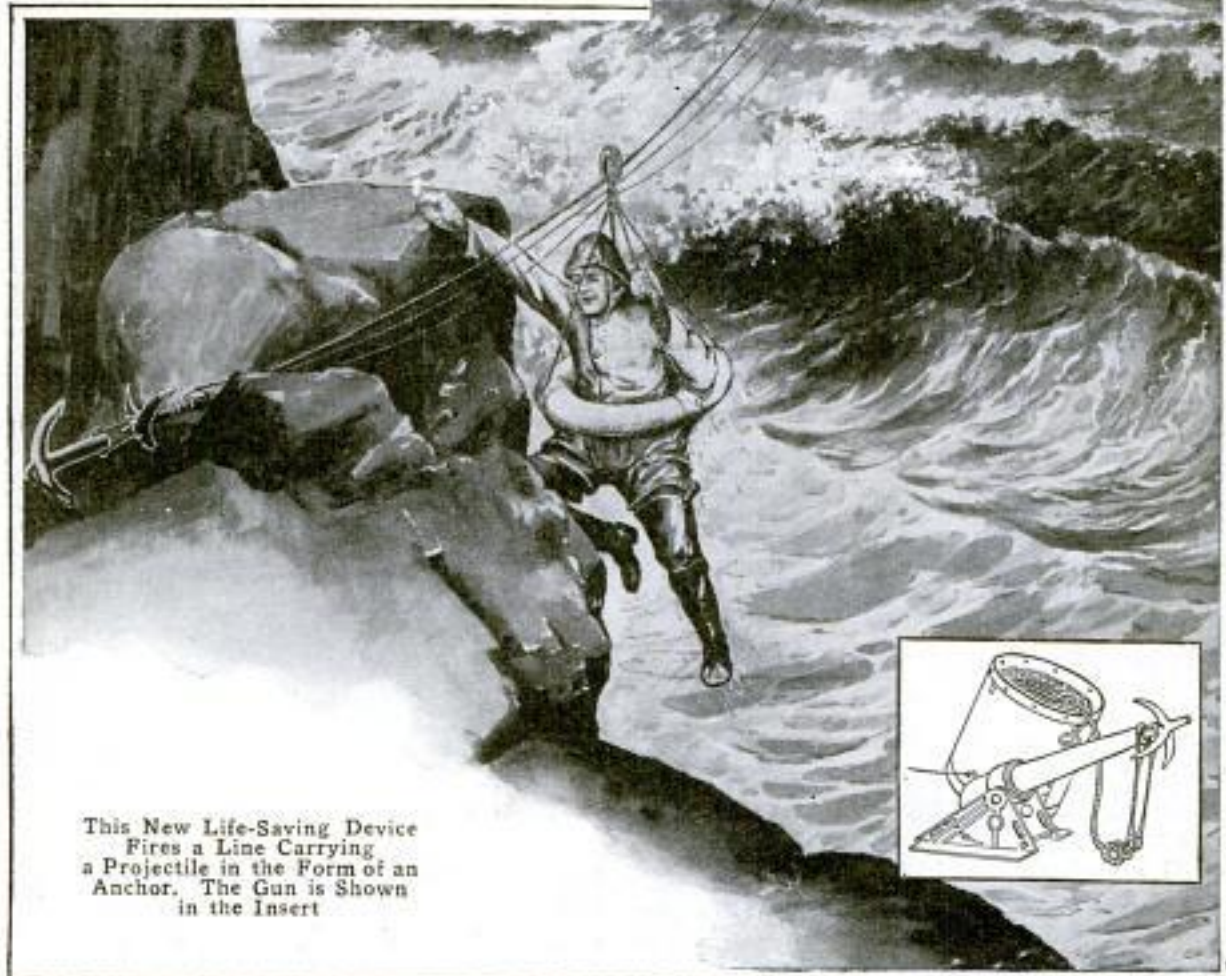

This New Life-Saving Device  
Fires a Line Carrying  
a Projectile in the Form of an  
Anchor. The Gun is Shown  
in the Insert

Submitted by W. Gallagher (does not know author)  
2707 Virginia St.,  
Berkeley, Calif.

8707 m  
mfgd in England, unable to obtain mfr's name

### PAPER CAP PROTECTS HAT CUSTOMER FROM INFECTION

A close-fitting fluted-paper cap has been invented for use in millinery and hatters' shops. It is designed to be



This Fluted-Paper Cap is Designed to Protect the Customer from Infection While Trying on Hats

worn next to the head by a customer while trying on hats so as to guard against the possibility of infection, and is to be thrown away after having been used by one customer.

### DISCOVER VALUABLE METHOD OF FINDING STEEL FLAWS

Considerable success in detecting concealed flaws in steel intended for marine engines and driving parts has been attained at the engineering experiment station of the United States Naval Academy by photomicroscopic examination of the finished products. The method consists of photographing through a microscope large objects, as for instance a propeller shaft, instead of confining such inspection to the small specimens taken from forged or cast parts during the course of manufacture. In order to examine such things as a full-sized shaft, connecting

9017 H  
marine journal and letter from J. W. Kirkard, Capt. U. S. Navy, - U. S. Naval Academy Annapolis, Md.

rod, or gun jacket, a portable photomicroscopic apparatus is clamped in various positions to the object under inspection so that a fairly comprehensive photographic exploration is made. From the results so far attained, it is believed that it is possible in this way to detect with reasonable certainty dangerous flaws or internal cracks in important parts upon which the safety of a vessel depends.

### MOTOR-CAR GARAGE BUILT ON 8795 # TURNTABLE

An objection which applies to nearly all small, private garages, is that either in entering or leaving one of them it is necessary to back the motor car. This difficulty has been overcome in a garage lately built in one of the suburbs of Chicago by constructing it on a turntable. The building is 20 ft. in length, 10 ft. wide, and has doors at both ends. This makes it possible to drive a machine in through the front doorway, swing the whole structure end for end, and drive out through what previously was the rear opening. The turntable has a 36-in. raceway and is provided with 100 ball bearings which lessen the friction and enable the building to be revolved easily. Another advantage of the plan is that a normal-width driveway, leading from



This Garage is Built So That It may be Turned End for End, Thus Eliminating the Necessity of Backing a Car Either When Entering or Leaving

the street to the garage, is all that is required and eliminates the necessity of disfiguring a back yard with an unsightly "Y" or turning space.

Geo. F. Nichols  
1090 Old Colony Bldg.  
Chicago, Ill.

8966 H. E. Zimmerman  
Mt. Morris, Ills.

## BUILDING LONG TRUSS BRIDGE AS CANTILEVER

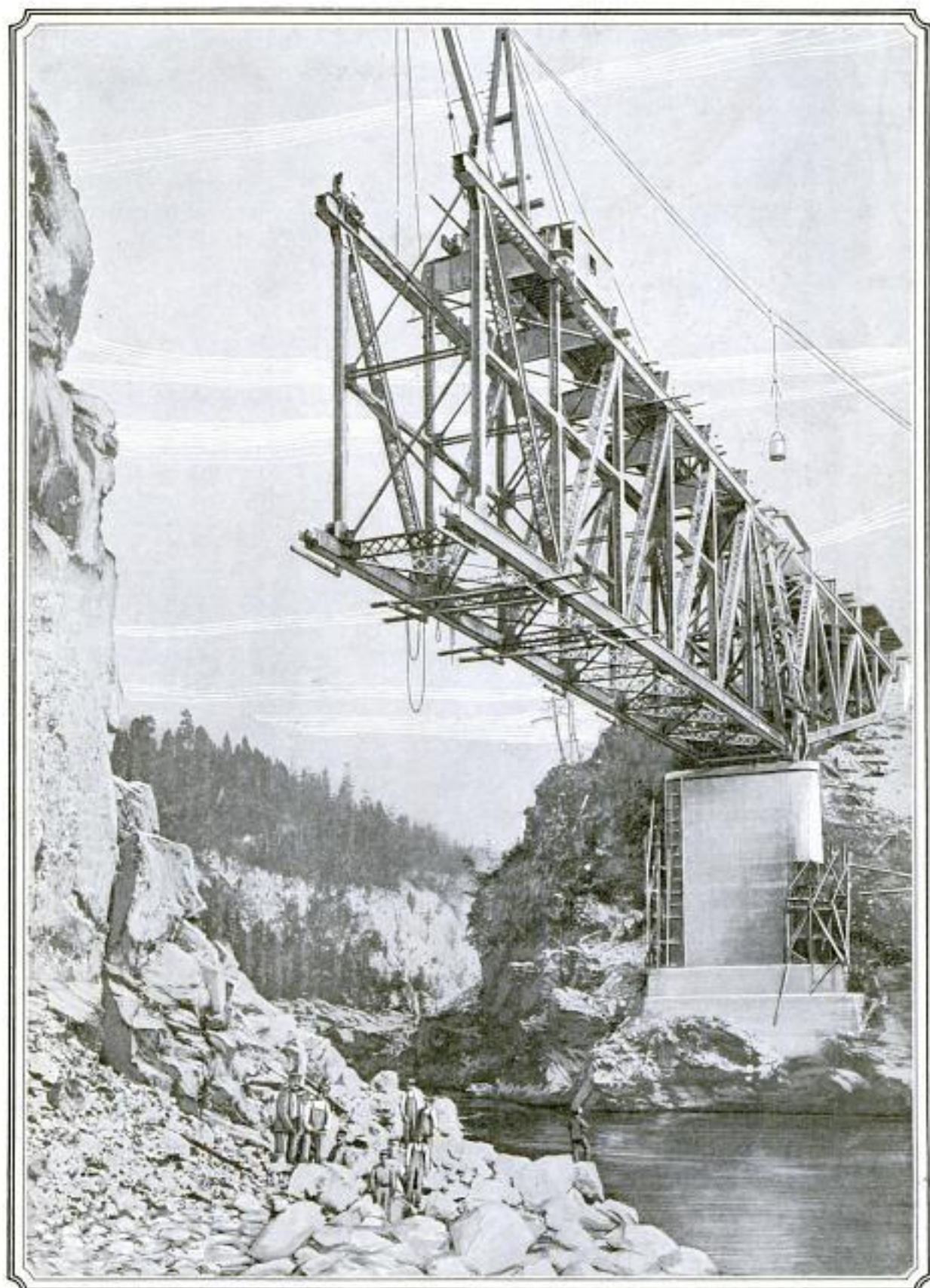

**B**ECAUSE of the extreme depth of the water beneath, it was impossible to construct center supports for this railway bridge, which is being built over the Pend Oreille River in Washington. For this reason it has been necessary to build it in a single span by cantilever construction, although, when completed, it will be a truss bridge. At the present stage of work the mass of structural steel which extends out from a cliff, 150 feet in height, is being balanced by 600 tons of steel placed on the anchor arm. The river at this point is said to have a depth of approximately 230 feet.

## BEACH-SAILING CARTS USED BY ALASKAN MINERS

Miners working on one of the Alaskan beaches have adopted what they term beach carts for the overland transportation of their provisions and "pay dirt." These odd-looking vehicles, fitted with large sails and built substantially, are capable of carrying heavy loads over the hard-beaten sand of the shore line at a rate of four or five miles an hour without requiring much exertion on the part of their owners. In many particulars they are similar to the sailing wheelbarrows of China, used by the inland farmers in transporting their produce to the market, as described in a previous issue of this magazine. The Alaskan carts usually are built with two broad wheels tired with barrel staves, nailed crosswise. There is usually a strong wind blowing in one direction or the other.



With a Generous Breeze One of These Carts will Roll Easily under a Heavy Load

### INSULATION MATERIAL MADE FROM SEAWEEDS

Fiber materials suitable for practically all general insulation purposes are being manufactured from a seaweed which is found in the shallows on the southern coast of Australia. By mixing the refined product with certain proportions of wool, a durable fabric is also made from it. Deposits of this vegetation abound in the vicinity of Spencer's Gulf and are accessible for commercial exploitation. Factories have been started at Port Broughton and Port Pirie during the last year, and from the pioneering work which has been done it is believed that the industry will prove to be one of some importance.

Christian Science Monitor  
1. Posidonia australis

### DEADLY STEEL ARROW USED BY FRENCH AIRMEN

French military airmen are employing a new weapon, known as a "fliche," which is proving to be as effective in harassing the personnel of an army as any offensive instrument yet designed for use with lighter-than-air machines. It consists of a steel arrow of about the same size and much the same appearance as a lead pencil. The head of it is tapered, while lengthwise grooves serve to give it the proper balance and allow it to travel through the air point downward. A score or more of these are dropped at one time over a trench. A report of the effect of these arrows, falling from a height of about 3,000 ft., states that one of them, striking

Underwood & Underwood  
417 Fifth Ave.,  
N. Y. City

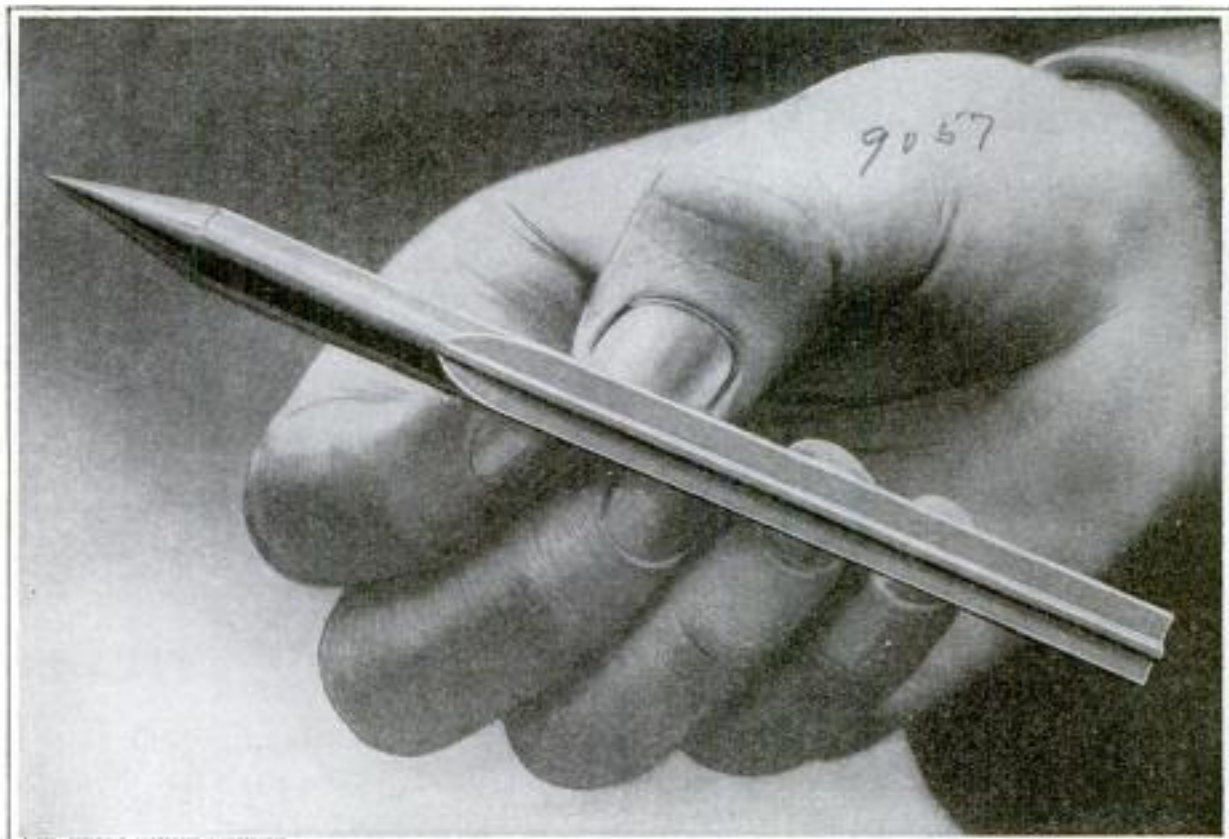

Because of Their Lightness It Is Possible to Carry Large Numbers of These Arrows in an Aeroplane, a Thing Which Helps to Make Them of More Value Than Bombs in Operations against the Personnel of an Army

ing a soldier on the shoulder, passed entirely through his body, and traversed the length of his leg, emerging through his foot. The president of an American steel company recently asserted that he had refused orders from the French government for the manufacture of arrows of this nature.

tions of the separate parts without interfering with the vibration of the diaphragm as a whole. It consists of a combination of metallized rubber disks, stiff celluloid disks, and soft paper cushions, which is secured to the rear face of the diaphragm.

**CLARIFIER FOR TELEPHONES AND PHONOGRAPHS**

8672m

A tone clarifier, recently invented, apparently provides a satisfactory cure for the tendency of the diaphragms used in telephones and phonographs to emit a shrill, squeaky sound in which the low and characteristic tones are nearly if not entirely obliterated. This tendency is due to the fact that the natural rate of vibration of one of these small diaphragms is many times higher than the natural rate of vibration of the tones commonly used in talking, singing, or playing. The new device works on the principle of weighting the diaphragm to retard its vibration and of damping the vibra-

This Tone Clarifier, Which is Designed to Do Away with the Shrill Tones in a Telephone or Phonograph, is Inserted in the Telephone Receiver Back of the Diaphragm

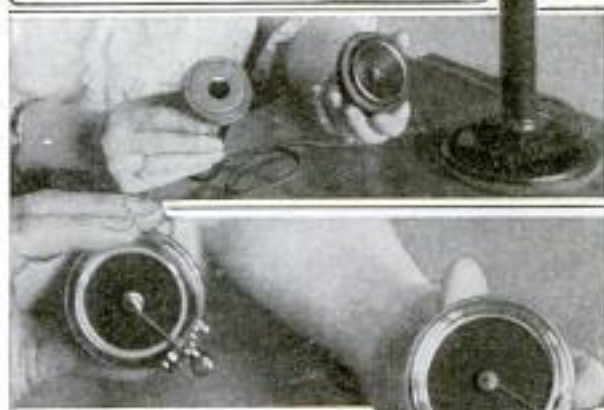

Applying the Tone Clarifier to the Sound Box of a Phonograph

*The Stetson Manufacturing Co.,*  
*Ohio Sales Bureau of Manufacturers, Leader - News Bldg.,*  
*Cleveland, Ohio.*  
*Invented by Mrs. Cora Stetson Butler, Cleveland, Ohio.*  
 3/22/15  
 See March 1914-165  
 C. D. V.  
 Copyrighted material

Jack Brooks, 1 Dagenham Road,  
Romford, Essex, England

8874 **RACING WITH MOTOR CARS IN  
WOODEN BASIN**

One of the most spectacular things recently seen at the Anglo-American Exhibition held at Shepherd's Bush,

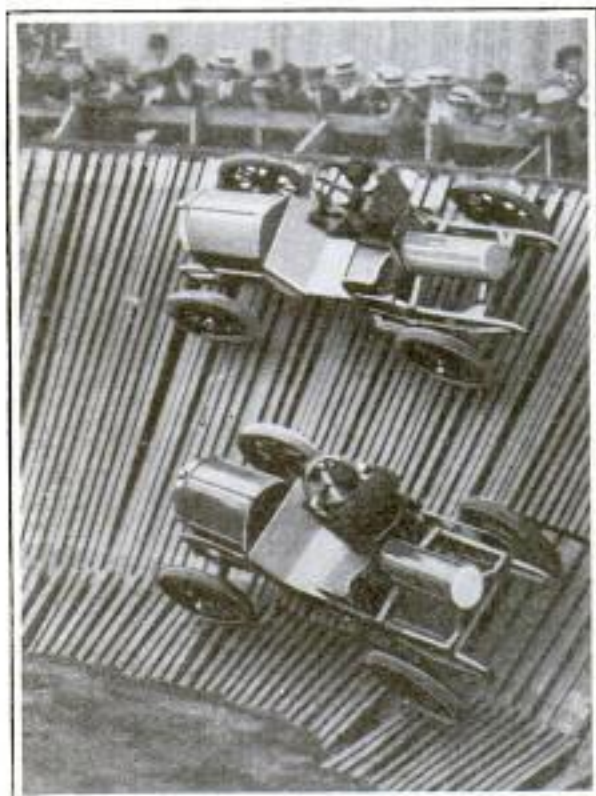

Racing Basin at Shepherd's Bush, England, Showing Two Cars Going at a 60-Mile-an-Hour Speed

London, England, was a race between motor cars in a wooden bowl. The diameter of this speed basin was small, and its side, which was made of narrow planking separated like lattice, was built on a sharp angle. Starting at the bottom the cars gradually mounted the steep slope as they gained in velocity, racing alongside at times for lap after lap while going at the rate of 60 miles an hour.

8930 **RESIDENCE HEATING SYSTEM  
DIRT AND SMOKE-PROOF**

For heating medium-sized residences, a new system has been devised in Sweden which entirely eliminates smoke and dirt and apparently approaches the ideal plan so far as convenience is concerned. A thoroughly insulated tank of from 100 to 300-gal. capacity, fitted with an electric heater,

Merchant Plumber & Fitter  
10-25-14

is installed in the upper part of the house. At night, when electricity is available at a low rate, the current is turned on and the water heated. At the proper time the following morning the circuit is automatically broken and a small motor pump is started, which acts on water in an auxiliary tank in the basement, bringing about a circulation of water through the radiators. At the right time in the evening the pump is stopped and the current again turned into the tank-heating device. Practically no attention is required in operating the plant and it is asserted that 40 kw.-hr. of energy will serve to adequately heat five rooms.

7604 **"POTATO BUG" AS BIG AS A  
BUNGALOW**

A model of a potato bug 100,000,000 times as big as the real thing is one of the novel exhibits now being installed in the Horticultural Building at the Panama-Pacific Exposition. The model is not intended as an amusement feature but as an object lesson for the farmer. This bug lies on its back, and is 40 ft. long, 20 ft. wide, and 40 ft. high from the floor to its feet. It consists of a frame of gas pipe over which a painted canvas skin is laced. It contains three rooms, which are electric-

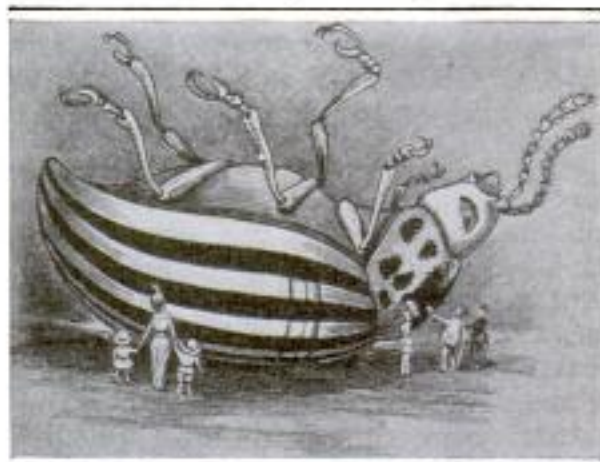

This Model of a Potato Bug, 40 Feet Long, is to be Exhibited in the Horticultural Building of the Panama-Pacific Exposition

ally lighted, and which will contain exhibits relating to the extermination of this pest. One entrance to the bug will be through its mouth.

Hamilton M. Wright  
Panama Pacific Exposition  
San Francisco, Calif.



# WAR UNDER THE SEA

*Warfare*  
 The Submarine Torpedo Boat and the Submerged Mine are  
 8341 Revolutionizing Naval Strategy

WHEN the three British armored cruisers "Aboukir," "Hogue," and "Cressy" were all sunk within the space of about an hour by one German submarine, the world was given a startling demonstration of the possibilities of this type of underwater fighting craft. In the subsequent fighting at sea these vessels have played such an important part as to give considerable justification to Admiral Sir Percy Scott's prediction that when submarines have been fully developed they will entirely displace the great dreadnaughts that form the principal fighting strength of the navies of the present time.

Next to this first decisive blow struck by the German submarine, the most striking underwater attack up to the present stage of the war was that of the British submarine "B-11" which stole past five cordons of mines laid to block the Dardanelles, torpedoed and sunk the Turkish battleship "Messudieh" lying at anchor at Tchanak Kalessi, and then worked its way back to safety after being under water continuously for nine hours. In December the British made a combined sea and air attack on the German naval base at Cuxhaven which not only demonstrated the fighting qualities of the submarine but its value for scouting purposes as well. It is now reported on good authority that the reason this attack could be carried out without disaster to the attacking party was that the mine defenses designed to protect the naval base had been thoroughly explored in advance by British submarines.

During the five years preceding the war, submarine fighting craft had been developed to a high state of efficiency. Among the new vessels, submersibles had almost entirely superseded the original type that bore the name of submarine. For understanding the character of the fighting craft that has come

into such prominence it is necessary to distinguish between the two types of vessels. The original submarine was designed primarily to operate under water and was far from being a seaworthy craft when running on the surface. These vessels were therefore valuable mainly for coast defense and for operations within restricted limits in connection with a fleet of warships. The submersible, while having all the underwater efficiency of the submarine, is built to operate on the surface as well; and is practically as seaworthy as a destroyer. Such vessels are capable of making long voyages and of taking the offensive independently and not simply as auxiliaries to a fleet of warships. All the later vessels, while commonly called submarines, are in fact submersibles. The original submarines still in service are used almost exclusively for coast defense.

A convincing demonstration of the seagoing qualities of the submersible was given a short time before the war when the French boat "Papin" made a voyage of 1,800 miles in 14 days, traveling much of the distance under water. In this voyage the "Papin" started from the French port of Cherbourg, passed around the coast of Spain, through the Strait of Gibraltar, and along the north coast of Africa to the port of Bizerta, in Tunis, completing the trip with only two landings. The "Papin" is over 170 ft. in length and carries six torpedo tubes.

The leading nations, belligerents and neutrals alike, are building bigger submersibles all the time. According to reports the Germans are building four of such size that they will be able to keep at sea for 40 days without having to replenish their stocks of oil or provisions. So far as is definitely known, however, a submersible to be built for the United States will be the largest of all. This vessel is to be 260

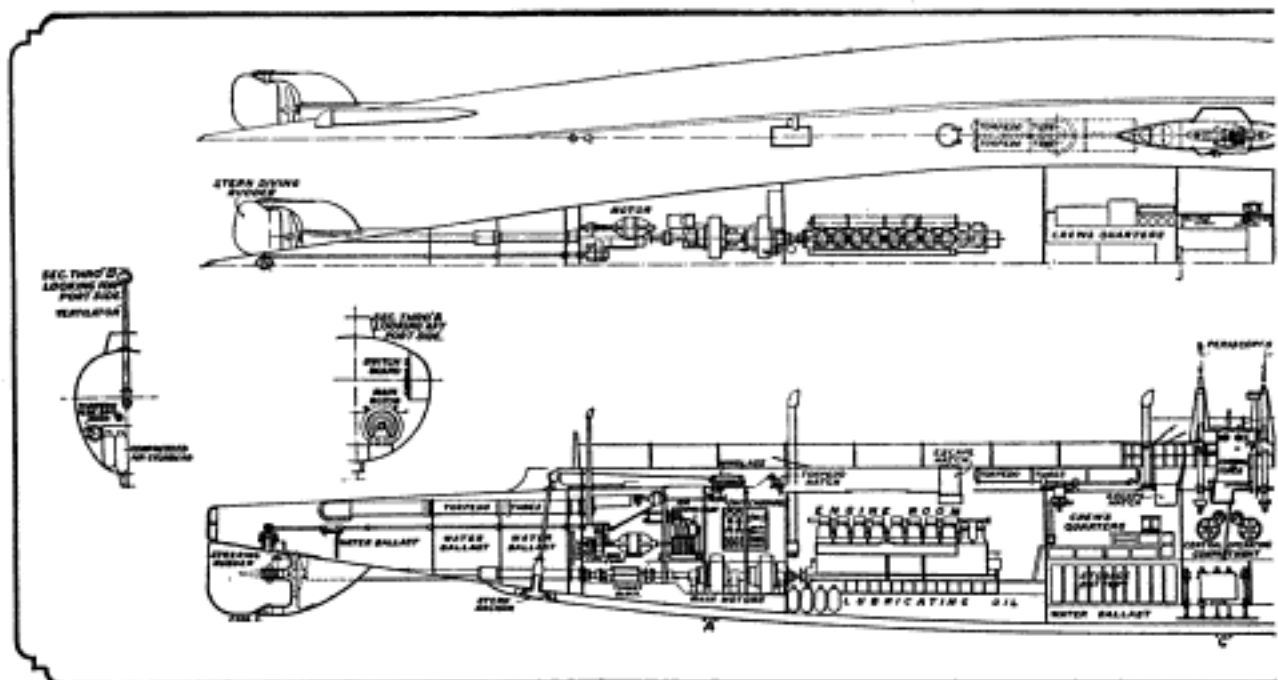

These Diagrams Show How a Typical Modern Submersible is Built; the Vessel is Equipped with Torpedo with Two Periscopes, One Facing Straight Ahead and the

ft. long and will have a radius of action of 5,500 miles. It will be capable of making a speed of 23 miles an hour on the surface and of  $12\frac{1}{2}$  miles an hour when submerged. A contract for the construction of this modern "Nautilus" was awarded recently by the Navy Department, the cost being \$1,350,000.

The submarine is shaped like a cigar, a cross section at any point along the hull being practically circular. In the submersible this shape is retained for the inner shell, but over this is built a hull that gives the completed vessel the shape of a torpedo boat. The inner shell contains all the working parts of the boat, while the space between the two shells is utilized for the water-ballast compartments which, when filled, overcome the buoyancy of the craft and cause it to sink to any desired depth beneath the water. The interior of a submersible impresses one as being a thing of supreme nervous energy, with every detail devoted to the accomplishment of just one thing—that of slipping in close to the enemy's ship and sinking it with a torpedo. So completely is the vessel filled with machinery and equipment for this purpose that only very limited space can be utilized for quartering and feeding the crew.

While the newer submersibles are equipped with tubes for firing torpedoes from the stern and even from the side, the principal fighting equipment is at the bow. Here are located either two or four torpedo tubes. Unlike the guns of a battleship, these tubes must be aimed at the mark by aiming the entire vessel. Each tube is closed by a trap door that opens automatically when the torpedo is fired and closes the instant the torpedo has started on its journey of destruction. Back of the torpedo tubes is a compartment for the storage of torpedoes and in this are also sleeping quarters for the officers of the vessel. In the deck above this compartment is a hatch for taking in the torpedoes. Next comes a compartment containing one of the two electric storage batteries which furnish power for propelling the vessel when it is under water. Back of this, at the center of the vessel, is the central operating compartment, from which every movement of the vessel is controlled. Next comes a compartment containing the second set of storage batteries, then the engine room and workshop, and finally the compartment at the stern containing the propelling and steering machinery. The crew, which often numbers from 20 to 30

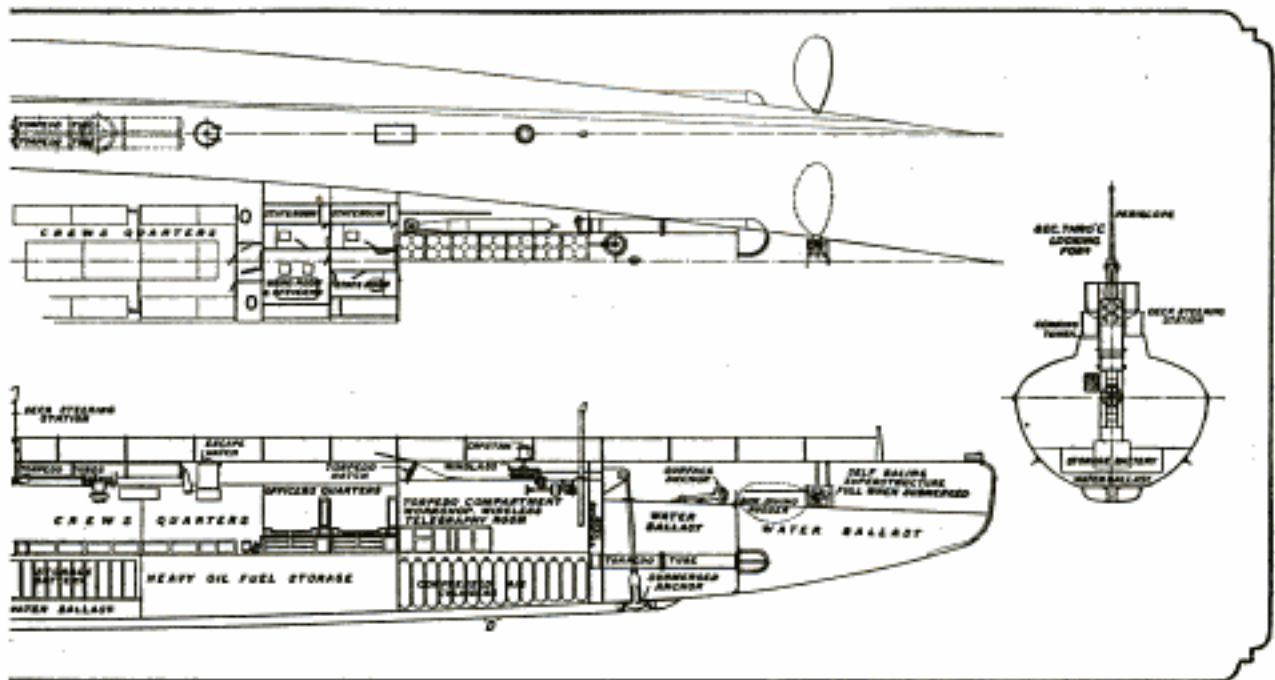

Tubes at Bow and Stern and Has Torpedo Tubes Amidships Which may be Trained Like Guns. It is Provided Other Mounted so That It can be Turned in Any Direction

men on a submersible, is usually quartered in hammocks in the compartments containing the storage batteries.

Every naval submarine vessel has two complete power plants, one for propulsion on the surface and the other for propulsion when submerged. The main power plant of the most modern submersibles consists of Diesel engines using heavy oil, but gasoline engines and steam turbines are both used for this purpose. This plant supplies power for operation on the surface and for charging the storage batteries. One of the first things in preparing for submergence is to shut off this power plant, and from this time until the vessel again comes to the surface it runs on the power stored in the batteries. The next step is to close all the hatches and let the water into the water-ballast compartments. The vessel then begins to settle in the water, and as the process is continued, first the deck and then the conning tower go under water. For sinking to a greater depth, diving is usually resorted to, the vessel being inclined downward at an angle by means of horizontal rudders at the stern or by sea planes at the bow. Ordinarily the submarine is kept under the surface by the action of these devices, a portion

of the buoyancy of the vessel being retained so that it will rise to the surface in case of accident and as soon as it stops. It is easily possible, however, to take all the buoyancy out of the vessel so that it will lie securely on the bottom, or will hang as if suspended at any desired depth beneath the surface. One type of submarine is designed to be sunk to any depth by means of its water-ballast compartments alone, and is even provided with wheels for running on the bottom of the sea.

Of all the equipment of submarine vessels the most important is the periscope, a simple device that serves as the eyes of the craft when it is running submerged. On the latest submersibles two of these instruments are used, one being fixed to give a view straight ahead and the other being so mounted that it can be turned to face in any direction. Although serving such a vital part in the operation of a submarine the periscope is exceedingly simple in construction. The light enters the hood of the periscope horizontally. It then passes through a prismatic lens that deflects it downward at right angles into the vertical shaft of the periscope. At the bottom of the shaft is a second lens that again turns

Photograph Showing What was Left of a Torpedo After It had Exploded: This Was the Second Torpedo with Service Charge Ever Fired by Any Vessel of the United States Navy



The Crushing Power of the Torpedo is Indicated by Its Condition When Fished from the Bay



Hinged Tube Cap That Opens Automatically When the Torpedo is Fired

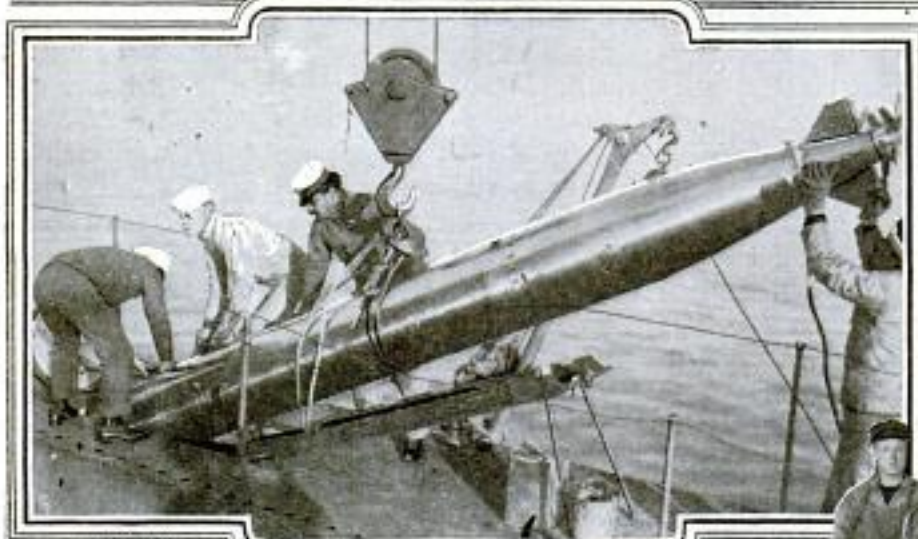

PHOTO COURTESY INTERNATIONAL NEWS SERVICE

Loading an \$8,000 Torpedo aboard the U. S. Submarine "K-5" at the Charleston Navy Yard: The Torpedo is being Lifted by a Derrick and Let Down through a Hatch into the Storage Compartment Adjacent to the Torpedo Tubes



Tail End of a Torpedo, Showing the Rudders and Propellers



Charging the Storage Tank with the Compressed Air Which Furnishes Power for Propelling and Steering the Torpedo

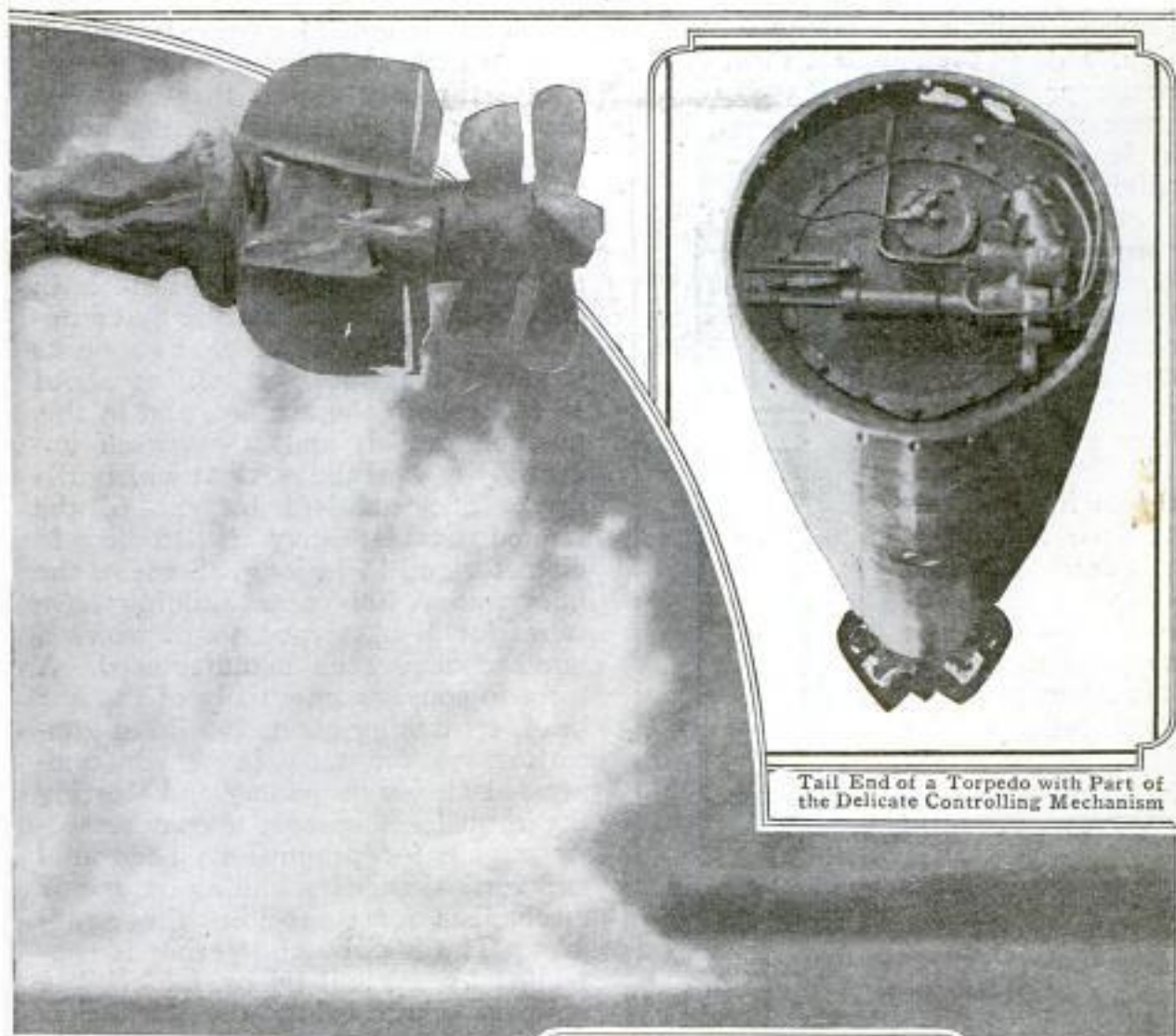

Tail End of a Torpedo with Part of the Delicate Controlling Mechanism

What Happens to the Ocean When a Torpedo Explodes: This Upheaval was Caused by Torpedo Shown Above



The Pilot of the Torpedo Is a Small Gyroscope, Which is Rotated by Compressed Air. With This Instrument the Torpedo is Steered Unerringly from the Launching Tube to the Mark

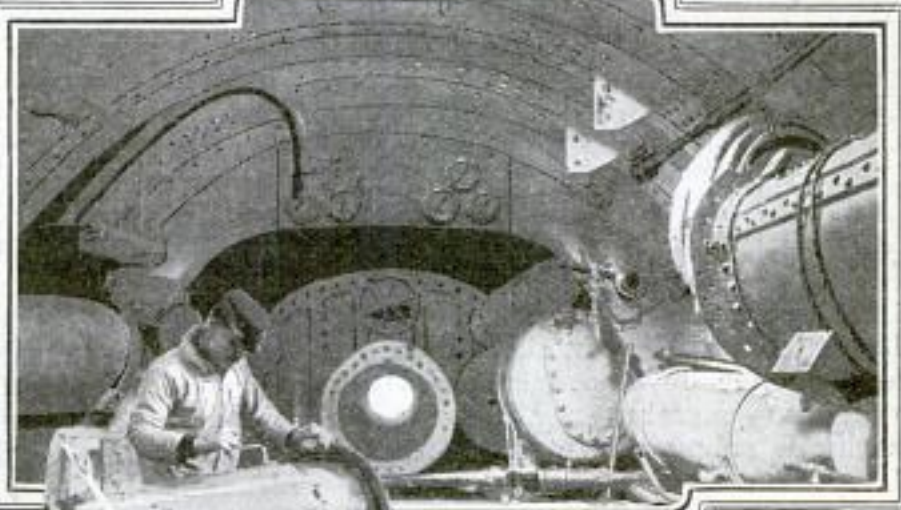

Where the Torpedo is Made Ready and Launched on Its Journey of Destruction: In This Picture the Gunner is Shown Charging the Torpedo with Compressed Air; Straight Ahead is the Torpedo Tube, While at the Right and Left are the Flasks Containing Compressed Air with Which the Water is Expelled from the Water-Ballast Compartments When the Submerged Submarine is to be Brought to the Surface

the rays of light to a horizontal direction. This is the simplest form of the periscope. Usually there are additional lenses for magnifying the view. After passing through the bottom lens the image is either thrown on a screen or is viewed directly through a telescope by the officer in command. The one disadvantage in the periscope is that it gives only a limited view in the one direction in which it happens to be facing. Attempts have been made to develop a panorama periscope that uses

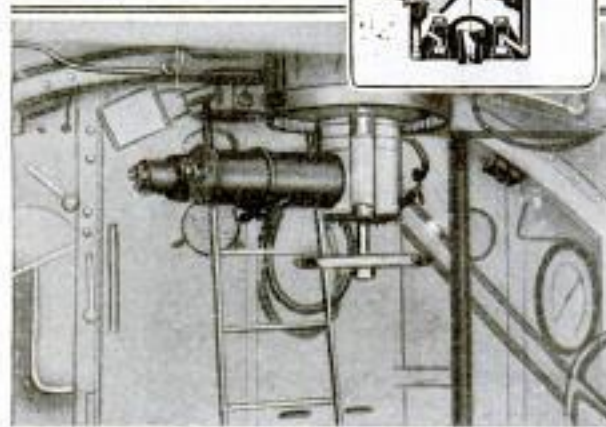

Without Its Periscope a Submarine would be Blind When Submerged. This Picture Shows How the Commanding Officer Has a Constant View above the Surface by the Aid of This Ingenious Instrument

a "fish-eye" lens and gives a view of the entire horizon, but this device has not yet been developed sufficiently to come into general use. When the submarine is submerged, only the tops of the periscopes are visible above the surface. These are difficult to see and still more difficult to hit, and this accounts for the apparent ease with which a submarine can steal up within range of a battleship and fire its torpedo without being discovered.

Although submarines and submer-

sibles are designed for firing torpedoes, and for little else, they are not by any means the only vessels that use these deadly projectiles. Torpedo boats, cruisers, and battleships are equipped with torpedo tubes. With surface vessels the torpedo is often fired from above the water, but the result is the same in any case. The torpedo is in effect a miniature submarine that automatically takes and keeps, as soon as it enters the water, a position about 15 ft. beneath the surface, and in this position propels and steers itself unerringly toward the mark at which it is fired. The standard torpedo of the United States Navy is 18 in. in diameter and 16 ft. long. Some of the new war vessels now building have tubes for 21-in. torpedoes, of which a number have been manufactured. A torpedo consists essentially of the war head, containing about 250 lb. of gun-cotton; an air tank in which compressed air for propelling and steering the torpedo is stored; a compressed-air engine for propulsion; horizontal and vertical rudders, and an automatic mechanism for controlling these rudders. The horizontal steering is controlled by a small gyroscope, while a uniform depth below the surface is maintained by hydrostatic pressure applied in an ingenious but simple manner. A pipe open to the water projects from the stern into the body of the torpedo, where it opens against a piston. On the opposite side of this piston is a spring made to exert a pressure exactly equal to that of water at a depth of 15 ft. This piston is connected with the apparatus operating the rudders that control the vertical depth. When the depth of water is greater than 15 ft. this piston is forced inward with the result that the rudders are turned upward, and when the depth of water is less than this the spring forces the piston outward and the rudders are turned in the opposite direction.

Projecting forward from the nose of the torpedo is a plunger which is thrust into the detonating charge when the torpedo strikes. This fires the detonating charge, which in turn fires the



Right: The U. S. Submarine "K-5" Riding at Anchor; the Vessel Is in Fighting Trim with All Hands Below



Forward Deck of the "K-5": In This Picture is Also Shown One of the Hatches That Furnish the Only Means of Entering and Leaving the Submarine

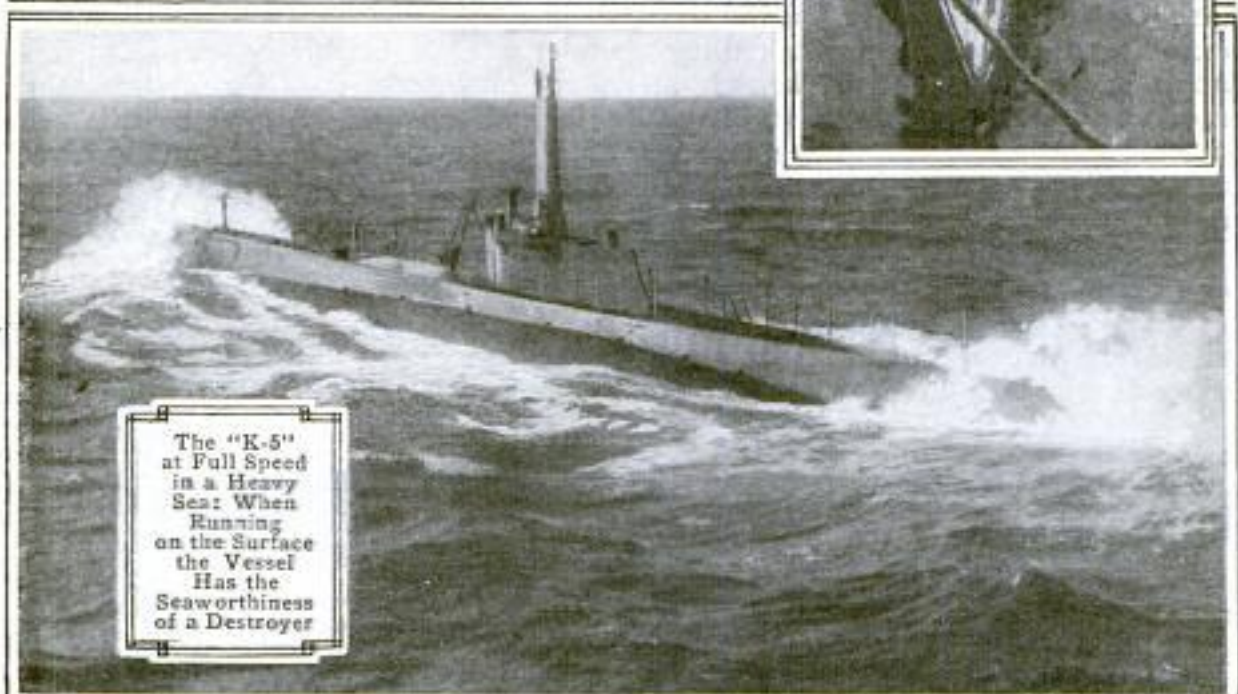

The "K-5" at Full Speed in a Heavy Sea: When Running on the Surface the Vessel Has the Seaworthiness of a Destroyer

PHOTO COPYRIGHT INTERNATIONAL NEWS SERVICE

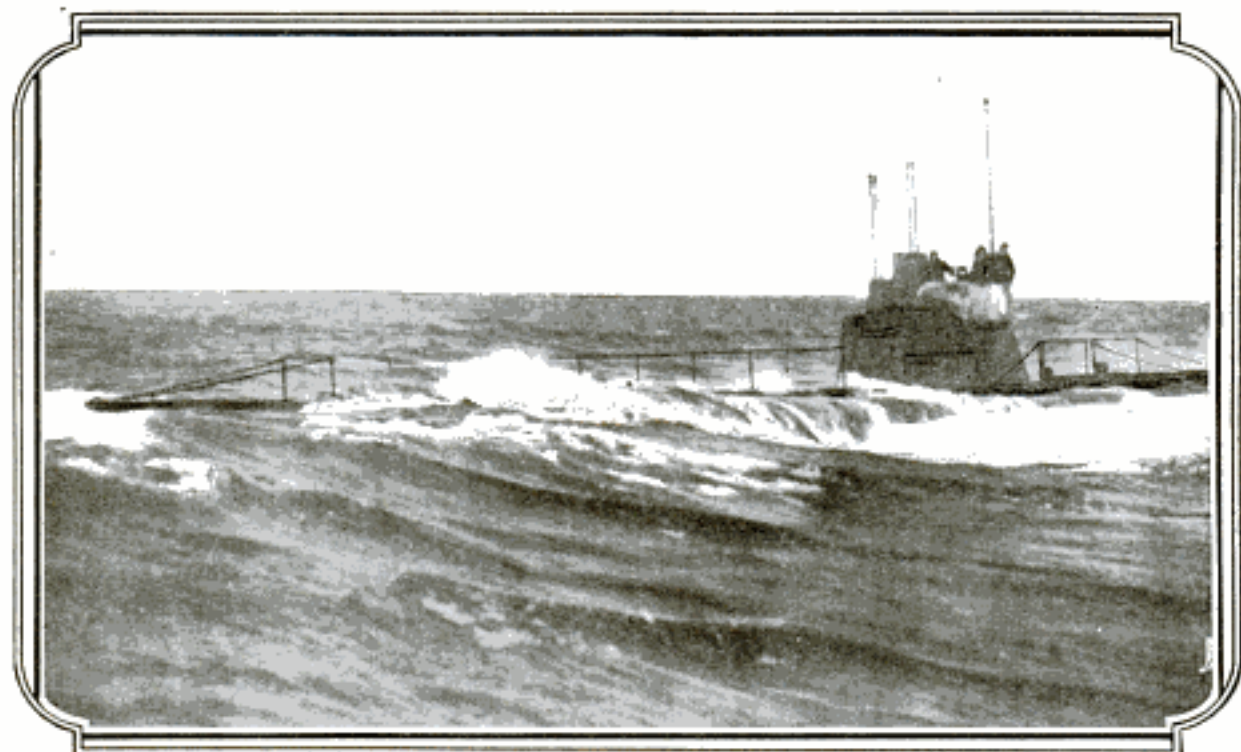

COPYRIGHT, INTERNATIONAL NEWS SERVICE

The German Submarine "U-9" Running Partially Submerged: This Vessel is Credited with Having Sunk, Single-Handed and within the Space of an Hour, the Three British Cruisers "Aboukir," "Cressy," and "Hogue"

main charge of guncotton. To prevent all danger of explosion before the torpedo is launched, the plunger is securely held away from the charge by a pin which must be removed just before the torpedo is placed in the tube. The torpedo is launched from the tube by compressed air, but the instant it enters the water it begins operations independently. So perfectly has all the controlling apparatus been worked out that it is now possible to launch a torpedo broadside from a ship and have it turn at a right angle after entering the water and go straight ahead or straight astern.

A single torpedo costs about \$8,000, and this accounts for the fact that a recent test shot fired by a United States war vessel was the second torpedo with service charge ever fired by any vessel

of the United States Navy. This was done at the Newport torpedo station for the purpose of testing a new device for destroying torpedo nets. The twisted remains of the exploded torpedo were recovered and preserved for study.

In spite of the deadly menace of the submarine there is such a thing as an effective defense against it. For a ship under way, high cruising speed and frequent change of course constitute the principal defense. Added to this are rapid-fire guns and a constant lookout from the ship and from aeroplane scouts. Where the ship is accompanied by torpedo boats or destroyers, these are constantly on the alert to ram and sink a submarine the moment its periscopes are seen. One weakness of the submarine is its low speed when sub-

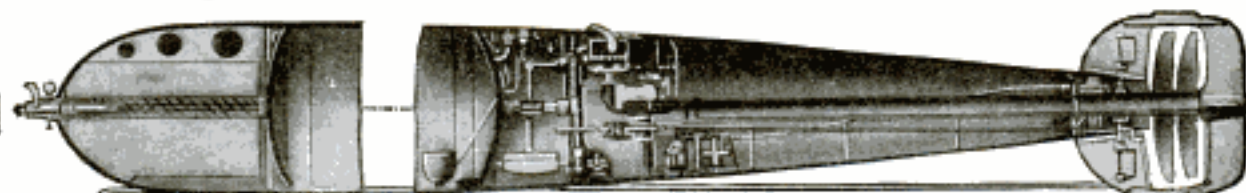

The Nose of This 18-Inch Torpedo Carries about 250 Pounds of Wet Guncotton, Enough to Blow a Hole in Any Ship. Next to This is the Compressed-Air Tank, While Back of the Tank Is the Intricate and Delicate Mechanism That Drives the Propellers and Controls the Rudders



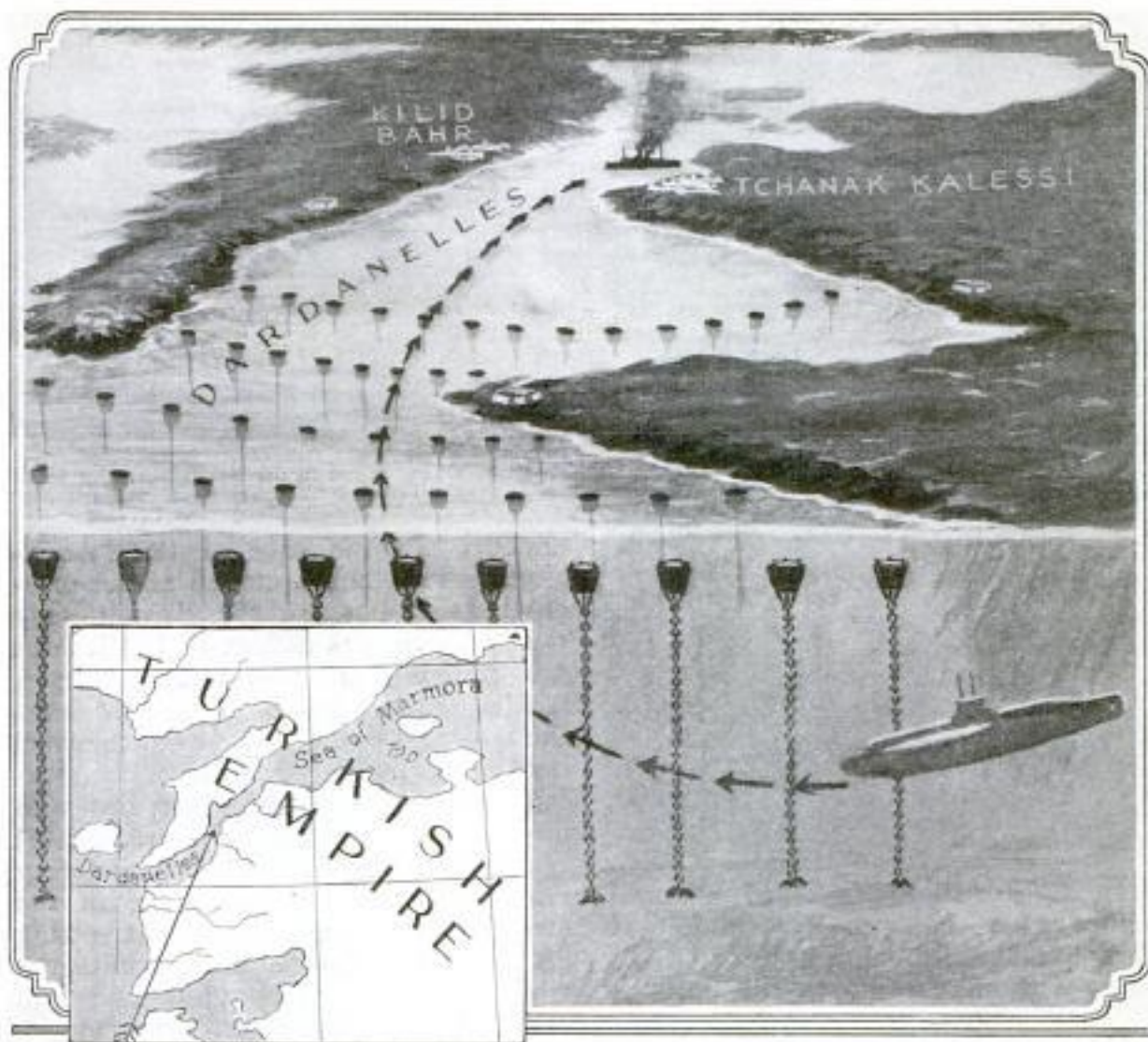

Arrangement of Mines in the Dardanelles and Location of the Turkish Battleship "Messudieh" When Sunk at Anchor by the British Submarine "B-11": In Performing This Remarkable Feat the Submarine Was under Water Continuously for About Nine Hours. The "B-11" Running with Its Decks Submerged is Shown Below.



PHOTO COPYRIGHT, INTERNATIONAL NEWS SERVICE

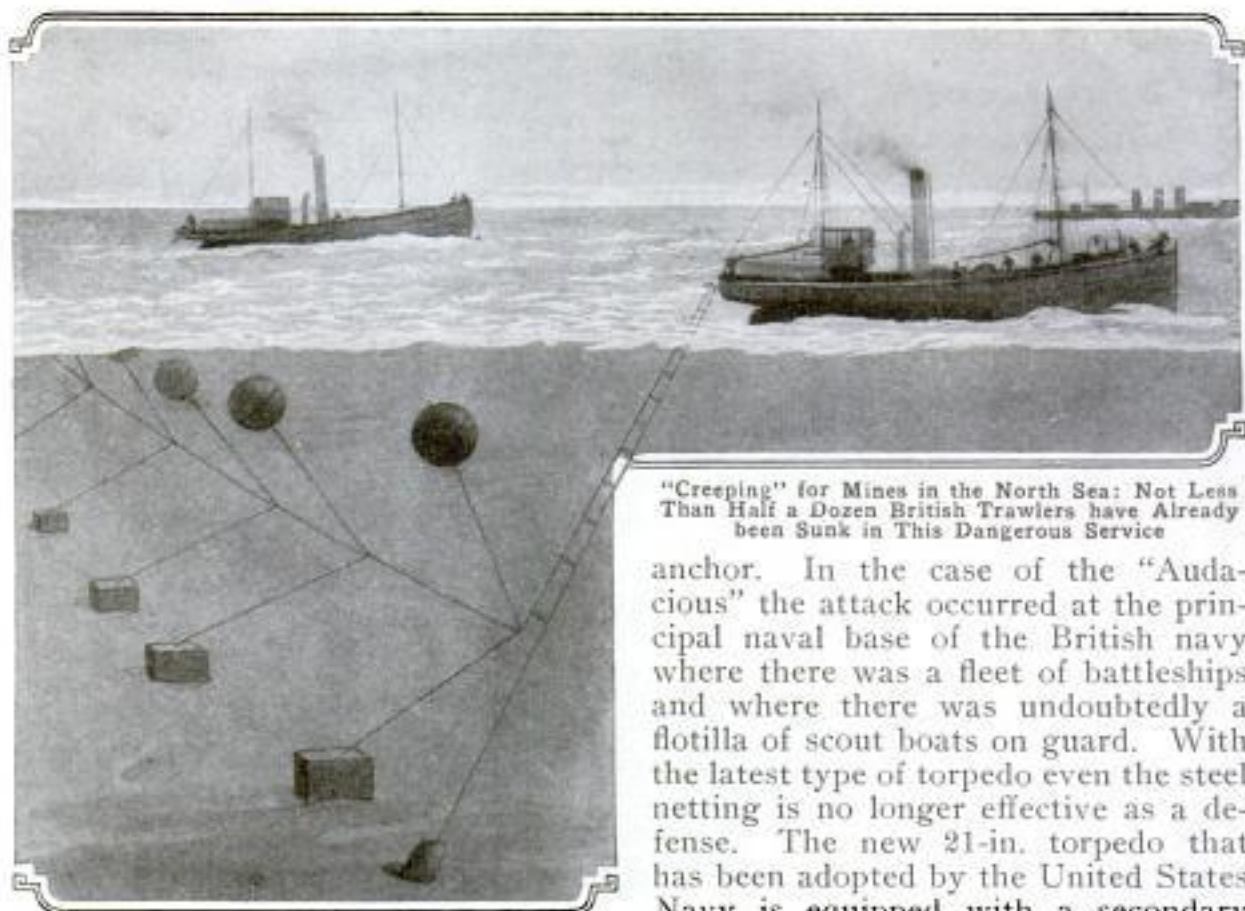

"Creeping" for Mines in the North Sea: Not Less Than Half a Dozen British Trawlers have Already been Sunk in This Dangerous Service

merged. For this reason such a vessel cannot give chase to a warship. It cannot make its escape by running away without coming to the surface, where it is exposed to gun fire. Its only chance for a successful attack is in lying in wait for a ship that is under way, or in stealing in close to a ship lying at anchor. The range for firing a torpedo successfully, however, is not so great as might be supposed, in comparison with the range for successful battleship action. A hit is almost certain at a range of 700 or 800 yd., while 1,500 yd. is considered a good range. Some of the submersibles now being built are designed for firing at a range of from 7,000 to 10,000 yards.

When a battleship is at anchor, defense is likely to be a much more difficult matter. Such protection as is possible is provided by mine fields, heavy-chain entanglements, and by steel torpedo nets, suspended from spars and floats around individual ships. This protection is not always effective. Both the "Audacious" and the "Messudieh" were sunk while at

anchor. In the case of the "Audacious" the attack occurred at the principal naval base of the British navy where there was a fleet of battleships and where there was undoubtedly a flotilla of scout boats on guard. With the latest type of torpedo even the steel netting is no longer effective as a defense. The new 21-in. torpedo that has been adopted by the United States Navy is equipped with a secondary war head that blows a hole in the strongest steel netting without setting off the main charge, and permits the torpedo to pass through. The first charge is fired by contact with the netting. This explosion lights a time fuse that explodes the main charge after a given interval of time.

Although it cannot make a definite attack on a ship, the submarine mine is perhaps the greatest menace of all to battleships and other surface vessels, and up to the present stage of the war more ships have been sunk by this means than by the submarines with their torpedoes. Three kinds of mines are in common use, and all are so deadly in their effect that there is little hope for a ship that even brushes against any one of them. The one in most common use is the trigger mine, which is usually anchored at a depth of 15 ft. below the surface. The method of anchoring a mine of this class is shown in one of the illustrations. When the mine is in place, the trigger projects out from one side. A ship striking the trigger pushes it to one

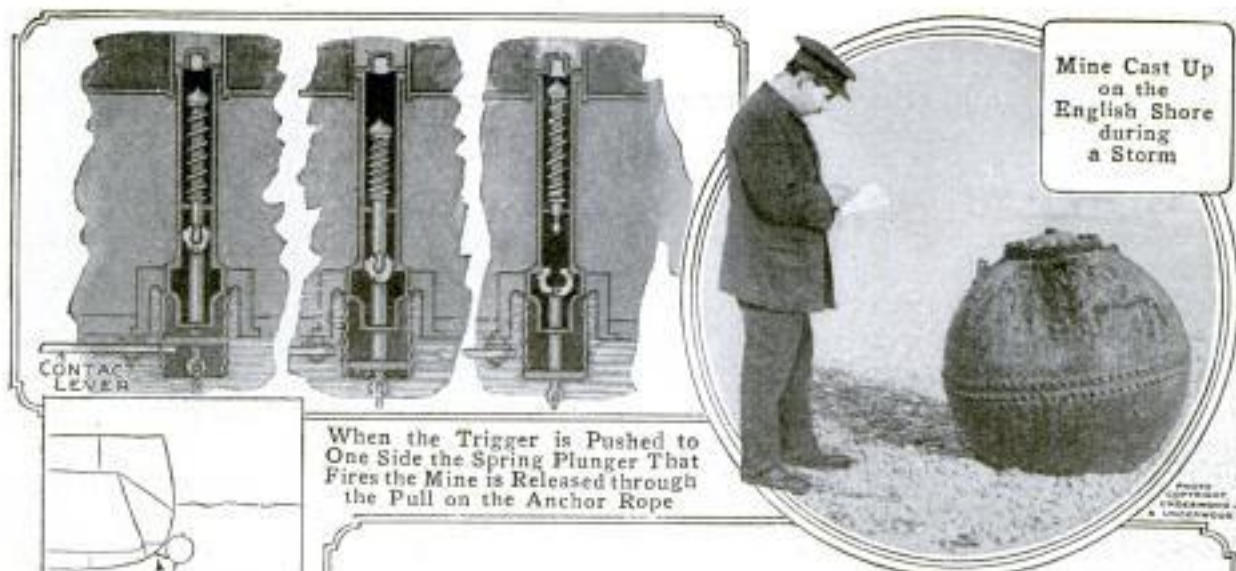

When the Trigger is Pushed to One Side the Spring Plunger That Fires the Mine is Released through the Pull on the Anchor Rope

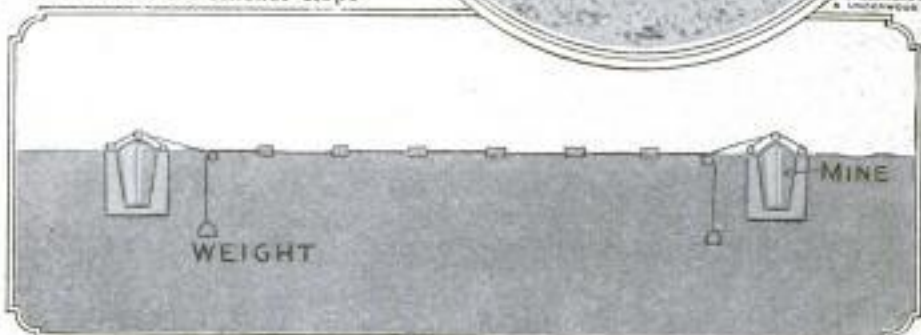

Drifting Mines Float on the Surface and are Connected by a Buoyant Cable; a Ship Striking One of the Mines or the Cable is Almost Certain to be Sunk

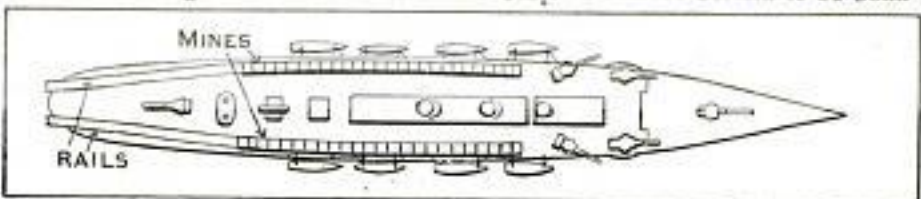

How the Mines are Stowed Away on the Deck of a Mine-Laying Ship

A Ship Rolls the Mine Until the Trigger Comes in Contact with the Hull, When the Trigger is Pushed to One Side; This Releases the Plunger That Fires the Mine

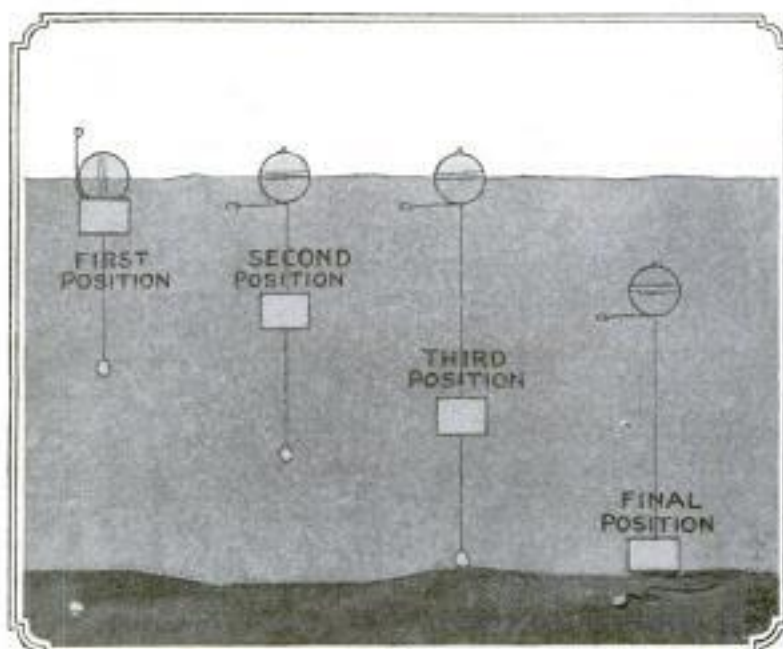

The Four Stages of Laying a Mine: In Its Final Position the Mine is Held About 15 Feet below the Surface, with the Trigger Standing Out Horizontally

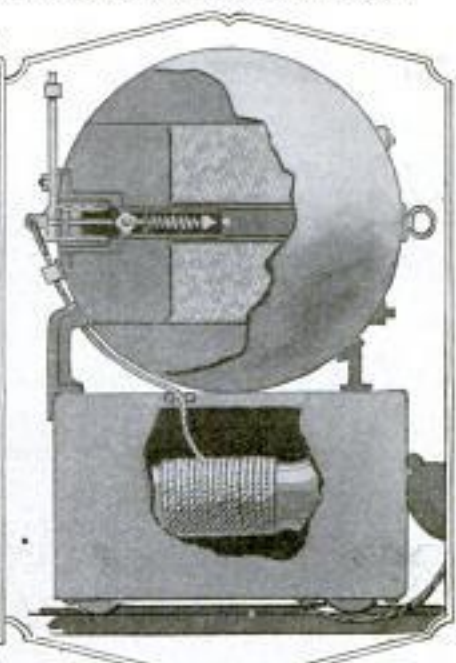

How the Mine is Nested on Its Anchorage When Stowed Away on Board Ship

side and releases a spring-actuated plunger that explodes the detonating charge. The mine responsible for the destruction of the cruiser "Amphion" is said to have been what is known as the "contact" mine. A mine of this type is globular in shape and is studded with small leaden spines. Each of these spines is in contact with a glass receptacle filled with acids and placed within the mine. When one of them is struck the glass receptacle is broken and the acids, flowing into a chamber containing chemicals, set up an action that explodes the gun-cotton. The electro-contact mine is suited only to harbor defense. It is exploded by the closing of an electric circuit from a station on shore, and for this reason is dangerous only to the enemy's ships. The electric control of this type of mine has been developed to a high degree of perfection. In the latest installations a number of mines are grouped together on one electric circuit. When one of the mines is struck an electric bulb is lighted in the shore station. Then when the operator closes the electric switch this mine, and this mine alone, is exploded. The only way of clearing a mine field is by "creeping." This is done by two

trawlers which drag between them a sagging chain, the purpose being to explode the mines by dragging the chain against them at a safe distance. The work is extremely dangerous. Not less than half a dozen British trawlers have already been sunk by striking the mines that they were attempting to destroy. The drifting mine with which the North Sea was said to have been studded at the beginning of the war is a contact mine of any type that floats on the surface. Such mines are arranged in pairs and connected by a floating cable so that a ship striking either of the mines or the cable is practically certain to be destroyed.

Just what the submarine strength of the warring nations was at the beginning of the war is not definitely known, but according to the best authority available, England and France each had 78 submarines and submersibles, Russia 37, Germany 24, and Austria 6. This gave the allies a total of 193, and Germany and Austria a total of 30. By this time, however, these figures have undoubtedly undergone a great change, as all the belligerents have been and are still busily at work building more and larger submersibles.

#### TIRE PUMP FOR MOTOR CARS 67 # ATTACHED TO ENGINE

Designed to be permanently screwed into the valve cap of one of the cylinders of an engine, a pump for inflating

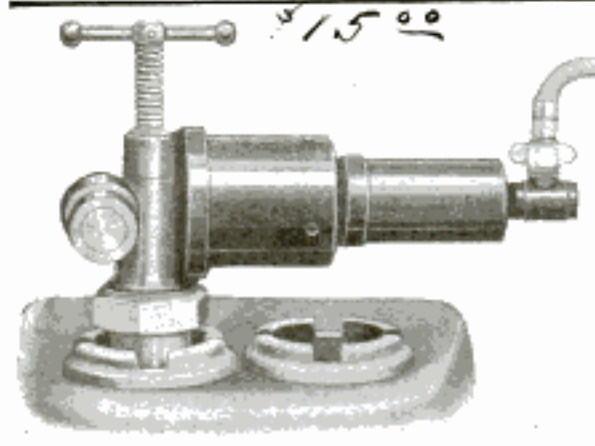

Tire Pump for Motor Car Which is Permanently Attached to the Valve of an Engine Cylinder

motor-car tires has been invented which, when once installed, is always ready for immediate use. In employing it, it is only necessary to attach a rubber hose to a tire and then open a poppet valve in the pump by pressing down a plunger, and locking it by a quarter turn. The pump is operated by the suction and compression in the engine cylinder to which it is connected. Air is admitted to the cylinder through a valve by the suction created by the descending piston, instead of gas entering from the carburetor. This in turn is forced into the pump on the return stroke, where it is compressed by a second piston and forced into the tire. A pressure of 150 lb. is obtainable, while a 34 by 4-in. tire can be inflated to a 75-lb. pressure in approximately three min-

*Valve cap must be tapped 1 3/8". Be sure this can be done before ordering, if not already. This can not be done. Consult local machinist about getting new valve cap & before ordering.*

*Mayo Mfg. Co.  
54.60 East 18th St.  
Chicago, Ills.*

utes. The pump is stopped by again turning the plunger, which unlocks it and closes the valve, cutting out the device so that gas is again allowed to enter the cylinder, which then resumes firing in its regular turn.

### GAS CONSUMPTION CONTROLS

#### 8635 ACETYLENE GENERATOR

Designed particularly for welding purposes, an acetylene generator has been invented with a feed mechanism which is directly controlled by the consumption of gas, so that it is automatically started or stopped when the flow is turned on or off. Measured quantities of carbide, varying in amount according to the volume of gas being used, are dropped into the water by the action of a motor that is driven by the gas passing from the generator

into the service pipe. The greater the amount of gas burned, the faster the motor is driven, which in turn causes larger quantities of carbide to be released by the feeder. In order to insure safety in operation, it is so arranged that should the pressure become greater than normal, the gas would be turned through a bypass and the feed device rendered inoperative until the pressure were lowered by consumption of gas.



vice rendered inoperative until the pressure were lowered by consumption of gas.

### MAINSRING OF ALARM CLOCK WHICH IS EASILY REMOVED

8871 A new feature of alarm-clock construction is a cartridge mainspring, which makes it a simple operation to repair such a timepiece when this part of the mechanism is disabled. Very frequently the source of trouble in clocks of this type is found to be in the mainspring, and in the past the arrangement of the works has been such

Western Clock Co.,  
La Salle, Ills.

that it was hardly worth while attempting to make repairs. One company, however, has altered the works so that

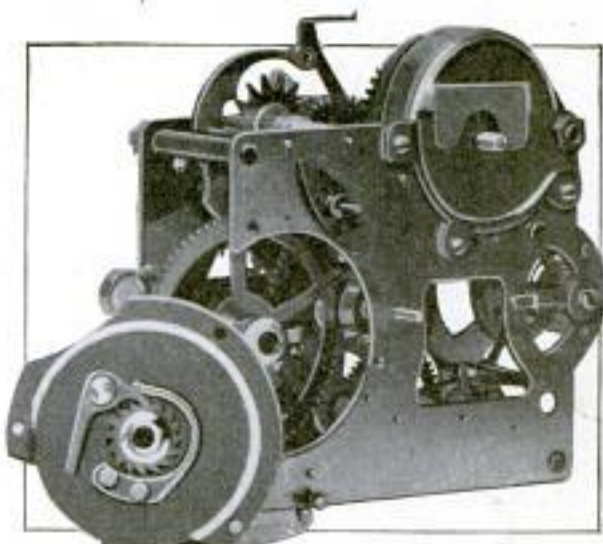

The Mainspring of This Alarm Clock may be Removed and a New One Inserted without Difficulty

this spring is easily accessible and may be replaced without difficulty. Dealers are provided with extra springs so that in case of trouble the clock may be repaired by merely removing one cartridge and inserting a new one.

### ODD MECHANICAL TOY USED AS ADVERTISING NOVELTY 8866

A performing snake which wiggles and dances much to the delight of children is a toy which has been introduced as an advertising novelty. A metal serpent darts back and forth over the flat surface of a case that houses a top, the magnetized pinion of which extends through the cover. When this protruding shaft is revolved rapidly a light piece of metal, shaped and colored to represent a snake, clings to it and is carried in first one direction and then another, squirming in quite a life-like manner.



Interest in Brazilian diamond fields has been stimulated as a result of the European war.

# Logan Sales Agency (Adv)  
3664 Milwaukee Ave.,  
Chicago, Ills.

W. A. C. Novelty Co.  
Fruition, Ill.

8996 H  
**WATER-COOLED MACHINE GUN ADOPTED  
FOR U. S. ARMY**

After conducting a series of tests the War Department has adopted for the United States Army the British, water-cooled, automatic machine gun, a large number of which are being used in the present war by several of the European armies. The weapon is adapted not only for general military service, but may also be used either with or against air craft. It is operated by recoil and has a maximum firing speed of approximately 500 shots a minute. While this is somewhat slower than the air-cooled gun now in service, it is contended that in reality it can fire a greater number of shots in a given period than its predecessor, because the time consumed in inserting the short feed strips used by the latter gun is saved. The regulation .30-caliber cartridge employed by all of the service rifles is also used in this gun, which has an effective range varying from 1,500 to 1,800 yd. The ammunition is fed into it by means of belts holding 250 rounds each. These pass through a slot between the muzzle and the firing and recoil mecha-

nism in the breech, the back pressure from the initial shot ejecting the empty cartridge, withdrawing a fresh one from the strip and inserting it in the chamber, where it is automatically fired. This operation continues at a split-second rate so long as pressure is exerted against the trigger. The barrel is incased in a water jacket which prevents it from becoming overheated. This is refilled from time to time during heavy firing. When the supply of water is limited, an apparatus is employed which condenses the steam generated in the jacket and allows the water to be used over and over. The weight of the gun is 36½ lb., and that of its adjustable tripod approximately 40 lb. This latter member has two short legs at the front and a long one protruding in the rear, all of which telescope. The level is changed by raising or lowering this rear leg and turning an adjusting gear. When the weapon is used at its highest position, 32 in., the operator sits on a saddle attached to the tripod. It has been recommended that this mounting also be used with the air-cooled guns now in service. Such of the guns as are to be used probably will be manufactured in this country.

Street-railway companies of Detroit and Cleveland are trying a plan of placing conductors at crowded corners to collect fares before patrons enter the cars.

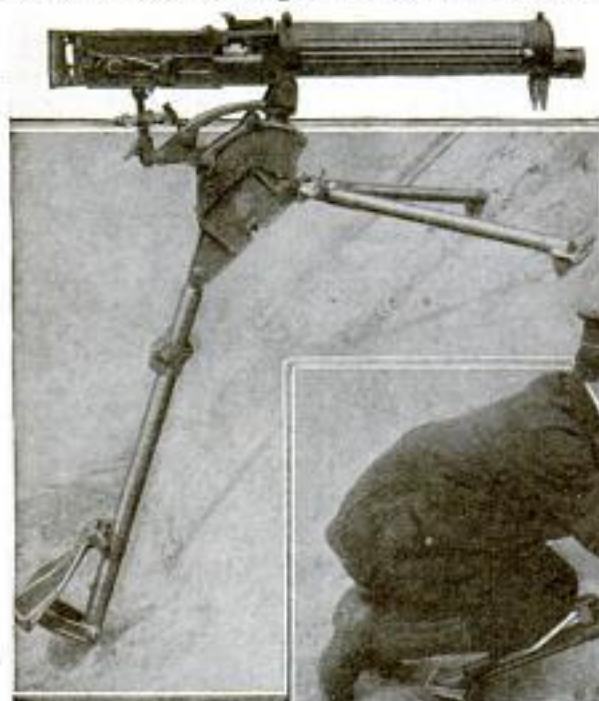

British Machine Gun  
Which Is of the  
Water-Cooled Type,  
Adopted for the United  
States Fighting Forces

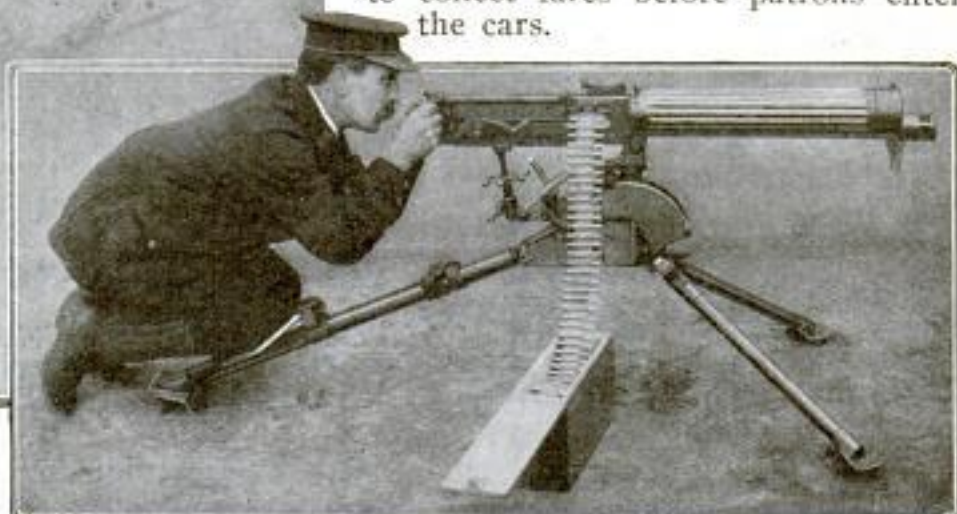

Florence A. Clark  
412 Greenwood Ave.,  
Canon City, Colo.



One of the Wing Dams Built on the Ice of the Upper Mississippi River in the Government's Work of Deepening the Channel

**BUILD WING DAMS ON ICE OF  
8982 H UPPER MISSISSIPPI**

In carrying out its work of deepening the channel in the upper part of the Mississippi River, the government is constructing scores of wing dams out from both shore lines in order to restrict the waters and prevent a spreading of the river bed. In the past this work has been done with boats during the season of open navigation. Engineers this last winter, however, took advantage of the ice by building the dams on top of it over the shallows where access would be difficult at other times. These were built up with alternating layers of willows and rock to the required height and, in some cases, left to drop by their own weight at the first thaw. Frequently, however, the ice has been cut around them. Besides being a time-saving method, this form of construction is much more economical than that of building the dams from barges.

¶The virtual completion of a railway circling the Gulf of Bothnia has materially improved transportation between Petrograd and points on the Swedish coast.

**SURFACE-GRINDING MACHINE  
8521 H USES ABRASIVE BELT**

Designed for polishing metal as well as wood, fiber, and rubber, a new surface-grinding machine has recently been invented which employs an abrasive belt in lieu of a revolving disk. In construction it is simple, its essential parts consisting of a mounting carrying two cylinders and an idler wheel about which a flint or garnet-cloth belt operates, passing over a metal plate, or table, to which an angular brace is fixed for holding the work. The polishing band is made of

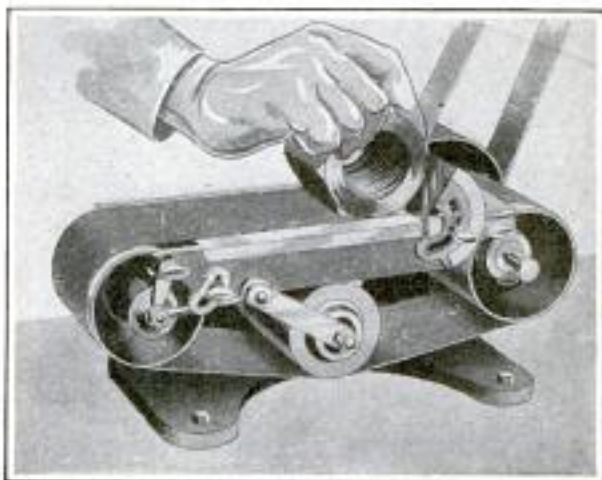

New Surface-Grinding Machine Which may be Used in Polishing Many Different Materials

Callender and Co., Ltd.  
61 Broadway, N.Y. City  
Copyrighted material  
Metal Industries

*Harold M. Sawyer  
Spalding Bldg.,  
Portland, Oregon*



Stairway in a Portland, Ore., Park Cut in a  
Fallen Fir Tree

fabric woven in one piece so that it is without a seam. This may be fitted in place in a moment's time, so no difficulty is encountered in changing from one to another. No particular skill is required in using the apparatus, while great freedom is given the worker by the fact that all the parts are below the table where they cannot interfere with the article which is being ground.

### CONVERT FALLEN FIR TREE 8976 INTO LONG STAIRWAY

By a rather peculiar coincidence a giant fir, which was blown over in one of the parks of Portland, Ore., during a severe storm, fell along a steep, slippery path where it previously had been decided a stairway was needed for safety. Instead of attempting to remove the tree, it was left where it had fallen and steps were cut along its trunk, thus providing the required stairs. The length of the trunk from end to end is slightly more than 100 ft., while its diameter varies from approximately 5 ft. at one extremity to 3 ft. at the other. Fifty-seven steps were cut, each with a length of about 2 ft., a width of 11 in., and a rise of 6 in. A rustic railing was constructed along either side from the limbs trimmed from the trunk.

### SEARCHING COTTON BALES 9021 FOR INFERNAL DEVICES

Following the discovery at New Orleans of a plot to destroy a British mule transport, which was sailing for France, by placing an automatically timed infernal machine in its hold, extreme precautions are being taken in order to frustrate any similar attempt which may be made by aliens in this country. In carrying out this work, every bale of cotton contained in shipments billed for ports in belligerent countries is being inspected by means of X-rays before it is allowed to be placed aboard a vessel. The bales are carried on trucks before these instruments and examined care-

*Underwood & Co.*

*177th St. Ave., N. Y. City*

*Louis A. Dodge, 4528 Danneel St.,  
New Orleans, La.*

*photo of infernal machine*

Copyrighted material



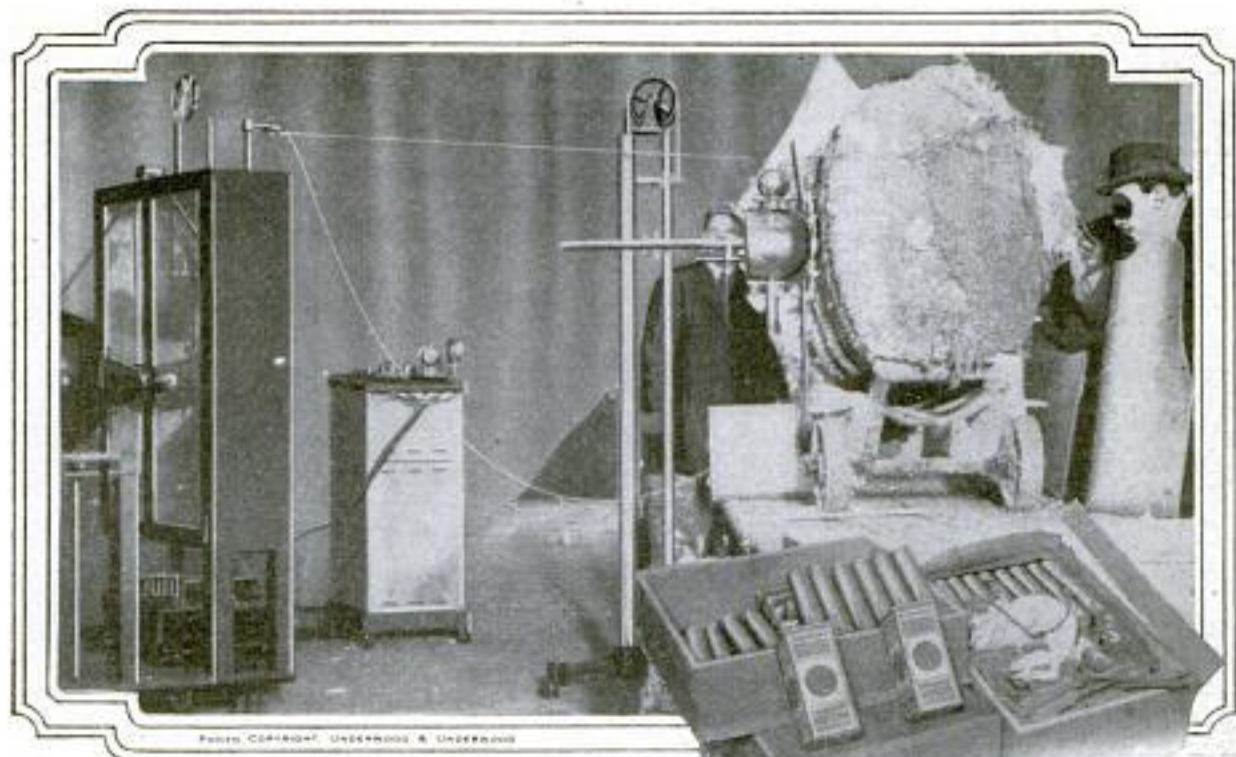

Inspectors Searching Bales of Cotton with X-Rays to Frustrate Attempts to Destroy Vessels of Foreign Register by Placing Infernal Machines in Their Cargoes

Seventy-Five Pounds of Dynamite, Timed to Explode in Six and a Half Days from Sailing, Which was Intended to Destroy a British Mule Transport

fully prior to being passed by the inspectors. Were it not for this, it would be a very simple operation to conceal enough explosives in a single bale of cotton to sink, or at least set fire to, a merchant ship. The infernal machine that was discovered by secret-service agents, and which has led to these precautions being taken, contained 75 lb. of dynamite. This was packed in a heavy box in which a clock, electric batteries, and detonating caps were arranged so that an explosion would occur six and a half days after the vessel left port. The box was ready for shipment when it was discovered, and its maker, a German, arrested.

through a flume, being sufficient to revolve the wheel and to lift the water in small bamboo cups to a trough that leads to the bamboo aqueduct. Although no metal nails were used in its

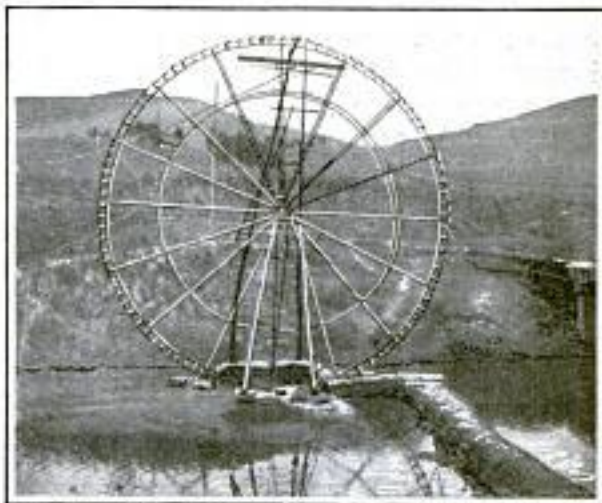

A Water Wheel in Southern China Which Lifts the Water Nearly 50 Feet to a Bamboo Aqueduct

### CHINESE WATER WHEEL OF ENORMOUS SIZE

8547 m At one point in southern China there is an old water wheel of enormous size used for lifting water about 50 ft. to a bamboo aqueduct which carries the water to an irrigation ditch for rice culture. The wheel is self-operating, the swift flow of the stream, diverted

construction, the wheel runs true after having been in use for many years.

Flag Island, Me., has been offered to the government as an aeroplane landing station.

Geo. F. Worts

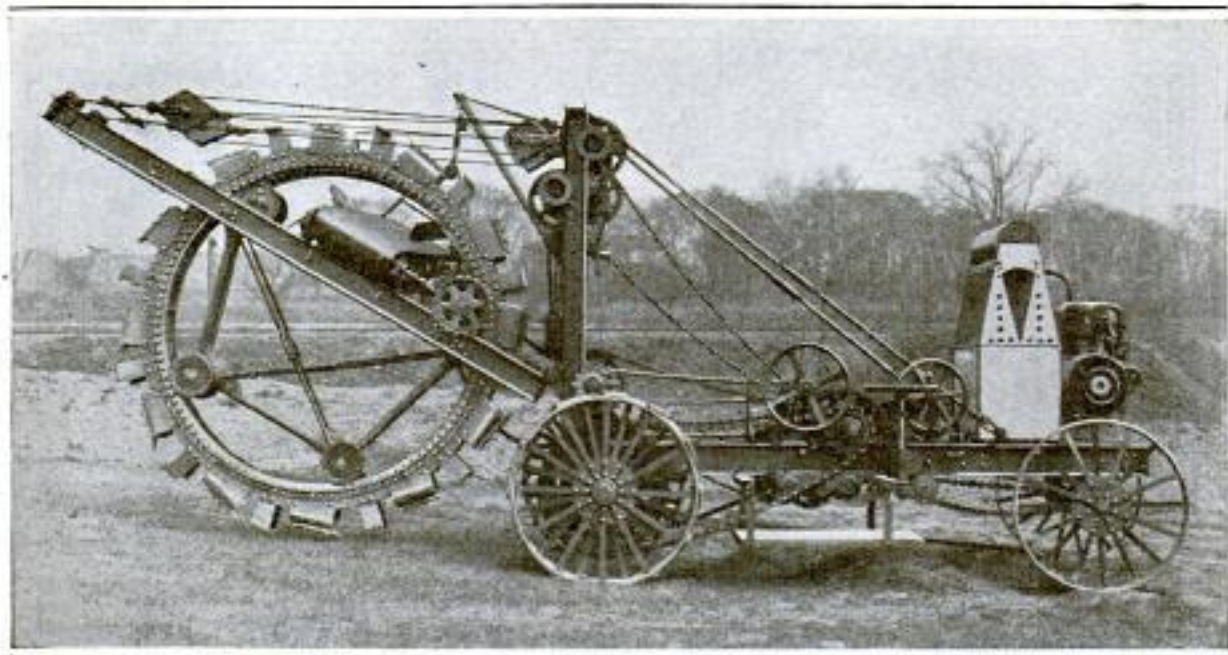

A Trench-Digging Machine That is Propelled and Operated by Gasoline Power

*Necktie*  
**PRESSING DEVICE COMBINED WITH TIE RACK**

Combined with a rack for men's cravats, a roller device is being made which smooths out the wrinkles from neckwear. At the top of the fixture is a mirror, beneath which is a pair of rollers, the upper one provided with strong springs which tend to press it against the other member. When a cravat is wound tightly about the lower cylinder and left until the following morning the wrinkles from the previous day's use are eliminated.

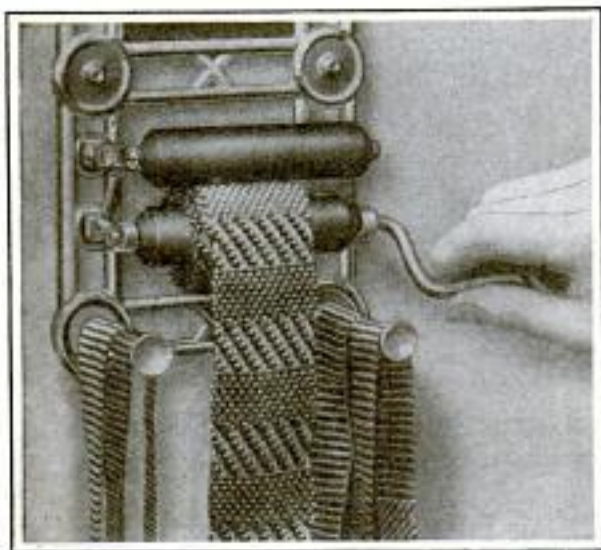

A Tie Rack Which Provides a Means for Keeping Neckwear Freshly Pressed

*8559*  
**TRENCH DIGGER DRIVEN AND OPERATED BY GASOLINE**

Among the many types of excavating machines that have in recent years made digging by hand an uneconomical process is a trench digger propelled and operated by gasoline power. The digging wheel of this machine is of steel and is rotated by steel pinions working on a rack placed on the inner side of the rim. The buckets fixed to the rim are of steel, with sharpened edges and tool-steel teeth. An endless-belt conveyor is used for catching the dirt as it falls from the buckets and depositing it at one side of the trench.

*9094*  
**NEW STYLE OF MEN'S SHOE HAS ELASTIC TOP**

A shoe, the top of which is made entirely of rubber-and-cotton webbing like the fabric used for the elastic gores of congress gaiters, is one of the late styles in footwear for men. In appearance it is the same as the ordinary cloth-top buttoned shoe, but the buttons are merely decorative, the whole top stretching to admit the foot. One advantage claimed for the new shoe is that it offers a better fit than is usually possible with button shoes.

The Fisher Knitting Machine Co., Utica, N.Y.

India Rubber World  
 mfr. Hub Gore makers  
 Boston, Mass.

C. E. Drayer  
1801 East 93rd St.,  
Cleveland, Ohio.

The Sentinel Automatic Gas  
Appliance Co.,  
New Haven, Conn.

8889  
**LARGE BUILDING IS MOVED  
EIGHT MILES OVER WATER**

An unusual piece of house moving was recently accomplished at Cleveland, Ohio, when a three-and-a-half-story building, occupied by a yacht club, was blocked up on barges and towed eight miles over Lake Erie to a new site on an island in Rocky River. The structure is 52 by 78 ft. in size, and placed an aggregate weight on the three scows which were employed of approximately 310 tons. The largest of the barges, 40 ft. wide and 120 ft. in length, was lashed in the middle and supported 80 per cent of the load. When the scows had been prepared to receive the building a timber runway was built between them and the structure. A steel cable was then stretched across a cove, some 700 ft. wide, in front of the club, to a capstan. With the assistance of block and tackle, this was turned by a single horse, pulling the building up a 10-per-cent grade onto the scows. In six hours the house rested on the blocks and everything was ready for the tugs, while only about two hours' time was consumed in towing it to its new location in the mouth of the river.



8600  
**AUTOMATIC GAS STOVE AND  
FIRELESS COOKER**

Automatic control is the principal feature of a new combination gas stove

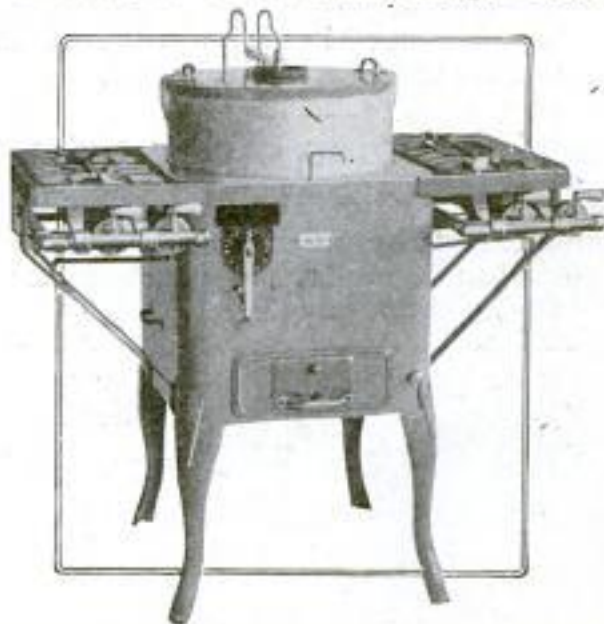

Combination Gas Stove and Fireless Cooker Equipped with Timer for Automatically Extinguishing the Fire at the End of a Given Time

and fireless cooker. The cooking is begun by direct heat from the gas and

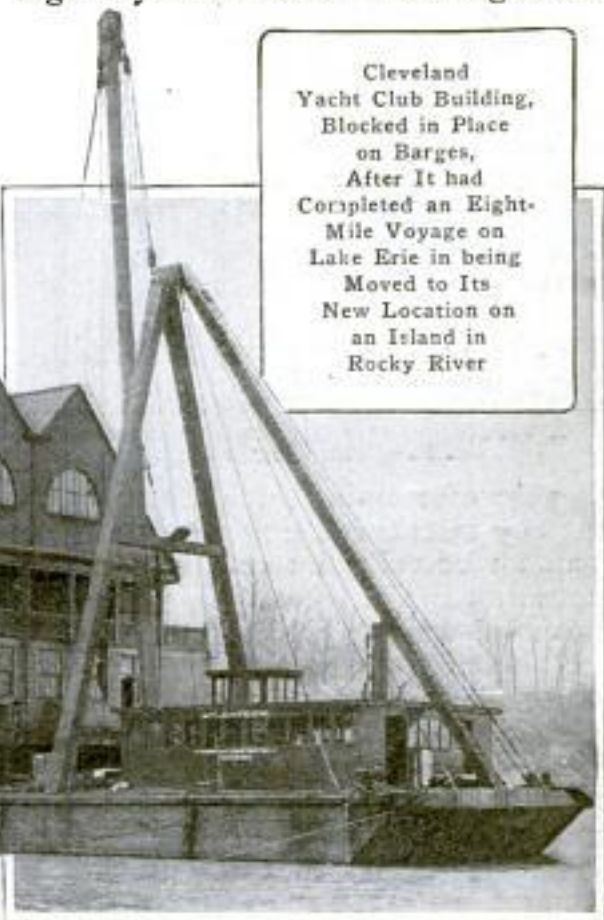

Cleveland Yacht Club Building, Blocked in Place on Barges, After It had Completed an Eight-Mile Voyage on Lake Erie in being Moved to Its New Location on an Island in Rocky River

this is continued until the food is browned. At the proper time the fire is extinguished automatically, and the remainder of the cooking is done by the heat retained in the compartment. This is accomplished by means of a timer which may be set to shut off the fire at the end of any given time.

### SELF-WINDING CLOCK RUNS WITHOUT ATTENTION

Operated by a thermal motor, a clock has been devised which under favorable atmospheric conditions is

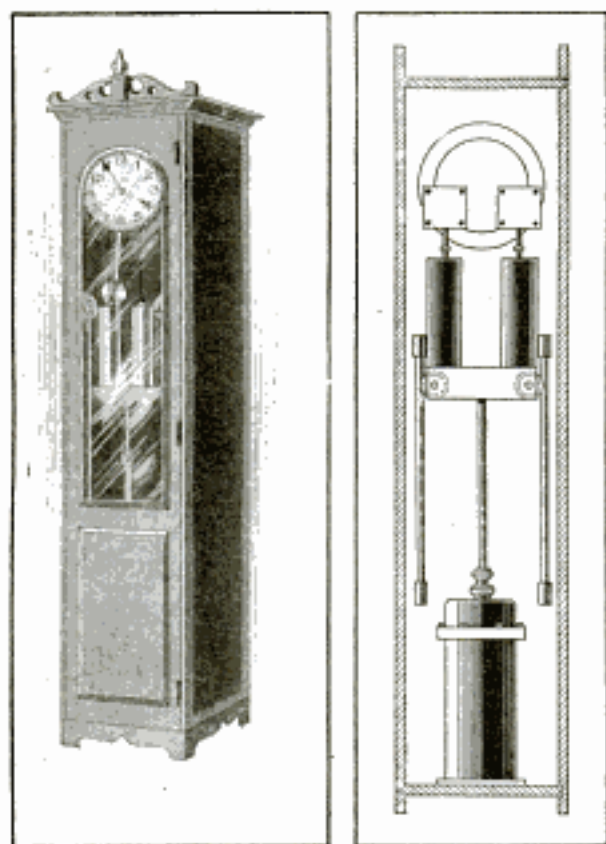

A Variation of Five Degrees in Temperature will Keep This Clock Running

capable of running indefinitely without any attention being given it other than an occasional resetting for time correction. The winding is effected by means of weights which are raised by the piston of the motor, the action of which depends upon a variation in temperature. Its cylinder is filled with two liquids, one of which is heavier than the other and has a greater coefficient of expansion. When the temperature of these liquids is changed so that they expand, the

heavier one is forced to raise the piston in order to escape. A subsequent drop in temperature, causing a contraction of the liquids, allows the clock weights to descend and thus wind the coil springs. The piston is prevented from rising too far by providing an overflow outlet, through which the heavy liquid is allowed to flow into a reservoir at the top of the motor. From this chamber, however, there is a feed duct leading to the cylinder, which allows the liquid to return to that receptacle when the pressure is lowered by the contraction of its contents. This makes the operation of the motor automatic. A temperature variation of 5° every 24 hours is sufficient to keep the instrument running.

### HOUSEHOLD GOODS SHIPPED BY PARCEL POST

"Moving" by parcel post is the latest of novel uses to which this service is being put. This plan was used by a family in shifting their home from a town in Nevada to Grass Valley, Cal., and it is said to have resulted in a considerable saving in transportation charges. The furniture could not be shipped in that way, since it did not come within the 72-in. limit prescribed by the Post Office Department, but all the smaller articles were packed in square boxes and turned over to the mail man. When the shipment reached its destination the owner backed his wagon up to the post office, loaded his boxes and hauled them to his new home.

### BANK VAULT IS PROTECTED BY SYSTEM OF MIRRORS

In constructing a vault in the basement of one of the Los Angeles banks, a plan has been followed which makes the six sides of the chamber visible to a watchman and eliminates all chances of its being entered by tunneling beneath it. It is set on concrete columns in the middle of a white-tiled pit which is brightly illuminated. To

C. L. Edholm  
1353 West 36th Place  
Los Angeles, Calif.

Inventor & Contributor  
A. G. Schweitzerman  
330 Meyer St.  
Dayton, Ohio.

Arch Macdonald  
280 Lee St.  
Oakland, Calif.

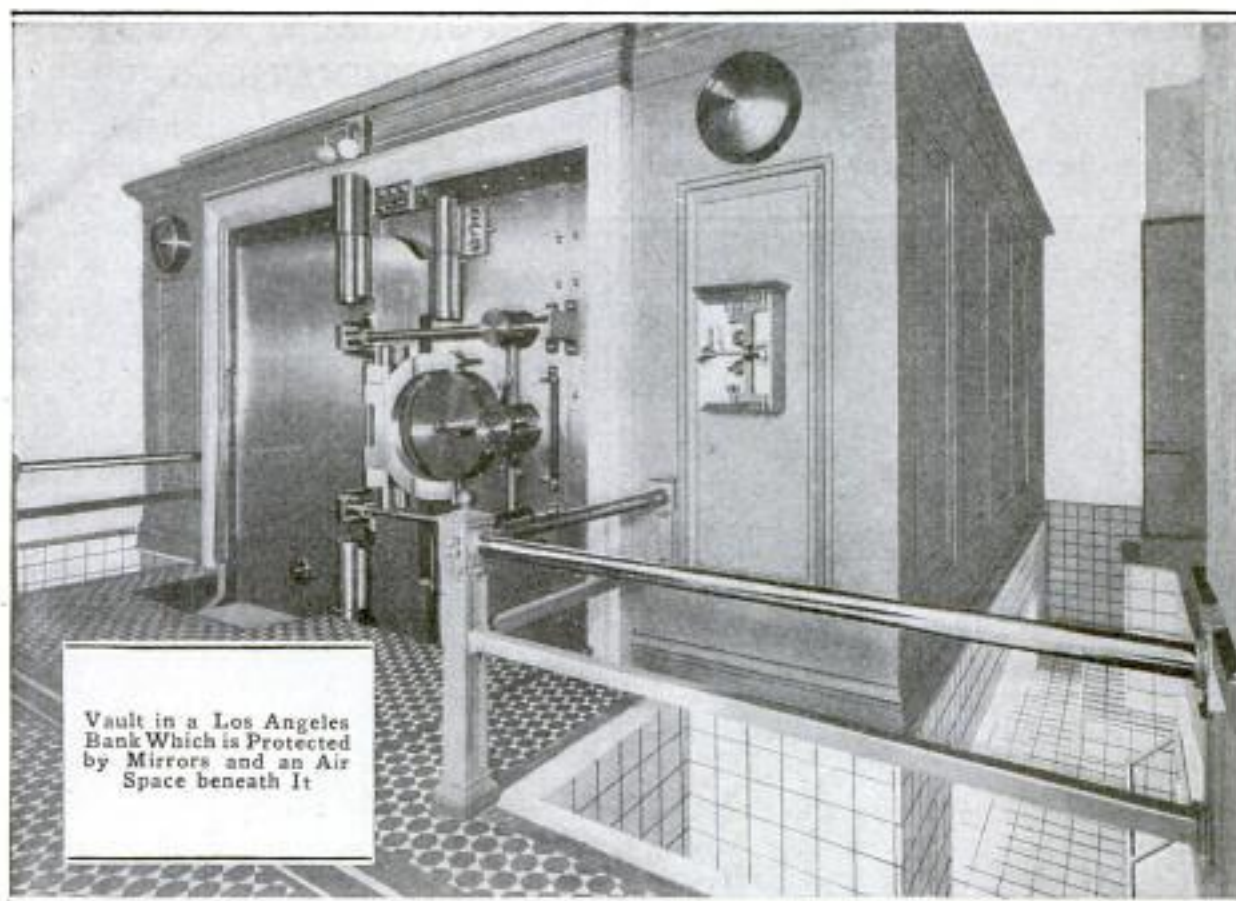

Vault in a Los Angeles Bank Which is Protected by Mirrors and an Air Space beneath It

make it possible to command a view of the space beneath the vault, from the level above, mirrors have been arranged on the floor at such an angle that every part of the space is reflected in them. Light is reflected by the white walls so that the top of the vault is illuminated and easily inspected.

#### CONVENIENT FORM OF APPLE- 8566H PICKING SACK

An apple-picking sack, which enables rapid work and careful handling of the fruit as it is taken from a tree, is used in an Indiana orchard. It consists of a folded bag, with both ends open, and is secured to the wearer by means of straps which pass over the shoulders. The top and bottom ends are brought together, as the bag is folded at the middle, and held in that position by means of hooks and rings. The top of the bag is bound by a heavy wire, semicircular in shape, which holds it open. As it commences to be filled, the hooks are taken from the top

and inserted in the middle rings so that additional capacity is provided. When it is time to empty the sack, the hooks are merely unfastened, and the apples allowed to fall through the open end.



Apple Picker's Sack, Showing How It Appears When being Filled, and How It is Emptied

*Lola A. Pinchou, Seymour, Ind.*  
*Invented by James Jackson, Kingston Apple Orchard*  
*Seymour, Ind.*

8512 **MOUNTAIN-RAILROAD WRECK**  
**HAS CURIOUS RESULT**

A railroad wreck that is of interest not only because no one was injured

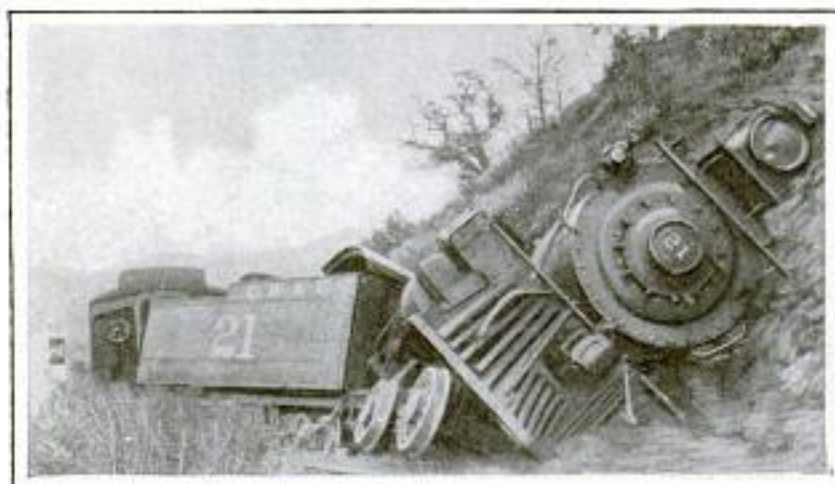

Peculiar Train Wreck on a Colorado Railroad in Which No One was Injured

but from the peculiar position assumed by the locomotive, as if it had simply decided to stop and rest a while, occurred on a Colorado railway recently. Late at night, as the train was rounding a mountain curve, the engineer saw a pile of rocks on the track ahead, a landslide having occurred a few minutes before. The brakes could not prevent the locomotive from striking the rocks, but although the engine's cab was entirely demolished, not even the engineer or fireman was hurt, while many of the passengers in the sleepers were not even awakened.

8473 **PERMANENT GARRISON FOR THE PANAMA CANAL**

According to the plans of the War Department the Panama Canal is to be fully garrisoned at the earliest possible date, as the rapidity with which events have followed each other in the European war has demonstrated that it would be practically impossible to send troops to the Isthmus after a war had been declared or even threatened. This garrison is to consist of three regiments of infantry, one squadron of cavalry, one battalion of field artillery, and 12 companies of coast artillery.

*Arms & Navy Journal*

Prometheus 8-15-14  
 8927 **CARBONIC ACID EMPLOYED IN PNEUMATIC RIFLE**

Compressed carbonic acid is used as the propulsion medium in a new pneumatic rifle recently invented in Germany. The acid is contained in a small cylinder, or cartridge, which holds a quantity sufficient for from 100 to 800 shots, according to the caliber of the gun. By pulling the trigger a valve is opened which allows the gas to pass from the tank into a small cylinder from which it drives the bullet or shot. When shot is used in the rifle, the range for accurate firing is about 80 ft., while with a bullet this distance is increased to approximately 100 ft. The gas cylinder is easily inserted.

**BURGLAR LOCK AND ALARM FOR OUTSIDE DOOR**

A door lock, recently invented, is designed to perform the twofold service of helping to keep a burglar out of a house and giving warning at the same time if one is attempting to break in. It consists of a catch on the inside of a door to which one end of a chain fastens, the other end being attached to the heavy clapper of a gong screwed to the casing. Sufficient slack is left in the chain so that if the door is opened, after the other locks have been picked, the chain is drawn taut with a jerk that rings the bell. The door then cannot be opened farther until the chain is broken or uncaught.

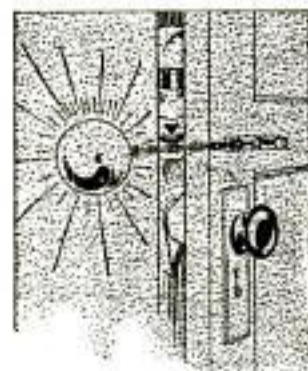

# COMMENT AND REVIEW

**W**ITH all the din of discord of war, it is encouraging to catch even an occasional note of harmony. The world, its people, and conditions are never all bad: in the worst years of crop failure there is always some scant yield. In no spirit of boastfulness, but merely as an evidence of the brotherhood of man, our people are taking advantage of the opportunity, as state after state fills its ship with food for the starving millions of helpless women and children across the sea. As an expression of gratitude and thankfulness for our own immunity from strife, we should give freely out of our abundance. The value to ourselves in years to come of the Christmas ship will far outweigh all the joy which its contents could possibly bring to the forlorn orphans for whom it sailed. The spirit of friendship and the reaching out of millions of little hands on this side to other millions of little hands across the sea cannot fail to implant in young, impressive minds on both sides the seeds of amity which years hence will bear fruit when these children take on the responsibilities of mature life.

*Harmony  
out of  
Discord*

It is ever one of the strange fantasies of war that during moments of intermission the soldiers of two belligerents so easily fraternize. Our own Civil War was full of such incidents; and now there comes to us an account of a football contest between Allies and Germans on Christmas Day, played by soldiers and witnessed by officers and the ranks of both sides. That the interest in the friendly game was so great it was even proposed to postpone hostilities for two days in order to play the game to a satisfactory finish, reveals the great-heartedness of the thousands of individual soldiers and a startling absence of personal hatred. That the kaiser, on learning of the incident, prohibited its repetition on the part of his own men, as detrimental to a proper spirit of enmity between foes, is greatly to be regretted.

Can there be any doubt as to the answer, could a settlement of the present trouble be submitted to the popular vote of the warring nations?



**S**O much has been done in the campaign for "Safety First" during the past three years, it is gratifying to present some actual figures of tangible results, and this record should go far toward convincing and encouraging those hundreds of thousands of men to whom the sermon has been so widely preached.

*Safety-  
First  
Results*

The figures are found in the recent report of the Pennsylvania Railroad, which during the past year operated 26,198 miles of track and carried 188,411,876 souls without the loss of life to a single passenger. This wonderful accomplishment is better comprehended when we learn that more than one million trains were necessary to transport a total almost twice the entire population of the United States. In two years the lines east of Pittsburgh carried over 311,000,000 without loss of life to a passenger in a train accident.

This splendid achievement was not due so much to massive bridges and careful train dispatching, but was only possible because every man of thousands who are seldom seen and of whom the public never hears, was faithful to his responsibility. A loose spike or two here, a rail brace neglected there, have more than once been the straws which yielded to some unusual strain. Many a switch tender, at some little mountain siding, almost too ill to walk, has fought his way through sleet and snow to place the signal lights in their accustomed place. How many times has a tired rear brakeman, in the middle of a stormy night, where no one would have been the wiser, faithfully gone back the required distance with his red lantern, instead of shirking his duty and taking the chance which ninety-nine times out of a hundred might have worked no harm? The management who plan, and direct, and superintend, are justifiably proud of the record, but also should the thousands of employes take equal pride in their no less important part in this grand result.

This conscientious, faithful observance of responsibility, always and every time, especially when it seems most unnecessary, is a lesson of far more value for our boys and girls to learn than any taught in books; and some of us older persons might well take a postgraduate course with profit.



**F**OR some years past our production, especially in manufactures, has been gaining on our home consumption. With natural resources which seemed inexhaustible, we treated the future with the same disregard a young man has for life—it appears to be so long and large ahead. Already has come the time when we hoped to send our wares to distant lands, as England and France and Germany have done for years. With a few notable exceptions, and those chiefly very large interests, we have not progressed very far. Hence, when the war occurred, the great uninformed majority immediately declared that now was our opportunity which generous Fate had handed us on a silver platter. South America, the Orient, Australia, and various islands in numerous seas must stretch out suppliant hands for us to fill with all manner of manufactured goods.

*Our  
Export  
Trade*

That was over six months ago, but thus far the outstretched arms, if any, have not been long enough to bridge the gulf. On the contrary, a great volume of exports previously leaving our shores has been largely curtailed or entirely suspended. Evidently we have yet much to learn.

For many reasons export trade is hard to get and slow to secure. We have judged foreign temperaments by our own. We, who do things quickly and decide important matters in a moment, fail to estimate properly the calm indifference to time characteristic of most foreign lands. We make the wrong approach, and not only fail, but are regarded badly in consequence. Our salesman rushes in, breathless; spreads out samples with the skill of a magician; pulls out the order book, and, pencil in hand, looks expectantly and impatiently at



the customer. Whereas he should have spent a week or more in patient cultivation of acquaintance and, above all things, avoided mention of business until the psychological moment. Our credit system and banking facilities and ships to deliver goods are all in the kindergarten stage, where England and France and Germany are postgraduates.

These conditions, however disappointing, should work to our ultimate advantage. We will be wise to take the lesson seriously and, without further loss of time, set ourselves diligently at work to learn and prepare for the future. The work requires careful and thorough training not only in the language of the country selected, but its history, customs, manners, and etiquette. These things call for young men of ability and perseverance, who are also keen students of human nature—good observers.

To the young man of quality, possessed of these requirements, there are offered great opportunities, but success can only be attained with a lot of hard preparatory work. The reward, however, will be adequate.

H. H. WINDSOR

January 22, 1915.

### DUMMY SHIPS ARE TARGETS FOR BRITISH GUNNERS

At Whale Island, near Portsmouth, the British admiralty maintains a large school where English seamen are trained as gunners for the navy. At this institution many ingenious devices are employed in schooling the men in quickness and accuracy in marksmanship,

among which is the large moving target shown in the accompanying photograph. Two dummy ships are held at either end of the long structural-

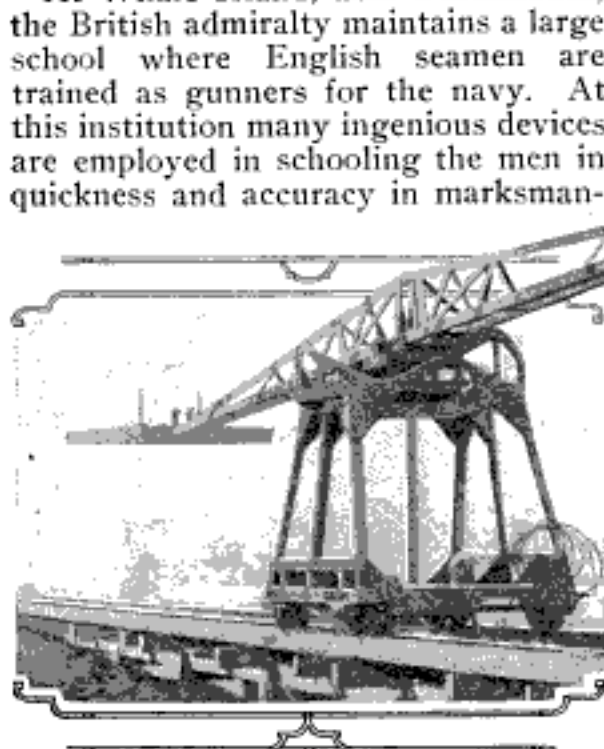

COURTESY OF ILLUSTRATED LONDON NEWS

Moving Targets of This Kind are Used in Training Gunners for the British Navy

*Illustrated London News*  
Nov. 21, 1914

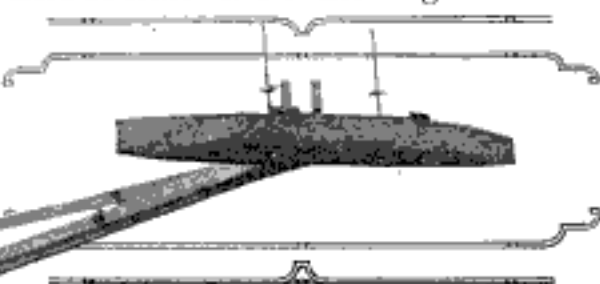

steel crossbar of the supporting apparatus, which is mounted on trucks and operates along a track. These boats are fired at by large guns while they are in motion.

¶The temperatures of 109 stars have been measured by German astronomers. White and blue stars are the hottest, having temperatures up to 9,600°. Yellow stars are cooler than 6,300°, and some red stars are as cool as 3,200° centigrade. Many individual stars are much hotter than any of these, one being estimated at 400,000°.

9018 H WINDSHIELD TO PROTECT  
TRAFFIC POLICEMEN

As a means of shelter to be used during bad weather by traffic policemen stationed at street intersections,



a windshield has been built and placed in use at Richmond, Va. It consists of a sheet-iron drum slightly less than 6 ft. in height, provided with a wooden flooring, raised several inches above the pavement, and a hinged door. It is also supplied with a large umbrella which affords additional protection dur-

ing rainstorms. The weight of the device is sufficient to prevent it from being overturned by the wind, while its appearance is not such as to frighten horses. Only the head and shoulders of the policeman are exposed, but it has been found that this is sufficient to allow him to perform his duties without difficulty.

8928 H TALK HOLE THROUGH BOARD  
DURING SCIENTIFIC TEST

Literally talking a hole through a board was the unusual feat performed recently in Germany during the course of scientific experiments conducted to ascertain the action of phonograph membranes under certain conditions. The apparatus used in making the tests was so constructed that the force of vibrations of the human voice acting on a recording diaphragm, such as is used in making original records, was made to revolve a drill which in turn bored through a board.

The needle in the center of the thin, vibrating membrane of a transmitter, rested on a lever that operated a

*Reclams Universum*

ratchet wheel. This gear was fitted with a worm shaft that revolved a larger gear, the shaft of which constituted the drill spindle. This latter member was so weighted that it pressed the drill head against a board. Thus, when a person talked loudly into the phonograph horn, the drill, through the action of the intervening mechanism, was made to bore into the wood. In this way a young woman talked a hole through a board .4 in. in thickness in 15 minutes. Further tests illustrated the varying powers of the voices of different individuals and showed that the feminine voice has a pronouncedly greater effect than the masculine.

8894 H CURIOUS SHOVEL MADE BY  
BOOTHIA NATIVES

The snow shovel shown in the accompanying photograph was made by



natives of Boothia from wood taken from the "Victoria," the ship used on one of Sir John Ross' arctic expeditions. The blade is tipped with whalebone, ground to a sharp edge and held in place by thongs, while in the middle is a handle made of walrus tusk and also bound with thongs. This curious implement was presented several years ago to Captain Roald Amundsen, the explorer, who later presented it to a Norwegian club. It was used in

breaking the ground for the Norwegian Pavilion at the Panama-Pacific Exposition.

The metric system of measurement has at last gained a foothold in England, having been adopted in the new edition of the British pharmacopoeia.

*Hamilton W. Wright*  
*Panama Pacific Exposition*  
*San Francisco, Calif.*

9127 m Underwood & U. 417 Fifth Ave. N.Y.C.

## RESCUING VICTIMS OF NEW YORK SUBWAY FIRE

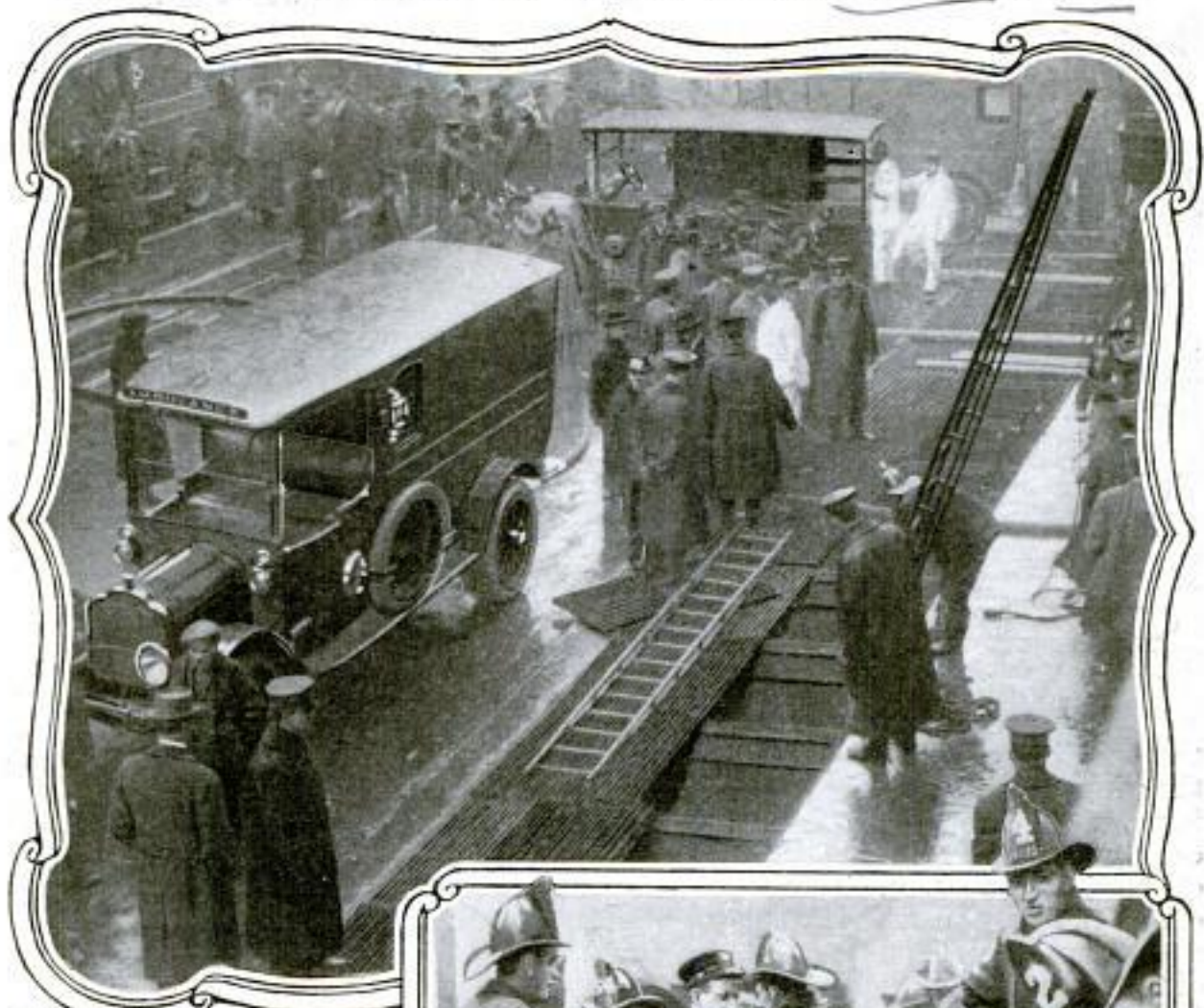

PHOTO COPYRIGHT © INTERNATIONAL NEWS SERVICE

**T**HESSE photographs show how the fire department was able to give the prompt relief that saved the lives of hundreds of passengers imperiled by fire that broke out in the Broadway subway during the morning rush hour, January 6, 1915. Wherever the street is wide enough, removable covers for emergency access to the subway are placed along the side of the street, and it was through these openings that the firemen brought out most of the victims. The fire was caused by a short circuit among the wires composing an electric feed cable, which heated and set fire to the rubber insulation of the cable. The accident occurred near the point where the feed cables from the power house enter the subway and where the cables contain the greatest number of wires and carry the heaviest current. The greatest danger was not from the fire but from panic and the choking fumes of the burning rubber. One woman was killed and about 172 passengers were so badly injured that they were taken to hospitals.



PHOTO COPYRIGHT UNDERWOOD & UNDERWOOD

Inspection by J. E. M. See - July '16 - 90-1792 Vista  
 Literature from " - Jan'y '14 - 85-4761 - Haynes  
 R. M. Owen & Co., Inc.,  
 735<sup>351</sup> 7th Ave ~~NY~~ New York

POPULAR MECHANICS

NEW MAGNETIC TRANSMISSION FOR MOTOR CARS

9247

One of the latest developments in motor-car equipment is an electrical apparatus through which the power of

the second unit becomes successively weaker and the magnetic drag of the first unit stronger, until in the seventh and last stage the first unit acts alone as a magnetic clutch, current for energizing the magnets being created

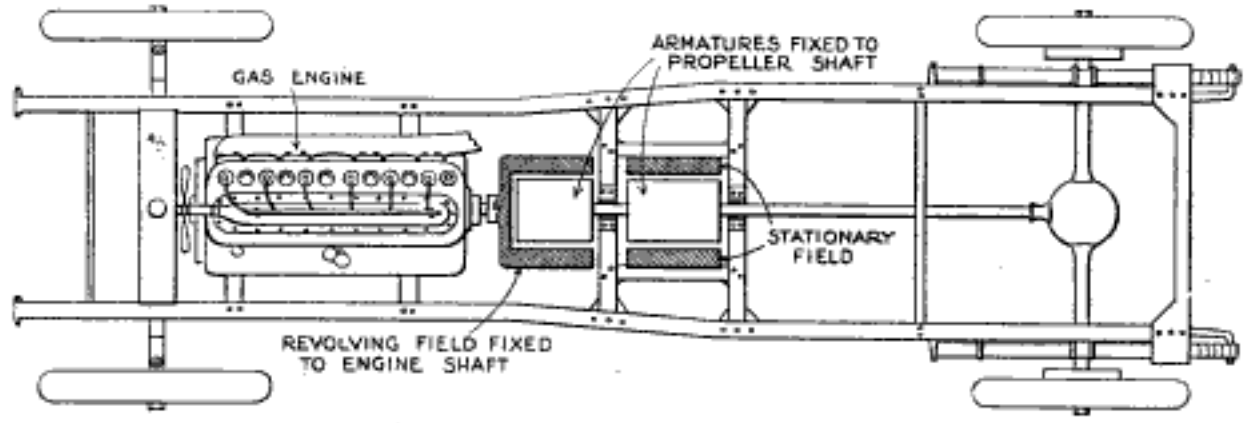

Diagram Showing the New Magnetic Transmission: In This Apparatus Only so Much of the Power of the Engine as is Required for Transmission Purposes is Converted into Electric Force

the gasoline engine is transmitted to the propeller shaft solely by magnetic force, thus doing away with the necessity for gear shifts, or other mechanical transmission. This apparatus differs radically from the ordinary electrical transmission in that only so much of the power of the engine as is required for transmission purposes is converted into electrical force. The apparatus consists of two electrical units, in both of which the armature is fixed to the propeller shaft of the car. In the first, or forward, unit the field is fixed to the engine shaft and revolves with it, while in the second, or rear, unit the field is stationary and is supported on the frame of the car. In the various stages of operation the first unit acts as dynamo, magnetic clutch, and motor, and the second unit as motor and dynamo. The action of these units is controlled through resistance coils.

by the slip between the revolving field and the armature on the propeller shaft. The amount of slip required for this purpose is surprisingly small, being estimated at about 50 revolutions in 1,000. In the seventh stage the second unit is idle, so far as the running of the car is concerned, but acts as a dynamo for storing up power in the small storage battery that supplies current for lighting and for starting the engine.

METHOD OF MAKING DUSTLESS CONCRETE FLOORS

9058

A new method of making dustless concrete floors consists simply in spreading dry sand and cement over burlap, laid on the wearing surface coat immediately after it is struck off. Up to the time of applying the burlap, standard specifications are followed. A dry mixture, similar to that used for the wearing course, is spread lightly over the burlap to a depth of about 1/2 in. It is claimed that capillary attraction takes out the excess of water in the concrete in from 20 to 30 minutes, leaving the surface in perfect grade and ready for final finishing by float or trowel. After being used for this purpose, the mixture is dumped into the mixing box for the next batch of con-

With the engine running, the rotation of the field of the first unit about the armature on the propeller shaft sets up an electrical current which is transmitted to the second unit and operates it as a motor for turning the shaft. In this action the first unit exerts a magnetic drag which serves to augment the action of the second unit. By varying the resistance the motor action of

Engineering 12-5-14

The Anderson Sales Co.,  
 Unity Bldg., Springfield,  
 50¢ + 12¢ postage  
 355

POPULAR MECHANICS

crete. The cause of "dusting," which this process is designed to overcome, is in the partial setting of the cement that occurs under ordinary conditions while the surface is drying sufficiently to be troweled. Some setting is sure to occur during this interval and the subsequent troweling breaks up the crystals formed in this way. In addition to this, the troweling has a tendency to bring the excess water to the surface, forming a film of "drowned" cement. This scales off under wear and exposes a sandy finish that is subject to excessive abrasion. The new process, by extracting the water quickly, gives no time for the partial setting, so that no injury is done to the surface by the troweling.

ICE BOAT DRIVEN BY AN  
 AERIAL PROPELLER

9134 m

A motor ice boat driven by an aerial propeller and capable of making a speed of 50 miles an hour on smooth ice has been built and is in service in the East. This boat is 22 ft. long and 8 ft. wide, and carries eight passengers in addition to the pilot and engineer. The power plant consists of a 45-hp. motor which drives the aerial propeller, 8 ft. 8 in. in diameter. Each of the front runners is 44 in. long, while the rear runners are each 54 in. long. Both the front and rear runners are spaced 9 ft. apart. The front runners are connected to the body of the craft by vertical pins and are steered with an ordinary steering wheel.

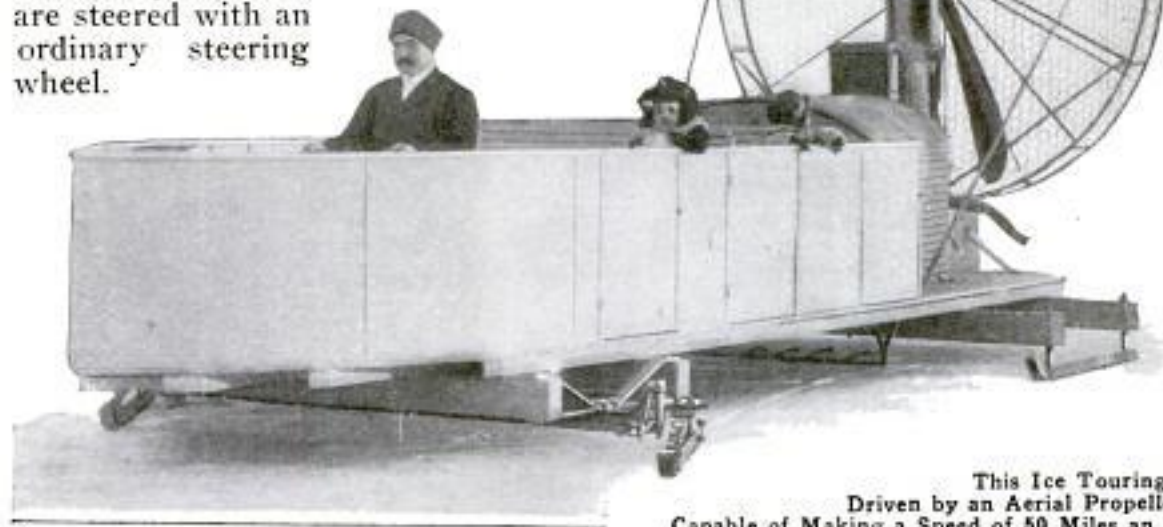

CARD HOLDER FOR PLAYING  
 THE GAME OF "RUM"

9170 m

A board to be used in playing the popular card game known as "rum" has just been placed on the market.

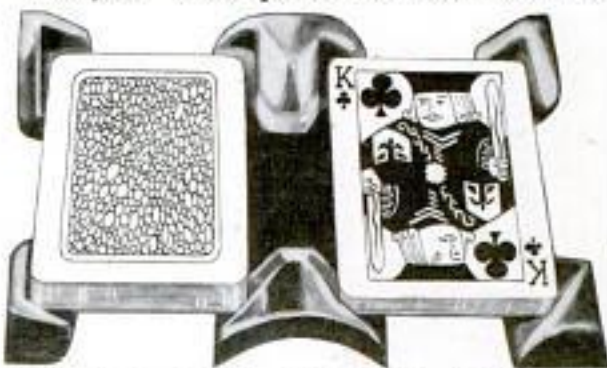

This Board, Used in Playing "Rum," Keeps the Cards from being Scattered about the Table and Prevents Any but the Top Card in the Discard from being Seen by the Players

This board is virtually a metallic tray divided into two compartments, one for the pack and the other for the discard. Each compartment is open at the ends and sides, the cards being held in place by the upstanding corners. The purpose of the board is to keep the cards from being scattered about the table as well as to prevent any but the top card in the discard from being seen by the players.

Monroe with 716 at ...  
 A. C. McElroy - A. 218 So. 1st St. Wash. D.C.

Paul Thompson  
 10 Spruce St., N.Y. City

This Ice Touring Car, Driven by an Aerial Propeller, Is Capable of Making a Speed of 50 Miles an Hour

Underwood + U. 417 Fifth av. N.Y. City

9067  
m

### RUINS OF BURNED CHURCH INCASED IN ICE



This Curious and Beautiful Ice Formation Was the Result of Turning the Hose on a Burning Montreal Church, Which was Destroyed by Fire on Christmas Day, 1914, with the Thermometer Registering 18 Degrees below Zero

## TALKING ACROSS CONTINENT

### 9231 H FOR FIRST TIME

On Jan. 25, 1915, telephonic communication was held between New York and San Francisco. This was the first time that the human voice had ever been transmitted across the continent, or in any other direction for such a great distance.

The circuit when put up extended from New York to Washington, D. C., Jekyll Island, Georgia, and California. From the capital, President Wilson spoke to President Moore of the Panama-Pacific Exposition, while the president of the American Telephone and Telegraph Company "listened in" from Jekyll Island. Before this, however, Dr. Alexander Graham Bell, inventor of the telephone, seated at a desk in Gotham, talked with Thomas A. Watson in San Francisco. These two men the first to speak across the continent, were also the first ever to use the telephone.

After a formal interchange of messages the original telephone instrument was cut in on the line. And even with this crude-looking apparatus it was possible to hear quite clearly from ocean to ocean. It is the same instrument through which Mr. Watson, then a young electrician working with Doctor Bell, heard the first spoken words ever transmitted over a wire. This was on March 10, 1876, in the basement of a building at 109 Court Street, Boston. Doctor Bell at the time was in his workshop on the top floor of the structure shouting with all his strength into the transmitter. The words were, "Mr. Watson, come here, I want you."

Some months ago construction parties working between San Francisco and Salt Lake City met at the Utah-Nevada state line, completing the first transcontinental telephone circuit, as described previously in this magazine. Had wires extended from coast to coast at the time Doctor Bell and Mr. Watson held their first telephonic conversation, however, it would have been impossible for them to have communicated across the continent, even

though it is possible today with the identical instrument they used 39 years ago. The reason is that the realization of the interoceanic system came not merely by the erection of wires, but as the result of numerous inventions relative to long-distance communication, one of the most important of which is the Pupin coil.

## MEDALS GIVEN TO HEROES

### 9126 M OF VERA CRUZ

In recognition of their heroic conduct during the occupation of Vera Cruz, 14 sailors and marines of the United States Navy have each been presented with a medal granted under a special act of Congress. The presentation was made on Jan. 6, 1915, by the secretary of the navy, the ceremonies being held at the New York navy yard on the deck of the U. S. S. "Florida," on which all of the men receiving medals are stationed.



COPYRIGHT,  
INTERNATIONAL NEWS SERVICE

## GERMAN MILLS USE WIND AND

### 8937 M STEAM POWER

A curious combination of ancient and modern power is seen in some sections of Germany where many of the mills are equipped with windmills; much like those of Holland, as well as with modern engines using superheated steam, one serving as auxiliary to the other. One flour mill, which is typical, is driven by wind power whenever possible, but is provided with an 80-hp. engine which assists in furnishing the power when the wind power is lacking or insufficient.

Prometheus

C. L. Edholm, 1353 West 36th Place  
Los Angeles, Cal.

Canal Record 11/11/14

358

### POPULAR MECHANICS

See Mch 1917-422 same

#### NEW ROTARY ENGINE WITH HORIZONTAL CYLINDERS

8542 m

A rotary internal-combustion engine recently brought out by a California inventor differs radically from any

"Macomber"

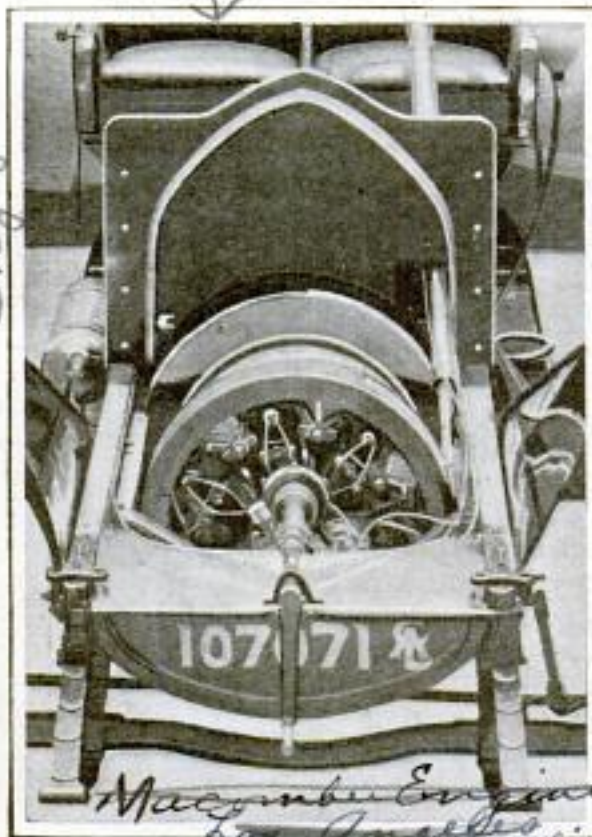

Front View of Rotary Internal-Combustion Engine Having Cylinders Placed Parallel with the Shaft

Engle-Macomber 11000  
13505 Mich. Av.  
Calif

been used successfully for driving an aeroplane, and the other a 12-hp. engine particularly adapted to cyclecars. The 50-hp. engine weighs 250 lb. The simplicity of construction is indicated by the fact that the engine has only one cam, no valve push rods, and only two bearings for preserving alinement. Both engines are air-cooled.

#### HEAVY GRAIN SHIPMENTS THROUGH PANAMA CANAL

8827 m

The largest item of cargo so far carried through the Panama Canal is grain shipped from the north Pacific ports of the United States and destined for Europe. In the 2 1/2 months of canal operation, ended Nov. 1, 1914, the canal was used by 17 east-bound vessels engaged in this traffic, while eight west-bound vessels passed through in ballast to return later laden with grain. During this period an aggregate of 122,258 tons of grain was carried through. By having the canal available and thus being able to avoid the Magellan route, each of these vessels saved about 5,550 miles of distance and about 23 days of time in making the trip from the Pacific coast to English ports.

Magellan

#### HANDLE WORN BY FRICTION OF HANDS

8601 m

A hammer handle worn nearly in two by the friction of the hands during years of constant use is one of the curious relics preserved in a wagon maker's shop at Elkhart, Ind. This

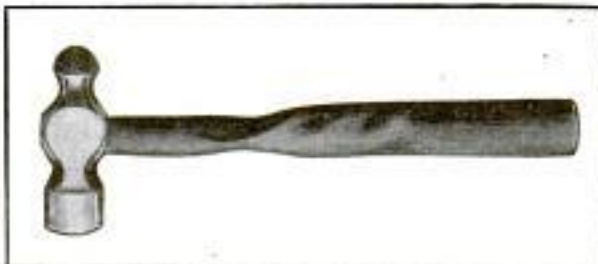

This Handle was Worn Down by One Man's Fingers in 25 Years

handle is of hickory and was used in an ordinary machinist's hammer for a period of more than 25 years.

L. A. Curtis, Elkhart, Ind.

used in Factory Studs -  
baker wagon works,

Dr. Reed, Ind.

made in that it has the rotating cylinders placed parallel with the shaft instead of radial, as is the practice with the Gnome and other rotary engines. In the new engine the horizontal motion of the pistons is transformed into a rotary motion by the action of the piston rods against a circular plate, or spider, which is held in an inclined position. In this way the centrifugal force, which is sometimes the cause of bad accidents, is greatly reduced. The engine acts as its own flywheel, as practically the entire mechanism rotates. Lubrication is positive, being arranged to take advantage of the centrifugal force which carries the oil to every part of the engine needing lubrication. Two sizes of the engine have been built and tried out, one being a 50-hp. engine that has

used by

Engle-Macomber

13505 Mich. Av.

Calif

Copyrighted material



AN UNUSUAL KIND OF UNDERSEA PHOTOGRAPH



**R**EADERS of Popular Mechanics Magazine who recall the articles on making motion pictures under water, published several months ago, will be interested in this portrait of one of the young men who constructed the apparatus by means of which movies can be made at the bottom of the sea. This photograph of George Williamson was taken at a depth of 30 feet under water. His brother, Ernest Williamson, operated the camera from inside the glass-fronted steel chamber which, connected with the surface by a canvas and rubber tube large enough to admit a man's body, constitutes the submarine photograph gallery. The device was invented by the father of the Williamson boys, Captain Charles Williamson.

**PROJECTILE MELTS STEEL BY THERMIT PROCESS**  
 8737 *m*

According to reports of tests to which it has been subjected, a projectile just invented by an American is one of the most deadly implements of war ever known. When this projectile strikes and explodes, molten metal at a temperature high enough to burn a hole through steel, or melt down solid concrete walls, is scattered broadcast. Curiously enough the metal with which the projectile is charged and the means used for making it molten comprise the application of a process that is in common use in the industries—that of thermit welding. The mixture known as thermit consists of fine grains or filings of aluminum mixed with a metallic oxide, usually that of iron or chromium. Aluminum has a high affinity for oxy-

gen. When this mixture is heated to a certain temperature the aluminum combines with the oxygen, the chemical reaction being so violent that the mixture instantly becomes molten and white hot with a temperature of something like 5,000° F. In the welding process the resulting aluminum oxide rises to the surface and is allowed to flow off as a slag, while the remaining metal binds together the parts to be welded. These parts are, of course, heated to a fusing temperature in the process.

The principle of the action that takes place within the projectile is easy to understand, although it has not been explained in detail. The projectile carries a high explosive that is detonated when the projectile strikes, though it can, of course, be exploded with a time fuse. Arranged around this explosive

*Australasian Hardware & Machinery Oct. 1, 1914*  
*Letter from Geo. A. Walton, Newbury Mass*

is the thermit mixture. The heating of the thermit mixture is started as the projectile leaves the gun. Five seconds later the chemical reaction has taken place and the mixture is a mass of molten metal. When the projectile strikes and explodes, this molten metal is scattered in every direction, setting fire to everything within range that is capable of being burned. The projectile can be used in any of the modern siege guns. While it can doubtless be employed effectively against troops its principal use is expected to lie in the destruction of fortifications, buildings, observation balloons, and flying craft.

and determines its grade by comparison with the standard grades in the receptacle.

**HAT ACTS AS CONDUCTOR OF ELECTRIC CURRENT**

That there may be danger for electrical workers even in the hats they wear was demonstrated in a fatal accident that happened in an electrical substation in northern Indiana. With hat in hand the foreman was explaining the details of some of the work in the new substation. The hat came in contact with the high-tension wiring, and the foreman received a fatal shock. The hat was an ordinary stiff hat having a band of steel reinforcing in the rim. The explanation of the accident is that the steel acted as a conductor, with the result that a circuit was completed through the hat and the foreman's body to the ground.

**A SIMPLE DEVICE FOR GRADING COTTON**

A simple cotton-grading device, especially designed for the convenience of farmers, is being introduced in the South. This is a pan-shaped receptacle, about 18 in. in diameter and 2 in. deep, divided into nine equal compartments arranged radially around a central opening 6 in. in diameter. The entire front is covered with glass, but the central space is left open at the back. In each compartment is placed a sample of one of the nine standard grades of cotton. In grading, the farmer takes a fair sample of his cotton, holds it in the opening under the glass

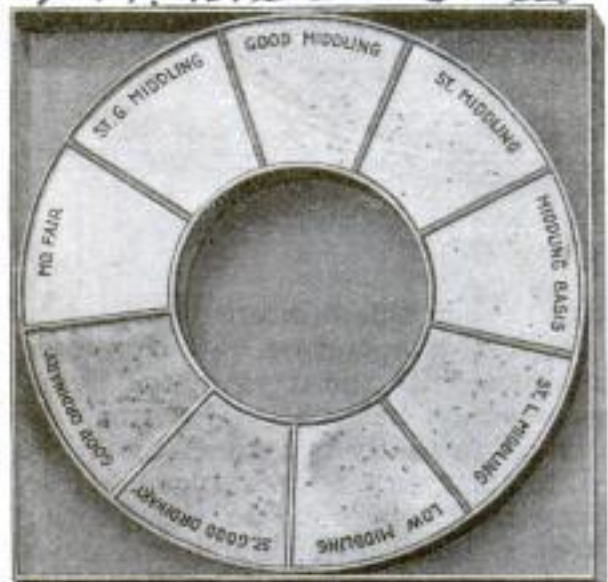

Cotton-Grading Device in Which are Displayed the Nine Standard Grades of Cotton

tacle, about 18 in. in diameter and 2 in. deep, divided into nine equal compartments arranged radially around a central opening 6 in. in diameter. The entire front is covered with glass, but the central space is left open at the back. In each compartment is placed a sample of one of the nine standard grades of cotton. In grading, the farmer takes a fair sample of his cotton, holds it in the opening under the glass

**MACHINE MAY LESSEN USE OF POSTAGE STAMPS**

The adoption of a stamping machine which it is proposed to lease to large users of the mails, and which, if put in service, would do much to lessen the use of adhesive stamps, thus effecting a material saving in the expenses of both the postal department and the large commercial houses of the country, is being considered by the government. The chief purpose of the machine is to expedite the handling of outgoing mail. In appearance it is not greatly unlike the ordinary canceling machines used in practically every post office of any size in the United States. The work accomplished by it is that of sealing, imprinting a prepaid stamp in lieu of the ordinary stamp, and counting and facing approximately 250 letters a minute. The important feature of the apparatus is its stamping, which is done by means of a cylinder that may be set to revolve a specific number of times, printing one label on each turn. The action of this cylinder is controlled by a meter which, when turned to a certain num-

The Farmers Cotton Grader Co., 150 W. Jackson St., Dallas, Texas.

9140 m

794 m

8843 m

10. F. O. B. Dallas Texas

Tom Shiras  
Mountain Home, Ark.

R. H. Ross, Room 1085, 440 S. Dearborn St. Chicago

American Postage Meter Co. 511-608 S. La Salle St.  
163 621 639 Dearborn St.

POPULAR MECHANICS Chicago, 361 Ill.

ber, will automatically stop the machine when it has stamped that number of impressions, representing the amount of postage for which the user has paid. The impression, which appears in the same position as would a stamp, bears a figure indicating the

estimated that by the use of this machine the government would save a considerable amount of money annually in the cost of manufacturing stamps, including the cost of paper, printing, gumming, perforating, sorting, accounting, transporting, distributing,

PITNEY POSTAGE METER

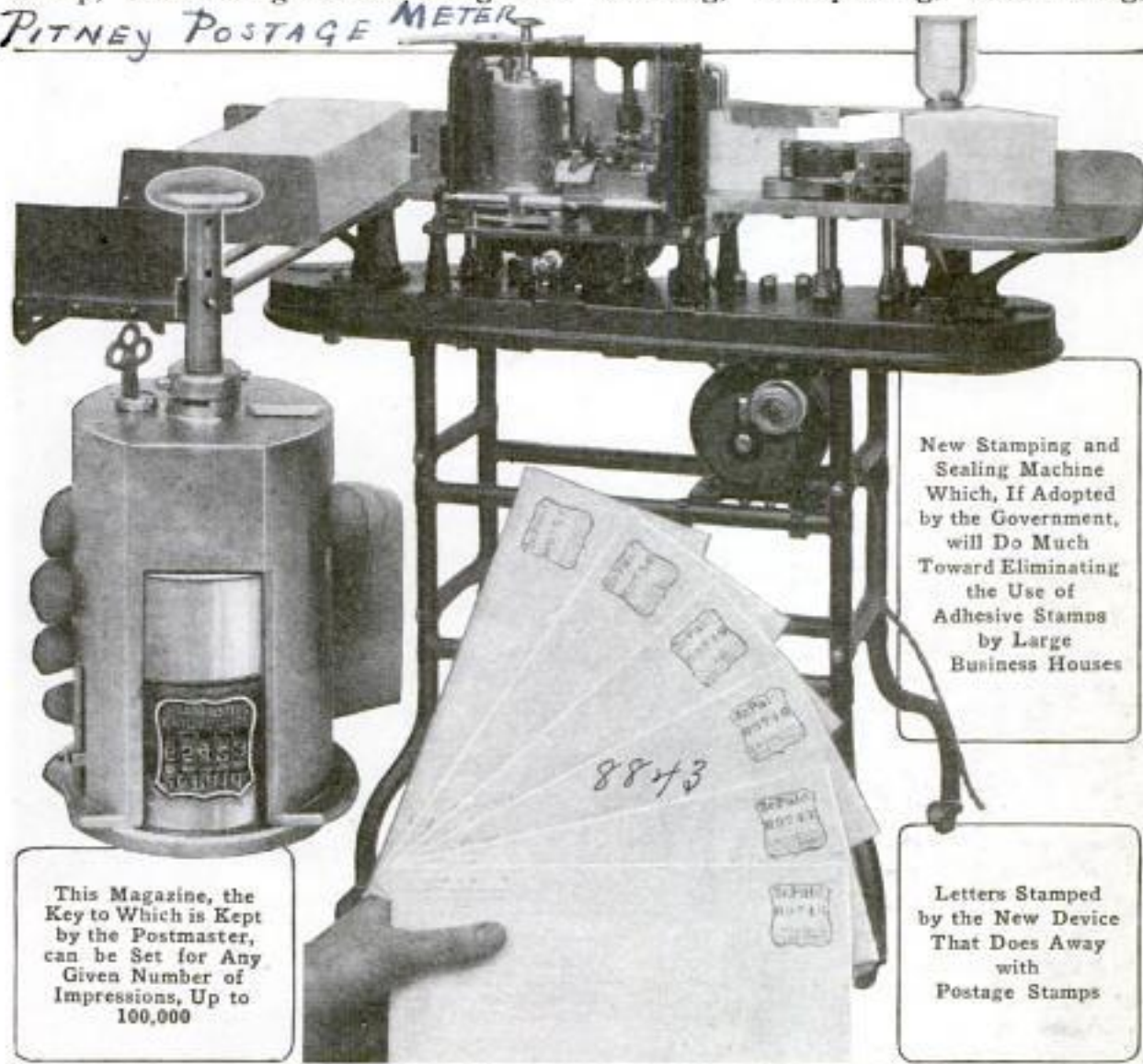

This Magazine, the Key to Which is Kept by the Postmaster, can be Set for Any Given Number of Impressions, Up to 100,000

New Stamping and Sealing Machine Which, If Adopted by the Government, will Do Much Toward Eliminating the Use of Adhesive Stamps by Large Business Houses

Letters Stamped by the New Device That Does Away with Postage Stamps

amount of postage, a descending serial number which shows the number of impressions still due the user on his purchase, the name of the post office, and the license number.

A metal casing incloses the printing mechanism and register, and this must be taken to the post office before it can be reset. Each machine is fitted with interchangeable cylinders of this kind, carrying the various denominations of postage required for the different classes of mail sent out. It is esti-

and canceling. On the other hand, a saving in money and time would accrue to the individual users, it is asserted, since the machine facilitates the stamping, sealing, and counting of letters, and eliminates much manual work. Machines of a similar nature have been in use in New Zealand and Bavaria for several years. The principal saving of time at the post office in handling mail stamped in this manner would come in the elimination of cancellation.

## FIELD TELEPHONE AND TELEGRAPH IN USE



German  
Engineers in  
Belgium  
Repairing  
Telegraph  
Conduits



Germans Erecting  
Telephone and  
Telegraph Wires  
through the  
Argonne Forest



Field Telephone  
of the Germans  
Operated in  
Connection with  
an Observation  
Post Maintained  
in Top of Tree  
in Background

## IN VARIOUS CONTINENTAL BATTLE ARENAS

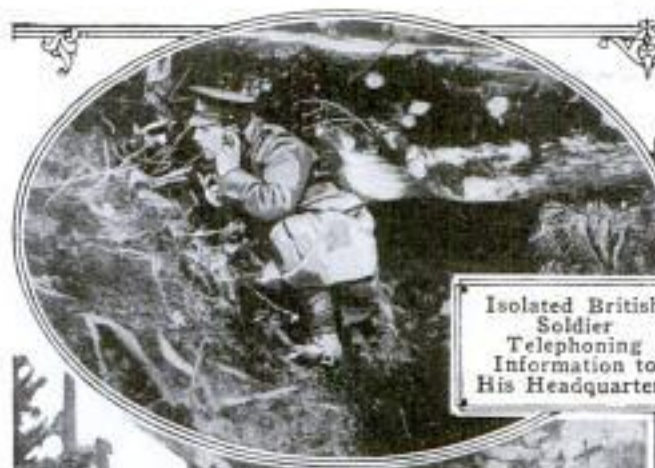

Isolated British  
Soldier  
Telephoning  
Information to  
His Headquarters



Germans  
Restoring  
Telegraph Poles  
and Wires  
Destroyed by  
the Russian  
Forces



Itinerant  
Field  
Telephone,  
in Use by the  
Germans,  
While being  
Moved from  
Point to Point

## TROOPS FROM AFAR FIGHTING IN EUROPE



Copyright International News Service  
**Raw Recruits for the Germanized Turkish Army Disembarking from a Steamer in Constantinople After the Holy War was Declared**



Copyright International News Service  
**Fiji Islanders, Who might be Termed Christianized Cannibals, are to Fight with the Allies in Europe. This Group is under the Command of a British Officer**

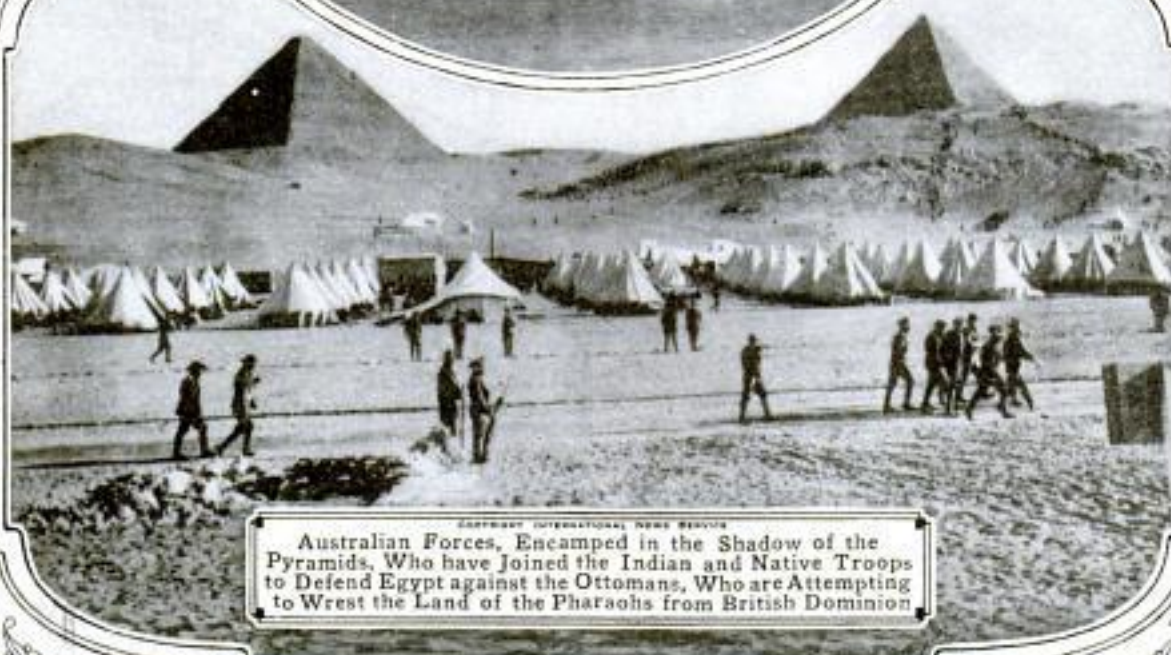

Copyright International News Service  
**Australian Forces, Encamped in the Shadow of the Pyramids, Who have Joined the Indian and Native Troops to Defend Egypt against the Ottomans, Who are Attempting to Wrest the Land of the Pharaohs from British Dominion**

## MAKING MILITARY OBSERVATIONS UNDER FIRE



COPYRIGHT INTERNATIONAL NEWS SERVICE  
**Belgian Reconnaissance Airman Handing a Dispatch to a Motorcycle Messenger after Flight over Enemy**



COPYRIGHT UNDERWOOD & UNDERWOOD  
**Lookouts on the French Line Watching the Movements of the Enemy through a Periscope**



COPYRIGHT INTERNATIONAL NEWS SERVICE  
**Behind Russian Lines during One of the Prolonged Engagements in Galicia: The Officers Observing Effect of Fire on Enemy**



**Members of the French Signal Corps Ascending in a Captive Balloon above the Battle Field at Arras**

CURIOUS GLIMPSES CAUGHT OF EUROPE'S WAR



French Sharpshooters in Action during the Battle of the Yser. Pollarded Trees are Used by Military Observers of Both the Germans and Allies as Vantage Points and Places of Partial Concealment



Entrance of a Subterranean Tunnel, Leading from the French Lines to Within a Few Feet of the German Trenches



Members of an Austrian Alpine Regiment on Skis Ready for a Dash across the Mountains. Some Carry Parts of Machine Guns on Their Backs

KODAK  
COPYRIGHT HADERWOLD & WUNDERWOLD



## WRECKAGE ALONG EUROPEAN BATTLE PATHS

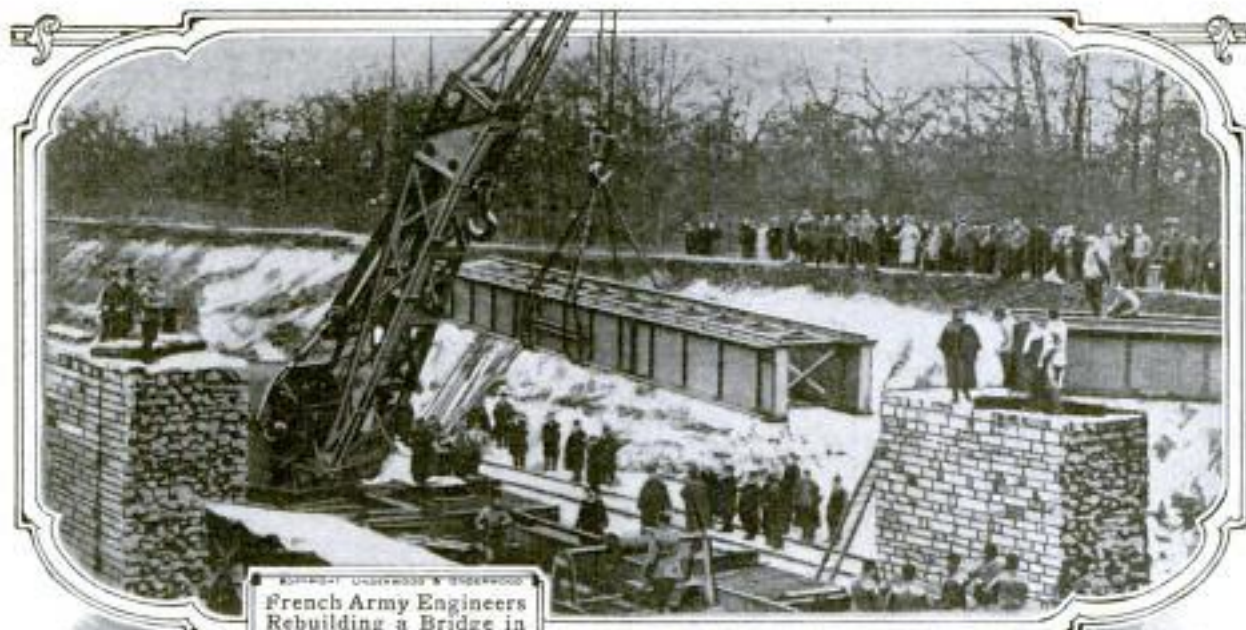

WESTPHAL UNDERWOOD & UNDERWOOD  
French Army Engineers Rebuilding a Bridge in the Forest of Argonne Which was Destroyed by Retreating German Forces in Order to Cut Off Their Pursuers

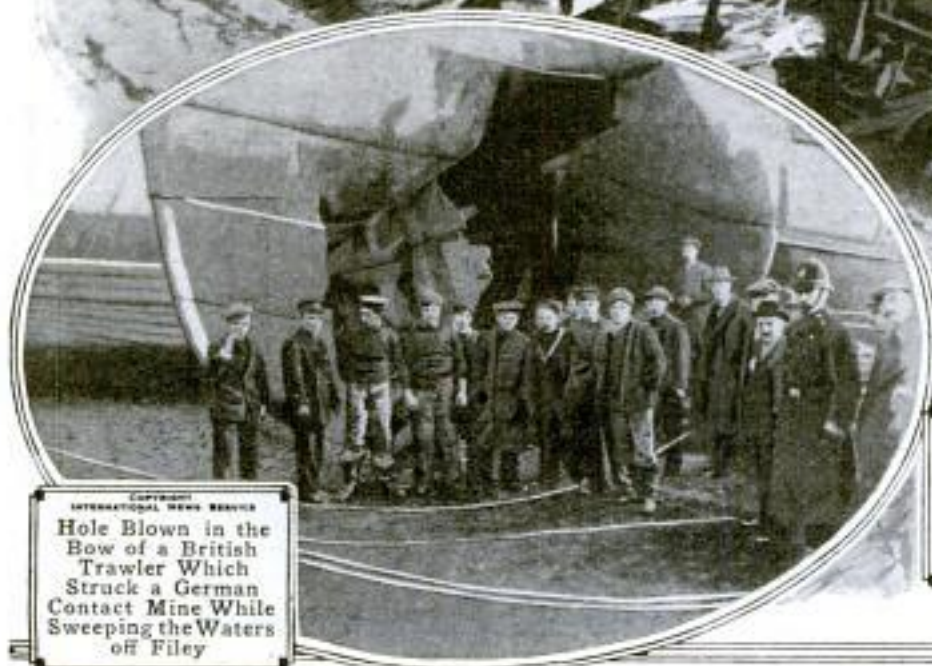

COURTESY INTERNATIONAL NEWS SERVICE  
Hole Blown in the Bow of a British Trawler Which Struck a German Contact Mine While Sweeping the Waters off Fieley

WESTPHAL UNDERWOOD & UNDERWOOD  
A German Train Loaded with Soldiers Crashed into the Rear of a Freight Train near Stendal, Telescoping Its Cars and Killing Many



## HARDSHIPS SUFFERED IN WINTER CAMPAIGNS



German Soldiers in "One-Man Trenches," Such as are Frequently Dug When an Army Is under Fire. Individual Holes are Dug Which Later may be Connected under Cover of Darkness



Servian Soldiers Quenching Their Thirst by Drinking River Water through Holes Cut in the Ice. When There is No Snow, Water is Often Difficult to Find



Soldiers have Suffered Intensely from Exposure. This Shows a Servian Sentry Frozen to Death at His Post, a Not Uncommon Thing during the Winter

PHOTOS COPYRIGHT, UNDERWOOD'S UNDERWOOD

# BENEATH THE TRICOLOR IN THE WAR ARENA



French Forces Lined behind a High Concrete Wall Waiting to Surprise the Germans as They Pass along an Unprotected Road



Member of the French Cyclist Corps Firing upon a German Pursuing Him in an Open Field near Arras



The Bathing Facilities of a Detachment of the French Forces at Soissons, One Hundred Yards from This Are the Advanced Trenches of the German Troops



This Curious Thatched Box Affords a French Sentry on the Road to Ypres a Protection against the Cold Winter Winds

EDITOR COPYRIGHT UNDERWOOD & UNDERWOOD

## BEHIND FIRING LINES WITH THE BRITISH



British Field Gun Concealed behind Shocks of Wheat in Order to Make It Difficult for the Enemy to Locate Its Position

Battery of Alpine Artillery in Action in the Vosges Mountains Where This Division of the French Forces has Distinguished Itself during Winter Engagements against the Enemy

One of the British Field Howitzers, Hidden in a Thicket, being Cleaned and Put in Condition after a Day of Heavy Firing

## AND FRENCH FIELD ARTILLERY BATTERIES



English Artillerymen, Protected under Bomb-Proof Gun Shelter, Wearing New Sheepskin Coats of British Army



PHOTO BY BENEDETTO.  
This Shows One of the New 4.75-Inch Guns of the French Artillery Trained on a German Position

Convalescent French and British Soldiers Playing with Toy Cannons



Instructing Soldiers in the Mechanism of a British Water-Cooled Machine Gun

# FALL OF GERMAN STRONGHOLD IN FAR EAST



Wounded Japanese  
Soldiers being  
Transported to the Rear  
from the Scene of Action  
in a Chinese Cart.  
The Improvised  
Ambulance is Forging  
the Pasha River

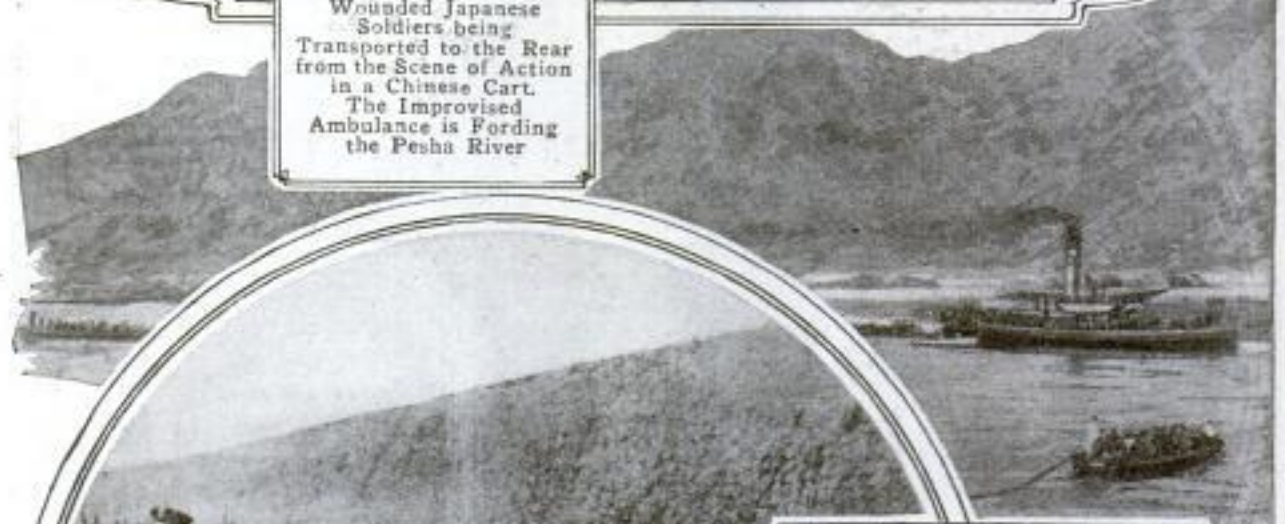

COPYRIGHT, INTERNATIONAL NEWS SERVICE  
Network of Wire  
Entanglements  
Which Protected  
the Approaches  
to the German  
Fortifications  
at Tsingtau



COPYRIGHT, INTERNATIONAL NEWS SERVICE  
Effect of a  
Japanese Shell on One  
of the Defense Guns  
of the Iltis Fort

## UNDER STUBBORN FIRE OF NIPPONESE GUNS



COPYRIGHT,  
INTERNATIONAL NEWS SERVICE  
Iltis Fort  
after the  
Bombardment:  
An Example  
of the Inability  
of Strong  
Fortifications  
to Withstand  
Modern Guns



During Heavy Firing  
in the Early  
Fighting at Tsingtau  
One of the Large  
German Defense Guns  
Exploded. This Shows  
the Remains of It



Landing of the Japanese Forces  
at Laoshan Bay, Which Is near  
Tsingtau. The Photograph  
Shows the Troops Loaded in  
Open Boats and being Towed  
Ashore from the Transports



Nipponese Soldiers Pouring into  
Tsinganfu on Hand Cars at the Opening  
of Hostilities against Germany

# SCARBOROUGH AFTER THE GERMAN NAVAL



COPYRIGHT, UNDERWOOD & UNDERWOOD  
**A Shell Striking This House Wrecked the Roof and Interior, but Did Little Damage to the Walls**

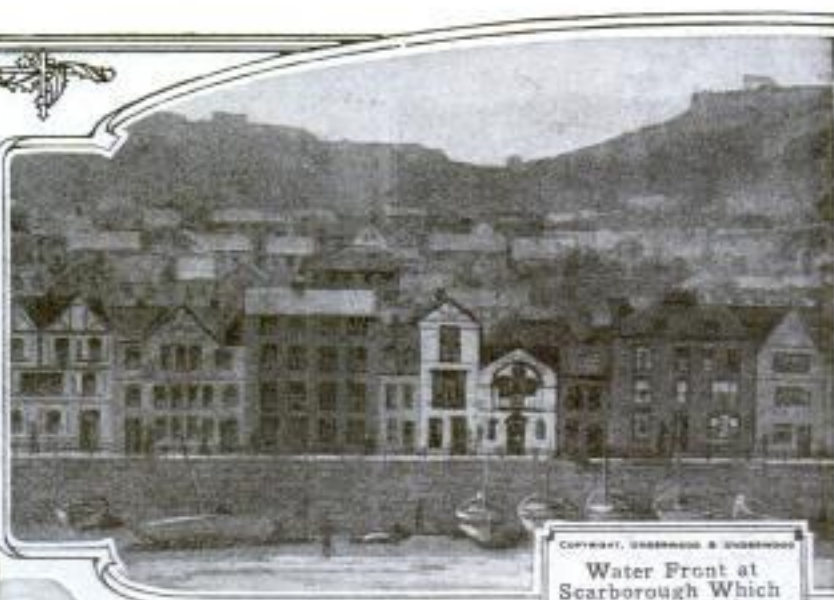

COPYRIGHT, UNDERWOOD & UNDERWOOD  
**Water Front at Scarborough Which for Centuries has Been the Point of Attack against England by Her Enemies**

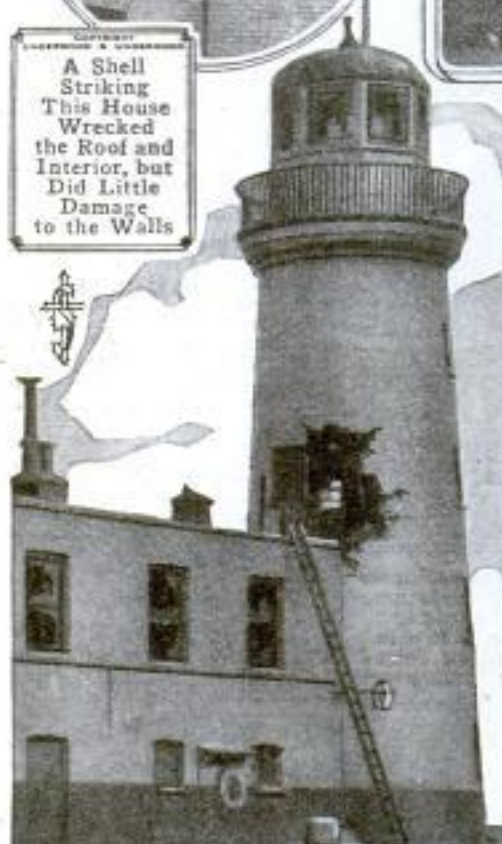

COPYRIGHT, INTERNATIONAL NEWS SERVICE  
**Half of the Population Was Still Asleep When Shells began Falling. This Shows the Wreck of a Hotel**



COPYRIGHT, INTERNATIONAL NEWS SERVICE  
**Tower of the Scarborough Light-house Which was Pierced by a Projectile during the Assault**



COPYRIGHT, UNDERWOOD & UNDERWOOD  
**In This House a Mother and Two Children were Killed**



## RAID ON UNFORTIFIED BRITISH COAST CITIES



COPYRIGHT  
UNDERWOOD & UNDERWOOD  
Several  
Persons were  
Killed and  
Many Houses  
Demolished  
When Whitby  
was Fired  
Upon without  
Warning



COPYRIGHT  
UNDERWOOD & UNDERWOOD  
Remains of  
Another  
Scarborough  
Home Which Was  
a Target for  
German Gunners

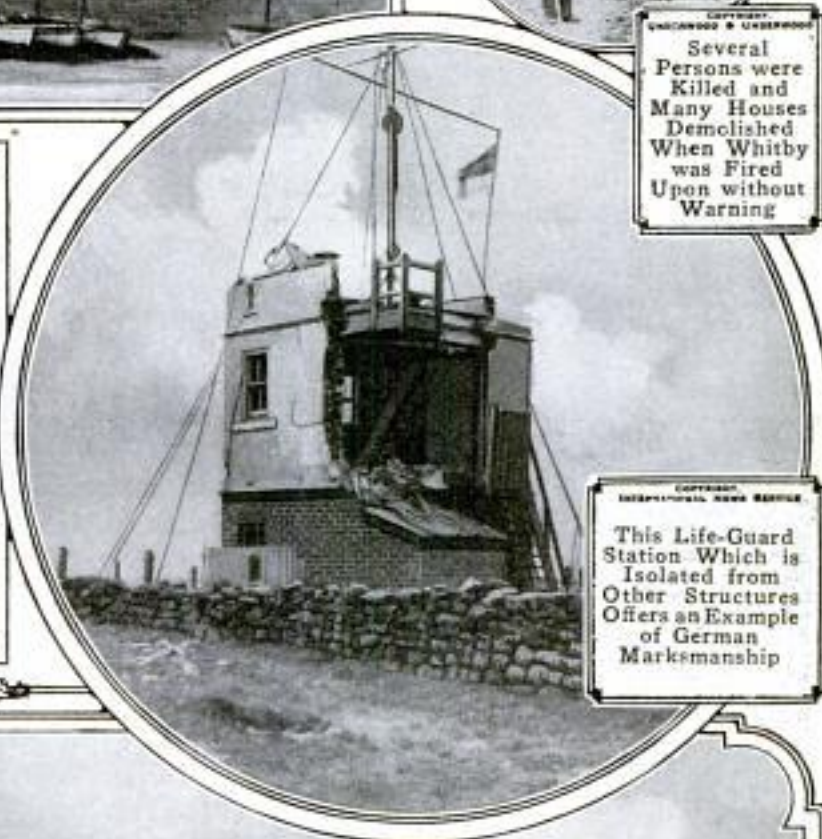

COPYRIGHT  
INTERNATIONAL NEWS SERVICE  
This Life-Guard  
Station Which is  
Isolated from  
Other Structures  
Offers an Example  
of German  
Marksmanship

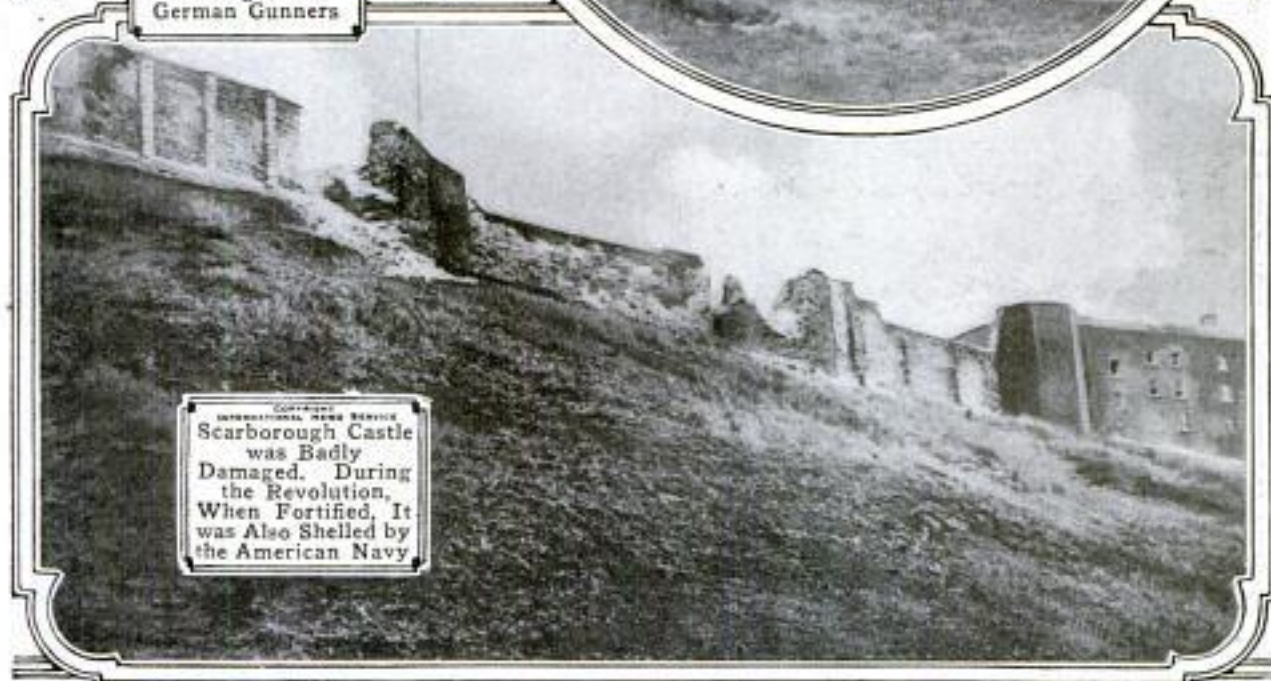

COPYRIGHT  
INTERNATIONAL NEWS SERVICE  
Scarborough Castle  
was Badly  
Damaged. During  
the Revolution,  
When Fortified,  
It was Also Shelled  
by the American Navy

# DANGERS WAITING IN THE PATH OF AN ARMY



COPYRIGHT INTERNATIONAL NEWS SERVICE  
**Barbed-Wire Entanglements and Sharp-Pointed Spikes Planted by Belgian Forces near Dixmude to Impede the Advance of German Troops**



COPYRIGHT INTERNATIONAL NEWS SERVICE  
**Heavily Charged Mines Like This Guarded Approaches to Tsingtau Forts**



COPYRIGHT UNDERWOOD & UNDERWOOD  
**French Scout at Ypres Using a Pollarded Tree as a Protected Lookout While Watching the Movements of the Enemy through a Binocular**



**From This Observation Platform in a Tall Tree near Dixmude, Belgian Lookouts Were Able to Survey the Country for Several Miles in All Directions**

## CURIOUS GLIMPSES BEHIND BRITISH LINES



Group of Typical Indian Soldiers, Who are Fighting with the Allies in Belgium, Weighing Out Daily Rations for Their Forces Fighting in the Field near Ypres



Bandoleers Carrying Ammunition, Strapped about Necks of Horses in One of the British Cavalry Regiments



Dogs Trained for Sentry Duty are being Used by the British Army. This Shows One of Them under Fire in a Trench

# RUIN AND DEVASTATION MARK THE BATTLE

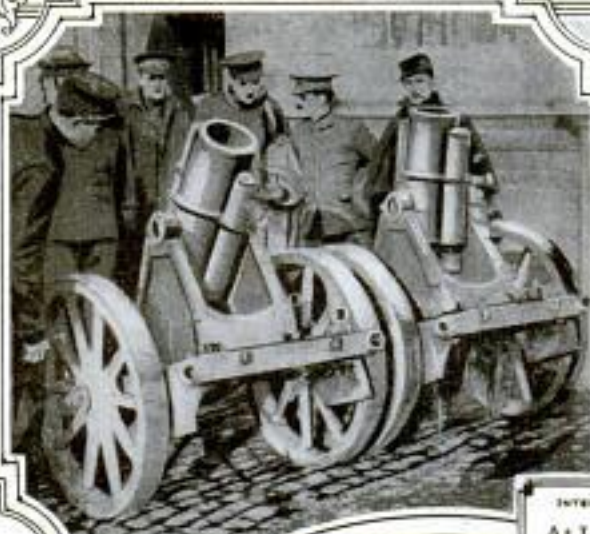

At Left: Two Mortars  
Abandoned by the  
Germans in Flanders  
and Subsequently  
Taken by the British



To Retard the Advance  
of the German Forces a  
Railway Bridge across  
the Oise at Verberie,  
France, was Blown Up  
by the Allies

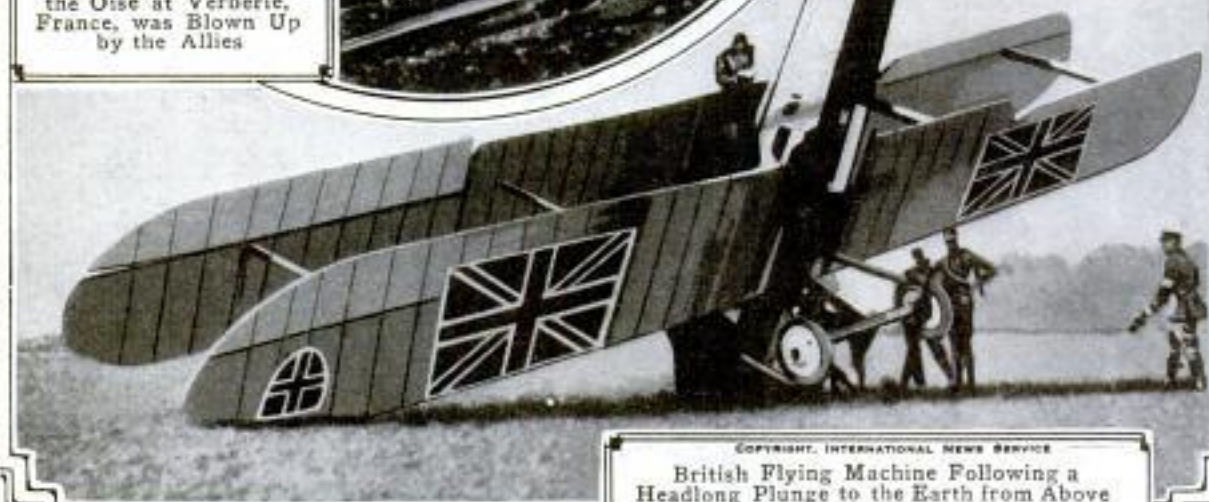

British Flying Machine Following a  
Headlong Plunge to the Earth from Above  
the Battle Field at Ypres Where It was  
Engaged in Observation Work

## PATHS CUT THROUGH WAR-HAUNTED EUROPE



COPYRIGHT  
UNDERWOOD & UNDERWOOD  
Typical Group  
of Prussian Refugees  
Fleeing Westward  
into the Interior of  
Germany before  
the Advancing Columns  
of Russian Troops

COPYRIGHT, UNDERWOOD & UNDERWOOD  
Railway Station at  
Albert, France, Which was  
Damaged by Rifle and  
Shrapnel Fire

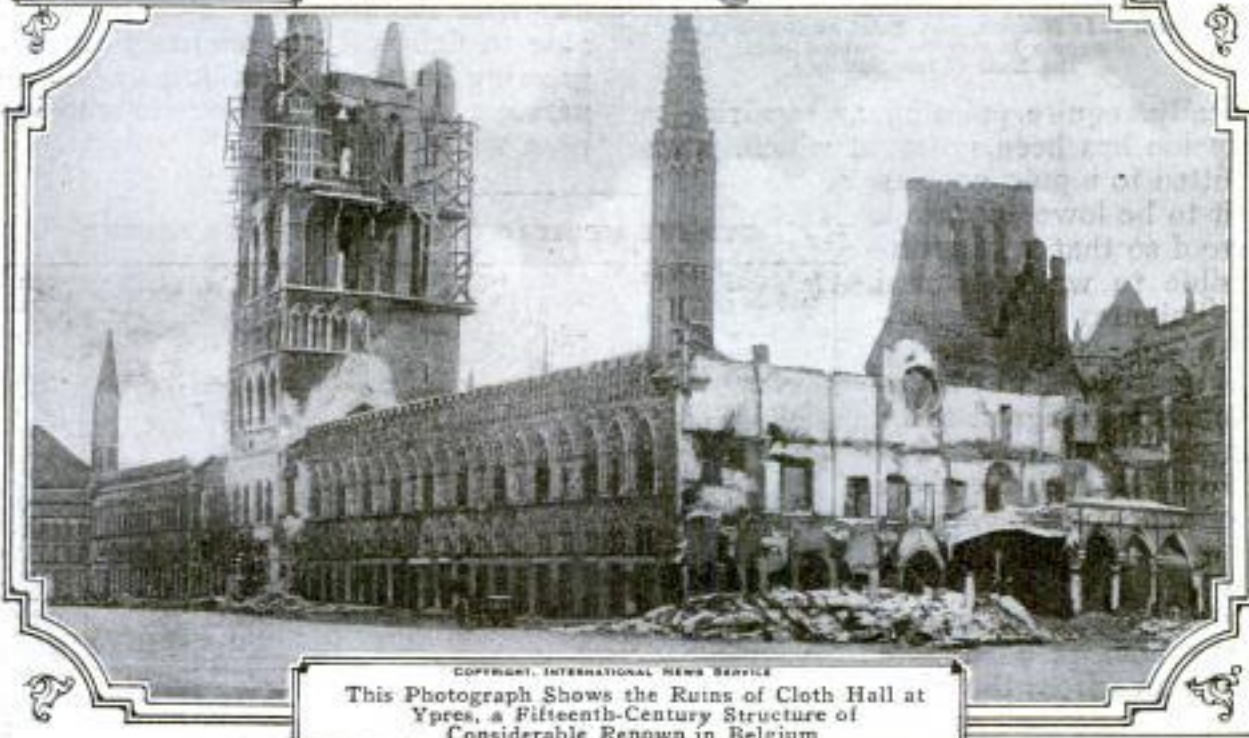

COPYRIGHT, INTERNATIONAL NEWS SERVICE  
This Photograph Shows the Ruins of Cloth Hall at  
Ypres, a Fifteenth-Century Structure of  
Considerable Renown in Belgium

*H 8978*  
**NEW KIND OF FLAGPOLE FOR LARGE BUILDINGS**

In order to simplify the maintenance of flagpoles which period-

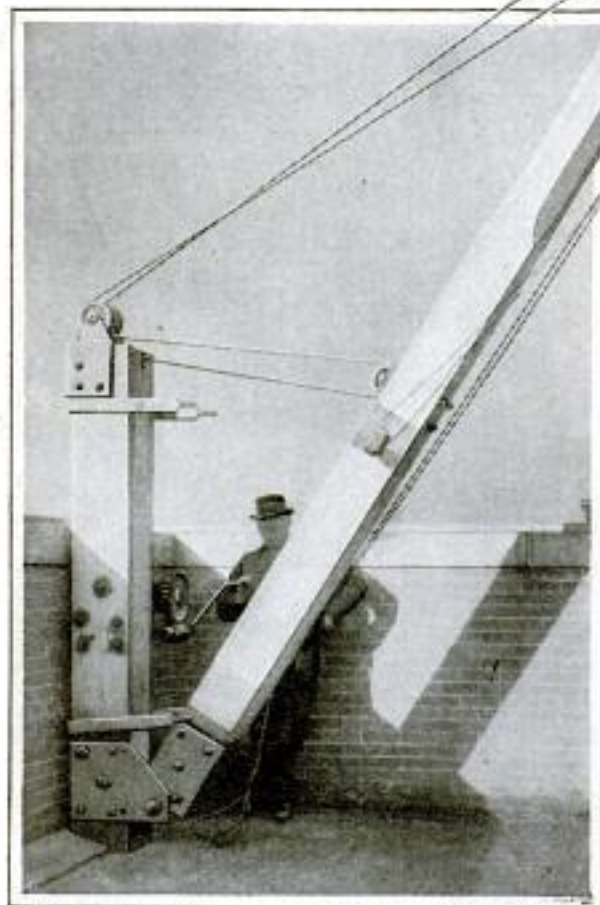

When It Is Necessary to Paint or Repair This Flagpole It may be Lowered onto the Roof of the Building



ically require painting or repairing, a tackle has been invented which, when fitted to a pole, enables it to be lowered onto a roof so that it is accessible to workmen and eliminates the necessity of employing a steeple jack. The apparatus is designed to be used with poles fastened to stub members on flat-roofed buildings. A shackle provided with a rope sheave is placed around the pole at a suitable distance from the base, while a second plate is bolted to it near the top

of the stub, which also carries a pulley. A cable is put through these three sheaves and fastened to a drum, attached to one side of the stub, the gear of which is engaged by a worm shaft. When the pole is in a vertical position it is bolted in place so as to relieve the cable from unnecessary strain. But a moment's time is required to lower it.

*H 8980*  
**SUGAR IS SHOWN VALUABLE RATION FOR SOLDIER**

Sugar and chocolate, because of their strength-giving properties, are being supplied as a part of the daily rations of soldiers fighting in the trenches in various parts of Europe. It has been found that a liberal allowance of sugar greatly increases a soldier's ability to resist fatigue and cold, while it also gives him added strength for muscular work. It is asserted that the best results are attained when the sugar is dissolved in some liquid, such as tea or coffee. When about 10 oz. of the product is given a soldier regularly each day it is claimed that he is far better able to fight off the tendency toward growing stale and breaking under the nervous tension, than the man who has been without sweets.

**TYPICAL MEXICAN CEMETERY IN OPEN DESERT**



Curious burial grounds, such as this one, are to be found in out-of-the-way places, often many miles from a habitation, in the sparsely settled districts of the Southwest. The mounds usually are simply marked with rough wooden crosses or protected by picket fences.

*Ask Mr. Windsor*

**9056** **CURIOUS MOTOR-CAR BODY CUTS AIR RESISTANCE**

Designed for an Italian motor car in accordance with recent theories of aerodynamics, a torpedo-shaped body

**8204** **GASOLINE MOTOR CAR IN RAILROAD SERVICE**

A gasoline motor car, having a capacity of 30,000 lb., has recently been placed in service for handling express

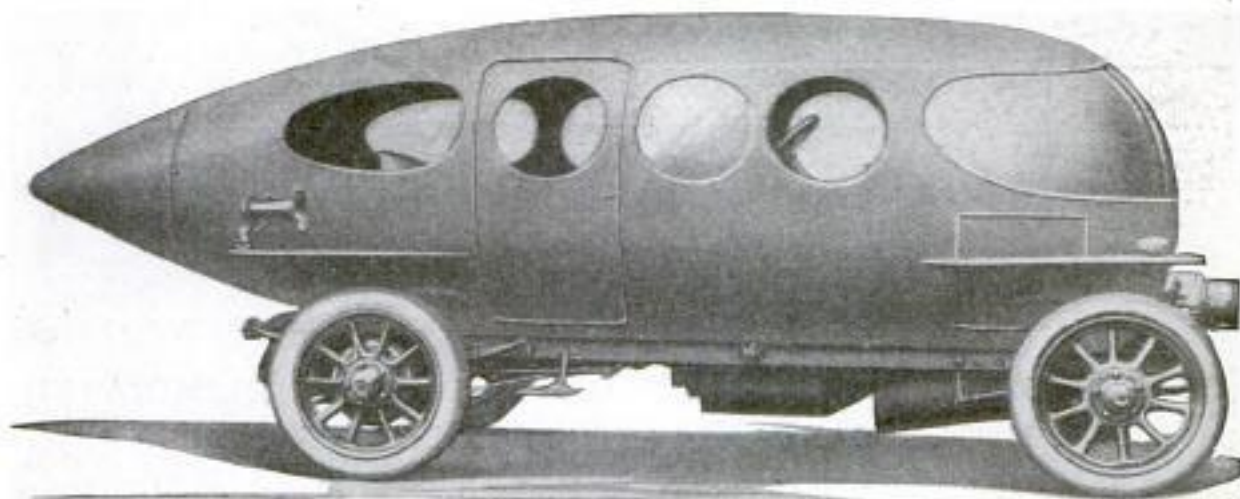

COPYRIGHT, UNDERWOOD & UNDERWOOD

The Torpedo Body on This Italian Motor Car Gives the Machine an Added Speed of 14 Miles an Hour

has been built which tests have shown overcomes a material amount of air resistance. The machine is equipped with a 50-hp. engine and when tried out with its chassis bare, was able to reach a maximum speed of 66 miles an hour. It is reported that when this curious-looking body was put in place and the car run over the same course with its gearing unchanged and its motor developing the same amount of power as on the previous test, it attained a speed of 80 miles. The subject of air resistance is one which is of material importance in designing all vehicles which are expected to develop high speed, since the resistance increases as the square of the velocity. Because of this, the experiments conducted with this new body have aroused considerable interest in Milan, as it gives the car a speed 14 miles an hour greater than it is able to attain without it.

¶ New torpedo-boat destroyers to be built for the United States Navy will be equipped with four more torpedo tubes than are carried on destroyers now in service, as well as with two antiballoon guns.

and light freight on a railroad operating out of Minneapolis, Minn. This car is of a convertible type, being designed also for use as a passenger car during periods of heavy passenger business, and with this in view seats that are easily installed or removed are provided. It is of an unusual shape, having a pointed front end, from which the pilot is suspended, and a square rear end provided with steps for the ingress and egress of passengers. The power plant, located at the front end, consists of a 200-hp. gasoline engine. The car body is 45 ft. long, while the single traffic compartment has a clear length of 34 ft. Freight and express are handled through the side doors.



Gasoline Motor Car Built to Carry Freight and Express on a Minnesota Railroad

Wm. A. Watson, Box 243, Morton, Pa.  
 Method used by Philadelphia Electric Co.

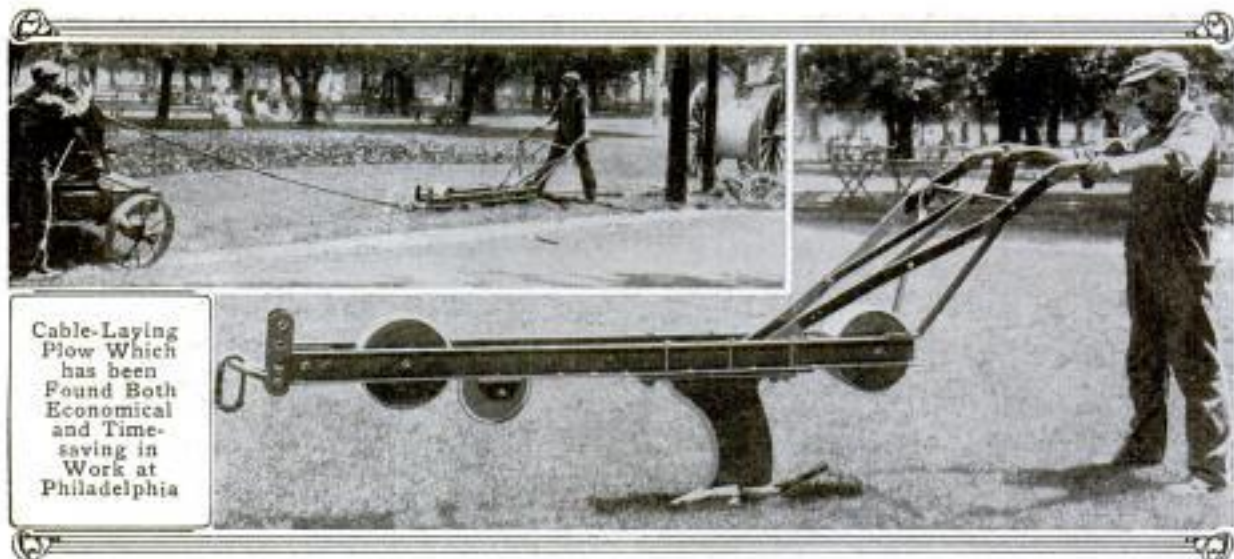

**GEAR-SHIFTING INDICATOR  
 FOR MOTOR CARS**

7938 #

To indicate the proper moment at which to reengage the gears in changing the speed of a motor car after

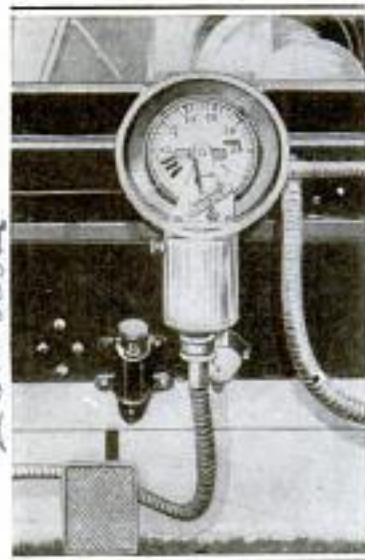

COURTESY OF THE CAR

neutral has been attained, an instrument has been constructed which shows the peripheral speed of the secondary and clutch shafts. This informs a driver the instant the two are revolving at the same rate, allowing the meshing to be done smoothly and quietly. A speedometer is used to record the motion of the secondary shaft, while mounted over it is a transparent disk, marked according to the various possible speeds of the car, which is actuated by the clutch shaft. When the disk turns so that the number representing the speed about to be entered is even with the needle of the speedometer, the right time to shift has come. The device is easily applied to a car.

**DITCH DIGGING ELIMINATED  
 IN LAYING CABLES**

8906 #

Underground electric-light cables are being installed by a new method at Philadelphia, which, besides being economical and timesaving, goes far in lessening the damage done to parkings and lawns by trench digging in a city. The cable is attached to a torpedo-shaped pilot device fastened at the bottom of a deep, straight-bladed plow which is pulled by a gasoline engine mounted on a truck. The motor operates a winch, pulling the plow along by means of a steel rope, and thus draws the cable underground through the small bore cut for it. The share is mounted beneath a steel frame consisting of two parallel beams between which, at either end, is a heavy roller. The rear cylinder rolls the narrow strip of sod back in place as it is turned up by the neck of the plow. Not only is the expense of digging a ditch thus escaped, but also that of refilling, tamping, and resodding. Sixteen hundred feet of cable has been laid in this way in a single day. In doing this, 12 laborers were used, while several times that number would have been required by the old method.

©Cotton-khaki suits are furnished British army recruits to be worn over civilian clothing while they are being drilled for service.

Royal Automobile Club  
 89-91 Pall Mall, S. W.  
 London

The Car, July 15 1914  
 #634 #359



Clyde J. Applegate  
1452 Thome Ave.  
Chicago, Ill.

8554 H  
**LANDING BOAT PASSENGERS AT NOME, ALASKA**

Because the nature of the coast at Nome, Alaska, is such that the construction of a steamship dock which would withstand the force of the heavy waves that frequently batter the shore line is a difficult problem, passengers arriving there are taken ashore on large barges. While this method is only a little less primitive than that used a number of years ago during the gold rush when rowboats were employed in the absence of barges, it is nevertheless the only means available. When the water is too rough for a

boat to discharge its passengers safely in this manner it usually remains far

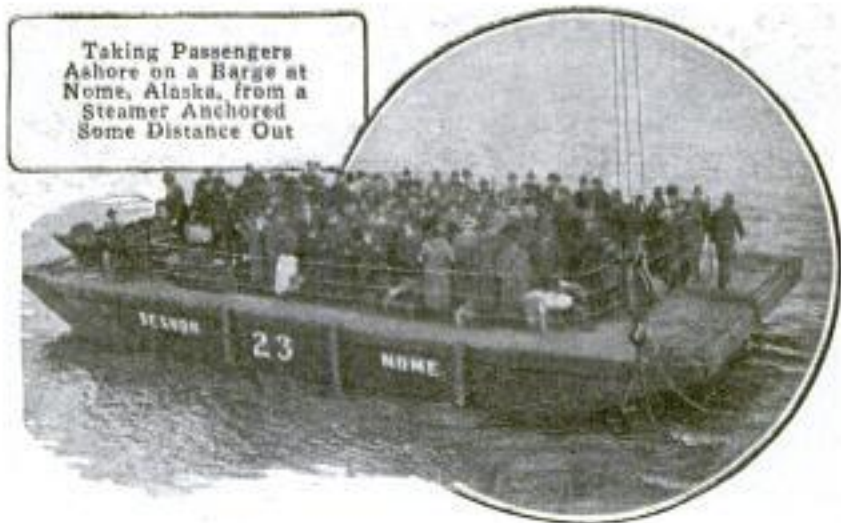

Taking Passengers Ashore on a Barge at Nome, Alaska, from a Steamer Anchored Some Distance Out

enough off shore to avoid the danger of being beached.

9028 H  
**NEW AERO-SLEIGH FOR USE AS AN OMNIBUS**

An aero-sleigh capable of making a speed of 35 miles an hour on ordinary roads while carrying passengers, has been built by a mechanic at Lake Forest, Ill., who contemplates the establishment of a sled-bus line between that suburb and Chicago next winter. The experimental machine is 14 ft. in length and is fitted with two sets of runners which have a height of about 2 ft. It weighs approximately 300 lb., and is driven by a 60-hp. motor and aeroplane propeller mounted at the rear. The sled is steered the same as an automobile and has been tested on city streets where

it was subjected to the usual traffic regulations. It is said to be easily controlled and much better adapted for deep snow than an automobile. For general use the aero-sled will be fitted with a limousine body, which will give it the appearance of a motor car on runners, but not change its operating principle.

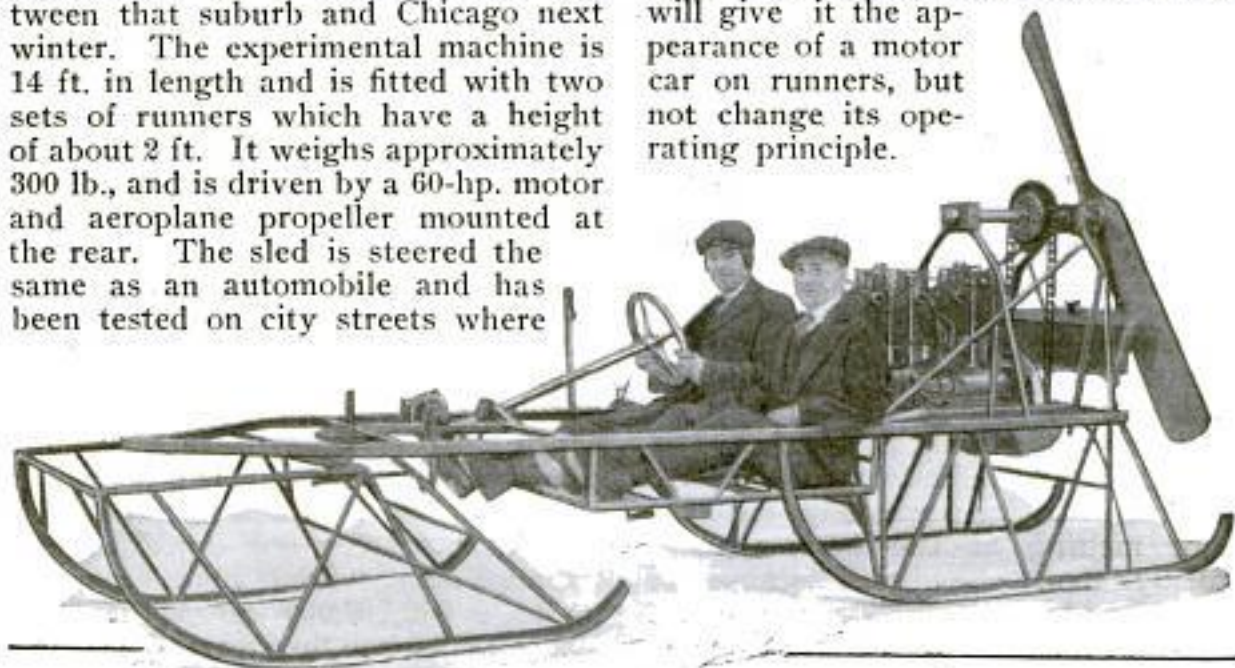

Experimental Aero-Sleigh Which has been Used on City Streets and Driven at a Speed of 35 Miles an Hour

Constructed by Harvey A. Beilgard, a garage proprietor of Lake Forest

*Edward B. Thompson, 1412 Federal St.,  
N. S. Pittsburgh, Pa.  
Located on grounds of the Red Raven Co.,  
POPULAR MECHANICS Red Raven, Pa.*

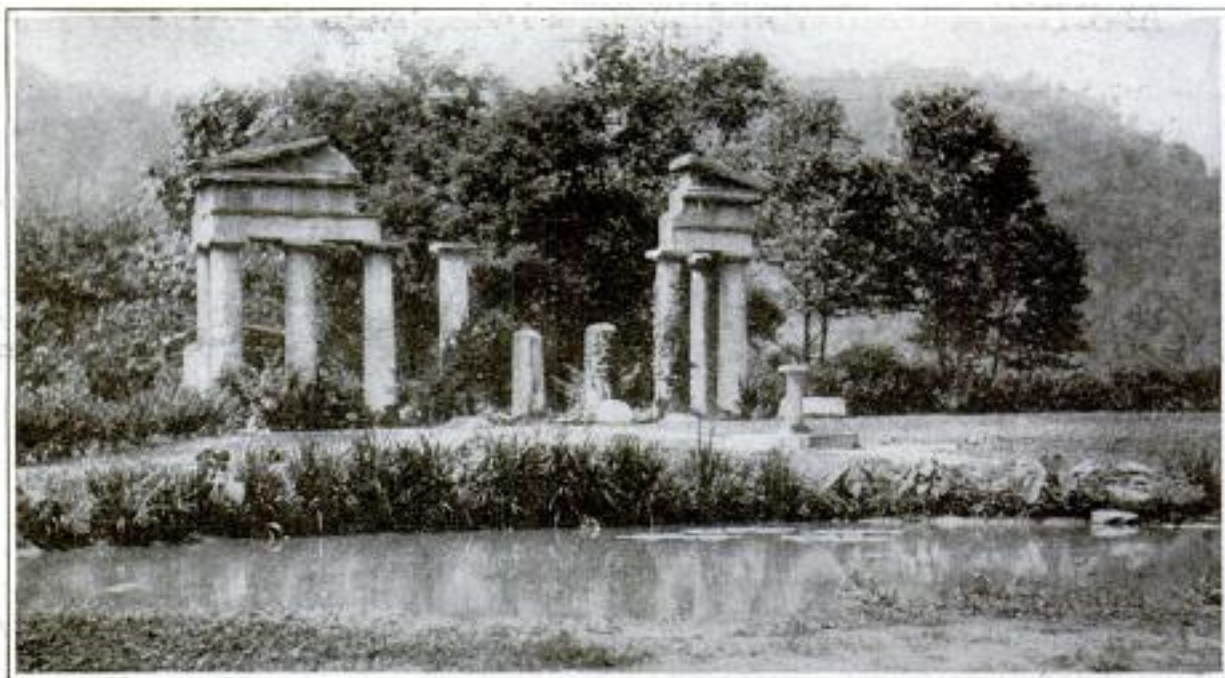

Ruins Built of Concrete in Imitation of a Doric Temple Form a Striking Feature of a Garden near Pittsburgh

**SANITARY DELIVERY BUCKET  
FOR ICE CREAM**

*8369 H*

Ice-cream containers made of heavy waterproof pasteboard are being introduced as a substitute for the wooden buckets and metal cans customarily used for delivery purposes. One of the advantages claimed for the lighter carrier is that it eliminates the necessity, as well as the expense, of collecting and washing empty cans, and provides a sanitary receptacle for the frozen product. The cylinder in which the cream is contained fits within a bucket, which is made of the same material, and is packed in salt and ice. Air spaces beneath this holder prevent its contents from melting at the bottom more quickly than elsewhere because of warmth taken up from whatever it may rest upon. The waterproofing is sufficient to protect the product from contamination by salt water.



*The Weeks Carrier Co.,  
385 Washington St., N. Y. City*

**CLASSICAL RUINS MADE OF  
CONCRETE**

*8699 m*

The ruins of a Greek temple overlooking a miniature lake form a novel and striking feature of a garden installed by a manufacturing company near Pittsburgh as a breathing place for its employes. These ruins are artificial, being built of concrete in imitation of a Doric temple. The garden is located on one of the most important automobile routes in Pennsylvania and is visited by hundreds of motorists every summer.

*Ship Salvage*

**SEARCH SEA FOR TREASURE  
LOST HALF CENTURY**

*8391 H*

Two whaling vessels have been equipped at San Francisco for deep-sea salvage work and probably will spend the winter months in the South Pacific searching for a treasure ship which has been beneath the waves for nearly a half century. The boats are owned by rival companies, both of which are sending out expeditions in the hope of recovering what is reputed to be a \$12,000,000 cargo that was lost in 1866 when the steamer "General Grant" foundered on a coral reef somewhere in southern waters.

*Arch Macdonald  
280 Lee St., Oakland, Cal.*

*m*  
8756 **RAILROAD BREAKS RECORD  
IN HANDLING TROOPS**

A railroad feat that is probably without parallel in the whole history of railroading was accomplished in the transportation of England's first expeditionary force to tidewater at the outbreak of the war, according to a report that has just been given out. Four days after the war began, the government requisitioned 350 trains of 30 cars each to be ready within 60 hours, but the railroads met the situation so promptly that the trains were all ready within 48 hours. During the departure of the expeditionary force, 73 trains were handled daily for a period of three weeks within the space of 14 hours a day. Almost without exception the trains came in on time, and landed the troops with their ammunition, guns and horses at the boat's side without a hitch.



How a Wounded Miner is Strapped to the Carrier for Removal from the Mine to the Hospital

gen helmets to enable them to enter a burning mine or one which is full of gases. Under conditions as nearly like the real thing as possible, the team

*m*  
8735 **FIRE DRILLS REPLACED BY  
MINE-RESCUE DRILLS**

Throughout the state of Washington mine-rescue drills are fast taking the place of the village fire drill, and a state-wide contest was recently held in Seattle between teams of mine rescuers that was much like the old contests held at the county fairs between village firemen. It is expected that this contest will be made an annual affair. The events in these contests are entered by teams consisting of six men, four of these being workers and the other two being the captain and the man who acts as victim. All five of the rescuers are equipped with oxy-



Mine-Rescue Worker Equipped with Oxygen Helmet and Ready for Work, Shown Below

rescues the victim, gives him artificial respiration for a few minutes and dresses his imaginary wounds. One exhibition event was that of showing how a man can be pulled out of a chute after he has entered and been overcome by powder fumes from a

blast. The contest was held under the auspices of the U. S. Bureau of Mines, and in accordance with the methods employed by that organization.

*John Oscar, 6109 Dorchester Ave., Chicago, Ill.*

CURIOUS LAND AND WATER

8211 *m* VEHICLES

An automobile that will run on water and a watercycle that will run on land are two curious recent inven-

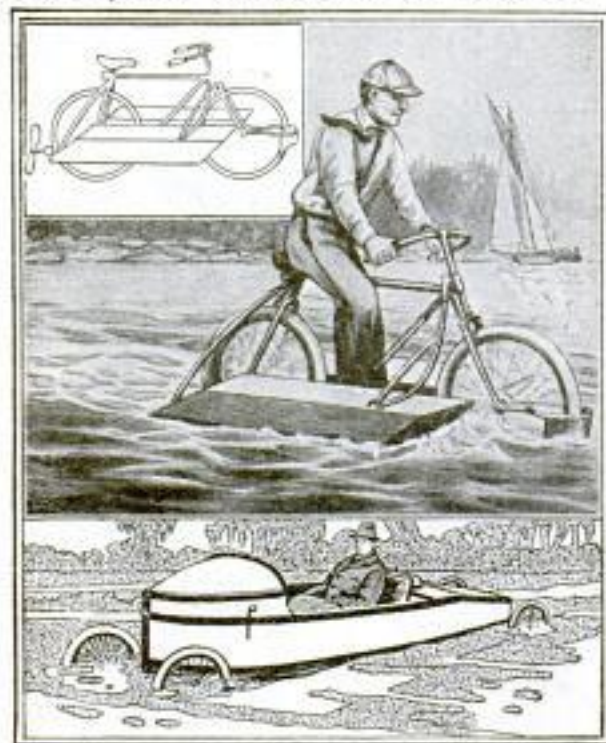

Above: This Curious Machine is Supported on the Water by Hollow Wooden Floats That do Not Interfere with the Action of the Wheels on Land  
Below: Automobile That Runs on the Water; the Rudder is at the Front and Turns with the Front Wheels; a Small Engine Drives Either the Propeller at the Rear or One of the Rear Wheels

tions. The automobile is a Scotch invention and is called a "hydro-car." The body and chassis are combined in one, the backbone of the machine being two longitudinal angle bars that carry all the weight. Upon these the engine, gear box, and seat are mounted, while the body is suspended fore and aft only. The body is made watertight, and has a pointed stem and a square stern. The power plant consists of a single-cylinder 4½-hp. engine. When the car is afloat this engine drives a propeller through bevel gearing, and on land it works on one of the rear wheels through a two-speed gear and chain. The rudder is at the bow and swings with the front wheels. The watercycle is an ordinary bicycle fitted with two hollow wooden floats, one fixed to each side

of the machine several inches above the ground and far enough from the frame to avoid interference with the pedals. On land and water the driving power is applied through the pedals, the two-blade propeller being driven through a chain by the rear wheel. The rudder consists of a piece of metal bent around the front wheel and supported on the fork so that it will swing with the wheel.

8374 *H* TRAINING RECRUITS TO USE BAYONETS SKILLFULLY

One of the mechanical devices now being used in England to train recruits in the art of handling the bayonet is shown in the accompanying illustration. The apparatus has a wooden frame, approximately 10 ft. in height, with a horizontal beam at the base and top. Suspended in the center, between these two members, is a wire on which several thickly woven straw balls are threaded. These are so controlled mechanically that they may be dropped in rapid succession, slipping from the top to the bottom of the wire. As each ball falls it is the soldier's aim to pierce it with his bayonet, working quickly so as to stab each one in turn. This practice trains the infantryman to act quickly and accurately, and also develops his wrist muscles.



This Device is Used Particularly by the English Army in Training Its Recruits in the Skillful Use of the Bayonet

Jack Brooke, Bowford,  
Essex, England

cycle from Jack Brooke, Bowford, Essex, England

Henry Russein, 108 Fulton St., New York City  
New York Press Clipping

## BY RAIL THROUGH DARKEST AFRICA

Longest Link in the All-Steam Route from the Cape  
to Cairo will be Finished This Year

8826

SOME time in the year 1915 the last spike will be driven in the 2,600-mile railway stretching from the Cape of Good Hope to the southern end of Lake Tanganyika in the heart of Africa, and with that act will be completed the longest link in the great Cape-to-Cairo Railway of which Cecil Rhodes dreamed and to the promotion of which he devoted the later years of his life. Rhodes dreamed of an all-rail route stretching the full length of the continent. In spite of his prestige and his record of success in big undertakings the project was laughed at as a wholly visionary scheme at the time it was first proposed. Now his dream is about to be realized.

Out of a total of a little more than 6,000 miles required for connecting Cape Town with Cairo practically 4,000 miles will have been built with the completion of the railway construction now in progress south of Lake Tanganyika. Of the remaining links, five are navigable waterways on which lake or river steamers can be used. Three will require the construction of railways aggregating only 410 miles in length, and with the completion of these, there will be established an all-steam route consisting of a succession of railways and steamboat lines connecting Cape Town with Cairo. The construction of these lines can only be a matter of a year or two, while the full completion of the all-rail route will doubtless come in a short time, as time is measured in projects of such magnitude. When Cecil Rhodes died he left the most difficult parts of the line not only planned but financed.

Particular interest is given to this great undertaking at the present time by the European war. If the German arms are victorious the Cape-to-Cairo Railway, with the territory it serves, will be one of the richest prizes to fall to the victor. If Germany is defeated that country will doubtless lose its African possessions, which include Ger-

man East Africa, with the result that the construction of that portion of the all-rail route extending from the southern end of Lake Tanganyika to Uganda will be greatly simplified. The best location for the railway lies to the east of this lake, in German territory. An arrangement somewhat similar to that under which the United States holds the Panama Canal Zone has been made for a right of way through the Congo Free State, to the west of the lake, but if German East Africa should become British territory as a result of the war the eastern route will undoubtedly be chosen.

When finally completed the Cape-to-Cairo Railway will form a continuous route spanning the continent from north to south, but it will be made up of a number of separate railway systems, north and south trunk lines of each of these systems being used as parts of the through route. These individual systems are the railways of the Union of South Africa, the Rhodesian railways, the Sudan government railways, and the Egyptian state railways. Some of these trunk lines have been built for years, but each was so planned that it would not only serve local needs but would be suitable as a part of the Cape-to-Cairo route.

No railway line ever built is comparable to this in the varied interest of the regions which it traverses. Crossing the narrow coastal plain from Cape Town the railway climbs a succession of terraces to the central tableland of South Africa, and after crossing the Orange River it passes through Kimberley and the greatest diamond-mining district in the world, then through Vryburg and Mafeking to Palachwe, a town in Bechuanaland, near the Limpopo or Crocodile River. Much of this country is desert or semiarid and is subject to droughts and hot winds in summer and to extreme changes in temperature. After leaving Palachwe the line passes over the divide into the



Steel Arch  
Spanning the  
Gorge of the  
Zambezi River  
Just below  
the Famous  
Victoria Falls

basin of the Zambezi River, a basin that is nearly all well watered and is characterized by its tropical fertility. The Zambezi River is crossed near the famous Victoria Falls, which have almost three times the height of Niagara and twice the volume of water. The line then passes through the middle of the Zambezi basin to Kituta at the southern end of Lake Tanganyika. This is the end of the all-rail route and for the next 400 miles transportation will be by steamboat over the longest fresh-water lake in the world. Lake Tanganyika is 2,600 ft. above sea level and lies at the southern end of the great central rift valley that forms one of the most curious features of the African continent. This rift extends north into and beyond the headwaters of the Nile and was



Most of the Cape-  
to-Cairo Railway  
was Built by  
Native  
Construction Gangs  
Like This

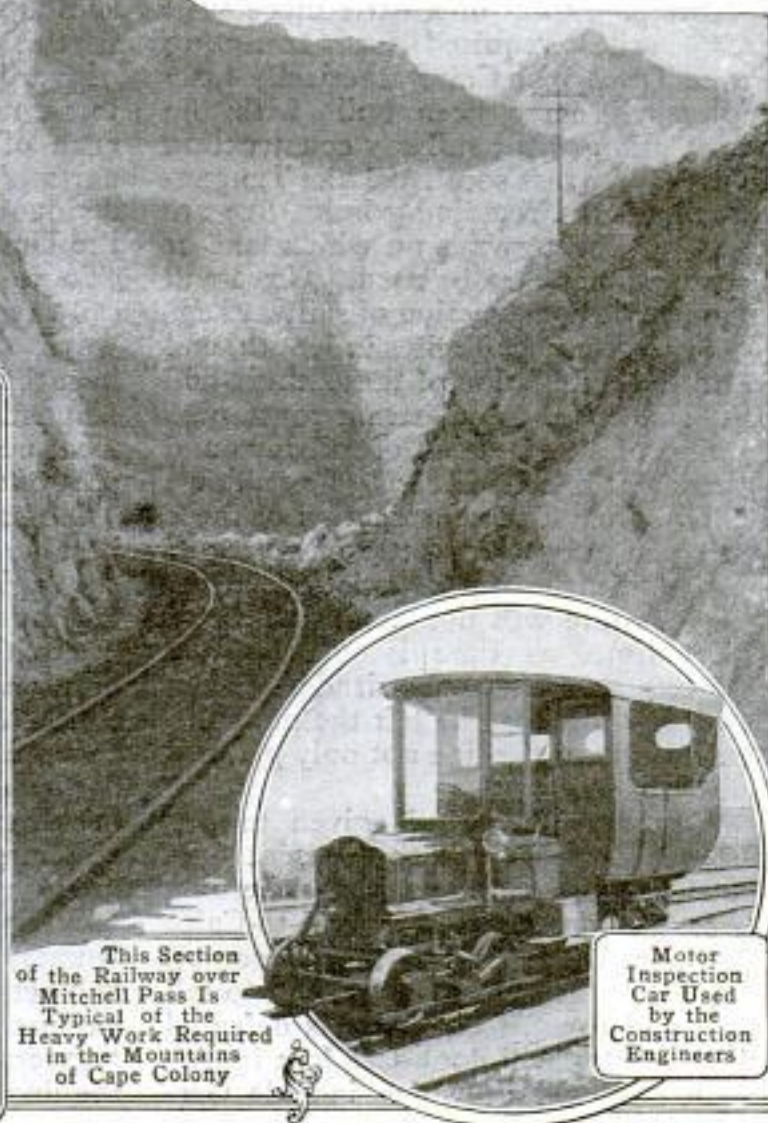

This Section  
of the Railway over  
Mitchell Pass Is  
Typical of the  
Heavy Work Required  
in the Mountains  
of Cape Colony

Motor  
Inspection  
Car Used  
by the  
Construction  
Engineers

formed, according to geologists, by the sinking of an enormous section of the earth's crust. The line from Usambara at the north end of Lake Tanganyika to Rejaf, a town on the White Nile about 670 miles to the north, constitutes the undeveloped link in the all-steam route. Lake Kivu, Lake Albert Edward, and Lake Albert are all navigable, and will be used as waterways, leaving three short connecting railways to be built. At Lake Albert Edward, where there is always a heavy fog during the dry season and a remarkably clear atmosphere during the rainy season, the line reaches the headwaters of the Nile, which it follows to the Mediterranean.

By the time the traveler has reached Rejaf he has seen every fea-

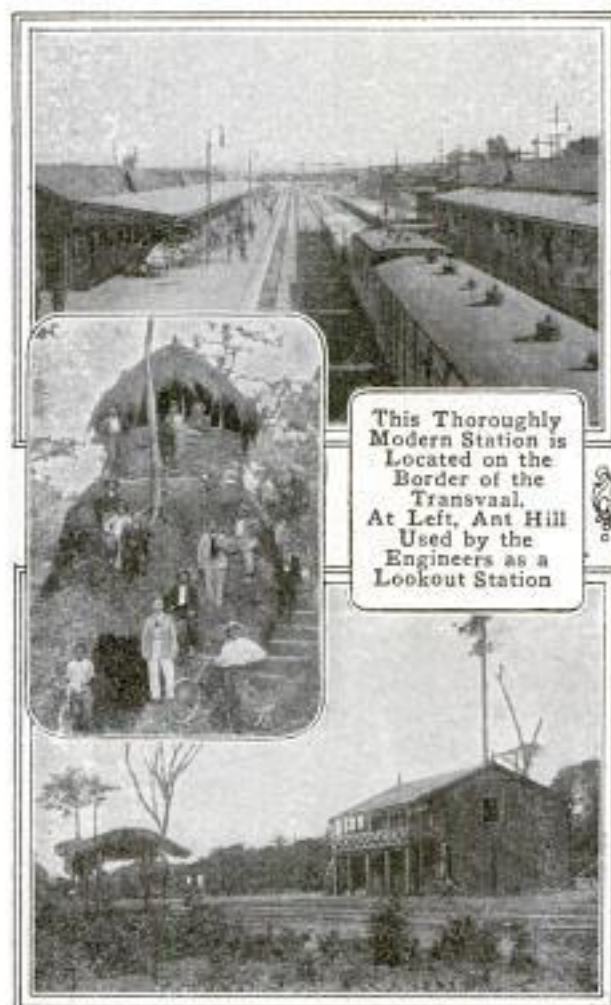

This Thoroughly Modern Station is Located on the Border of the Transvaal. At Left, Ant Hill Used by the Engineers as a Lookout Station

Typical Jungle Station in the Congo Section  
The Map Shows the General Location of the Railway, with Approximate Distances

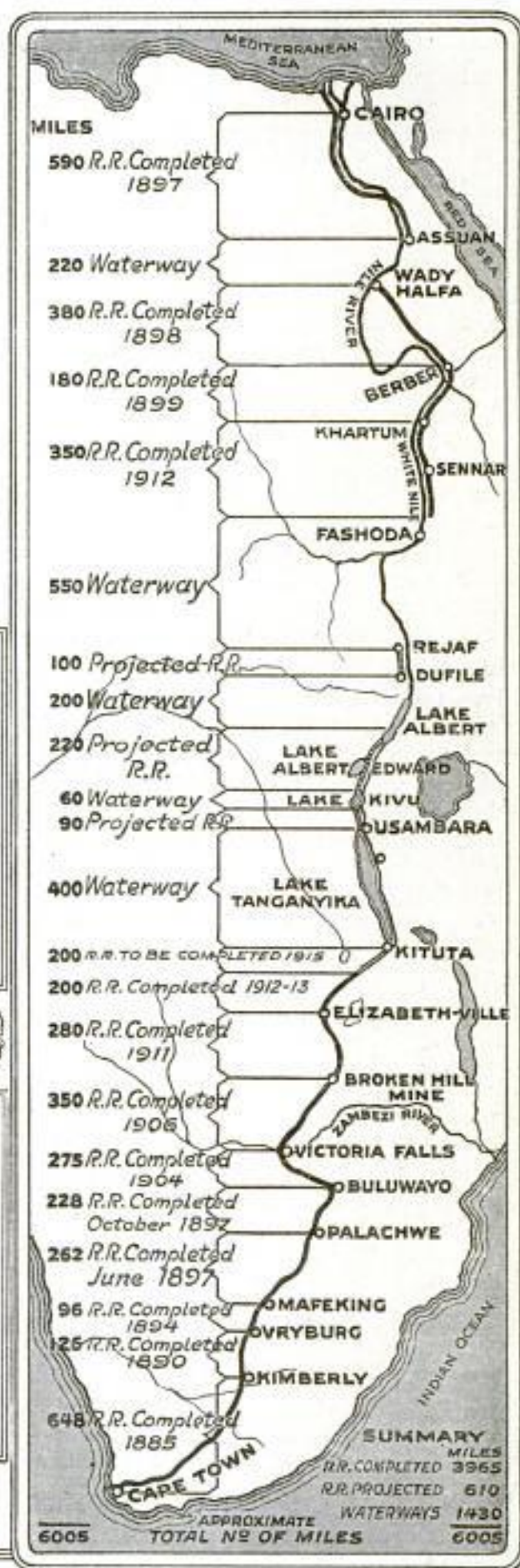

ture of African veldt and desert and jungle, as well as the startling contrasts between modern civilization and the primitive and savage life of the surrounding desert or jungle, that is only to be found in Africa. At Rejaf the line enters the Sudan Desert, and from this point to the Mediterranean the route lies through the scenes of an ancient civilization. From this point the Nile is used for reaching Fashoda, about 550 miles distant, where connection is made with a railway extending to Wady Halfa and passing through Khartum, Berber, and Karnak, a village noted for its ancient ruins. From a commercial point of view this line is said to have been one of the most unpromising pieces of desert construction ever attempted. It was built by Lord Kitchener for the transportation of troops during the uprising of the Khalifa in 1896, and, contrary to all expectations, has proved a profitable investment ever since it was built. From Wady Halfa the Nile is again used for reaching Assuan, where the biggest dam in the world is located, while from Assuan there is a continuous line of railway following the Nile to Cairo.

Considering the magnitude of the project there have been few great engineering difficulties to overcome. While there are many important and interesting bridges the greatest engineering achievement is probably the steel arch bridge across the gorge of the Zambezi, just below Victoria Falls, which is one of the highest bridges of its type in the world. The greatest difficulty in the building of the line was in the character of the country itself. Clearing the line through the jungles and keeping it cleared was a difficult matter. Throughout the route it was necessary to maintain elaborate systems of food supplies, to use native police to preserve order among the native workers, and to organize staffs of physicians to look after sanitary conditions. In central Africa, hostile natives, deadly tropical fevers, smallpox, and sleeping sickness were a constant menace. It is reported that in one sec-

tion alone sleeping sickness caused the death of more than 4,000 natives. Attacks by wild animals were frequent, hundreds of laborers being carried off by lions, leopards, and other ferocious beasts, and by the crocodiles that inhabit the river swamps. Along the upper Nile the laborers were frequently driven from their work by herds of wild elephants, which even attacked several temporary villages along the line, destroying men, huts, and everything else that lay in their path. In one section monkeys would swing on the telegraph lines until the wires were broken down, and it was finally necessary to replace the wires with steel bars. In central and southern Africa the builders had the white ants to contend with. These ants live in colonies and build hills ranging from 20 to 30 ft. in height. They attack and devour the wood used in construction work, so that it was necessary to build all bridges of steel and to use this material for telegraph poles and, in some sections, for the cross ties.

In spite of the difficulties and the enormous cost of construction there is little doubt that the Cape-to-Cairo Railway will pay. It is a significant fact that not one of the main or branch lines built by the British in Africa has failed to prove a profitable investment. The interior of the continent is a vast storehouse of treasure containing thousands of square miles of forests, mineral lands, and rich agricultural lands that are still untouched and only need the intelligence and skill of the white man for their profitable development.

#### EXPLOSION OF FLOUR DUST WRECKS MILL BUILDING

A dust explosion which occurred in a Nebraska flour mill tore away one side of the structure. The photograph reproduced herewith shows in a striking manner what terrific force often accompanies a detonation of this kind. When the atmosphere in a mill becomes filled with flour dust, which is a carbohydrate, only a spark is needed to

*W. G. Loeber*

*1600 East Talla St.,*

*Beatrice, Nebraska*





The Result of a Flour-Dust Explosion in a Nebraska Mill

make it unite with the oxygen of the air. The effect is the same as if the dust were gas. In this particular case the blast tore away a large part of one wall of the building, threw the others out of plumb, and hurled one of the employes of the mill from the third floor into the river.

#### MOVING PARTS ARE HOUSED ON DICTATING MACHINE

8379H One of the noticeable changes which have been made recently in the construction of a dictating machine is that all moving parts have been housed so that the user of the instrument is not distracted by its mechanical operation. The slow turning of the wax cylinder is the only movement now perceptible to the eye. A rest, upon which the speaking tube is laid when it is not in use, controls the operation of the motor. This consists of a lever which connects with the switch and breaks the current the moment it is pressed down. The opposite action takes place when the tube is lifted, the raising of the lever immediately start-

ing the machine, thus making it possible for a person to pick up the tube and commence dictating without giving further attention to the instrument.

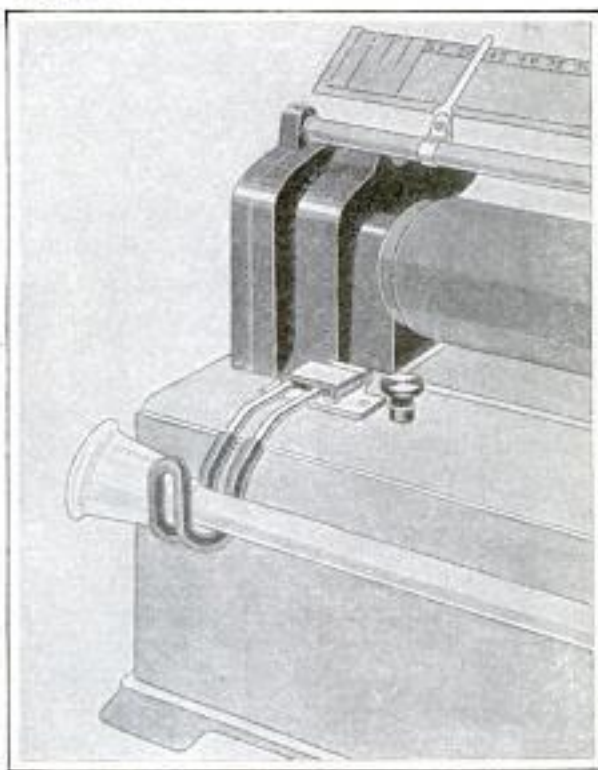

The Moving Parts of This Dictating Machine have been Housed So That the User is Not Distracted by Their Action

Thomas A. Edison, Inc.  
Orange, N. J.

Erwin G. Dunlap Dunlap Jr.,  
1029 Cleveland Ave., Niagara Falls, N.Y.

*Illustration*



The Proposed Peace Bridge Designed to Span the Niagara River and Join the Shores of Canada and the United States

### PEACE BRIDGE IS PROPOSED TO SPAN NIAGARA RIVER

8534 To commemorate the centennial of peace between Great Britain and the United States and mark this period of friendship and prosperity with an enduring monument, it has been proposed that a bridge be built to span the Niagara River, immediately below the falls, joining this country and Canada. Preliminary plans for such a structure have been drawn by a member of an American committee which has the

matter in charge, but the outbreak of the European war has temporarily interfered with any attempt which might have been made to execute the idea. If built as designed, the bridge would be a white, single-arch, reinforced-concrete structure, and the fifth bridge over the river below the falls. Two of the bridges now in use are of steel-arch construction, one steel cantilever, and the other suspension.

### 8841H ELECTRIC CAPSTAN WITH MOTOR INCLOSED

Embodying the qualities of lightness in weight, strength and compactness, an electrical capstan for use on motorboats and yachts has been invented which has

its various parts self-contained. The driving mechanism, which is inclosed in an oil and water-tight housing, consists of a motor with reduction gears, which travel on an angular ring inside the shell, built in. All the operating switches are placed on the capstan, the largest size of which has a drawing power of about 2,500 lb. and a speed of 23 ft. a minute. By a brake arrangement the mechanism may be quickly disengaged and an anchor dropped. The use of light-weight alloys in both the foundation and shell serves to keep the weight down to 500 lb. It is suited for either rope or chain and may be turned either forward or backward.

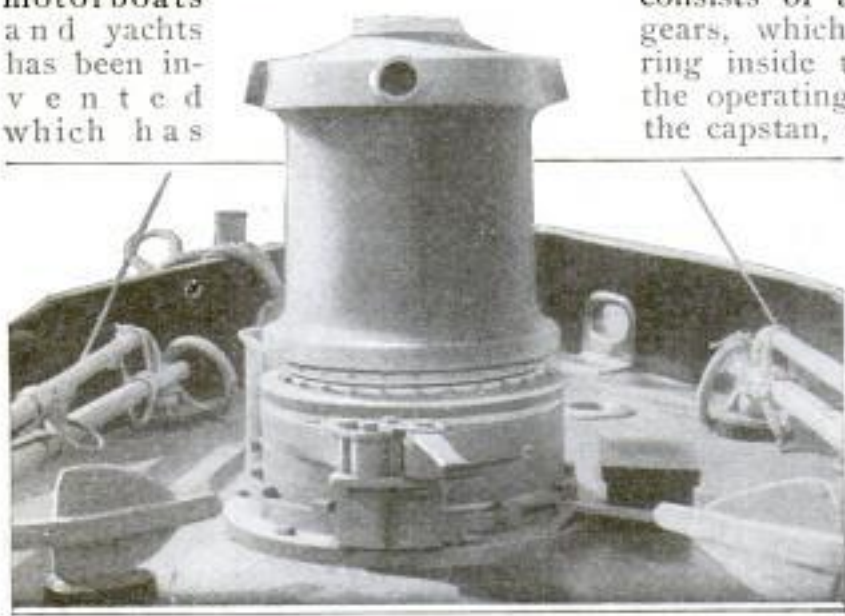

This Electric Capstan, Which Combines Lightness and Strength, Has Its Driving Mechanism Self-Contained

The Matthews Boat Co,  
Port Clinton, Ohio.

NEW METHOD OF SHIPPING

8716 EGGS

A new method of shipping eggs which, it is reported, results in a great reduction in the amount of breakage, consists in installing spring buffers on the inner sides of the end walls of the car, and in loading the egg cases on a rack which bears against these buffers and is supported on iron-pipe rollers extending across the car floor. The egg cases move as a unit with the rack, and the buffers absorb practically all shocks in the direction of the car's motion. When one test shipment was unloaded, all the cases were found to be in perfect condition with the exception of one which had evidently come in contact with some projection on the side of the car, and even in this case there were no broken eggs.

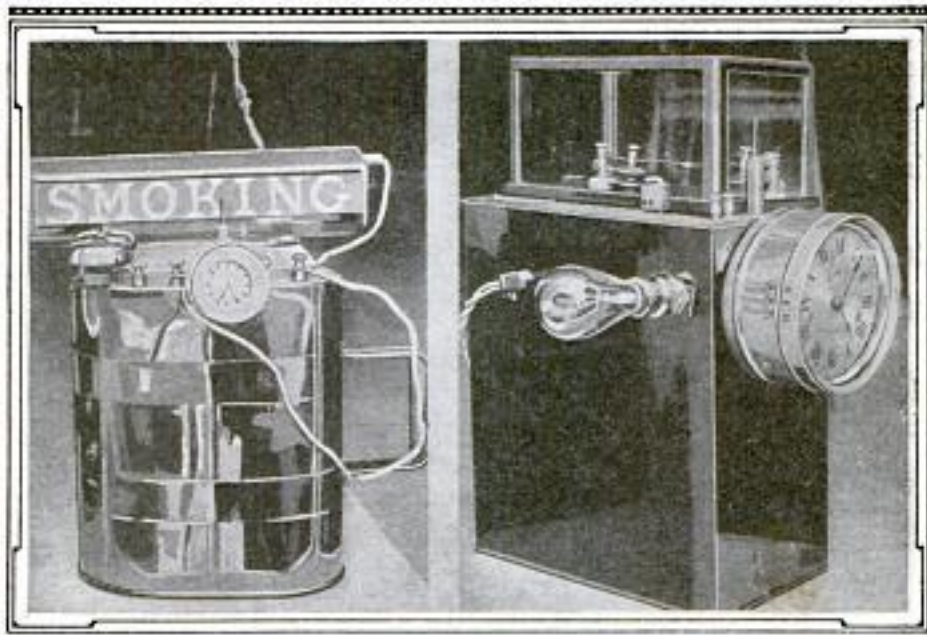

This Sign, "Smoking," is Illuminated When the Smoke from the Factory Stack Exceeds a Reasonable Minimum. Upper Right: Alarm Clock That Rings When the Chimney Smokes, and Records the Time

set of firing rules for the benefit of the fireman, the city's pure air is unsoiled, and at the same time money goes into the pockets of the owner of the stack.

- SMOKING**
- 1 FIRE ONE DOOR AT A TIME AND WAIT UNTIL FIRE IS IN GOOD SHAPE BEFORE CHARGING THE OTHER DOOR.
  - 2 LEAVE FURNACE DOOR SLIGHTLY AJAR FOR ABOUT 2 MINUTES AFTER FIRING.
  - 3 FIRE FREQUENTLY AT REGULAR INTERVALS AND IN SMALL QUANTITIES.
  - 4 KEEP THE FIRES CLEAN.
  - 5 CARRY A LEVEL SURFACE OVER ENTIRE GRATE. AVOID THIN OR BARE SPOTS ON GRATES.
  - 6 BREAK LUMPS OF COAL TO FIST SIZE.

Rules for Stoking to Prevent Smoke are Provided for Fireman

ELECTRIC SMOKE DETECTOR

8604 GIVES WARNING

Almost every city has its smoke inspector perched on the top of some skyscraper spying on the tall stacks that violate the law as to the proper behavior of chimneys. This man, at best, cannot observe many stacks, especially on calm and misty days. But a new electrical smoke inspector is on the job every minute of every day. Not only is the fireman notified when his furnace is wasting money by improper firing, but the superintendent is told as well. By the ringing of electric bells located in convenient places, and by the illumination of a

The smoke-detecting instruments in use in a number of factories are especially interesting in that they make use of a somewhat new electrical application, known as "ionization" or the electrification of gases. The smoke monitor depends for its operation upon changes in the conductivity of the gases, due to the variable amount of smoke. The machine consists of an indicator, transformer, spark gaps, a condenser, bells, and signs. The sparks used in the indicators are essentially similar to those used in wireless telegraphy. The sign reads "Smoking." This is a cut-out-letter metal sign

(25 6/19/15)  
 The Scientific Instrument and Electrical Machine Co.,  
 Mechanicsburg, Penna.

# K. H. Hamilton, 1619 E. Lincoln Ave., Cincinnati, Ohio.

covered with ground glass. Ordinarily the sign is not seen, but whenever smoke fumes, or dust, exceed a certain amount an electric light behind the sign is automatically turned on. Another arrangement is in connection with an ordinary alarm clock, which not only rings when the chimney is smoking, but by means of special recording apparatus makes note of the time when the smoking occurred.

### COMBINED LAMP AND MIRROR FOR SHAVING

A novel development in portable electric lamps is one designed especially for the man who shaves himself. The lamp is mounted in a metal reflector, at the front of which is a circular mirror, held in place by clips and of such size as to leave a space of 1 in. around the edge between the mirror and the reflector. In shaving, the user simply faces the mirror and the light is diffused over the face through this open space. A hinged joint permits the adjustment of the lamp and mirror in any position. With the mirror removed, the lamp can be used as a reading lamp.



The British Admiralty has made arrangements to supply all of the officers and men of the navy with rubber swimming collars. These will be carried by each individual during the hours he is awake, and will be kept inflated and within easy reach during sleeping periods.

### CUTTING PEARL BUTTONS FROM MUSSEL SHELLS

The first step in the process of manufacturing pearl buttons consists of soaking freshly dug mussel shells in large vats of water for a week or more in order to soften them for cutting. After being removed from these tanks and drained, the shells are sorted according to size by separating machines and then distributed to lathes where the button "blanks" are cut from them by revolving, saw-tooth-edged, cylindrical instruments. The blanks of a like diameter are sorted mechanically according to their thicknesses and then churned in barrellike tumblers filled with water and pumice stone to smooth their edges. They are next placed in a grinding machine and passed on a belt beneath a carborundum wheel which cuts away the back, or rough side, of the shell, giving them all a uniform size. After they are again washed and put through a centrifugal drier, the blanks are fed into forming and drilling machines, in which they are cut to the shape desired and the holes drilled in them. At this stage, the buttons are in their final form, the only work remaining to be done on them being the cleaning, polishing, and ultimate sorting and packing. In finishing them they are placed in tumblers, partly filled with a sulphuric-acid solution, where they remain two hours before being transferred to a second receptacle, where they are kept for a corresponding length of time in a solution of hydrochloric acid. When the operation is completed, they are thoroughly washed and placed on wire-bottom trays which are set in a hot-air drying oven for several minutes. The buffing process consists merely of placing the buttons in rotary tumblers and allowing them to rub against each other for a half hour, after which they are run through a cylindrical sieve and dusted, and finally distributed to sorting tables where they are separated by hand, according to colors and conditions. After this they are packed in pasteboard boxes, or sewed to cards, as the case may be.

Dorothy Scarborough  
Baylor University, Waco, Texas

8887

POPULAR MECHANICS

395

ARCHWAY AND STATUARY MADE OF  
COTTON FOR EXHIBITION

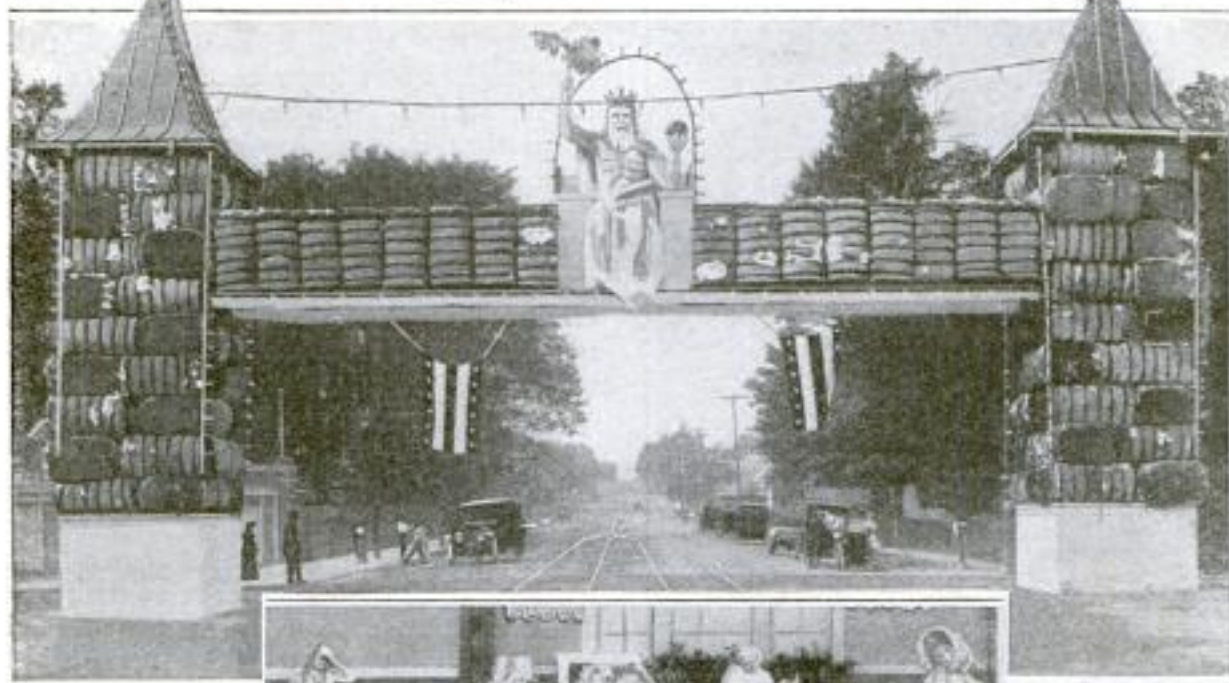

This Arch, Made of Bales of Cotton, Formed the Entrance to the Exhibition Grounds at the Cotton Festival Recently Held at Waco, Texas



Numerous Figures Made of Cotton to Represent the Emblems and Trade-Marks of Different Local Business Houses were Exhibited

During a cotton festival held at Waco, Texas, scores of bales of cotton were utilized in the construction of a large arch which was built to span a street in front of the exhibition grounds and serve as the entrance to the place. In the middle of the structure appeared the figure of King Cotton, made entirely of the product. At

night it was brilliantly illuminated by electric lights.

Numerous pieces of statuary modeled from cotton, its hulls and seeds, were displayed at the exhibit. Many of these, which showed considerable ingenuity, served as advertising mediums for different local business houses.

**AEROPLANE GIVEN ODD FORM  
TO OBTAIN SAFETY**

In one of the queerly constructed flying machines developed in France in the interest of safety in aerial navigation, the supporting surface has been given the form of a semicylindrical vault. This is twice as long as it is broad and is fitted with semicircular stabilizers at either end, which have

the effect of giving it somewhat the appearance of a dirigible. A device which is operated simultaneously from both sides of the craft permits a reduction of the sustaining surface, this being accomplished by reefing the covering fabric. Suspended from the center is a pyramid-shaped frame which carries the body, mounted at the front of which is a 14-cyl., 100-hp. motor of the rotary type. Cables arranged at

*L'Aerophile + La Science et La Vie*

Wm. H. Watson, Morton, Pa.  
Designed by John F. Cozani, supt. Phila.  
S.P.C.A. 36 S. 18th St., Phila.

the extremities of the longitudinal axis of the craft permit the angle of

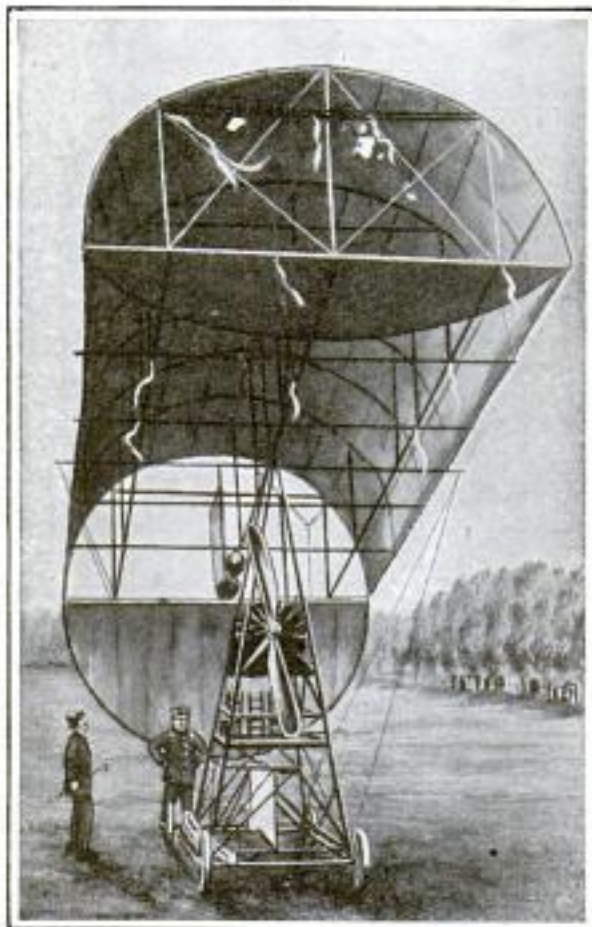

Strange-Looking Monoplane Designed for Safe Flying

incidence to be controlled. The machine has a height of about 25 ft., a length of 15 ft., and a breadth of  $7\frac{1}{2}$  ft.

### ALUMINUM REPLACES COPPER FOR TRANSMISSION LINES

Because of its pronounced durability and its freedom from corrosion in districts where the air is permeated with salt, aluminum wire is becoming quite extensively used both in Great Britain and on the Continent in the construction of overhead transmission lines. Since improved methods of producing the metal have been developed, resulting in materially decreasing its cost, its use has been found more economical than that of copper in certain phases of the electrical industry. Several hundred miles of aluminum mains have been run in Europe. When used for

The steamship

very small and heavily armored cables, however, the saving is not so great as it is with those of ordinary size. When they first commenced to be used, considerable difficulty was experienced in joining the lines, but although this trouble has not been completely overcome, it has been minimized to the point that it is no longer considered a serious drawback. When care is taken that all moisture is excluded, the joining may be affected with comparative ease. Several different mechanical clamps have also been developed which may be used for this purpose satisfactorily.

### SANITARY DRINKING BAGS FOR HORSES

Individual water buckets for horses, constructed much the same as sanitary drinking cups, have been introduced at Philadelphia for the purpose of preventing the spread of glanders and similar diseases among stock watered at public fountains. The containers, which are made of paper and provided with reinforced bottoms so that they may be used several times, are arranged so that they may be folded and carried in a coat pocket by a driver. They are sold by an anticruelty society for slightly more than one cent each, and are believed to have done much toward keeping hundreds of horses free from infection.



Sanitary Water Buckets for Horses have been Used at Philadelphia to Prevent the Spread of Glanders

U. W. Kellick, 1521 Oak St.,  
Glendale, Cal.

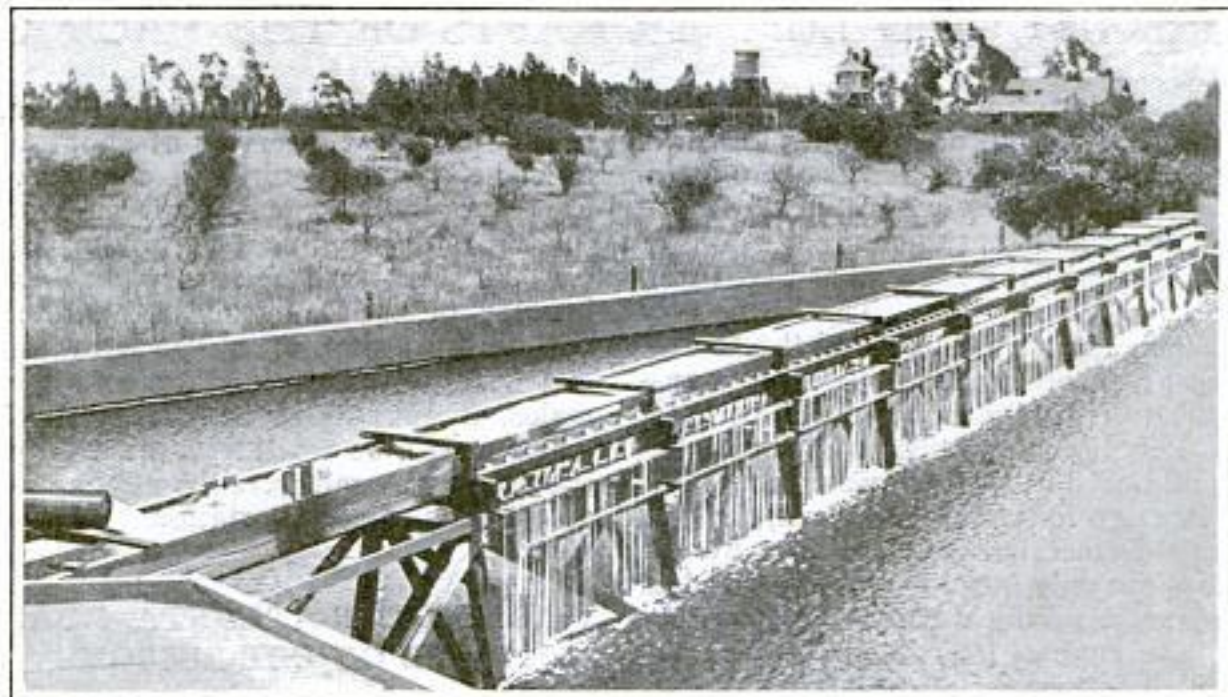

Simple Plant for Aerating Sulphur-Tainted Water: The Water Trickles through Small Openings in the Trough to Corrugated Aprons, and from These into the Reservoir

8003 **TREATING SULPHUR-TAINTED WATER BY AERATION**

A simple but effective aerating plant is used in treating the water obtained from deep wells at a town in southern California. The water, as it comes from the wells, is so strongly impregnated with sulphur that it is almost jet-black in color and has an offensive smell and taste. The plant consists of a shallow trough extending across the reservoir and kept uniformly filled by the supply pipe leading from the pumps. Through small openings spaced along the trough, the water trickles upon corrugated aprons and from the lowest of these into the reservoir, the idea being to subject the water to the action of the air for as long a period as possible in its travel from the trough to the surface of the water in the reservoir. This simple process is said to have proved entirely successful in eliminating the sulphur gas and making the water palatable for drinking.

☞ Kerosene may be used in winter for cooling motor-car engines, eliminating the danger of the radiator freezing.

8489 **CURTAINS ELIMINATE GLARE OF MOTOR-CAR LIGHTS**

Transparent curtains for motor-car headlights which break up the blinding glare of powerful lamps for street use and unshade them instantly when they are needed for country driving, are being introduced. The shade is mounted on a roller which is contained in a small cylinder that may be attached above a lamp. A cord extends from the bottom of it to a foot button which is operated from the driver's seat. By pressing the plunger the curtain is either lowered in front of the lamp, or raised, as is desired. When the light is covered there is practically no glare and yet the illumination is strong enough for most ordinary purposes.



Eclipse Mfg. Co., Auburn, N. Y.  
Smith Bros., Auburn, Cal.  
Sales Agts.

## OCEAN-GOING LUMBER RAFTS OF THE PACIFIC

8942  
K Several times each year during the shipping season, ocean-going log rafts as large as some of the greatest inter-continental liners are towed down the Pacific coast from the lumber camps of Oregon into the harbors at San Francisco and San Diego. This is the way certain lumber interests of the Northwest are solving the problem of transportation of raw timber, for in contrast to a charge amounting to \$10 per thousand board feet, which was made a few years ago for shipment by rail, the cost by this medium is reduced to \$1. It does not only mean lower prices and an immense saving to the consumers, but it also enables low grades of material, which otherwise would represent a loss, to be placed on the market profitably.

In the last few years, 29 of these titanic log barges have been successfully floated to San Diego. In no case, so far as is known, has any serious trouble been experienced, and in most cases not even a log has been lost, despite the fact that the average length of these rafts is about 700 ft., the thickness approximately 30 ft., and the breadth amidships 55 ft. Between 4,000,000 and 5,000,000 board feet of timber is contained in each one.

Such a raft is made by poling timbers into a large floating cradle and then binding them securely into a cigar-shaped barge by means of heavy encircling chains. When about half of the logs have been arranged in this framework, the longest and most flexible ones being placed on the outside and all with their butts pointing amidships so that either end of the raft tapers properly, a 2½-in. steel chain is laid along the axis. Radiating diagonally from this center chain are placed several other chains which are joined with those placed to encircle the tapered ends, so that they are prevented from slipping, and the whole mass is given a certain rigidity. The rest of the raft is then built up with the assistance of a floating derrick

and bound together tightly by 1¾-in. chains placed at intervals of about 12 ft. The chains required in constructing one of these large rafts weigh more than 100 tons and cost approximately \$10,000. It is not necessary that the interior of the raft should be filled with uniform timber, or even with that suited for ordinary logging, and this makes it possible to include material which would be worthless, practically, if shipment by rail were the only available means of transportation.

## WASHINGTON-ATLANTA ROAD TO BE OBJECT LESSON

8984  
H Under the supervision of government engineers a continuous series of model roads is to be constructed between Washington, D. C., and Atlanta, Ga., one purpose of the propaganda being to establish an "object-lesson" highway on a sufficiently large scale to attract public attention and assist in the movement for better roads. The plan which has been adopted for carrying out the venture places the expense of maintaining the roads, after their construction, upon the respective counties through which they pass. All teams, labor, and material are supplied locally and on this condition the government provides engineers to supervise the work. A similar arrangement is made in the improvement of post roads in different states. When an agreement is entered into, the state or county which is party to it bears two-thirds of the expense. The area of various roads constructed during 1914 under government supervision aggregated 691,535 square yards.

¶All motor trucks operating in New Jersey must be fitted with mirrors so that their drivers may view the road in the rear. The reason for this is that the position of the driver of the average truck is such that he is unable to see behind his vehicle.

Information sheet sent out  
by Dept. of Agriculture  
Copyrighted material



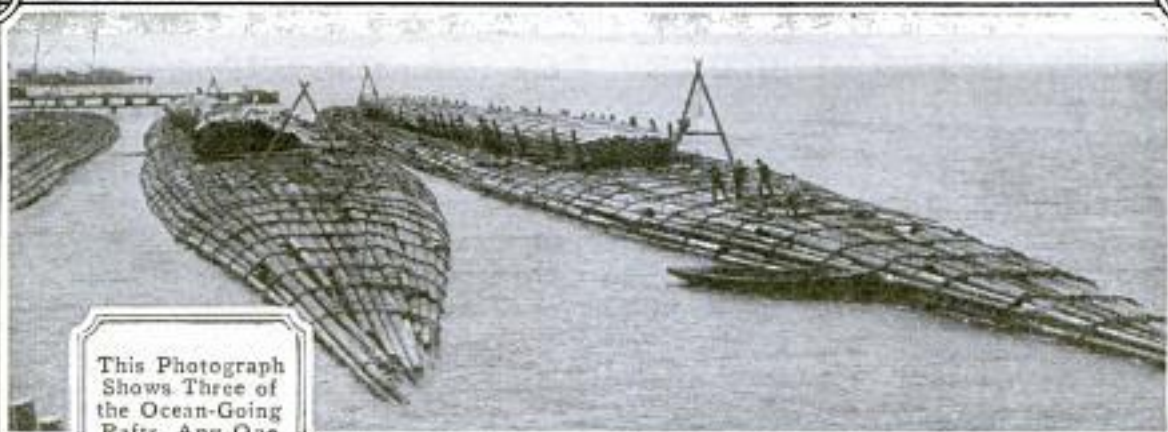

This Photograph Shows Three of the Ocean-Going Rafts, Any One of Them as Large as Most of the Transpacific Steamers, Anchored in the Harbor at San Diego After being Towed down the Coast from Oregon



One of the Great Rafts, Bound Together by More Than 100 Tons of Steel Chain, being Drawn into Port. Twenty-Nine Such Barges have been Piloted down the Coast in the Last Few Years

Russell Raymond Voorhees  
513 Clinton Ave.,  
Newark, N.J.

Geo. F. Worts  
405 W 118th St.,  
N.Y.C.

**FAN WHIRLED BY SIMPLE  
8562 m DEVICE**

A whirling fan that is worked by alternately pressing together the ends of a double handle is a novelty. The fan is mounted on a stiff rod that passes down between the handles. The handles are spaced apart at the middle by a wire loop, and have, attached at each end, cords that wind around the rod. When one end of the double handle is pressed together the cord at the end winds around



the rod, while that at the other end unwinds, giving the fan a whirling motion.

**POCKET MICROSCOPE OF  
8447 m HIGH POWER**

A pocket microscope having a magnifying power of 30 diameters and a focal length of only 1 in. has been brought out in France. The distance that the light travels in this instrument in passing from the objective to the eye is 5 in., and this distance is provided for in the compact little case by reflecting prisms that are arranged on the same principle as the prisms in a modern binocular. The holder for the object is mounted on sliding bars and may be drawn inside the case by means of a thumb-screw, which also serves for focusing

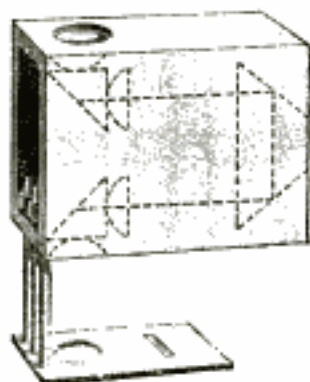

the instrument. Magnifying powers up to 75 diameters are obtained in the same type and size of instrument by making one end slidable, so that the distance traveled by the light may be increased. This microscope is only 2 1/3 in. long, 2 in. wide, and 3/8 in. thick.

**NONEXPLOSIVE MOVIE FILM  
8998 m PRODUCED IN FRANCE**

What is stated to be a completely satisfactory, noninflammable motion-picture film has recently been produced by a French company, but on account of European conditions it is not available in sufficiently large quantities for general use in this country at present. Its basic composition is acetate of cellulose, which is not explosive, is difficult to ignite, and burns only when held in a flame. The principal constituent of ordinary films is nitrate of cellulose, which is highly explosive and readily bursts into flame when subjected to high degrees of heat.

About a year ago a nonexplosive film was introduced in the United States by the same company that has produced this latest one, but at that time there was an objection to the material used, the contention being that it quickly became brittle and cracked. Subsequent improvements with it are said to have entirely eliminated this. The new film has been in general use in Europe for some time. In appearance the noninflammable film is identical with ordinary ones, while for photographic purposes there is said to be no difference between them.

**TRAP GUN FOR FUR-BEARING  
8700 m ANIMALS**

One of the latest aids for the trapper is a specially made trap gun which discharges unerringly at the head of an animal as the bait is pulled, but which is not dangerous to horses and cattle, as it cannot be discharged in any other way. The bait is placed on the end of a rod that projects in front of the gun muzzle. The gun is mounted on a swivel and is controlled by the rod so

La Nature 7/18/14

176 Boulevard St. Germain Paris Copyrighted material

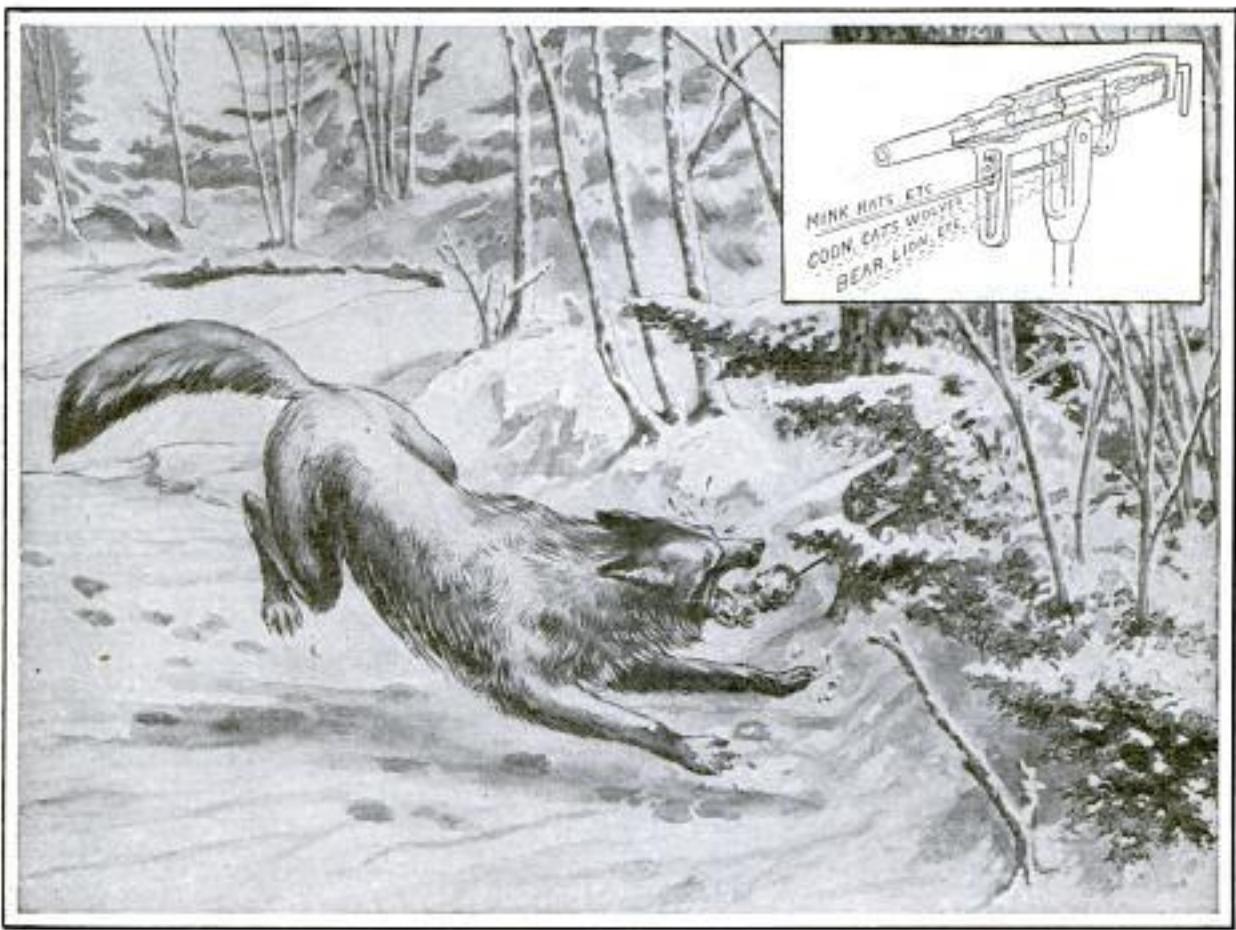

New Trap Gun That Discharges Unerringly at the Head of an Animal as It Backs Off with the Bait

that it follows the motions of the rod from side to side or up and down, and always points a few inches above the bait. In setting, the steel stake on which the gun is mounted is thrust into the ground, the end of the rod is baited, and the gun is loaded and cocked. The gun does the rest when an animal tries to back off with the bait. As the gun invariably discharges at the head of the animal the fur is not injured.

perfectly resilient. Steel of seven different degrees of hardness is used in the manufacture of the casing, the tread being of extremely hard steel, and the side walls of softer and tougher metal. The weight of tire and casing is about double that of the ordinary nonskid tire.

**AUTOMOBILE TIRE WITH STEEL SHOE**

One of the latest developments in automobile equipment is a steel-shod pneumatic tire that is apparently proof against puncturing and skidding. The outer casing of this tire consists of approximately 100 hinged and interlocking sections of steel plates which extend over the tire from one side of the wheel rim to the other. Each section consists of 13 plates with hinges parallel to the rim, so that the casing is

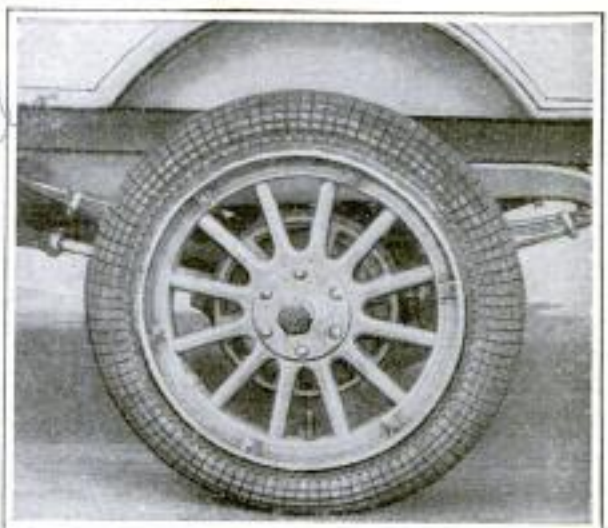

Steel Shoe in Place over Automobile Tire: Each Section is Composed of 13 Hinged Steel Plates

W. S. Wood, Auto Editor, Evening Herald, Los Angeles, Calif.  
Inventor, A. H. Savage, manufacturer of *Savage* fire arms  
U.S. Pat. 1,111,111

**MACHINE SHOWS PRODUCTION EFFICIENCY OF FACTORY**

8752

A machine has been devised which automatically watches each producing unit in a manufacturing plant and re-

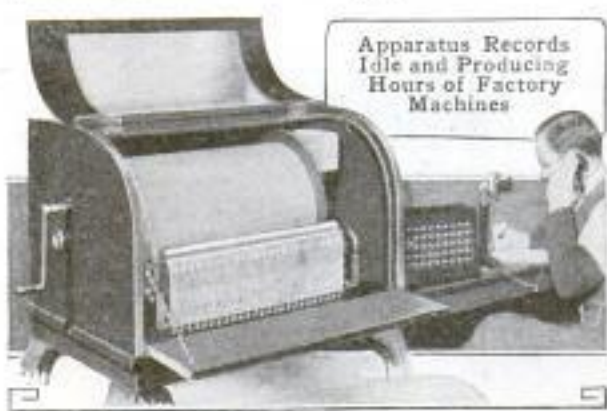

Apparatus Records Idle and Producing Hours of Factory Machines

records its behavior. The apparatus, which is electrically controlled, is provided with a large drum on which a ruled chart, divided into hours and minutes, is mounted. This cylinder is revolved by a weight and controlled accurately by clockworks, while the record is made on the chart by means of styluses actuated by electromagnets, from which wires lead to the various machines under scrutiny. Electric con-

nections are made with these by especially designed switches. Adding devices are so arranged that all productive moments of a machine are footed minute by minute.

The recording machine is started at the moment work is supposed to commence for the day. As each machine in the plant is started up, the fact is indicated on the chart. If a lathe, for instance, is running idly, a staggered mark is drawn by the stylus in the chart column corresponding to its number, while, if it is producing, a straight mark is made. The instant the lathe is stopped, the marker moves to an idle position and the adding instrument stops its operation. When the man in control of the indicating apparatus sees that a machine has stopped during work hours, or that it is not producing when it should, he ascertains the cause and makes a record of it so that the loss of efficiency, which is ordinarily covered by vague reasons, is clearly explained in every instance.

**SINKING CONCRETE PILES WITH WATER JETS**

8782

Reinforced-concrete piles molded ready for use and sunk to a firm bearing with the aid of water jets, issuing through holes in the concrete connecting with a central water tube, is the latest method for building foundations and bulkheads. With this method the pile is not hammered into place, a proceeding that is always liable to result



Raising Reinforced-Concrete Pile into Place: The Pile is Sunk by the Aid of Water Jets at the Point and along the Sides



Edwards & Binnett, Inc. Dupont  
Lincoln, Neb.  
Ashland, Neb.  
Bridge  
Platte River  
"Edwards & Binnett Piling"  
Superior, Wis.

Frank E. Perkins  
Eric Co. Savings Bank Bldg,  
Buffalo, N.Y.

C. L. Edholm  
1353 W. 36th Place  
Los Angeles, Cal.

in damage to the pile, but is simply churned up and down as the water jets play along the sides and under the point. The jets along the sides supply a water skin so that the pile is easily raised and lowered while the jet under the point softens the material and permits the pile to force itself downward at each impact. It is claimed that this method furnishes a means of sinking concrete piles without danger of damage through practically any kind of material except solid rock.

**SOMETHING NOT OFTEN SEEN  
8790m ON THE LAWN**

After dressing up in his "working" clothes, a professional contortionist allowed himself to be photographed in the front yard of a friend's house while going through some of his peculiar acts. One of the snapshots is reproduced herewith, and shows the performer as he appeared in the guise of a



This Is Not a Frog, but a Contortionist Performing on a Lawn

gigantic frog, an apparition somewhat terrifying to the uninitiated passer-by.

**PERSIAN FAT-TAILED SHEEP  
8744 INTRODUCED IN UTAH**

The curious Persian fat-tailed sheep are now being introduced in this country, there being several herds, numbering about 2,000 in all, on the national forest lands of southern Utah. The tails of these sheep sometimes grow to a weight of 40 or 50 lb., and, like the hump of the camel, serve as a reserve

supply of nourishment when food is lacking. The sheep shown in the illustration does not have the tail devel-



Specimen of Persian Fat-Tailed Sheep Now Reared on a Utah Ranch

oped to such a degree as is common in Persia, where it is often necessary to lash a small cart to the tail to keep it from dragging on the ground.

**CONVENIENT TOOL GUIDE FOR  
8533 GRINDING WHEEL**

For use with a grinding machine, a simple tool holder and guiding device, which has been introduced, consists of a steel plate that may be moved along a rod mounted parallel with the axis of a carborundum wheel. An instrument which it is wished to sharpen is secured to the guiding plate by means of a clamp, while it may be tilted to any desired angle by the exertion of slight pressure. There are no set-screws to be adjusted when the device is used.

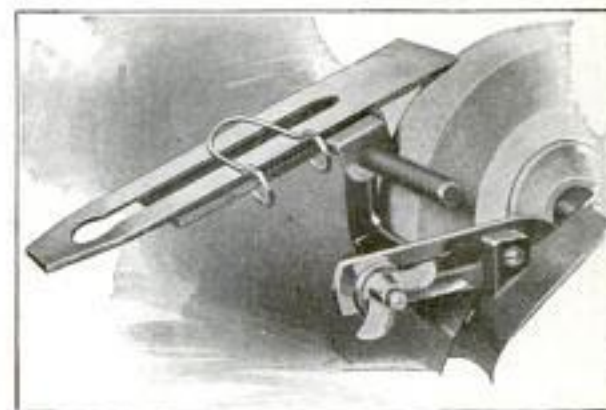

Tool Holder and Guiding Device for Grinding Machine

Bristow Adams  
Forest Service, Wash. D.C.

mfg. by: The Carborundum Co.,  
Niagara Falls, N.Y.  
Copyrighted material  
W. C. Sells, Adv. Dept.

DISAPPEARING PEACH TREES OF  
COLORADO ORCHARDS

8787H

Some of the Colorado fruit growers on the eastern slope of the Rocky Mountains have adopted an ingenious method for protecting their peach orchards during the winter season. The plan, which has been found to be a meritorious one, consists of bending the trees down to the ground, covering their branches with hay or straw and then burying them under about two inches of soil, in much the same way as blackberry and raspberry bushes are cared for in cold climates. Although in the past the peach trees in this section suffered much damage and frequently were killed outright during the winters, by this method of culture they

are surviving severe weather without difficulty and bearing good yields of fruit.

As soon as the trees of a new orchard begin to grow, they are given their preliminary preparation for the winter treatment. On two opposite sides of each tree the roots are cut away and braces substituted to keep them in an upright position during the summer. Just as quickly as the leaves fall in the autumn, the orchard is flooded with water and the earth around the roots of the trees thoroughly saturated. The dirt on one side of each trunk is then removed and the braces are taken down so that the trees fall to the earth,

their narrow strip of roots, however, remaining intact in the ground, since they are pliable enough to allow this operation without breaking. Each tree is then covered with hay and dirt and left undisturbed until some time in



Peach Trees Blossoming on the Ground. Above: Raising a Tree with Tackle



A Colorado Peach Orchard Where the Trees Are on Natural Hinges and are Turned Down and Covered to Prevent Them from Freezing in the Late Spring

J. C. Mc Carthy  
Evening Star, Wash. D. C.

April, when the layer of soil is removed. It is usually well into May before all of the hay is taken away and the trees are raised to their normal positions by means of block and tackle. The ground is tamped about their roots, the braces put in place, and in a few days a blooming orchard stands where there was apparently only a waste field during the winter.

**STORM INDICATOR IS USED BY  
8611 ELECTRIC COMPANY**

An electric-light and power company at Washington, D. C., has developed a wireless apparatus which automatically detects approaching storms and indicates their movements, so that when necessary it is possible to fire extra furnaces and plug in additional generators in sufficient time to meet the heavy load caused by thousands of lights being turned on during daylight hours. The instrument and its equipment consists of an aerial, a coherer, relay, bell, and several dry cells.

When a storm gathers within a radius of 200 or 300 miles the electrical discharges in the atmosphere charge the antenna and pass through the coherer and condensers to the ground. As the current enters the coherer it causes the silver and nickel filings to cohere, thus reducing the resistance sufficiently to allow current to pass from a single dry battery and operate the relay, which in turn closes a six-cell circuit and taps the bell once. As the clapper falls away from the gong it strikes the coherer, separating the filings and placing it in readiness for the next discharge. The distance of the storm determines how often the bell sounds. When it is seven hours away the gong will ring once in 15 minutes, but when only a half hour away the tapping is continuous. A complete table has been prepared which shows the relation between the time intervals in the ringing of the bell and the distance of the storm, so that by timing the former it is possible to determine how far away a storm is and at what speed it is approaching the

city. It has been found, for instance, that when a storm is 59 miles away

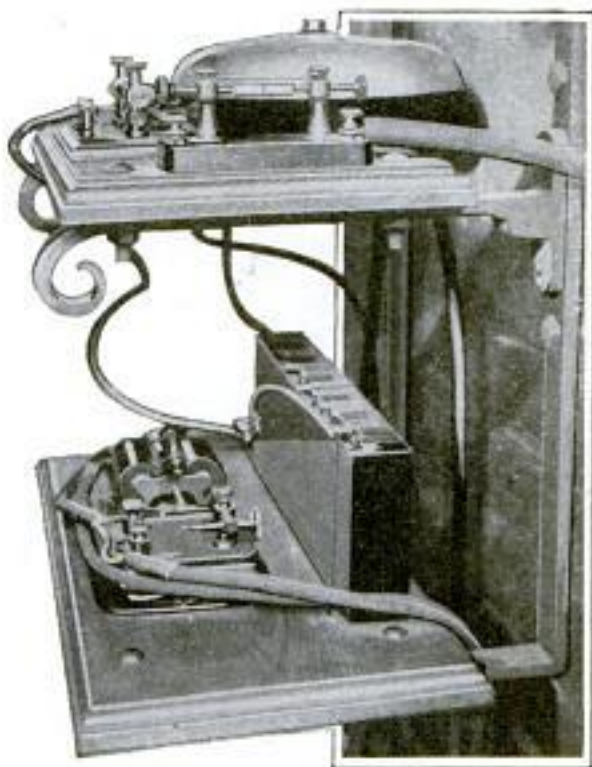

This Instrument, in Use by an Electrical Company, Detects Approaching Storms and Indicates Their Distances and Rates of Travel

the bell rings every 15 seconds, and when 280 miles, every 15 minutes.

**NOVEL MINIATURE POSTERS  
8855 USED FOR ADVERTISING**

Miniature posters, such as are reproduced in the accompanying illustration, are being used for advertising purposes by the New York Aquarium. The institution has some two million visitors annually, many of whom purchase these stamps at a cent each and send them broadcast through the mails, pasted on the backs of the envelopes of their letters. By this means the aquarium is given wide publicity entirely without expense, since the popular fad for collecting these tiny posters makes it little trouble to dispose of them.



*Zoological Society Bulletin*

*Revised*

**"FOR SALE" SIGN MADE OF  
CONCRETE LETTERS**

*8530m*

To avoid disfiguring the premises with the conventional wooden signs, a



Novel Concrete Sign Used by a Los Angeles House Owner for Advertising the Sale of His Property

Los Angeles house owner advertised his property by making seven letters of concrete and spacing them across the sloping lawn so that they formed the words "For Sale." The letters were held in place by wooden pegs driven into the sod. The resulting sign attracted much attention.

**THE BEGINNING OF RAILWAY  
BLOCK SIGNALING**

*8910m*

In December, 1839, or a little more than 75 years ago, the first block system ever installed on any railway was put in service on the Great Western Railway in England. This system consisted in telegraphing the arrival and departure of trains at stations for a short distance out of London, with a rule prohibiting any train from entering a section until telegraphic advice had been received that the train ahead was out of it. Two years later efforts were made to introduce simple instruments showing whether the different sections were clear or blocked. This was the beginning of the present elaborate and efficient systems of block signaling in use on modern railways.

*The Indian Railway Gazette  
Oct. 1914*

**WRIGHT PATENTS VALID IN  
ENGLAND**

The validity of the Wright patents covering certain features of aeroplane construction has been recognized by the British government by the payment of £15,000 (about \$75,000) to cover both past and future uses of the protected features by the government, as the result of suit brought on account of the use of these devices in the royal air-craft factory. This decision is interesting in view of the hard legal fight in this country in which the Wright brothers established their right to practically basic patents.

The principal feature of the Wright patents is that of warping the wings for controlling the lateral balance.

**A SPIRIT LEVEL DETERMINES  
DEGREES OF ANGULATION**

*8848*

Besides being suited for use on horizontal, transverse, and vertical planes, a mechanics' spirit level has recently

*UNIVERSAL LEVEL TOOL CO.  
1177 MARQUETTE BLDG. CHGO.*

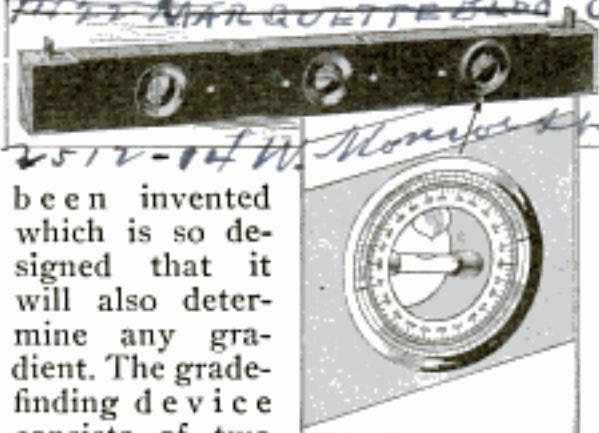

been invented which is so designed that it will also determine any gradient. The grade-finding device consists of two pairs of graduated, concentric rings, one revolving within the other. Attached to the inside rims of the inner pair is a

This Spirit Level, Besides Doing the Work of the Ordinary Tool, Shows the Degree of Angulation of an Object

*The Toledo Indicating  
Level Co., Dec. 1915  
1341 Nicholas Bldg.  
Toledo, Ohio.*

Registered material



W. D. Goodwin  
527 W. 124th St.,  
N. Y. City

cylinder which contains the spirit glass. By turning these rings in either direction until the vial is in a horizontal plane, the degree of angulation of an object and also the gradient in fractions of an inch to the foot are indicated. Over each glass is a 2-cp. electric light which enables a workman to read the instrument readily when using it in dark corners.

### SAND BOXES AS BASES FOR ELECTRIC-LIGHT POLES

8876 H

In preparing decorations for the streets of New York on the occasion of a public celebration, a plan for erecting temporary electric-light poles was devised which made it unnecessary to excavate through the sidewalks or pavements. Pyramid-shaped boxes, slightly more than four feet in height,



were filled with sand and used as bases for metal poles between which strings of lights were suspended. The boxes were approximately 34 in. square at the base, while the posts were securely held in concrete so that they were prevented from working out of plumb. Poles of this kind can also be used on temporary street planking during the course of subway construction.

### PARCEL-POST RATES SHOWN BY COMPUTING DEVICE

8691 H

A parcel-post rate-computing device which by a simple manipulation shows accurately the charge exacted for sending a package of specific weight into a certain zone, has been invented by a railway-mail clerk. It consists of an octagonal case, having two holes in each plane, through which the pound

Inventor: Clyde Musgrove  
Box 606, El Reno, Okla.

and rate figures may be read. This case houses a cylinder on which a rate sheet is mounted. The openings are



A Simple Device Which Computes Parcel-Post Rates Quickly



offset so that they appear over different columns on the roll chart. By turning the cylinder until the number corresponding to the weight of the package to be sent appears in the left-hand opening in the zone desired, the correct rate is registered. The instrument is made of nicked brass and serves as a paper weight on a desk.

### COMBINATION TOOL FOR CLEARING LAND

8481 m

A handy combination tool has been brought out for the convenience of workmen engaged in clearing land of brush and timber. One side of this tool is so shaped that it can be used as a hook or a brush scythe, while the other side has the form of an ax with a curved blade.

Burgess-Norton  
Mfg. Co.,  
Geneva,  
Ills.



A network of concrete toll roads throughout Texas, exclusively for motor cars, is planned. A fee of one cent a mile, or \$50 a year for general privileges, is to be charged for their use.

Mrs. Avis Gordon Vestal  
4243 N. Kostner Ave.,  
Chicago, Ills.

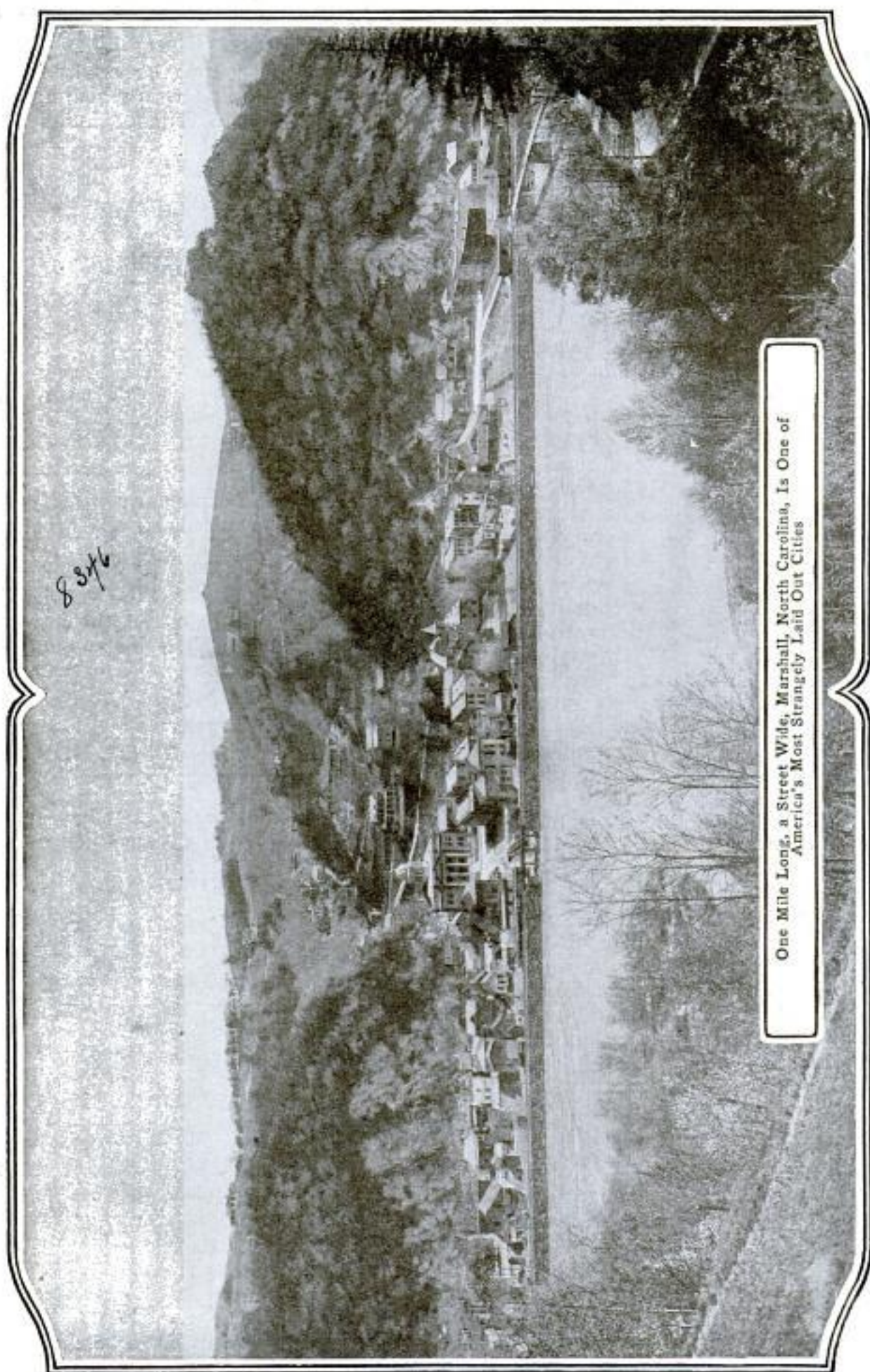

8 Sept 1916

One Mile Long, a Street Wide, Marshall, North Carolina, Is One of America's Most Strangely Laid Out Cities

Frank H. Zumbel

729 Eighth St.,

Beloit, Wis. POPULAR MECHANICS

409

International News Service  
AUTOMATIC TRAFFIC SIGNAL

FOR SWINGING BRIDGES

Signaling devices which operate automatically and warn traffic of danger

### ODD TOWN OF ONE STREET IN NORTH CAROLINA

8846 H

The town of Marshall, N. C., is approximately one mile in length and one block in width, lying hemmed in between the French Broad River on one side and a range of mountains on the other. In all of North America there is probably not a more curiously laid out town than this one, which has a single street extending through it. Along either side of this thoroughfare is a row of business buildings and dwellings, constituting the city in its entirety. Contrary to what might be expected, the place is not a sleepy little village, but a thriving town of several hundred inhabitants. The available ground space for building purposes is small, and for the most part, when there is to be a new residence constructed, it either replaces an old one or is erected 50 ft. farther along the single street from the center of town than the last one. To protect the place against the contingency of destruction by an avalanche or injury from rolling stones, many of the large boulders on the mountain sides have been chained and braced.

### LINEN AEROPLANE WINGS BETTER THAN SILK

8836 m

Various kinds of material, including linen, silk, cotton, celluloid films, and aluminum foil, have been tried for covering the wings of aeroplanes, but none has proved so satisfactory so far as linen covered with several coats of a solution of casein. This coating increases the strength of the linen about five per cent, makes it more enduring under varying weather conditions, and causes it to stretch to an absolutely smooth surface, a feature that is of the utmost advantage in fast flights. Silk, which would seem to make an ideal covering on account of its lightness and strength, has been found unsatisfactory, as it does not withstand exposure to sun and rain, and does not lend itself readily to the application of coating compounds.

Scientific American



Electric Flagging Device  
Which Operates  
Automatically

both during the daytime and at night, have been installed at either end of the Rush Street bridge at Chicago. The apparatus consists of a metallic disk, in which there are two electrically illuminated red lenses, and is suspended from an iron post above the approaches. As the bridge is opened to allow boats to pass, the signal disks are illuminated

and swung back and forth, while a loud electric gong is also sounded. Each of these functions is performed independently, so that the disablement of one part of the apparatus does not interfere with the operation of the others. Two electric lamps are provided within the disk and so arranged that should one of them be burned out, the other would be cut in by an automatic relay.

(8461) S. M. Yorks, Dept. Supt. Plant, The Western Union Telegraph Co., New York City  
 Article by L. E. Weigel, 1006 S. 22nd St., Omaha, Neb.



In This Telegraph Office the Messages, as Fast as Received and Typewritten, are Tossed on the Moving Belt and Conveyed to the Distributing Table. From the Latter the Messages are Distributed by Pneumatic Conveyors to the Different Divisions Where They are Handled by Girls on Roller Skates

**NEW ELECTRIC HEATER FOR TREATMENT OF EYE**

A new electrical device for the application of heat in the treatment of the eye has been brought out in Germany. It consists of an electric heating element inclosed in an aluminum case which is curved to fit over the eye and is held in place by elastic bands passed around the head. The device is easily kept clean and is durable.



Die Umschau  
 5/14/14

The use of coconut water instead of acetic acid as a coagulant for the latex or sap of the rubber tree is believed possible in view of a recent discovery which has been made in Ceylon. Experiments indicate that the new method will produce better rubber than is possible by the present method.

**DISTRIBUTION SYSTEM OF A BUSY TELEGRAPH OFFICE**

In order to save a few minutes in the handling of each message, an elaborate and thoroughly modern system of conveyors has been installed in a new telegraph office at Omaha, Neb., where a great many operators are employed and the business is unusually heavy. Running above the center of each of the long tables at which the operators work is a conveyor belt operated by small electric motors. These belts are placed high enough to be out of the way, but are within convenient reach of the operators. As each message is received and typewritten it is tossed on this belt and is carried to a chute through which it drops to another belt, known as the floor belt. The messages are then carried by the floor belt to the distributing room and dumped on the distributing table. Here they are placed in overhead pneumatic conveyors similar to those used in department stores and distributed to the different divisions, where the final work of distribution is done by girls on roller skates.

(Much of the oak wood now used on the Pacific coast is imported from eastern Asia.

8461  
 m  
 1914 V. 52 p. 267  
 X  
 Klichische Hochaltdrucker  
 für Augenheilkunde 1914 V. 52 p. 267  
 he... of more...  
 ...

#7900 Inventa Dr. Carl Emanuel (Augenarz)  
 Frankfurt a/M Germany.  
 Mfr Veifa-Werke  
 Wildungerstr. 9  
 Frankfurt a/M.

**INCREASING SILK OUTPUT BY  
NEW CULTURE METHOD**

8650 H According to what are considered authentic reports, a Japanese silk producer has lately made public a new process of raising silkworms which shortens their life cycle and thereby allows them to be cultured approximately ten times a year instead of only once or twice. It is claimed that the silk made by worms thus raised is not only of a greater quantity, but also of a finer texture than is procured by other means. The method consists simply in immersing the egg cards in hydrochloric acid for five or ten hours. Within a couple of weeks after this operation has been performed the eggs are perfectly hatched, and the resulting worms both stronger and larger than those hatched otherwise. The cocoons of worms bred in this manner usually contain 1,200 ft. of silk fiber, while those of ordinary worms rarely measure more than 700 feet.

*Ventilator — component*

**SUBMARINE-RESCUE DEVICE  
OF NOVEL TYPE**

7779 H One of the recently invented submarine-rescue devices is designed to furnish the imprisoned crew a supply of air and also extend a line to the surface of the water for facilitating the

raising of the disabled craft. An important part of the apparatus consists of a collapsible box containing an air bag, which when inflated rises to the surface, carrying with it a swivel-jointed pipe within which is a hose. The air for this lifting chamber is taken from the submarine, but as soon as it reaches the surface, the

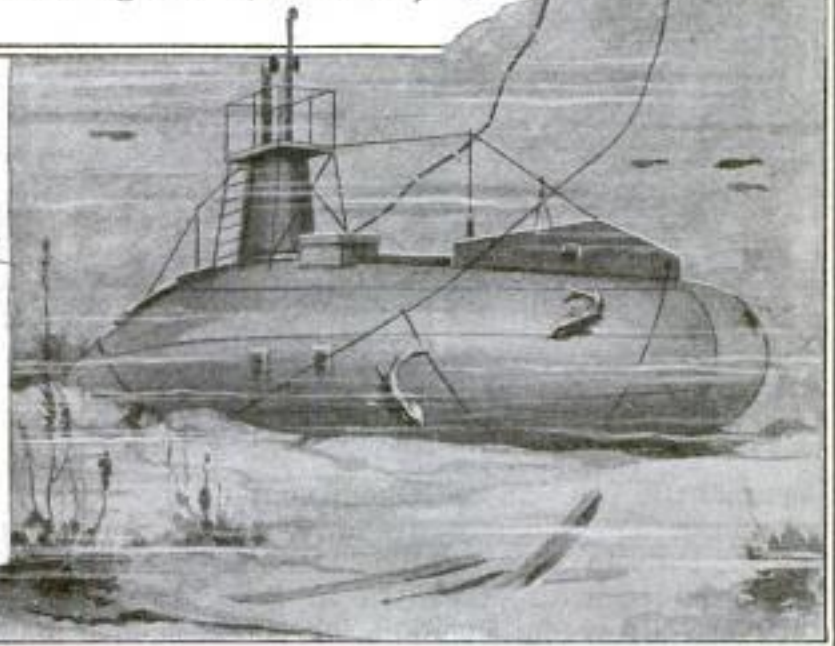
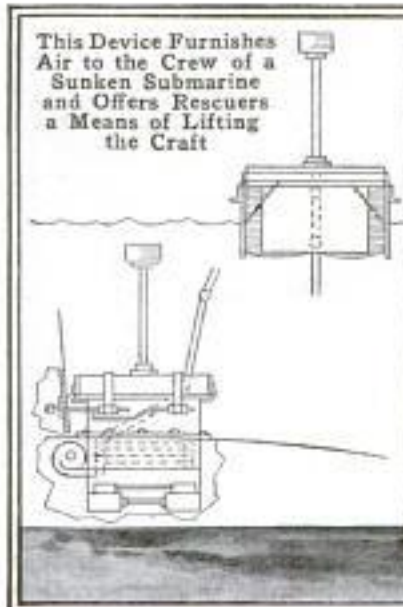
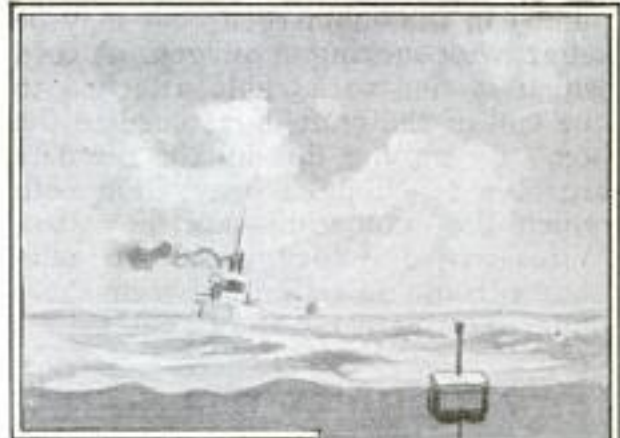

Invented by: *Geo. W. Winslow*

*458 East 47th St.*

*Chicago, Ill.*

pumps in the submerged boat may be set at work sucking in oxygen. A cord which is tied to a cable attached to one end of the craft is fastened to the box. By pulling this up the rescuers are able to obtain a heavy line with which the submarine may be raised. Wires carried by the box establish telephonic communication between those under the water and the rescuers.

### NEW HAMMOCK HAS NOVEL FEATURES

7931 m A hammock that seems to be the last word in comfort has just made its appearance on the market. It is equipped with the usual pillow and has also a second pillow that serves as a seat and prevents the continual slipping down that often proves annoying in using an ordinary hammock. The foot end is made in three longitudinal sections, and through the openings between these



This Hammock is Equipped with a Pillow Seat and Has Longitudinal Openings for Resting the Feet on the Ground

sections the feet can be rested on the ground without the necessity for twisting the body to one side. The sections are provided with spreaders so that they are always in position for supporting the feet if desired.

*avis Gordon Vestal*

*J. E. Palmer Co., Middletown,  
Conn.*

*Christian Science Monitor*  
**SAVE WARSHIP BY BLASTING  
ROCK FROM BENEATH IT**

8933 After nine months of continual work, the "Tapperheten," one of the largest vessels of the Swedish navy, which was grounded near Stockholm and was at first believed to be a complete loss, has been refloated and again placed in commission. It was found impossible to raise the ship and this left but one method by which it could be saved: that of blasting away the rock from beneath it. The drilling and the planting of the explosives were done by divers, and in six months' time 2,000 tons of stone was removed, allowing the vessel to slide into the water.

### TRADE ROUTES THROUGH THE PANAMA CANAL

8711 m Nearly 600,000 tons of cargo were carried through the Panama Canal during the first two months that it was in operation, from Aug. 15 to Oct. 15, 1914. This traffic followed fairly well-defined trade routes and may be divided into four groups. The heaviest traffic was between the Atlantic and Pacific coasts of the United States, and this trade was restricted to vessels of American registry. A route between the eastern coast of the United States and the west coast of South America was second in importance, and shipments of grain from the Pacific ports of the United States and southwestern Canada to Europe were third. The fourth route in importance was that from the Atlantic seaboard of the United States to China and Japan, over which were carried mainly shipments of petroleum and petroleum products.

*Canal Record, Oct. 28, 1914*

Joe. S. Hagans  
Uniontown, Pa.



A New Way of Expressing the "Home, Sweet Home" Idea

*8538 m*  
**HOUSE WITH MOTTO INLAID**

**IN ROOF**

Instead of hanging "Home, Sweet Home" mottoes in the parlor, as was once the custom, a Pennsylvania builder has expressed the same idea in such a conspicuous way that no one passing the house can fail to see it. Running lengthwise of the roof is the word "Home," worked out in enormous letters by means of slates of different colors.

**FORCIBLY FEED BIG SNAKE**

*8963* **WITH FOOD GUN**

After being imported from India, the largest snake caged in the Lincoln Park Zoo, at Chicago, steadfastly refused to take nourishment and was believed to be gradually starving to death. In the several months of his captivity his weight decreased from 300 to 215 lb. Numerous methods for rousing him were tried without success, until a food gun was purchased and

*J. S. Reid, 506 Belden Ave.  
Chicago, Ill.*



Using a Food Gun to Forcibly Break the Fast of a Large Snake

the reptile fed forcibly. The instrument is provided with a large cylinder and a plunger actuated by a crank. The snake was taken from his cage, given a hot bath, during which his summer coat was removed, and then placed on a board, 50 ft. in length, at the end of which the food gun with its cylinder, loaded with 20 lb. of chopped pork and beef mixed with fresh pig's blood, was mounted. The strength of 20 men was required to

carry out this operation. A board through which a circular hole was drilled was then inserted between the reptile's jaws, and a tube extending from the nozzle of the food machine passed through this into his throat. The crank was turned, and the meat forced into the snake. Before the operation was finished 50 lb. of the mixture was disposed of in this manner, and the snake was then returned to his cage.

8902 *A* **RESTAURANT SIGN APPEALS  
TO AERIAL TOURISTS**

The proprietor of a restaurant at Burlington, N. J., who caters particularly to the trade of motor tourists, has

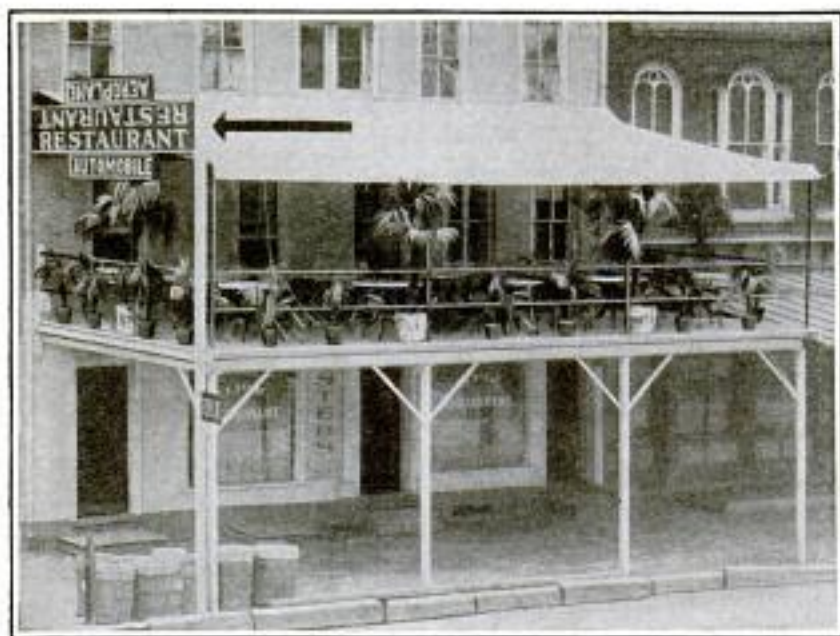

Unusual Sign Erected by a Burlington, N. J., Restaurant Keeper Which has Attracted Sufficient Local Discussion to Serve as a Profitable Advertising Medium

recently erected a somewhat novel sign ostensibly for the purpose of attracting possible patrons passing the town in air craft. The board which informs airmen that a welcome is waiting them at the emporium is inverted and placed immediately over one directed to automobilists. Because the letters of the aero sign appear upside down, considerable attention has been attracted, arguments stimulated, jokes passed, and the restaurant advertised.

*Les A. Pollock*  
*Evening Telegraph,*  
*Phila., Pa*

8836 *H* **CAUSE OF DUST EXPLOSIONS  
STUDIED BY GOVERNMENT**

On account of the number of fatalities and the great amount of damage resulting from grain-dust explosions during the last several years, the government is now conducting an investigation into the explosibility of carbonaceous dusts for the purpose of discovering, if possible, some means of safeguarding mills and similar industrial plants from this danger. During the last twelvemonth 16 different disasters, which have occurred in recent years, killing at least 80 and injuring 122 men, have been studied. Considerable difficulty has been encountered, however, in obtaining adequate information concerning

explosions at the time of their occurrence, and for this reason it has been urged that all cases, irrespective of the amount of damage done, be reported immediately to the Bureau of Chemistry of the Department of Agriculture.

Records of the Forest Service show that cinders from a forest fire in northern Washington were carried by the wind for a distance of 20 miles.

*Information sheet sent out by*  
*Dept. of Agriculture*  
Copyrighted material



8736  
m

## FOOTBALL GAME SIGNALLED BY "HUMAN SEMAPHORE"

Every move in a football game at the Harvard Stadium is signaled instantly to the man in charge of the score board by means of an elaborate system of signals made by a man in red sweater and white hat who for years has been known to the thousands who

to play, and to record intelligibly. This system has since been developed from its original simple form to a code that conveys every detail about a play as completely and accurately as if the information had been sent by telephone. In addition to signals repre-



witness the games as the "human semaphore." These signals are made principally with the hands and feet, but many of them require particular postures of the body as well. The system of signaling came into use about 1905, when mass playing was abolished, and when keener strategy and tactics made the game more difficult

senting numbers and the letters of the alphabet, there are single signals that represent the usual features of a football game, such as "touchdown" and "right half back passing to left end." It is estimated that at each game the man who does the signaling travels about 10 miles as he follows the game from one end of the field to the other.

**A CONVENIENT ELECTRICAL  
WASHING MACHINE**

8482  
m

A new electrical washing machine is particularly designed for apartments and houses where laundry space is

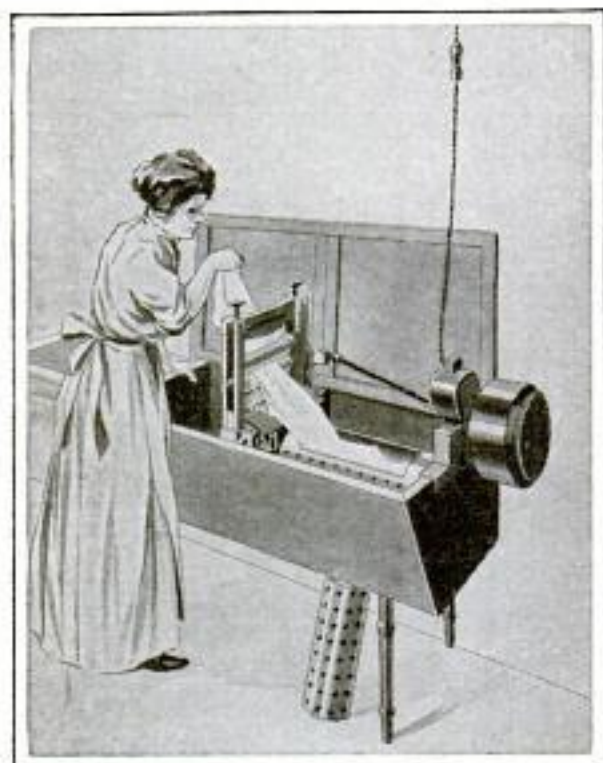

This Washing Machine Consists of Three Distinct Units, a Motor, Washing Cylinder, and Wringer, Which are Easily Attached to Any Stationary Tub

scarce, since it can be attached to any stationary washtub. This machine consists of three distinct units, a motor, washing cylinder, and wringer. The motor takes its current from any electric-light socket, is light enough to be carried about the house easily, and can be used for other purposes than washing, such as running a sewing machine.

**LIST OF PRIME NUMBERS  
COMPILED IN TABLE**

89524

The Carnegie Institution of Washington has published a remarkable book which contains a complete list of all the numbers from 1 to 10,006,721 which are divisible only by themselves and one. The compilation of these prime numbers, which was the work of years, constitutes a valuable contribution to science, for it has been done with the utmost accuracy. Often it is important

Science, Dec. 11, 1914

to know whether a given number is prime, as in the case of developing theorems relating to prime numbers, and if it be of a large denomination it is often a laborious thing to determine. The table that has been prepared answers such a question almost instantly, while a glance will show exactly how many prime numbers exist between any two given quantities.

**MONUMENT TO PIONEER IN  
PHYSICAL CULTURE**

8742  
m

A novel memorial stone has been erected in Cincinnati to the memory of Friedrich Ludwig Jahn, affectionately known as "Father Jahn," because of his activity in founding the first Turnverein. He was the originator of playgrounds and gymnastic fields in Germany. This monument is 10 ft. high, 7 ft. wide, and 3 ft. thick, and weighs about 30,000 lb. The body of the monument consists of a block of rough-hewn stone on which is a life-size bust of "Father Jahn," carved in the finest Italian marble, and a knotty and storm-beaten German oak.



Monument to the Founder of Turnvereins Recently Erected in Cincinnati

H. E. Zimmerman  
Mt. Morris, Ills

Submitted by Mrs. Ave Gordon Vental  
14243 N. Foster Ave

R. W. Fisher  
827 Hobson St.,  
Walla Walla, Wash.

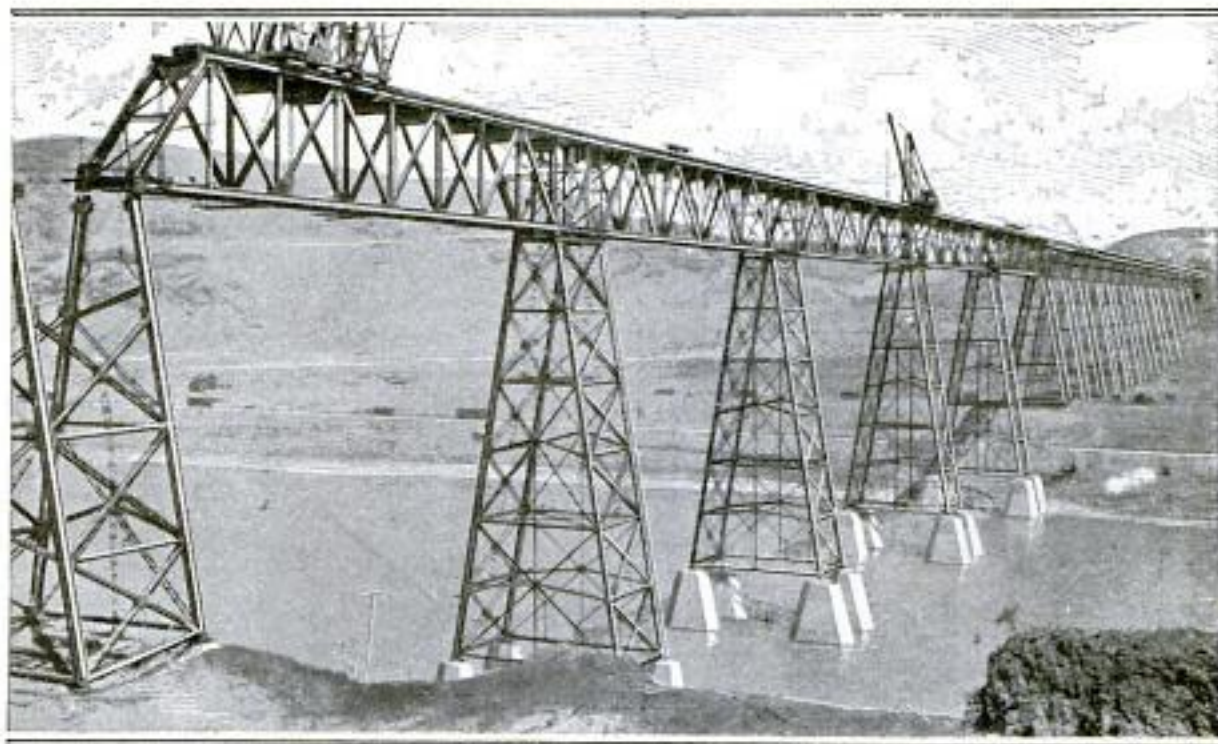

This \$2,000,000 Railroad Bridge over the Snake River in Washington was Built to Cut Off 52 Miles of Distance between Spokane and Portland

8001 **RAILROAD BRIDGE OVER THE SNAKE RIVER**

One of the most important railroad structures in the West is a bridge just completed over the Snake River in Washington, which cuts off 52 miles of the distance between Spokane and Portland, and cost about \$2,000,000. The bridge stretches from bluff to bluff and is 4,000 ft. in length. The approaches are steel trestles, while the river portion consists of steel-truss spans carried on steel towers, each of which is supported on four concrete piers. The track is 285 ft. above the water, and the concrete piers extend down to bedrock from 18 to 30 ft. below the water.

8806 **FARM TRACTOR COSTS LESS THAN TEAM OF HORSES**

Large farm tractors have been in use for years on the large farms and ranches of the West, where they long ago demonstrated their worth and economy. The initial cost and expense of operation of these machines, however, makes them anything but economical for the smaller farms of the

East and Middle West. This condition is being met by the development of light tractors that cost less than a good team of horses, are operated at less cost than providing feed for a team, and are powerful enough to do plowing and other kinds of farm work. A new machine of this class which is exceedingly simple in construction is shown in the illustration.



Farm Tractor That can be Economically Used with a Single Plow

Fred Telford  
605 So. Douglas Ave.,  
Springfield, Ills.

Bull Tractor Co.,  
Minneapolis, Minn.  
Copyrighted material

Miss Dorothy Scarborough  
717 Speight St.,  
Waco, Texas.

Waverly and away.  
White Star Line  
9 Broadway, N.Y. City

87634  
X Dr. James M. Cain, Brownwood, Texas  
The Queen Horns, Van Antwerp, Texas  
New York, fine collection.

PASSING OF THE LONGHORN CATTLE OF SOUTHWEST

It is only a few decades ago that the longhorn cattle of the Southwest ran rampant over the unfenced ranges in herds of thousands, yet today they are practically extinct. The grazing lands of the plains for the greater part have been cut into farms, and cattle ranches



Horns of Some of the Wild Cattle Once Grazing in Herds of Thousands on the Ranges of the Southwest

as they once were are rare. It is partly because the longhorn takes up too much room and is a dangerous creature in close confinement that it has been supplanted by other breeds. For this reason good specimens of the horns of these rapidly disappearing wild cattle are valuable. The accompanying photograph shows several pairs, the longest of which measures <sup>over</sup> eight feet and some inches from tip to tip. They were taken from one of the finest collections in Texas.

INSTALLING THE EQUIPMENT OF THE "BRITANNIC"

One of the three biggest ships in the world is the "Britannic," now nearing completion at Belfast, Ireland. Originally planned for the transatlantic passenger service, the exigencies of the war may cause it to be diverted to military purposes. Much of the equipment for this vessel has already been made and installed, and an idea of the immensity of some of the parts is given in the accompanying illustrations. Power for driving the "Britannic" across the Atlantic at the estimated speed of 22 knots, or 25 1/2 miles an hour, is to be supplied by 29 boilers, each 16 ft. 5 in. in diameter, 21 ft. 10 in. long, and weighing 105 tons. Connected with these will be four funnels of elliptical cross section, the two diameters of each funnel being 24 ft. 6 in. and 19 ft. 10 in. The tops of these funnels will stand 150 ft. above the furnace grates. In the two condensers there are 19,240 tubes, which, if placed end to end, would reach 50 miles. The vessel will be driven by three propellers, of which two are to be operated by reciprocating engines, and one, the center propeller, by a Parson's turbine, capable of developing about 10,000 hp. when running at 165 revolutions a minute. This turbine operates on the steam exhausted from the reciprocating engines, receiving the steam at 24 lb. absolute pressure, and exhausting it at 16 lb. The rotor alone, which is 16 ft. 11 in. in diameter and 13 ft. 8 in. long between the first and last rings of blades, weighs 145 tons, while the entire turbine weighs 420 tons. The blades range from 18 in. to 25 1/2 in. in length. The center propeller has four blades, and consists of one solid piece of manganese bronze. It weighs 22 tons and has a diameter of 16 1/2 ft. The blades in the turbine number 58,946, and if placed end to end they would reach 12 1/2 miles.

CA n automatic sewage-pumping station, having a daily capacity of 151,000,000 gal., and said to be the largest in the world, is being built at Boston.

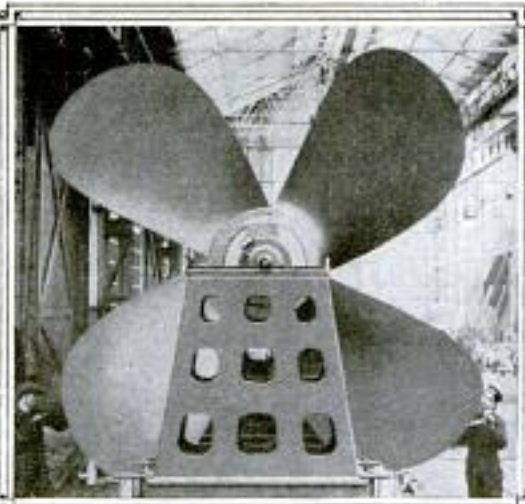

The Center Propeller, Driven by the Parsona Turbine, Is One Solid Piece of Manganese Bronze Weighing 22 Tons

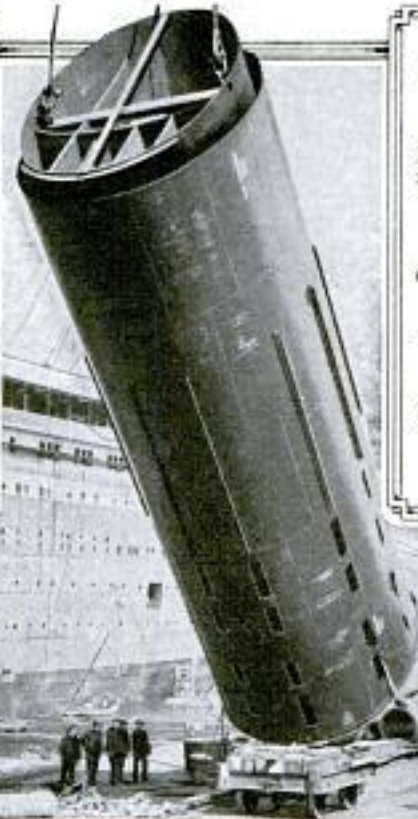

Hoisting One of the Four Funnels on Board the "Britannic": These Funnels are Elliptical in Cross Section and of Enormous Size, the Two Diameters of Each Funnel Being 24 Feet 6 Inches and 19 Feet 10 Inches. When Installed, the Tops will Stand 150 Feet above the Furnace Grates. About 20 Uptake Branches Connect Each Funnel with the Furnaces

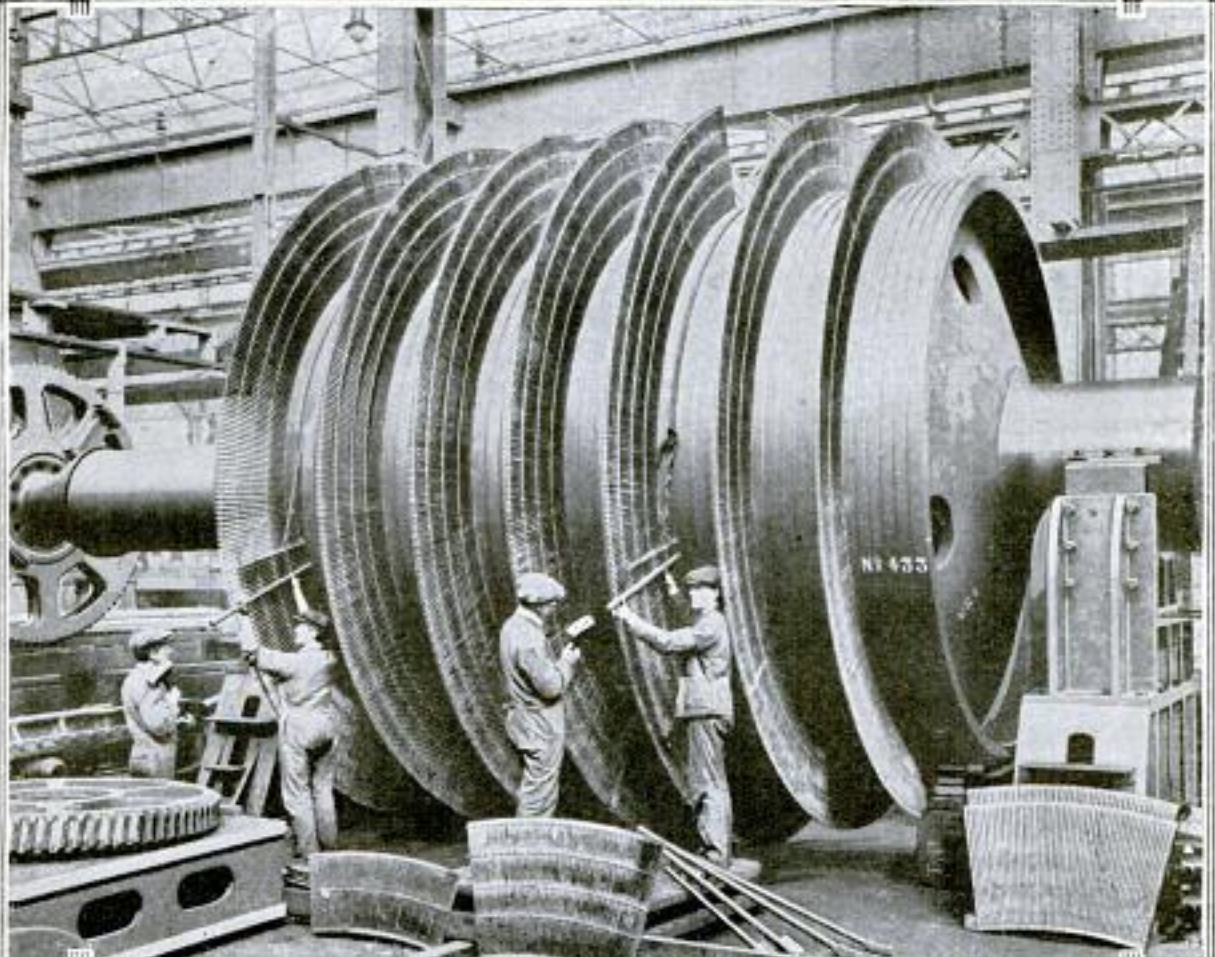

Putting the Blades in the Parsona Turbine: The Blades in This Turbine, 58,946 in Number, would Reach  $12\frac{1}{2}$  Miles If Placed End to End

Albert Marple, 322 Beaynton St.,  
Tropic, Cal.

STONE TREE FORMS BRIDGE

8201H OVER WIDE RAVINE

Spanning a wide ravine near Flagstaff, Ariz., is a natural bridge which



This Petrified Tree, Which Is More Than 100 Feet in Length, Spans a Ravine and Forms a Natural Bridge

constitutes such an unusual curiosity that the government has undertaken to protect it against possible injury. It is in reality a petrified tree, approximately 3 1/2 ft. in diameter and 125 ft. in length, which apparently rests where it originally fell after being blown down during a heavy storm. In order that it may not be destroyed, strong concrete piers have been constructed to support it.

W. W. C. C. C.

THE "DEMOLOGOS," FIRST STEAM WAR VESSEL

8830m

In comparison with the dreadnaughts of the present day, the "Demologos," the first steam war vessel ever built, furnishes some interesting contrasts. This ship was 167 ft. long. It made its first speed trial on July 4, 1814, and developed a speed of a little more than six miles an hour, which was thought to be very good at that time. The "Demologos" never engaged in battle. On June 4, 1829, the ship was destroyed in the New York navy yard by an explosion of its boilers, which killed 29 persons. Some of the naval launches of the present time have a greater horsepower than that of the "Demologos."

marine Journal

Reclams Universum  
WEAVING DRESS FABRICS FROM WOODEN THREAD

8451

Commercial chemists in Great Britain have recently devised a simple process for manufacturing dress goods from wood. In appearance the cloth bears quite a close resemblance to silk. The fabric is made by cutting wood into thin sheets and treating it chemically so that it is converted into a thick fluid. This is passed through a series of heated pipes so that the moisture is evaporated rapidly and the product changed into a solid which passes through a fine-mesh screen in the form of thread. These hairlike strings are then given a chemical bath, thoroughly dried and woven into fabrics. The resulting cloth has a silky gloss and is produced very inexpensively.

REQUIRED HEAT MAINTAINED BY NEW CANNER

For complete success in canning, the fruit or vegetables should be subjected to a temperature considerably higher than the boiling point of water, but it is impossible to obtain a higher temperature than this when the filled cans are boiled in an open vessel, as the excess heat passes off in steam as fast as it is produced.



A canning vessel now being introduced is designed to overcome this obstacle and to furnish a means for obtaining any temperature required for canning and to maintain that temperature as long as may be

mfgr: West Mfg. Co.  
662 Bullitt Bldg.,  
Phila., Pa.

copyrighted material  
Visit us at: www.woodgarden.com

Jack Brooks, Wagonham Rd  
Romford, Essex, England

necessary. This canner is in effect a steam chest, being provided with a close-fitting cover and water seal that confines the steam. On the cover is a thermometer which shows at a glance just what the temperature is inside the vessel. The size for ordinary household use holds 17 three-pound cans or 11 one-quart glass jars.

*Army + Navy Jour.*  
**COST OF RAISING HORSES AND AMERICA'S SUPPLY**  
*8454*

In spite of the constantly growing use of motor vehicles and mechanical devices on the farm and in the city, the United States today possesses nearly one-fourth of the horses of the world. At the beginning of the Civil War there were approximately 5,000,000 horses scattered through the various states, while during that conflict, it is estimated, more than 250,000 were killed annually. The number of horses now in this country approximates 23,000,000. The government maintains three breeding stations which have been in existence for some time, and while it has attempted to develop animals suitable for military purposes, it has been unable to bring them to an age of three years for a cost less than approximately \$1,000 each, it is claimed. At the same time \$150 is the amount which it offers in the open market for horses, a price which raisers assert the government's experiments show to be less than the actual cost of breeding and raising good stock.

**WAR VEILS THE LATEST PARISIAN FASHION**  
*8940*

French women have found a new way of expressing their patriotism by wearing veils in which war emblems are woven. These war veils are grotesque in appearance and scarcely add to the beauty of the wearers, but they have nevertheless become a popular style, especially in Paris. One type of veil has a black cannon woven in the mesh just where it rests on the cheek. Another popular veil has a



Veils Like These, Carrying Emblems of War, are Worn by French Women for Expressing Their Patriotism

"beauty spot" woven to the shape of the Red Cross, but done in white on a black background.

**BASE FOR ADJUSTING JACK ON SLOPING GROUND**  
*8446*

A simple device intended for the convenience of motorists is a base to be used with a lifting jack, with which the jack can be placed in a vertical position on a sloping road or can be used in sand or mud. This base gives a much greater bearing than the base of the jack and is wedge-shaped so that it can be swung on a slope to give the jack a level footing.

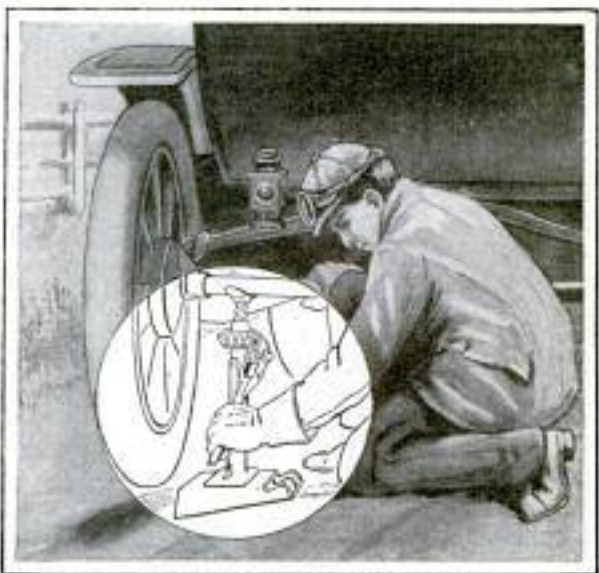

Automobile Jack with Adjustable Base

*Motor Age - July 30, 1914*  
*Goodnow Mfg. Co. Boston,*  
Copyrighted material

Mr. M. J. Dion, 1926 Oakland Ave.,  
Merriam Park, Minn.

Reumeyer & Diamond  
82 Beaver St., N.Y. City

**PRIVATE WIRELESS STATION  
OF GREAT POWER**

8002 m

What is probably the largest private wireless station has just been installed in the city hall at Minneapolis, Minn., by a noncommercial organization of wireless experts and amateurs, known as the Minneapolis Wireless Association. The instruments in this station have been arranged with particular reference to experimental work, which will include tests and comparisons of new apparatus, studies of stray electrical disturbances, and the development of new apparatus. The aerial, which consists of 11 wires stretching between the two towers of the building, is 400 ft. above the ground at the upper end. This station has a receiving range of 4,000 miles and a sending range by the power of special li station to be length of

of 4,000 miles and a range limited only used. Although a cense permits the operated with any wave and with any power, every precaution will be taken not to interfere with other stations.

A wireless telephone set, to be operated in connection with the station, is now under construction.

**AUTOMATIC PIG-CASTING  
MACHINE**

6807 m

A horizontal pig-casting machine that is capable of turning out from 20 to 30 tons of small-sized pigs an hour is being successfully used in Germany. This machine is in effect two turntable machines that work in conjunction and are served by one ladle and pouring trough, with 64 horizontal molds arranged radially between two concentric rings in each table. The ladle is placed on pivoted bearings between the two machines and adjacent to the blast furnace for filling, while the pouring troughs are arranged to swing automatically from one machine to the other. The tables rotate alternately a distance equal to the distance between two molds, so that while one table is stationary and a mold is being poured the other table moves ahead the required distance and stops. In this way there is always an empty mold under the spout when it is swung from one table to the other. After each poured mold has moved forward about 270°, a distance that gives it time to cool, it is automatically tilted and the pig drops into a railroad car, the tables being

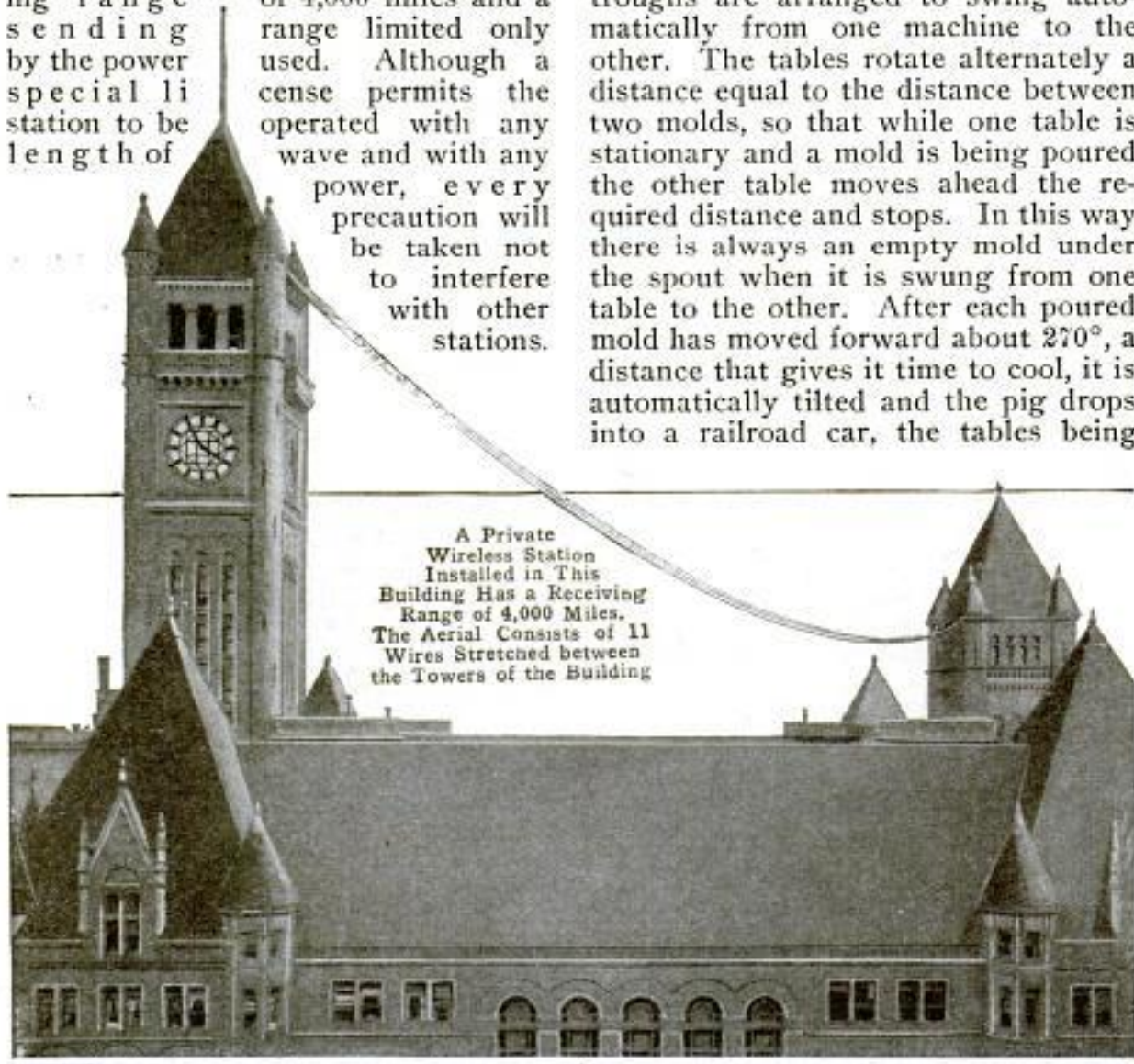

A Private Wireless Station Installed in This Building Has a Receiving Range of 4,000 Miles. The Aerial Consists of 11 Wires Stretched between the Towers of the Building



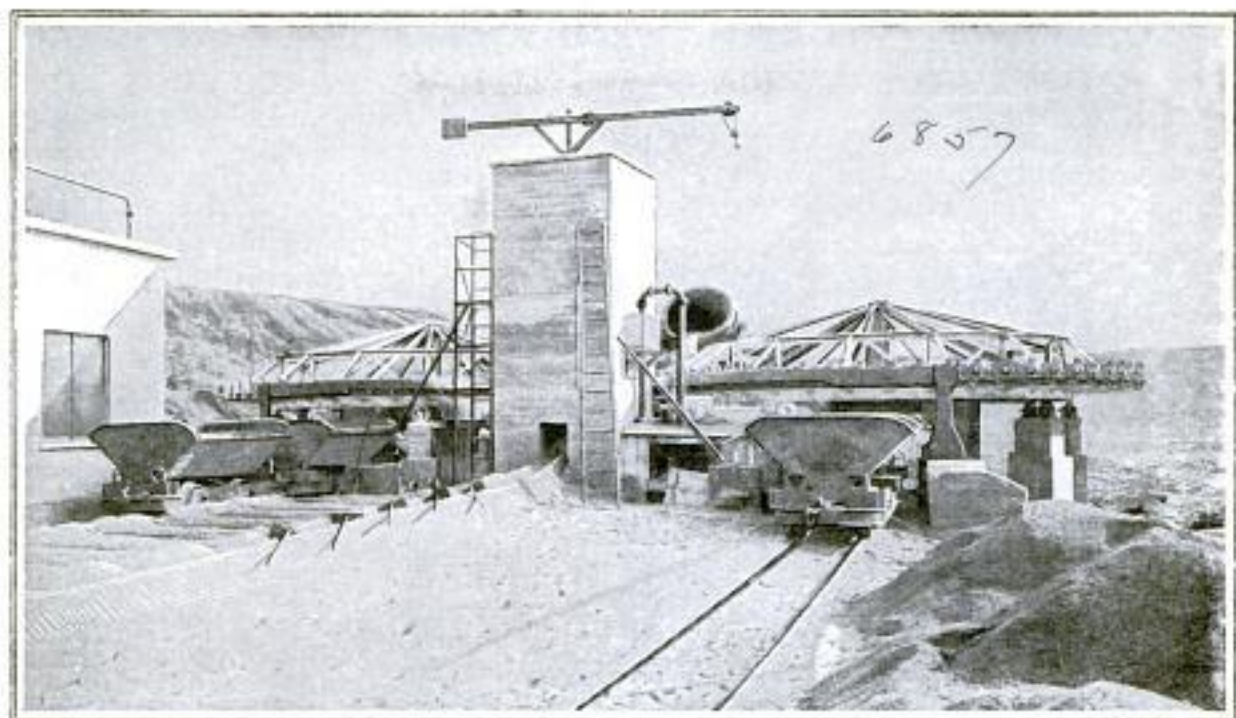

In This Pig-Casting Machine the Two Turntables Carrying the Molds Work in Conjunction and are Served Alternately by One Ladle and Pouring Trough; the Machine Is Capable of Casting from 20 to 30 Tons of Metal an Hour

placed high enough to permit a car to be run under them. The entire machine is driven by an electric motor of 10 hp. It is adapted not only for casting pig iron but for casting copper, zinc, lead, and other metals.

### NEW DISHWASHER WORKS AUTOMATICALLY

8454

In a new dishwasher the dishes are cleaned by the impact of water thrown upward among the dishes by a rapidly revolving "dasher." The outer case of the machine has a funnel-shaped bottom and in this the dasher revolves without any danger of striking the lower tray on which the dishes are placed. Two wire trays, placed one above the other and supported independently of each other, are used, the lower tray being used for dishes and plates, and the upper for cups, saucers, and other small articles. In the middle of the lower tray is a compartment in which knives, forks, and spoons are stood on end. The trays are so made that dishes of various shapes and sizes are held securely on edge. The machine is made for operation either by electric power or by hand. In the

electric machine the dasher makes 310 revolutions a minute, and in the hand-operated machine it makes three revolutions for each movement of the handle. In using, all that is necessary is to fill and place the trays in the machine, put in water and soap and start the dasher going.



Section of New Dishwasher, Showing How the Dishes are Arranged in Trays above the Dasher

Walker Bros. Co., 225 Walton St., Syracuse, N.Y.

Elect. 65. 80. 110.  
Hand Oper. 24. 30.

Lewis N. Freeman  
287 E. California St.,  
Pasadena, Cal.

424

## POPULAR MECHANICS

### TO GROW TIES FOR THE RAILWAYS OF AFRICA

7666  
m

A "tie plantation," planted about five years ago in Cape Colony, for supplying the railways of South



An Evergreen Lane in the "Tie Plantation" of Cape Colony

Africa with ties, has now reached such a state of maturity that the first cutting of the trees is soon to begin. Heretofore practically all the ties for the South African railways have been imported from Australia, and in late years the cost has averaged about \$1.75 apiece. On account of this high cost it was decided to try planting a forest of native evergreens as a source of supply, previous experience with the evergreen wood having shown that it was suitable for tie material.

ⒸThe Post Office Department has authorized postmasters to furnish patrons information by telephone regarding parcel-post rates and packing requirements.

The Jeweller's Circular Weekly

### 8935H DISCOVER NEW METAL ALLOY WITH VALUABLE PROPERTY

Having a coefficient of expansion amounting to only .0000004, a new metal alloy has been discovered which is especially valuable for precision pendulums. The composition of the material has been kept secret and its name, "indilatans," is derived from its insensibility to varying degrees of temperature. Although it is surpassed in this quality by quartz, it has, when used for a pendulum, the advantage of being simpler in construction and more easily transported.

### 8361 m AUTOMATIC GUARD FOR CIRCULAR SAWS

A guard for circular saws, now being introduced, is connected by a swivel joint with an arm that projects down from the ceiling, or with an upright clamped to the side of the table, so that it is free to rise as the wood goes through, but falls back instantly into place as soon as the wood has passed beyond the saw. The nosepiece of the guard is adjustable for any thickness of lumber. When up-end work is to be sawed, the swivel joint makes it easy to swing the guard out of the way.

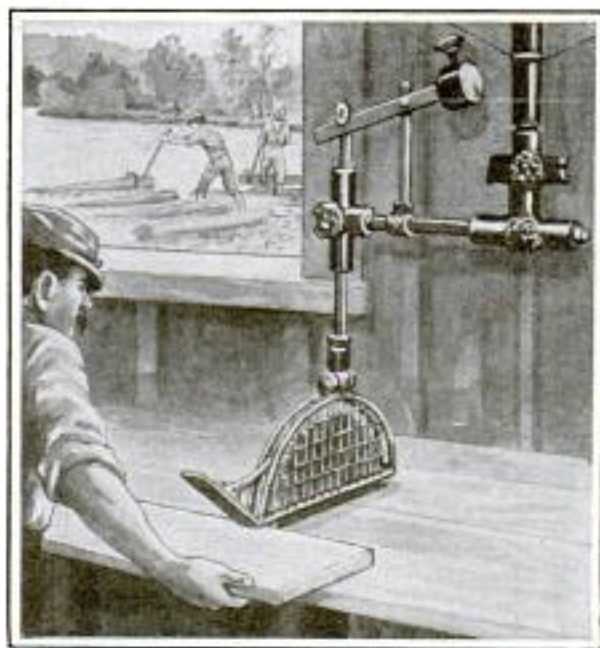

This Saw Guard is Lifted Automatically as the Wood Goes Through, but Falls Instantly into Place as Soon as the Wood Has Passed the Saw

mfr: Cass Brothers  
82 Walker St.,  
New York City

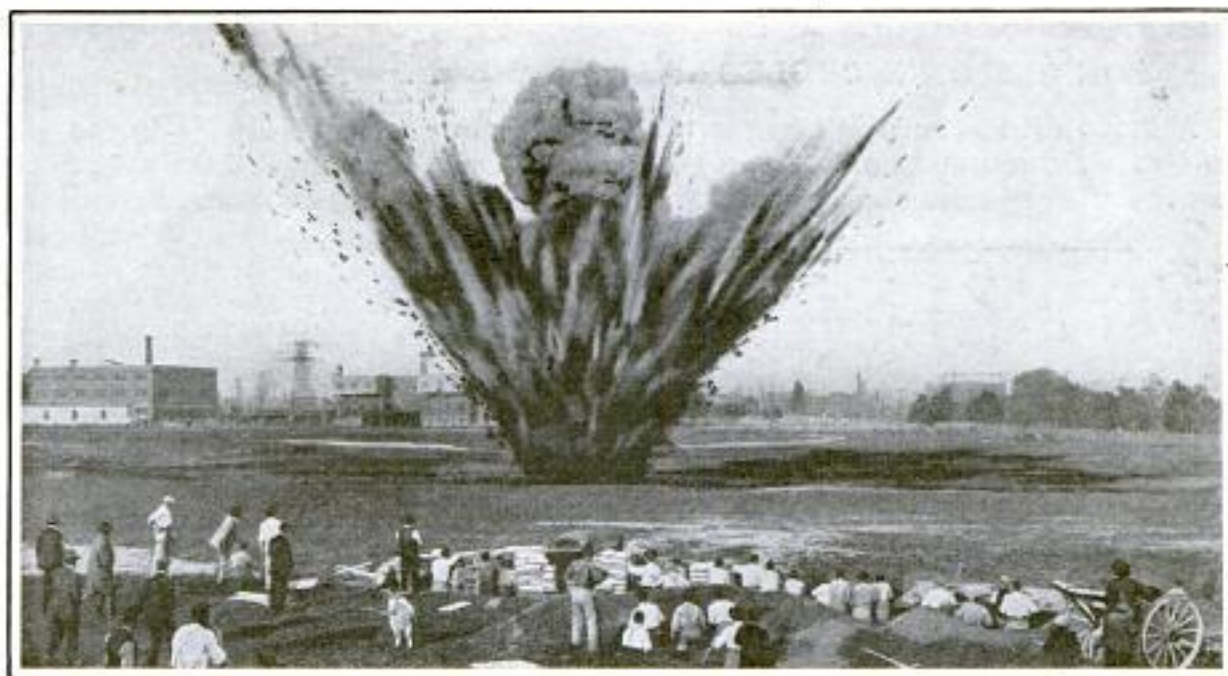

This Earth Mine Consisted of Only 25 Pounds of Black Gunpowder

### CANADIANS DRILLING WITH 8673 FIELD MINES

Every form of military movement and practice is included in the training of the Canadian recruits who are preparing for active service in Europe. One of the most spectacular of these drills is that of the placing and exploding of field mines by the military engineers. The severe nature of these explosions is shown in the photograph of a mine set off on Garrison Common, Toronto. Only 25 lb. of black gunpowder was used, but earth and fragments of rock were thrown 300 ft. into the air, while a hole, 5 yd. square, was made in the ground.

### CURIOUS VEHICLE MADE OF 8002 ODDS AND ENDS

Because of lack of funds or a disinclination to spend any money on transportation, an enterprising homesteader in Montana built a two-wheeled cart from odds and ends picked up about the railroad station, loaded his slight belongings on this curious vehicle and then trundled it across 35 miles of country to his homestead. The rims of the wheels are made of saplings bent as nearly as possible to a circular shape.

Dr. J. P. Regan  
Bloomfield, Neb.

The rim of each wheel is held and thoroughly braced to this shape by barbed wire stretched back and forth after the fashion of wire spokes, the result being a suspended wheel working on the principle of a bicycle wheel. The wires are wound around the ends of a scantling, which serves as an axle and revolves with the wheels. The middle of this axle was rounded with an adz and from this the load was suspended by wire loops. This improvised cart stood the trip very well, although it was loaded with a trunk, bedding, a box of chickens, and a roll of fence-wire netting.

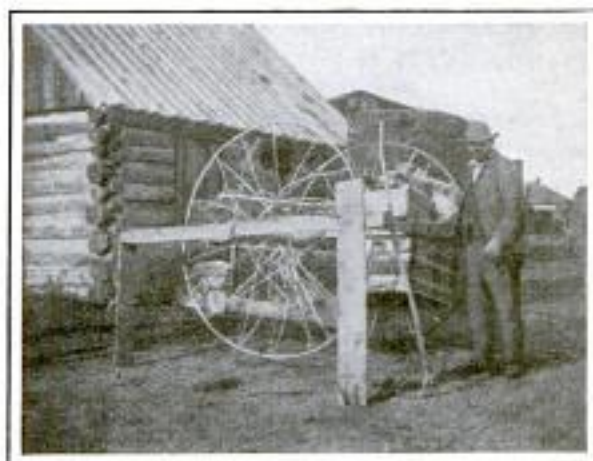

This Cart, Made of Saplings, Barbed Wire and a Scantling, Carried a Heavy Load 35 Miles

Cycle Mfg + Supply Co.,  
180 N. Dearborn St.,  
Chicago, Ills.

APR 16 1917

Mfg. by: Sturmer-Archer Gears, Ltd.,  
8540 #  
Faraday Rd., Nottingham  
Eng.

### THREE-SPEED HUB IS MADE FOR USE ON BICYCLES

Although it has been in common use in Great Britain and on the European continent for a number of years, a

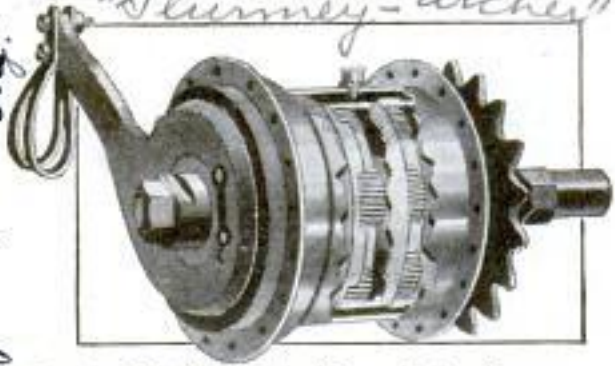

Bicycle Hub Which Provides a Brake, Coaster, and Three Speeds

three-speed gear designed for use on bicycles has only recently been introduced in this country. The mechanism consists of two sets of gears arranged

on the epicyclical principle. The shifting is done by means of a wire, operated by a thumb lever attached to the handle bars, which extends to the hub axle. On low speed both trains of gears are in operation; on second, both are locked so that the hub revolves normally, and on third, one train of gears is placed in service. The cycle may be wheeled backward on any gear, or the brake used at any time. The advantage of more than one speed is that a cyclist encountering a hill or stretch of heavy road may reduce his gearing, while a high gear is also available for racing purposes.

Four fast cruisers to cost about \$12,000,000, six torpedo boats, 28 submarines, and three gunboats, as well as a general development of coast defense, are provided for in a bill introduced in the Spanish chamber of deputies.

### ELECTRIC MOTOR OPERATES SEWING MACHINE

8820 m

A small and compact electric motor designed for running a sewing machine



How the Electric Motor is Applied to a Sewing Machine

alternating current and may be run by connection with any electric-light socket. It may be used with any type of machine, and is easily detached when not needed. The application of the motor in no way interferes with the ordinary working of the machine. It is started and stopped by a lever at the will of the operator.

### SHIPPING PLANTS BY PARCEL POST

8915 m

As a result of the amendment to the parcel-post regulations permitting the shipment of plants and bulbs at regular parcel-post rates, it is expected that there will be a tremendous increase in the business of post offices located in plant-growing sections. At one town in South Carolina having not more than 50 inhabitants, the annual business has heretofore been about \$5,000, made up largely of advertising sent out by the plant growers. In anticipation of the effect of

has recently been placed on the market. This motor operates on direct or  
L. H. Hamilton  
Wisconsin Electric Co.,  
Racine, Wis.

Christian Science Monitor

10/27/14

# J. S. Schroeter  
 1321 East 56th St.,  
 Chicago, Ill. 427

POPULAR MECHANICS

the new regulation the postal authorities are arranging facilities for handling \$2,000 of business a day at this point, or about 25 tons of plants and bulbs.

Mfr: The Fuel Meter Co., 957 E. 54th St.,  
 N. 516-29 So. La Salle St.,  
 8868 CONSUMED  
 W. Chicago, Ill.

A recent invention of interest to motorists, and to users of internal-combustion engines generally, is a meter for measuring the amount of fuel consumed. This meter is simple in construction, is much like an ordinary water meter, and is intended to be used with gasoline, petroleum, or crude oil. The amount consumed is shown on a dial. When the meter is used on an automobile it is an easy matter to determine by comparison with the odometer the exact amount of gasoline used per mile of travel.



C. P. Blackley (Inventor)  
 R. 516-29 So. La Salle  
 Chicago

**MOTOR STREET CLEANER**  
 8319 USES AIR SUCTION

One of the latest features in street cleaning is a motor truck equipped with apparatus that loosens and breaks up the dirt and refuse on the street, and then picks it up by air suction and deposits it in a receptacle carried at the rear of the truck. The lower ends of the suction pipes are made of flexible material so that they fit irregularities in the street surface, while the pipes at the sides of the truck are so made that they are not injured by contact with the street curb. The dirt and refuse is broken up by oscillating brushes as the truck moves along the street, and is picked up by the suction pipes placed close behind the brushes. One engine, by means of two sets of controls, supplies the power both for propulsion and for operating the cleaning mechanism. The brushes and suction pipes are easily raised and lowered from the driver's seat, and can be varied from 2 to 10 lb. of pressure, while the suction can be varied to suit the speed of the truck and the character of the street surface.

Wooden piles, 114 ft. in length, are used in supporting the falsework of a railroad bridge over the Mississippi River at Memphis, Tenn.

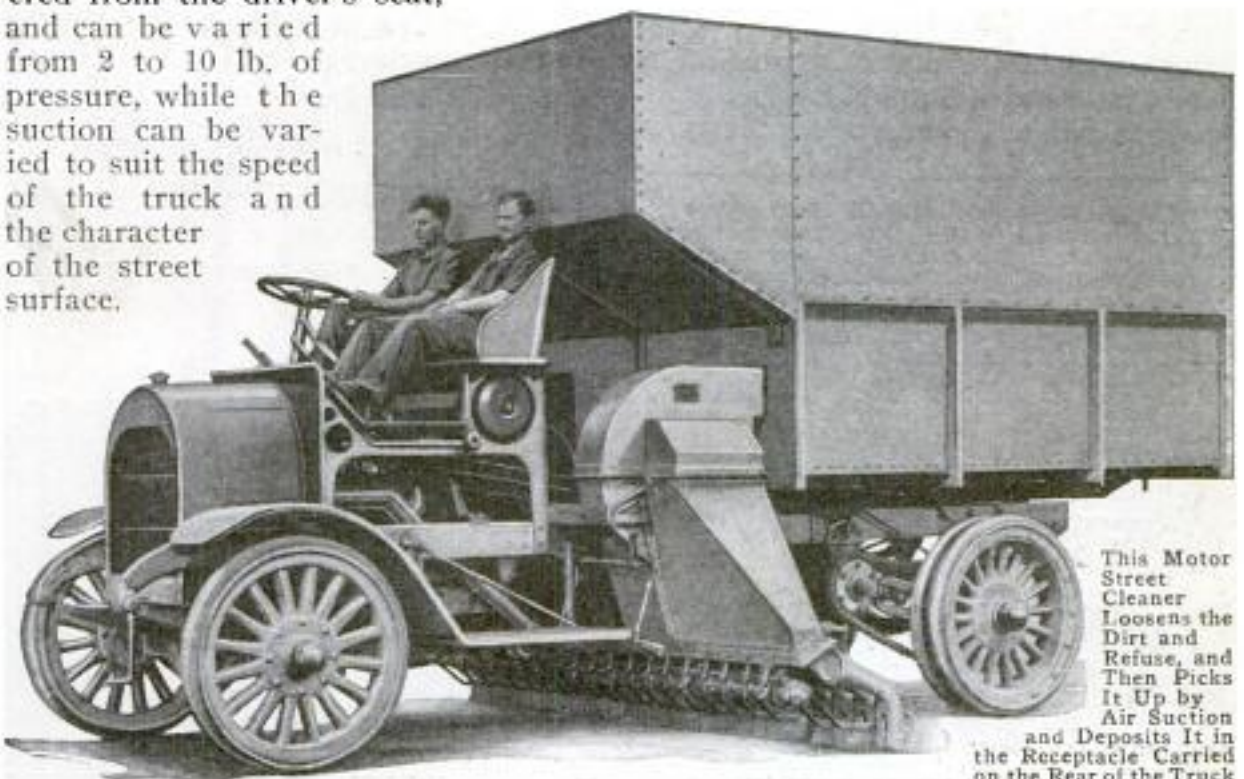

This Motor Street Cleaner Loosens the Dirt and Refuse, and Then Picks It Up by Air Suction and Deposits It in the Receptacle Carried on the Rear of the Truck

Sanitary Vacuum Street Cleaner Co.,  
 Minneapolis, Minn.

### CLOCK SHOWS TIME AROUND THE WORLD

*8844 m*  
A clock showing the correct time of day and the longitude for every part of the world has been adopted and in-

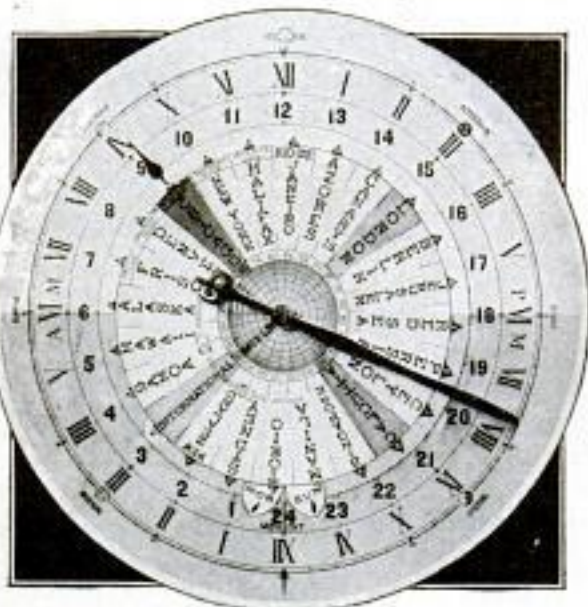

This Clock, Now being Introduced in Public Schools, Shows the Correct Time and the Longitude for Every Part of the World

stalled in the Chicago public schools. This clock has two dials, one of these being stationary and the other making one revolution each 24 hours. The stationary dial is the same as that of an ordinary clock except that it is a 12-hour and 24-hour dial combined. The new feature about the clock is the revolving dial, which represents the earth

revolving on its axis from west to east. This is divided into 24 sectors, each representing 15° of longitude, or one twenty-fourth of the earth's circumference, and in each of these sectors is the name of the principal city or island within the longitudinal boundary. Not only does this dial show the time of day in each of the sectors but it also shows at a glance which of two days it is at any point. This is accomplished by the international date line marked on the revolving dial and used in connection with a small dial on which two successive days of the week show at one time. One of the advantages of the clock for school use is that it demonstrates clearly how the sun stands still and the earth revolves on its axis.

### SIAMESE RICE-GRINDING MACHINE

*8507 m*

Crude but effective machines of a type that was in common use centuries ago, are still used by the natives of Siam for grinding rice. The grinding is done by two roughly hewn stones, the upper of which is rotated back and forth by a lever having one end slung to a wooden support, as shown. The rice is placed in a basketlike hopper, and after being ground it falls into a sort of trough placed around the support.

This Machine for Grinding Rice is of a Type That has been in Use by the Natives of Siam for Centuries. The Rice is Ground between Two Roughly Hewn Stones. One being Rotated Back and Forth by the Bamboo Arm Slung from the Wooden Support



*Henry Buschin, 108 Fulton St.,*  
*N. Y. City.*

*Jarvis Universal Clock Co.,*  
*1008 So. Halsted St., Chicago, Ills.*  
*(Mr. Angeler) 635 Vermont*  
*549 W. 79 St.*

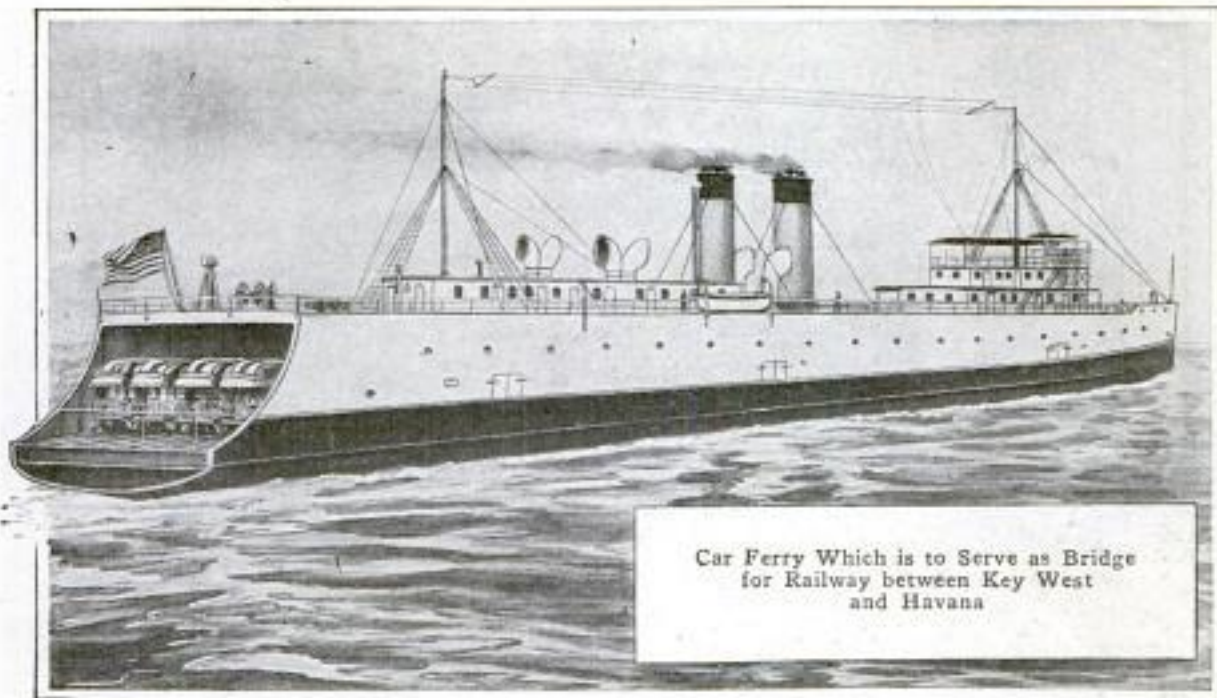

Car Ferry Which is to Serve as Bridge  
for Railway between Key West  
and Havana

### FERRY WHICH WILL BRIDGE 8212 DISTANCE TO HAVANA

One of the largest car-ferry steamers ever constructed has been launched and is expected to be ready for the inauguration of "railway communication" between Key West, Fla., and Havana, Cuba, early this year. The vessel will have a carrying capacity of 30 freight cars and will make the 96-mile voyage in approximately eight hours. Its hull is built of steel; its length over all is 350 ft.; its breadth of deck, 57 ft., and its depth, 22 ft. The main deck is fitted with tracks upon which the cars will be carried, while its stern is shaped to fit into the docks provided at the two terminal points. The weight of the cars will be supported upon jacks, after they are loaded aboard the vessel, so that the trucks will be relieved from the added strain caused by the rolling of a ship.

### BARBER SHOP HAS NOVEL 7790 SYSTEM OF FANS

A simple method for keeping flies away from the customers while they are being barbered is in use in a barber shop in Racine, Wis. Over each chair, and just above the head of the cus-

tomers, is a Japanese fan suspended from the ceiling by a rubber band. An electric fan at the end of the room is directed at these fans so that the current of air keeps them swinging. When the barber has finished giving a shave, he uses the suspended fan in place of the regulation palm-leaf fan for drying the customer's face.



Simple but Effective Fan System in Use  
in a Wisconsin Barber Shop

M. E. Duggan, 472 Chicago St., Kenosha, Wis.  
In Barber shop of George & D. Hute, Racine, Wis.

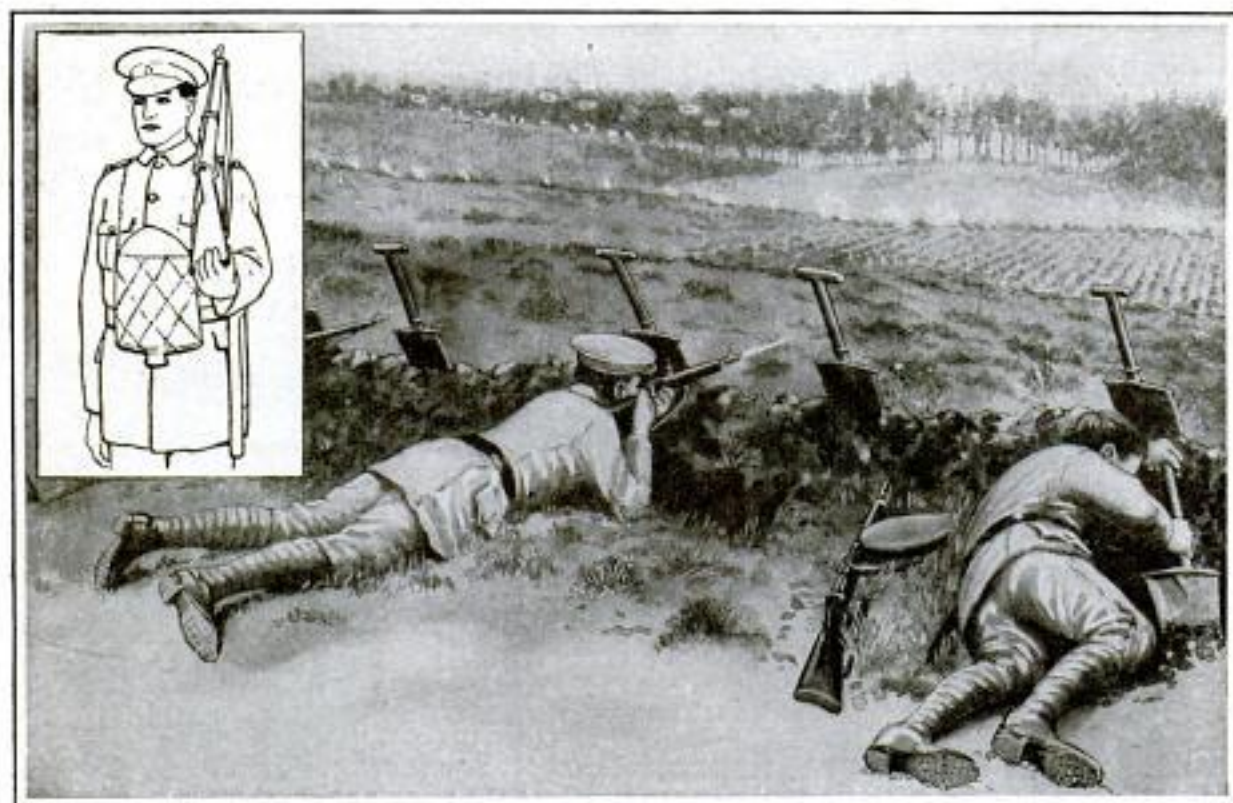

Infantrymen Using Their Intrenching Tools as Shields While Moving the Firing Line Forward

### USING INTRENCHING TOOL AS SHIELD IN BATTLE

8293 A British military authorities are considering a plan for utilizing the intrenching tool of the infantryman as a shield against rifle fire. This would entail the adoption of an implement somewhat different in form from that now in use, and preferably one about the size of the ordinary turf-cutting spade, with a thickness of approximately three-sixteenths of an inch, which would be capable of turning a projectile at 250 yd. Instead of being carried in the haversack, the blade would be worn over the abdomen, its point resting on the breastbone. Within the fire zone on the battle field the plate would be used to assist in the continuous advance of the line. A rear-rank man would hand his implement, for instance, to an odd number, who would make a rush under cover of his comrade's fire, carrying the tool as a shield, his own implement at the same time being strapped in place to protect his stomach. The pick end of the spade would be thrust in the

ground in front of a soldier as he threw himself down at the end of a rush. Then, using his own implement, he would dig himself in behind the cover thus provided. Next, he would dig a place for his comrades, who at the signal would rush with the even numbers. As soon as it would be time for the next advance, the even numbers would take the intrenching tools and repeat the operation. One point about this plan worthy of notice is that members of the rear rank would be deprived of head shields while their comrades were making a rush and digging in. It is reasoned that this would give them an incentive to move forward at an order and occupy the sheltered positions prepared for them.

### MUNICIPAL SERVICE TRUCK WITH RADIO EQUIPMENT

8688 For use in the maintenance of the municipal conduit system of Baltimore, the electrical commission of that city is employing a new service motor truck which in addition to its other equipment is provided with a wireless

*Curtis M. Pippou*  
2950 Clifton Ave.,  
Baltimore, Md.

*Army & Navy Journal*



telegraph apparatus. Unlike most other portable radio outfits in general use, this is so arranged that messages may be received while the car is being driven at high speed through streets flanked by tall buildings of steel construction. At the same time the appearance of the machine is not such as to attract attention. The antenna, which is suspended beneath the roof of the truck, is composed of several hundred feet of copper wire laced back and forth so that it forms a net of about 40 parallel wires. No direct connection is made with the earth, since the metal chassis of the car serves as a counterpoise ground. With this equipment it is possible for the electrical commission to be in constant touch with the car over a radius of 10 miles and direct its crew to any part of the city when emergencies arise. Immediately back of the driver's seat is a suction pump, driven by a marine engine, which is capable of pumping 12,000 gal. of water an hour. In addition to this, there is an electric-lighting equipment which provides sufficient illumination for the inspection of man-holes and duct chambers. The machine, besides housing a compact, but complete, machine shop, and carrying considerable paraphernalia, has room for the transportation of a crew of several men.

**PORTABLE ELECTRIC LAMP  
SERVES MANY PURPOSES**

A portable electric lamp which has recently been devised is so designed that it may be employed in any one of many different capacities. It is provided with a substantial base which supports a flexible mounting for an incandescent globe and socket. Inside of this standard is an extension coil of wire cord which may be run out to the exact length desired by pressing a release button. A clamp, fitted on the bottom of the lamp, enables it to be attached in any position to an object, so that it may be used in a sick room; on a piano or a sewing machine; or be fastened to the top of a mirror for shaving; on the back of a chair for reading; or be used simply as a desk light. The shade is a convex disk supplied with wire clamps which grip over the globe and hold it at any angle. The lamp is less than a foot in height and may be carried conveniently in a suitcase or a traveling bag.



Service Motor Truck Employed by the Baltimore Electrical Commission Which is Equipped with Wireless So That the Department may Communicate with It Whenever Emergencies Arise

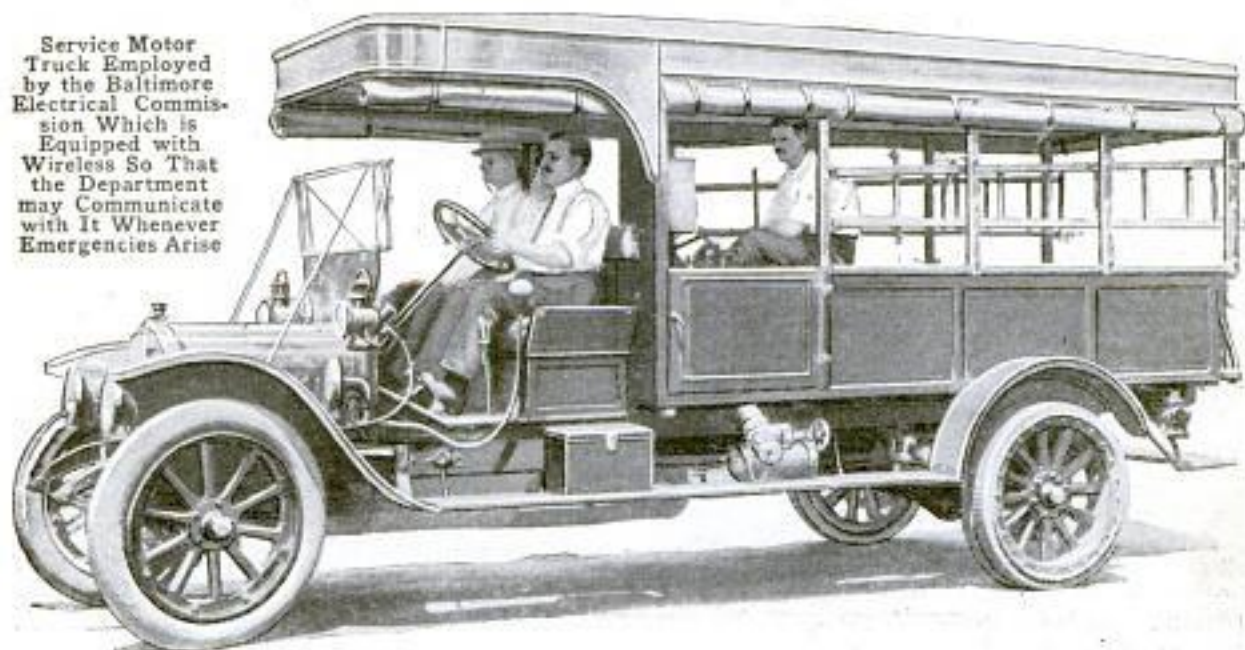

John A. Evans  
P. O. Box 598  
Asheville, N. C.  
432

## POPULAR MECHANICS

### PAPER AND TRASH RECEIVER OF ORNAMENTAL DESIGN

8624

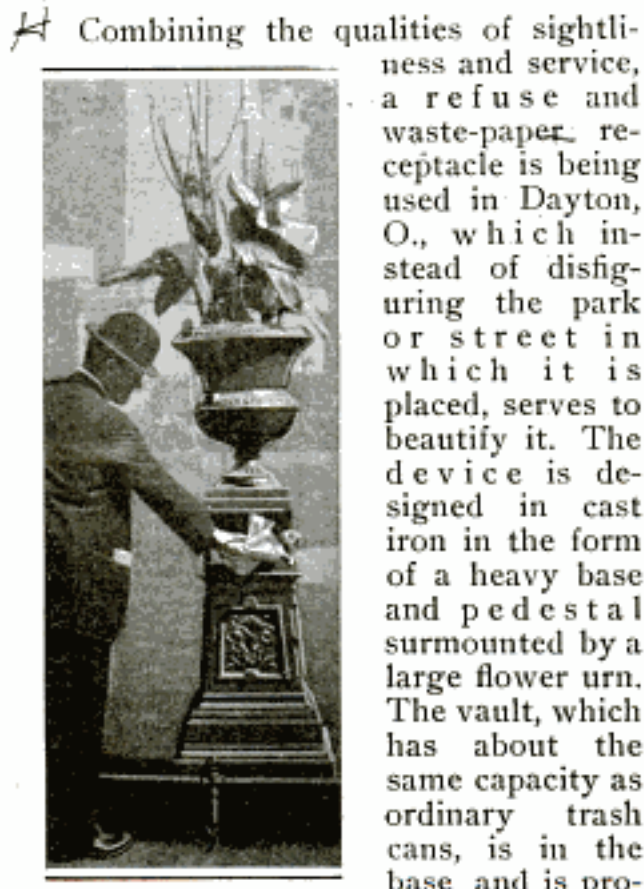

Combining the qualities of sightliness and service, a refuse and waste-paper receptacle is being used in Dayton, O., which instead of disfiguring the park or street in which it is placed, serves to beautify it. The device is designed in cast iron in the form of a heavy base and pedestal surmounted by a large flower urn. The vault, which has about the same capacity as ordinary trash cans, is in the base and is provided with a hinged door which remains closed when not in use. Refuse is easily removed from the receptacle.

### AUTOMOBILE WHEEL WITH RESILIENT RIM

7107 m

An interesting feature in a new spring wheel for automobiles is a flexible metal rim that is designed to adjust itself in taking the weight of the car much after the fashion of a pneu-

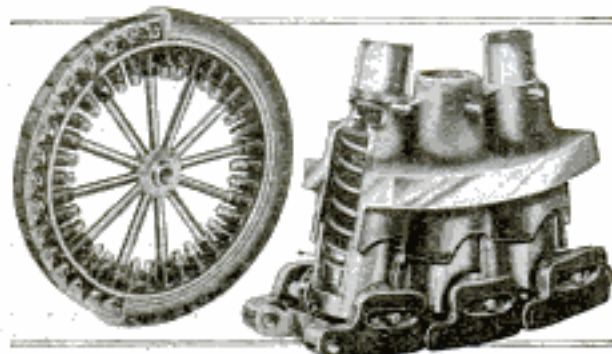

In This Spring Wheel the Rim Consists of a Flexible-Metal Endless Chain That Adjusts Itself to the Weight after the Fashion of a Pneumatic Tire

matic tire. This rim consists of an endless chain of blocks, each block being pivotally carried on the end of a plunger that works in a cylinder, and is constantly pressed outward by a coil spring within the cylinder. The blocks are connected with each other and with the plungers in such a way that they can not only move inward against the action of the springs, but are free to rock and float slightly in the direction of the periphery of the wheel. As the wheel is ordinarily made, there are three blocks, with corresponding cylinders, to each spoke. The spokes are not directly connected to the springs, but have their ends fixed to the rigid framework of which the cylinders form a part. In this way all the resilient action takes place in the outer portion of the wheel, the spokes and hub forming a rigid construction. The rim is designed to be covered with a solid-rubber tire.

### RAISING OF FUR BEARERS GOVERNMENT EXPERIMENT

8983

Since silver-fox farming has proved a successful venture in Canada, the Department of Agriculture has commenced experiments in raising other fur-bearing animals in view of encouraging, if the idea is shown to be a feasible one, their propagation for commercial purposes. Experiment stations are being maintained at Prichard, Ida., and at the National Zoölogical Park, where study is now being made with minks and martens. The condition of the young minks which have already been raised has encouraged more extensive work, and during the present year it is intended to add raccoons, skunks, and possibly foxes to the animals included in the experiments. Investigation has shown that the moles, which are prolific in the eastern part of the country, have a superior quality of fur to those which have been imported in great numbers from Europe in recent years, and it is believed that the same is true of those found in the northwest.

Patented + Owner:  
Mr. Lycrugus Anderson  
Lake Creek, Delta Co.,  
Texas.

Information sheet sent out  
by Dept. Agriculture

Keystone 11/13/14

Edmond H. Von Kaenel  
312 Wendell St.  
307 Hill Chicago

**USING ALUMINUM PENCILS  
8929<sup>H</sup> IN GLASS ETCHING**

It has been found by a Swiss chemist that designs, sketched on glass or porcelain with a pencil made of aluminum, will become etched on the material when treated with hydrochloric acid. Before the operation is attempted, however, it is necessary that every vestige of grease or oil be removed from the working surface by rubbing it thoroughly with chalk. In case a design is burnished instead of etched, it is said it bears a close resemblance to inlaid silver.

**SAFETY ATTACHMENT FOR  
7182<sup>m</sup> ROLLER SKATE**

A simple device intended as a boon to roller skaters consists of a steel attachment with a rubber tip secured to the back of the skate and projecting downward to within 1/8 in. of the floor or ground. This does not interfere in any way with the skating so long as the skate is flat on the surface, but the instant the skate tips backward the rubber tip comes in contact with the surface and acts as a brake. It is designed principally to prevent the skate from

flying out forward and throwing the skater, but is also useful in preventing



When the Roller Skate Tips Backward the Rubber Tip Comes in Contact with the Floor and Acts as a Brake

the floor from being damaged by the back part of the frame.

**WINDOW GAZERS GIVEN TALK BY ELECTRIC SIGN**

7417<sup>H</sup>  
An electric window sign which prints a lengthy advertisement in illuminated

letters, one line at a time automatically, recently attracted so much attention on one of the Chicago streets that the police were forced to clear the crowds.

The flasher which operates the sign and makes 32 changes of matter, consists of a series of disk circuit breakers mounted on a common rotating shaft. Between each pair of disks is a contact arm containing 25 contacts, each connected with a separate set of wires. The letter sticks project about the circumference of the disks, fitting into small grooves, which enable them to be set as easily as type. Each letter plate contains 25 individual electric lamps, which enable the formation of any letter on any plate. When the copy is set on the operating machine and the switch turned, the motor starts the

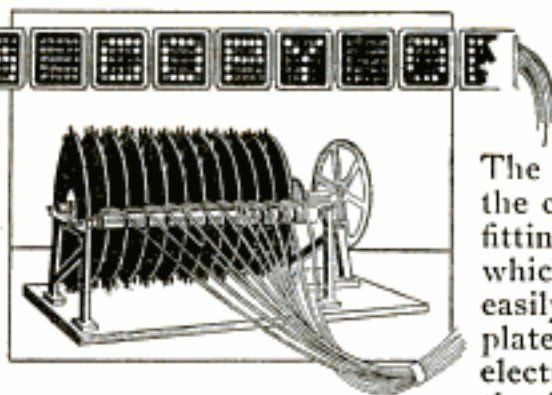

Electric Sign Which Shows 32 Changes of Matter before Repeating

set on the operating machine and the switch turned, the motor starts the

set on the operating machine and the switch turned, the motor starts the

E. B. Electric Sign Co.,  
209 N. Jefferson St.,  
Chicago, Ills

Illustrated Official Jour. of Patents  
(English)  
Invented by S. Whittaker, and S. W.  
Cooper, 434, Royal Exchange,  
Manchester, England.

## POPULAR MECHANICS

rotation of the shaft and the sign begins its work. As soon as the 32 changes in matter have been made, the sign then repeats. Different copy may be run off daily. The sign is made in all sizes for both interior and exterior display. It also may be used as a train announcer or bulletin board.

### APPARATUS FOR STEERING SHIP WITHOUT RUDDER

A curious ship-steering apparatus that has been patented in England eliminates the rudder and uses in its



With This Rudderless Steering Apparatus the Ship is Steered by Water Jets Directed to Starboard or Port as Required

place water jets that are directed to starboard or port as required. This apparatus is placed at the stern of the ship and well below the water line, and consists of a rotary pump with two horizontal pipes which lead off from the pump in opposite directions, each pipe serving either as feed or discharge pipe. When the ship is to be swung to starboard the pump is run so that water will be drawn in through the port pipe and discharged through the starboard pipe, while for swinging the ship to port the pump is reversed and the water is discharged in the opposite direction.

### EFFECT OF EUROPE'S WAR ON AMERICAN LEATHER

Before the outbreak of the European war certain American manufacturers strongly advocated cloth tops for shoes because of the shortage of suitable leather. Since that time the situation has steadily grown more perplexing.

Dup. Du Pont Co.  
Wilmington,  
Delaware

Agents for foreign governments have literally scoured the country for hides, and the result has been that the prices of some grades of leather have greatly increased, while others have doubled.

The effect of this has been to turn attention to artificial leathers and other substitutes. "Split leather," which rightfully comes under this classification, has been in general use during recent years, especially in the upholstering industry. Its appearance is so nearly like that of the genuine product that, when it is made up, it is often difficult for the layman to detect the difference between it and real grain leather. In making it, the lower portion of the hides are cut into two or three sheets which are first coated with a special treating solution and then embossed to give a characteristic grain. It is asserted that two-thirds of leather upholstery is made of this material. The growing demand for substitutes has caused the development of purely artificial leathers which in appearance also bear a close resemblance to leather, and in some cases have good wearing qualities for certain uses.

### NOVEL HOLDER KEEPS DOOR IN PLACE

During the months when doors are kept open a good deal, some contrivance is necessary to keep them from



blowing shut, and a little device for this purpose has just been put on the market. It consists of a thin plate of spring steel, curved to catch and hold the bottom edge of the door, with screw holes for fastening to the floor at any point desired. When the door swings open it forces the clip down, gliding over it until the groove in the clip catches the bottom, holding the door fast. A pull on the door depresses the spring, and the door is released.

Mfgs: The Specialty Mfg. Co.,  
Westboro, Mass.

**4 THIN STEEL RIBBONS USED  
8932 FOR DRIVING BELTS**

Especially hardened charcoal steel of a thickness not greater than  $\frac{1}{8}$  in. is being used in making metal transmission belts. The steel used for this purpose is prepared by a secret process and is credited with having a tensile strength of approximately 95 tons to the square inch. The belts of this kind now in use vary in width from  $1\frac{1}{2}$  to 8 in. The two ends are connected in such a manner that the joint does not interfere with transmission, while the circumferences of the pulleys are covered with a thickness of canvas over which thin sheets of cork are glued.

**A GERMAN WOMAN PATENTS**

**6695 A PENHOLDER GUIDE**

To insure a correct position of the fingers and pen in writing, a guide which fits over the forefinger and thumb of the right hand has been invented and patented by a German woman. It is composed of metal clips and hooks so arranged that when the penholder is inserted it maintains the correct angle with respect to the hand. The device tends to prevent excessive bending of both forefinger and thumb, without interfering with such limited flexibility as may be needed for easy writing.



*Inventor: Helene Mayer  
Höcher a/M, Ber.*

**FUEL COMBUSTION AIDED  
7922 BY SIMPLE DEVICE**

Intended to reduce fuel consumption and increase the heating efficiency of stoves and furnaces of various types, a device which assists combustion has been invented, submitted to tests by the government and adopted for use in both the army and navy. By applying it to a heating apparatus consuming either coal or wood, the escape of gas is prevented, clinkers are eliminated, and the wear on the grates less-

*Francy, Shore & Co.  
180 Broadway, N.Y.C.*

ened, it is claimed. The appliance consists of a hollow casting, and in the case of the one built for use with a



**A Device Which Lowers Coal Consumption and Increases Its Heating Efficiency**

range, is fitted on one side with a  $\frac{3}{4}$ -in. nipple. This is inserted in a hole bored in the top sheet of an oven, and allows the air from that compartment to flow into the inner passages of the casting and finally through teethlike outlets into the firebox. As this heated air comes in contact with the fire it furnishes a fresh supply of oxygen which provides for the complete combustion of the inflammable gases that otherwise would escape.

**NOVEL CAR WASHER FOR  
6994 W GARAGE**

The labor of washing an automobile is considerably reduced by a device put on the market by an English concern, combining a rose spray from a hose with a brush. The pressure of the water is regulated by means of a thumb lever on the nozzle of the hose. In application, the mud is first softened and loosened by the water, without using the brush, which is brought into play later, "the flow of water being

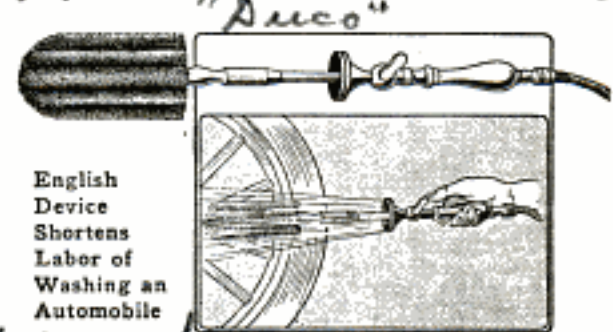

**English Device Shortens Labor of Washing an Automobile**

then directed on the brush while the paint work of the car is being gone over carefully with the brush.

*The Light Car & Cyclecar  
2-9-14  
Sold by: Brown Bros. & Co.  
Great Eastern St.,  
New York, N.Y.*

## NOVEL AND PRACTICAL THINGS

8962 H FOR DAILY USE



Convenient Ironing-Board Cover

COVERS for ironing boards are being made which may be detached and washed without trouble or unnecessary work whenever it is desired. Sewed to both sides of the cloth are substantial straps which are gripped tightly by especially designed clamps, attached to the under side of the board.



Serving Cup Keeps Egg Hot

A serving cup for soft-boiled eggs that keeps its contents hot for 15 minutes after it is placed on a table, may be obtained in German silver, nickel, or copper. About a tablespoonful of hot water is placed in the metal holder before the glass cup is inserted. This fills the space between the two walls and keeps the egg heated.

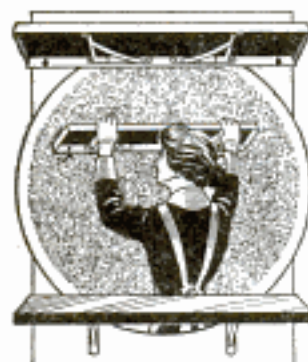

Easily Attached Metal Shelf

ENAMELED metal shelves which may be attached to a wall in a moment's time whenever needed, without requiring any carpenter work, are being manufactured. They are neatly finished and appear more sightly in a toilet room, or an office, than do most wooden shelves unless they are well made.

In the center of an artistic bowl is a steel anvil upon which to crack nut shells. The dish is made of polished hardwood, while the anvil, as well as

the small hammer which accompanies it, is plated in silver or gun metal.

A convenient utensil, which is among the lately devised kitchen accessories,



Nut Bowl with Anvil and Hammer

is a long wire fork intended for handling hot meats or vegetables. It is provided with a jointed arm fitted with a sliding foot, which, when pushed forward by the thumb or forefinger, quickly removes any-

thing caught on the prongs.

Patent rights are being asked on a

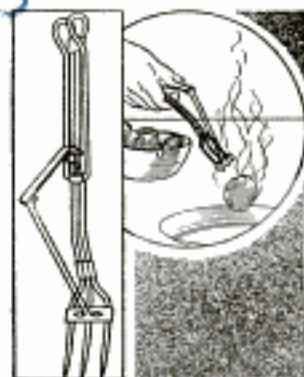

Serviceable Fork for Kitchen

simple stovepipe brace which holds the sections of a pipe together rigidly without requiring them to be wired to the walls or ceiling of a room. The device consists of two metal hoops joined by a bar to which a

thumbscrew is attached. The bands are tightened about the pipe on each side of the joints by adjusting two screws and throwing the lever into a horizontal position.

An adjustable ring which may readily be made to fit a finger of any size and easily passes over enlarged joints, has re-

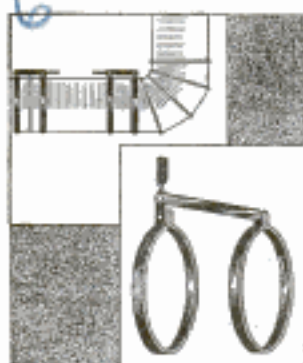

Simple Stovepipe Brace

cently been invented. A spring wire, forming the shank of the ring, has one end free so that its circumference is expanded or contracted in the process of placing it on the finger.

An inexpensive and compact umbrella holder, which may be used either indoors or outside, is being made of sheet metal. It is designed to be screwed to a baseboard at an angle which prevents wet umbrellas from soiling a wall, while the water which drains into it may be removed by taking out a stopper in the bottom. The device has places for five umbrellas and is only 8 by 7 by 2 in. in size.

Application for a patent has been made on a garbage pail fitted with a perforated cover which separates water from solids and prevents the drain pipes of a sink from being clogged with coffee grounds, or other waste matter. The cover, which is

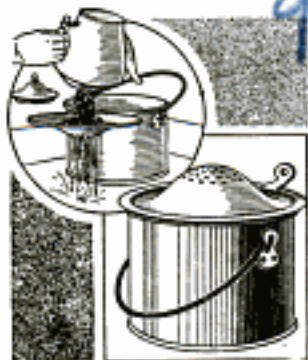

Garbage Pail with Strainer

with an ordinary dry cell is supported by a bracket which is intended to be



Adjustable Ring Fits Any Finger



Compact Metal Umbrella Holder

dish-shaped, is hinged to the pail, and when it is folded back refuse may be dropped upon it, drained, and then dropped into the bucket by closing the lid.

An electric hand lamp designed to be used

screwed to the positive post of the battery. A wire extends from the negative pole to the socket, holding a small tungsten bulb. The device is provided with a handle and bail so that it may be used as a lantern.

A ring supplied with a scoop-shaped knife with which to cut heavy cord, is intended for the use of bundle

wrappers. It is worn on the little finger of the right hand, in such a position that a quick snap of the wrist will sever a piece of twine after a knot has been tied. Extending from the band on the side opposite the knife, is a small lug which rests in front of the third finger, thus preventing the ring from turning when the blade is used.

Designed particularly for household use, a mop is being made which, besides presenting a flat working surface, is provided with a wringing device that makes it unnecessary, when cleaning a floor, to wet the hands with scrub water. The end of the cloth, which in most mops is ordinarily free, is in this instance held by a wire device that is turned by a handle. The cloth may be twisted tightly and the water wrung from it more quickly than by the customary method.



Lamp Used with Ordinary Dry Cell



Knife for Cutting Heavy Twine

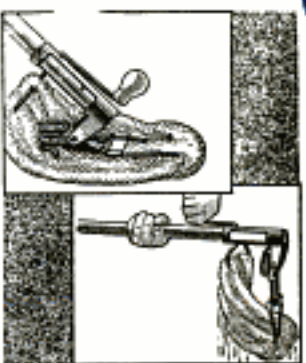

Mop with Wringing Device

Sirkwood Re-enforced Concrete Fence Post Co.,  
204 Burke Building  
Seattle, Wash.

250 South St.,  
Newark, N.J.

6782 **CONCRETE FENCE POST WITH NEW WIRE FASTENING**

One of the greatest troubles in connection with concrete fence posts has heretofore been in providing an efficient and economical fastening for the wire. This is apparently overcome by a new reinforced-concrete post that has just made its appearance on the market. For holding each wire in place this post has a slot

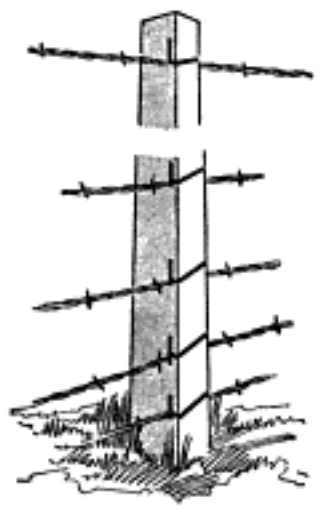

shaped like a narrow vertical cut running through the post from side to side, while a diagonal slot connects this with the adjacent face of the post. The wire is inserted through the diagonal slot, and when drawn taut it is held securely in place, as it is out of line with the diagonal slot.

small pieces which are looped, and their ends then pressed together so that the circular piece of dough will keep its shape while being baked.

7263 **NEW SPRING CASING FOR FLEXIBLE SHAFTS**

A casing for flexible shafts recently placed on the market is so made that it will bend readily without taking a set and will fly back to a straight line the instant the bending force is removed. This is accomplished by an ingenious arrangement of two spiral wires, one working within the other and each provided with wedge-shaped edges so that the two spirals nest closely together. When the casing is bent to a curve the outer segments of the outer spiral are forced apart by the wedge action of the inner spiral, while the inner segments of the inner spiral are forced apart by a similar action of



This New Flexible-Shaft Casing Bends Readily, but Flies Back to a Straight Line the Instant the Bending Force is Removed

the outer spiral, and it is this, combined with the ordinary spring action of the two spirals, that gives the casing its strong tendency to resume a straight position when the bending force is removed. To prevent wear on the shaft, the inner face of the casing is made flat.

7423 **"COOKIE GUN" USES DOUGH FOR AMMUNITION**

Frequently Norwegian housewives coming to this country bring with them what is known there as a cookie gun.



Cookie Gun Such as is Commonly Used by Norwegian Housewives

It is a cast-iron instrument similar to the ordinary grease gun employed in oiling heavy machinery. By removing the top and taking out the screw plunger, cookie dough may be put into the tube. It is then forced out through the narrow nozzle into a long tapelike strip. This is cut into

8997 **DREADNAUGHT "CALIFORNIA" TO HAVE ELECTRIC DRIVE**

Electric propulsion has proved so successful in the operation of the recently built collier "Jupiter" that the Navy Department has ordered the new dreadnaught "California," described in a previous issue of this magazine, to be similarly equipped. This will be the first electrically driven battleship ever constructed for any navy. By placing a dynamo and motor between each steam turbine and propeller shaft, it is possible to maintain the engines continuously at their most ef-

J. Crosby McCarthy  
Evening Star,  
Washington, D.C.

Battleship  
All Jan. 14-18  
All Nov 14-65



Francis P. Mann  
12 Boulevard Arago,  
Paris, France

Infgrs: The Kuffner Rule Co.,  
Saginaw, Mich

Letter - envelope, agent generale,  
(5/24/15) 16 Rue du Rocher,  
Paris

ficient and economical speed. On the other hand, by driving the propellers electrically, greater flexibility and more rapid and accurate control is provided. The new vessel is to be built with the money received from the sale of the battleships "Idaho" and "Mississippi" to the Greek government.

LETTER AND ENVELOPE IN ONE PIECE

A clever French inventor has brought out a brand new envelope by resurrecting an idea in vogue when the post chaise traversed Europe, and combining with it the modern transparent patch seen on many business letters, whereby the address, written on the letter, does not have to be repeated on the envelope. The French device consists of a sheet of writing paper with two gummed flaps, and the transparent patch referred to. Upon writing the communication and folding the letter twice, the missive becomes an addressed envelope, needing only the adhesive action of the gummed edges and a proper postage stamp. Another advantage is the fact that the cancellation stamp of the post office, giving the date, is affixed to the letter itself, thus avoiding a common source of dispute which the ordinary system of correspondence



Folding Letter Sheet Which Records Date of Mailing

is subject to, by reason of throwing away the envelopes upon opening letters.

A new device working on the principle of the Maxim gun silencer is designed to do away with the noise of steam safety valves and of boiler blow-off valves.

TERMINAL HOOK FOR USE WITH STEEL TAPE

The convenience of the flexible steel tape has brought it into common use in building and construction lines,

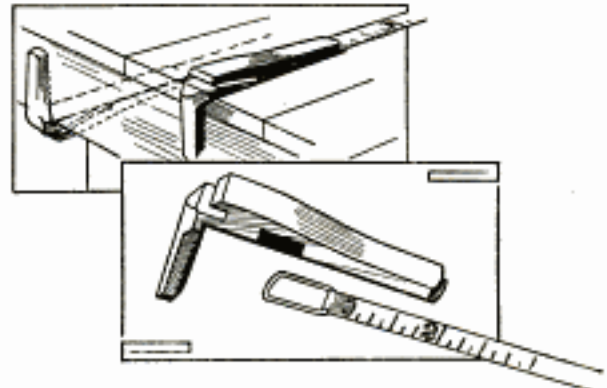

This Hook Attached to a Steel Tape Takes the Place of an Assistant for Holding One of the Ends

but there is an obvious disadvantage in that long measurements require the driving of a nail or the assistance of a second person to hold the end of the tape in position. A device which remedies this consists of a small hook with a toothed under side, and a slotted passage for the introduction of the steel tape, which is held firmly by a spring. With this hook in use the end of the tape may be held without assistance and accurate measurements made, as the hook is so constructed that measurements begin from its under surface. The hook may be adjusted on the tape in a moment or removed quickly by the pressure of the spring.

LONG BREAKWATER IS PROPOSED FOR PANAMA CANAL 8926

It is proposed to construct a 7,000-ft. breakwater running southwest from Margarita Island, at the east entrance to Panama Canal, in order that vessels may be afforded protection from the trade winds during the dry season without being compelled to enter the canal. This bulkhead, which it is estimated will cost about \$3,000,000, if ordered by Congress, will provide a place where ships may be coaled, and along which barges and small boats can tie up safely.

Christian Science Monitor

Reported by Consular Gen. R. E.  
Manafield, Vancouver, B. C. Canada  
9-30-14

*Technische Monatshefte*  
GERMAN INVENTS ELECTRIC

6694 W BURGLAR ALARM

From Germany comes a new device designed to give warning when a key or other instrument is inserted in the lock of a door or other opening. Two bolts which project from the lock into the door frame are connected with an electric-bell circuit. When a key or other metal object is inserted in the lock, the circuit is closed and the bell starts ringing. The device may be switched off when desired.

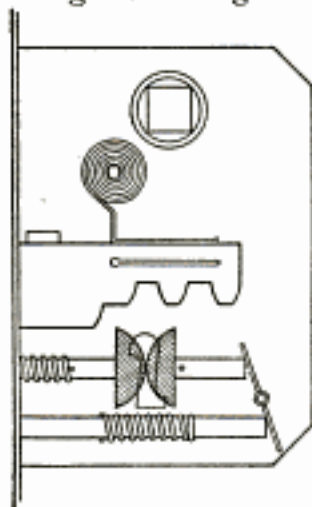

RADIAL BUNSEN BURNER

7040 W IS LATEST TYPE

A powerful heating flame is given by the latest type of Bunsen burner in which the flames converge into one, by means of several jets arranged in circular, semicircular or conical form. The principle is identical with the ordinary Bunsen burner, in which gas is mixed before ignition with suitable quantities of air, producing a bluish flame of great intensity, but certain objectionable



New Form of Bunsen Burner Has Flames  
Converging

qualities of the single jet are overcome by the use of the radial burner which is noiseless, steady and has no "cool center."

It is costing the British government approximately \$5,000,000 a day to participate in the European war.

8332 OVER GOOD ROADS

In the Pacific coast states and extending over the Northwest through British Columbia, as well as provinces to the east, into Alaska, there has been a pronounced movement for better roads, the effect of which is noticeably resulting in much construction work. Before the close of 1915 the Pacific coast highway, planned to extend from southern California, via Vancouver, to some point in Alaska, is expected to be completed from San Diego to British Columbia, enabling motorists to make the entire trip on hard-surfaced drives. This route, besides touching the principal cities and extending over some of the most attractive districts in the region west of the Rockies, will also connect with the transcontinental Canadian highway which is now being built.

The original trails through the western provinces of Canada for the most part lie east and west, which is also true of the railroads. Attention is now being given particularly to the establishment of coastwise routes to connect with these arteries, many of which extend to the central and eastern provinces. The progress which has been made in British Columbia in this respect has been considerable. Every section which is settled is building roads, and in 1913 the amount expended for this work reached approximately \$7,000,000.

Strides in a similar direction are reported as being made in the Yukon country. Between Dawson and Whitehorse grades are being cut and dangerous turns eliminated, together with considerable filling and resurfacing. It is intended to construct a system of roads connecting with those through British Columbia, which will complete the northern part of the coast highway. The survey for the proposed government road to the summit of White Pass, connecting with the Canadian routes to the Atlin section, has been completed, and maps are now being prepared.



## Difficult Weld by the Chemical Process

By F. W. BENTLEY, JR.

**T**HE efficiency of chemical welding as a restorer of broken machinery parts has long been widely recognized and put into practice. The use of it in repairing heavy casting parts, where the necessity of extreme accuracy is not a paramount factor, makes the process to some extent a simple one. However, in a great many instances where such welding is attempted the operation calls for considerable skill and knowledge of the many points which go to make the work a success.

Shafting and other journal pieces of moderate diameter present a phase of welding that is covered to some extent with varying results. The illustrations represent a piece of work successfully executed in a small railway shop. The shaft was from an alternating-current generator, belonging to a plant on the

railway line at some distance from the railway shop. The shaft was 14 ft. 8 in. long, and 8½ in. in diameter at the largest part. The break occurred about 4 in. from a fillet on the larger portion of the shaft. It was successfully repaired at a safe margin of cost under one-fifth the price of a new one. The operation of welding covered a period of less than one day, and when placed in the lathe for trial, the shaft did not run out of alinement more than ¼₆₄ inch.

To those not familiar with the process, a brief description of the operation may be of interest. A number of large V-blocks are shaped from a block of iron bars bolted together on the bed of a slotter. The V-blocks, each of exactly the same size, are then stood up on the bed of a large planer,

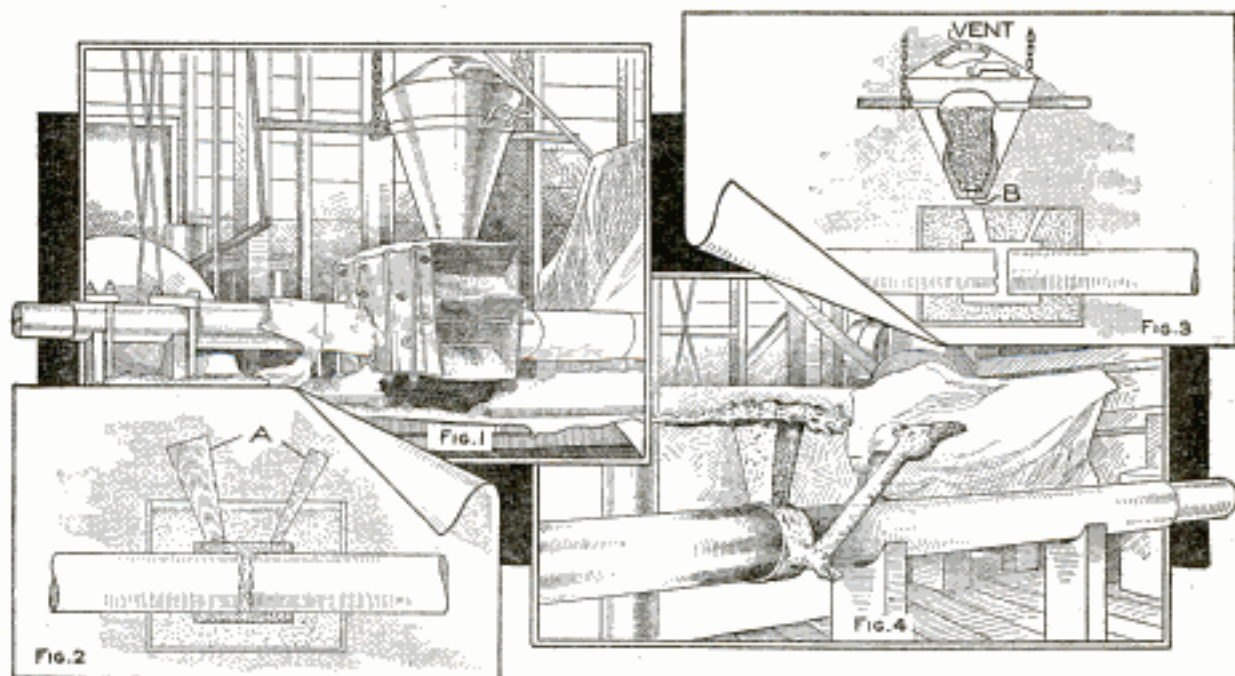

The Mold as It is Built Up around the Broken Ends of the Shaft, the Crucible with the Welding Compound Suspended over It, and the Weld after Removing the Mold

and the shaft pieces laid horizontally in them, as shown in Fig. 1. The shafting is then lined up, the faces of the break being set about 1 in. apart. Softened paraffin is next placed, shaped, and filled in around the broken ends of the shaft, as shown in Fig. 2. This forms the body mold of the welding mass. The sand, or mold, box is then built in sections and bolted around the shaft, and the sand pounded firmly around the paraffin filling over the break. Through the sand and touching the paraffin extend two triangular, or circular, pieces of wood, A, which make the pouring opening, or gate, and overflow, or vent, in the mold. A gasoline blowtorch is then applied to the mold and the whole arrangement heated, causing the paraffin to run out through a small hole made for it in the bottom of the mold. This hole is plugged with sand when all the paraffin has run out. The application of the torch is continued until the ends of the shaft are heated to almost a melting point. This leaves a coring space to be filled by the welding com-

pound when it is allowed to run from the crucible into the sand, or pattern, boxes.

The funnel-shaped arrangement over the sand box, or mold, holds the powderlike chemical, freely mixed with small special-steel billets. The funnel is nothing more than a special crucible, made of sheet metal and lined with fire clay. This is shown in section in Fig. 3. When the combination is lighted, the burning of the thermit, or welding, compound melts the steel, which at the right moment is let down into the mold through the hole B. This hole is stoppered the same as a cupola. The shape of the welding mass, after removing the mold, is shown in Fig. 4. The protruding parts are then drilled and cut off, leaving the weld complete.

The chemical compound most commonly and successfully used is known as the thermit welding compound, a mixture the nature of which is but little known, but the oxidization caused by it heats the crucible of welding steel in from 10 to 15 seconds.

### Folding Rule Used as Marking Gauge

An ordinary 2-ft. folding rule and a lead pencil can be readily used in place of a regular marking gauge. Place the pencil between the folds of the rule so its short wire pins will be forced into the wood of the pencil, firmly holding it in position. With the aid of a small block pressed tight against the bottom of the rule and held against the board to be marked, any desired gauge line may be drawn. The block may be omitted if no fear is felt of running splinters into the hand, in which case the gauging must be done with the forefinger of the hand sliding along the board, the thumb resting on top of the rule as before.—Contributed by Abner B. Shaw.

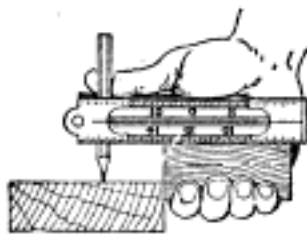

### A Painter's Air Brush

*J. N. X11(16) 2448*

In painting complicated machinery, or irregular surfaces, spraying may often be resorted to, which will result in covering every part neatly, and in considerably less time than required to do it with a hand brush. To make the illustrated air brush, or spraying device, a glass jar should be obtained, having a metal screw top. In this cover, two holes should be made as far apart as possible; one, for connecting with the angle valve A, and the other with an air-pressure regulating needle valve, B. The handwheel and stem of the valve A should be removed. From the inner, or valve, end of the stem, a  $\frac{1}{8}$ -in. hole should be drilled lengthwise through the center to within  $\frac{1}{4}$  in. of the outer end. If the stem is longer than convenient, part of its outer end may be cut off, but the precaution should still be observed not to drill all the way through with the  $\frac{1}{8}$ -in. size.

An outlet is provided by a  $\frac{1}{64}$ -in. hole continued through the undrilled  $\frac{1}{4}$ -in. section. In order to make a connection between the drilled stem and the contents of the glass jar, a piece of copper tubing, C,—such as is used on gas-engine carburetors—should be threaded at one end to fit a drilled and tapped hole in the hollow valve stem, so that, when the valve is in position on the jar and the stem tightly fitted to its seat, the tube can pass into the jar and reach to within  $\frac{1}{4}$  in. of the bottom.

With the spraying head finished, the necessary piping can be cut and fitted, connecting the regulating valve B and stop valve D with the head A. It is necessary to have all joints tight, and the valves A and B so spaced that they will fit the holes made for them in the cover. A nipple fitted with a hose coupling must be attached to the stop valve to connect it with the air-pressure tank. All the necessary piping being completed, the screw cover should be soldered to the valves A and B. With the jar filled with paint, the cover may be screwed on and the sprayer is ready for operation.

The air necessary for spraying may be supplied by a small tank and hand pump, capable of furnishing a pressure up to about 15 lb., depending on the kind of paint to be sprayed. In operating the sprayer, the valve D is first

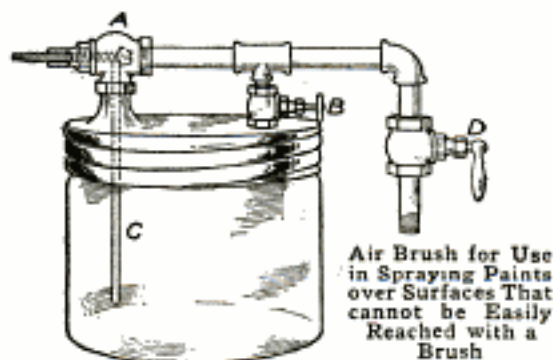

Air Brush for Use in Spraying Paints over Surfaces That cannot be Easily Reached with a Brush

turned open. The pressure inside the jar, regulating the flow of paint, is adjusted by the needle valve B.—Contributed by A. H. Waychoff, Koenig, Col.

☞ Cover the exposed parts of a damp clay runner with oil—preferably kerosene—before pouring in melted babbitt.

### Umbrella Equipped with Celluloid Window

If a piece of about 2 by 6-in. transparent celluloid, such as is used on



A Small Celluloid Window in the Umbrella Top Is Convenient in a Driving Rain

automobile tops, be sewed over a prepared opening in an umbrella, the difficulty of looking ahead in a driving rain can be overcome, without the necessity of raising the umbrella and thereby running the risk of getting wet, or having the umbrella turned inside out.—Contributed by H. W. Hahn, Chicago, Ill.

### Solid Object in a Barrel Kept Away from Opening

A bung, plug, or cork pushed into a barrel will cause trouble when tapping until the entire contents are removed. It will push its way into the outlet as the liquid flows and obstruct the opening. An excellent way to keep the trouble maker away from the opening is to drive four small nails in the end of the faucet around the hole before inserting it in the barrel bung. The nails are only driven in far enough to hold, allowing most of their lengths to project. The nails will keep away any floating object from the opening.—Contributed by A. H. Woodyard, Ada, Oklahoma.

### Reducing Traction Power by Filling Space between Wagon-Wheel Spokes

Considerable power can be saved, when pulling a heavy load, by filling in the space between the spokes of the wheels on a wagon or truck, as illustrated. This method was devised by a driver after observing how the sand would fill in between the spokes, and be lifted almost level with the hub as the wheels revolved, before it spilled out. The added weight of the sand was considerable, and a load on the wagon formerly requiring six horses, could be easily pulled with four horses after the spaces had been filled.

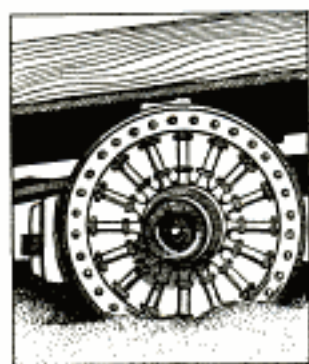

### Safety Chain for a Door

Timid women frequently dread to open a door if they suspect that strangers are on the outside. Security can be assured if the door is provided with a chain and hook as shown in the illustration. It is necessary to have two strong screw eyes, 6 or 8 in. of strong chain, and a hook with a loop 3 or 4 in. long. One of the screw eyes is opened up sufficiently to allow an end link of the chain to enter, after which it is again closed up tight. The long hook should be attached to the other end of the chain in the same manner. The screw eye, with the chain attached to it, should be screwed into a convenient place in the door casing a little above the door knob. The second screw eye should be so placed in the door that it would be necessary to have this nearly closed before the hook could be put on or taken off the



screw eye. This precaution will prevent the possibility of an intruder unhooking the chain from the outside. When in position, the chain will allow the door to be opened merely sufficient to see the stranger or carry on a conversation; it would be impossible for anyone to enter.—Contributed by L. R. Buzzell, Malden, Mass.

### A Pocket Bath Spray

The pocket bath spray consists of a nickelplated copper tube bent in the shape of a fishhook with a 1/2-in. opening or slit in the curved end, the body being flattened out so as to produce the spray when the water is forced through it. The other end of the tube is inserted

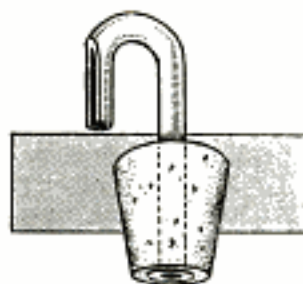

through the center of a cork, cut tapering to fit various-sized faucets, and has a round plate soldered to the upper end to prevent it from slipping through the cork. The attachment can be carried in the vest pocket and is instantly fitted to any bathtub or lavatory faucet, or it can be used outdoors on a hydrant for removing the salt water after a dip in the ocean.—Contributed by D. S. Rockwell, Ocean Beach, Cal.

### Metal Lining for Clothes Pocket

To safely carry articles in a pocket where they would be easily broken or crushed, metal linings can be provided. For this purpose a very thin, hard sheet brass is used. A strip is cut having a width equal to that of the pocket, and a length corresponding to twice the depth, with an additional amount of approximately 3/8 in. to form the bottom of the pocket and a

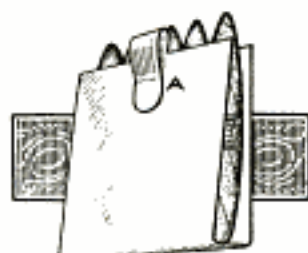

small strip,  $\frac{1}{4}$  in. wide by  $\frac{3}{8}$  in. long, at the center of one end for securing the lining in place. The metal is folded, as shown, to form a pocket, the top having a tendency to spring shut. The extra lap A, on the one end, is bent over the outer side of the pocket, securely clamping the lining in place.—Contributed by J. E. Noble, West Toronto, Ont.

### To Prevent Dust When Removing Ashes from Furnaces

In removing ashes from furnaces, there is always a considerable amount of dust created that makes the task disagreeable, besides covering everything near by. One resident eliminated the dust with a homemade device, as illustrated. A piece of pipe was procured that would reach to the rear part of the ash pit in the furnace and project far enough to make a handhold. The pipe was capped on one end and fitted with a hose connection on the other end. The part that extends into

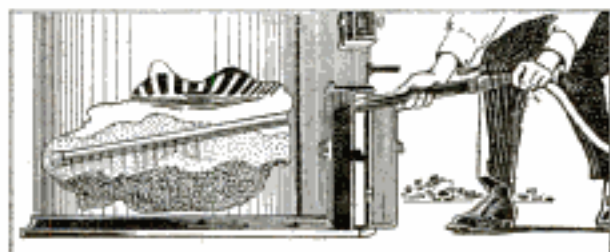

A Pipe with Numerous Holes is Fastened to a Hose for Wetting Ashes to Prevent Dust

the pit was drilled to make a number of small holes evenly spaced throughout its length. The pipe was then connected to a hose running from the laundry tubs.

In removing the ashes, the pipe is connected up and run into the ash pit, the water turned on, and by swinging the pipe about, the ashes are well wetted down so that in removing them no dust will be raised.

ⒸA 2-in. paperhanger's roller, covered with soft plush and inked on glass in the same manner as a printer's roller, makes an excellent device for inking over stencils.

### A Singletree for Use in an Orchard

In getting in around apple trees in an orchard with a cart drawn by a horse, many trees are skinned by the

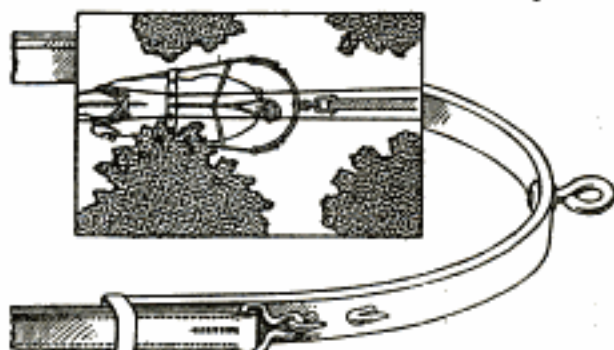

The Rounding Ends of the Singletree do Not Present Any Projection That will Bark a Tree

ends of the singletree. Sometimes a bunch of rags tied on the ends will prevent the skinning, but a much better way is to have a special singletree made in a semicircle, as shown. It can be bent to shape from a piece of heavy tire iron, a leather loop being attached to each end for passing the traces through, and hooks to engage the traces riveted on. The location of the hooks should be far enough back so that they will not be exposed. No part of the singletree, nor the hooks, will then touch a tree, and the leather traces will slip past easily.

### Pole to Loosen Window Catches

The height of some window sash brings the catch out of reach, and to open a window means to climb a chair and loosen the catch. To overcome this difficulty, I made a device as follows: A stick, long enough to reach the catch, was procured, and a coat hook attached close to one end. In use, put the hook on the catch and push up or pull down, and, for catches that turn sideways, give the stick a twist.—Contributed by Maurice Baudier, New Orleans, La.

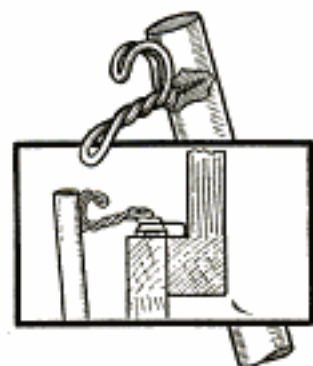

### Coat and Hat Hanger for Shops

In many shops coats and hats are frequently hung up on pegs fastened to boards, which are provided with holes at the upper end to suspend them from nails in the walls. It often occurs that the hat drops off, into the dust or dirt, causing much annoyance. If the board is equipped with a spring, as shown in the sketch, the hat will be securely clamped in place, and cannot fall off accidentally. To avoid the fishing necessary in placing the board on a nail, a tapering slot can be cut into the board with its point above the opening. The nail is easily caught anywhere within the wide opening, and will guide the board to the narrow end of the slot, supporting it in the usual way.—Contributed by John J. Kolar, Maywood, Ill.



### Gasoline Can with Combination Whistle and Vent

Even though gasoline cans are distinctively colored, usually being painted red, dangerous mistakes are very apt to occur if the can happens to be in a dark place, or otherwise so situated that its contents are not readily detected. A better safety device is to provide a whistle which automatically blows every time the can is tipped.

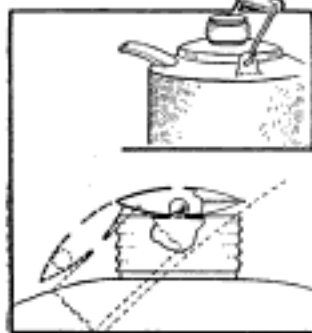

To make this device, a small oval whistle is required which will fit within the screw cap of the can. Inside of the whistle is placed a steel ball, sufficiently large to cover the

whistle hole, but free to roll around inside when the can is tilted. A hole is made in the screw cap and the whistle, on the inside, so that the hole in the cap will line up with the one in the whistle.

When the can is tilted for pouring out oil, the ball will roll away from the hole, allowing air to pass through which will serve two purposes: it will blow the whistle, thereby giving an alarm which will probably result in an examination as to the contents of the can; and it will also act as a vent, enabling a freer flow of oil from the can.—Contributed by W. C. Loy, Rochester, Ind.

### To Stop Noise of a Valve Push Rod

A common fault of a gasoline engine is its noisy operation when the valve is lifted. This is usually caused by the steel-to-steel contact of the valve stem proper and the lifter-adjusting screw A. Bore a hole,  $\frac{3}{8}$  in. in diameter, in the screw to a depth of about  $\frac{5}{8}$  in., countersinking it slightly, as shown. A piece of hard-fiber rod,  $\frac{3}{8}$  in. in diameter and approximately  $\frac{1}{2}$  in. in length, is pressed securely into the hole and hammered down until the countersunk portion is completely filled. The extending portion of the fiber is filed flush with the top surface of the screw. All the screws are fixed in a like manner. This will make an engine almost noiseless.



### Starting Motorcycle Engine in Cold Weather

In starting a cold motorcycle engine, close the air shutter on the main jet, and then, by quickly opening and shutting the throttle while cranking, the motor will draw a rich mixture and start quite easily. The auxiliary jet will usually pick it up, and the air shutter can be again adjusted where it runs best.—Contributed by F. L. Prescott, Starke, Fla.



# To Locate and Correct Troubles in Direct-Current Dynamos

By A. E. ANDREWS

## PART I—Sparking at the Brushes

IT is the purpose of this article to present the methods of locating and correcting the troubles that may occur in generators and motors at any time while they are in service. While the description may not be complete in every detail, it will cover a large percentage of all the cases of trouble that may arise, and will thus serve as a useful guide to those in charge of machinery. In the majority of cases the trouble is very easily remedied after its cause is once found, but the greatest difficulty is to recognize the cause, and for this reason a greater stress will be laid upon a method to determine the cause. It is always best to try to locate the cause with as little interference to the service of the machine as possible. Proper care should be exercised at all times not to expose oneself unduly to electric shock, or contact with bare conductors. With the exception of one or two cases, the following description deals with what are termed low-voltage machines, and nothing above 250 volts. Extra care should be taken in working around machines of higher voltage, as the danger is much greater. In making the simple tests that are suggested, it is assumed that the operator has the use of a voltmeter and an ammeter.

### Fault of the Brushes

The one main cause for sparking at the brushes is that they are not set diametrically opposite. The setting of the brushes should be done while the dynamo is at rest, by counting the bars, by measurement, or by the use of reference marks on the commutator. The center of adjacent brushes should be  $180^\circ$  apart. This can be done, if necessary, while the machine is running by moving the rocker arm so that the brushes on one side will show the least spark, then adjust the brushes on the other side to the least-sparking point, and clamp them in place.

Another cause for sparking is that the brushes are not set at a neutral

point. This may be remedied by moving the rocker arm back and forth until the sparking stops.

If the brushes are not properly trimmed and set, they will spark. If sparking begins from this cause and

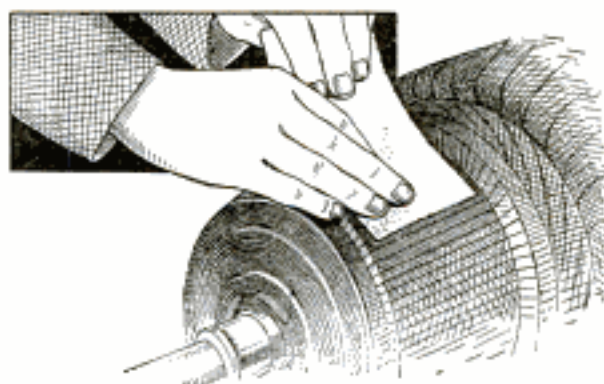

Fig. 1—Smoothing a Commutator with a Piece of Sandpaper Backed with a Piece of Heavy Cloth

the machine cannot be stopped, bend back the brushes and cut off the loose and ragged wires, if metal brushes are used, and retrim them as soon as possible after the run is over. If there are two or more brushes in each set, they may be removed one at a time, and properly trimmed ones put in the place during the run, on any low-voltage machine. To trim the brushes, first clean them from oil and dirt with benzine, soda, or potash, then file, or grind, them carefully by the aid of a standard jig, and reset carefully.

The brushes of a set should be adjusted separately until they are all in line and square with the same commutator bar, bearing evenly for their entire width, unless purposely set staggered. Adjust the pressure by the tension screws and springs until a light, firm, yet even, contact is made. The pressure should be about 1.25 lb. per square inch.

### Fault of Commutator or Magnetic Field

The commutator may cause the brushes to spark by its being rough, worn in grooves, not round, or by one or more bars being too high or too low. To grind down a commutator, use fine sandpaper laid in a block, concaved to

fit the circumference. Never use emery cloth or paper, nor emery in any form. Polish with a soft, clean cloth. A method that may be employed in clean-

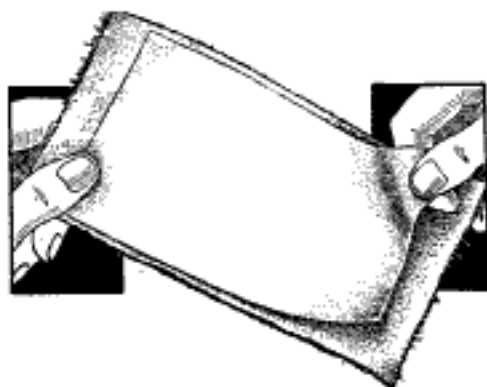

Fig. 2—The Heavy Cloth Extending over the End of the Sandpaper Prevents Any Copper Dust Passing under the Brushes

ing a commutator when the surface is not worn too badly is shown in Fig. 1. A piece of heavy cloth should be placed over the sandpaper, as shown in Fig. 2, which prevents the fine copper dust from being carried under the brushes. If the surface of the commutator is rough, the sandpaper should be held against the surface by means of a curved piece of pine instead of the fingers. The sandpaper should be given a slight endwise movement along the commutator, to prevent the formation of grooves.

If the surface is too badly worn to be ground down, turn it off with a special tool and rest while the armature is turning slowly in the bearings, or remove the armature and turn off the commutator with light cuts in a lathe. The armature, when set in its bearings, should have from  $\frac{1}{16}$  to  $\frac{1}{8}$ -in. play, so as to distribute the wear evenly and prevent wearing ruts and ridges. The brushes may be shifted sideways occasionally to assist in the distribution of the wear.

If one or more commutator bars are high, set each down with a block of wood, or a mallet, being careful not to bend, bruise, or injure the bar, and then tighten the clamping rings. If this does not remedy the fault, file, grind, or turn the high bar or bars down to the level of the other bars. The high bar may make the brushes

jump or vibrate, and cause them to "sing." If one or more bars are low in a commutator, turn down the others to true the surface and remove the low spots. The insulation between the bars will not wear as fast as the metal, and should be ground or turned down when necessary to remedy this fault.

A weak magnetic field will sometimes cause trouble, and this may be due to a broken circuit in the field. It can be remedied by repairing the broken line, and rewinding if the break is inside of the winding. A short circuit of the coils will cause the same trouble. If the short circuit is external, repair it, but if internal, the coil will need to be rewound. The same trouble will result if the dynamo is not properly wound, or does not have the proper amount of iron. In the latter case, the only remedy is to rebuild it entirely.

#### Excessive Current in Armatures

Sparking at the brushes is also the result of an excessive current in the armature, which is caused, in a generator, by too many lamps on the circuit (constant-potential system); by a ground or leak from a short circuit on the line, or by a dead short circuit on the line. In motors, it is caused by excessive voltage on a constant-potential circuit; by excessive amperage on a constant-current circuit; by friction, or by too great a load on the pulley.

To overcome the difficulties of the dynamo, reduce the number of lights and thus diminish the current called for on the plate. Test out, locate, and repair the ground. A dead short circuit will blow the safety fuse. Shut down the dynamo, locate the trouble, and repair it. Put in a new fuse before starting again. The fuse should not be inserted until the fault is corrected, as it will blow out again upon starting the machine. If the trouble is not located, the voltage of the machine should be brought up gradually from a low value, and the current output observed. An excessive current will indicate the trouble still ex-

ists, and the machine should not be operated until the trouble has been corrected.

In motors, the proper value of voltage should be used and no other. Make sure that the motor has the proper current capacity. Remedy any cause from undue friction, and reduce the load to the proper amount for the rating of the motor.

#### Fault of the Armature

A short-circuited coil in the armature will cause sparking at the brushes. A method of testing out, to find a short-circuited coil, is shown in Fig. 3. When a coil between the segments to which the voltmeter is connected is shorted, the reading will be very low. Examine the commutator and remove any copper dust, solder, or any metallic substance, that might be making a contact between the commutator bars. See that the clamping rings are properly insulated from the commutator bars, as well as from carbonized oil and copper dust or dirt which may form a short circuit. Test out for an internal short circuit or cross connection. To remedy such a trouble, reinsulate the conductor, change the connection, or rewind the armature. Examine the insulation of the brush holders. Dirt, oil, or copper dust may form a short circuit from the brush holder to the

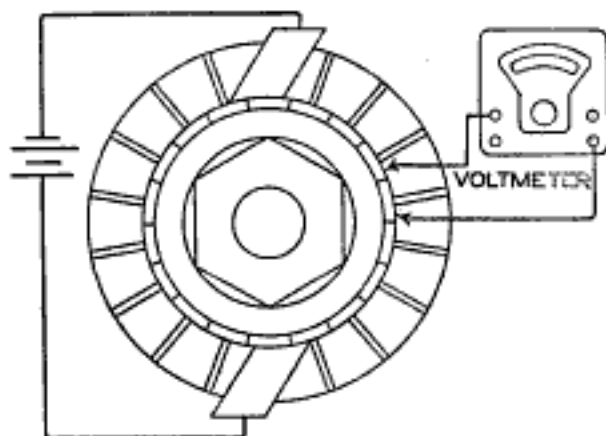

Fig. 3—Connecting a Voltmeter and Current to a Commutator to Test Out for a Short-Circuited Coil rocker arm, and thus short-circuit the machine.

A broken circuit in the armature will cause the same trouble. A run may be finished by bridging the break tem-

porarily, which is done by staggering the brushes till the run is finished. This is only a temporary makeshift to stop the sparking of the bar during

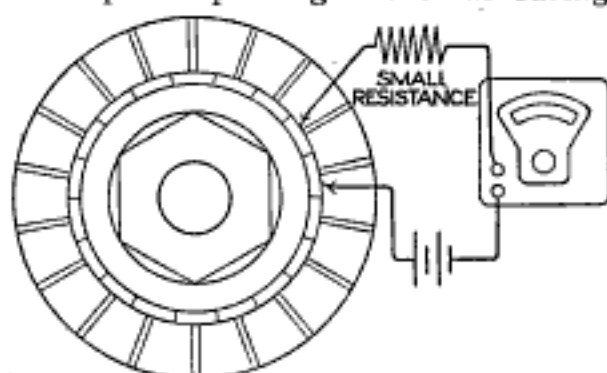

Fig. 4—Connections for an Ammeter to a Commutator to Test Out for an Open Armature Circuit

a run when the dynamo cannot be shut down and must be followed by testing out and repair. A method of testing for an open armature circuit is shown in Fig. 4. When the ammeter reads low, it indicates that there is an open coil between segments. If the dynamo can be shut down, look for a loose or broken connection to the bar, and if one is found, repair it. If the coil is broken inside, the only remedy is to rewind it. The break may be bridged temporarily by hammering the disconnected bar until it makes contact across the mica insulation to the next bar of the commutator. This remedy may be of use to complete a run, but the bars must be repaired and the insulation replaced when the fault is corrected. Another way to make the bridge across, is to solder two lugs of the commutator together or use a piece of heavy wire to cut out the broken coil. In doing so be careful not to short-circuit a good coil and thus make sparking from a short-circuited coil.

A cross connection in the armature will also cause the same trouble. The cross connections may have the same effect as a short circuit, and they are to be treated as such. Each coil should show a complete circuit with no connection to any other coil.

ⒸIn repairing a fair-sized hole in an inner tube, it is better to place a patch on both sides, and then vulcanize.

### Easily Adjusted Automobile-Top Holder

In the usual method of fastening automobile tops when down, leather straps are used to bind the ribs in

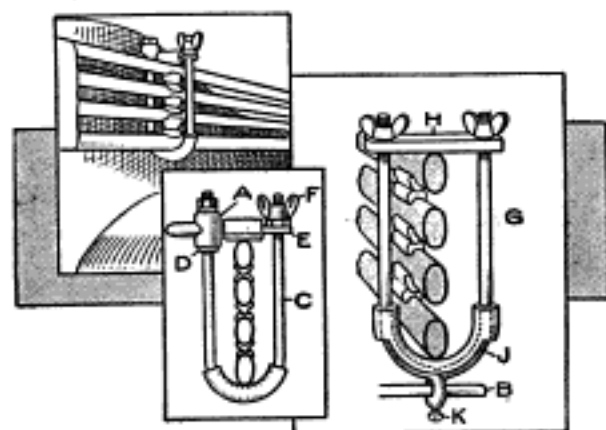

Automobile-Top Holder with Thumbscrew Adjustment, and Special Arrangement for Use with a Horizontal Bar

place. If the straps are not bound tight, the top will rattle. In order to prevent this noise, a strain must be put on the leather so as to reach a place where the strap will be tight. To avoid the tugging nuisance, and breaking of straps, an attachment may be made as illustrated, for automobiles having brackets similar to A, or a holder can be fitted to automobiles having a horizontal bar, as B, to support the top. In the former case, a rod, C, is selected which will enter the hole of the bracket A. This rod is upset, or a collar welded to it, at D, so that sufficient length will be allowed on the short end for the bracket A and a standard nut. The rod is then bent U-shaped to accommodate the several top ribs, sufficient length being allowed for a crosspiece, E, and thumb nut, F. The piece E is drilled to fit the rod C. It is covered with a piece of hose and the rod C is similarly covered at the bend to prevent marring of the ribs. In putting the top down, it is only necessary to swing the piece E out of the way, and drop the top into the U-shaped bracket, where it may be securely held by bringing E to bear on it, and screwing down the thumb nut F.

In the second case, the U-bracket may be formed of a suitable rod, forged

so as to fit the rod B, and with the ends G extended to accommodate the top ribs and the crosspiece H, thumb nuts being provided at the extreme ends. Protective covering can be placed around H, as before. For the lower part, one half of the hose should be removed at the center, as shown at J, so each of the ends can slip over one of the sides G; the half section will still provide the necessary protection. The setscrew K locks the bracket in position on the bar B.—Contributed by Chester S. Ricker, Indianapolis, Indiana.

### Recoil on a Gun Stock

In order to lessen the kick of a gun, a recoil attachment can be used, as shown in the illustration. For this purpose, a special loose shoulder piece must be provided, or can be obtained by sawing the regular stock in two near the end. To keep the parts in line two  $\frac{3}{8}$ -in. steel pins are necessary, being provided with heads at one end only. The loose shoulder end of the gunstock should be drilled through, to fit the  $\frac{3}{8}$ -in. pins, and countersunk to about  $\frac{1}{2}$  in. on the inner edge, to fit suitable recoil springs. Two  $\frac{5}{8}$ -in. bushings should be provided to serve as guides for the pins.

In assembling the attachment, the bushings are first placed on the pins so that they will bear against the heads, whereupon the springs are inserted. The pins can then be put through the holes in the special shoulder piece, and their outer ends riveted

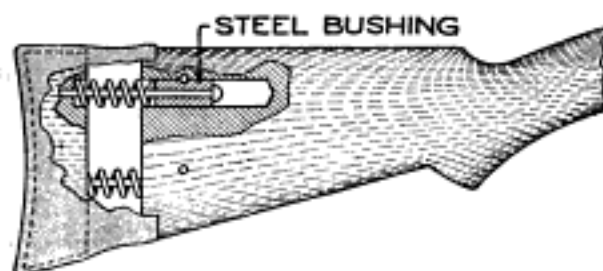

Recoil Device on a Gunstock to Take Up the Shock from the Firing

over to prevent them from pulling out with the recoil of the spring. In the main part of the gunstock, two holes

are drilled to fit the guide bushings, and counterbored for about  $\frac{1}{2}$  in., if necessary, to fit the springs. These holes must extend sufficiently beyond the inner ends of the bushings so that the heads of the pins will not strike the stock when the springs are compressed to their limit. To fasten the bushings, holes are drilled for  $\frac{1}{8}$ -in. pins, so that half of the pin is held by the gunstock and the remainder by the bushing. The opening in the gunstock may be covered with a strip of canvas, one edge being fastened to each piece of the stock; or, if preferred, a rubber casing can be used to cover the gap.—Contributed by L. Hamm, Moline, Ill.

### Perforator for Postage Stamps

Where return envelopes are sent out with a stamp attached many of them are detached for personal use. This could be guarded against by the use of a stamp perforated with a device having a series of needles or prongs, as shown. These could be arranged to suit the fancy of the user. A stamp perforated with the needles is almost impossible to remove without being torn.



### A Show-Window Attraction

One of the best methods of attracting the attention to a show window is to place in it some device which apparently operates of its own accord. Such an arrangement is shown in the illustration. It consists of an improvised paddle wheel driven by a concealed fan. The rotating device consists of a ball of cork, or other light material, to which are symmetrically hung razors, knives, toothbrushes, or similar articles, which will serve as paddles for the wheel. This ball is balanced on the point of a screw or

nail driven through a cork, which in turn fits in the neck of a bottle, thereby clearly indicating the absence of any

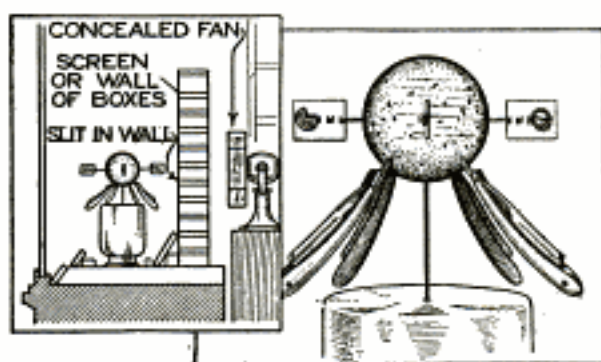

The Air Coming from the Slit Strikes the Projections on One Side Only

source of power through the base. On one side of the device a wall, or screen, must be provided, having slits, or holes, in it, and on the opposite side is placed a fan, carefully concealed from the observers. To rotate the ball, the fan is operated, which sends the air through the openings in the wall, causing it to strike the paddles and turn the ball.—Contributed by F. Armstrong, Pittsburgh, Pa.

### An Adjustable Precision Square

A machinist's, or toolmaker's, square, of novel, yet practical design, is shown in the illustration. Instead of the blade being solidly attached to the base of the square, it is pivoted on a pin. The plungers exert pressure against the blade on opposite sides of the pin. These plungers in turn are actuated by two blind setscrews. All that is necessary to adjust the square is to turn the setscrews. This square is easily con-

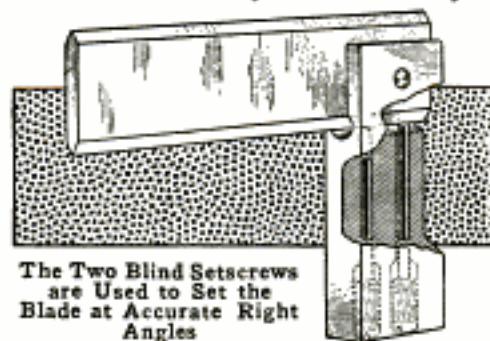

The Two Blind Setscrews are Used to Set the Blade at Accurate Right Angles

structed and may be made as accurate as it is possible to make any square.—Contributed by S. V. Brook, Hartford, Connecticut.

### A Bench Soldering-Iron Heater

The handy man at home can provide himself with a soldering-iron holder and heater that will serve the purpose of an

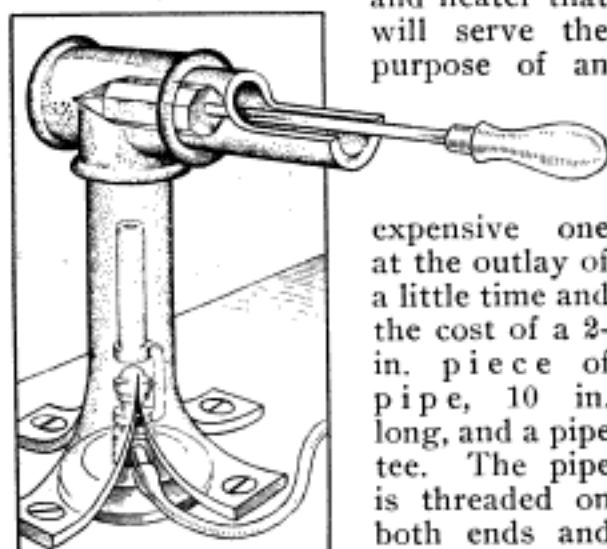

expensive one at the outlay of a little time and the cost of a 2-in. piece of pipe, 10 in. long, and a pipe tee. The pipe is threaded on both ends and cut to make

two pieces, one 7 in., and the other, 3 in. long. The unthreaded end of the long piece is split, or sawed, to make it quartering; the pieces are turned out to form feet and holes are drilled in them. This pipe is screwed to the bench over a Bunsen burner. The tee is turned on the top of the pipe and the other short piece is screwed into one end of the tee. The short piece is then filed to the shape shown, to receive the soldering iron.—Contributed by O. F. Germaine, Mansfield, Ohio.

### Bushing Valve Cap to Raise Spark Plug

Poorly designed valve caps on an automobile engine placed the spark plugs so low that it was difficult to



get a socket wrench on them when it became necessary to remove a plug.

This also made the lower portion of the plugs extend into the combustion chamber, resulting in clogged platinum points and causing ignition trouble.

The difficulty was overcome by making a shoulder bushing to receive the plug, and enlarging the hole in the

cap to receive the bushing. The shoulder of the bushing was slotted to provide a means of turning it in place. The work of fitting four such bushings was quite a job, but it was well worth the time.—Contributed by Adolph Kline, New York City.

### Muffler Cut-Out Made from Pipe Fitting

A simple and cheap muffler cut-out can be made for a gasoline engine from a pipe tee, a piece of sheet iron, and an iron rod. The tee should have a large side opening—unthreaded would be best. The valve consists of a thin sheet of stiff sheet metal, cut to a circular form, to fit the side outlet of the tee. The axis about which the valve turns consists of a round rod with one end bent at right angles. The other end should be sufficiently long to pass clear through the large part of the tee; the bent end simply forms the handle

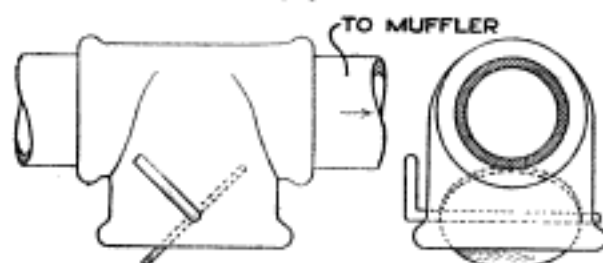

Cut-Out Made of a Tee Fitting Having a Large Side Outlet for the Disk Valve

for operating the valve. The axis end of the rod should be slotted to receive the valve disk. The side outlet of the tee is suitably drilled for the rod. In assembling the parts, the disk is put in place, and the slotted end of the rod put through the tee straddling the disk.

When carefully adjusted for proper operation, the disk and rod may be soldered together, or holes drilled through them, for rivets. The cut-out is then ready to be connected between the engine and muffler.—Contributed by D. C. Goff, Knoxville, Tenn.

CA machinist must remember that the warmth of the hand will change the size of a caliper or gauge of any kind.

### Rack for Storing Chain or Rope Tackle

In order to store rope or chain tackle conveniently, a rack can be provided, as shown in the illustration. It consists of two frames, one for the tackle and the other for the hoisting gear. The first consists of two angle irons connected by a rod on which to suspend the tackle. The ends of the rod are threaded sufficiently so they can be fastened to the angle irons, with a nut on each side of the webs. The frame for the hoisting gear is similarly made but further provided with a loose sheave on its connecting rod, which should be free to slide back or forth, or revolve. The angle irons should be shorter than in the former case so that the sheave rod will be above the tackle support.

To rigidly fasten the frame, each of the angle irons should be cut at its upper end, with one web of each bent at right angles to its length, as shown at A, and each end drilled to fit a supporting bolt. The frames can then be placed and fastened to a convenient support overhead, so the sheave rope—used for raising or lowering the tackle—will tend to pull the tackle hook over the supporting rod when, by slightly lowering the hook, it will catch on the rod and be suspended from it. In taking down any tackle, the looped rope is first placed so as to catch under

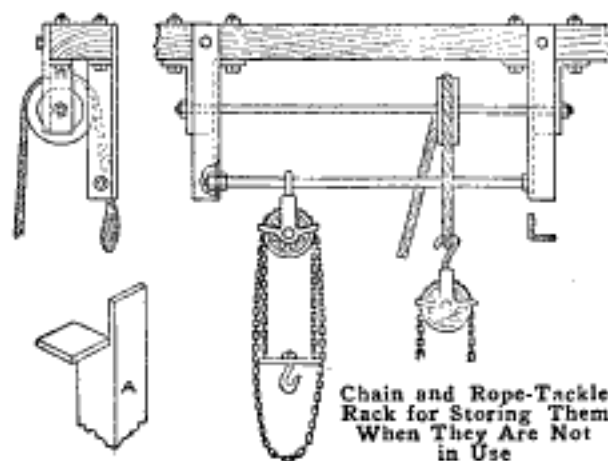

Chain and Rope-Tackle Rack for Storing Them When They Are Not in Use

the hook, which can then be raised off the rod, and the tackle lowered to the floor.—Contributed by John Harger, Honolulu, H. I.

### A Lock for a Theater Emergency Exit

A good panic-proof emergency-door latch for theaters that is always locked

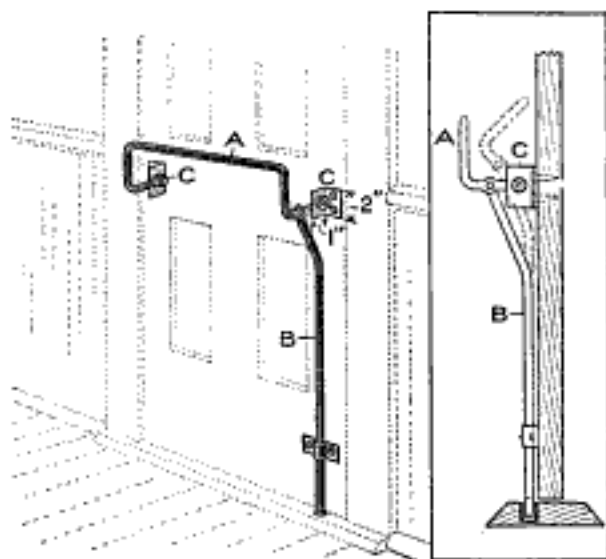

The First Person in a Rush for the Emergency Door Releases the Latch Automatically

from the outside, but which complies with any fire ordinances, can be made at small cost in the following manner. The latch is formed of a rod, about  $\frac{1}{2}$  in. in diameter. The piece A is bent as shown in the sketch and one end is flattened for  $\frac{3}{4}$  in., through which a  $\frac{1}{4}$ -in. hole is drilled, while the other end is flattened for 2 in. and provided with two  $\frac{1}{4}$ -in. holes, one near the end, and the other  $1\frac{1}{4}$  in. from the first hole.

The rod B is flattened on one end only, and a  $\frac{1}{4}$ -in. hole drilled through this end. It is then bent, as shown, so that it will clear the door about  $\frac{1}{2}$  in. The angles C are made of iron, 2 in. square and  $\frac{1}{4}$  in. thick. These are bent at right angles, so that each part extends 1 in. Two holes are drilled in one end for screws, and a  $\frac{1}{4}$ -in. hole is drilled in the other end, to admit a bolt to hinge the rod A. The parts are assembled with stove bolts having double nuts, so that the rods A and B will swing easily. The rod B engages in a hole in the floor, or preferably, in a small iron plate screwed to the floor. A light pressure on the bar A will raise the rod B from its keeper, and allow the door to swing open. On theater doors all other locks

should be removed. A rush for the door causes the latch to be released by pushing against it.—Contributed by R. R. Cantrell, Red Oak, Iowa.

### Homemade Steam Trap

It is frequently desirable to have a trap for draining water from steam mains, but the purchase price for the manufactured article may not be on

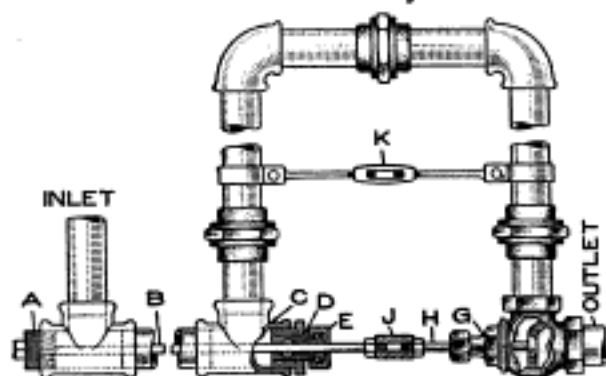

Steam Trap Made of Pipe and Fittings to be Used with the Bend Lying on Its Side

hand. In most places sufficient odds and ends are lying around to construct one as shown in the figure. The necessary fittings are: two tees, two ells, one angle valve, six pipe nipples, three unions, one plug, one reducing bushing, one packing box, gland and nut, two bronze, or brass, valve stems, and a threaded coupling for the same.

The side outlet of one tee forms the inlet of the trap. One end of this tee is closed with a plug, A, which is drilled and tapped for a suitable brass, or bronze, rod, B, of sufficient length to extend about halfway between the uprights of the U-bend trap. The second tee, C, is fitted with a reducing bushing, D. Into this is screwed a packing box, E, which should be made to fit a gland and nut from a discarded valve. The angle valve G requires a few slight changes before it can be used for the trap. The valve stem should be turned down to the diameter of its projecting end, thereby permitting it to move back and forth without the necessity of rotating it. The valve stem H and the rod B are threaded and connected by means of a coupling, J. Lock nuts should be used to keep the valve in the set posi-

tion. Adjustment may be made by turning the stem H. Three unions are used in the pipes forming the U-part so that the trap may easily be assembled or removed without breaking the main line. Should the trap vibrate excessively, it will be necessary to bind the sides of the U-bend by means of a tie rod, K. Whenever the pipe line is full of water, the valve G should be open, allowing the water to leave at the outlet. When the pipe is drained and steam starts to flow, the steam, being hotter than the water, will cause the stem B to expand. This in turn forces the stem H and valve against the seat, thereby shutting off further escape of water or steam.—Contributed by H. L. Hauptmann, Cleveland, Ohio.

### A Weed Remover

Having a hand cultivator which broke up the soil well but did not remove very many weeds, I tried the following plan with success: Some strong but rather small wire was stretched tightly between the teeth and fastened at such a height that the wire just cleared the surface of the ground. When in use the teeth break up the soil and the wire pulls out the weeds as it is drawn along close to the ground.—Contributed by Abner B. Shaw, N. Dartmouth, Mass.

### Sign Painter's Palette

The conical tin caps of varnish and other similar cans come in very handy when one has to use small quantities of various colors on one job. The caps can be inserted in holes bored in a piece of board, or fastened to a tin plate with a bit of solder. The tin plate can be turned up at the edges.—Contributed by James M. Kane, Doylestown, Pa.





## Core Boxes for Square and Rectangular Cores

By J. A. SHELLY

IT is not the purpose of this article to describe all devices used for making the kind of cores under this subject, but a number of the most common forms will be mentioned.

It is always best to have the core box part at opposite corners, unless they are very shallow or have plenty of draft, in which case they can be safely fastened at all four corners. There are cases where it is necessary to have the box part at all four corners, as, for example, when there are small projections on the four sides of the core, that cut into the sides of the core box and make it necessary to draw the sides of the box away in lines at right angles to the sides of the core.

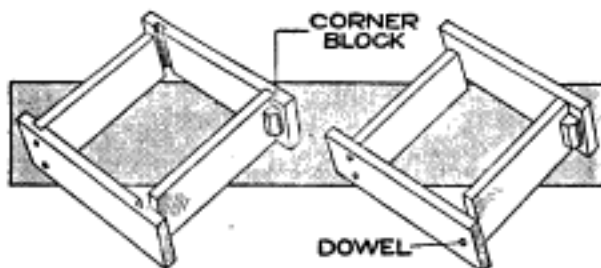

Fig. 1

Fig. 2

Two Ways of Forming the Joints to Make the Core Box Part on Opposite Corners

The most common kind, and probably the best corner joint, is the housed joint, shown in Fig. 1. By its construction, it effectually prevents the ramming out of the ends of the box. It is the standard form for first-class work.

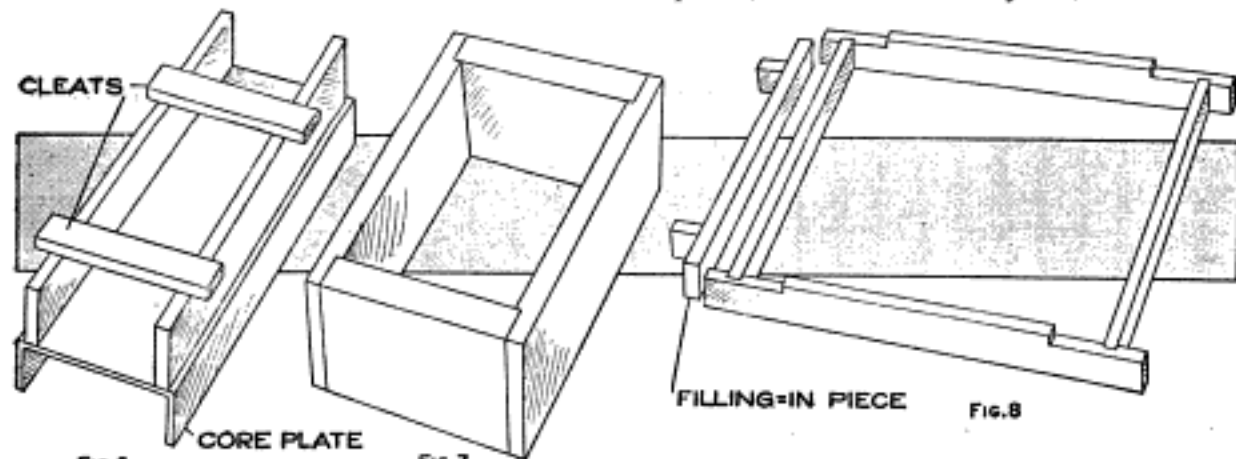

Fig. 6

CORE PLATE

Fig. 7

FILLING-IN PIECE

Fig. 8

Where It Is Necessary to Make a Long Core for a Column, or a Similar Piece, It is Shaped on a Channel Iron with Straightedges, and Cores for Large Work are Made Up of Separate Pieces into Box Form

Where a cheaper job is required, the box shown in Fig. 2 is frequently used. It is of butt-joint construction

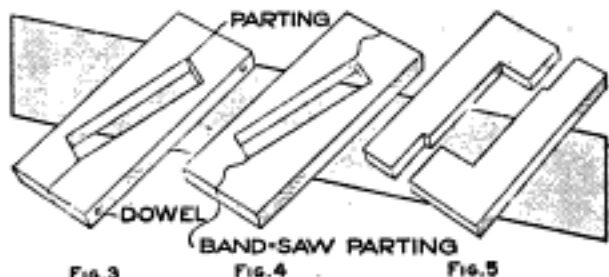

Fig. 3

Fig. 4

Fig. 5

Small and Thin Cores are Made in Boxes Formed of Two Pieces of Wood

and depends on dowel pins in the loose corners to withstand the end strain of ramming. This form is not to be compared with the one shown in Fig. 1, but where only a few cores are required, it answers every purpose.

For smaller cores of the same general shape, the box shown in Fig. 3 is the usual form. The two halves are cut from single pieces of wood and doweled together before the rectangle is laid out. Laying the rectangle out as shown makes it very easy to draw the sides of the box away from the core.

A core box made from a single piece of wood is shown in Fig. 4. It is cut out with a band saw. The irregular joint does away with the dowels. The joint line and rectangle are laid out before any cutting is done, and in drawing the lines for the rectangle, or square, as the case may be, allowance

must be made for the stock removed by the band saw in cutting on the joint line.

Another standard form that is in general use is shown in Fig. 5. This is used where a thin core is desired and when the thickness of the box will not permit dowels. The box is only used for small, light cores.

The device shown in Fig. 6 is extremely simple, and gives excellent results on long cores for columns, and similar work. Two parallel straightedges, placed as far apart as the depth or thickness of the core, constitute the core box. These straightedges are kept to the proper width, or distance apart, with battens, or cleats, fastened across the face with screws. These battens are spaced about 28 or 30 in. apart. Channel iron is used for the core plate, and it is only necessary to remove the battens to free the core.

It happens sometimes that a very large core is required, and to save lumber and the necessity of handling a large and heavy body of sand, the core is made in four pieces and set up in place in the mold, as shown in Fig. 7. The sketch, Fig. 8, shows the box for making the sides with both ends cut down to receive the end cores. A filling-in end piece is used in each end of this box, to form the short end cores.

### Safety Dog for Small Lathe Work

A great many methods are used and tried for the protection of workmen from the danger of being caught in revolving set-



screws of lathe dogs. The screws are usually provided with hoods, or are placed in countersunk holes. These methods frequently turn out to be a nuisance, or special wrenches must be provided, which are frequently lost when required.

The simple lathe dog illustrated combines the necessary factors of

safety and convenience. It consists of a plain metal ring, drilled and tapped for a left-hand thread. A steel rod, threaded at one end to fit the washer, is bent with its ends at right angles to each other, forming the tail for the dog and the wrench for the setscrew. No sharp corners, or dangerous projections, are presented, and the thread being left-handed, the dog tends to grip the work more firmly as it is being driven by the lathe.

### Testing Small Motors with a Magnetic Brake

In testing small motors by means of a prony brake the results are far from satisfactory, and other methods must be employed which are capable of giving more accurate and consistent tests. A method used with excellent results in testing very small motors of about  $\frac{1}{20}$  hp. is shown in the illustration. The principal parts that constitute the testing device are a copper disk, A, mounted on the armature shaft; two electromagnets, B, connected by a yoke, C, the combination being mounted on a shaft, D, which is pivoted on the knife edges E and F, and a spring G, one end of which is fastened to the shaft D and the other end attached to a piece, H, mounted on the support J, as shown. The pointer K is attached to one end of the piece H, and so arranged that it may be moved over a graduated circular scale, laid out on the surface of the support J.

The operation of the device is as follows: When the disk A is revolved opposite to the poles of the electromagnets there are electric currents produced in the disk which react upon the magnets and tend to carry them around with the disk. Any movement of the electromagnets is prevented by turning the pointer K in the opposite direction to that in which the disk is turning, thus producing a torque in the spring until the pointer L is at its zero position. The position of the pointer should be noted and also the input to the motor together with its speed. If the torque produced in the

spring G were known, the output of the motor could be easily calculated.

To determine this torque, proceed as follows: Attach two lever arms to the yoke C so that they extend out on opposite sides perpendicular to the axis of the yoke. Suspend from these two lever arms two scale pans of exactly the same weight. The points of suspension of the two pans should be exactly the same distance from the center of the shaft. Turn the pointer K to the position it occupied when a balance was obtained during the test, and then place in the proper scale pan sufficient weights to bring the pointer L back to the zero mark. The product of the weight in pounds, required to produce a balance, and the distance in feet the point of suspension is from the center of the shaft, gives the torque in pound-feet. This value of the torque may then be substituted in the following equation and the horsepower calculated.

$$\text{Hp.} = \frac{\text{Torque} \times 6.2832 \times \text{R. P. M.}}{33,000}$$

The accuracy of the device will depend upon the care exercised in constructing and operating it. The deflections of the pointer K for the various outputs may be changed by varying the strength of the electromagnets or the size of the spring. The supports E

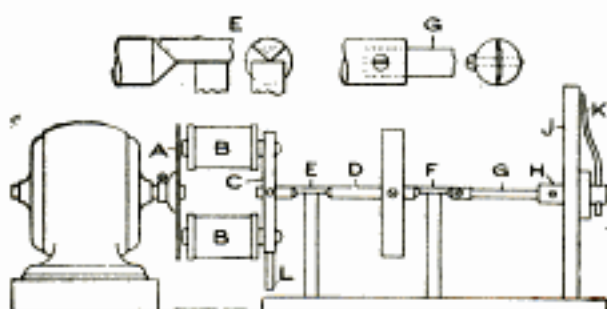

A Torque is Used as Basis for Calculations in Finding the Horsepower of a Small Motor

and F are so constructed that any movement of the shaft amounts to its turning on its own axis.

Ⓒ When brushing chips and dirt from a machine, be careful to keep them from falling into journals or parts where they will cause injury.

### Recoating Worn Plated Parts on Automobiles

An outfit that will recoat worn nickel parts on automobiles without removing them, is shown in the illus-

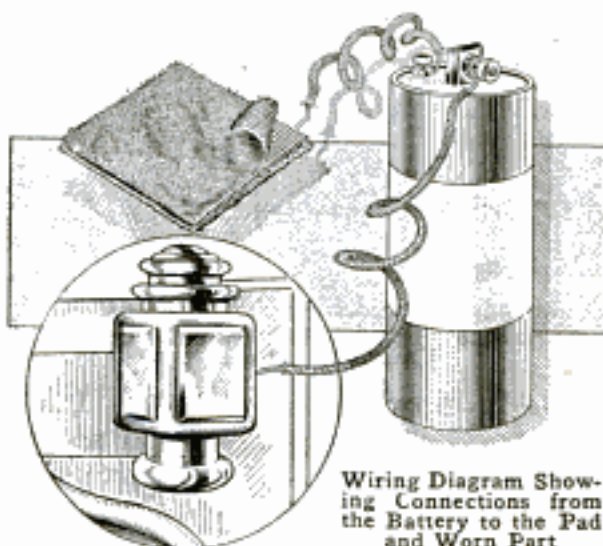

Wiring Diagram Showing Connections from the Battery to the Pad and Worn Part

tration. While this device will not put on the regular plate, it will refinish places where the nickel is worn off so they look like new and will last for some time.

Procure two pieces of good flannel, each about 6 in. square, also a piece of brass screen of the same size, and sew them together, with the screen between the flannel pieces. At one corner of the screen, solder a piece of copper wire for a connection. Make the electrical connection from the pad to the battery and to the article to be plated, as shown.

Prepare a solution as follows: Place in a 2-qt. bottle 6 oz. of nitric acid, and 4 oz. of mercury. This mixing should be done in the open air, and when doing it, one should be very careful not to inhale the fumes, or vapor, as it is a deadly poison. Allow the mixture to stand until it stops boiling, then add nickel, about the weight of two five-cent pieces, and let the solution stand for half an hour. Fill the bottle with distilled, or rain, water.

Apply the solution to the pad and rub it over the part to be coated. The result will be a fine lustrous color that will wear for a considerable length of time.

### Sockets for Broken-Shank Drills

When a drill shank is twisted off it is usually thrown away and a new one milled, or else some special socket

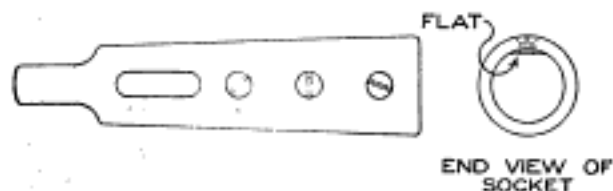

VIEW SHOWING DRILL IN SOCKET  
A Socket for Holding a Drill That Has Its Shank Twisted or Broken Off

must be provided to drive it. With but very little change, a regular socket can be used to drive such drills without spoiling its service for drills regularly provided with shanks. For this purpose, several holes are drilled and tapped in the socket to fit slotted, headless or flat-head setscrews. The twisted-off drill is ground to provide a flat bearing for the setscrews. When inserted in the regular socket, it can be securely held in place by the setscrews provided with flat bottoms, which are screwed against the flat place on the drill.—Contributed by J. V. Romig.

### Simple Flexible Coupling for Transmitting Small Power

In connecting shafts that transmit small power, the simple flexible coupling illustrated can be made to serve the purpose as well as a complicated and expensive connection. The shafts are

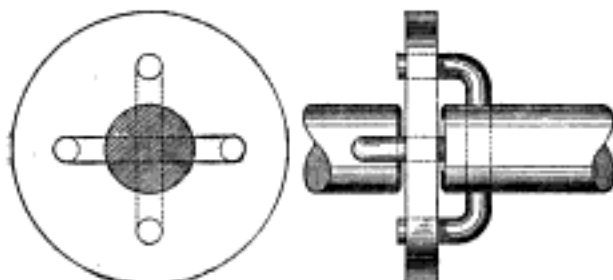

The Leather Disk Provides the Flexible Joint between the Revolving Shaft Ends

drilled for suitable-sized pins. These are bent at one end and then pressed or driven in place, after which the other

end is also bent, thereby forming a letter C with the parallel ends equally distant from the shaft. A driving disk is required to complete the coupling. The disk is a circular piece of thick leather, provided with four holes to match the projecting ends of the coupling pins, but sufficiently large to give ample clearance for flexibility and free end movement of the shafts.

### Electric-Bell Alarm for Passenger Elevator

Speed governors, or brakes, are usually provided on passenger elevators to prevent them from dropping or traveling too fast. Hardly any attention is paid to the actual load carried, except to judge it approximately by the number of persons in the cage, which can only be a rough guess as regards actual conditions. In order to indicate when a limit load is being carried, an arrangement, as shown in the illustration, can be used by which

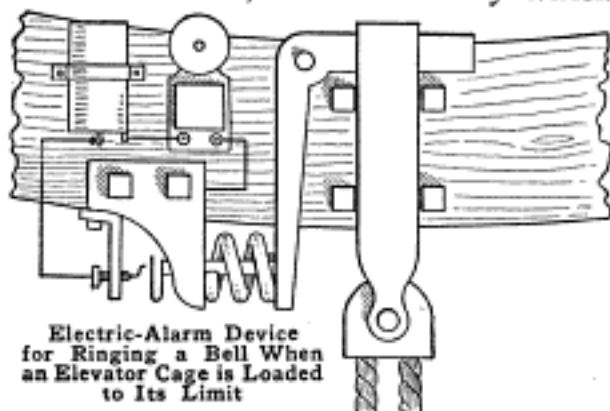

Electric-Alarm Device for Ringing a Bell When an Elevator Cage is Loaded to Its Limit

an electric alarm bell is rung. A bell-crank lever, attached to the cage frame, is supported at one end by a clevis fastened to the elevator cables; the other end fits up against a compression spring which rests against a bracket fastened to the elevator frame. One contact of the electric-circuit switch is rigidly fastened to the cage frame, and the other to a rod connected with the spring end of the bell crank. During an overload, the spring will be compressed sufficiently to allow the switch contacts to come together, thereby closing the circuit and ringing the bell.—Contributed by T. B. Lambert, Chicago, Ill.

## Inexpensive Wood Pulleys

By PAUL A. BAUMEISTER

**A**T one time I had occasion to use some wood pulleys in connection with a small gasoline engine. The cost of manufactured pulleys was prohibitive, so it became necessary to devise some simple, cheap way to make them with the tools available. There were just three things to be considered, the material, how to turn them, and how to key them to the shafting.

The first was easy. A block of pine boards was built up in layers, as shown in Fig. 1. The joints between the boards of one layer were set at an angle to the joints of another layer. Enough layers were added in this way to make a block of sufficient thickness for a pulley of the desired width.

The boards were then screwed, or nailed, together, care being taken to leave no nails or screws projecting on the surface to be turned. A rough circle was then drawn on the boards, and the block was roughed out with a hand saw, to make the turning easier.

This latter operation was performed on an improvised lathe, made from a circular-saw mandrel and driven by a gasoline engine. A faceplate, as shown in Fig. 2, was made of wood. The pulley block was fastened to it with wood screws, and the whole mounted on the saw mandrel. An ordinary carpenter's chisel with a very slight bevel was used to do the cutting. Care must be taken to do all the turning from the face of the block, or the chisel will catch in the end grain of the wood and cause considerable trouble. Frequent grinding of the tool will help a great deal, as a sharp edge is the secret of smooth work. A slight crown is turned on the pulley to keep the belts from running off.

The pulley is bored to fit the shaft by using a narrow chisel. If the pulley is very wide, it may be easier to bore a few layers, then remove them, and finish the remainder. After the turning is finished, the pulley may be polished with some coarse sandpaper.

A very simple, as well as an effective, way of keying the pulley to the shaft is shown in Fig. 3. Assuming that the pulley is to be at least four layers thick, although this is not absolutely necessary, the two inner layers are notched, as shown in Figs. 1 and 3,

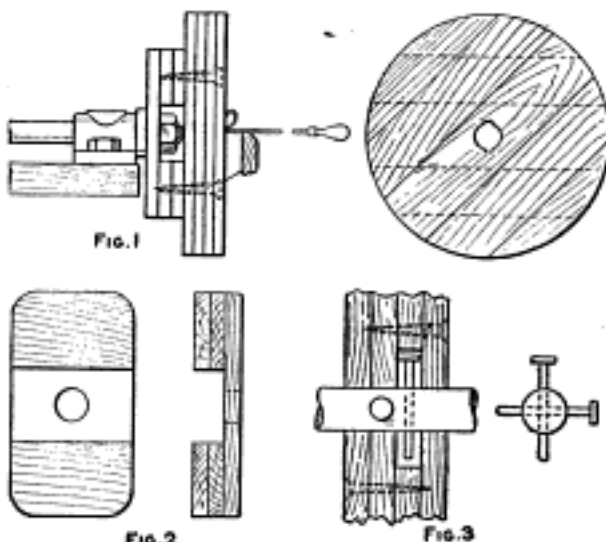

FIG. 2  
Operations Necessary in Building Up a Pulley from Pieces of Board, and Method of Keying It

the notches in one being at right angles to the notches in the other. Two holes are drilled in the shaft, at right angles to each other and at a distance apart equal to one layer of boards. The keys are parts of large nails, the size of which will depend on the construction of the wheel. The pulley is then assembled by slipping the layers over the shaft so that the nails fit in the notched layers, as shown in Fig. 3. The end layers are put on, and all four screwed together. The outer layers will prevent the pulley from slipping on the shaft. If there is one joint in each layer which comes on a diameter, the pulley can be assembled without slipping it over the shaft. This would allow its being put on a shaft upon which there were already other pulleys.

More than likely the pulley will need some turning after assembling, as it is nearly impossible to bore the pulley absolutely true. This can be done by

driving in wood wedges between the pulley and the shaft. If the face is not smooth, a light cut can be taken while the pulley is in place, or coarse sandpaper can be used. If just ordinary care is taken, good serviceable pulleys can be made, even though they may look a bit more clumsy than those purchased of a regular manufacturer.

### Automobile-Radiator Cover for Winter

The owner of an automobile, having almost constant use for his car, desired to have some arrangement for a

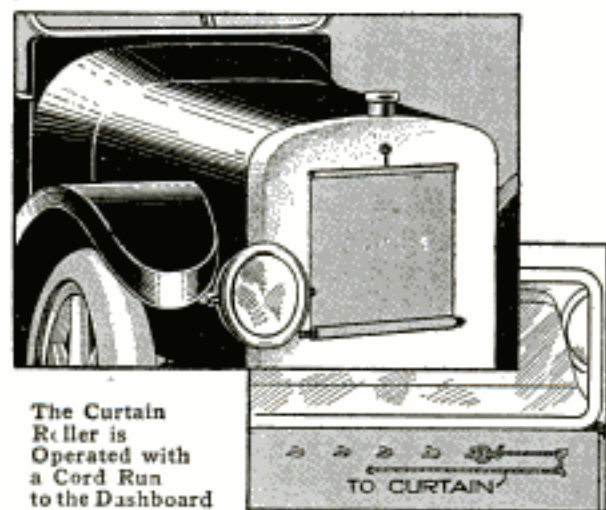

The Curtain Roller is Operated with a Cord Run to the Dashboard

radiator cover that could be regulated from the driver's seat so that, in going against the wind, very little air should be admitted to the radiator, and when turning with the wind, it could be changed without stopping and getting out of the car. A short curtain roller, with its attachments, was procured and fastened over the open space in the radiator covering. A piece of the same material as used for the covering was attached to the curtain roller as a curtain, and a cord was fastened to the stick at the bottom.

The cord was passed through eyelets set to run it through the dashboard, where a ring was tied to its end. Hooks were screwed into the dashboard at various points over which the ring is slipped in making the curtain adjustments. It is only necessary to give attention to the cord end, when turning toward or with a brisk cold

wind, to regulate the proper amount of air for cooling the radiator.

### Lifting Microscopic Cover Glasses

To lift the very thin microscopic cover glasses in research work one person employs a device as follows: The device consists of a small brass tube about the size of a lead pencil, with a brass plate on one end, having a hole in its center, and a rubber bulb on the other—one taken from a medicine dropper. To lift one of these delicate glasses it is only necessary to moisten the surface of the brass plate, press the rubber bulb and then press the brass plate upon the glass. The suction holds it in place until released by pressing the bulb.

### Storing Sulphuric Acid

Sulphuric acid that is kept for any length of time in bottles not having a glass stopper, will become blackened by particles of carbon and organic matter resulting from contact of the acid with the cork, which will be quickly destroyed. The acid should be kept in glass-stoppered bottles. However, the blackened acid need not be thrown away, as it will do very well for charging batteries, and for many other purposes where extreme purity is not essential.

### Repairing a Broken Spirit-Level Bulb

A carpenter accidentally broke his spirit level and not being able to purchase a new glass and being sorely in need of a level, he repaired it in the following manner: The glass being broken on one end, the tube was filled with alcohol and then the opening sealed with sealing wax. The glass was put back in the frame and adjusted, and it worked as well as before.

⚠ Keep all automobile electric globes screwed tightly in their sockets to prevent the breaking of the filaments by sudden jars.



## A Musical Doorbell

By H. MARCELLE

*A. M. 7-781*

**I**N the construction of this doorbell it is best to purchase a small instrument known as the "tubaphone." It consists of a rack with several pieces of brass tubing cut to different lengths to give the proper tones as they are struck. Such an instrument with eight tubes will play almost any tune, and can be purchased from 50 cents up, depending on the size. Brass tubes can be purchased, cut, and toned, but the time taken in doing this is worth more than the price of the instrument, and no changes are necessary in it to make the doorbell.

Several strips of pine, 2 in. wide and  $\frac{7}{8}$  in. thick, are procured for the framework. The tubes are placed on a table top, 1 in. apart and with their lower ends on a line at right angles to their length.

additional material to fasten on the ends of two uprights, which are cut long enough to admit the longest tube and allow sufficient room for a large roller and space at the top to swing the tubes.

A base is cut from a board,  $\frac{7}{8}$  in. thick and of sufficient size to admit the roller and tube rack, together with a small battery motor. The tube rack is fastened to the back of this base by making a tenon on the lower end of each upright, and a mortise in the base-board to receive it.

A roller is turned from a piece of soft pine, large enough to provide room on its surface for a number of horizontal lines equal to the number of notes in the composition to be played. These lines should not be

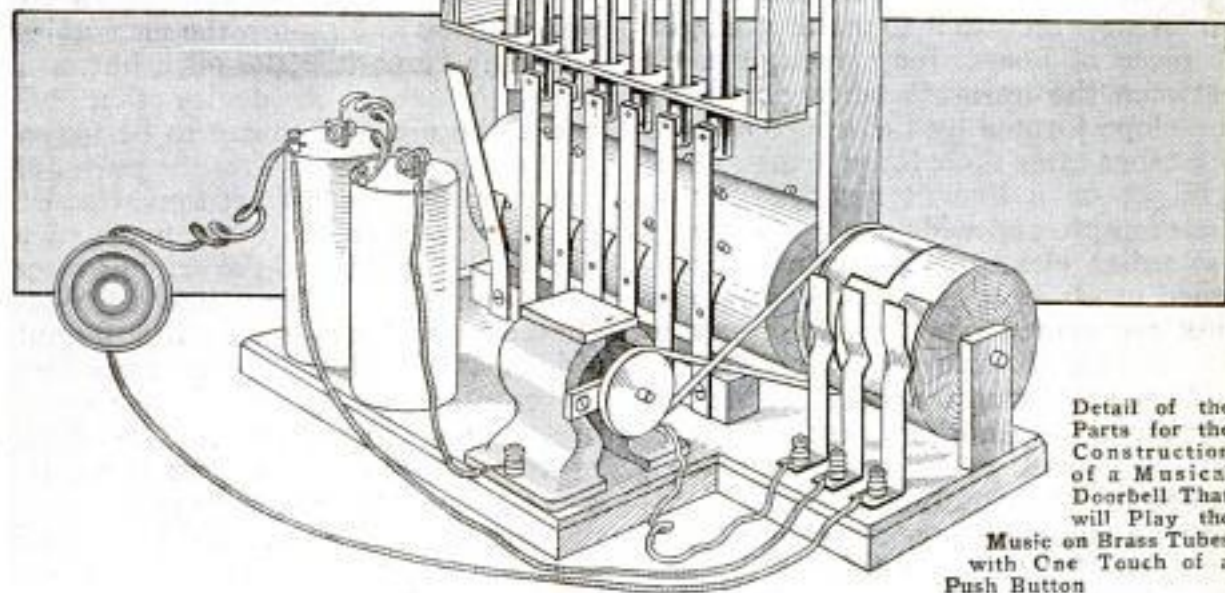

Detail of the Parts for the Construction of a Musical Doorbell That will Play the Music on Brass Tubes with One Touch of a Push Button

Allow a space of 1 in. outside the first and last tube, and cut a piece of the wood to this length, allowing sufficient

too close together. Supposing the music it is desired to play has 15 notes in its composition, then 15 horizontal

lines must be spaced evenly on the surface of the roller. The length of the roller should be a free-working fit between the uprights. A  $\frac{1}{4}$ -in. steel rod is run through its center for a shaft,

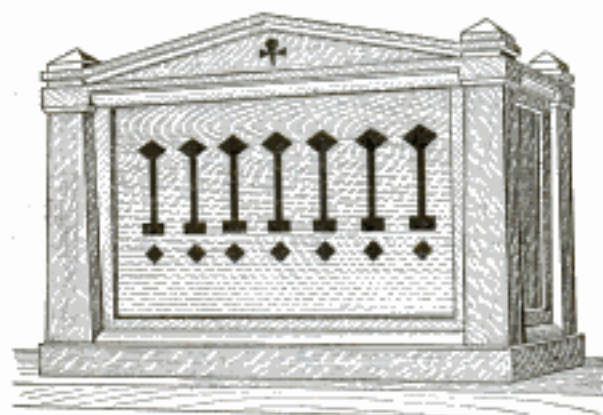

The Appearance of the Doorbell Is That of a Mission Clock on a Mantel

allowing sufficient ends for the bearings, and, in addition, at one end sufficient length for a pulley.

The motor is lined up on the base, so that its pulley wheel will run a belt on the large wheel of the roller. The current is turned on after making belt and wiring connections, a lead pencil is held directly centering the place where each tube hangs, and a line is drawn on the circumference of the roller.

A  $\frac{1}{8}$ -in. hole is drilled through each tube, near one end, and a piece of cat-gut string run into it to make a hanger. A piece of board, long enough to fit between the uprights when placed on the slope formed by the upper ends of the tubes after their lower ends are set straight on a line at right angles to their length, and wide enough to swing the tubes clear of the frame, is fastened in place, as shown. Small screw eyes are turned into the under side of this board, at even spacings of 1 in., and used to swing the tubes by the cat-gut strings. Another piece of board, the same width as the former, is placed, perfectly horizontal, between the uprights a short distance above the lower ends of the hanging tubes. Evenly spaced holes are bored in this cross-piece to admit the ends of the tubes. The holes should be of such size that when they are lined with a piece of felt,

the tubes will have a little play without touching the sides at any point.

The hammers are each made of a strip of sheet brass, having a length that will extend from the base to a short distance above the lower ends of the tubes. A hole is drilled in each end of the strip, the lower one being of a size to fasten it to the base cross-piece with a round-head wood screw. The hole in the upper end is used to fasten a small block of wood with a screw, for the hammer head. A small strip of felt is glued to the striking side of the block. Another piece of brass, used for a trip, is fastened to the center part of each long piece with rivets, so that its upper end will be near the center of the roller for height, and strike the end of a small peg driven into the roller. The length of these pieces, in fact, of all pieces, will depend on the length of the tubes in the tubaphone and the size roller required for the music.

The setting of the pegs in the roller requires some patience in order to get the tune correct, but one mistake will be of more value than an hour's description. The pegs can be procured from a shoemaker. If the roller is of pine, they can be driven into the wood of the roller with a hammer.

With ordinary connections to the push button and motor, the mechanism will only run while the push button is being pressed. A device that will cause the piece of music to be played through to the finish after the push button is pushed for a short time, consists of a turned piece of wood fastened to the outside surface of the driving wheel on the roller. This piece of wood should be carefully set, so that its outside surface will be true as it revolves. Three brushes, made of copper strips, are fastened to the base. The length of these brushes will depend on the size of the roller and height of the block of wood. They should be evenly spaced and fastened, so that they will be insulated from each other. One strip of brass, or copper, is fastened around the turned piece of wood. This strip must be as wide as two brushes,



except for a short distance to make a break in the electrical circuit. The notch in the strip, to make this break, should be on the outside edge where it will disconnect the center brush, and its location on the turned piece of wood should be on a line with the end and the beginning of the pegs for the music. Another short strip is fastened to the turned piece of wood, where it will make a contact with the first brush when the second or middle brush is in the notch, or disconnected, and is connected to the other notched strip with a piece of wire run beneath the wood.

The wiring shown will make it possible to start the motor with the push button which will turn the roll far enough to connect the center brush; then the roller will turn until the music is played, at which point it will stop and remain in rest until the push button again makes the contact.

The entire mechanism can be made to set on the mantel or shelf, incased like a mission clock, and the wires running to it may be concealed.

### Replacing Buckle Tongues

Having several buckles without tongues I tried to repair them with pieces of wire, but could not get them to bend short enough to fasten around the buckle frame. Some cotters were at hand and seeing them gave me the idea of using one leg, with the eye part, as a tongue.

By using the proper-sized cotter, a substantial and quickly made repair will be the result.—Contributed by Everett Hoar, Bowmanville, Ont.

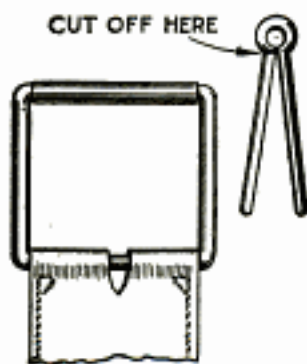

☞ Bread crumbs thoroughly rubbed over a pencil drawing will remove most of the dirt and without disturbing the pencil lines.

### Drying Towels in Photographer's Dark Room

In doing a large amount of photographic work the towel becomes wet, and to dry the hands on it is impos-



An Electric Globe Makes Heat in the Spool for Drying a Portion of the Towel

sible. To obviate this annoyance, I made a galvanized-iron pipe, about 2 ft. long and 8 in. in diameter, with a disk, or circular piece, of metal about 10 in. in diameter soldered on each end to form flanges. One flange was fastened to the wall of the dark room in a convenient place to support the device. On the inside of the spool, or towel support, an ordinary incandescent electric globe was placed. The heat of the lamp would easily dry 12 in. of the towel, and when the dry part was pulled down for use another wet portion was brought into position for drying.

Those who have tried to handle gelatin dry plates with moist hands will readily appreciate the value of this simple contrivance. The lamp in the spool is connected on the switch with the ruby light, so that it is not forgotten, when leaving the room, to turn it out.—Contributed by T. B. Lambert, Chicago.

### A Combination Electrically Operated Door Lock

The illustration shows a very useful application of an ordinary electric door lock in the construction of a combina-

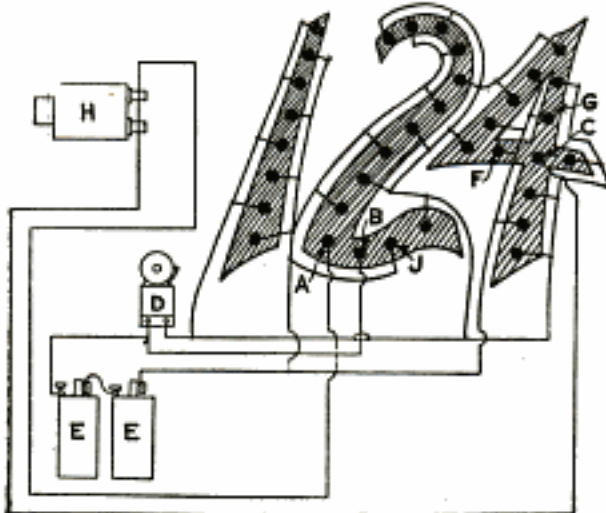

The Brass-Tack Heads Holding the Numerals in Place Constitute the Combination Points

tion lock and alarm to be operated from the outside of the building.

The three numerals, 1, 2, and 4, or any other combination of numbers constituting the house number on a door, are made of some kind of insulating material and fastened in place on a base of insulating fiber, or wood, about  $\frac{1}{4}$  in. thick, by means of ordinary brass-headed tacks, as indicated by the black dots. The tacks will extend through the base a short distance so the electrical connections may be made by soldering wires to them, as shown by the diagram, alternate tacks being connected together with the exception of three; for instance, A, B, and C.

The terminals of the leads that are connected to alternate tacks are in turn connected to the terminals of a circuit composed of an ordinary vibrating bell, D, and battery, E. If any two adjacent tack heads be connected together, except tacks A, B, and C, the bell circuit will be completed and the bell ring, which will serve as an indication that some one is tampering with the circuit. The person knowing the combination, connects the tack heads A and B, and at the same time connects the tack head C with F or G, or any

other tack head that is connected to the plus side of the battery, whereby a circuit will be completed through the lock H and the door is opened. Any metallic substance, such as a knife, key, or finger ring, may be used in making the above indicated connection, and there will be no need of carrying a key for this particular door so long as the combination is known.

The base upon which the numbers are mounted and through which the points of the tacks protrude, should be mounted on a second base that has a recess cut in its surface to accommodate the wires and points of the tacks.

The combination may be made more or less complicated, as desired, by connecting the tacks in different ways, and by using a separate battery for the bell and lock. The circuit leading to the door lock, if there is one already installed, may be used and then no extra circuit is needed.

Such a device has been used on a private-desk drawer with entire satisfaction. The battery was placed in the back end of the drawer, and if it happened to fail, a new one could be connected to the points B and J so that the drawer could be opened and a new battery put in.

### Lock for a Fancy Hairpin

To avoid losing a fancy hairpin, bend one leg of the pin as shown in the illustration. The hair caught in the notch



The Bend in the Pin will Hold in the Hair and Prevent the Loss of the Pin

formed by the bend will prevent the pin from dropping out.—Contributed by W. C. Loy, Rochester, Ind.

CA metal surface polished with oil will keep clean longer than when polished dry.

## Trick Bottles and Glasses

BY GEORGE W. CATLIN

The performer presents to his audience two pasteboard covers, one bottle and one glass. Saying that he

press by using a round copper tube, with fine emery applied to its end, as a drill. The hole should be so placed



Under Each Cover Used Is a Bottle and Glass, and by Pinching the Cover the Bottle is Made to Rise with It, Thus Leaving the Glass in View

wishes to secure the safety of the bottle and glass, he places covers over them, cautioning the audience to note carefully which cover incloses the glass and which the bottle. Then he says that, to prevent any misunderstanding as to their positions, it is desired the audience designate which cover holds the glass. The response will be unanimous, "the left" or "the right" as the case may be, but on raising that cover the bottle is exposed. Covering the bottle again, and asking the audience if they were quite sure that their eyes did not deceive them, he states that the glass is really under the cover just lifted and returned to its place. To prove it, the cover is lifted again, to show the glass this time. The changing can be done as often as desired, or will amuse the crowd.

The secret of the trick consists in the use of two covers, two bottles and two glasses, and the manner of performing it is as follows: The bottles are bottomless and of such size as to admit the glass without sticking. A round hole is cut in one side of each bottle, about  $2\frac{1}{2}$  in. above the bottom. This can be accomplished in a drill

that a finger will strike the top of the glass when both bottle and glass are set on the same surface. If dark-colored bottles are used, a false bottom can be made and fitted in each bottle above the upper edge of the glass. This bottom can be cemented in place and made liquid-tight, so that some wine may be placed in the bottle and poured into the opposite glass to show that it holds liquid. In doing this part of the trick, make no more changes with the wine in one glass.

Under each cover is a bottle and tumbler, and by pinching the cover, the bottle is made to rise with it, thus leaving the tumbler in view. When it is necessary to show the bottle, just raise the cover, and the bottle covers the glass. When the bottle is lifted from the table, the thumb is inserted in the hole to press the tumbler against the opposite side, where it is held and raised with the bottle. Be sure to keep the side of the bottles with the hole back and away from the audience.

It will be seen that it matters not which cover is mentioned; the performer can show just the article he desires.

### Stretching a Curtain without a Frame

A good way to avoid using the ordinary four-pole curtain stretcher is to make use of the following method.

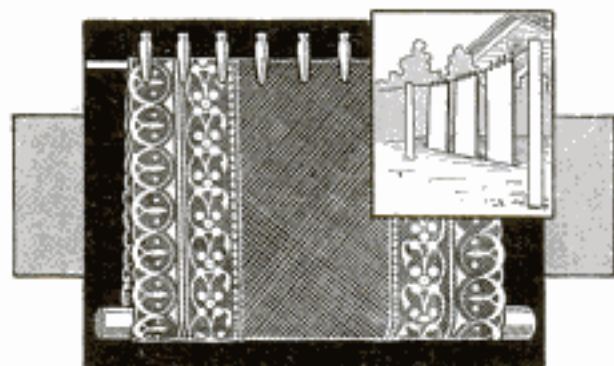

A Lace Curtain Hung Double on a Line with a Pole Inserted in the Fold

Take the lace curtain and fold it once lengthwise; then pin it up on a tightly stretched line with a large number of clothespins, and slip a clean pole between the two sides to keep it taut. This method not only stretches the curtain satisfactorily, but saves considerable time otherwise required in pinning the curtain to the four-sided frame.—Contributed by H. Wynning, Chicago, Ill.

### Welding Small Resistance-Wire Connections

In making connections, especially in electrical heating devices subject to high temperatures, it is out of the question to use solder, since the temperature reached in the device would cause

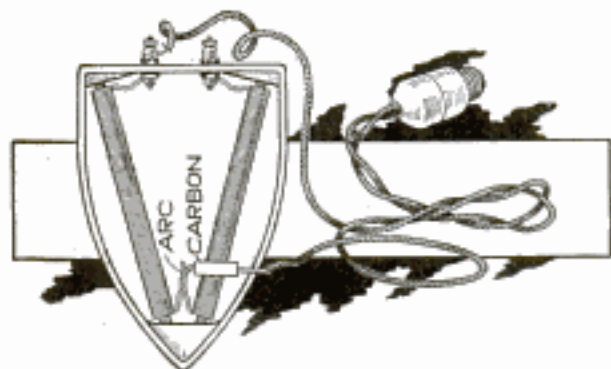

An Arc is Formed with a Piece of Carbon, to Weld the Twisted Ends of Wire Together

the solder to melt and run out. A convenient arrangement for welding the connections of flatirons, or any other

fine wires, is shown in the illustration. The ends of the wires to be welded are twisted together, and the weld is completed by forming an arc, one electrode of which is the twisted connection and the other a piece of carbon. The resistance of the heating unit in the iron is sufficient to limit the amount of the current flow so that a short circuit does not result.—Contributed by G. Irving Davis, Albany, N. Y.

### Bench with Folding Seats

To provide a bench with seats, or shelves, which cannot easily be taken away unless the table is brought along, hinged brackets are attached to stationary crosspieces, which are fastened



Bench, or Table, with a Seat on Each Side That can be Folded for Carrying Purposes

on the extended end braces of the table. When in use, the brackets are turned down, thereby providing a rigid support for anything that may be put on them. If it is desirable to have the brackets out of the way, as when carrying the bench, it is only necessary to fold them up.—Contributed by J. M. Kane, Doylestown, Pa.

### Rim of Wire Wastebasket Wrapped with Felt

In offices where wire wastebaskets are used, the finish of the desks is often marred by the top rim of the baskets rubbing against them. This can be overcome by wrapping strips of felt around the rim to form a buffer.—Contributed by Miss F. D. Schweiger, Kansas City, Mo.

## Fishing-Rod Making and Angling

BY STILLMAN TAYLOR

Box 472 Deep River  
Conn.

## PART I—A One-Piece Casting Rod

**T**HE pleasures of outdoor life are most keenly enjoyed by those sportsmen who are familiar with all the little tricks—the “ins and outs”—of the open. It is the active participation in any chosen sport which makes the sport well worth while, for the enjoyment gleaned from little journeys to forest and stream largely rests with the outer's own knowledge of his sport. Not all of the fun of fishing lies in the catching of the fish, since the satisfaction which comes through handling a well-balanced rod and tackle must be reckoned the chief contributor to the outing. In other words, the pleasures of fishing do not depend so much upon the number of fish caught, as the manner in which the person fishes for them. The rod is naturally the first and important consideration in the angler's kit, and it is the purpose of these articles to set forth, at first, a few hints which my own long experience leads me to think may be of some assistance to those anglers who enjoy making and repairing their own rods and tackle, to be followed, later, by some suggestions on the art of angling generally. The hints given are merely my own methods, and while they may not be the best way of accomplishing the desired end, a good fishing rod may be constructed. Like the majority of amateurs, I have achieved the desired results with a few common tools, namely, a saw, plane, jackknife, file, and sandpaper. These simple tools are really all that is needed to turn out a serviceable and well-finished rod of excellent action.

**Kind of Material**

The great elasticity and durability of the split-cane or split-bamboo rod cannot be easily disputed. The hand-made split bamboo is unquestionably the best rod for every kind of fishing, but it is also the most expensive and the most difficult material for the amateur to work. In making the first rod or two, the beginner will be better sat-

isfied with the results in making a good solid-wood rod. Of course, glued-up split-bamboo butts, joints, and tip stock may be purchased, and if the angler is determined to have only bamboo, it is advisable to purchase these built-up sections rather than to risk certain failure by attempting to glue the cane. However, there are several good woods particularly well adapted for rod making, and while slightly inferior to the finest bamboo in elasticity and spring, the carefully made solid-wood rod is good enough for any angler and will probably suit the average fisherman as well as any rod that can be purchased.

Bethabara, or washaba, a native wood of British Guinea, makes a fine rod, but it is a heavy wood, very hard, and for this reason is perhaps less desirable than all other woods. With the single exception of snakewood it is the heaviest wood for rod making and is only used for short bait-casting rods. Possessing considerable strength Bethabara can be worked quite slender, and a 5-ft. casting tip can be safely made of 5 oz. weight.

Greenheart, a South American wood, is popular alike with manufacturers and amateur rod makers, and 90 per cent of the better class of solid-wood rods are made of this material. It resembles Bethabara in color, but is lighter in weight, although it apparently possesses about the same strength and elasticity. In point of fact, there is little, if any, choice between these woods, and providing sound and well-selected wood is used, the merits of a rod made of Bethabara or greenheart are more likely to be due to the careful workmanship of the maker than to the variety of the wood used.

Dagame, or dagama, a native of the forests of Cuba, is in many respects the ideal material for rod making, as it has strength and elasticity. This wood is straight-grained and free from

knots, which makes it easily worked; it polishes well and is durable. While there is always more or less difficulty about procuring first-class Bethabara

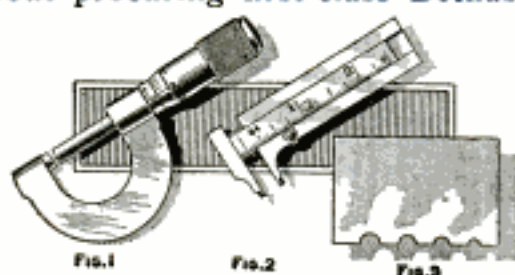

Two Tools for Gauging the Diameter of the Rods, and a Homemade Scraper

and greenheart, dagame of good quality is easily obtained.

Lancewood is much used in turning out the cheaper grades of fishing rods, but it is somewhat soft and has a marked tendency to take set under the strain of fishing and warp out of shape. It is less expensive than the other woods, and while it has a straight and even grain, there are numerous small knots present which make this material less satisfactory to work than the other woods. For heavy sea rods, lancewood may serve the purpose fairly well, but for the smaller fishing tools this material is inferior to Bethabara, greenheart, and dagame. Other woods are often used, and while a good rod may be frequently made from almost any of them, the three mentioned are held in the highest esteem by the angling fraternity. For the first rod, the amateur will make no mistake in selecting dagame, whether the slender fly rod or the more easily constructed short bait-casting tool is to be made.

#### The Necessary Tools

The construction of a thoroughly well-made and nicely balanced rod is more a matter of careful work than outfit, but a few suitable tools will greatly facilitate the labor. A good firm workbench, or table, 4 ft. or more in length, will be needed. A regulation bench vise will come in handy, but one of the small iron vises will do very well. A couple of iron planes, one of medium size for rough planing-up work, and a small 4-in. block plane for finishing, will be required. As the cut-

ters of the planes must be kept as sharp as possible to do good work, a small oilstone—preferably one in a wood case with cover to keep out dust—will be needed; a coarse single-cut mill file about 16 in. long; a few sheets of No. 1 and No. 0 sandpaper; a sheet or two of fine emery cloth; a small thin "back" or other saw, and a steel cabinet scraper.

A caliper of some kind is a necessity, and while the best is a micrometer, Fig. 1, registering to a thousandth part of an inch, as well as indicating 8ths, 16ths, 32ds, and 64ths, this tool is somewhat expensive, but a very good caliper may be had in the sliding-arm type, Fig. 2, with the scale graduated to 64ths and taking work up to 2 in. in diameter. Cheaper measuring gauges are to be had in plenty, but as the brass and boxwood scales are provided only with coarse graduations, the better quality of mechanics' tools will give better satisfaction.

The set of grooved planes used by the professional rod makers are rather expensive, although they are most convenient for quickly rounding up the rod to the desired diameter. However, the beginner may dispense with the planes by making the tool illustrated in Fig. 3. To make this handy little tool purchase a steel wood scraper, such as cabinetmakers use, and file a series of grooves along the edges with a round file. File at right angles to the steel, finishing up with a finer file to give a

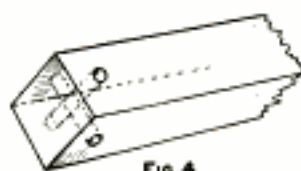

Fig. 4

sharp cutting edge. The tool thus made is very handy for scraping the rod after it has been roughly rounded

with the plane. Its use will be mentioned later on in the description.

#### Five-Foot Bait-Casting Rod

The short one-piece bait-casting rod with but one ferrule is the easiest rod to make, and for this reason the beginner will do well to select this popular type for the first attempt. As the total length of the rod is to measure

5 ft., exclusive of the agate tip, the wood should be 1 or 2 in. longer to allow for cutting down to 60 inches.

Having selected a good strip of

grasp distance by running a knife mark around the rod 12 in. from the butt end.

Lay out a diagram showing the full length of the rod by placing a strip of

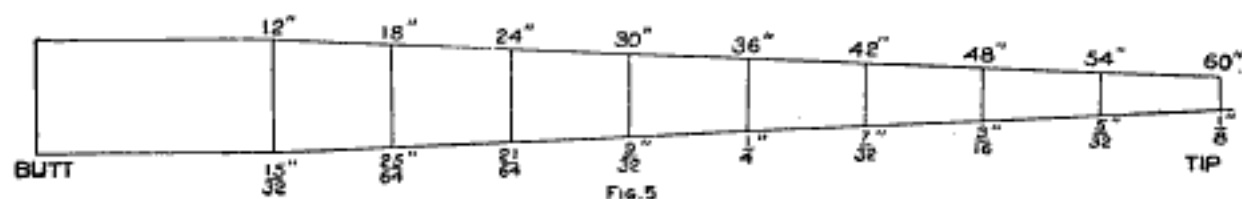

Diagram or Layout for a One-Piece Bait-Casting Rod, Showing Calipered Dimensions for Each Six Inches of Length. A Paper Pattern of Any Rod may be Drawn Up, Providing the Amateur Rod Maker Has a Rod to Use for a Pattern, or Possesses the Exact Diameter of the Rod at Intervals of Six Inches along Its Length

dagame,  $\frac{5}{8}$  in. square, run the plane along each side and from both ends. This will determine the direction in which the grain runs. Drill two holes at the end decided upon for the butt, spacing them about  $\frac{1}{4}$  in. from the end, as shown in Fig. 4. Drive a stout brad in the corner of the bench top and hook the butt end over the nail. By rigging the stick up in this manner it will be securely held, and planing may be done with the grain with greater ease and accuracy than when the end of the stick is butted up against a cleat nailed to the bench top.

The wood should be planed straight and true from end to end and calipered until it is  $\frac{1}{2}$  in. square. It may appear crooked, but this need not trouble one at this stage of the work, since it may be made perfectly straight later on. Overlook any kinks, and do not attempt to straighten the stick by planing more from one side than the other. The chief thing to be done is to fashion a square stick, and when the caliper shows the approximate diameter, draw crosslines at the ends to find the center.

The length of the hand grasp should be marked out. If a double grasp is wanted, allow 12 in. from the butt end. This will afford an 11-in. hand grasp after sawing off the end in which the holes were drilled. For a single hand grasp make an allowance of 11 in. However, the double grasp—with cork above and below the reel seat—is preferred by most anglers because it affords a better grip for the hand when reeling in the line. Mark the hand-

paper—the unprinted back of a strip of wall paper is just the thing—on the bench and drawing two lines from the diameter of the butt to that of the tip. While the caliber of casting rods differs somewhat, the dimensions given will suit the average angler, and I would advise the beginner to make the rod to these measurements. For the butt, draw a line, exactly  $\frac{1}{2}$  in. long, across the paper and from the center of this line run a straight pencil mark at right angles to the tip end, or 60 in. distant, at which point another crossline is drawn, exactly  $\frac{1}{8}$  in. long, to represent the diameter. Connect the ends of these two crosslines to make a long tapering form. Divide this pattern into eight equal parts, beginning at 12 in. from the butt end, marking a crossline at every 6 in. This layout is shown exaggerated in Fig. 5. If it is desired to copy a certain rod, find the diameter at the several 6-in. stations with the caliper and write them down at the corresponding sections of the paper diagram. However, if a splendid all-around casting



Gauge Made of Sheet Brass Having Slots Corresponding in Length and Width with the Caliper-Layout Measurements

rod is desired, it is perfectly safe to follow the dimensions given in Fig. 5, which show the manner of dividing the paper pattern into the equal parts and the final diameter of the rod at each 6-in. station, or line.

Procure a small strip of thin brass, or zinc, and file nine slots on one edge to correspond in diameter with the width of the horizontal lines which indicate the diameter of the rod on the pattern. This piece is shown in Fig. 6. By making use of the pattern and the brass gauge, the rod may be given the desired taper and the work will proceed more quickly than if the caliper is alone relied upon to repeatedly check up the work.

When a good layout of the work is thus made, the next step is to carefully plane the stick so that it will be evenly tapered in the square. Plane with the grain and from the butt toward the tip end, and make frequent tests with caliper and gauge, noting the diameter every 6 in. Mark all the thick spots with a pencil, and plane lightly to reduce the wood to the proper diameter. Reduce the stick in this manner until all sides have an even taper from the butt to the tip. The stick should now be perfectly square with a nice, even taper. Test it by resting the tip end on the floor and bending it from the butt end. Note the arch it takes and see if it resumes its original shape when the pressure is released. If it does, the elasticity of the material is as it should be, but if it remains bent or takes "set," the wood is very likely to be imperfectly seasoned and the rod should be hung up in a warm closet, or near the kitchen stove, for a few weeks, to season.

To facilitate the work of planing the stick to shape, a length of pine board with a groove in one edge will be found handy. A 5-ft. length of the ordinary tongue-and-groove board, about 1 in. thick, will be just the thing. As the tip of the rod is smaller than the butt, plane the groove in the board to make it gradually shallower to correspond to the taper of the rod. Nail this board, with the groove uppermost, to the edge of the workbench, and place the rod in the groove with one of the square corners up, which can be easily taken off with the finely set plane. Plane off the other three corners in a like manner, transforming

the square stick into one of octagon form. This part of the work should be carefully done, and the stick frequently calipered at each 6-in. mark, to obtain the proper taper. It is important to make each of the eight sides as nearly uniform as the caliper and eye can do it. Set the cutter of the small plane very fine, lay the strip in the groove and plane off the corner the full length of the stick, then turn another corner uppermost and plane it off, and so on, until the stick is almost round and tapering gradually from the mark of the hand grasp to the tip.

To make the rod perfectly round, use the steel scraper in which the grooves were filed and scrape the whole rod to remove any flat or uneven spots, and finish up by sandpapering it down smooth.

The action of the rod differs with the material used, and in trying out the action, it is well to tie on the tip and guides and affix the reel by a string in order to try a few casts. If the action seems about right, give the rod a final smoothing down with No. 0 sandpaper.

For the hand grasp nothing is so good as solid cork, and while hand grasps may be purchased assembled, it is a simple matter to make them. In Fig. 7 are shown four kinds of handles, namely, a wood sleeve, or core, A, bored to fit the butt of the rod and shaped for winding the fishing cord; a built-up cork grasp, B, made by cementing cork washers over a wood sleeve, or directly to the butt of the rod; a cane-wound grip, C, mostly used for salt-water fishing, and the double-wound grip, D, made in one piece, then sawed apart in the center, the forward grip being glued in place after the reel seat is in position.

To make a grip, select a number of cork washers, which may be obtained from dealers in the wholesale drug trade, or from any large fishing-tackle dealer. Make a tool for cutting a hole in their centers from a piece of tubing, or an old ferrule of the required diameter, by filing one edge sharp, then cov-



ering the other end with several thicknesses of cloth. Turn this tube around in the cork like a wad cutter. If the cutter is sharp, a nice clean cut will result, but the opposite will likely oc-

and force the sleeve tightly in place. A day or two should be allowed for the glue to set and thoroughly dry, before giving the hand grasp the final touches.

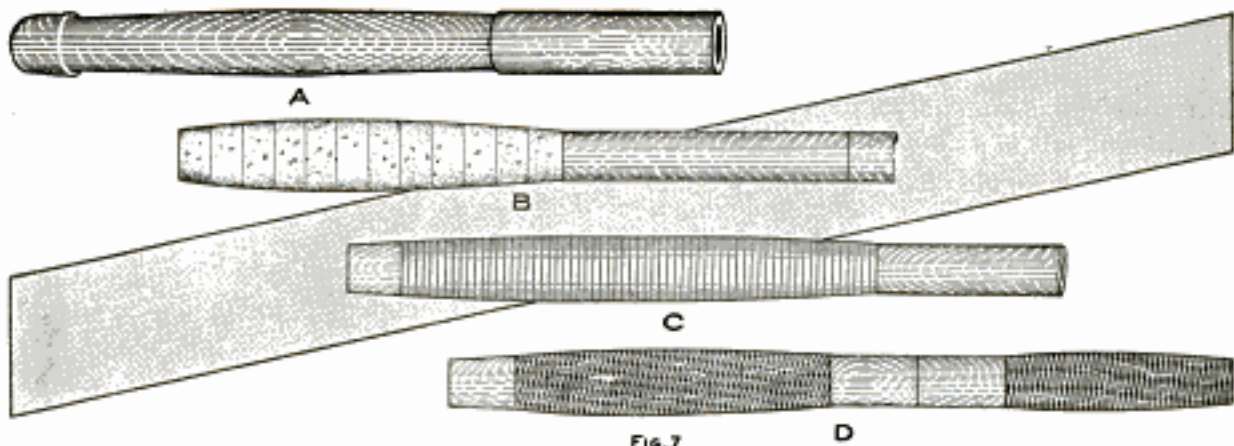

FIG. 7  
The Four Different Types of Hand Grasps Are a Wood Sleeve Bored to Fit the Butt of the Rod; the Built-Up Cork over a Wood Sleeve; a Cane-Wound Grasp, and the Double Cord-Wound Grasps with a Reel Seat between Them

cur if an attempt is made to hammer the tube through the cork.

Having cut the butt end of the rod off square, about 1 in. from the end, or enough to remove the holes, smear a little hot glue on the end, drop a cork washer over the tip of the rod and work it down to the butt. Cut another cork, give the first one a coat of glue, slip the former over the tip and press the two together, and so on, until about 10 corks have been glued together in position. This will give a hand grasp a trifle over 5 in. long.

A sleeve will be needed for the reel seat to slip over, and a soft-wood core of this sort can be purchased from any dealer in rod-making materials, or it can be made at home. For the material procure a piece of white pine, about  $\frac{3}{4}$  in. in diameter and 5 in. long. A section sawed from a discarded curtain roller will serve the purpose well. Bore a  $\frac{1}{2}$ -in. hole through the piece and plane down the outside until it slips inside the reel seat. It should be well made and a good fit, and one end tapered to fit the taper of the reel seat, while the opposite end should be about  $\frac{1}{4}$  in. shorter than the reel seat. Slide this wood sleeve down the rod, as shown in Fig. 8, coat the rod and the upper part of the last cork with glue

If a lathe is at hand, the hand grasp may be turned to any desired shape, but most anglers prefer a cylindrical-shaped grip, leaving the top cork untrimmed to form a kind of shoulder when the metal reel seat is pressed into the cork. If corks of  $1\frac{1}{4}$ -in. diameter are purchased, but little trimming will be necessary to work the hand grasp down to  $1\frac{1}{8}$  in. in diameter. This size seems to fit the average hand about right. The lower corks will need a little trimming to fit the taper of the butt cap so that it may fit snugly in place. Cement the butt cap in place by heating the cap moderately hot, then rub a little of the melted ferrule cement inside the cap, and force it over the cork butt. When the cement has hardened, drive a small brass pin or

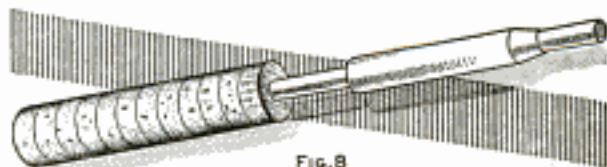

FIG. 8  
The Corks Glued in Place on the Butt and the Wood Sleeve, or Reel-Seat Core, Ready to Slide Down and Glue in Position

brad through the cap, and file the ends off flush with the metal surface. All the guides, ferrules, and reel seat are shown in Fig. 9.

The regulation metal reel seat is about  $4\frac{1}{2}$  in. long, and in fitting it to the old type of bait rod, the covered hood is affixed to the upper end of the reel seat. This arrangement is satisfactory enough for the 9-ft. bait rod, but it is rather awkward in fitting it to the short bait-casting rod, as with the hood at the upper end the reel is pushed so far forward that it leaves 1 in. or more of the reel seat exposed, and the hand must grip this smooth metal instead of the cork. To avoid this, it is best to cut the reel seat down to  $3\frac{7}{8}$  in. and affix the reel seat to the rod with the hood at the lower end near the hand. For a single hand grasp, a tapered winding check will be needed to make a neat finish and this should be ordered of the correct diameter to fit the reel seat at the lower end and the diameter of the rod at the other. In the double hand grasp the winding check is used to finish off the upper end of the cork, which is tapering to fit the rod at this point.

In assembling the reel seat, push it with the hooded end well down and work it into the cork to make a tight waterproof joint. Push the reel seat up the rod, coat the sleeve with cement and push the reel seat home. Drive a small pin through the hooded end and reel seat to make the whole rigid. This pin should not be driven through the rod or it will weaken it at this point. Just let it enter the wood a short distance to prevent the reel seat from turning.

The upper or double grasp is fashioned after the reel seat is in position, and the corks are cemented on and pushed tightly together in the same manner as used in forming the lower grasp. The first cork should be pressed tightly against the upper end of the reel seat and turned about so that the metal may enter the cork and form a tight joint. As many corks as are required to form a grip of proper length are in turn cemented to each other and the rod. After the glue has become dry, the cork may be worked down and tapered to make a smooth, swelled grasp. The winding check is now ce-

mented on, to make a neat finish between the upper grip and the rod.

Before affixing the guides, go over the rod with fine sandpaper, then wet the wood to raise the grain, and repeat this operation, using old sandpaper. If an extra-fine polish is wanted, rub it down with powdered pumice and oil, or rottenstone and oil, and finish off with an oiled rag.

To fit the agate tip, file down the end of the rod with a fine-cut file until it is a good fit in the metal tube. Melt a little of the ferrule cement and smear a little on the tip of the rod, then push the agate down in place.

Spar varnish is often used to protect the rod, but extra-light coach varnish gives a better gloss, and it is as durable and waterproof as any varnish. It is only necessary to purchase a quarter pint of the varnish, as a very small quantity is used. The final varnishing is, of course, done after the rod has been wound and the guides are permanently whipped in position. However, it is an excellent idea to fill the pores of the wood by rubbing it over with a cloth saturated in the varnish before the silk whippings are put on. Merely fill the cells of the wood and wipe off all surplus, leaving the rod clean and smooth.

The guides may now be fastened in place, and for the 5-ft. rod, but two of them are necessary. The first guide should be placed  $19\frac{1}{2}$  in. from the metal taper which finishes off the upper hand grasp, and the second guide spaced  $15\frac{1}{2}$  in. from the first. By spacing the guides in this manner, the line will run through them with the least possible friction.

#### Winding, or Whipping, the Rod

Before whipping on the guides, take a fine file and round off the sharp edges of the base to prevent the possibility of the silk being cut. Measure off the required distances at which the guides are to be affixed, and fasten them in position by winding with a few turns of common thread. Ordinary silk of No. A size may be used, but No. 00 is the best for small rods. Most anglers

agree that the size of the silk to use for the whippings should be in proportion to the size of the rod—heavy silk

from the spool and tuck the end under the whipping by pulling on the ends of the waxed loop, as shown at G.

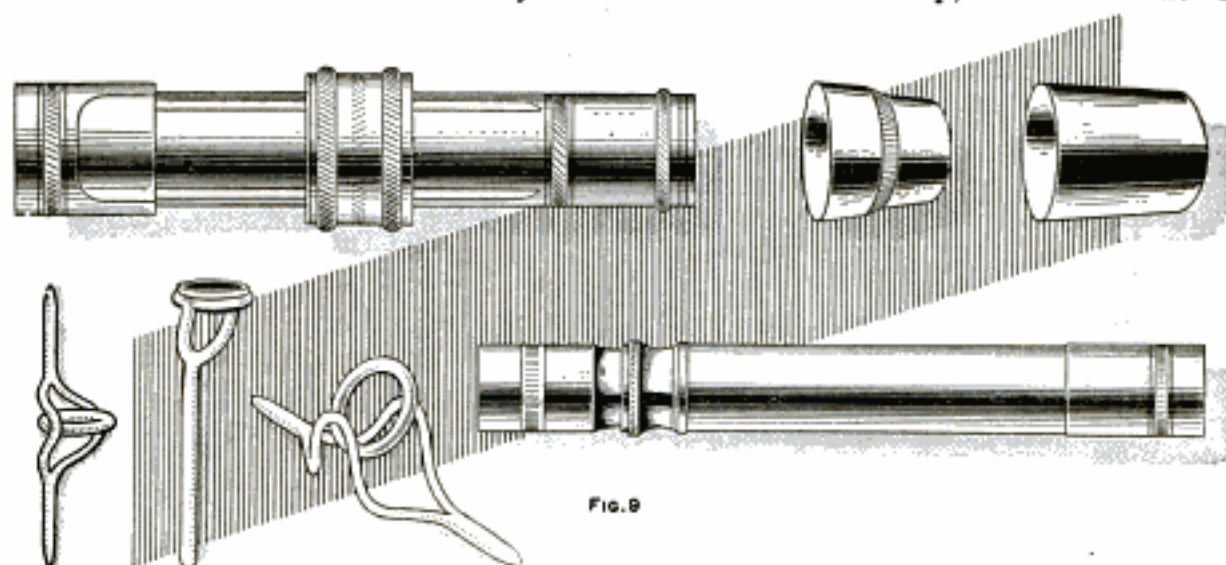

FIG. 9

The Mountings Used on a Bait-Casting Rod Consist of a Reel Seat, Butt Cap, Taper Sleeve, Narrow Agate Guide, Agate Offset Top, One Ring Guide, and a Welted, Shouldered Ferrule

for the heavy rod, and fine silk for the small rod. Size A is the finest silk commonly stocked in the stores, but one or more spools of No. 00 and No. 0 may be ordered from any large dealer in fishing tackle. As a rule, size 0 gives a more workmanlike finish to the butt and joints of fly and bait rods, while No. 00 is about right to use for winding the tips. In fact, all rods weighing up to 6 oz. may be whipped with No. 00 size.

In whipping the rod, the so-called invisible knot is used. Begin the whipping, as shown at E, Fig. 10, by tucking the end under the first coil and holding it with the left thumb. The spool of silk is held in the right hand and the rod is turned to the left, sufficient tension being kept on the silk so that it can be evenly coiled with each strand tightly against the other. A loop of silk, some 4 in. long, is well waxed and placed so that its end will project a short distance beyond the last coil which finishes the whipping. This detail is shown at F. In whipping on guides, begin the whipping at the base and work over the pointed end of the flange, winding on sufficient silk to extend about  $\frac{1}{8}$  in. beyond the pointed flange of the guide base. When the last coil is made, cut off the thread

Cut off the ends neatly with a sharp knife.

For colors, bright red and a medium shade of apple green are the best, since these colors keep their original tint after varnishing, and are less likely to fade than the more delicate shades. Red finished off with a narrow circle of green always looks well, and red with yellow is likewise a good combination. Narrow windings look much better than wide whippings, and a dozen turns make about as wide a winding as the angler desires. For edgings, three or four turns of silk are about

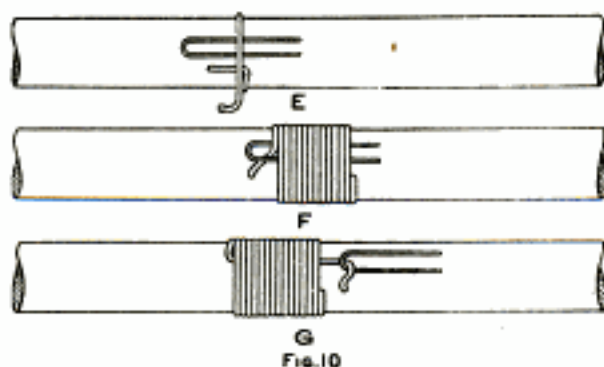

FIG. 10

Both Ends of the Silk Thread are Placed under the Winding to Form an Invisible Knot

right, and these should be put on after the wider windings have been whipped on and in the same manner, although it is best to tuck the ends of the edging

beneath the wider winding when pulling the end through to make the invisible knot.

#### Varnishing the Rod

After winding the rod, see that all fuzzy ends are neatly clipped off, then go over the silk windings with a coat of shellac. The shellac can be made by dissolving a little white shellac in grain alcohol. Warm the shellac and apply it with a small camel's-hair brush, giving the silk only two light coats. Allow the rod to stand a couple of days for the shellac to become thoroughly dry.

A small camel's-hair brush will be required for the varnishing—one about  $\frac{1}{2}$  in. wide will do. If the varnishing is to be done out of doors, a clear and warm day should be selected, and the can of coach varnish should be placed in a pot of hot water for five minutes, so that the varnish will spread evenly.

A temperature of about 75 deg. is best for this work, as the varnish will not spread if cold or in a cold place. The varnish should be evenly brushed on, and care taken that no spots are left untouched. Hang up by the tip to dry in a room free from dust. While the varnish will set in four or five hours, it is a good plan to allow three days for drying between coats. Two coats will suffice to protect the rod, but as coach varnish, properly applied, is rather thin in body, three coats will give complete protection to the wood.

The materials required for this rod are, 1 dagame or greenheart stick, 5 ft. long and  $\frac{5}{8}$  in. square; 1 reel seat with straight hood,  $\frac{3}{4}$  in.; 1 butt cap, 1 in.; 1 taper, small end  $\frac{1}{8}$  in.; 1 offset, or angle, agate top,  $\frac{3}{8}$  in., and 2 narrow agate guides,  $\frac{1}{2}$  in., all in German silver; 2 doz. corks,  $1\frac{1}{4}$  by  $1\frac{1}{8}$  in., and two 50-yd. spools of silk, red and green, 00 size.

#### Automatic Watering System for Poultry Yards

Where a large number of poultry is cared for, the annoyance and attention necessary to furnish a constant water supply can be overcome by using the system shown in the illustration. For this purpose a storage tank must be provided. This may be some old toilet flush tank, or any open reservoir that will hold sufficient water to keep all the drinking pans supplied. A float is provided and connected with a stop

valve, so that when the float drops below a certain level, the valve will be turned open, and a fresh supply of water will enter the storage tank, thereby again raising the float and closing the valve.

Each drinking pan should be about 10 in. in diameter by 4 in. deep, and is drilled for a  $\frac{7}{8}$ -in. hole to fit a  $\frac{1}{2}$ -in. pipe. At the pan end, the pipe is threaded so that a lock nut and leather washer can be attached on each side of the pan bottom, to provide a water-tight joint; at the other end, the pipe

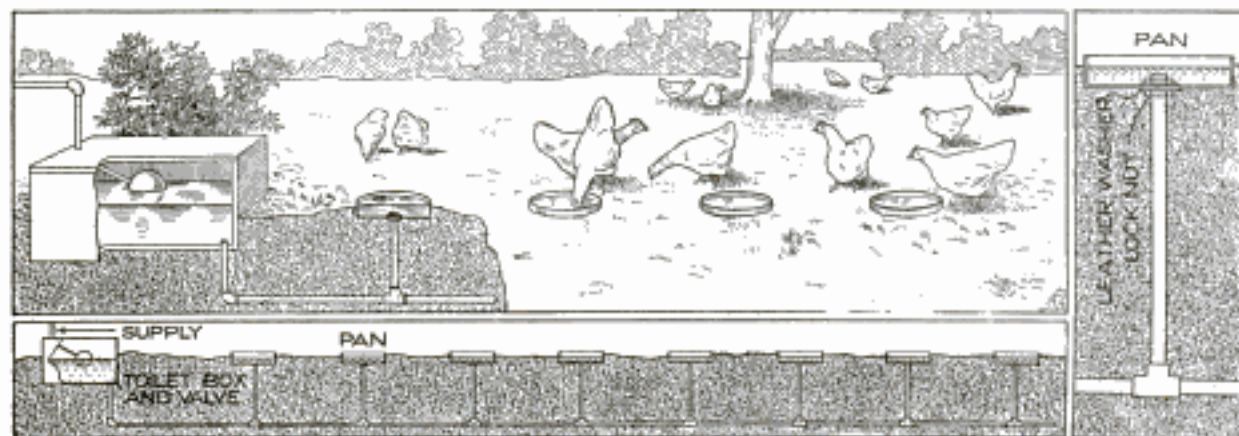

Simple Arrangement of a Flush Tank in Connection with a System of Pipes to Supply One or More Pans of Water for the Poultry Yard

is screwed into a tee in the  $\frac{1}{2}$ -in. main line which connects with the storage tank.

In using the system, sufficient water is run into the tank to fill the pans about three-quarters full. The float may then be adjusted to a shut-off position for the inlet valve. All pans are automatically kept at one level, even though several may be used considerably more than others. When the general water level has dropped sufficiently, the float, dropping with it, will open the stop valve, and cause the water to enter the tank and pans until the original level is again restored.—Contributed by D. E. Hall, Hadlyme, Connecticut.

### Changing Pip on a Card

Cut out the center pip on the five-spot of spades with a sharp knife. Cut a slot centrally in another card, about  $\frac{3}{8}$  in. wide and  $1\frac{1}{4}$  in. long. Glue the surfaces of both cards together near the edges to form a pocket for a slide, which is cut from another card and has one-half of its surface colored

black. A drop of sealing wax attached to the back of the sliding part, so that it projects through the slot, provides a means of moving the slide in the pocket. A lightning change can be made from a five-spot to a four-spot while swinging the card.

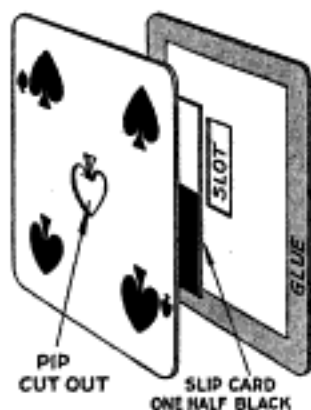

### To Make a Special Envelope

Any size of envelope for mailing special papers or documents can be made as follows: All envelopes are of the same shape as shown in Fig. 1; the size for the papers to be inclosed is represented by the dotted lines in Fig. 2. The projections A are coated with

paste, and the flap B is folded over them. The envelope is then ready for the inclosure. The flap C is pasted and

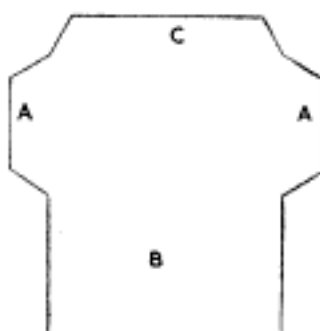

FIG. 1

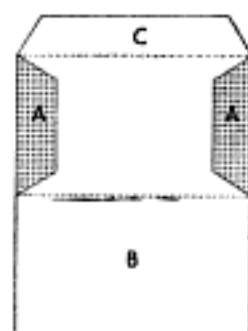

FIG. 2

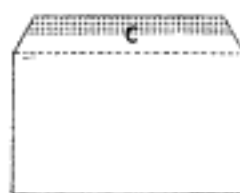

FIG. 3

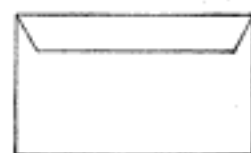

FIG. 4

Various Stages in the Forming of an Envelope to Make Any Size for Special Papers

folded over as with an ordinary envelope.—Contributed by L. E. Turner, New York City.

### Automatically Extinguishing a Candle

Candles can be easily fitted with attachments to extinguish the light at a set time. To determine the length of time, it is necessary to mark a candle of the size used and time how long a certain length of it will burn. Then it is sufficient to suspend a small metal dome, or cap, to which a string is attached, di-

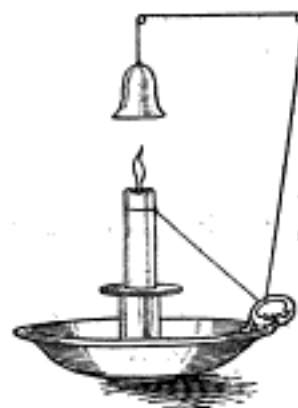

rectly over the flame, and run the opposite end of the string over nails or through screw eyes, so that it can be tied around the candle such a distance from the flame end, that the part between the flame and the string will be consumed in the time desired for the light to burn. When this point is reached, the string slips off the candle, and the cap drops on the flame.

### To Enlarge or Reduce Plots

Sometimes it is necessary to enlarge or reduce a plot to a different scale. This can be easily and quickly accom-

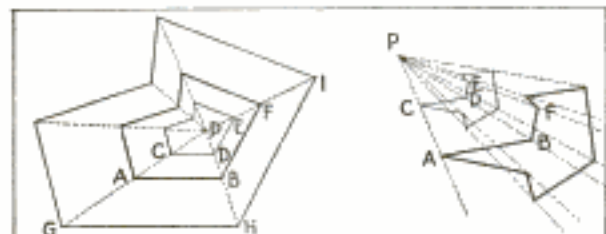

Enlarging and Reducing Plots by Radial Lines from a Common Point Located Properly

plished without resorting to the slow process of protracting the angles and scaling the individual lines.

Take any point, P, and from it draw light pencil lines through each of the corners of the plot. On any one of these lines, as AP, lay off with dividers AC equal to CP. Place a triangle on the line AB and with a straightedge, or another triangle, laid on the line AP, slide the former to the point C, then draw line CD parallel with AB until it intersects the radial line PB. In the same manner draw line DE parallel with BF, and so on, all about the plot. A test of accuracy will be in striking the point C with the last line. If the original plot has a scale of 40 ft. to the inch the reduced plot would be 80 ft. to the inch. If it is required to enlarge the plot to 20 ft. to the inch, make AG equal to AP, and proceed as in the first case, using G as the starting point.

The location of the point P is

arbitrary and may be outside of the boundary of the plot or figure to be enlarged or reduced, but should be so located, if possible, that the radial line to any corner does not parallel either of the plot lines to that corner. If the point cannot be so located for all the lines, it may be necessary to scale the lines. A little practice in picking out the best location for the point will give gratifying results. — Contributed by Junius D. McCabe, Pittsburgh, Pa.

### A Lathe Bench

While working at a bench, or foot-power lathe, it is quite convenient to have some sort of a seat to sit on while at work, or between operations. In making such a seat, I used a board, 27 in. long and 12 in. wide, for the top, and two boards, 19 in. long and 12 in. wide, for the supports. These boards were  $\frac{3}{4}$  in. thick. The supports were squared at the ends and securely fastened to the top with nails, their positions being 3 in. in from the ends of the top board. These were well braced, as shown, and a cross board

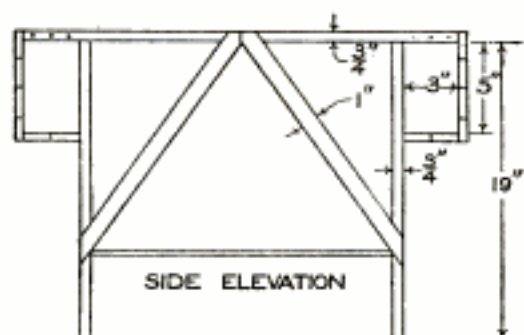
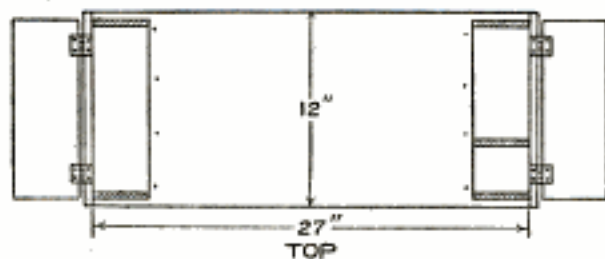

The Bench Provides a Seat for the Worker in Doing Operations on a Small Foot Lathe

was placed between them, near the lower ends.

The projecting ends of the top were cut out, and a box, 5 in. deep, constructed against the supports. A

covering was made to fit in each of the openings in the top board and hinged to the outer edge of the box. The boxes made a convenient place for the tools used in the turning work.—Contributed by Harold R. Harvey, Buhl, Idaho.

### Cleaning and Polishing Shoes

In using the polishes now on the market for tan shoes, I found that the leather cracked in an unreasonably short time. The following was suggested and tried out with good results. Wash the shoes with castile soap and water by applying the mixture with a dauber. Work up a little lather and then rub dry with a cloth, without rinsing. The leather will be cleaned without becoming dark, and it will not crack. A higher polish may be obtained by using some paste polish in the usual manner.—Contributed by George Bliss, Washington, D. C.

### Shaving Cabinet Mounted on an Adjustable Pedestal

The illustration represents a shaving cabinet mounted on an adjustable pedestal, whose style and size are such that it may easily be moved about or set away without requiring much room. The material required for its construction is as follows:

- 1 framed mirror, 8 by 10 in.
  - 1 square-head bolt and wing nut,  $\frac{1}{2}$  by 4 in.
  - 2 cabinet sides,  $\frac{1}{2}$  by 7 by 15 in.
  - 2 partitions and shelf,  $\frac{1}{2}$  by 6 by 6 in.
  - 1 cabinet top,  $\frac{1}{2}$  by 7 by 10 $\frac{1}{2}$  in.
  - 1 cabinet bottom,  $\frac{1}{2}$  by 6 by 10 $\frac{1}{2}$  in.
  - 2 cabinet backs and doors,  $\frac{1}{2}$  by 6 $\frac{1}{2}$  by 10 $\frac{1}{2}$  in.
  - 4 cabinet moldings, 1 by 4 by 4 in.
  - 1 cabinet support, 2 by 2 by 26 in.
  - 4 pedestal moldings, 1 by 1 by 6 in.
  - 4 pedestal frames, 1 by 3 by 36 in.
  - 1 base, 2 by 12 by 12 in.
- Screws, nails, and varnish.

The sidepieces of the cabinet are extended at one corner, thereby forming the supports for the mirror. The door fits in between the sides and may be attached either by hinges or two wood screws, one on each side, holes being bored in the sides forming a loose fit for the screw so they can freely turn with the door. The pedestal consists of a 4-in. square box resting on the base block, and secured in place by

means of molding strips. The sliding support for the cabinet consists of a 2-in. square piece secured to the bot-



The Mirror and Cabinet are Mounted on a Pedestal That can be Moved as Desired

tom of the cabinet by means of molding, and provided with a slot so the support can freely slide over the clamp bolt, which fastens it in place by clamping it against the pedestal. If it is desired to conceal the head of the bolt, a recess should be made in the pedestal frame for it, as shown, so the support will freely slide over it. Before assembling the pedestal it will be necessary to drill a hole in the front side in line with the recess of the back side, and insert the bolt. If this precaution is not taken, it will not be possible to insert the bolt, unless a hole be made for the head either through the back side or front side.—Contributed by D. Toppan, Watervliet, N. Y.

## INTERESTING NEW PATENTS



Fig. 1

**GUN CAMERA** (Fig. 1)—This curious camera is aimed in the same manner as a gun and is operated by the trigger. At the muzzle end of the barrel are the camera, film holder, and shutters. When the trigger is drawn back, the bulb within the breech is compressed, and the resulting action is exactly like that of an ordinary camera operated with a bulb and tube.



Fig. 3

**COMBINED WASHTUB AND WASHBOARD** (Fig. 2)—This washtub has a wall formed of a single piece of metal inclined outwardly, as shown. It is much like an ordinary metal washtub except that a portion of the wall is made straight, and is provided with the corrugations necessary for forming a washboard.



Fig. 5

**RUBBER OVERSOLE** (Fig. 3)—This device consists of a thick cushion of rubber designed to be fitted over the sole of the shoe. It is made with a recess and flange to fit over the edge of the sole, and is further held securely in place by hooks.

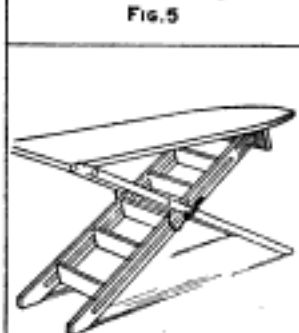

Fig. 7

**MACHINE FOR CLEANING WINDOWS AND WALLS** (Fig. 4)—The principal purpose of this machine is to permit the window cleaner to clean the outside of a window without climbing out on the window ledge. The cleaning brush is carried at the end of a collapsible shaft, and is rotated by a crank arm within the building. The whole device is easily clamped to the window ledge, while the brush is moved about as required by means of the controlling lever.

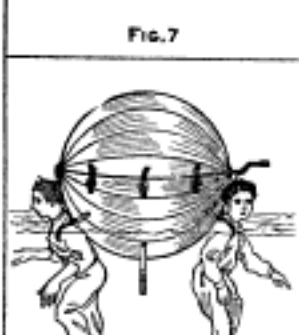

Fig. 9

**UNDERGROUND AIRSHIP SHELTER** (Fig. 5; British patent to a German)—The central circular space is an open excavation in the center of which is a turntable. Opening into this excavation are underground shelters as well as a passageway connecting with the surface of the ground. Each shelter is closed with a sliding door. The airships are received on a car that runs on rails, the wheels being so arranged as to grip the rails against the lifting impulse of the airship.



Fig. 10

**DOOR HOLDER AND BUFFER** (Fig. 6)—This buffer is made of one strip of metal, one end being bent to the form of a vertical stop and the other to the form of an inclined spring that acts against the bottom of the door. The device is designed to lie flat on the floor and to hold the door in any position.



Fig. 8

**COMBINATION STEPLADDER AND IRONING BOARD** (Fig. 7)—This device is made to be used as an ironing board when placed in the position shown, or as a stepladder when stood on end. When used as a stepladder, the supporting ends are spread apart as far as the chains connecting the sliding sidepieces and the ladder portion will permit.



Fig. 9

**HOLDER FOR EAR CORN** (Fig. 8)—The end plates of this curious device may be adjusted to any length of ear by means of the ratchet teeth and slots at the connection of the rods at the bottom. Two toothed heads hold the ear securely when the parts are drawn against the ends of the ear, while the journaled mountings permit free rotation.



Fig. 10

**SPHERICAL LIFE PRESERVER** (Fig. 9)—The feature about this invention is that it can easily be folded compactly, or opened out to spherical form by the rotation of the handle, which operates a series of semicircular ribs on which the air-tight covering is mounted. The user is supported by shoulder straps as shown. Fastenings are provided for holding the life preserver in spherical shape, and when secured in this way it is air-tight.



Fig. 10

**COLLAPSIBLE DRINKING CUP** (Fig. 10)—The two halves are pivoted together at the top, as shown. When opened out, the parts form a conical drinking cup, but take a flat form when one of the halves is rotated over the other.



Fig. 2

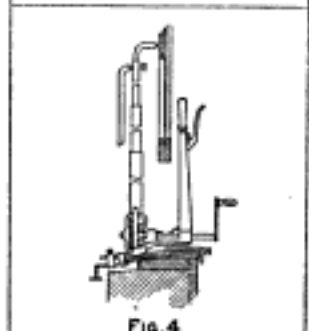

Fig. 4



Fig. 6

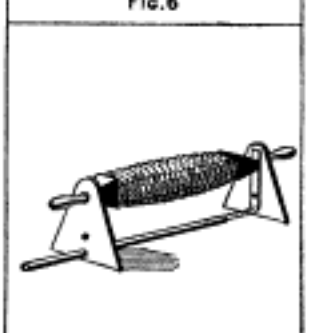

Fig. 8

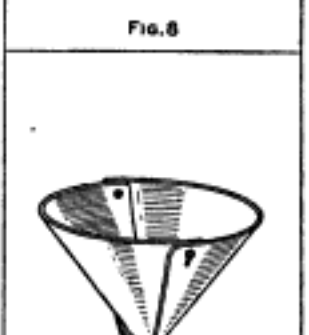

Fig. 10





Fig. 11

**SAW HANDLE** (Fig. 11)—The interesting feature of this invention is that the handle can be rotated to any angle with reference to the saw blade and fixed in that position. The blade holder has a flat surface, and against this the flat surface of the handle works. The handle is fixed in position by a clamping nut, as shown.



Fig. 13

**EMERGENCY WHEEL FOR VEHICLES** (Fig. 12)—This is simply a two-wheeled truck intended to support temporarily the axle of a vehicle when a wheel has been broken. The wheels of the truck are of the caster type and support the truck frame by means of vertical spindles. The curved tongue projecting forward from the truck is strapped to the frame of the vehicle.

**REPEATING DEVICE FOR PHONOGRAPHS** (Fig. 13)—This device consists of a spiral track that rotates with the record table, and is so shaped that it lifts the sound box as it reaches the inner edge of the record, transports it across the record, and then lets it down on the outer edge. This is accomplished by curving the inner end of the track downward so that it runs under the sound box when it reaches the inner edge of the record. One turn of the track transports the sound box back to the outer edge, where it is let down gently through the action of a flexible end. While the record is being played, the track rotates above the sound box.



Fig. 15

**YIELDING FENDER FOR SHIPS** (Fig. 14)—The object of this invention is to provide a fender that will yield under the impact of a collision and protect the ship from damage by absorbing the shock gradually. The fender consists of hinged sections which are held out from the hull by pivoted links, the point being normally thrust out from the bow by a plunger. A worm gear and an air cushion cause this plunger to retard the deflection of the fender when force is brought to bear against the point.

**TIRE PUMP WORKED BY MOTION OF WHEEL** (Fig. 15; British patent to an Austrian)—With this device the power of the revolving wheel is used for inflating the tire. The pump is attached to the hub and revolves with the wheel, and is operated by a lever arm connected by levers and links with the pump piston. The compression stroke is brought about when this lever arm strikes a lug on the vehicle frame. As soon as the lever arm clears the lug, it is brought back to its original position by a spring.



Fig. 17

**HEDGE TRIMMER** (Fig. 16)—The purpose of this invention is to provide a hedge-trimming machine that works much like a mowing machine. The teeth work between guards, as shown, and are drawn back and forth by a small wheel in the handle. This wheel is rotated through a flexible shaft by hand power, or electric power. Adjustments are provided for giving the trimmer a curved form.

**LIFE-SAVING APPARATUS** (Fig. 17)—The body portion of this life preserver floats horizontally on the surface of the water. At one end is a hood made up of hinged sections, which may be opened or closed to suit the comfort of the user.

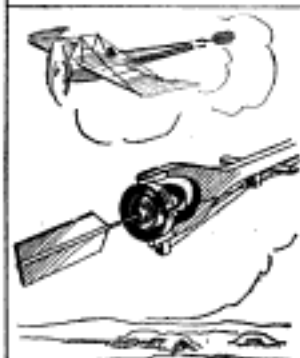

Fig. 19

**SCAFFOLD FOR USE IN FELLING TREES** (Fig. 18)—This scaffold is designed to support the workman at any desired level when a high stump is to be left. It consists of a collapsible frame which is easily attached to the tree trunk, and on which is held a plank for supporting the workman.

**STEERING APPARATUS FOR AIR CRAFT** (Fig. 19; American patent to a Canadian)—The steering gear is mounted in a forked-tail frame and has two movements, as shown. The rudder can be swung horizontally or can be rotated on its shaft to any angle.

**NONSINKABLE SHIP** (Fig. 20)—The ship is provided with side extensions in which are air containers. The air containers are separated by bulkheads, so that if one is punctured it does not affect the others.

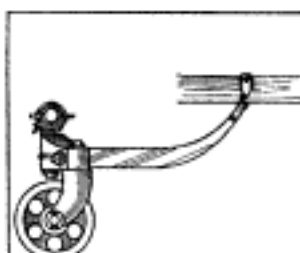

Fig. 12



Fig. 14



Fig. 16



Fig. 18

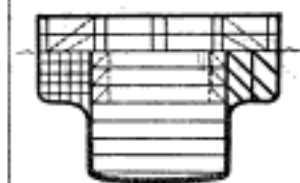
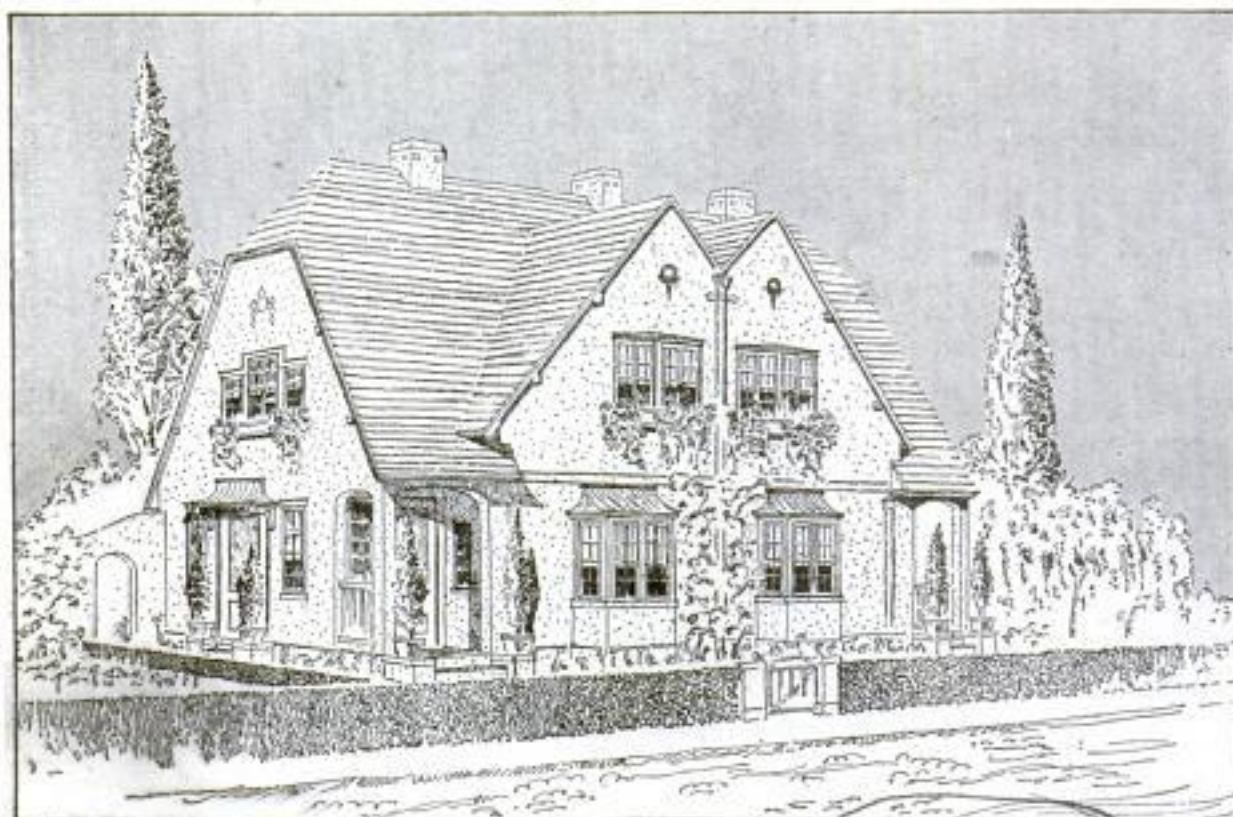

Fig. 20

5656

Ernest C. Redstone  
25 Arch St., Boston, Mass.

## PICTURESQUE TWIN HOUSE OF MODERATE COST



ERNEST C. REDSTONE, ARCHITECT, BOSTON, MASS.

**T**HIS picturesque twin house contains six rooms on each side in addition to hall, passage, and pantry, on the first floor, and stair hall and bathroom, on the second floor. The cost of the house is about \$9,000, a figure that includes heating, plumbing, and electric wiring. The walls are built of hollow tile and are faced with gray pebble-dashed stucco. The color scheme of the exterior has been carefully studied to produce a subdued and harmonious effect. The exterior trim is dark brown, the window blinds and flower boxes are dark green, and the tin flashing of the roof is verdigris. The entire building is 54 ft. long and 24 ft. wide. The ceiling height is 8 ft. in both stories and basement. The two halves of the building are the same, except for the necessary reverse in the arrangement of the rooms.

The living room on each side has a beamed ceiling and is provided with a brick fireplace built into the dividing wall. A door leads from this room directly to the dining room, while access from the kitchen to the dining room is through the pantry. The stairway leading to the second floor is placed in the entrance hall. On this floor, there are three chambers and bath, all of which are conveniently arranged with reference to the stairway.



FIRST FLOOR LEFT-HAND HOUSE

SECOND FLOOR RIGHT-HAND HOUSE

# \$595 For This Complete Aladdin Bungalow



**C**ONTAINS porch, hall, living room, dining room, two bedrooms, bath, kitchen and closets—a cosy and charming home. This particular Aladdin Bungalow has delighted many owners. It is built in almost every state and never fails to have a host of admirers. Wouldn't you like to know more about it—to own it? The beautiful Aladdin catalog describes it fully and tells also of dozens of others, larger and smaller. Shall we send you this book?

## ALADDIN Dollar-a-Knot Quality

**Knotless Inside—Knotless Outside.** Aladdin quality has set a new standard for lumber quality—is raising the old-time lumber standards of quality to a new plane. As yet, no other lumberman in the world has had the courage to equal the Aladdin Dollar-a-Knot Guarantee. But you can secure knotless lumber—at a distinct saving in price, too—in an Aladdin House.

## Build an ALADDIN Yourself

You can build an Aladdin Read-Cut House yourself. All material is cut to fit accurately and leaves our mills both marked and numbered. All you do is follow the instruction sheet and drive the nails. Thousands of Aladdin customers in every state have enjoyed the simple work of erecting their own Aladdins. And they have saved the cost of high-priced labor by doing the work themselves in spare time. You can do this, too.

**Cut Out Builder's Profits** Why should you pay one thousand dollars for a home that you can buy for \$700? Why should you let the dealer add his \$300 profit to your bill? This is plain talk—and meant to be. Middlemen are necessary only when manufacturers won't deal with consumers. You are the consumer—the home builder. We manufacture and produce the goods. *We will not sell to middlemen.* If we did, you would have to pay thirty cents more on every dollar's worth of our goods. Labor and profit are the biggest parts of the price you pay for any article. That's all the middleman adds to the goods—labor and profit. And you foot the bill.

**Aladdin Price Includes Everything** Aladdin houses are complete. You get material absolutely guaranteed to be sufficient for the completion of your house, as follows: cut-to-fit sills, joists, studding, building paper, subfloor, rafters, roof sheathing, siding, outside finish, flooring, lath and plaster or plaster board, inside finish, doors, windows, sash, glass, nails of all sizes, locks, hinges, paints, oils, varnishes, stains, with complete drawings, illustrations and instructions for erection—*The Complete House.* The big Aladdin catalog No. 180 tells all the interesting facts.

**North American Construction Co.**  
961 Aladdin Avenue Bay City, Michigan  
*Mills in Michigan, Florida, Louisiana, Oregon*

\$997



\$794



Five Rooms \$298



## ALADDIN Products

Aladdin products include high grade heating plants of all kinds, plumbing, lighting fixtures, hardware, furniture, rugs and carpets—in fact, everything for the home. Ask for the Merchandise Catalog, too, if interested in these products.

North American Construction Co., 961 Aladdin Ave., Bay City, Mich.  
 Send me your House Catalog No. 180.  
 Send me your Merchandise Catalog No. 180.  
 Name.....  
 Street.....  
 City.....  
 State.....

Please Mention Popular Mechanics



# GRAY & DAVIS

## STARTING - LIGHTING SYSTEM

for  
**Ford  
Cars**

\$**75**

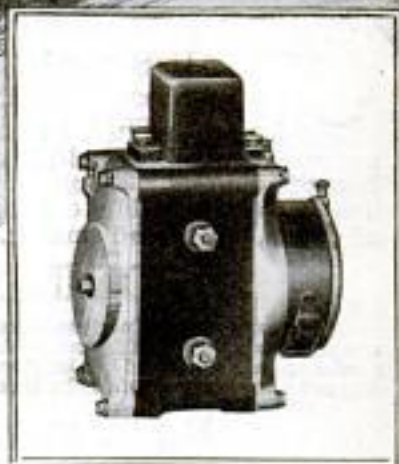

**Only a few weeks  
away is spring!**

**H**ERE are two questions to ask yourself before your new Ford arrives or your old Ford goes to the Man in Overalls for its spring overhauling.

One is, "Will I do away with hand-cranking so that the good wife and daughters can have the pleasure of driving when I'm not around?"

The other runs, "Do I want gas lamps any longer when I can have steady and brilliant electric light?"

Your automobile supply dealer can now secure delivery of a complete Gray & Davis Starting-Lighting System for



any new or used Model "T" Ford Car. He can install it while he is getting your car ready for a busy spring.

During 1915 we will produce 100,000 Ford Systems, but contracts already signed by automobile supply dealers call for so many thousands of these systems that it is doubtful if we can meet the total demand.

Early spring is but a few weeks away. This matter calls for your immediate consideration. May we send our "Ford" catalog?

### *What the System Comprises*

**T**HIS Ford System is simple, compact, light in weight, and can be quickly and easily installed on any new or used Model T.

A 6-volt battery, battery box, switches, wiring and all necessary connections are included.

Below we print a list of our distributors. Your local supply man, dealer or agent can secure delivery for you by ordering from the nearest distributor.

# GRAY & DAVIS

## STARTING - LIGHTING SYSTEM

### FOR Ford CARS

Price Complete **\$75** F. O. B. Boston

#### DISTRIBUTORS

Denver, Col.....Auto Equipment Co.	Detroit, Mich.....F. S. Holmes Co.	Cincinnati, Ohio....Coughlin & Davis, Inc.
Hartford, Conn.....R. R. Ashwell	Minneapolis, Minn.....Electric Mfg. Co.	Cleveland, Ohio.....
Washington, D. C.....	St. Paul, Minn.....Electric Mfg. Co.	.....Pennsylvania Rubber & Supply Co.
.....Miller Bros. Auto & Sup. House	Kansas City, Mo. Kansas City Auto Sup. Co.	Columbus, Ohio....Rogers Supply & Tire Co.
Atlanta, Ga.....Elyen-Austell Co.	St. Louis, Mo.....Fred Campbell	Toledo, Ohio....Roberts-Toledo Auto Co.
Chicago, Ill.....Erwin Greer & Co.	Ostaha, Neb.....Powell Supply Co.	Oklahoma City, Okla. Hurwell-Smith Sup. Co.
Indianapolis, Ind....Gibson Automobile Co.	Buffalo, N. Y.....Jan. G. Barclay, Inc.	Philadelphia, Pa....J. H. McCullough & Son
Des Moines, Iowa....Herring Motor Co.	New York, N. Y. Gray & Davis, Inc., Branch.	Pittsburgh, Pa.....Jos. Woodwell & Co.
Louisville, Ky.....Roy E. Warner Co.	245-7-9 West 35th St.	Providence, R.I. Providence Auto Equip. Co.
New Orleans, La....Interstate Electric Co.	Rochester, N. Y....Barclay-Brown Co., Inc.	Dallas, Tex....Ferris-Dunlap Auto Supply Co.
Boston, Mass.....Mitchell & Smith, Inc.	Wellington, N. Z.....Colonial Motor Co.	Richmond, Va.....Kaehler Motor Car Co.

Pacific Coast Representatives, Hughson & Merton—San Francisco, Los Angeles, Portland and Seattle

GRAY & DAVIS, Inc., BOSTON, MASS.

New improved body, genuine streamline effect—identical in style with high priced two-passenger cars. Wood or wire wheels. Electric lights and starter, \$70. Standard or 60-inch tread.

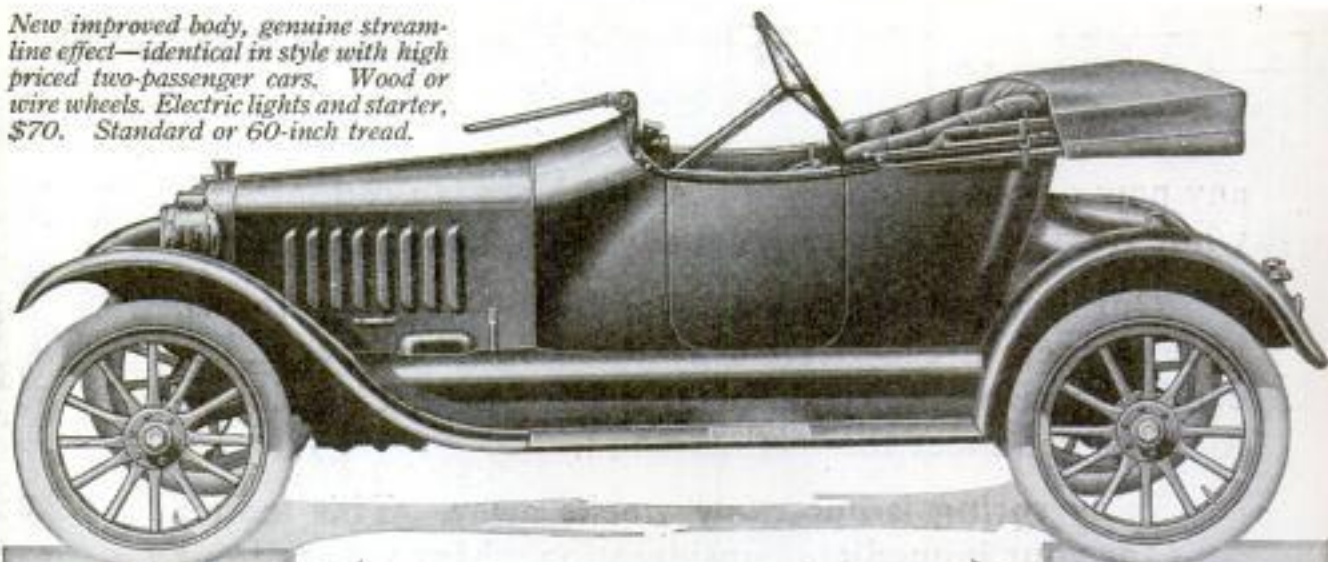

**\$395**

What it  
Costs to  
OWN  
One

**SAXON**

The car that makes  
both ends meet

$\frac{1}{2}$  cent  
per Mile

What it  
Costs to  
RUN  
One

The Saxon has removed the last objection anyone ever had to owning an automobile—the *price* reason.

For the *first cost* of the Saxon *places* this sturdy car within reach of everyone. Its price is \$395.

And the *after cost* of the Saxon *keeps* it within the means of everyone. Owners are amazed at the economy records of their Saxons—28 to 36 miles per gallon of gasoline; 75 to 100 miles per pint of oil; 3500 to 5000 miles on a set of tires. Saxons average half a cent a mile in operation cost—one-fourth of a cent per mile per passenger.

And the Saxon *stands up*. It endures the hardest kind of usage without flinching. Many thousands of Saxons now in use all over the United States, in Canada, and in foreign countries have proved the sterling goodness of Saxon construction.

### How We Can Do It

Some folks wonder how we can possibly build for \$395 a car that will do the things a Saxon will do. *Good design* is the answer—knowing how—having the right idea of what a light car should be and do, and then figuring

out the best way to get these results at the lowest cost consistent with quality.

Our engineers had at their disposal all that has been learned about automobile building. They started from the beginning to design a light car for economical manufacture and upkeep. They adopted nothing freakish, but they found new ways to use many standard features. They also were first to use some brand new things of proved efficiency.

By taking thought, we are able to offer for \$395 a better automobile than could be bought only a few years ago for five times the price. Saxon is the *modern* car.

A year ago some might have called the Saxon "an experiment." But not today. It *has made good*.

### Saxon "Six" \$785

For those who want a touring car, this 5-passenger six-cylinder Saxon is truly an unusual value. It is generously roomy—in no sense a small car. It has a 112-inch wheelbase, 32 x 3½ inch tires, 30-35 horsepower, high speed motor, electric lights and starter as regular equipment, and many other unexpected features. And the price, too, is unexpected—\$785, fully equipped.

Write today for current issue of "Saxon Days" and name of your nearest dealer. Address Dept. J.

**Saxon Motor Company, Detroit**





# Home Billiards

## Turns Years Backward!



**"Baby Grand"**  
Pocket Style

This princely sport—like some good fairy godmother—is helping men and women to outwit old age!

In thousands of homes that now have Brunswick Carom and Pocket Tables, the mothers and fathers and sons and daughters are chums.

Each evening there are lively doings in the billiard room. Each round of hand-clapping proclaims a brilliant shot—each burst of laughter another innocent trick that billiards has played on some unlucky member of the party.

Bless *your* home with billiards! Let all the family—and *your* guests—share in the golden hours of youth it brings.

## Superb BRUNSWICK Home

# BILLIARD TABLES

Real Brunswick regulation tables, modified only in size and design. Fast Monarch cushions, accurate angles, slate bed, speed, life and durability.

### "Grand" and "Baby Grand"

The finest and fastest home tables in the world. Beautiful mahogany, richly inlaid. Equipped, if desired, with interchangeable cushions, giving two perfect tables in one—for all games of Carom or Pocket Billiards.

Also "Convertible" models that serve as perfect Library or Dining Tables when not in use for Billiards.

### 30-Day Trial—Outfit FREE

We give with each table complete high class Playing Outfit—Balls, Cues, Rack, Markers, Brush, Tips, Cue-Clamps, expert book on "How to Play," etc. And you may try any Brunswick 30 days in your Home!

### 20 Cents a Day!

Pay us a little each month for a year. Thousands are buying like this; terms low as 20c a day!

Get our beautiful new book—"Billiards—The Home Magnet"—and see these tables in actual colors. Full descriptions, prices, terms, etc., included. Send the coupon *Now*.

## Mail For Billiard Book FREE

The Brunswick-Balke-Collender Co.  
Dept. 11M, 623-633 S. Wabash Ave., Chicago

Send postpaid, free, color-illustrated book—

**"Billiards—The Home Magnet"**  
and details of your 30-day Home Trial Offer.

Name.....

Address.....

(396)



## Creating a New Art

At the Centennial Exhibition at Philadelphia, the exhibit of the Bell System consisted of two telephones capable of talking from one part of the room to another.

Faint as the transmission of speech then was, it became at once the marvel of all the world, causing scientists, as well as laymen, to exclaim with wonder.

Starting with only these feeble instruments, the Bell Company, by persistent study, incessant experimentation and the expenditure of immense sums of money, has created a new art, inventing, developing and perfecting; making improvements great and small in telephones, transmitter, lines, cables, switchboards and every other piece of apparatus and plant required for the transmission of speech.

As the culmination of all this, the Bell exhibit at the Panama-Pacific Exposition marks the completion of a Trans-continental Telephone line three thousand four hundred miles long, joining the Atlantic and the Pacific and carrying the human voice instantly and distinctly between New York and San Francisco.

This telephone line is part of the Bell System of twenty-one million miles of wire connecting nine million telephone stations located everywhere throughout the United States.

Composing this System, are the American Telephone and Telegraph Company and Associated Companies, and connecting companies, giving to one hundred million people Universal Service unparalleled among the nations of the earth.

**AMERICAN TELEPHONE AND TELEGRAPH COMPANY  
AND ASSOCIATED COMPANIES**

*One Policy*

*One System*

*Universal Service*



# Keep the Wolf From YOUR Door

As long as you are well you know you will pay your way; but if from a clear sky there falls upon you some accident, or some illness, where will you be? Then it will be too late. **Now is the time to be careful.**

Send this coupon — it will be your first step on the road to safety. Typhoid and pneumonia and grippe come to the strongest without warning. One man in seven dies or is injured from an accident every year.



## AETNA-IZE

Take out this *Accumulative* Disability Policy. It protects your wife against your death—it protects you against accident—and sickness, too.

Consider this: out of 128,000 claims paid by the Aetna—24,000 were for falls—4,000 for burns and scalds—5,800 for cuts with edged tools or glass—5,000 for crushed fingers—4,000 for stepping on nails or glass—hundreds for tripping over mats or rugs, for splinters in hands or feet and for crushed toes—2,500 for blood poisoning. Every step you take you are liable to some such accident as these.

### We Pay You Up To \$50 a Week

If you are engaged in a "Preferred" occupation, and under 50, all it will cost you is \$60 a year. For that small sum—we will pay you \$25 a week as long as you live, if you are disabled by an ordinary accident, or \$50 a week if disabled by a railway, steamship, or burning building accident.

Half the above for partial disability.

And we will pay you \$25 a week up to fifty-two weeks if you are sick. We will pay hospital charges or for a surgical operation.

If you are killed in an accident, if you lose two limbs or both eyes, we will pay from \$5,000 to \$15,000. Half as much for loss of one hand, foot or eye.

There is one sure way to keep the Wolf from your door—that is to send this coupon today. It costs you nothing—it binds you to nothing. **SEND IT RIGHT NOW!**

**AETNA LIFE INSURANCE COMPANY**  
Drawer 1341 HARTFORD, CONN.

*The largest company in the world writing Life, Accident, Health and Liability Insurance*

Agency opportunities for all Casualty and Bonding lines

Name \_\_\_\_\_ P.M. 2-15  
 Occupation \_\_\_\_\_  
 Bus. Address \_\_\_\_\_  
 AETNA LIFE INSURANCE COMPANY  
 Drawer 1341  
 I have marked the kinds of insurance I wish to know about: Accident  Health  Life  Disability  \$50 Life Certificate  My age is \_\_\_\_\_ years. I am in good health.

Please Mention Popular Mechanics

# HARTMAN Will Trust You

## Remarkable Bargains Never Before Equaled

More than ever before you owe it to yourself and family to get acquainted with the startling Hartman values in Furniture, Carpets, Rugs, Silverware, Draperies, Clocks, Stoves, Refrigerators, Sewing Machines, Jewelry, Washing Machines, Bedding, Curtains, etc., which as the largest home furnishing concern in the world our \$10,000,000 purchasing power enables us to buy in such immense quantities that we secure the best the market affords, at absolutely rock bottom prices.

## Your Credit Good Pay A Little At A Time

We ship dependable home furnishing goods to more than a million customers year after year, in every part of this country. The plan has proven so satisfactory that we say to you—"Your credit is good, no matter where you live, no matter how small your income; order what you need, pay a little every month. We require no references, ask no embarrassing questions, charge no interest, ask no security." Most liberal and satisfactory credit plan ever devised.

## Don't Miss These Wonderful Get-Acquainted Bargains

The Hartman Company alone has such unbounded confidence in its goods that it offers to send to any reader of this publication any one of the remarkable get-acquainted bargains in this advertisement—and that without asking you to send any money in advance. But at these prices we can afford to send but one to each family. Order any one you wish from this advertisement; when you get our mammoth catalog, order any amount you desire.

## Every Hartman Bargain Sells On Its Merits

Read our guarantee: "We guarantee to ship each and every article on approval and if within thirty days from receipt of the goods anything is not perfectly satisfactory, for any reason whatever, we will accept their return and when the goods are returned to us, we will refund all moneys paid on them, including payment of freight both ways."

## FREE HARTMAN'S MAMMOTH CATALOG

This is the most interesting Homefurnishing Catalog you have ever seen. Hundreds of pages done in beautiful colors. You need a copy. Send your name and address on postal today and receive a copy absolutely free, prepaid.

## HARTMAN

Furniture & Carpet Co.,  
3945 Wentworth Ave., Chicago, Ill.

## No Reference Is Required

## Comfortable Rocker Bargain No. MH110.

Large, comfortable Rocker at bargain price. Solid oak, golden finish, choice design. Is upholstered with "Imperial" Spanish brown leather seat and back. Seat has 4 springs, stuffed with tow and cotton. Front and back posts handsomely carved. Seat front plaited and back is button tufted. Strong posts and runners. The best rocker value ever offered at the low price of

\$3.45



50c  
Per Month

## Collapsible Go-Cart

No. MH122. One motion collapsible Go-cart, equipped with large convenient automobile hood with roll-up side curtains, large footwell, padded seat, two position reclining back, 10-inch wheels with 1/2 inch rubber tires, nickel fenders, heavy push rods and cross handle. Covering is of "Imperial" leather. Cart is of all steel construction and can be ordered with Black, Green or Brown covering. Price.....\$8.38 75c Per Month



## Porch Swing Bargain

MH121. Made of Solid Oak in Imitated finish; seat 45 in. long, 17 in. wide. Back constructed of stout padding. 20 in. high. Cushion equipped with chains and ceiling hooks. Price \$2.69 50c Per Month



No. MH 105.

## Washing Machine

Bargain 8 shirt capacity, made of Louisiana red cypress, corrugated on inside. Finished natural color. Four pronged 10 in. cypress dasher block, cannot slip or crack. Gearing is durable; roller bearings, easy to run. Tub supported by 3 legs which bolt into iron sockets. Don't tear clothes. Price \$4.50 50c Per Month

## Lawn Swing Bargain

No. MH127. This delightful hardwood Lawn Swing holds four passengers and is exceptionally well made and durable. Posts are painted red and swing operates freely and noiselessly. Remarkable bargain at our price. \$4.65

50c Per Month

## 2-Inch Post Steel Bed Outfit

No. MH123. Complete bed outfit bargain, consisting of elegant 2-inch continuous post steel bed with heavy fillers in artistic design, 58 inches high; link fabric steel frame bed spring, and cotton top fibre filled mattress. Outfit comes in all sizes: 3 ft. 3 in.; 4 ft. or 4 ft. 6 in. (full size). Colors: White, Pea Green or Vernis Martin.

Our price only \$9.77 75c Per Month



## Three-Piece Mission Set Bargain

No. MH109. Solid oak, fumed finish, 3-piece Mission Set. Table 24x34 inches, strongly built; convenient book shelf at either end. Rocker and Arm Chair made to match; upper and outside panels upholstered with "Imperial" Spanish leather; seat set on 4 springs, expertly filled and upholstered. Price.....\$11.78 75c Per Month

## No Money In Advance

## Brussels Rug Bargain

No. MH125 Beautiful Brussels Rug in 4 sizes. Design is very charming; neat medallion center; conventional border. Colors: Tan, Green, Brown, Red and light colorings. This is a great opportunity to get a magnificent rug for little money. Size, 6 ft. 9 in. x 9 ft. Price.....\$6.85  
Size, 8 ft. 3 in. x 10 ft. 6 in. Price.....\$8.95  
Size, 9x12 ft. Price.....\$10.75

75c Per Month  
Size, 10 ft. 6 in. x 13 ft. 6 in. Price...\$18.50



\$1.25 Per Month





# TYPEWRITER SENSATION

Free TRIAL—Use As You Pay

Only \$3.00 a month until the low total price of \$48.30 is paid, and the machine is yours

This is absolutely the most generous typewriter offer ever made. Do not rent a machine when you can pay \$3.00 a month and own one. Think of it—Buying a \$100.00 machine for \$48.30. Cash price, \$45.45. Never before has anything like this been attempted.

Standard Visible **L. C. Smith**

Perfect machines, Standard size, Keyboard of Standard Universal arrangement writing 76 characters—universally used in teaching the touch system. (Keyboard writing 84 characters \$1.00 extra.) The entire line of writing completely visible at all times, has the tabulator, the two color ribbon with automatic reverse, the Back Spacer, in fact every late style feature and modern operating convenience. Comes to you with everything complete, tools, cover, operating book and instructions, ribbon, practise paper—nothing extra to buy. You cannot imagine the perfection of this beautiful typewriter until you have seen it. I will send it to you F. O. B. Chicago for five days' free trial. It will sell itself, but if you are not satisfied that this is the greatest typewriter you ever saw, you can return it at my expense. You won't want to return it after you try it—you cannot equal this wonderful value anywhere.

**You Take No Risk—Put In Your Order Now**

When the typewriter arrives deposit with the express agent \$9.30 and take the machine for five days' trial. If you are convinced that it is the best typewriter you ever saw, keep it and send me \$3.00 a month until our bargain price of \$48.30 is paid. If you don't want it, return it to the express agent, receive your \$9.30 and return the machine to me. I will pay the return express charges. This machine is guaranteed just as if you paid \$100.00 for it. It is standard. Over one hundred thousand people own and use these typewriters and think them the best ever manufactured.

The supply at this price is very limited, the price will probably be raised when my next advertisement appears, so don't delay. Fill in the coupon today—mail to me—the typewriter will be shipped promptly. There is no red tape. I employ no solicitors—no collectors—no chattel mortgage. It is simply understood that I retain title to the machine until the full \$48.30 is paid. You cannot lose. It is the greatest typewriter opportunity you will ever have. Do not send me one cent. Get the coupon in the mails today—sure.

**HARRY A. SMITH, 231 N. Fifth Ave., CHICAGO**

**H. A. SMITH**  
231 N. Fifth Ave.  
CHICAGO, ILL.

Ship me a No. 2 L. C. Smith F. O. B. Chicago, as described in this advertisement. I will pay you the \$39.00 balance of the SPECIAL \$48.30 purchase price, at the rate of \$3.00 per month. The title to remain in you until fully paid for. It is understood that I have five days in which to examine and try the typewriter. If I choose not to keep it I will carefully repack it and return it to the express agent. It is understood that you give the standard guarantee for one year.

Name .....

Address .....

# Be a Manufacturer

## OF



## HAYWOOD RETREADS

### MAKE \$3,000.00 A YEAR TO START

and more as you get accustomed to the business. Sounds like a whole lot of money, and it is—looks pretty big from where you stand if you are earning just an ordinary salary at an ordinary job, but why continue the job—why be on that side of the fence? Why not come over on this side—the manufacturing side—where the grass is greener and the picking is better?

It is not every business that will permit you to start with a very small investment. Most manufacturing business require big capitalization. And rich men take the profits while you, the producer, get a salary and the small end. But here is a business that gives **big returns, quick returns**, and the demand for your product is ahead of the supply and increases every day in the year. Start a **Haywood Tire Repair Shop**

### MAKE \$250.00 A MONTH—\$3000.00 A YEAR

The certainty of success in this business is about as sure as anything in this world can be. **Automobile owners increase by the thousands each year and the tires are still the least durable part of the car.** Every owner tries to cut down his tire expense—every owner tries to repair his tires as long as they will hold together and this brings about

### YOUR WONDERFUL OPPORTUNITY

You might just as well be the first to enter this paying business in your town—**open your shop and let the money roll in.** Every automobile sold means more tires to mend. You start with one machine. The business grows fast. You need another and then another. Soon it gets to be a regular business of adding machine—after-machine until the first thing you know you are running a big shop—you are operating in a big way—you are a real business man and a factor in your community. **You know that punctures and blow-outs are common—tires need retreading and vulcanizing every day—something going wrong all the time—owner after owner forced to buy new tires because they cannot get the old ones fixed.**

If you are in the business, operate a tire repair plant as a side line in connection with your present business, garage or salesroom. Any place where there are many automobiles yields a big steady business, besides the transient work. Experience is absolutely unnecessary. You can learn quickly. Anyone with a little mechanical turn or who can simply follow directions, can learn in a few days on old tires, to do the best work. Then business comes fast and easy.

### REPAIR TIRES AT HOME

**Young men make money to attend college or start a garage and repair business. Automobile owners—repair your own tires. Save money.**

Pay for your outfit in a short time. We have special outfits for home use. Mr. Any-Man, it's worth while to investigate. There is money in it. It's a field of wonderful possibilities. Make up your mind and send for our catalogue today. Learn of the wonderful money making possibilities in this fascinating new business. Make something—supply a want—become a manufacturer. This is your chance.

Without any obligation upon my part please send me your complete FREE catalog of tire repair outfits.

HAYWOOD TIRE & EQUIPMENT CO.  
861 Capitol Ave.  
Indianapolis, Ind.

Name.....  
Address.....



THE  
HAYWOOD  
TIRE &  
EQUIPMENT  
CO.

861 Capitol Ave. INDIANAPOLIS, IND.

Please Mention Popular Mechanics

# Lower Power Cost Proves My Higher Engine Quality

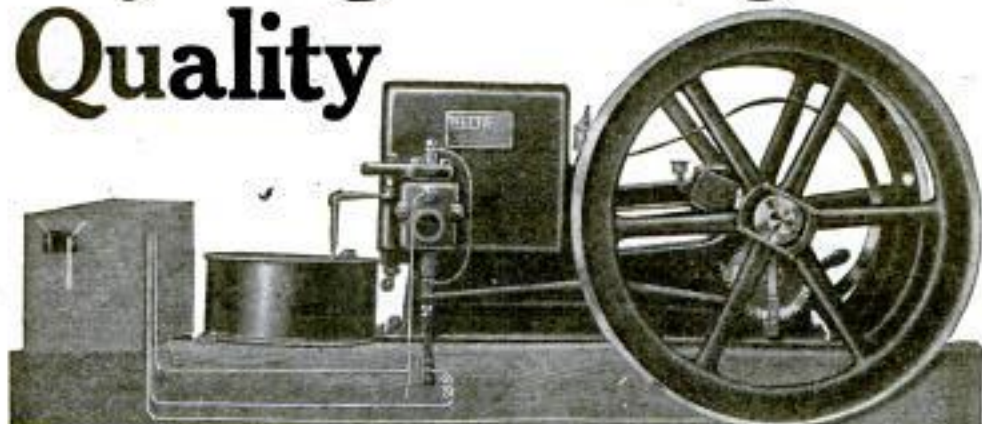

## Latest WITTE Prices

### STATIONARY

2 H-P.	\$34.95
4 H-P.	69.75
6 H-P.	97.75
8 H-P.	139.65
12 H-P.	219.90
16 H-P.	298.80
22 H-P.	399.65

### PORTABLE

2 H-P.	\$40.95
4 H-P.	82.80
6 H-P.	139.90
8 H-P.	190.40
12 H-P.	279.80
16 H-P.	378.70
22 H-P.	483.15

### SAW-RIG

6 H-P.	\$165.40
8 H-P.	227.10
12 H-P.	324.50

My engine H-P ratings have not been raised to make prices look low. My ratings are the same as in previous years—a liberal surplus of power in each size over the regular rating—while my prices are lower than ever.

A WITTE Engine of any size is guaranteed to give its full rated horse-power with a liberal surplus. So, probably, will any other strictly high-grade engine. But the mere ability to deliver its rated horse-power is not all that is needed to prove engine quality. The big question to consider is this: "How much will it cost in fuel, lubricant, and upkeep expense to get that rated horse-power out of an engine?" Real engine quality is measured by the engine's ability to keep that cost down to the lowest possible notch. And, other things being equal—strength, durability, simplicity, ease of operation, smoothness of running—the engine which keeps its operating cost down to the lowest notch is the engine for you to buy.

## WITTE ENGINES

### Kerosene, Distillate, Gasoline and Gas

Thirty years ago when gasoline and other like fuels were cheap almost any type of engine that could pull its rated load, regardless of amount of fuel used, would answer the user's purpose. Those early engines were mostly over-heavy and a large part of their own power was consumed in overcoming excessive friction of their over-heavy parts. Today fuel is a matter of first importance. I foresaw this years ago and began working toward a cheaper power cost. The result is the WITTE Engine of today which, measured by the cost of power put into the drive belt—its actual dollar-earning value—has set a new standard for engine efficiency. A saving of 25% of the fuel used by older type engines amounts, in a year, in many cases to more than enough to pay the entire first cost of a WITTE Engine.

## Sent Direct From My Factory To User CASH OR EASY TERMS

### Five Year Guarantee On Efficiency And Durability

For 28 years the WITTE has maintained its lead in Engine Quality. But it has been hard to keep the cost of manufacturing down to the point where I could also lead in low prices. But I've done it. Compare my prices with others and see how much you save on the first cost of a WITTE—to say nothing of the steady saving on fuel and upkeep.

**FREE ENGINE BOOK.** Tells why I use semi-steel castings, instead of common grey iron; why I make cylinder and bed separable; vertical valves; four-ring pistons; automobile style ignition; safety spark shift for easy starting; and explains other features without which no engine is of high grade quality. Mail coupon today.

ED. H. WITTE, Witte Iron Works Co.,  
1740 Oakland Avenue,  
Kansas City, Mo.

ED. H. WITTE, Witte Iron Works Co.,  
1740 Oakland Ave., Kansas City, Mo.

Without cost to me, and with no obligation on my part, I should like to receive your latest and finest Engine Book, and to investigate your New Liberal Selling Plan.



**WITTE Saw-Rig**  
Sizes: 6, 8 and 12 H-P. Kerosene and Gasoline engines furnished in this style.

Name .....

Address .....

Please Mention Popular Mechanics

## A real guarantee on roofing!

A useless risk is to buy roofing not guaranteed by a responsible concern. When you buy our roofing you get the written guarantee of the world's largest manufacturers of roofing and building papers.



Roofings, like most people, prove their worth by the test of time

Buy materials that last

# Certain-teed

Ask your dealer for products made by us—they bear our name.

### Asphalt Roofings

(All grades and prices)

Slate Surfaced Shingles  
Asphalt Felts  
Deadering Felts  
Tarred Felts  
Building Papers

## Roofing

1-ply guaranteed 5 years  
2-ply guaranteed 10 years  
3-ply guaranteed 15 years

Insulating Papers  
Wall Boards  
Plastic Roofing Cement  
Asphalt Cement  
Roof Coating  
Metal Paints  
Out-door Paints  
Shingle Stains  
Refined Coal Tar  
Tar Coating

### General Roofing Manufacturing Company

World's largest manufacturers of Roofing and Building Papers

New York City Boston Chicago Pittsburgh Philadelphia Atlanta Cleveland Detroit  
St. Louis Cincinnati Kansas City Minneapolis San Francisco Seattle London Hamburg Sydney

### Pictures that are Worth Money

are those that show lines of detail that the eye can not grasp and retain. The pictures snapped with

## GOERZ LENSES CAMERAS

revel scenes that can not be posed unless that atmosphere and are gone forever. That is why Goerz Lenses and Cameras are so widely used by special correspondents and professional photographers. A Goerz Lens can be fitted to the camera you own.

Our Book on "Lenses and Cameras" will be sent to you for the asking.

C. P. Goerz American Optical Co.  
323C East 34th Street, New York



The U. S. Weather Bureau, in 1914, found another opportunity for service in the timbered regions of the west during periods of unusual drought. This has been taken advantage of through the issue of special forecasts of hot, dry winds, which are disseminated directly to the officials of the fire patrols of the Forest Service, and other similar organizations, placing them on their guard at times of unusual danger of fire inception.

\$42<sup>25</sup> "GUARANTEED" GRADE "A" PLUMBING & HEATING SUPPLIES. COMPLETE AS SHOWN DIRECT TO YOU AT WHOLESALE PRICES J. HARDIN CO. 35 YEARS AT 4533-43 COTTAGE GROVE AVE CHICAGO, ILL. SEND FOR CATALOG

1½ to 18 H. P.

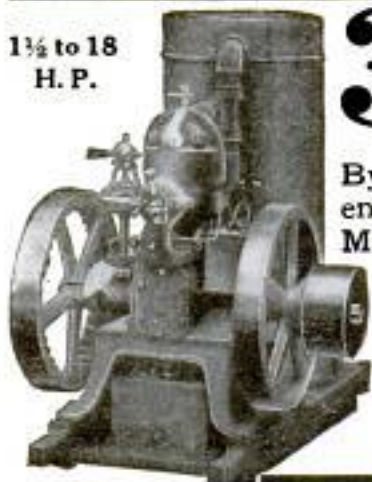

# 34c

## Runs this 6 H. P. Engine for a 10 hour day on KEROSENE

By means of the patent throttle you can run it as a 4 H. P. engine for 23 cents a day, or as a 2 H. P. for 12 cents a day. Many other strong points; force-feed lubrication; uniform speed; sight-feed fuel supply; automobile muffler; no cranking; runs either way; uses any fuel oil satisfactorily. And it's **Guaranteed for 10 Years.** Write for catalogue and 30 days' free trial.

WE PAY THE FREIGHT

ELLIS ENGINE CO., 2871 East Grand Blvd., Detroit, Mich.

Our collection of rare old violins is one of the largest in America. Write today for special art catalog.



# 10c a Day

## Now Buys This Superb Baader Violin

**A**N exquisite instrument—perfect in tone and superbly finished. Made by the great violin maker, J. A. Baader, and now offered direct to you at the rock-bottom price. *And you may pay this rock-bottom price at the rate of only 10 cents a day. 10 days' free trial.* Write for special circular.

## WURLITZER

200 years of instrument making

It is only because we have mammoth facilities for buying in large quantities that we are able to make this startling offer. Write today for special violin circular. We supply the United States Government.

## Scores of Violins to Choose From

Write today for our new violin circular showing handsome illustrations of all the superb instruments to make your selection from. The products of the leading violin makers of the world are yours to choose from—Farny, Baader, Glier, Heberlein, Fiedler, Wurlitzer and many others. Violins of the very highest grade, as well as those of moderate prices—from \$2.70 to \$50, and from \$50 to \$250. Write today for catalog matter that tells you about the instrument in which you are interested. See coupon.

## 10 Days Free Trial

We will send you any of these superb violins so that you can test them out in your own home for ten full days. You cannot judge a violin by seeing it in a store or by playing upon it once. Play on one of these instruments in your own home, in your own way for ten full days. Then you will be able to decide whether you wish to buy or not. If you are not satisfied send it back at our expense.



### 10c a Day

now buys this superb Lyric Cornet. Exquisite triple silver-plated long model Lyric Cornet direct to you on a startling offer. Ten days free trial before you decide to buy. Liberal allowance for old instruments. Write today for 225-page Catalog—showing 2500 instruments that you have to choose from.

## Send the Coupon

Write today. Send the coupon or a letter or postcard and indicate the catalog matter that you want us to send you. Absolutely no obligations of any kind. Find out about this startling money-saving offer. See handsome illustrations and detailed descriptions of instruments in which you are interested. No obligations of any kind. Send the coupon or a letter or post card.

**The Rudolph Wurlitzer Company**

4th St., Cincinnati, O. Dept. 9193 S. Wabash Ave., Chicago, Ill.

**The Rudolph Wurlitzer Co.**

Dept. 9193

S. Wabash Ave., Chicago

4th St., Cincinnati

Gentlemen—Please send me without obligations, free and prepaid the catalog matter checked below:

- The special violin circular.  
 Special low priced violins under \$15.00  
 Your 225 page illustrated catalog of musical instruments.  
 Catalog of music stands, cases and other stringed instrument accessories.  
 Art catalog of rare old violins.

Name.....

Address.....

# EARN \$20<sup>00</sup> TO \$30<sup>00</sup> A DAY



**T**HERE is no limit to your earning capacity—sounds exaggerated, but it isn't. In small town or large city there's a way for you to earn \$20 to \$30 a day—up to \$3000 a year and more—with one of our B. B. Power Vacuum Cleaners—

## 30 DAYS' TRIAL

Try it 30 days—see for yourself. It's a great chance to start a business for yourself—just what you want—the very opening you've been looking for.

**Tremendous Profits** \$20 to \$30 is easy with one machine—many operate two or three—and profit from others labor. No doubt that is what someone is doing with you. Change this—work for yourself. Get all the profits. Be independent.

Remember how much you can earn daily—\$20 to \$30 is clear profit—

**Start a Business of Your Own \$500 to \$1000 a month.** Profits soon pay for the machine. Business is not overrun

—profits steady—thousands and thousands of homes will never own a vacuum cleaner of their own.

These will never think of owning them when they can depend on you.

**You Can Start Small** Start with one home on a street—soon half the homes in that neighborhood want regular service. Endless things to be cleaned—rugs, matting, carpets, mattresses, curtains, upholstered furniture, besides walls and floors

Churches, lodge rooms, dance halls, hotels—

hundreds of places can use your work. No experience necessary—just a little push and courtesy. Clear \$3000 upwards a year.

Mr. Rainbow, writes: "The B. B. does all you claim. I knock out from \$20 to \$25 in six hours easily."

When the money is earned it's practically all yours. The expense is trifling for the gasoline engine.

Mr. Staley, writes: "It's the greatest dirt puller I ever saw. I make \$20 a day with it." Group all these opportunities. Learn that there is no other business where so small an investment will bring such wonderful returns. In fact we have such implicit confidence in the wonderful money-making possibilities of our "Giant" B. B. House Cleaner—that we will ship one to you on 30 DAYS' TRIAL.

**COME TO SEE US AT OUR EXPENSE**

Up to a distance of 300 miles we will pay your traveling expense if you buy. Start now—somewhere—

anywhere. Send today for our free book and complete particulars regarding the 30 days' trial.

Figure the number of homes in your town—compute how much it costs to clean them each week.

You can get part or all of this business. You have scores of friends who would gladly start you with their work—others will surely follow. You can depend upon a nice profitable business from the start.

**The McCreery Mfg. Co., 1012 Front St., Toledo, O.**



Write postal or letter for Free Book. Tells whole story.



## ELECTRIC LANTERN

(No Flash—Light with Wire Ball)

Full size, Solid Brass, Nickel Silver Plated, 10 years' Guarantee. Water, Wind and Fire Proof. Cheaper than all. Sells on sight. Agents crazy about it. Secure Exclusive County Sale. Profits will take the Wrinkles out of your Pocketbook. Agents' samples at cost. If you are alive this is the ad to answer.

Jenks Lantern Co., 206 N. 5th Ave., Chicago

## THE MASTER SLIDE RULE



IMPROVED INTERLOCKING RUST PROOF—FOOL PROOF

the only RULE in the WORLD whereby inside measurements of doors and windows, etc., can be taken rapidly and accurately. Also superior to any other rule for outside measurements of walls and ceilings, etc., as it can be extended and closed instantly. MECHANICS, BUILDERS, AND ARCHITECTS. TRY ONE TODAY! DON'T WAIT. Ask hardware dealer for it.

On receipt of 15 cents per lineal foot, a 4, 5, 6 or 8 foot rule will be sent to you prepaid. Large profits to agents. Write for circulars and particulars.

DAHL MFG. CO. 51-A East 42nd St. NEW YORK CITY

**FIRE LOSS IN THE U. S. IN 1914**—The total fire loss last year was \$235,591,350, which was about \$11,000,000 more than in 1913. The 1914 loss was higher than any year in the history of the country with the exception of the three conflagration years, 1908, when Chelsea, Mass., burned; 1906, the year of the San Francisco conflagration; and 1904, when the business section of Baltimore burned. However, it must be understood that values have materially increased.

## There is Big Money in Automatic Card Printing

The Automatic prints while you wait Business and Calling Cards, Tickets, Invitations Announcements & many others. Prints 100 per minute, 6000 per hour. Write today for our free catalog 36.

S. B. FEUERSTEIN & CO.  
542 W. Jackson Blvd., CHICAGO



Over One Million in Use.  
Millions to be Sold.

## AGENTS—The Million Dollar Hit!

New, wonderful home invention, just introduced, yet million sales already recorded. Tremendous, rapid sales stagger country. Agents happy—banking enormous profits daily. Might opportunity for you to get the mighty dollar. Failure impossible. Experience unnecessary. Money rolls in first hour—\$10 to \$30 daily. Amazing cash records made. Walters received

## \$50.00 FOR 7 HOURS' WORK

Never sold goods before. Arnold sold 160 in 2 days; Hagen 100 same time; Webb 10 per hour; O'Connell 25 first day. Hundreds like these. You, too, can have money in abundance. Grab's Scientific Shoe Cleaner sells itself—you take orders—that's all. Every family wants one on their doorstep. Replaces unsightly, unsanitary, crude door mat. Automatically removes mud, dirt, snow from shoe in one operation. Cleans sole, sides, heel. Works like magic—safe like sixty. Saves drudgery, time, money, shoes—saves carpets, floors. Mechanical wonder. Has 7 new patented features not found in any other shoe brush—10 steel blades—10 dirt outlets—twin adjustable and removable brushes—compound springs. Rotates for sweeping. Can't clog—practically self-cleaning. Handsomely enameled. Nothing else like it. Nothing so popular—so easy to sell. Selling price only \$1.00. You make half—100 per cent. Satisfaction guaranteed. Write quick for free catalog—exclusive agency. Better still, send order, sample territory. Invest where anyhow.

SECURITY MFG. CO., Dept. 93, TOLEDO, OHIO



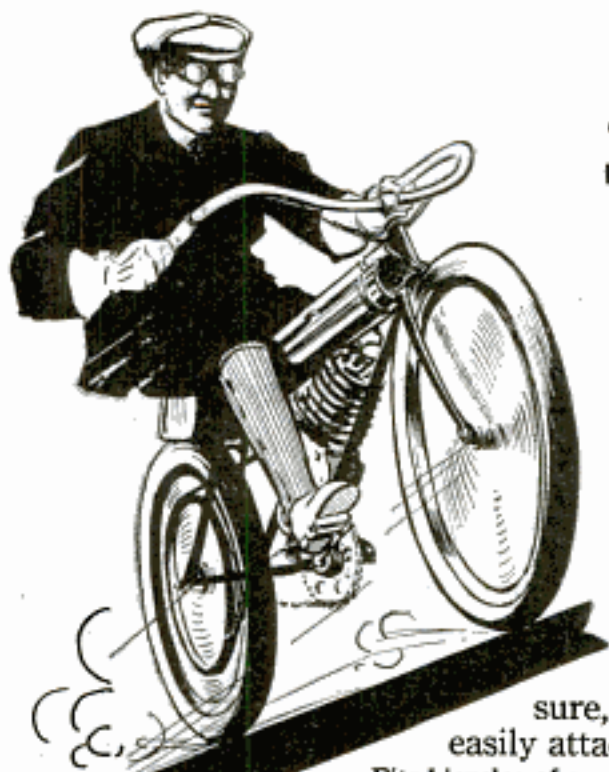

# Make Your "Bike" a Motorcycle

Yes, thousands of others have turned their old-fashioned bicycles into up-to-date, swift, sure, easy riding, high power motorcycles with the easily attached, inexpensive *Shaw motorcycle attachment!*

Fits bicycles of any make or size. Everything is complete and we send it to you all ready to attach to your bicycle in just a few minutes without the aid of an expert mechanic and without any special tools—just an ordinary wrench and screwdriver.

Built of highest grade, most serviceable materials; every part guaranteed; plain, easily understood directions sent with each equipment. Thousands of enthusiastic owners everywhere. Here is your chance to get a powerful, dependable, durable, fine looking and speedy motorcycle at a price so small you will wonder how you ever got along with the old-fashioned "leg power" machine!

## Read What These Users Say of the Shaw Motorcycle Attachment

### "IT'S THERE—RUNS FINE"

Moose Lake, Minn., December 7, 1914.  
Shaw Manufacturing Co., Galesburg, Kansas.

Gentlemen: The Motor Attachment that you sent to me is a dandy. It runs fine. It is right there, Johnnie on the spot, all kinds of roads and hills.

The boys here think it is a little dandy. There are quite a few of the boys thinking of buying an Attachment in the spring. As our winter is setting in now they could not make use of it any more this fall.

WALTER J. EHR.

### "HAS ENOUGH POWER FOR TWO"

Rockville, Mo., December 8, 1914.  
Shaw Manufacturing Co., Galesburg, Kansas.

Gentlemen: I got the engine and put it on Friday night. I towed two bikes with riders on to Rockville, a distance of five miles, and brought one back. The engine has power for two bicycles.

JOSEPH BIRN.

### "TAKES ME OVER ALL KINDS OF ROADS"

Shaw Manufacturing Co., Galesburg, Kansas.

Dear Sirs: In reference to your 2½ H. P. Shaw Bicycle Attachment, must call it a very reliable attachment for bicycles which does away with all foot propelling, giving one the sense of coasting down hills all the time. As to power it will take me over all ordinary roads and hills. Have run my machine in the dead of winter while 50 degrees below zero as well as towing two bicycles and riders in ordinary weather. A "Shaw" makes all roads look alike. The joy of bicycle riding without pumping.

GILBERT SEARIGHT, Milden, Sask., Canada.

### "I AM MUCH PLEASED"

Richmond, Va., August 12, 1914.  
Shaw Mfg. Co., Galesburg, Kansas.

Gentlemen: I am much pleased with the little attachment. I have seen two of them in action since writing you. They were working very nicely. I enclose my order and part payment. Please ship this order soon as possible by express, balance C. O. D.

W. R. COLEMAN.

3011 W. Clay St., Richmond, Va.

### "GIVES PERFECT SATISFACTION"

Shaw Manufacturing Co., Galesburg, Kansas.

Dear Sirs: The Motor that I purchased from you is giving perfect satisfaction and has plenty of power for all ordinary hill sand. As for speed there is no other make of motorcycle around here that has anything on it. Wishing you many sales, I remain HERMAN E. KRIFFER, Georgetown, Ohio

CONVERT YOUR  
BIKE INTO A  
MOTORCYCLE



Just What You Have  
Been Looking For!

Shaw Manufacturing  
Company

Galesburg, Kansas

Thousands in Use  
in America and  
Foreign  
Countries

SHAW  
Manufacturing Co.  
Dept. 74, GALESBURG, KANSAS

Please send me, free and postpaid, copy of your book illustrating and describing the SHAW Motorcycle Attachment as advertised in the March issue of POPULAR MECHANICS. Quote me your lowest net cash, factory price.

NAME .....

ADDRESS .....

## Write For FREE BOOK!

We want to send you, free and postpaid, a copy of our booklet illustrating and fully describing the SHAW Motorcycle Attachment. When you read about the simplicity and the low cost of the SHAW attachment you will no longer be satisfied with your old-fashioned, slow-going, tiresome bicycle, but will want to send and join forces with the thousands of other go-getters who are now hitting the high speed trail with a SHAW!

Send name on the coupon or postal card for the free booklet today

Shaw Manufacturing Co.  
Department 74 Galesburg, Kans.

# Western Electric Washer and Wringer

Simple - Saving - Sanitary

Washing clothes by electricity is easiest, quickest, cheapest and most thorough. Cost of current is very small. The saving on clothes and time will quickly pay for the electric washer.

In this Western Electric Washer the cylinder automatically reverses, gently swashing the clothes back and forth until perfectly clean. The wringer is also reversible, and has a safety release. The operating mechanism is enclosed and does not require attention while running.

Get full information—FREE. Write nearest house below for our Free Trial Plan and copy of Booklet No. 86-AW.



## WESTERN ELECTRIC COMPANY

Manufacturers of the 8,500,000 "Bell" Telephones

New York  
Buffalo  
Philadelphia  
Boston  
New Orleans

Atlanta  
Richmond  
Savannah  
Cincinnati

Chicago  
Milwaukee  
Pittsburgh  
Cleveland

St. Louis  
Indianapolis  
Minneapolis  
St. Paul

Kansas City  
Oklahoma City  
Dallas  
Houston

Denver  
Omaha  
Salt Lake City  
Los Angeles

San Francisco  
Oakland  
Seattle  
Portland  
Detroit

EQUIPMENT FOR EVERY ELECTRICAL NEED



### FREE BOOK Tells How to Win Song Birds to Live in Your Garden

That article on *Native Song Birds in Feb.* Popular Mechanics (pages 47 to 59) was illustrated by cuts of the famous **Dodson Bird Houses**—which are winning song birds as tenants in thousands of gardens. If you want to have native birds write for The Dodson Book About Birds at once—it's free.

Among the 24 kinds of houses, shelters, baths, etc. I make for birds are: Dodson Purple Martin House—20 rooms and attic. Price, \$12, or with all-copper roof, \$16. Dodson Bluebird House—Solid oak, copper roof, \$5. Chickadee or Nuthatch Houses, \$1.50 to \$3.00. Flicker Houses, \$2.50 to \$5.00. Tree-Swallow House, \$3. Bird Feeding Shelters, \$1.50 to \$10.

The Famous Dodson Sparrow Trap catches, automatically, as many as 75 sparrows a day. Price, \$5. Get rid of sparrows and so help the song birds. All prices are f. o. b. Chicago. Write for my free, illus. book—today.

**JOSEPH H. DODSON, 729 Security Bldg., CHICAGO**  
Mr. Dodson is a Director of the Illinois Audubon Society

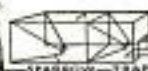

SPARROW TRAP

MARTIN HOUSE

BLUEBIRD HOUSE

BIRD BATH

A Base Ball Jersey



### Without a Cent of Cost to You

I give you a very fine pure wool sweater; double collar and cuffs, your choice of color. Just handle for me your club's spring order for baseball goods—at special discount, and this jersey is yours. Send for complete catalogue of my best grade sporting goods at wholesale prices—basketball, baseball, tennis, golf, etc. **WRITE ME NOW.**

**JACK SHANNON CO.**  
Dept. 22, 54 E. Monroe St., CHICAGO

## VENUS PENCILS FOR PERFECT SATISFACTION

Venus, made in 17 degrees to meet every technical requirement (6B softest to 9H hardest). Also 2 copying degrees for billing and manifold. Ask for booklet and free trial sample.

**AMERICAN LEAD PENCIL CO.**  
210 Fifth Ave. NEW YORK

## SATIN LINING FREE

Our Guarantee

*We guarantee to please you in style, fit, fabrics and workmanship or you don't pay us one cent*

## In This Handsome Blue Serge Suit

Our system of selling fine tailoring direct—through no stores, agents or dealers, saves you big money and enables you to dress better. We want you to become one of our regular customers—that's why we will make one of our regular all-wool worsted blue serge suits

**Tailored-to-Your-Measure (\$25.00 VALUE) \$15**

and line it with guaranteed \$4 satin lining free—also pay shipping charges. Read the guarantee—we take all the risk—you take none. Send for our NEW SPRING CATALOGUE.

**BIG BOOK—70 Samples—Mailed FREE** Contains generous samples of our plain and fancy suitings (prices \$15 to \$27)—explains our tailoring system—quotes lowest prices on men's furnishings, hats and shoes, also boys' clothes. Send for your copy today to

**Bernard-Hewitt Co.** Desk D93 564 W. Monroe St. Chicago



# 10 CENTS A DAY Buys This Standard Visible Oliver Typewriter

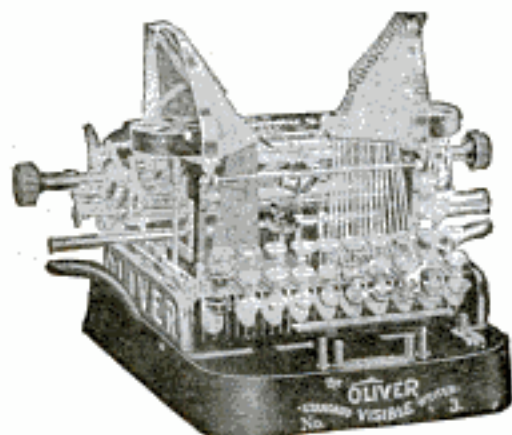

## Less Than Half Price FREE Trial—10 Year Guarantee

This is the best typewriter offer ever made. The typewriter is the genuine model No. 3 Standard, Visible Oliver with complete brand new equipment. Perfect machines only. Not shop worn, not damaged, not inferior. Warranted to be the equal in quality of any other \$100 typewriter.

This offer is not on some ancient style of blind typewriter but on an up-to-date, standard, visible machine, the same kind of typewriter that many thousands of the world's best business firms are today using.

### Oliver Points:

Nearly one-half million Olivers have been sold. Its record has never been equaled. It is easily "The Favorite."

Its simple efficiency, lightness and durability place it in a class ahead of all others; writing always in sight; writes in many different colors without changing the ribbon. Has the universal keyboard. The type is beautiful, it is so hard that nothing can mar it. It outwears type found on other machines.

It is the lightest of all the standard typewriters. It is the only practical, portable typewriter. It has the lightest key action. Its speed is unlimited. It has the patented "U" shaped type bar which insures perfect alignment of the letters. One can write on ruled lines with it or it can be used to draw lines. It makes an efficient billing machine as well as correspondence machine.

The downward stroke of the type bar gives greater power. The Oliver is nearly always chosen for manifolding—some firms write as many as 20 copies at one writing. It does any practical thing which any typewriter can do.

It has the fewest parts. It requires the least adjustments. There is nothing to wear out. We guarantee it for 10 years.

While it is the choice of the experts, it is so simple in its design that anyone can learn to write on it in 10 minutes' time.

### Sensational Reduction

Many thousands of purchasers paid \$97.50 for typewriters of this model. They were satisfied that at that price they were getting the best value that the market afforded.

Now without any reduction in quality and with brand new standard equipment, our price to you is but \$47.00—a saving of over half and we give you over a year in which to pay.

### Our Offer Is This

Send the coupon and we will forward one of these typewriters with complete equipment on five days' trial. We will ship it by express. When it arrives you leave \$5 with the express agent to be held while you try the typewriter.

If you do not find it to be the best typewriter that you ever examined, satisfactory in every respect, the best value offered anywhere, then you simply return it to the express agent who will give you back the \$5 and return the typewriter to us at our expense.

If you decide to keep it, the express agent will forward the \$5 to us and it will be deducted from the \$47.00 price, leaving a balance of \$42 which you can pay at the rate of \$3 per month, the first monthly payment not being due until one month after date of delivery.

There is no interest charges, no red tape, no salesmen, no collectors, no bother. The simple coupon is all we require.

The typewriter we will send you will be delivered in the original package as put up in the factory of the manufacturer, perfect in every detail.

Send the coupon today. Make sure of getting this bargain, as we will only supply 100 typewriters at this price.

### Typewriters Distributing Syndicate

(OFFICIAL DISTRIBUTORS)

166-54A No. Michigan Blvd., CHICAGO, ILLINOIS

### Trial Order Coupon

#### Typewriters Distributing Syndicate

(Official Distributors)

166-54A No. Michigan Blvd., Chicago, Illinois

You may send me a No. 3 Oliver Typewriter on approval.

When it arrives I will leave with the express agent \$5 with the understanding that if I do not wish to keep the typewriter that the \$5 will be returned to me by the express agent when I return the typewriter to him within five days from the date I receive it.

Otherwise I will keep the typewriter and the \$5 will be forwarded to you to apply on your special purchase price of \$47 and I will pay the balance of \$42 in 14 consecutive monthly installments of \$3 each, commencing one month from date of delivery.

The title of the Oliver Typewriter remaining in you until it is totally paid for.

Name.....

Address.....

References.....

(278)

# Manufacturers Calling for Over Two Hundred Inventions

## Money Is Waiting to Back the Good Idea

(By a Washington Patent Attorney)

Never was there so good an opportunity for the inventor of something—*anything*—of merit as right now.

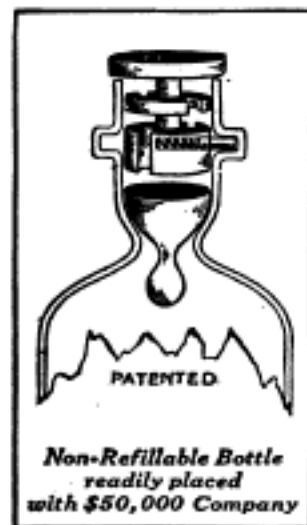

Manufacturers with money and facilities are asking for ideas—*calling* for them. The supply is not nearly equal to demand. Over 200 inventions are asked for in a list just given in a little book "What to Invent." The demand is not for anything extraordinary—just the common everyday things that make work easier or life more pleasant in the household, the shop or the field.

You might think the possibilities of the window screen had been exhausted, but I know of 28 concerns that are looking for a new screen, duly covered by patent, which they can manufacture. I know of 46 manufacturers and others who are ready to manufacture any good, patented household article such as can openers, baking pans, coffee pots, washing machines carpet sweepers and other devices.

Within the last few weeks I have received forty special requests for a dishwasher and drainer; seventeen others request an improvement in scissors. Manufacturers know that everyone must have a pair of scissors in the house, and they realize that a novelty in them would always sell in place of the old kind, and hence the demand. Among my letters are sixteen requests for a device to turn sheet music on a music stand or piano, and seventeen people are interested in the purchase of a patent on a device for holding an electric light in any position. Besides these there are hundreds of manufacturers who do not specify any particular device but state that they would be interested in anything of merit



A Chicago man says: "I want something that can be sold to farmers by mail. There is practically no limit to the investment my associates would make in a good proposition." A man in Woodhaven, N.Y., says he is in the market for a small household article, light in weight, which can be sold somewhere around ten cents.

A prominent manufacturing company is interested in something to sell to hardware stores, but would also be interested in other things promising to be money-makers.

A man in Revere, Mass., says: "I am looking for something that can be manufactured, plant equipped, etc., and marketed for an outlay of not over twenty-five thousand dollars."

A big textile machinery company says they are interested in newly patented devices that can be either bought outright or manufactured on royalty. They do not require machinery inventions alone, but anything of merit.

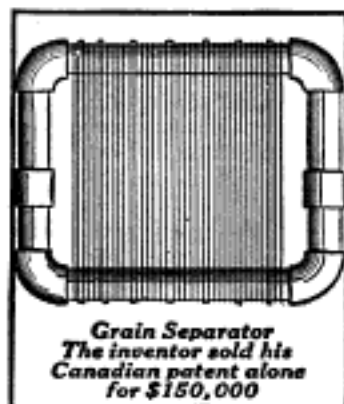

A company in Belvidere, Illinois, wants patents on small tools or metal novelties.

A Dayton, Ohio, concern writes for some machine or device that would have a general sale throughout the land.

The names and addresses of these prospective purchasers are supplied absolutely without charge by Messrs. Chandlee & Chandlee to those who obtain patents through their firm. This firm has been in practice before the Patent Office for over twenty years, and its members are, consequently, familiar with every detail of patent work. They also issue a booklet entitled "How to Obtain a Patent," which tells in simple words just how to go about protecting an invention. The two books, "What to Invent" and "How to Obtain a Patent," are both free. Why don't you write for them and learn what manufacturers are looking for and how to protect your ideas? If you have an invention, send a sketch or model and description of it to Chandlee & Chandlee, 953 F Street, Washington, D.C. They will give you a free opinion as to whether or not it can be patented.

Please Mention Popular Mechanics

# WANTED IDEAS



Inquiries from Manufacturers and Other Buyers of Patents  
Who Are Looking for Good Ideas

## Protected by Owen Patents

Are constantly being received. Hundreds of ideas are wanted—a market exists for them to-day. YOURS may be one of them. Send for my free books and see for yourself—read the requests for inventions protected by me. Many are simple. You can help supply this demand.

As soon as my clients' rights are protected I aid in every practicable way, **without charge**, to sell. Their **applications** are advertised free—their patents are called to the attention of the proper prospective buyers—every necessary thing is done. Get my booklets and see.

## THESE ARE FREE

You will incur no obligation by writing me. A simple request will bring them to you—the finest, most reliable and instructive patent books published. A postal will do.

**"Successful Patents"**—a 72 page guide book, tells how to proceed; describes my advantageous business methods; gives references, testimonials, etc.

**"Stepping Stones"**—gives hundreds of hints of inventions wanted; articles from interviews of noted authorities; tells the truth about prizes for inventions.

**"Patent Promotion"**—tells you how to sell; why some inventors fail; discusses the value of your idea; how I aid my clients; manufacturing aids furnished you; recent successful patents, etc.

You will also be sent from time to time, as new inventions are wanted, full information concerning them. Only in this way can you keep up to date.

**Write for These To-day**—Advice costs nothing. All communications confidential. I secure patents or receive no compensation. Your work will receive my personal supervision—but my fees are no higher than others.

## Results Speak Loudest—But Here Are Some References

Columbia National Bank,  
Washington, D. C.  
National Locktile Co.,  
Washington, D. C.  
The Carnahan Press,  
Washington, D. C.  
Lightning Gun & Cycle Works,  
Oklahoma City, Okla.  
Antholene Mfg. Co.,  
Hutchinson, Kans.

National Rack Co.,  
61 Hannover St.,  
Boston, Mass.  
The C. J. Loftus Co.,  
13 Spring Common,  
Youngstown, Ohio  
Whitehead Hosiery Mills,  
Burlington, N. C.  
Dickinson Mfg. Co.,  
Des Moines, Iowa.

A LARGE NUMBER OF OTHERS IN MY BOOKLETS.

**RICHARD B. OWEN** 9-303 OWEN BLDG.  
WASHINGTON, D. C.

Inventors submitting their inventions to me are protected in a tangible manner until their applications are filed.



### Search of Records

Send sketch or model of your invention for free search of **Patent Office Records** and report on patentability.

# PATENTS THAT PROTECT and PAY

Send for FREE 96-page book. Advice free. Terms reasonable. Highest references. Best results.

Send sketch or model for FREE examination and opinion.

Recommended Patent Lawyer in the Bankers' Register and special list of selected lawyers. Also in Martindale's Law Directory, Sharp and Alleman's Directory of Lawyers, The Gast-Paul Directory of Lawyers, and Kime's International Law Directory.

**ALL BUSINESS GIVEN PROMPT AND PROPER ATTENTION**

A large list of strong recommendations furnished free

**WATSON E. COLEMAN, Patent Lawyer, 622 F St., N.W., Washington, D.C.**

## Money in Patents

Manufacturers are always looking for inventions. All patentable ideas should be protected by a patent. (By a Registered United States Patent Attorney.)

The great majority of money making inventions are thought of by persons, I will term amateur inventors, and nearly always are some very small or simple thing, for the reason that a large invention takes too much time and money for the average person to produce. I have inquiries from all over the country, in which manufacturers and business houses are looking for patents in every line of industry. Owing to these inquiries I am about to put inventors in direct touch with manufacturers who want patents, and thereby find a ready sale for their invention, which, for results, is far more practicable than any other mode of assistance to inventors.

A book "How to get your patent and make your profits thereon," which contains general patent information, is free and I would be very glad to have you write me for a copy of it.

**MANSSELL F. MILLS**

Registered United States Patent Attorney

244 Commercial National Bank Building, WASHINGTON, D. C.

## PATENTS

**C. L. PARKER**  
Formerly Member Examining  
Corps, U. S. Patent Office  
**PATENT LAWYER**  
210 MCGILL BLDG.  
WASHINGTON, D. C.

Patents, Trade Marks, Copyrights, Patent Litigation

Handbook for Inventors, "Protecting, Exploiting and Selling Inventions" sent free upon request.

### A Fortune to the Inventor

who reads and heeds it, is the possible worth of the book we send for 6 cents postage. Write us at once.  
**E. S. & A. E. LACEY, Dept. Y, WASHINGTON, D. C.**

**THE YUKON FIFTH IN SIZE OF NORTH AMERICA'S RIVERS**—The Yukon River in Alaska is the fifth in size of the great rivers of the North American

Send for **FREE BOOK** { **WHAT TO INVENT**  
**WHAT NOT TO INVENT**  
**HOW TO SELL YOUR PATENT**  
Copies of nearest Patents and report in every case without charge  
**H. L. WOODWARD, 9th and G Sts., WASHINGTON, D. C.**



**MECHANICAL SUPPLIES AND MATERIAL** of all kinds. **EXPERIMENTAL AND LIGHT MACHINEWORK** to order.  
**132 MILK STREET, BOSTON**



## Models and Supplies

We make working models of any description and material, also dies, tools and sheet metal stampings. Send your drawing or sample for estimate. Write for catalog of gears and model supplies.

**The Pierce Model Works, 3405 Pierce Ave., Chicago, Ill.**

## PATENTS THAT PAY

OUR TRADE-MARK

**OVER \$600,000.00 MADE BY CLIENTS**

### PATENTABILITY REPORT

Send sketch or model of your invention for free search of the Patent Office Records and report as to patentability.

### 2 WONDERFUL BOOKS

entitled (1) "Inventor's Guide" and (2) 127-Page "What and How to Invent—Proof of Fortunes in Patents" which every inventor should have, and can have, FREE.

Highest References, including 100 manufacturers we serve  
— Promptness Assured —

Across the Street from the U. S. Patent Office  
**E. E. VROOMAN & CO., 871 F STREET, N. W., WASHINGTON, D. C.**

Please Mention Popular Mechanics



Active Powers of Inventive Genius

## INVENTORS

Our Brain Belongs to You. Our Ideas

Are Free of Charge.

All we want in return is to build your model, special machinery, dies, tools and jigs to manufacture sheet metal goods, etc. We are expert mechanics, over thirty years' experience and have one of the best equipped shops in the country. Ask for Booklet No. 17. Consultation free. Experimental work strictly confidential.

**A. Naecke & Son, J. Urman, J. Heldrich, Prop's**  
136-212 S. 9th St., Philadelphia, Pa.



## BRASS GEARS

Cut by an entirely new process. The most accurate made and at prices that cannot be equaled by others. Every gear has a hub, center painted ebony black, edges turned true, highest grade rod brass, and much heavier than others. We carry the largest stock in the world and every gear listed is always shipped on date of order.

SEND FOR CATALOGUE  
**CHICAGO STOCK GEAR WORKS**  
16 S. Fifth Av. Chicago

# Patents

Trade Marks and  
Copyrights Secured  
or Fee Returned

## Special Offer—Free Search of Patent Office Records

Send us a model or sketch and description of your invention, and we will make a *Free Search* of the *Patent Office Records* to ascertain if it is patentable. If we report the invention patentable, we will guarantee to obtain a patent or return our fee, and furnish a certificate of patentability backed by a bonded contract to that effect. **This Certificate of Patentability will protect the inventor and serve as proof of the invention until the case can be filed in the U. S. Patent Office.**

### Obtaining Assistance for Inventors

Our certificate is of great assistance to inventors who require financial aid to obtain patents.

### Our Five Books Mailed Free

(SEE COUPON BELOW)

to any address. Send for these books—the finest publications ever issued for free distribution.

#### How to Obtain a Patent

Our illustrated eighty-page Guide Book is a book of reference for inventors, and contains 100 mechanical movements illustrated and described.

#### Money in Patents

Tells how to invent for profit, and gives history of successful inventions.

#### What to Invent

Contains a valuable **LIST OF INVENTIONS WANTED** and suggestions concerning profitable fields of invention; also information regarding prizes offered for inventions, among which is

#### Prize of One Million Dollars

offered for one invention, and \$10,000 for others.

#### Patents That Pay

Contains letters from our clients who have built up profitable enterprises founded upon patents procured by us; also endorsements from prominent inventors, manufacturers, Senators, Congressmen, Governors, etc.

#### We Advertise Our Clients'

#### Inventions Free

In a list of Sunday newspapers with two million circulation, in manufacturers' journals and in the *World's Progress*. Sample Copy Free. We save you time and money in securing patents. After the patent is granted we assist you **TO SELL YOUR PATENT.**

#### Foreign Patents

**WE HAVE DIRECT AGENCIES IN ALL THE PRINCIPAL FOREIGN COUNTRIES** and secure **FOREIGN PATENTS** in the shortest possible **TIME** and at the **LOWEST COST**. Write for our Illustrated Guide Book on Foreign Patents, sent free to any address.



**VICTOR BUILDING**

Our new \$200,000 building opposite U. S. Patent Office  
SPECIALLY ERECTED by us for OUR own use

## WANTED NEW IDEAS

Send for **LIST OF PATENT BUYERS** who consult us when purchasing patents. Contains requests from **MANUFACTURERS, MAIL ORDER HOUSES** and **PROMOTERS** for patents secured by us, and suggestions as to **New Ideas** they wish to purchase. We invite manufacturers and promoters to address our Sales Department regarding the purchase or leasing of a number of meritorious patents secured by us.

### REFERENCES

Second National Bank, Washington, D. C.; Union Savings Bank, Washington, D. C.; Chamber of Commerce, Washington, D. C.; Pitner Gasoline Lighting Co., Chicago, Ill.; R. G. Dun & Co., Washington, D. C.; Smethport Glass Co., Smethport, Pa.; The Melvin Gauge and Signal Co., Scranton, Pa.; M. Winter Lumber Co., Sheboygan, Wis.; National Savings and Trust Co., Washington, D. C.

### FREE COUPON!

## VICTOR J. EVANS & CO., Patent Attorneys

NEW YORK OFFICES: 189-191 Broadway

PHILADELPHIA OFFICES: 1429 Chestnut St.

Main Offices: 765 Ninth St., N. W., WASHINGTON, D. C.

GENTLEMEN: Please send me **FREE OF CHARGE** your **FIVE** Books as described above.

NAME..... ADDRESS.....

## Water Without Pumping Plenty of It Too



**A**BSOLUTE reliability, low first cost, and no need of attention and repairs are the requisites of a perfect water system. Engines are often a source of annoyance, windmills depend entirely upon the wind, and hand pumping is enough to drive anyone off the farm. Be absolutely free from all water supply troubles—install a

### RIFE RAM

Any stream in your neighborhood having a fall of three feet or more and a supply of three gallons or more per minute, will operate it. The Rife Rams vary in size from a machine for one family's use to a city water system. Thus you can co-operate with your neighbor if there is no stream on your farm.



**REMEMBER:—Low First Cost—No Repairs for Years—No Freezing—No Fuel—No Labor** are the high qualities of the Rife Ram. No skilled labor required to install it. Over 11,000 in daily use. Satisfaction guaranteed. Write today for catalog and

Tell Us Your Water Supply Conditions

and we will send free estimate on your requirements.

Rife Engine Company 3131 Trinity Building  
New York City

## Jones Machine Moulded PULLEYS and GEARS Clutches, Sprockets Shafting and Hangers

THE LARGEST LINE OF  
Power Transmitting Appliances  
IN THE COUNTRY

SEND FOR GENERAL CATALOGUE A18

W. A. JONES FOUNDRY & MACHINE CO.  
1400 North Ave. CHICAGO

## "IDEAL" Lawn Mower Grinder

Grinds all makes of Mowers perfectly in 15 minutes without removing wheels, ratchets or reel-knife. Ball-bearing; operated by either hand or power. Skate Sharpener Attachment for sharpening skates.



"You Grind It As You Find It"

**Write Today** for full information of this great labor-saver and money-maker. Will do the work so much better, quicker and easier you cannot afford to do without it. The only practical machine for sharpening Lawn Mowers on the market. Over 6000 in use. Fully warranted. Sold on easy-payment terms. Write today. Don't delay.

THE ROOT-HEATH MFG. CO., Plymouth, O.

continent. Its drainage area is estimated at about 330,000 square miles, and its length, including the Lewes and Teslin rivers, at 3,200 miles. This may be compared with 6,000 miles for the Mississippi and Missouri; 2,868 miles for the Mackenzie; 2,000 for the Colorado combined with Green River, and 1,300 for the Ohio combined with the Allegheny. The flow of the Yukon is small as compared with its drainage area, which is accounted for by the small rainfall characteristic of the interior Alaska.

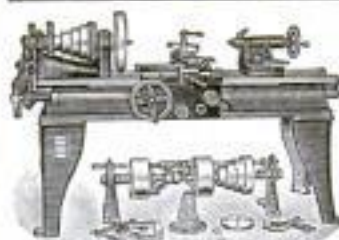

### OUR BIGGEST LATHE VALUE

16-inch Lathe with 6-foot bed, \$352.00; other sizes at proportionately low prices. Every lathe guaranteed. Buy your lathe from us and save \$50.00 or more. Machinery Catalog No. 80P139 sent free on request.

SEARS, ROEBUCK AND CO.  
CHICAGO

## SEBASTIAN LATHES HIGH QUALITY LOW PRICES

Do you delight in good tools? Then you will delight in a Sebastian Lathe. We have been building Lathes for 25 years. The big factory at Cincinnati is equipped with modern and most improved machinery, and employs skilled labor only. Nothing is built there but Lathes. Specializing on this one tool, together with the larger number manufactured makes Sebastian Lathes

### THE STANDARD FOR QUALITY AND LOW IN PRICE

Simple and durable construction makes them accurate and economical. This is proved by many re-orders and voluntary letters, like this one from The Kretschmer Mfg. Co.: "The Lathe we purchased from you 8 months ago is giving us entire satisfaction. We have given it severe work in every way that a Lathe is used, without the least dereliction from perfect work. Should we have occasion to purchase another Lathe it certainly would be a Sebastian." Our reputation stands back of every Sebastian Lathe. It has got to be as represented or you get your money back. Ask for our new catalog and look over the lines of Lathes for general repair work, garage and automobile work, etc., and when you buy a Lathe—say "Sebastian." Address,

THE SEBASTIAN LATHE COMPANY, 107 Culvert St., CINCINNATI, OHIO



### Sebastian 15-inch Lathe

Ideal for auto builder, garage, repair shop and general jobbing shop. Convertible, rigid, strong—rapid—accurate. Cuts standard threads with furnished gears from 5 to 26. Greatest machine in the world for small and medium sized work.



## Tools that Every Man Needs

Every man likes to work with tools, whether he earns his living with them or not. Many of our tools are useful not only to the skilled mechanic, but to the man who works about his home on conveniences or on his own inventions. Take, for instance, work on furniture and fine woodwork. You'll find that the

# Starrett Scraper

will put a smooth, satiny finish on any kind of wood. Ball and socket handle connections permit work in corners and narrow places. The blades are sharpened on four sides, giving eight cutting edges. Slip-on handle permits instant change from edge to edge and gives perfect protection. Price \$1.00.

Send for big free catalog No. 20 A-P describing the other Starrett tools for various purposes.

Our tools are sold at all good hardware stores

**THE L. S. STARRETT CO.**

THE WORLD'S GREATEST TOOLMAKERS.

42-228

ATHOL, MASS.



### South Bend Lathes

For the Machine and Repair Shop

11 inch Lathe Complete	\$100.00
12 inch Lathe Complete	125.00
13 inch Lathe Complete	165.00
16 inch Lathe Complete	200.00
18 inch Lathe Complete	250.00

Straight or Gap Beds. Send for free catalog giving prices on entire line. SOUTH BEND MACHINE TOOL CO. 423 Madison St., South Bend, Ind.

**How to Run a Lathe**  
A 50 cent book for 10 cents. Postpaid, stamps accepted

## THIS MACHINE WILL EARN \$20 to \$50 Daily Profit For You

Making Cement Bricks and Blocks



Factory owners are the biggest money makers in America and this machine will place you in their ranks. You can start with little capital and even without experience. This machine makes pressed cement bricks and blocks under 80,000 pounds pressure. No tamping and easy work. It makes 1,000 blocks or 100,000 bricks daily. No burning required. Ready for the market in a few day's time. They are necessary for the

### Helm DRY WALL Building System

This is the system that appeals to builders, contractors and architects. It overcomes the opposition to concrete because it offers absolutely DRY WALL construction. It saves money for builders, as no furring and lathing are required, and it makes rigid walls and fireproof walls. This is the system which is bound to get you business and give you the advantage over all other products. \$50 and up starts you.



#### Send for This FREE CONCRETE BOOK

Tear off the corner coupon right now before you turn the page. Let this free book tell you all about

this great opportunity which is open to you today. It will tell you all the details of this system, about the Helm Press and the DRY WALL building system. It will show you how easy it is to start a profitable business. It tells how each product is made, how it is cured and sold. Write today. Do it now.

**Helm Brick Machine Co.**  
123 Mitchell St.  
CADILLAC, MICH.

**Helm Brick Machine Co.**  
123 Mitchell St.,  
Cadillac, Mich.

Please send FREE the book on concrete and Helm Presses.

Name.....

Address.....



## LATHES

9 to 18-inch Swing

List price \$75 and up according to size. When ready to buy send for Lathe Catalog and prices.

**W. F. & John Barnes Co.**  
100 Ruby Street, ROCKFORD, ILL.

### DO YOU HAVE KNIVES TO GRIND, SILVER TO POLISH, SMALL TOOLS TO OPERATE, WASHING MACHINES OR WRINGERS TO RUN? LET THE RED DEVIL DO YOUR WORK

Attached to any water faucet will develop up to 3 Horse Power according to size of pipe and water pressure. Only perfect small motor made. Improved bucket wheel construction.

6 in. Motor for Mechanics and Tradesmen. Washing Machine, 1/2 H. P., on 1/2 in. pipe, 60 lbs. water pressure; 1 H. P., on 3/4 in. pipe, 80 lbs. water pressure. Net price \$5, cash with order.

No. 1492 - 4 in. Motor for grinding, polishing, fans, sewing machines; for Doctors, Dentists, Druggists, etc., with emery, buffing wheel, silver polish and pulser, \$3.

No. 1493 - 4 in. Motor and pulley only \$2.50, cash with order. Money back for any reason. Order your motor from dealer or from us. Send your water pressure and size of supply pipe. Active Agents wanted. Catalog free.

Only Motor to do this work



**DIVINE WATER MOTOR CO**  
DEPT P. UTICA, N.Y.

Please Mention Popular Mechanics



## A Combination Caliper and Divider

You can use it as an inside caliper, an outside caliper, an hermaphrodite caliper or as dividers. The holders have split chucks on the ends and the auxiliary legs can be quickly put on and taken off by turning the knurled nut. A pencil can be used in place of one of the legs for a compass. It's a handy tool, is made of steel and like all B. & S. tools is carefully finished.

### Brown & Sharpe Calipers and Dividers

are made in several styles and many sizes for various uses. They are in the tool kits of thousands of mechanics because they are well made, carefully finished and reliable tools.



If interested in high grade tools ask the hardware dealer to show you the Brown & Sharpe line. Ask him for one of our catalogs or send us a postal for free copy.

## Brown & Sharpe Mfg. Co.

PROVIDENCE, R. I., U. S. A.

## The Grinder for Your Tool Kit

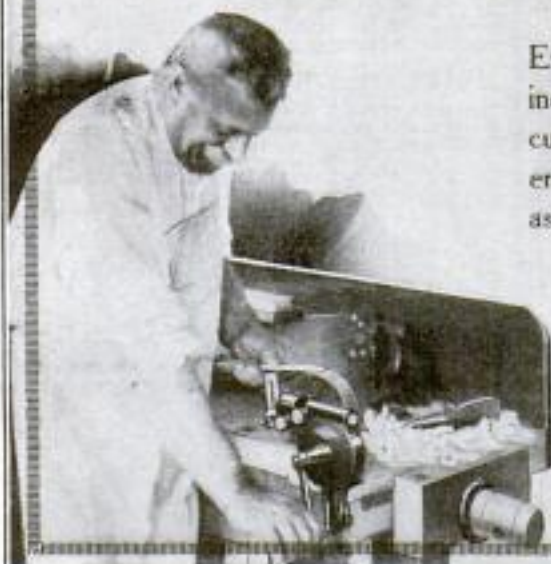

Is the durable, serviceable, easy-running machine—the machine that is made right of the best of materials—that has accurately cut gears, dust- and oil-proof castings, malleable handle and clamp. The grinder for your tool-kit is the

### Carborundum Niagara Grinder

Every machine equipped with a genuine Carborundum Wheel, the fastest-cutting, longest-lived wheel for general work—every machine carefully assembled.

*From your hardware dealer or direct.  
Made in several sizes. Send for catalog of Carborundum Grinders and Sharpening Stones.*

The  
Carborundum Company

Niagara Falls, N. Y.

Please Mention Popular Mechanics

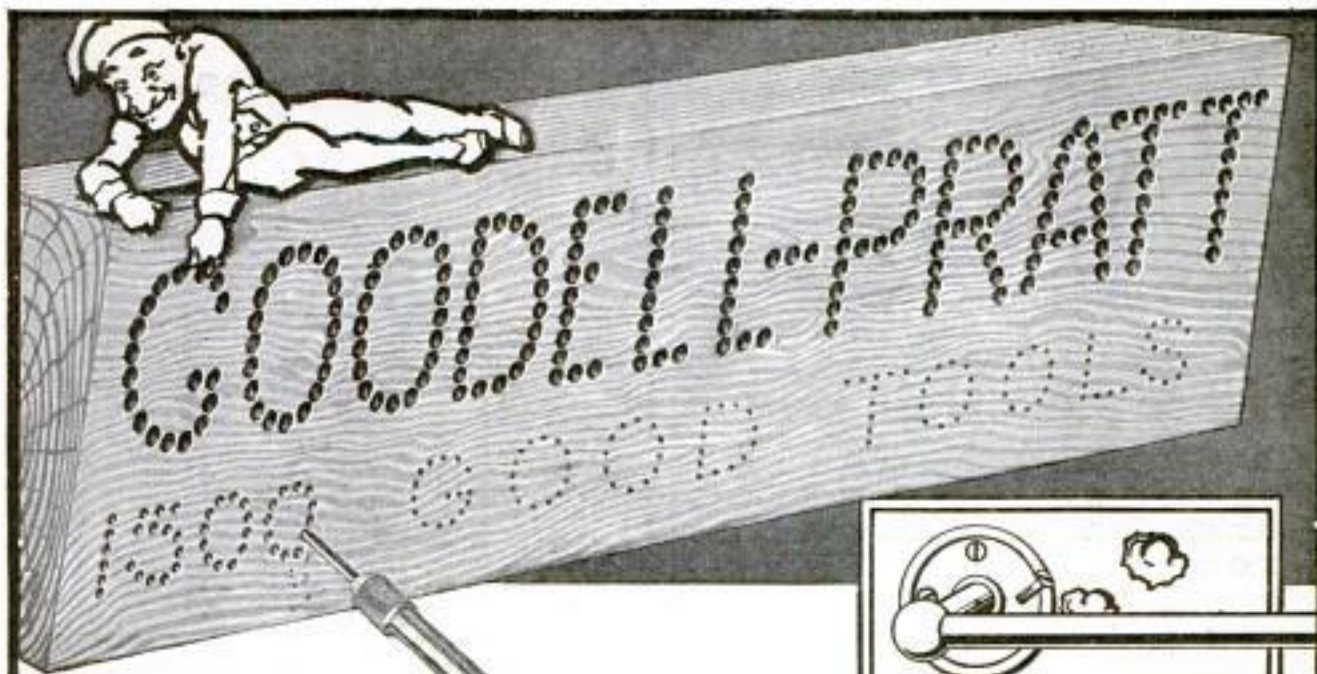

## You Push He Twists

Zip! and the drill bites through hardest oak in a few seconds.

Not like a gimlet that cramps the hand and splits the wood—it's as easy as sticking a match into cheese.

Mr. Punch makes a hole that starts a screw right. He is useful in a hundred ways round the house.

# Mr. Punch

Mr. Punch is known to mechanics all over the world as Goodell-Pratt Automatic Drill No. 185. It works by a spiral twist and automatically rebounds after each stroke. You simply place the drill point and push.

There are eight tool-steel drill points in the handle, each showing through a numbered hole. By turning the top the right size drill is released. Mr. Punch is solidly made of brass and is heavily nickel plated. Handle and chuck are machine knurled.

Mr. Punch is the handiest tool in the tool box and ought to be in every home. A joy to man and boy, and for women it takes the terrors out of household tinkering.

"The Goodell-Pratt 1500 Tools" are used by good mechanics everywhere. They are guaranteed. There are several of them which should be in every household, because they will pay for themselves over and over again in economy and in convenience and time saving. A useful book on tools, together with pocket catalog, sent on request.

Send for illustrated book about tools that are useful to everybody. Buy Mr. Punch at any hardware store—\$1.50. If your dealer cannot supply you, order from us.

**GOODELL-PRATT COMPANY, Toolsmiths**  
Greenfield, Mass.



## Don't Mar Walls

by driving in a screw a dozen times to find a lath. Mr. Punch's smallest drill makes a pin prick in plaster and the screw goes in straight.

Hack Saws  
Micrometers  
Saw Sets  
Gauges  
Grinders  
Screw-  
drivers

Punches  
Drills  
Lathes  
Levels  
Vises  
Bit Braces  
Calipers  
Squares

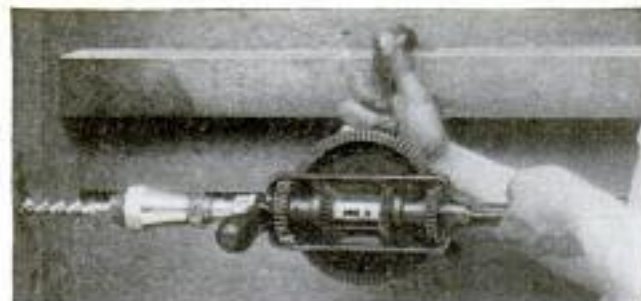

Although there is room for only an inch of movement of the crank—the drill cuts continuously

## Where no other could

This "YANKEE" No. 555 will drill continuously with every movement of the crank even through so small an arc as one inch.

Works in places and under conditions impossible for other drills. Big time and labor saver on repair work in machine shops. The 5 Ratchet adjustments, distinctive "YANKEE" features, include the convenient Double Ratchet on which the drill cuts continuously with every movement forward and back of the crank.

## "YANKEE" TOOLS

*Make Better Mechanics*

Other exclusive "YANKEE" advantages are—Double Speed (the shifting of a little lever changes speed to fast or slow, even with drill in work). Adjustable ball bearings. Cut

Gears. Chuck Jaws—drop forged steel. No. 555—2 jaw chuck for round or square shanks up to  $\frac{1}{2}$  in. No. 1555—3 jaw chuck for round shank only, up to  $\frac{1}{2}$  in. D-handle can be supplied.

### "YANKEE" Ratchet Breast Drill

No. 555—2 jaw chuck } Price  
No. 1555—3 jaw chuck } \$5.25

Your dealer can supply you.

Write for "Yankee" Tool Book" describing "Yankee" Tools, free; for mechanics and householders.

"Yankee" Tools in the Garage," free; for motorists.

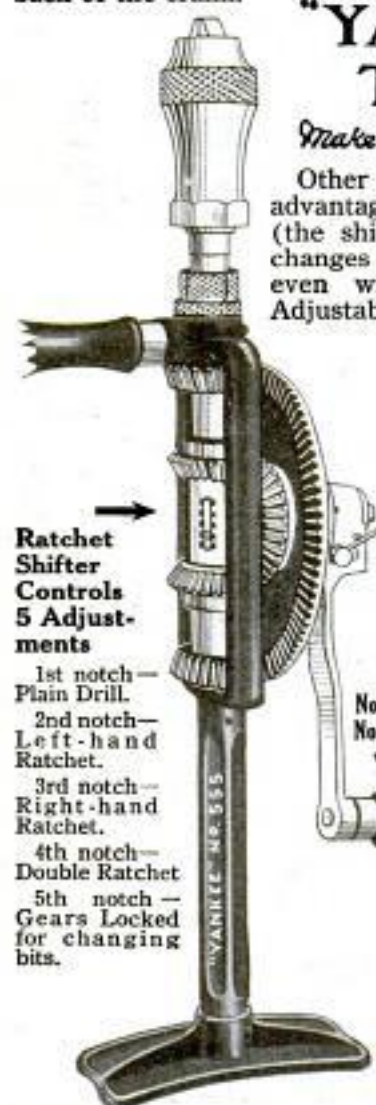

Ratchet Shifter Controls 5 Adjustments

- 1st notch—Plain Drill.
- 2nd notch—Left-hand Ratchet.
- 3rd notch—Right-hand Ratchet.
- 4th notch—Double Ratchet
- 5th notch—Gears Locked for changing bits.

**NORTH BROS. MFG. CO., Philadelphia, U.S.A.**

Please Mention Popular Mechanics

## Williams' Junior "Ford" Set "B"



A combination of thoroughly high-class tools and assured great utility. Each tool class tried out for service upon a model T "Ford" Car. Maximum service in a minimum number of Wrenches.

Send for pamphlet or go to your dealer

List prices, \$1.71, \$2.54, \$3.79 per set.

Roll lists 45c extra.

**J. H. WILLIAMS & CO.**

47 Richards St., BROOKLYN, N. Y. CITY  
Chicago Warehouse, 36 So. Clinton St.

**SKYSCRAPER DESIGNED IN SEVENTEENTH CENTURY**—In 1901, Jacques Perret, a French architect, designed a building that, although it was never erected, may properly claim to be the ancestor of the modern skyscraper. The building, according to Perret's plan, was to be 166 ft. long and 140 ft. broad, with a height of 361 ft., in 11 stories. The walls were to have been more than 12 ft. thick. But in 1901 the methods of building construction were by no means so modern as

## IRWIN BITS

Forged from a single piece of special crucible steel. This steel and IRWIN workmanship are found only in bits made by

THE IRWIN AUGER BIT CO., Wilmington, Ohio

## THE SPEEDY STITCHER

SEWS LEATHER LIKE A MACHINE

Price \$1.00

Send for terms to Agents

Automatic Awl Co., 26 Heron St., Worcester, Mass.



## Portable Cases

FOR TOOL MAKERS AND MACHINISTS

Twelve styles, felt lined drawers, solid brass trimmings, best of material, beautiful finish, low prices, satisfaction guaranteed. Ask for booklet of cases built for service.

The Pilliod Lumber Co.  
SWANTON, OHIO

## YOU OUGHT TO HAVE ONE OF OUR Insured "Vandor" Hammers

—Drop forged from Vanadium Steel, tempered in oil and Warranted for a Lifetime. Sent Postpaid anywhere on receipt of \$1 and Dealer's Name.



Made in four sizes. No. 21½, weight 16 oz. Standard Size. No. 22, weight 18 oz. Gen'l Purpose. No. 22½, weight 19 oz. Finishing Size. No. 22½, weight 16 oz. Hipping Style.

VAN DOREN MFG. CO., Dept. 103, CHICAGO HEIGHTS, ILL.



## Big Chief "Indian Red" Delighted with WHITING-ADAMS BRUSHES OF CIVILIZATION

FOR SALE BY  
DEALERS EVERYWHERE

Send for illustrated literature telling about Whiting-Adams Brushes

MANUFACTURED BY

**JOHN L. WHITING-J. J. ADAMS Co., Boston, U. S. A.**

BRUSH MANUFACTURERS FOR OVER 100 YEARS, AND THE LARGEST IN THE WORLD

A Bench like  
this is just the  
thing for the  
home.



## OHIO TOOLS



Planes, Chisels, Auger Bits, etc.  
It will pay you to insist upon  
getting tools of this brand.

CATALOG FREE

**OHIO TOOL CO.**  
Dept. 3 Charleston, W. Va.

## YOU CAN DRILL WHERE YOU CAN'T DIG

There is a big opportunity in every community for a capable man to establish himself in the well drilling business and make money. The right kind of a man with the right kind of equipment can be independent. Let your equipment be

**★ DRILLING  
MACHINES**

Equipped with either steam or gasoline power. Thousands of STARS are now in use. The demand for drilled wells is increasing. You can drill where you can't dig. It is a well known fact that there are but few places where water cannot be obtained by drilling. Write us today for catalogs (enclose 6c for postage) and let us show you the superiority of STARS. Furnished on payments, if desired.

**THE STAR DRILLING MACHINE CO.**  
506 Washington Street Akron, Ohio



Perret's plans; 12-ft. walls were none too thick to support 11 stories. But he found a way to make use of the walls without weakening their strength, by arranging stairways, cabinets, and cupboards in the walls, from the bottom floor to the top floor. The building was intended to accommodate comfortably 500 people. Considering the date of the design, this project was a remarkable prophetic vision. In its general lines the building represented a much later period in architecture.

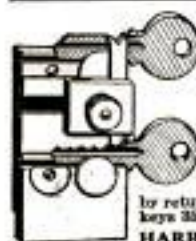

Duplicate Keys for all Pin Tumbler Locks can be made in a minute with  
**The Harrison M. L. P. Key Filing Machine**

Invaluable for Machinists, Building Superintendents, Hardware and Repair Shops, Locksmiths, Carpenters, Electricians, Garages, etc. Anyone can make a perfect duplicate key without injuring the original. Every machine unconditionally guaranteed. Money refunded if not entirely satisfactory. Price \$3.00 net. Send us P. O. order or N. Y. draft and receive the complete machine by return Parcel Post. Special diamond shaped files for angular keys 25c each or 4 for \$1.00. Send for circular.

**HARRISON & COMPANY, 81 NEW ST., NEW YORK**

## THE AWL YOU WANT

See That Reel



Is the genuine MYERS \$1.00 "Lock Stitch" Sewing Awl with the exclusive feature. See thread reel in front of handle under the finger tip. Natural tension. Sews heavy or light material, diamond point, full grooved needles used to protect the thread when sewing.  
**C. A. MYERS COMPANY, 6339 University Ave., Chicago, Illinois**

## The Oster way saves money



**No. 104**

6 sizes in  
one tool

**T**HE speed and accuracy of an Oster pipe-threading tool is a cash asset to the owner. He won't spend repair money if he threads his pipe with

**OSTER-CUT THREADS**

Our service to you is in giving you pipe threads quicker, easier and cheaper than anyone else. Send for the free catalog and meet the tools that make Oster-cut threads.

**The OSTER MFG. CO.**  
2100 East 61st St., Cleveland, Ohio



Kindly send me the Oster catalog free by return mail.

NAME.....

BUS.....

ADDRESS.....

CITY.....STATE.....(2100)

## ToolCases for Toolmakers and Machinists

Keep your tools orderly arranged in a Gerstlaer Portable Tool Case. There's a place for every tool in one of the felt lined drawers. Every up-to-date mechanic needs one and you'll find our Cases the best built, easiest and most practical on the market. We guarantee to please or refund all money. Write for our free booklet

**Gerstlaer & Sons**

Mfrs. of Mechanics' High Grade Tool Cases  
808 Columbia St., DAYTON, OHIO





**Stanley Tools**

## Portable Bench Dog

A new Stanley tool that will prove to be a mighty handy little article. Most convenient for all kinds of work requiring the use of a Bench Dog, especially where a well appointed work bench is not available.

One or more can be so placed as to securely hold a board or other work in almost any position required. Even in connection with a fixed or permanent Bench Dog, it will be found useful to hold steady the other end of a board while being worked.

Made entirely of metal, with well sharpened points and blued finish.

Price, \$0.20 Each

**STANLEY RULE & LEVEL CO.**  
NEW BRITAIN, CONN. U.S.A.

## "DON'T BUY BLADES" \$1.00

Sharpen your old ones, have 35c on each dozen, make one blade last a whole year. It hones and strops all make blades. Puts an edge on a blade in ten seconds, pays for itself in a hurry. Start a business sharpening blades for others.

**THE ALMORE CO.**  
856 Belmont Chicago, Ill.

Agents Wanted



## SEWS THIS DOLLAR AWL FOR ANYTHING 75c

Makes a perfect lockstitch

Engraving cut to show position of thread in handle

1915 Model

This Automatic Awl is superior to all others. It is of immense value for repairing all kinds of leather, harness, bags, belting, shoes, etc. **THREADED DIRECT FROM THE HEEL.** So simple a child can use it. Regular price \$1. For a limited time only we will send it postpaid anywhere, with waxed Thread, two Diamond Point Needles (curved and straight), and directions, for ONLY 75c. Extra Needles 1c, Thread 15c. **JOHNSON SMITH & CO., Dept. 2, 711 S. Dearborn St., CHICAGO**

Agents Wanted

## Sharp Tools All the Time Luther Hummer Tool Grinder

Puts keen cutting edge on all tools—easy and quick. No water needed. *Can't draw temper.* Enclosed dust-proof bearings and gears. Steel shaft drive. Perfect lubrication. Patented tool rest. 14 special attachments. Write for Big Free Book.

**LUTHER GRINDER MFG. CO., 180 Point St., MILWAUKEE, WIS.**



## BOY SCOUTS—ALL BOYS —TRY 3 IN ONE FREE

"Attention!" We want every Boy Scout and every other boy in America to give 3-in-One a good hard test, *absolutely free.*

Write *today* for a generous free sample and the valuable free 3-in-One Dictionary. 3-in-One has been for over 17 years the leading bicycle oil. It makes all bearings run much easier and prevents wear—cuts out all dirt and never gums or clogs. It cleans and polishes, prevents rust on all metal parts.

3-in-One is also the best gun oil. It oils exactly right trigger, hammer, break joint—cleans and polishes barrels, inside and out; polishes the stock like new, too.

Always use 3-in-One on your ice and roller skates, fishing reels, scroll saws, golf clubs, cameras and every tool you own. A few drops does the work. 3-in-One will keep your catcher's gloves soft and lasting, also prevents rust on your catcher's mask.



3-size bottles at all good stores: 10c, 25c and 50c. (The 50c size is the *economical* size.)

Write for the free sample *today.*

**3-in-One Oil Co.**

4200N Broadway, New York



Switzerland spends more on relief of the poor than does any other country.

## SOLDERING MADE EASY

**GASOLINE  
SOLDERING IRON  
BLOW-TORCH**



Address Dept. 1, ENMELMANN BROS. MFG. CO., INDIANAPOLIS, IND., U.S.A.

## CRESCENT Wood Working Machinery

is the best at the price and always satisfies our customers. Ask for free catalog of band saws, saw tables, jointers, planers, planers and matchers, swing cut off saws, shapers, wood workers, band saw blades.

**THE CRESCENT MACHINE CO.**  
93 Columbia St., LEETONIA, OHIO



## FREE THIS VALUABLE HAND BOOK

Tells how to *help save money* for yourself or employer. Just the thing for Mechanics, Electricians, Engineers, Contractors and Executives. Write *today* for this handbook—FREE.

State your business

**VAN EXPANSION BOLT MFG. CO.**  
1209C Fort Dearborn Bldg., Chicago, Ill.



## "RED DEVIL" GLASS CUTTERS

CUT GLASS—CUT COST



The latest magazine type. 5 extra wheels in rust-proof chamber—a new wheel always ready for use. Specially designed "fatigue-proof" hardwood handle. At your dealer—or from us at 30c. (Kid case free.) Send for booklet of 40 styles.

**SMITH & HEMENWAY CO., Inc., 161 Chambers St., NEW YORK CITY**

**E. C. SIMMONS**  
**KEEN KUTTER**  
TRADE MARK CUTLERY U.S. PAT. OFF.  
TOOLS

**Guaranteed Tools**

Perfect tools are not only an inspiration to do perfect work, but they are economical. Buy a Keen Kutter tool of any description and it will long outlast ordinary kinds because it is made of the right material. *It is built for long service.*

**KEEN KUTTER** Quality Tools

are backed by a trade mark famous for over 45 years. If any tool that bears this trade mark doesn't give satisfaction, your dealer is authorized to give you a new tool or return your money.

Send for our Home Furniture Design Booklet No. D 976.  
"The Recollection of Quality Remains Long After the Price is Forgotten."  
Trade Mark Registered. —E. C. SIMMONS.

If not at your dealer's, write us.  
**Simmons Hardware Co.**  
St. Louis New York Philadelphia  
Toledo Minneapolis  
Sioux City Wichita  
Band Saw, No. K98/26. Price \$2.00

Screw Driver No. K50/3 Price \$0.50  
Brace No. KR15 Price \$2.35  
Chisel No. KBB1 Price \$0.70

**NEED BRANCH MANAGERS**  
for my world-wide mail-order business. Operate from your home. Spare time. You should make \$50 weekly. Experience unnecessary.  
**C. A. BUTLER, 289 Factories, TOLEDO, OHIO**

**FREE BURGLAR-PROOF LOCK FREE**

Send no money, just your name and address on a postal card and get one of our New Locks to try in your own home. If entirely satisfactory, tell your neighbors, if not, tell us. **Live Agents wanted everywhere** for our 1935 safety lock for windows. Prevents rattling, also raising by Burglars even if window is partly raised for ventilation. Easily attached, never wear out, no home safe without them.  
**THE WARNER COMPANY Dept. 10 Muncie, Ind.**

**Rider Agents Wanted**  
in each town to ride and show a new 1935 model "RANGER" bicycle. Write for our liberal terms. **"DELIVERED FREE** on approval and **30 days' trial**. Send for big free catalog and particulars of most marvelous offer ever made on a bicycle. You will be astonished at our low prices and remarkable terms. **FACTORY CLEARING SALE**—a limited number of old models of various makes, \$7 to \$12. A few good second-hand wheels \$3 to \$5. Write if you want a bargain. Tires, lamps, wheels, sundries, parts, motorcycle supplies of all kinds at half usual prices. **Write us before buying.**  
**MEAD CYCLE CO., DEPT. D108, CHICAGO**

**\$10 A DAY EASY!**

**AGENTS Easily Earn \$10 a Day**

No selling experience necessary. Just demonstrating what iron will do. Every housewife will buy E-Z Sad Iron—only iron combining heat regulation and Spring Cushion Handle. Makes its own heat—runs 4½ hours without attention. Also get particulars about our new E-Z Tailors' Iron. It's a Big Seller. Write for territory, no matter where you live.  
**ENTERPRISE TOOL & METAL WORKS Dept. 15, 126 S. Clinton St., CHICAGO**

**FREE TO BOYS**

Have you a scroll saw? Have you run out of patterns? Then here's just what you want—our free catalog of

**Scroll Saw Designs**

Showing over 200 scroll saw patterns in miniature of sensible articles any boy can make. Write for it—now; it is FREE. Besides these patterns it shows and describes scroll saw machines, scroll saw wood and moulding, scroll saw supplies, fancy box trimmings, and turning lathe, tools and lots of other things boys want.

Any Boy who is Mechanically inclined needs this FREE BOOK.

**Schroeter Bros. Hardware Co.**  
725 Washington Ave. St. Louis, Mo.

**SET SIX SCREWS**  
And Save \$13.25

**"COME-PACKT"**  
FURNITURE

Sold on a Year's Trial

Our Price only \$11.75

YOU can save from 30% to 60% on the price of your furniture by buying the Come-Packt way.

For instance, this beautiful table, made from quarter-sawed white oak, with rich, deep, natural markings, in the white, only \$11.75; finishing materials, 50¢ additional.

Usual retail price—about \$25.00. Four Hundred equally attractive designs in our big catalogue. Write for it to-day. Factory prices. **The Come-Packt Furniture Company, 301 Dur St., Toledo, O.**



**A New Novelty**  
SELLS AT SIGHT

Send For Sample

**USEFUL**

**AMUSING**

NICKLE PLATE 50¢ SILVER PLATE \$1.00

THE CIGARETTES AS SHOWN IN CUT HAVE "CORK TIPS" BY CLOSING THE CASE AND OPENING IT FROM THE OTHER SIDE THEY WILL APPEAR AS "PLAIN TIPS"

(WHEN YOU KNOW HOW) THIS CASE CAN BE OPENED FROM EITHER SIDE VERY EASILY AND AS QUICKLY AS ANY OTHER CIGARETTE CASE.

A SAMPLE WILL PROVE IT'S MERIT AND YOU WILL USE NO OTHER

**MYSTERIOUS ATTRACTIVE**



USEFUL

**"TRICK" CIGARETTE CASE**

HAVE A LITTLE AMUSEMENT BY HANDING THIS CASE TO ONE OF YOUR FRIENDS AND SEE HOW LONG IT WILL TAKE HIM TO GET A CIGARETTE OUT OF IT.

SEND FOR ONE OF THESE CASES AND GET OUR SPECIAL AGENTS DISCOUNT.

**WHY NOT MAKE SOME EXTRA MONEY SELLING THESE IN YOUR LOCALITY? JUST SHOW THEM! THEY SELL AT SIGHT.**

**AGENTS WANTED**  
LARGE DISCOUNTS IN SMALL QUANTITIES  
*Terms with each sample*  
ADDRESS - **HORSTMAN MFG. CO., INCORPORATED**  
105 W. MONROE ST. CHICAGO, ILL.

**ORNAMENTAL** **INTERESTING**

I Am Making a Special Factory Price on  
**10,000 Rapid Fireless Cookers**



Big bargain to introduce cooker into new neighborhoods quick. Write before price advances.

**30 Days' FREE TRIAL**  
Cooker is aluminum lined, of course. Complete outfit aluminum utensils free. Write for Free Book with 150 recipes and Bargain Prices direct from factory.

WM. CAMPBELL CO., Dept. 64, Detroit, Mich.

**LITTLE-KNOWN INDUSTRIAL USES OF SUGAR**  
—This staple, of which the United States is doubtless the greatest consumer among nations, also finds a number of uses in the most widely different industries. It is used

**IF YOU BUY REAL DIAMONDS**



You invest hundreds of dollars you can't afford. Our imitation stones answer all purposes. They fool your friends. Fine cut—white—brilliant.

**\$2—SPECIAL OFFER—\$2**  
Just to advertise our wonderful values. Send \$2 paper money or P.O. order to cover all cost and we will send this Lion's head ring, 14 K. filled, 12 K. imitation diamond in mouth. Send for special catalog. Answer quick. Money refunded if not entirely satisfactory.

KRAUTH & REED, Dept. W, Masonic Temple, Chicago, Ill.

**RUTHSTEIN'S**

**STEELS**  
WITH ADJUSTABLE LEATHER TAPS

**THE WORLD'S GREATEST GENERAL PURPOSE SHOE**



Light, Easy, Waterproof, Comfortable, Healthy, Economical.

One Pair Outwears 3 to 6 Pairs Best All Leather Shoes.

Steels have settled the Shoe Problem in more than a million homes, by combining in a light, comfortable General Utility Shoe, more actual Protection and Service than has ever before been put into footwear.

Steels take the place of heavy leather shoes, rubber or felt boots, arctic and overshoes.

Steels are an absolute necessity to Every Man and Boy for rain, mud, snow, sleet, water, ice, sand, gravel or rocks—Warm in Winter—Cool in Summer—Dry and Comfortable—Always.

No more wet feet—no more Rheumatism, Lumbago, Coughs, Colds or Pneumonia—No more Corns, Blisters, Broken-down arch, or tired, sweaty feet—No more big Doctor Bills or Big Shoe Bills.

Put a pair of Steels on your feet—on your Boy's Feet—You'll like them—He'll like them.

Don't think of buying any general service shoe until you have seen my Steels.

**Mail a Postal Today for Free Book**

"The Sole of Steel" illustrates and describes this wonderful, Health- and Money-Saving Shoe with its sole of light, springy steel; with its Adjustable Leather Taps or Adjustable Steel Rivets, instantly renewed. A postal brings my new edition Shoe Book, and tells how you can try on and compare Steels with any other footwear. Spend 1c now to save \$20 a year shoe money. Address:

**N. M. RUTHSTEIN, The Steel Shoe Man, Dept. 132, RACINE, WIS.**

**Amazing Profits In Mushrooms**



Anybody can add \$8 to \$40 per week to their income, in spare time, entire year growing mushrooms in cellars, sheds, barns, boxes, etc. I tell you where to sell, at highest prices.

Free Illustrated Instruction Booklet

**HIRAM BARTON**  
Desk 2, 329 W. 48th St., New York

**WONDERFUL New Camera**



The newest invention in cameras. Scientifically constructed and so easy to operate that errors are practically impossible. Fitted with a genuine Acatic Lens, automatic focusing device, wide rapid lens to assure accurate optical alignment and new flexible wire release.

Write for the Camera Book **Ingenito Cameras** Backed by an unlimited guarantee

Never before have you been able to get high-grade cameras at anywhere near the low prices at which you can get the great new Ingenito.

Write for "The Camera Book" Send your name and address. No obligations. Write today.

**Burke & James Inc.**  
240-258 E. Ontario St.  
Dept. 1193, Chicago, Ill.

*Please Mention Popular Mechanics*



**\$2,500<sup>00</sup> a Year!**

Name.....

Address.....

HAVE you the training that is necessary to fill a \$2,500 job? Are your services in demand? Salaries are paid to the men who know. If you are ambitious to get into the big money class, send the coupon and find out about the opportunities in our profession. We need ambitious men and will give you the proper training right in your own home. Don't miss this wonderful offer. Send the free coupon today—do it right now.

**Be a Signal Engineer | More Men Are Needed**

Be the man who gets \$2,500 a year. Complete Signal Engineering is one of the most fascinating of professions. As a railroad man you travel from coast to coast. You are the man who tells the other fellow what to do. You can be the man who holds the big job.

Railroads are constantly looking for competent Signal Engineers. Thousands and thousands of miles of track are now being equipped with automatic signals. Many new positions will be open. Men are needed.

**Two Big Outfits FREE** We give each of our Signal Engineer's outfit and a draftsman's outfit—absolutely free.

**Send the Coupon for Big New Book** Put your name and address on the coupon or a letter or a post card and get the big new Signal book absolutely free. No obligations. The book is free. Write today—Now.

Department of Signaling, 1810 Wilson Ave., Room 9193, Ravenswood Sta., CHICAGO, ILL.

Department of Signaling  
1810 Wilson Ave., Room 9193  
Ravenswood Sta., Chicago

Gentlemen: Please send me absolutely free and prepaid your big new Signal book. It is distinctly understood that I assume no obligations of any kind.

**LONGACRE**

NEW YORK CITY HOTEL  
Broadway and 47th St.

**EXCLUSIVELY BACHELOR**

Convenient to Everything. The refined air and good service of a club

**RATES PER DAY**

50 rooms with lavatory \$1.00  
150 rooms with private bath 1.50  
50 rooms with private bath 2.00

Two-room Suites, \$3.00 to \$4.00  
Special Weekly Rates

Restaurant a la carte. Club Breakfasts

**DINING ROOM OPEN TO LADIES**

The best value in New York City  
both in rooms and restaurant.

Phone, 7790 Bryant

J. G. BOGGS

**Get Our Price FIRST**

On Finest Quality Stoves  
Latest Improvements

Your choice of 500 styles and sizes, on **Free Trial**, at factory price, freight prepaid, cash or easy payments.

**Write For FREE BOOK**

See all the latest improvements and note the big savings in price. Don't decide until you see this book anyway. A big help to every stove user. **FREE.**

Ask for Book No. 473

**KALAMAZOO STOVE CO.**  
Manufacturers  
**KALAMAZOO, MICH.**

Stoves &amp; Ranges



**A Kalamazoo**  
Direct to You

**This Catalog FREE****Write for It**

J. M. Hanson-Bennett Magazine Agency is the largest in the world.

**Save Magazine Money**

Our 1935 catalog lists more than 3000 Periodicals and Club Offers. It's a Big Money-Saver. Send us your name and address today.

**AGENTS WANTED** Write for full particulars.

**J. M. HANSON-BENNETT**  
Magazine Agency  
223 W. Jackson Blvd., CHICAGO, ILL.

**AGENTS—Make \$100 to \$300**

per month easy selling our new Triplicate Sauce Pan. Cooking utensil for 3 different foods on one burner. 400 Specialties — all whirlwind sellers. Write quick for exclusive territory and large catalogue.

**AMERICAN ALUMINUM MFG. CO.**

Div. S 61

LEMONT, ILL.

**PRINCE ALBERT**

the national joy smoke

as an ingredient in compounds for removing boiler scale. The shoeblacking industry consumes large quantities of

**Get These 12 Flirts by "Christy"**

All in Color—A New Series—All Girls—All Beauties—From Christy Paintings—All New—Twelve for 50 cents, or Six for 25 cents, or Three for 15 cents.

Contains no Advertising

**FREE** One 18 1/2" x 8 1/2" Christy Head in colors with order for full set—A Beauty.

Write today. Stamps or coin—Tell your friends.  
**GLOBE, 611 Security Building, CHICAGO**

**THROW YOUR VOICE!**

Into the next room, under the bed, down cellar, or anywhere. Fool your teacher, parents or friends. **LOTS OF FUN.**

**The Ventrilo** is a little instrument that fits the roof of the mouth, out of sight. Boys or Girls can use it. Sample with instructions in the art of **VENTRILLOQUISM**, with our big catalog of **Novelties**, books, games, etc. All by mail for **10 cts.**

**ROYAL NOV. CO.** Desk B So. Norwalk, Conn.



Hand Forged  
Razor Steel  
Blades. No. 57



This \$2 KNIFE 83¢  
DIRECT AT FACTORY PRICE

Handy shaped blade makes this knife best for mechanics, sportsmen and farmers; light but strong; resharpened easily. Stag handle, German silver finish; blades file tested, hand forged from razor steel and warranted. Sample 83c, 3 for \$2 postpaid. Cheapest pearl \$2 each. Send for our 80 Page List and "How to use a Razor" **FREE**

**MAHER & GROSH CO., 106 A. St., Toledo, Ohio.**

# 2c a Week Pays Wash Bill!

Write for  
FREE Book

Electricity or Water-Power Does the Work

Just a "Twist of the Wrist" Starts or Stops the Machine!

The 1900 Motor Washers are now at work in thousands of homes. They are doing the work formerly done by women, at a cost of 2c a week for power! Saving thousands upon thousands of dollars in wash bills. Saving worlds of wash-day troubles. Leaving the women free to do other work while the machines are doing the washing.

## The 1900 Motor Washer

1900 Water Motor Washer  
Can be connected with  
any water tap instantly

Washes a Tubful in Six Minutes!

Handles Heavy Blankets or Dainty Laces

The outfit consists of the famous 1900 Washer with either Electric Motor or Water Motor. You turn on the power as easily as you turn on the light, and back and forth goes the tub, washing the clothes for dear life. Then, turn a lever, and the washer does the wringing. All so simple and easy that it is mere child's play.

**A Self-Working Wringer Sent With Every Washer!**

The motor runs Washer and Wringer. We guarantee the perfect working of both. No extra charge for Wringer, which is one of the finest made. **Write for FREE BOOK and 30 Days' FREE TRIAL OFFER!** Don't doubt! Don't say it can't be done. The free book proves that it can. But we do not ask you to take our word for it. We offer to send a 1900 Motor Washer on absolute Free Trial for an entire month to any responsible person. Not a cent of security—nor a promise to buy. Just your word that you will give it a test. We even agree to pay the freight, and will take it back if it fails to do all we claim for it. A postal card with your name and address sent to us today will bring you the book free by return mail. All correspondence should be addressed to

Doing the wringing with  
1900 Electric Motor Washer



**1900 WASHER CO., 6175 Court St., BINGHAMTON, N. Y.**  
OIL IF YOU LIVE IN CANADA, WRITE TO THE CANADIAN WASHER CO., 355 YONGE ST., TORONTO, CANADA. (23)

## Scientific Device

That Does Away With

TRUSS-FREE TRIAL



Inner surface is made adhesive to secure the PLAPAO-PAD firmly to the body, keeping the PLAPAO continually applied and the pad from slipping. No straps, buckles or springs attached. Soft as velvet—easy to apply.

It's the Non-Slip-Pad, Yet Non-Rigid Pad and What is Within It That Counts

**Over 250,000 Now In Use**

We have proved to hundreds of thousands of sufferers from hernia (rupture) that to obtain lasting relief and develop a natural process for betterment comes by wearing a Plapao-Pad. This patented mechanico-chemico device can do the same for you. The wearing of an improper support aggravates rather than improves the condition. The Plapao-Pad can and does aid the muscles in giving proper support, thereby rendering efficient aid to Nature in restoring strength to the weakened muscles. Being self-adhesive there is no slipping and shifting of pad with resultant irritation and chafing. No discomfort whatsoever—no delay from work. Awarded Gold Medal at Rome and Grand Prix at Paris.

Send No Money. We will send you a trial of Plapao absolutely FREE, you pay nothing for this trial now or later. Write for it today, also full information.

**PLAPAO LABORATORIES, Block 70 St. Louis, Mo.**

sugar and molasses, and though in America these old blackings have been superseded by wax blackings, the latter are not considered so good as the old-fashioned blacking still much in vogue on the European continent.

## MONEY IN MUSHROOMS MAKE BIG INCOME

Men and Women grow mushrooms all the year at home in cellars, stables, sheds, boxes, etc. Sell as high as \$1.00 a lb. Great demand! Markets waiting. Start Now. Big Booklet telling how to do it Free. Nat'l Spawm Co., Dept. 12, Boston, Mass.

**BUILD A** We have accurate scale drawings and knock-down parts of all man-carrying aeroplanes for class-room demonstrations, exhibition purposes, etc. Students of aeronautics, everyone with an inquiring turn of mind, should construct one of these fascinating models.



**3FT. CURTISS FLYING BOAT** Hydroaeroplane, 25c; Curtiss Flying Boat, 25c; Nieuport Monoplane, 25c; Blériot Monoplane, 15c; Wright Biplane, 25c; Curtiss Convertible Complete Set of Six \$1.25 Postpaid. 50 pp. Ideal Model Aeroplanes Supply Catalog 5c. IDEAL AEROPLANE & SUPPLY CO., 82-88 West 17th St., N.Y.

**1/2 Price—to Introduce**

To prove to you that our dazzling blue-white  
**MEXICAN DIAMOND**

exactly resembles the finest genuine South African Gem, with same dazzling rainbow-hued brilliancy (guaranteed), we will send you this beautiful, high-grade 12 kt. gold-filled Tiff. Ring, set with 1 ct. gem, regular catalogue price \$4.98, for 1/2 price.

Only **\$2.50** Same gem in Gent's Heavy Tooth Bol-cher Ring, catalogue price \$6.26, for

Wonderful, dazzling, rainbow brilliancy guaranteed 20 years. Send 50c and we will ship C. O. D. for free examination. Money back if not pleased. Act quick; state size. Offer limited—one only to a customer. Catalogue free. Agents Wanted

**MEXICAN DIAMOND IMPORTING CO.** Box ET-3, Las Cruces, N. M.

(Exclusive Controllers of the Genuine Mexican Diamond.)

# Make Money In California This Year

There are many chances for money making to-day in the great San Joaquin Valley. There, in the heart of golden California, fruit growing, dairying and poultry raising offer returns that appeal to the man who wants to make his effort count for most. One woman's 75 acre ranch returns her net \$10,000 a year.

Soil, climate and irrigation make the San Joaquin Valley a great food factory.

It has hungry markets to feed. Two of the big cities of the Pacific Coast hold international expositions this year. Local mines and lumber camps never get enough farm products. And all the rest of the world is glad to get and pay good prices for California products.

You will find a well developed country. There are good schools, good roads, telephones, rural delivery, electric light, power and trolleys. You will find a neighborliness and get-together spirit that makes a success of co-operative effort in getting the profit for the grower.

The Santa Fe is not selling land. We want to settle contented, successful farmers along our lines. We know where the opportunities are. We gladly point them out, and put you in touch with men on the ground who will show them to you. We can save you time and money, because you need not duplicate the investigations we have made.

Our books, "San Joaquin Valley," "Dairying" and "Poultry Raising" give much information. Then if you will write what more you would like to know, we will be glad to tell you. The books are free; so is all the additional assistance of Santa Fe agricultural demonstrators, who will help new settlers in selecting the right crops to get the best results.

Just give your name and address, and say "Send California books."

**C. L. SEAGRAVES, Gen'l Colonization Agent**  
A., T. & S. F. Ry., 2200 Railway Exchange, CHICAGO

## Small Engines



Our illustrated book tells all about our wonderful small engines in  $\frac{1}{2}$ , 1 and  $1\frac{1}{2}$  h.p. They run perfectly and are sold on our positive guarantee. We ship on trial. Best for operating small machinery. Our \$19.50 size is a beauty. We'll tell you all about it if you write us.

Sieverkropp Engine Co., 1224 18th St., Racine, Wis.

## ABOUT MUSHROOMS



How to really make big money in mushrooms is fully explained in the wonderful book, "The Truth About Mushrooms," a great revolutionary improvement, things many growers never know before. Everything explained from A to Z, at first hand, from the greatest practical authority in America. Add \$10 to \$10 a week to your income. Demand exceeds supply. Grow in cellars, sheds, boxes, etc. Small capital to start. Profits bigger and quicker. Anyone can do it. Women and children too.

Now is best time. Send for free book.

BUREAU OF MUSHROOM INDUSTRY, Dept. 181, 1342 N. Clark St., CHICAGO

## 3 YEARS TO PAY



**Meister Piano** 30 days free trial in your own home

\$1 A WEEK or Price \$175.00  
\$5 A MONTH

No cash payment down. No interest—no extras. Piano stool and scarf free.

**ROTHSCHILD & COMPANY**  
Dept. 16C CHICAGO, ILL.

## Pay as You Wish

We'll send you a genuine Lachnite for you to wear for 10 full days. If you can tell it from a real diamond send it back at our expense. Costs but 1-3/4c as much. If you decide to keep it pay only a few cents a month. Write for catalog.

**Genuine Lachnite Gems**

keep their dazzling fire forever. Set in solid gold. Cut by world renowned diamond cutters. Will stand fire and acid tests. All kinds of jewelry at astounding low prices. Easy payments. **WRITE TODAY.**

H. Lachman Co., 12N. Michigan Av., Chicago Dept. 9193

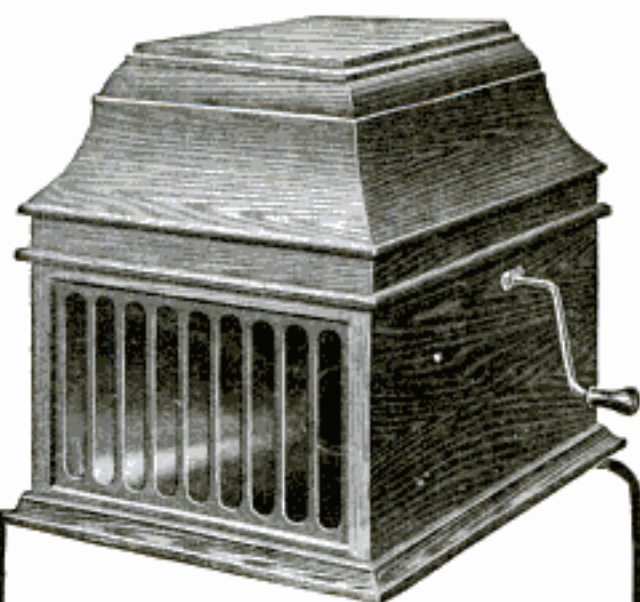

## The NEW Edison

*Mr. Edison's Latest Invention*

Write today for our new Edison Catalog—that tells about the superb new model Edison with Mr. Edison's new diamond stylus reproducer and our NEW Edison offer. Now read:

**The Offer:** We will send you the new model Edison and your choice of all the brand new records on an absolutely free loan. Entertain your family and your friends. Then, when you are through with the outfit you may send it back at our expense.

**The Reason:** We are tremendously proud of this magnificent new instrument. When you get it in your town we know everybody will say that nothing like it has ever been heard before, so we are sure that someone will want to buy one of these new style Edison's, especially as they are being offered now at the most astounding rock-bottom price and on easy terms as low as a few dollars a month.

**REMEMBER, not a penny down—no deposit—no guarantee—no C.O.D. to us—no obligation to buy—A FULL FREE TRIAL in your own home—DIRECT from us—DIRECT to you. Returnable at our expense or payable (if you want to keep it) at the actual rock-bottom price direct from us.**

## Our NEW Edison Catalog Sent FREE!

To F. K. Babson

Your name and address on a postal or in a letter, (or just the coupon) is enough. No obligations in asking for the catalog. Get this offer—while this offer lasts. Fill out the coupon today.

Edison Phonograph Distributors

Dept. 1193 Edison Bldg.

CHICAGO, ILL.

**F. K. BABSON**

Edison Phonograph Distributors

1193 Edison Bldg., CHICAGO, ILL.

Canadian Office

215 Portage Ave., WINNIPEG, MAN.

GENTLEMEN:—Please send me your New Edison Catalog and full particulars of your free trial offer on the new model Edison Phonograph.

NAME.....

ADDRESS.....

Please Mention Popular Mechanics

## Don't Waste Your Strength



WHEN women continue to sweep their carpets in the old-fashioned way it is because they are not convinced there is a better way—that in the Bissell sweeper lies relief from their bondage of drudgery.

### BISSELL'S "Gyro" BALL BEARING Carpet Sweeper

Is the final effort of 38 years in the exclusive manufacture of carpet sweepers. It will make your sweeping easy and save your carpets. The Bissell is truly the handy, inexpensive cleaning device for every day use. Ask the woman who owns one. An extra sweeper for upstairs will save steps. Let us mail you our booklet "Easy, Economical, Sanitary Sweeping." Bissell sweepers are sold at all the best stores at \$2.75 to \$5.75.

**BISSELL CARPET SWEEPER CO.**  
Grand Rapids, Mich.

**"WE SWEEP THE WORLD"**



### BEACON BURNER FREE

**FITS YOUR OLD LAMP**

100 Candle Power Incandescent pure white light from (kerosene) coal oil. Burns either gas or electricity.

**COSTS ONLY 1 CENT FOR 8 HOURS**

We want one person in each locality to whom we can refer new customers. Take advantage of our Special Offer to secure a Beacon Burner FREE. Write today. AGENTS WANTED.

**HOME SUPPLY CO., 111 Home Bldg., Kansas City, Mo.**



### The "BEST" LIGHT

A soft, luminous light, which casts no shadow. Brighter than electricity or acetylene. Makes and burns its own gas. Costs 2c a week. No dirt, smoke nor odor. Over 200 styles, ranging from 100 to 2000 candle power.

Absolutely guaranteed. Write for illustrated catalog.

AGENTS WANTED EVERYWHERE  
**THE BEST LIGHT CO.**  
324 E. 5th St., Canton, O.

Please Mention Popular Mechanics



### KEROSENE AND GASOLINE LANTERNS

Absolutely bug and wind proof and give 300 candle power of light, at a cost of  $\frac{1}{8}$  c per hour. Suitable for use on farms, watchmen, side shows, circuses, street carnivals, garages, livery barns, summer resorts, warehouses, boat landings, etc.

For complete catalog and agency proposition address  
**THE NAGEL-CHASE MFG. CO.**  
150 East Erie St. CHICAGO



### Sunshine Lamp FREE! 300 Candle Power

To Try in Your Own Home  
Turns night into day. Gives better light than gas, electricity or 18 ordinary lamps at one tenth the cost. For Homes, Stores, Halls, Churches. A child can carry it. Makes its own light from common gasoline. Absolutely SAFE.

**COSTS 1 CENT A NIGHT**

We want one person in each locality to whom we can refer new customers. Take advantage of our SPECIAL FREE TRIAL OFFER. Agents Wanted.  
**SUNSHINE SAFETY LAMP CO.**  
220 Factory Bldg. Kansas City, Mo.



### 300 C P Triumph Stand Lamp

Besides sunlight there is no other equalling that of the Triumph Lamp, Stand, System or Gravity. Its beams, pure white, brilliant yet mellow, will flood the largest living room with perfect illumination.

**PRaised by STUDENTS and MECHANICS** as the one perfect light for Home, Office and Work Bench. Exceeds electricity or gas in brilliancy—is safe and gives ten times the light of the old style round wick burning Kerosene Lamps—a menace to the eyesight. You get the light of mid-day for less than  $\frac{1}{8}$  c an hour.

Agents Wanted **BRILLIANT GAS LAMP COMPANY**  
1095 So. Wabash Ave., Chicago, Ill.



Some 30 explosives contain sugar in proportions of from 6 to 40 per cent. The dyeing industry consumes large quantities, especially in indigo and chrome work; sugar is also used in fillers for aniline colors. Tanneries use sugar in filling the leather and in removing the hairs.

### WHITE FLAME

**BURNERS** make your old kerosene lamps and lanterns give a brilliant white light better than electricity or gas. Doubles your light. Saves oil. **NO MANTLE TO BREAK.** Guaranteed Safe and Reliable. Delights every user. Send now for complete sample postpaid 35 cts., stamps or coin. 3 for \$1. **MONEY BACK IF NOT SATISFACTORY.**

Live Representatives Wanted. Exclusive Territory.  
**WHITE FLAME LIGHT CO., 65 Clark Bldg., Grand Rapids, Mich.**



### MAKE \$60 A WEEK

New gas-generating Coal-oil lamp. Absolutely safe. Big money saver.

**300 Candle Power** Light it and make a sale. Thousands can be sold. Retail for only \$6.50. Lowest priced high grade lamp on the market. Special terms to agents. Write quick for your home territory and free sample offer.

**THOMAS LAMP CO. 4248 Rome St. DAYTON, OHIO**



### SAFETY FIRST "Yale Electric" Lantern

Combination House Lamp, Search and Flash Light. Full size, regular shape. Just turn the switch and get a flood of light, twice as much as the old. The simplest, safest, handy light for autoists, campers, mechanics, farmers and the home. No matches, no oil, no wick trimming, no smoky chimneys, no danger of fire. Always ready. **\$3.50** Sent postpaid on receipt of price, on Money-Back guarantee. Big money for agents. Get our agent's proposition. Start today. Be the first.  
**YALE MANUFACTURING CO., Dept. B, 22-30 So. Clifton St., CHICAGO**

# BEAVER BOARD

WALLS AND CEILINGS

## For New Buildings or Remodeling

Saw it like wood—nail panels to studding—then paint—put on decorative strips.

Result—beautiful durable interiors, free from cracks. No more repairs, no wall-paper, easy to decorate. Relief from lath and plaster troubles.

Write at once for free sample and book "BEAVER BOARD and its Uses." All about our free design and decoration service.

The Beaver Board Companies  
157 Beaver Road, Buffalo, N. Y.

Branches in Principal Cities.



## An Attractive Bungalow Can Be Built for \$900.00

Plan of this bungalow and 117 other plans of bungalows, cottages and other houses in my new book, "Building Plans for Modern Homes," just off the press. One of the most complete and comprehensive books of plans ever published by any Architect. Nearly 300 illustrations of floor plans and elevations, costing from \$25.00 up; gives sizes and cost to build. Sent postpaid for \$1.00.



FREDERICK H. GOWING, Architect, 18 Tremont St., Boston, Mass.

## WHITE VALLEY GEMS LOOK LIKE DIAMONDS

Stand acid and fire diamond test. So hard they easily scratch a file and will cut glass. Brilliance guaranteed 25 years. Mounted in 14k solid gold diamond mountings. See them before paying.

Will send you any style ring, pin or stud for examination—all charges prepaid. No money in advance. Money refunded if not satisfactory. Write today for free catalog.

WHITE VALLEY GEM CO., 701 Wulsin Bldg., Indianapolis



We Teach You  
the Business  
FREE!

## 400% to 800% Profit in Popcorn—Crispette and Candy Business

Crowds swarm to buy our Kettle-Popped Popcorn—topped under glass—seasoned while popping!—GREAT BIG—CRISP—PLUFFY KERNELS! Corn pops 25 per cent bigger with the Dellenbarger machine and 100 per cent better product. Our delicious CRISPETTES melt in your mouth. Wonderful new Automatic Crispette Press is a regular money-mill! Big extra money in candy!

Course in Candy Making FREE with Every Outfit  
Write AT ONCE for FREE Catalog, new money-making plans, special prices and sensational easy payment offer. NOW is the time to start. No experience necessary and very little money. Write

C. E. DELLENBARGER CO., 39 Bissel St., JOLIET, ILL.



One of the 33 Styles

## Superb Wing Piano Shipped on 4 Weeks' Free Trial

Yes, we will ship you on 4 weeks' absolutely free trial a Genuine highest-grade Wing piano or player-piano DIRECT from our own factory freight prepaid. The most amazing piano offer ever made. We will allow you to use any Wing piano—you choose of 33 superb new styles in any shade of mahogany, walnut or oak—in your own home for 4 full weeks at our expense.

## No Money Down—Freight Prepaid

We ask no money down—no security—no bank deposit—no C. O. D.—no obligations. Just choose any Wing from our large catalog. We'll ship the instrument no money down, freight prepaid. Use it just as if you owned it. Let your friends play it. At the end of 4 weeks' trial, if you wish, you may return it at our expense. We pay return freight to New York. You alone are the judge. We employ no salesmen to visit and annoy you.

## Rock-Bottom DIRECT Offer

You will be amazed at our rock-bottom direct-from-our-factory proposition on the genuine highest-grade Wing, guaranteed 40 years. No other manufacturers dared to meet our baffling offer. Let us quote you prices that local dealers cannot approach. Cash or easiest monthly payments as you prefer—but first four weeks' free trial. Since 1868—for 47 years—we have been building Wing pianos—renowned everywhere for their sweetness of tone and sterling merit. The Wing has all the fine qualities and every improvement of any strictly high-grade piano and superior tone. You pay not a cent for the trial—no deposit.

## Valuable Book on Pianos Free

"The Book of Complete Information About Pianos"

The N. Y. World says: "This is a book of educational interest every one should own." Tells you all about pianos, how to judge the fine points of quality and price in buying a piano. You will be astonished at the amount of information about piano quality and piano prices, and how to answer the arguments of piano salesmen. The Coupon brings this 136-page book FREE. This magnificent book, a complete encyclopedia on the piano, posts you on the making of a piano from start to finish. Free and prepaid, provided you write at once. With this piano book we will send free our beautiful catalog showing new art styles and full explanation of our Rock-Bottom Prices on the Wing Piano. Just drop a postal or a letter, or mail the coupon—today.

WING & SON, Dept. 1193, (Estab. 1868)

Wing Bldg., 9th Ave. and 15th St.

New York  
N. Y.

Piano Book  
COUPON

WING & SON (Est. 1868) Wing Bldg.  
9th Ave. & 15th St. Dept. 1193, New York, N. Y.

Gentlemen:—With the understanding that I am not buying anything, you may send me the 136-page Piano Book containing the ten tests, also your free shipment offer on the Wing Piano.

Name.....

Address.....

Please Mention Popular Mechanics

## ELGIN WATCHES

**ON — CREDIT**



**25 YEARS**

**17 Jewel**

Now, during this Special 30-day Sale, is the time to buy this elegant 17-Jewel Elgin. Factory tested and fitted in a 25-year Gold-Filled Case.

**NO MONEY DOWN—\$2 A MONTH**

Because we want to prove to you that the great volume of our business enables us to save you nearly half on this \$20.00 Elgin. **Special \$12<sup>75</sup>**

**3 Fine Books FREE!** Mr. Harris wants to send you his three latest books free—one the story of "The Diamond," its discovery, where and how mined, cut and marketed; the other, "Facts vs. Funs," or all about the Watch Business, both at home and abroad, also our Big Free Watch and Diamond Book.

*You do not pay a cent until we have placed the Watch or Diamond in your own hands for approval—no security—no interest—no red tape.* **Big Catalog Free.**

Dept. 1546  
**HARRIS-GOAR CO. KANSAS CITY, MO.**

# Famous Acousticon

You must not confuse the Acousticon with any other instrument. The Acousticon is the instrument which you regulate instantly to clearly

## Hear Every Sound

near or distant—loud or low, indoors or outdoors, under every conceivable condition. The Acousticon receives the sound by our exclusive indirect principle, and transmits it to your hearing in its original tone. Not a word blurred—not a single sound is harsh. The Acousticon covers

### 48 Degrees of Deafness

Unless "stone deaf" the Acousticon enables you to hear every sound—perfectly. Not a theory—not new or untried—but a world-known success for many years.

### NO DEPOSIT

**Ten Days Free Trial**  
Write for special limited offer—no money down—not even a promise to buy. Let us prove the Acousticon is the instrument you must use.

**EASY TERMS** Learn how to secure an Acousticon on easy monthly payments before special offer expires.

**WRITE** now for greatest free book of facts for the deaf—testimonial from ministers, judges and hundreds of others everywhere.

**General Acoustic Co.,**  
1112 Candler Bldg, 120 W. 42nd St. New York City  
448 Yonge Street, Toronto, Canada

**on free trial**



**for the**

# D E A F

## Now Direct By Mail

SUPERIOR SINCE 1904

**OVER 100,000 IN USE**

Mostly sold through recommendation. For Personal Desk or General Office. It checks mental calculations. Buy through your stationer.

**Write for 10-Day Trial Offer**  
E. Geacher A. A. M. Co., 148 Duane St., New York

**Agents Wanted**



**Golden Gem**  
PORTABLE Adding Machine

**Multiplies—Subtracts**

## AGENTS: \$6 PER DAY AND UP

**MEN AND WOMEN**

Out of work? Got a lot of spare time? Handling a poor line now? We want an active man or woman in each town to open an agency for our famous

### NON-ALCOHOLIC FOOD FLAVORS

Colors, Soaps, Perfumes, Toilet Preparations, etc. Over 100 different varieties. Flavors put up in tubes, not bottles. Fast sellers, steady repeaters. Every home a customer. Commissions paid in real money—\$4, \$6, \$8, \$10 a day. Little or no capital required. Experience unnecessary. Full instructions for beginners. Fine light sample case furnished. Write for full particulars



**FREE**

ACT QUICK WRITE TO-DAY

**AMERICAN PRODUCTS CO., 173 Third St., Cincinnati, O.**

Tannin extracts are also "filled" with sugar. Ordinary copying ink has one part of sugar. Printers' rollers and hectograph pads are made in part of sugar. In Europe sugar is used in the process of silvering mirrors. The ancients in the Far East used sugar in mortar to strengthen it. In recent times, the Museum of Natural History in Berlin was built with mortar consisting of one part lime, one part sand, and two parts sugar. Plaster molds are also made in part of sugar.

## Made \$42<sup>50</sup> in 8 hours

writes Engineer of Oregon. Hundreds of other proud owners are making big money with the new platform

### DAYDARK POST CARD MACHINE

5 cards a minute, complete—3 size cards. Experience unnecessary. Write for particulars and FREE TRIAL offer now.

Daydark Specialty Co., Dept. 2, St. Louis, Mo.

## 10 days FREE TRIAL



Regular Price **\$1.25**

### THE RAPID VACUUM WASHER

Sold on 30 days' trial.

**The only Washer with Automatic Suction**

Washes everything from blankets to fine laces. Tub of clothes washed in 5 to 10 minutes. A child can operate it.

**AGENTS WANTED. Special price on sample postpaid.**  
Write for terms and trial offer.

**STEWART-SKINNER CO., 26 Cherry St., Worcester, Mass.**



# DIAMONDS ON CREDIT

**20% DOWN 10% MONTHLY**



Let us send you any Diamond you may select from our catalogue so you may compare our values with those offered by other dealers; be convinced that our IMPORTER'S PRICES offer you a great saving.

We furnish a guarantee certificate with every Diamond and allow the full purchase price on all exchanges. We will send express prepaid any Diamond or other article, for examination and approval, you to be the sole judge as to whether you keep it or return it at our expense.

Write today for our free catalogue de luxe No. 6, and see how easy it is for you to own and wear a beautiful Diamond. **L. W. SWEET & CO., Inc., 2 and 4 MAIDEN LANE, NEW YORK CITY.**



# \$8,000 to \$10,000 YEARLY



## Make Money Out of Others' Fun

Pleasing the Public Pays Big Profits and owners of our famous attractions frequently make from \$8,000 to \$10,000 every year. We make everything in the Riding-Gallery and Carrousel line from the smallest to the highest grade. Bring in hundreds of dollars daily. It is a delightful, attractive, big paying, healthful business. Just the thing for the man who can't stand indoor work, or is not fit for heavy work.

Just the business for the man who has some money and wants to invest it to the best advantage. Our goods are finest appearing, easiest running, and most attractive line manufactured. They are simple in construction and require no special knowledge to operate. Our latest new 1915 Carrousel is mounted on trucks to facilitate and reduce cost of moving and shipping. If you want to get into a money-making business write today for catalog and particulars.

**HERSCHELL-SPILLMAN COMPANY**

PARK AMUSEMENT OUTFITTERS

333 Sweeney St., N. Tonawanda, N. Y., U. S. A.

## Red or Black "Vulcan" Ink Pencils

The ONLY perfect, non-leakable ink pencils at moderate prices.



TWO SIZES.

4 1/2 and 5 1/2 inches

Extra Size, 8 inches

(black only), \$1.25.

FREE—Liberal supply of ink with retail orders.

AGENTS WANTED. BIG PROFITS

J. C. ULLRICH & CO., 27 Thames St., NEW YORK

Order today \$1

## TYPEWRITERS ALL MAKES ALL PRICES

Look at these bargains! Typewriters Rebuilt in our own Factories, and guaranteed for one year.

Remingtons \$20 to \$35 Smiths \$15 to \$40

Underwoods \$35 to \$60 Royals \$25 to \$45

L. C. Smiths \$30 to \$50 Oliverts \$20 to \$35

We have others, of course. Send for catalog describing them, and address of nearest branch office.

American Writing Machine Co., Inc., 345 Broadway, N. Y.



## Are You Open to Conviction?

If you desire good, clean, clear-cut representation among your business associates and customers, there is nothing that will reflect these qualities surer or quicker than a clean, smooth-edged, unrumpled

### PEERLESS PATENT BOOK FORM CARD

This selection of a card is as sure an index to the character and personality of yourself and your house as the goods you sell, or the cause you represent; and these detachable, smooth-edged cards are the last word in quality and character. If our statement alone is insufficient to convince you, then a sample of the cards themselves will convince you—no need for a sample tab today and convince yourself—show that you are at least open to conviction.



Our Smart Card in Case

**THE JOHN B. WIGGINS CO. (Established 1857)**

Engravers, Plate Printers, Die Embossers

62-64 East Adams Street CHICAGO



**\$1.00  
DOWN  
FREE TRIAL**

## Play Billiards at Home

Billiards and Pool are fine, clean, interesting games—games that fascinate with their close, exciting, constantly changing situations—games that test the skill of hand, eye and brain, and arouse the keenest sort of friendly rivalry—games that the whole family will enjoy. Billiards and Pool are expensive if played in a public poolroom, but almost anyone can afford to have at home a

# BURROWES

## Billiard and Pool Table

You can play on it while you are paying for it. The prices are from \$15 up, on easy terms of \$1 or more down (depending on size and style selected), and a small amount each month. Sizes range up to 4 1/2 x 9 feet (standard). Complete playing equipment of balls, cues, etc., free.

No special room is needed. The Burrowes Table can be set on your dining-room or library table, or mounted on its own legs or folding stand, and quickly set aside when not in use. Burrowes Tables are

## Used by Experts

for home practice. The most delicate shots, calling for skill of the highest type, can be executed with the utmost accuracy.

### FREE TRIAL—NO RED TAPE

On receipt of first installment we will ship Table. Play on it one week. If unsatisfactory return it, and on its receipt we will refund your deposit. This ensures you a free trial. Write today for illustrated catalog, or mail this coupon:

THE E. T. BURROWES CO., 165 Spring St., PORTLAND, ME.  
Please send Catalog of Billiard Table offers.

NAME .....

ADDRESS .....

Please Mention Popular Mechanics

# DUCK'S NEW 325 Page Electrical No. 8 and Wireless Catalog



Is a TREATISE on ELECTRICITY and WIRELESS. With prices a little lower than the lowest. Bound in imitation leatherette with bronze lettering.

This unrivalled catalog mailed to anyone upon receipt of 8c in stamps or coin which may be deducted on first dollar purchase. Great cost of catalog and low prices prohibit distribution otherwise.

## WHY WASTE TIME AND POSTAGE IN SENDING FOR A DOZEN CATALOGS

when this catalog contains practically everything worth while in wireless and electrical goods, advertised in this and all other magazines,—and in most cases at more attractive prices.



**IMPROVED TYPE R14 AUDION DETECTOR**  
5 Control Points—Fine Adjustment—More Sensitive Than Ever

**\$18**

The Audion Detector is 1 1/2 to 3 times as sensitive as any form of crystal or electrolytic detector. These two characteristic testimonials from Council Bluffs, Ia., and St. John, Kans., speak for themselves.

"I suppose it sounds almost unbelievable when I say that I can hear Port Arthur (VBA) with the phone a foot away from my ears and (NAB) Key West almost that far, but such is the fact."

"I set the Audion up and after a few adjustments I was able to hear Sayville, Colon, Panama, Key West and a host of others that are here closer at home."

### What This Big Catalog Contains

- |   |   |   |
|---|---|---|
| 125 pp. Wireless Apparatus for Commercial and Experimental use; | 8 pp. Flashlights;                      | 2 pp. Fans;   |
| 10 pp. Raw Material;  | 5 pp. Massage Vibrators;                | 12 pp. Telephone Equipment;   |
| 5 pp. Transformers;   | 10 pp. Miniature Railways;              | 6 pp. Heating Appliances;   |
| 8 pp. Storage Batteries;  | 5 pp. Lighting Plants;                  | 10 pp. Auto Accessories;  |
| 15 pp. Telegraph Insts.;  | 10 pp. Ammeters and Voltmeters;         | 13 pp. Victrolas, on our Easy Payment Purchase Plan; (No Down Payment); |
| 42 pp. Motors and Dynamics;                                     | 25 pp. Electrical and Mechanical Books; | 30 pp. General Electrical Supplies.                                     |
| 10 pp. Miniature Lamps;   |   |   |

## SEND 8c for THIS CATALOG TODAY

(Reasons for requesting 8c mentioned above)

The most elaborate, comprehensive, educational and artistic catalog in its line published. Glance through the contents. Note the amazingly low prices of products representative of the best in the field of electrics. Then you will know why the overwhelming mass of users of electrical and wireless supplies have for so many years adopted the slogan:

**"IF DUCK SELLS IT, IT MUST BE GOOD; IF DUCK DOES NOT SELL IT, THERE'S A REASON"**

**THE WILLIAM B. DUCK COMPANY 428-434 ST. CLAIR ST., TOLEDO, OHIO**  
(Our Former Name "THE J. J. DUCK COMPANY")



### BRANDES WIRELESS RECEIVERS

Our "Superior Type" is the best amateur receiver for the price. Wound to 2000 ohms per pair, price complete \$5.00. Single receivers only, 1000 ohms, \$1.65 each.

Send stamp for our New Catalogue

**C. BRANDES, Inc.**  
11a Liberty St. NEW YORK

**FIRST SHIP TO NEW ZEALAND VIA PANAMA CANAL**—The British ship "Purley," which arrived in Auckland, New Zealand, in the latter part of November, 1914, was the first steamer from New York to make that long voyage via the Panama Canal. By the old route vessels coming to New Zealand from New York, occupied about 72 days' time, while the time through the canal in this instance was only 37 days, and the voyage

**ELECTRIC LIGHT PLANTS** Complete gasoline engine, dynamo, switchboard and storage battery \$240.  
Agents wanted. American Battery Co., 1139 Fulton St. Chicago (Estab. 1880.)

### Get This Hand Lighting Plant

Get a bright, powerful Electric Light to carry right in your hand by handle or ball. The Federal Safety First Electric Lamp is not a pocket flasher. The Best Lantern for autoists, boatmen, farmers, repairmen, plumbers, electricians, store-keepers, janitors, and for use in any home. Safe. Wind and rain proof. Batteries cheap—long lived.

Lamp complete, \$2.00

FEDERAL SIGN SYSTEM (ELECTRIC), 208 N. Dearborn St., CHICAGO



### DYNAMO-MOTOR

As a dynamo it will operate induction coils, light lamps, charge storage batteries, electroplate, etc., makes an ideal machine for experimenting. As a motor it will operate heavy models, amey wheels, and other useful appliances.

18 watt dynamo-motor	\$3.00
24 " " "	3.85
40 " " "	5.25

Send 2 cent stamp for catalog of wireless apparatus, trains, electrical supplies, novelties, tools and books.

**LOOMIS ELECTRIC COMPANY**  
1427 N. Artesian Ave. Chicago, Ill.



**10¢**

Wireless Detector. Guaranteed to receive long distance messages with our \$0.39 telephone receiver, or money back. Our Cyclopedic sent FREE with it. Price **PREPAID \$0.10**

**Static Machine.** Turning crank gives powerful 3 in. spark. No batteries required. Made of steel and hard rubber. Performs 500 experiments. Size 8 x 5 x 10 ins. Weight 6 lbs. Price . . . **\$3.70**

**341B**

**Smallest Tungsten Flashlight** made. Powerful light. Weight 4 oz. Price . . . **\$0.50**

**Hustler Motor.** Runs on 1 dry cell. Size 3 x 3 x 4 ins. Weight 1 lb. Price . . . **\$0.80**

**1043**

**Flashlight Lamps.** 3 1/2 Volts give brilliant light. Weight 4 oz. Price . . . **\$0.09**

**Dynamo.** Very powerful. Gives 6 Volts, 6 Amperes. Lights 12 tungsten lamps, charges storage cells, runs as power motor. NOT A TOY. Size 6 x 6 x 6 ins. Weight 7 lbs. Price . . . **\$3.69**

**1024**

**Telephone Receiver.** 75 Ohms. Hard rubber shell, powerful magnet. With two phones and no batteries, you can talk 500 feet. Size 2 1/2 x 1 1/2 ins. Weight 1 lb. Price **\$0.39**

**9000**

**1231**

# BOYS

We carry the largest stock of experimental electrical goods in the world, and are the originators of the Wireless experimental business. ASK YOUR FRIENDS ABOUT US. When ordering above goods enclose postage, else goods must go by express. Shipping weights are given. We ship in 24 hours. Send today 8c. postage for a copy of our famous Electrical Cyclopedic No. 14, containing 400 illustrations, 1,600 articles, "Treatise on Wireless Telegraphy" and 20 coupons for free Wireless Course. With any of above goods, Cyclopedic included FREE. "Everything for the Experimenter" **THE ELECTRO IMPORTING CO., 233A, Fulton Street, New York City**



## The Simplest, Most Economical and Reliable Portable Electric Light



made, for the home, factory, garage, farm, on the automobile, motor boat; when camping or any occasion where an artificial light is required.

### Absolutely Safe

Can be thrown into hay, straw or other inflammable material without danger, as there is no flame to ignite or heat to generate combustion.

### Light is Clear Bright and Steady

Not affected by rain or snow. The strongest gale cannot blow it out. Absolutely reliable where a candle, oil lamp or lantern would be valueless.

**Economical** in the use of current. The RED SEAL DRY BATTERY will give approximately 50 hours of intermittent service. Every up-to-date electrical house, garage or hardware store carries the RED SEAL DRY BATTERY which does not deteriorate when not in use.

It is made of brass, nickel plated with tungsten miniature lamp, reflector and lens. Extremely simple in construction and will fit any standard size battery, so if the RED SEAL DRY BATTERY cannot be had, other dry batteries will answer.

Get your name on file for a copy of our new pocket catalogue, P28, ready Feb. 1st.

No. 5337 Redsealite \$1.00 complete with battery. This price does not include transportation or mail charges.

## Manhattan Electrical Supply Co.

New York Chicago St. Louis San Francisco  
17 Park Place 114 S. 5th Ave. 1106 Pine St. 604 Mission St.

can be made in much less time. The distance via Cape Horn is 11,571 miles, and the distance via the Panama Canal is only 8,500, making a saving of upward of 3,000

## 250 "WIRELESS" TRANSFORMER \$9.00

CLOSED-CORE TYPE SELF CONTAINED 14000 VOLTS 3 DIFFERENT POWERS Shipping Weight 20 Lbs.  
Send 2c stamp for catalogue of Wireless Supplies, folders, etc. Winger's Telegraph Code Charts free with \$2 orders; otherwise 25c. each. Furnished in "station" or "pocket" sizes. Continental or Morse code; please state which, otherwise Continental "pocket" size will be sent. Winger Electric & Mfg. Co., 711 So. Western St., Chicago, Ill.

**ELECTRIC HOME, FARM and STORE LIGHT PLANTS. LIGHTS, DYNAMOS, MOTORS, ENGINES. Belts, Books, Rectifiers, Storage & Medical Batteries, Railways. Bicycle, Carriage & Xmas Lights, Massage, Ozon & M.P. Machines. MOTION PICTURE THEATRE Permanent and Traveling Equipments. Big Opportunity. Catalog 3 cts. OHIO ELECTRIC WORKS, CLEVELAND, OHIO**



### "THE ELECTRICAL EXPERIMENTER"

The big electrical Magazine for those who dabble in electricity and Wireless. Chuck full of experiments. Intensely interesting. Monthly prizes of \$5.00 for best experiments. Amateur Electricians, wireless news. Complete Electric Course etc. 50 to 100 illustrations. Only 50c a year in U. S. and Canada. On all News-stands. Send for free sample.

Electrical Experimenter 234 Fulton St., N. Y.



## ELECTRICITY

BOYS—Send today for our new 128-page catalog of everything electrical. Motors, Dynamos, Flashlights, Lamps, Coils, Batteries, Transformers, Magnet and Resistance Wires, Telegraph Outfits, Miniature Electrical Railways and Parts. Catalog with coupon sent only for 6c in stamps or coin. No postals answered. VOLTAMP ELECTRIC MFG. CO. Voltamp Block, BALTIMORE, MD.



## \$2 a DAY or \$2 an HOUR?

The difference is only a matter of **training**. The man who works with his hands will always take orders from the man who knows how to use his brains.

Are you going to be an order-giver or an order-taker? Are you going to be paid for what your brains **know** or for what your muscles can do?

*The International Correspondence Schools can qualify you to be an order-GIVER. They can help you to a better job by giving you the TRAINING that the better job requires. They can help you to earn more money. They can help you to a more congenial position and send you to work in the morning chock full of ambition and determination.*

For 24 years the I. C. S. have been aiding men just like you to rise to positions where salaries are larger and opportunities greater. Every month more than 400 men of all occupations voluntarily report better jobs and more money as a result of I. C. S. training.

### Mark the Coupon

Start your real success today. Mark the coupon for a higher salary

## INTERNATIONAL CORRESPONDENCE SCHOOLS

Box 872, U2 SCRANTON, PA.

Please explain, without further obligation on my part, how I can qualify for a larger salary and advancement to the position, trade, or profession before which I have marked X.

Electrical Engineering  
Electric Lighting  
Electric Railways  
Electrician  
Electric Car Running  
Dynamo Foreman  
Wireman  
Mining Engineer  
Tel. and Tel. Engineer  
Surveyor  
Civil Engineer  
Automobile Running  
Agriculture

Mechanical Engineer  
Mechanical Draftsman  
R. R. Construction  
Concrete Construction  
Architect  
Contracting & Build'g  
Architect'ral Draftsman  
Plumbing and Heating  
Chemist  
Bookkeeper  
Advertising Man  
Civil Service Exams.  
Salesmanship

Name \_\_\_\_\_  
St. and No. \_\_\_\_\_  
City \_\_\_\_\_ State \_\_\_\_\_  
Present Occupation \_\_\_\_\_

Please Mention Popular Mechanics

## Is Your Refrigerator Poisoning Your Food?

A leading medical authority says: "A poor refrigerator means not only wasted ice, but often wasted lives from spoiled food." Read what physicians and others say about wonderful ice-saving and health protection the Monroe affords.



Approved by Good Housekeeping Institute

**G<sup>h</sup> Monroe**

The Monroe food compartments are Genuine Solid Porcelain ware—in one piece—over an inch thick—every corner rounded. Not cheap porcelain-enamel on metal base—but one piece of white unbreakable porcelain ware which can be truly kept free of germs—no cracks, joints, or corners—nothing to break or chip.

**30 Days' Trial—Cash or Credit**  
Sold direct from factory at factory price. Freight paid and all money back if not absolutely satisfactory.

Monroe Refrigerator Co. (Established 1868), Sta. 28 B, Lockland, O.

"Using about one-third the ice the others did."—T. G. Mackie, New Orleans.

"Cut ice bills from \$36 to \$8."—T. W. Williams, Milwaukee

"Reduced ice bills nearly 40 per cent."—Dr. B. H. Wells, Southport, Conn.

"Much more economical than any other of several I have had."—Dr. O. B. Shreve, Salem, Mass.

"Saved about 50 lbs. of ice per day over another make of same size."—W. M. Kleke, Paducah, Ky.

"An ice saver, a germ preventer, hence a health preserver to any family."—Dr. Chas. Hups, Lafayette, Ind.

"Economical in use of ice; and preserving in best manner articles placed in it."—Dr. R. E. Sparkweather, Evanston, Ill.

Send at **FREE BOOK** once for

**about refrigerators**

It tells you how to select the home refrigerator—how to keep food longer without spoiling—how to cut down ice bills—how to guard against sickness—doctor's bills.

## The Truth About Poultry



Get the Facts by Reading

## The One-Man Poultry Plant

Successful Methods of Men on Farms or Small Acreage. Complete in twelve parts; printed in one volume.

By **DR. N. W. SANBORN**

**REAL** work, with real poultry, on a real New England Farm. This is a simple story of what has been done by a man, at forty-five years of age, town bred and city educated, getting out of practice of medicine, buying a small farm in the hill country, and making a success of the venture. Not only is the rearing of chicks and the management of adult fowl completely covered, but the interesting side issues of fruit growing, grain raising and the production of milk, that cannot be escaped on a real farm. You get rugged facts—rarely found in print. The truth about poultry as found in actual life on a one-man poultry farm.

**You Can Do the Same, Book Tells How**

**OUR SPECIAL OFFER**—The One-Man Poultry Plant, in twelve parts (book form), and the American Poultry Advocate, one year, for only 50 cts., book and Advocate, three years, for only \$1.00, if order is sent at once.

Our paper is handsomely illustrated, practical, progressive and up-to-date on poultry matters. Established 1892, 44 to 132 pages monthly, 50 cents a year, 3 months' trial 10 cents. Sample copy free. Catalogue of poultry literature free. Address

**AMERICAN POULTRY ADVOCATE, 523 Hodgkins Bldg., Syracuse, N.Y.**

## Lice Proof Nests

Banish Lice and Mites



Healthy Hens—More Eggs—No more Poultry troubles—Banish Lice and Mites. **KNUDSON**

Wonderful flat, galvanized steel nests. Not trap sets.

**FREE** Write for catalog and special offer, \$3.50 per set. Save \$1.75 by special offer. Address

**KNUDSON MFG. CO., Box 600, ST. JOSEPH, MO.**

## Greider's Fine Catalogue



and calendar of pure bred poultry; 70 varieties illustrated and described, many in natural colors. A perfect guide to poultry raisers—full of facts. Low prices on stock and eggs for hatching. Incubators and brooders, 22 years in business. You need this noted book. Send 10c for it—today.

**B. H. GREIDER, Box 19, Rheems, Pa.**

## Join World's Champions



13 more championships won by owners of Belle City hatching outfits. Makes

**Belle City 21 Times World's Champion**

Free Book "Hatching Facts" tells whole story. My \$800 Gold Offers come with Free Book—Money-Back Guaranty. Hatching outfit shown in actual colors. Jim Rohan, Pres.

**Belle City Incubator Co., Box 164, Racine, Wis.**



Freight Prepaid, 1, 2 or 3 Months' Home Test

## Values Ripped Wide Open

Big Money in Poultry

My 1915 values are creating a SENSATION. I have the largest incubator factory in the world. My tremendous output is enabling me to rip values wide open. The same high-grade world-beating quality that has made **RELIABLE INCUBATORS AND BROODERS** the steady of experienced poultrymen all over the world. Don't buy until you get my 1915 prices and book of facts. You'll regret it if you DON'T. Write now. **J. W. MYERS, Pres., RELIABLE INCUBATOR & BROODER COMPANY, Box B-81, Quincy, Ill.**



miles. The "Purley" was only 6½ hours passing through the canal. It brought 9,500 tons of general cargo for Auckland, and two other New Zealand ports. The merchandise, generally speaking, was well packed, but sev-

**MONEY IN POULTRY and SQUABS** Start small. Grow BIG. Get winter eggs. Keep healthy fowls. Save your chicks. **Foy's big book tells how.** Describes largest poultry and pigeon plant. Shows fowls in natural colors, how to feed for eggs, how to select best layers. Mailed Free. **F. FOY, Inc., Box 39, DES MOINES, IOWA**



## SHOEMAKER'S BOOK ON POULTRY



and Almanac for 1915 has over 200 pages with many colored plates of fowls true to life. It tells all about chickens, their prices, their care, diseases and remedies. All about incubators, their prices and their operation. All about poultry houses and how to build them. It's an encyclopedia of chickendom. You need it. **Only 15c.** **C. C. SHOEMAKER, Box 1107, Freeport, Ill.**

## Hatches Every Chick

Poultry raisers ought to follow the simple and easy Buckeye system, which positively hatches every hatchable egg. Now to make \$200 a season with one incubator that costs \$7.50 is fully explained in a most interesting book which will be sent absolutely free to any reader who mentions this magazine. Everyone should write today for this valuable free book to **BUCKEYE COMPANY, 635 Euclid Ave., Springfield, O.**

## POULTRY PROFITS FOR YOU

**HOW TO WIN THEM** on City or Town Lot, on Village Acre and on the Average Farm is the timely subject treated at length in our 1915 **FREE 200-page Complete Catalogue and Poultry Keepers Guide.** Tells all about our **EIGHT DIFFERENT SIZES** of incubators, ranging in price from \$10 to \$88; also about the Cyphers all-metal Brooding Hovers, and nearly 100 other valuable, practical articles used by **MONEY-MAKING** poultry keepers. **WRITE TODAY.** **CYPHERS INCUBATOR COMPANY Dept. 161 Buffalo, N.Y.** Boston New York Chicago Kansas City Dallas Oakland

# 6 MONTHS TO PAY



## Made To Order

Again we lead in lowest prices and save you over half! Our nation-wide reputation as America's greatest price smashers is retained. Our tremendous buying power enabled us to buy world's finest fabrics at lowest prices known.

## Save Half

Can you equal these prices? Regular \$35 tailored-to-your-measure suits and overcoats only \$15 from us; \$45 values only \$18, etc. These are only examples. Don't buy ready-mades and pay double our price. Don't pay other tailors four times as much as we charge.

## Just Off the Press

This season Stanley-Rogers styles and fabrics are more nifty more handsome than ever before. Send now for gorgeous 1915 Spring and Summer Fashion Book—just off the press—74 latest, handsomest, exclusive styles.

## \$2.00 Monthly

Our remarkable credit plan beats every plan known. No security—no references—no red tape—no delay. Our terms and long credit make it easy for every man to dress up-to-date at lowest prices, no matter where he lives.

## Don't Be Deceived

by houses advertising "made-to-measure" clothes. Don't let them fool you into believing that they are making your clothes tailor-made-to-your-measure. They send you hard-measure. They secretly alter them here and there and charge you twice their value. That's why you're dissatisfied—no style, no fit, no class, no wear.

**\$1,000 Reward** to anyone who proves that we do not make all our garments, no matter how low the price, absolutely tailor-made to your individual measurements. We do not sell ready-made garments—would not have them in the place. We give a legal guarantee of money back if you are not surprised, delighted with Stanley-Rogers garments. We treat our customers right.

## FREE 1915 Spring and Summer Fashion Book

Over 70 Magnificent New Styles. Best all past designs in beauty and class. The cream of the greatest mills. Styles are exclusive—cannot be duplicated. Write for free copy. Don't be without one.

**WRITE Now for Special Offer** Save big money—dress smart—get better fit, better wear, better service. Write us now for most startling clothes facts, proof that we save you over half and free style catalog. Don't buy clothes until you hear from us. Send no money—all is free.

**STANLEY-ROGERS COMPANY,**  
544 South Clark Street, Chicago, Ill.

## TOUCH WOOD

Give the grumps the gleeful go by.  
Displayed wherever jewelry is sold.

## High-Grade MUSIC ROLLS

45% to 50% saved on regular prices; choice of over 2000 Popular, Classic and Operatic Selections; famous for *exquisite tone arrangement*. (88-note rolls only.) Get our

## Money-saving Prices

in 88-page FREE Catalog—write NOW, save money; service *exceptionally* prompt.

S. H. CONSUMERS MUSIC CO.  
Station C Buffalo, N. Y.

## AGENTS ENORMOUS PROFITS



Great new toilet proposition—country taken by storm. Beautiful line—handsome case—quick sellers. Every woman—every man—sees something to buy. Easy for you to get

## This Meximol Sample Case Outfit FREE

by our liberal plan—no money needed. Hustlers given grand opportunity to appoint agents—share in profits of others' work. Exclusive territory. Special offer if you answer quick.

Ask for Free Outfit terms today

FRANCIS E. LESTER CO., Dept. ET-3-Y, Meadville Park, N. M.



Only \$375

Symphonic Pianos and Player Pianos

## What Shall I Play For You?

With the Symphonic or Symphonola in your home you are always safe in asking that question. Music lovers have placed the stamp of approval upon these instruments. They are recognized as correct-toned, always affording delightful, pleasant, acceptable entertainment for your family and friends. Play the Symphonic Piano by hand. Play the Symphonic Player by music rolls as well as by hand. Play the Symphonola with Victor or Columbia records. These instruments bring you the best vocal and instrumental music.

## Three Instruments

### Sold with Larkin Groceries and Supplies

Practice worth-while household economy for a number of months, deal with the Larkin Factories and your savings will help pay for a Symphonic or Symphonola. We help you to save 35c to 50c on the dollar on 800 every day necessities including Flour, Sugar, Coffee, Tea, Canned Goods, Soaps, Toilet Articles, compared with usual prices.

## 1 to 4 Years Time Without Interest or Rent

Your Symphonic or Symphonola will be shipped after we receive your first order for our Groceries and Supplies. Then you may take a year to pay for the Symphonola or four years for the Symphonic Piano or Player Piano. Symphonolas are made by Messrs. Knabe of Knabe Bros. Co., formerly, but no longer makers of the Wm. Knabe Piano. Their fame as piano builders is known to music lovers everywhere. Symphonolas are made by one of the two largest makers of such instruments. Great savings result from purchasing these instruments at our bedrock Factory-to-Family prices.

## FREE Instrument Catalog

Send today for this book. It describes and illustrates all these instruments in the actual colors of Figured Mahogany, Circassian Walnut, and Fumed Oak. It also explains in detail our money-saving Plans of Sale. Ask for it today.

### MAIL THIS COUPON

Symphonola Only \$60

LARKIN CO., Buffalo, N. Y.  
Dept. FM-315

I am interested in the instrument checked. Send your Instrument Catalog and offer.

Piano

Player-Piano

Symphonola

Name .....

Town .....

State .....

R. D. or St. Address .....



## CLASS PINS

FACTORY TO YOU

For College, School or Society

Catalog with attractive prices mailed free upon request. Special offer, either style of pins here illustrated with any three letters and figures, one or two colors of enamel, STERLING SILVER, 30c each; \$3.00 dozen. SILVER PLATE, 15c each; \$1.50 dozen. BASTIAN BROS. CO., 551 Bastian Bldg., ROCHESTER, N. Y.

**AGENTS**

SALESMEN  
MANAGERS  
YOUNG OR OLD  
NEW BUSINESS

**NEW BUSINESS JUST OUT**

**DROP THE DEAD ONES. AWAKE! START WITH THIS NEW INVENTION, THE 20th CENTURY WONDER**

Get started in an honest, clean, reliable, permanent, money-making business. Sold on a money-back guarantee

*The Blackstone Water Power Vacuum Massage Machine*  
For the Home. No Cost to Operate. Lasts Life-Time

**LISTEN**

No Competition, New Field, New Business. Price within reach of all. That's why it's easy to sell. Endorsed by Doctors and Masseurs. Removes Wrinkles, rounds out any part of the face or body, brings back Nature's beauty. Almost instant relief can be given all kinds of pains. A demonstration convinces the most skeptical person. Sales easily made.

**Read On! What Others Do, So Can You.**

Parker writes, sold eight machines first day. Margwarth says, I am making \$10.00 per day. Schermerhorn, eight dozen machines first month. Shaffer writes, am selling four out of five demonstrations. Vaughn, orders one dozen, four days later wires "ship six dozen by first Express." Lewis, sells four first hour. Men, women, everybody makes money. No experience necessary. Protected territory to active workers. We own all patents. Big book entitled, "The Power and Love of Beauty and Health" Free. Investigate now, today. A postal will do. A big surprise awaits you. Address, BLACKSTONE MFG. CO., 38 Meredith Bldg., Toledo, Ohio

**AGENTS**

GENERAL AGENTS  
ROAD MEN  
MAKE MONEY HERE  
Start Now - Today

**New HERNIAL Appliance**

The Brooks Appliance Holds More Firmly, Comfortably and Surely than Any Truss

**Sent on Trial**

The new Brooks Appliance for rupture so thoroughly meets every test and requirement that it is ordered by the U. S. War Dept. and is recognized as the most reliable support ever invented. It is fitted with an Automatic Air Cushion which follows every movement of the body and always covers the ruptured spot. The cushion which comes in contact with the skin is soft, pliable gum rubber and clings closely, so that slipping is impossible, and it is cool and comfortable because of the constant circulation of air through it.

This Appliance is sold under a positive guarantee of money refunded if not satisfactory. We do not guarantee to cure any more than any doctor will guarantee to cure his patient. We do guarantee to furnish a perfect fitting Appliance, which will give the wearer solid comfort and retain the protrusion at all times. The purchaser is the sole judge and if for any reason whatever (which does not have to be furnished us) it is returned, the price paid will be refunded in full.

Further information regarding the Appliance, rules for self-measurements and catalog sent FREE. Just send your name and address to

BROOKS APPLIANCE COMPANY  
1817 State St. Marshall, Michigan



C.E. BROOKS, the inventor

**I will send my 25c Book Strong Arms**

for 10c in stamps or coin

Illustrated with twenty full-page half-tone cuts showing exercises that will quickly develop, beautify and gain great strength in your shoulders, arms and hands, without any apparatus.

PROF. ANTHONY BARKER  
644 Barker Building, 110 W. 42nd St., NEW YORK

For MEN, WOMEN and CHILDREN

**TYPEWRITERS**

ALL MAKES

Underwoods, Remingtons, Oliviers, Smiths, from \$10 to \$60. Guaranteed 5 years. 500 Typewriters at \$12.50, every one perfect. Write for liberal FREE trial offer at once. All Makes Typewriter Exchange Co., 168 N. Dearborn St., Chicago, Ill.

**Print Your Own**

Cards, circulars, menus, newspaper, book, etc. PRESS \$5, larger \$18, Rotary \$90. Save money. Big money printing for others. All easy, rules sent. Write factory for illustrated press catalog, TYPE, cards, paper, samples, etc. THE PRESS CO., Meriden, Conn.

eral improvements could have been made; for example, a shipment of tool handles arrived with the ends of the cases broken open, not being sufficiently well packed for export. A consignment of washboards should have been packed in crates instead of being in open bundles. One long crate containing wallboard was broken clear through

**BARODA DIAMONDS**

FLASH LIKE THE GENUINE - AT 1-50 THE COST  
SOLID GOLD MOUNTINGS Stand acid test and expert examination. See them first, then pay. Catalog FREE. Patent Ring Gauge included for 5 two-cent stamps. The Baroda Co., Dept. 15, 1456 Laird Ave., Chicago



Eriksen Artificial Limb Co., 38 Wash. Ave. No., Minneapolis, Minn.  
Light Durable  
Does Not Chafe Overheat or Draw End of Stump



We are Under Govt. Bond

**Deafness**

Perfect hearing is now being restored in every condition of deafness or defective hearing from causes such as

Relaxed or Sunken Drums, Roaring or Hissing Sounds, Perforated, Partially Destroyed Drums, etc.

**Wilson Common-Sense Ear Drums**

"Little Wireless Phones for the Ears"—

require no medicine but effectively replace what is lacking or defective in the natural drums. They are simple devices, which the wearer easily fits into the ears where they are invisible. Soft, safe and comfortable to wear at all times.

Write today for our 168 page FREE book on DEAFNESS, giving you full particulars and plenty of testimonials.

WILSON EAR DRUM CO., Incorporated  
528 Inter-Southern Building LOUISVILLE, KY.

Please Mention Popular Mechanics

**NO MORE BALD HEADS**

When our VACUUM CAP is used a few minutes daily. We accept no pay until you have tried the Cap 60 days and are satisfied. The Vacuum Cap is an appliance that draws the blood to the Hair Roots and starts a new healthy crop of hair. It stops Dandruff, stops the hair from falling out. Bought by Doctors and men who

know that it is the only reasonable HAIR GROWER known to science. No Drugs Used. Write for application blank, testimonials, and booklet on "HAIR," sent sealed in plain envelope, FREE.

**THE MODERN VACUUM CAP CO.**

P. 559 BARCLAY, DENVER, COLO.

"Let There Be More Light"

Goodbye Old Oil Lantern

Price only

**METEOR**  
ELECTRIC LANTERN  
COSTS LESS THAN OIL



**75c**

(postpaid)

This price does not include Dry Battery. Batteries can be obtained at any hardware store throughout the country, or direct from us, for 25 cents, and can be attached in a few seconds.

So Useful

This Electric Lantern is designed to take the place of the kerosene lantern wherever used. It costs less to burn and is a hundred times more convenient and safe.

USES ANY NO. 6 DRY BATTERY. ABSOLUTELY SAFE AROUND GAS, GAS-OLENE OR KAY.

1 BATTERY LASTS FROM 6 TO 8 MONTHS

The Meteor Electric Lantern is furnished with high power and improved Turgoite bulb which will stand any jar or rough usage. Simple—convenient—safe—economical. Light is clear, bright and steady. Unaffected by weather—absolutely reliable. Practical—no toy. Not simply a flashlight, but can be used for continuous burning. Simply press the switch with thumb, and you have a most brilliant white light for over 10 feet ahead.

Don't be without one another day. Agents wanted

Johnson Smith & Co., Dept. 2, 711 S. Dearborn St., Chicago

**AGENTS \$50 to \$90 Per Week**  
Men or Women



**NEW INVENTION—Just Out 20th Century YOUTHIFIER!**

Nature's remedy for beauty ills. Lowest price massage machine on the market. Marvelous outfit without a peer. Puts massage facilities within reach of all.

No Electricity or Water Power Needed. Nature's laws utilized. Slight pressure of the thumb gives an exhilarating, fascinating massage. Brings back the energy, buoyancy and beauty of youth. Produces natural glow of health. Pleases, delights, satisfies. Enormous business everywhere. Women attracted, interested, fascinated—buy at sight, without urging.

BEAUTY FOLDER FREE

**GET OUR PROPOSITION**

Fortune will be made by live agents who answer this ad. We furnish you help that absolutely prevents failure. Act on our liberal proposition. No charge for territory. Circular and advertising matter furnished free. Excellent territory still open. Be the first in your locality. Hurry. Send no money. Simply write a postal for free particulars.

Aztec Remedy Co., Dept. 144, Toledo, Ohio

**BUY PLUMBING and HEATING SUPPLIES**



at WHOLESALE

Will Save You 30%

Don't pay retail prices. Full stock on hand for prompt shipment. Send for free catalog.

B. P. KAROL, 768 to 772 W. Harrison St., CHICAGO



**Made-to-Measure**

Express Prepaid **\$275**

Pants cut in the latest style. Made-to-your individual measure.

Fit, workmanship and wear guaranteed.

**No Extra Charge**

for peg tops, no matter how extreme you order them.

**Agents Wanted**

A good live hustler in every town to take orders for our celebrated made-to-measure clothes. Samples of all the latest materials FREE.

**We Pay Big Money**

to our agents everywhere. Turn your spare time into cash by taking orders for our stylish clothes. Write today for beautiful FREE outfit.

**The Progress Tailoring Co.**

Dept. 600, CHICAGO, ILL.

**FREE TRIAL**

**10 to 30 Days**

on any strictly high-grade violin in our famous stock of rare instruments. A positively free trial right in your own home. There are no strings to this liberal offer. Send in the coupon for details.

We make and import all our own instruments and sell direct, giving you the benefit of the regular middleman's profits. We have 34 years of expert violin experience.

We will allow you 10 to 30 days' trial free. We insist that you shall be satisfied and we will pay the express charges both ways on any returned instruments. Send the coupon today—now.

**Rare Offers Now**



Our instruments are all fine hand-made tone violins for professional use, sold at exceptionally low prices for the value given. Some styles are wonderful copies of old violins, owned by the greatest artists. They are far superior in quality and power of tone to the old violin at four times the cost. Test any instrument you choose, right in your own home at our expense. Many wonderful values just now. Easy payments if you prefer not to pay cash.

**Free VIOLIN BOOK**

Write today for free copy of the new Lewis catalog of Violins, Cellos, Etc. Don't think of buying a Violin, Cello, Viola or other stringed instrument until you have seen this book. War conditions have not affected the price of our violins. A fortunate purchase enables us to make our special offers of rare bargains in high-grade violins at no advance in price. While others ask as much as double their former prices, we still make our special rock-bottom offers on all violins. Write for Violin Book—FREE.

**Send Coupon Today**

Just fill out the coupon and mail to us at once. We will send you free and postpaid full description of our high-grade instruments. Don't delay—send the coupon now for our Free Catalog. If you are a teacher enclose your professional card.

**Wm. G. Lewis & Son**

(ESTAB. 1869)

225 S. Wabash Ave., Dept. 1193

CHICAGO, ILL.

Attention, Violin Makers—We make a specialty of Imported Woods, Varnishes and Tools.

Name.....

Address.....

**COUPON**

Wm. G. Lewis & Son  
Dept. 1193  
225 S. Wabash Av.  
Chicago

GENTLEMEN: With no obligations whatsoever upon me you may send me free and postpaid one copy of the new Lewis Catalog and full particulars of your great free trial offer on high-grade violins.

Please Mention Popular Mechanics



## Hansen's "Protector"

Your Choice of  
Horsehide  
Cordobuck  
Peccary Pig  
Buckskin

**YOU** have all kinds of insurance when you wear this "Protector." You are insuring your hands against injury, your job against delay, your pockets against waste.

# Hansen's Gloves

Insure the right fit and style with flexibility and long service. Special Hansen tannage prevents stiffening. No shrinkage under repeated soaking.

When soiled or greasy they can be easily restored with gasoline, and in the long run are much cheaper than the ordinary kind.

### Send for Free Book of Gloves

Shows many of the 500 styles. For railroad men, mechanics, farmers, motorists, linemen, lumbermen, etc.—for every sport, profession and trade. If no dealer is handy, write us for information.

**O. C. Hansen Mfg. Co.**

291 A. B. Milwaukee St. Milwaukee, Wis.

## DRUMMOND

8-inch English Precision self-acting, sliding, boring, screw cutting and milling

## LATHE

complete as shown

Forty-two Dollars

Our book, "Lathe Work by Some Amateurs," will be sent to you free on request.

W. R. Price, New York

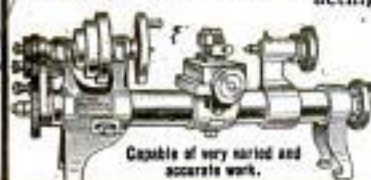

Capable of very varied and accurate work.

## WONDER LIGHT OUTFIT

### Lots of Fun for Boys

Consists of 3½ volt, 2 C. P. lamp, switch, socket, 20 ft. insulated wire and 3 cells of dry battery all ready to install.

May be used to light a dark closet or hall.

PRICE ONLY 60c.

Post. Extra 15c

SEND NOW

## LITTLE GIANT MOTOR

Is nearly 3 in. high. Runs at high speed on a single cell of battery. Very powerful and may be used to run small toys, etc. Just the motor every boy has been looking for.

Sent postpaid for only 50 cents

## THE SIMPLEX TELEGRAPH



An opportunity for every boy to learn to telegraph and to put up a line with his chum. This is a full sized telegraph set consisting of a fine key and sounder mounted on a polished base. Will work any distance. An excellent Field Telegraph for Boy Scouts.

Sent postpaid for only 98 cents

## UPRIGHT STEAM ENGINE

A fine engine, made of the best materials, 9 in. high. The right engine for any boy. Runs at high speed on low pressure. Each engine tested at the factory and fully warranted.

Sent postpaid for only 50 cents

## SIMPLEX

## WIRELESS OUTFIT



Every boy wants a wireless outfit. Get in this interesting game and read the messages flying around you. This outfit is the greatest bargain ever offered. Consists of a large double slide tuner, a sensitive cat whisker detector, condenser, telephone receiver and cord. Size 9x6x4 inches. Wt. 5 lbs.

Special price, complete, \$1.95



## EXPERIMENTERS

THIS IS THE Experimenter's Reference Book EVERY BOY NEEDS IT

It's the latest edition of the famous **AMCO Catalog**, nearly 200 pages, fully illustrated. Complete description and prices of the latest Electrical and Experimental Apparatus—Storage Batteries, Rectifiers, Transformers, Induction Coils, Wireless Apparatus, Lamps, Flashlights, Meters, X-Rays, Books, Tools, Electric Railways, Steam Engines, Water Motors, Dynamos, Motors, Telegraphs, Telephones, Electrical Supplies, Model Aeroplanes and parts for building your own apparatus. A treatise on Wireless Telegraphy telling how to put up an aerial, connect apparatus, etc., together with a Call List and Wiring Diagrams, FREE with every catalog. 5c in stamps will bring you this wonderful book. The best catalog of wireless apparatus, etc., published.

**ADAMS-MORGAN CO.** "THE EXPERIMENTER'S SUPPLY HOUSE"  
Dept. M, Upper Montclair, N.J.

the middle. A case containing red oilcloth was broken open because it was made of white pine and the boards nailed from the inside. One decided improvement in packing American merchandise for export would be the substitution of oak, and other tough lumber, for white pine. All boxes should be banded, unless dovetailed, and these, too, if in large sizes, should be banded. The merchandise arriving in the best condition was a consignment of typewriters.

## BIG CHANCE FOR AGENTS



### You can earn BIG MONEY

selling the most complete line of guaranteed transparent handle Knives and Razors with Photo, Name and Lodge Emblem—also full line of cutlery. Write today for catalogue and terms **Golden Rule Cutlery Co., 554 W. Lake St., Dept. 202, Chicago, Ill.**

## Delivered to You Free

A sample 1915 model "Ranger" bicycle, on approval and 30 DAYS TRIAL and free riding test.

Write at once for large illustrated catalog showing complete line of bicycles, tires and supplies, and the most marvellous offer ever made on a bicycle. You will be astonished at our low prices and remarkable terms.

**RIDER AGENTS Wanted**—Boys, make money taking orders for Bicycles, Tires and Sundries from our big catalog. Do Business direct with the leading bicycle house in America. Do not buy until you know what we can do for you. WRITE TO US.

**MEAD CYCLE CO., DEPT. D108 CHICAGO**





## "Skat Skatters Dirt"

Just rub a little SKAT on your hands, and it will loosen all dirt, grime, grease or dust in the pores, so that it readily rinses off. Can't injure the skin. Leaves your hands soft, white and clean. Cuts out the scrub and rub. 10c at dealer's. If YOUR dealer hasn't SKAT, send us his name, and we'll see that you're supplied. **SALESMEN WANTED**



Ask Your Dealer for  
**SKAT KLEANSER (Powdered)**  
"Keeps Kitchen Klean"  
**THE SKAT COMPANY, Hartford, Conn.**

## GO INTO THE MOVING PICTURE BUSINESS

Write For  
**FREE Catalog**



ON OUR **Easy Payment Plan**  
**Make \$20 to \$50 PER NIGHT**

With our moving picture outfit. We sell everything—Films, etc.

**DEARBORN NOVELTY CO.**  
Dept. P, 537 S. Dearborn St., Chicago, Ill.

Southern Office: MONARCH FILM SERVICE, Dept. P, 228 Union Avenue, MEMPHIS, TENN.

In 1900 there were 62 beef cattle in the United States for each 100 persons of population; now there are only 17 cattle to each 100 of population.

**PATENTS** secured on square deal fee plan with free search.

**MILO B. STEVENS & CO.,** 603 F St., WASHINGTON, 346 Monadnock Bldg., CHICAGO. Established 1864

## PATENTS

**MASON, FENWICK & LAWRENCE**

Est. over half a century. 610 F St., Washington, D. C. Also New York City, Chicago, Ill. **BOOKLET FREE.**

## Do Your Own Printing

You can make good money from the start and build up a profitable business by printing cards, letter-heads, circulars, etc. Requires little money.

Write today for our 96 page catalog. It's free. Contains full printing instructions.

**ROWELL PRINTERS SUPPLY CO.**  
75 Main St. (Est. 1865) Louisville, Ky.

**Boy Electrician** with 75 illustrations for making Batteries, Dynamos, Motors, Telegraph apparatus, Telephone, Lights, Bells, Alarms, Coils, "Wireless" Current Reverser, Electric Engine, Etc. By Electrical Experts so that anyone can understand it. With Cat. All 10c Ppd.

**J. C. DORN, 705 So. Dearborn St., Dept. 21, Chicago, Ill.**

**Big Entertainer** 320 Jokes and Riddles, 153 Parlor Games and Magic, 18 Tricks with Cards, 73 Toasts, 7 Comic Recitations, 3 Monologues, 22 Funny Readings. Also Checkers, Chess, Dominoes, Fox and Geese, 9 Men Morris. All 10c. postpaid.

**J. C. DORN, 709 So. Dearborn Street, Dept. 17, Chicago, Ill.**

**Boys' Own Toy Maker**

Tells how to make a Talking Machine, Camera, Electrical Motor, Bicycle Bunk, Canoe, Boomerang, Bobbed, Wind Mill, Microscope, Water Wheel and Motor, Skits, Toboggan, Snow Coaster and Ball Boat, Telephone, Electric Bell, Railroad Wind Mobile, Paddle Raft, Traps, Kites, etc. All 10c. postpaid.

**J. C. DORN, 707 So. Dearborn St., Dept. 38, Chicago, Ill.**

**World's Lowest Prices**

# DIAMONDS

**SEND NO MONEY**

**JUST SEND US YOUR NAME AND ADDRESS, and we will ship to you, on approval, at our risk, all delivery charges prepaid, the famous No. 105 Loftis "Perfection" \$50 Diamond Ring.**

**You Pay Nothing Not One Cent**

until you see this beautiful Diamond Ring. We want you to examine it right in your own hands. We want you to compare it. We want you to judge the ring after you see it, and we want to give you the same chance to see for yourself that is afforded customers in any of our large city stores. You assume no obligations, for we send you the ring before you pay one penny. **IMMEDIATELY ON RECEIPT OF YOUR NAME, we will select a special Diamond for you, mount it in 14 karat solid gold, case it in a handsome velvet ring box, and send to you prepaid.** If you find it to be all that we claim—if it meets your expectations in every way, and if you are absolutely satisfied (and it is an unusual bargain, pay \$10 and keep the ring, then \$5 a month for eight months, making a total of \$50, and the ring is yours. That's the "Loftis System"—which means a square deal to all.

Write for our Free Catalog containing over 2,000 photographic illustrations of Diamonds, Watches, Jewelry, Silverware, Novelties, etc. It tells all about our easy credit plan. Write today.

**LOFTIS BROS. & CO.**  
The Old Reliable Diamond and Watch Credit House  
Established 1854  
Dept. L894 108 N. State St. Chicago, Ill.  
Stores in: Chicago; Pittsburgh; St. Louis; Omaha

**Our Big Leader**

**LOFTIS Perfection Diamond Ring No. 105**  
**Special Price \$50**  
**CREDIT**  
**Terms \$5 Per MONTH**

## 30 DAYS FREE TRIAL

Total cost only **\$7.50** By Our **7 MONTHS TIME Purchase Plan**

to prove to you that this magnificent Royal has the **SWEETEST, PUREST, LOUDEST and CLEAREST TONE**—

to prove to you that it is as large and handsome as the trust machines that sell at \$25.00—

to prove to you that it has the strongest motor, the best reproducer and tone arm and the most ingenious devices to start, stop and control the music.

Shipped with a supply of 10-inch double disc records of your selection, so you can enjoy the finest entertainments for one whole month. Return the outfit **AT OUR EXPENSE** if for any reason you do not wish to keep it. Drop a postal for our big list of unsolicited testimonials, record book and other literature—all Free.

**Central Distributing House**  
Dept. F 41 6101-11 Bay St., CHICAGO

## Finished Pictures In One Minute

This new camera eliminates plates, films, dark room and printing. No experience needed. Pictures snapped direct on cards—finished right in the camera in one minute! The

# MANDEL-ETTE

A sure-shot picture taker. Makes 2 1/2 x 3 1/2-inch pictures at any distance. A child can operate it.

**\$5.00** Outfit includes camera and supplies to make 16 finished pictures. Tripod \$1 extra. Additional cards 25c per package of 16. Add 50c for parcel post. **Booklet Free.**

**THE CHICAGO FERROTYPE COMPANY**  
4469 Ferrotyping Bldg., Chicago, Ill., or Dept. A469, 89 Delancey St., New York

## A Real Kerosene Engine

Here's the biggest engine value ever offered in a 1½ H. P. engine. Same cylinder capacity as many 2½ H. P. engines. Throttling governor adjustable while running; crankshaft extends on both sides. Runs either way. Starts without cranking. Equipped with Ellis Patent Fuel Device, guaranteeing successful operation on cheap oils. Beautifully finished in genuine engine enamel.

### Runs on 9c a Day

Just the engine for pumping, separating, churning, corn-shelling, sawing, shop work, electric lighting and dozens of other light jobs. Sold on 30 days' trial. Guaranteed for 10 years. We make other sizes from 3 to 18 H. P., vertical and horizontal, single and double cylinders.

Ask for our free book, "ENGINE FACTS," telling how to judge and buy an engine.

**ELLIS ENGINE CO., 2873 E. Grand Blvd., Detroit, Mich.**

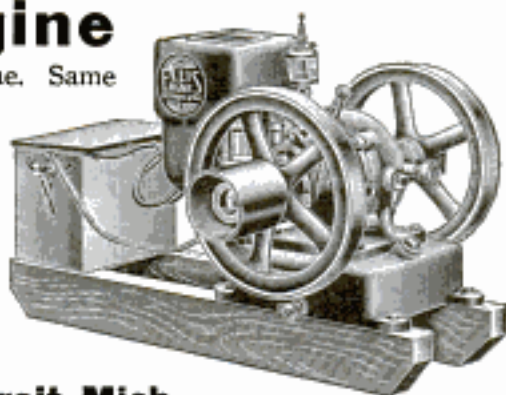

## FREE TRIAL 30 DAYS BESSEMER NON CRANKING KEROSENE ENGINE

"The Masterpiece of the Largest Manufacturers of 2-Cycle Engines in the World"

Every time you hitch a Bessemer Kerosene Engine to a load you know it will pull it. No guesswork, no uncertainty—The Bessemer goes when you start it and goes until you stop it. It will run on less fuel because the wonderful Bessemer Universal Fuel Feeder automatically feeds the right amount to carry the load—no waste. The greatest little workers in the world. Only three moving parts—2 to 10 H. P.—30 days' free trial—immediate shipment. Write for Catalog "K." If you require a larger engine use the

### BESSEMER FUEL OIL ENGINE

Lower picture shows the famous Bessemer Fuel Oil Engine. Widely used in irrigation, flour mills, factories, electric light plants, etc. Runs on cheap fuel and crude oils. No batteries or magnets required; ignition is automatic after starting. 15 to 165 H. P. Special Catalog "O" free.

**THE BESSEMER GAS ENGINE COMPANY  
121 Lincoln Ave. GROVE CITY, PA.**



## More Power for Less Money 6 H.P. \$98.75



The New Galloway Masterpiece "Six" is the most down-to-the-minute engine that mechanical ingenuity can produce. It is perfectly adapted to furnish power to the shop, the mill, the contractor anywhere and where ready, steady, reliable, efficient and economical power is needed.

### My New 1915 Proposition

is the greatest offer ever made by any manufacturer and is the first time in the history of engine building that an A 1 high-grade engine of this h. p. could be bought for so low a price. Write for particulars and price-reducing sliding scale schedule.

**Wm. Galloway, Pres.  
The Wm. Galloway Co.  
965 Galloway Station, Waterloo, Iowa**

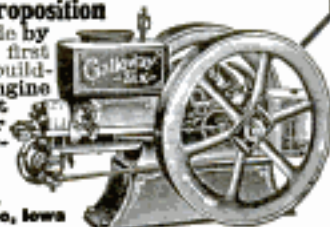

**RECORD RAINFALL IN INDIA**—In consequence of a heavy and abnormal fall of rain, the main line of a narrow-gauge railroad was recently washed away between Capper Quarry and Coleroon, in the Madras Presidency, southern India. The normal rainfall of the district is about 49 in. per year, but in one month alone rain fell to the extent of 41 in., of which 25 in. fell in 48 hours. The consequence was that numerous canals and tanks burst their banks, and all the rivers, of which there are four in the district affected, overflowed their banks. The

## 6 H.P. \$96.75

1½ H.P. \$24.75	5 H.P. \$ 87.50
2 H.P. 28.75	8 H.P. 135.50
3 H.P. 53.90	10 H.P. 179.90
4 H.P. 68.90	12½ H.P. 214.90

Many other sizes—all sold direct and fully guaranteed. **86 32-PAGE CATALOG FREE.** Write today.  
**OTTAWA MFG. CO., 252 King St., OTTAWA, KANS.**



## Generate Your Own Electric Light

for home or store with a Fairbanks-Morse Electric Plant that you or your boy can operate. Plant is completely independent.

### 24 Hour Service

Not necessary to start engine to get light, because storage batteries supply current at night or in daytime when engine is not running. Ask for details.

**Fairbanks, Morse & Co.**  
Chicago New York San Francisco (449-4A)

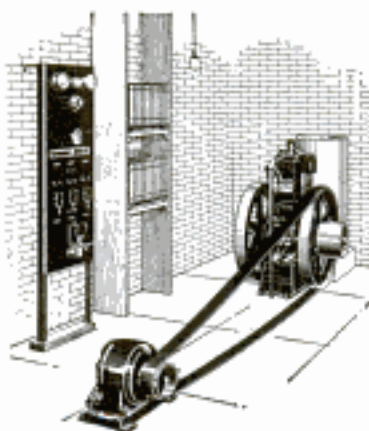

Please Mention Popular Mechanics



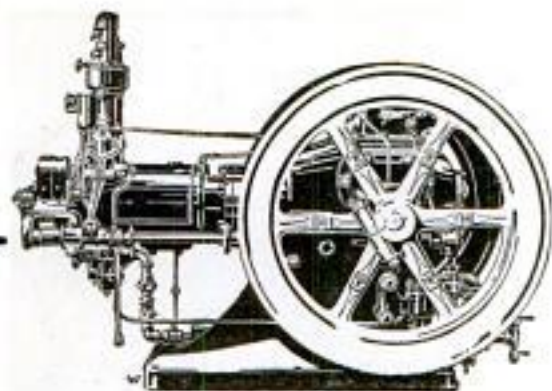

## We Say This with Confidence

Knowing the unsurpassable standards that IHC engine makers have set for themselves in manufacturing, and the absolute perfection they have always aimed at, we do not hesitate one moment in saying—whatever difficult qualifications you can possibly demand in a 1915 engine you will find them in the greatest degree on

### International Harvester Oil Engines

Care and time and money are not spared in the designing of IHC engines. Elaborate and thorough experimental work is never at an end, and is always resulting in IHC engine improvements. Manufacturing expense and cost of material are not considered whenever a betterment suggests itself. IHC quality is never questioned.

International Harvester oil engines are of all styles, built for all power purposes, in sizes from 1 to 50 H. P. They run on the cheapest or most convenient fuel.

Ask us to do these two things—Send you an interesting catalogue showing the IHC engine features, and tell you the name of the nearest IHC engine dealer.

### International Harvester Company of America

(Incorporated)

16 Harvester Building Chicago U.S.A.

railway was breached almost continuously for 10 miles. The damage was so extensive that all traffic over the 10 miles had to be suspended for a month.

## "VIM" ENGINE \$25 COMPLETE



Save money by using a **VIM 1 1/2 HP. Farm Motor** for churning, washing, pumping, separating, spraying, etc. Women operate easily. No valves, cams, gears or complicated parts. Water Cooled, automatic positive lubrication, sensitive governor. Weighs only 75 lbs. Comes ready to run. Fully guaranteed. Get catalog and special agency offer. **THE VIM MOTOR CO., 803 Water St., SANDUSKY, OHIO**

### REDEMOTOR SMALLEST GAS ENGINE



in general use. Runs washing machine, churn, pump, cream separator, dynamo, bench lathe, railway speeder, or any machine requiring light power. Starts easy and gives as reliable service as an electric motor, with same floor space and weight. Run it anywhere, anytime.

Invest in a Redemotor and see how much easier your chores will be. Three sizes, 1/2, 1 and 1 1/2 H. P. Send for catalog J. Low Prices.

**ELGIN WHEEL & ENGINE COMPANY, ELGIN, ILL.**

### 2 H.P. AMERICAN OUTBOARD MOTOR



Equal to any \$70 row boat motor on the market. Made of the same high-grade materials by the most skilled mechanics in the industry. But instead of charging you the dealer's commission, we sell

**Direct From Factory to You** cutting the price to only \$44.95. Instantly attached to any row boat. Speed from 6 to 9 miles an hour. Adjustable for any angle or depth of stern. Runs forward or backward. Weighs about 60 lbs. Can be used in salt or fresh water. Steers with propeller. We also build a rudder steered model. Magneto ignition if desired, at small extra cost. Send for details.

American Engine Co., 605 Boston St., Detroit, Mich.

\$44.95

# Here's Health and Power, Vim and Vigor



**ALL YOURS!**

Strength that is more than mere muscular strength. The strength of perfect health, abundant nerve force—the strength of keen relish is now within your reach through vibration! Nine out of ten

people are only half alive. How about yourself? Listen! All the joys of life, strength and youth may be returned to you by vibration. Send the free coupon for the big new book that will tell you all about it.

## WHITE CROSS ELECTRIC VIBRATOR



White Cross Electric Vibrator and its Attachments.

This wonderful instrument gives you three of nature's greatest curative agents—vibration, faradic and galvanic electricity. We will send this wonderful machine to you on free trial. Feel its health-giving vibrations for yourself. Don't be weak. You can be strong and healthy if you will by using the White Cross Electric Vibrator.

## Vibration Is Life



It will chase away the years like magic. Every nerve, every fibre, of your whole body will thoroughly tingle with the force of your own awakened power.

All the keen relish, the pleasure of youth, will fairly throb within you. Rich, red blood will be sent coursing through every vein and artery, you will be made over—new from head to foot. You'll sleep the health giving restful sleep like you used to. Your self-respect even will be increased a hundredfold.

**LINDSTROM-SMITH CO.**

Dept. 9193  
1100 S. Wabash Av.  
CHICAGO, ILL.

### Send the Free Coupon

Just your name and address on the free coupon or a letter or post card is enough. We will send you absolutely free and prepaid, our new book, "Health and Beauty." It's free. No obligations of any kind. Write at once.

Please send me, absolutely free and prepaid, your new book "Health and Beauty," and full particulars about the free trial offer on the White Cross Electric Vibrator. I assume no obligation of any kind.

Lindstrom-Smith Co.

Dept. 9193  
1100 S. Wabash Av.  
CHICAGO

We manufacture White Cross electric irons, hair driers, stoves. Dealers write.

Name.....

Address.....

My Electrical Dealer's Name is

# Caille Speed Motor

## Push-Button Control

Has a high speed, trolling speed, a neutral, slow reverse and fast reverse adjustments, all accomplished by simply pressing a button without stopping the motor or interfering with its normal speed. Pressing another button stops the motor. Action is absolutely mechanical and positive—no unreliable springs or automatic devices.

## Has Enclosed Magneto

of the high tension water-proof type, embodied in the fly-wheel. Gives a good, hot spark down to practically the last revolution.

## Other Caille Features

Caille Silencer Dual Ignition if desired. Water-tight gear housing. Double seamed fuel tank. Reinforced bracket and stern adjustment. Non-linking water tube. Heavy rubber steering handle. Complete details in our Free 1915 Literature.

## DEALERS WANTED

The Caille Perfection Motor Company  
1523 Caille St.,  
Detroit, Mich.

We Also Build Marine Motors from 2 to 30 H. P.



## UNMATCHED SPEED—Extra Power—No Vibration

Speed that runs away from any other rowboat motor—power to carry heavier loads—no vibration to shake boat

## The 2-Cylinder KOBAN ROWBOAT MOTOR

Last season's record proved its mettle. Absolutely dependable—easy to start—reverses by simply pressing button—weedless propeller.

## 2-CYLINDER—RACER TYPE

The Koban has two opposed cylinders—that's what removes vibration—3 H. P.—nearly double that of other motors—speed line propeller. Best constructed rowboat motor on the market.

Write for 1915 Catalog—Active Agents Wanted  
Koban Mfg. Co., 291 So. Water St., Milwaukee



2 Cylinder  
3 H. P.

Put Your Trust in an  
*"Old Town Canoe"*

It looks like a sturdy canoe that stands the gaff and it lives right up to its looks. It's speedy, easy to handle and safe—more so than any canoe that ever touched water. That's its reputation among knowing sportsmen and guides.

Don't drag your arms out in a rowboat and don't gamble on other canoes. Come to canoe headquarters and buy an "Old Town Canoe"—it's a dependable buy—\$30 up. 4000 new canoes ready, immediate shipment. Write for the "Old Town" story of canoe value; we'll tell you name of nearest dealer.

OLD TOWN CANOE CO.  
463 Middle Street, Old Town, Maine, U. S. A.

## EVINRUDE

The Evinrude Detachable Rowboat and Canoe Motors embrace the Evinrude Automatic Reverse—Built-in Magneto—and Maxim Silencer, besides all the characteristics of the 1914 Model.

Prices: \$60.00 to \$80.00  
Battery Ignition \$5.00 less

12 Beautiful Poster Stamps sent for 4 cents

EVINRUDE MOTOR COMPANY  
No. 31 Erie Street, Milwaukee, Wisconsin, U. S. A.



## Toledo MARINE MOTORS

"Nothing Cheap but the Price"

3 H. P. 1 cyl. complete	\$ 65.00
6 H. P. 1 " "	84.00
6 H. P. 2 " "	125.00
12 H. P. 2 " "	160.00
18 H. P. 3 " "	250.00

Fully guaranteed by a responsible concern. 2 cycle, 2 port, 3 1/2" and 4 1/2". Send for free catalog "C."

THE UNIVERSAL MACHINE CO., Pike Ave., Bowling Green, O.

## The Outings You Look Forward To

LATER on, this Spring and Summer, when lake and stream have called you out into the country—will you still be limited in your fishing or picnicking to "easy rowing distance?" Or will you have a trusty, sturdy little row boat motor—a *Wisconsin*—to swing you and your boat smoothly and swiftly along, or slowly if you're trolling, mile after mile as far as you care to go?

## Wisconsin Detachable Row Boat Motor

Your row boat motor should be a *Wisconsin* because you don't want any outings spoiled by motor trouble.



The *Wisconsin* is the most dependable of all outboard motors because it is built by men of 13 years' experience in marine motor building—it has no experimental features—it has proved itself in years of general use. It has, for instance, High Tension Reversible Magneto ignition, so it doesn't miss or stutter at slow speeds. It has Rudder Steering, so you can make sure landings with motor still. Main bearings Nickel Babbitt, interchangeable. Pistons have two rings. Crankcase Nickel Aluminum. Motor is two-cycle type, speed 200 to 900 R. P. M. All parts standardized.

Write today for Free Catalog U

WISCONSIN MACHINERY & MANUFACTURING CO.  
Minor Street, MILWAUKEE, WIS.



**Early Morning—**  
A winding stream—scent of the woods—sunshine—dew drops—all the musical sounds of the wild places—and you with your Mullins canoe—fascination!

**MULLINS CANOES**

are so modeled and finished as to gratify your every wish for beauty, grace and durability—combining the lightness of the Indian Canoe with the exquisite finish of expert workmanship.

The Mullins Canoe Catalog, interesting and complete, is yours for the asking.

Wherever canoes are sold you will find a Mullins.

**The W. H. Mullins Co.**  
44 Franklin St. SALEM, OHIO  
World's largest manufacturers of Steel and Wooden Boats.

An exhibit showing how a community can aid itself in making progress was arranged recently by the University of Wisconsin extension division. Among the features were model garbage cans, drawings of model private and public sewage-disposal plants, sanitary housing, good roads, parking, public markets to aid in reducing the cost of living, and street lighting.



**WATKINS' SPECIAL MOTORS**

3 H. P. Single Cylinder . . . 30 lbs.  
6 H. P. Double Cylinder . . . 60 lbs.  
12 H. P. Four Cylinder . . . 100 lbs.

A strictly HIGH GRADE Motor that will give CONSTANT and EFFICIENT service. Especially adapted for CANOES and LIGHT BOATS. Aluminum base, copper water jacket, steel shaft, bronze bearings.

**THE WATKINS MOTOR CO.**  
837-839 West Sixth Street . CINCINNATI, OHIO



GET THIS CATALOG  
FULL OF VALUABLE INFORMATION TO EVERY BOAT OWNER ON  
**RACING PROPELLER WHEELS, REVERSE GEARS AND MARINE ACCESSORIES**  
LARGE CATALOG FREE. SEND TODAY  
**MICHIGAN WHEEL CO.**  
1179 MONROE AVE., GRAND RAPIDS, MICH.



**KERMATH BOAT MOTORS** \$180.00

4 Cycle, 4 Cylinder, 12 to 20 H. P.  
Highest quality. Silent operation. No vibration. Controls like the finest Motor Car engine. Extremely economical on fuel. Used as standard equipment by over 60% of the world's leading boat builders. Catalogue on request.  
\$180 to \$300 depending on equipment.  
**KERMATH MFG. CO., Dept. P., Detroit, Mich.**

## MAKE MONEY THIS WAY



I want to prove entirely at my expense that I can take you out of your small, low wage job and into a profession that always offers you a bigger salary, \$2400 and more yearly, steady employment and an independent future of prosperity. I want to show you how I have helped all kinds of men out of the lowest-paid jobs and into success through training them by my personal method to become Expert Draftsmen.

Become a

## DRAFTSMAN

\$2,400.00 a Year

If you realized the almost unlimited opportunities of big income and success open every day for competent Draftsmen—if you realized the independence, the influence and the prosperous future afforded in this wonderful profession—I am sure you would lose no time in becoming a Draftsman. Draftsmanship is the profession that means steady employment and prosperity regardless of unsettled conditions. Right now the need for competent Draftsmen is tremendous. Buildings, machines and structural work of all kinds are always planned and Draftsmen are needed everywhere at handsome salaries. Let me prove absolutely that right now is the time for you to begin preparing yourself for the vast opportunities in Draftsmanship.

**I Teach You** No matter who you are or what you

work at now, let me prove quick how easy I can train you in your own home in your spare time—how plain and practical my personal instructions are—how I teach you personally everything a successful Draftsman must know. I give you the training the big employers of Draftsmen in this country demand. When you follow my personal instructions you learn under a Draftsman who is successful. You need no previous experience—I train you from the ground up in the shortest time. Keep your present position and earn while you learn.

**YOU ARE NEEDED** Big positions paying \$2400

and more yearly are open right now. These grand opportunities are open to you if you begin at once. Let me prove how competent Draftsmen can advance to big, powerful positions as Chief Draftsman, Chief Engineer or Superintendent at big salaries or open an office and make big money.

**FREE \$17.50 DRAFTSMAN'S OUTFIT** Write me now and I will give you absolutely free a magnificent set of Draftsman's Drawing

Instruments, valued at \$17.50—same as I use. Every Draftsman needs these—they last a lifetime.

**SMALLEST, EASIEST PAYMENTS**

### SPECIAL TUITION OFFER

To a few more students I offer my personal instructions at such small, easy payments that no matter how small your present salary, you can now become an Expert Draftsman and as an inducement for you to enroll at once I make an extra special offer of a free \$25.00 TUITION CREDIT. I am the only Expert Draftsman giving his personal instructions on such small payments. Mail free coupon now for my great proof and fascinating free book. This is your opportunity. Send coupon today—investigate.

**Chief Engineer**

Chicago Engineering Works 445 Cass St., Chicago, Ill.

**CHIEF ENGINEER, 445 Cass St., Chicago**

Without obligation or cost to me send prepaid your free book, "The Road to Success," and particulars of your limited offer.

Name .....

Address .....

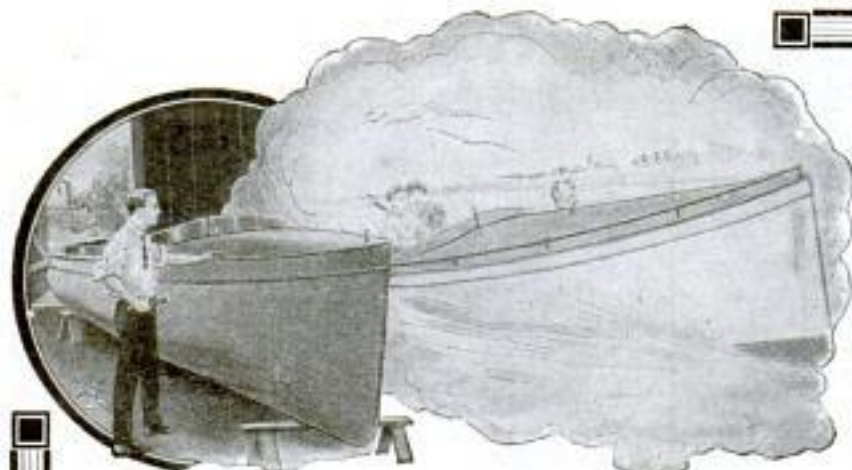

## Build a Brooks Boat— Enjoy Boating Charms

Haven't you always had a dream of some day owning a beautifully designed cruiser, a speedy motor boat or a handsome launch, and that you could go wherever and whenever you pleased on lake or stream, in your own boat? Let us tell you how easily you can make that dream come true with the aid of the Brooks System. Thousands of men and boys are today able to enjoy the charms of boating only because the Brooks System enabled them to build their own boats easily, in a surprisingly short time and at a low cost.

### Brooks System Saves You $\frac{2}{3}$ in Price

All the parts come to you cut, shaped and fitted. Full-sized patterns and illustrated instructions show you how to put the parts together. With the Brooks System, you pay for only the actual material needed. You save just about two-thirds what the boat-builder would ask. You have complete confidence in your boat because you know that it is designed to be thoroughly seaworthy and that it is built with the very highest-grade materials. The directions are so clear—the full-sized patterns are so easy to work with that any one can build a beautiful boat. You do not need experience. We will show you the way. Mail a postal today for the Brooks Boat Book—it's free. Address

**Brooks Manufacturing Company** Originators of the Pattern System of Boat-Building. The Largest Plant of Its Kind in the World. 8203 Brooks Ave., Saginaw, Mich.



### Write—Get This Boat Book Free

See illustrations of beautiful new-style cruisers, "V" Bottom Models, Motor Boats, Launches, Sailboats, Rowboats and Canoes, boats of all kinds that you can build easily, economically, in your spare time.

### Only \$37

buys the complete knocked-down frame for a 12-passenger 23-ft. handsome motor boat—speed  $9\frac{1}{2}$  to 14 miles per hour. This includes full-sized patterns and directions to finish building the boat. We make 3 propositions: (1) We send complete full-sized patterns. (2) We send knocked-down frame and patterns. (3) We send complete knocked-down boat. Fully illustrated instructions always included.

### Boat Patterns \$3 and Up

All patterns are taken from actual models. We design and build a complete boat, put it through the most rigid tests if it proves itself perfect in design and construction, we use the boat as a model to make patterns from. Write for boat book showing illustrations of latest, most seaworthy styles.

# Joymotor

## For Rowboats and Canoes

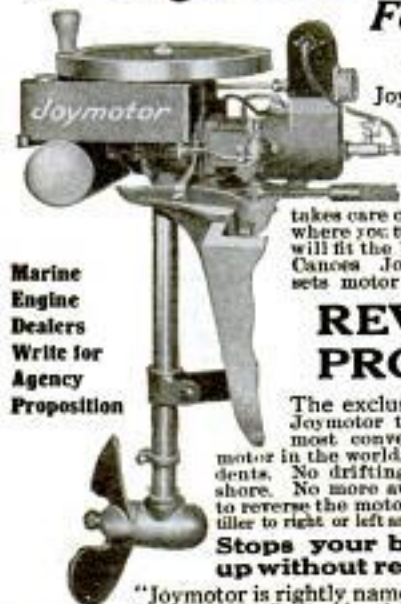

Joymotor will fit any boat ever made—square stern, pointed stern or decked stern—without additional attachments. Just hook it on or off in a jiffy. Joymotor's unusual bracket

takes care of everything. No matter where you take Joymotor you know it will fit the boat you have to use. For Canoes Joymotor special bracket sets motor low down—safety first.

## REVERSING PROPELLER

The exclusive patented feature of Joymotor that makes it the safest, most convenient, easiest to handle motor in the world. No more danger of accidents. No drifting or paddling to dock or shore. No more awkward, hurried cranking to reverse the motor. Just move the steering tiller to right or left and Joymotor almost instantly—**Stops your boat and backs it up without reversing the engine**

"Joymotor is rightly named"—

"A joy to own"—evidently built to enjoy—that's what owners tell us. Easily portable. Weighs 52 lbs. Runs your boat 7 to 9 miles per hour—canoes 10 to 12. Has real high tension magnets and real carburetor, efficient oiling system and does not have unsightly, tangled up pump hose. Write postal now for catalog and life size picture of Joymotor giving full details of the finest, most satisfying portable motor to be had. Write postal now to

**JOY ENGINEERING COMPANY**  
330 Tribune Bldg., CHICAGO

Please Mention Popular Mechanics

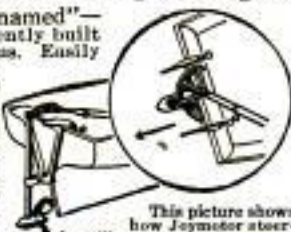

This picture shows how Joymotor steering tiller swings and reverses position of propeller. Compare this position with large picture.

The total export of coal from the United States for the fiscal year ended June 30, 1914, was valued at, \$86,000,000.

## SWEET ROWBOAT 4 H.P. MOTOR



Fastest—most dependable—best built—4 H.P.—reversible—fits any boat. Float feed carburetor—battery or spark. Sold only direct from factory. Write for free catalog and owners' letters. 30 Day Special Price. **SWEET MFG. CO.** 361 Griswold St. Detroit, Mich.



## VIM MOTORS

5 to 27 h. p.  
1, 2 and 3 cylinder  
Gasoline or Kerosene  
Speed, regular, or heavy duty. Strong, simple, accessible—absolutely dependable. Built for a lifetime. The boat-builder's pride. Double ignition. Non-backfiring. Heavy brass fittings.



"Only built with my Vim is that I did not get it sooner. It runs and sounds like an electric fan. Ran it steady last Sunday on 6 gal. gasoline—that's a right good for a 10 H.P. engine. My friend says his motor is a gasoline eater and if he can sell it, a Vim goes in his boat." This from Rex M. Prall, Warren, Pa.

**VIM MOTOR CO.**  
103 Water St., Sandusky, Ohio



## GRAY MOTORS & BOATS

50 Leading Boat Builders have joined with the Gray Motor Company in issuing a catalog showing the specialties of each, which includes fishing launches complete from \$125 upward to mahogany finished express launches with Self-starting 6-Cylinder 4-Cycle Gray-Motors for \$2500. Cruisers from \$450 up. This book helps you select just the model of boat you have been looking for and tells you where to buy it and what it will cost. Send for this big Boat Catalog today. Free. Also Gray Marine Engine Catalog showing full line of 2 and 4 cycle marine motors from \$55 upwards, one to six cylinders. **GRAY MOTOR CO., 338 Gray Motor Bldg., Detroit, Mich.**

## The Perfect— The Powerful Rowboat Motor!

The one that you can depend upon, never to falter or fail! The rowboat that is equipped with the same reliable ignition system that is today standard equipment of the highest grade automobiles—the Bosch High-Tension Magneto. Before you invest a dollar in any rowboat motor, you want to investigate the

**Spinaway**  
Detachable  
Rowboat Motor

Enjoy the benefits of the Three Exclusive Spinaway Features—the unique Under-Water Exhaust, that obviates all the noisy chug-chug of the usual motor—Self-Locking Tiller that will hold the boat true to its course without any attention on the part of the operator—Disappearing Crank-Handle, that unique device that prevents accidents from twirling crank-handle that stands upright. Write for the free 1915 Spinaway book today.

SPINAWAY BOAT  
MOTOR COMPANY  
266 Chicago St., FREEPORT, ILL.

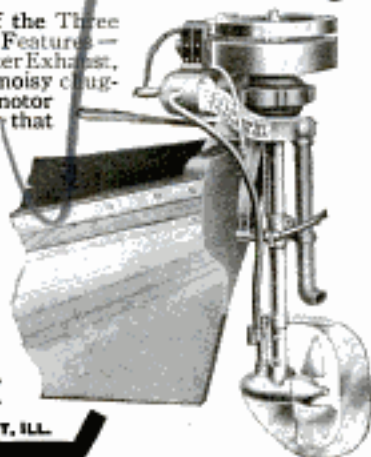

# SPECIAL

**\$4.75**

Size 7 x 7 ft.  
Genuine Full Weight  
8 oz. Duck



## Boys' Special Offer Genuine Wall Tent Complete

Just think of it. This 7x7 foot genuine eight-ounce duck wall tent for only \$4.75 Everything complete. Poles, ropes and pins. Big enough for four boys. Strong enough to stand blizzards or storms. You can have lots of fun this winter. Don't stay in the house. Take your boy friends out in the tent. You cannot possibly get wet. It's nice and warm too. Great to sleep in. Start to save today. Sign your name to the coupon and tear it off and send it to us. We will mail you at once a beautiful book telling you many things you ought to know about outdoor life. This book is absolutely free and prepaid.

## Army Shelter Tents

Commonly Called "Dog Tents" — Made up in 2 Sections, Complete with Poles and Pins

Special White Cloth  
**\$2.25**

Special Khaki Cloth  
**\$3**



Just like the regular soldiers use. Boy Scouts all over the country are using them. Can be set up and taken down in a minute. When not in use can be easily carried on your back. Absolutely waterproof. This tent is 5 ft. 3 in. long by 3 ft. 6 in. wide by 3 ft. 9 in. high. The poles are spliced. Every boy ought to have one of these tents. Send your order in today. They are going like hot cakes.

## Send FREE Coupon for New Camp Guide

Just put your name and address on free coupon and mail it at once. We will send you our new 1915 Camp Guide. Gives a hundred pointers on camping boys should know. Tells how, when and where to camp out. We also send a list of supplies you need and where you can get them cheapest. Book is sent free and prepaid. No obligations of any kind. Mail coupon now. Do it now as the supply of these books is limited.

**H.Channon  
Company**

Dept. 1193  
150 North  
Market Street  
Chicago  
Illinois

**FREE  
Camp Guide  
Coupon**

H.Channon Company

Dept. 1193  
150 North  
Market St., Chicago

Gentlemen: Please send me, absolutely free and prepaid your new 1915 Camp Guide. Also full particulars of bargains you are offering on tents and other supplies.

Name .....

Address .....

## Electric Light for Your Home

This newly invented system enables every rural home to make their own electric current; operates from one to fifty lights; and will drive small electric motor, electric iron, toaster, etc. Everything complete in one compact unit; no batteries or switchboard. Uses standard lamps and fixtures that any dealer can supply. Nothing to watch but the small, high-speed gasoline motor, which requires slight attention once a week.

The ideal electric lighting system for country homes. Nothing like it ever sold before. Costs less than other systems to buy and to operate. Will last for years.

**WATERMAN MOTOR COMPANY**  
382 Mt. Elliott Ave. DETROIT, MICH.

Write today for  
descriptive lit-  
erature and  
prices.

**Uni-Lectric**  
GASOLINE-ELECTRIC UNIT  
LIGHTING SYSTEM



Please Mention Popular Mechanics

SAFETY  
AND  
SERVICE

## MULLINS BOATS

SAFETY  
AND  
SERVICEReady for the  
First Trip.

"I am glad we decided upon a Mullins Boat. There's another one out there! See how she glides over the water—swiftly—gracefully—easily—see how she answers the wheel—how the bright work glistens! We may well be proud of our boat."

Built of both wood and steel in the largest boat factory in the world, powered with 2 and 4-cycle motors, pronounced by 60,000 owners the most boat for the money in the country.

Send for interesting, free catalogue and learn where you can see a Mullins Boat

**The W. H. Mullins Co.**  
59 Franklin St. SALEM, OHIO  
Also Manufacturers of the Celebrated  
Charles River Model Canoe

ROW BOAT MOTOR  
**FERRO**

Don't Go Rowing  
Go FERROWING

## The Safest Investment of All

The motor you buy must be powerful, speedy, economical, simple and reliable—it must be so constructed as to give best results in hardest service. The price must be reasonable, too. Write at once for our literature and see for yourself why the **Ferro** is the motor. State whether interested as dealer or user.

The Ferro Machine & Foundry Co.  
343 Hubbard Ave. Cleveland, Ohio

**\$85**

With  
Reversible  
Waterproof  
Magneto

**\$65**

With  
Waterproof  
Battery  
Ignition



## Waterman PORTO



1915 model, 3 h.p., weight 59 lbs. Sold direct from factory to you, freight paid. The original out-board motor. Tenth year—50,000 in use. Guaranteed for life. Fits any shaped stern; has separator—patented valve; removable bearings; solid bronze gear, protecting 50/32 in. propeller. Steers by rudder from any part of boat. Water cooled exhaust manifold; noiseless under-water exhaust; bronze gear water pump; spin copper water jacket; any special equipment desired. Demand those essentials if you want your money's worth. Write today for free engine book. Our prices will surprise you.

WATERMAN MARINE MOTOR CO.  
330 M. Elliot Ave., Detroit, Mich.

Makes Any Boat A Motor Boat

## L-A Rowboat Motor

## PLAY SAFE: Try It 30 Days

in your own boat. Test it thoroughly. Be your own salesman and keep the salesman's profit—and it is for you to say when the sale is completed.

Thousands of L-A Rowboat Motors sold and running everywhere. Light weight; detachable; reversible engine; speeds up to 8 miles an hour or slow enough to troll; silent muffler; steers with rudder; bronze under-water parts; magneto furnished at slight extra cost.

Take us up on our 30 day free trial offer today; no sale unless you are satisfied. Catalog free—postal today brings it.

LOCKWOOD-ASH MOTOR CO., 376 Horton Street, Jackson, Mich.

**\$45.00**  
Freight  
Paid



Direct  
from  
Factory  
to User

## "I'm through with Cheap Tires"

Every bicycle rider says that sooner or later. A good bicycle tire gives you your money's worth every time.

A cheap tire comes as close to being worthless as anything you can buy.

# VITALIC

## Bicycle Tires

You can depend on Vitalic Bicycle Tires for months of hard riding because of the quantity of pure rubber in them and because they have an unbreakable, motorcycle tire fabric. Pay less than the price of Vitalic Tires and you get less rubber, weaker fabric and an undependable tire.

Send for Sample of Tire and for Story,  
"The Man Who Rode On His Rims"

Continental Rubber Works, 840 Liberty St., Erie, Pa.



## Don't Throw Away Your Worn Tires

For over three years European motorists have been getting from 10,000 to 15,000 miles out of their tires by "half-soleing" them with Steel Studded Treads. In eight months 20,000 American motorists have followed their example and are saving \$50 to \$200 a year in tire expense.

**We ship on Approval** without a cent deposit, prepay the express and allow you to be the judge.

**Durable Treads** double the life of your tires and are sold under a signed guarantee for 5,000 miles without puncture. Applied in your own garage in thirty minutes.

**Special Discount** offered to motorists in new territory on first shipment direct from factory. A postal will get full information and sample within a week. State size of tire. Don't wait—write today. Address nearest factory office.



**THE COLORADO TIRE & LEATHER CO.**  
103 Gertz Bldg., West Austin Ave., CHICAGO, ILL. 103 Gale Bldg., DENVER, COLO.



**Convert Your Bicycle into a Motor-Cycle** Motor fits any wheel. BEST, MOST RELIABLE. Best hill climber. More STEFFEY'S in use than all others. Stump for circulars. STEFFEY MFG. CO., 5007 Brown Street, PHILA., PA.

## \$40 MOTORCYCLES!



New and Rebuilt Motorcycles. Largest stock in the world. Lowest Prices. We guarantee to save you from \$20 to \$50. We repair any make of motorcycle. Send us your motorcycle for repairs. Motorcycle tires \$4, best belts, \$5. Buy direct; save dealer's profits. Send for Catalogue. DENINGER CYCLE CO., ROCHESTER, N. Y.

## 5 H. P. 1915 Peerless Motorcycle

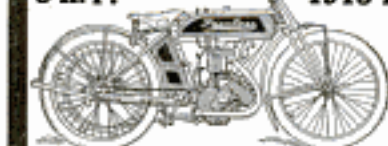

with Free Engine, Bosch Magneto, together with the best there is in Motorcycle construction, Power, Speed, Silence, Endurance, and those wearing qualities so essential for low cost of maintenance. 5 MILES FOR ONE CENT Agents Wanted—Liberal Discount!

PEERLESS MOTORCYCLE CO., 179 Hunting Ave., BOSTON, MASS.

## 30 Days FREE TRIAL

and freight prepaid on the new 1915 "RANGER" bicycle. Write at once and get our big catalog and special offers before buying.

Marvelous improvements. Extraordinary values in our 1915 price offers. You cannot afford to buy without getting our latest propositions. WRITE TODAY.

Boys, be a "Rider Agent" and make big money taking orders for bicycles and supplies. Get our liberal terms on a sample to introduce the new "RANGER."

Tires, equipment, sundries and everything in the bicycle line half usual prices. Auto. and Motorcycle Supplies. MEAD CYCLE CO., DEPT. D-108, CHICAGO



## REFLEX SPARK PLUGS

Give Increased Power and End Ignition Troubles

**BECAUSE:** Every Reflex plug has our patent baffle that reflects the soot and dirt away from the interior and drives it out through the spark gap at every explosion. Made right, shoot hot flashes; stay clean, keep your motor on the go. 16 leading automobile and motorcycle manufacturers use Reflex plugs as standard equipment—convincing proof of their superiority.

**30 DAYS' TRIAL AT OUR RISK** Buy a set of Reflex plugs from your Dealer or direct from us; use them 30 days. Then if they are not the best you ever had, you can return them and get your money right back.

Spark plugs for every purpose—Send for Catalog and prices

The Reflex Ignition Co., 213 High Ave., Cleveland, Ohio



## Morgan Gas Lighter

Factory Representatives wanted everywhere to handle our Auto and Hardware Necessities, Unusual Contract, Large Profits, Increasing Demand. Write today, letter—no postals—Exclusive Territory, Samples, FREE SALES-PLANS!

**Morgan Rolling Wedge Spring Leaf Opener** Only instantaneous opener on market. For lubricating Wagons, Auto. or any spring. Real Opportunity for Hunters, Instructive field. Popular Prices. Millions will be sold. All our Specialties every Money-Back Guarantee. Write Now to MORGAN MFG. CO., Bellevue St., Newport, R. I.



## FORD RACERS

REBUILD YOUR FORD CAR. Sketches, Specifications and Instructions. Information for Two-cent Stamp. T. M. Co. Dept. A. Box 212, Woodford, Maine.

## The Acetylene Blow Torch Prest-O-Torch

Costs less to buy than a good gasoline blow torch and costs less to use.

In all soldering and brazing, the Prest-O-Torch avoids the delays and uncertainties of gasoline outfits. Provides a concentrated, intense flame that doesn't blow out even in a high wind. Needs no attention whatever. Used with handy sizes of Prest-O-Lite cylinders—ready-made gas, instantly available.

Style "A" sells for 75c. Used with the small MC size Prest-O-Lite. Will braze up to 3/8 inch round rod. This outfit can be fitted with handle and hook for added convenience in bench and overhead work. Style "C" Prest-O-Torch is recommended for large work. Will braze up to 1/2 inch round rod. Sells for \$2.35. For use with the larger sizes of Prest-O-Lites. Write for special literature and learn where you can see the Prest-O-Torch in operation.

The Prest-O-Lite Co., Inc. 816 Speedway, Indianapolis, Ind. Exchange Agencies Everywhere



## Details That Count

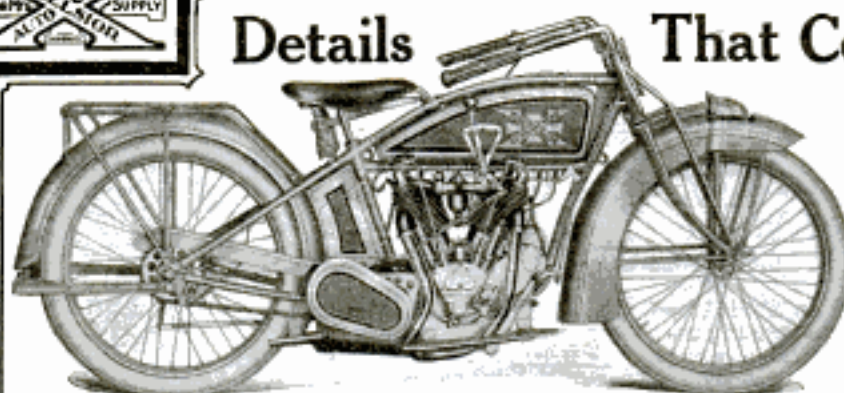

### THE NEW EXCELSIOR AUTOCYCLE

Models 15-3 and 15-1

Have more features of real superiority than were ever before combined in a single machine. Note the following features that insure satisfaction in every detail.

#### THE EXCELLENT AND DISTINGUISHING NEW FEATURES INCLUDE

- Extra strong outside joint; low saddle position frame with permanent side car lugs.
- Nickel steel forgings throughout; 12 gauge cold drawn seamless tubing; five leaf nickel steel fork springs.
- Beautiful round cornered tank with anti-leak needle valve fittings.
- Extra large enclosed valves; nickel steel valve mechanism.
- Positive, gear driven, mechanical oil pump.
- Automobile type three speed; automatically oiled nickel steel transmission.
- Automobile type annular ball bearings; non-gran bronze bushings.
- Over size, automatically oiled, multiple disc clutch.
- Nickel steel neutral shaft; powerful double brakes.
- Over size, knock-out axle, hubs; tool steel cups and cones.
- Extra heavy roller chains; non-splash fenders.
- Long, double hinged foot boards; heavy, unbreakable, armless stand.

Model 15-3, Twin,  
Three Speed  
**\$275.00**  
Model 15-1, Same,  
Single Speed  
**\$225.00**

Write today for handsome illustrated catalog describing these and four other models

## Excelsior Motor Manufacturing & Supply Co.

3702 Cortland St., CHICAGO

\$150.

Model H



## Pope Motor Cycle

### The Standard Lightweight of America

Low in price—the top notch of efficiency. The very best lightweight motor cycle possible to produce—a little machine with a big record: the greatest value ever offered for the money.

Every part is perfect—built to stand the hardest kind of cross-country work. Easy riding—easy control—4 H. P., speeds varying from 4 to 45 miles per hour. Look for the Pope trade-mark—it guarantees the quality and is the sign of the most complete line in the world of Motorcycles and Bicycles.

**MOTOR CYCLES**—6 models. Single cylinder—twins and 2 speeds. **BICYCLES**—92 models. Special light and heavy weights and juveniles.

Send for either catalog you wish.

THE POPE MFG. CO.

16 Cycle Street

Westfield, Mass.

A stream runs most rapidly one-fifth of the depth below the surface, and its average speed is that of the current two-fifths of the depth above the bottom.

**SOME CAR! BOYS!** Send for Booklet Today



### The Lad's Car

Send 20c today for Booklet, telling how to build this automobile. Complete instructions and descriptions of parts and sizes, illustrated with diagrams, blue print, cuts made from photographs, and price list of parts.

**SPECIAL INDUCEMENT** to first boy in your town  
Niagara Motor Car Corp'n, Dept. A, Niagara Falls, N. Y.

## QUICK ROAD TO HEALTH

Boys and girls from 4 to 15 years of age can now have fun out of doors while they build up strong bodies. Speed without labor. The rider's own weight keeps the car whizzing along. No pushing. Perfect control and safety. Induce the child to spend long hours out of doors in the wind and sun. The



### Skudder Car

will develop the lungs, shoulders and legs. Ball bearing, unbreakable steel frame. Let us send you one and show you how it will make your child happy and healthy. Write for free circular

SKUDDER CO.

Room 516 Straus Bldg., CHICAGO



## The Henderson

is the greatest single development in the motorcycle industry. The changes in design and in materials used make the 1915 Henderson the most reliable, the most efficient and the most economical motorcycle in the market.

Have you met "Henderson Bill"?  
Write for an introduction.

# HENDERSON



The Henderson Motorcycle Company  
1160 Cass Ave.  
Detroit, U.S.A.

The population of France has increased only 10 per cent in 40 years.

## RIDERS FREE THIS CATALOG

Write for it to the largest supply house in U.S.

## WE SAVE YOU \$\$\$\$

Our 1915 catalog lists 3015 accessories you should know about. You can't be an up-to-date rider without one. It is the one others try to copy. You need it so send us your name and address today.



## Grow Mushrooms Add \$5 to \$20 a Week to Your INCOME

Grown at home, in basements, barns, sheds, etc. Does not interfere with regular employment. Others are making money in this business. Why not you? It costs nothing to find out how to start, how to sell, etc. Send for illustrated booklet. Address A. V. JACKSON, Falmouth Mushroom Cellars, Inc. 342 Giffard Street, FALMOUTH, MASS. The Largest Modern Mushroom Farm in the World

## Large Profits from Small Capital



A Business of your own bringing you an income of at least \$10.00 per day with practically no experience or overhead expense.

### The Green AUTOMATIC MACHINE

sharpens, hones, and stropps all kinds of safety razor blades, all in one operation, at the rate of 150 to 250 blades per hour, you can readily figure your profits. Let us send you our free booklet explaining everything.

Am. Sharpening Machine Co. (Inc.)  
Dept. 3, 184 W. Washington St., Chicago

## The 1915 ←ARROW→

## Electric Light



## The Wonderful New Motorcycle Type

Send the coupon below today for new catalog of the 1915 "Arrow" Bicycle. Read the sensational improvements in the new 1915 model.

Other features too. Send the coupon for free catalog.

### 1915 Features

#### Electric Light

Reinforced motorcycle frame—large, easy motorcycle saddle—long, rubber grip, motorcycle handlebars—New Departure coaster Brake—special motorcycle pedals—motorcycle mudguards, stand and parcel rack—imported anti-friction chain—Flak, Red Tread Clincher Tires—beautiful enamel finish.

Nothing like this bicycle has ever been offered before. Built with all the durability and elegance of the very highest grade motorcycles. A positive wonder for speed, easy riding and comfort. The biggest bicycle value ever built. All sizes for boys, men and women. Send the coupon today for free catalog.

## Pay As You Ride

Find out about our special rock-bottom direct offer on this New 1915 Arrow. A special 30-day, reduced price offer. We ship the bicycle to you without a penny down. Start riding and enjoying the Arrow right away. And pay the special rock-bottom price—a small amount each month—while you ride. If you do not agree when you see the 1915 Arrow that it is the biggest bicycle bargain you ever saw, send it back at our expense. You be the judge. Send the coupon for free catalog.

**Pays for Itself:**—The coupon brings our liberal rider-agent proposition. The easiest ever! Just ride your Arrow around. People will admire your handsome bicycle and ask about it. Just answer their questions. You can pay for your Arrow and get extra money besides. Just send the coupon for full particulars and New Catalog.

## Send the Coupon Now! Don't delay.

Learn about the sensational 1915 Arrow right away. Take advantage of our special, 30-day rock-bottom price offer. Get the free catalog and details of easy Rider-Agent offer. Send the coupon NOW!

### Arrow Cycle Co.

Dept. 1193  
19th Street and  
California Ave.  
Chicago, Ill.

Arrow Cycle Co.  
Dept. 1193  
19th St. & California Ave.  
Chicago - Illinois

Please send me free catalog of the New 1915 Arrow and particulars of your 30-day rock-bottom "Pay-As-You-Ride" Offer and Rider-Agent Proposition.

Name .....

Address .....

Please Mention Popular Mechanics



**SAVE \$8.25**

on this handsome Rocker

Simply fasten 8 thumb-screws—all you need is a pair of hands and five minutes time, to save **\$8.25** when buying this beautiful—quartered oak—Japanese leather upholstered—arm rocker. Finished in golden, fumed or early English style, at the direct-from-factory-to-you price of \$11.75.

No. 102

**This Rocker** is built according to the best furniture traditions—seat upholstered, with oil tempered Turkish spiral springs, and plenty of them, fastened securely—the back stuffed with cotton felt, very soft and comfortable.

**Rocker Shipped Completely Finished** but knocked down to save freight. Simply shows the wonderful possibilities for saving on all your furniture needs by buying the DIRECT way.

**Send Today**

for our complete **FREE** catalog H of modern furniture—shows hundreds of pieces for living rooms, dining rooms and bed rooms.

**DIRECT FURNITURE CO.**  
Dept. H 35, Federal Plaza, CINCINNATI, O.



**Firestone**  
CYCLE TIRES

Toughest, thickest, most resilient tread. Built like a motor-car tire. All sizes! Non-Skid and corrugated tread.

Firestone Tire and Rubber Company  
Akron, Ohio—Branches and Dealers Everywhere

**RULE AND LEVEL**



**NEW**  
Accurate  
Practical

**2-FT. GENUINE BOXWOOD RULE** folding to 8 inches, graduated both sides, middle section fitted with spirit level. 1" wide, handy to carry, 9/16" thick when closed. Cheapest and best thing you can get to serve the two purposes.

**ONLY 75c POSTPAID**

**THE LUFKIN RULE CO.** SAGINAW, MICH.

**A Profitable Vocation**

Learn to letter Price Tickets and Show Cards. It is easy to do rapid, clean-cut lettering with our improved Lettering Pens. Many persons make good money by lettering price tickets and show cards for the smaller merchant, outside of regular working hours. Practical lettering outfit consisting of 3 Marking and 3 Shading Pens, 2 colors of Lettering Ink, sample Show Card in colors, instructions, figures and alphabets, Prepaid \$1.00.

**Practical Compendium of Commercial Pen Lettering and Designs**

100 pages, 8x11, containing 122 plates of Commercial Pen alphabets, finished Show Cards in colors, etc., also large list of crisp business Advertising Phrases—a complete instructor for the Marking and Shading Pen, Prepaid, \$1.00. Catalogue free. Address,

**NEWTON AUTOMATIC SHADING PEN CO., Dept. A, Pontiac, Mich., U. S. A.**



TRADE MARK



**LET OUR EXPERTS Draw Up Your FREE Heating Plans**

**TAKE** advantage of our trained experts—be sure of heating every room. Keep down coal bills. Deal direct with manufacturer—save \$25 to \$75 by buying at **Low Wholesale Factory Price**



We grant year's test—back guarantee with bank bond—cash or long time credit—easy payments. *We pay freight. Blue prints free*, whether you order or not—no obligations. Write today for

Catalog No. 936.

**Kalamazoo Stove Co., Mfr.**  
KALAMAZOO, MICH.

**"A Kalamazoo Direct to You"**

Trade Mark Registered

Women employed in the rubber industry in British Guiana get 20 to 25 cents a day.



**TYPEWRITERS ALL MAKES**

Prices \$15.00 up. **BOLD or RENTED ANYWHERE** at 1/2 to 1/3 MANUFACTURERS' PRICES, allowing **RENTAL TO APPLY ON PRICE**. Free Trial. Installment payments if desired. Write for Catalog L.

**TYPEWRITER EXPOSITION, 24-26 W. Lake St., Chicago, Ill.**

**Any SIZE ONLY \$5 DOWN—One Year to Pay**

**\$38** buys the reliable U. S. Engine (size 1 1/2 H. P.) direct from our factory on easy payments of only \$5 down and \$3 a month. Free Catalog Folder shows nine larger sizes all sold at similar low prices and on very easy terms. All guaranteed 5 years and backed by 62 years manufacturing experience; all shipped on 30 days' free trial.

**U.S. ENGINES**

Burn Gasoline, Kerosene or Distillate—have double the power of other engines of equal weight—are easiest to move—easy to get at—take up least space—run smoothest—start easy—burn less fuel and last longer. Free Catalog Folder gives 18 reasons for U. S. superiority and quotes low easy-to-pay factory prices. Write now.

(1) **U. S. ENGINE WORKS, 3712 Ogden Ave., CHICAGO**

# Own a Factory like this You Can

We Built This Factory Paid For it In 3 Years



We will furnish Equipment Free

Here's a chance for any ambitious man or woman to get into a business that requires no experience and but very little capital (from \$50.00 to \$200.00.) We start you in your own town—furnish the tools free—teach you how to make canvas gloves—show you how to market them.

We do all this for you. Start your factory simply with the understanding that you buy your supplies from us so long as our prices are as low or lower than you can get elsewhere.

The demand for canvas gloves is enormous, everybody everywhere wears them—the farmer—mechanic—doctor—lawyer—laborer. Millions of canvas gloves are required yearly to supply the demand.

## Right in Your Own Locality is Your Market

Your surplus can be sold to jobbers and dealers whose names we furnish—you make money from the beginning—profits are immense—are borrowed the money a few years ago to start—beginning with two sewing machines. Today we own the factory pictured above.

You become in reality, a branch of the **McCreery Mfg. Co.** working independently—we furnish the raw material—you turn out the finished product—reap the big profits. You are not bound by any contract to buy from us—only a man to man agreement. That's all.

We tell you all about the business in our interesting booklet. Costs you nothing to learn about it. Your copy is now ready to mail to you. Write for it. **It's FREE.**

Write today for this book. Don't delay it. Only a limited number of equipments will be offered free.

**McCREERY MFG. CO., 1081 Front St., TOLEDO, O.**

## NEW SQUIRT RING

**HERE YOU ARE BOYS,** a medallion ring of Sept. Morn. Everyone will see it on your finger and try to get a better look. Press the bulb concealed in your hand, and Miss Sept. Morn will do the rest by squirting a fine stream of water all over the curious one. Will squirt 2½ feet. Greatest joke out, and brand new. By mail with Big Catalog 15c.

**FISHER NOV. CO., Dept. 65, 721 Sterling Place, BROOKLYN, N. Y.**

## SEPTEMBER MORN

**WATCH FOB. ROSE GOLD Finish.** Just like illustration. The bewitching little figure of Miss "September Morn" handsomely embossed on heavy metal. Size of Fob 1¼ x 1¼. Genuine black leather strap. Boys, a real work of art. Classy, alluring. **Makes 'em all take notice.** Agents wanted everywhere. Dandy sample fob and our great easy money proposition to hustlers sent postpaid 25 cents. Address

**EMBLEM JEWELRY CO., 451 Morgan Bldg., BUFFALO, N. Y.**

**To Get Your Clothes FREE**

**A NEW WAY**

**WE DON'T ASK YOU TO SPEND YOUR PROFITS FOR CLOTHES**

**Make Big Money During SPARE TIME**

Something Different, bigger, more liberal than any offer ever made. **Lower prices—better clothes—bigger cash profits** Express paid on everything.

**Complete AGENTS Outfit FREE**

Your name on a postal card brings 60 real cloth samples and everything needed to start earning big money free.

**Spencer Mead Co., Dept. 576, Chicago**

# The Farm YOU Want

is compact, easy to pay for, and enormously productive—and it must be suburban to a big live city



Here it is—and it's yours for

**IN OUR NEW LITHIA TRACT** suburban to Tampa, the metropolis of South Florida. It is one of the few choice suburban farm tracts left in Hillsborough County, the recognized center of Florida's grape fruit and orange belt.

This is the third great Hillsborough County tract that has been opened to homeseekers and investors by our old established, responsible, thoroughly experienced organization. Over 2,500 families are now rejoicing because they bought at opening prices in our two former tracts. Every family can tell you they got a square and generous deal.

Our new Lithia Tract now offers you the same wonderful opportunity—and more, because of the rapid growth and development on all sides within the past four years.

The visible supply of select Hillsborough County grape fruit land is melting away very fast. Prosperous homes are scattered around the Lithia Tract—grape fruit and orange groves are flourishing on all sides. Already buyers are building homes on our new Lithia Tract, and values are due to rise here just as they have in our two former suburban farm tracts in this same county.

**Free—Absolutely Free—100 grape fruit and orange trees** to each and every purchaser who reserves one of these farms before April 1st, 1915. These trees will be held in our Nurseries until you are ready to plant them. This will give you a splendid start in developing a grove which will bring you an ever increasing income and greatly increase the value of your entire farm. Mail the coupon today.

One judicious investment, remember, means more to your bank account than years and years of labor. Honestly, now, what have you to show for that little 3½ cents per acre per day that might just as well be buying you a beautiful 10 acre farm? Where else could you put aside a few odd dollars so safely, so securely, and with such surety of seeing your modest savings fund develop into a great big investment?

No use trying to make yourself believe that savings bank interest will ever make you independent, nor 6 per cent loans make you rich. Your money isn't working when you tie it up in such ways—it's **LOAFING**. Make your money work for YOU; right here in these rich fruit lands is your opportunity—here where a few dollars put to work NOW will reap all the benefit of development work constantly being done by the fast increasing population.

Get our big new Florida book and look at the map—read the many enthusiastic testimonial letters from settlers now living on the farms they bought from us. Four big railroads intersect these suburban tracts—all the comforts of modern farm life right at hand!

Think of it—a ten-acre farm suburban to a city like this—a farm big enough to keep you in comfort all your lives, yet one you can pay for at the rate of just 3½ cents per acre per day!

**Larger Farms if Desired**—We also have a number of splendid tracts of 40 to 160 acres which are ideal lands for general farming, forage crops and stock raising. Write us for special information, prices and terms on these large farms if interested.

Get the facts now. The coupon brings them to you without cost or obligation. Get this new opportunity clearly before you while prices on this newly opened tract are still low and terms easy. Today \$1.00 per acre per month buys you independence and a future. Tomorrow—who can say!

Tear off the coupon and mail it NOW and we will lay before you, by return mail, full and complete information showing how you can easily become the owner of one of these beautiful grape fruit and orange groves, and why it is sure to prove the shrewdest, most profitable investment you can possibly make.

## North Tampa Land Co.

C. E. THOMAS, President

837 Marquette Bldg.

CHICAGO

**North Tampa Land Co., 837 Marquette Bldg., Chicago**

Please send me P.P.H. assortment blank for 100 grape fruit and orange trees, and your latest illustrated book on choice citrus fruit and truck farms suburban to Tampa, Florida.

Name \_\_\_\_\_ Street No. \_\_\_\_\_ City \_\_\_\_\_ State \_\_\_\_\_ P.M. 5-15

Please Mention Popular Mechanics



## Own a Beautiful Store Like This

You can do it. Once I was just a struggling candy maker. I had no more of a start in life than you—the profits from Crispettes, the new, delicious popcorn confection built this big business for me. I made fortune smile on me in this dignified, profitable, honorable business. I have made a SUCCESS—can look the whole world in the face, and am respected by my friends and neighbors.

**I Will Help You to Start.** The very proposition that made me, should do the same for you. Don't slave away for some one else. Start in the Crispette Business for Yourself. Build a business of your own as I did. Get a window—a small store—a cozy nook, where the rent is low. Keep all the profits. I'll teach you the Crispette business—tell you how to succeed—show you how to make Crispettes by my special secret formula. I do it right here in Springfield—personally or by mail. But the thing for you to do is to start.

### Every Nickel Nets You Almost 4 Cents Profit

Every 20 cents invested means practically one dollar in cash. Not theory—not guess work—not imagination—but the actual proven records of crispette merchants from one end of country to other.

### Come to Springfield at My Expense

Within a radius of 300 miles of Springfield, I will pay your expenses if you buy a machine. Come to investigate every phase of this business—make us prove every statement herein—make us show how the big, honest, legitimate profits are made with such a small investment and light running expenses. Make us prove that any man of ordinary intelligence, ambition and energy can make these big earnings. Send for our FREE Booklet, "Dollars & Sense". It tells the whole story—how and where to start—how to succeed—gives the experience of others. It is worth reading, even if you do not start. If you are looking for a good proposition—a big money maker—send now.

W. Z. LONG CO.



## EARN \$7,179.12 IN ONE YEAR

C. B. Kunkle of Michigan, did it last year from an open candy stand, just selling Long's Crispettes and candy. Got the start from answering just such an ad as this,—bought one of my famous Crispette Machines and now takes in a fortune every year. He is just a plain, ordinary, everyday man, who wanted to get ahead.

**YOU CAN DO THE SAME.** Somewhere in your town there is a little vacant store—part of a building, a vacant window, a peanut stand where the rent is low. There you can start and set up your machine and make and sell Crispettes—grasping the opportunity that means success.

Another man—another place—made \$1,500 in one month with a Long Crispette Machine. H. W. Fakins is his name and he only had a little store window which cost him his last \$90.00 for a month's rent, but at the end of that 30 days he had \$1,500 in real money and clear profit in bank. Today he is independent.

1039 High St., Springfield, Ohio



This is a recent picture of the man who made \$1,500 in one month with a Long Crispette machine, in a store window.

# PATENTS

If you have an invention which you wish to patent you can write fully and freely to Munn & Co. for advice in regard to the best way of obtaining protection. Please send sketches or a model of your invention and a description of the device, explaining its operation.

All communications are strictly confidential. Our vast practice, extending over a period of nearly seventy years, enables us in many cases to advise in regard to patentability without any expense to the client. Our Hand-Book on Patents is sent free on request. This explains our methods, terms, etc., in regard to Patents, Trade Marks, Foreign Patents, etc.

All patents secured through us are described without cost to the patentee in the SCIENTIFIC AMERICAN.

MUNN & COMPANY  
SOLICITORS OF PATENTS  
359 BROADWAY, NEW YORK  
and 625 F STREET, WASHINGTON, D. C.



## WAVECURL

imparts beautiful wavy curls however listless your hair is. One testimonial says: "My hair soon became a mass of wavy curls." For either ladies or gentlemen. Send 15c stamp or coin. Dept. 16, WAVECURL CO., ST. PAUL, MINN.

During the fiscal year 1914 services in saving of life and property were rendered and acts of heroism performed by employes of the U. S. Lighthouse Service on vessels or at stations on 124 occasions.

## STOP HERE JUST OUT—New automobile

necessity. Deflector for Headlights—puts light on the road, out of people's eyes. Makes better driving light. Not a dimmer. No adjustments—no knobs to turn—once put on is permanent. Lasts as long as the car. Price complete, \$2 per Set. Recommended by police in all large cities. Fine for driving on country roads. Fits any car with electric lights. Dealers and salesmen wanted.

HICKMYER DEFLECTOR CO., 4450 S. & B. Bldg., TOLEDO, OHIO

## Furniture On Credit

Write for Mammoth Bargain Book picturing 4,918 articles  
SPIEGEL, MAY, STERN CO.  
1089 West 35th Street, Chicago



## Diamonds on Credit

20% Down; 10% a Month

Every customer is protected by our written guarantee to refund his money if his dealer can duplicate our diamond at our price. Write for Illustrated Catalog No. 3.

J. M. LYON & CO., 71-73 Nassau St. New York City

**AGENTS—\$5.00 to \$25.00 a Day—It's Easy****Grand Invention. 150% Profit. Great Excitement  
Recognized as most phenomenal seller****Experience Unnecessary. Spare time can be devoted if desired  
LISTEN: One man's orders \$2,650.00 one month—profit \$1,650.00**

Lowry, of Montana, who sold 25 dozen the first two weeks (without previous experience) and made \$187.50, enthusiastically writes: "Why, I could sell this article blindfolded and with a gag in my mouth." Mere boy in Pa. made \$9.00 in 2½ hours. "I do not see how a better seller could be manufactured," reports Parker J. Townsend, Minn. "Started out at 10 a.m., sold 35 by four o'clock," says J. R. Thomas, Colo. "Sold 131 in two days," G. W. Handy, New York. See what a wonderful opportunity. These remarkable reports proven absolutely true by oath-covered evidence—proven to satisfy you beyond a doubt. You can make this money. Work for us and get rich. We want representatives Agents, Salesmen, Managers—everywhere. Write today. Territory in all sections of the United States, Canada, Mexico and foreign countries to be assigned. The New Easy Wringer Mop tremendously in demand by housewives. Every woman exclaims in delight: "Just what I want!" No more tiresome, back-breaking, miserable mopping days. Drudgery actually transformed into pleasure. The greatest, grandest, most necessary household article ever invented. No need to recite selling arguments. Talking hardly necessary at all. Simply show—order's landed. This is indeed a wonderful opportunity. Establish yourself in this business at once. Send your name and address on a postal now—right now.



The Easy Wringer Mop (Patented)  
Hands do not touch the water.

Think of It

A Self-Wringing Mop. Two turns of the crank wrings out every drop of water. Mopping is now a pleasure.

U. S. MOP CO., 283 Main St., TOLEDO, OHIO

**Learn How to Solder 10¢**

Solder at home—save money. Solder for others—make money. Send 10¢ in stamps for complete instructions; fully illustrated. Money back if not satisfied. **THE M. W. DUNTON COMPANY, SO. PROVIDENCE, R. I.**

**THE NEVER SLIP CLOTHES LINE FASTENER.** No knots to tie or undo. Big profits—No Patent Pending competition. Every home buyer \$1.00 to a Green. AGENTS, here is your chance to get a wholesale seller. Write for literature. Send 2¢ for sample set of six and Special Prices to Agents. **STANDARD WIRE CO., Dept. F, Baginaw, Mich.**

**WILL YOU TAKE ORDERS?**

Many earn \$30 to \$60 every week demonstrating our 1915 Model Steel Automatic Handi-Tool, Lifting and Pulling Jack, Wire Stretcher, Splicer and Mender, Post and Stump Puller, Tire Tightener, Cable Maker, Press, Vise, Hoist, Wrench, etc. Operates automatically. Has power of 40 men. Guaranteed for life. Spare time or permanent work. Demonstrator loaned. Credit given. Write for factory agency offer. **Chas. E. Benefiel Co., 293C Industrial Bldg., Indianapolis, Ind.**

**FINE OLD VIOLINS**

On Easy Payments  
30 Days Free Trial

allowed, no matter where you live. If not more than pleased with our values return violin AT OUR EXPENSE—and no harm done. Ability to play the violin brings social and financial success. Get a violin with a rich, mellow tone and it will create in you a desire to master it.

**Free! Magnificent Album-Catalog**

containing portraits of the world's great violinists since Paganini's time, a half-tone of "Stradivarius in His Workshop," and the romantic story of The King of Musical Instruments. A postal brings all to you FREE—no obligations.

**CREMONA VIOLIN SHOP  
Dept. A541 CHICAGO**

**Any Watch  
You Want  
ON CREDIT**

**WALTHAM  
ELGIN  
HOWARD  
HAMILTON  
ILLINOIS**

Sent on 30 Days Free Trial

**No Money Down**

**Express Prepaid in Advance by Me**

You take no chances with me. I am "Square Deal" Miller and I trust the people. That is why I am doing the greatest Credit Watch, Diamond and Jewelry business in the country. Suppose you want any one of the country's best makes of watches? Name any one, I have it for you, No Money Down, Express Prepaid, A Full Month to Carry it in Your Pocket and the easiest of Long Time Payments. That's the test that tells. All these watches **Guaranteed 25 Years**

**I Smash the Terms**

**No References Demanded**

My terms are made to suit you. You get unlimited credit with no red tape, notes or collectors—no unnecessary detail

**An "Open Charge" Account**

the same kind of credit you get from your grocer. No matter where you live or what your income is, you can now own the finest watch, a beautiful diamond or any rare piece of jewelry and never miss the money.

**Costly Catalog FREE**

Send me your name and address on the coupon, a post card or letter, so I can mail you, Free and postpaid, the most beautiful catalog of its kind ever printed. I want you to have this book. It's a gem. It illustrates all makes of valuable **Watches, Elegant Genuine Diamonds** and a vast assortment of **Beautiful Jewelry**, all on the easiest and most liberal terms. Write for this book today and get a letter from me that will make you a friend of mine from the start. **Take My Word For It.**

**Square Deal MILLER, Pres.**

**MILLER-HOEFER CO., 434 Miller Bldg., Detroit, Mich.**

**This Coupon Brings My Big FREE Book**

**SQUARE DEAL MILLER, Pres.  
434 Miller Bldg., Detroit, Mich.**

Dear Sir: Please send to me without cost or obligation your Big Book on all Makes of High Grade Watches, Genuine Diamonds and Jewelry, and full information on your Easy Payment, No Money Down and 30 Day Trial Plan.

Name \_\_\_\_\_

Address \_\_\_\_\_

Please Mention Popular Mechanics



## What the World's Nations Think of Each Other

It is the very soul of the nation that is seen by the Cartoonist. It is he who actually crystallizes public opinion. His pencil is the sixth arm of war. And in these bitter days when the mask of diplomacy is discarded and pretenses are laid aside, when the hearts of people are laid bare, there is no better way of looking deep under the surface than through the eyes of the Cartoonist.

# Cartoons Magazine

(Published by H. H. Windsor, Publisher of Popular Mechanics Magazine)

*Presents every month a vivid panorama of the war. Each issue is a veritable Message from Mars, nor have the Thunderbolts of the War God more telling effect than the Cartoon Shafts of these Master Satirists.*

Cartoons Magazine is a symposium of world caricature. There are cartoons voicing the hatred of England, or blazing forth Germany's contempt for the Allies. Echoes of British pride are found in cartoons from South Africa, Australia and Canada. Cartoon masterpieces from the Italian journals give an insight into the real spirit of Italia. Spain and Latin America, Russia, Holland, and Japan are represented by their leading Cartoonists. From every section of the United States come cartoon sermons that reflect America's attitude toward the world crisis. Thus, as if through a magic lens, one gets the viewpoint of all nations.

An attractive grouping of the cartoons makes it possible to illustrate every phase of the war, and the subject is treated each month from many different angles. The accompanying comment, selected from the world's representative newspapers and journals, gives substance to the work of the cartoonist.

War has always been the harvest time of the cartoonist, whose silent battles are not less bitter than those fought with lead and steel. The Napoleonic era, the Crimean war, and the Franco-German war still live in the cartoons of the periods. Within a few years a collection of cartoons on the present war will be almost priceless. There is not another such collection in the world, and the files of Cartoons Magazine for 1915 will make the most fascinating history of the conflict yet published. It is a unique review in every way.

**Single Copies 25 Cents      \$3.00 a Year**

On sale at News-stands or at 6 N. Michigan Ave., Chicago  
**A Dollar Bill and the Attached Coupon will  
Bring a Four Months' Trial Subscription**

### CARTOONS MAGAZINE

6 North Michigan Ave., Chicago

Enclosed find \$1.00 for which please send Cartoons Magazine to my address for four months.

Name .....

Street .....

City .....

TO EVERYMAN  
EVERYWHERE

YOU CAN DRESS \$  
ALWAYS for

10



Good Clothes  
Always \$10.00 Suit or Overcoat

72 SAMPLES & BOOKLET  
FREE

Sounds impossible, doesn't it?—smacks of exaggerated advertising—looks like imagination run riot—but IT ISN'T. We are the largest manufacturers of men's clothing in the world, doing business DIRECT with the wearer. The entire output of our factory—just suits, overcoats and top coats—is sold by mail or from our six stores. Price always \$10. We specialize—make clothes at one price only. Everything going into them—the pure wool cloth—the linen canvas—

linings—hair cloth—all are of a standard quality bought in immense quantities. We sell thousands of garments, instead of hundreds—make hundreds of a model instead of a few, all of which reduces the cost on each item and makes possible, always \$10.00.

**Big Business Men Wear 'Em**—The Men Who Make Money and Keep It—wear these suits. They know Richman Clothes are worth a great deal more than \$10. They prefer several clean suits to one shabby one. In Cleveland, home of our factory and largest store for 35 years every sixth man of its 650,000 inhabitants buys a suit or overcoat of us once a year. Men in every walk of life are wearing them—they are the clothes for YOU—whoever you are, wherever you are. A ten dollar bill and postage will bring you Richman clothes right to your door—parcel post. Satisfaction guaranteed or money back.

STYLE BOOK FREE—write for Spring catalog of latest styles—and 75 newest fabrics.

THE RICHMAN BROTHERS CO., Dept. 25, CLEVELAND, O.  
Milwaukee, Wis.; Cincinnati, O.; St. Paul, Minn.; Minneapolis, Minn.; Duluth, Minn.



The largest exclusive clothing store in America where nothing but clothes of our own make are sold



Learn the perfection, luxury and economy of  
**Colgate's Shaving Lather**  
STICK—POWDER—CREAM

"As You Like It"

Your dealer can supply you with the method you prefer, or we will send you a trial size of your favorite for 4 cents in stamps.

COLGATE & CO., Dept. 81, 199 Fulton St., New York



Taxidermy  
Book  
FREE

**Mount Birds**

We teach you by mail to stuff and mount all kinds of **Birds, Animals, Game Heads**. Also to tan skins and make rugs. Be your own taxidermist. Decorate your home with your beautiful trophies or increase your income selling specimens and mounting for others. Easily, quickly learned in spare time by men and women. Highest endorsements by thousands of students. Write today for our great free book "How to Mount Birds and Animals" Free—write today.

N. W. School of Taxidermy, 1128 Filwood Bldg., OMAHA, NEB.



**Mobiloils**

A grade for each type of motor

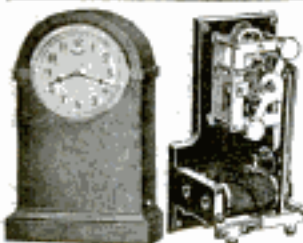

**Self-Winding Clock**

Marvelous new electric clock—dry cell battery—no wiring—runs anywhere. Winds itself. Clocks complete in many styles. For home, office and factory. No worry or care. Runs in any position. Low price. Special offer to introduce. Movements sold separate for timing devices and experimental work. Book on self-winding clocks and movements postpaid free. Send coupon or write.

American Self-Winding Clock Co., 136 W. Lake St., Dept. 5247, Chicago, Ill.

Name.....

Address.....

American Self-Winding Clock Co.  
136 W. Lake St., Dept. 5247, Chicago, Ill.

Gentlemen: Send free book on self-winding clocks and movements and special introductory offer. No obligation.



STOP THAT LEAK  
**WATERTITE**  
REPAIRING  
COMPOUND



Always ready for use. No preparation necessary. All repairs absolutely permanent and waterproof. Leaking Roofs, Tanks, Skylights, Water and Gas Pipes, etc., cause immense losses when the plumber is too busy or too far off to attend when required. Leakages and breakages are constantly happening, even in the best of houses, and, unless you have **Watertite Compound**, it is difficult, if not impossible, to have such repairs done promptly.

**Watertite Compound** will save you many a plumber's bill, because you can make your own repairs promptly, effectively. It is ALWAYS READY FOR USE, in its convenient form, and will not become dry or brittle, even if kept indefinitely. Can be used in any climate during any season, and is unaffected by changes of temperature.

Useful in a hundred ways around the House, Farm, Homestead, Shed, Stable, Boat, etc., for stopping leaks of every kind, small or large, of the most stubborn kind on WOOD, STEEL, TIN, IRON, SHINGLES, around skylights, scuttles, eavestroughs, tanks, spouting, boats, washbasins, etc.

**NO DIRT, NO LABOR, NO EXPENSE, NO TROUBLE**  
SPEEDY, SAFE AND PERMANENT  
Price, 50c postpaid; 3 for \$1.25 postpaid  
AGENTS AND DEALERS SUPPLIED

JOHNSON SMITH & CO., Dept. 2, 711 So. Dearborn St., Chicago

**Marlin**  
GUNS

A good gun lasts a life-time. Buy the right gun! The Marlin is the thoroughbred among sporting firearms. Splendid repeating rifles and shotguns; guns for every purpose. Marlins cost no more than less desirable arms. Send 3 stamps postage for 136 page gun book. Marlin Firearms Co., 65 W. St., New Haven, Conn.

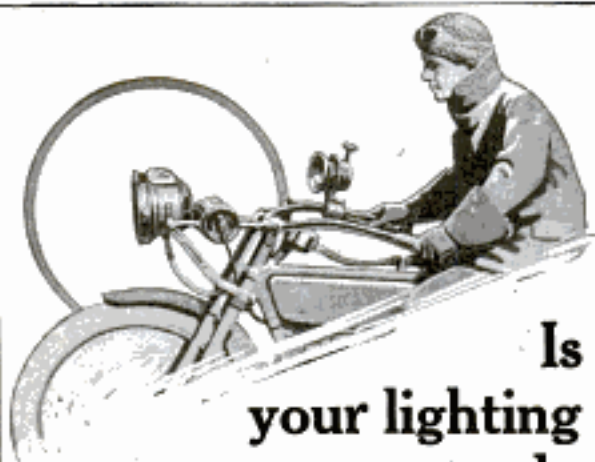

## Is your lighting system as sturdy as your motorcycle?

Your motorcycle can be no stronger than its lighting system.

When you ride at night, you must have good light. Your safety demands it.

Practically all riders use Prest-O-Lite because it gives unfailing service and satisfaction, and stands up under severe use and abuse.

## PREST-O-LITE for Motorcycles

Be as careful in the selection of a lighting system as you are about the other mechanical features of the machine you buy.

Insist upon Prest-O-Lite because it is the only practical light for motorcycles—because it furnishes a flood of rich, mellow light—because it costs less to buy and less to use than any other system of brilliant lighting, and because it has no delicate parts or adjustments to get out of order or demand expensive repairs or replacements.

## 30 Days' Free Trial

Any dealer will give you the opportunity to test out Prest-O-Lite on your own machine for 30 days free. Prove every claim to your entire satisfaction or the test doesn't cost you a penny.

You can get Prest-O-Lite in any combination of motorcycle equipment. If the dealer knows night riding conditions himself, he will recommend Prest-O-Lite to you. When you know the truth about all lighting systems, you will insist upon Prest-O-Lite.

## Send for Facts

"All the Facts about All Lighting Systems" free upon request. Have this information before you buy a machine. Your name and address on the margin of this page will do. Write today.

## The Prest-O-Lite Co., Inc.

The World's Largest Makers of Dissolved Acetylene  
265 Speedway Indianapolis, Ind.  
Prest-O-Lite Exchange Agencies Everywhere



## BUTTER-KIST The Tantalizing Pop-Corn Treat

Save the Bags for Prizes

Folks stand spellbound in stores all over the land and watch the miraculous way the BUTTER-KIST Corn Popper runs itself.

Look for the one in your neighborhood. See how it feeds the raw corn from the hopper; watch the kernels swell, jump and burst into big, fluffy white flakes—crisp, crackling and clean—untouched by hands and piping hot. See how this marvelous little machine butters each morsel evenly—more dexterous than human fingers.

Turns out 1 bag in 48 seconds—\$2.75 per hour!

You never tasted such enchanting pop-corn as BUTTER-KIST. Folks walk blocks to get it.

And stores are putting in BUTTER-KIST Corn Poppers as fast as we can supply them.

Get the Prize Book FREE—and see the handsome articles for folks who send us trademarks for BUTTER-KIST Bags. If your storekeeper cannot give you this book, send us his name, with a 2c cent stamp. Then we will mail you a copy and also 6 valuable BUTTER-KIST trademarks to start your prize collection—all absolutely free!

## Merchants! \$25 to \$60 More Profits Weekly

Scores of records to prove that BUTTER-KIST Corn Popper pays 5 times as much profit per sq. ft. of floor space as anything else in the store. Stands

anywhere—needs only 26 by 32 inches—move a chair and you have room for it!

Adopted by drug, candy, department and cigar stores, news-stands, picture theatres, etc.

All-year, spot-cash business—no stock to carry. Great trade winner in practically any store or location. One store sold \$679.45 first 28 days.

A small payment down brings BUTTER-KIST Corn Popper—all privileges included. Soon pays for itself from its sales.

Dealers! Write for "Little Gold Mine," FREE!

Photographs, sales records, proof of profits and full particulars in our handsome new dealers' book, "The Little Gold Mine." Sent free, postpaid. Write at once—every day gained means \$5 to \$16 more sales!

Holcomb & Hoke Mfg. Co.  
1623 Van Buren St., Indianapolis, Ind.





# WHICH?

Same Quality  
Same Finish  
Same Price

But—  
Here's the  
Difference

This you can Re-Blade

YOU can replace a broken blade in a Nagle ReBlade Knife in ten seconds. No tools required. Think of it—a knife that's always new—always 100% efficient. Here is our Introductory Offer for quick action. Send us a dollar bill (or money order) for the finest jack-knife you ever saw, with two Sheffield steel blades and an extra blade for reblading. Looks exactly like a fine old-style knife. Equally strong. Blades can't

This you can not Re-Blade

come out accidentally. Sturdy, handsome handle. Actual size of knife, 3 3/8 in. long. Additional blades as you need them for 25c each. Fully guaranteed.

Write for Premium Proposition. Agents or dealers wanted

**NAGLE ReBlade KNIFE ©**

72 Parker Ave. Poughkeepsie, N. Y.

Reference: First Nat. Bank, Poughkeepsie, N. Y.

335 Candle Power  
Cost 1c 10 hrs. fuel

## POWERLIGHT THE HOME LAMP



Clean  
No Smoke  
No Noise  
Odorless

Winner of the Gold Medal, the highest award at the International Safety Exposition, New York, December, 1914. The only lamp to receive an award. It's the safest, brightest and best. Burns kerosene or gasoline without wick. Can't explode or spill. Plain or art glass dome.

### OTHERS LOOK LIKE CANDLES

Must be seen to be appreciated. Don't buy any lamp until you see this one. An ornament to any home. Write for special offer. **AGENTS:** make big money, exclusive territory, samples loaned. Write today.

**POWERLIGHT SALES CO.**

95 Chambers Street

NEW YORK

British colonies total 13,002,321 square miles in area, with a population of 389,065,035.

## Drafting Will Promote You!

These courses will give you the knowledge that means promotion and big salary. Architectural, Mechanical and Structural Drafting and Design, Estimating and Contracting, Builders' Courses and Plan Reading.

EVERY  
DAY  
IF  
YOU

### DRAFTING

Complete \$15.00  
Outfit and all Blue  
Print Plans FREE.

Day, Evening, Home-Study Courses. Write today.

**CHICAGO TECHNICAL COLLEGE**

1050 Lake View Building

CHICAGO, ILL.

## 1/16 and 1/8 H.P. Gas and Gasoline Engines

Small Steam Engines. New type Dynamos, 18-24-40-60 and 80 Watts. Electricians' Mechanical and Experimenters' Supplies.

SEND STRIP FOR CATALOGUE No. 104  
**DYNAMIC MFG. CO., 1st Nat'l Bank Bldg., CHICAGO**

# \$3000 FOR YOU



That's the money you should get this year. I mean it. I want County Sales Managers quick, men or women who believe in the square deal, who will go into partnership with me. No experience needed. My folding Bath Tub has taken the country by storm. Solves the bathing problem. No plumbing, no water works required. Full length bath in any room. Folds in small roll, handy as an umbrella. I tell you it's great! GREAT! Rivals \$100 bath room. Now listen! I want YOU to handle your county. I'll furnish demonstrating tub on liberal plan. I'm positive—absolutely certain—you can get bigger money in a week with me than you ever made in a month before. I KNOW IT!

## TWO SALES A DAY—\$300.00 A MONTH

That's what you should get—every month. Needed in every home, badly wanted, eagerly bought. Modern bathing facilities for all the people. Take the orders right and left. Quick sales, immense profits. Look at these men—Smith, Ohio, got 18 orders first week; Meyers, Wis., \$250 profit first month; Newton, California, \$60 in three days. You should do as well. **TWO SALES A DAY MEANS \$300 A MONTH.** The work is very easy, pleasant, permanent, fascinating. It means a business of your own.

Little capital needed. I grant credit—Help you out—Back you up—Don't doubt—Don't hesitate—Don't hold back—You cannot lose. My other men are building houses, bank accounts, so can you. Act

then, quick, **SEND NO MONEY.** Just name on penny post card for free tub offer. Hustle!

Exclusive  
Territory.  
100% Profit.



Demonstrating  
Tub Furnished

**H. S. Robinson, Pres.** 787 Factories Bldg., TOLEDO, OHIO  
Canadian Branch—Walkerville, Ont.

## HOW TO BUY A PIANO



After you have made a thorough investigation of the different methods of selling pianos just figure what you can save if you buy direct from the factory. Remember, a retailer has large expenses in selling a piano, besides his profit. You can save all of this at our factory.

We make as fine pianos as are manufactured anywhere, and we sell direct to the homes. We never sell through dealers or agents, but we will give their profits to you.

The Adler Piano received the highest award at the National Conservation Exposition at Knoxville in 1913.

You can try an Adler Piano in your home free. You can put it to any test and make any comparison you desire. You do not obligate yourself to purchase. Ship it back at my expense if you are not more than satisfied to keep it.

My plan of selling direct from the factory saves you \$100 to \$150. If it is not convenient to pay cash, you can use my strictly confidential "Charge Account Plan" whereby you can pay in small amounts to suit you, and without interest.

**Send No Money In Advance**

Send today for free catalog showing you pictures and prices of Adler Pianos. Select the style you would like to try, and it will be sent to you free. No matter whether you are thinking of buying an instrument now or some time in the future, you will want this handsome catalog so as to know all about the finest, squarest and most liberal piano buying proposition you ever heard of. Every piano guaranteed for 25 years, backed by my million dollar factory.

A postal today will bring my style book and selling plan.



**C. L. ADLER, Pres., Adler Mfg. Co.**  
4082 W. Chestnut St., Louisville, Ky.

You should have it

The East J. Early Company  
307 Arch St.,  
Philadelphia,  
U.S.A.

Your dealer should have it



The Drawing Attraction  
of the Drawing World

Line-O-graph  
Patented Dec. 13-14. Means equal

Jr. 75¢ Draftsman 1.00 Sp. 1.50

**Make \$15.00 to \$35.00 Per Day**

With Our Latest Invention, the Wonderful Ever-Ready Camera. Makes 9 styles single or group pictures direct on postcard or tintypes without film or negative, finished for delivery in less than one minute. **No Experience Necessary.** Get into a good, clean, respectable business of your own and become independent. **Big Money** at fairs, carnivals, parks, picnics, anywhere. Photos cost you from 1 to 25¢; sell at 10, 15 and 25¢ each. Write Today for Free Proposition and Catalogue.  
**THE NEW YORK FERROTYPE CO.**  
Dept. M39, No. 168 Delancey Street, NEW YORK, N.Y.  
Dept. M39, No. 1126 S. Halsted Street, CHICAGO, ILL.



## The Boy Mechanic

**GREATEST BOYS' BOOK PUBLISHED**

Describes 700 Things for Boys to Make and has 1,000 Illustrations. Price \$1.50 Prepaid

POPULAR MECHANICS BOOK DEPT., 6 N. Michigan Ave., Chicago

## OXY-ACETYLENE

### WELDING AND CUTTING

Including the Operation and Care of Acetylene Generating Plants and the Oxygen Process for Removal of Carbon

By C. F. SWINGLE, M. E.

200 Pages—76 Illustrations—Pocket Size Bound in Cloth, \$1.00

OXY-ACETYLENE  
WELDING  
AND CUTTING  
SWINGLE

Full Leather—Round Corners—Red Edges  
Stamped in Gold, \$1.50

Here is a brand new practical instruction book on the methods of welding and cutting by the oxy-acetylene process. The thirteen chapters cover the following general subjects:

Welding—Welding Flames—Oxygen Acetylene—Acetylene Gas Purification and Handling—Oxy-Acetylene Torches—Characteristics of Welding Torches—Welding Installations—Preheating and Annealing—Operating a Welding Installation—Metal Welding Practice—Oxy-Acetylene Cutting—Oxygen Carbon Removal—Index.

Sent postpaid upon receipt of price by

**POPULAR MECHANICS BOOK DEPT.**  
6 N. Michigan Ave., CHICAGO

## YOUNG MAN! LEARN DRAFTING.



ONE of the most practical subjects of study today; an essential in most lines of engineering; indispensable in many occupations and often the secret of successful advancement; of no less importance to the farmer than the mechanic. There is bound to come a time when you will feel the need of the ability to "lay out" something in accordance with the rules and conventions used in the drafting profession.

**Individual Study**

may be successfully engaged in with the aid of our new enlarged edition of the book

## A Practical Course in Mechanical Drawing

By WM. F. WILLARD

(For several years instructor in Mechanical Drawing at Armour Institute of Technology, Chicago)

160 PAGES—SIZE 5x7—157 DRAWINGS—CLOTH COVER

Price 50 Cents, Postpaid

There has been a real need for a book of this kind, as it clinches each problem in the mind of the student by giving the practical application of that problem to every day practice in some phase of the world's work. It meets every modern requirement and is in advance of any other work on the subject. Excellent for use in shop classes, trade or high schools. A complete detailed description of the contents of this book sent free upon request.

Order of your Book Dealer or direct from the publishers

**POPULAR MECHANICS BOOK DEPT.**  
6 N. Michigan Ave., CHICAGO

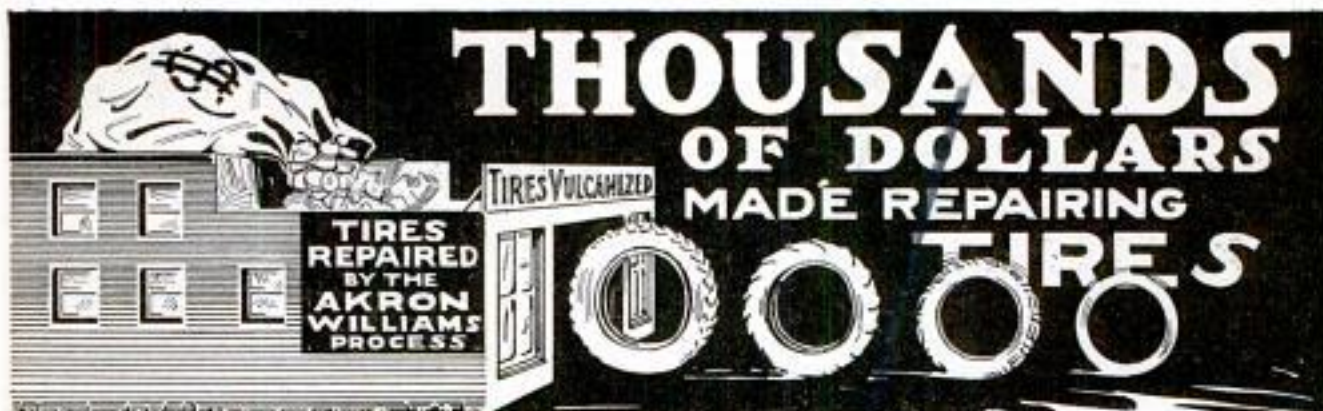

# THOUSANDS OF DOLLARS MADE REPAIRING TIRES

The amount you can make in dollars repairing tires is measured by your own energy. You can make anywhere from \$1500 to \$3000 a year above expenses. Your investment to start in business is small, returns are quick and your income easy. Profits are large on every job you turn out. The tire repair business is in its infancy. It's growing every year, because more tires are being used every year. In almost every city and town there is a crying need for a good tire repair man. **That means opportunity for you.** Start in your home town if you want to. This is a new **money making business.** Don't delay getting busy. But above all be prepared with an equipment that means satisfactory work for your customers. Buy only an

## AKRON WILLIAMS TIRE REPAIR EQUIPMENT

The better your equipment, the better your work and the greater your volume of business.

Let us start you in business right. Use an equipment which is

**ENDORSED BY 30 LEADING TIRE MANUFACTURERS**

It takes you but a short time to become an expert tire repair man. We help you here. We are making an unusual offer to everybody who buys our equipment. You can become an expert by our plan.

**SEND FOR OUR 30 DAY SCHOOL PLAN**

It means when you start in business, you start right. You are prepared to make money from the jump. No experimenting. No failures. You become a practical, first class repair man. **WRITE FOR CATALOGUE NO. 244.**

**WILLIAMS FOUNDRY & MACHINE CO.** 89 Howard St. AKRON, OHIO

# Ideal

## POWER LAWN MOWER

## Exquisite Lawns

Surrounding a beautiful home must be a beautiful lawn, if an impression of true gentility is to be conveyed.

House exteriors present an unchanging appearance; but the lawn, if neglected or abused, is as quick to show it as it is prompt to respond to proper treatment.

An Ideal-kept lawn is the owner's delight—the caretaker's pride and the best advertisement of all for the Ideal Power Lawn Mower.

This machine is a combination mower and roller; 5 horse power, S.A.E. rating; high tension National magneto; 6 adjustable cutter blades; 38-inch cut; climbs 35% grades; cuts 2 to 8 acres a day; speed 1 to 4½ miles per hour; operating cost 30 cents a day. Automatic sharpening device furnished.

A smaller machine—the Ideal Junior Power Lawn Mower for smaller lawns—sells for \$225. If your lawn presents a problem, write for catalog describing Ideal Power Lawn Mowers.

**THE IDEAL POWER LAWN MOWER CO.**

418 Kalamazoo St.

R. E. OLDS, Chairman

LANSING, MICH.

\$400

Combination Mower and Roller 38-inch Cut

Something  
New

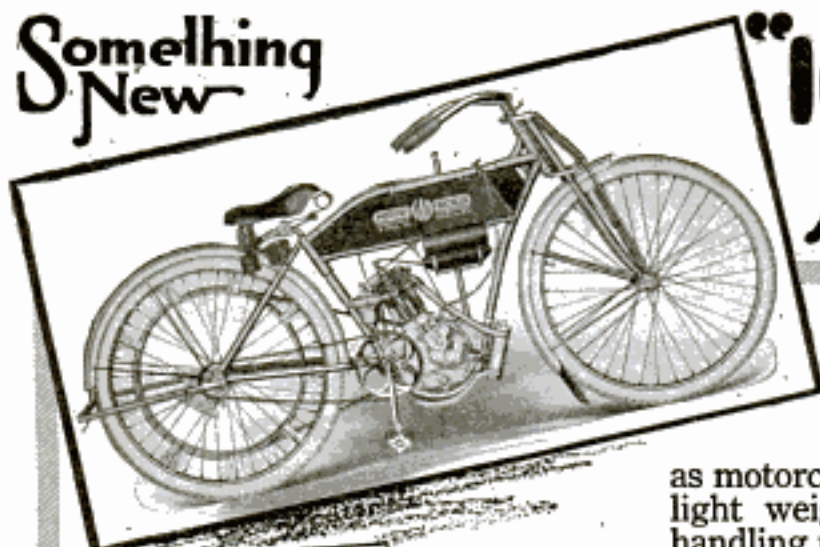

"100 MILES  
for 10 cents"

## It's Not a Motorcycle

as motorcycles are known today. Its light weight, low cost and ease of handling mark the difference between it and the present day motorcycle. Neither is it a bicycle with a motor attachment.

## It is a REAL Motor Bicycle

carefully and completely designed as such, with all the skill and experience of twenty-one years in the manufacture of high-grade bicycles and motorcycles built into it.

It's as simple and clean to run as a bicycle, and as quiet as a sewing machine. It appeals to all classes—professional and business men, clerks, mechanics, salesmen, farmers, students, boys and girls—to anybody who desires economical travel without exertion, exhilarating recreation without fatigue—healthful exercise without effort—and a practical conveyance without inconvenience.



Light weight means low upkeep cost. The slogan "One Hundred Miles for Ten Cents" is based upon thorough tests for fuel consumption. Tire wear and other items of maintenance cost are proportionately low.

For those who object to the expense, speed and heavy weight of the present day motorcycle, the Miami Motor Bicycle is the ideal mount.

### WRITE AT ONCE FOR FREE BOOKLET

telling all about the Miami Motor Bicycle and its many uses. You can purchase one from your dealer or direct from our factory.

## THE MIAMI CYCLE & MFG. COMPANY

"America's Greatest Cycle Makers"

600 Mobile Ave., Middletown, Ohio

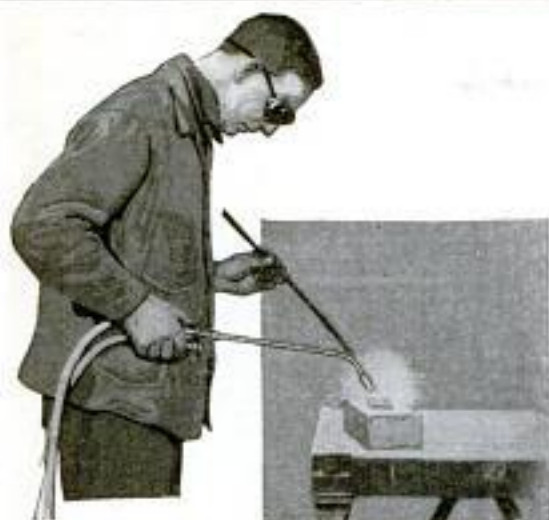

## Oxy-Acetylene Welding simplifies manufacture and repair of metal parts

Wherever two or more pieces of metal are to be joined, you will find a profitable use for Oxy-Acetylene welding.

The manufacture of intricate parts is simplified by the economy and convenience of this process. You can reclaim defective castings, correct mistakes in design, and cut production costs by using this process in your shop. Quick repairs of damaged or worn equipment are made "on the spot," with tremendous savings of time, labor and material.

A welding outfit soon pays for itself. We furnish a thoroughly high grade welding apparatus for \$60.00. The average user will also need gas cylinders at an additional cost and about \$10.00 worth of welding supplies. Truck and special equipment for cutting operations at extra cost.

To get complete efficiency, and enjoy the utmost in economy, portability, simplicity and convenience, with good apparatus of any make, use

## PREST-O-LITE Dissolved Acetylene (Ready-made carbide gas)

Prest-O-Lite Acetylene Service furnishes the highest grade of Dissolved Acetylene in portable cylinders, used as conveniently as you use cylinders of oxygen. Saves the large initial outlay and heavy depreciation, trouble and inconvenience of making crude Acetylene in carbide generators. Besides, Prest-O-Lite Dissolved Acetylene is perfectly dried, cleaned and purified—makes better welds and is cheaper to use.

If you use Acetylene for ANY purpose, you should have full details of the liberal Prest-O-Lite Service Plan—made possible by our position as the world's largest makers of Dissolved Acetylene.

### A Profitable Business of Your Own

Enterprising men looking for new and highly profitable fields should investigate the wonderful opportunities in doing Oxy-Acetylene repair work for others.

Others are saving money by using Oxy-Acetylene welding and cutting. Send for information of how the process will help you.



**The Prest-O-Lite Co., Inc.**  
The World's Largest Makers of Dissolved Acetylene  
816 Speedway Indianapolis, Ind.

53 direct factory branches and charging plants in principal industrial centers.

## 100 USES

The Jiffy Overall Apron is a patented garment which completely protects the front of the clothes. As the name implies it goes on in a "jiffy" and comes off as quickly. It is universally used by autoists, repairmen, carpenters, printers, engineers, mechanics, bench workers, butchers, butlers, chefs, chauffeurs, laboratory men, manual training students, store clerks, postal clerks, freight and express handlers, cartage and baggagemen, as well as men who take care of their own motor car, furnace or garden.



## SPECIAL FEATURES

Combination tool or watch and pencil swinging pocket. Two large pockets used for tools or other articles. Two elbow length over-sleeves with each garment. Patented Clip at bottom of each leg—holds garment in place. Union made in Detroit by the highest skilled labor obtainable. Each garment is guaranteed.



### FOUR STYLES

The Jiffy Overall Apron is made in four different styles. \$1  
(1) Highest quality blue denim.  
(2) Extra heavy, blue and white striped Steffel.  
(3) Highest grade water-proofed white duck.  
(4) Extra quality, brown khaki.  
All garments are of the best workmanship and sold for.....  
If your dealer cannot supply you, we will ship direct by parcel post paid upon receipt of one dollar

The Jiffy Overall Apron is made in 10 different sizes,—to fit the small man of 5 ft. 3 in., up to the tall man of 6 ft. In ordering give your height to the dealer or direct to us, and you will get the correct size.

### Demonstrator Agents Wanted

There are many towns in which we desire successful men to represent us. Liberal commission allowed for such representation. If interested, write quick.



In the shop

# JIFFY OVERALL APRON

(Patents Applied For)



at the bench



in the garage

**NOW**  
**JIFFY**  
**APRON**  
**CO.**

303 Smith Bldg.  
Detroit, Mich.

Please send me by parcel post paid one Jiffy Overall Apron complete with over-sleeves,

style..... for which I enclose \$1.00. My height is.....ft.....in.

Name.....

Address.....

# Cut the Cost of Furniture in Two

We can help you do it. Because we are manufacturers with an original method of shipping beautiful, "Master-Built" furniture in sections—direct from factory. We manufacture everything needed in furniture for home, office or club—100 designs in Colonial, Mission and Flanders—all carefully selected quarter-sawed oak.

## Buy Direct from Factory and Save Half of Your Furniture Money

only best furniture is considered. We are not a mail-order house—not

**ROCKER No. 107**  
Dealer's Price \$24.00  
Brooks Factory Price \$12.25  
Beautiful quarter-sawed Oak. 10 minutes' work saves about \$12.00.

An unusually big, rich-looking chair. Beautiful quarter-sawed Oak. 10 minutes' work saves about \$12.00.

jobbers or wholesalers. We are straight manufacturers, and we have devised a twentieth century method of reducing the size of the package. All Brooks "Master-Built" Furniture is

## Shipped in Sections—Assembled in Ten Minutes by Anyone

Why not let a few minutes' pleasant work save you many dollars? Our plan is to ship direct to you, the user. Hundreds of dealers now assemble Brooks "Master-Built" furniture in their stores, and sell it at from 40 to 60 per cent above our prices. They recognize its superior quality and the economy of our plan.

**Our Original Sectional Method Saves 75% Packing Costs--** Do you wonder why we can save you half your furniture money? The real wonder is why you haven't taken advantage of this money-saving plan before. Write us and receive the Brooks "Master-Built" Furniture catalog. You cannot afford to buy furniture before seeing this book. Send for it today.

**BROOKS MANUFACTURING CO., 2703 Brooks Ave., Saginaw, Mich.**

Largest Plant of Its Kind in the World

For years we have supplied government institutions and finest homes all over the world where jobbers or wholesalers. We are straight manufacturers, and we have devised a twentieth century method of reducing the size of the package. All Brooks "Master-Built" Furniture is

**BUFFET No. 409**  
Dealer's Price \$65.00  
Brooks Factory Price \$37.75  
Beautiful quarter-sawed Oak—massive size. 15 minutes' work saves you about \$28.00.



Write for Our Free Book of Finest Furniture

## Oh, You Skinny!

Why stay thin as a rail? You don't have to! And you don't have to go through life with a chest that the tailor gives you; with arms of childish strength; with legs you can hardly stand on. And what about that stomach that flinches every time you try a square meal? Are you a pill-feeder?

Do you expect Health and Strength in tabloid form—through pills, potions and other exploited piffle?

**You can't do it; it can't be done.**

The only way to be well is to build up your body—all of it—through nature's methods—not by pampering the stomach. It is not fate that is making you a failure; it's that poor, emaciated body of yours; your half-sickness shows plain in your face and the world loves healthy people. So be healthy—strong—real. That's living. Don't think too long; send 4 cents in stamps to cover mailing of my book, "INTELLIGENCE IN PHYSICAL CULTURE," written by the strongest physical culture instructor in the world.

**LIONEL STRONGFORT**  
2528 Hancock Avenue, Jersey City Heights, N. J.



## Put Your Body in Tune

The Flynn System of Health Culture makes you clear-eyed, erect, vigorous, ambitious, buoyant, vibrant. It vitalizes and energizes every organ; develops a reserve force of body, brain and nerve—puts your whole being in tune. A rational and simple system that brings you health and gives vigor, happiness and success.

For thirty-six years I have taught this system from lecture platform and in class, teaching a yearly average of 287,000 persons. My correspondence course enlarges the work and makes it more effective. Cost small, no extra to buy; investment returned many times a year in savings and increased efficiency. For men and women. Write for free literature.

**W. EARL FLYNN Dept. 16, Lincoln, Nebraska**



## Repair Tires—Make Money

Many Men are Making \$60 or More a Week

No experience needed. We teach you everything free. Every car owner in your town is a possible customer. Tires blow out every day. Jobs are plentiful—always. The money will come rolling in fast. There's no stopping it once you are known as a tire repair man.

## SHALER Vulcanizing Outfits

Anyone with ordinary intelligence can make a perfect repair the first time. Shaler Vulcanizers are the standard everywhere. Instructions are easily understood.

**Send No Money** Investigate this now before some other wide-awake fellow gets ahead of you. Don't send a penny! Get all the particulars first and find out how the big money is made. Write today—at once. Don't delay—the automobile season will open up big. Tire repairs will soon be needed every hour of the day. Write at once. Learn the facts about this immensely profitable business.

**C. A. SHALER CO., 1500 Fourth Street, Waupun, Wis.**





## Make It of Steel Tubing

IF YOU design, build, or improve metal products of any kind, investigate the merits of Stanweld Steel Tubing.

Stanweld Steel Tubing is made of the finest steel procurable for the purpose. It is exceptionally strong. It is very light in weight. And, it has the finest finishing-surface known to steel tubing.



# STANWELD TUBING

### Made of STANWELD TUBING

Automobile Parts  
Motorcycle Parts  
Bicycle Parts  
Metal Furniture  
Machine Tools  
Typewriters  
Telephones  
Cash Registers  
Gas Engine Parts

### Made of STANWELD TUBING

Lamps, Clocks  
Toys, Models  
Railings, Handles  
Vacuum Cleaners  
Sewing Machines  
Pneumatic Tools  
Strap Hangers  
Sword Scabbards  
Gravity Carriers

Stanweld Steel Tubing has replaced copper and brass tubing and expensive machined parts in the manufacture of thousands of mechanical specialties—adding to the quality, and reducing the cost.

It is used extensively by the world's largest maker of motor cars; by the world's largest manufacturer of motorcycles; and by the world's largest producer of bicycles.

It can be furnished in straight lengths of from one to a million feet. Or, we can develop from your ideas, suggestions, or drawings, special tube parts that will exactly meet your requirements. No order is too big—no job too difficult.

Our service-department will gladly answer questions regarding the use of steel tubing for any purpose. Manufacturers building new products, or improving old ones—inventors designing new equipment, or building models, will find this service-department of real assistance.

*For information and catalogs, address*

## The Standard Welding Company

"World's Largest Producers of Bent Tube Parts"  
Detroit Avenue CLEVELAND, O.

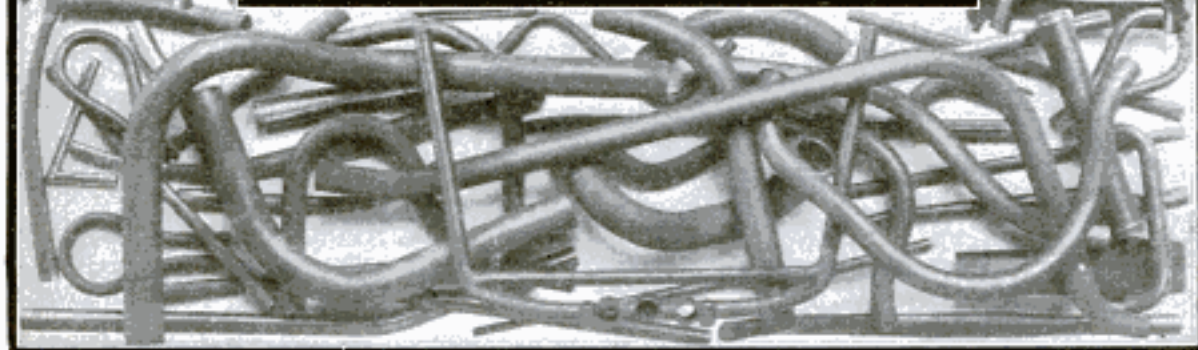

## An Appeal to Americans

By

## The Commission for Relief in Belgium

### Sole Clearing House for All Belgium Relief

We, as Americans, are enlisted for the war to save seven million men, women and children. It is the greatest commissary undertaking in the history of the world, and in the lexicon of America there is no such word as fail.

### **We Need Food Supplies as Well as Cash**

*Every penny donated to this commission goes, without reserve, for the purchase of food. Money donated will be credited to your state, and, whenever it can be done advantageously, spent within the borders of your state. We pay the freight from a special fund donated to organization and transportation.*

Railroads, express companies, postoffice, governors and state committees are aiding. Our Flotilla of Mercy, comprising thirty-five chartered ships, is constantly carrying food. **But—Our Supplies Are Far Too Short!**

**Has Your State Sent a Ship to Belgium? Is It Planning to Send One?**

*Is there a committee for Belgium relief in your community?  
If there is none, start one under our official sanction.*

**Are You Helping? If Not, Send in Your Name Now!**

*Make out your check or money order, or send cash either to your state committee co-operating with this Commission or to the New York Headquarters:*

## The Commission for Relief in Belgium

71 Broadway, New York, N. Y.

Checks to the Woman's Section should be made out to  
Miss Anne Morgan, Treasurer, No. 1 Madison Avenue, New York.

### The Commission for Relief in Belgium

American Commission for Relief in Belgium  
Spanish Commission for Relief in Belgium

#### Honorary Chairmen

His Excellency Walter Hines Page  
*The American Ambassador in London*  
His Excellency James Gerard  
*The American Ambassador in Berlin*  
His Excellency William C. Sharp  
*The American Ambassador in Paris*

Senior Don Alfonso Merry Del Val Y Zulueta  
*The Spanish Ambassador in London*

His Excellency Le Marquis De Villakobar  
*The Spanish Minister in Brussels*  
His Excellency Brand Whitlock  
*The American Minister in Brussels*  
His Excellency Henry Van Dyke  
*The American Minister in The Hague*

Auditors and Accountants  
Deloitte, Plender, Griffiths & Co.,  
New York and London

Italian Commission for Relief in Belgium  
Comité National de Secours et D'Alimentation

Executive Officer—London  
Herbert Hoover, Chairman

Executive Officers—New York  
Lindon W. Bates, *Vice-Chairman*  
Robert D. McCarter, *Hon. Secretary*

The Woman's Section  
No. 1 Madison Avenue, New York  
Mrs. Lindon Bates, *Chairman*  
Miss Anne Morgan, *Treasurer*

Mrs. August Belmont Mrs. William K. Vanderbilt  
Mrs. Edward R. Hewitt Miss Maude Wetmore  
Miss Mary Parsons Miss Grace Parker, *Secretary*

Bankers  
Guaranty Trust Co.,  
140 Broadway, New York



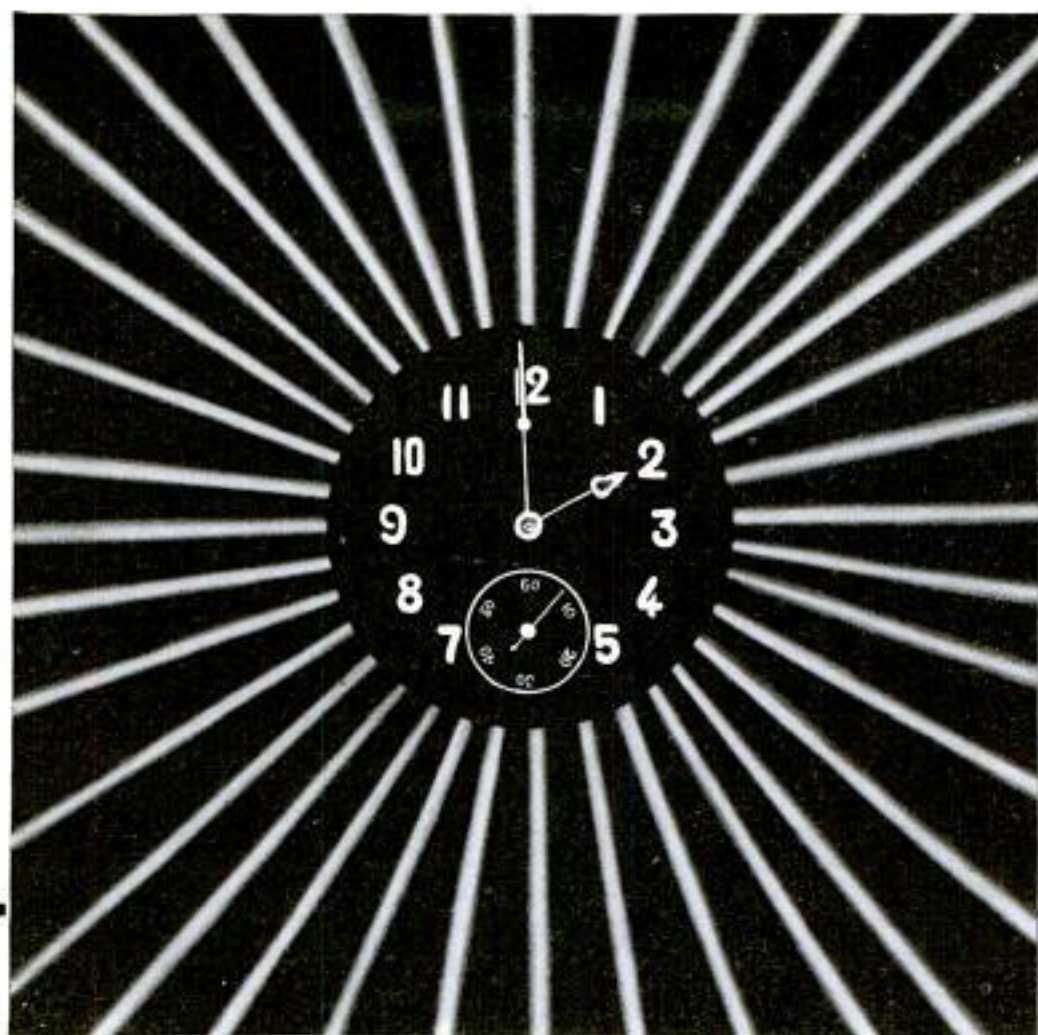

# Startling New Ideas in Watches

**S**END for watch catalog describing, among others, the new radium dials that shine at night—the remarkable discovery enabling you to read time plainly in pitch darkness! The new catalog shows many other novel ideas in Burlington watches. The newest ribbon and enamel monogram designs—exquisite new ideas—your own initials in colors on a rich gold background. Send the coupon today.

**On Approval:** The new radium dial Burlington or any other Burlington, with your own monogram engraved on the superb gold strata case will be sent to you *on approval*, prepaid, without a cent in advance. You risk absolutely nothing—you pay nothing—not one cent, unless you want *this exceptional offer* after seeing and thoroughly inspecting the watch.

**If**—after examination—you decide to keep it, pay only the **direct** rock-bottom price—the same price that **even the wholesale jeweler** must pay. And in order to encourage everybody to secure this watch now we allow this rock-bottom price, either for cash or \$2.50 a month. Remember—we send this watch **on approval**.



## Send the Coupon for New Watch Book

Learn the inside facts about watch prices and the many superior points of the Burlington over double-priced products. Just send the coupon or a letter or a postal. Don't delay—write—get this great offer while it lasts.

**Burlington Watch Co.**  
19th St. & Marshall Blvd., Dept. 1193  
Chicago, Ill.

**Burlington Watch Co.**  
19th St. & Marshall Blvd., Dept. 1193  
Chicago, Ill.

Please send me (without obligations and prepaid) your free book on watches with full explanation of your cash or \$2.50 a month offer on the Burlington Watches.

Name .....

Address .....



## Smith & Wesson Automatic

*Doubly safe*

Accurate and Strong,  
as are all

## Smith & Wesson's

Get your Dealer to show  
you the special features  
of the S & W Automatic

*Booklet on request*



**SMITH & WESSON**  
814 Stockbridge St.  
SPRINGFIELD, MASS.

*Every Smith & Wesson is the Best of its kind*

## Startling Steel Shingle Prices !!!

War has knocked prices flying. Renew that roof now — make it steel-proof against rot, rust, fire, water and after-expense. Do it with Edwards Steel Shingles. Cheaper and better than wood. Easier to apply. Last five times as long. Edwards patented "Tightcote" process makes roof weather-proof and trouble-proof. Patented Interlocking Device makes roof covering virtually one-piece.

## Edwards STEEL Shingles

Dipped in molten zinc **after** they are cut. No raw edges to rot. Come in big handy clusters of 100 or more. Applied ten times faster than wood shingles. Hammer and nails are the only tools you need. No **after** trouble or expense. Forget you have a roof.

### Free Insurance Against Lightning Loss

135,000 Edwards users are protected against lightning loss under a \$10,000 Guarantee Bond. This offer holds good to you. But act **NOW** on this war-time offer. Prices may jump any day. This is a factory-to-

you proposition. You save every way. Write for Prices and Catalog 350 NOW. Give us dimensions of roof, if possible. We help you buy. We also make steel roofs for every kind of building. Write now — right now!

**The Edwards Manufacturing Company**  
300-350 Lock Street  
CINCINNATI, OHIO



## Like a clean china dish



Superb Porcelain Lined—the delight of every woman's heart—the pride of every housekeeper. Here's that famous refrigerator with the seamless, scratchless, germ-proof lining, the genuine

## Leonard Cleanable

Don't confuse this wonderful one-piece lining with paint or enamel. I will mail you—free—a sample of Leonard Porcelain that will quickly show you the difference. **You can't scratch it even with a knife.** It's everlasting—easily kept beautifully sweet and clean. You'll never be satisfied with anything else. Can be arranged for outside icing and water cooling. Style shown is No. 4 in polished oak case. Size 35x21x45. **\$35.00**

**50 Styles, \$15.00 up; Freight Paid**

to Ohio and Mississippi Rivers. I take the risk; send for catalog today. Money returned if you are not perfectly satisfied. Ask for sample of porcelain and I'll mail my booklet, "Care of Refrigerators." Every woman should have a copy of this valuable book.

**C. H. LEONARD, President**

**Grand Rapids Refrigerator Company**  
157 Clyde Park Ave., Grand Rapids, Mich. (1)

## Go In Business With Me

### Big Money at Once

I want to set you up in business that means personal independence; guarantees better than an average living and a sure return for every honest effort. I have put the best 14 years of my life into this business, and now I am ready to give the benefit of my experience, and coach you straight to success.

### Ann Arbor Lamps

solve the problem of small town and farm house lighting; give the most light for the least money — 100 candle power lamp costs one cent for three hours' light.

They sell on sight — W. H. Phillips, Painesville, O., says, "I sold and collected for 26 lamps out of 27 trials in 4 days. They sell themselves."

The farmer has the money and needs better lights than the old-fashioned kerosene oil lamps. This is your opportunity. — Write me the very next thing you do — it will be the most important step you ever took. No matter what you think of your ability to sell goods — my me plan is fail-safe.



**H. H. SEELEY**

President SUPERIOR MFG. COMPANY  
294 Second St. ANN ARBOR, MICH.



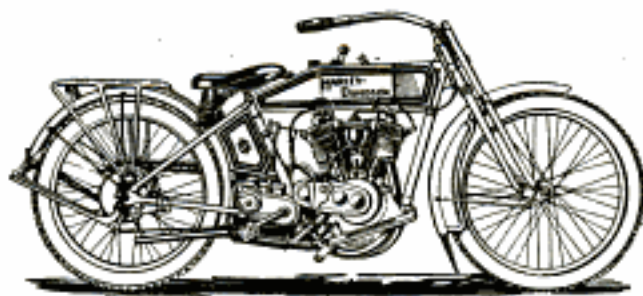

# The 1915 Harley-Davidson

*with sidecar and extra passenger  
going up a 40 per cent grade*

**T**HE 1915 Harley-Davidson three-speed twin is the logical sidecar machine. The eleven horsepower motor (horsepower guaranteed) together with the three-speeds supply sufficient power to carry rider, sidecar and passenger anywhere on a public highway.

When used in conjunction with a Harley-Davidson sidecar with adjustable tread (44 to 56 inches) it becomes an all the year round machine. It will easily negotiate sand, snow and mud, that is impassable for the ordinary automobile. Such an outfit is ideal for country use. It provides pleasure for the family at a small fraction of the operating or up-keep cost of other popular methods of travel.

The 1915 Harley-Davidson is a masterpiece mechanically. The three-

speed transmission is so well designed and the gears so perfectly made that they are absolutely noiseless when in operation. In fact nearly everyone of the ninety-eight improvements and refinements are mechanical superiorities.

These improvements, as well as the complete details of the 1915 Harley-Davidson models are described in the catalog which may be obtained of any Harley-Davidson dealer or will be sent on request.

## More Dealers for 1915

Additions to the Harley-Davidson factories enable us to add more dealers for 1915. If, as a dealer, you are situated in a locality where we are not represented and feel qualified to represent the Harley-Davidson in keeping with the Harley-Davidson name and reputation, get in touch with us at once.

**Harley-Davidson Motor Co.,** 409-B STREET  
MILWAUKEE, WIS.  
Producers of High Grade Motorcycles for Nearly Fourteen Years.

**Small Enough**  
For Your Coat Pocket  
**Big Enough**  
For Almost Any Boring Job

Here is the acme of compactness and efficiency in a boring tool. A time and labor saver practically indispensable in the shop and about the home.

**MILLERS FALLS**  
**STAR AUTOMATIC BORER No. 8**

Length when extended 7¼ inches. When compressed 4⅞ inches. Magazine handle contains 8 drill points, ranging from ⅛ to ⅜ inches in diameter and an extra screw driver bit. Each bit is released from magazine through small opening at the top without disturbing the others. The screw driver bit is used when tool is compressed. Powerful chuck grips firmly and centers with absolute accuracy. See this tool at your dealer's. A genuine Millers Falls quality product.

**Other Millers Falls Tools**  
**You Should Examine**

Ask your dealer to show you Millers Falls Hand Drill 306; Bit Brace 732; and Hook Saw Gauge 53. Send for handy pocket catalog describing complete line.

**MILLERS FALLS CO.**  
Millers Falls, Mass.

**MILLERS FALLS**  
**TOOLS**



Send for  
**Style Book**  
and 64 Samples  
**FREE**

THE man who reads this ad and does not sit down and send for our big new Style Book and 64 samples of Spring and Summer fabrics, is simply refusing \$6.50 which we guarantee to save him on his next suit.

Our catalog is our only salesman. Because we sell entirely by mail we eliminate representatives and commission men, and are able to deliver the smartest New York tailoring in a positive

**\$20 Suit \$13<sup>50</sup>**

Made to Measure for

We guarantee to fit you perfectly and give you satisfaction in every respect—otherwise you need not accept the clothes.

Write for catalog and samples to-night. You have nothing to lose and a great deal to save.

**BELL TAILORS of NEW YORK**  
130-132 Walker St. NEW YORK



**The Self-Starting Dollar**

A great new important economic thrift development, a club that embodies the principle of concentrated purchasing, obtaining goods for its members at wholesale prices; large savings; furniture, house furnishings, clothing, books, sporting goods, row boat motors, engines, automobile supplies, automatic water heaters, gas ranges, gas heaters, fixtures and appliances, vacuum cleaners, motors, generators, batteries, wireless and electrical goods of every description; wood and metal patterns, washing machines, filters, plumbing supplies, typewriters, violins, musical instruments, cameras, tools, motorcycles, bicycles, watches, jewelry, diamonds, etc.; all at lowest net cost; you can join this big efficiency movement with unlimited dollar saving possibilities, in best quality goods, buying at less than your retailer, NOW, at special rate of \$1.00 for limited time until membership is filled. Write us for quotation on your needs; remit club fee (\$1.00) by check, money order or registered letter, to

**UNITED STATES CONSUMERS THRIFT CLUB**  
123 West Madison Street CHICAGO

(The Great Central Market)

Please Mention Popular Mechanics

# Heat Bill Only \$20<sup>25</sup> For 10 Rooms



## 1/2 to 2/3 Saving Guaranteed

**H**ERE'S a big house in cold Illinois. 10 rooms, exposed on all sides. The kind that's usually hard to heat. Yet read the letter. We have thousands of others like it from Underfeed users telling of warmer, cozier homes, and a saving in fuel bills of from *one-half to two-thirds*.

Carbondale, Ill., March 11, 1914.

Gentlemen: I have used one of your Underfeeds three winters and am highly pleased with it. From the day my furnace was installed in October to the 20th day of March my coal bill was \$20.25. I have a ten-room residence and the entire building was heated all thru the winter. We are not bothered with dust, gas nor smoke.

Yours truly, (Signed) W. J. BROWN

And 30,000 other Underfeed users are equally enthusiastic over the greatly reduced fuel expense; the better, cleaner heat; the small amount of care and attention required.

**WILLIAMSON** CUT  
NEW-FEED COAL  
**UNDERFEED** BILLS  
Furnaces and Boilers 1/2 to 2/3



**Cut-Out View  
of Furnace**

Showing how live coals are always on top. This is the candle principle. A candle gives a clean, smokeless flame only when flame is at top. Turn a lighted candle upside down and see the difference.

In the Williamson Underfeed, the live body of fire is always on top in direct contact with the most effective radiating surfaces. Coal is fed from below, underneath the fire. No smoke, no gas, no dirt. All these are consumed, giving more heat. Every bit of coal burnt to a clean white ash. Clinkers virtually unknown. And this year sees the Underfeed brought to a still higher degree of perfection in the New-Feed UNDERFEED. No stooping to feed in coal or shake down ashes.

### Burns Any Size of Coal

No special coal is prescribed for the Williamson New-Feed UNDERFEED. Any size can be used successfully. Cheap, slack soft coal; and pea or buckwheat hard coal, or larger sizes if desired. It's all the same to the Underfeed. Adapted to warm air, steam or hot water. May be installed in any building new or old, or to replace ordinary furnaces, boilers, stoves or grates.

### 50 Per Cent Saving Guaranteed

We guarantee a saving over your present coal bills of at least one-half where the Williamson New-Feed UNDERFEED is properly installed and operated. This guarantee is backed by a \$1,000,000 company. Send the attached coupon today, for our great free book "From Overfed to Underfed" which fully explains just how the New-Feed is operated and how it effects this great saving.

**THE WILLIAMSON HEATER CO.**

(Formerly The Peck-Williamson Co.)

65 FIFTH AVE.

CINCINNATI, O.

**The Williamson Heater Co.**  
65 Fifth Ave., Cincinnati, Ohio

Tell me how to cut my coal bills from 1/2 to 2/3 with a Williamson New-Feed.

Warm Air.....Steam or Hot Water.....  
(Mark an X after system interested in)

NAME .....

ADDRESS.....

My Dealer's Name is.....

DEALERS! Let us tell you about the New-Feed UNDERFEED and our 1915 proposition. Both are winners.

**LEWIS-BUILT HOMES**

SMALL TO YOU  
BIG COST TO THE TRADE

**\$425**  
Buys this Beautiful Lewis-Built Home

*The Madrid*

**-A Price Possible Only by the LEWIS METHOD**

This beautiful bungalow, "The Madrid," is our challenge to the old-style local contractor. It is only one of over a hundred houses shown and priced in our great free book. We supply any house you select complete, saving you money, time, labor and bother with architects, middlemen, lumber dealers and the hosts of other expensive, unnecessary people now displaced by modern efficiency methods.

**Lewis-Built Ready Cut Method** means preparing the house at the mill, sawing and working to fit, then shipping direct to you with only one small profit to pay. Architects working plans furnished. Best grade of lumber obtained, and plaster, hardware, paint, etc., all included.

**Send for the Lewis-Built House Book** containing many original bungalows, cottages, houses of every description, some as low as \$248. Pick out your house—the one you have dreamed of owning some day. Build now, while building is cheap, and a home is within your reach.

LEWIS MFG. CO., Dept. 378, Bay City, Mich.

**Garage \$69.50**

10x12feet "Steelcote" Edwards ready-to-use garage, \$69.50 complete. Factory price. Fireproof. Portable. Quickly set up. All styles and sizes of garages and portable buildings. Send postal for illustrated catalog.

**THE EDWARDS MFG. CO.**  
320-370 Eggleston Ave., Cincinnati, O.

**Rex Visible**

**A Brand New REX Visible \$2.50**

**Only \$2.50** brings you this brand new highest-grade latest improved model REX VISIBLE—the new typewriter sensation. A stupendous value—positively \$100 quality for only \$29.50—on easy monthly payments, a few cents a day. The final perfect typewriter. Guaranteed for 10 years. You save \$41.50 on our great offer. *Delivered on 5 days' free trial by our dealer in your town or direct from factory.*

**Write for Free Catalog** No obligations. Write today for our catalog while offer lasts. Send no money. A postal will do.

**Rex Typewriter Co.** 28 E. Jackson Boulevard Dept. 3193 - Chicago

**This Man Wears a "Glen Rock" Suit**

**It's Stylish and Saved Him \$8**

You, too, can have the most stylish spring suit made and save \$8 in the bargain if you order your suit (or light-weight overcoat) by the "Glen Rock" plan.

Here's the plan. We send you our 1915 STYLE BOOK showing 20 large size illustrations of latest spring styles and 40 popular cloth patterns. You pick out the style and cloth that suits your fancy best. Fill out the order blank. A few days later we send you the suit perfectly made and perfectly tailored in every respect.

Every "Glen Rock" suit must fit to your satisfaction or we give you back your money quick.

A safe and easy plan to get a new suit and still save \$8. Thousands of regular customers prove the merit and saving power of our plan. Legal guarantee protects you absolutely.

**\$10 SPRING SUITS \$22 FREE!**

**1915 Spring Style Book**

You surely ought to have a copy of this authoritative Style Book. Send us a postal today.

**Glen Rock Woolen Co.**  
219 Main St., Somerville, N. J.



**KEITH'S ON HOME BUILDING**

20 Cents Copy—Newsstands. (Established 15 Years)  
A beautifully illustrated 80-page monthly magazine devoted to building, decorating and furnishing artistic homes at moderate cost. In each issue are 8 New House Plans by leading architects. Subscription \$2.



**Big \$1.00 Offer**

Six Big Building Numbers of Keith's showing 50 Unique Home Plans, and my Book, "100 Artistic Homes," making a total of 150 Plans, all for \$1.

Any \$1 Plan Book with Keith's 12 Months for \$2

125 Bungalow Plans . . . . . \$1	175 Homes catg. below \$6,000 \$1
104 Cottage . . . . . \$1	125 " " over \$6,000 \$1
125 Homes catg. below \$4,000 . . . \$1	100 " " cement and brick \$1
175 " " \$5,000 . . . \$1	50 Garage and 40 Duplexes \$1

**M. L. KEITH, 724 McKnight Bldg., MINNEAPOLIS, MINN.**

**AMUSEMENT MEN, HERE'S THE WINNER!**



The very latest and most novel amusement attraction for Parks, Resorts, Carnivals, etc.  
**A BIG Money Maker.**

**THE CIRCLING WAVE GETS THE CROWD**

and keeps them spending their nickels. The most successful fun and profit-maker ever invented. Some operators have made **\$400 in ONE day**. Moves up-to-date and costs 50 per cent less than the old-fashioned Carousel. Easily moved in two wagons. Operated by one man with gasoline or kerosene motor. Can be erected in four hours. Seats 80 people. Price includes complete machine with gasoline motor and either piano or organ. Write for details—a postal will do.

**ARMITAGE & GUINN, Mill St., SPRINGVILLE, N. Y.**

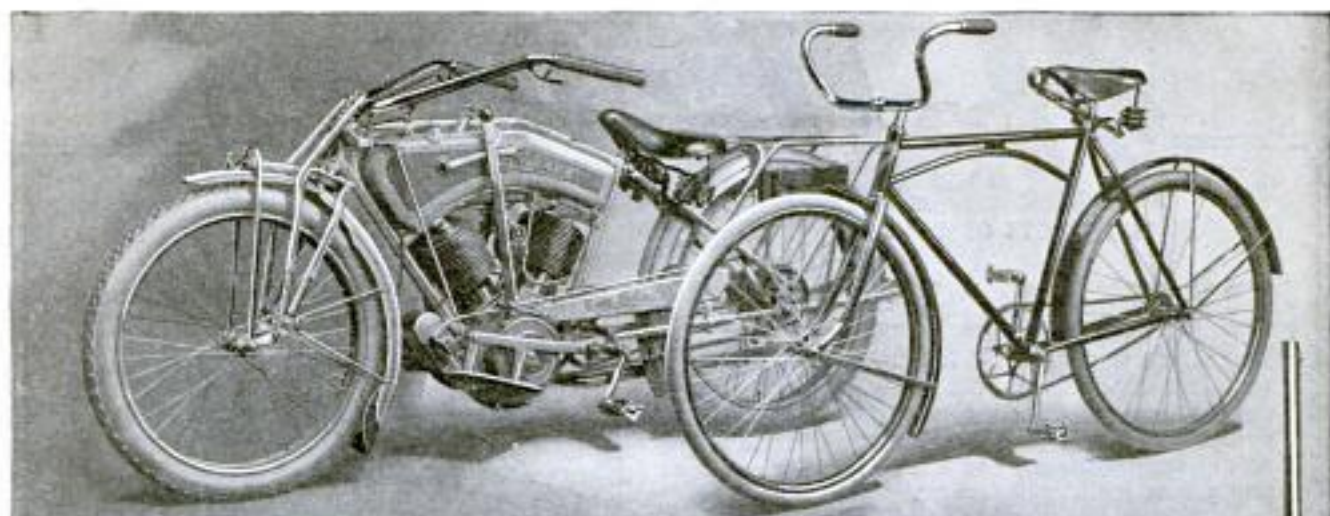

# IVER JOHNSON

## Mechanically Perfect!

The chief reason Iver Johnson Revolvers, Shotguns, Bicycles and Motorcycles are known all over the world for their splendid service is because of the matchless quality of the machine work that goes into our goods.

It would be difficult to construct an instrument of greater precision than the Iver Johnson Revolver. It is perfect in operation and absolutely safe even in the hands of a novice. You can Hammer the Hammer. Note different models below. Prices \$6 to \$8.50. Learn to shoot an Iver Johnson.

Iver Johnson Shotguns are made in Single-barrel and in Double-barrel Hammerless.

Iver Johnson's Bicycles rank as America's leading bicycles. Most racing men ride them. They are fast, durable and beautifully finished. \$25 to \$60.

The Iver Johnson Motorcycle is conceded by engineers to be the most scientifically designed and the most superbly built machine ever produced.

Send for our 84-page book on Bicycles, Motorcycles, Revolvers and Shotguns—single and double-barreled.

This book is bound in stiff board covers and gives all the information anyone needs to know to buy a cycle or firearm intelligently.

It's a costly book, but we want everyone who is interested to have a copy—so it is free.

**IVER JOHNSON'S ARMS  
& CYCLE WORKS**  
307 River Street  
Fitchburg, Mass.

99 Chambers St.  
New York  
717 Market St.  
San Francisco

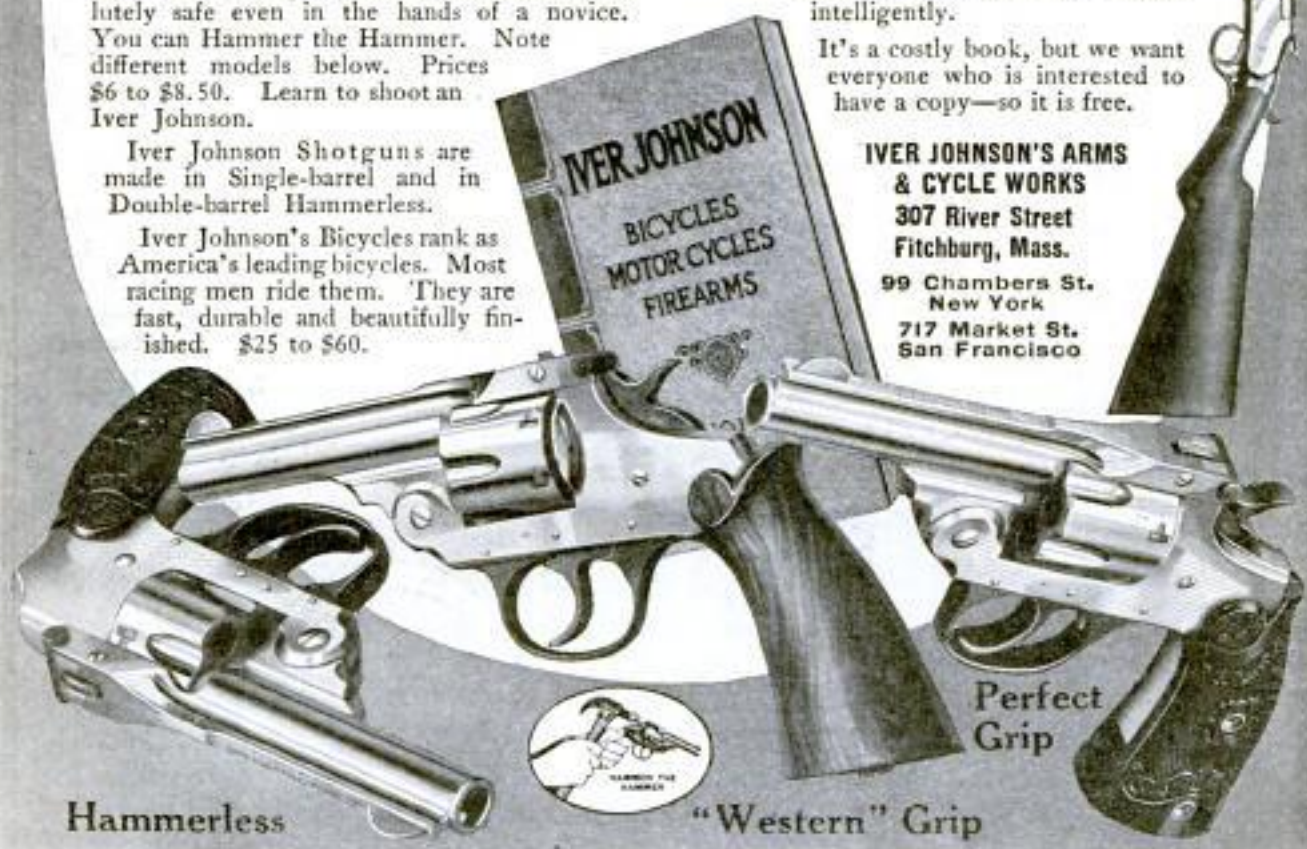

Hammerless

"Western" Grip

Perfect  
Grip

Please Mention Popular Mechanics

# Hello Boys!

MAKE LOTS OF TOYS

## BUILD NEW MODELS AND WIN

I want you boys to build for me the biggest, best and most original Models produced for any construction toy. I am willing to dip deep into my pocket to pay you to make a big effort.

**THINK OF IT!—300 PRIZES!**  
Worth \$3,000

Try hard for the Auto—but if you don't win *that*, there are 299 other prizes. Motor Cycles, Bicycles, Camp Outfit, Tents, Canoe, Camera, Skates, Air Rifles, \$25, \$15, \$10, \$7.50, \$5.00 and \$3.00 Erector sets, etc. I want these models to use in showing other boys what can be built.



# PRIZES

BRAND NEW

# AUTO IS ONE

## ERECTOR

(The Toy with Girders like Structural Steel)

You do not have to buy Erector to compete. We cannot tell the full story here. I have prepared a big, special folder full of pictures. Ask your toy dealer for free copy. It gives all details about the auto: its name, specifications, etc.; also illustrates and describes minutely all prizes.

**FREE FOLDER** If your toy dealer has no folders write me his name and I will supply you. He sells Erector in sets running from \$1 to \$25. There's an electric motor in all sets at \$5 and over. Yours for a dandy good time, A. C. GILBERT, PRESIDENT.

**THE MYSTO MFG. CO., 253 Foote St., NEW HAVEN, CONN.**

Send  
now  
for  
this  
Big  
New  
Folder



Tells  
Whole  
Story  
It costs  
Nothing  
to enter  
contest

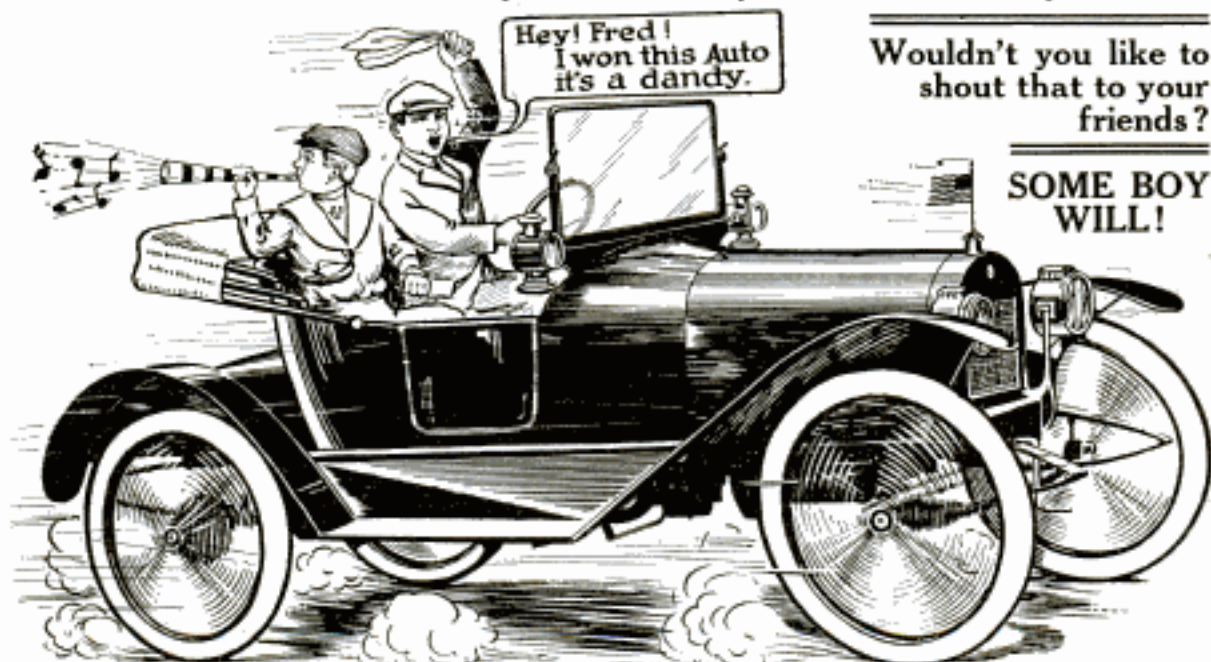

Wouldn't you like to  
shout that to your  
friends?

**SOME BOY  
WILL!**



# A Reasonable Cash Payment and 38 Cents per Day Buys this Beautiful Sterling Bungalow

## Cheaper than Paying Rent

Not satisfied with making absolutely the **finest Homes ever designed** or with selling at **LOWEST PRICES**, we now offer American Home Builders an Opportunity to buy on **simple, easy, monthly payments**—payments which, in all probability, are actually **LESS than your monthly rent!**

Never before has such an Astounding Offer appeared in print. It marks a **new era** in Home Building. Thousands, who otherwise would not be in position to build for **several years** can be living in their new homes before the first of next May.

## The Famous Sterling "Two-Years-To-Pay" Plan

For example, suppose you chose the "Miracle"—the handsome Bungalow here pictured—you make a reasonable cash payment, we ship you your Home and you pay the balance in monthly installments of \$11.51, or—38c per day.

Suppose you want the "Martindale"—the charming 5-Room Cottage pictured below—small cash payment—then only \$5.20 per month or 17c per day. No matter

what size or style Home you want, you will find it in the latest Sterling Home Builders Book. **And you can buy it on our "Two-Years-To-Pay" Plan—easy, monthly payments!**



**THE "MIRACLE"**

One of the most remarkable Homes ever designed—Living room and Dining Room—two large bedrooms—bath—model, work-saving kitchen. Fine Porch—all complete. Can be erected in 12 to 14 days.  
**\$414 down, balance, \$11.51 per month. Total Cost \$691**

## As To Price, Quality and Design

Sterling designs are **matchless**. Sterling Materials are the **finest**. Sterling prices are **unbeatable**. **OUR CATALOG WILL PROVE IT TO YOU BEYOND QUESTION.** The price includes—all materials from the ground up—lumber, hardware, plaster, paint—down to the last nail.

And your lumber comes all **MEASURED AND CUT-TO-FIT**. That saves you two-thirds the usual carpenter expense. And your Home will be finished in a few weeks. Sterling Homes are **permanent, not** in any sense portable. Made in a factory which last season built 20 Homes per day.

Prices, \$300 to \$3000. Sold on easy monthly payments so low that—well, send for the **Sterling Book** and get the whole story. See the new Sterling Designs—large photographs—floor plans and diagrams—beautiful interiors—list of materials furnished—and all about our new "Two-Years-To-Pay" Plan which makes it easier to own a Home than pay rent.

Postal Mailed Now Brings Book by Return Mail

**INTERNATIONAL MILL & TIMBER COMPANY**

Dept. Q-3

Bay City, Michigan

Be sure to address Dept. Q-3



**18c PER DAY**

**THE "MARTINDALE"**—This handsome, 5-room Cottage can be erected in 7 to 9 days. Price and terms: \$187.00 down and \$5.20 per month. Total cost, \$312.00.

Please Mention Popular Mechanics

# Krupp Gun Designer Will Teach You Drafting



Chief Draftsman Dobe, formerly with Krupp Gun Works, Essen, Germany

**T**HE draftsmen who design the great German Krupp guns are known all over the world as leading experts of the profession. The Krupp Company puts them to the most severe tests and very few men can qualify. I am proud to say that I passed the examinations and for several years held the position of designer with this wonderful world-renowned works.

I am now Chief Draftsman of a large and well-known company. In my spare time I will train a few ambitious men in practical drafting and designing. I will give you the practical training that I have found to be essential to success—the kind of training that the big companies demand—and I will continue this training just so long as you need it—until you are satisfactorily filling a position as a regular draftsman. You learn in your own home—during your spare time.

## Men Are Needed

There is an urgent demand for skilled draftsmen.

Positions paying \$125 to \$175 are open this very minute, and employers are looking for men who have had practical training. This is the kind of training I will give you, and that kind of working training will qualify you for the highest salary. Send the coupon and I will tell you about the big things other men are doing whom I trained personally. Here is an opportunity that come to but few.

This illustration will give you some idea of how complex the work of Krupp Draftsmen really is. One of the expert Krupp Draftsmen will teach you Drafting in your own home during your spare time. Send the coupon for full particulars of special limited offer.



SIZE 20x25 INCH

**\$15.00 Outfit FREE**

Yes, I will give you a complete set of regular Draftsman's instruments absolutely free. They are just the kind of instruments the Krupp expert draftsmen use. You could not buy them for less than \$15. But I know that good draftsmen must have good tools. And any man who gets my personal training is going to have the knowledge that makes him capable of holding one of the high-salaried positions.

## Send the Coupon for Big New Book

Put your name and address on the coupon or on a letter or a post card and send it to me now. I'll send you, free and prepaid, the new book, "Successful Draftsmanship" that tells you about the golden opportunities that await the men who join our profession. Absolutely no obligations of any kind. I'll tell you how the former Krupp Gun designer will give you the practical training that will make you a high-salaried draftsman right in your own home. Send the coupon now—immediately—it's the first step up the ladder of success.

Chief Draftsman, Dobe  
Div. 9193  
Engineer's Equipment  
Company  
Chicago, Ill.

**Chief Draftsman, Dobe**  
Engineer's Equipment Co.  
Div. 9193 Chicago, Ill.



Without any obligation to me whatever, please mail your book "Successful Draftsmanship" and full particulars of your liberal "Personal Instruction" offer to a few students. It is understood that I am obligated in no way whatever

Name .....

Address .....

Please Mention Popular Mechanics

# THE MARVELOUS STEWART ENGINES



**Stewart Little Major**  
1/2 horse power with battery  
\$7.50; with high tension  
magneto \$37.50.

**1/2, 2 and 3 1/2 horse power, only**

You can buy a poor and cheap watch or you can pay a little more and get a good one and the satisfaction you get with the good one will more than repay you every day you use it. It's the same with engines—you can buy bulk and weight at a price, but real quality engines at a little more in price means so much more in the satisfaction you get out of them that it is worth while.

**Stewart Quality Engines**  
*Consist of only those shown here*

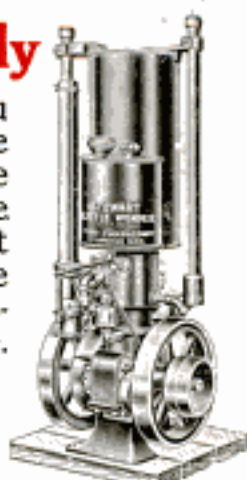

**Stewart Little Wonder**  
2 horse power water  
cooled, with battery  
\$50.00; with high tension  
magneto \$60.00.

Stewart Little Major is the simplest, sturdiest, most practical 1/2 horse power engine made. It will do anything that 1/2 horse power can do. Just the thing to run a hand or foot press, washing

machine, ice cream freezer, emery wheel, grindstone, small dynamo, churn, cream separator, pump, saw, feed mill, lathe, horse clipping machine, sheep shearing machine, polishing and buffing wheels, etc. Half a gallon of gasoline runs it for full 10 hour day. Beautifully made and beautifully finished. Get one to run your hand operated machine. It will pay you big.



**Stewart Little Wonder**  
2 horse power, air cooled,  
with battery \$45.00; with  
high tension magneto  
\$50.00.

**Stewart 2 and 3 1/2 horse power engines**  
**operate on gas, gasoline or kerosene**

If you want a real quality engine that will stand up and deliver the goods year after year, place your order now to insure early delivery. Send \$5.00 with order and pay balance when you get the engine. Money back always if not satisfactory, that's the real guarantee.

*Write for 1915 catalogue*

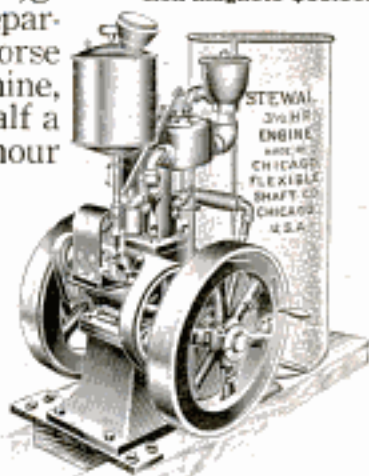

**Stewart**  
3 1/2 horse power engine with high  
tension magneto \$125.00.

**HAVE YOU A HANDY WORKER?**

Price, complete, as shown, with all attachments, \$12.50 Weight, boxed, 100 pounds  
Size of box, 27" x 13 1/2" x 9"

A unique tool that will quickly pay for itself around any home. Strong and durably built—powerful and efficient in operation. If you have not already secured one, send your order today. Send \$3 and pay balance when you get it.

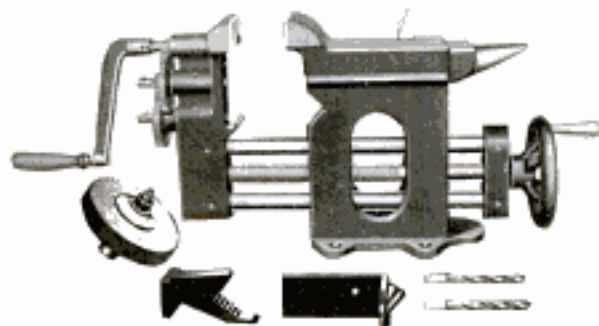

**It Comprises:**  
A strong and powerful vise, up to 4 1/4 inches. Width of jaw, 4 inches. Cutting hardy. Pipe vise takes up to inch and a half pipe. Drill Press which may be operated at two speeds. Anvil. Carborundum grinding wheel, 5 inches x 1 inch. Speed ratios are: direct, 4 to 1 and 16 to 1.

Every automobile owner, every farmer, small shop, garage, etc., will find this compact and practical tool a big dividend payer. You have a dozen uses for it every day of the year. It will pay for itself in no time and is practically everlasting.

The gears where crank-handle attaches are cut from the solid steel bar and permit of three speeds.

The entire tool and attachments are of first quality through-

out. No other tool ever offered at anywhere near this price has the same superior quality and workmanship.

Can be easily and quickly attached to bench or table. Buffing wheel, scratch brush, small circular saw, etc., can be used where grinding wheel attaches.

This tool can be used to advantage hundreds of times every year around any home or small shop. It is the ideal handy worker. You need it. Order one today.

**CHICAGO FLEXIBLE SHAFT COMPANY, 105 N. La Salle St., Chicago**

White Cross  
Electric  
Stove

Guaranteed  
for 5 years

Made of pressed  
steel  
Highly nichel  
plated

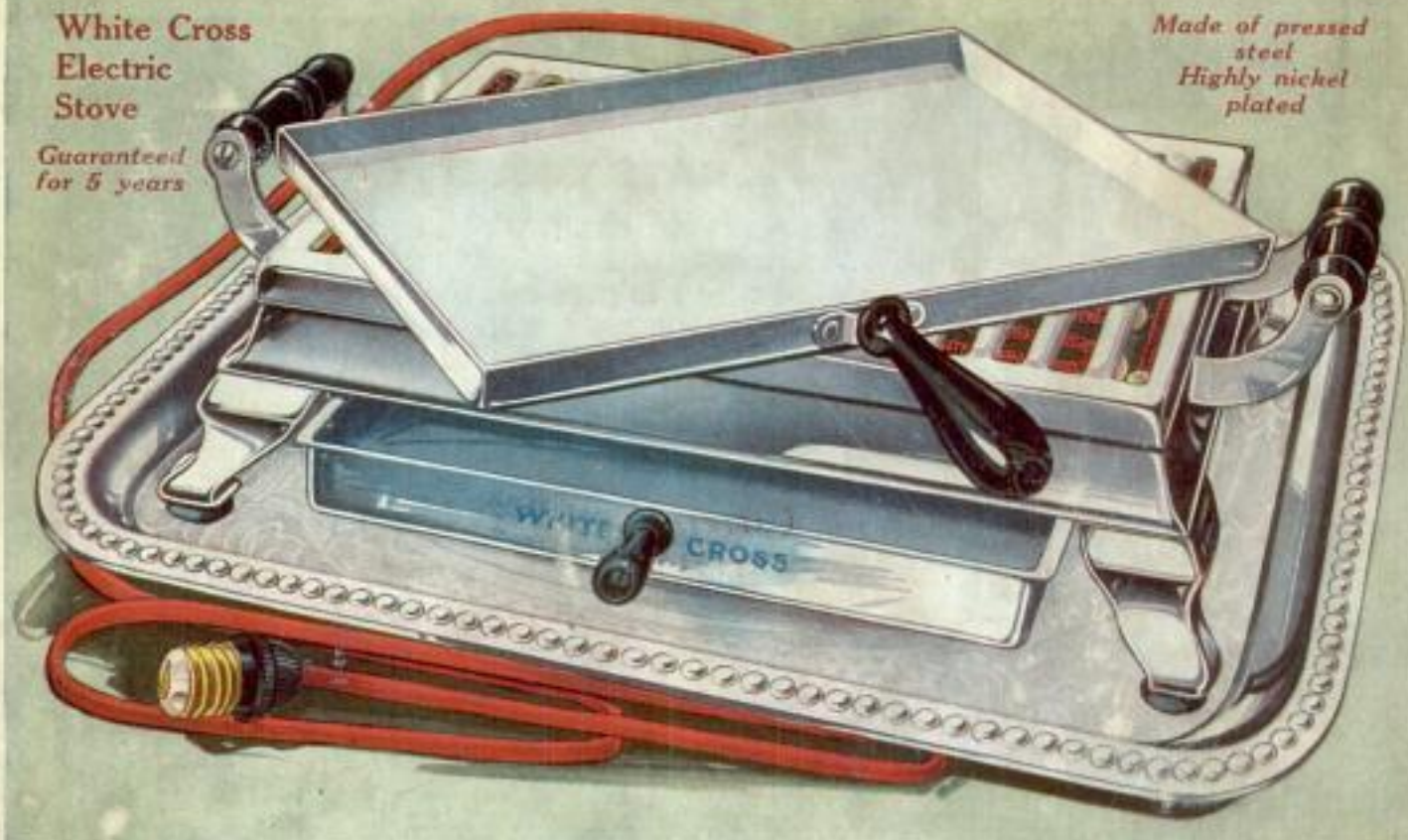

# Electric Stove \$4.50

Toasting, Frying, Broiling, Tea-Making, Chafing Dish, Boiling

After Free  
Examination

Here at last is a simple electric stove which will do almost any kind of cooking. It is inexpensive to buy—costs but little to run, may be operated on a table, in buffet, dining room or living room. Light enough to be carried about. Run with no more effort than turning on an electric light. If your dealer does not carry it we will send you the new White Cross Electric Stove *prepaid*, so that you may see it for yourself. If, after examining, you wish to purchase you may do so. The price is only \$4.50 complete, (West of Rocky Mountains \$5.00.)

We prepay the transportation charges on every stove. There is nothing for you to pay but the price of the stove, \$4.50, (west of Rocky Mountains \$5.00) and that only after examination. And this money will be returned to you any time within 10 days if you do not wish to keep the stove.

## Try It 10 Days FREE

Take the stove into your home—make the most delicious toast, tea, coffee—fry steaks, eggs, ham—use for chafing dish and do many other things. Give it a thorough test for 10 days and then if you do not wish to keep it, return it to us and we'll refund every cent of your money.

**Send No Money** To get this stove all you need to do is to mail the coupon attached to this announcement. Pay only after the stove arrives and after examination. We prepay expressage.

## Mail This Coupon

If your dealer does not carry White Cross Electric Stoves put your name and address on the coupon and mail to us today. Remember, we do not expect you to send any money. Upon receipt of coupon we will send you the stove *prepaid* for your examination. Then use your own judgment about buying. If you do not think you would like the stove, return at our expense.

**LINDSTROM-SMITH CO.**

Stoves, Electric Fibrolators, Auction Chambers, Fuel Trays, etc.  
1100-1110 S. Wabash Ave., Dept. 1193, Chicago, Illinois  
If you are not ready to send an order now drop a post paid envelope for complete literature on White Cross Stoves, or write for our big new catalog of electrical specialties.



For tea, coffee or the chafing dish. The White Cross Electric Stove will start them cooking in a jiffy. No boiler, no mess. Just turn the switch and the stove starts working.



Use for boiling anything—water, breakfast food, eggs, vegetables; heat baby's milk; use for candy making.



With the White Cross Electric Stove you can fry the eggs and bacon and make toast, all at the same time. If you wish only toast it is large enough to accommodate from four to six pieces.

**Lindstrom-Smith Co.**

1100-1110 S. Wabash Ave.  
Dept. 1193, Chicago

Please send me prepaid, one White Cross Electric Stove, complete with cord ready to be connected. If, after I have seen and examined it, I like the stove, I will pay \$4.50, total price of the stove (west of Rocky Mountains \$5.00). If I use the stove for ten days I may return it if I wish and you will send my money back.

Name .....

Address .....

My Electrical Dealer's Name .....

Mail postal for literature IF you don't want to order now.