

February

15 Cents

POPULAR MECHANICS MAGAZINE

WRITTEN SO YOU CAN UNDERSTAND IT

TRADE MARK

THE SPY AND
HOW HE WORKS

OUR ARMY AND
NAVY FLYING
FORCES

A WIRELESS
HERO



Copyrighted material

— Clothing Office — For Sale No Subscription Se

\$699 BUYS THE MATERIAL To Build This Harris Home

THIS IS OUR WELL KNOWN HARRIS HOME No. 161

Why Pay Rent?

A home is within your reach—no matter how limited your income.

4

Big Lumber Shipping Points

The material to build this or any of the more than a hundred modern Harris Homes in our free \$10,000 Book of Plans, can be shipped "direct to you" from our main lumber yards at Chicago or St. Louis, also from our stocks at Washington and Mississippi for quick delivery and lowest freight expense.

No Money Down Save 1/3 to 1/2

Send Us Your Lumber Bill

We will name you freight pre-paid prices on everything—Lumber, Millwork, Hardware, Plumbing, Heating, etc., that will mean a saving of from 1-3 to 1-2. Upwards of 20,000,000 feet of brand new lumber is in our mammoth stock at all times. We would not dare ship this material without one cent down if we were not certain that you would be pleased.

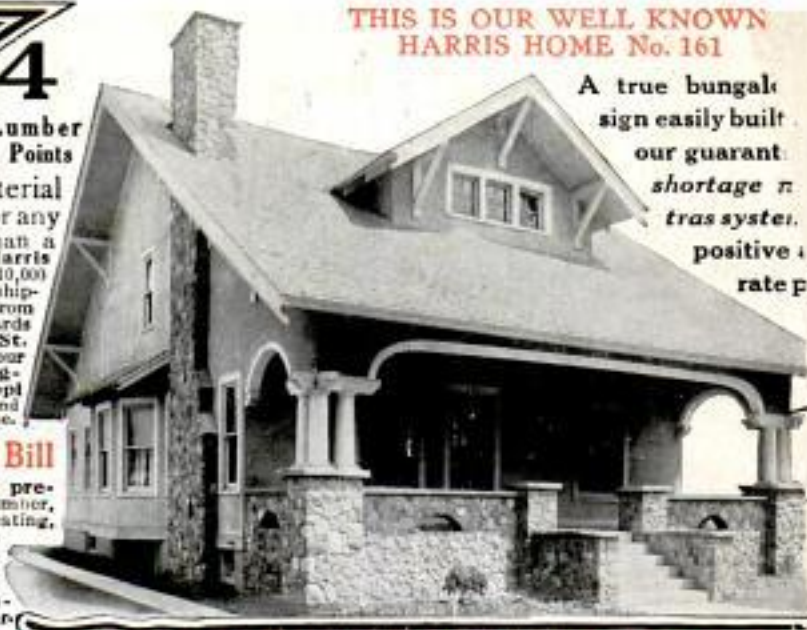

A true bungalow sign easily built—our guaranteed shortage extras system—positive rate p

BUILD THE HOME YOU HAVE BEEN DREAMING OF FOR YEARS—AT THE PRICE YOU OUGHT TO PAY

Our Guarantee Protects You

Greatest of all is this Harris Home Building Plan. A truly wonderful offer—clean and straightforward. This was the first real helpful home building plan. We placed the opening wedge and made it possible for the many thousands of satisfied Harris home owners to realize their dream of years. In dealing with us you reap the benefits of these vital essentials—22 years of expert planning, designing and close study of economy in material and labor. Through all these years we have maintained, with ease, our lead, never finding it necessary to recognize competition. Make us prove this to your satisfaction. It won't cost you a penny to get our offer now—today. Our binding guarantee, backed by every cent of our \$10,000,000 capital stock and surplus, gives you an iron clad protection. You can't possibly go wrong for we take all of the risk.

THE DESIGN The Harris Home No. 161, above, is a perfect combination of comfort, convenience and economy; modern in every respect. Six rooms, bath, large closets, pantry and modern stairway. This is but one of the many splendid designs which can be carefully studied from our Free Plan Book in your own home during your leisure hours. Mail the coupon below for your copy of our Plan Book today.

THE MATERIAL The above price includes all first class lumber, Clear Mission Georgia Pine Interior Trim, Clear Flooring and clear Cedar Shingles. No. 1 Dimension Lumber; up-to-date Hardware. Ready-cut door and window frames, inside door jambs; outside door and window casings. All glass in and back puttied—saves time and labor. All Harris homes are of sound construction and are architecturally correct in every detail.

Mail Coupon Below Today

PLANS FREE We will send you a complete set of blue print plans of above house, such as would cost you from \$25 to \$100 if drawn up by any reputable architect, upon receipt of the coupon below and \$1. We will also include along with the plans, free of charge, Specifications, Material List and a guaranteed delivered price to your station. If you decide to purchase, you will be credited with this remittance of \$1 on your bill. If you see this service is absolutely free. If the plans did not suit and you are not ready to buy, return the coupon and \$1 will be refunded. We also make plans to order after your own ideas—prices way down. Write to

Dept. E-7
Harris Bros. Co.
Send me your Free \$10,000 Plan Book I am also interested in

Plumbing and Heating You can easily install your own heating plant and plumbing material with the assistance of our free expert engineering service. We show you how to eliminate much of the biggest expense. Mail the coupon for your copy of our new plumbing and heating book. Complete bathroom outfits, \$37.50. Enamelled bath-tubs as low as \$13. Warm air heating plants, \$67. Steam heating plants, \$85. Hot water heat, plants, \$95.

Quality Roofing Our new roofing book is full of practical information. Tells you the correct grade and style of material adapted to your particular purpose. Everything explained by diagrams. Biggest values ever offered, in ready roofing, metal roofing, siding, ceilings, etc. Prices represent savings of from 1-3 to 1-2 in every instance. Mail coupon for FREE copy today.

Building Material Mail the coupon today for our 200-page building material book, replete with bargains in lumber, doors, windows, millwork, paint, roofing, plumbing, hardware, light fixtures, mantles, grates, color shades—in fact, everything structural materials for construction of any building. Substantial savings evident every instance.

Name _____

Address _____

The Chicago House Wrecking Co. has been favorably known to the public everywhere for more than 20 years as "The Great Price Wreckers." The Harris Brothers who have been the owners and executive officers through all these years have decided that their best interests require more prominent use of the owners' names and will now advertise and sell their goods under the name of

HARRIS BROTHERS CO. 35th & Iron Sts. CHICAGO

Tone

That's where
the Victrola
is pre-eminent.

The Victrola brings to you the pure and varied tones of every musical instrument, and the beauty and individuality of every human voice—all absolutely true to life.

Such fidelity of tone was unknown before the advent of the Victrola—the *first cabinet style talking-machine*; and this pure and life-like tone is exclusively a Victrola feature.

"Why exclusive with the Victrola?"

Because of the patented Victrola features, which have been perfected after years of study and experiment:

"Goose-neck" sound-box tube—the flexible metal connection between the sound-box and tapering tone arm, which enables the Victor Needle to follow the record grooves with unerring accuracy.

Concealed sounding-boards and amplifying compartment of wood—provide the very limit of area of vibrating surface and sound amplifying compartment, so absolutely essential to an exact and pure tone reproduction.

Modifying Doors—May be opened wide thereby giving the tone in its fullest volume; or doors may be set at any degree graduating the volume of tone to exactly suit every requirement. Closed tight the volume is reduced to the minimum and when not in use the interior is fully protected.

Victor system of changeable needles:—A perfect reproduction is possible only with a perfect point—therefore a new needle for each record is the only positive assurance of a perfect point. You also have your choice of full tone, half tone or further modification with the fibre needle.

It is the perfection of every part, and its perfect combination with all other parts, that gives the Victrola its superior tone—that makes the Victrola the greatest of all musical instruments.

There are Victrolas in great variety from \$15 to \$200 and any Victor dealer will gladly demonstrate them and play any music you wish to hear.

Victor Talking Machine Co., Camden, N. J., U. S. A.

Berliner Gramophone Co., Montreal, Canadian Distributors

Always use Victrolas with Victor Records and

Victor Needles—the combination. There is no other way to get the unequalled Victrola tone.



Modifying doors
Sounding boards
"Goose-neck" tube and tone arm
System of changeable needles

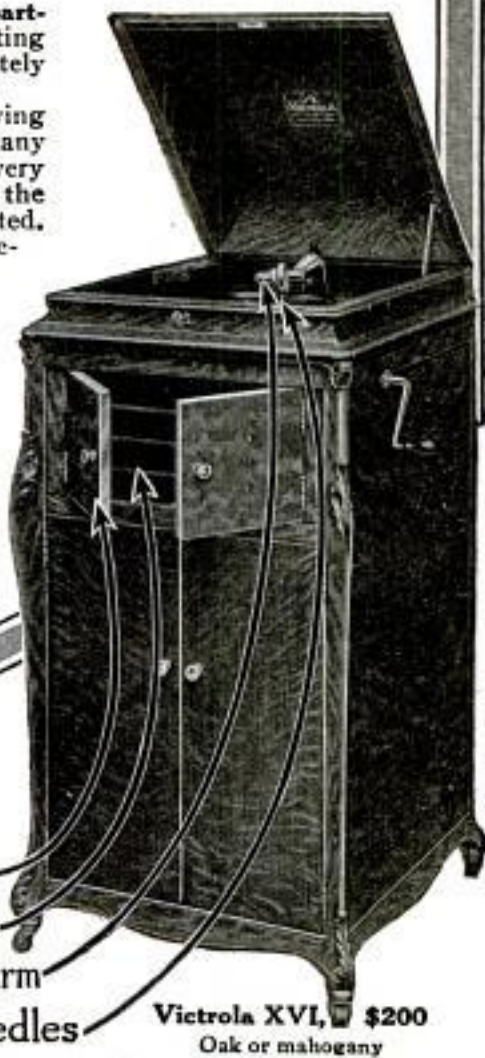

Victrola XVI, \$200
Oak or mahogany

Please Mention Popular Mechanics

This One



88PQ-NQZ-7HLN

"Oh, you mustn't go down cellar, Mamma!"

"Father's down there making Cypress Furniture—it's going to be a grand surprise for *you*—so you mustn't know!"

These are the days of thrift as well as days of sentiment.

Vol. 38 of the famous Cypress Pocket Library (a real departure) contains detail sketches (on sheet 24x36,) specifications and complete directions how to easily make correctly-designed, artistic, "craftsy" furniture of "the wood eternal" in your spare hours. *"Furniture that you make yourself you love as well as use."*

Write for **Vol. 38.**



CYPRESS IS "EASY ON EDGED TOOLS"—THE FAVORITE IN MANUAL TRAINING SCHOOLS.

When planning a Pergola, Mansion, Bungalow, pasture-fence or sleeping porch, remember—"With CYPRESS you BUILD BUT ONCE."

Let our "ALL-ROUND HELPS DEPARTMENT" help YOU.

Our entire resources are at your service with Reliable Personal Counsel.

SOUTHERN CYPRESS MANUFACTURERS' ASSOCIATION
1219 HIBERNIA BANK BUILDING, NEW ORLEANS, LA.

INSIST ON CYPRESS AT YOUR LOCAL DEALER'S.

IF HE HASN'T IT, LET US KNOW IMMEDIATELY.

Please Mention Popular Mechanics

Popular Mechanics Magazine

6 N. Michigan Avenue, Chicago, U. S. A.

EDITED BY H. H. WINDSOR

England: The International News Co.
5 Breams Bldg., Chancery Lane, London, E. C.

Australia: The Australasian News Co.
126 William St., Melbourne

ISSUED MONTHLY

SUBSCRIPTION:

SINGLE COPY, 15 CENTS

In United States, and its possessions, Cuba and Mexico, per year, postpaid \$1.50
To Canada 1.75
To all other countries in the Postal Union 2.50

All subscriptions are discontinued at expiration. Please examine the date printed on your wrapper.

Entered as Second Class Matter Sept. 15, 1903, at the Post Office at Chicago, Illinois, under Act of March 3rd, 1879.
Entered as Second Class Matter at the Post Office Department, Canada.

Published monthly by POPULAR MECHANICS CO.

Copyright, 1915, by H. H. WINDSOR.
Copyright, in France.

Birdhouses 12747-5-9

Contents for February, 1915

Aerial Tramway across Gila River.....	175	Electricity—High Voltage Lines, Outdoor Sub-stations for	244
Aeroplane Accidents, Fatal, in 1914.....	193	Elephant Hauled on Truck through City Streets.....	242
Aeroplane, Instrument for Studying.....	257	Explosive, Liquid Oxygen as an.....	271
Aeroplane Motors, Testing Stand for.....	276	Explosive, New, Is Safe and Powerful.....	235
Airship or Aeroplane, How to Shoot.....	168	Explosives Classified by Mines Bureau.....	268
Alcohol, Wood, Danger in Inhaling Fumes of.....	250	Fire, Stubborn, Burning Matches Cause.....	235
Alligator Aids in Sewer Cleaning.....	261	Firemen Make Thrilling Leap for Life.....	179
Automobile Breaks Speed Record.....	230	Flying Boat, Launching from a Ship's Deck.....	178
Automobile Climbs Slope of Forty-Five Degrees.....	164	Forest Service, Signal Lanterns in.....	219
Automobile Pedals, Pads for.....	273	Funerals, Military, Reversed Boots a Feature of Gas, Artificial, Purifying with Electricity.....	186
Automobiles, Combination Horn and Fan for.....	232	Gas Industry of England and Synthetic Ammonia Gas Range, New, Saves Fuel.....	273
Automobiles, Electric Signal Device for.....	267	Gas Ranges, Ignition Device Designed for.....	241
Automobiles, Sight-Seeing, Aid in Mobilization.....	258	Grapefruit, Remarkable Cluster of.....	279
Automobiles, Stopping Distances for.....	182	Gun, Oddly Mounted, Used for Fortress Defense.....	245
Aviation—Air Forces, Military, Making Adequate for Nation's Needs.....	171	Gunpowder is Saved by Rock That Disabled It.....	161
Aviation—Continuous Flight Record for America Broken.....	217	Hammer Drill, Mechanical, Strikes Rapid Blows.....	222
Aviation—Zeppelin Bombs, London Takes Precautions against.....	186	Handles, Hickory, Forest Service Standards for.....	250
Bank Vaults, Enormous Doors of.....	176	Hardware Costumes Show Fashions.....	279
Barges, Self-Propelled, in Lakes to Gulf Traffic.....	237	Holder, New, with Spring Clamp.....	234
Bed Contains All Furniture of Bedroom.....	243	House Plans—Eight-Room Residence Built at Low Cost.....	233
Bird Houses, Rose Vines Protect from Cats.....	192	Hudson Bay Route, Variation of the Compass over Ice Cofferdam Used in Repairing Dredge.....	272
Boat, Old, Putting a New Skin on.....	254	Insect Ravages Cost \$500,000,000 a Year in Damage to Crops.....	218
Bonnie, University Students Set.....	164	Insulator Pin, New, for Electric Lines.....	247
Brass Castings Made by Hydraulic Pressure.....	238	Kelp Beds, Giant, of the Pacific Contain Wealth in Potash.....	262
Bridge is Strengthened by Novel Method.....	242	Land, Canadians Wait Long to File on.....	221
Bridge, Old, with a Mixture of Grades.....	218	Lathe Arbor Centers, Automatic Grinder for.....	181
Bridge Rolled into Place in Eleven Minutes.....	184	Laundry Device—Fan Blows Hot Suds through Clothes.....	233
Brushes, Water Color, Made from Hair of Cow's Ear.....	258	Lenses, New, That Shut off Harmful Rays.....	277
Building, Bank, No Larger Than a Hallway.....	236	Level, Spirit, is Combined with Pocket Rule.....	217
Buildings, School, Planned by Boy Architects.....	243	Life Belt Inflated by Contact with Water.....	279
By Charleton Lawrence Edholm		Lighting Bills in Winter Triple Those of Summer.....	162
Bullets, Man's Weight in, to Kill One Man.....	185	Locomotive, New, Hauls Record Load.....	273
Cables, Ships, How Made and Tested.....	233	Lost Articles, Device to Recover from Water.....	280
Caboose, All Steel, Novelty in Railroading.....	183	Lumber, How Piled in English Yards.....	176
Calipers, Handy Attachment for.....	248	Machine Shop in One Machine Tool.....	235
Canaries, Mine, Revived with Oxygen.....	182	Militia, State, Plan for Reorganization of.....	224
Cheese, Big, for Exhibition at San Francisco.....	259	Milk, Bottling While Hot.....	278
Cider, Apple, Concentrated by New Process.....	232	Money—Bank Notes, Small, Issued in France and England.....	192
Cigar Lighter Has Case Like Small Watch.....	239	Money, Paper, Artistic New Designs for.....	270
Clock on Door Shows When Bank is Open.....	202	Motorcycle Driven along Perpendicular Wall.....	232
Coal Mines, Dust Catching Liquid for.....	240	Motorcycle Made into Motor Sleigh.....	180
Comment and Review, by H. H. Windsor:		Motorcycles, Electric Light Equipment for.....	240
Army Reserves, Plan for.....	191	Motors, Long Stroke, Coming into Favor.....	235
Defense, Question of.....	190	Motors, Steel Cylinder, Made at Low Cost.....	262
Peace, The Century of.....	191	Mower, Motor Driven Three Wheeled.....	246
Rate Increase.....	182	Mustard, Separating from the Screenings.....	239
Work, Equalizing Periods of.....	189	Niagara Falls, Novel Plan for Utilizing Power of Novel and Practical Things for Daily Use.....	192
Cow Secludes Movie Man Taking Bird Pictures.....	241	Organ Tone, Lowest Ever Produced.....	162
Cows, Sacred, of Bali and Their Huge Bells.....	252	Panama Canal at Night is a Beautiful Spectacle.....	274
Crane, Floating, Built for Panama Canal, Wrecked.....	198	Panama-Pacific Exposition, Lamp Pedestal for.....	258
Crib and Scale Combined.....	217		271
Cross, Iron, Converted into Marble Symbol.....	180		236
Dog Picture Formed by Wood.....	181		
Dry Batteries, Handy Lighting Cap for.....	278		
Egg Carrier for Shipping by Parcel Post.....	180		
Election Results, Electric Lights Wink.....	178		
Electric Light without a Central Station.....	217		

[Continued on Page 6]

SENT FREE



LAW

COURSE SENT FREE ON APPROVAL

Not one penny down. Get this greatest home-study course in law—consisting of a magnificent fourteen-volume law library, the most complete library of its kind in existence, and the first individual lessons; clear, comprehensive discussions of the law—in your hands positively free of charge, without any obligation whatever. We want you to see this course, examine it critically, put it to every test, compare it with other courses, before you even decide. Mail the coupon now—right now—to get the details of this startling offer—to find how you can, without risking a penny, get started right on your legal education.

Get Your Degree by Mail

No other school even dares to make an offer of this nature. They don't dare send out their courses in open competition with the LaSalle Extension University Course in Law.

We are authorized by the State of Illinois to confer on our graduates the degree of Bachelor of Laws (LL. B.). Our course prepares you to pass the bar examinations in any state. Should you fail to pass we guarantee to coach you without charge until you are successful.

In a recent Bar Examination at Lansing, Michigan, only six out of fourteen applicants for admission were successful and two of those who passed were LaSalle Students. Not one of the LaSalle students who entered the examination failed. Among the eight rejected, four were graduates of leading resident University Law Schools. These are some of the reasons why it pays us to send out our course on approval, without obligation. Satisfy yourself absolutely that this is the very best home-study law course offered by any school in the country before obligating yourself, before spending a penny.

\$100.00 Tuition Credit Free For a short time only, in connection with our free on approval offer, we are giving students the opportunity of saving one hundred dollars. Write at once for full particulars of this unusual opportunity.

Mail Coupon—Offer Limited

Send no money. Just your name and address on the coupon below, and we will forward by return mail full particulars of our remarkable free on approval offer and our wonderful free book "Guide to the Law," showing how to study law at home. This is the first time in history that a University Home-Study Law Course has been offered on approval; our course is the only one that will stand this acid test. Moreover, if you act promptly we will save you more than half your tuition. We are doing it for advertising purposes only and the offer is subject to withdrawal in a short time, without notice. So act now. Get all the facts in your hands—NOW. Simply sign and mail the coupon.

LaSALLE EXTENSION UNIVERSITY, Dept. F. 415, Chicago, Ill.

Coupon Brings Details—Tear Off and Mail

LaSALLE EXTENSION UNIVERSITY, Dept. F. 415, Chicago, Ill.

Please send me full particulars of your free on approval, without obligation offer, showing also how I can secure \$100.00 Tuition Credit free, and a copy of your free book "Guide to the Law".

Name _____

Address _____

We Assist Students Getting Actual Driving Experience



YOU CAN LEARN the AUTOMOBILE TRADE WITH DYKE'S NEW IDEA WORKING MODEL METHOD

IF OTHERS CAN, YOU CAN

Bert Tippey, De Soto, Ill., writes us that he knew nothing about autos when he started with us, but is now doing repair work, owns his own car, and owes his success to Dyke's Course. In a recent letter he states he began repair work before completing course and paid for course out of first job. He started in a small way, but is now doing general repair work. He grinds valves, cleans carbon, greases cars, times valves, sets magnetos, adjusts carburetors, etc., etc., and sells supplies. We started him. We first taught him the principle of all parts and then helped him get his start, just as we can do for you if you have any hustling ability.

If we prove to you that we have started hundreds of others into the repair business and as chauffeurs—who had no previous experience and who knew no more about an auto than you do right now—you must admit we can do the same for you. Write me today—now—and let me prove it.

A. M. Atkin, Repairing, Overhauling and Supplies, Lone Tree, Iowa, R. D. No. 1, in a recent letter says: "I have a lot of repairing to do; have been called upon several times to inspect second-hand cars."
 Harry J. Herbin, Jamestown, Kans., was a farmer, but has doubled his income repairing and selling autos.
 Mr. G. Strickland, Westport, Ont., Canada, writes us: "I am glad I took your course. Have just overhauled a car; timed the valves and set the magneto. Owner says engine has more power. This is my first job. Thanks to your course."
 Donald Stewart, Oakland City, Ind., became a chauffeur at \$25 a week.
 H. M. Festina and B. T. Slayback, both students, are now running a Garage and Repair Shop at Woodbine, Iowa.

And we could continue until we had filled this and several more pages.



Our book of testimonials, showing photos of students and their shops—free.

All the Result of the Dyke System

We can thoroughly train you during spare time. Open a repair shop or drive a car and make many times more than you are making now. Don't forget, we help you get your start with our *Employment Plan*, if you want it.

DYKE'S NEW IDEA OF TEACHING BY MAIL WITH WORKING MODELS

is something new. We use *real* working models—not just one, but *five*. On these models you get actual practice, see the actual operation and learn more than you could from the auto itself—it's easy and quick. You don't have to study hard with this system—we teach through the eye—a new idea. We are the originators of the system of teaching by mail with models. We also use charts—268 of them and a 16 page manual. Our 40 instructions and Repairman's Instructions are simplicity itself—simple as A B C.

Our Employment Plan for Students

This represents years of work to provide something that no other school had, namely, a way for our students to get started in the practical line of work.

Mr. Dyke has been identified as a pioneer inventor, supply man, etc., with the auto industry since its beginning. He originated the first auto supply co., and published the first book on autos in America. No other man with such experience is to-day teaching others. And all the experience and inside information of the auto business he has thus gained, is embodied in this *Employment Plan*.

WRITE TO-DAY FOR THIS FREE BOOK

It is instructive and interesting—does not cost you a cent and places you under no obligations whatever—you need it for your own sake, not mine. Don't wait—there's no profit in waiting—WRITE NOW and learn how you can obtain all this training for only \$15, if you act immediately.



DYKE'S CORRESPONDENCE SCHOOL OF MOTORING
 Box 189, Roe Bldg. ST. LOUIS, MO.

NOTE—Beware of Imitators—Deal with the Originator

CLEAR A CHILD CAN UNDERSTAND EXPLANATIONS SO EXPLANATIONS SO STARTING AND LIGHTING SYSTEMS DELCO AND OTHER



What Clarkson is Doing for the Book Buyer

IN several hundred thousand Libraries in the homes of people in every walk of life—from the day laborer to the college professor and high government official, from the persons who buy a few books of popular fiction to the persons who pride themselves on having the complete works of all the standard authors in De Luxe Editions artistically printed and bound—almost every book was bought from me. WHY? Because, I have no agents and sell you just the books you want—all new—many at a saving of from 50 to 90 per cent—you examine the books in your own home for five days before paying for them. If not satisfied, return them at my expense—and owe me nothing.

Sample Prices:

- The Eyes of the World, 90c
- Shakespeare, 40 vol. full flexible Morocco, largest type; best notes of any Shakespeare published, publisher's price \$50, my price \$34
- Home Library, 9 vols. cloth, publisher's price \$4—my price \$30
- Wild Animals of North America, publisher's price \$3—my price 65c
- Messages and Papers of the Southern Confederacy, 3-4 Morocco, publisher's price \$18—my price \$10
- Options, Addresses and Club Essays, publisher's price \$1.50—my price 60c

Here are De Luxe Editions, Morocco bound, complete works, many of them at less than 25 cents on the dollar. Hugo, Kipling, Poe, Eliot, Dickens, Thackeray, Scott and scores of others.

Get My Big, New Catalogue

My new catalog, sent free for the asking, tells you how to save 50 to 90 per cent on thousands of books. It is a course in literature, giving nationalities, date of birth and death of authors, the author's life and standing in literature, etc. Hundreds of sets and thousands of single volumes listed. I sell more books direct to the booklover—the individual reader—the rich man who insists upon his dollar's worth—the man who watches his pennies—and sell them for less money—than any other man in America. Every book new and fresh, and guaranteed to please you—you to be the judge. I do not quibble, and would rather have a book or set of books returned at my expense than to have a dissatisfied customer.

David B. Clarkson, The Book Broker
 244 Clarkson Building Chicago, Illinois

DO YOUR OWN

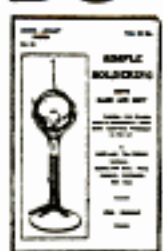

Soldering — and Save Money

Send 55c for cloth bound Book "Simple Soldering"—and learn how to join metals, both hard and soft.

CONTENTS—Soldering. The Uniting of Metals. Soft Soldering. The Flux. Hard Soldering or Brazing. Soft Soldering. Heating the Work. Flux for Soldering. Etc. Methods of Holding Work. Wiring Work. Silver Solder. Soldering Copper, Etc. Cleaning Up Work. Polishing. Scraping Down. Honing. Etc. Standard Apparatus. The Blow-Pipe. Foot Bellows, Etc. Home Made Apparatus.

SPON & CHAMBERLAIN
 123 P. M. Liberty St. NEW YORK

J-M ASBESTOS ROOFING

Never needs scating. An excellent fire protection. Write for illustrated catalog No. 71.
 H. W. Johns-Manville Co., New York and every large city

123
 456
 789

Place the 9 figures so the 2nd row is twice as much as first row and third row as much as first and 2nd row added together. All correct replies will receive 25 cents' worth of our iron puzzles with catalog postpaid. Answers not correct will receive solution. Catalog of 200 puzzles and one of our leading 15c products. All answers to enclose 10c, in stamps or coin to cover mailing, packing, etc.

WESTERN PUZZLE WORKS, St. Paul, Minn.



Boy Craftsman

10c Tells how to make all kinds of Toys. New Book just printed. How to make Canoe, Railroad Model, Talking Machine, Telephones, Electric Motor, Bicycle Boat, Pocket Flashlight, and hundreds of other things. Fully Illustrated. Sent postpaid for 10c. 4 for 25c.

NATIONAL CO., 3422 Lyndale Ave., Dept. 16, CHICAGO

Please Mention Popular Mechanics

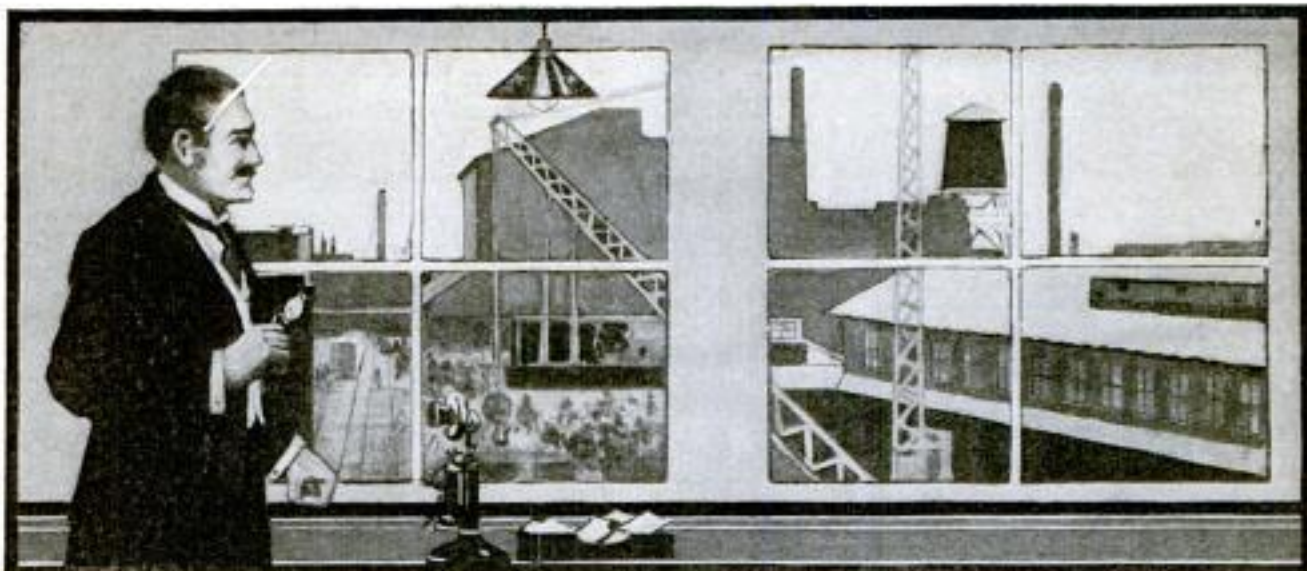

Partial Contents

The Law of Great Thinking.
 The Four Factors on which it depends.
 How to develop analytical power.
 How to think "all around" any subject.
 How to throw the mind into deliberate, controlled, productive thinking.
 Detailed directions for Perfect Mind Concentration.
 How to acquire the power of Consecutive Thinking, Reasoning, Analysis.
 How to acquire the skill of Creative Writing.
 How to guard against errors in Thought.
 How to drive from the mind all unwelcome thoughts.
 How to follow any line of thought with keen, concentrated Power.
 How to develop Reasoning Power.
 How to handle the mind in Creative Thinking.
 The secret of Building Mind Power.
 How the Will is made to act.
 How to test your Will.
 How a Strong Will is Master of Body.
 What creates Human Power.
 The Six Principles of Will Training.
 Definite Methods for developing Will.
 The NINETY-NINE METHODS for using Will-Power in the Conduct of Life.
 Seven Principles of drill in Mental, Physical, Personal Power.
 FIFTY-ONE MAXIMS for Applied Power of Perception, Memory, Imagination, Self-Analysis, Control.
 How to develop a strong, keen gaze.
 How to concentrate the eye upon what is before you—object, person, printed page, work.
 How to become aware of Nerve Action.
 How to keep the body well-poised.
 How to open the Mind and Body for reception of incoming power.
 How to throw off Worry.
 How to overcome the tyranny of the Nervous System.
 How to secure steady nerves.
 How to maintain the Central Factors of Body health.
 Difficulties in Mastering Harmful Habits.
 The Law of Will-Power in Habits.
 The Mental Law of Habit Cure.
 Etc., etc., etc.

His Power of Will Brought Success

He had no better chance than you—he simply made the most of that God-given faculty of will, which is latent in all of us. Instead of allowing himself to be everlastingly turned aside by petty fears, by insignificant daily incidents, instead of letting instincts and appetites run away with him—instead of permitting others to control him, he exercised his will—he became master of himself—he learned to dominate others instead of allowing others to dominate him.

Great men are born with no greater gifts than others. The secret of their achievements lies in the fact that they use their faculties instead of allowing them to become scotched and dormant. If you sprained your ankle and didn't touch your foot to the ground for months, it would become so weak you couldn't put your weight on it. The same is true of the will. It becomes weakened like a muscle from lack of use.

A Wonderful Course in Will Training

Psychologists found years ago that memory can be trained by intelligent exercise. Now it has been proven by over 40,000 people that the will can be strengthened in the very same way by the proper kind of exercise.

Professor Frank Channing Haddock, Ph.D., the great psychologist, has written a book containing 28 lessons in will-training based on a profound analysis of Will-Power in human beings. He gives actual methods, rules and principles for training, strengthening and developing will-power; and they are so clear, so easily understood that anyone can apply the simple instructions.

Helps Everybody

They have made decisive men of action out of the most miserable "down-and-outs." They have provided an extraordinary stimulus to young people, and to older people who have feared that they were becoming "failures."

They have been a veritable well of strength to sick and nervous people. They have cured drunkards and victims of other vices. Most of all they have been used by business men—who realize the need of an **INFLEXIBLE WILL** for success.

Men like Judge Ben. B. Lindsey, Supreme Court Justice Parker, Wu Ting Fong, Ex. U. S. Chinese Ambassador, Lieut. Governor McKelvie of Nebraska, Asst. Postmaster Gen'l Britt, General Manager Christeson of Wells-Fargo Co., Ernst Kuebel, Asst Attorney Gen'l of the U. S., E. St. Elmo Lewis, now Vice-Pres. Art Metal Cons. Co.—and thousands of other men like them read, use, and praise "Power of Will."

Send No Money—Examine Book First
 The publishers will send you a copy free—without deposit—so that you may judge for yourself how much "Power of Will" will help you in your daily life. The price of the book is \$3.00, but send no money now. Merely mail the coupon, enclosing your business card or giving a reference. You can keep the book five days. Then, if you don't want it permanently, send it back. Tear out the coupon now, before you turn this page.

Pelton Pub. Co., 52 Pelton Bldg., Meriden, Conn.

What Readers Say

"I hand you \$3 in payment; from what I have already seen I believe I can get \$300 to \$30,000 worth of good out of it. Better still, I believe it worth more than money in any amount."—C. D. Van Vechten, General Agent No. West Life Ins. Co., Cedar Rapids, Ia.

"It is the greatest book I ever looked into. The testimonials regarding it are inadequate as to its merits. It has startled me already—though I have read only a few chapters."—Rev. A. Turkington, Blanchester, Ohio.

"Will-power is a compilation of mighty force. My first week's benefit in dollars is \$900—cost \$3; profit \$897.00."—J. W. Hiestand, 916 Tribune Bldg., Chicago, Ill.

"In my judgment 'Power of Will' is wonderful."—Owen J. McCarthey, Sec. of Corp. Securities Co., St. Louis, Mo.

"The two last chapters are worth one hundred times the price of the book. But the entire work is a great teacher."

—Mrs. Nera R. Temple
 18 East 32d St., Kansas City, Mo.



Pelton
 Pub. Co.
 52 Pelton Bldg.
 Meriden, Conn.

Gentlemen:—
 Please send me a copy of "Power of Will" without charge. I agree to remit \$3.00 or re-mail the book in 5 days.

Name.....

Address.....

Cadillac Eight-Cylinder
V-Type Engine,
Front View

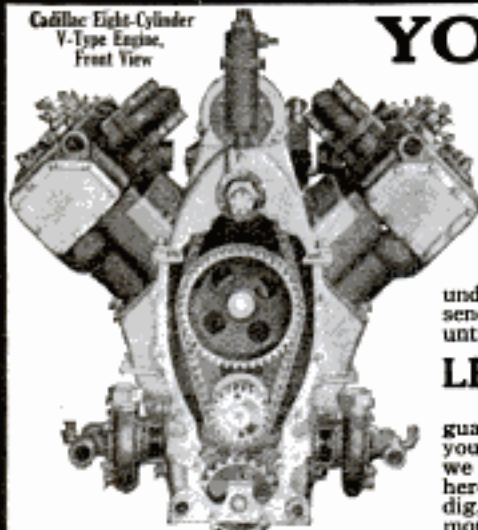

YOU CAN MAKE \$25 BY REPLYING TO THIS ANNOUNCEMENT TODAY SWEENEY AUTO SCHOOL

If you ever intend to learn the automobile business here is your chance, and prompt action will make you \$25.00. On March 1st the Sweeney school raises its tuition, as with our magnificent equipment, full enrollment, more teachers, etc., it is costing us \$1600 a month more to teach than it did one year ago. Hence the tuition will be advanced. Write today if you wish to get in under the old terms, and also get a \$50 traction engineering course free. Don't send us any money; we don't take cash reservations; we don't accept one cent until you have seen the school and know what you are getting.

LEARN IN 6 WEEKS—EARN \$100 A MONTH

We are not a Chauffeur school. We are a mechanical school. We do not guarantee you positions or guarantee to learn you the business. We can teach you but we cannot make you learn. We guarantee our school to be exactly as we represent it, and if you have a back bone instead of a wish-bone and come here to school, knowing that you cannot get gold out of a gold mine unless you dig, you can qualify yourself in six weeks' time to earn from \$75.00 to \$150.00 a month, as an automobile repairman, driver, garage manager, salesman, demonstrator, truck driver, Gas Traction Engineer or any branch of the gas engine business that you may wish to follow.

Wonderful Equipment

The Sweeney School is the only school in the world owning and teaching the new 8-cylinder Cadillac car. This is a great evolution in the motor car business but the Sweeney School is the only place to learn how to handle and repair this motor. We have also just purchased 2 more complete Delco systems, making 3 in all.

We have also added one 15-30 International Gas Traction Engine and set of Oliver plows, one 20-40 Case Gas Tractor and set of Case Racine plows, one 25-50 four-cylinder Avery Tractor and set of Avery plows. We are making a special inducement of giving a \$50.00 Course in Gas Traction Engineering FREE to any student who enrolls in our automobile course this season.

Free Catalog We have just issued one of the finest and the largest photographic catalogs ever issued by any automobile school in this country. This valuable book contains 115 illustrations, actual photographs, showing the students here in the school at every phase of repair work on automobiles and traction engines. It is practically a moving picture show, demonstrating the unique advantages of the Sweeney System of Practical Experience. How men are taught in six weeks' time every detail of the automobile business and are fitted to earn \$75.00 to \$150.00 a month as skilled mechanics, garage owners, etc.

It tells you how we teach the business, the opportunities there are for the skilled man and shows hundreds of letters from our graduates who are making good. If you are mechanically inclined you should get this catalog. It costs us 50 cents apiece to publish it, but we will send it to you absolutely free, also one of our papers which gives a full description of the new Cadillac eight-cylinder car.

Simply send name today, if you are interested, and you will receive what hundreds of men have said to be the most complete catalog ever issued and it is absolutely FREE to you. It is the only book we use. When you arrive in school you use tools instead of books.

Sweeney Auto School, 1168 E. 15th St., Kansas City, Mo.

YOU Can LEARN This Newest, High Grade MONEY-MAKING PROFESSION



—by correspondence study—in your own home. An hour or two a day, of your spare time, soon qualifies you as a

Doctor of Physcultopathy

—the new, common-sense, effective healing science. Drugless, painless, harmless—without operations of any sort—PHYSULTOPATHY is fast becoming

RECOGNIZED EVERYWHERE

—by intelligent people, as superior to all so-called "medical practice." NO DRUGS USED. Pleasant, dignified work—the honorable, congenial, remunerative employment of a PROFESSIONAL MAN. Some of our doctors earn

\$5,000 TO \$10,000 A YEAR

Our THOROUGHLY PRACTICAL Home Study Course in Physcultopathy will fit YOU—in 32 easy personal lessons, to command splendid income. And included, is the

Great 10-Volume FREE

Macfadden Library

Start now! Many good positions waiting.

Mail, Today—This Coupon

—for handsome FREE PROSPECTUS,

explaining this glorious opportunity—

and Special Scholarship Plan.

Full particulars; no obligation.

MACFADDEN COLLEGE
OF PHYSULTOPATHY

4200 Grand Blvd., Box 617, Chicago



FREE INFORMATION COUPON
Macfadden College of Physcultopathy
4200 Grand Blvd., Box 617, Chicago, Ill.
Without cost to me, please give
further detailed information by
returning this coupon to Home
Instruction Course,
by mail, to Phys-
cultopathy, and
Special
Offer.

Name _____
Town _____ State _____
No. _____

Learn to PAINT SIGNS and SHOW CARDS

I'll teach you personally by mail. 16 years' successful teaching.

Big field for men and women. You can

Earn \$18.00 to \$45.00 a Week

Lane, (Pa.) says, "Since enrolled have made

over four times cost of course." Send for complete

details.

DETROIT SCHOOL OF LETTERING

Chas. J. Strong, Founder Dept. 302, Detroit, Mich.



IF YOU STAMMER

attend no stammering school till you get my large FREE book and special rate. Largest and best school in the world curing by natural method. Write today.

Lee Wells Millard, Pres., North-Western School, Inc.

2317 Grand Avenue Milwaukee, Wis.

BE A DETECTIVE

Earn from \$150.00 to \$300.00 per month; travel over the world. Write

C. T. LUDWIG, 133 Westover Bldg., Kansas City, Mo.

EARN \$1200 to \$2000 PER YEAR

tuning pianos. Easily learned by mail in your own home by our practical course. Be your own boss. Write for information.

LUNDBERG & CO., 140 No. Dearborn Street, CHICAGO, ILL.

BE AN ILLUSTRATOR. Learn to draw. We will teach you School of Illustration 112 Page Bldg. Chicago, Ill. Send for Catalog

Learn Watchmaking At Home



You can learn by our modern and original system of instruction every part of the Watchmaker's Trade at home as good or better than at a shop. You can earn money while learning and secure a well paying position or start in business after completing our course of instruction. Good watchmakers are always in demand and earn from \$20 to \$35 per week. For particulars apply to the Wisconsin School of Watchmaking, 37th Bldg., Milwaukee, Wis.

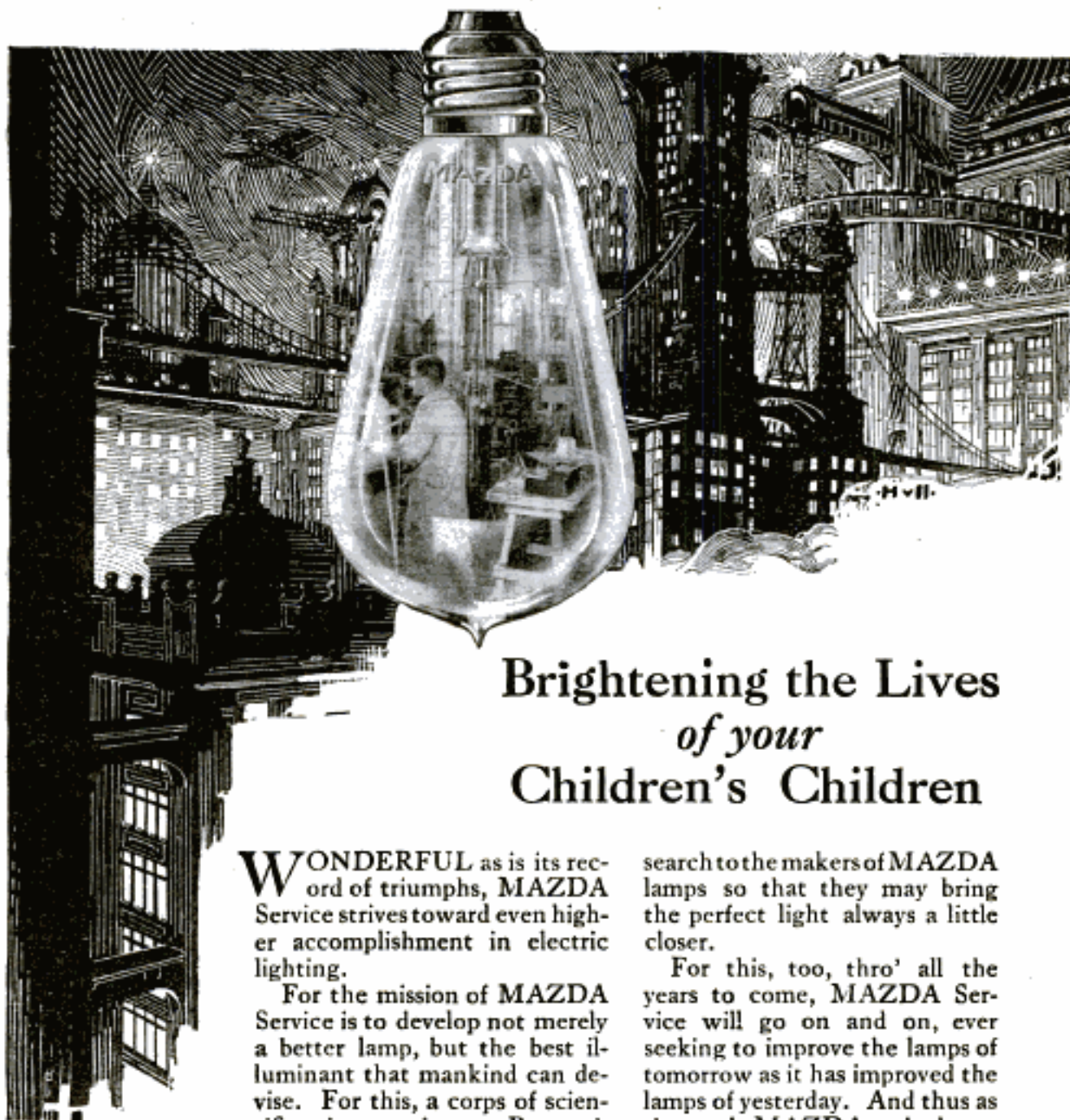

Brightening the Lives *of your* Children's Children

WONDERFUL as is its record of triumphs, MAZDA Service strives toward even higher accomplishment in electric lighting.

For the mission of MAZDA Service is to develop not merely a better lamp, but the best illuminant that mankind can devise. For this, a corps of scientific pioneers in our Research Laboratories at Schenectady delves unceasingly into the hidden ways of science—exploring the whole world for new materials, new methods, new thoughts and supplying the results of this

search to the makers of MAZDA lamps so that they may bring the perfect light always a little closer.

For this, too, thro' all the years to come, MAZDA Service will go on and on, ever seeking to improve the lamps of tomorrow as it has improved the lamps of yesterday. And thus as the mark MAZDA etched on a lamp means to you the best lamp of today, so to your children's children, MAZDA will mark the lamp that sums up in their day all this endless search for the perfect light.

GENERAL ELECTRIC COMPANY 

MAZDA

"Not the name of a thing but the mark of a Service"

4618

Please Mention Popular Mechanics

Copyrighted material

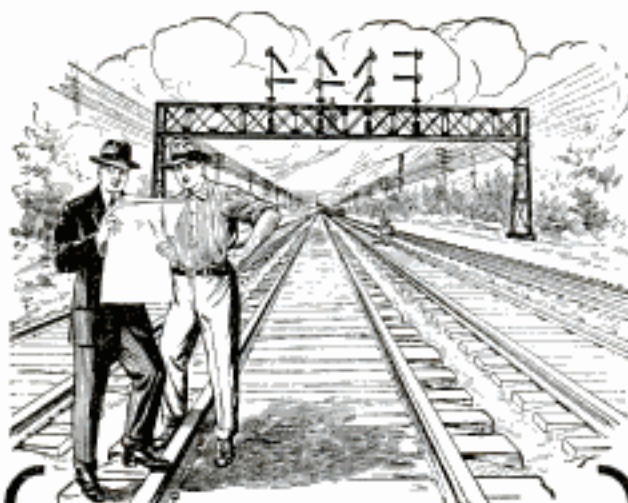

Be a Signal Engineer

The profession of Signal Engineering is only in its infancy. Thousands of men are needed. At the present time, scarcely more than 25% of the railroads are fully equipped with automatic electric block signals. We must find more Signal Engineers to superintend the installation of the new systems and the maintenance of the ones that are already installed. **Big money is being paid.** You can get just the kind of instruction you need to hold one of the big jobs in your own home—during your spare time. Send the coupon now for the big new book on Signal Engineering. Find out how you can be the boss and the man who gets the fat pay envelope. Write today.

Earn \$2,500 a Year

Yes, that is what your salary will be when you are a full fledged Signal Engineer. Many men making more than that. Even while you are learning you can hold one of the positions under a Signal Engineer paying you a handsome salary. Here is your opportunity. Be the man who tells the other fellows what to do. Send in the free coupon for full particulars.

MORE MEN NEEDED

Railroads are constantly looking for competent Signal Engineers. Thousands and thousands of miles of track are now being equipped with automatic signals. More Signal Engineers are needed to superintend the work. Electric Signal Engineering is one of the most fascinating of professions. As a railroad man you travel from coast to coast. You can be the man who knows. You can be the man who tells the other fellow what to do. You can be the man who gets the fat pay envelope and free transportation. Here is your chance.

TWO BIG FREE OUTFITS

Complete Signal Engineer's Outfit and Complete Draftsman's Outfit given away absolutely free to students. The Engineer's Outfit consists of a miniature railroad system of tracks, locomotive, signals, lights, wires, bell, switches, etc., etc. The Draftsman's outfit is complete, consisting of drawing instruments, T square, drawing board, triangles, etc., etc. Actual working instruments. On this great special offer given away to you absolutely free. Send the coupon.

Send the FREE Coupon for Big New Book

Department of Signaling
Room 1192
1810 Wilson Ave.
Ravenswood Station
Chicago, Ill.

GENTLEMEN: Please send me absolutely free and pre-paid your big new Signal book. Also full particulars about your great special free outfit offer. It is distinctly understood that I assume no obligations of any kind.

Name.....
Address.....
Age..... Occupation.....

Department of Signaling
Room 1192
1810 Wilson Ave.
Ravenswood Station
Chicago Ill.

Please Mention Popular Mechanics

SHORTHAND IN 30 DAYS

We absolutely guarantee to teach shorthand complete in only thirty days. You can learn in spare time in your own home, no matter where you live. No need to spend months as with old systems. **Boyd's Syllabic System** is easy to learn—easy to write—easy to read. Simple. Practical. Speedy. Sure. No ruled lines—no positions—no shading as in other systems. No long lists of word signs to confuse. Only nine characters to learn and you have the entire English language at your absolute command. The best system for stenographers, private secretaries, newspaper reporters and railroad men. Lawyers, ministers, teachers, physicians, literary folk and business men and women may now learn shorthand for their own use. Does not take continual daily practice as with other systems. Our graduates hold high grade positions everywhere. Send today for booklets, testimonials, etc.

Chicago Correspondence Schools
969 Advertising Bldg., CHICAGO, ILL.

Get A Government Civil Service Position

A job with Uncle Sam under Civil Service protection means employment for life with good pay, short hours, pleasant work, annual vacations and the assurance that you will get your pay regularly in spite of panics or hard times.

Post Office, Railway Mail, Rural Carrier, Custom-Internal Revenue and other examinations are being held all the time.

If you're an American citizen 18 or over, we can help you secure one of these good jobs. Our 64 page booklet tells how you can prepare for "exams" under personal supervision of a former U. S. Civil Service Secretary-Examiner—a man who knows and whose knowledge is at your disposal. Write today for booklet. It's free, without obligation.

PATTERSON CIVIL SERVICE SCHOOL
102 Irving Place ROCHESTER, N. Y.



Learn to Draw

Illustrators—Cartoonists—Designers are in demand. Many of our pupils obtain paying positions before completing the course. **Personal instruction** by artist of 25 years' experience. Correspondence and local school. Send sample of work for free criticism, and 6c in stamps for illustrated book. **Artist's outfit FREE to enrolled students.**

WASHINGTON SCHOOL OF ART
934 F St., N. W., Washington, D. C.

CORNET FREE! We guarantee to teach you to play by mail and will give you a Beautiful Cornet or any Band Instrument absolutely FREE. You pay weekly as lessons are taken. Instrument is sent with first lesson. Write today for our booklet and wonderful tuition offer.
INTERNATIONAL CORNET SCHOOL
45 Federal St., Boston, Mass.

RAG-TIME Learn to play Rag-time on the Piano. We teach you quickly by mail. **BOOKLET SENT FREE.**
CHRISTENSEN SCHOOL OF MUSIC
918 Christensen Building CHICAGO

DO NOT STAMMER

My book, "How to Stop Stammering"—a treatise on "Scientific Talking and Psychic Training." School and circular literature FREE. **M. L. HATFIELD**, Prin. of The Pacific School for Stammerers, 1918 Grove St., OAKLAND, CAL.

ARITHMETIC SELF-TAUGHT

A plain, easily-understood volume for all who have not had the opportunity of learning this subject thoroughly, or who have forgotten what they once learned. **257 Pages. Requires no teacher.** This great little book sent postpaid for **60 CENTS.** Stamps accepted.

GEO. A. ZELLER BOOK CO.
Est. 1878, 4472 W. Belle Place ST. LOUIS, MO.

SPANGENBERG'S
PRACTICAL
ARITHMETIC
Self-Taught

This Splendid LIBRARY of ELECTRICITY

Sent Free for Examination

\$1 Per Volume—Pocket Size—Leather Bound

Why You Should Own Hawkins Electrical Guide

It is a work of education, explanation and encouragement.

It is a royal road to a practical knowledge of Electricity.

It answers your electrical questions in concise, practical and easily understood language.

It covers thoroughly the elementary principles as well as the most approved practice.

All important points are fully illustrated by drawing or a full descriptive illustration, which adds greatly to the clearness and value of the work.

It contains the correct and most up-to-date safety rules for installing Modern Electric Machinery and Appliances.

It gives complete explanation on Electrical Construction. It is a practical, authoritative, comprehensive guide for all desiring a working knowledge of Electricity.

No catalogue description can do justice to the work; it contains too many thousand points; only the important headings are shown in the list of contents.

*Sign the Coupon
now and get this
practical Education in
Electricity "written so
you can understand
it"*

Endorsement of Satisfied Users

"After a thorough examination we find they are the best that have ever been published on this particular subject. I am thoroughly convinced that after examination these books can sell themselves."—Triumph Electric Co. (H. H. Fanschar), Cincinnati, O.

"I wish to say that I have been doing Electrical Work for 15 years, and have upwards of \$100 worth of Electrical books, but I consider the Hawkins Electrical Guides the best ever for the practical electrician."—O.A. Armfield, Mulberry, Fla.

"They are the most complete set of books on the subject for that price that I have ever seen. Perfectly satisfactory; they cover the subjects in a way that can easily be understood by anyone."—J. W. Gledhill, Vineland, N.J.

"The Hawkins Electrical Guides seem to me to be the best and most complete set of Electrical books that I have ever had the opportunity to find."—T. J. Messinger, Columbus, Pa.

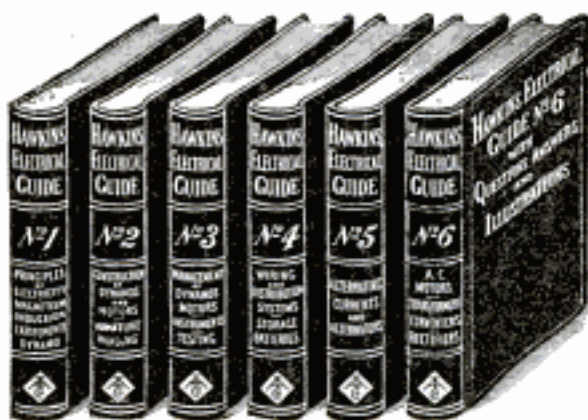

"That's Just What I Need"

HERE is a set of books that no man in the ELECTRICAL FIELD should do without. This is the ELECTRICAL AGE in which we live; ELECTRICITY now controls more trades, directs more men, offers more opportunities than any other power that man has yet discovered. Do you wish to know the underlying principles of **Modern Electrical Practice**?

If so, **HAWKINS ELECTRICAL GUIDES** will give you the information. In reality they are a school within themselves, containing a complete study course with **QUESTIONS, ANSWERS AND ILLUSTRATIONS**, written in plain everyday language so that a practical man can understand.

The How, When and Why of Electricity

Read over the titles shown on the back of each volume, and note the scope of each book. They are handsomely bound in flexible black leather with gold edges and will readily go in the pocket. **They are not only the best, but the cheapest works published on Electricity.**

Each book is complete in itself and will be supplied \$1.00 per copy, but we believe that the complete set is the best bargain. The books can speak for themselves and a careful examination, page by page, and illustration by illustration, will convince you of their big value. If you will fill out the following coupon giving all the information requested, we will submit the six volumes for examination on conditions named.

Feb. 15
Pop. Mech.

Please submit me for examination the **HAWKINS ELECTRICAL GUIDES** (Price \$1 each). Ship at once prepaid the 6 numbers; if satisfactory I agree to send you \$1 within seven days and to further mail you \$1 each month until paid.

Theo. Audel Co., 72 5th Ave., New York—Free Examination Offer

SIGNATURE

OCCUPATION

BUSINESS ADDRESS

RESIDENCE

REFERENCE

Become a TRAFFIC EXPERT

Learn at Home



UNLIMITED POSSIBILITIES ^{PAY}

Thousands of large shippers and all Railroads need trained Traffic Experts and Managers—newly created positions are open with salaries of \$35 to \$200 weekly. The demand for trained men is greater than the supply. Recently enacted railroad rate laws and interstate commerce regulations have produced new conditions that necessitate trained specialists—men who know how to route shipments, to obtain shortest mileage, quickest deliveries—lowest rates. With such knowledge you can qualify for an important, big-salaried position with a future—quick.

WE TRAIN YOU BY MAIL

at home, in spare time, without giving up your position or income. The cost is small—we make the payments to suit you. All you need, to get into this powerful, big paying occupation is our training. No matter where you live, what you work at now, how small your pay, how long your hours—no matter what your age or education—if you can read and write intelligently—our Interstate Commerce Course will train you expertly to handle profitably a big Traffic job—to merit and retain influence, respect, power and puts you in way to earn \$35.00 to \$200.00 weekly.

MOST THOROUGH METHOD KNOWN

The LaSalle method is simple, practical, logical—anybody can readily master it. It is the work of some of the greatest Traffic Experts in America. It covers thoroughly every feature of the profession you will ever need to know—it is different and more complete than any other method of home-training in Interstate Commerce ever known. This is the largest home-study Extension University in the world—our graduates are recognized as real experts—they are trained to do the kind of work that commands big positions.

NEW, UNCROWDED OCCUPATION

This is a new, uncrowded occupation—there's room for you if you prepare at once. Let us train you now for a big future, with power, dignity, respect and a big income, with almost unlimited opportunities. Don't remain in a small job that thousands of men are constantly after—let us make you the master—the big man—a successful leader among men.

FREE—Wonderful Book

Send the coupon below now and receive free copy of our much-talked-of book "10 Years Promotion in One"—learn more about the opportunities afforded Traffic Experts with our training—learn about the big opportunities now open—learn how easy it is for us to make you a traffic specialist. Remember only trained men can secure the big positions now open—remember that big employers are seeking trained and competent office men. Send the coupon—no money.

La Salle Extension University, Chicago

La Salle Extension University, Dept. C413 Chicago, Ill.

Send at once, without expense to me, FREE copy of your famous book "10 Years Promotion in One"; also book telling how I may, without interfering with my present position, prepare myself as Traffic Expert.

Name

Address

Occupation



Learn a Paying Profession

that assures you a good income and position for life. For twenty years we have successfully taught

PHOTOGRAPHY

Photo-Engraving and Three-Color Work

Our graduates earn \$20 to \$50 a week. We assist them to secure these positions. Learn how you can become successful. Terms easy—living inexpensive. Write for catalogue—NOW!
ILLINOIS COLLEGE OF PHOTOGRAPHY, 999 Wabash Avenue, Effingham, Ill.

New York Electrical School

THE only school in the world devoted to teaching every angle of Electrical Industry by "actual practice." All ages from sixteen to sixty enter this school on the same level and are shown "how" and "why" in a manner that ensures absolute success.

No preparation needed to become a "learner" in this school. You can start this Course any day of any week throughout the whole year. Drop a postal card for free Catalogue. We particularly desire to have it known that all VISITORS are heartily welcomed at this unique training institution.

44 West 17th Street, NEW YORK
PHONE CHELSEA 2633

TRADE SCHOOL

COURSES

Machinist, Automobile Mechanist, Chauffeur and Manual Training. Courses with little book study but much shop work give just the practical training needed to qualify for good paying jobs. Save a year's time. Automobile, Machinist and Manual Training Courses, 48 weeks. Chauffeur Course complete in 12 weeks—general knowledge of the auto—how to drive and locate trouble in car. Special 6 weeks' driving course. Engineering. Low fees and living costs. For catalog address
Geo. P. Magill, Pres., Highland Park College, Des Moines, Ia.

The University of Chicago

HOME STUDY

in addition to resident work, offers also instruction by correspondence.

For detailed information address

23rd Year U. of C. (Div. 20) Chicago, Ill.



DRAWING

Learn by mail. Cartooning, Newspaper, Magazine and Commercial Illustrating, Water Color and Oil Painting. Free Scholarship Award. Write for Illustrated Art Annual.
FINE ARTS INSTITUTE, Studio 752 Omaha, Neb.



Learn the Auto Business

Earn a Splendid Salary



By practical experience we train you for a good position as automobile mechanic, salesman or chauffeur. Over 3,000 graduates are earning big salaries. Complete training in 4 weeks, including extensive practice in repairing and driving high powered cars. Tuition and board reasonable

Send today for free catalog and list of graduates

Cleveland Automobile School
2338 Euclid Ave., CLEVELAND, OHIO

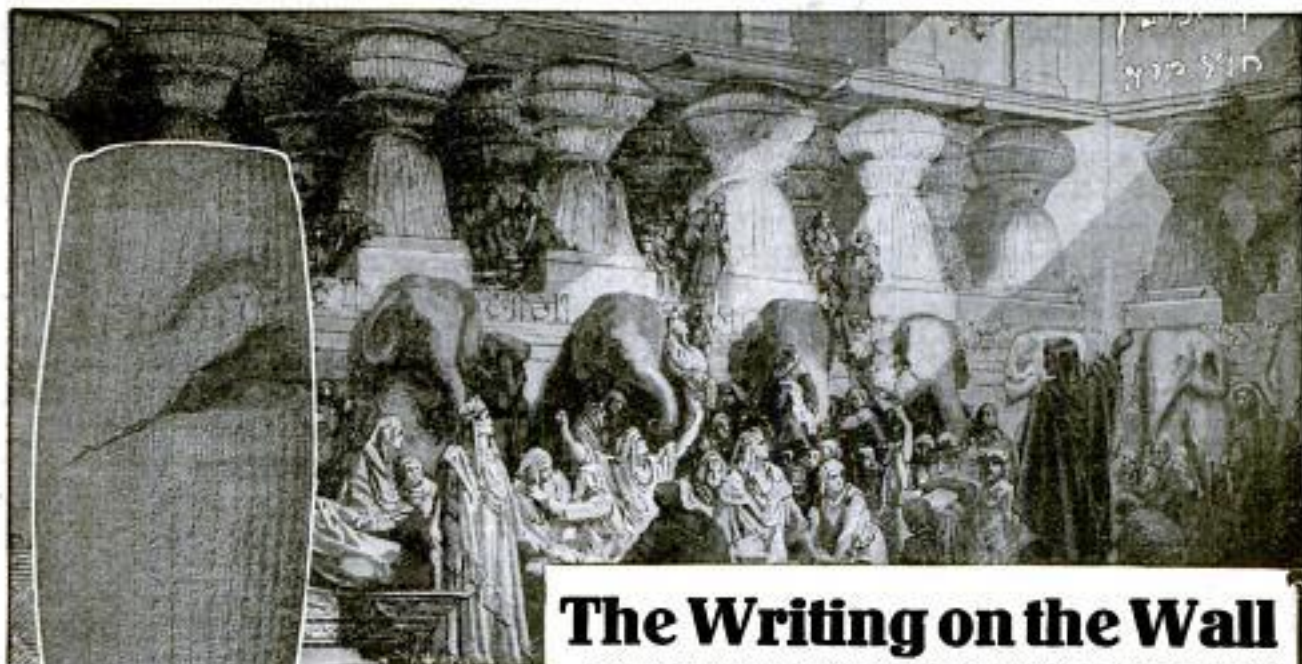

Terra-cotta cylinder containing Cyrus' own story of the "Fall of Babylon"

The Writing on the Wall

It was at the famous feast of Belshazzar, King of Babylon, that the prophet Daniel read the awful dictum—"Mene, Mene, Tekel Upharsin." That night Cyrus and his army captured the city, but not until thousands of years later was unearthed the inscribed cylinder that told the real story of the "Fall of Babylon." This curious account is but one of many thousand "original documents" contained in the marvelous work

The Library of Original Sources

now for the first time available to the general public. This remarkable Library had previously been sold by subscription, but by purchasing the *entire unsold edition* from the publishers we secured it at an *absolutely unheard of reduction*. Therefore we are able to offer a few sets to POPULAR MECHANICS readers at

AN EXTRAORDINARY BARGAIN

Send us the attached coupon AT ONCE, and we will tell you how to get the Library on EASY MONTHLY PAYMENTS, and mail you FREE a book of rare documents showing curious inscriptions of the Ancients. Remember there are only a limited number of sets, so act quickly. Mail the coupon NOW. You assume no obligation. No salesman will call. The book is FREE.

THIS MARVELOUS WORK is revolutionizing modern thought. It gives the authoritative, rock-bottom sources of our knowledge on ALL SUBJECTS OF HUMAN INTEREST from the earliest civilization down to today—the inside facts which the average person has never even heard of.

OVER 100 RESEARCH SPECIALISTS spent 10 years gathering the contents of this great work. Ancient and remote and forgotten civilizations in all parts of the globe were uncovered, and age-buried hieroglyphics on monuments, tablets, sun-baked bricks and palimpsests yielded their secrets; untiring workers ransacked the hidden literature of every age, ancient, mediæval and modern, to find these "original documents." Nothing like it has ever been attempted or thought of before. You'll be amazed at the wealth of information this unique library contains.

DO YOU KNOW that the old Egyptians 5000 years B. C., had a Bible? Do you know that the Assyrian sacred literature gives the story of the Creation? Do you know that books and newspapers were printed in Asia thousands of years before printing was invented by Gutenberg? Did YOU ever read Columbus' personal log of his great voyage—filled with strange happenings and ominous forebodings? Do you know that there occurred in Mediæval England a great Socialistic protest? Do you know by what unique process Harvey demonstrated the circulation of the blood? Do you know who Machiavelli was, or what world famous treatise he wrote?

YOU'LL FIND THEM ALL—and thousands of others equally as curious and important—in The Library of Original Sources. Every document is in the exact words of the original, translated; every contribution is from the actual eye-witness or person who took part; every idea is in the words of the thinker, discoverer or inventor.



MAIL THIS COUPON FOR FREE BOOK

15 PM

University
Research
Dept. G
Milwaukee, Wis.

Send me the FREE book of rare documents, showing inscriptions of the Ancients and tell me of your easy payment offer. I assume no obligation, the book and all you send me is to be free, and no salesman is to call.

Name.....

Address.....

STUDY LAW

AT HOME

Become an LL.B.

Only Law School of its Kind in America

Special and Exclusive Features

ONLY recognized resident law school in the United States conferring Degree of Bachelor of Laws—LL.B.—by correspondence. ONLY law school in U. S. conducting standard resident school and giving same instruction, by mail. ONLY law school giving over 450 class-room lectures to its extension students. ONLY law school giving a full 3-year, University Law Course, by mail, having an actual faculty of over 24 prominent lawyers in active practice. ONLY law school in existence giving Complete Course in Oratory and Public Speaking, in conjunction with its law course.

Written Bar Guarantee

We give an absolute written guarantee to prepare our students to pass bar examinations.

The Hamilton College of Law is a regular, thoroughly recognized, bona fide College of Law and NOT an "institute," "correspondence school," etc. It occupies the entire third floor of the New Advertising Bldg., where its large and commodious resident class-rooms and executive offices are located.



Our Degree Bachelor of Law, LL.B. NOT a Diploma or Certificate

Direct From Class-Room to Student



From Lecture Room to Student
No Other Law School Can Do This

The illustration shows the way we teach law. We are the only school doing this. Our system of teaching is intensely interesting; not dull and dry like the average law course. Our system of conducting examinations is the most thorough, complete and expensive (to us) of any examinations ever given. A student can, if he chooses, take part of our course by mail and finish in our resident school where he will receive full credit for all work done by mail. Our resident school is recognized by all standard law schools in the United States.

The Hamilton College of Law is highly endorsed and recommended by Government Officials, Business Men, Noted Lawyers, Graduates, and Students. We have as students a number of practicing lawyers (not graduates of recognized law schools) who are now earning their degree of LL.B. Many other lawyers are using this course as a review. A probate Judge, one of our active students says: "I am delighted with the course prescribed and your method of teaching law. It is far in advance of what I expected to receive."

Our Law Library

consists of 24 volumes of Student's Standard Text Books, two volumes bound together under one cover, making a total of 12 books. These books were prepared at an enormous cost especially for the students of the Hamilton College of Law, by one of the largest and best law book publishers in America. This is the only set of law text books ever prepared exclusively for student's use. We would be glad to have you submit these books to any lawyer or judge in the country and get his opinion regarding them.



These 12 Volumes are Free to Students

Mail Coupon Today

and get our Big, Beautifully Illustrated Prospectus and complete information. Place you under no obligations whatever. This may mean the turning point in your career.

Hamilton College of Law, 327 Advertising Bldg., Chicago, Ill.

Gentlemen: Kindly send me your Illustrated Prospectus and full particulars regarding your method of teaching law by mail.

Name.....

Address.....

Write plain and in full

Please Mention Popular Mechanics

Learn to Write

I Teach by Mail

I CAN make a good penman of you at your home during spare time, no matter where you live or how poorly you now write. My simplified system has shown thousands of others the way to good penmanship during the past twenty years—it can and will do the same for YOU!

Beautifully Illustrated Book
"How to Become a Good Penman"

It contains general information, with testimonials and beautiful specimens of penmanship showing what others have accomplished by the Tamblin System. **FREE!** (Your name elegantly written on a card if you enclose stamp for postage.) WRITE TODAY. Address

F. W. TAMBLYN
418 Meyer Bldg., Kansas City, Mo., U. S. A.



VIOLIN MANDOLIN GUITAR or CORNET

FREE FINE TONE

To introduce our wonderful new system of teaching note music by mail, Violin, Guitar, Mandolin, Piano, Organ or Brass Band, will give you a dainty instrument absolutely FREE and guarantee to make you a player or no charge. Complete outfit FREE. Special offer to first pupil. Write at once. SLINGERLAND'S CORRESPONDENCE SCHOOL OF MUSIC, Dept. 29, Chicago, Ill.

Big Money for You!

BUILDING, SELLING AND REPAIRING AUTOMOBILES

We train you by mail in few easy lessons, and give you exclusive agency for "Coey Junior," World's Champion Light Car. Write immediately and learn how you can get one of these speedy little roadsters.

OFFER STRICTLY LIMITED. HURRY! A POSTAL WILL DO.
C. A. Coey's School of Motoring, 212 Coey Bldg., Chicago



Coey Junior

DRAWING

Cartoons, Cartoon, Comic, Commercial, Fashion, Newspaper and Magazine illustrating taught by mail. Illustrated book 5c in stamps. THE BOSTON SCHOOL OF DRAWING, 755M Boylston St. BOSTON, MASS.



LEARN JEWELERS' ENGRAVING

A high salaried and easily learned trade, taught thoroughly by mail. We will teach the beginner better engraving than he can gain in years of rigid apprenticeship. We will also improve the skill of any engraver. Send for our catalog. The Engraving School, 112 Page Bldg., Michigan Ave., Chicago, Ill.

Be a Traveling Man

Hundreds of good positions now open. No experience required to get one of them. Write today for list of openings offering opportunities to earn Big Money selling goods while you learn and testimonials from hundreds of our students who are earning \$100 to \$200 a month. Address nearest office. Dept. 507

NATIONAL SALESMEN'S TRAINING ASSOCIATION
Chicago, New York, Kansas City, San Francisco

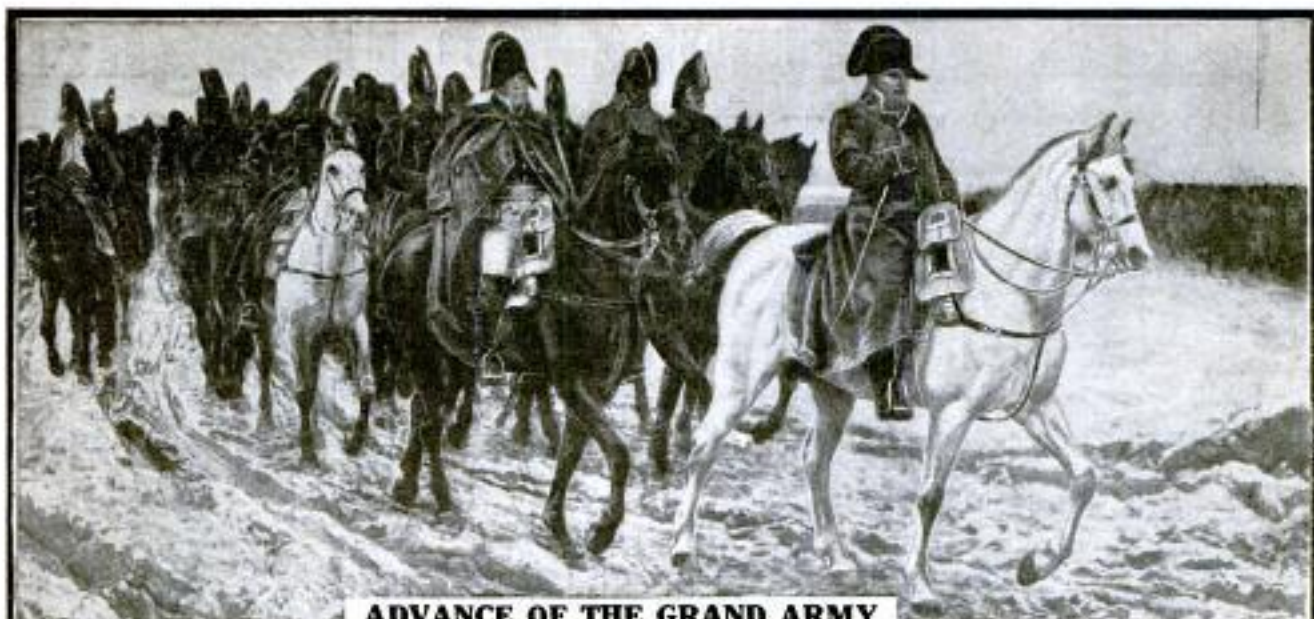

ADVANCE OF THE GRAND ARMY

NAPOLEON'S name fills more pages in the world's solemn history than that of any other mortal. The advance of his Grand Army into Russia is the turning point of his career and marks the beginning of his downfall. Mighty armies are once again marching over the same battle-fields where Napoleon fought a hundred years ago. The picture shown herewith from Ridpath's History is one of the 2000 in the work and illustrates but one event of all the thousands fully described in the world-famed publication

Ridpath's History of the World

Dr. John Clark Ridpath is universally recognized as America's greatest historian. Other men have written histories of one nation or period; Gibbon of Rome, Macaulay of England, Guizot of France, but it remained for Dr. Ridpath to write a History of the entire World from the earliest civilization down to the present day.

Never Again Such A Book Bargain

We will name our special low price and easy terms of payment only in direct letters. A coupon for your convenience is printed on the lower corner of this advertisement. Tear off the coupon, write your name and address plainly and mail. We do not publish our special low price for the reason Dr. Ridpath's widow derives her support from the sales of this History, and to print our low price broadcast would cause injury to the sale of future editions.

Six Thousand Years of History

Ridpath takes you back to the dawn of history long before the Pyramids of Egypt were built; down through the romantic troubled times of Chaldea's grandeur and Assyria's magnificence; of Babylonia's wealth and luxury; of Greek and Roman splendor; of Mohammedan culture and refinement to the dawn of yesterday. He covers every race, every nation, every time and holds you spellbound by its wonderful eloquence. Nothing more interesting, absorbing and inspiring was ever written.

The European War

If you would know the underlying causes which have led up to this conflict, the great racial antipathies, the commercial rivalries, the sting of past defeats, the vaulting ambitions for world empire, then embrace this opportunity to place this History in your home.

Ridpath's Graphic Style

Ridpath pictures the great historical events as though they were happening before your eyes; he carries you with him to see the battles of old; to meet kings and queens and warriors; to sit in the Roman Senate; to march against Saladin and his dark-skinned followers; to sail the southern seas with Drake; to circumnavigate the globe with Magellan. He combines absorbing interest with supreme reliability.

**WESTERN NEWSPAPER ASSOCIATION
CHICAGO**

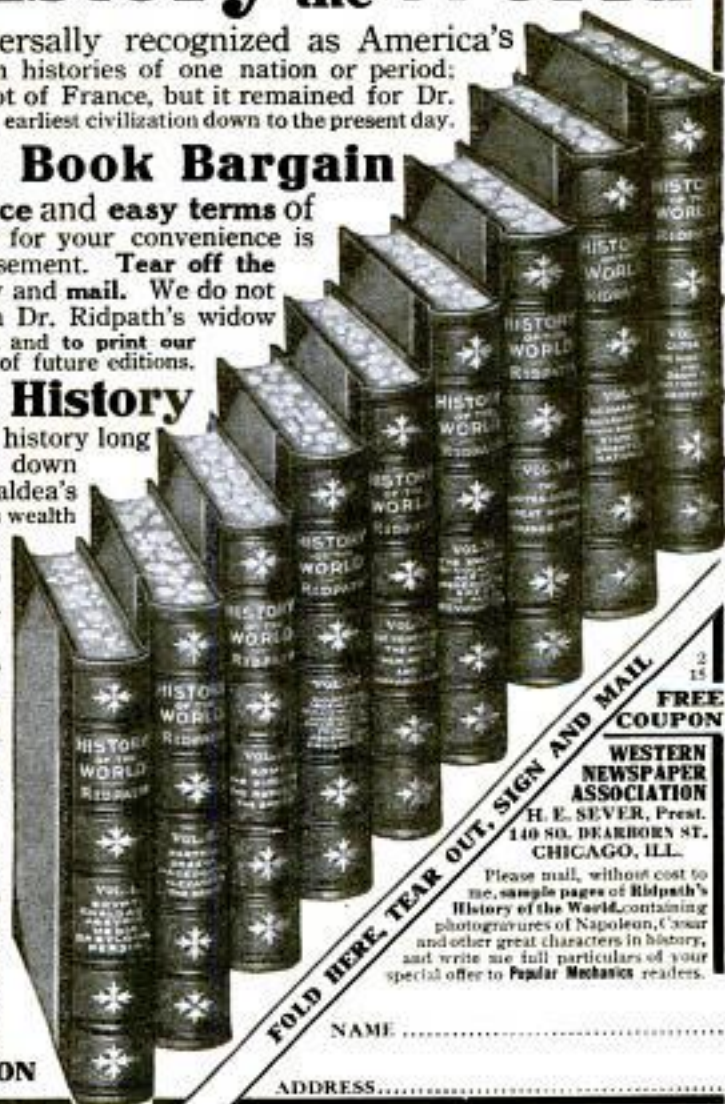

FOLD HERE, TEAR OUT, SIGN AND MAIL

2
15
**FREE
COUPON**

**WESTERN
NEWSPAPER
ASSOCIATION**
H. E. SEVER, Pres.
140 SO. DEARBORN ST.
CHICAGO, ILL.

Please mail, without cost to
me, sample pages of Ridpath's
History of the World, containing
photogravures of Napoleon, Caesar
and other great characters in history,
and write me full particulars of your
special offer to Popular Mechanics readers.

NAME

ADDRESS



Chief
Draftsman
Dobe, formerly
with Krupp
Gun Works,
Essen,
Germany

Krupp Gun Designer Will Teach You Drafting

THE draftsmen who design the great German Krupp guns are known all over the world as leading experts of the profession. The Krupp Company puts them to the most severe tests and very few men can qualify. I am proud to say that I passed the examinations and for several years held the position of designer with this wonderful world-renowned works.

I am now Chief Draftsman of a large and well-known company. In my spare time I will train a few ambitious men in practical drafting and designing. I will give you the practical training that I have found to be essential to success—the kind of training that the big companies demand—and I will continue this training just so long as you need it—until you are satisfactorily filling a position as a regular draftsman. Send coupon for a blueprint proof from a drawing made of one of the Krupp guns.

Men Are Needed

There is an urgent demand for skilled draftsmen.

Positions paying \$125 to \$175 are open this very minute, and employers are looking for men who have had practical training. This is the kind of training I will give you, and that kind of working training will qualify you for the highest salary. Send the coupon and I will tell you about the big things other men are doing whom I trained personally. Here is an opportunity that come to but few.



SIZE
20x25
INCH

**\$15.00 Outfit
FREE**

Yes, I will give you a complete set of regular Draftsman's instruments absolutely free. They are just the kind of instruments the Krupp expert draftsmen use. You could not buy them for less than \$15. But I know that good draftsmen must have good tools. And any man who gets my personal training is going to have the knowledge that makes him capable of holding one of the high-salaried positions.

Blueprint Proof of Krupp Gun Free

Send the coupon now. I will send you absolutely free a blueprint of a drawing of one of the big Krupp guns. See how the work is done by the master draftsmen in the great Krupp works. I will also tell you how I can train you to become a high salaried draftsman during your spare time—right in your own home—and I will send you the new book, "Successful Draftsmanship," all absolutely free. Send your name and address today—now.

Chief Draftsman, Dobe
Div. 1192
Engineer's Equipment
Company
Chicago, Ill.

This illustration will give you some idea of how complex the work of Krupp Draftsmen really is. One of the expert Krupp Draftsmen will teach you Drafting in your own home during your spare time. Send the coupon for blueprint proof of Krupp Gun and full particulars of special limited offer.

Free Offer Coupon Chief Draftsman Dobe

Engineer's Equipment Co. Chicago, Ill.
Div. 1192

Without any obligation to me whatsoever, please mail your book "Successful Draftsmanship." Also send me a blueprint proof from a drawing of a Krupp Gun and full particulars of your liberal "Personal Instruction" offer to a few students. It is understood that I am obligated in no way whatever.



Name

Address

Please Mention Popular Mechanics

CLASSIFIED ADVERTISEMENTS

We have records to prove that a classified ad in these columns will find a buyer for almost anything which can be sold. Doubtless you have some article of value to some one else which you no longer need. Why not turn it into money?

Advertisements in this section, 15 cents per word, each insertion, minimum 10 words, payable in advance. To insure ads being inserted under proper classified head in the March issue, copy must reach this office not later than February 1st.

Popular Mechanics Magazine, Chicago, Ill.

Gentlemen: We are sorry not to be able to renew the classified advertisement of S. Sterling, for the reason that the four-line insertion in your October issue has to date brought over five hundred inquiries, which are more than we can use, and a considerable number will probably come from the November insertion. The writer cannot understand this amazing return from your columns. Getting inquiries at approximately a cent apiece—and inquiries, in the main, of a very good type—has not happened before in a somewhat extended experience with classified space. Very truly yours,

THE PROCTOR & COLLIER CO.
Advertising Agency.

AUTOMOBILES

PAINT Your Car Yourself—Save \$25 to \$75 by doing the work at home with the Arsenal system. Our big free booklet "The Car Beautiful" tells how. Send for it today. Arsenal Varnish Co., Dept. P, Rock Island, Ill.

AUTOMOBILE Instruction—\$55.25. Four weeks' course. Best equipped school in the country. Men enrolled from all parts of the U. S. Boudlet P. M. on request. West Side Y. M. C. A., 318 West 57th Street, New York.

AUTOMOBILE Repairs made from Maine to Florida and California. Cylinders reground or rebored, new pistons and rings fitted. Accuracy guaranteed. Worn or broken parts duplicated. Specialists in welding of all metals. Write us. Everts Machine Company, 14 Hicks Street, Hartford, Conn.

YOU can earn an auto by my new, easy plan; anyone over 16 years old can get a brand-new Ford Touring Car for a little easy, respectable work among neighbors. Free Book tells all about it. Postal brings it. Send Auto Tom, 647 S. 16th St., Omaha, Nebr.

SAVE cylinder reboring; use Sta-Lite rings, 90¢ each; R. H. Steering gears, complete, \$10; Pressed steel frames with kick up, \$15; Motors—4x5 "L" Head, \$150. Grossman Auto Parts Company, White Plains, N. Y.

AUTOMOBILE parts for any car made, tremendous quantity in stock at all times; send description of what you want. Gifford Auto Parts Co., 28 West 33rd St., Bayonne, N. J.

ELEGANT five-passenger touring car \$150. Excellent condition, Model N Ford roadster, good running order, \$85. George Willis, Canal Dover, Ohio.

SAVE dollars in repairs and your anti-freezing solution by using Newman's Perfection Radiator Compound. Positively and permanently stops leaks without injury to radiator or engine parts. Send 20 cents for large sample. Salesmen wanted. P. A. Newman, Manufacturer, Brownsville, Texas.

"THE How and Why of the Automobile"—A 200-page book of practical information for seekers after the fundamental facts regarding the gasoline engine and its application to the motor car. Interesting and instructive to both the beginner and the expert. Bound in full cloth—250 illustrations. Price \$1 postpaid. Popular Mechanics Book Dept., 6 N. Michigan Ave., Chicago.

\$25 DOWN. Write for installment proposition and latest bargain bulletin, describing over 100 automobiles and easy payment plan. Eureka Auto Co., Rebuilders, Beavertown, Pa.

FORD cylinders rebored, fitted with 4 oversize pistons, 12 rings, 4 wrist pins, 8 bushings. Cost of complete job \$15. Delivery in 24 hours. Every job guaranteed. Everts Machine Company, 14 Hicks Street, Hartford, Conn.

THE Last Word in Automobile Literature—New Book. "The Modern Gasoline Automobile," 700 6x9 in. pages, 500 illustrations, is superior to any treatise heretofore published. Deals with every modern improvement. Price, \$2.50 postpaid. Popular Mechanics Book Dept., 6 N. Michigan Ave., Chicago.

AUTOMOBILE Repairs—Automobile owners, Garages and Repairmen should subscribe for the Automobile Dealer and Repairer; 100-page illustrated monthly devoted exclusively to the care and repair of the car. The only magazine in the world devoted to the practical side of motoring. The "Trouble Department" contains five pages of questions each month from car owners and repairmen which are answered by experts on gasoline engine repairs. \$1 per year, 15¢ per copy. Postals not answered. Charles D. Sherman, 50 Windsor Road, Hartford, Conn.

LIFE and Money Saver—Send \$1 and make of automobile to "Vapor Gasket Co., Erie, Pa." Satisfaction or money back. Agency?

FOR Sale—New Hudson Light Six-40 (\$1,050). E. F. Aubrey, Ottawa, Ill.

CYLINDER Regrinding—First-class equipment, fifteen years' experience, and specializing in this work enable us to do high-grade work at lowest prices. We manufacture the "Neverleak" individual cast piston rings. Prices will interest you. Bridgeport Piston Ring Co., 346 Connecticut Ave., Bridgeport, Conn.

STUDEBAKER 30, late "1912" fore-door touring, looks and runs like new, \$250. Also Studebaker "20" runabout \$150. Others from \$75 up. Automobile Buyers Association, 2407 Walton Ave., New York City.

CYLINDERS scored by piston pin, restored to original shape; use same piston. No welding. Cobb Machine Shop, 2935 Detroit Ave., Cleveland, Ohio.

AUTOMOBILE SUPPLIES

AUTO Engg.—60 H. P. Thomas \$160, 45 H. P. Stoddard-Dayton \$100, 25 H. P. Oswald \$75, 45 H. P. Royal Tourist \$75, 2-cyl. air-cooled De Luxe \$50, 2-cyl. Maxwell, 2-cyl. Buick, and Type 10 Buick parts for sale. Auto Salvage Co., 1436 Wab. Ave., Chicago.

TIRE—3,500 miles guaranteed, and guaranteed tubes, 28x3, \$8.50, tube, \$1.80; 30x3, \$9.40—\$1.90; 30x3½, \$12.50—\$2.75; 32x3½, \$13.25—\$2.80; 34x4, \$17.50—\$3.90; 36x4, \$18.95—\$4.15; 35x4½, \$22.50—\$4.95. Non-skid 10% more; other sizes, prices accordingly. Write for bargain sheet, 10% with order, balance C. O. D. Examination allowed. Para Auto Tire Co., 1417 Michigan Ave., Chicago, Ill.

FOR Sale—Second-Hand Gasoline Engines, list 29. Lucas & Son, Bridgeport, Conn.

RADIATOR mascot. Handsome 10 inch nickel plated bronze Chauviere model Aero-plane propeller, ready for attachment to silver cap. Postpaid \$1. Stephens Co. Engineers, Bond Boulevard, Chicago.

SHOP Vulcanizer, Bargain. Tires at cut prices. Vanderpools, Springfield, Ohio.

USE an Air-Friction 1914 Model "C". Increases power and economy of motor one-half. Absolutely impossible to choke or load. Uses distillate, gasoline or half kerosene with finest results. Starts easily in coldest weather. We fit all motors, guaranteeing definite results or refund money. Exclusive county rights. Liberal exchange on other carburetors or old-style Air-Frictions. The Air-Friction Carburetor Co., Dayton, Ohio.

BALL and Roller Bearings, all makes. We are Engineers and Specialists in Bearings, we repair ball bearings. The William Company, 1789 Broadway, New York.

AUTOMOBILE Cylinder Rebores, including piston and rings \$7 to \$11. Sterling Engine Co., 331 S. Clinton St., Chicago, Ill.

AUTO Parts—Build or repair your own car, as we can furnish parts for any make of car at cut prices and discounts. State your wants to Grossman Auto Parts Company, White Plains, N. Y.

FOR Sale—Schaler vulcanizer, nearly new, \$40. Otto Zorn, Troy Grove, Ill.

PRESTO tanks \$12.50, \$10 horns \$5; 6-100 Batteries \$10. Magneto \$5-\$10. Get bargain list everything. O'Brien, 6550 State, Chicago.

AT Bargain Prices—Send for our monthly bargain list on new and used dynamos, lamps and electric equipment for automobiles and boats. The Esterline Co., 234 E. South St., Indianapolis, Indiana.

OXYGEN Decarbonizer—Big money is being made by cleaning cylinders by this new method. Write for descriptive matter. Bateman Bros., Centerville, Ia.

ALL kinds Automobile Parts bought and sold. State what you want or desire to sell, with price of same. Motor Parts Listing Company, Detroit, Mich.

CARBURETORS, slightly used, Schebler, Stromberg and Rayfield, 1-inch \$6; 1¼-inch and 1½ inch \$8 each. Conditions guaranteed. Henry A. Currier, Auburndale, Mass.

GET our prices on new and used magnetos and coils. Inventory sale. Any magneto repaired. Pellet's Magneto Exchange, 1606 Michigan Avenue, Chicago, Illinois.

FRONT and rear shaft and chain-drive axles, wheels, cone clutches, steering gears, etc. Badger Motor Comp'y, Milwaukee, Wis.

RECTIFIERS for garages. All sizes. Charge one to eight batteries, \$12 upwards. American Battery Company, 1129 Fulton St., Chicago.

FLEXIBLE Metal Automobile Tubing for carburetors, wire covering, exhaust pipe, tire inflating, speedometer shafting and protector, and air, water, gas, steam, oil and grease conveyors. Get catalog. Breeze, Newark, N. J.

MOUNT power vacuum cleaner on your auto. Buy parts, assemble, \$50 cost—earn \$15 daily. Vacuum Supply Co., Ann Arbor, Mich.

"NEW Touring and Roadster Bodies for most any small or large car. All kinds of Auto parts to build a car." New Ford Touring Tops \$16. Nicholds, Detroit, Mich.

AUTOMOBILE cylinders reground and fitted with new pistons and rings for \$7 to \$11 per cylinder. We do this class of work exclusively and produce highest grade of work. Crown Machine Shop, Crown Point, Ind.

GENERATORS for batteries. Garagemen investigate our low voltage system for recharging automobile batteries. Garage Equipment Co., 919 Locust St., Des Moines, Ia.

4 CYLINDER 35 h. p. Automobile Motor complete \$40. Box 275, Burlington, Wis.

WELDING

VULCAN Oxy-Acetylene Welding and Cutting Plants are most advanced, economical and efficient known. Torch uses less oxygen for best results, made for difficult work. Hundreds of mechanics making more money by our process than ever before. Complete welding and carbon-burning apparatus, the best ever sold at price, \$75.00. Experts say our Instruction Book on welding and cutting is best. New third edition almost double former size, price \$1.50. Write us today. Vulcan Process Company, Minneapolis, Minn.

EARN \$1000 a month. The Admiral Welding Equipment, with Decarbonizer, Supplies and Instruction Book outfits you for conducting a general welding business. You can't buy a better outfit. Handles any class of work. Many of our customers have earned the cost the first week. We conduct the largest Job Welding Shop in Kansas City, and use this equipment exclusively. Booklet Free. Admiral Welding Machine Company, 1322 Walnut St., Kansas City, Mo.

IF your car hasn't the compression and power it once had, you'll probably find that your cylinders are worn or scored and need regrinding. We've reground thousands of cylinders in our six years' experience and can refer to pleased customers everywhere. Advise make of car and bore diameter, so we may quote. Do it now before you forget. Waterbury Welding Corporation, Waterbury, Conn.

WELD your own castings. Save time, freight charges, and keep the profits yourself. Big profits, small investment. Write today for free 32-page book on welding. Welding Apparatus Co., 211 National Union Bldg., Toledo, O.

FORD ACCESSORIES

FORD Accessories for Less. T-Handle Grease Cups for replacing oil cups, 14c each; Fan Belt 25c; Valve Grinders 31c; Valve Stem Adjuster 29c; Steering rod Anti-Battler 58c. Postpaid. Ask for state agency offer. Lowe Supply Co., 102 So. Spring St., Los Angeles, Cal.

FORD owners, send \$15 for 4½-lb. guaranteed Starter with Primer. Agents, write for exclusive sales proposition. Suite 406, 1779 Broadway, New York.

MOTORCYCLES, BICYCLES & SUPPLIES

PRE-INVENTORY Sale on Slightly Used Motorcycles. We have about 30 left to sell, in standard makes, which we are offering at big bargains, such as twin and single cylinder Indians, Yales, Harley-Davidsons, Merksels, Thors, Excelsiors, Pops, 4-cylinder Hendersons and others. We will accept 10% deposit and store the one you select free to May 15th; this will save you 35% by buying now. Write to-day for our list giving description and prices. Gotham Sporting Goods Co., 57 Warren St., New York City.

TWIN Excelsior, 1914 model, good as new. Presto light. Good tires. \$160. Ross Tullis, 600 South Cedar, Abilene, Kansas.

1914 TWO Speed Excelsior, guaranteed perfect condition, \$185. Run 500 miles. Looks like new. \$25 with order, balance C. O. D. Ray Hindenbach, Parsons, Kans.

1915 EAGLE 2 Speed 12 and 16 Horsepower used machines, all makes, rebuilt, guaranteed \$40 up. Get list 112. Agents wanted. South Side Motor Works, 4365 Cottage Grove Ave., Chicago, Ill.

1914 INDIAN 7 Horse Power Twin, new in August, will sell for \$145 complete. 1 Four Horse Power Red Indian Magneto, excellent condition, \$95. Geo. Buss, New Philadelphia, O.

1913 MERKEL 7 Horse Power, excellent condition, \$135. White Thor 7 Horse Power, \$145. Howard Amos, New Philadelphia, O.

EQUIPPED Harley-Davidson, two speed twin, like new. Side-car. Bargains. Dr. Lewis, Bennington, Vt.

NEW 4 Cylinder Pierce Arrow motorcycle with magneto \$75. Lucas & Son, Bridgeport, Conn.

1913 FLYING Merkle, Brand new condition; fully equipped. To sell quick—\$130. This is the sweetest bargain of the new year. Send for photo. David Stern Co., 1047 W. Madison St., Chicago.

SINGLE cylinder Pierce, like new, \$90. Thor single battery model, 60. Overhauled and in A1 condition. Send for list, \$25 deposit, balance C. O. D. Thor Motorcycle Co., 356 Columbus Ave., Boston.

SIXTY used motorcycles, all makes, must be sold. Cheap for cash. Opportunity ripe for buyers. Steeber & Hothelns, Buffalo, New York.

LOWEST prices on New and Used motorcycles. Ask for list M. Prices \$29 up. Rebuilt Motorcycle Department, 891 Centre Street, Brockton, Mass.

For Sale—4-h.p. chain-drive motorcycle. Good condition, \$75. J. R. Wynn, Chiefland, Fla.

HENDERSON 4-cylinder, first class running condition. Fully equipped and guaranteed. Price \$125. M. P. Woodward, Coldwater, Mich.

HARLEY-DAVIDSONS—Twin cylinders, thoroughly overhauled, \$110 to \$175. Get list. Kinse Bros., 912 Third, Louisville, Ky.

MUST sell my Pierce four-cylinder two-speed motorcycle, just overhauled, in perfect condition throughout; first check over one hundred dollars gets it. Frank Walters, 452 E. Delevan Ave., Buffalo, New York.

INDIAN Magneto Model, fully equipped like new, \$40. Motors \$15, Spark-Plugs 15c, Long Leather Leggings 75c. Heitger Carburetors \$3.50. Crankhangers complete \$1. Electric Motorcycle Horns. Wandersee Company, 129 Gratiot, Detroit, Michigan.

MOTORCYCLES of various descriptions and all makes from \$25 to \$200. Mostly high-grade used machines in first-class condition. Please write us for list and description. C. H. Lang, 1704 Michigan Ave., Chicago.

LIVE agents wanted in open territory for the new 1915 line of Eagle motorcycles. Write for circular and proposition. Act quick and make good money as our local representative. Sterling Motor Company, 720 Centre Street, Brockton, Mass.

RELIABLE place to buy dependable used motorcycles, all makes, \$25 up. Guaranteed as represented or money refunded. Write for winter lists and terms. Few brand-new 1914 Thor twins, greatly reduced prices. Thor Motorcycle Co., 356 Columbus Ave., Boston, Mass.

\$50 TO \$150 buys the best Motorcycles, every make and model, in our large stock—must be cleared. Half price. Send for list today. Talking Machines \$5 and up. Brown Music Co., 9119 Commercial Ave., Chicago, Ill.

WINTER Bargains: Second-hand motorcycles, 1914 to 1914 models of all makes, \$25 up. Each machine guaranteed. Write for descriptive catalogue and price, bicycle and accessories. Wash. Motorcycle Clearance House, S. E. Cor. 6th and G., Wash., D. C.

BIG bargains in good motorcycles we have taken in exchange on new ones. Send for special bargain list. Shaw Mfg. Co., Galesburg, Kansas.

MOTORCYCLES—your own price, all makes. Write for list, 109 N. 12th Street, St. Louis, Mo.

SUPPLIES—Our big catalogue with prices lower than usual sent free to motorcycle owners. Meco. Hammesdsport, N. Y.

SEND for latest Bulletin of real Motorcycle Bargains, used and slightly used, all makes, models and prices; if you have \$25 and really want a powerful Motorcycle, send for this Bulletin; hundreds of machines at all prices, new ones on easy payments; tell us what you want and how much you can pay; we can fix you up. Peerless Motorcycle Co., Dechester, Mass.

BIG bargains in second-hand motorcycles, \$25 up. Indians, Harleys, Thors, Excelsiors and Merksels. Write for descriptions. Howard A. French & Co., Baltimore, Md.

REAL Motorcycles for \$25 to \$50 less. All standard makes, rebuilt as good as new. 100 to select from. Send for free list. Western Supplies Co., 1450 Larimer, Denver, Colo.

MOTORCYCLE parts and accessories at reduction prices. First quality pedals complete one dollar per pair. Send for bargain list. Grossman Auto Parts Company, White Plains, N. Y.

USED Motorcycles, all makes. Send for list. Ward Brothers, 212 Broadway, Camden, N. J.

BARGAINS—75 used motorcycles, all makes, overhauled in good order, good tires. Send for list. Mueller Cycle Co., Milwaukee, Wis.

SAVE \$35 on 1915 Thor, any model; sickness, sacrifice \$100, credit for \$65 check. O. S. Halch, 137 W. Lewis St., Ft. Wayne, Ind.

USED Motorcycles—Real Bargains—All Makes—Several late models slightly used. Send for descriptive list. Pendleton, Norwich, Conn.

DON'T buy a Bicycle Motor Attachment until you get our catalogue and prices. Shaw Mfg. Co., Dept. 27, Galesburg, Kansas.

METZ, two cylinder, good order, \$50. Bill Lundy, Berwick, Pa.

MY 1914 Two-speed Excelsior twin in first-class condition. No use. Price \$160, \$25 down, balance C. O. D. Otto Maxton, 637 Alder St., Scranton, Pa.

CHEAP—2-cylinder, 7 H. P. Flying-Merkel, 1913 Model. Nearly new. Cost \$265. Tires and everything in perfect condition. Only \$97 takes it. A. L. Stangland, Alta, Iowa.

NEW Motorcycle Book—Just Published—Motorcycles, Side Cars and Cyclecars, Their Construction, Management and Repair—550 pages, cloth, 350 illustrations. The Dealer, Mechanic and Rider will find this treatise a work of reference without an equal. Price \$1.50 postpaid. Popular Mechanics Book Dept., 6 N. Michigan Ave., Chicago.

1912—7 H.P. TWIN Merkel, Thoroughly overhauled. Including equipment \$150, cost \$325. Without equipment \$125. R. W. Pellett, Danielson, Conn.

CYCLECARS

NEW Serrips-Booth \$250. Complete, top windshield, Electric equipments. Wandersee Company, 129 Gratiot Avenue, Detroit, Michigan.

CYCLECAR MATERIAL

CYCLECAR Friction Transmissions, Aluminum disc, tarred fiber wheel, Roller bearings. Guaranteed. Cogswell Manufacturing Co., Hall St., Springfield, Mass.

CYCLECAR parts: busted prices. Write for circular. Act at once. Address Motorette, Hartford, Conn., U. S. A.

AERONAUTICS

GET the world's largest and most explicit Aeronautical catalogue, just off the press. Sent anywhere for 6 red stamps. Heath Aerial Vehicle Co., Chicago, Ill.

GUARANTEED World's Record Models. Plans. "Axis" hydro-aeroplane, "Champion" Racer, 35 cents each. "Record" Flying-Boat, flies 600 feet, 50 cents. Catalog 2 cents. Walter H. Phipps, 503 Fifth Ave., New York.

THE most complete aeronautical motor catalog in the world, now off the press. Send 3 red stamps. Heath Aerial Vehicle Co., Chicago.

BEST and lowest priced aeroplanes, motors and propellers. Bates, 104 Oak, Chicago.

LIGHT Weight, Gasoline Engines, 2½ lbs. Guaranteed ¼ H. P. The Weiss Co., Torrington, Conn.

HEATH Propellers for air, water and land; represent the survival of the fittest. Five years of propeller production proves perfection. Three stamps brings our propeller catalogue. Heath Aerial Vehicle Co., Chicago.

LEARN Aviation by mail; complete preparatory course by Russell Shaw, well known aviator of Shaw Aeroplane Co., Indianapolis.

GUARANTEED World's Record Models—Drawings "Axis" Hydro-aeroplane, "Champion" Racer, 35 cents each. "Record" Flying-boat, flies 600 feet, 50c. Send stamp for catalog. Walter H. Phipps, 503 Fifth Ave., New York.

COMPLETE Plan, drawn to scale, with precise instructions for building a Curtiss 3-foot Model Flying Boat, 25c. Other plans: Bleriot, 15c; Wright, 25c; Newport, 25c; Curtiss Hydro, 35c; "Peep" Racer, 25c. Set of six, \$1.25. 48-pp. Model Supply catalogue, 3c. Ideal Aeroplane Co., 82½ West Broadway, N. Y.

HOW to Make a Biplane Glider—Our book "Amateur Mechanics No. 2" contains a complete detailed description of how to make one. Price of book, 25c postpaid. Popular Mechanics Book Dept., 6 N. Michigan Ave., Chicago.

FOR Sale: 6 cylinder, 75 h.p. Roberts aviation motor in good condition with propeller and radiators, \$475 cash. National Aeroplane Company, Machinery Hall, Chicago.

89 H. P. Eight-cylinder V-type air-cooled aeroplane motor with equipment, \$295. Badger Motor Company, Milwaukee, Wis.

BUILDING and Firing an Aeroplane—168-page handbook covering the building of small models and full sized gliders and machines. In both biplane and monoplane models the well-known Curtiss and Bleriot types are followed. Fully illustrated with detail drawings. Price, \$1 postpaid. Popular Mechanics Book Dept., 6 N. Michigan Ave., Chicago.

FOR Sale, genuine Bleriot with fifty horse power Gnome Motor. Louis Horn, 3128 Mozart Ave., Cheviot, Ohio.

CONTEMPLATE opening aeroplane school and exhibition business in the spring. If interested, write, Aeroplane Co., 563 W. 63rd St., Chicago.

AVIATION motors up to 150 H.P., from \$250 up. Complete aeroplanes from \$500 up. Iceboats, motor-sleighs, from \$500 up. Aero Exchange, 35 Park Row, N. Y. C.

BLERIOT, without motor, nearly finished, \$75. G. L. McCarthy, 18 Pleasant St. S. E., Grand Rapids, Mich.

BOOKS AND PERIODICALS

"THE World's History at a Glance." A History and Geography combined—as necessary and useful as a dictionary. Three dollars postpaid. Ask us how, for a few days, you can secure this wonderful book without cost. We want your recommendation. The Ball Publishing Co., 1290 Summer St., Boston, Mass.

MATHEMATICAL Revelation of the 20th Century. All Arithmetical and Geometrical Calculations solved with ease, accuracy and great saving of figures by latest method of Cancellation. 145 pages. \$1 postpaid. Satisfaction guaranteed or money refunded. Herrick & Horton, Publishers, Princeton, Ill.

WORLD'S Best Self-Educational Books (and Periodicals); Electrical, Mechanical, Agricultural, Sciences, Chemistry, Business, Art, Literature, Languages; any subject. Lists 6c. Explain subject thoroughly. C. Higene Co., N2441 Post St., San Francisco.

FREE! Send for a copy of the best magazine published on hunting, trapping, fur-farming, dogs and all outdoor sports. A postal will do. Hunter-Trapper-Trapper, Box 39, Columbus, Ohio.

"SHE," dandy book, 25c. Catalogue, 2c. Duff, 2713 Mozart, Chicago.

ENGINEERS' questions and answers for license, by Hobson, for twenty-five cents, postpaid. Send stamps. Reilly's Book Store, Philadelphia, Pa.

METAL Work and Etching—A 96-page hand book for art metal workers telling how to make a great variety of useful and ornamental objects, such as desk sets, artifacts, jewelry, etc. Price, 50c postpaid. Popular Mechanics Book Dept., 6 N. Michigan Ave., Chicago.

"BOY Electrician," a new, practical book, 10c. Enterprise Co., PM-1102 Morton Bldg., Chicago.

INSTRUCTION Books, Automobile, Inventors', Electricity, Engineers', Jewelers', Machinists', Plumbers' (best published), Lamont Co., Beacon, New York.

SEND stamp for our book "How to Make Patents Profitable." Benjamin & Bassett, 141 S. Dearborn St., Chicago, Ill.

WAR Books—A careful selection of all the most vital and trustworthy books on the great European War situation. Send for complete descriptive list free. Popular Mechanics Book Dept., 6 N. Michigan Ave., Chicago.

FREE Catalog of Mechanical Books—Our 96-page catalog of 560 books on 160 different subjects will show you where to find that particular information you are in need of on any mechanical subject. Send for it today. Popular Mechanics Book Dept., 6 N. Michigan Ave., Chicago.

BOOKS, the rare kind; send 2c stamp for large list. A. H. Stogun Publishing Company, 320 Tompkins Ave., Brooklyn, N. Y.

"OXYACETYLENE Flame and Its Uses"—The most complete instruction book upon welding shop practice ever published, \$1, prepaid. Admiral Welding Machine Co., Kansas City, Mo.

HOBBIES Magazine; also tools for intensely interesting Antiofretwork, Scrollwork and Home occupations. W. R. Price, New York.

BOYS—10c brings our 9x12 illustrated boys' magazine, one year. Canada, 20c. Dandy stories, Mechanics, Electrics, Stamps. Youth's Magazine, 3633 Ogden, Chicago.

CORRESPONDENCE courses and technical books bought and sold, cut rates. C. A. Bubbs, Detroit, Michigan.

SELL "United Guide," 40% profit. Guide in mail-order business. Value \$1.00, sample with proposition 25c. W. P. King, Little Silver, New Jersey.

BOOKKEEPING, Rapid Calculations, Expert Auditing, 25c in stamps. Garfield Commercial School, 1016 Germantown Ave., Philadelphia, Pa.

EDUCATIONAL AND INSTRUCTION

TRAINED Advertising Men demand, and get, \$2,000 to \$8,000 yearly. We have trained hundreds and can train you. Greater openings every day. Let us tell you how to qualify. Particulars free. Powell School, 1920 Meyerowitz Bldg., N. Y. City.

25c COIN BRINGS you copy of my complete instructions for increasing the vocabulary and enriching the conversation. J. Greenberg, 25 Lewis St., New York City.

WRITING lessons for home practice. Over 250 copy lines, postpaid, 50 cents. Circulars free. Patrick Commercial School, Desk 6, York, Pa.

SELF instruction in steam, gas, electrical, mechanical engineering, mechanical drawing, etc. Write for particulars. Address T. H. Knight, Racine, Wis.

WEST POINT, Annapolis—Appointments; examinations. Booklet, complete instructions for entering, 25c. Baker Pub. Co., Rochester, N. Y.

ARTIFICIAL marble, sanitary flooring, ornamental casting, concrete, plaster, papier-mache composition, interior, exterior decorations, garden furniture, statuary, life casting, etc. Making elastic moulds; complete instructions \$1. Particulars and 200 illustrations free. Mahler, 117 Russell St., Brooklyn, N. Y.

LEARN Transphotography—Make transparent photographs on watch dials, chinaware, etc.; instructions 25c. Cabecajahub, Station B, Buffalo, N. Y.

SUCCESS! How? Study at home; fit yourself for a better paying position through one of our 60 courses, including Business, Normal, Kindergarten, Agriculture, Engineering, and Law. Thousands of successful graduates. Chartered 1903. Write for free 30-page catalog, stating instruction wanted. The Modern School of Correspondence, San Francisco, Cal., Dept. M.

BOOKKEEPING—Complete course in bookkeeping, taught by an expert auditor and accountant; small fee; individual instruction. Full particulars, address Edger S. Tolmie, 1643 Park Ave., Chicago.

DO you need help? Chemical questions answered. Formulas. Technical advice. Frederick Wirthman, Chemist, Kansas City, Mo.

EIGHTEEN Ways to Make Money! Interesting isn't it! If you are mechanically or electrically inclined don't fail to write for our free book. Efficiency Company, 104-A, East 16th St., New York.

BOOKKEEPING in six lessons—A brand new book prepared especially for those who desire to learn the Fundamental Principles of Bookkeeping without spending the time and money necessary to attend a business college. Satisfaction guaranteed or money refunded. Paper, \$1; Cloth, \$2. Frederick W. Morton, 1248 Brooklyn Ave., Detroit, Mich.

LEARN Mechanical Drafting. Cost small. Returns large. Individual instruction by expert. Garfield Drafting School, 525 West 134th St., New York City.

LEARN Brave Belgians' Language. Study Hugo's French Course. Money-making preparation for immigrant influx. Sample lesson 25c. Burgoyne, 902 World Building, Vancouver, Canada.

WANT to secure a marine or steam engineers' license? For that great class of ambitious and hard working men, the oilers, coal-passers, watertenders, firemen or anyone who wants real practical and useful information regarding the every-day operation of a steam plant, Chief McAlistair of the U. S. Revenue Cutter Service has written an engineering story called "McAndrew's Floating School," that makes it possible for those who have not had previous training to absorb the necessary information. Cloth, 250 pages and 37 diagrams. Price, \$2. Popular Mechanics Book Dept., 6 N. Michigan Ave., Chicago.

IRREGULAR handwriting changed to a rapid business style by mail. Journal free. F. B. Courtney, Box 492, Detroit, Mich.

LEARN to letter attractive show-cards in six short lessons (by mail). Personal instruction—no failures. Write for information now! M. E. Tice, Frankfort, Ind.

TRADE SCHOOLS

YOUNG MAN—Learn the plumbing, heating, ventilating trade from practical work on jobs. Good position for students. Write for particulars. Litchfield Trade School, Libertyville, Ill.

PAINTING, Decorating, Paper Hanging taught by actual practice. Free catalogue. Chicago School of Painting, 150 West Austin Ave., Chicago.

MAKE \$5 to \$8 a day as skilled Electrician, Plumber, Draftsman, Bricklayer, Moving Picture Operator. We teach you in short time at small expense, profitable trades. Free employment bureau places graduates in good jobs. Special limited offer now. Write at once for catalogue and full particulars—no obligations. Dept. 8192, Coyne National Trade School, 51 E. Illinois St., Chicago, Ill.

AUTOMOBILE instruction. A complete home study course that shows you exactly what you want to know about the automobile, 220-page book, giving definite, thorough, authentic and practical detailed information about every part of the automobile as well as thorough instruction in regard to driving, repairing and general care of the complete car. 190 illustrations, \$1.50 postpaid. Popular Mechanics Book Dept., 6 N. Michigan Ave., Chicago.

TELEGRAPHY

TELEGRAPHY taught in the shortest possible time. The Omnigraph Automatic Transmitter combined with standard key and sounder. Sends you telegraph messages at any speed just as an expert operator would. Five styles, \$2 up, circular free. Omnigraph Mfg. Co., 41 G. Cortland St., New York.

TELEGRAPHY—Morse and Wireless—also Station Agency taught. R. R. and Western Union wires and complete Marconi Wireless Station in school. Graduates assisted. Marconi Co. employs our wireless graduates. Low living expense—easily earned. Largest school—established 40 years. Investment \$25,000. Correspondence courses also. Catalog Free. Dodge's Institute, 15th St., Valparaiso, Ind.

WIRELESS

500-MILE receiving sets, \$2. Variable condensers, 60c. Stamp for circular. Daniel Russell, 134 Glenwood Ave., Jersey City, New Jersey.

WIRELESS Set. How to Make—96-page book telling how to construct at small cost an outfit suitable for transmitting four or five miles. Price, 50 cents, postpaid. Popular Mechanics Book Dept., 6 N. Michigan Ave., Chicago.

PICTURES, POSTCARDS, PENNANTS

MYSTIC Photos—Photos without a camera. Now before considered possible. Marvelous results. Entertains and astonishes. Makes pictures instantaneously. Trial sabbies or money back. Send 10c for samples. Enough for 32 pictures. Alpha Co., Longbeach Building, New York.

EXCHANGE pretty postcards with our members far and near. Best card club, Membership, 10c. Jolly Card Exchange, Box 126, Decatur, Indiana.

IF you really want to exchange postcards, try our splendid club. Lists circulate in many countries. Membership, 10c. Halcyon Club, Box 133, Erie, Pa.

PANAMA and Canal. Also coins, minerals, curios, novelties, 3c for list. Willoughby Culbertson, 72 P. Cristobal, Canal Zone.

MEMBERSHIP in press immediately, 10c. Pacific Card Exchange, Bryn Mawr, Wash.

BOOKS and Art Photos. Sample of either, 10c; both 15c. Globe Co., Box 39, Ann Arbor, Mich.

ART Poses. Rare Imported Models: samples and catalog, 10c. Girard Novelty Co., Pawtucket, R. I.

STUNNING Photos of pretty girls. Real "Beauties." Very clear. Set, 25c. Renzleit, Stone St., Newark, N. J.

RECEIVE Post Cards from everywhere. Join our jolly club. Send 10c. H. J. Teeple, Decatur, Indiana.

PHOTOS—Fascinating subjects. 10 for 25c. Duff, 2713 Mozart, Chicago.

3,000 SELECTED Pictures for \$3. A Panorama of World Events. Political, Industrial—Social—Humorous—Tragic—all of intense human interest. A wonderful collection of 3,000 cartoons reproduced from the newspapers of the United States, Canada, Mexico, Cuba and the cities of the Old World, has been made by Cartoons Magazine from more than one hundred and fifty thousand published cartoons, and, bound in an artistic and durable cover, are now ready for your library table. Vol. I, Jan.-June, 1912—\$1. Vol. II, July-Dec., 1912—\$1. Vol. III, Jan.-May, 1913—\$1. Cartoons, 6 N. Michigan Ave., Chicago.

CROSS-SECTIONAL view of ocean liner "Britannic," showing interior arrangement of ship in colors, size, 14x20 inches, on heavy plate paper for framing or hanging. Very interesting. Reproduced from front cover design of July issue Popular Mechanics. Will be sent postpaid to any address in the world on receipt of 4 cents in stamps to cover packing and mailing. Popular Mechanics Magazine, 6 N. Michigan Ave., Chicago.

BETTER than "September Morn'g" Two new pictures by same painter. These and "September Morn'g" silver quarter. Box 592, Minneapolis, Minn.

ROCKY Mountain Views, 10c each. C. R. Birch, Casper, Wyo.

SIX Little Masterpieces: attractive, interesting, 20c. Joseph Tucker, 1233 Arch, Philadelphia, Pa.

JOIN Postcard Exchange; membership 10c. David Cota, Mancelona, Mich.

EXCHANGE pretty postcards with our members in far-off lands. Membership, 10c. Elise Exchange, R31, 3827 North Kenneth, Chicago.

20 PHOTOS of beauties taken from life for 10c. Kay I. Co., Box 57, Ottawa, Ill.

UNIQUE Mail Order Plan and Kodak picture of Giant Royal Palm Trees of Florida for a dime. C. C. Wall, 2100 N. Tremont St., Kansas City, Kansas.

POSTCARDS—Showing Female Beauties in attractive poses. Imported; hand-colored; no trash. Catalogue and one sample 10c. Ritz Publishing Co. (Not Inc.), Dept. 43, Chicago.

GIRLS Bathing; genuine photos. Splendid samples (postcards), 25c. "Real" goods. G. Olivo, Willmar, Minn.

10 CLASSY Postcards and Catalogue 10c. Stewart Co., Providence, R. I.

REAL Photos of Pretty Girls, samples and catalogue, 10c. E. L. Sun Co., Harrison, Mich.

LARGEST card exchange. Big membership. Results guaranteed. No cheap club. Membership 10c. World Wide Card Exchange, Book Building, Oceanic, N. J.

FIFTY high grade post cards Free. Send 10c today for postage on special samples and big bargain offer to The Ritz Sales Co., New Brunswick, N. J.

SIX photo postcards and one 8x10 of the Panama-Calif. Exposition, 50c. No stamps. P. S. Daniels, 1298 13th St., San Diego, Cal.

If you like "Real Fascinating" pictures, books, novelties, etc., send dime for sample hand-tinted photo of beautiful girl in "Bewitching Pose" and illustrated catalogue, sealed. You'll want more. Williams Publishing Co., 721-C North Dearborn, Chicago.

BEAUTIFUL Oriental Dancing Girls. 6 pictures 10c. L. Comstock, Charlestown, N. H.

CAMERAS AND PHOTO SUPPLIES

WE buy, sell and exchange. Bargains in Microscopes, Telescopes, Binoculars, Cameras, etc. Bargain list sent. Kahn & Son, Opticians, No. 54 John St., New York. Established 62 years.

SEND any photo and \$1, we will send retouched negative and material to make 50 photographs. Guaranteed. Pursell, Albuquerque, N. Mex.

FILMS developed 10c, all sizes. Prints 2 1/4-3 1/4, 3c; 2 1/4-4 1/4, 3 1/4-5 1/4, 4c; Post Cards, 50c doz. Work guaranteed and returned 24 hours after receiving. Postpaid. Send negatives for samples. Girard's Commercial Photo Shop, Holyoke, Mass.

BIG Money Saved on Photographic Lenses and Apparatus—poods exchanged; repairing done. Ralph J. Golsen, 65 East 46th St., Chicago, Department P.

WHY not equip your camera with the best Anastigmat at the lowest price? Rodenstock Emrysars have stood the test. A trial cheerfully granted. Send for description. Laflury Co., 305 North Fifth Ave., Chicago.

FILMS developed 10c; prints 3c to 5c. Take no chance on bathroom finishing; send to a reputable Incorporated Company conducting largest plant in existence. Price list and special offer. Enlarging our specialty. Chicago Photo Finishing Co., 54 W. Lake St., Chicago.

ARE your spare moments utilized to your advantage? Why not learn Photo-Coloring? The cost is very small. Send for circular. Kell-Burr Company, 56P Pine Street, New York.

SEND us 10 of your favorite Kodak negatives, any size; we will print one picture from each negative for a total of 40c (stamps). This is only a trial offer and is made to show our high-class finishing. Will also develop any size roll films and furnish one print each for 10c. 8x10 Kodak mounted enlargements, 25c. Roanoke Cycle Company, Roanoke, Va.

GET prices for enlarging, developing, printing and copying; work guaranteed. King's Studio, 4526 Jefferson, Kansas City, Mo.

FOR Sale—3A Graflex; first-class condition. Cost \$125, will take \$75. Oliver, 2334 S. Juniper St., Philadelphia.

25 FORMULAS for latest fads in photography, 25c. Includes disappearing photos. Phosphorescent photos. Trick pictures; simple enlarging apparatus. Transferring to cloth, chinaware, etc. Satisfaction or money back. P. Benson, Stewartville, Minn.

KODAK Films Developed, 10c per roll, any size. Prompt attention given mail orders. Prints, 2 1/4x3 1/4, to 3 1/4x4 1/4, 3c; 4 1/4x5 1/4, 4c. J. M. Manning, Box B, 1662 Third Ave., New York City.

HAVE You a Camera? Write for Samples of my magazines, American Photography and Popular Photography, which tell you how to make better pictures and earn money. F. R. Fraprie, 683 Pope Bldg., Boston.

SAVE 40% on Photo Paper from factory, prepaid. "Instanto" has a sparkling quality no other gaslight paper possesses, quick printing develops easy. Money back guarantee. Send 25c for 3 dozen postals or 4x5 size, price list and full directions. Photo Products Co., Dept. J, 6100 La Salle St., Chicago.

SPOT Cash paid for high-grade Kodaks, Lenses and Cameras. Send full description stating lowest price. Cameras exchanged. In business since 1885. David Stern Co., Dept. M, 1947 W. Madison St., Chicago.

ROLL Film developed, 10c a roll. Packs 20c each; Prints, Brownies, 2c; 1a, 3x4, 3x5, and Post Cards, 3c each. Work returned next day. Postage paid. Kodak Film Finishing Co., 112 Merchants Station, St. Louis

MOTION PICTURES

WRITE Moring Picture Plays, \$25 to \$100 for each photoplay, work in spare time. Particulars free. Palmer-Cherney, 2810 Franklin, St. Louis, Mo.

AMERICAN Cinematograph Motion Picture Camera, 200 ft. capacity. Good as new, cost \$225. Sell for one-half. F. E. Slocum, 406 Main, Peoria, Ill.

\$35 PROFIT Nightly—Moring Picture Business—small capital starts you, no experience needed. Teach you—furnish everything. Ralph J. Golsen, 65 E. 46th St., Chicago, Dept. M.

CASH for Moring-Picture Plays, Stories, Poems. Write Photoplay Pub. Co., D61, St. Louis, Mo.

MAKE \$100 to \$300 weekly in the morning-picture business. No experience necessary. Small capital required. We furnish everything. Large illustrated catalog free. Monarch Film Service, Dept. G, 228 Union Avenue, Memphis, Tenn.

OUR Guide gives 100 companies buying photoplays, short stories, poems. Tells kind each wants. A key to success. Postpaid \$1. Money back if dissatisfied. Gordon Publishing Co., 894, Cincinnati, Ohio.

WE accept manuscripts in any form; criticize free; sell on commission. Quick sales; big prices. Don't waste money on "Instructions," etc. Write us. Story Revision Co., Box 37, Smethport, Pa.

\$50 TO \$100 weekly writing moving picture plays. Send for free booklet, valuable information and special prize offer. Chicago Photoplaywright College, Box 278 T. B. Chicago.

"HOW to Write and Where to Sell Photoplays" is a new book. Contains model scenario. Price 25c. Enterprise Co., 1162-PM, Morton Bldg., Chicago.

WRITE Moving Picture Plays, \$50 each. All or spare time. Correspondence course unnecessary. Details free. Atlas Publishing Co., 304, Cincinnati, Ohio.

MAKE a complete Motion Picture Camera and Projector from instructions given in our book Amateur Mechanics No. 4. Full details given. Not hard to construct. Worlds of enjoyment taking and exhibiting subjects dear to the heart. Price of book only 25c postpaid. Popular Mechanics Book Dept., 6 N. Michigan Ave., Chicago.

BIG money writing motion-picture plays. Experience unnecessary. Best instruction on market, 50c. Free personal instruction. Look after sale of all you write. Yeager, Paton, Pa.

MOVING Picture Machines, new, \$75. Films most any subject, 1c per foot. Davis Exchange, Watertown, Wis.

I GUARANTEE \$10 for first photoplay you write by my method. As former scenario editor, I speak with authority. Send for free booklet, "How to Write Photoplays." Elbert Moore, Box 772 P. N., Chicago.

MOTION Picture Films for sale, \$3 reel up. Box 417, Montpelier, Vermont.

FREE—A Course in Photoplay Writing. Write to the Enterprise Co., P.M., Morton Bldg., Chicago.

MOTION Picture Work—A large 618-page book covering every phase of the moving picture, its production and its theatre. Indispensable for reference and instruction to the thousands of workers in the motion picture field. Price \$3, postpaid. Popular Mechanics Book Dept., 6 N. Michigan Ave., Chicago.

BUSINESS OPPORTUNITIES

\$130 HAS been earned in 3 days by our representatives, some even better. Introducing our new advertising method which solves the advertising problem for merchants in smaller cities and towns. If you are or want to be a salesman I will show you how to build up a big profitable repeat business quick. Whole or part time. Big money if you act now. Write Salesmanager, Winslow Cabot Company, 60 Congress Bldg., Boston, Mass.

OPERATE profitable Mail Order Book Business, 700% profit each sale; small outlay, everything furnished. Spare time. Particulars free. Rollins & Co., Box 5272, Boston.

EARLY to bed and early to rise. Work like h—l and advertise, with M & M sales letters. They have the punch; they land the orders. Martin & Miller, Advertising Counselors, 229 Fourth Avenue, New York.

\$75.00 WILL start very profitable business in your town. Up-to-Date Advertising Company, 161, Winnipeg, Canada.

BIG Kansas Company will start ambitious man or woman in fast growing business; any locality; \$3,000 yearly; spare time; no canvassing; no experience. We furnish everything. Write for unique selling plan. C. W. Eyestone, President, 174 E. 5th, Pittsburg, Kansas.

MAKE Big Money Opening Safes and Setting Combinations. Wayne Strong, Box 1139, Los Angeles, Cal.

INSTRUCTIONS for manufacturing six big sellers and 100 business opportunities only 10c. Address: The Ritz Sales Co., New Brunswick, N. J.

READ "Booster" and make more money! Operate Mail Order business during your spare time. We'll show you how! Special: Two months trial, 10c. Booster Magazine, Northwestern Bldg., Chicago.

MANUFACTURE profitable, fascinating Antofretwork novelties at home. Materials, tools, details. W. R. Price, New York.

LET the parcels post help you. Add (\$15 to \$25 weekly) to your present salary or income. Start during spare time and build up a permanent mail-order business of your own. We show you how and help you make good. No canvassing. Experience unnecessary. The Parcels Post makes success doubly sure. Our new ideas and up-to-date plans bring the money. No so-called "Course of Instruction" to sell. We give that free. Write today. Address: Pease Mfg. Co., Inc., Dept. A, 70 Broadway, Buffalo, N. Y.

RELIABLE Man with Small Capital can start a profitable business selling our guaranteed goods. \$200,000 firm and liberal credit plan backs you. Wm. J. Dick, Mgr., Dept. F-10, 20 West Lake, Chicago.

I GUARANTEE \$10 for first photoplay you write by my method. As former scenario editor, I speak with authority. Send for free booklet, "How to Write Photoplays." Elbert Moore, Box 772 P.G., Chicago.

BE Wise. Don't experiment in mail order. I can tell you how to succeed. B. Neunham, Waukegan, Ill.

300 WAYS to make money, 220 page book of valuable information, 25c (no stamps). Wm. D. Black, 72 Spruce St., S. Manchester, Conn.

SILVERING mirrors; 150 other money-making formulas; Digest one year, 25c. Digest, Grand Rapids, Mich.

80-PAGE mail-order advertising rate book—6c exact sealed postage. Kline Advertising Agency, Cleveland, Ohio.

START a Light Manufacturing business at home in spare time. Big profits, 150 money-makers 10c. Service Bureau, 3311-BC, Belleplaine Ave., Chicago.

FOURTEEN Big Circulares describing 800 plans, schemes—for making money—guaranteed Formula for renewing Old Dry Batteries (original price \$1.00), all for 10c. Northern, 154 West Randolph, Chicago.

WATCH and Jewelry catalog, illustrated, 16 pages, with your imprint; 500 for \$5. Walwen Co., 150 Nassau St., New York.

A BRILLIANT opportunity awaits you. Manufacture a household necessity in your own home, and make \$5.00 profit on each dollar invested. New England Sales Co., Stamford, Conn.

WE will start you in business cleaning either houses or clothing; small capital required; good income earned in towns of 2,000 and over. We manufacture electric and gasoline driven vacuum cleaners. Write today. Thurman Vacuum Cleaner Co., Dept. H., St. Louis, U. S. A.

RESILVERING mirrors, renewing dry batteries and book filled with formulas and trade secrets, all 25c. Formula Service, 3311-B, Belleplaine Ave., Chicago.

TWELVE years ago I started a small mail-order business at home in spare time with a few dollars capital. I wanted to make \$30 or \$40 a month, evenings. The net profits the first year averaged \$200 a week. Five years' work netted me \$50,000. I will show you how to start a small mail-order business. Send today for my proposition. It's interesting. No canvassing. Heseock, Box 857, Lockport, N. Y.

EARN \$7 daily, restoring faded colors in rugs and carpets. No capital. Particulars free. Eldred, D. 75, Detroit, Mich.

UTILIZE your spare time. Start a sensible mail business at home. Become your own boss. I'll show you how without advance payment. You pay my fee from profits. No success, no fee. Particulars free. Postage appreciated. Expert, 420 Home Bank, Baltimore, Md.

"DOLLARS" yearly in your back yard. No ginseng, mushroom dope. New ideas never before published, particulars free. Metz, M 306 East 88th St., New York.

MANUFACTURERS, Promoters and Patent Buyers are invited to write us stating the line of invention in which they are interested, as we can supply their wants in any class of patents. Victor J. Evans & Co., 162 Ninth St., Washington, D. C.

MANUFACTURE Typewriter and Other Inked Ribbons. Demand enormous. You can lease the wonderful little machine from us—we furnish material, teach you everything—also act as district manager, leasing machines to big consumers—small capital. Sample ribbon any machine, 25c in stamps. National Ribbon Inking Machine Co., General Offices, Tenth Floor, City Hall Square Bldg., Chicago.

WOULD You Like to Own a good-paying mail-order business? We have a line that gets repeat orders all the time. You can start in spare time; invest a dollar or two a week and soon own a nice business of your own. Particulars free. Nadico, 1664 Belmont Ave., Chicago, Ill.

INDEPENDENCE and fortune quickly attained in the Manufacturing Mail Order business. I furnish Formulas, Manufacturing Processes and Trade Secrets in all lines. Sold under positive guarantee; 18 years' practical experience. Revision and improvement of Formulas and Processes—reduction of manufacturing cost—utilization of waste materials, etc., a specialty. Booklet, Formula List, and Valuable Information Free. W. L. Cummings, Ph. D., 127 Standard St., Syracuse, N. Y.

STOP Here! Let me start you in a home business that will bring you money every day. Experience unnecessary. Spare time. No canvassing. I furnish everything. Send for proofs. Voorhies, Desk C. R., Omaha, Neb.

HOW to Operate a Mail Order Business. 30 Big Profit Plans and year's Mailing service sent for 10c. Mail Dealers Wholesale House, 521 Franklin Bldg., Chicago.

START a Mirror Factory!! We teach thorough methods! Trust you! 10c brings illustrated lesson! Prospectus \$5 daily, easily! Hullinger's Institute, Francesville, Ind.

ADVERTISEMENTS, Mail Dealers: Our 1915 Rate Book lists 2,000 Principal Publications, rates, circulation. Includes 30 Mail-Order Plans. Price 10c. Dearborn Advertising Agency, 210 Franklin Bldg., Chicago.

LEARN New Tartaric Mirror-Silvering Process—It Pays! Address Wm. Barstow, 513 23rd Street, Oakland, Calif.

THIS beats Illinois. Charters for stock companies lower than other states. Information free. Philip Lawrence, former assistant secretary of state, Huron, S. D., 101 Dakota Ave.

HOW to originate a successful mail order business. Particulars free. George Fenner, Louisville, Ky.

VALUABLE to M. O. Dealers, Agents—Herb Doctor Recipe Book and herb catalogue, 10c, worth dollars. Teaches how to make herb medicines for all diseases. Ind. Herb Gardens, Dept. 44, Hammond, Indiana.

I GET 30 to 40 letters a day, each containing a dime. You can do the same. Particulars 10c. Hoyer, Perry, Oklahoma.

START a Stock Food Co. Be independent. We tell you how. Leslie Cole Stock Food Chemists, Ewing, Mo.

PATENTABLE ideas wanted—Send for 3 free books. R. B. Owen, 30 Owen Bldg., Wash., D. C.

BUSINESS wanted for cash buyers. Send description and price. John B. Wright, Real Estate Expert, 1308 Adams Express Building, Chicago. Established 1881.

IF you want facts instead of fancies about Patents, address Benjamin & Bassett, 140 S. Dearborn St., Chicago.

GO into the cleaning, dyeing and pressing business. Big profits. Complete course only \$2. Edw. Ellis, Menominee, Mich.

EITHER sex earn \$5 to \$10 weekly in your spare time mailing circulars for responsible concerns. Detailed instructions, 12c. Wilks Mailing Bureau, Box 6411-G, Philadelphia.

WANTED—Men in every locality to open a Cleaning, Dyeing and Pressing Shop. Big profits. No experience or capital required. A. Lamar Specialty Co., Alliance, Ohio.

MAKE more money. How? Collect more money. Form 10 will do it. Write us. Associated Mercantile Representatives, St. Louis.

A BUSINESS of Your Own—\$10.00 daily profit. Make Koko-Wheat-Crisp. New confection. 5c package costs 1 1/2c. Sells everywhere. Repeater. Can of samples 10c. Free particulars. Cerneau Co., 541 No. Parkside, Chicago.

LEARN to collect money. Good income; quick results. Send for free booklet, "Skillful Collecting." Collectors' Association, Long Street, Newark, Ohio.

"MYSTERIES of Money" Dime. C. C. White, Hazelhurst, Miss.

OPERATE profitable mail order business. Instructive literature free. Autrey, 327-PM, Cuthbert, Ga.

START Profitable Mail Order Book Business. Further information and sample catalogue sent for stamp. Sheridan Co., 417 E. 151st St., New York.

I WANT to send you proof of the wonderful pulling power of Popular Mechanics classified pages. What's your proposition? Write me today. F. W. Johnson, Classified Dept., Popular Mechanics Magazine, 6 N. Michigan Ave., Chicago.

OWN a business. Co-operate with me evenings at home. Everything furnished. Don't worry about capital. Boyd H. Brown, Dept. K-2, Omaha, Nebr.

WRITE Moving Picture Plays, \$50 each. All or spare time. Correspondence course unnecessary. Details free. Atlas Publishing Co., 3046, Cincinnati, Ohio.

WE start you in business, furnishing everything; men and women, \$30.00 to \$200.00 weekly operating our "New System Specialty Candy Factories," home or small room anywhere; no canvassing. Opportunity lifetime; booklet free. W. Ragsdale Co., East Orange, N. J.

NEW way to paint signs. Our life-size patterns do the work. No experience required. Complete outfit prepaid, \$5. Satisfaction guaranteed. Butts Advertising Co., 15 W. 19th St., Kansas City, Mo.

YOUR advertisements placed in 133 different magazines; special price 5c per word. Lists free. King's Magazine, Box 1370, Little Silver, New Jersey.

FEW valuable, practical patents for sale; reasonable; fine chance. Saunders, 114 W. Van Buren St., Chicago.

DANDY home business. Comfortable living awaits anyone who investigates. Particulars free. Write President, 407 Park Pl., Milwaukee.

"THE Art and Process of Dry Cleaning." A very profitable business. Send for our booklet, 25c. Auburn Supply Co., Dept. D2, 745 Peoria St., Chicago.

CONDUCT a "Candy Kitchen." Clear \$1 to \$25 daily. Small capital required. Particulars free. The Kennon School, 143 W. Ontario St., Dept. A, Chicago.

FORMULAS and instructions for manufacturing six big sellers, and 100 business opportunities. Sent for 10c. H. B. Essex, Box 476, Baltimore, Md.

UNLIMITED Possibilities in Specialty Candy Manufacturing anywhere. We teach by correspondence, furnishing everything to start. Low price. Literature free. Gerlip, 1204 Broadway, New York.

ADVERTISE—21 words in 50 family weeklies, \$1. Cope Agency, St. Louis.

GINSENG Raising—Most profitable business in the world. Address Thomas C. Davis, Room 18, Wright & Bogart Bldg., Clinton, Ind.

PROFIT-Sharing Mail-Order Plan; absolutely new. Goods, literature furnished. DeLyle Distributing Co., Station B, Baltimore, Md.

INVENTOR'S Advocate, Washington, D. C. Best inventor's paper. One year on trial, 10c.

EARN more! Be more! Success literature and advice-letter free; will open your eyes to many new possibilities. Write today. Everts School, D-51, St. Louis.

WE will start you in the cleaning and dyeing business; little capital needed, excellent profits. Write for booklet, Ben-Vonde System, Dept. C, Charlotte, N. C.

PROFITS from foreign patents; offering quarter share for costs. Long-felt need effectively provided. Hascall, 578 Public, Providence, R. I.

BIG money-making opportunity. See page 165, advertising section.

WE can start you in a profitable business making big money placing Premium Punch Board Deals. Devote all or spare time. Small investment required. Washington Sales Co., Dept. C, Chicago.

\$5.00 PER day, spare time, small mail-order business; I do it, so can you. Complete plan and sample 25c. Satisfaction guaranteed. W. P. King, Little Silver, New Jersey.

WANTED—Names and addresses by mail-order houses; big pay; home work; information free. Direct Appeal Co., Drawer A, Plymouth, Ind.

RESILVER Mirrors and make money. Others are doing it. The best formula 25c. Auburn Supply Co., Dept. B2, 745 Peoria St., Chicago.

START a Manufacturing Business. - Make and sell your own preparations. No experience required. Big income. Our practical formulas do the work. 60 money-makers, 35c. Formula Service, 3311-B, Belleplaine Av., Chicago.

WE have several openings for establishment of independent mail-order business. Energy, good habits and sound judgment more important than capital. Spare time at first. Particulars free. Opportunities Exchange, Buffalo, N. Y.

MAIL ORDER SUPPLIES

SELL Joker's Novelties! 16 samples 10c. Chambers Works, Plainwell, Mich.

INCREASE your sales. Place your proposition before the readers of "Cartoons Magazine." 30,000 copies guaranteed every month. Classified rate 2c per word. Mail in a trial ad today. Cartoons Classified Dept., 6 N. Michigan Ave., Chicago.

SCHEME and particulars 10c. Star Exchange, Elon College, N. C.

PAN-AMERICAN INVESTMENTS. A. B. C. REPUBLICS, SOUTH AMERICA

CAPITALISTS desiring to investigate with the view to investing in Coal, Iron, Petroleum, Nitrate or Borax deposits, etc.; Mining Properties (Copper, Tin, Silver, Gold, etc.); Real Estate (large land tracts, Government or private, all forest, grazing or agricultural), located in the "ABC" and adjoining South American Republics, are invited to write for information, enclosing 20c in stamps, to T. Dennis Locking (Pan-American Real Estate Dealer), P. O. Box 1891, Santiago, Chile.

TO INDUSTRIAL ENTERPRISES, MANUFACTURERS, ETC.

GOVERNMENTAL and Municipal Franchises solicited in the "ABC" and adjoining South American Republics, water powers, etc.; bids presented for execution of public works, supplying materials, etc.; legal and commercial representation of manufacturers, reports on establishment of industrial enterprises. Ample and satisfactory references offered. Address, T. Dennis Locking (Pan-American Industrial Representative), P. O. Box 1891, Santiago, Chile.

DUPLICATORS AND DEVICES

A DUPLICATOR \$1.00. Letter size. Make over 50 copies from pen or typewritten original. Send for circulars, Selentek Laboratories, Dept. 1, Madison, Maine.

THE Modern Duplicator, made without glue or gelatine, is the World's Standard. Fifty to seventy-five exact duplicate copies can be made from each one you write or draw with pen, pencil or typewriter. \$2.40 to \$6.00 according to size. Booklet Free. Durkin, Reeves & Co., Mfrs., 239 Fifth Ave., Pittsburgh, Pa.

FOR ADVERTISERS

If you can increase your sales 15% with stronger trade letters, you lose money not to do so! M & M will give your field and your business exhaustive study, then construct letters that must bring you orders. Martin & Miller, Advertising Counselors, 229 Fourth Avenue, New York.

20 WORD advertisement and one year subscription 25c. Extra words 1c. Circulation 35,000. Digest, Grand Rapids, Mich.

ADVERTISERS—Here's your opportunity. Your proposition placed before the readers of "Cartoons Magazine" for only 2c per word. Circulation 30,000 copies guaranteed. Send a trial ad for our next issue. Cartoons Classified Dept., 6 N. Michigan Ave., Chicago, Ill.

YOUR 24-word ad in our big postcard magazine, 25c. Inch display, 50c. Elite Exchange, 3827 N. Kenneth, Chicago.

10,000 BOYS read our large, 9x12 magazine. Display 6c line, Minimum 7 lines. Classified, 1c word, Minimum, 25c. Two insertions 15% discount. Youths' Magazine, Chicago.

ADVERTISE in 133 different magazines: special price, 5c a word. Lists free. Write King's Magazine, Box 13-P, Little Silver, New Jersey.

PERSONAL

If you like "Real Fascinating" books, pictures, novelties, etc., send dime for sample hand-tinted photo of beautiful girl in "Sensational Pose" and illustrated catalogue, sealed. You'll want more. Williams Publishing Co., 721-B North Dearborn, Chicago, Ill.

GET valuable mail whole year, thirty cents. P. Cornish, Schenectady, N. Y.

ST-STU-T-T-ETING or Stammering. Let me tell you, by mail, how I cured myself, after 30 years of misery and failure. Discovered a natural method which anyone can use, at home. Since then have won social and business success. Send me your address, in confidence. Walter McDonnell, Drawer F511, Station-F, Washington, D. C.

"QUIT Tobacco" my harmless way. Quick—Secret—Pleasant—Inexpensive. Interesting Booklet Free. J. Bradford, Asheville, N. C.

BROTHER—Accidentally discovered root cures tobacco habit. Gladly send particulars. P. Stokes, Mohawk, Florida.

AGENTS WANTED

DISTRICT Managers: We Have An Organization of National Reputation, a high-class product essential to every merchant, a clean-cut method of doing business. We will give the right men as big an opportunity as the most successful representatives in any specialty company have ever received. If you have good habits, health, brains, plenty of "pep" and selling power, and ability to train and manage a small sales force, you can make big money. Your earnings will be limited only by your energy and ability. Write for particulars, New Era Mfg. Co., 450 4th Ave., New York City.

ATTRACTIVE Peace Postals showing six rulers praying; beautiful in Art and Poetry; sell on sight to everyone, especially in Church Fairs or Bazaars. Net profit given to Red Cross Society. Samples 5c, quick action. Vondrann, 544 West 149th St., New York.

AGENTS Wanted. Great opportunity. You can make big money—\$10 per day—with little effort, just showing to your friends our new spring and summer sample line of made to measure tailoring. Complete outfit ready to start business sent you absolutely free. You can wear the swellest clothes in your town and always have your pockets full of money. Write today—quick—for the agency in your locality before some one beats you to it. Just mail a postcard to the Reliable Tailoring Co., Dept. 201, Chicago, Ill.

SAFETY First! Sell our line of Sanitary Twisted Wire Brushes. Big income assured. Exclusive territory given. Goods sell themselves. Households, Offices. Catalogue free. 3 in 1 Brush Co., 105 Beckman Street, New York.

AGENTS. Sit down and write this minute for free circular of our great war book. Ward Publishing Co., Box 433-P, Chicago.

AGENTS—Geo. Birt, Russell Ave., Indianapolis, is selling changeable signs at 7c each. Particulars free.

AUTO Bob Sted (patent pending), tremendous demand wherever snow and boys. Box 295, Inwood, N. Y.

AGENTS wanted handle merchandise direct from manufacturer. Crescent Comb Co., Box 442, Leominster, Mass.

MAIL-ORDER instructions complete and 27 propositions to begin with. Literature free. Write I. Hale, Box 192B, College View, Neb.

MAGAZINE subscription solicitors; crew managers. 50c proposition will sweep country. New plan. Get in quick. Co-operative Co., 367 Arcade, Cleveland.

BIG Kansas Company will start ambitious man or woman in fast growing business; any locality; \$3,000 yearly; spare time; no canvassing; no experience. We furnish everything. Write for unique selling plan. C. W. Eyestone, President, 169 E. 5th, Pittsburg, Kansas.

LET me start you Manufacturing and Selling Extracts. H. Lake Co., Adair, Ill.

SELL Oil Painted Pillow Tops. Beautiful designs. Retail \$1. Cost \$4 doz. Complete sample and particulars 25c. Fantasy, 321 Dearborn, Chicago.

READ the Agents Magazine and make more money. 2 issues 10c. Agent's Magazine, Chicago.

NEW, practical, profitable specialty, every merchant buys. Snap for agents. Columbia Co., 115 North Ave., Chicago.

AGENTS Wanted—If you know a chance when you see it you'll see this one now. Big money—stylish, nifty clothes—little work—no experience or capital needed—can you beat that? We want agents everywhere to take care of our business in their localities and to advertise our nobby, nifty suits by wearing them. We furnish everything complete and charge nothing for agents' outfit. The swellest dressers everywhere are our agents and all we ask is that you tell people who inquire about your fine clothes where and how they can get them. You make big money—\$10 a day—without trouble. Just a postal brings you full outfit free. Big, new sample book of up-to-the-minute suitings sent so you can pick out your first suit; also measuring blanks and everything you need. We pay express on everything—not a penny for you to pay. Send quick before some one else gets the agency there—mail postal today to the American Woolen Mills Co., Dept. 214, Chicago, Ill.

PERFECTION Pocket Adding Machine. Lightning seller. Agents wanted. Cincinnati Specialty Mfg. Co., Dept. R, Cincinnati, Ohio.

AGENTS—Get our Big Three selling combination, Hundreds recorders. Exclusive territory. Sample free. A. Lederer, 730 West 19th Place, Chicago, Ill.

DISTRICT Managers, have few openings for live district managers to handle exclusive territory. Staple specialty for hardware and automobile trade, exceptional standing and financial ability to carry stock essential. Junkune Bros., 962 W. 71st St., Chicago.

ELECTRIC Chairs—Big fun maker for clubs, societies, amusement places; send for circular; agents wanted. Odenwald, 1264 H-N.W., Washington, D. C.

AGENTS. 100%. Desirable goods. Repeaters, Lorna Laboratories, Cambridge Bldg., Chicago.

GUARANTEED hosiery manufacturer selling direct to consumer wishes agent in every county. Permanent, big paying business. Protected territory. Credit. D. Parker Mills, 2733 No. 17th St., Phila., Pa.

AGENTS—Best proposition you have seen. Particulars free. J. F. Woodard, Nardin, Okla.

MAKE and sell chewing gum. Big profits. No machinery needed. Complete instructions, 10c. Service Bureau, 3311-B, Belleplaine Ave., Chicago.

DON'T waste your evenings! Sell our attractive brass easel poster frames to theaters; big demand; easy sales; liberal commissions. Newman Manufacturing Co., Cincinnati, O.

AGENTS make \$5 profit daily. Name Plates, House Numbers, Signs. Particulars free. Roscoe Lynch, Hausman, Pa., Dept. B.

AGENTS, Mail-Order Dealers, see our New Safety Tea Kettle Illustrated January issue, page 118. Get particulars. Weber Manufacturing Co., 1605 Warner Ave., Peoria, Ill.

PLEASE don't answer this advertisement unless you mean business; \$1.50 Sample Free. Fountain Pen Searchlight Co., Hartford, Conn.

AGENTS. Send now for list of 342 air brush show cards. Ward Publishing Co., Box 433-P, Chicago.

SALESMEN-Agent; for excellent staple advertising mediums; pocket samples; liberal commissions. E. N. Doring, Weehawken, N. J.

AGENTS—New game for cigar stores; easy seller; big repeater. Particulars free. United Sales Co., 263 Walnut place, Philadelphia, Pa.

AGENTS—Sell transparent handle pocket knives and razors. Liberal commission. Write for terms. Morris Cutlery, Morris, Ill.

AGENTS—Fifteen Whirlwind Sellers, new in your territory; pay you steady income \$5 a day or better if you are a worker. Liberal credit. Sample case and outfit free to workers; control of your territory and other advantages. Write quickly for proposition. E. E. Briley, Box No. C-722, Linton, Indiana.

INK Eraser. Best yet. Sample 25c. Agents wanted. Va. Sales Co., Box 321, Frederickburg, Va.

80% PROFIT—Art Show Cards—Every merchant buys. Samples 10c, worth 50c. Merchants Specialty House, Chicago.

1,000% PROFIT—Prepared Sign Lettngs. Share co-operative business free. Johnston Co., Quincy, Ill.

AGENTS Wanted—Right here is the one big chance of your life. If you want to make good money—\$10 a day or more, as easy as rolling off a log, and get your swell clothes free besides, you can do it by acting as our agent. We are the biggest people in the business and want our agents to make big money and be nifty, stylish dressers. Send a postal today for free \$10 outfit, including a big book of nobby selling samples to select your swell agent's suit from. Then take orders from people who admire your nifty clothes. They come to you—not you to them. This is the way to get rich—the sure, easy way. Remember, you need no money—everything is furnished by us free. We pay express on everything. Just send a postal, but do it today. You can't get started too quick, making this big money and wearing these stylish clothes. Address card to Paragon Tailoring Co., Dept. 214, Chicago, Ill.

AGENTS—Average \$5 to \$12 daily selling astonishing Aztec massage machine. New. Just patented. Different. No electricity or water power required. Nothing complicated. Affords exhilarating massage without cent expense. Lowest priced, but best outfit. Retail \$2.50 allowing you big end of the profit. Particulars and "beauty" folder free. Aztec Remedy Co., Dept. 132, Toledo, Ohio.

100% PROFIT—Exclusive territory to first man. Dollar Safety Razor sells quickly. Send 25c for samples today. DeHart Co., Rutherford, N. J.

AGENTS—500% profit, free sample Gold and Silver Sign Letters for store fronts and office windows. Anyone can put on. Big demand everywhere. Write today for liberal offer to agents. Metallic Letter Co., 305 N. Clark, Chicago, U. S. A.

AGENTS—Graham's Self-Gartered Socks. Patented. Price no higher. Guaranteed never creep down. Fine gauge, wear forever quality. Big sellers. Send 25c for samples. State size. Graham Company, 525-P, Forest Ave., Oak Park, Ill.

NEW 1914 Model—Send no money. Just your name written plainly on a postal card and learn by return mail how to get the best Vacuum Cleaner on the market, without costing you one cent! We are putting them out for demonstrating purposes. Guaranteed 5 years. Reliable, live agents wanted everywhere. Write today to Warner Vacuum Cleaner Company, Dept. Z, Muncie, Ind.

AGENTS Wanted—Agents make 500 per cent profit selling "Novelty Sign Cards." Merchants buy 10 to 100 on sight. 800 varieties. Catalogue free. Sullivan Co., 1234 Van Buren St., Chicago, Ill.

GET Money—I did; got \$301.27 in two weeks doing plating, writes M. L. Smith of Pennsylvania (used small outfit); start as Smith did—that's easy; hundreds already started, money coming in, goods going out; people everywhere have tableware, watches, jewelry, etc., for the "Gray Plating Man." Practical outfits, all sizes, heavy plate, guaranteed. Pure Gold, Silver, Nickel, Metal Plating, latest process, taught free, quickly; experience unnecessary; secrets exposed; own and boss a business that pays \$15 to \$50 weekly—you can; write today. Gray & Co. Plating Works, 627 Gray Bldg., Cincinnati, Ohio.

200% PROFIT. You can't beat it. Sells everywhere. Free pocket sample. Our goods get the orders. Wm. J. Jack, Mgr., Dept. S-1, 29 W. Lake St., Chicago.

MAGIC Ink Eraser. No blade, no acid. Removes ink like magic. Sells like bread in a famine. Sample 10c. Sells 25c to 35c. S. Mfg. Co., 29X, Warren St., N. Y.

YOU can be your own boss with our Key Check Outfit. Good for \$5 a day stamping names on pocket key checks, fobs, etc. Sample check with your name and address, 15 cents. Pease Die Works, Dept. M, Winchester, N. H.

AGENTS—250% profit. Wonderful little article. Sells like wildfire. Can be carried in pocket. Write at once for free sample. H. Mathews, 1962 Third St., Dayton, Ohio.

WE manufacture the largest line of Aluminum Utensils and Specialties in the world. Sales course free. \$50 a week easy to hustlers. Answer quick. American Aluminum Mfg. Co., Div. P.M., Lemont, Ill.

OUR national advertising helps you sell Fuller Sanitary Brushes and Dustless Mops and Dusters—full line—easy sellers. We tell you how. Biggest factory for twisted wire brushes in U. S.—reliable, strong concern. Your territory is valuable. Write at once. Fuller Brush Co., 33 Hoadley Place, Hartford, Conn. Western Branch, Rock Island, Ill.

AGENTS who have the gut to tackle a job and stick. Men and women who will tell the truth and want to make money and can give all or part time. Then we will trust you to \$3.65 worth Starr's Powdered Enamel. It repairs chipped and rusty spots on granicware. Stops all leaky metalware without heat, soldering iron or tools. A case-knife does the trick. Never hardens in the box. Hardens in a few hours after mixing with soft water. The newest and best selling household necessity now on the market. Agents all coining money, selling at every home, shop, office, factory, garage. Coats 5c, sells for 25c. A free premium with every sale. 10c gets large sample and particulars. Better get on our free mailing list. Starr, 1919 Monroe St., Toledo, Ohio.

STOP Here! Let me start you in a home business that will bring you money every day. Experience unnecessary. Spare time. No canvassing. I furnish everything. Send for proofs. Voorhies, Desk C. R., Omaha, Neb.

BIG Profits for You! Manufacture Barley Crisp. New Confection. 5c package costs you 1c. Machine, instructions complete \$7.50 prepaid. Send 10c for samples. Barley Crisp Co., 1295 Broadway, San Francisco.

AGENTS—Sell rich-looking imported 36x 68 Rups, \$1 each. Carter, Tenn., sold 115 in 4 days, Profit \$57. You can do same. Write for sample offer selling plan; exclusive territory. Sample rug by parcel post prepaid, 98c. Condon, Importer, Stonington, Maine.

500% PROFIT selling our wonderful sign letters for office windows, store fronts and glass signs; resembles finest gold leaf; easily applied; samples free. Metallic Letter Co., 486 N. Clark St., Chicago.

AGENTS—Drop dead ones. Awake! Grab this new invention. Low-priced, waterpower home massage machine. Magical, marvelous, mysterious. New field. Big profits. Sold on money-back guarantee. "Margworth sold 5 in 10 minutes; \$1 in 2 days." "Parker sells 8 first day." Vaughn, "your machine has merit. Express 6 dozen." Free information. Blackstone Co., 31 Meredith, Toledo, Ohio.

YOUNG MAN, would you accept and wear a fine tailor-made suit just for showing it to your friends? Or a \$10-on Ralenoat free? Could you use \$5 a day for a little spare time? Perhaps we can offer you a steady job? If you live in a town smaller than 10,000, write at once and get beautiful samples, styles and this wonderful offer. Banner Tailoring Co., Dept. 934, Chicago.

EASY pleasant work for Mechanics, Shop Men, Clerks, during spare hours, will add many dollars to their salaries. Also want persons who can give full time. Big wages assured. Novelty Cutlery Co., 67 Bar St., Canton, Ohio.

AGENTS make big money and become sales managers for our goods. Fast office sellers. Fine profits. Particulars and samples free. One Dip Pen Company, Dept. 2, Baltimore, Md.

AGENTS make \$100 monthly selling our 500 handy household articles. Catalogue free. Schuff Company, Desplaines, Ill.

OUTFIT Free to Agents. Best selling Handkerchiefs, Dress Goods and Fancy Goods on the market, quick sellers, big profits. Deal direct with a large manufacturer. Send stamp for particulars. Freeport Mfg. Co., 59 Main St., Brooklyn, New York.

BIG Textile Mills will employ everywhere reliable people to take orders for dress fabrics, hosiery, underwear and neckwear from samples. Factory prices. Many making over \$20 weekly. Spare or all time. No experience. Permanent. Steadfast Mills, 30 Remson St., Cohoes, N. Y.

AGENTS—Stamping names on Pocket Key Protectors; sample Check with your name and address, 12c. Stamping Outfits, Emblem Checks, Check Fobs, Name Plates. Hart Mfg. Co., Desk 2, 305 Degraw St., Brooklyn, N. Y.

FIRST dozen free to agents, men, women, demonstrate 25c household article. Quick seller, exclusive territory, constant repeater. P. M. King, Coudersport, Pa.

MEDALLIONS—300% profit. Make up your own goods and be independent. Catalogue free. Resag Co., 1265 Randolph St., Chicago.

MAIL-ORDER Opportunities: 25 new Propositions. No competition! Make 95c profit on dollar order; complete outfit 10c. Mail Dealers Wholesale House, 521 Franklin Bldg., Chicago.

30% TO 40% Profit to Agents selling our guaranteed U. S. Fire Extinguishers. Tremendous demand. Orders repeat. Exclusive territory to county and district managers. United Mfg. Co., 1025 Jefferson, Toledo, Ohio.

AGENTS make \$5 to \$10 a day on the spot. Alkinson writes: "The best proposition I have found in my forty years' canvassing." Permanent work. Household necessity. Saving 80%. Write today for General or Local Agents terms. Free sample. C. H. Stuart & Co., 16 Union St., Newark, New York.

FROM Dance Hall to White Slavery, 400-page, cloth book, illustrated, \$1. Immense sale. Experience unnecessary. Outfit free. Big money quick. Charles C. Thompson Co., Manufacturing Publishers, 1128 Wabash Ave., Chicago.

AGENTS—Here's a winner. The Midget Vest Pocket Garment Hanger—sells on sight. The most attractive proposition ever offered, 150% profit. No competition, as article is fully protected by U. S. and foreign patents. Address: Dept. "M," The Silver Company, 171 Madison Ave., New York.

PHOTO Pillow Tops, Portraits, Frames, Sheet Pictures, Photo China Plates. Rejects credited. Prompt shipments; samples and Cat. free to agents. 30 Days' credit. Jas. C. Bailey Co., Desk A-2, Chicago, Ill.

AGENTS—Great opportunity to be permanent representative largest manufacturers high-grade soaps and toilet goods. \$27-\$75 weekly. Write for immediate appointment. E. M. Davis Co., R. 64, Davis Bldg., Chicago.

AGENTS—\$5 daily selling our Handy Tool, 12 articles in one. Lightning seller. Sample free. Thomas Mfg. Company, 462 Third St., Dayton Ohio.

AGENTS—\$50 weekly. We manufacture the best needle case made; a wonderful seller; 200% to 500% profit; talking unnecessary; our "Trust Scheme" envelopes do the work; general agents can make \$100 weekly; particulars free; 25c sample outfit for 10c; buy direct from the factory. Paty Needle Co., 102 Davis St., W. Somerville, Mass.

YOU can make \$\$\$\$ as our general or local agent. Household necessity; saves 80 per cent; permanent business; exclusive territory; salary or commission; free sample; credit. J. Pitkin, 113 Redd St., Newark, N. Y.

AGENTS of ability and high character wanted on a new household article. Over 100 per cent profit. Special selling plan that pulls results. Address Merritt & Brock, 59 to 69 Temple Place, Boston, Mass.

AGENTS—Make big money selling our automobile specialties to owners and dealers. Send for particulars. Leather Tire Goods Co., Niagara Falls, N. Y.

AGENTS. Cost 3c, sell 25c. Gold window letters. Any one can apply. Samples free. Chicago Letter Co., 2513 Lincoln Ave., Chicago.

AGENTS: \$1,000 to \$3,000 yearly selling over eighty everyday articles to farmers. Pleasant, permanent business. Full instructions. Big chance. Write quick. Duoform Factories, North Java, N. Y.

AGENTS—Here's the best line of food flavors, perfumes, soaps, toilet preparations, etc., ever offered. No capital needed. Complete outfits furnished free to workers. Write today for full particulars. American Products Co., 561 Third St., Cincinnati, O.

AGENTS—\$15 profit on two sales a day. Machine fine seller to saloons. Free sample and salesmanship course. Write Mohler, 1059 North California Ave., Chicago, Ill.

BUYERS, Mail Order Men, Agency Houses: List or push the Pocket Safety Lock. A necessity for everyone who travels, lives in hotels, apartment houses, or those who want their apartments, office, or store secure from burglars. Big profits, low prices quoted everywhere. G. F. Tadini, 265 West 87th St., New York, N. Y.

AGENTS—Send 10c for terms and sample of staple 25c article. Large profits. C. Lutz Manufacturing Co., York, Pa.

AGENTS, splendid seller, big profit, for housewives, motorists, farmers, mechanics, electricians, plumbers. Write us. Biddle Distributing Co., Dept. A, 89 Wall St., New York.

AGENTS: "Billy Sunday's Book" (authorized); illustrated; wonderful selling success. One agent sold 42 books in five hours; others earn \$6 to \$15 per day; little work. Every Christian home wants copy. Circulars, with name and address, furnished mail order dealers and agents. Write for terms; outfit free. Marvello, Binghamton, New York.

AGENTS—A free course in General Salesmanship is given to every man of our Sales Organization. This organization is a body of successful men selling the Handy Light; that unique electrical device which cuts the cost of electric lighting in half. Sells for \$3.50, is used in home, office, store, factory; weighs only one pound. Sold by demonstration. All agents furnished with well planned methods for gaining interviews. A high-grade business for a man of ability and standing in his community. General Agents preferred. Inquire for our full proposition by addressing The Handy Light Co., 199 Handy Light Block, Cincinnati, Ohio.

UNIQUE repeat order novelty; advertiser; mails flat; unusually big profits; particulars free; photopaper prepared for 32 pictures 25c; money back if you cannot produce real photos with this sample without using camera. Irnus Co., 2141 Seventh Ave., New York.

ONE drop "Venereo" Solution, three ounces Paraffine Oil, one ounce water, total cost one cent, produces 25-cent bottle high gloss furniture polish. Sells wonderfully. Agents enthusiastic. Bottle Venereo Solution and Polish Formula, 25 cents (silver). Paradox Company, Yonkers, N. Y.

AGENTS—We have a winter seller that will bring you a mint of money. Every home, office building, factory and store requires it. A real money, labor and time saver. Send 25c for sample and particulars. Cold weather creates big demand. W. E. Co., Dept. M, Delta, Colorado.

MAKE and sell your own goods. Our Information Bureau tells how. Fine Formula Catalog for stamp. B. Mystic Company, National Union Building, Washington, D. C.

QUIKERNLIGHTING cleans the hands Quikernlighting. Agents wanted. Joliet Novelty Company, Joliet, Ill.

SURE Profits for house to house canvassers, either sex, carrying our Mountain Spring Filters. Fits any faucet. Kneuper Filter Co., 26 West 40th St., New York City.

MYSTIC Photos—Photos without a camera. Never before considered possible. Marvelous results. Entertains and astonishes. Makes pictures instantaneously. Trial satisfies or money back. Send 10c for samples. Enough for 32 pictures. Alpharis Co., Longbeach Building, New York.

IT will pay you to write me before taking any agency for guaranteed aluminum utensils. Wm. J. Dick, Mgr., Dept. F-12, 20 W. Lake, Chicago.

AGENTS—Souvenir Badges Kaiser Wilhelm. Send 6c for dozen. Big profits. Philadelphia Badge Co., 134 N. 8th St., Philadelphia, Pa.

PORTRAIT Agents make big money selling our goods. Our quality is tight. Prices low. Delivery guaranteed. Credit for rejects. Ask for our latest catalog. Adam J. Kroll & Co., 602 Blue Island Ave., Chicago, Ill.

ENDLESS Neckties—Something new, twelve ties in one; costs no more than old style; man made \$70, three days; woman made \$92, week; write for special agents' offer. Endless Necktie Mfg. Co., Dept. 10, Kansas City, Mo.

NEW Automatic \$2.50 Adding Machine. Sell 10 a day easy. Big profit. Everyone buys. No competition. Repeat orders. P. Bassett, 5921 Indiana Ave., Chicago.

ENGESSER made \$42.50 in 8 hours with Plateless Daydark taking Photos direct on cards, finishing instantly. Experience unnecessary. Trial proposition free. Daydark Specialty Co., Dept. H, St. Louis, Mo.

400% PROFIT—Evergrip Gliders—No rollers; pocket samples free; anyone can attach; cost 3c, sell 15c; homes buy dozens, hotels hundreds; save floors and carpets. S. Mfg. Co., 29H, Warren St., N. Y.

GOODLUCK booklet containing your name and address on 129 gummed labels, 25 cents postpaid. Big profit for agents. Riley Publishing Co., Kansas City, Mo.

AGENTS—Get particulars of one of the best paying propositions ever put on the market. Something no one else sells. Make \$4,000 year. Address E. M. Feltman, Sales Mgr., 569 Third St., Cincinnati, O.

AGENTS Wanted for a new Duplicate. Sells to every business man. Fisher Company, 115 Amsterdam Avenue, New York City.

AGENTS, either sex; big money selling our new high-grade household specialties; a sale at every home; write today. Hrdlicka Specialties Company, 1695 Haskell Avenue, Rockford, Ill.

AGENTS are coining money selling our big 10c Packages of 20 Assorted Postal Cards, "5,000 Varieties." "Big Profits." Sell everywhere at Sight. Sample Package 10c. Particulars Free. Sullivan Card Co., 1234 Van Buren St., Chicago, Ill.

SQUARE Hole Drill, metal or wood; rotary motion; seven sizes, retail \$1.00, wholesale \$2.75 dozen sets, prepaid. Agent's sample drill and guide 30c postpaid. Fredrick Stolle, 1288 Mission St., San Francisco, Cal.

\$9 TO \$18 a day easily made selling our Guaranteed Fire Extinguisher; tremendous demand. Send for particulars. Emmons Supply House, 160 Springfield, N. J.

STEADY business, liberal profits, quick repeats with our Sanitary Wire Frame Brushes and Cleaning Specialties. Household necessities. No capital required. Exclusive sale if you write today. Kleand Co., 71 Taylor St., Springfield, Mass.

AGENTS, Imperial Products and free advertising plan get the orders. Particulars free. Fagne, 2894 Harrison, Kansas City, Mo.

AGENTS—Sell our Household Specialties in every home. Catalogue free. Pecosset Sales Co., 56 Whittier Ave., Providence, R. I.

YOU can make big profits selling our Order Getting Line of Guaranteed Goods, \$200,000 firm and Liberal Credit Plan backs you. Valuable Premiums for you and for your customers. Wm. J. Dick, Mgr., Dept. 8-21, 20 W. Lake St., Chicago.

WE make live, energetic agents in every locality to handle first-class specialty. Particulars Free. Write today. Manchester Mfg. Co., 927 East Cedar Street, Denver, Colo.

AGENTS—\$2.50 razor free to hustlers. "Try-it-before-you-buy-it" plan sells Climax Automatic Razor Sharpener to every man; 150% profit. Write quick for territory, guarantee and free offer. Victor Specialty Co., 15 Victor Bldg., Canton, O.

BUTTER 4c per pound in five minutes by adding milk. Small machine, just out; everybody interested; big commission. Agents wild. Two dollars gets sample and holds territory. Write instantly. L. A. Brown & Co., Clay Center, Nebr.

STOP Here—Agents, Salesmen—Just out—brand new invention. Splendid seller. Deflector for Automobile Headlights—puts light on the road instead of in other peoples' eyes. Not a dimmer—makes driving light stronger. Endorsed everywhere. No knobs to turn—no adjustments—lasts as long as the car. Simple, easy to put on. Wanted on every car—sells like lightning. Nothing like it patented. Big profits—Listen: Johnson, Ohio, made \$22 first day. Harris, N. Y., made \$68 one week. Walker, Iowa, cleared \$58 in three days. Hurry—write for details—Sales guaranteed—no charge for territory. Address the Hickmeyer Deflector Company, 443 S. & B. Bldg., Toledo, Ohio.

\$15 WEEK Salary and Commission paid one person each locality, taking orders for non-alcoholic flavorings and toilet articles. Linton Co., Kansas City, Mo.

AGENTS—Sell "The Yankee" electric iron cord supporter. Sells on sight. Sample 50c. Particulars free. Polson & Paulson, 40 Bluff Ave., La Grange, Ill.

STOP here and write The Sign Co., Silver Creek, N. Y.

NEW—Practical—Durable. The L. S. Self-Threading Sewing Machine Needle sells like "Hot Cakes." The only one of its kind sold with a guarantee. Made to fit all machines. Send 10c at once for sample and territory. The Roett Specialty Co., Putnam, Conn.

I HAVE a contract to distribute a million free packages Borax Soap Powder. Want reliable men and women to help. Chance to earn good pay. L. Waverly Brown, 730 N. Franklin St., Chicago.

MILLION Dollar Winner. Tremendous, rapid sales stagger country. Agents happy, banking enormous profits daily. New invention, yet million sales already recorded. Walters sold 51 first 7 hours; Arnold 80 first day. Everybody wants Grabs scientific Shoe Cleaner on doorstep. Saves drudgery, carpets, shoes, money. Automatically removes mud, snow. Mechanical wonder. Investigate quick. Territory free; worth fortune. Security Mfg. Co., Dept. 46, Toledo, O.

WANTED—Men and women canvassers to handle new kitchen article. Easy seller, never been seen before. Exclusive sale to hustlers in outside towns. Experience unnecessary. Satisfaction guaranteed. Write Kobelle Mfg. Co., Box 308, Central Station, Toledo, O.

NEW money-maker for agents, see page 165, advertising section.

OUR Leaders: Hygienic Milk Bottle Holder, "Dandy" Mail Box, "Dandy" Kitchen Set. Catalog, 50 Specialties, free. Weymouth Household Supply Co., Box 387, Springfield, Mass.

SEND dime for calculator; figures parcel postage, any zone, quick as a wink; simple, accurate, useful; agents wanted. H. Stearns, Sales Manager, Schenectady, N. Y.

AGENTS wanted for our splendid line gold sign letters, 500-1,000% profit. Anyone can put on. Unlimited demand. Five samples 10c. Everbrite Co., Long Island City, New York.

SAMPLES Free to Agents—Quick selling line of Dress Goods. Good steady profit. Send stamp for particulars. H. M. Kennedy, Jr. Co., 357 Fourth Ave., New York.

LINOLENS—New, handsome and useful article; sells itself. Send 50 cents for sample and mention territory wanted. Adams Novelty Co., Westmont, N. J.

START 1915 right. Glenco specialties needed in every home. 100% and exclusive territory. Write now. Glem Co., Edgewood, R. I.

AGENTS—To solicit orders for Finest Quality Business and Calling Cards, write for sample and profit sharing plan, Sterling Print, Dept. M, Sterling, Mass.

JUST out, 300% profit; large changeable sign with 240 letters, 50c complete. Every merchant buys. Changeable Sign Co., 589 1-2 St., Cleveland, Ohio.

NEW. Three good selling novelties. Patented; big profits. Stamp for circulars and prices. Edw. Hutchinson, Winsor Ave., Elmira, N. Y.

SIGN Agents, Attention: We have something to offer you that beats selling other peoples' manufactured letters and signs all to pieces. No previous experience is necessary. Investigate. Address, Ross System, 261 Lincoln Inn Court, Cincinnati, O.

AGENTS—New invention. Electric Cigar Lighter. Used on cigar cases. Quick seller to Hotels, Drugstores, Restaurants, Pool-halls, Cafes. Big profits. Special offer. Drake Mfg. Co., 142 Reed St., Milwaukee, Wis.

3-3 WEEKLY easily selling newly patented article. Every woman a buyer. G. C. Coffman, Box 56, Huntingdon, Penna.

BARGAINS—Men's Neckwear. Agents, storekeepers. Webster, 477 Eighth Avenue, New York.

SPECIAL—Your ads in 133 different magazines, special—3c a word. Lists free. Address, King's Magazine, Box 1369, Little Silver, New Jersey.

MY Mail-order business pays handsome profits. Particulars free. Zerbe, Sacramento, Penn.

AGENTS, either sex, sell Ho-Lo-Co skin and scale soap, perfumes, toilet articles. Big profits. We help earnest workers. Ho-Lo-Co, 212 N. Second St., St. Louis, Mo.

AGENTS, Raincoat Free. Big cash commissions. Low prices. Guaranteed. Made to measure. Men and women. Free samples. The Brookline Co., Dept. B, Springfield, Mass.

PANAMA Coin Jewelry. Pin 10c, Clasp 15c, Links 25c, or set 50c. Mail Order Supply Co., 228 Dinwiddie, Pittsburgh, Pa.

AGENTS to take orders for Visiting and Business Cards. Large profits. Outfit free. Foreman Printery, Waterbury, Conn.

AGENTS—Salary or commission. Greatest seller yet. Every user pen and ink buys on sight. 200 to 500 per cent profit. One agent's sales \$629 in six days; another \$32 in two hours. Monroe Mfg. Co., X 6, La Crosse, Wis.

"JIFFY" Ironing Board Cover and Clamps is the biggest red-hot seller ever invented. 150% profit. No competition. Lake Shore Manufacturing Company, Michigan City, Ind.

STOP here and write The Sign Co., Silver Creek, N. Y.

AGENTS—\$10 daily easy selling Clean compound through our new sales plan; everybody buys; no talking or experience required. Send 10c for samples and proposition. Address Morgan, Box 550, Salisbury, N. C.

INVENTOR'S Advocate, Washington, D. C. Best inventor's paper. One year on trial 10c.

WE Pay \$80 a month salary and furnish rig and all expenses to introduce our guaranteed poultry and stock powders. Address Bigler Company, X368, Springfield, Illinois.

\$61.50 WEEKLY introducing and selling a new gas light burner for kerosene lamps. Beautiful light. No chimney. No mantle. Perfectly safe. Simple in construction. Nothing to get broken or out of order. Will not burn out. Durable. Will last for years. Low price. Easy to sell. 200 per cent profit. Experience not necessary. Sample free. Why not try one on your lamp? Beware of imitations. No branch offices. Luthar Manufacturing Co., Dept. 401, Cincinnati, Ohio.

SELL Dry Goods Remnants. Greatest bargains on earth. Remnant Store Co., Cincinnati, Ohio.

WE have several openings for establishment of independent mail-order business. Energy, good habits and sound judgment more important than capital. Spare time at first. Particulars free: Opportunities Exchange, Buffalo, N. Y.

AGENTS, Apple-ene Figs, laxative, best proposition; special territory. Big profits. Great repeater. Holds customers. Permanent business. Life income. Samples and particulars free. Laxative Fig Co., 2743 Graham Ave., Louisville, Ky.

WANTED—Agents everywhere to sell the famous "Crescent" 4-cylinder light delivery motor trucks, completely equipped, \$550 and freight, fully guaranteed. Absolutely no competition at this price. Several thousands now in use proves that "Crescent" cars sell themselves. Address the manufacturers, Mission Motor Car Company, 1312 South Grand Ave., Los Angeles, Calif.

WANTED—Distributors. Men and Women—to give away free pkgs. Perfumed Borax Soap Powders; no money or experience needed; good pay. S. Ward & Company, 218 Institute, Chicago.

FLO-REE-DA captivates, pleases. Agent's package 10c. Sells fast; show it, that's all. Big profits. Shur-Ax Company, Pawtucket, R. I.

AGENTS—Smash poverty. 50c profit every 75c sale. Our specialty sells all homes, stores, offices. Daily use makes quick, steady repeater. Bonuses for increasing sales. Experience, capital, unnecessary. \$40 week easy. Get protected territory quick. Ekhardt Specialty Co., Ekhardt, Ind.

EASY money selling Self-Threading Needles. Everybody buys. Send stamp for sample. Write for territory. Budke Co., University City, Mo.

\$35 To \$100 weekly made easily selling our match lighting systems and portable lamps; they sell like wildfire both in towns and rural districts. No experience necessary; exclusive territory to right parties. Write for Free catalogue and full information; this is an opportunity of a lifetime. Round Lighting Company, 174 D, No. Sangamon, Chicago.

STOP here and write The Sign Co., Silver Creek, N. Y.

AGENTS—To sell the newest electric appliance on the market; sold everywhere there is electricity, in the home and office; liberal profits; sales-driving sample, weighs a pound, no experience or knowledge of electricity required; it shows how to use one light instead of two and get the same results; sells for \$3.50 and saves the purchaser an investment of \$25. Write for particulars. The Handy Light Co., 15 Handy Light Block, Cincinnati, Ohio.

SELF-WRINGING Mop. Hands don't touch water. Demonstrate in an instant. Gets into corners. Price right. Big profits. Your territory valuable. Write today. Secretary, 711 Hartford Bldg., Chicago, Ill.

AGENTS sell rich-looking imported 36x48 rug \$1 each. Carter, Tenn., sold 115 in four days, his profit \$57. You can do as well. Write for sample offer and selling plan. Sample rug by Parcel Post, prepaid, 98c. A. Cendon, Importer, Stonington, Maine.

MANUFACTURERS of high-class, exclusive electrical specialties want man of proven ability and unquestionable standing; familiar with big propositions, for General District Manager in all open territory. May require investment up to \$500. Should net \$3,000 to \$6,000 first year. State age and experience. The Sterling Corporation, 1276 West Third Street, Cleveland, Ohio.

AGENTS: Big profits selling our New Electric Light specialty to offices, homes, stores, factories, hotels, etc. Greatest convenience and most practical device ever invented. Sells rapidly. Demonstration means sale. Write quick for excellent proposition. International Automatic Utilities Co., 402 Marquette Bldg., Chicago.

SALESMEN: agents everywhere. New auto fuel. Permanent. Profitable. Tankil Chemical Sales Co., Cleveland, Ohio.

SALESMEN WANTED

WANTED: Reliable Salesmen to handle one or more States exclusively. Also China, Crockery and Glass dealers to sell our improved Sanitary Sugar Bowls. For particulars write Schoenheit & Pease, 6212 Penn Ave., Pittsburgh, Penn.

SALESMEN wanted. Automobile Specialty. Sells fast. Demonstration easy. Carry sample in pocket. Big profits. Particulars free. Emar Co., Llanerch, Pa.

MANUFACTURER requires general agents for patented demand of centuries. Self demonstrator. Financial independence to acceptable parties. S. C. Osborn, Masonic Temple, Chicago.

SALESMEN—Get our plan for Monogramming Automobiles and Motorcycles by transfer method. Very large profits. Motorists' Accessories Co., Ashland, O.

SALESMEN wanted who have capital to invest in territory for a new invention. Has prospects of being good seller. Write for full particulars. Address J. W. Barford, Music Leaf Turner, East Chatham, N. Y.

WANTED—Hustlers to take orders for made-to-measure, high grade men's tailored suits from \$9.00 to \$22.00. Make \$25.00 to \$50.00 weekly. Elegant large book outfit free. Experience unnecessary. No pocket folder affair. Splendid opportunity to make money. Handy Dandy Line, Dept. S, Sangamon St., Chicago.

SALESMAN—Experienced traveling salesman. State experience and references first letter. Well advertised line. Satisfactory commissions. The Limoges China Co., Sebring, Ohio.

TRAVELING Salesmen Wanted—Experience unnecessary. Earn big pay while you learn by mail during spare time; only eight weeks' time required, one or two hours a day. Steady position, easy work, hundreds of good positions to select from. Write today for free book, "A Knight of the Grip," containing full particulars and testimonials from hundreds of students we have recently placed in good positions and who are earning \$100 to \$500 per month. Address Dept. B-16, National Salesmen Training Association, Chicago, New York, Kansas City, San Francisco.

WANTED—If you are an experienced and successful salesman, we want you on our force; have a high class, 6%, ten-year bond, with stock bonus. For information, address, Exchange, 549 Wesley Roberts Building, Los Angeles, California.

SALESMEN—Agents: Competition killed. Electric Flashing sign; over 36 different display arrangements possible with 210 three and six inch letter combinations—in colors. 30-inch model \$10. Sample to producers. Multiform, 367 Manhattan Bldg., Chicago.

GREAT opportunity for general agents selling new specialty to merchants; retails \$3, \$10, \$15 each. Your profit 200%. No competition. Exclusive territory. Free samples. Sayers Co., 408 Olive St., St. Louis, Mo.

SALESMEN, learn true art of salesmanship, gist of experience in great international corporation, \$1.00, refunded if dissatisfied. No refund yet requested. Hoerr & Co., 609 W. 158th, N. Y.

DON'T fail to read page 105, advertising section.

SALESMEN—We have some excellent territory open to salesmen of ability. This is a proposition that appeals to the best class of concerns. Sales are easy and your profits large. Write us today for catalog F. M., covering the Schick All-Steel Paper Haler. Davensport Mfg. Company, Davensport, Iowa.

WANTED—Distributors, Men and Women—to give away free pkgs. Perfumed Borax Soap Powders; no money or experience needed; good pay. S. Ward & Company, 218 Institute, Chicago.

HELP WANTED

MEN between 18 and 35 wanted. \$75.00 month. Government Railway Mail Clerks. Examinations likely announced everywhere Jan. 15th. Full description free. Franklin Institute, Dept. O-21, Rochester, N. Y.

LEARN Automobile Repairing, driving on up-to-date cars; electrical, civil engineering; surveying; methods most practical; room and board while learning; many positions secured; satisfaction guaranteed; catalog free. National School of Engineering, 2110 W. 7th, Los Angeles.

BECOME detectives—Large salaries; nice work; experience unnecessary; write Superintendent Wagner, 1243 Lexington Avenue, New York.

I GUARANTEE \$10 for first photoplay you write by my method. As former scenario editor, I speak with authority. Send for free booklet, "How to Write Photoplays." Albert Moore, Box 772, P. F., Chicago.

GET a civil service appointment. Work for Uncle Sam. Liberal pay. Steady job. We teach you how to secure appointment by mail. Write for free book, "The Easy Boss"—It's free. Commercial Correspondence Schools, 204 Schools Bldg., Rochester, N. Y.

BE a Detective—Earn from \$150.00 to \$300.00 per month. Travel over the world. Write C. T. Ludwig, 340 Westover Building, Kansas City, Mo.

WRITE Moving-Picture Plays. \$50 each. All or spare time. Correspondence course unnecessary. Details free. Atlas Publishing Co., 3045, Cincinnati, Ohio.

STOP Here! Let me start you in a home business that will bring you money every day. Experience unnecessary. Spare time. No canvassing. I furnish everything. Send for proofs. Voorhies, Desk C. R., Omaha, Neb.

WANTED—An Idea! Who can think of some simple thing to patent? Protect your ideas; they may bring you wealth. Write for "Needful Inventions" and "How to Get Your Patent and Your Money." Randolph & Co., Patent Attorneys, Dept. 144, Washington, D. C.

THOUSANDS Government Jobs Open to Men and Women. \$65.00 to \$150.00 month. Write for list. Franklin Institute, Dept. O-21, Rochester, N. Y.

GOVERNMENT Examinations. Most thorough preparation, \$5; returned if not appointed; particulars free. American Civil Service School, Washington, D. C.

GO on the Stage. Vaudeville career offered you. Experience unnecessary. Managers endorse my method. Instructive vaudeville book free. Write today. Frederic LaDelle, Sta. 10, Jackson, Mich.

WRITE moving picture plays. \$25 to \$100. Experience, correspondence course unnecessary. We help revise, sell. 40 companies here. Free information. Photoplay Bureau, 335 "C," Los Angeles, Calif.

WE spent \$1.65; made \$27.50. Easy, after supper; no canvassing; opportunity. Complete directions 25c. Listing Co., Atoka, Okla.

ANYONE can earn \$25 weekly silvering Mirrors; no capital. Write Wallace Abel, Lima, Ohio.

RAILWAY Mail Clerk Examinations everywhere soon. Commence \$75.00 month. Sample questions free. Write Franklin Institute, Dept. O-21, Rochester, N. Y.

FREE Illustrated Book tells of about 200,000 protected positions in U. S. service. Thousands of vacancies every year. There is a big chance here for you, sure and generous pay, lifetime employment. Just ask for booklet S-29. No obligation. Earl Hopkins, Washington, D. C.

PLEASANT spare-time work; mailing circulars. Good pay. No scheme. Details free. Home Pub. Society, 46 N. 12th, Philadelphia, Pa.

SPEND summer gathering butterflies, insects. I pay highest cash prices. Instructions. Send stamp. Sinclair, D. 6, Los Angeles, Cal.

OWN a business. Co-operate with me evenings at home. Everything furnished. Don't worry about capital. Boyd H. Brown, Dept. K-2, Omaha, Neb.

POSITIONS—High as \$1,500 and \$1,800 open to persons trained by us in special Lettering and Map Drafting; real opportunity. Particulars and booklet, "Topographic Drafting," on request. Columbia School of Drafting, Tenth and G, Washington.

LEARN Tartaric Mirror-Silvering—It pays! Long, closely guarded secret of big factories. Particulars free. Wm. Barstow, 514 23rd Street, Oakland, Calif.

GET a Government Job! See ad on page 12. Write now—today! Patterson Civil Service School, Rochester, N. Y.

RAILWAY Mail Clerks Wanted. Commence \$75.00 month. Sample examination questions free. Franklin Institute, Dept. O-21, Rochester, N. Y.

YOUNG Man! Learn Drafting—one of the most practical subjects of study today—indispensable in many occupations—engage in individual study successfully with the aid of our new book, "A Practical Course in Mechanical Drawing." 160 pages, 157 drawings, cloth, 50 cents, postpaid. Popular Mechanics Book Dept., 6 N. Michigan Ave., Chicago.

BECOME Chauffeurs. \$18.00 week. Earn while learning. Sample lessons free. Franklin Institute, Dept. O-502, Rochester, N. Y.

BE a detective. Earn big money. Write John J. Gilles, Licensed and Bonded N. Y. State Detective. Retired Member N. Y. Police Dept. 22 years Experience. 254 Huguenot St., New Rochelle, N. Y. Investigation solicited.

WANTED—Distributors, Men and Women—to give away free pkgs. Perfumed Borax Soap Powders; no money or experience needed; good pay. S. Ward & Company, 218 Institute, Chicago.

EARN \$500.00 annually; commercial information wanted; spare time; confidential; exceptional opportunity for stamp. "Cleo," P.M.C., Peru, Indiana.

WE want young men everywhere with some natural mechanical ability to take up a new and rapid method of doing an old-established line of work always in demand. Average pay—\$1.00 for every hour's work. Address: Ross System, 201 Lincoln Inn Court, Cincinnati, O.

IF you desire to better your present position, send 25 cents for book "Positive Ways To Secure the Position You Desire," to J. Johnson, 162 E. 32nd St., Brooklyn, N. Y.

BRANCH managers wanted for nationwide Mail Order Business. Work in spare time. Experience unnecessary. You should make \$50 weekly. Am. Sales Co., Dept. 34, Chaitanooga, Tenn.

WANTED—Distributors of advertising matter everywhere. Send 10c for Application Contract. Sample Magazine (none free). Barkley's Distributing Agency, (403) Blairsville, Pennsylvania.

OUR Guide gives 100 companies wanting short stories, poems, photoplays. Tells kind each wants. A key to success. Postpaid \$1. Money back if dissatisfied. Gordon Publishing Co., 8043, Cincinnati, Ohio.

MEN and Women Wanted. \$45 to \$150 month. Government Life Jobs. Common education sufficient. Thousands vacancies yearly. Write immediately for list of positions and examination schedule. Franklin Institute, Dep't O-21, Rochester, N. Y.

WE have several openings for establishment of independent mail-order business. Energy, good habits and sound judgment more important than capital. Spare time at first. Particulars free. Opportunities Exchange, Buffalo, N. Y.

DON'T fail to read page 105, advertising section.

A MONEY Proposition—Co-operate with me in a profit-sharing mail-order business. Will place trial advertisement, furnish printed matter, goods to fill orders and divide the profits. Particulars, Desk 153, Hazen A. Horton, Tekonsha, Mich.

I HAVE a contract to distribute a million free packages of Borax Soap Powder. Want reliable men and women to help. Chance to earn good pay. E. Waverly-Brown, 784 N. Franklin St., Chicago.

SILVERING Mirrors and Auto-trimings. Plating tableware home. Plans free. Clarence Sprinkle, East Grant, Marion, Ind.

THOUSANDS Government Jobs Obtainable. List free. Write Franklin Institute, Dep't O-21, Rochester, N. Y.

FIREMEN, Brakemen, all Railroads, \$120. Experience unnecessary. Send age, postage. Railway Association, Dept. 208, Brooklyn, N. Y.

CASH quick. Our Free Booklet Number Ten gives Magic Secrets of Success. Stephens School, Muncie, Indiana.

BE a Detective. Earn \$150 to \$300 monthly. Travel over the world. Write American School of Criminology, Dept. F, Detroit, Michigan.

WANTED

HIGH grade gas-welding plant, standard lathe, air compressor, alternating current motor. Must be bargains. Box 258, Eugene, Ore.

WANTED, by Mail Order concern, novelties of every description. Address, P. O. Box 559, So. Norwalk, Ct.

FOR SALE

FIELD Marine Day and Night Glasses with beautiful case, 25 mile adjustment, \$30.00 value, only \$6.50. Money back if not satisfied. Ye Curiosity Shop, 20 S. Second St., Philadelphia, Pa.

VACUUM cleaner pumps and parts for assembling, save 75%. Vacuum Supply Co., Ann Arbor, Mich.

MATERIAL and Patent for 10c novelty. Address Novelty Works, Boydell Building, Detroit, Mich.

SLOT Machines—Bells \$12 to \$18, like new. Floor Venders \$28. Send for price list of parts. Less than one-half Mfg.'s price to close out. Auto Vending Co., Minneapolis, Minn.

SALE OR EXCHANGE

MOTORCYCLES; cyclecar; moving-picture camera; typewriter; for what? O'Brien, 6350 State, Chicago.

POWERFUL Microscope; sell or trade. Clarence A. Smith, Vernon, Texas.

GUNS, SPORTING GOODS, ETC.

FIREARMS Wanted. Buy, sell or exchange all sorts. Stephen Van Rensselaer, Dept. 18, West Orange, N. J.

MACHINERY, TOOLS AND SUPPLIES

ONE Table Drill with drills for drilling boiler flue holes with belt and gear guards, \$50. Two plate splitting shears with belt and gear guards 5/16 in. capacity, \$50. 1/2 in. capacity with crane and chain hoist, \$200. Two swinging jib cranes with 3-ton traveling air hoist, \$125 each. One crane swinging from wall with a two-ton chain hoist, \$75. One emery grinder with belt, countershaft and safety guard, \$15. National Boiler Works, 354 Fulton St., Chicago.

FOR Sale—All sizes new and second-hand Pulleys, Belting, Shafting, Hangers, Couplings, Pillow Blocks, Collars, etc. Passman Bros., 28 and 30 So. Green Street, Chicago, Ill.

FOR Sale—Turret Lathe, \$90; punch presses, \$35; grinders, \$10; drills, hoists, etc. Ickow, 31 S. Desplaines St., Chicago.

DRUMMOND "Precision" self-acting, sliding, boring, screw cutting and milling guaranteed lathes, swinging eight inches; forty-two dollars. Book "Lathe Work" free. See page 148. W. R. Price, New York.

PULLEYS, Gears, Sprockets, Shafting, Hangers; see page 140. W. A. Jones Foundry & Machine Co., Chicago.

CONCRETE mixer, first-class machine, cost \$550; will sell for \$250. The Oregon Lumber Co., Denver, Colo.

SHEET metal stamping plant manufacturing specialty selling for \$1 and \$2. Presses, Screw machine, Seamer, Thread roller, Riveter, Motor, Lathes, and Dies. Eastern Pennsylvania, M. P. 9th Floor, 72 E. Madison St., Chicago.

VACUUM cleaner pumps, tools, etc., for stationary house or wagon outfit. Vacuum Supply Co., Ann Arbor, Mich.

16"x5" BEMENT Lathe, compound rest, chuck, \$165 cash. Western Machinery Co., Cincinnati, Ohio.

PLUMBERS, Pipefitters, stop guessing at your pipe measurements when using degree fittings; circular difficult pipe measurements made easy, on request. Kolar Manufacturing Company, Portland, Oregon.

REBUILT Leather Belting. Half the price, equal new in service, excellent appearance, all sizes, satisfaction guaranteed. Also new, 25% under dealers' prices. Canvas and rubber Belting. Fredrich Belting Co., Manufacturer, St. Louis, Mo.

FOR Sale—Several old-style lathes and planers suitable for repair work. Geo. J. Adams, 29 South St., New York.

FOR Sale—25 Lincoln milling machines, \$25 to \$100 each. Lucas & Son, Bridgeport, Conn.

HAVE for sale several sizes of lathes, milling machines, drill presses, punch presses, shapers, planers, boilers, steam engines, oil, gas and gasoline engines and wood-working machinery. Pinner, 122 Water St., New York, N. Y.

ENGINE Lathe, swings 9 1/2 in., takes 25 in. between centers. Complete set gears cutting all size threads 3 in. to 40 in., \$13.50. Grammes & Sons, Allentown, Pa.

FOR Sale: 5 good Engine lathes, 16" to 22"; state size wanted. Lucas & Son, Bridgeport, Conn.

JUST Published—Popular Mechanics Shop Notes for 1915—626 Easy Ways to do Hard Things. This is Vol. XI and is similar in style to the other numbers in the series. 224 pages, 517 illustrations. Paper 50 cents. Cloth, \$1. Postpaid. Popular Mechanics Book Dept., 6 N. Michigan Ave., Chicago.

ENGINES AND MOTORS

WESTINGHOUSE, 25-H. P., 2-cylinder vertical engine; Williamsport 20-H. P. horizontal engine; complete Special Electric Governor, \$300 each; Mathewson 4-cylinder remodeled French auto engine, 50 H. P., with throttling governor, \$150. Johnston, West End, Pittsburgh, Pa.

ALTERNATING current, single-phase motors, 1/30 H.P. to 5 H.P. Bargains in direct current and three phase motors, all sizes. Motors bought, sold, repaired. Satisfaction guaranteed or money refunded. Send for new bargain list electrical supplies. Hyrs Electric Co., 613-Z So. Dearborn St., Chicago.

BARGAINS marine engines all sizes. Send for list. Boat Factory, McHenry, Ill.

FOR Sale—4 1/2 H.P. Automobile Steam engine and boiler complete, \$40. 1423 North Ave., Bridgeport, Conn.

SEVERAL Generators—all new—110 volts—less than half price; 40 lights, \$35; 100 lights, \$60; 175 lights, \$90; several larger—also 3 low-voltage charging outfits. Johnston, Evans Ave., Ingram, Pa.

6 HORSE Power Gas or Gasoline Engine, used but little, cost \$325, will sell for \$95. Harry Scheffler, West High St., New Philadelphia, Ohio.

TWENTY-Five Horse Power marine engine at half its value. C. W. Meeker, Astor, Fla.

BRAND new 4x5, 4 cyl., water cooled, gasoline motor, our own make, no equipment. Highest bid over \$30 takes it. Ship subject to examination. Winnetka Garage, 562 Lincoln Ave., Winnetka, Ill.

MOTOR Generator Set; 1 K. W.—new—110 volts—60-cycle—for wireless telegraph work, \$95, worth \$165; several larger. Chas. Johnston, West End, Pittsburgh, Pa.

FOR Sale—2 1/2x36-in., 100 revolutions, 125-lb. automatic cutoff Conway engine, right hand, shaft 18 ft. 6 in. long with two wheels 12 ft. 2 in. by 26-in. face and 11 ft. 10 in. by 20-in. face. In good condition and can be seen in storage at this point. Built by Filer & Stowell Co., Milwaukee. Is as economical as a Corliss. Worcester Lumber Co., Ltd., Chassel, Mich.

REBUILT Engines—We have on hand a number of rebuilt "Buffalo" engines, guaranteed, at greatly reduced prices. Write for bargain list. Buffalo Gasoline Motor Co., 1203-1205 Niagara Street, Buffalo, N. Y.

CASTINGS for small stationary gasoline engines, with drawings. R. H. Bowersox, Hanover, Pa.

JUST Issued—Amateur Mechanics No. 6. Another great book of 203 articles for those who like to make things. Similar in style to the other numbers in the series. 128 pages. 261 illustrations. Paper. Price 25 cents postpaid. Popular Mechanics Book Dept., 6 N. Michigan Ave., Chicago.

LOT small A. C. and D. C. Motors and Generators—all new—110 volts, 1/4 H. P. A. C., 60-cycle, \$11.50; 1/4 D. C., \$5; 6-light generator, \$8; 10-light, \$12. Johnston, Evans Ave., Ingram, Pa.

FLOUR & FEED MILLING MACHINERY

SPECIAL bargains in second hand Attrition mills, barr mills, crushers, corn shellers, bean dusters, dust collectors, purifiers, reels, double, single, 2 and 3-pair big roller mills, sieve bolters, receiving separators, scourers, etc. Write for description and prices. Sprout, Waldron & Co., P. O. Box 429, Muncie, Pa.

BOATS, LAUNCHES, ACCESSORIES

MOTORCRAFT Encyclopedia—A 150-page book that tells 1001 things every motor boatman should know. How to overcome engine troubles. Price \$1. Postpaid. Popular Mechanics Book Dept., 6 N. Michigan Ave., Chicago.

MOTOR Boat Hulls. Finish your own boat and save two-thirds the cost. Our 19'x5' ten-passenger Runabout Hull, \$95. Rice Brothers Company, East Boothbay, Maine.

FOR THE SHOP

FOR That Boy—He will appreciate a copy of the great boy's book "The Boy Mechanic" that tells about 700 different things for boys to do and has 800 pictures. 430 (7x10) pages, cloth, big, handsome book for the price, \$1.50 postpaid. Popular Mechanics Book Dept., 6 N. Michigan Ave., Chicago.

BLACKSMITHS

BLACKSMITHS, get out of the rut; be progressive. Get Toy's modern methods of doing hard jobs easy. Make solid welds. Temper all tools to a standard with Toy's Colored Tempering Charts. Do the job the other smith can't do. All for \$1. Send for free samples. W. M. Toy, Sidney, Ohio.

SHOP Notes—Many valuable kinks for blacksmiths are contained in our series of Shop Notes books. 19 volumes, 50c each, postpaid, or \$5 per set prepaid. Popular Mechanics Book Dept., 6 N. Michigan Ave., Chicago.

BLACKSMITHS—Learn hand-wrought ornamental ironwork. Our 200-page book "Hand Forging" points out clearly all the guiding principles and methods which underlie all forge work. Written by a practical authority. 122 illustrations, cloth, \$1 postpaid. Popular Mechanics Book Dept., 6 N. Michigan Ave., Chicago.

CEMENT

IF you want the best information on cement and concrete construction, subscribe for Concrete-Cement Age, leading cement and concrete monthly. Sample copy, 19 cents. Yearly subscription, \$1.50. Concrete-Cement Age, 135 Newberry Bldg., Detroit, Mich.

ELECTRICAL

115 V. 3 K.W.D.C. GENERATOR and 6 H.P. Automatic engine combined. Price \$250. Lucas & Son, Bridgeport, Conn.

SEND for bargain list electrical supplies, flashlights, etc. Hyre Electric Co., 613-V, S. Dearborn St., Chicago.

EIGHT inch electric fans \$3, Magneto-Generators \$2, Edgar Philip, 187 Field Ave., Detroit, Mich., for Bargains.

"BOY Electrician." Make Batteries, Dynamos, Motors, Electric Engine, Telephone, etc. 75 illustrations, 10c. Renew Dry Batteries, 3 guaranteed processes, 20c. Both 25c. Novelty Shop, 3311-B, Belleplaine Ave., Chicago.

LEARN to use a slide rule. The "Gilson Slide Rule" does work equaling a \$10 rule. Results of computations given to five figures. Price with complete instructions, 50c. Clair Gilson, Niles, Mich.

FREE: Transformer prospectus; Engineering, Box 41, Hanover, N. H.

50 LIGHT Dynamos and 2 Horse Electric Motors. Highest quality. Lowest price. Easiest terms. Write Hobart Bros. Co., Troy, Ohio.

AMATEURS' Electric Heating Apparatus. Complete parts semi-finished for Electric Iron or Toaster \$1.75 each, both \$3.00. Ceb, Hesperia, Ontario.

BIG Bargains; regular \$1.50 Flashlight Pistols, Tungsten Lamp and Battery, only 98c—three for \$2.75; \$9.50 a dozen. Don't miss this sale. Almore Co., 356 Belmont, Chicago.

ENGINE CASTINGS AND BLUE PRINTS

FOR Sale—Castings for two cycle engines. Richards Iron Works, Manitowoc, Wis.

GASOLINE Engine Castings, with drawings. Cheap. Catalog for stamps. Novelty Manufacturing Co., 853 West 6th St., Cincinnati, Ohio.

RARE COINS

OLD Coins Bought and Sold. Spring catalogue list of coins for sale, free to collectors only. Buying catalogue quoting prices I pay for coins, 10 cents. Wm. Hesslein, 101 Tremont St., Boston, Mass.

\$50 PAID for Half Dol. 1853. no arrows; \$5 for 1878 Half, 8. Mint. \$100 for 1894 Dime, 8. Mint. Many valuable coins circulating. Get posted. Send 4c. Get our Illus. Coin Circular. It may mean large profits to you. Send now. You have nothing to lose. Numismatic Bank, Dept. 8, Fort Worth, Texas.

\$4.25 EACH Paid for U. S. Flying Eagle Cents dated 1856. We pay cash premiums on hundreds of Old Coins. Send ten cents at once for New Illustrated Coin Value Book—4x7. It may mean your fortune. Clarke & Co., Coin Dealers, Box 15, Le-Roy, N. Y.

BUFFALO Nickels—5c each paid for them and Lincoln pennies, certain kinds. Highest prices paid for all old coins. Send 19c for coin catalog and particulars. Jones, Coin Dealer, Newton, Ill.

COINS, Antique Belles—Five curious, rare coins with catalog, 10c. Ray Chapin, New Berlin, N. Y.

ALL for 50c. A 25c California gold piece, a Premium Coin Catalog, a selling list, a Columbia nickel and a lucky seed. C. J. Carey, New Rochelle, N. Y.

10 COINS from the Warring Nations, 25c. 10 foreign coins, 15c. 10 coins, 5 bills, 30c. 290 different stamps, 15c. Burgess Co., 522B, Beacon, Toledo, Ohio.

ALL for \$1.00. A 50c and a 25c California gold coin or token and five Confederate State Notes, Coin Exchange, New Rochelle, N. Y.

STAMP COLLECTING

104 DIFFERENT stamps, including United States 1861 Civil War, Japan, Argentine, etc. Large price list and sample New England Stamp Monthly, only 5c. Finest approval sheets. 50% discount. New England Stamp Company, 19 Washington Bldg., Boston.

STAMPS, 100, all different, free. Postage 2c. Mention paper, Quaker Stamp Co., Toledo, Ohio.

STAMPS—12 different from warring nations, 15c; 10 different foreign coins, 15c; 20 Belgium stamps, 10c. Lists free. Toledo Stamp Co., Toledo, Ohio.

STAMP Album with 538 Genuine Stamps, incl. Rhodesia, Congo (tiger), China (dragon), Tasmania (landscape), Jamaica (waterfalls), etc., 10c. 100 dif. Jap., N. Zel., etc., 5c. Big list; coupons, etc. Free. We buy stamps. Hussman Stamp Co., St. Louis, Mo.

STAMPS sent on approval at 50% discount. Reference required. 1000 Pelebe Hinges 5c. Emory Renold, Hanover, Pa.

24 VARIETIES Cuban stamps, 10 cents. List of 6,000 low-priced stamps free. Chambers Stamp Co., 111 P. Nassau St., New York City.

STAMPS—105 China, etc., stamp dictionary and list, 2c. Bullard, Sta. A, Boston.

FREE—15 So. American to approval applicants. Weed Stamp Co., Centerville, Mich.

FREE! 50 different, including unused New Hebrides (Pictorial). Send 4c postage, mention Gift F10. Bright & Son, 164 Strand, London, Eng.

FREE packet foreign stamps to approval applicants. Reference. Litten, Rock Island, Ill.

1,000 VARIETIES stamps free. 2c brings particulars. Phillips, Levison, California.

TWO unused sets free for names of two collectors. Dam City Stamp Co., Keokuk, Iowa.

PACKET of 23 stamps; no two countries alike, 500 hinges. Set of \$1 and \$2 U. S. Rev., all for 5c. Mention paper, Miami Stamp Co., Toledo, Ohio.

FREE—205 different foreign stamps or 104 United States, 60 Japanese or 50 Asiatic. Remit 25c six months subscription McKee's Stamp Weekly, Boston, Mass.

25 DIFFERENT British Colonials to applicants for stamps on approval who send 2c postage. Nickles, 122 Florida Ave., Washington, D. C.

FIVE new issues free to approval applicants. Leon Cass, Quakertown, Pa.

AFRICAN Stamps. Congo, Abyssinia, Sudan, Tunis, Benadir, Madagascar, Somali, Obock, etc., 100, \$1.10; 200, \$3; 250, \$5. Satisfaction guaranteed. Felix Cohen, Port Said, Egypt.

STAMPS—1,000 different, fine (no trash) \$3.00, 500 \$1, 2,000 \$8. Rev. Seidenberg, Beecher, Ill.

FOREIGN Stamps Free; 52 different foreign, including China and Venezuela, to all who apply for our high grade approval selections. Send two cent stamp for return postage. Edgewood Stamp Co., Dept. H, Millford, Conn.

APPROVALS? 5,000 varieties at 1c and 2c each. P. Riedell, Schenectady, N. Y.

1 AND 2c net approval books, sent anyone interested; 500 varieties 50c. 100 various U. S. 15c. P. G. Beals Stamp Co., 19 Pearl St., Boston, Mass.

FREE—Any ten stamps from my one-cent sheets. H. Codwise, Melrose HT's, Mass.

FOR MEN

SAVE money on shoes! Factory to feet. You save retailer's profit and get better shoes. Fit and entire satisfaction guaranteed or money back. Style book free. Pathfinder Shoe Co., Dept. P, Webster, Mass.

HEATLESS Trouser Press. Press in 5 minutes without heat, prepaid 50c. Money refunded if unsatisfactory. Circular free. Wilbur-James Co., Box 749P, Bridgeport, Conn.

KENTUCKY Tobacco, old and sweet; the natural leaf, guaranteed best chewing and smoking. 50c a pound postpaid. J. L. Workman, Mayfield, Ky.

MEN buy your hats direct from the manufacturer. Save money. Send for catalogue. Orange Hat Mfg. Co., Dept. E, Orange, N. J.

MEN, a very useful present Free. No money. Send stamp only. The L. T. M. Co., Desk Z, Baltimore, Md.

SAFETY BLADES SHARPENED

SAFETY razors sharpened; two cents each. Guaranteed. Blade box free. Electro Shropping Co., 131 Shelby St., Detroit, Mich.

FOR THE HOME

HOME Furnishings and Decorations; easy with Hobbies designs, tools, materials. W. K. Price, New York.

SAVE your money. Send twenty cents for instructions how to care for plumbing, also care of pipes during freezing weather. E. B. Grady, The Plumber, P. O. Box 194, Concord, N. C.

FACTORY Prices. Favorite Washers \$2. Ball-Bearing Wringers \$2.75. Catalogue free. Favorite Washer Co., Honey Creek, Ind.

BEAUTIFUL arts-crafts lamps—Anyone can make them out of paper, cardboard and wood. 16 designs. Inexpensive yet artistic. Complete book of instructions. Price, 50c postpaid. Popular Mechanics Book Dept., 6 N. Michigan Ave., Chicago.

MAKE your own mission furniture at the minimum of expense. Our 3 books "Mission Furniture. How to Make It." Parts 1, 2 and 3, tell in plain, simple language just how to make 98 different pieces. Full dimensions, working drawings and half tons of finished articles. Price, 50 cents each or \$1.50 for the three volumes, postpaid. Popular Mechanics Book Dept., 6 N. Michigan Ave., Chicago.

ARTISTIC Lamps and Shades in metal and art glass easily made by the amateur craftsman from instructions given in our book of 18 designs ranging from ordinary reading lamps to pretentious chandeliers. Expense only slight. Price of book 50c postpaid. Popular Mechanics Book Dept., 6 N. Michigan Ave., Chicago.

DIAMONDS, WATCHES AND JEWELRY

BARGAINS in Diamonds and Watches. Special 60 days. Latest Thin Model 15 Jewel Elgin movement, in Hand Engraved 20 year gold filled Wadsworth case, complete \$10.55. Sent C. O. D. subject to examination. Chas. W. Trice, Diamond and Watch Specialist, Barnes Bldg., Wichita, Kans.

MUSIC

"DREAMS," the greatest waltz ballad in years. For sale everywhere or direct from us, 10 cents. Marks-Goldsmith Co., Dept. 91, Washington, D. C.

229 SONGS, with music, 10c. Enterprise Co., PM-3348 Lowe Ave., Chicago.

PAN-AMERICAN, American Conqueror, best two schottisches ever written. Both 15c postpaid. Heavy coated papers. Above and 23 others \$1.19. Wpress, Wauregan, Conn.

SONGWRITERS. Let us write music to your songs and help you dispose of them to music publishers for cash or royalty. National Manuscript Sales Co., 366 Theatrical Exchange Building, Broadway and 49th Street, New York.

PLAY Piano instantly—first trial, World's greatest invention. Musician Self-maker, 2811 Lake, Chicago.

SHEET Music—Latest Assorted. Regular 50c kind. Send 25c, 7 copies. Merchants Specialty House, Chicago.

BEST Music Bargain Ever Offered; ten penny stamps or coin. Opportunities like this come but once. J. Fefel, 815 Broad St., Bridgeport, Conn.

PIANOS AND MUSICAL INSTRUMENTS

TALKING Machine Records at cut prices. 100,000 10-inch records for Victor and Columbia Talkers, 60c kind, our price, 20c. Send for catalogue. Deringer, the Price-Cutler, Rochester, N. Y.

FOR Sale—Two fine violins. Very reasonable. Ernest Osler, 13 Broadway, New York.

COLUMBIA Grafanola and twenty records \$12. Easy terms. Earl Starrock, Post Townsend, Wash.

BUSINESS SERVICE

INCORPORATE. Our lawyers do the work, saving you time, annoyance and money in incorporating under the most liberal laws of Arizona. Laws and forms free. Southwestern Securities & Investment Co., Box D488, Phoenix, Ariz.

ESTIMATING and Contracting by Radford—A 800-page manual of up-to-date methods for rapid, systematic and accurate calculation of costs of all types and details of building construction, with quotations of ordinary prices for labor and materials, standard schedules and forms, labor-saving tables and other data useful to the building trades. Flexible leather illustrated—\$2 per copy postpaid. Popular Mechanics Book Dept., 6 N. Michigan Ave., Chicago.

FORMULAS AND TRADE SECRETS

RELIABLE Formulas on anything, 25c each. Rosa Information Bureau, 87 W. Cedar St., Boston.

CHEMICAL Analyses of Commercial, Household and Technical Products. J. B. Dunnigan, Chemist, 230 Electric Ave., Rochester, New York.

1,000 TRADE Secrets and formulas, 25c. 500 selected formulas, 20c. Resilver mirrors, guaranteed process, 20c. Sneezing Powder, Itch Powder, 10c each. Entire lot 50c. Service Bureau, 3311-B, Belleplaine Ave., Chicago.

A HIGH grade, guaranteed formula for almost any occasion. Prices reasonable. Correspondence confidential. Cole Chemical Company, Chicago.

LAST call to get that formula for a quarter. Raymond, Box 172, Scranton, Pa.

20,000 FORMULAS—Price \$1, postpaid; complete list 4c stamps. Edm. Bromley, Watervliet, N. Y.

\$2 BRINGS you formula for making ice less than one-fourth cost. Will not answer letters. W. P. Rockow, Winslow, Ill.

10,000 SELECTED scientific, chemical technological, and practical recipes and processes, including hundreds of so-called trade secrets for every business, alphabetically arranged in one large volume of 800 pages. Price \$3 prepaid. Popular Mechanics Book Dept., 6 N. Michigan Ave., Chicago.

GAMES AND ENTERTAINMENTS

BARGAINS in Magic! Magician's Rising Cards, 30c; Magician's Trick Cards, 25c; Multiplying Billiard Balls, 25c; Table Lifting Trick, 15c; Disappearing Ball, 15c; Smoke Trick, 15c; Vanishing Thumb, 15c; 84 New Card Tricks, 15c. All above Tricks prepaid, only \$1. Bargain Catalogue No. 14 Free. Order from nearest place. Eagle Magic Company, Minneapolis, Minn.; New Bedford, Mass.; Kiowa, Okla.; Blackfoot, Idaho.

TRICKS, Puzzles, Magic Goods, Sensational Escapes, and Illusions. Big catalogue free. Oaks Magical Co., Dept. 124, Oshkosh, Wis.

GREENBACKS — Yellowbacks, Stage money. New kind, 10c bunch; 4—25c, Baska Supply, P.O. 1, 3827 N. Kenneth, Chicago.

"CACHOO"—Snuff, Itching Powder, any 4—25c. Classy Den Photos—Set 25c. T. Sullivan, Abbott Ave., S. Fitchburg, Mass.

MAGIC tricks for the profession. Magic Parlors, 192 Clifford, Providence, R. I.

MAGIC pocket trick free. Worth 25c. With illustrated catalog of 250 tricks, puzzles, illusions for 6c. Stamps, Magic Co., Sta. 10, 249 West 38th St., New York.

NOVELTIES, Books, Tricks, Games, Etc. Illustrated catalogue free. Sample 25c Card trick, 10c. Auburn Supply Co. Specialty Dept., 7745 Peoria St., Chicago.

LOOK—Jumping Card Trick ten cents, three for quarter. You can fool everybody and have lots of fun. Sterling Magic Co., Box 338, San Rafael, Cal.

WIGS and Makeups (for Theatricals). Percy Ewing, Decatur, Ill.

FAKE money, closest imitation possible. Flashy roll with joke catalog, 10c. \$1000.00 worth second hand tricks for sale cheap. Immense Magic bargain sheet, catalog, 25c. Samples, 10c. Gilmore, Morgan Park, Ill.

47 TRICKS, 250 jokes, riddles, 73 toasts, 8 Fortune Telling secrets, 52 money-making secrets, 22 funny readings and big catalog 10c. Novelty Shop, 3311-B, Belleplaine Ave., Chicago.

MAGIC Tricks, Puzzles, Jokers' Goods. The latest Shooting Deck of Cards sent for 25c. Sneezing powder, itching powder, anarchist bombs, shooting cigars and cigarettes. Trick matches, creeping bugs, latest out; 100 others. Get acquainted with our goods and prices. J. Grandfield, Mfg., 1238 Theriot Avenue, Bronx, N. Y.

MAGIC disappearing coin and ring trick. Mystifies, amuses. Send 10c in coin. Catalog. Powell Sales Company, Dent, E. Ossining, N. Y.

BUY Magic Goods direct from manufacturer. No connections with small, unreliable dealers. Oaks Magic Co., Dept. 148, Oshkosh, Wis.

BE a handcuff king. We teach you. Escape from handcuffs, boxes, ropes, etc. Secrets of 20 sensational escapes \$1. Particulars free. The Magicraft Co., Dept. A, Box 251, Detroit, Mich.

EIGHT Games for 10 cents. Chess, Checkers, Fox and Geese, Nine Men Morris, Authors, Introduction Game, Spanish Prison, Dominoes; a whole year's amusement and the whole thing for only 10c. Send 10c today and get all eight games. Carl Co., 123 E. Chicago Ave., Chicago.

PLAYS, Vaudeville Sketches, Monologues, Dialogues, Speakers, Minstrel Material, Jokes, Recitations, Tableaux, Drills, Musical Pieces, Entertainments for all occasions. Make-up Goods. Large Catalog Free. T. S. Denison & Co., Dept. 11, Chicago.

MAGIC Catalogue, 100 pages, greatest on earth, ten cents. Learn magic at home. We teach you to do these tricks as good as the great professionals—escape acts, rope ties, mind reading, handcuff secrets. Satisfaction guaranteed. Chicago Magic Co., Dept. B, 72 W. Adams St., Chicago, Ill.

MYSTIC Photos—Photos without a camera. Never before considered possible. Marvelous results. Entertains and astonishes. Makes pictures instantaneously. Trial satisfies or money back. Send 10c for samples. Enough for 32 pictures. Alpharis Co., Longbeach Building, New York.

BE a Magician. Travel; give shows; earn money. I tell how. Send stamp. Prof. Rapp, Box F1115, Madison, Wis.

"DIAMOND Shower." Beauty Stone-set Squirt Ring, 20c. Stovers, Millersburg, Pa.

BARGAINS in Magic! Jokers' Goods and Books. Catalog free. Douglas Co., Kiowa, Okla.

FREE! Souvenir Trick; also catalog magic goods. Rex, Oshkosh, Wis.

GREENBACKS—Big wad, 10c; 4—25c. Enterprise Co., 1102-PM, Morton Bldg., Chicago.

SEND 6c, get best card trick ever invented, complete; also two catalogues. Home of Magic, Albany, N. Y.

MAILING LISTS

FREE to business men, copy of our comprehensive "Silent Salesman." Contains over 2,000 different classifications of Mailing Lists with number and price of each list, and information every business man needs. Accept this free offer. Trade Circular Addressing Co., G 164½ W. Adams, Chicago.

TYPEWRITERS AND SUPPLIES

GUARANTEED typewriters, \$10 up. Underwoods, back spacer, \$38. A. Bassett Typewriter Co., 180 N. Dearborn St., Chicago, Ill.

SEE special offer \$3 monthly page 161 this issue. Harry A. Smith.

ALL standard makes of typewriters. Big saving. Liberal guarantee. Catalogue, bargain list and valuable typewriter information free. The leading mail order typewriter house. A. E. Atchison, 110-112 No. LaSalle St., Chicago.

GOOD, serviceable typewriters \$7.50 and up. Post card brings list. Hub Typewriter Co., 286 Devonshire St., Boston.

TYPEWRITERS—Rare bargains from \$5 to \$50; all guaranteed; shipped with privilege of 15 days' free trial; get our proposition before purchasing a writing machine. We can save you dollars. Coast Typewriter Exchange, Atlantic City, N. J.

RENEW old carbon papers; simple, effective method; no chemicals. Directions dime (silver). C. Swayne, Merchants Station, St. Louis.

SPECIAL Note: If you want a real bargain in a dandy, high-class, substantially guaranteed rebuilt typewriter of any make—on time, rental or cash—be sure to write the big house today. Young Typewriter Co., Dept. 148, Chicago.

BUY direct: Typewriters of every description. Underwoods, Remingtons, Oliviers, Foxes, etc. Tremendous savings, \$10 up; guaranteed 2 years. 15 days' free trial. Money refunded if unsatisfactory. Bank references. Catalogue free. Agents wanted. National Typewriter Exchange, 357 Broadway, New York.

REMYINGTONS \$10; Smiths \$10; Oliviers \$17.50; Underwoods, Monarchs, Loyals. Rebuilt and guaranteed for five years. Send for special circular. C. H. Alcock, 620 So. Hermitage Ave., Chicago.

1,000 FULL Size, Imitation Typewritten Letters, heading black, body blue, \$3.00. Satisfaction guaranteed. Anchor Printing Co., 1614 Market, St. Louis, Mo.

1,000 REMINGTONS \$10.00. Other bargains. Department F, Mdsce Co., Bellevue, Ohio.

PRINTING, ENGRAVING AND MULTIGRAPHING

PREPAID, 200 gummed labels 10c; 1,000 circulars 3x5, 35c; 500 bond letterheads and envelopes \$2.85. The Majestic Printing Co., 2044 Leeward Ave., Los Angeles, Calif.

BETTER Printing—Hammermill Bond envelopes, letterheads (white, gray, pink, blue, buff, café, goldenrod, russet), 250 \$1; 1,000, \$2.75 postpaid. Samples 2c. 6x9½ press, throw-off, treadle, pulley, \$22. Kigerpress, Donnellson, Iowa.

100 CARDS, 50c prepaid. Strictly first class work. H. B. Kadana, 12 E. Chicago Ave., Chicago.

GUMMED labels, 3,000, \$1. Catalogue 2c. Also Taggart, 1235 Arch, Philadelphia, Pa.

YOUR name on 200 gummed labels, 10c. Starr Co., Clintonville, Conn.

125 ENVELOPES, 125 letterheads, printed, delivered, \$1, cash. Ask for agent's proposition. Burgess, Newark, New York.

QUALITY Printing—Bond Letterheads, Envelopes, Billheads \$1.25 1,000, Manila Envelopes 55c 1,000. Samples Free. Our estimate on Booklets, etc., will save you 30%. National Printing Service, 2638 Grand Ave., Chicago.

1,000 3x6 BOND Circulars, 150 words, postpaid 9c. Keimsoott Press, Hatfield, Minn.

50 LETTERHEADS and 50 Envelopes, printed, 60c, prepaid. 1,000 3x5½ Envelope 50c, 100 words, \$1. Patterson, Printer, Beaver Falls, Pa.

PRINTING Presses, Type and Supplies. Big bargain sheet for stamp. Popular Bargains, Richmond, Pa.

ENVELOPES, Billheads, Statements, Cards printed \$1.30 per thousand. Samples free. J. M. Hunt, Lambertville, N. J.

YOUR name and address on 500 Gummed Stickers 50c. Pearl Card Co., D-6, Clintonville, Conn.

500 BOND letterheads or 500 white wove envelopes \$1.25; both \$2.35. Elite Press, 1331 3827 North Kenneth, Chicago.

PRINTING Outfits—Presses, type, supplies. Catalogue free. The Model Press, York, Pa.

1,000 HAMMERMILL Bond Letter Heads, \$1.50; 5,000, \$5; 1,000 envelopes, \$1.75. Samples. Mescraull, Printer, Kansas City, Kansas.

PRINTING Presses, type, supplies. Catalogue free. L. M. Carroll & Co., 326 Madison St., Chicago.

PRINTING—500 either noteheads, envelopes, statements, cards, \$1; 1,000, \$1.50; 1,000 linen finish letterheads or envelopes, \$2.50; 1,000 typewriter letters, \$2. Samples. Model Company, Manchester, Iowa.

100 TWO-COLOR Letterheads and 100 Envelopes, bond; postpaid, \$1. Satisfaction guaranteed. Free samples. Westall Printery, 11 Vine, Worcester, Mass.

EMBOSSSED Letterheads and Envelopes very low price. Samples. Turner & Dunlap, Wilkes-Barre, Pa.

50 CALLING Cards, 10c, prepaid. F. Shepard, Rome, N. Y.

GUMMED Labels, 3,000—\$1, 1x2 inches, printed to order. Catalogue 3c. Helmers Co., Hoboken, N. J.

GOOD Printing at low prices. 1,000 good letterheads, envelopes, cards, billheads, labels, circulars, \$2.50. Samples free. Catalogues, booklets, and circulars our specialty. Ernest L. Fantus Co., 525 S. Dearborn St., Chicago.

PROPER printing at right prices. Splendid quality letterheads, envelopes, cards, statements, \$2.50 per 1,000. Samples free. Robinson Printery, Curwensville, Pa.

ADVERTISING Poster Stamps. Greatest novelty of the age. 15 words or less, printed two colors; 1,000 only \$1.50; 3,000, \$2.75. Samples free. Address Central Commercial Co., 2333 Summit St., Kansas City, Mo.

SPECIAL—1,000 6 1/2 White envelopes, prepaid, \$2. Rural Printers, Pawnee, Neb.

ADVERTISERS—Here's your opportunity. 25 word classified ad inserted in "Cartoons Magazine" for 50c, one inch display ad, \$2. 30,000 copies guaranteed. Send in your ad for the next issue. Cartoons Classified Dept., 6 N. Michigan Ave., Chicago.

100 **BOND** Envelopes printed to order, 50c, postpaid. Write for samples. Francis M. Bauer, 22 Seventh St., Rochester, N. Y.

DOCTORS, Dentists—100 Letterheads, Envelopes embossed, \$2.50. Samples. Lock Box 264, Wilkes-Barre, Pa.

PAN-AM. PATENTS AND TRADE MARKS

T. DENNIS LOCKLING, C. E. (Pan-American Patent Attorney), P. O. Box 1861, Santiago, Chile. Patent and trademark protection procured in the "ABC" and adjoining South American Republics; workings effected; prosecution of legal defenses; industrial representation; reports, translations; charges and powers forwarded patent attorneys on request.

PATENT ATTORNEYS

MONEY saving information every inventor should have before applying for a patent. Dependable advice which has saved thousands for inexperienced inventors. Enlightenment is not followed by regrets. Free upon request. Geo. J. Otsch, Patent Attorney, 712 Studebaker Bldg., South Bend, Ind.

"**PATENTS** and Patent Possibilities" is a 72-page treatise which tells all about patents, what to invent and where to sell it. It gives honest advice to inventors, and is full of valuable and interesting information. Write for it today! It is Free. H. S. Hill, 905 McLachlen Bldg., Washington, D. C.

PATENTS—Herbert Jenner, patent attorney and mechanical expert, 698 F St., Washington, D. C. I repeat free of charge if a patent can be had and its exact cost. Send for circular.

C. L. PARKER, Ex-member Examining Corps Patent Office, Patent Attorney, 910 G St., Washington, D. C. Inventor's handbook, "Protecting, Exploiting and Selling Inventions," sent free upon request.

FOR dependable advice about Patents, address Benjamin & Bassett, 140 S. Dearborn St., Chicago, Ill.

PATENTS build fortunes for you. Our free booklets tell how; what to invent, how to choose an attorney. Write today. D. Swift, 317 Seventh St., Washington, D. C. Established 1889.

WANTED—New Ideas. Write for List of Inventions Wanted. \$1,000,000 in prizes offered for inventions. Our Four Books sent free upon request. Victor J. Evans & Co., 166 Ninth St., Washington, D. C.

PATENTS explained in my free books, telling what you should know—what to invent—what not to invent—how to sell your patent, etc. Write today. H. L. Woodward, 902 G St., Washington, D. C.

PATENTS that protect and pay. Advice and books free. Rates reasonable—highest references; best results. Watson E. Coleman, Patent Lawyer, 622 F St., N. W., Washington, D. C.

PATENTS That Pay. Proof given. Two wonderful guide books free. E. E. Yrooman & Co., 871 F St., Washington, D. C.

PATENTS—Send sketch for free search and report. Books on patents and book of reference letters sent free. John S. Duffie & Co., 610 F Street, Washington, D. C.

PATENT what you invent. It may be valuable. Write me. No attorney's fee until patent is allowed. Estab. 1882. "Inventor's Guide" Free. Franklin H. Hough, 522 Loan & Trust Bldg., Washington, D. C.

PATENTS—Trade-Marks. Send for my free book "How To Get Them." It's full of information you should know. Joshua R. H. Poets, 8 Dearborn St., Chicago; 529 Chestnut St., Philadelphia; 895 G St., Washington.

INVENTIONS Worth Thousands—Their value is governed by the strength of the patent. Get the advantage of our 39 years' experience in procuring your patent. Clients in your state. Write and send sketch. Louis Bagger & Co., 699 Barrister Bldg., Washington, D. C.

PATENT your invention. \$10,000 offered for inventions wanted. Booklet and opinion free. M. B. Stevens & Co., established 1864, 685 F St., Washington; 353 Monastock Block, Chicago.

THE Patentsome is free. An education in obtaining patents. Established 1865. Anderson & Son, Attorneys, 707 7th St., Washington, D. C.

MAKE patents pay. I can show you how. Write for my free book. Learn what my service means to you. Carl H. Crawford, Janifer Bldg., Washington, D. C.

PATENTABLE Ideas Wanted—Send for 3 free books. R. B. Owen, 39 Owen Bldg., Wash., D. C.

PATENTS—Books. 100 mechanical movements and full information free. Expert service. Best terms. Write today. Fred G. Dieterich & Co., patent lawyers, 600 Ouray Bldg., Washington, D. C.

PATENTS secured or fee returned. Send sketch for free search. Latest and most complete patent book ever published for free distribution. George P. Kimmel, attorney, 212 Barrister Building, Washington, D. C.

C. W. GERARD, formerly Patent Office Examiner, Scarritt Building, Kansas City, Mo.

NO Attorney fees until patent allowed. Send sketch for free report. Books free. Frank Fuller, Washington, D. C.

INVENTORS, send sketch or model for free search of the Patent Office Records. C. O. Meeds, McGill Bldg., Wash., D. C.

"**The Equitable Plan for Patenting an Invention**," sent on request. Geo. R. Hamlin, 809 H St., Washington, D. C.

PATENTS secured through credit system. Patentability search free. Booklet free. John Louis Waters & Co., Hutchins Bldg., Washington, D. C.

PATENTS sold on Commission. Inventions perfected. Jacobsen, 4101 Eddy St., Chicago.

PATENT specifications fully prepared for Patent Office \$5. Patent News, Washington, D. C.

OFFICIAL Drawings Free. Patents procured or fee refunded. Expert services. Send sketch for Free search. The Patent Exchange, Washington, D. C.

PROTECTIVE patents procured promptly. 112 page blue book on patents sent on request. Trade-marks registered. Robb & Robb, 211-215 Southern Bldg., Washington, D. C.

PATENTS Secured—Take advantage of my personal experience; send sketch or model. Get my free book containing 200 mechanical movements. W. N. Boach, Jr., 954 McGill Bldg., Washington, D. C.

FOR INVENTORS

INVENTORS: We are admirably equipped with modern tools and years of experience and expert mechanics for assisting you to develop your ideas. We also make dies, tools and metal stampings. High-grade work and service guaranteed. Acme Tool & Die Wks., Indianapolis, Ind.

WE'LL tell you without charge why your invention is, or is not, worth patenting. Benjamin & Bassett, 143 S. Dearborn St., Chicago, Ill.

A GOOD reliable institution wants to manufacture patented articles on a royalty, or make some satisfactory arrangement with the inventor, something in the line of brass or electrical goods preferred,—or we are in a position to finance a small manufacturer who has not sufficient capital to carry on his business by buying it outright or by making some other arrangement that might be satisfactory to the owner. Address K. E., 799-35 S. Dearborn St., Chicago.

HAVE you a Patent to sell? You'll be interested in my proposition. Write now for free particulars. F. W. Johnson, 6 N. Michigan Ave., Chicago.

IDEAS, Patents, Inventions, developed and perfected. Expert Model and Machinery Building. Scientific experimental work. Regal Model and Tool Works, 122 Clark St., Chicago.

HAVE You an Idea? If so, you should protect it by a patent. Send us a model or sketch for free opinion as to patentability. Write for our Four Books sent free to any address. Victor J. Evans & Co., 157 Ninth St., Washington, D. C.

PATENTS, Trade-Marks and Copyrights. Our handbook on patents will be sent free on request. All patents secured through us are described without cost to the patentee in the Scientific American. Munn & Co., Patent Attorneys, 359 Broadway, New York, Washington, D. C. office, 383 F Street.

PATENTS Wanted—Will purchase or handle on royalty good Automobile Accessories. Box 124, Sta. B, Cleveland, O.

WANTED to buy patent on article with merit. State price and particulars. F. C. Desch, 321 St. Paul St., Baltimore, Md.

INVENTORS: My patent made a fortune. Particulars free. Let me help you. Eugene Pearl, 23 M. Union Square, New York.

WANTED—An Idea! Who can think of some simple thing to patent? Protect your ideas; they may bring you wealth. Write for "Needed Inventions" and "How to Get Your Patent and Your Money." Randolph & Co., Patent Attorneys, 620 F St., Washington, D. C.

WE contract with inventors to manufacture most all kinds of patented wire goods. Cooley, 533 W. Monroe St., Chicago, Ill.

YOU do not wish another to get the benefit of your patent. Market it yourself at small expense and the money will all come to you. M & M original selling plans will instruct you how to do this. Be your own boss. Martin & Miller, Advertising Counselors, 239 Fourth Avenue, New York.

PATENTS sold for cash or royalty. Write for terms. Green, Union Bank Bldg., Chicago.

PATENTS and Patentable ideas sold on commission basis. R. Fuller, 506 Fifth Ave., New York.

CAN you invent? Why not sell your invention for cash? Write Adam Fisher Mfg. Co., 291, St. Louis, Mo.

PATENTS Sold; we do the business, not merely collecting advance fees. If you own a patent send for free booklet "How We Get Cash for Your Invention." No charge for listing. Patent Sales Co., Frankford, Philadelphia.

INVENTORS, Attention! Fortunes are made after getting impartial, expert assistance and necessary information about your invention. Write Inventors Information Bureau, 1647 Hudson Ave., Chicago, Ill.

INVENTORS! Write for List of Inventions Wanted; handsome new book 4c postage. Sanders, 7 Webster Building, Chicago, Ill.

INVENTORS: We develop and perfect inventions, make models, dies, tools. Metal stampings and special manufacturing. Gerdling Bros., Cincinnati, Ohio.

INVENTOR'S Advocate, Washington, D. C. Best inventor's paper. One year on trial 10c.

PATENTS without advance attorney's fees. Send sketch for free report. Books free. Frank Fuller, Washington, D. C.

PATENTS FOR SALE

PATENT 45811 just granted, finest Electric Sign and Show Case, large profits. C. Bechtel, First and Main, Kansas City, Mo.

TOY, Combination Game of sheet metal. P. Maier, 23; Niles St., Elizabeth, N. J.

MUSIC leaf turner, attach to any music stand or piano. Simple in construction. Sale or royalty. W. Elman, 49 S. 15th St., College Point, L. I., N. Y.

PATENT on good household article. B. L. Mohney, Glenwillard, Pa.

PATENT on Lock-striker gage and holder. Just allowed. W. B. Carpenter & Co., 112 Mathewson St., Providence, R. I.

"**SHOVEL**," New device for removing snow and ice from rails in single operator. Thoroughly tested for practicability. Best offer accepted. Geo. E. Brown, care J. L. Smith, Shipoon Point, Stamford, Conn.

FOR Sale or royalty, a combination knife and fork in a case. Write for photo, etc. M. S. Hewitt, Georgetown, Texas.

PATENTED Funnel for sale. Prevents receptacle running over. Frank Landeen, 765 Public Square, Clinton, Ill.

PATENT for Sale—Just issued. Already doing business. Fine mail-order proposition. Good by-product for leather manufacturers. Pronounced by the best authority in the U. S. as the best article ever produced for the purpose. Chas. E. Gaskill, 150 Newman St., El Paso, Texas.

PATENT Buyers are invited to address our sales department for information on any class of Patents they wish to purchase or lease on a royalty. We have secured a number of valuable patents in all lines of invention. Mail Order, Department Store and Household Novelties a specialty. Victor J. Evans & Co., 160 Ninth St., Washington, D. C.

SALE or royalty; patented cards for playing 14 interesting games. Circular free. Ora Lewis, Rushville, Illinois.

OUTRIGHT Patent 1,077,664. New combination ferrule with a glueless tip for billiard cues. Millions boxes can be sold annually. Ankenmann, 170 W. 83rd St., New York.

AUTOMATIC Door Holding Spring, 1,112,620. George Johnson, Pigeon Cove, Mass.

FOR Sale—My Improved Rail Joint; can be used with or without bolts. Wm. Orr, 3641 Lucky St., St. Louis, Mo.

PATENTS: Several good ones cheap. They will increase your business. Ed Parker Co., Springfield, O.

IF you want to know why you cannot sell your patent, write Benjamin & Bassett, 140 S. Dearborn St., Chicago, Ill.

PATENTABLE Ideas wanted—Send for 3 free books. R. B. Owen, 30 Owen Bldg., Washington, D. C.

MUST sell valuable patent on combined Seed Planter and Fertilizer Distributor. Entirely new principle, broad claims. Spaces hills uniform. Investigate and make offer. A. J. Burkett, Wakefield, Va.

FOR Sale outright, registering attachment for firearms, the very thing for shooting galleries. Albert Rey, 306 E. 3rd, Oklahoma City, Okla.

FOR Sale—Patent No. 1016221. New puzzle. P. G. Toomey, Sanford, Me.

AIR purifying and cooling device, of simple construction. Fixed or portable. Cheaply manufactured. Materials inexpensive. Quickly attachable. Air mild and invigorating. Carl F. Lundberg, 36 Willow St., Hartford, Conn.

SAFETY Cuff-button; new device. Hildner, 2805 Columbia, Indianapolis, Indiana.

FOR Sale—Automobile Lock, patented Dec. 14, '14. Fuller & Coats, 319 Bridge St., Grand Rapids, Mich.

FOR Sale—Patent combined Coat and Hat Rack. Hat cannot fall. Something new and salable. Cost of manufacture small. B. Trice, 1217 Penn. Ave., Dallas, Texas.

PATENT, just allowed. Auto Folding Repair Truck. Patent pending on Combination Repair Truck and Luggage Carrier. Can be folded, placed in tool box. Has real merit. Scott Power, Zanesville, O.

MACHINE to twist wire stays for repairing wire fences of all kinds. Strachan, P. O. Box 685, Kansas City, Mo.

"CAPTIVE Aeroplanes." The world's greatest park amusement; American patent rights for sale. Apply Thomas H. Wade, 1219 Locust St., Philadelphia, Pa.

PATENTS for sale. Patents sold. Patent News, Washington, D. C. One year \$1. Sample free.

FLY Screen Eject—lets flies out but not in. Simple, cheap, useful, necessary. Enormous sales. Big profits. Investigate. Albert Almon, Glace Bay, N. S., Can.

LIGHT metal manufacturing business, including patents; fast-selling novelty; must sacrifice. Novelty Pipe Co., 8345 Garesche, St. Louis.

CLOCK controlled device which automatically opens furnace or boiler drafts and heats the house at any predetermined time. Cost about \$2.00 each, complete. Best offer takes patent. I. G. Wagner, Lancaster, Pa.

10c NOVELTY patent. Address Novelty Works, Boylston Building, Detroit, Michigan.

WALL Clothes Rack, best yet, look into this, write for price and information. D. A. Leonard, Bentonport, Ia.

CONSULTING ENGINEERS

CONSULTING Engineer—A. M. American Institute Electrical Engineers. Practical advice. Ideas, Inventions perfected. Maximilian M. Weil, 2 Rector, New York.

J. ED SHEPHERD, Research Engineer, inventing, designing, supervising, 125 Watts St., New York.

MODELS AND MODEL SUPPLIES

MODELS, designing, tool and die work and special machine building are our special work for which we are thoroughly equipped. We also do punch press work and make dies for, and develop difficult stamped and deep-drawn parts of sheet metal. Prices right and high-grade work guaranteed. Acme Tool & Die Works, Indianapolis, Ind.

I MAKE models for inventors and guarantee first-class workmanship; also do repair work and light manufacturing. George Wood, 223 Postal Telegraph Bldg., Kansas City, Mo.

PRODUCERS of Results; Inventions Developed, Light Mfg., Models, Experimental Work, Tools, Dies and Stampings. Johns Machine & Stamping Works, Middle Bldg., Dept. C, Cleveland, Ohio.

INVENTORS: We manufacture metal articles of all kinds to order. Also, special machinery, tools and dies, punchings, lathe and screw machine work, metal stampings, castings, plating, wood and metal patterns, etc. Send sample for estimate and expert advice, free. The Eagle Mfg. Co., Dept. B, Cincinnati, O.

MODELS made for inventors; general machine work; designing and perfecting; developing automatic devices and machinery. In a position to do all kinds of light tool and machine work. Prices reasonable; estimates cheerfully given. Ideal Machine Works, 62 Ann Street, New York City.

WE make working models for inventors; also dies and stamping of specialties, and carry a complete stock of brass gears and model supplies. Send for catalogue. The Pierce Model Works, 3405 Pierce Ave., Chicago, Ill.

PATTERN makers! A book devoted to the principles of pattern and core making and molding. Written by G. H. Willard, a practical pattern maker of years' experience. This book, just published, treats the subject in a much more simple, direct and effective manner than most books along this line. 224 pages, 312 illustrations. Price, \$1, postpaid. Popular Mechanics Book Dept., 6 N. Michigan Ave., Chicago.

NEW Lithographic Model of a Monster Mallet Compound Locomotive. All parts shown and numbered. Size 9x19 in. in colors. Other models in series are, Atlantic Type Locomotive—Steamship—Automobile—Gas Engine—Steam Engine—Steam Turbine—Dynamo—Wireless Telegraph. Price, 50c each or set of 9 for \$4 prepaid. Popular Mechanics Book Dept., 6 N. Michigan Ave., Chicago.

PATTERNS of every description for inventors. Castings furnished. Wood or metal models for demonstration. Estimates cheerfully given. Prices moderate. Andrew Fleming, 48 Dean St., Brooklyn, N. Y.

WE develop and perfect working models for inventors. Light machinery building, scientific experiment work. Dies made and stamping done. Modern Die & Tool Company, 70 Shtp St., Providence, R. I.

FREE catalogue of model supplies. Castings, metal specialties on contract. North Chicago Tool Works, 15 Grove Ave., North Chicago, Ill.

MAKE models yourself. Why not? Drummond lathe illustrated page 148. W. R. Price, New York.

SPECIAL Electrical and Mechanical devices built to order. Models, Tools, Dies, Benj. Levi, 357 West Broadway, N. Y. City.

MODELS, dies, etc., made for inventors by holders of "Tools That Work." La Croix Tool Co., 214 N. 21st St., St. Louis, Mo.

MANUFACTURING

DIES—Drop-forged. Bending. Blanking and Hot Punch. Pencil sketch and explanation of how to make any piece. Designer, 49 Clark Court, Detroit, Mich.

CASTINGS made in any metal for amateurs and model-makers. Send drawings for estimates. R. B. Denton, Wellesley Farms, Mass.

FACTORY—prices—quoted—Manufacture anything in Iron, Steel or Brass. Our foundry can handle large tonnage of Gray Iron, Brass or Aluminum Castings. Practical Iron Works, North Chicago, Illinois.

MANUFACTURER of wire, wire goods and springs of all descriptions. Thomas Hamilton, 4563 N. 15th St., Phila., Pa.

A SMALL, Incorporated Manufacturing Company whose salesmen call on the Hardware, Furniture and Grocery trade, wish to get in touch with other manufacturers with the view of jobbing their products. D. & S. Specialty Co., Detroit, Michigan.

WIRE Goods, all kinds, made to order. Cooley Mfg. Co., 553 W. Monroe St., Chicago.

INVENTIONS perfected and manufactured. Reference, your banker. Russell Machine Co., Dallas, Tex.

SPECIALTIES manufactured for Inventors. Lyons Machine Works, Lyons, Iowa.

DESIGNING and making of tools and dies, laying out economical production methods and building special machinery our specialty. High grade service guaranteed. Acme Tool & Die Works, 1621 Prospect St., Indianapolis, Ind.

GLASS for power is taking the place of steam for reasons of economy. Learn all about this great change by reading our new non-technical book on this subject, written by a first-class authority for the practical man. 192 pages, profusely illustrated, cloth binding. Price, \$1, postpaid. Popular Mechanics Book Dept., 6 N. Michigan Ave., Chicago.

REAL ESTATE AND FARM LANDS

SAN Joaquin Valley, California—What Another Man Did: At Riverbank, Stanislaus County, California, he bought 12 irrigated acres at \$150 an acre. A small farm? Yes, but 1/4 acre of strawberries realized \$265 and other small fruits brought his returns to over \$500, in addition to the living for the family. Hundreds of small farms like this have made their owners independent of hard times or a "boss." Do you want to abundantly provide for your family in the heart of Sunny California? Then write for our free booklets about "Poultry Raising," "Dairying" and the "San Joaquin Valley." Write now, to-day, to C. L. Seagraves, Gen. Colonization Agent, AT&SF Ry., 1806 Ry. Exchange, Chicago.

THAT Dream of yours, about getting the most out of life in "The Land of Sunshine, Fruit and Flowers"—California—will come true, just as soon as you desire, if you let me tell you where you can get excellent land, in large or small tracts, at reasonable prices and on easy terms. So write to me today. Accurate information free for the asking. R. A. Smith, Colonization & Industrial Agent, Union Pacific R. R. Co., Room 4122 Union Pacific Bldg., Omaha, Neb.

FOR Sale—Farms, all sizes. Large list free. Hagib Agency, Greensburg, Ind.

COMING to California? Little farms, 5 acres up. Irrigating water. Small payment, balance 8 years. \$250 up. S. Reynolds, 611 South Hill, Los Angeles.

SARASOTA Bay District in famous Manatee County, Florida. Own ten acres where there are no tree killing frosts. Raise oranges, grapefruit, strawberries, vegetables and chickens under a warm winter sun. Flowing wells. Invigorating salt air. Pine woodland breezes. 360 per acre. Terms, \$3 per acre first payment, balance \$3 per acre quarterly. Write for Free Booklet. West Coast Realty Company, Sarasota, Fla., Dept. D.

ARKANSAS—The Ozark Mountain Region is a most delightful place in which to live, having splendid climate and abounding in living springs of pure water. It has hill, valley and prairie land, a variety to suit everybody. Little Orchards of ten acres on long time. Write for free booklet. W. O. Nicholson, Immigration Agent, Kansas City Southern Railway, Kansas City, Mo.

MONEY-MAKING Farms throughout 17 states; one acre to 1,000 acres, \$500 to \$50,000; many with livestock, tools and crops included. Big illustrated list sent free. E. A. Strout Farm Agency, Station 3043, 47 West 38th St., New York.

BUY a farm without paying commission, from owner. Descriptions and addresses free. Write A. Mohler, 1059 North California Ave., Chicago, Ill.

Additional Classified Ads on Page 34

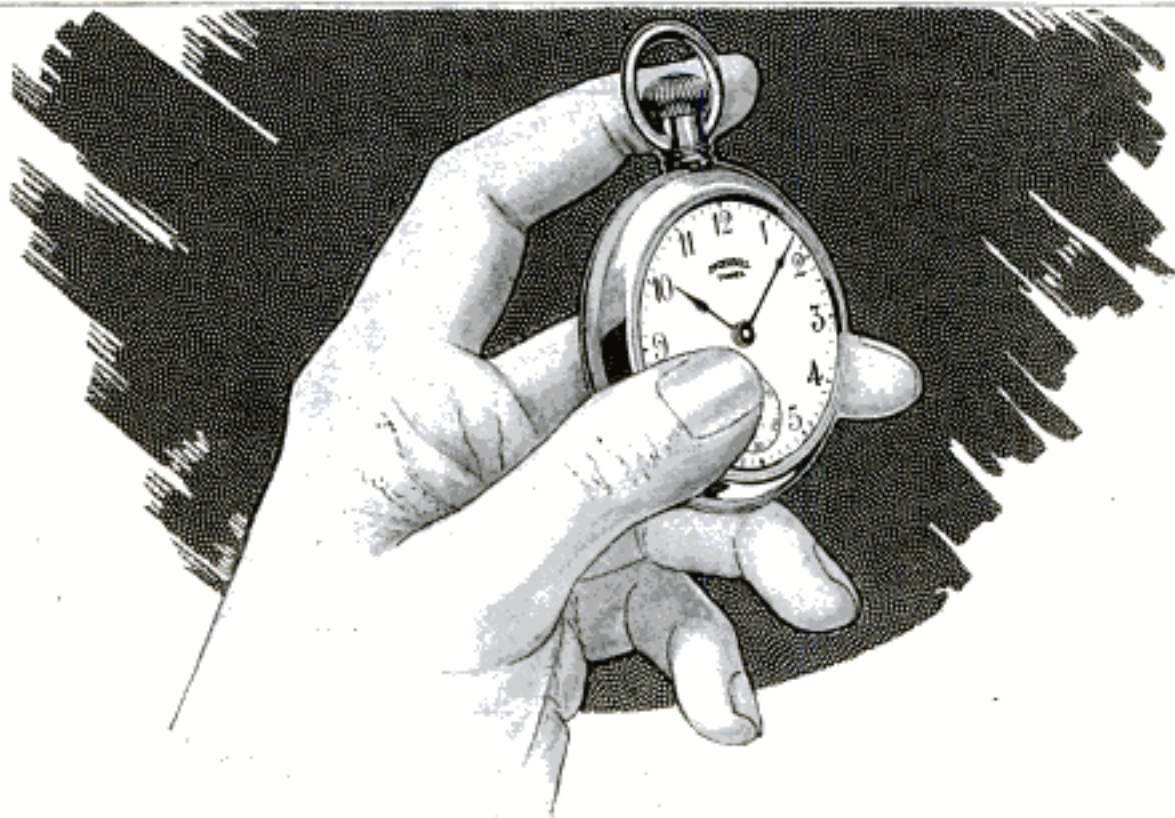

This Watch Cost \$50,000

New Thin Model

Ingersoll

Dollar Watch

Including the cost of the new machinery it took to make it—the first of the new thin model Ingersolls cost over \$50,000!

Fifty thousand dollars invested just to make the dollar watch a little better-looking.

A lot of money—but worth it when you think how very *many* watches this expenditure will improve.

It is the millions of you who have bought Ingersoll Watches—the thousands of you who *are* buying them every day—that enable us to spend more on the mere *improvement* of this, the lowest-priced watch in the world, than can be spent in the *creation* of the expensive watches made for the few.

The result is a wonderful little time-keeping machine, ticking away the seconds at the rate of 360,000 beats a day—and never skipping one.

Jolted and turned over and handled, looked at and tested and counted on time after time every hour;—treated as no other machine is treated;—its hundred and twenty-eight parts so harmoniously designed, so accurately made, as to fit into the smallest possible space, the Ingersoll is the finest piece of mechanism the world has ever seen for a dollar, a product worth a year of a skilled watch-maker's time for half the cost of a ditch digger's daily wage.

See the new thin Ingersoll—and marvel at it—and get your share of the benefit by laying in one to have as your own.

ROBT. H. INGERSOLL & BRO., 315 Fourth Ave., New York

Continued from Page 32

THE South offers unequalled opportunities for farmers, with its mild climate, ample rainfall, two to four crops a year, great possibilities in live stock, dairying and food crops, low cost lands and good markets. Let me send you information. M. V. Richards, Ind. & Agri. Commissioner, Room 64, Southern Railway, Washington, D. C.

BEAUTIFUL winter home lots at Bay View, Fla., on big Choc-taw-hat-chie Bay. Delightful climate winter and summer. Land high and well drained. Extremely healthful. Flowing artesian wells. Salt water bathing, boating and fishing. Excellent hunting. Good auto-riding. Sweet magnolias, live oaks and other magnificent trees. Lumber at wholesale prices. Living cheap. Ideal place to raise oranges and all kinds of fruits, vegetables, chickens, etc. Only limited number of lots to be had. Prices very low while they last. Write for free, beautifully colored, illustrated prospectus. Santa Rosa Plantation Co., R. 417, 308 N. 34th Ave., Chicago, Ill.

FARMS for sale or exchange anywhere in the U. S. or Canada, direct from the owners. State where you want to locate. Information free. American Investment Association, 37 Palace Bldg., Minneapolis, Minn.

REAL Estate Educator—Containing inside information not generally known. "Dunt's" in Real Estate, "Pointers," Legal Forms, etc. It gives in condensed form the essential knowledge of the Real Estate Business. What you need to know; what you ought to know; what you want to know. 256 pages, cloth, \$1.00, postpaid. Popular Mechanics Book Dept., 6 N. Michigan Ave., Chicago.

SELL your property quickly for cash, no matter where located. Don't pay big commissions. Particulars free. Real Estate Salesman Co., Desk B, Lincoln, Neb.

LANDOLOGY, a magazine giving the facts in regard to the land situation. Three months' trial subscription, free. If for a home, or as an investment you are thinking of buying good farm lands, simply write me a letter marking it personal and say, "Mail me Landology and all particulars free." Address Lloyd M. Skinner, Gen'l Mgr., Skidmore Land Co., 40 Skidmore Bldg., Marinette, Wis.

FOR Sale—Michigan Fruit and Chicken Ranches. Five and Ten acre Happy Home Tracts. Terms, \$10 down, \$4 monthly. Write for description. Frank P. Cleveland, owner, Fallmouth, Missaukee County, Michigan.

WRITE me if you want to buy or sell a farm or business. Established 1881. John R. Wright, 1308 Adams Express Building, Chicago, Ill.

FREE Government Lands—Million acres now open to homestead entry in 25 states. Official 112-page book describes every acre in every county. How secured free. New laws, lists, etc. Price 25c postpaid. Also maps, soil guides, complete information. Webb Pub. Co. (Dept. 711), St. Paul, Minn.

LITTLE Farms in Valley of Virginia, 5 and 10-acre tracts, near R. R. town, \$250 and up, easy terms—good fruit, vegetable, poultry and live stock country. Send for literature now. F. La Baume, Agr'l Agt., N. & W. Ry., 250 Arcade Bldg., Roanoke, Va.

EAST N. Carolina—700 acres, \$5,000—level black cutover pine land on which herds of cattle pasture all winter without extra feed. Jay Finch, Jefferson, Ohio.

FARM for Auto—160 acres, farm fenced, level, 3 miles from railroad town, \$15 per acre, no less; take serviceable Auto as part pay. A. L. Stone, Texline, Tex.

HOW much do you want for your farm? Let me know at once. Write A. Mohler, 1659 North California Ave., Chicago, Ill.

FOR Sale—20 acres walnut timber. Will Ross, Fowler, Indiana.

TEXAS school land for sale by the state. You can buy good land at \$2 per acre; pay 5c per acre cash and no more for 40 years, but 3 per cent interest. Send 5c postage for further information. Investor Pub. Co., Dept. 3, San Antonio, Tex.

CO-OPERATIVE Colony locating here. Co-operators invited. Edward Miller, Crystal Springs, Fla.

GINSENG

GINSENG culture giving information how to grow for 10 cts. W. N. Long, Florence, Ky.

DOGS, BIRDS, POULTRY AND PETS

HOW to make 100 egg Electric Incubator. Easy instructions, 25c. Bailey Co., Kerrisdale, R. C.

RARE Belgian Hares for breeding. For particulars address The Belgian Hare, Box A, Holmes Park, Mo.

POULTRY raisers succeed with Mandy Lee Incubators, Lee's Lice Killer, Germozone, and Lee's Egg Maker. Sold by dealers or direct. Send for Catalogs and Lee's Poultry Book, Free. Geo. H. Lee Co., Mfrs., Dept. 36, Omaha, Nebr.

WRITE your name on a postal for our new 112-page 1915 book on Poultry Raising—just out. Nothing published like it—better than last year. Full of practical helps—how to breed, feed and rear. Tells how leaders succeed—which breeds lay and pay best—gives plans for poultry houses—how to build brooder out of old piano box, etc. Describes the famous Prairie State Incubators and Brooders. Worth Dollars—free for writing. Prairie State Incubator Company, 621 Main St., Homer City, Pa.

YOUNG trail hound. Partly trained on coyote. Good hunter. \$20 buys him. Joe Niemeler, Hope, Kans.

AIREDALES—Puppies and grown dogs. We also breed collies. Write for list. W. R. Watson, Box 130, Oakland, Ia.

FOR Sale—Broke Bird Dogs, \$25. Flem Thomas, Columbia, Tenn.

GOLDFISH—Rare specimens, artistic aquariums, snails, plants. Catalog free. Pioneer Goldfish Hatchery, Racine, Wis.

CHOICE Single-Comb Rhode Island Red Cockerels. Reasonable. Levi Fenstermacher, Danville, Pa.

MISCELLANEOUS

EGG-O-LENE, the newly discovered, highly nutritious, real substitute for fresh eggs. Send stamp for this and my new Formula Lists of Latest Specialties in all lines. Disinfectants, Soaps, Cleaners, Polishes, Inks, Dry Cleaners, Food Products, Beverages. Don't peddle; make your own goods. Free information regarding any formula or preparation. H. Lascombe Miller, Ph. G., Marietta, Georgia.

HOW to make Printing cuts cheaply and 150 high-grade selected formulas 25c. Service Bureau, 3311-B, Belleplaine Ave., Chicago.

GET an "Edge On" Skate Sharpener and key combined. It makes the skate grip the shoe and the blade grip the ice. Send 25 cents in coin to Edge On Skate Co., Box 398, Newark, N. J.

GLASS bending, beveling, etching, drilling and silvering. All purposes. Automobile lamp glass in stock. Alpha, 125 Church Street, N. Y.

HOW to open any lock pin-tumbler cylinder without keys, picks or tools. Wonderful secret. Copyrighted instructions. \$1. R. L. Dodd, Rome, Ga.

MARVEL—Best for aftershave, chapped hands, face, lips; beautifies skin; \$1 bottle. Park City Co., 1141 George St., Chicago.

DON'T fail to read page 105, advertising section.

CANDY Making a fine art. Splendid instructions how to make and sell. 50c. Auburn Supply Co., Dept. C2, 7745 Peoria St., Chicago.

TINNERS! Send 25 cents coin for Elbow Chart, Protractor, Circumference table, complete instruction. Will make 30 patterns in 90 degrees and 68 separate elbows; in all diameters, any sweep in throat. Two, Three, Four and Five pieces. The Osborne School, Box 371-H, Springfield, Mass.

WE need one active, reliable person in every community to take orders for our popular mechanical books. You don't have to be a book agent. These books do their own talking. Simply show them. They contain just that sort of information about how to do and make things that every mechanically inclined person is looking for. And they are reasonable in price. We allow you a liberal commission for this pleasant work which you can do during spare time without interfering with your regular occupation. Don't neglect this real opportunity, but write now for full details to Manager Book Dept., Popular Mechanics Magazine, 6 N. Michigan Ave., Chicago.

GRANDFATHER'S Clock Works, \$5. Slightly shop-worn, quantity limited, others with chimes, all prices; also several nice Grandfather's Clock cases, exceptional bargains. Clock Company, 1673 Ruffner St., Philadelphia, Pa.

SPEND summer gathering butterflies, insects. I pay highest cash prices. Instructions. Send stamp. Sinclair, D. 6, Los Angeles, Calif.

TEN cents secures a Swiss bird warbler. Throw your voice, imitate birds and beasts. Surprise and mystify your friends. H. Latz, Atlantic City, N. J.

FIRST book out on Automobile Design, also treats Construction and Repair. By Victor Page, a good authority. Book has 600 (6x9) Pages, 350 illustrations. Right up-to-date. Price, \$1.50 postpaid. Popular Mechanics Book Dept., 6 N. Michigan Ave., Chicago.

CUTS anybody can make. Simple Etching Process, \$1. Particulars, specimens, for stamp. M. Day, Windfall, Ind.

GENUINE Sioux Indian Beadwork and Curios, also Elk Teeth, Moccasins, Febs, Belts, Handbags, Pouches, Warclubs, Indian Costumes. Send 10c for price list. Strong Curio Co., Gordon, Neb.

EGYPTIAN Mystery Rediscovered, Royal Incense. Mystifying, satisfying, soothing, unusual, sure to please and benefit; two grades, 25c and 50c, prepaid. Traffic Company, PM1157 Sheffield St., Pittsburgh, Pa.

GERMANY'S Submarines! What can they do to England's Navy? Learn all about the construction and operation of a submarine of the latest type from our chart, a lengthwise cross-sectional view showing and naming over 200 parts. Size 14x28 inches, on plate paper, mailed in a tube, for 25 cents. Popular Mechanics Book Dept., 6 N. Michigan Ave., Chicago.

RUBBER stamps, photo negative type, steel dies, metal badges, seals, stencils. Catalogue 10c. Buckeye Stamp Works, Market, Dayton, Ohio.

A HIGH Grade Fountain Pen for 75c postpaid, 14-karat solid gold. Here is an unusual offer. Write today. F. C. Burtch, Great Barrington, Mass.

YOUR Name on steel stamp, to identify your knives, forks, spoons and for marking tools. \$1. Three initials, 50c. Glendon Pike, Attleboro, Mass.

CALIFORNIA Gem Crystals for sale at lowest prices—direct from the mines. Albert Everitt, Escondido, California.

KISSES—The latest thing in verse for ten 2c stamps, postpaid. Al Harris, Lubbock, Texas.

MEN between 18 and 35 wanted. \$75 month. Government railway mail clerks. Examinations likely announced everywhere Jan. 15. Full description free. Franklin Institute, Dept. O-22, Rochester, N. Y.

AUTOMOBILE model. Every part shown and named. You can to all intents and purposes take off the wheels, raise the hood and remove the body, exposing to view the vital parts. The only practical method of studying the automobile. Price 50 cents postpaid. Popular Mechanics Book Dept., 6 N. Michigan Ave., Chicago.

WOOD-WORKING for Amateur Craftsmen—128-page book, profusely illustrated, giving every essential step in wood-working. Valuable for either self-instruction or for use in manual training courses. Cloth, 50 cents, postpaid. Popular Mechanics Book Dept., 6 N. Michigan Ave., Chicago.

WAR Atlas—Large 20-page (11x15 in.) Atlas of the War in Europe, containing large colored scale maps of the battle-ground, showing Europe, Austria, Serbia, Germany, England, Belgium, France, Russia, Italy, Greece, The World, etc. Special data showing comparison of armies and Navies involved, pictures of rulers, etc. Price, 25 cents. Postage and packing, 5 cents additional. Address Popular Mechanics Book Dept., 6 N. Michigan Ave., Chicago.

Get Into a Business that Pays Big Money

Do you realize what it means to you that 300,000 more automobiles will be running in 1915 than last year? It means just that many new jobs waiting for trained men—jobs as chauffeurs, garage men and salesmen — at \$75 to \$300 per month.

But Get in Right!

Our course trains for any or all of these jobs. Trains from the ground up. It puts you through the grind of shop and repair work, as well as plenty of actual driving, under all sorts of conditions.

You'll be made to overhaul cars—to rebuild motors—to weld broken parts—to adjust carburetors—to wire-up ignition systems and self-starters and "find the trouble." You'll know every inch of every part of the automobile. And you'll take your own time to learn it.



Where This School is Better

1. It is a school — a real school — and not a side-line to a garage or repair shop. It puts real practical instruction first.
2. It has for your use every distinct type of every part found in the automobile—besides the complete cars used for road work.

3. There are no extra charges. Tools and all other equipment are furnished free, and become your personal property when you leave the school.

4. You take your own time to learn. The average student finishes in three to six weeks. You stay just as long as there is anything more you want to know about an automobile.

A full description of our school and the course it gives is contained in our complete, illustrated catalog. Just write your name and address on the coupon in the corner, and mail it. That little act may mean the turning point in your career. *So Do It Now!*

NATIONAL AUTO SCHOOL
2625 Reading Road CINCINNATI, OHIO

NATIONAL AUTO SCHOOL, Cincinnati, Ohio

Send me without charge or obligation your complete illustrated catalog and full particulars about your course in automobile shop and road work.

NAME.....

ADDRESS.....

P.M. 2-15



BE A BANKER

Splendid opportunities. Pleasant work, short hours, all holidays off, yearly vacation with pay, good salary. Learn at home. Diploma in six months. Catalog free. EDGAR G. ALCORN, Pres. AMERICAN SCHOOL OF BANKING, 119 McLENE Bldg., COLUMBUS, OHIO



IF YOU STAMMER

I can cure you. Attend no Stammering school until you hear from me. Write at once for information to ALBERT R. BELLEROSE, Princ. of the Conn. School for Stammerers 73 Park Street MERIDEN, CONN.

LEARN WATCHMAKING

and become independent. Good-paying positions secured. Easy to learn. Send for FREE CATALOG. ST. LOUIS WATCHMAKING SCHOOL, Dept. 5, ST. LOUIS, MO.

Be an Auctioneer

Travel over the country and make big money. No other profession can be learned so quickly, that will pay as big wages. Write today for big free catalogue of Home Study Course, as well as the Actual Practice School. Largest in the world. W. B. Carpenter, Pres. Missouri Auction School 330 HALL BLDG. KANSAS CITY, MO.

WHY NOT BE AN ARTIST?



STUDY drawing at home under Expert Faculty. We have successful students in every part of the world. Turn your Talent into money. Our Students are filling high salaried positions. 14 years successful teaching. Endorsed by high authorities. 18 Courses in Commercial and Illustrative Drawing. Teachers' Normal and Applied Art, Profit or Culture. Thoroughly Equipped Residence School. Artist's Outfit FREE to Enrolled Students.

SCHOOL OF APPLIED ART, 755 Applied Art Bldg., Battle Creek, Mich.

Practical Electrical Education

Our practical course in Electrical Science and Engineering trains you to get and keep the big-pay jobs. Enter at any time, no matter what your education. Advance as fast as you can master the work. Course combines theory with actual practice in all branches of Electrical Science, Individual instruction. Only practical training school of its kind in U. S. Endorsed by leading electrical employers past 15 years. Our trained students always in demand and well paid. WRITE FOR FREE ILLUSTRATED CATALOG. New Term Begins Feb. 1, 1915.

SCHOOL OF ENGINEERING OF MILWAUKEE, 185 Sixth Bldg., MILWAUKEE, WIS.



Send the Coupon

It's the First Step Toward a \$3,000 Job

Absolutely no obligations. Put your name and address in the "Good Job" coupon and send it to us at once. We will send you absolutely free and prepaid full particulars of a great special offer that we are now making in order to induce men to start the study of Meter Engineering. There are thousands of positions open now. During the coming year over 500,000 new meters are going to be installed. Big money is being paid. Send the coupon now.



Be a Meter Engineer

Get into the \$3,000 class. Be the man who is looked up to by everyone in the plant. The profession of Meter Engineering is in its infancy. Few men have the training that qualifies them to hold the big jobs. But you can get it—right in your own home—during your spare time.

More Men Needed Over 500,000 new meters are going to be installed this year. A vast army of men will be needed. Large salaries are offered. You can get one of the big jobs.

Send the Coupon

Fill out the "Good Job" coupon or a letter or a post card and send it to us at once. No obligations. It's just a request for the big new book on Meter Engineering. Act today. Opportunity waits for no man. Send the coupon now.

Ft. Wayne Correspondence School — Dept. 1192 — Ft. Wayne, Indiana

"Good Job" Coupon

From.....

To
Ft. Wayne Correspondence School
Dept. 1192 Ft. Wayne, Indiana

Gentlemen; Please send me absolutely free and prepaid your new book on Meter Engineering and full particulars of your great special offer. It is distinctly understood that I assume no obligations of any kind.



Prof. F. W. Foote
Psychologist

Do You Know
the LAWS which
CONTROL Your
Brain?

Concentration and
Personal
Power Can
Be Obtained as
an Absolute Result
from a Knowledge of
MENTAL LAWS

You know that your Brain plays tricks with you and that you are conscious of **Constant Mental Leakage**; **Constant Loss of Mental Power and Energy**; **Constant Worry, Anxiety and Muddle**.

Now, **Why work in the Dark?** Realize that you can **Train Your Brain to Think**

just as you can train YOUR MUSCLES TO ACT. It is useless for you to attempt any kind of study unless you can so master your Brain so as to obtain instant Obedience. Brain control is the first requisite for Success.

A TRAINED BRAIN

will give you ability to bring all the facts of any problem into the focus of your MENTAL machine when needed. It is not only mental activity, but control and use of that activity so that the greatest results may be obtained. Let me teach you these laws which will give you this **MASTER POWER**. The systematic study of Mental Laws which is the

**Science of
Psychology**

will give you
Positive Success.

Your

Personality will
be ex-
pressed in
all your ac-
tions; and you
will have the con-
scious knowledge and
use of your own
Trained Will Power

Nothing will be able to throw you down for you will have a Mental Equipment which will be able to penetrate and **Master every Circumstance**. Your struggles will be opportunities for Success. You will thus **Master Your Destiny**, by using your powers to the full.

My scientific training in the great Universities of the world is at your disposal. It will be my pleasure to personally train you to increase your Mental Powers. My knowledge will enable me to know which is the law for you to use and master. You cannot afford to ignore the opportunity which this course of study offers. It is based on the fact of law. **YOUR SUCCESS is POSITIVE and ASSURED**. You will send for this Free Book and obtain the information which will mean **POWER and MONEY for YOU**.

Send for this **FREE BOOK** at Once

FREE BOOK COUPON

2-15
PROF. FREDERICK W. FOOTE
Principal Chicago Institute of Menti-Culture
30 No. Michigan Blvd., Chicago, Ill.

Send me Free Book "Masters of Destiny" and all particulars of your Mental Training Course.

NAME.....

ADDRESS.....

Popular Mechanics Handbooks



PRICE

50 Cents
EACH, POSTPAID

A series of high-class, up-to-date books on mechanical subjects, "Written so you can understand it." Clearly printed on high-grade book paper and durably bound in cloth. Size, 5x7 inches. Each book contains many original illustrations.

Mission Furniture, How to Make It
(In Three Volumes)—Each book gives plain directions and working drawings.

Part 1—30 Designs, 128 Pages—69 Illustrations.
Part 2—32 Designs, 128 Pages—69 Illustrations.
Part 3—36 Designs, 128 Pages—77 Illustrations.

Wood-Working for Amateur Craftsmen

Explains every cut, joint and process, proper use and care of tools, working up of material.

128 Pages, 125 Illustrations.

Arts-Crafts Lamps, How to Make Them

16 beautiful lamp designs with instructions, working drawings and illustrations.

96 Pages, 50 Illustrations.

Lamps and Shades in Metal and Art Glass

19 designs in four different kinds of construction; built up, soldered, etched and sawn shades.

128 Pages, 64 Illustrations.

Metal Work and Etching

A complete manual for art metal workers. Tells how to make a variety of articles, such as desk sets, jewelry, hinges, match boxes, pipe racks, etc.

96 Pages, 50 Illustrations.

Electroplating

One of the best books ever written on this subject. It is by a practical plater of 30 years' experience.

112 Pages, 62 Illustrations.

Wireless Set, How to Make

Explains the construction of an outfit for transmitting four or five miles.

96 Pages, 11 Illustrations.

Metal Spinning

A practical working manual on this fascinating art.

80 Pages, 33 Illustrations.

Heat

An immensely interesting and instructive book pertaining to heat and its relation to modern mechanics.

128 Pages, 50 Illustrations.

The Kingdom of Dust

A remarkable book dealing with a scientific subject in a non-technical manner.

128 Pages, 40 Illustrations.

ADDRESS

Popular Mechanics Book Dept.
6 N. Michigan Ave., CHICAGO



AUTOMOBILE WATCH FOB

The neatest and most novel Fob ever designed. Has a leather strap and nickel buckle. Wheel is made of Rubber and is an exact reproduction of an automobile wheel with a quick detachable tire which can be removed and put on in a "jiffy." We will mail you this novel watch fob

ABSOLUTELY FREE

If you will send us 25c in coin or stamps for a three months' trial subscription to the AMERICAN CHAUFFEUR AND AUTOMOBILE DIGEST, the new illustrated technical Automobile magazine, which is full of valuable, interesting, helpful Automobile information.

Send today, as our supply of Watch Fobs is limited. Address

THE AMERICAN CHAUFFEUR
261 Butler Bldg. CINCINNATI, OHIO

A GOOD POSITION

with **UNCLE SAM** is most desirable. Life positions, pleasant surroundings, good pay, steady work, short hours, promotions on merit. Both sexes. No political pull. Thousands of appointments yearly. Most thorough preparation \$5. Returned if not appointed. Full information and questions used by the Civil Service Commission free.

AMERICAN CIVIL SERVICE SCHOOL WASHINGTON, D. C.

DO YOU LIKE TO DRAW?

That's all we want to know

Now we will not give you any grand prize—or a lot of free stuff if you answer this ad. Nor do we claim to make you rich in a week. But if you are anxious to develop your talent with a successful cartoonist, so you can make money, send a copy of this picture with 5c. in stamps for portfolio of cartoons and sample lesson plans, and let us explain.

The W. L. Evans School of Cartooning
821 Leader Bldg., Cleveland, O.



We Want Representatives Everywhere

to work for us, buying and selling Real Estate, Mortgages, Bonds, Stocks, etc. We pay part salary and part commission. Good hustlers may earn from **\$3,000 to \$10,000 per year or more**—no previous experience necessary. We equip and start you out.

INTERNATIONAL REALTY CORPORATION
3236 Otis Bldg., 10 S. La Salle St. CHICAGO

FREE—Increase Your Income

IN AN UNDEVELOPED, PROFITABLE FIELD



Learn Show Card-Writing and Lettering. We furnish a reliable and thorough course, absolutely free, to introduce ALPHA colors, if you purchase an assortment to use while practicing. Particulars for stamp.

Alpha Color Co., Inc., Dept. K, 1960 Broadway, N.Y. City

FREE to Hunters and Trappers

Fine Taxidermy Book Now Free! 32p. with hundreds of photos of mounted birds and animals. Learn this profession. Save your trophies. Decorate your home and den. Great value to sportsmen.

Learn to Stuff Birds—animals, game heads, tan furs, make rugs and robes. Quickly learned by men and boys. Big Profits from spare time. Intensely interesting. **INVESTIGATE! Write Today for Free Book.** Only a few free—so rush.

Northwestern School of Taxidermy, 1192 Elwood Bldg., Omaha, Neb.

FREE "Linene" COLLAR

State size on postal and whether you want collar like cut or low turnover style.
REVERSIBLE COLLAR CO., Dept. U, Boston, Mass.

Every Boy His Own Toymaker

Greatest boys' book ever written. Tells how to make a Steam Engine, Telephone, Magic Lanterns, Boats, Kites, Balloons, electrical and mechanical toys, trams, fishing tackle, 300 illustrations; also catalog of 150 puzzles, Keller's Magic Ace Trick Card and "DOUBLE THREAT" warbler and bird call all for only 10c. **WESTERN PUZZLE CO., ST. PAUL, MINN.**



Don't Let This Stool Be as High as You Rise!

Don't waste your time in a small job with no prospects of future success. Begin now to prepare yourself for a position of power and big money. No matter what you work at now, here is a big, powerful, prosperous position for you.

Let Us Make You An EXPERT ACCOUNTANT

Right now big concerns, corporations and railroads need Expert Accountants at big salaries.

The need is greater than the supply. Now is the time to let us prepare you for this lucrative vocation—the vocation that offers you remarkable possibilities of advancement into big, powerful executive positions.

We Train You By MAIL

at home, in spare time. Tuition very low—terms to suit your needs. No matter what your work now you can qualify for this big paying position. You do not need to even understand bookkeeping. We have a course that prepares you in bookkeeping from the ground up for more advanced work in Higher Accountancy. Prepared by noted experts—covers Theory of Accounts, Practical Accounting, Cost Accounting, Auditing, Business Law, etc. Prepares you for C. P. A. examinations in any state. Under personal supervision of William Arthur Chase, nationally recognized leader—Ex-President American Association of C. P. A. Examiners and Ex-Secretary Illinois Board of Examiners in Accountancy.

ACT! Write now for remarkable free book on How to Become an Expert Accountant. It explains studies, examinations, state regulations, salaries and positions to be had. Become a big factor in business—prepare yourself for power and prosperity. We make it easy. Send no money—everything is FREE. Send now before offer expires.

LaSalle Extension University,
Dept. H-414
Chicago, Ill.

Name _____

Street No. _____

City _____

\$3,000 to \$10,000 Yearly

Special Reduced Rate

SCHOLARSHIP
Write quick and learn how, for a limited time you can secure special reduced rate scholarship. Do not miss this Special Offer.

MAIL COUPON NOW

LaSalle Extension University,

Dept. H-414 Chicago,

Send at once, your free book, How to Become an Expert Accountant, and full details of your Course in Higher Accountancy; also advise me about Special Limited Reduced Rates. I am obligated in no way.

City _____ State _____

Please Mention Popular Mechanics

Learn Electricity!



Earn \$150⁰⁰
TO
\$300⁰⁰
a Month

Electricity is today the great motive power of the world. Its use has extended to every phase of life and industry.

Thos. A. Edison says that the field of electricity is in its infancy—that electrical workers of the future will discover uses for this great force now undreamed of.

Right now there are not enough electrical engineers to fill the big paying positions open. Every month our Free Employment Bureau has calls for Electrical Engineers greater than we can fill. Therefore, we are making a very special offer to students.

Write today! Send the free coupon for our catalog and free information.

We Teach You in a Short Time — at Small Expense In order to supply more electrical engineers we are charging a small tuition fee. Your tools and equipment of all kinds are furnished FREE by the School. You may have easy payments if desired. Our course of instruction is clear, simple and thorough. Our Graduates demand handsome salaries. Don't pass up this opportunity.

FREE TOOLS

We will furnish all the material and tools you use in taking our course — ABSOLUTELY FREE. All we charge is a very small amount for tuition. Many of our students earn their expenses while taking the course.

We also teach the trades mentioned above. There are unlimited possibilities in any one of these trades. When you have completed our course you will be in a position to demand from \$5.00 to \$8.00 a day right at the start. Or go in business for yourself and make from \$3,000 to \$7,500 a year.

Send the FREE COUPON for Catalog and Particulars

FREE COUPON

L. L. COOKE,
Director

Coyne National
Trade Schools

39-51 E. Illinois St.
Dept. 1192, CHICAGO, ILL.

GENTLEMEN: Without any obligations on me whatsoever, please send me your school catalog and full particulars of this offer to men—ALL FREE.

NAME.....

ADDRESS.....

Please Mention Popular Mechanics

LEARN TO
PAINT SIGNS AND SHOW CARDS



THERE'S MONEY IN IT

I'll teach you personally by mail. 16 years' successful teaching. Three courses: (1) Complete Lettering, Sign and Card Writing; (2) Show Card and Ticket Writing; (3) Lettering. It is a wonderful field for men and women. You can succeed—big. No limit to the window cards, sale cards, banners, and signs used by merchants and others. Gold lettering on glass and wood valuable feature of course. Teaches everything you need. This knowledge will help you wherever you are. Pay good, work fascinating, hours short.

Earn \$18.00 to \$45.00 a Week
Make big money in business for yourself. Natural talent unnecessary. Williamson (Ind.) says, "Ability I have developed under your tuition is surprising"; Lane (Pa.) "Since enrolled have made over four times cost of course."
Send for complete details, new circulars, and samples.

THE DETROIT SCHOOL OF LETTERING
Chas. J. Strong, Founder, Dept. 2020, Detroit, Mich.

Guarantee —
I guarantee to place my graduates in positions paying \$35.00 to \$75.00 when they have graduated and are competent. We have constantly more requests for men at good salaries than we can supply.

Learn to be An Auto Expert

Six weeks from the day you commence your studies at this great practical school you will be able to repair any make of automobile and drive any car on the market.

Earn \$75 to \$200 a Month

Many of our graduates make even more than this. Big demand for competent repairmen, demonstrators, garage managers and chauffeurs. All practical work. No books used. No tools to buy. Write today for big illustrated free book. Address,

AUTOMOBILE TRAINING SCHOOL, 1168 Leunst St., Kansas City, Mo.



MEN WANTED

Prepare as Firemen, Brakemen, Electric Motormen, and colored Train Porters. First Class Standard Roads. Hundreds put to work—\$65 to \$150 a month without any experience. 500 more wanted. Uniforms and passes arranged for when necessary. Enclose stamp for Application Blank. Name position you want.

I. RAILWAY C. I., Dept. 35, Indianapolis, Ind.

BIG MONEY FOR YOU

Send for my free illustrated Booklet No. 30 which tells how you can become a Commercial Letter Artist and Designer, Card or Sign Writer and make \$100 to \$300 a month. Write today.

The Rosing School of Lettering & Design
The 1908 Euclid Building, Cleveland, O.

LEARN WATCHMAKING AND ENGRAVING

Earn while learning. Most practical watch school. Individual instructions. Graduates in great demand. Book free.

Chicago School of Watchmaking, 63 E. Van Buren St., Chicago

LEARN TO WRITE ADVERTISEMENTS **EARN \$25 to \$100 A WEEK**

We can positively show you by mail How to increase your salary. BOOK MAILED FREE.

PAGE-DAYIS CO., 112 Page Building, Chicago, Ill., or 150 Nassau St., New York

LEARNED BY ALMOST ANYONE AT HOME SMALL COST

VENTRILOQUISM

Send today 2c stamp for particulars and proof.

O. A. SMITH, Room D 121, 823 Bigelow St., PEORIA, ILL.

New Titles

Your Dealer Has Them

Applied Electrochemistry and Welding	\$1.50
Business English and Correspondence	1.00
Carpentry	1.50
Civil Engineering Specifications and Contracts	1.00
Electrical Measurements	1.00
Electrical Wiring and Lighting	1.00
Elevators—Hydraulic and Electric	1.50
Estimating	1.00
Machine Drawing	1.50
Motion Picture Work	3.00
Practical Lessons in Electricity	1.50
Reinforced Concrete	1.00
Steel Construction (Flexible Leather, Pocket Size)	2.75
Strength of Materials	1.00

Our Practical Handbook Series now numbers 90 live, up-to-date titles. The authors are the biggest and best known engineering experts in America. Written especially for practical self-instruction—so clear that the beginner can understand them and so thorough that the trained man can learn from them.

These books are sold at bookstores the world over. Send for our new catalog. If your dealer does not have the particular book of this series you want, ask him to order it for you or order it direct from us. Any book ordered direct will be shipped post paid on receipt of price, and may be returned after a five day examination if not suited to your needs in every way.

SOLD AT ALL BOOKSTORES

American Technical Society, Chicago, U. S. A.

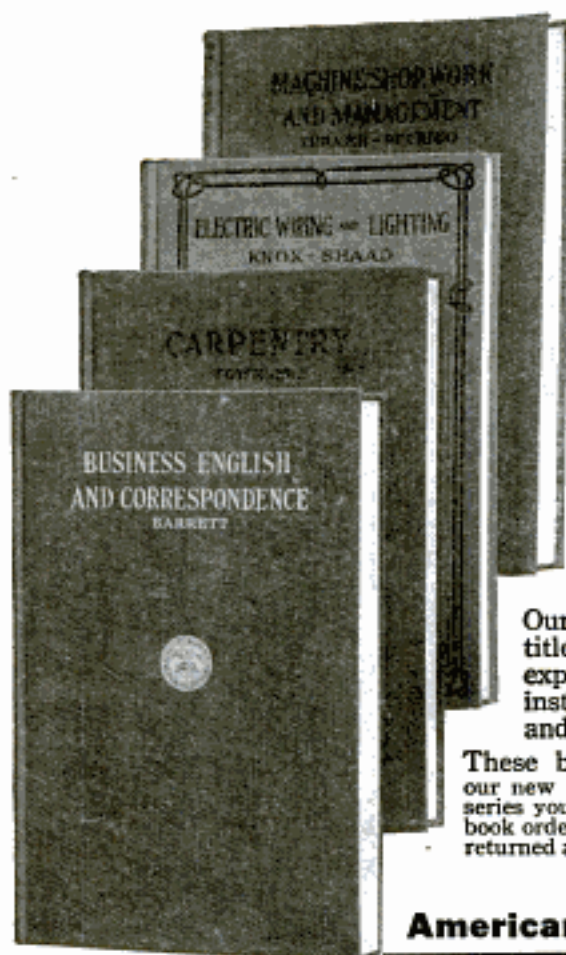

GET THIS BOOK FIRST.

DON'T TRY TO BE A CHAUFFEUR

or go to ANY SCHOOL to learn, or part with your hard earned dollars until you have read our valuable guide **FIRST**. It tells what you should **PAY** and what you should **GET**. Do not be deceived by schools which claim everything and give you nothing. **YOU CAN'T AFFORD TO SPEND ONE CENT TILL YOU GET OUR GUIDE.** It costs nothing and may save you many dollars. Write now for this **FREE BOOK**.

PRACTICAL AUTO SCHOOL, 68 Beaver St., New York

SHORTHAND Now Taught By Mail

In 18 Easy Lessons! Positively guaranteed. System taught by us adopted by public schools in Boston, Denver, Buffalo, Omaha, Seattle and more than 2000 other cities. America's most popular shorthand because easy to learn, read and write. Complete stenographic courses by mail. Typewriters furnished. Low cost, easy terms. Write now for free book on big salaries and opportunities. Positions everywhere.

CHICAGO UNIVERSITY OF COMMERCE, Dept. 1932, Chicago, Ill.

COPY THIS SKETCH

and let me see what you can do with it. You can earn \$20.00 to \$125.00 or more per week, as illustrator or cartoonist. My practical system of personal individual lessons by mail will develop your talent. Fifteen years successful work for newspapers and magazines qualifies me to teach you. Send me your sketch of President Wilson with the initials (name and I will send you a test lesson plate, also collection of drawings showing possibilities for you.

The Landon School of Illustrating and Cartooning
1438 Schotfield Building, CLEVELAND, O.

MUSIC TAUGHT FREE In Your Home **FREE**

By the Oldest and Most Reliable School of Music in America—Established 1895

Piano, Organ, Violin, Mandolin, Guitar, Banjo, etc. Beginners or advanced players. One lesson weekly. Illustrations make everything plain. Only expense about 2c per day to cover cost of postage and music used. Write for **FREE** booklet which explains everything in full.

AMERICAN SCHOOL OF MUSIC, 51 Lakeside Building, CHICAGO

Wanted—Railway Mail Clerks

there is \$900.00 to \$1,800.00 a year in it for you.

Examinations are likely to be held everywhere soon

Rapid advancement to higher Government Positions. "No lay-offs" because of STRIKES, WARS, FINANCIAL FLURRIES or the WHIMS OF SOME PETTY BOSS. THE POSITION IS YOURS FOR LIFE.

Country residents and city residents stand the same chance for immediate appointment. Common-sense education sufficient. Political influence NOT REQUIRED.

Write immediately for schedule showing the places and dates of ALL SPRING examinations. Don't delay. Every day you lose means the loss of just so much coaching before the rapidly approaching examinations.

FRANKLIN INSTITUTE, Dept. R-106, Rochester, N. Y.

Hundreds of Railway Mail Clerks Appointed Yearly

FRANKLIN INSTITUTE (The Pathway to Plenty), Dept. R-106, ROCHESTER, N. Y. This coupon, filled out as directed, entitles the sender to free specimen questions; a free copy of our book, "Government Positions and How to Obtain Them," a list of Government positions now obtainable, and to consideration for Free Coaching for the examination here checked.

COUPON

.. Railway Mail Clerk... (\$900 to \$1800)	.. Customs Positions... (\$800 to \$1500)
.. Bookkeeper..... (\$900 to \$1800)	.. Stenographer..... (\$800 to \$1500)
.. Postoffice Clerk.... (\$800 to \$1200)	.. Internal Revenue... (\$700 to \$1800)
.. Postoffice Carrier... (\$800 to \$1200)	.. Clerk in the Departments at Washington..... (\$800 to \$1500)
.. Rural Mail Carrier... (\$500 to \$1100)	.. Canadian Gov't Positions.....
.. Auto Chauffeur.....	

Name..... Address..... R-106
Use this before you lose it. Write plainly.

Come to Detroit, the
Automobile
Center,
to

Then Earn \$75
to \$200 a
Month
IN ANY
LOCALITY

LEARN THE AUTOMOBILE BUSINESS

Big demand anywhere for competent men in every branch of this wonderful and growing business. Splendid chance in every locality for ambitious men to open garage and repair shop in down town or residence districts. Detroit trained men get preference over all others. Detroit is auto center—44 factories—67 out of every hundred cars are made in Detroit. Our students lose no time—practical instruction starts first day, in construction, repairing and driving standard makes of cars. Average man has his own business.

How We Teach Our Students

Everything is practical—real work on real up-to-date cars. Instruction includes all leading types of self-starters—Gray, Davis, Delco, Westinghouse, Ward-Leonard, etc. We actually have a Delco ignition lighting and starting system, a Gray & Davis system and Ward-Leonard system in operation on a motor for students to work on. Others are constantly being added.

Students Actually Build New Cars FROM START TO FINISH

thus getting regular practical factory experience in assembling, block-testing, road-testing, etc. Students learn to handle any auto problem that could possibly come up.

Block Test Dept. has from 7 to 15 different motors including 6 cylinder, 110 H. P. Lozier and 8 cylinder King motors. Students are getting practical experience in turning motors, adjusting carburetors, magnetos, and taps, grinding valves, scraping bearings, etc. Present students have just finished building our new 6 cylinder Lozier Touring Car which will be used for road work instruction. Everything is absolutely up-to-date with all latest equipment.

Our Guarantee

We guarantee to qualify you for a position as chauffeur, repairman, tester, salesman or demonstrator in a short time, or we will refund your money.

And don't forget, we furnish positions, too

On account of being in the auto center, we can furnish positions that cannot be obtained elsewhere

Electric Automobiles Arrangements just made put students through service department of Detroit Electric. No extra charge for learning this branch which in itself offers big field. Read our guarantee. You learn in Detroit but you can work anywhere. Always a job for a good man. Thousands of fine chances to start business of your own on little money. Remember ours is the old reliable school in heart of the auto industry. Anyone can learn by our method. Write today for full particulars. Ask for copy of "Auto School News." It's free. Write the other schools. Compare our propositions. Learn the automobile business in Detroit and get a good start toward success. Write today. You'll be glad.

ADDRESS, DEPT. P

MICHIGAN STATE AUTO SCHOOL
THE OLD RELIABLE SCHOOL
11-13-15-17 Selden Ave., DETROIT, MICH.

EIGHT CYLINDER CHASSIS

is regular equipment with us, exclusively for our students to work on; not a private car brought around for them to look at occasionally.

The Old Reliable School. Successful Graduates in Every State



LANGUAGES

German—French—English—Italian—Spanish

or any other language learned quickly and easily by the Cortina Method at home with Disk Cortina-Records. Write for free booklet today; easy payment plan.

CORTINA ACADEMY OF LANGUAGES
1284 Mecca Bldg., 1000 Broadway,
Corner 48th Street, New York

Quickly Learned AT HOME by the Original Photographic Method



CORTINA-PHONE

Would You Like to Write 100 Words a Minute Without Knowing Shorthand? If So, Learn

BRIEFHAND

The modern substitute for stenography, using longhand characters. Easy to learn, write and read. Invaluable to business and professional men and women, ministers, teachers, secretaries, clerks, students, boys, girls—EVERYBODY. Recommended by many responsible persons. Complete self-teaching Manual, \$1.00. Sample lesson free. Representatives wanted everywhere.

PREMIER BRIEFHAND SCHOOL, Dept. B, WASHINGTON, D. C.

LEARN WATCH REPAIRING

Be a watchmaker—you can learn this profitable trade by correspondence in a few weeks in your own home by the DeSelms Chart System. After you complete the course you will know a watch from A to Z. You will know just what the matter is and how to repair one. When you graduate you will be a practical watchmaker and repairer and competent to fill any position. Positions for our graduates.

Ask for our Free Book. It explains our system and terms.
THE DeSELMS WATCH SCHOOL
23 Perry Street
ATTICA, INDIANA



Ideas Wanted

\$500 each, according to merit, for a few hours work in spare time at home. Special education not necessary. I show you how and

I Guarantee You \$10 For Your First Photoplay

This means you. Tremendous demand caused by 30,000 movie theatres changing program daily accounts for this unusual offer. It costs nothing to investigate. Send post card or letter at once, while this offer lasts, for free booklet "How to Write Photoplays." **Elbert Moore, Box 772PH, Chicago.**

For Photoplays
At \$10 to \$500 Each
Your "happy thoughts" are as good as anybody's and may bring you \$10 to

Attend My School and Become Qualified For A Splendid Position

Enlarge your outlook, increase your income in the oldest, most successful and largest school of the kind in America—expert instructors. Two large modern buildings with railroad and Western Union wires and complete \$3,000.00 Marconi Wireless Station installed.

A course at my school should assure you of a bright future and continuous, remunerative employment. The Morse Railway and Commercial Telegraph and Station agency work offers excellent opportunities. The radio (wireless) work is congenial, entertaining, instructive and intensely interesting, and offers great possibilities. I have a contract with the Marconi Company whereby my graduates are given preference for positions on the Great Lakes and Gulf of Mexico.

My school is endorsed by Railway, Western Union and Marconi officials. Established 40 years. Annual enrollment exceeds 600 students. Investment exceeds \$25,000.00. Tuition and living expenses very low. Can earn living expenses. Correspondence courses also. All graduates assisted. Send for my free illustrated catalog. **GEORGE M. DODGE, President**

Dodge's Telegraph Railway & Wireless Institute, 8th Street, Valparaiso, Ind.



Enroll Now

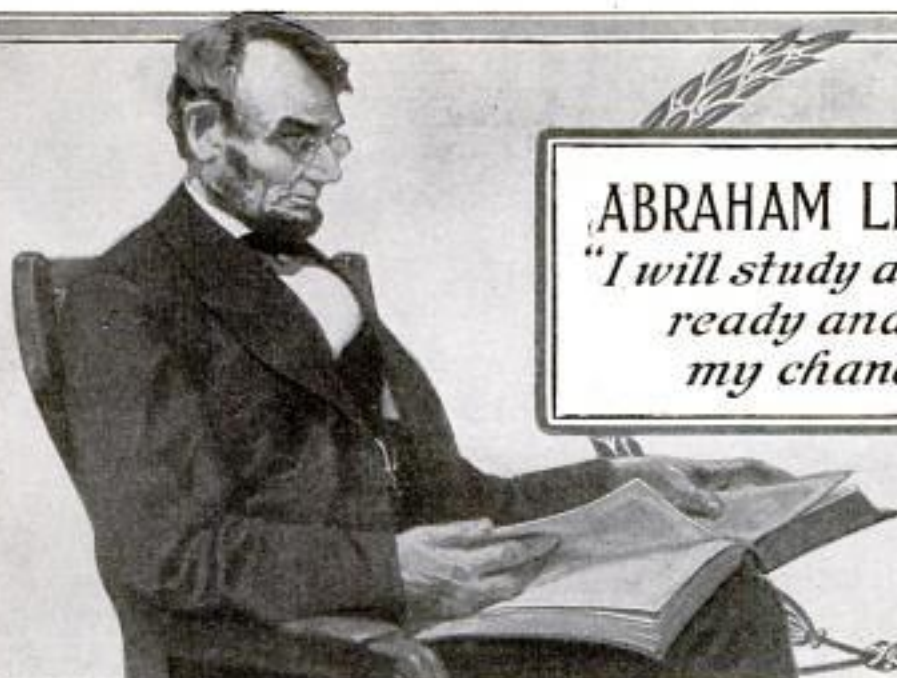

ABRAHAM LINCOLN *said:*
*"I will study and get
 ready and maybe
 my chance will come."*

YOUR Chance Will Come

Born in a one-room log cabin on the Kentucky frontier, Abraham Lincoln had very little chance to acquire an education. But he was determined to succeed. "Some day," he said, "my chance *will* come." So he studied and got ready. And his chance *DID* come.

Your chance will come. Some day you'll be considered for promotion or for a good job in some other line of work. If you are ready, you'll go up—there will be no limit to your chances to advance if you are ready to meet them.

And you *CAN* get ready. No matter if your schooling was limited—if you do have to work long hours. If you really want a better job, the International Correspondence Schools can train you for it at home during your spare time.

Every month more than 400 I. C. S. Students voluntarily report promotions or salary increases due to the help of the I. C. S. What the I. C. S. have done for these men they can do for *YOU*.

Mark the Coupon NOW

Just mark on the attached coupon the position or occupation you most like and mail the coupon to the I. C. S. This will not obligate you in the least—but it will bring you the facts that may change the course of your life.

INTERNATIONAL CORRESPONDENCE SCHOOLS

Box 872-T, Scranton, Pa.

Please explain, without further obligation on my part, how I can qualify for a larger salary and advancement to the position, trade, or profession before which I have marked X.

Electrical Engineering
 Electric Lighting
 Electric Railways
 Electrician
 Electric Car Running
 Dynamo Foreman
 Wireman
 Mining Engineer
 Tel. and Tel. Engineer
 Surveyor
 Civil Engineer
 Automobile Running
 Agriculture

Mechanical Engineer
 Mechanical Draftsman
 R. R. Construction
 Concrete Construction
 Architect
 Contracting and Build'g
 Architectural Draftsman
 Plumbing and Heating
 Chemist
 Bookkeeper
 Advertising Man
 Civil Service Exams.
 Salesmanship

Name _____

St. and No. _____

City _____ State _____

Present Occupation _____

3000 PRICELESS RECIPES

Hundreds of Profitable Trade Secrets
Money-Making Wrinkles About Every Trade and Manufacture
Valuable Formulae for Many
Processes Hitherto Jealously Withheld

Establish yourself in business. Become independent. Whether you are a man, woman, boy or girl, you may secure a **Constant Income** and a **Respectable Business**, without hard work or worry. Make at your own home in spare time some of the hundreds of articles which find ready sale everywhere, the manufacture of which is clearly described in this valuable book. A single recipe properly employed may be the foundation of a fortune. Fear's Soap, Beecham's Pills, Halloway's Ointment, hundreds of similar things, from which huge incomes are derived, may be equalled or even surpassed by some of the articles described among the 3000 Priceless Recipes. This valuable work of 364 pages is the result of the life-work of the famous Scientist, Dr. N. Y. Oliver, who has selected and published only the best of the many formulae submitted to him, having thoroughly tested every recipe, many of which cost large sums to acquire. Not a cookery book. It is a book of recipes, and **NOTHING BUT RECIPES**, of inestimable value to Farmers, Housekeepers, Mechanics, Manufacturers, Chemists, Confectioners, Metal Workers, to Everybody. Write at once for this valuable book. Will be sent by post to any address for only 35 cents or two copies for 65 cents.

Only 35 Cents



Johnson Smith & Co., Dept. 1, 709 S. Dearborn St., Chicago

SEWS THIS DOLLAR AWL FOR 75c

ANYTHING Makes a perfect lockitch



This Automatic Awl is superior to all others. It is of immense value for sewing all kinds of leather, harness, bags, belting, shoes, etc. **SHREDDER DIRECT FROM THE HEEL.** So simple a child can use it. Regular price \$1. For a limited time only we will send it postpaid anywhere, with waxed thread, two Diamond Point Needles (curved and straight), and directions, for ONLY 75c. Extra Needles 5c, Thread 10c.

Johnson Smith & Co., Dept. 1, 709 S. Dearborn St., Chicago

UNCLE SAM WANTS YOU



Government Examinations for Many Positions Everywhere During the Winter and Spring

Rapid advancement to higher Government Positions. No "Layoffs" because of STRIKES, WARS, FINANCIAL PLURIES or THE WHIMS of SOME PETTY BOSS. THE POSITION IS YOURS FOR LIFE. Country residents and city residents stand the same chance for immediate appointment.

Common sense education sufficient. Political influence NOT REQUIRED.

We Will Give 25 Free Scholarships

Write immediately for schedule showing the places of the Winter and Spring examinations. Don't delay. Every day you lose means the loss of just so much coaching before the rapidly approaching examinations.

FREE COACHING COUPON

FRANKLIN INSTITUTE, Dept. R 104, Rochester, N. Y.

The coupon, properly filled out, entitles the sender to free sample questions, full list of positions now obtainable, a free copy of our valuable copyrighted book, "GOVERNMENT POSITIONS AND HOW TO OBTAIN THEM," and to consideration for FREE COACHING for the Civil Service Examination here checked.

... Railway Mail Clerk (\$900 to \$1800) ... Customs Positions (\$600 to \$1500)
... Postoffice Clerk (\$800 to \$1200) ... Internal Revenue (\$700 to \$1800)
... Postoffice Carrier (\$800 to \$1200) ... Stenographer (\$800 to \$1500)
... Rural Mail Carrier (\$900 to \$1200) ... Panama Canal Clk (\$1200 to \$1800)

Name.....

Address.....

Use this before you lose it. Write plainly.

An Interesting New Book For Those Who Like to Make Things



AMATEUR MECHANICS No. 6

293 Articles

261 Illustrations

128 Pages

Price 25c Postpaid

THIS book which is similar to the previous numbers in the Amateur Mechanics series but contains entirely different matter describes how to make the following as well as scores of other interesting and practical things.

Tandem Monoplane Glider - Camp Bed - Sail for Boys' Wagon - Surveyor's Transit - Motion Picture Machine - Small Rheostat - Folding Bookrack - Sunlight Flasher for Garden - Camp Furnishings - Water Motor - Model Steam-Turbine Boat - Hurdle - Pocket Voltmeter - Mechanical Camera - Cyclemobile - Small Series Motor - Cut Press - Helicograph - Electric Heater - Electric Horn - Ski Staff - Monorail Sled - Fire and Burglar Alarm - Blowgun - Pea Shooting Gun - Drill Press - Pushmobile - Ice Racer - Galvanometer - Ellipsograph - Snowball Thrower - Power Windmill - Flymobile - Pantograph - Small Hydro Electric Power Plant.

The other books in this series, Amateur Mechanics Nos. 1, 2, 3, 4 and 5 and Mechanics for Young America, are similar in style but each contains matter entirely different from that in the others.

Price 25 Cents Each, Postpaid

Popular Mechanics Book Dept.
6 N. Michigan Ave., Chicago



The Ideal Book for Every Wide-Awake Boy

The Boy Mechanic

700 THINGS For Boys to Do

480 Pages—700 Articles—800 Illustrations

Price \$1.50 Prepaid

A wonderful and interesting collection of articles that tell how to make all those things boys love to build or experiment with.

Wholesome—Practical—Instructive

ADDRESS

POPULAR MECHANICS BOOK DEPT.

6 N. Michigan Ave., CHICAGO

Personality is the Secret of Success

You can be trained to be one of the men who dominate and control the business world. You can develop a **MAGNETIC PERSONALITY** and learn to avoid the unscrupulous, how to unmask their pretensions, how to discover their real traits. You can transform a pessimistic, discontented temperament into a **firm determination to win**. If you lack concentration, suffer from poor memory, you can overcome these defects, **turn all your failures into success.**

This most practical course is by Theron Q. Dumont, Founder of the Art and Science Institute of Paris. It explains the subtle, irresistible, fascinating charm that attracts one mind to another. By this course you can secure the **winning personality** you must have before you can reach the higher positions of life. You have the latent powers—this teaches you how to develop them. Complete in 2 cloth volumes, \$2. Refunded if not satisfied, or write today for full particulars.

ADVANCED THOUGHT PUB. CO., 212 Federal Life Bldg., Chicago



The Best Art School



Correspondence and Resident Instruction in Designing, Cartooning, Illustrating, Chalk-talking and Lettering. Most thorough, practical and best courses obtainable. We can prove it. Send at once for FREE fine illustrated catalog.

THE LOCKWOOD ART SCHOOL, KALAMAZOO, MICH., Dept. 15

JEWELRY ENGRAVING

We teach you, by our new and original method of instruction, this clean, fascinating and profitable business **right at your home**, and furnish you all tools needed absolutely **free**. Write for free book to the **WISCONSIN SCHOOL OF ENGRAVING, 52nd St., MILWAUKEE, WIS.**



DENTAL ASSISTANT
OR
DENTIST

Only field not crowded. Salaries no limit. **Young Man, Young Woman**

WHICH?

Study at home. Send for catalogue. **Dental Correspondence College**
617 Wood Street Chicago, Illinois



CIVIL SERVICE

positions are in all parts of the country. Good pay steady work, life positions, congenial surroundings, promotions on merit, short hours, annual vacation and sick leave with pay. Many thousands appointed yearly. Both sexes. No political pull. Nearly 300,000 classified positions. Common school education sufficient. Full information and questions used by the Civil Service Commission free.

COLUMBIAN CORRESP. COLLEGE, Washington, D. C.

CACHOO! Make the whole family and all your friends "just sneeze their heads off" without knowing why, with **Cachoo**, the new long distance harmless snuff. Sent anywhere for 10c. 3 for 25c. 1 doz. and special premium for 90c. **AMERICAN SUPPLY CO., St. Paul, Minn.**



LEARN TO BE A SALESMAN

SALESMANSHIP offers a profitable field for men and women. Successful, trained Salesmen **earn \$100 to \$500 a month**. Write for free book with testimonials of others who have succeeded through our Home Course. Endorsed by greatest Salesmen.

BROWN'S HOME STUDY SCHOOL, 100 Brown Building, PEORIA, ILL.



HERE YOU ARE, BOYS A medallion pin of Foxy Grandpa. Everyone will notice it on the lapel of your coat and try to get a closer look at it. All you have to do is press the bulb.—Foxy Grandpa will finish the job by squirting a fine stream of water over the inquisitive one. Will squirt 20 feet. Greatest joke out. Order one today and fool your friends. Price 15c. Foxy Grandpa and Hoogan both for 25c. 5 for 50c or 1 doz. for \$1.00. A beautiful fountain pen free with every \$1.00 order.

AMERICAN SUPPLY CO., 918 Union St., St. Paul, Minn.

60 LAW POCKET SIZE TEXT-BOOKS

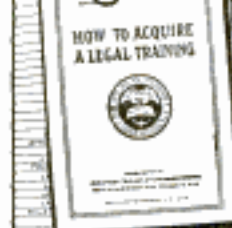

furnished with our easily mastered law course. A novel idea—no other school has them. Take your lessons with you and study in your spare time. This method of instruction makes the study of law as simple as reading a magazine.

← LAW BOOK FREE

Read our 80-page book before enrolling for any law course. Tells how to judge the claims of all correspondence schools, and describes thoroughly the American School's simplified new law course. Prepared by 56 of America's greatest legal authorities—28 more subjects and 30 more authors than any other correspondence law course. 13 volume Library of American Law and Practice, 60 Text Books, and 36 Case Books furnished every student. Don't fail to investigate before taking up the study of law. Send postal today for your free book.

AMERICAN SCHOOL OF CORRESPONDENCE
Dept. 1192 Chicago, U. S. A.



CIVIL SERVICE

positions are in all parts of the country. Good pay steady work, life positions, congenial surroundings, promotions on merit, short hours, annual vacation and sick leave with pay. Many thousands appointed yearly. Both sexes. No political pull. Nearly 300,000 classified positions. Common school education sufficient. Full information and questions used by the Civil Service Commission free.

COLUMBIAN CORRESP. COLLEGE, Washington, D. C.

CACHOO! Make the whole family and all your friends "just sneeze their heads off" without knowing why, with **Cachoo**, the new long distance harmless snuff. Sent anywhere for 10c. 3 for 25c. 1 doz. and special premium for 90c. **AMERICAN SUPPLY CO., St. Paul, Minn.**



LEARN TO BE A SALESMAN

SALESMANSHIP offers a profitable field for men and women. Successful, trained Salesmen **earn \$100 to \$500 a month**. Write for free book with testimonials of others who have succeeded through our Home Course. Endorsed by greatest Salesmen.

BROWN'S HOME STUDY SCHOOL, 100 Brown Building, PEORIA, ILL.



HERE YOU ARE, BOYS A medallion pin of Foxy Grandpa. Everyone will notice it on the lapel of your coat and try to get a closer look at it. All you have to do is press the bulb.—Foxy Grandpa will finish the job by squirting a fine stream of water over the inquisitive one. Will squirt 20 feet. Greatest joke out. Order one today and fool your friends. Price 15c. Foxy Grandpa and Hoogan both for 25c. 5 for 50c or 1 doz. for \$1.00. A beautiful fountain pen free with every \$1.00 order.

AMERICAN SUPPLY CO., 918 Union St., St. Paul, Minn.

EARN \$5.00 TO \$15.00 PER DAY TUNING PIANOS



A. J. LOCKSLEY
writes us on Sept 24, 1924:

"Am delighted with diploma. Have been very successful since taking course. Best investment I ever made; worth four times its cost. Got my money back several times in two months. Have made \$15 in one day and often \$10 and \$12. Have fixed 3 churches organs; have another order today. I give satisfaction every time, due only to instructions from the Niles Bryant School of Piano Tuning."

Start now, earning good money. Daniels, Kansas, made \$53 first week. Others making big incomes. You can learn easily, quickly, by my patented **TUNE-A-PHONE**, home study method; the practical and scientific way, absolutely accurate; more correct than tuning by ear. No guess work; musical training unnecessary.

Splendid chance in every town to establish permanent business. Your reputation spreads quickly. It's an independent profession, throws you with nice people. At least investigate. Get started toward success. Mail this opportunity coupon.

COUPON

Niles Bryant School of Piano Tuning

Dept. 302, Battle Creek, Michigan

Send me the free illustrated book, graduates' records and full information to start me in Piano Tuning Business.

Name.....

Address.....

Please Mention Popular Mechanics



UNITED STATES



ENGLAND



JAPAN



AUSTRALIA



CHILE



FRANCE



SOUTH AFRICA



RUSSIA

What the World's Nations Think of Each Other

It is the very soul of the nation that is seen by the Cartoonist. And in these bitter days, when Civilization itself is on trial, there is no better index to public opinion than the work of the Cartoonist.

CARTOONS MAGAZINE

Published by H. H. WINDSOR
Publisher of Popular Mechanics Magazine

Presents every month an international symposium contributed by cartoonists from Tipperary to the Coral Strands.

In the February number will be found the Point of View from German, British, American, Italian, Russian, French, Austrian, Dutch, Spanish, Spanish-American, Japanese and Colonial Sources.

Cartoons that reach the heart, cartoons that make you think, cartoons that make you laugh; Italian cartoons portraying the Deity, and smacking of the mediaeval; quaintly curious Japanese cartoons; cartoons blazing forth the anger of Britain and the wrath of Germany.

Timely articles on German militarism, on the Mission of Italy, on the Jewish soldiers, on Cossack life, on the quickening business pulse at home.

Articles on War-time Humor in England, on Lincoln in Caricature, on Emperor Wilhelm (by a Buenos Aires writer); on the new book of Alsatian History by "Hansi," the soldier-cartoonist.

These and many other features will make the February Cartoons Magazine the liveliest review of the month.

Single copies 25 cents. \$3.00 a year

The file of Cartoons Magazine for 1915 will be the most fascinating war history ever published

Send Subscriptions now to H. H. WINDSOR
6 N. Michigan Ave., CHICAGO



ITALY



AUSTRIA



SWEDEN



CANADA

I Will Qualify You To Make \$2,400 Yearly

Be A DRAFTSMAN



Let me prove to you entirely at my expense that right now thousands of competent Draftsmen are needed at big salaries—\$2,400 yearly and more. Let me prove to you—I can do it—beyond all shadow of doubt that Draftsmanship is the profession for you—the profession that **always** means steady employment and prosperity. Today Draftsmen are reaping a great harvest of dollars—today buildings and machines are being built everywhere, more are being planned and competent Draftsmen are needed everywhere at handsome salaries. Never before has such an opportunity unfolded itself. Never before have Draftsmen or men of any other profession met with such wonderful opportunities of wealth and future.

Thousands Now Needed

Write me quick! Let me prove everything **free!** I want to show you how I can help you out of your present rut and into success as a Draftsman. I don't care who you are or what you now work at. I train all kinds of men for success. I take men out of the lowest paying, most discouraging jobs and qualify them easily for success and a prosperous future as a Draftsman. I want to show you the boom times now prevailing for Draftsmen—the future of wealth before you—the independence and influence awaiting you, and prove Draftsmanship is by far the most promising profession of all today.

Success and Prosperity for You

Write me today. Now is the time to begin. I send you most startling facts you have ever read. I prove everything. I show you free how **you** can qualify at home in your spare time for this remarkable profession. I tell you how to earn big money on the side as Draftsman after you have learned the first few lessons. The cry for Draftsmen is so great—there is so much work to be done—that many of my students are making big money now, long before they have graduated. I show you how to get out of your present low-salaried job quick—to connect with some big firms as Draftsman at a handsome salary. Let me prove how competent Draftsmen can advance to big, powerful positions as Chief Draftsman, Chief Engineer or Superintendent at enormous salaries or open an office and employ other Draftsmen.

I Can Easily Train YOU

In your own home, by mail. You need not give up your present position. Your spare time only is required. Let me show you at once how plain, how simple, how easy I make it for you to learn. I tell you and show you everything in a practical way. I teach you personally. I give you the benefit of my personal training, experience, knowledge and science. I stick by you all through the course. I stick by you after you have graduated—give you the benefit of my personal advice. My students succeed because of this wonderful personal guidance.

For many years I have been a practical, high-salaried Draftsman and Designer, holding important positions with some of the

largest firms. Because of the thorough instruction I received, and the many years of practical experience I have had, I am acknowledged to be the best qualified expert in America to successfully instruct others in Draftsmanship. When you follow my personal instructions you follow the instructions of a Draftsman who has personally made a big success and who knows the necessities of a finished Draftsman. I want to tell you all about this fascinating and profitable profession—I want to show you how I guide you to success and prosperity. Let me send you Free the most complete and clearest Book on Drafting ever published.

No Experience Needed

Do not make the mistake of believing that you need any previous experience—nothing of the sort. I show you from the beginning—right from the ground up. Show me just how to start, and carry you through in the shortest time in the easiest, most fascinating manner you could imagine. It's all explained so thoroughly in my **free book**. Just send coupon below and get all the information needed.

FREE \$17.50 DRAFTSMAN'S OUTFIT If You Enroll At Once

If you enroll in the next 30 days I will give you, absolutely **free**, this magnificent set of Draftsman's Drawing Instruments, valued at \$17.50—the same as I use in my professional work. Lasts a lifetime. But you must act at once to get it **Free**.

Special Tuition Offer!

Smallest, Easiest Payments!

For a short time only I offer my personal instruction at such small, easy payments that anyone, no matter how small his income, can now become an Expert Draftsman, and as an **Extra Special** inducement for prompt enrollment I am offering a \$25.00 Tuition Credit. I am the only Expert Draftsman giving personal service at such small payments, but I must withdraw this offer before long. So send the coupon today for my remarkable easy terms and wonderful proposition. It means a grand opportunity for you if you act quick.

Write NOW! Send No Money

Mail free coupon now for the most remarkable, most conclusive proof of the vast opportunities awaiting competent Draftsmen. Let me send you **proof** that you can qualify for this grand success and that right now is the time to begin. Don't be satisfied to work for a mere living wage—don't be at the mercy of adversity. Get into this prosperous profession now—command your own salary—carve your future. Mail coupon now for facts and proof.

CHIEF ENGINEER, Chicago Engineering Works, 441 Cass Street, Chicago, Ill.



MAIL THIS FREE COUPON
Chief Engineer,
441 Cass Street, Chicago, Ill.

Dear Sir: Without any obligation on my part, send me your book, "The Road To Success," and full particulars of your limited offer. Send everything **free and prepaid**.

Name.....

Address.....

Here's Health and Power, Vim and Vigor



ALL YOURS!
Strength that is more than mere muscular strength. The strength of perfect health, abundant nerve force—the strength of keen relish is now within your reach through vibration! Nine out of ten

people are only half alive. How about yourself? Listen! All the joys of life, strength and youth may be returned to you by vibration. Send the free coupon for the big new book that will tell you all about it.

THE WHITE CROSS
ELECTRIC VIBRATOR



White Cross Electric Vibrator and its Attachments.

This wonderful instrument gives you three of nature's greatest curative agents—vibration, faradic and galvanic electricity. We will send this wonderful machine to you on free trial. Feel its health-giving vibrations for yourself. Don't be weak. You can be strong and healthy if you will by using the White Cross Electric Vibrator.

Vibration Is Life

It will chase away the years like magic. Every nerve, every fibre, of your whole body will thoroughly tingle with the force of your own awakened power. All the keen relish, the pleasure of youth, will fairly throb within you. Rich, red blood will be sent coursing through every vein and artery, you will be made over—new from head to foot. You'll sleep the health giving restful



sleep like you used to. Your self-respect, even will be increased a hundredfold.

LINDSTROM-SMITH CO.
Dept. 1192
1100 S. Wabash Av.
CHICAGO, ILL.

Please send me, absolutely free and prepaid, your new book "Health and Beauty," and full particulars about the free trial offer on the White Cross Electric Vibrator. I assume no obligation of any kind.

Send the Free Coupon

Just your name and address on the free coupon or a letter or post card is enough. We will send you absolutely free and prepaid, our new book, "Health and Beauty." It's free. No obligations of any kind. Write at once.

Lindstrom-Smith Co.
Dept. 1192
1100 S. Wabash Av.
CHICAGO

We manufacture White Cross electric irons, hair driers, stoves. Dealers write.

Name.....

Address.....
My Electrical Dealer's Name is

WAR BOOKS

The first intimate, vital and trustworthy accounts of the great war crisis can now be obtained in book form. Everyone wants all the reliable information he can possibly get regarding this momentous event which will affect the future of the whole world. The following books can be depended upon to be authentic and are written by men ably qualified to handle so great a subject.

Germany and the Next War

By **GENERAL F. VON BERNHARDI**
Great Exponent of German Militarism

Authorized American Edition. This book discloses Germany's war plans for the crushing of England and France. Bernhardt's programme, as outlined in this book, is actually being carried through. *Price 85 Cents, Postpaid*

The War and America

By **HUGO MÜNSTERBERG**, of Harvard University

No writer of the century is better qualified to discuss the world issues now at stake than this great German-American. His book will be read with eager attention and respect. *Price \$1.10, Postpaid*

The Secrets of the German War Office

By **DR. ARMGAARD KARL GRAVES**, Secret Agent

The author was for twelve years a spy in the Kaiser's service. He exposes the details of secret missions that have had a startling influence upon the present war. He also reveals for the first time the intricate and sensational operations of the great German Spy System. *Price \$1.60, Postpaid*

Germany's Fighting Machine

By **ERNEST F. HENDERSON**

Divided in three parts: **The War**, in which the author gives a clear and authoritative statement of Germany's position; **The Army**, in which he discusses in detail the marvelous organization which has so challenged the wonder of the world; **The Navy** covers both the fleet of the open seas and the fleet of the open air. 100 Remarkable Photographs. *Price \$1.35, Postpaid*

Men Around the Kaiser

By **F. W. WILE**

The only book giving complete and accurate information about all of the great German warriors, statesmen, business men, scholars and all those who figure most prominently in the affairs of that country at the present moment. By a man who has viewed German affairs at closer range than any other American outside of the Embassy. 30 Portraits. *Price \$1.35, Postpaid*

The Germans

By **I. A. R. WYLIE**

A timely, comprehensive and valuable survey of conditions in Germany and an intimate, masterly, vital and graphic picture of the German people on the eve of the great conflict. Written without bias or partisanship by one of England's foremost writers after many years of residence in Germany. *Fully Illustrated. Price \$2.15, Postpaid*

War's Aftermath

By **D. S. JORDAN** and **H. E. JORDAN**

With an Introduction on the Present European Conflict
A study of the effect of our Civil War on the quality of manhood in the South which will attract the attention of all students of history. The authors have gone deeply into conditions of the South before and after the war, presenting some startling results as to the deterioration of the quality of stock occasioned by the lamentable waste of the war. *Price 85 Cents, Postpaid*

War Atlas

Large 20 page (11 x 15 in.) atlas of the war in Europe, containing large colored scale maps of the battle-ground—Europe, Austria, Serbia, Germany, England, Belgium, France, Russia, Italy, Greece, The World, etc. Special data showing comparison of armies and navies involved, pictures of rulers, etc. *Price 30 Cents, Postpaid*

Any of the above books sent postpaid upon receipt of the price by
POPULAR MECHANICS BOOK DEPT.
6 N. Michigan Avenue, CHICAGO

Stop Forgetting!

Now, What Was That Fellow's Name?
I Can't Remember Those New Terms.
I Know—But Can't Find Exact Word.
What on Earth Did He Say About It?



A Perfect Memory Is the Key to Success

The mind of the average person is filled with thousands of single unrelated ideas which waver and fluctuate with every emotion, like the billows of the sea.

The man with a Wandering Mind can never hope to Make Good—he will always be a drug on the market—he has too many competitors. The great men of all ages are those who acquire the ability to concentrate and to memorize.

You Can Be Trained to Remember Accurately

In the business battle—matching wits each hour of every day—the ability or inability to think on your feet, to remember instantly and accurately means gain or loss. To succeed you must be "forget-proof." Just as surely as a poorly organized business can be placed upon a basis of perfect systematization and thereby made thoroughly efficient—so can your mind be trained and made a classified indexed and cross indexed filing system of facts so that you can command, on the instant, any thought, fact or argument.

The Dickson Method of Memory Training Will Do This for You

It will enable you to classify impressions, ideas, names, facts and arguments so as to have them ready at a moment's notice at any time. It will train you to think on your feet, to converse in a natural, interesting way, to overcome self-consciousness and bashfulness, to acquire easy, logical thinking. My course is not a theory, but is purely and absolutely scientific—the result of more than 20 years of close, intimate contact with students in schools and colleges and searching their developing minds for means of strengthening their memories.

I Want to Send You My Book, "How to Remember," Absolutely FREE

Simply clip the coupon and mail it today. It will explain clearly the course that has raised thousands of men from failures to great successes. You can have this same training. My free book is the first step. Don't delay. Age, education, vocation or place of residence makes no difference. Send the coupon today.

How to Get a Free Copy of This Valuable Book

De luxe edition handsomely illustrated, richly bound. Is exactly suited to meet the needs of the man or woman who desires to be a successful public speaker. The price of this 1915 de luxe edition is \$2.00. I will, however, present a copy absolutely free to every student who enrolls for my course of memory training within ten days after reading this offer.

Send the Coupon or Postal Today.



Prof. Henry Dickson

America's foremost authority on Memory Training, Public Speaking, Self-Expression, and Principal of the Dickson Memory School, Auditorium Building, Chicago.

Henry Dickson, Principal, Dickson School of Memory, 705 Auditorium Building, Chicago, Ill.

Please send me, free of charge and without obligation, copy of your valuable book, "How to Remember;" also your Free Copyrighted Memory Test, the most ingenious and conclusive test for your memory ever devised, and full particulars showing how I can get, free of charge, your de luxe book, "How to Speak in Public."

Name _____

Address _____



\$45 Course FREE IN MECHANICAL DRAWING

Also \$15 DRAWING OUTFIT Furnished on this Great Offer

Here's YOUR Chance to Learn DRAFTING

A special limited offer to men who cannot attend the day and evening classes of this old established College. Act now before it is withdrawn.

DRAFTING — ENGINEERING Civil—Electrical—Mechanical—Architectural PAYS BIG SALARIES

All branches are calling for trained men. We can't fill all the applications we get. There's a job for you if you have grit and learning. You supply the grit, we'll furnish the learning that will turn into earning.

Let These Experts Teach You In Your Own Home



CHARLES W. MOREY, ESQ., M.E.
President



CARL T. NEWGARD
Vice-President

Pres. Morey is one of Chicago's prominent consulting engineers. Vice-Pres. Newgard is head of the firm that made the structural plans for the great new \$2,000,000 Cook County Hospital and other big structures in Chicago. These men

head the faculty of Engineering and Architectural experts, all of whom are in constant charge of real work, big work, in Chicago, New York and elsewhere.

They know exactly the practical training you need and they train you. No books to sell. Live, up-to-date blue prints of work in actual construction.

NO OTHER CORRESPONDENCE COURSE IN AMERICA GIVES THIS ADVANTAGE

No other similar correspondence course in America has a resident college of National reputation back of it, nor a faculty of active experts actually engaged in municipal and corporation engineering work. These men know exactly the kind of training you need because they are in constant charge of big work.

STUDY AT HOME Devote your spare hours for a short time only and learn this profitable and pleasant profession, and get in the class drawing the big pay envelope. Hundreds of men are in daily attendance at this old established college. In your own home you can do the same work these men are doing, and the same experts that teach them will guide you toward the big job. These well known engineers prepare your instruction matter. Your work is examined and approved by them. In your own home you work with plans of machinery, buildings, steel work, etc., actually being constructed in Chicago, New York and other large cities.

\$45 COURSE IN MECHANICAL DRAWING FREE

This College has set aside a limited number of Free Scholarships and will give the regular \$45 Course in Mechanical Drawing free with any one of the Home Study Courses named in the coupon below—this is in addition to the complete \$15 Drawing Outfit which is also furnished to students free. Take advantage of this unusually liberal offer today, as it will be withdrawn when the allotted number of Free Scholarships has been awarded. It costs you nothing to get full information. No obligation on you.

ACT NOW—FILL OUT COUPON TODAY

Machine Drafting Builders' Course
 Electrical Drafting Plan Reading
 Architectural Drafting Estimating
 Structural Drafting Sheet Metal Drafting
 College or Home Study Course.....

Name

Address

Town..... State.....

CHICAGO TECHNICAL COLLEGE
1050 LAKE VIEW BLDG. CHICAGO, ILL.

JUST OUT SHOP NOTES FOR 1915



626 Easy Ways to
Do Hard Things

224 Pages 517 Illus.

Price,
Paper, 50c; Cloth, \$1
Postpaid

A book that is indispensable to everyone who uses tools, either for pleasure or as an occupation. This is Vol. XI in our remarkable series of Shop Notes Annuals and, in addition to the many hundreds of practical time and labor-saving kinks each of these books gives, this volume contains the following articles which are of special value:

Home Garage—Gate for Stock Farm—Concrete Wall—Lawn Sweeper—Glass Cutter for Circular Work—Segment Work in Pattern Making—Simple Level—Locomotive Parade Float—Paving and Pavements—Concrete Garbage Furnace—Portable Boat Landing—Camper's Sleeping Outfit—Water-Power Vacuum Cleaner—Foot-Power Hammer—Automobile Turntable—Reversed Action of Oars—Hammock Swing—Engineer's Kerosene Torch—Elbow Pattern—Power-Driven Catamaran—Air Circulation in Furnace Heating—Windmill—Open-Air Swinging Bed—Self-Contained Gasoline Soldering Torch—Disk Cutter—Electric Cigar Lighter—Simple Resistance Thermometer—Oxyacetylene Welding Torch—Water-Heating Attachment for Furnace—Basement Hotbed—Heating an Automobile—Portable Cottage—Bed Desk for Invalid.

SHOP NOTES SETS 11 Vols.—Comprise

5742 Articles—5482 Illus.—2436 Pages

Price, per Set, \$5.50 Prepaid to any address

This great series of books is a veritable "gold mine" of easy ways to do hard things and will make an encyclopedia of priceless value to the owner.

The subjects treated cover every department of mechanics with useful, time and labor-saving kinks for all the trades. Here is the experience of years of hundreds of successful mechanics—"Written so you can understand it"—and of equal value to the professional worker and the amateur.



Popular Mechanics Book Dept.
6 N. Michigan Ave., CHICAGO

Making Useful Men

THE NAVY is a vast training school, where many thousands of young men are instructed each year, and receive their start in life.

¶ A man need not be experienced in order to join the Navy. All that is required of him is that he be an American citizen, of good health, sound in body and mind, with a clean record, a fair education, and willing to work. He is offered a chance to advance himself in the line for which he is best fitted. He will find life in the Navy interesting and instructive. He will probably have frequent cruises to foreign shores, with unusual facilities for sight-seeing. He will have opportunities to serve his country, and demonstrate the results of his Navy training. If he completes his enlistment with credit, the Honorable Discharge awarded him will prove the best kind of recommendation in seeking employment.

¶ The Navy offers many advantages to men who decide to remain in the service after discharge. All these advantages, as well as the rates of pay, hours of duty, privileges, and requirements of the naval service, are fully described in pamphlets which will be sent free upon request. Apply at nearest Navy Recruiting Station, or

ADDRESS BOX 67

BUREAU OF NAVIGATION

NAVY DEPARTMENT

WASHINGTON, D. C.



Ask this man how he came to make a failure of his life and he'll probably say, "I never had a chance." Hundreds of men who walk the streets make this complaint—men who started out in life with the same high hopes—the same ambition—the same natural ability that you have today. They say they "never had a chance." But as a matter of fact their failures are "self-made"—they overlooked the one thing every man must have if he wants success—*training*.



This young chap holds a responsible position in a big business. He earns a large salary and is worth it. Hard times don't worry him because he knows the business can't do without him. But don't think for a moment that outside influence or a pull with the boss put him where he is, for his success is just as "self-made" as the failure of the other fellow. *Training* made him what he is—made him a valuable man in the business world. And *training* will do the same for you.

Choose your own future today

It will be exactly what you make it. You can drift along, barely holding a job and drawing mighty small pay, getting "let out" in hard times, headed for a "self-made" failure—or you can take your first step now towards success, a "self-made" success, a big job, big pay.

For over eighteen years the *American School of Correspondence* has been training men for bigger jobs and bigger pay. It has trained thousands for entrance into the leading colleges—trained even more in all branches of *Engineering, Business and Law*. No matter where you live, what your occupation, or education, the *American School of Correspondence* will give you—in your spare time, in your own home—exactly the kind of training you need to achieve success.

Your future is in your own hands—you yourself make or break it. Take the first steps toward *real success* by signing and mailing the free coupon—right NOW.

American School

of Correspondence. Chicago, U.S.A.

Your Opportunity Coupon

Mark the position you want and mail the coupon now

- | | |
|--------------------------------|--------------------------|
|Electrical Engineer |Lawyer |
|Elec. Light & Power Supt. |Business Law |
|Hydroelectric Engineer |Business Manager |
|Telephone Engineer |Auditor |
|Architect |Accountant |
|Architectural Draftsman |Cert'd Public Ac'nt |
|Building Contractor |Private Secretary |
|Building Superintendent |Stenographer |
|Structural Engineer |Bookkeeper |
|Structural Draftsman |Fire Ins. Inspector |
|Mechanical Engineer |Fire Ins. Adjuster |
|Mechanical Draftsman |Fire Ins. Expert |
|Civil Engineer |Sanitary Engineer |
|Steam Engineer |Plumber |
|Shop Foreman |Reclamation Eng. |
|Shop Superintendent |Textile Boss |
|Sheet Metal Draftsman |College Preparatory |

We also prepare for civil service examinations in all engineering subjects

NAME

ADDRESS

Pop. Mech. 2-15

This school has no connection with any other school using the name "American"

Popular Mechanics Magazine

REGISTERED IN U. S. PATENT OFFICE

WRITTEN SO YOU CAN UNDERSTAND IT

Vol. 23 *82354* FEBRUARY, 1915

No. 2

Illustrated London News Oddly Mounted Gun Used for Fortress Defense

ONE of the machine guns which has been used with success by both the Belgian and French armies during the present hostilities, is supplied with a parapet mounting which adapts it particularly for fortress defense. The gun itself is similar to many used in aeroplane service, but its mounting in this instance fits it for use behind ramparts and entrenchments in defensive action, and even in scaling walls and breastworks of the enemy during offensive operations. The instrument has an angular mounting on a geared shaft, the lower end of which has a wheel-and-brace mounting, while the upper end is supplied with arms that hold it in place at the top of an embankment. When the pole is raised for use, the gun and its platform, which carries the ammunition box, is drawn up to firing position by a hand crank. It is then possible for

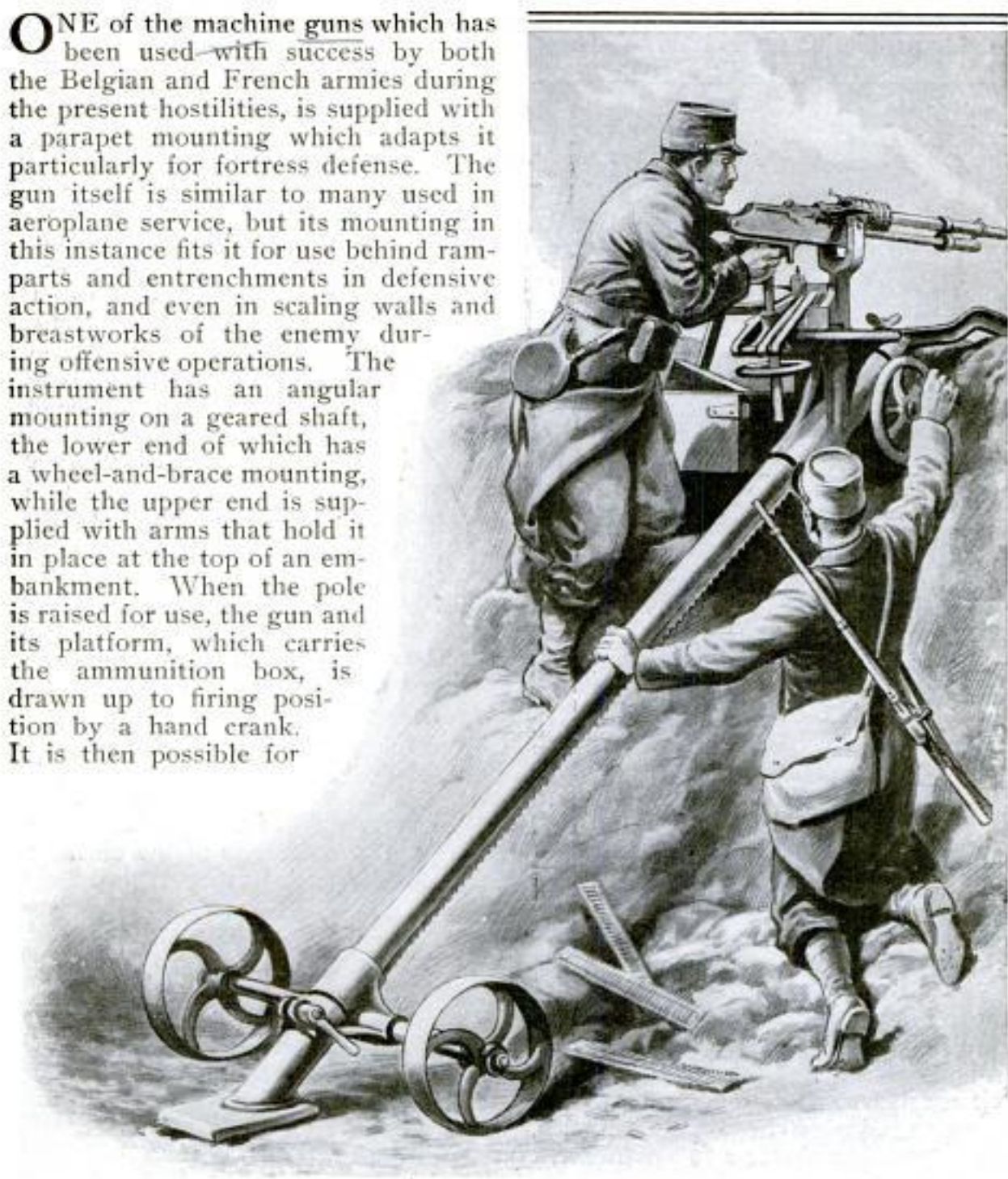

Machine Gun Used by the Allies for Fortress Defense and Even for Offensive Operations

the gunner to sweep the field before him while being sheltered behind the rampart. The gun is manufactured by a firm which was originated in France by an American.

LIFE BELT INFLATED BY CONTACT WITH WATER

The ordinary life belt is a cumbersome thing to wear, and in order to provide protection for airmen or others

THE GOBBI LIFE BELT

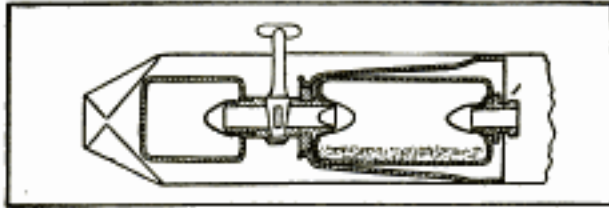

This Life Belt becomes Inflated Automatically When the Wearer is Thrown into the Water

who are likely to be thrown into the water a life belt has been invented that lies flat about the chest under ordinary conditions and becomes inflated when brought in contact with the water. This belt consists of a flexible tubular girdle, at one end of which are two receptacles, one containing water and the other a carbide which becomes a gas and inflates the tube when mixed with water. A valve permits the wearer to let the

water into the carbide receptacle, while a wick that passes from the outside of the belt into this receptacle causes the water to enter and inflate the tube automatically in case the wearer is unconscious after being thrown into the water. Provision is made for preventing the entrance of water after inflation has taken place and for preventing overinflation of the tube.

NOVEL PLAN FOR UTILIZING POWER OF NIAGARA FALLS

A plan for saving and utilizing from 75 to 80 per cent of the power now going to waste over Niagara Falls without diminishing the scenic beauty of the falls has been worked out in detail and is being promoted. Two of the most important features of the falls, in a scenic way, are the deflection of light through the water as it curves over the crest, and the rising spray from the impact of the water at the base of the cliff, and both of these features are to be preserved. This is accomplished by an ingenious arrangement of penstocks by which a portion of the water is caught as it falls from the crest, is led through the turbines, and is then discharged into the falling sheet of water at the foot of the cliff, care being taken not to divert enough of the water through the penstocks to impair the beauty of the falling sheet. The plan involves the building of a permanent concrete crest for the falls, to prevent future erosion, as well as the construction of a tunnel across the river back of the face of the cliff. To divert the water from successive sections so that this work can be done, dams are to be made by building cribs in the river above the falls, and then floating them down to a point near the crest and sinking them. After the work is completed, these dams are to be removed by blasting, or by unloading the cribs and floating them to a new site.

Valuable platinum deposits have been discovered in ore from the Yellow Pine mining district in Nevada.

*J. S. Harvey, Menaggio, Italy
Clipping taken from "The
Aeroplane" Enquiry to Mrs.*

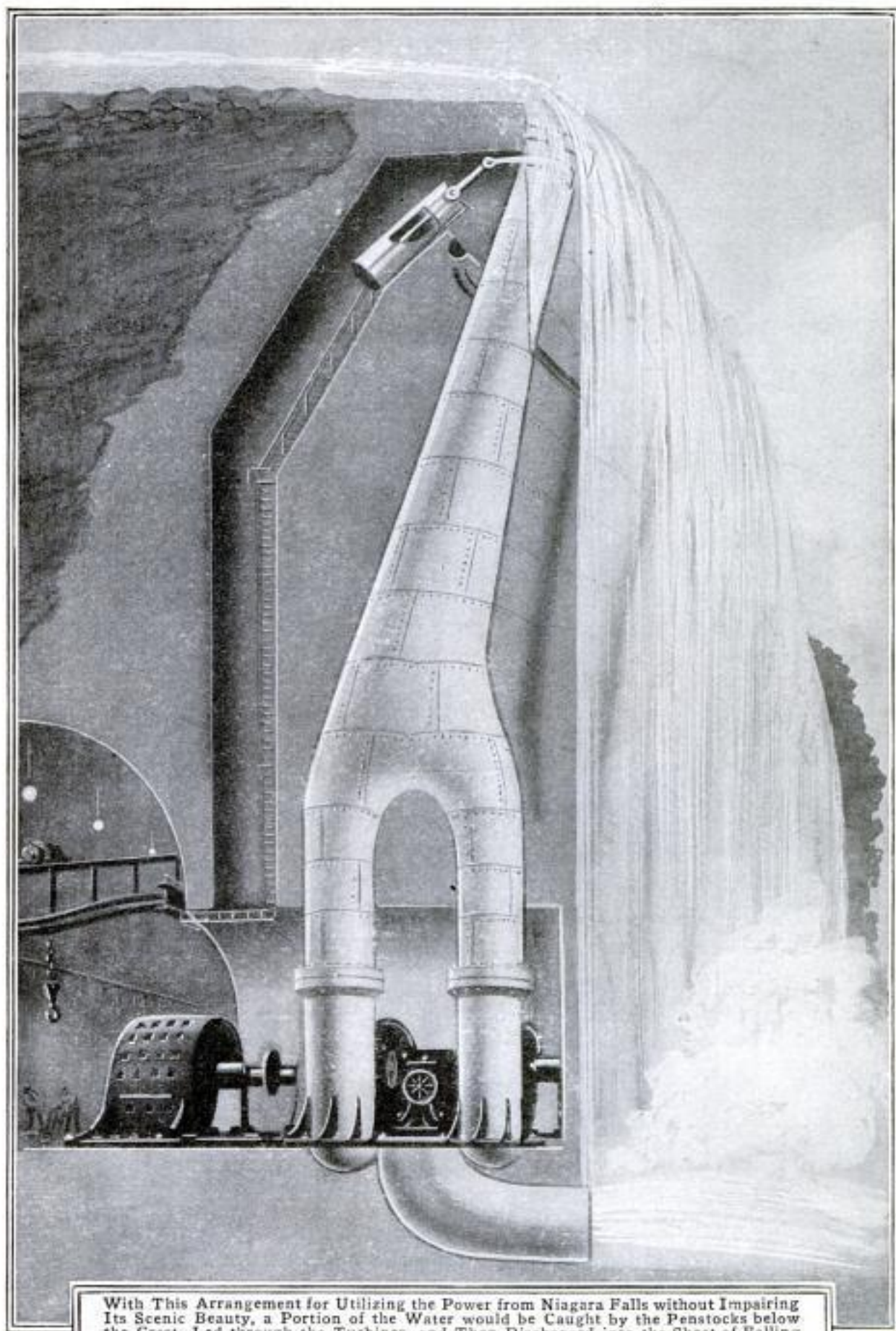

With This Arrangement for Utilizing the Power from Niagara Falls without Impairing Its Scenic Beauty, a Portion of the Water would be Caught by the Penstocks below the Crest, Led through the Turbines, and Then Discharged into the Sheet of Falling Water at the Foot of the Cliff

Wm. H. Watson, Norton, Pa.
Box 206

Carter Car Co., Philadelphia, Pa.

164 Pontiac, POPULAR MECHANICS
Mich.

AUTOMOBILE CLIMBS SLOPE OF FORTY-FIVE DEGREES

8676
m An automobile carrying five passen-
gers performed a remarkable feat re-
cently by climbing up a slope having

The Japan Magazine HOW PAPER IS MADE FROM MULBERRY BARK

8857
m The making of paper from the bark
of the kozo shrub, or paper mulberry,
is one of the oldest industries in Japan,

being so old that it forms a part of some of the ancient Buddhist myths of that country. The process of making this, the "hashikirazu" paper, is simple in the extreme, but results in a high grade of paper having remarkable strength in the direction of the fiber. The bark is first cut into lengths of two or three feet, and is boiled in a caldron until the coarse parts of the bark can be removed. The remaining fiber is then beaten to a pulp in a mortar while it is mixed with juice from hollyhock roots. The pulp is next put into a box having a sieve bottom made of bamboo, and all the water is drained off, after which it is spread over a board to the thinness of paper and left to dry and harden. The side next to the board has the smoother



Automobile Breaking the Record for Hill Climbing

an angle of more than 45°. The car attained a position about two feet higher up the slope than that shown in the illustration, but could not hold the position on account of the dirt slipping out from under the hind wheels. This climb was made by a standard car equipped with friction drive.

As a result of the efforts of the Federal government to stamp out foot and mouth disease among cattle, American glassware manufacturers find a serious shortage in the supply of hay and straw used in packing their products, since these products are also quarantined.

surface and becomes the face of the paper. This paper can be used for a great variety of purposes, the latest being that of making paper boats, the process for which was described in the January, 1915, number of this magazine.

UNIVERSITY STUDENTS SET OFF BIG BONFIRE

8817
m A bonfire produced by burning up a carefully built wooden structure, 30 ft. square and 50 ft. high, was the principal feature of a football rally at Stanford University, California. This pyre,

Geo. W. Fenimore, 204 University Ave.,
Berkeley, Calif.

which cost about \$100 besides the work of 400 students for several weeks, was built to represent the campanile of the rival University of California, and the resulting bonfire was intended as an amiable expression of intercollegiate feeling. In order to provide a sufficient

evening of the rally the pyre was drenched with crude oil and kerosene, and then set off by means of a long



The Stanford University Bonfire as It Appeared Ready to Light



As It Appeared after being Soaked in Oil and Set on Fire by a Fuse

draft for the fire, a flue, 6 ft. square, was constructed in the center. On the

fuse. It was burned to the ground in less than 30 minutes.

8852 H *Sheworth*
RADIO GONE, SHIP SIGNALS RESCUERS WITH LIGHTS

Lashed to a mast of the ill-fated steamer "Hanalei," which struck the Duxburg Reef, off San Francisco, during a recent storm, a wireless operator for nearly 12 hours after the vessel's radio equipment became disabled directed the rescue work of life-savers ashore by flashing messages in the Morse code by means of an electric torch. The tragedy was one of the saddest that has occurred on the Pacific coast in years. Although within 500 ft. of land, more than 20 of the 63 persons aboard the ship lost their lives. The vessel went on the rocks in a fog

about the middle of the day, but it was night before mortars could be procured for firing life lines. It was then that the operator, by flashing dots and dashes with the electric light, informed the rescuers where the lines were falling and how to shoot the next ones, although all this was in vain. In turn, messages of cheer were sent out from the shore with a motor-car headlight.

Each time after the mortar boomed and the line shot out into the dark, there was a suspense. Then the light high on the ship's mast would commence blinking. "Windward and too

*Arch Macdonald, 280 Lee St., Oakland, Cal.
photos - Inter. news service, San Francisco Tribune
Los Angeles Tribune - letter from Dept. of Commerce*



For Hours the Wireless Operator of the Ill-Fated "Hanalei" Directed the Rescue Work of Life-Savers by Blinking Out Messages in Dots and Dashes with a Flashlight

low. Send her higher," would come the message. Then another shot would ring out, followed by another message. This continued throughout the night. Before dawn on the following morning the ship broke in two and its passengers and crew were set adrift on the wreckage. A short time after this the revenue cutter "McCulloch" succeeded in picking its way through the debris and reaching some of the half-drowned survivors. Others were reached by life-savers—some of whom gave up their own lives in the strug-



This Remarkable Photograph of Life-Savers Actually at Work Shows the Rescue Party Taking Some of the

gle—and a few drifted ashore on the timbers.

The last bomb, the only one that went true, was fired at two pieces of wreckage in line with each other, to which a large number of the passengers were clinging. This was just at day-break. When the line was fastened, the wreckage was drawn within 100 ft. of the shore. The Secretary of Commerce of the United States sent a personal letter of thanks to L. A. Lovejoy, the "Hanalei's" wireless operator, for his courage and ingenuity, measuring up to the high standards of the wireless service.



Those
Ashore,
Vainly Try-
ing to Shoot
Out a Life Line
through the Darkness,
Sent Words of Cheer
to the Sinking Ship by

Flashing Messages in the Morse Code with Motor-Car Lights



Half-Drowned Survivors from a Small Piece of Wreckage Which was Pulled Ashore by Means of a Life Line

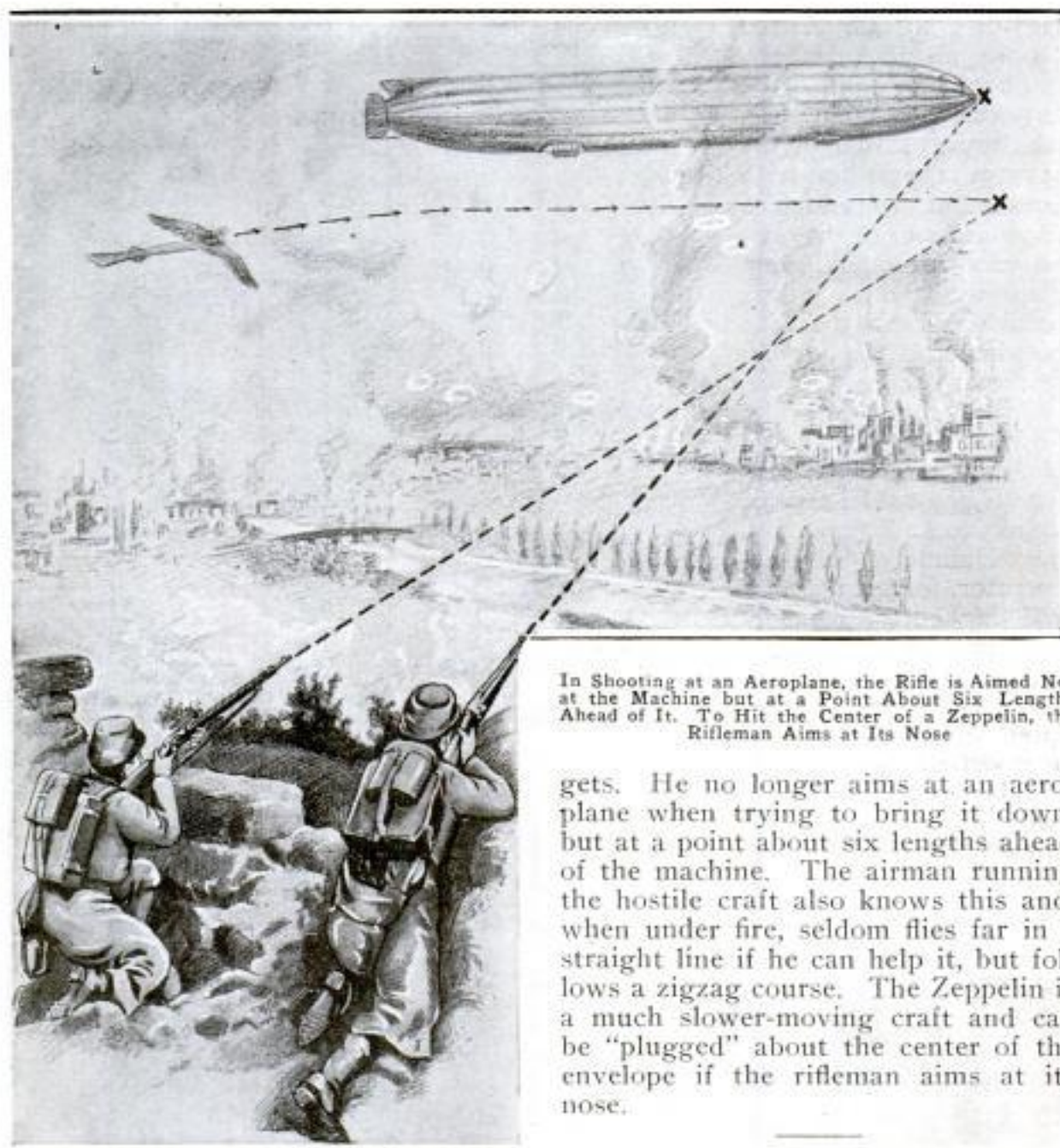

In Shooting at an Aeroplane, the Rifle is Aimed Not at the Machine but at a Point About Six Lengths Ahead of It. To Hit the Center of a Zeppelin, the Rifleman Aims at Its Nose

HOW TO SHOOT AN AIRSHIP OR AEROPLANE

The advent of the aeroplane and the airship has introduced a hard problem for the rifleman, whose duty it is to bring down hostile craft of this kind. Even with its enormous speed the bullet discharged by a modern rifle is not fast enough for the aeroplane, as has been discovered in the European war, but the expert riflemen who are constantly on the watch for hostile air craft are fast learning the requirements for hitting these swiftly moving tar-

gets. He no longer aims at an aeroplane when trying to bring it down, but at a point about six lengths ahead of the machine. The airman running the hostile craft also knows this and, when under fire, seldom flies far in a straight line if he can help it, but follows a zigzag course. The Zeppelin is a much slower-moving craft and can be "plugged" about the center of the envelope if the rifleman aims at its nose.

ORGANIC BASE STABILIZES SMOKELESS POWDER

In manufacturing smokeless powder for use in the navy, a stabilizing powder is now being incorporated in it to prevent its decomposition so that it may be kept in perfect condition for indefinite periods of time. The process consists of using an alkaline organic substance, which immediately neutralizes any acid that may be liberated, and which otherwise would tend to decompose the explosive. Previously no means of indefinitely preventing the powder from decomposition and pos-

your. U.S. Artillery p. 243

Refer to J. E. Lee, 107-28 St., Milwaukee, Wis.

R. F. Downey, 391 Pryor Ave., Milwaukee, Wis. 169

POPULAR MECHANICS,

sible spontaneous combustion was known, but to safeguard against these dangers a special coloring matter was incorporated in the powder, which gave it a brilliant red color that faded entirely away the moment decomposition commenced, thus serving as a stability indicator. This finally was abandoned because of the fact that the different plants making powder for the government were not able to produce a uniform color. Subsequently the new stabilizing process was discovered and put in use.

EGG CARRIER FOR SHIPPING BY PARCEL POST

An essential feature of the farm-to-consumer movement is a container in which eggs in small quantities can be shipped by parcel post, or in any other way, without danger of breakage. What is said to be the only container adapted to the mail pouch has just been invented and placed on the market. The holder for the eggs consists of two circular end pieces spaced apart by heavy wires that have loops for suspending the eggs. The eggs are twisted singly in heavy paper and secured to the loops as shown. The result

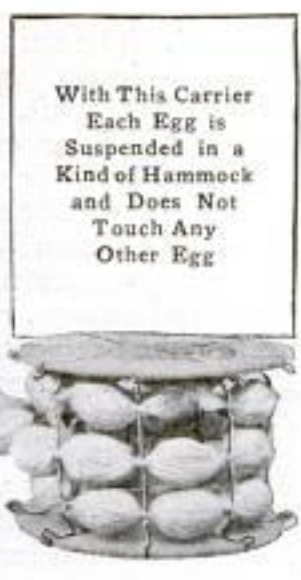

With This Carrier Each Egg is Suspended in a Kind of Hammock and Does Not Touch Any Other Egg

is that each is carried in a kind of hammock and does not bear against any other egg. When the holder is filled it is inclosed in a solid case and is ready for shipment.

SINGLE-RUNNER SLED IS A COASTING NOVELTY

With surprising ability for maintaining equilibrium, a one-runner sled has been patented, which, it is said, is Pat. 1026023 - May 14 1912. *Magdalena Dierer and Charles Fredolin Urban, Milwaukee, Wis.*



"Urban Mono-Runner"

A One-Runner Sled Which Attains Great Speed

able to develop a greater speed than the usual coasting device. In shape it is roughly triangular with curved ends. The seat is supported by mountings braced against the running bar, while a foot rest is provided near the vertex of the angle. Owing to the fact that there is less resistance with one runner than with two, speed is gained quickly. The sled is able to take curves while racing at great velocity with almost the same ease as a motorcycle. The posture of the rider is similar to that of a cyclist.

The plans for land defenses in the Canal Zone contemplate the construction of field works in certain localities. In front of these the land will be cleared sufficiently to cover the range of musket fire. Trails will be built connecting the land defenses with each other.

*3907
May 1917
p. 730
same*

*Inter. News Service
200 Williams St., N.Y.C.*

Made by the Hammock Carrier Corp., Syracuse, N.Y.

MAKING OUR MILITARY AIR FORCES

8612 H

THE SECRETARY OF WAR SAYS:

THE immediate plans of the War Department contemplate the training of sixty officers and two hundred and sixty enlisted men added to the aviation section of the Signal Corps; the organization and equipment of the aero squadrons that the above-mentioned officers and men will supply; the establishment of aviation centers for their stations; the permanent establishment of the Signal Corps Aviation School at present located near San Diego, California; the establishment of an experimental laboratory and shops for the development of new types of machines, and the creation of a reserve for the personnel of the flying corps.

"Its future plans will depend upon the results obtained from carrying out the above projects and the lessons of experience taught by the present war in Europe. In order to carry into effect the plans now on foot, it will be necessary to have adequate appropriations and it is felt that Congress will always be ready to vote such sums as may be necessary. The subject of lighter-than-air machines is being given careful study, and the department's projects will be carried out when occasion demands. It is the intention of the department to develop the aeronautic arm of the service to an extent commensurate with the needs of the army, and it bespeaks for its projects the interest and support of the public.

"In considering this whole question of aviation in connection with the army, it should constantly be kept in mind that material without trained personnel is worse than useless. If we were to ask and receive appropriations for more material than we could usefully man, we would not be acting the part of wisdom. Our purpose is to train personnel as rapidly as possible, consistent with safety, and to ask Congress from time to time for appropriations for as much material as we can properly handle."

—Lindley M. Garrison, Secretary of War.

IN view of the renewed public interest in aviation due to recent military developments in Europe, this magazine undertook to ascertain exactly the conditions that exist in our own army and navy regarding aviation, and with the cooperation of the Secretary of War and the Secretary of the Navy is able to present here for the first time a complete and comprehensive statement of just what the situation is, just what developments are under way, and just what plans the officers in charge of this work in both arms of the service have for the future.

The United States Army now has 11 aeroplanes. All of these are biplanes, the oldest of which was delivered in January, 1913, and the newest, Sept. 21, 1914. Reliance has been placed solely in this type of machine because of the belief that it is superior to the monoplane for war purposes, a decision the wisdom of which, it is now considered, is being proved by current events. The "pusher" type of craft has recently been abandoned in favor of the tractor, which will be the design of machines hereafter purchased for this arm of the service. None of the

biplanes is equipped with either wireless or guns, although this could be easily done. Various stabilizing devices are being experimented with, but so far no army aeroplane has been fitted with such an apparatus. Tests have been made with several bomb-dropping devices and at least one has been adopted. The same is likewise true of guns designed for defensive work against air craft, while none of the troops has been equipped with them.

Thirty-five officers of the army have qualified as military aeroplane pilots. No enlisted men have so qualified, although eight are under instruction. So far, five hangars, or military aero stations, have been established by the War Department. These are located at San Antonio, Texas; San Diego, Cal.; Fort Kamehameha, H. I.; Manila, P. I., and Fort Leavenworth, Kan. Since aviation was instituted in the army in 1908, 13 army airmen have been killed in accidents. During the same period experiments have been conducted with dirigibles, and military authorities announce that these will be continued in the future. This form of craft, however, is not looked upon with a great

*J. C. McTearty got signed statements
from secretaries*

ADEQUATE FOR THE NATION'S NEEDS

THE SECRETARY OF THE NAVY SAYS:

"WHILE an American discovered the principle of flying heavier-than-air machines and demonstrated the success of aviation, our own country has not made the progress of some European countries in utilizing the fruits of this marvelous invention. I have urged upon Congress the importance of providing an adequate aeronautical division for the navy. An aeronautic station and flying school for officers and men has been established at Pensacola, and the 'North Carolina' has been designated the aeronautic ship of the navy. We are but on the threshold of the development and utilization of air craft, and their steady increase on a large scale is a fixed policy of the department.

"The department contemplates the purchase at an early date of two small dirigibles for experimental purposes and 32 aeroplanes from American manufacturers. It is to be regretted that conditions in Europe have made it impossible to obtain foreign-built aeroplanes to study their construction and equipment. The best types of American makes have been ordered, but home manufacturers have not been able to supply the navy's demand for air craft of the most approved design. They have confined their efforts almost entirely to machines for land flying and have not completely developed the manufacture of hydro-aeroplanes.

"It has always been the policy of this country to put great dependence on its militia, and it is most gratifying to the department to be able to accept the offers from a large number of skilled private aviators who have volunteered their services in case of necessity."

—Josephus Daniels, Secretary of the Navy.

deal of confidence by army authorities. The chief signal officer declares that it is doubtful whether the dirigible is worth its cost for offensive operations, while for reconnaissance or defense it is apparently of much less value than the aeroplane. Its value as an observation station is considered great under circumstances which prevent its destruction by the fire of the enemy, or by hostile aeroplanes. The general feeling, though, is that the dirigible requires so many favorable conditions for valuable operation that its worth for land operations, in comparison to its cost, is questionable.

"Why," it is often asked, "does not the War Department organize an aeroplane militia, or at least make arrangements for the use of the scores of privately owned aeroplanes in case of war?" The army's reply is emphatic and interesting. According to the officers who have studied the subject, the majority of privately owned machines are nothing more than toys, and dangerous ones at that. The lack of sufficient lifting power, speed, and stability renders them unsuitable for military purposes. It is therefore up to the

army to develop its own air craft. Private manufacturers are not building machines suitable for military purposes. When the United States Army last summer announced an offer of prizes totaling \$30,000 to manufacturers who would develop, according to set specifications, biplanes suitable for military purposes, only one machine meeting the requirements was submitted.

This, briefly, is the status of America's preparedness for aerial warfare so far as the army is concerned. As compared with the aeronautical establishments of the great military powers of the world, this country's condition might be considered by the lay mind pitiable as well as alarming. Great Britain has, according to the latest figures in the hands of the Navy Department, 900 aeroplanes and 12 dirigibles; France, 1,400 aeroplanes, 30 dirigibles; Germany, 1,400 aeroplanes, 60 dirigibles; Russia, 1,000 aeroplanes, 2 dirigibles; Austria-Hungary, 600 aeroplanes, 8 dirigibles; Italy, 300 aeroplanes, 4 dirigibles; Belgium, 60 aeroplanes, no dirigibles; and Japan, 20 aeroplanes and 2 dirigibles. In considering the difference in the conditions



Some of the Officers and Men of the Newly Organized Aviation Section of the United States Army
Where Government's New

bearing upon the development of this branch of our army with those in the armies of Europe, however, the progress has been greater than is apparent. The organization of an aerial service by the War Department could not be undertaken without enabling legislation and appropriations by Congress. Until July 18, 1914, no such authority was given. At that time, however, an act was approved which increased the army by 6 officers and 260 men for aviation. Under this new law developments have been rapid.

The army aviation section is a part of the signal corps, to which is assigned the duty of training officers and enlisted men for the service. With certain exceptions, aviation officers are selected from among those holding commissions below that of captain. They are rated in two classes, "military aviators" and "junior military aviators," and all men on aviation service receive increased pay.

Before such men qualify for these positions, however, they must pass severe examinations. These are made to show their fitness not only as airmen, but also their understanding of meteorology and topography. They must know how to take care of their machines, how to dismantle and assemble motors, and also show a thorough knowledge of all engines in use at the stations at which they are detailed. The tests to which they have been subjected in the past have been much more difficult than those made by the Aero Club of America before granting a pilot's license. Despite this,

however, new and even more difficult requirements are being prepared at the present time.

The formation outlined for the first aerial squadron of the United States Army consists of a squadron headquarters and two companies. The commissioned personnel of the headquarters consists of a major, commanding the squadron, and a captain or lieutenant. Each aero company is commanded by a captain, while there are eight other commissioned officers ranking from lieutenants to captains. The total formation consists of 20 officers, 90 men, 8 aeroplanes, 16 motor trucks, and 6 motorcycles. As yet the organization of this squadron has not been completed. The plans of the War Department contemplate equipping it fully, first, and then making further developments as rapidly as appropriations will permit. For doing this, the army has at the present time the unexpended balance of an appropriation of \$250,000 allowed by Congress for the fiscal year ending June 30, 1915.

There are 15 aeroplanes in the aerial service of the navy. All of these are biplanes, the oldest of which was purchased four years ago, and the newest, the new Burgess-Dunne tractor, acquired late last fall. None of these machines is fitted with guns, but provisions have been made for thus equipping them in the event of necessity. A special gun for this purpose is now being developed. Wireless apparatus, although not regularly installed, is now being experimented with. The same is essentially true concerning stabilizing

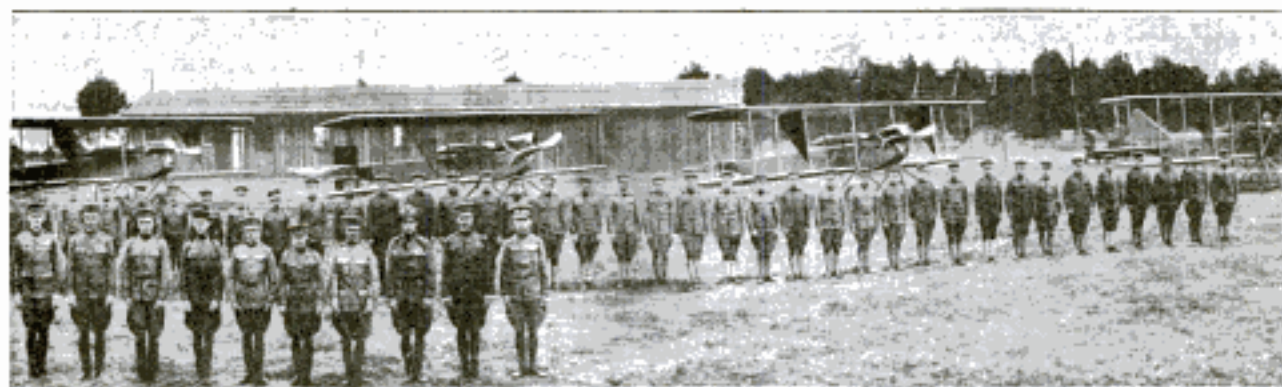

States Army Photographed at the Military Aero Station near San Diego, California,
Air Craft are Tried Out

devices. What is termed a very good type of gun for attacking air craft has been developed and proved successful in tests made against aerial targets. There are 16 officers who have qualified as fliers, but, as in the army, no enlisted man has passed the tests admitting him to the service, although several of them are being instructed. Only two officers have been killed in aeroplane accidents. Experiments have been made with different kinds of bomb-dropping devices, but none has been adopted for regular use. The Navy Department in this connection states that the effectiveness of bombs thrown from an aeroplane is still a matter of doubt on account of the small amount of weight that such a craft is capable of carrying. The only naval aeronautic station is situated at Pensacola, Fla.

No experiments have been made with dirigibles. The navy, however, is now in the market for at least two such craft of minimum displacements of 75,000 cu. ft. American manufacturers have been asked to submit plans, specifications, and estimates on balloons of the general type of the Parseval, Astra-Torres, or other European dirigibles of the nonrigid type, to be built in this country. For naval purposes this type is preferred to the Zeppelin, or rigid, style. These airships are intended to be used in training American seamen in this phase of aerial navigation, and for general experiments. The department has funds available for the immediate purchase of such machines and is willing to enter

into any reasonable plan to assist domestic companies to supply its wants.

Like the army, the navy has received very little help from American manufacturers in developing aeroplanes suitable for war purposes in its arm of the service. While it has been extremely difficult for the army to find aeroplanes meeting its requirements, it has been even more difficult for the navy. Nearly all flying boats so far produced in this country have been designed for use on inland waters and are not suited for sea service. Therefore, the navy, like the army, is now confronted with the task of developing its own machines.

What it will be able to do in carrying out its plans for the future depends entirely upon appropriations being made by Congress. There is now no specific appropriation available. There is an allowance, however, of about \$350,000, which has been made up from the various bureaus, available for acquiring and equipping air craft. The expenses for maintaining and repairing the machines already in service, however, must be borne also by this fund. The General Board of the Navy, of which Admiral Dewey is chairman, has recommended that an appropriation of \$5,000,000 be approved for the purchase of air craft for this arm of the service. With the money now on hand, it is hoped to purchase within a very short time 32 new machines. This depends entirely upon the ability of American manufacturers to develop a type of machine satisfactory for ordinary conditions at sea. The Navy De-

partment does not now contemplate manufacturing its own machines, although it is doing a great deal of experimental work at the Washington navy yard and at Pensacola, Fla. At the former place model machines are tested in an air tunnel to ascertain their characteristics of flight, while floats, or pontoons, are tested in a model basin. In this way valuable information is being collected with which it is expected that, within a short time, it will be possible to formulate specifications and invite American manufacturers to supply machines for the navy.

A reserve aviation corps for the navy has been organized on paper. Several private airmen have volunteered their services, and a list of these men is kept by the department. In case of war, this reserve corps could be put into service. A further plan has been drawn up, however, establishing an aerial service in the naval militia. All the men in this service will be drilled in the same course of instruction as is given the regular naval airmen and organized under the same regulations.

Congressional inactivity and the inability, or lack of enthusiasm, of American manufacturers of motors have been the main factors in hampering the development of military aviation in this country. It has seemed

almost hopeless to depend upon the United States to build adequate motors for aeroplane use. Because of this, it was necessary for both the army and navy to purchase motors abroad. While these have given excellent service, the signal corps now finds itself in the embarrassing position of being unable to obtain extra parts for these engines, on account of the conditions existing in Europe. It is equally difficult to have parts for foreign-made engines constructed in this country, since the metric system of measurement is used almost exclusively on the continent, while, of course, no new foreign-made engines can now be obtained. The chief signal officer of the army in his annual report asserts, however, that the present outlook for obtaining suitable motors here is more encouraging than it ever has been. It is stated that at least one American-made engine now will compare quite favorably with those produced in Europe. It is believed it will naturally follow that the increased demand for American motors, a thing now assured, will result in their further development, and that within the next year or two the aerial defenses of the United States, the parent nation of aviation, will be made sufficiently extensive and efficient for the country's needs.

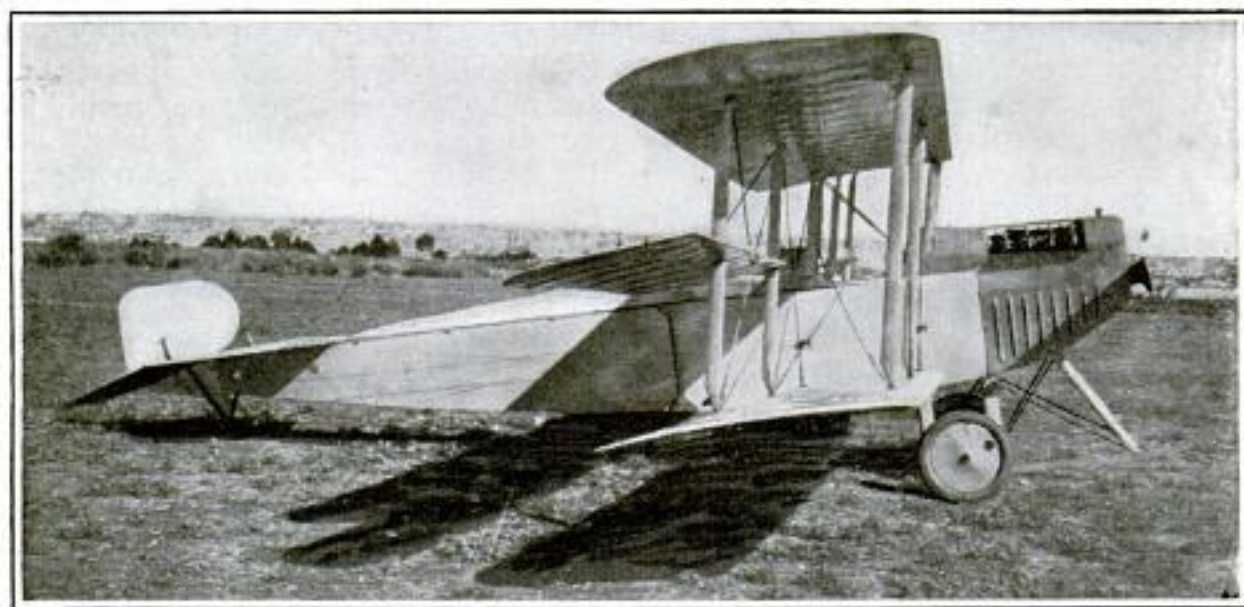

The New Curtiss Military Tractor Biplane, the Only Machine That Came Up to the Army's Specifications in the San Diego Tests

Don W. Lusk, % Inde-
pendent Pub. Cos., 212
Yankie St.,
Silver City, N. Mex.

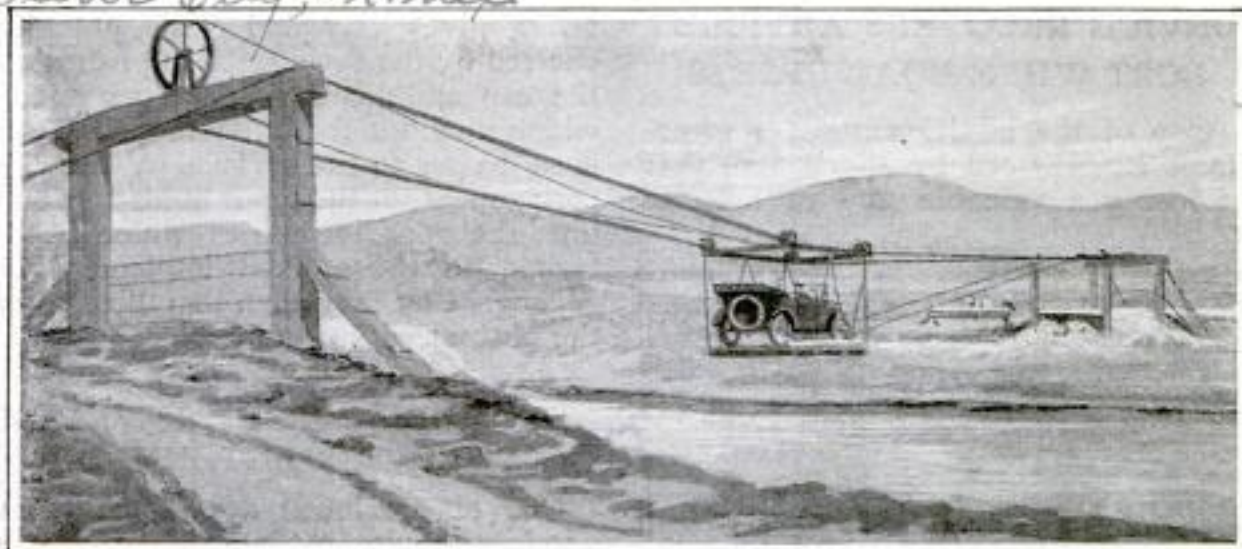

This Cableway, Built by a Farming Company across the Gila River in New Mexico, Is Capable of Carrying the Heaviest Motor Trucks

AERIAL TRAMWAY ACROSS 8808 GILA RIVER

An aerial cableway capable of carrying automobiles and the heaviest motor trucks has been built by a ranch company across the Gila River in New Mexico, a stream that is dangerous at all seasons of the year because of frequent floods and treacherous quicksands. The cableway consists of two steel bands, each 670 ft. long, 5 in. wide, and $\frac{1}{2}$ in. thick, and having a breaking strength of 120,000 lb. The main span of the cableway, across the river, is 340 ft. The steel bands are spaced 8 ft. apart and are 14 ft. above the water. From these cables is suspended a platform, 18 ft. long, capable of carrying 20,000 lb. with safety. This platform is suspended by four flanged wheels, two of which run on each of the steel bands, and is propelled by an endless steel cable driven over a series of grooved wheels operated by a horse sweep. The time required for carrying a load across the river is approximately three minutes.

Speaking before a meeting of coal operators in England, an expert recently expressed the opinion that owing to the constant increase in the cost of mining, the days of cheap coal are past and can never return.

SIGNS REGULATE VEHICLES 8407 IN CITY STREETS

"Safety-first" traffic signs have been placed along the business thoroughfares of Los Angeles, Cal., on which



A "Safety-First" Sign in a Los Angeles Street

there are surface traction lines, in order to regulate motor cars and other vehicles at points where passengers are taken aboard and discharged by street cars. The signs are placed far enough from the street intersections so that they stand several feet back of a street car when it stops at a crossing. Vehicles are compelled by ordinance to remain in the rear of the signal as long as a car is stopped at a crossing.

Herbert Bachenberg
Box 804 R#5
Los Angeles, Cal.

**DEVICE RECOVERS ARTICLES
LOST WHEN BOAT UPSETS**

8214 H

One of the unpleasantnesses sometimes experienced by sportsmen, that of losing a valuable gun or favorite

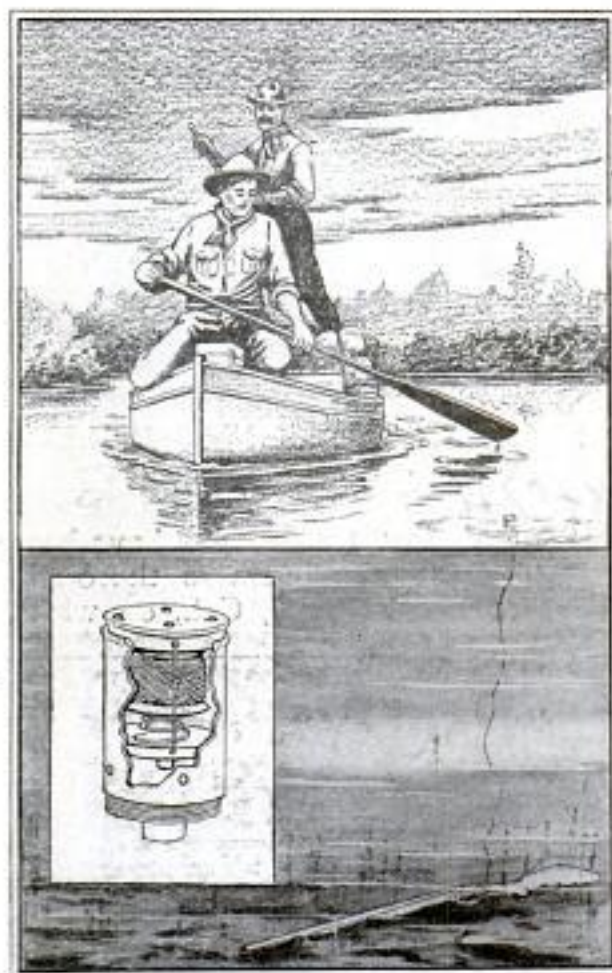

A Gun Dropped in a River may be Saved If It is Fitted with This Restorer

fishing rod in the water, is eliminated through the application of a simple mechanical device which has recently been patented. With it an article which drops to the bottom of a lake when a canoe unexpectedly capsizes may be restored in a few minutes' time. The instrument is made of brass, is cylindrical in shape, weighs 2 oz., and may be screwed to the end of a fishing rod or clamped to a gun so that it is not cumbersome. Its mechanism consists of a strong spring, a cork spool carrying from 40 to 75 ft. of silk line, and a perforated cap which is held in place by a fiber cord. Within a few seconds after it is submerged in the water, the fiber

string gives way under the pressure exerted by the spring. This pushes off the cap and liberates the cork spool, which unwinds the line wrapped about it as it rises to the surface. When the cork appears at the top it holds a strong line, the opposite end of which is attached to the sunken implement or package, that may then be pulled from the bottom without difficulty.

**AUTOMOBILE TOP SERVES AS
WIRELESS ANTENNAE**

8576

One of the latest developments in wireless telegraphy in warfare, which consists in converting the stripped wires of an automobile top into antennae for a telephone apparatus carried on the car, was brought to light recently when a British patrol captured a German touring car in Belgium. The engine had broken down, and the two German officers in the car were made prisoners. The raised top consisted only of the wire skeleton, and in glancing over the car one of the patrol noticed that a wire led from this to a point under one of the seats. At the end of this wire was a telephone receiver, and when this was placed to the ear messages could be distinctly heard coming from the headquarters of the army corps to which the German officers belonged.

**ENORMOUS DOORS FOR BANK
VAULTS**

Two of the largest bank-vault doors ever built have recently been made for banking institutions in New York City and Toronto. The door for the New York institution cost \$75,000, while the total cost of the door and vault will be about \$200,000. Door and vestibule together weigh 120 tons. This door is made of armor plate, the same as used in the construction of modern battleships, and will withstand drilling, sledging, wedging, and even a cannon shot. It is 9 ft. in diameter and 45½ in. thick, and is locked by twenty 5-in. plungers. So great is the precaution against both robbery and the danger of

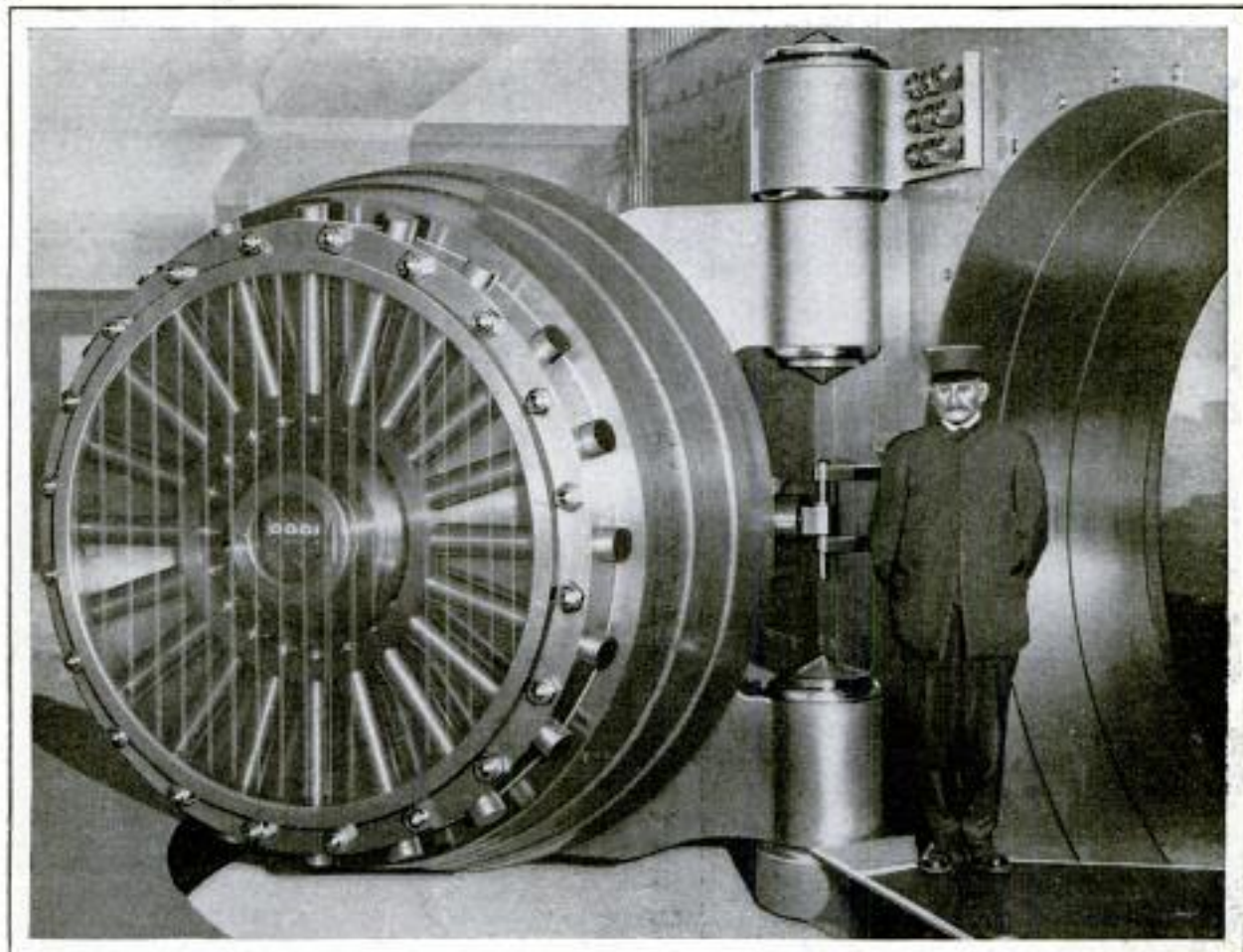

Door and Entrance to Safety-Deposit Vault of Bank in Toronto, Canada

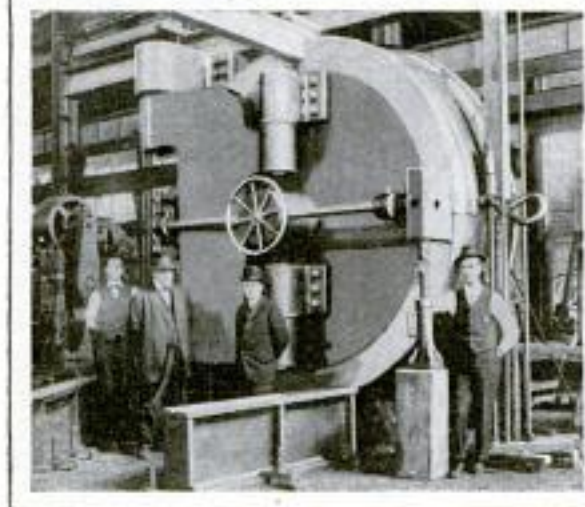

Vault Door Made for New York City Banking Institution

lockout that the plungers are controlled by combination locks, which in turn are controlled by a time lock having four movements, any one of which will permit the opening of the combination locks. This massive door swings on a crane hinge and is operated by a mechanical pressure apparatus. When closed, it is air-tight and water-tight, so that there is no possibility of intro-

ducing a liquid explosive for blowing open the door. The vault is three stories high, and is so solidly built that if the building should collapse, the vault would remain intact.

The vault in Toronto is one of the most strongly built vaults in the world. It consists of a hollow cube made of hardened steel and cement, and measures 30 ft. in each direction. This vault has two stories, the upper story being for the use of the public as a safety-deposit vault, and the lower story for the storage of the bank's currency and securities. A floor of solid steel separates the two stories. The vault is guarded by circular steel doors, 10 ft. in diameter, 4 ft. thick, and weighing 41 tons, which are opened and closed by electric motors. When all the precautionary devices are set, three different alarms are sounded by the slightest tampering with the doors, one of these alarms being located outside of the building.

LAUNCHING A FLYING BOAT FROM A SHIP'S DECK

8606

Various methods, none of which has proved satisfactory in case the ship is rolling or pitching, have been tried for launching a flying boat from the deck of a ship, and for taking the air craft on

board after a flight has been finished. A recent English invention apparently solves the problem. The apparatus consists simply of a floating pontoon with a submerged launching way and connected with the ship by a bridge that is equipped with rollers over which the flying boat is drawn by cable to the deck, or let down to the pontoon. The bridge is hinged both to the pontoon and to the ship, so that the pontoon moves freely with the surface of the water, regardless of the rolling or pitching of the ship, or the roughness of the water. The entire apparatus is so designed that the sections can be disconnected, hoisted on deck by derricks and stowed away on board the ship.

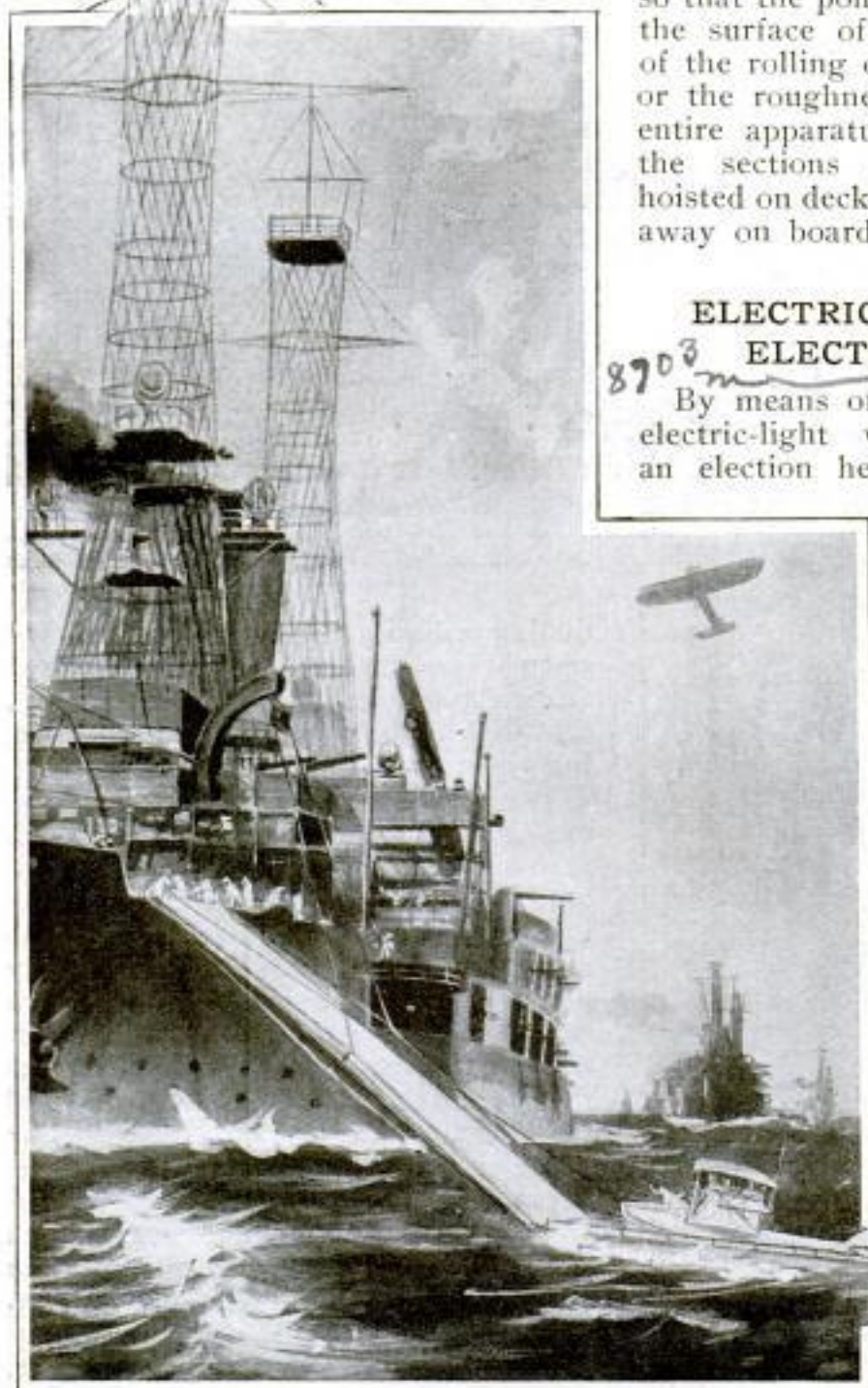

This Floating Pontoon, Connected with the Ship by a Hinged Bridge, is a New Invention for Launching or Taking on Board Flying Boats

ELECTRIC LIGHTS WINK

8703

ELECTION RESULTS

By means of signals sent over the electric-light wires, the results of an election held in St. Louis were flashed into 50,000 homes and practically all the theaters in the city within five minutes after the vote had been counted. These signals consisted of a code of "winks," or flashes, the meaning of which had been made known in advance, and which were produced by opening and closing the switches in the substations. In this way several hundred thousand persons were informed in less than five minutes that a \$2,750,000 bond issue had been passed, to finish the municipal free bridge that had been costing the city about \$490 a day in interest.

Wm. J. Rice, 3501
Washington Blvd.,
St. Louis, Mo.

Saul Verkin, 1922 Avenue M^{1/2} Galveston,
884¹⁵
m Texas

FIREMEN MAKE THRILLING LEAP FOR LIFE

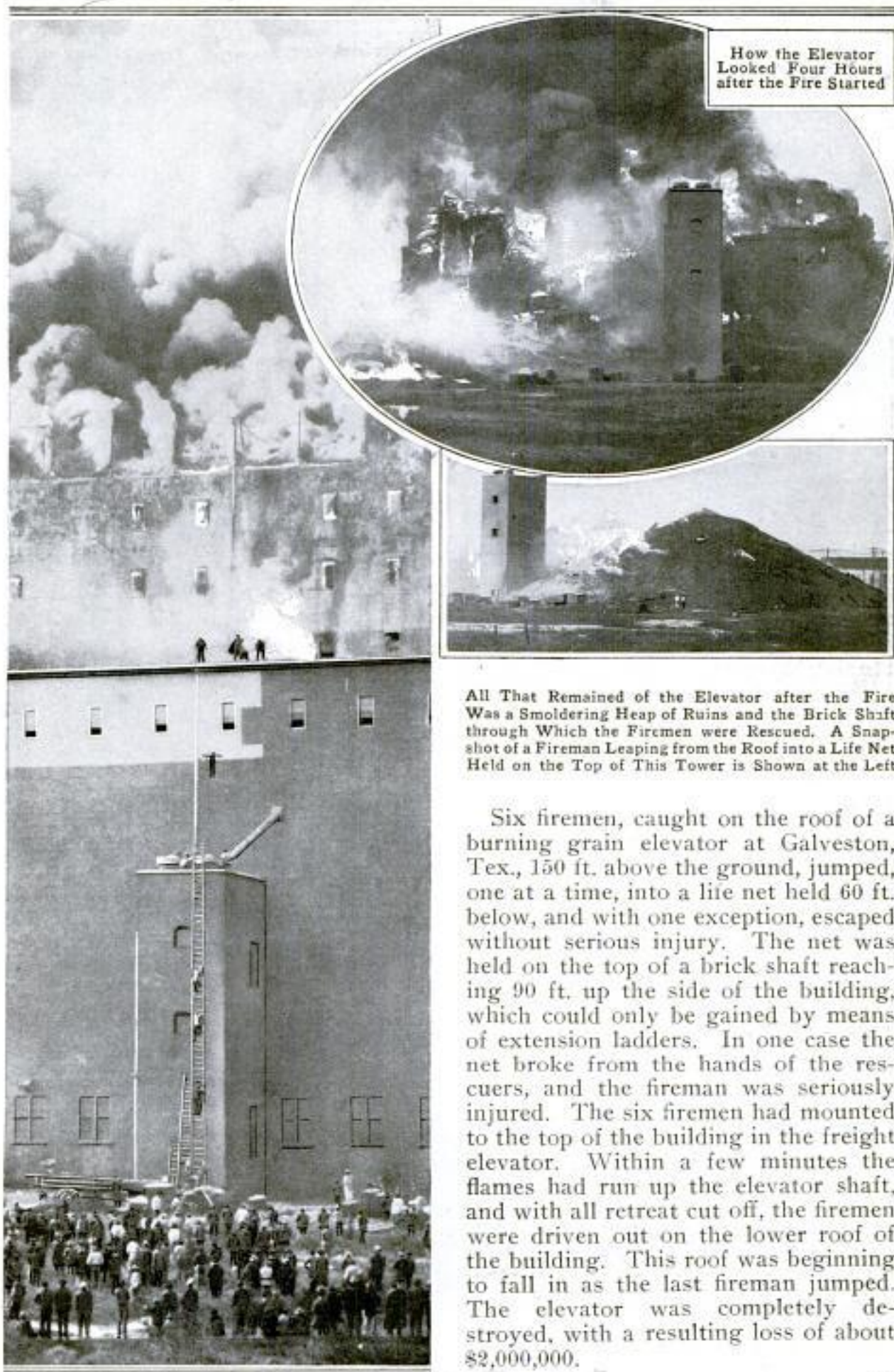

How the Elevator
Looked Four Hours
after the Fire Started

All That Remained of the Elevator after the Fire Was a Smoldering Heap of Ruins and the Brick Shaft through Which the Firemen were Rescued. A Snapshot of a Fireman Leaping from the Roof into a Life Net Held on the Top of This Tower is Shown at the Left

Six firemen, caught on the roof of a burning grain elevator at Galveston, Tex., 150 ft. above the ground, jumped, one at a time, into a life net held 60 ft. below, and with one exception, escaped without serious injury. The net was held on the top of a brick shaft reaching 90 ft. up the side of the building, which could only be gained by means of extension ladders. In one case the net broke from the hands of the rescuers, and the fireman was seriously injured. The six firemen had mounted to the top of the building in the freight elevator. Within a few minutes the flames had run up the elevator shaft, and with all retreat cut off, the firemen were driven out on the lower roof of the building. This roof was beginning to fall in as the last fireman jumped. The elevator was completely destroyed, with a resulting loss of about \$2,000,000.

C. L. Vandergriff
1421 Prospect Ave.,
Kansas City, Mo.

**IRON CROSS CONVERTED INTO
MARBLE SYMBOL**

8636 m

An iron cross in a cemetery at Kansas City, Mo., known locally for

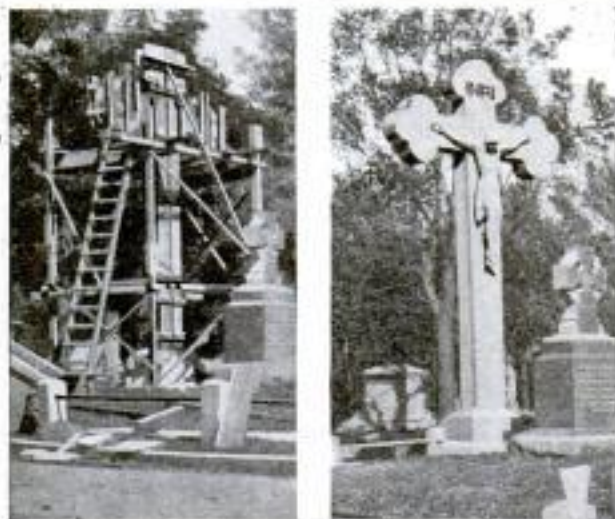

"The Black Cross" with the Form in Place for Molding the Marble Concrete

How the Cross Looks after Its Transformation into a Marble Monument

many years as "The Black Cross," has been converted into a marble cross by the simple expedient of covering it with concrete made from crushed marble. Even in this age of concrete building a monument of this kind made with a "form" instead of a chisel is unusual

enough to merit attention. The form used in molding the concrete was set up around the iron cross, which now serves simply as reinforcement. After the form was removed the surface of the concrete was buffed and polished so that even on close inspection it has the appearance of chiseled marble. It measures 15 ft. high and 12 in. thick, and is 6 ft. wide at the cross and 2 ft. wide along the shaft. The figure carried by the cross is sculptured from a solid piece of white marble and is held in place by iron spikes.

**MOTORCYCLE DRIVEN ALONG
PERPENDICULAR WALL**

8853

Going at a speed of from 75 to 85 miles an hour, a motorcyclist succeeded in driving his machine around the perpendicular wall at the top of a motordrome. This is a regular amusement-park feat for automobiles, but is seldom attempted with a motorcycle, since the machine must be driven at terrific speed and must stand out almost horizontally from the wall. It is a good example of the power of centrifugal force, as well as of the skill and nerve of the driver.

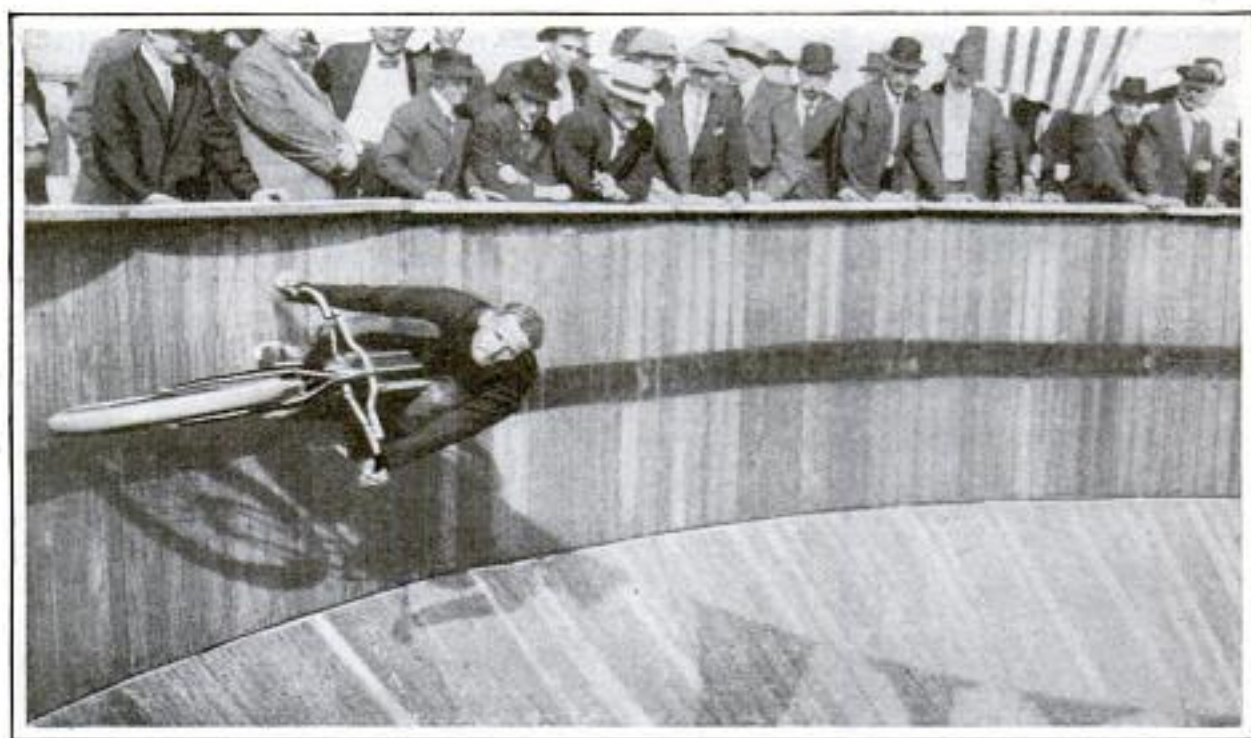

This Remarkable Feat could Only be Performed with the Motorcycle Going at a Speed of from 75 to 85 Miles an Hour

J. H. Blaine, General
Delivery, San Diego, Cal.

Francis J. Dickie
 17-18 Hanover Blk.,
 Bellamy St.,
 Edmonton, Canada



Land Office and the Rude Shelters the Homesteaders Occupied during Their Long Wait for a Chance to File on Canadian Land

The Men at the Right of the Door Waited Eight Months in Order to Hold Their Turn

CANADIANS WAIT LONG TO FILE ON LAND

8458 m

What is believed to be the longest wait in history for a chance to file on public land has just been completed at Grouard, Alberta, Canada, where a few valuable tracts of government land were assigned to homesteaders. The land was given out in the order of priority at the land-office door, and some of the men camped in front of the land office for eight months in order to hold their turn, sleeping in rude shelters through the greater part of the Canadian winter, and taking their regular positions at the door each day. This method of allotting land is somewhat like that employed in the United States before the system of drawing by lot to determine priority was established, when all applicants were lined up half a mile from the land office and started by a pistol shot on a race for the door. The Canadian land regulations recognize only the right to priority as determined by a man's position in the line at the time of the allotment, but the principle that the first on the ground shall have first place in the line is so well recognized by the men throughout western Canada that a newcomer trying to break in ahead of his turn would be sure to receive drastic treatment.

DOG PICTURE FORMED BY GRAIN OF WOOD

8704 m

When a workman had finished cutting a strip of veneer from a log of black ash, he was surprised to find a "dog" in it, the dog in this case consisting of an arrangement of grain and color that formed a very good representation of the head of a bull pup. This was photographed just as the saw



This Interesting Picture of the Head of a Bull Pup Is Due to the Natural Arrangement of the Grain in a Strip of Black-Ash Veneer

had left it, and the result was the animated and intelligent-looking portrait shown in the illustration.

A method for detecting minerals in flour and drugs by means of X-rays has been developed by an Italian inventor.

C. D. Eckstein, 1903 Wood & Paper

HOW THE FRENCH COLONISTS DEFENDED PAPEETE

Shortly after the opening of the European war, Papeete, the principal town of Tahiti, one of the French islands of the Society group, in the South Pacific, was bombarded by two German cruisers and partly destroyed. The photographs of the results of the bombardment, published herewith, were accompanied by a detailed account of the assault, written by a French photographer who took part in the defense of the port. Because of the interesting and direct way in which his story is told, it is printed here without change.

"Bombardment of Papeete, Sept. 22nd. '14.

"6 P. M. Regular soldiers and soldiers of the reserve went to the casement as usual, and were sent home very early on account of the rain.

"7 A. M. Everything was very quiet, we were glad to be free once more. All at once the signal gun fired. We rush to the casement and heard that two cruisers were in sight having no pavillon [flag]. The atmosphere was dull. Our battery fired two shots in order to ask the pavillon. The answer was a shell and the German vessels raised up their pavillon. We were joking on the ranks, thinking it was English or Japanese vessel. When we heard the shells above our head we got anxious. It was the two largest German cruisers of the Chinese division, Scharnhorst and Gneisenau, 11,600 tons each.

"They opened fire and asked the town to surrender. The Commandant Destremeau answered by signal No we shall not and ordered to set fire to the coal. After a few minutes a thick smoke indicated the German the coal was burning and there was no chance for them to renew their provision. They got mad and set fire on the town who quickly set in fire. They tried to shot the battery without success. The French sailors started to open the watergates of the French gun boat Zelée who was disarmed in the harbor closed to the wharf. The German

help the work in sending some shells to the boat. We did the same thing to the captured German cargo boat Walkure and they gave us the same help.

"It is a miracle if we have not been all killed as we were sheltered only by some wood houses. Fortunately the German could not see the town all covered with trees. Greater damage might have been done. Women, children and natives fled away. After three hours gunning we saw the two cruisers going away thinking very likely the whole town was in fire. When we saw they were not shooting any more we started against the fire and after some hours heavy work we mastered it. Owing to the rain and the absence of wind the town could be preserved. If the German had gone on shooting and the wind blowing everything would have been destroyed. We have been very lucky to save our place from being German and to lose only two lives, one Chinaman and one native. About 100 to 127 shells were shot. Some say more."

STOPPING DISTANCES FOR AUTOMOBILES

8412
Experiments made in New York for determining the shortest distances in which an automobile can be stopped when running at different speeds show that every increase of 50 per cent over 20 miles an hour increases the distance required for stopping over 100 per cent, and that a car running 40 miles an hour will go more than four times as far, before it can be stopped, as a car running at half that speed, or 20 miles an hour. The tests were made with a 50-hp. car with brakes in perfect working order. At eight miles an hour, the car was stopped within 6 ft., while at 15 miles an hour, 15 ft. of distance was required. A space of 25 ft. was required for stopping with the car going at 20 miles an hour; 53 ft., at 30 miles an hour; 87 ft., at 35 miles an hour, and 103 ft., at 40 miles an hour.

American
The Motorist, Sept. '14

437-5th St.

Ref. to A.S.C.A. N.Y.



Above: Section of Papeete's Principal Business Street Still Smoldering from the Fire Caused by German Shells

Below: The German Steamer "Walküre," a French Prize of War, Sunk by German Shells in Papeete Bay during the Assault

The "Walküre" Captured by French Gunboat



Town Market Place Cut to Pieces by the German Shells

Below: The Chinese Quarter of the Town Suffered Severely from the Attack. Its Buildings Were in the Line of Fire and Hardly a Wall was Left Standing When the German Cruisers Put to Sea



J. W. Lee, Jr., Machinery Agent,
Penn. R.R. Co., Broad St.
Station, Phila., Pa.

**BRIDGE ROLLED INTO PLACE
IN ELEVEN MINUTES**

8696 H

Rolling into place a three-span steel bridge, having a total length of 720 ft. and weighing 7,000,000 lb., and finishing the job within 11 minutes without interfering with traffic, was the feat accomplished recently at Tyndall, Ohio, when a permanent bridge was installed for the Pennsylvania Railroad over the Muskingum River to take the place of the one washed out in the big flood of 1913. The new bridge consists of three truss spans, each 240 ft. long, which were built across the river on a line 45 ft. downstream from the permanent line of the railroad. The interesting feature of the work was the method used for moving this structure to its final position. As soon as the new spans had been put together, traffic was diverted to the bridge in its temporary position, and the old repaired structure was removed. When all was ready, the three spans were shifted as one structure with ties and

rails in place, being rolled into place on 2½-in. steel rollers resting on rows of 85-lb. rails. Power was supplied by two derrick cars equipped with hoisting engines, which were placed end to end on the middle span and anchored. From each of the four drums of the hoisting engines steel-wire cables were led through a series of sheaves attached to various points on the spans and anchored to "deadmen" at the upstream ends of the piers and abutments. An ingenious indicator, made of piano wire, pulleys, weights, and a scale graduated to feet and inches, in plain sight of the person directing the operations, served as a guard against one span being moved faster than the others. The actual moving required less than seven minutes, while the tracks were disconnected for a period of only 10 minutes 17 seconds.

**HUNDRED-FOOT STANDARD
CAREFULLY GAUGED**

8831 H

Under the supervision of the United States Bureau of Standards, a 100-ft. length standard has been installed in the city hall at Chicago for the use of those who have occasion to compare or rectify the graduations on steel tapes, or other long instruments of measurement. It is one of the very few such rods in existence in this country, and is claimed to be the most nearly accurate of any.



The New Bridge, 11 Minutes Later, with Train Running over It

The New Bridge Complete and Ready for Moving

Western Society of Engineers - Chicago

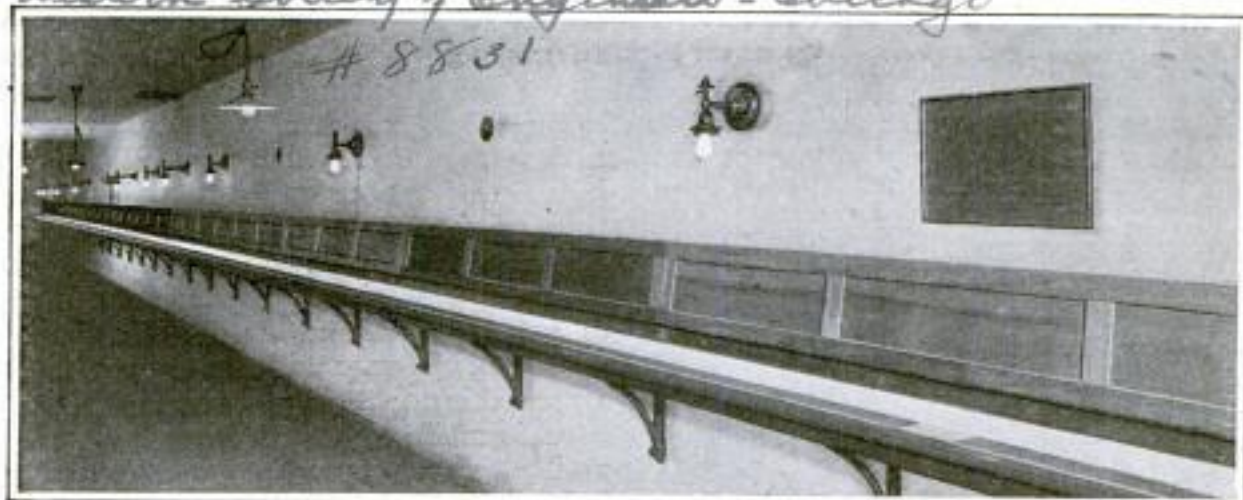

This 100-Foot Length Standard Agrees More Nearly with the Standards at Washington Than Any Other in This Country

The rod, which is made of steel, is 102 ft. long, 2 in. wide, and $\frac{1}{2}$ in. thick. To facilitate its installation, it was originally made in six sections, which, when placed in the room especially designed for the standard, were welded together by the oxyhydrogen process. It rests on rollers which are fixed to wall brackets allowing perpendicular adjustment, so that the top surface of the rod is secured in a level plane. Cylindrical disks of a platinum-iridium alloy were inserted flush with the surface of the rod, to carry the graduation marks, at zero, 1 ft., 1 yd., 1 meter, 10 ft., 25 ft., 50 ft., 66 ft., 20 meters, and 100 ft. At the zero end a clamp is provided to grip one end of the line to be tested, while at the opposite end is a spring balance that exerts a pull of a desired number of pounds upon the tape.

The extreme accuracy of the rod is indicated by the Bureau of Standards certificate, which shows that the error of the 100-ft. interval at 83° F., reduced to 62° F., amounts only to $+.002$ in., while the intervals of 25 ft., 50 ft., and 30 meters are absolutely exact with the standards at Washington. The rod was presented to the city by an engineering society. A record of every comparison made is kept by the map department of the city.

To prevent its exportation, the Russian government has placed an embargo on lumber.

MAN'S WEIGHT IN BULLETS

8818 TO KILL ONE MAN

In spite of the efficiency of modern weapons it is estimated that the average weight of bullets required to kill one man in the present war is something like 168 lb. This is a little more than the weight of the average man himself.

NEW PORTABLE ELECTRIC TOASTER STOVE

A portable electric stove designed for toasting, frying, and grilling, and small enough to be used on a dining table, is arranged so that two pieces of bread can be toasted at one time, one being placed on the top grating and the other in the grill pan below the heating element. For frying, the pan is drawn out and placed on the grating, the body being so designed



Portable Electric Stove of New Design

that the pan covers the entire top surface. The stove is equipped with a grid which fits into the pan and is used for grilling.

The Putnam Electric Co.
Logansport, Ind.

The American Boy - October 1914
MINE CANARIES REVIVED
 8422 **WITH OXYGEN**

Owing to the fact that canary birds are extremely sensitive to the effects of carbon monoxide, the deadly "white

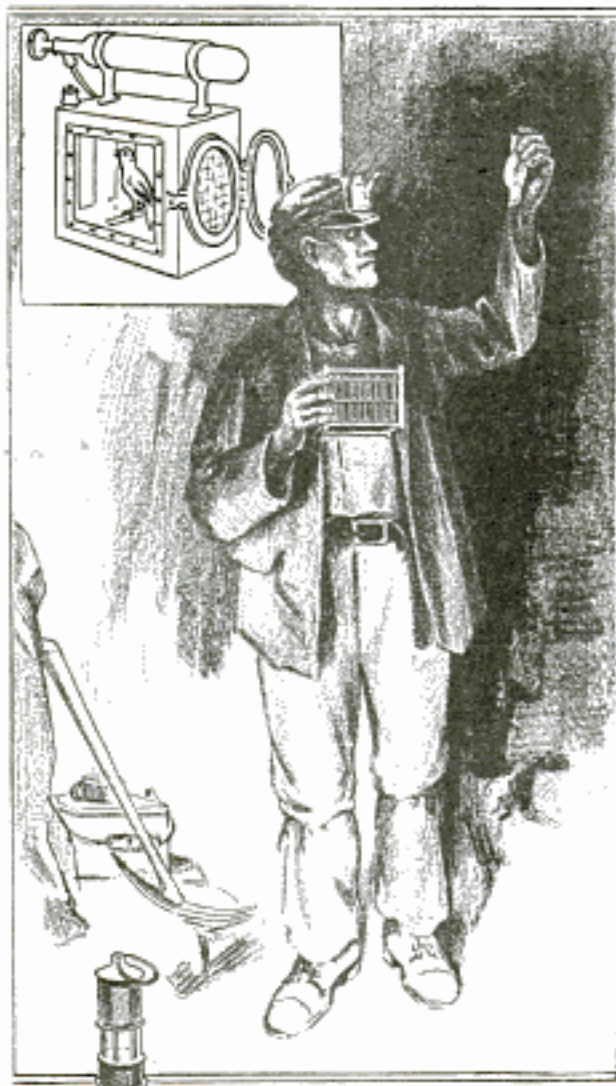

In a Test for Determining the Effect of Carbon Monoxide, It was Shown That a Miner could Survive at Least Eight Minutes after a Canary had Died from Asphyxiation. Insert Shows Canary-Bird Cage with Oxygen Tank for Reviving the Bird

damp" of coal mines, they are now regularly used for detecting this gas in the workings of coal mines. This proceeding is rather hard on the birds, as they are immediately affected by gas in such small quantities that it cannot be detected in any other practical way, and they often fail to recover when gas in dangerous quantities is found. The extreme sensitiveness of the canaries to the effects of the gas was demon-

strated recently when a canary bird and an inspector of the U. S. Bureau of Mines were shut up together in a glass cabinet, into which a small quantity of carbon monoxide was piped. Without feeling any serious effects, the inspector was able to remain in the cabinet for eight minutes after the bird had died from asphyxiation. To save the lives of as many birds as possible in actual mine work a cage with an oxygen tank attached is now being introduced. This cage is made tight and has glass sides and a glass door, the door opening being screened. The door is left open while tests are being made, but as soon as the tests are completed the door is closed and the birds are revived with the oxygen.

The Sketch - Oct 21, 1914
LONDON TAKES PRECAUTIONS
 876 **AGAINST ZEPPELIN BOMBS**

Among the precautions taken by Londoners in anticipation of a raid by German airships is the anti-Zeppelin insurance issued by Lloyd's. Policies insuring against damage done by bombs dropped from these airships are issued at the rate of about \$6.25 for each \$5,000, on residence property, and at from \$8.25 to \$12.50 for the same amount, on business property. As a measure of protection against the bombs, some of the houses are being equipped with strong steel netting firmly supported above the roofs, with the idea that the netting will be sufficient to explode the bomb and save the building from damage.

NATIONAL WIRELESS-RELAY
 8494 **LEAGUE IN OPERATION**

The organization of a national league of amateur wireless-telegraph stations for relaying messages, which was noted in a recent number of this magazine, has been completed, and it is now possible to transmit messages to practically any part of the country. There are now about 400 stations in the league, forming an almost continuous chain from coast to coast.

Hiram Percy Maxim
The Maxim Silencer Co.
Hartford, Conn.

8508
H

ANNUAL SWINGING FESTIVAL AT SIAMESE CAPITAL



At about the same time each year that the Christian peoples of the world are celebrating the Christmas holidays, the swinging festival, a pompous harvest ceremony, is observed at Bangkok by the Siamese Brahmanists. This custom is religious in its character and held for the purpose of thanksgiving for the crops that have been reaped, and to invoke divine favor for the

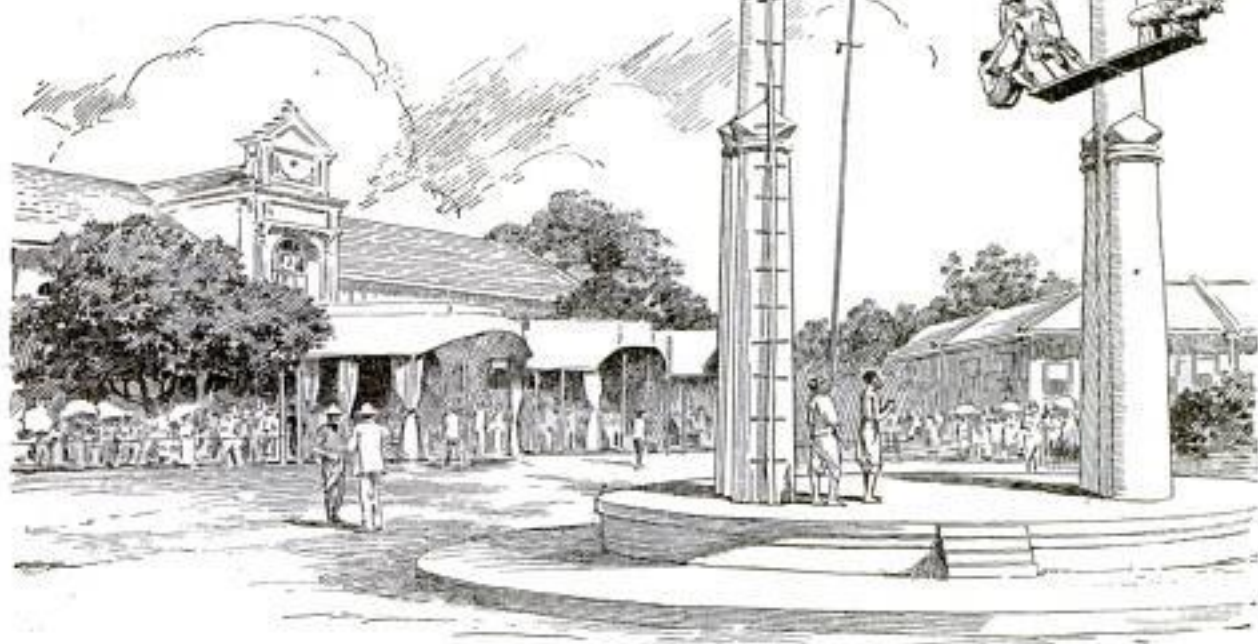

Annually at the Capital of Siam a Swinging Festival is Held to Invoke Divine Favor and Insure Prosperity for the Coming Year

coming year that there may be a sufficiency of rain to insure general prosperity. The central figure on this occasion is a nobleman, appointed by the king, who appears as the "sovereign of the lower heaven." At the proper time, ostensibly coming down from above, he makes his way in state to the public square at the capital, where the rites are performed, is received ceremoniously and led to a temporary throne, before which, in the middle of the common, is a large swing, the framework of which extends to a height of about 50 ft. A short distance west of this is a tall pole at the top of which is fastened a bag of coins.

When the "sovereign" arrives on the day of the festival and is stationed at the place prepared for him, he seats himself and crosses his legs. This is a signal for the invasion of the square by the populace. With much scrambling and laughter the people pack the

area, while at the same time four men who proclaim themselves to be in the grace of the "rain giver" take their places on the swing. The priests take their places, and prayers are offered while the men, pulling at the ropes, start the great swing moving slowly to and fro. As they are carried out far to one side and then to the other, one of the men leans out, watching his opportunity, and attempts to grab the bag of coin with his teeth. If he performs the feat at the first trial, shouts of extreme satisfaction greet him from below, but if he fails, there are equally loud cries of discontent. The performance is repeated three times while the mock king looks on intently, not changing his posture, and when it is completed he departs, so satisfied with the manner in which the swinging has been conducted, if it has been well executed, that he promises prosperity for the coming year.

NOVELTY IN RAILROADING IS ALL-STEEL CABOOSE

8492
In order to provide greater safety for freight-train crews as well as to prevent property loss in wrecks and

caboose ever constructed. The designing of this car offered several interesting problems, as it had to be built as strongly as the heaviest freight cars, while providing accommodations approximating passenger grade. The caboose is 31 ft. long, and above the floor has been constructed without posts, the necessary rigidity being achieved by means of sheet-steel bulkheads. The equipment includes three pairs of bunks, the lower ones serving as seats, for which the upper bunks, when lowered, serve as backs.



All-Steel Caboose to Provide Greater Safety and Comfort for Train Crews

comply with various state laws regulating the comfort of railway employes, the Pennsylvania Railroad has built and placed in service the first all-steel

A stove for heating and cooking, water cooler, washstand, refrigerator, desk, and lockers and drawers for the crew's personal belongings, are also provided.

J. W. Lee, Jr., Publicity Agent Penn. R. R. Co.
Broad Street Station, Phila., Pa.

COMMENT AND REVIEW

JUST as the previous issue of this magazine came into the hands of its readers, the long-hoped-for decision of the Interstate Commerce Commission was declared. It allows the 5-per-cent increase so long deferred. Of course, the railroads included in the decision should be duly grateful, but it seems a pity the ruling body could not have reached the same mind months ago.

The Rate Increase

When the question was pending in the spring of 1914, a prominent railroad official in one of the larger railroad centers stated that in that one city alone the roads running out of it would hire and send out on the various lines for track repairs an aggregate of 40,000 men if the favorable decision were reached then. For weeks these men by the thousands besieged the railroad employment bureaus, waiting in vain for the ship which did not come in. While some weeks must necessarily elapse before the roads can cash in on the new rate, the management will feel warranted in planning for long-needed repairs that will be undertaken the coming summer and which will furnish employment for many thousands. If the increase is right and proper now, it was equally so a year ago, and would have been a godsend to those who were out of employment in consequence.



SQUIRRELS, ants, and bees lay by, in season, food supplies against the winter; man as he became civilized did the same. It's a far cry from the potatoes and apples which the New England colonist put away in his cellar each fall to the mammoth cold-storage plants of our great cities, but each is based on the idea of equalizing the supply of food and carrying over into those months when such things are not produced the foods which otherwise are abundant for short seasons only.

Equalizing Periods of Work

As long as the great majority of the people raised sufficient foods in part of the year to carry them through an entire year, they could afford to do little or nothing during the winter months. Under our present division of labor, the people who raise foods are less than half the population. The others work in mills and stores and at a thousand things which are worth doing, but are not food producers but food buyers. Hence, it is more difficult for many of them to lay by either food or the price of food against the winter when the work they are accustomed to do is scarce or lacking entirely.

If, then, some philanthropist of employment can study out a practical plan by which part, even, of the less skilled, manual work could be equalized, it would be a great boon to thousands. In other words, instead of using up all that class of work during the summer months, put enough of it in a sort of cold storage to be given out during the winter months of restricted employment. No small part of public improvements might be used as winter work, for instance. The objection, of course, is that owing to the weather a man cannot do as much as in summer, which means the same work must cost

more in winter. The only way to equalize this would be to pay less per hour. The labor unions would doubtless object, preferring the men go without work than to accept less than what goes as standard summer wage. It would seem reasonable, however, to make this adjustment, the lower scale to be in force during winter months only, and thus provide work where otherwise there would be none.

We plan years ahead in laying out streets and parks and all sorts of things, but apparently no one has made a consistent effort to plan a few months ahead to provide employment for those thousands who are willing to work, but find themselves without work every winter.



NOT in years, and certainly at no time in the past half century, has there been as earnest, wide-spread consideration of the question of national defense as now. Mark the word, defense. Of all the great

*Question
of
Defense*

nations of the world, ours alone may fairly lay claim to an honest and sincere policy of not wanting colonies. On the other hand, those recent acquisitions which fell to us as an accident of war cannot honorably be left to face the world alone in their present strength. The question of national defense, however, does not now hang so much on our responsibilities across seas as

on what our own vast seacoast requires. In addition, there is the Monroe Doctrine, which is liable to be put to the test at any moment.

Our unprotected boundary to the North is offered by some as a glowing emblem of a century's peace with unpreparedness. Our friendly relations with Canada, however, are, unfortunately, an isolated instance, and exist under conditions not found anywhere else. In addition to that close relationship of color, speech, habits of life, education, opportunity, and blood relationship, it must be remembered Canada also is not striving after colonies in distant climes.

Nothing could be farther from the wish or consent of our people than to call down the monolith of militarism which has so long hung about the neck of European countries. Yet there is fitness and appropriateness in all things. No one questions the frequent increase in men and machines for the fire department of a growing town, and, until our cities are rebuilt and made entirely and absolutely fireproof, there will and must continue a necessity for protection, and the more city the more protection required. And will any one say our nation, of which its cities are only parts, should be any less prudent in safeguarding against the infinitely greater conflagration of war?

Our railroads in the snow zone have invested, I don't know how many million dollars, in giant snowplows. The railroad manager is never tempted to parade his snowplows just because he has them; they are seldom ever seen by the public, yet until the day when the clouds cease to shake down their snow mantles, the snowplow cannot be neglected. A transcontinental road would not expect to operate through trains with a single plow for each 500 miles. Neither does the railroad manager deplore the winter when his plows remain idle; on the contrary, an idle snowplow pays its largest dividends.

Our army and navy should be commensurate with our national size and responsibilities; not an unwieldy, overbearing octopus, but

suitable and fit. The spirit and temperament of our people effectually take us out of any suspicion of ever reaching for what belongs to others. To be in a position to defend what is already ours can command only respect.



IN addition to more men for exclusive work in army and navy, our second great need is a trained soldiery without taking large armies of men from their ordinary occupations. This is something which

*Plan for
Army
Reserves*

has not yet been worked out. President James, of the University of Illinois, suggests a plan which seems good. Most of the state universities already have a few drills each month, under the direction of a commissioned army officer. Doctor James would go farther and recommends the payment of wages to each student who will devote sufficient time each week,

throughout the collegiate year and the entire course, to make himself proficient in the study of arms. Such students could easily graduate with the rank of at least second lieutenant, and while engaged in whatever business or occupation they chose, would always be available for immediate use in time of need. He estimates such a graduation of 2,000 young men annually after the first four years, from his state alone. It will be seen what the yearly outturn would amount to in the entire country. The plan, with doubtless some modifications and additions, would seem to be both practical and economical, and avoids the objection to a compulsory military service which would take the entire two or three years out of a young man's life at a time when he should be fitting himself for his life's work.



IT is a matter of profound regret to the millions of both countries that the anniversary of 100 years of undisturbed peace between Canada and the United States seems unlikely to be celebrated at the

*The
Century
of Peace*

time set. Under the circumstances a postponement was the only course. We can, however, as individuals, each of us recall with mutual satisfaction the long years of friendliness which each succeeding year has served to strengthen. Three generations have enjoyed immunity from strife; and were it not for the good-natured offices of a few customhouse officials, it would

be difficult for one to know when he had left one country and entered the other. There is no desire or attempt on the part of either country to take unfair advantage of the other. Travel and communication between us is unrestricted. Neither is jealous, and each sincerely wishes for the other the largest degree possible of wealth and happiness. With a confidence born of a hundred years of mutual trust and regard, Canada and the United States step out arm in arm with the new century. That those coming years may bring to our good neighbor on the north the fulfillment of all those grand possibilities her great natural resources offer, and her brave and determined people so richly deserve, is the sincere hope of every true American.

H. H. WINDSOR

Dec. 22, 1914.

**SEPARATING THE MUSTARD
FROM SCREENINGS**

8539 m

A device of the greatest interest to millers is a machine for separating

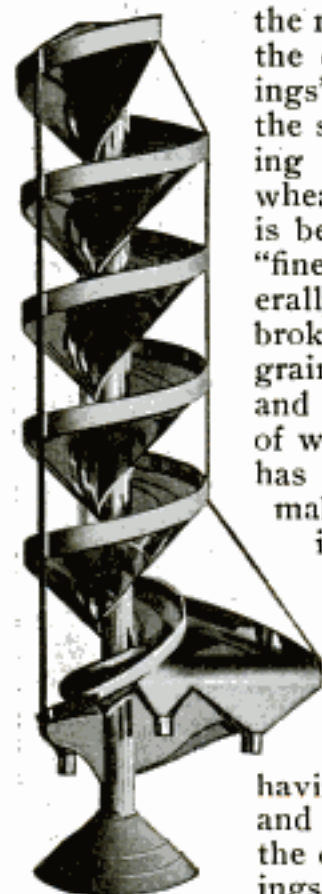

the mustard seeds from the other "fine screenings" that come from the sieves of the cleaning machine when wheat, barley, or oats is being handled. The "fine screenings" generally consist of grass, broken and shriveled grains, and other seeds, and a large percentage of wild mustard, which has a market value making it worth saving.

The separator has no moving parts and consists of three inclined spiral chutes of different diameters having smooth surfaces and placed one above the other. The screenings are fed into a hopper at the top of the separator and drop on the central chute surrounding the column.

The mustard seeds, being round, attain a velocity which causes them to roll from the central chute to the middle one, and a little farther down they jump from the middle to the outer chute. The other seeds, being irregular in shape, slide down the middle chute, while the remaining screenings cling to the central chute. Each chute is equipped with a hopped outlet at the bottom.

**BOTTLING MILK WHILE IT
IS HOT**

8631 m

Laboratory experiments conducted by investigators in the Department of Agriculture indicate that milk may be pasteurized, bottled hot, capped with ordinary paper caps, and then cooled with a blast of air, with results that are satisfactory both economically and

as a reliable means of reducing bacteria. One of the advantages in the method is that there is less danger of infecting the milk, in case of a slightly defective cap or chipped bottle neck, than there is when the bottled milk is heated by steam and then cooled with cold water, as in the present commercial process. If the experience in the laboratory is found to hold true in commercial practice, which remains to be seen, it is possible that this method will supersede the present method of pasteurization.

**ROSE VINES PROTECT BIRD
HOUSES FROM CATS**

7736 m

Bird lovers often find it a most difficult problem to devise means to



prevent neighborhood cats from frightening away their feathered pets and robbing the nests of their young. A New York man who makes his garden an aviary, and who at the same time is not a hater of cats, planted climbing-rose vines about the base of the poles supporting his bird houses. While these added greatly to the appearance of the garden, they also served very

efficiently in keeping cats from crawling up the posts. The birds, understanding their security, were no longer frightened from their nests.

A tunnel has just been completed under the Rhine for connecting coal-mining properties located on opposite sides of that river.

Information sheet from
Dept. of Agriculture

FATAL AEROPLANE ACCIDENTS IN 1914

Exclusive of Deaths in War, One Hundred and Forty-Nine Airmen were Killed

HOW many lives were lost in 1914 in aeroplane accidents will not be definitely known until official reports of the aviation fatalities of the great war are made public. The meager reports that have come from European battle fields have told of the heroic deaths of many flying warriors. The full list of airmen sacrificed in the conflict of the nations may not be available for months, or even years. It is therefore impossible at this time to make an exact comparison of the aviation deaths of 1914 with those of 1913.

Excluding fatalities directly due to the war, or occurring since the war began and not reported because of war conditions, the total aviation-death list for 1914 contains 149 names. Added to the 192 of 1913, 140 in 1912, 77 in 1911, 32 in 1910, 4 in 1909, and 1 in 1908, this makes a total of 595 persons who have lost their lives through aeroplane accidents since the Wrights made the first mechanical flights. In the first seven months of 1914, for which complete figures are available, 130 deaths occurred, as against 114 in the same period of 1913.

Only 15 American airmen were killed in all of 1914. Eighteen Englishmen, 24 Frenchmen, 37 Germans, 18 Russians, 7 Italians, 3 Belgians, and 15 persons of other nationalities were killed in the first seven months of the year, while peaceful accidents in the remaining five months, so far as reported, caused the deaths of 7 Englishmen, 4 Frenchmen, and 1 Argentinian. One hundred and sixteen of the victims of the year's accidents were aeroplane pilots and 33 were passengers and mechanics. In 1913 there were nine deaths of spectators who were struck by falling aeroplanes or hit by propellers, but not a single accident of this kind occurred in 1914. One death not tabulated here was that of a spectator who was uninjured, but died of shock after seeing M. Borrer fall to his death in Switzerland.

Ten of the year's fatal accidents

were reported as due to the carelessness or mismanagement of the pilot. Eight were caused by engine trouble, 7 by collisions in the air, 25 by capsizing or side-slipping, and 20 by faulty machines. Nine deaths were due to accidents in landing, while the causes of the others are unknown or unreported. Nine of the victims of the year's accidents fell into the sea, or other water, and were drowned, while six were burned to death. Thirty-six of the machines in which these accidents occurred were biplanes, 26 monoplanes, and 9 flying boats, the types of the others not being reported.

Perhaps the best-known airman whose death was recorded in 1914 was Gustav Hamel, an Englishman whose skill as an air pilot was recognized everywhere. Hamel, on May 23, after making a successful nonstop flight from London to Paris in a monoplane, started to return to England. He was last seen alive on the coast of Brittany, apparently about to start on a flight across the channel. Weeks later fragments of a monoplane, believed to be his, were picked up at sea. Another distinguished airman killed in 1914 was Jorge Newberry, president of the Argentine Aero Club, who lost his life in an attempt to fly over the Andes Mountains on March 1. Three American officers, Lieut. J. D. Murray of the Navy, and Lieuts. Henry B. Post and F. J. Gerstner, of the Army, were killed. Lieutenant Murray died at Pensacola, Feb. 16; Lieutenant Post at San Diego, Feb. 9, and Lieutenant Gerstner, Dec. 22, at Oceanside, California.

In 1913, fifty persons were killed in accidents to dirigible balloons. Outside of the war, there were but nine such deaths in 1914.

The following tabular list includes all reported aviation fatalities throughout the world from Jan. 1 to July 31, 1914, and all occurring outside of the zone of war and not due to military causes, for the remainder of the year.

AVIATION DEATHS, JANUARY 1 TO JULY 31, 1914

NAME	PLACE	DATE	MACHINE
Lieut. Méry	Santiago, Chile	Jan. 11	
Military pilot	Kalgan, China	Jan. 11	
Alfred Schweizer	Schleissheim, Germany	Jan. 21	Biplane
George Lee Temple	Hendon, England	Jan. 25	Monoplane
Lieut. Maximo Ramos	Cuatro-Vientos, Spain	Jan. 26	Biplane
Lancelot Gipps	Lark Hill, England	Jan. 26	Monoplane
— Keybaud	Gusdeloupe, W. I.	Jan. 27	
Lieut. Delvert }	Bourges, France	Feb. 2	Biplane
Capt. Niquet }			
Emile Brodin	Isle d'Adam, France	Feb. 2	Biplane
		(Died Feb. 3)	
Sellner, military pilot	Munich, Bavaria	Feb. 4	
Raoul de Reals	Villacoublay, France	Feb. 5	Biplane
Lieut. Soeliner	Bromberg, Prussia	Feb. 6	
Non-Comm. officer	Bromberg, Prussia	Feb. 6	
Lieut. Henry B. Post	San Diego, Cal.	Feb. 9	Flying Boat
— Degner	Johannisthal, Germany	Feb. 10	Monoplane
Lieut. J. D. Murray	Pensacola, Fla.	Feb. 16	Flying Boat
Ewart Temple Haynes, passenger }	Chichester, England	Feb. 23	Biplane
Capt. Fethi Bey }			
Lieut. Sadik Bey }	Between Damascus and Jerusalem	Feb.	(Date uncertain)
Gabriel Wroblewski, Pierre Wroblewski, also known as Salvez }			
Jorge Newberry }	Near the Andes, Argentina	Mar. 1	Monoplane
Jimenez Lastra }			
Lieut. Eugene Elsner }	Aspern, Austria	Mar. 9	Biplane
Serena, passenger }			
Capt. Cyril R. Downer	Salisbury Plain, England	Mar. 10	Biplane
Capt. C. R. W. Allen	Salisbury Plain, England	Mar. 11	Biplane
Lieut. J. E. G. Burrows }			
Nouri Bey	Jaffa, Turkey in Asia	Mar. 11	
Lieut. Alexander Bella	Santiago, Chile	Mar. 13	
Lieut. de Lesser	Königsberg, Prussia	Mar. 14	Biplane
Elie Hanouille	San Sebastian, Spain	Mar. 16	Biplane
Lieut. Bongard	Metz, Germany	Mar. 18	
Lieut. H. F. Treeby	Salisbury Plain, England	Mar. 19	Biplane
Capt. Andreadi	Sebastopol, Russia	Mar. 21	
M. Borrer	Basle, Switzerland	Mar. 21	
Capt. Reinhardt, passenger	Strassburg, Germany	Mar. 30	Biplane
Lieut. Griffa	Turin, Italy	Mar. 31	Monoplane
Dr. F. M. Bell	Meridian, Miss.	Mar.	
		(Date uncertain)	
Emile Védrières	Rheims, France	April 1	Monoplane
Pierre Léon Testulat }	Châlons, France	April 1	Biplane
Clement Avlgny, mechanic }			
Lieut. Valerio Griffa	Mirafiori, Italy	April 1	
Lieut. Langmeier	Schleissheim, Germany	April 2	Biplane
Sergt. Eric Deane	Brooklands, England	April 8	Biplane
François Verschaeve	Antwerp, Belgium	April 8	
— Reichelt	Kaditz, near Dresden, Germany	April 10	Monoplane
Miss Selma Steglich, passenger }			
— Remoine, Bourhuysse, passenger (both airmen) }	Aspern, near Vienna, Austria	April 12	
Léonce Ehrmann			
François Deroye	Bône, Algeria	April 18	
Marcel Dublin, passenger }	Buc, France	April 19	Monoplane
Raimond Pitschmann			
Lieut. Napoli	Oberwalkereith, Germany	April 23	Monoplane
Lieut. Bastaglioni, passenger }	Mirafiori, Italy	April 24	Monoplane
Maj. Shigenatso			
Phillippe Marty	Tokyo, Japan	April 25	Biplane
Lieut. Moni	Hendon, England	April 25	Monoplane
Sergt. Wally	Tokyo, Japan	April 27	Biplane
Charles C. Roystone	Wiener-Neustadt, Austria	April 28	
Major Mayer	Dominguez Junction, Cal.	April 28	Monoplane
H. P. Harris	Halberstadt, Germany	May 1	Biplane
Lieut. Liachenko }	Near Moscow, Russia	May 4	
M. Savitsky }			
Lieut. Sainte-Lagüe	Rabat, Morocco	May 5	
Percival Van Ness	Utica, N. Y.	May 8	Biplane

NAME	PLACE	DATE	MACHINE
Lieut. Fabre }	Near Stettin, Germany	May 9	Biplane
Lieut. Kurtz }	Alexandro-Mikailowsk, Russia	May 10	
Lieut. Hartman }	Farnborough, England	May 12	Biplane
Capt. E. V. Anderson }	North Allerton, England	May 15	
Mechanic Carter }	Sebastopol, Russia	May 16	
Lieut. J. Empson }	Halberstadt, Germany	May 16	Monoplane
A. M. Cudmore, mechanic }	Moosbrunn, Germany	May 17	Biplane
Semichkourof }	Hechtsheim, Germany	May 17	Monoplane
Lieut. Wiegandt }	Moscow, Russia	May 21	
Lieut. Fellingner }	Baku, Russia	May 21	Monoplane
Lieut. Müller }	Wellendorf, Germany	May 23	Biplane
Lieut. Rohde }	English Channel	May 23	Monoplane
Lieut. Kolbe }	Antibes, France	May 30	
Mechanic Mouchin }	Odessa, Russia	May 30	
Ubeiko }	Lago Maggiore, Italy	June 2	Flying Boat
Lieut. Otto Boeder }	Portsmouth, England	June 4	Flying Boat
Lieut. Siegfried Reinhardt }	Dijon, France	June 5	Monoplane
Gustav Hamel }	Dijon, France	June 8	
Alfred Agostinelli }	Toul, France	June 13	Biplane
Lieut. Kousminski }	Jehannisthal, Germany	June 14	
Lieut. Toustanowski }	Chartres, France	June 17	Monoplane
Cevasco }	Eagle River, Wis.	June 17	Flying Boat
Lieut. Thos. F. Creswell }	Gatchina, Russia	June 19	Monoplane
Capt. Arthur Rice }	Gatchina, Russia	June 20	Monoplane
Lieut. Adam Gironne }	Vienna, Austria	June 20	Biplane
Pioneer Rioux }	St. Petersburg, Russia	June 22	Biplane
Lieut. Boissière }	Görries, Germany	June 24	
Corporal Blot }	Kiel, Germany	June 25	Flying Boat
Pioneer René Cheveau }	Metz, Germany	June 26	Flying Boat
Krieger }	Bitsch, Germany	June 26	Biplane
Maj. Julien Felix }	Arlon, Belgium	June 28	
Gus. Eckland }	Pskof, Russia	July 2	
Jankowsky }	Soesterberg, Holland	July 2	
Capt. Stoiakine }	Rheims, France	July 3	Monoplane
Lieut. Pilatz }	Angeles Camp, Cal.	July 4	
Lieut. Blatschka }	Saumur, France	July 6	Monoplane
Lieut. Borislavsky and }	Novara, Italy	July 8	Monoplane
passenger }	Gatchina, Russia	July 9	
Lieut. Kolbe }	Hasselt, Belgium	July 9	
Lieut. Schroeter }	Odessa, Russia	July 10	
Lieut. Grünow }	Schwerin, Germany	July 14	
Maj. Buchner }	Ochakof, Russia	July 15	
Lieut. Liedel }	Saarburg, Germany	July 16	
Capt. Bojaroglo }	Fort Grange, England	July 18	
Lieut. Spandaw }	Brussels, Belgium	July 22	
Corporal G. Godefroy }	Juvisy, France	July 27	Flying Boat
Corporal Emile Mirat }			
Arthur Rybitsky }			
Georges Legagneux }			
Giovanni M. Caviggia }			
M. Camiletti, passenger }			
Lieut. Chenskine }			
Lieut. Hubert }			
Capt. Firsof }			
Lieut. Von der Luehe }			
Lieut. Karl Geigant }			
Capt. Jassipof and mechanic }			
Non-Comm. Officer Wilke }			
Lieut. L. C. Horden }			
Caya de Castella }			
Lieut. Benjamin Valency }			

AVIATION DEATHS OUTSIDE OF WAR ZONE, AUGUST 1 TO DECEMBER 31, 1914

NAME	PLACE	DATE	MACHINE
Lieut. Robt. Skeene }	Netheravon, England	Aug. 12	Monoplane
Mechanic Barlow }	Bardstown, Ky.	Sept. 4	Biplane
Charles A. Hibbard }	Hendon, England	Sept. 14	
Richard T. Gates }	Pueblo, Colo.	Sept. 16	Biplane
Weldon B. Cooke }	Saint Cyr, France	Sept. 23	
Two pilots (names not given) }	Hempstead, Long Island	Oct. 2	{ Homemade Biplane
Wm. Piceller }	Cicero, Ill.	Oct. 9	Biplane
Alphonse Huth }	Woolston, England	Nov. 1	Flying Boat
Mechanic Alston }	Issy-les-Moulineaux, France	Nov. 5	
Capt. Faure }	Aldershot, England	Nov. 5	Biplane
Capt. Remy }	Avon, England	Nov. 5	
E. T. Busk }	Chesterfield, S. C.	Nov. 13	
Lieut. P. B. Murray }	Buenos Aires, Argentina	Nov. 27	
Frank P. Terrell }	Upavon, England	Dec. 1	Biplane
Jalil }	Los Angeles, Cal.	Dec. 2	Monoplane
Lieut. H. R. Fleming }	Near Oceanside, Cal.	Dec. 22	Biplane
Thomas J. Hill }			
Lieut. F. J. Gerstner }			

H. E. Zimmerman
Mt. Morris, Ills.

TABLET TO GERMAN SOLDIERS WHO FOUGHT FOR AMERICA

8891 H

In honor of the German-Americans who fought under the Stars and Stripes during the American Revolution and



Tablet to the Memory of Germans Who Fought for the United States

the Civil War, a bronze memorial tablet was recently dedicated at Dayton, Ohio. The event was participated in by nearly 2,000 members of German societies, and was held at Memorial Hall. At the bottom of the tablet are the words, "Our New Fatherland."

PURIFYING ARTIFICIAL GAS WITH ELECTRICITY

8955 H

Electricity is being employed with success at a Detroit coke oven for the purpose of removing tar from artificial gas in the purifying process. The gas is passed through a highly ionized field,

The Engineer

which is produced by a high-tension discharge of current ranging as high as 80,000 volts, with the result that the tar forms in large drops which are then easily separated. There are no high-tension leads exposed, since the ionizer contains the transformer.

ATLANTIC COAST IS SWEEPED BY SEVERE STORM

8980 H

The east coast from New England to Virginia was battered, its villages inundated, and many of its most fashionable resorts devastated early last December when a severe northeasterly gale lashed the Atlantic Ocean and rolled up the highest tide that has swept into New York Harbor in more than a decade. Shipping was paralyzed and liners were forced to remain outside of Sandy Hook and battle against the waves, while telegraphic communication was interrupted, and damage aggregating hundreds of thousands of dollars done to property.

The full force of the ocean bore against the New Jersey shore. At Seabright heavy waves broke across the low, narrow beach between the sea and the Shrewsbury River, completely obliterating many of the beautiful summer residences situated there. At Sandy Hook the wind reached a velocity of 68 miles an hour. Across the bay the shore line of Staten Island was strewn with debris from wrecked boats. At Coney Island, Brighton Beach, and at Sea Gate, residences and buildings were demolished. At Rockaway Beach, on Long Island, the waves rolled more than 25 ft. above the high-tide mark, while points on Long Beach, on the Jersey coast, suffered extensively. Along the beach here for miles there is a marginal ledge of land, much of it quite low and practically all of it backed by narrow bays, which was subjected to the fury of the sea. In some sections of Atlantic City water covered the streets to a depth of four feet. Boats in the Delaware River suffered, and business districts along the waterfront at Philadelphia were inundated. The storm lasted for several days.

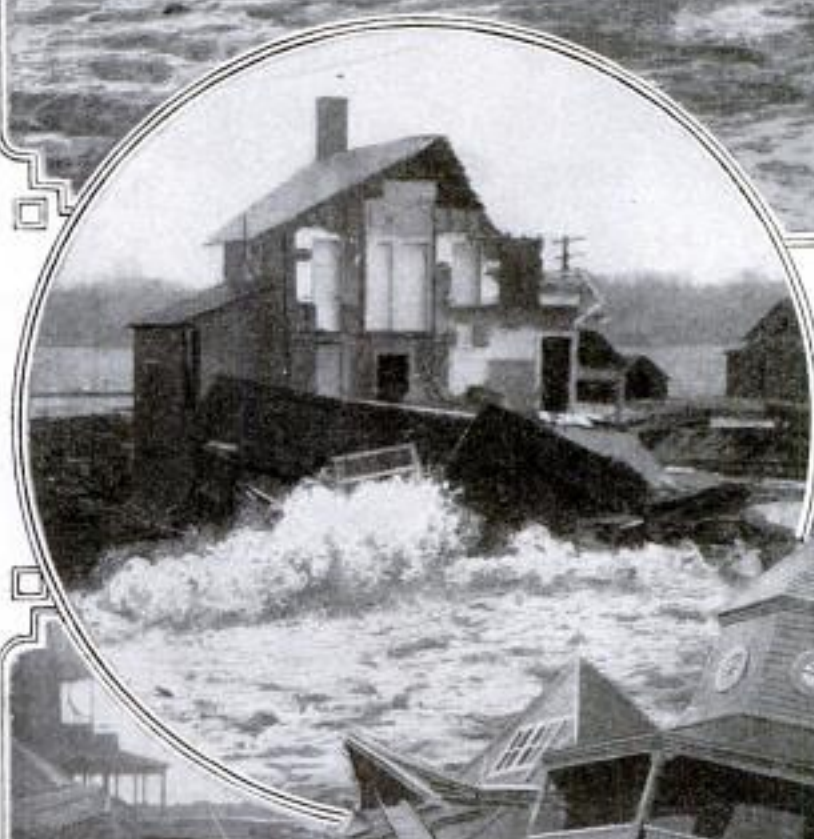
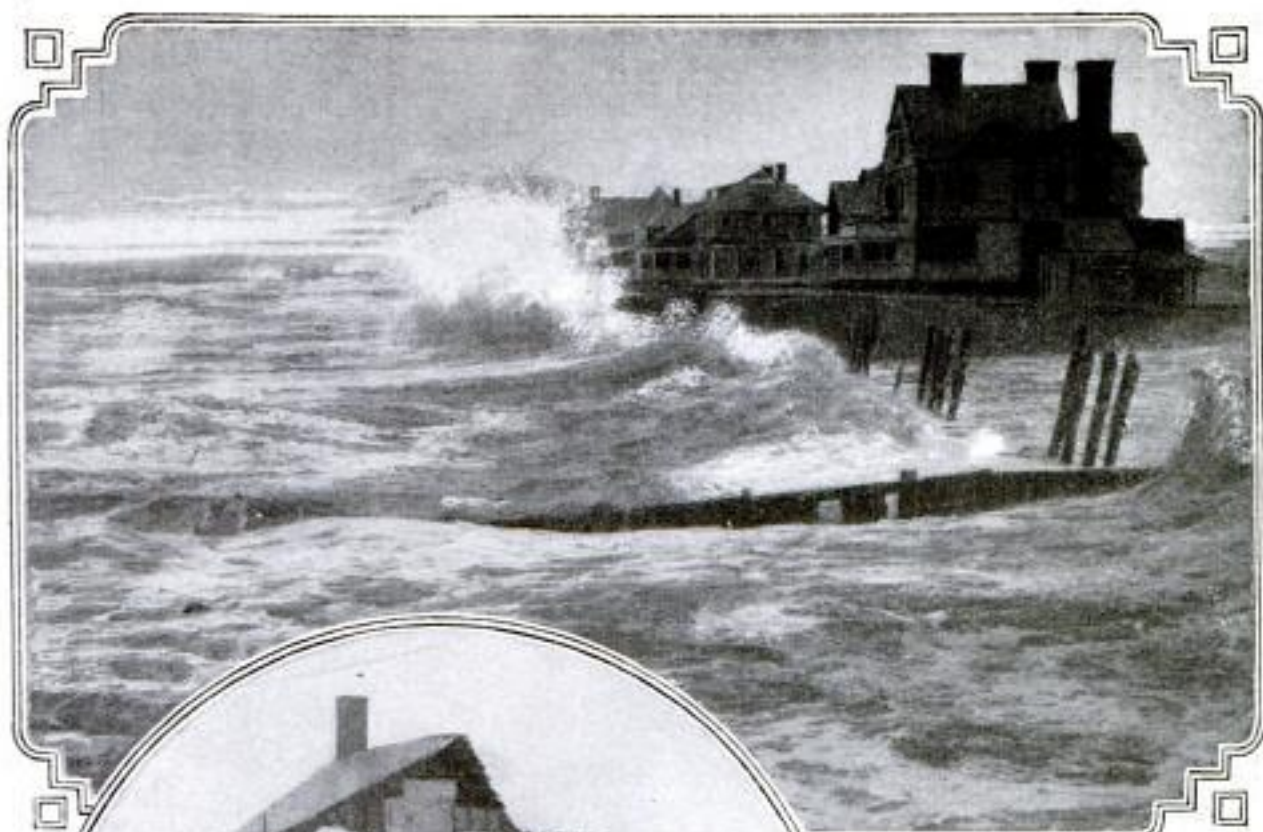

The Above Photograph Gives a Conception of How Incapable the Sea Walls Were of Withstanding the Force of the Waves at Some Points. At the Left and below is Shown the Wreckage of Summer Cottages at Seabright, N. J., Where the Storm Worked Extensive Damage



PHOTO COPYRIGHT, INTERNATIONAL NEWS SERVICE

Houses along the Beach at Sea Gate, L. I., were Washed into the Sea after the Bulkheads Gave Way

200 Williams St., N.Y. City

Donor refer
anyone to
W. C. Sawyer
B 726/15

W. C. Sawyer 626 S. Hope St.
Los Angeles Calif.

POPULAR MECHANICS

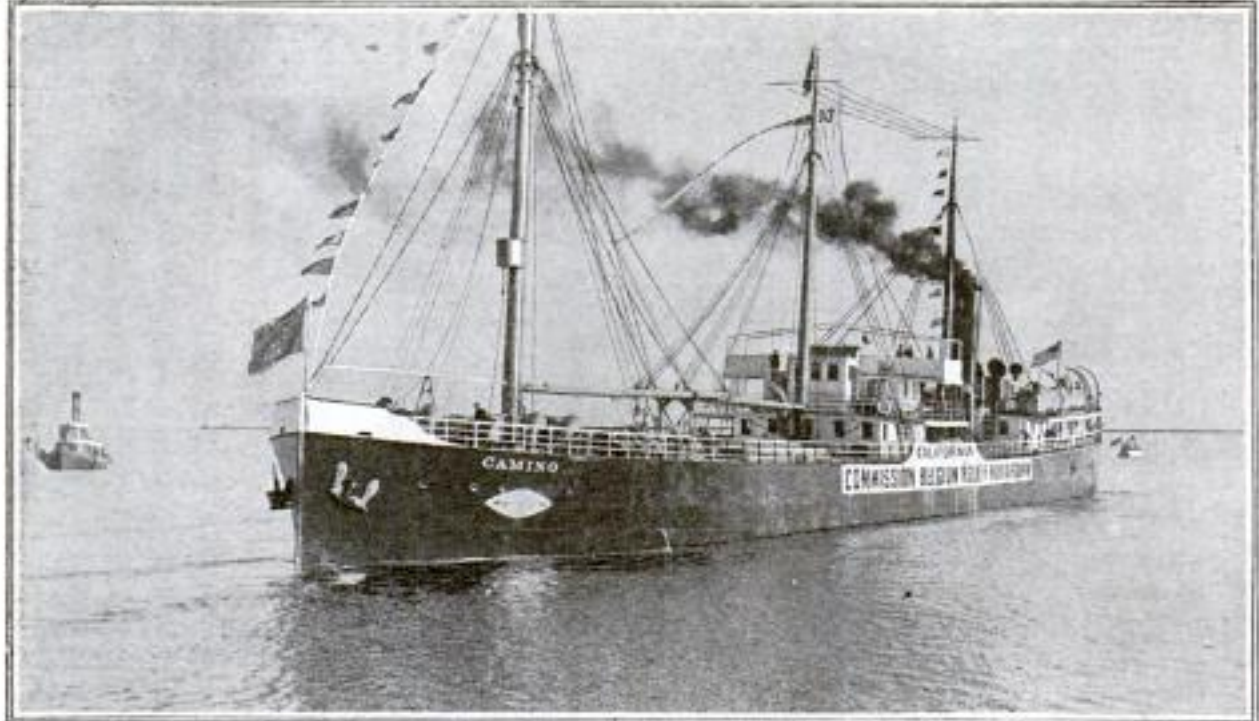

CALIFORNIA SENDS FOOD TO STARVING BELGIANS

The Pacific coast responded with characteristic generosity to the appeal for aid for the Belgian war sufferers. The photograph shows the first relief ship from California starting on its voyage by way of the Panama Canal.

8988 m

FLOATING CRANE BUILT FOR PANAMA CANAL WRECKED

The jib of the floating crane "Ajax," which is one of the two powerful floating cranes built for handling the biggest and heaviest pieces required in repairing the Panama Canal locks, collapsed while lifting a test load at Cristobal, Dec. 7, 1914. The crane was rated for loads varying, according to the reach of the jib, from 100 gross tons to 250 gross tons, but before being accepted by the government it was required to lift loads 20 per cent in excess of the rated load for each reach. According to reports, the collapse occurred when the jib was working over the side of the pontoon at a reach of 81.6 ft. The rated load for this reach is 100 gross tons, and this with the 20-per-cent overload required in the test made an actual load of 120 gross tons. This load, consisting of a solid block of concrete weighted with steel rails, had been lifted about 4 ft. above the ground when the steel framing of the jib collapsed and fell, the nose of the jib burying itself several feet in

the ground. The loss due to the collapse is estimated at from \$100,000 to \$150,000. The pontoon and tower portion of the crane were not damaged. The only man injured was a West Indian laborer who was riding at the top of the jib, and who escaped with only slight injuries by jumping when the jib started to fall. This crane and its mate, the "Hercules," were built in Germany and are said to be the largest floating cranes in existence. Each has a maximum rating of 250 tons at a reach of 21 ft. over the end of the pontoon, or 22.3 ft. over the side. With the 20-per-cent overload for testing, this makes 300 gross tons, or 672,000 lb., as shown in the illustration.

¶The last legislature of the state of Missouri worked out a good-roads plan which contemplates connecting every county seat by improved highways. A motor road between St. Louis and Kansas City, Mo., is being built.

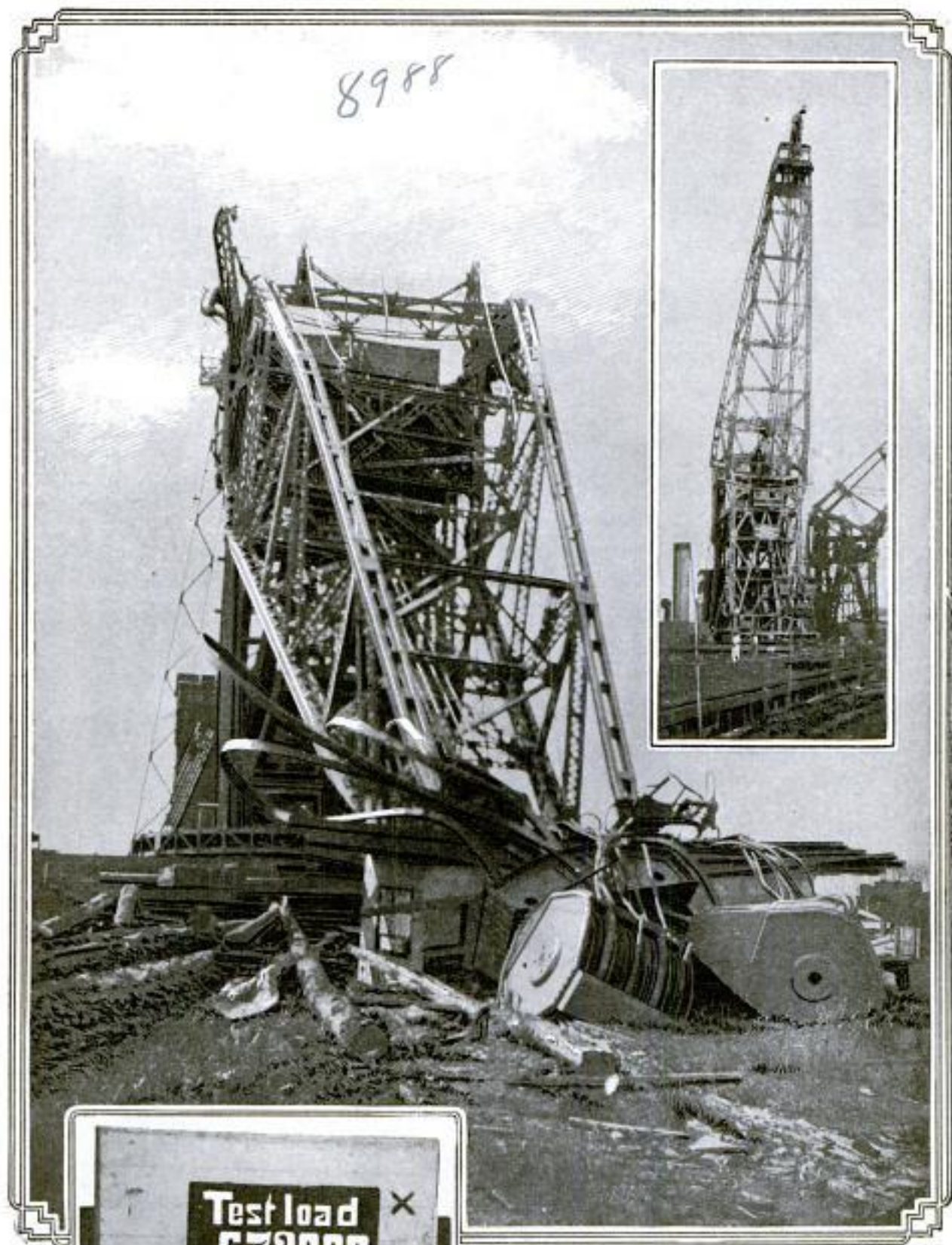

Wreck of the Floating Crane "Ajax," the Steel Jib of Which, a Framed Structure Built Up of Heavy Structural Materials, Collapsed While Undergoing the Tests Required by the Panama Canal Authorities. The Test Load, Consisting of a Solid Block of Concrete Weighted with Steel Rails and Weighing 120 Gross Tons in All, was being Lifted at a Reach of 81.6 Feet when the Jib Buckled and Fell. The Test

Load Required for the Shortest Reach of the Jib was 300 Gross Tons, or 672,000 Pounds

SCENES OF ACTUAL FIGHTING IN TRENCHES



COPYRIGHT,
INTERNATIONAL NEWS SERVICE
Belgian Soldiers
Using a Hyperscope,
Which Allows Them
to Watch the Enemy
without Exposing
Themselves

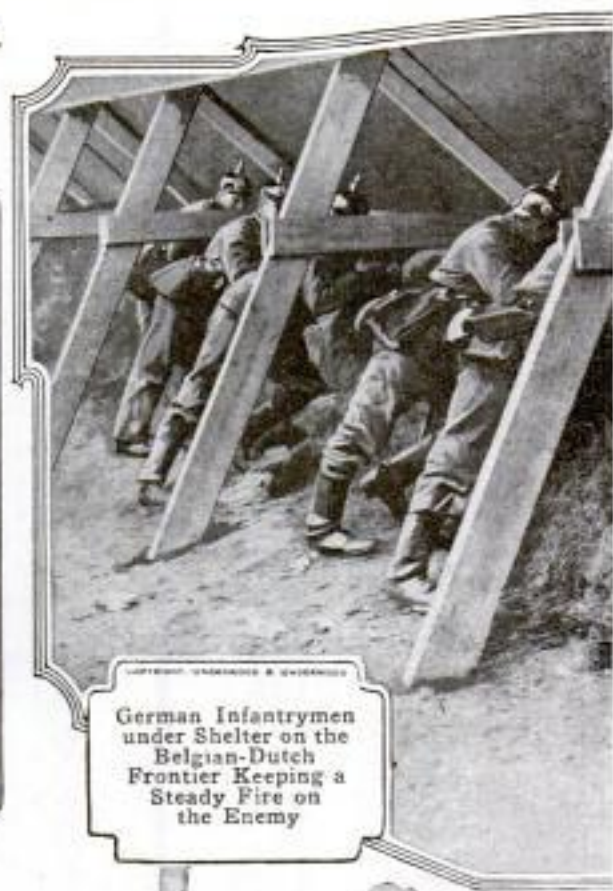

COPYRIGHT, UNDERWOOD & UNDERWOOD
German Infantrymen
under Shelter on the
Belgian-Dutch
Frontier Keeping a
Steady Fire on
the Enemy



COPYRIGHT,
INTERNATIONAL NEWS SERVICE
British Soldiers in
Belgian Trenches
Using Field Glasses
to Find the Position
of German
Sharpshooters

ON BATTLE FIELDS OF WAR-RIDDEN EUROPE

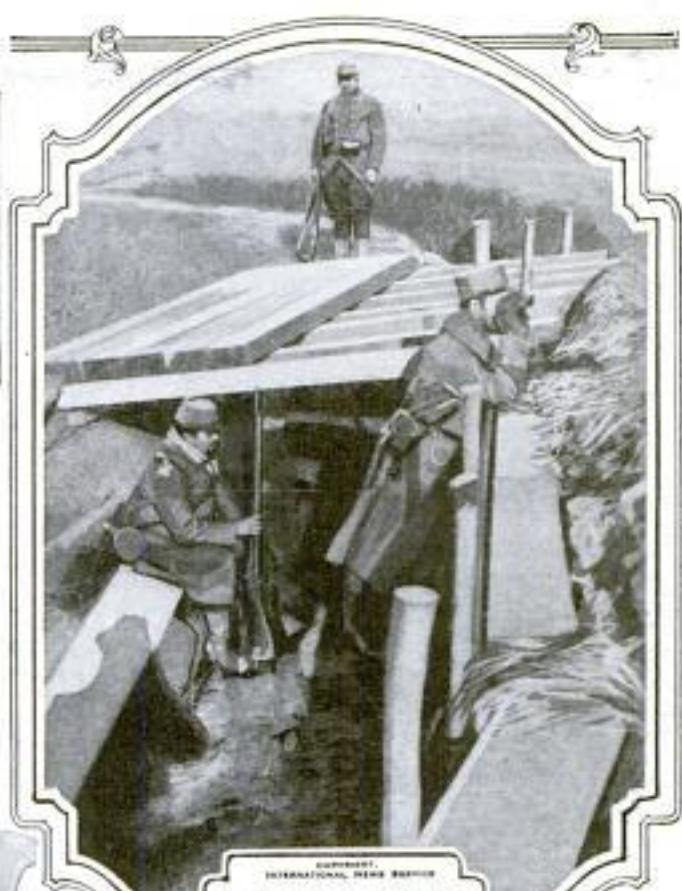

COPYRIGHT, INTERNATIONAL NEWS SERVICE
Bomb-Proof Shelter
Erected over One of
the Advanced French
Entrenchments on the
Eastern Frontier

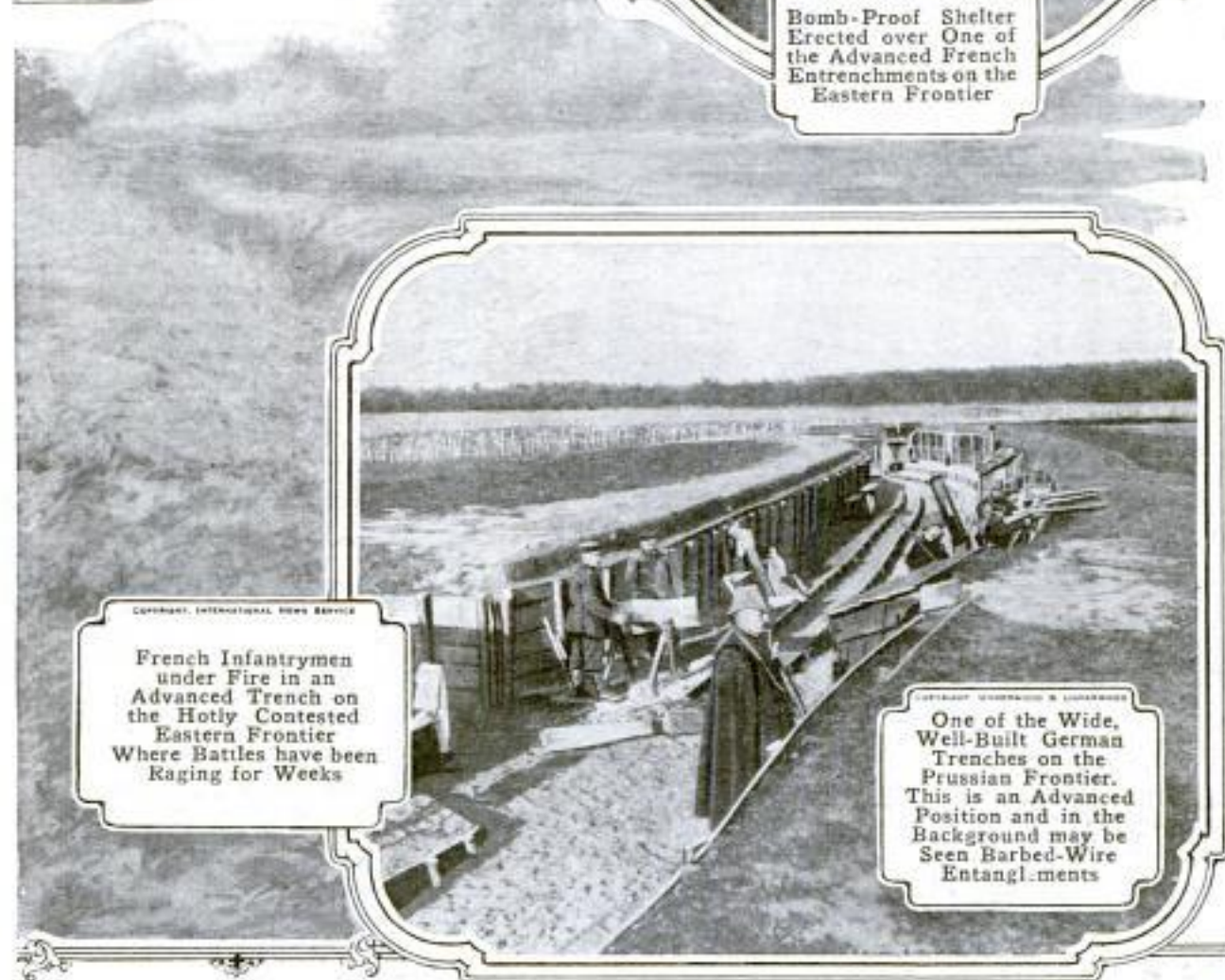

COPYRIGHT, INTERNATIONAL NEWS SERVICE
French Infantrymen
under Fire in an
Advanced Trench on
the Hotly Contested
Eastern Frontier
Where Battles have been
Raging for Weeks

COPYRIGHT, INTERNATIONAL NEWS SERVICE
One of the Wide,
Well-Built German
Trenches on the
Prussian Frontier.
This is an Advanced
Position and in the
Background may be
Seen Barbed-Wire
Entanglements

TIME-WORN RUSES OF WAR THAT STILL WORK



Pieces of Large Water Pipe were Used Here by the Germans to Simulate a Silenced Battery of Artillery. Had the French Attacked the Position, They would have been Trapped by Fire from Hidden Guns

Dummy Cannon, Made of Old Cart and Empty Barrel, Placed by Germans to Deceive Aerial Scouts of the Enemy

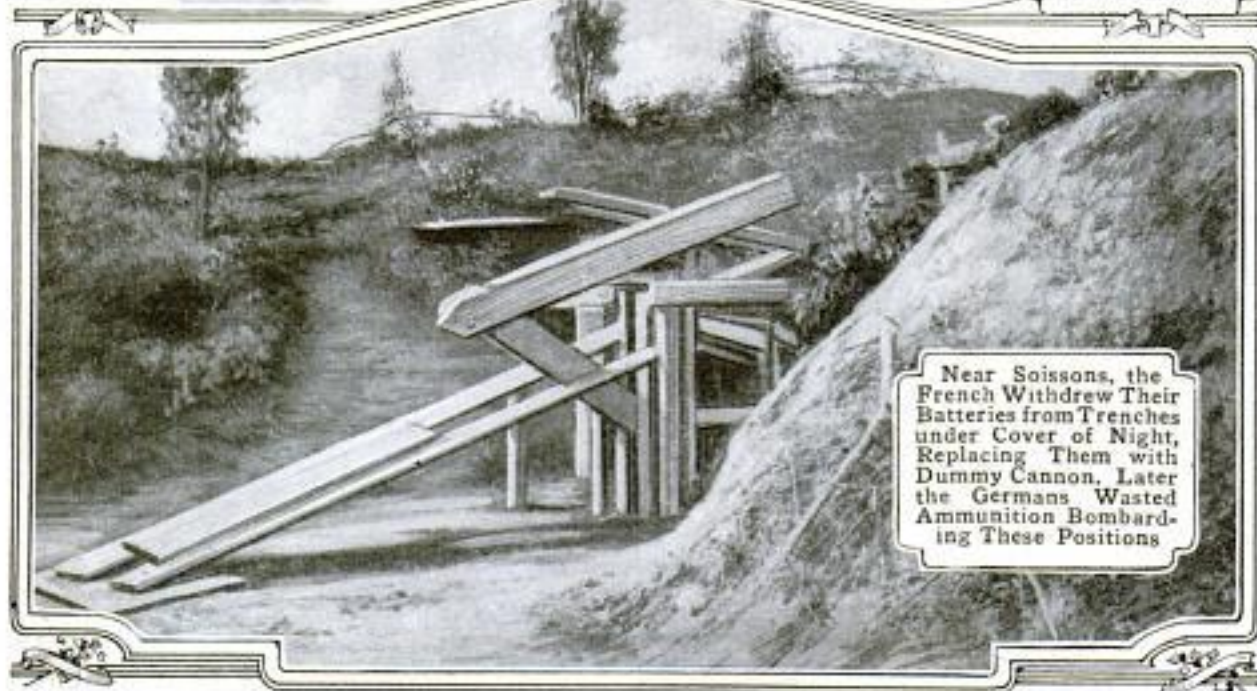

Near Soissons, the French Withdrew Their Batteries from Trenches under Cover of Night, Replacing Them with Dummy Cannon. Later the Germans Wasted Ammunition Bombarding These Positions

WITH THE RED CROSS IN FIELD AND HOSPITAL



PHOTO BY PAUL THOMPSON

Dead and Wounded Soldiers are Found Where They would be Missed Entirely but for Hospital Dogs



This Illustration Shows the Character of Uniforms Proposed for the Use of Women Field Nurses of the German Red Cross. The Color of the Garments Is the Same Gray as That of the New Service Attire of the Soldiers



COPYRIGHT, INTERNATIONAL NEWS SERVICE

The Small Red Cross Flag Seen in the Background Marks the Site of the Japanese Red Cross Station near Tsingtau. The Geneva Insignia is above Trees on a Kite String



COPYRIGHT, INTERNATIONAL NEWS SERVICE

Interior of Diamond-Cutting Establishment at Amsterdam Which has been Converted into a Hospital for Wounded Soldiers

THINGS SEEN IN THE WAKE OF EUROPE'S WAR

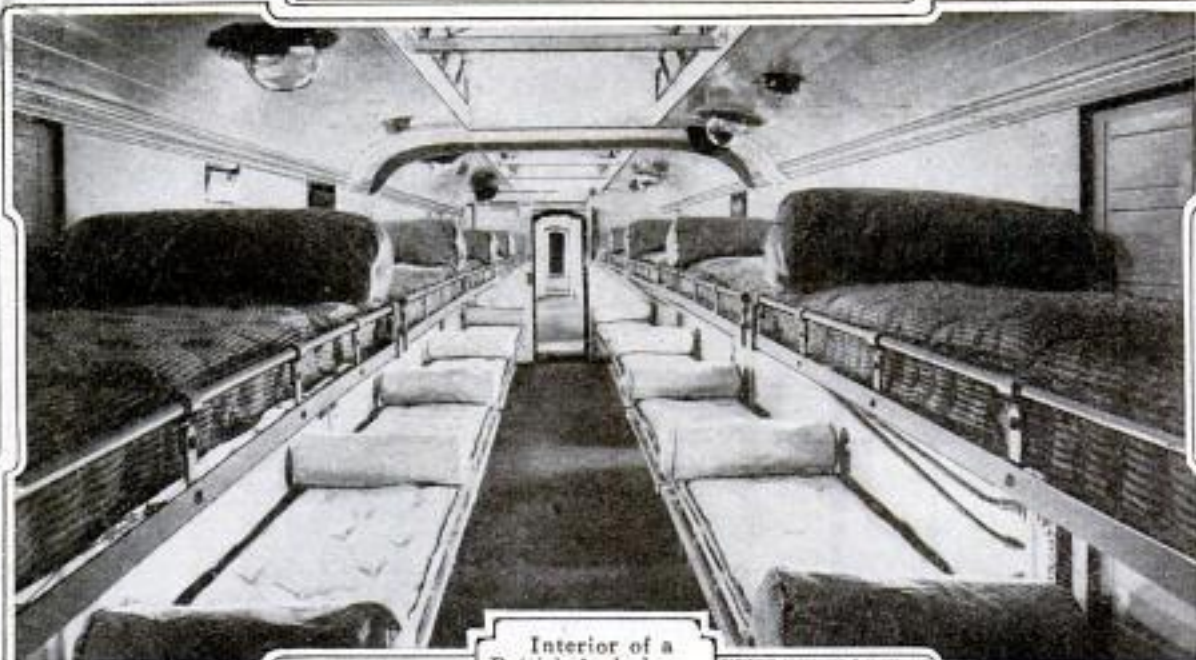

Interior of a British Ambulance Train, Many of Which have been Fitted Out for the Government by the Various Railway Companies



The Life of a German Officer was Saved by This Prayer Book Which was Struck by Shrapnel



With One Pair of Hands between Them, These Two Wounded French Soldiers are Attempting to Assist Each Other Roll a Cigarette



Sleigh Ambulances of This Type are being Used by the Hospital Corps of the French Alpinists Who are Fighting in the Mountainous Districts

GERMAN MEDIUMS OF TRANSPORTATION IN WAR



Detachment of German Cavalrymen Crossing a River. The Horses Held Alongside are Made to Assist in Propelling the Pontoon

Landing the Cavalry Horses on a Steep Bank after Successfully Fording the Stream

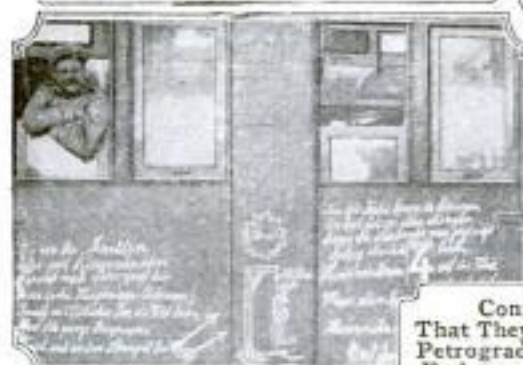

Confidence That They will Enter Petrograd and Put an End to the Czar is Expressed in This Jingle on the Side of a German Train

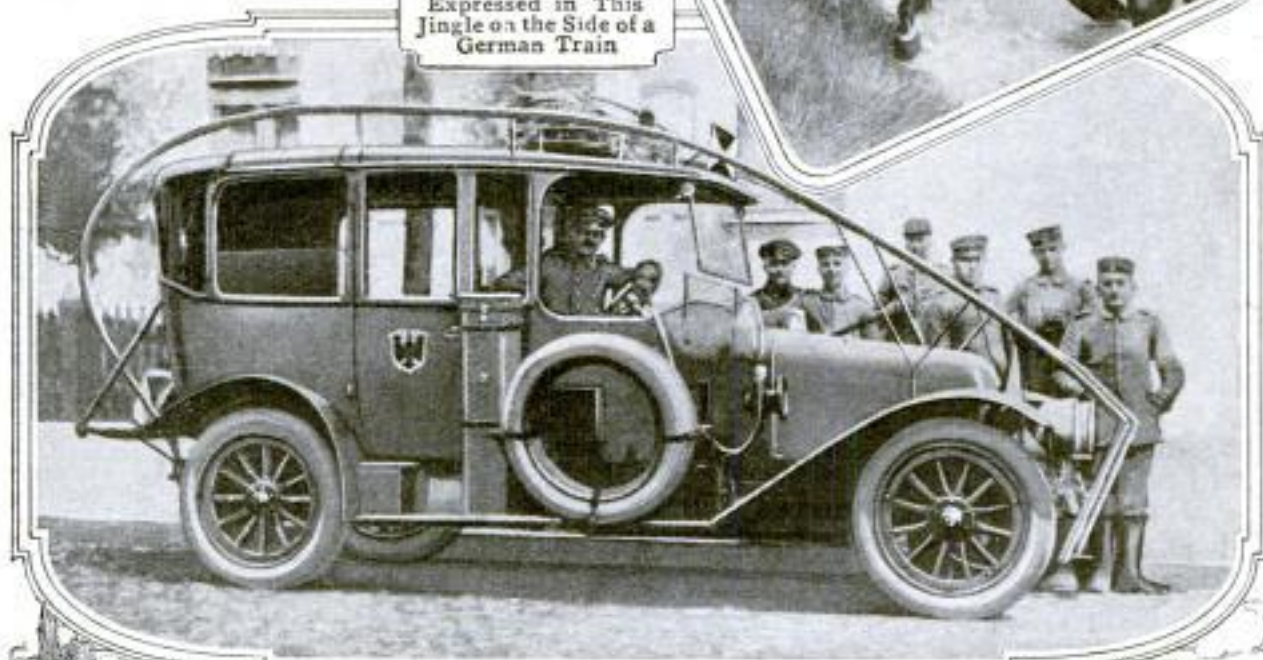

One of the German Motor Cars, Fitted with Wire Guards, which is being Used by Kaiser Wilhelm While at the Front

HOW BRITISH TROOPS ARE FIGHTING OFF COLD



COPYRIGHT,
UNDERWOOD & UNDERWOOD

At One of the Kitchens in the Trenches Where Food is being Prepared for the Soldiers on the Firing Line



COPYRIGHT,
UNDERWOOD & UNDERWOOD

A Lean-To Occupied by Several Officers of a Scottish Regiment Wintering in the Western Theater of War

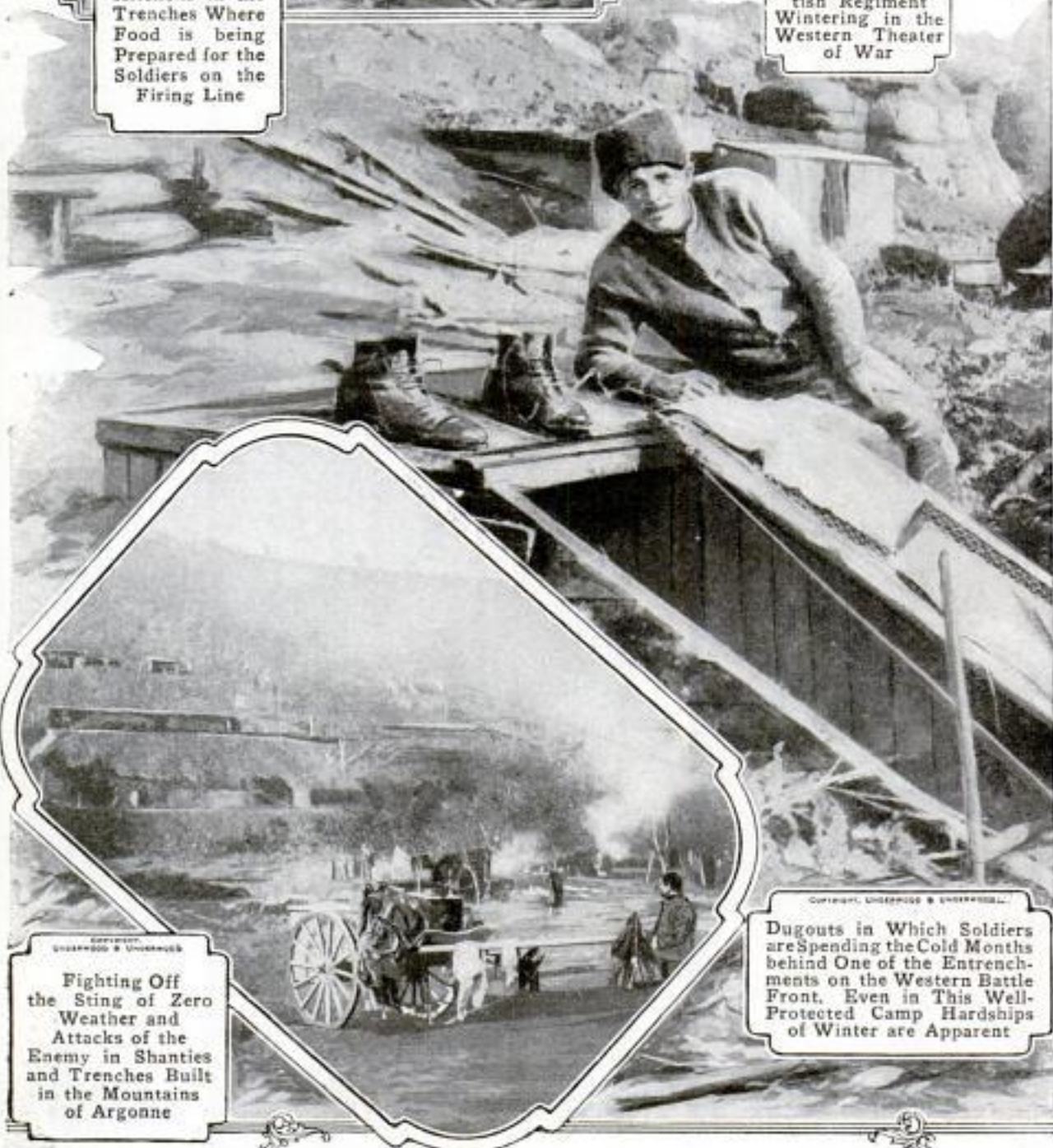

COPYRIGHT,
UNDERWOOD & UNDERWOOD

Fighting Off the Sting of Zero Weather and Attacks of the Enemy in Shanties and Trenches Built in the Mountains of Argonne

COPYRIGHT, UNDERWOOD & UNDERWOOD.

Dugouts in Which Soldiers are Spending the Cold Months behind One of the Entrenchments on the Western Battle Front. Even in This Well-Protected Camp Hardships of Winter are Apparent

IN THEIR WINTER QUARTERS ON THE CONTINENT



COPYRIGHT
UNDERWOOD & UNDERWOOD
Writing a Letter
to the Home
Folks in One of
the British Dug-
outs on the
Battle Front



COPYRIGHT
UNDERWOOD & UNDERWOOD
British Troops,
Encamped on the
Western
Battle Front,
Swathed in
Greatcoats to
Withstand the
Winter Storms



COPYRIGHT UNDERWOOD & UNDERWOOD
In Some Places on the
Firing Line the Conditions
to Which the Soldiers are
Subjected are Wretched, the
Floors of the Trenches being
Covered Ankle-Deep with
Mud or Half-Frozen
Slush

This British
Trench, Which from
a Short Distance is
Almost Invisible, is
Built for a Long
Stand. The Side
Protections Shield
the Men from Burst-
ing Shells and
Shrapnel Fire

ON FROZEN AND SNOW-COVERED FIRING LINES



One of the Servian
Fortress Batteries
Which has Stood
Out against the
Austrians, Seen
during a Lull in the
Fighting



Detachment of
Servian
Infantrymen
Advancing under
Fire on a
Snow-Carpeted
Battle Field



Heavily Clad
Russian Artillerymen
in Action on a Storm-
Swept Hill between
the Vistula and
the Warthe during
Severely Cold
Weather

BITTER COLD ADDS TO HARDSHIPS OF WAR



French Infantrymen near Ypres Wrapped in Blankets and Huddled Together before a Fire to Fight Off the Cold



Above: French "Chasseurs Alpins" on Skis Resting While Making Their Way through Mountainous Country. Left: German Landsturm Patrolling the Frontier



EVERYDAY LIFE OF THE MEN AT THE FRONT



Soldiers of the Kaiser Preparing Breakfast on the Field with Utensils Carried in Their Haversacks



Right: Sharpshooters Shoeing a Horse during a Halt in the Course of a March



Indian Bakers on the Field Making Bread for the Troops Fighting in the Trenches



An Improvised Outdoor Barber Shop in a German Army Camp. Often Accessories are Noticeably Lacking, as in This Case a Razor is being Strapped on the Shoulder Strap of a Rifle

PATHETIC SIDE OF WAR SEEN BY THE CAMERA



Lowering a Wounded Zouave into the Hold of One of the Hospital Barges on the Seine Which have been Fitted Out by the Women of France



Each One of These Fourteen Brass Helmets Marks the Alien Grave of Its Wearer, a German Soldier Who Fell at Charleroi



A Prussian Family, Returning Home after the Russians had been Repulsed, Found Only Charred Bricks and Crumbled Walls

PHOTO COPYRIGHT, UNDERWOOD & UNDERWOOD

"TO ARMS!" BRITAIN'S APPEAL TO ITS YOUTH



WAR MOTOR CARS, THE BATTLESHIPS OF LAND

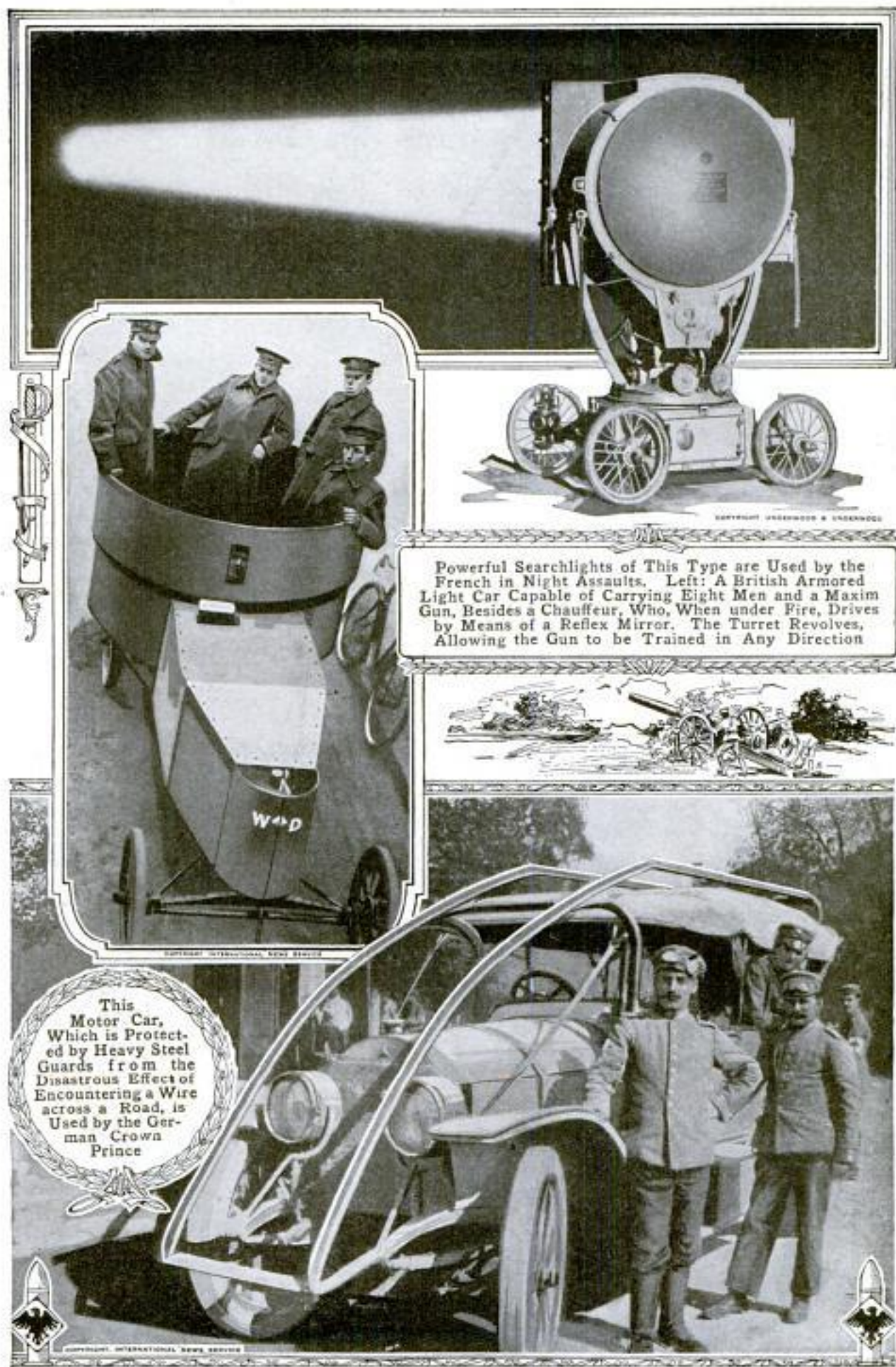

Powerful Searchlights of This Type are Used by the French in Night Assaults. Left: A British Armored Light Car Capable of Carrying Eight Men and a Maxim Gun, Besides a Chauffeur, Who, When under Fire, Drives by Means of a Reflex Mirror. The Turret Revolves, Allowing the Gun to be Trained in Any Direction

This Motor Car, Which is Protected by Heavy Steel Guards from the Disastrous Effect of Encountering a Wire across a Road, is Used by the German Crown Prince

WITH GERMANY'S AIRMEN AND SHARPSHOOTERS

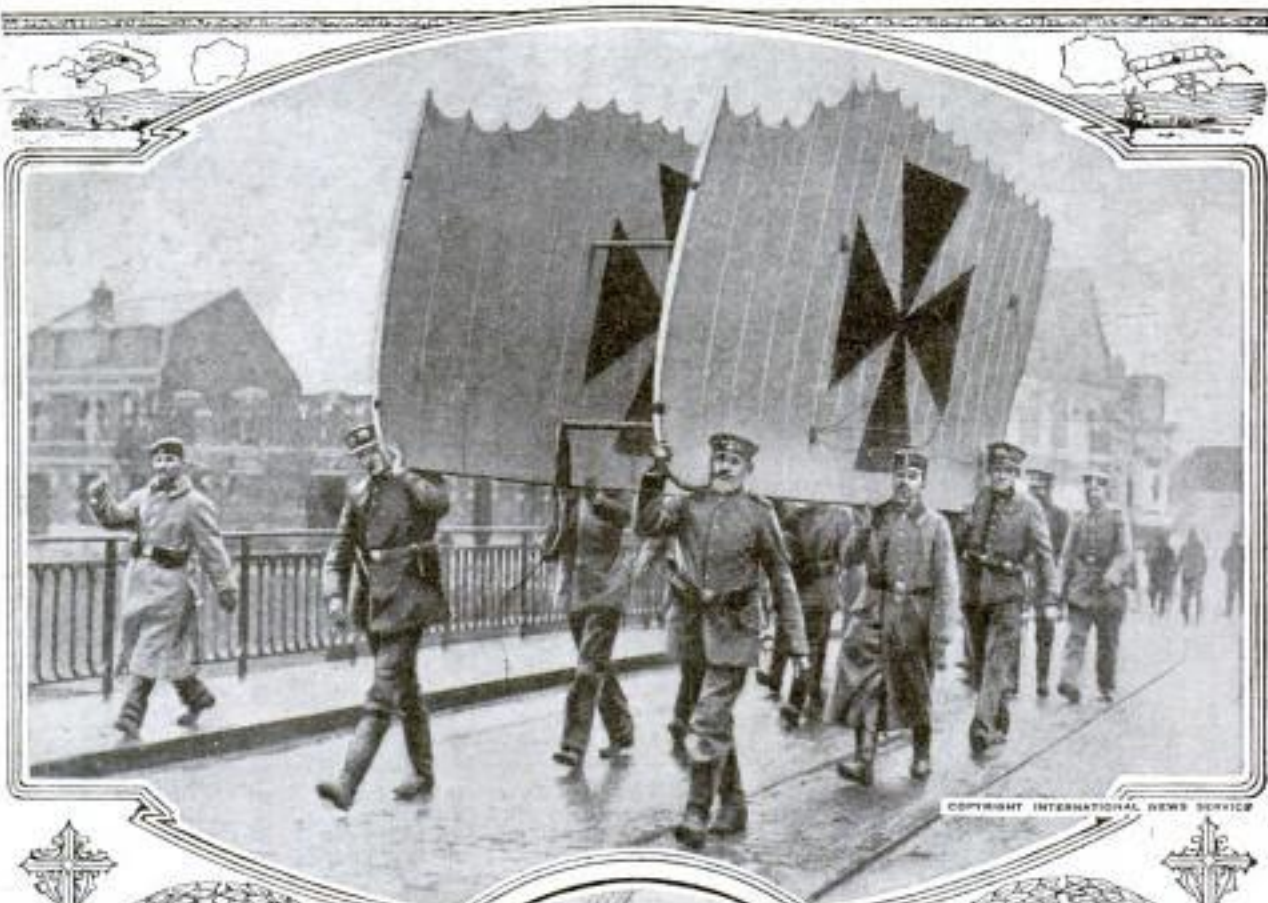

COPYRIGHT INTERNATIONAL NEWS SERVICE

Large
Maltese Crosses
Painted on the
Under Side of German
Aeroplanes Distingu-
ish Them from the
Enemy's Air Craft,
and Protect Them
from the Fire of
Their Own
Troops

Until
Discovered and
Made Prisoners,
German Sharp-
shooters, during the
Battle along the
Nieuport - Dixmude
Road, Used This
Old Mill as a
Shelter

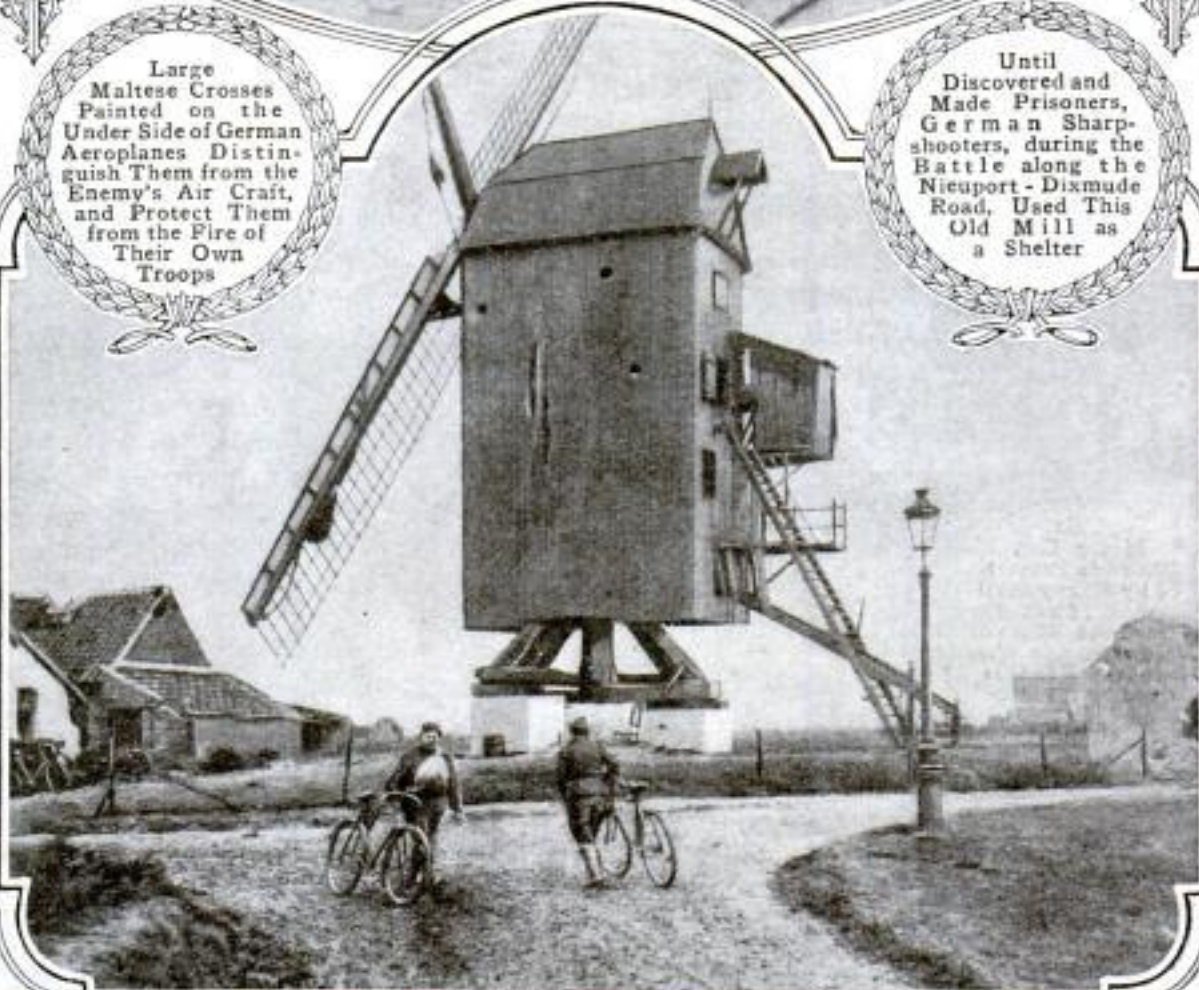

COPYRIGHT UNDERWOOD & UNDERWOOD

SCENES IN BRITISH CAMPS ON THE CONTINENT



Below:
Indian Troops
Watering Their
Pack Mules at the
End of a March. The
Trough is Made of
Canvas and Held
in Shape by
Stakes

Some
Idea of What
It Means to Hold
Ground in the Face
of a Bayonet Charge
is Conveyed by the
Above View of the
"London Scot-
tish" in Action

Lances Supporting a Trooper's
Improvised Shelter





Curious Arrangement of Grades That Resulted from Building a Bridge for One Location and Then Erecting It, with Spans Transposed, on Another Site

PHOTO BY E. W. S. ARD, H. ZACK, CARLISLE, SCOTLAND

OLD BRIDGE WITH MIXTURE OF GRADES

8799m

A curious old bridge in Scotland that is soon to be replaced by a concrete structure comprises three spans built of cast iron over the River Esk, at Longtown. This bridge is supposed to have been built for another location, and when it was erected on the present site it was found necessary to transpose the spans, which resulted in placing the high span, originally intended for the center, at one end of the bridge. The structure now has a striking succession of up and down grades, as will

NEW MACHINE SIMPLIFIES MAKING OF METAL RODS

By means of a new machine that is being introduced in the metal-working industry, rods of copper, brass, and aluminum are cast from the molten metal at one operation, in contrast with the present process of casting into bars, then heating and passing through the rolling mills. The essential feature of the machine comprises two endless chains of mold blocks which are in sections and join in center alinement in a straight line. These mold blocks form a traveling mold orifice into which the liquid metal flows from the melting furnace. As the liquid travels with the mold blocks, it solidifies and emerges from the bore of the machine as a solid rod. Since the chains are endless the rods may be produced in any desired length.

Changes in section are made by changing the mold blocks. The machine occupies a floor space of only 150 sq. ft. A vertical machine on the same principle has been built.

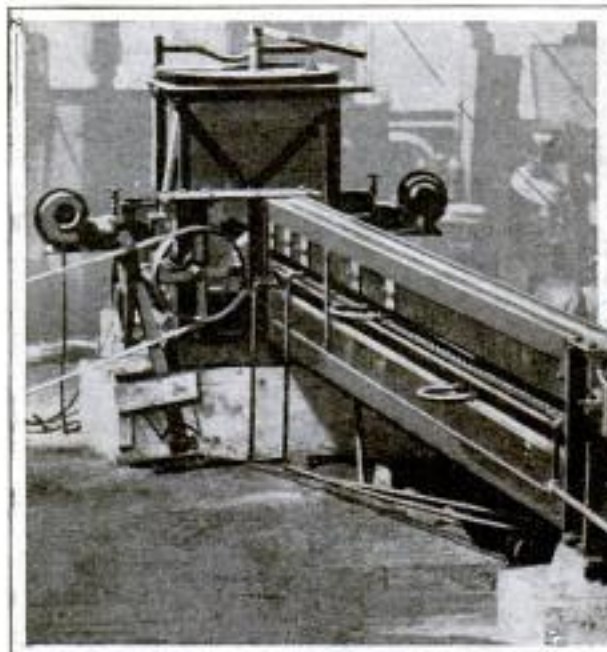

Machine for Casting Metal Rods: The Metal, in Molten Shape, Enters at One End of the Machine and Emerges from the Other End as a Solid Rod

be seen from the illustration. The high span, which is the one at the near end of the bridge, is 150 ft. long, while the other two ends have a length of 105 ft.

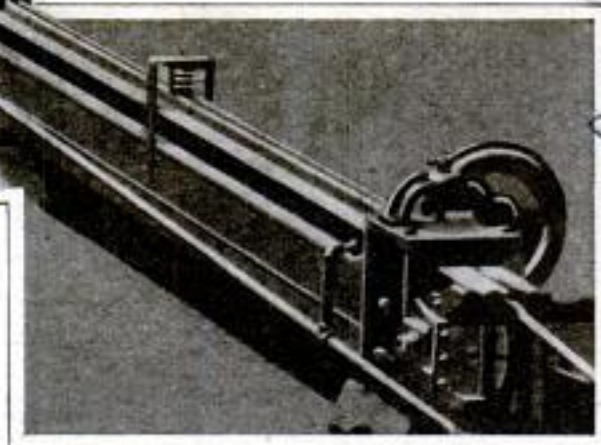

*Refer to
Inventor
Greenwell
Mellon &
East Orange, N.J.*

*United Aluminum Ingots
323 Procter Exch. Material
N. Y. C.*

NEW LENSES THAT SHUT OFF CONTINUOUS-FLIGHT RECORD
HARMFUL RAYS FOR AMERICA BROKEN

8771
Optical lenses that cut off all the harmful ultraviolet rays and 40 per cent of the heat rays while letting through 84 per cent of the visible light rays have been invented by Sir William Crookes, the famous English physicist, and are now being manufactured in America. One type of this new glass is of a neutral tint, so pale as to be almost colorless, while another is of a medium tint. The quality of filtering out the ultraviolet rays is due to various metallic oxides of chromium, uranium, etc., and certain rare earths, which are introduced in the process of manufacture.

8572
The American record for continuous long-distance flight was broken in

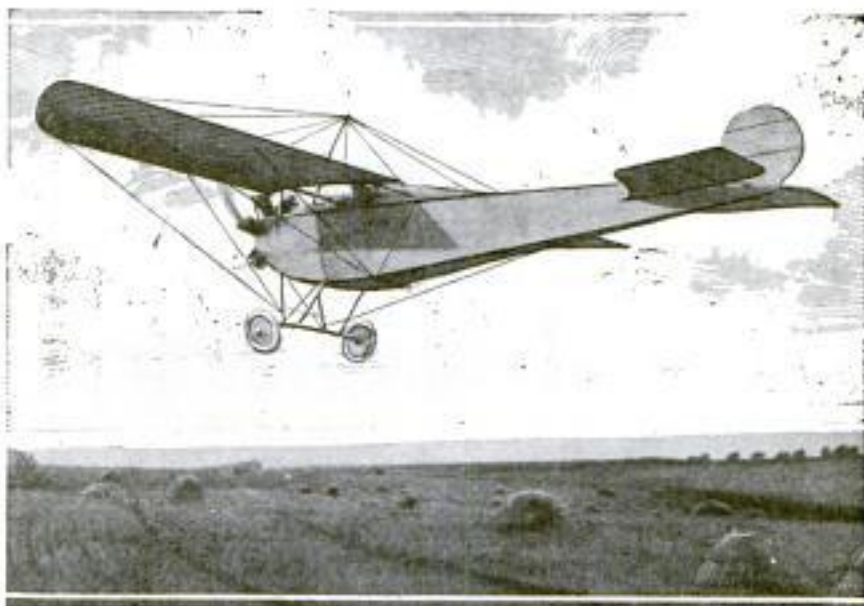

New Type of Monoplane in Which the American Continuous-Distance Record was Broken

ELECTRIC LIGHT WITHOUT A CENTRAL STATION

8605
A new electrical invention on which patents are now pending is an electric table lamp which operates on dry batteries. The cost of operation is said to be exceedingly small, since the lamp burns from 200 to 300 hours on one set of batteries. The current is supplied by four dry cells.

These are installed in a compact case equipped with a handle, and are connected with the lamp by an ordinary insulated wire.

W. W. Carson, Electric Co.,
Waukegan, Ind.

Submitted by Nichols-Finn Advertising Co.,
222 So. State St.
Chicago, Ill.

the fall of 1914, when W. C. Robinson in a monoplane of his own design and manufacture flew from Grinnell, Iowa, to Kentland, Ind., a distance of approximately 365 miles, without descending. The airman had started for Chicago, but lost his way in a dense fog. The previous record for continuous flight in this country was made by C. M. Wood, who flew from Westbury, Long Island, to Gaithersburg, Md., a distance of 264 miles, on Aug. 9, 1913. The new type of monoplane in which this latest flight was made is so constructed that the pilot can see the ground continuously, the wings being so set with reference to the body as to provide a clear space for vision.

VILLAGE THAT HAS TWENTY MINUTES OF SUNSHINE

8743
In the village of River Portal, Colo., there is only 20 minutes of sunshine each day. This unique condition is due to the fact that the village is located at the bottom of the Gunnison Cañon, where, on account of the lofty and pre-

H. E. Zimmerman
Int. Morris, Ill.

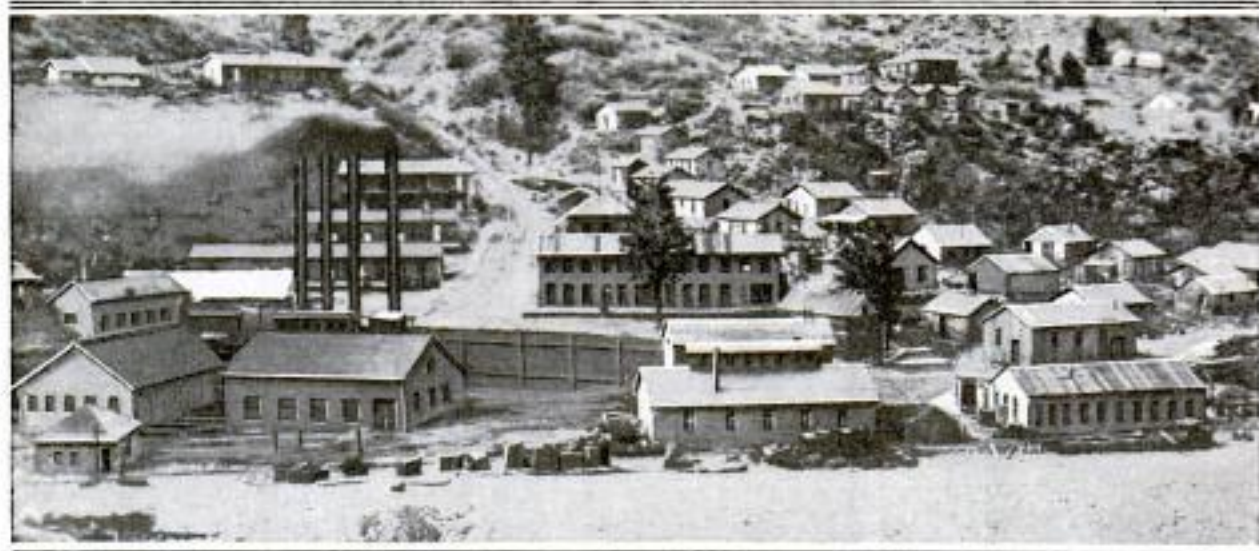

Nestling in the Bed of a Cañon Half a Mile Deep, This Village Gets Only 20 Minutes of Sunshine on the Longest Summer Day

cipitous walls and the narrowness of the cañon, the sunlight can reach to the bottom only during the interval from 11:20 to 11:40 in the morning. The village was built in connection with the construction and operation of the great irrigation tunnel that takes the water from the Gunnison River westward under the mountain range to the Uncompahgre Valley. It can only be reached by a roadway dug out of solid rock down the side of the cañon.

¶To facilitate the passage of ships through the Panama Canal a special telephone system has been installed connecting all the points of control along the canal.

ICE COFFERDAM USED IN REPAIRING DREDGE

8444
Forming an ice cofferdam inclosing the part to be repaired was the novel method used in getting to a leak 34 in. below the water line of the United States dredge "Warroad" while it was laid up for the winter in Lake of the Woods on the border between Minnesota and Ontario. When the ice had formed to a depth of 18 in. a trench 20 ft. long, 3 ft. wide and 12 in. deep was dug in the ice alongside the dredge, and on each following day when the temperature had been below zero the night before, this trench was deepened from an inch to an inch and a half, care

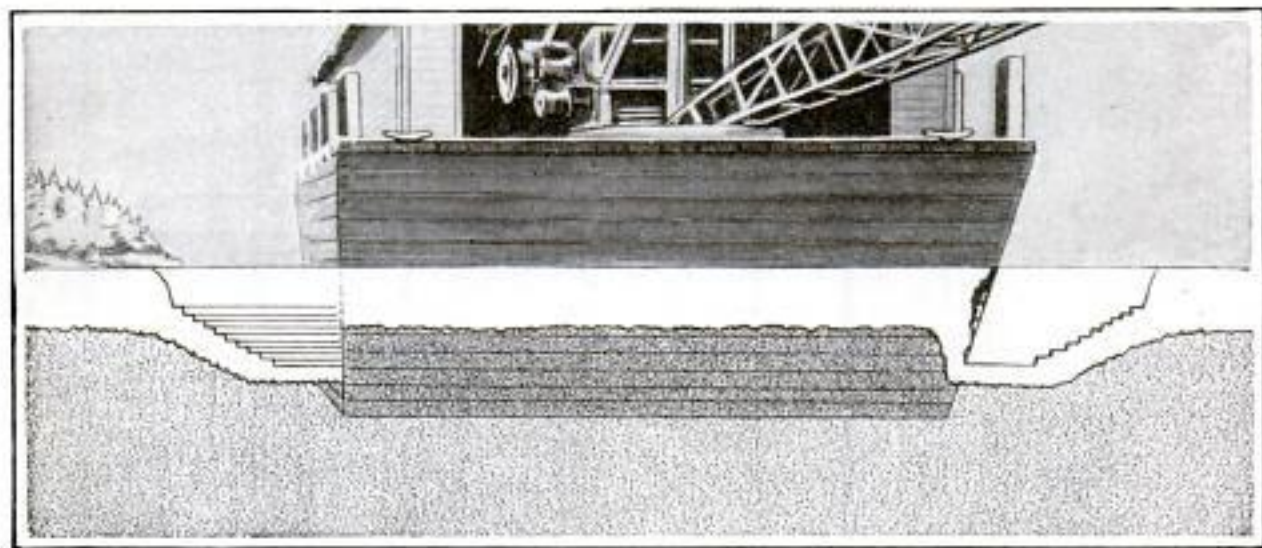

Ice Cofferdam Formed alongside a Dredge by Gradual Deepening of Trench in the Ice

Engineering News
7-23, 1914

being taken to leave about five inches of ice under the trench at each cutting. With this slow deepening of the trench the walls were given a chance to freeze to a safe thickness so that the ice served as a perfect cofferdam during the work of repairing the leak. While this work was being done the temperature dropped as low at times as 47° below zero.

HOW PLUMBAGO IS MINED

8654_m IN CEYLON

In spite of the fact that Ceylon is one of the largest plumbago-producing countries in the world the methods of mining and handling this mineral are crude and comparatively inefficient. In one of the principal mines the vein is located 648 ft. below the surface, and since it is only 10 in. thick, great quantities of rock must be taken out to give access to the mineral. The plumbago is cut out by drills, and the rock is drilled and blasted. Both the plumbago and the rock are lifted to the surface in 10 "dabara" stages. The material is placed in a bucket and wound up by the dabara to the first stage. The bucket is then detached from this dabara and attached to the second dabara, which takes it to the second stage, and so on, until the top is reached. The plumbago is stored below as it is mined, and is taken to the surface once a month. In some of the mines now being developed more efficient methods of hoisting are used. In one of these, a straight incline leads from the main pit, 96 ft. below the surface, to the vein, which is 558 ft. below the surface. The material is hauled up the incline by one cable and is then taken to the surface by a hoist.

SIGNAL LANTERNS IN THE 8453_m FOREST SERVICE

One of the latest methods of night signaling in the national forest service is that of suspending two lanterns from the cross arm of a mast erected on top of the signal station and raising and

lowering these lanterns in accordance with the wigwag code. Not only arbitrary signals are sent in this way, but



Forest Officer Signaling with Lanterns from the Top of a Range-Finder Station

complete messages as well. This method of communication is available at any time for night signaling, and is designed particularly for emergency use when the telephone is out of commission.

Statistics covering the first six months of 1914 show that diamonds aggregating 2,262,817 carats and valued at more than \$22,000,000, were produced in South Africa. Compared with the same period of the previous year, the production represents a decrease.

Bristow Adams
U. S. Forest Service
Wash. D. C.



The Bulb of a Common Variety of Kelp



Kelp of This Kind is being Gathered along the California Coast and Used for Commercial Purposes

This Kelp Plant Is 60 Feet Long. It Grows Prolifically in Northern Waters



This Gives Some Idea of the Length of the Ropelike Stipes of Many of the Heavy Seaweeds

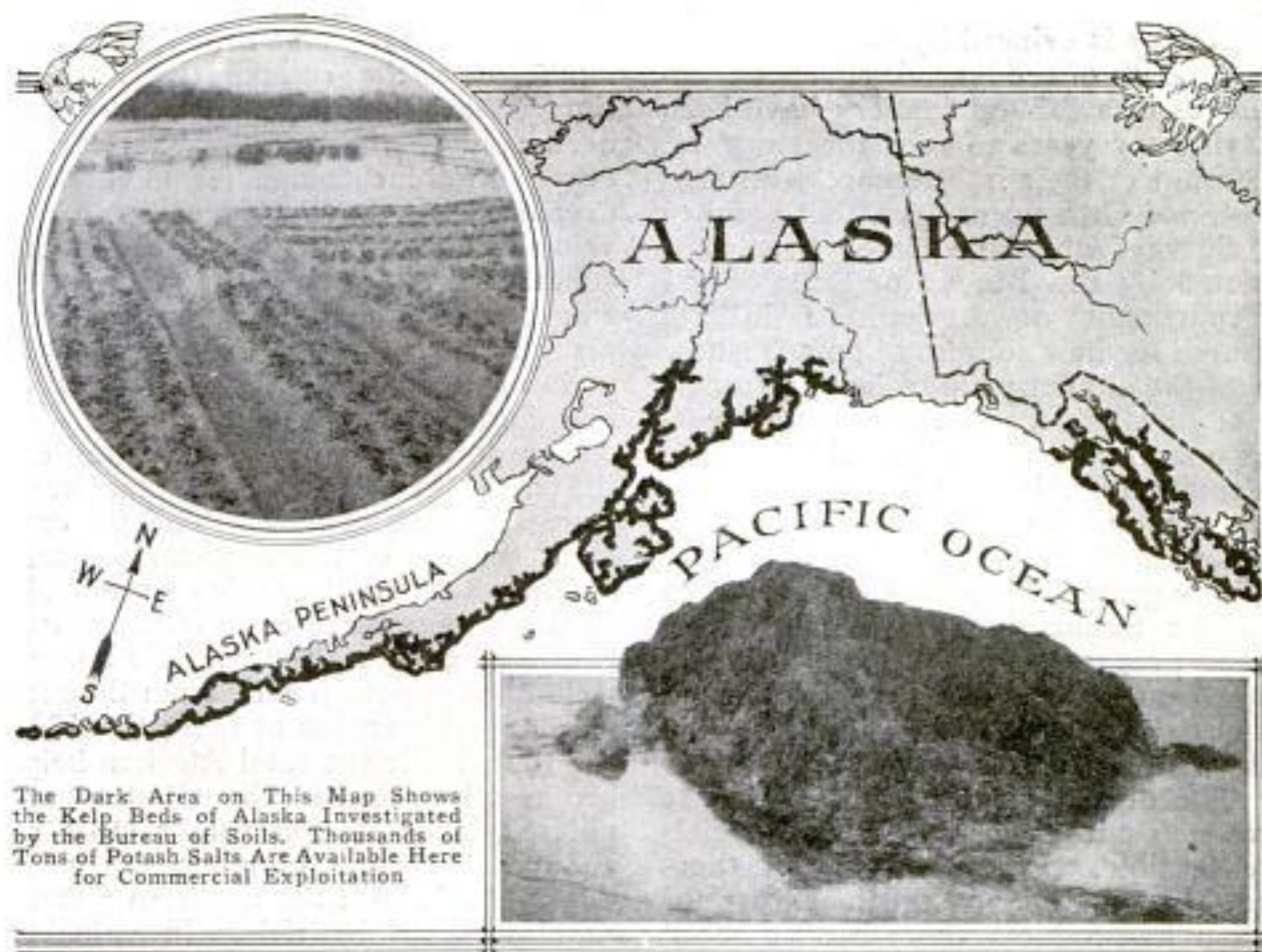

The Dark Area on This Map Shows the Kelp Beds of Alaska Investigated by the Bureau of Soils. Thousands of Tons of Potash Salts Are Available Here for Commercial Exploitation

In the Circle is Shown an Alaskan Kelp-Fertilized Truck Garden. Below: A Rock Covered with Alaria

8860 H GIANT KELP BEDS OF THE PACIFIC CONTAIN VAST WEALTH IN POTASH

PARTLY because the European war has checked the importation of potash from Germany, and partly because of the results of recent scientific inquiry, interest is being manifested in the conservation and utilization of the giant kelp beds of the Pacific coast and Alaskan waters. It is now a fairly well established fact that the inexhaustible supply of marine vegetation off the west coast of the United States holds this country's largest store of potassium salts.

In numerous places, as far north as the Aleutian Islands, kelp grows prolifically and is available for commercial purposes. In view of the fact that comparatively little use has been made of it by Americans, it is interesting to note that the natives of the south shores of Alaska and its near-by islands

have for years employed it in a crude way as a fertilizer. As a result, the gardens in this section have thrived remarkably well. In the cultivation of potatoes, for instance, it is a common practice to bury a thick layer of seaweed in the ground before the planting. Certain varieties of kelp grow abundantly where the water is less than 10 fathoms in depth, the tide strong, and the bottom rocky. Most of these are anchored to the rocks by means of a spreading growth, attached to which is a long ropelike stem, known as the stipe, which terminates in a bulb from which the large leaves sprout. The stipes, which are strong and flexible, have been used much by the Indians as fishing lines and rope, while the bulbs are frequently employed as bottles. The plants are very

hardy, as is evinced by the fact that at the mouth of the Karluk River the employes of a salmon cannery have been trying for years to root them out, on account of their interference with fishing, and have never been successful.

Surveys which have lately been completed by the Bureau of Soils of the Department of Agriculture in the search for new sources of potash, show that the annual yield of kelp, commercially available, actually offers a greater quantity of this essential fertilizing element than is now being consumed by the entire world. With this fact determined, working maps of nearly all the groves, from the Cedros Islands to the Shumagins, off Alaska, have been prepared. These show that the aggregate area of the field amounts to approximately 400 square miles, practically all of which is easily accessible.

The development of these valuable resources, it is declared, is commercially feasible. From one ton of thoroughly air-dried kelp, in excess of other by-products, there is an assured available yield of at least 500 lb. of

pure potash salts and three pounds of iodine. In the comparatively short time that studied attention has been paid to the question, at least a dozen different companies have been organized on the Pacific coast to develop this new industry. Most of the concerns are located in the vicinity of Puget Sound, while there are others planning to utilize the kelp available at Long Beach, San Diego, Point Firmin, San Pedro, and elsewhere.

The potential value of the kelp off the coast of Alaska alone has been shown to be immense. The government surveys of the southeastern and southwestern coasts, which were made during an extensive expedition a short time ago, estimate the possible annual yield of pure potash salts from the seaweeds in this region at more than 80,000 tons, while the total Alaskan kelped area is placed at about 160 square miles, which offers a yearly store of about 734,000 tons of potassium chloride. The kelp of the northern waters was found to be richer in valuable chemicals than that of the southern.

COMBINATION HORN AND FAN FOR MOTOR CARS

One of the newest accessories for motor vehicles is the fan-horn, a combination of a cooling fan and a horn.



The horn is at the center of the fan and is in the form of a diaphragm of steel. At the front it is open, so that the sound waves may emanate when it is vibrated. The vibration is caused by a stationary anvil with teeth which cause the

diaphragm to vibrate when the fan is rotating. The anvil is brought into

contact with the diaphragm by the pressure of a button. The tone produced is like that of an electric horn, and can be varied in pitch by varying the pressure on the button. When the motor is not running the horn cannot be sounded. This prevents children from sounding the horn when the car is left standing.

GUNBOAT IS SAVED BY ROCK THAT DISABLED IT

A very unusual engineering feat was accomplished recently when work was undertaken to save the United States gunboat "Princeton," after it had been disabled by striking an uncharted, submerged rock in the harbor at Pagopago, Samoa. A pinnacle of the rock which was struck entered the hold of the vessel, filling the rent torn in the hull and preventing a further movement of the boat. By employing canvas and plank sheathing it was possible to

Outlook

*Chester S. Richer
State Life Bldg,
Indianapolis, Ind*

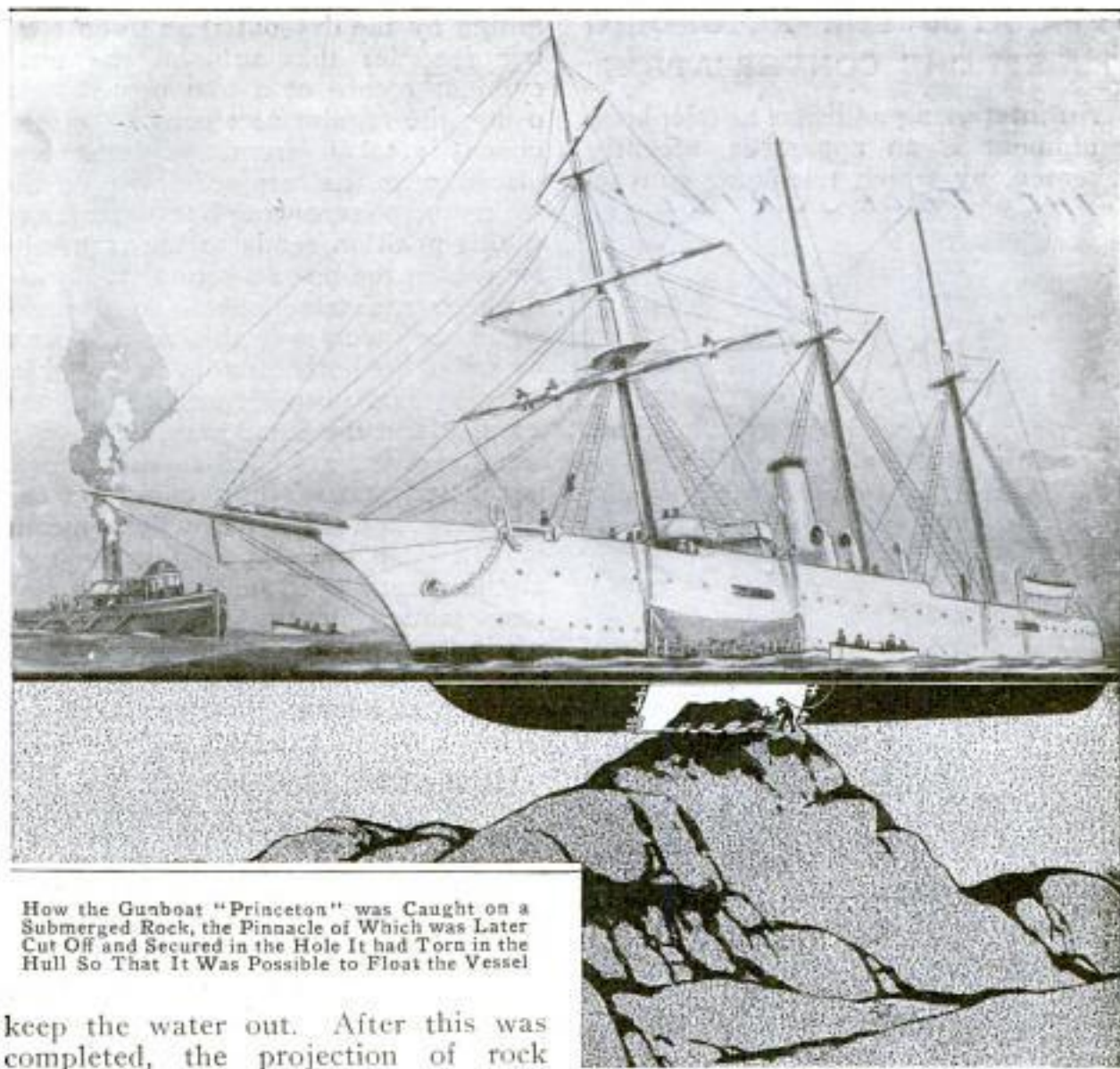

How the Gunboat "Princeton" was Caught on a Submerged Rock, the Pinnacle of Which was Later Cut Off and Secured in the Hole It had Torn in the Hull So That It Was Possible to Float the Vessel

keep the water out. After this was completed, the projection of rock which had pierced the boat was cut from its ledge, and by reinforcing and cementing made fast so that it completely plugged the hole it had made. The "Princeton" was then able to make its way to a dry dock where it could be repaired.

PROCESS FOR MAKING TRUE PORCELAIN TILE

The difficulties involved in making a true porcelain tile are apparently overcome by a process that has just been developed. The tile made by this process consists of a thin layer of porcelain faced with a translucent glaze and backed with a stoneware body, the stoneware constituting about $\frac{1}{2}$ of the tile. The composition of the different

materials is such that they have exactly the same degree of shrinkage, so that there is no danger of warpage in the kiln, and after being fired, the materials are bonded together to form one compact and solid body. The finished tile presents, under the white translucent glaze, an impermeable layer of true porcelain backed by a gray, vitreous stoneware body. No lead is used in the process, and it is therefore free from any danger of the lead poisoning that characterizes the manufacture of some classes of glazed tile.

During the 12 months ended June 30, 1914, the government propagated and distributed approximately 4,000,000 food and game fish.

~~Frank A. Parker
1/2 The Globe
N.Y. City~~

Inventor: Chas. Stegmayer.
Mfr.:
Clifton Porcelain Tile Co.,
51 Clifton New York
N.Y.

**APPARATUS FOR RECORDING
TELEPHONE CONVERSATION**

An interesting addition to telephone equipment is an apparatus, recently invented, by which telephone conver-

"THE TELESCRIBE"



Telephone Recording Apparatus as Used with an Ordinary Desk Telephone

sations may be recorded for future reference. This apparatus consists of a small metal box which contains a set of dry batteries and an extremely sensitive telephone transmitter. Both ends of the telephone conversation are taken up by this receiver and retrans-

mitted by the dry batteries to an electric recorder that acts on the wax-cylinder record of a phonograph. In using, the regular receiver of the telephone is taken from the hook and placed, with the earpiece down, on the socket of the recording instrument, and in this position sends to the transmitter within the box all sounds that pass through the telephone. To use the telephone receiver in this way, it must be wired to both circuits in the telephone. The user then talks into the telephone in the usual way, but uses a small receiver attached to the recording instrument. The phonograph can be started and stopped at will by means of two push buttons, so that no part of the record need be used up during long pauses in the conversation or while "central" is making the connection. The idea is to file the wax cylinder as a permanent record.

**A MACHINE SHOP IN ONE
MACHINE TOOL**

A lathe, drill press, milling machine, and keyseater are all included in one universal machine tool that has just been brought out. This machine is intended for tool rooms, steamships, garages, and establishments generally where special construction or repairs are to be carried out, but where a regular machine-shop installation is not required. It is driven either by a motor or by a line shaft, and occupies a floor space of 11 ft. by 22 inches.

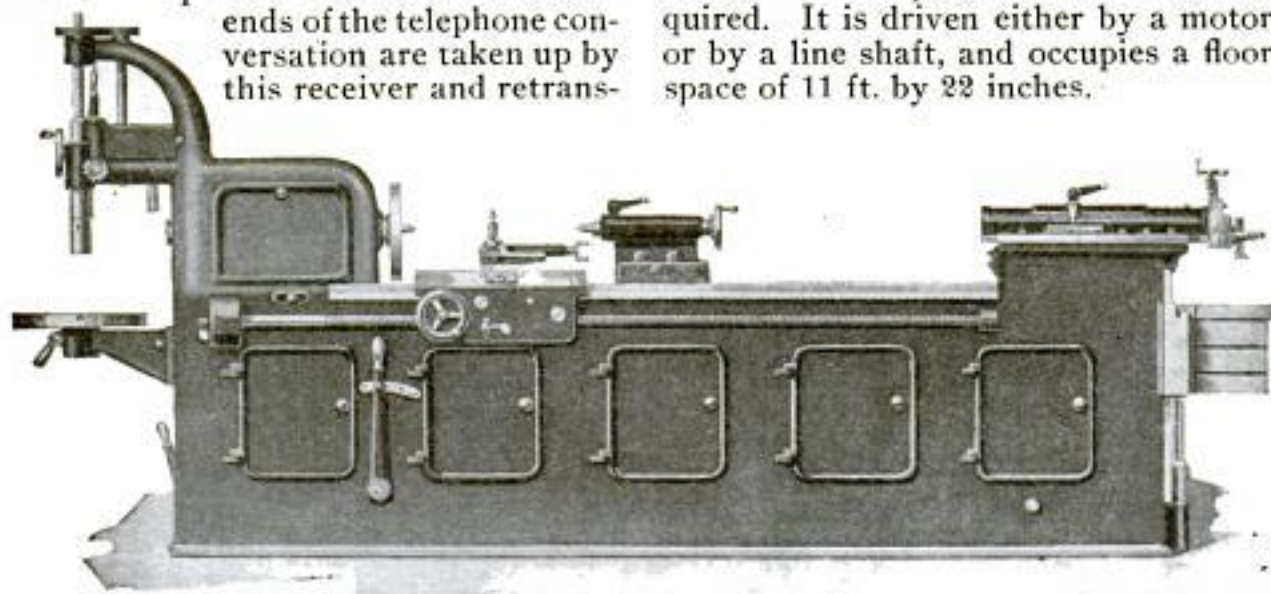

This Machine, Which Occupies a Floor Space of 11 Feet by 22 Inches, Comprises a Lathe, Drill Press, Milling Machine, and Keyseater

Canadian Linderman Co.,
Woodstock, Ont. Canada

m
8463

Scientific American
Feb. 7. 1906

Photo - Underwood & U. 417 Fifth Ave. N.Y.C.

See Data - extracts from various newspapers &

THE SPY AND HOW HE WORKS

Risks Run and Ruses Resorted To by the Men Who Work within
the Enemy's Lines in the Service of Their Country

S. 748 H

By SEARLE HENDEE

WHEN the cables carried the news that Carl Hans Lody, a former resident of Omaha, had been shot as a spy in the Tower of London, a grim picture of the ugliest, and at the same time most romantic, side of war was brought home to Americans.

"Shot as a spy!" The phrase thrills veteran and schoolboy alike and heats the blood of anyone who has a spark of imagination or the spirit of adventure in his veins. In all the English language, there is hardly a word that carries with it such a connotation of contempt as "spy." On the other hand, whether in the preparation for war, or in war itself, there is no more patriotic or self-sacrificing work, nor scarcely any of more profound value to the country which is being served, than that performed by the much-despised, little-appreciated spy.

The rules of war relating to spies are clearly defined and offer no redress, regardless of sex, age, or nationality, to one coming under that classification. If a person, whether man or child, operates secretly within the territory occupied by an enemy during the time of war, for the purpose of communicating information to a hostile army, he is subject to the death penalty. The single provision made in his behalf is that he must be given a fair trial. Yet even this is not assured, for if he be court-martialed and shot, and later shown to have been innocent of the charges against him, there is no redress against his executioners.

Even in the time of peace, the lot of a spy is a hard one if he is captured. In all great countries there are severe penalties for those who work clandestinely to obtain military or naval information for another country. In England, the "Official Secrets Act" makes the communication of such information a felony punishable by long terms of imprisonment, while in Germany there is a sim-

ilar law. To photograph or sketch any of the fortifications of the United States is a crime, while President Wilson recently issued an executive order forbidding airmen to fly over the Panama Canal, and the editor of a western magazine was lately brought into the Federal court for trial because he published photographs of the canal taken from an aeroplane. For 20 years, both France and England have feared that they were infested with German spies. In our own country, the stories of Japanese spies have come to be looked upon almost as a joke, and many persons in Great Britain have so regarded the "German spy" scare there. As concrete evidence of the unmistakable operations of the German intelligence department, however, the British government recently announced that the police had investigated 120,000 suspicious aliens, and as a result 342 persons were imprisoned, against some of whom there is claimed to be unquestionable evidence of guilt. Even more startling than this was the discovery early in the war that a German spy was serving in the British navy, communicating all available information about his ship to an uncle in Berlin, who in turn presented it to the intelligence department. This suggested the possibility, when the British battleship "Bulwark" was blown up, apparently from within, that this was the work of a spy.

Of all the systems of espionage ever organized, that of the German war office is unquestionably the farthest-reaching and most efficient. On the heels of the British government's assurance that the German system of espionage had been effectively broken in the United Kingdom, numerous British war vessels were torpedoed, many sentries were shot, dispatches containing accurate information important to the enemy were intercepted merely by

chance, while a German squadron succeeded in stealing past patrol boats, navigating uncharted and mined passages, firing on the Suffolk coast and then escaping. How some of the information which made these things possible leaked out, is known, although the spy has not been apprehended and is still carrying on his work. A secret agent, possibly a dozen of them, stationed on the coast, signaled after nightfall to a "neutral" fishing boat lying a short distance off shore. This was accomplished by means of lights displayed from an upper window of a house a short distance from the water. As soon as the cryptic message was received, the boat—which was unrestricted—put off toward the Dutch coast. But down in the hold of this vessel, protected so as to escape detection in case the craft were searched, was a pigeon loft. A few hours from the time a pigeon was liberated, the chief of the German intelligence department had a translation of his spy's advices before him. This system continued uninterruptedly for days until finally some of the vessels, with their pigeon lofts, were searched by British patrols, and the North Sea was subsequently closed to traffic. But the spies were not captured, nor their communications stopped.

The Rev. Lord William Cecil recites the story of how a British raid on a German squadron in the North Sea was frustrated. During a heated argument in an alehouse, an English sailor, championing the prowess of his navy, declared that he knew positively that dreadnaughts, cruisers, and torpedo boats were at that moment pushing ahead under full steam to surprise the German boats. Shortly afterward the bar was closed for the night, and one of the group, who had precipitated the argument, mounted a bicycle, which had a brilliant headlight, and struck down a road leading along the coast. After a time he jumped from the cycle, released the air from the front tire and then set about to mend a "puncture." In doing this he repeatedly passed in front of the lamp, crossing the patch

of light now for just an instant, now deliberately stopping in front of it. Presently he inflated the tire and pedaled back to the city. When the British battleships arrived at the scene of the intended raid, the Germans were not there. The bicyclist was a German spy. His message, flashed in dots and dashes, had been seen through the periscope of a waiting German submarine.

Yet, flashing code signals to a waiting boat is not nearly so hazardous an occupation as that of the aerial spy who uses the enemy's territory as a base of operation. This method of espionage is distinctly new, and apparently it is as effective as it is unique. As evidence of this, a notice has been posted extensively throughout Scotland, offering a reward of \$500 for information leading to the discovery of secret aeroplane bases which, it is believed, are located in unfrequented parts of Scotland, where supplies of oil, gasoline, and mechanical parts are stored by the enemy. The frequent appearance of unknown aeroplanes over North Britain has given rise to this belief.

The spy does not always work as openly as this. His operations are usually carried on so subtly that he might easily escape detection so long as no untoward circumstance points suspicion directly to him. There are few who would have a keen enough perception to catch the significance of an impressionistic charcoal drawing of a picturesque landscape. And it is for this very reason that German spies were successful, at least in the early part of the war, in making sketches according to a pictorial code which apparently bore no more relation to things military than the ordinary wash drawings or pencil sketches one sees daily in the art shops. In the hands of the German war office, however, these innocent-looking pastoral scenes are not studied for their artistic values. The gently sloping knoll represents a fortification; the quaint rail fence, a barbed-wire entanglement; the bushes on a crest of the hillock, armored gun turrets, and the trees, outer gun positions.

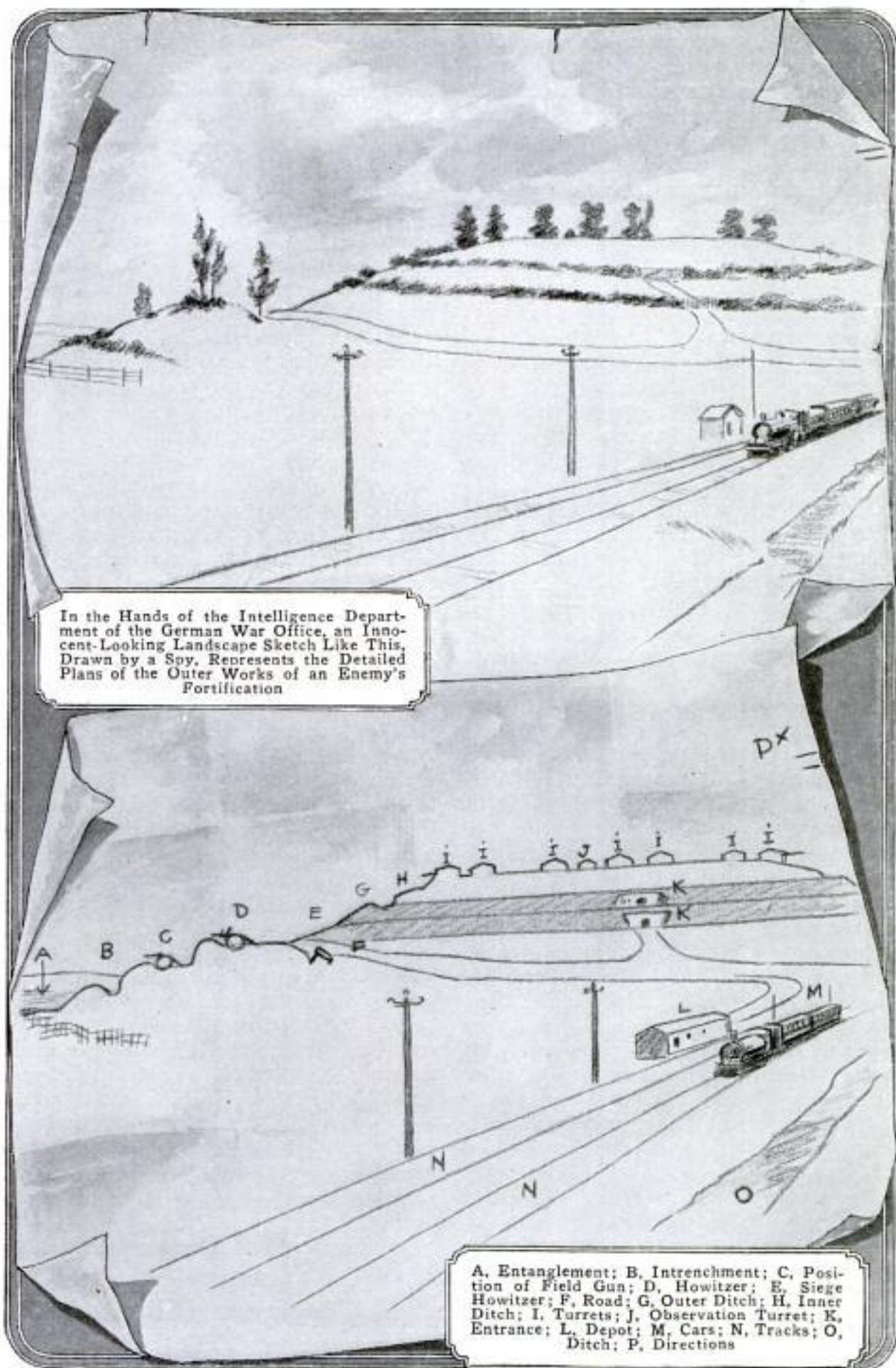

In this way the spy, who for the time being is an "art student" sketching from nature and entirely ignorant that he is near an important fortification, provides his government with a detailed map of the fortress in question.

A similar system which is being used extensively by the Germans, and evidence of which is to be found through Belgium and over the frontier of France, is carried out by crudely drawn pictures of cows scrawled on gates, fences, and buildings. These drawings have been encountered by the allies on numerous occasions. They are sketched according to a code, different postures conveying different facts to the German forces. Just what the code actually is, is not known, but how it works is evident. A cow with its tail in the air means one thing, with its horns curved down, another—every different posture has a different significance. Like this was the sign posted over the frontier of France ostensibly advertising a German brand of desiccated soup, but in reality pointing out fortifications, mined ground, food stores, and similar things, for the enemy.

There are many other ways by which an agent, working ahead of his army, may and does communicate information to it without passing back through the lines. Some of these systems are employed to inform the artillery, for instance, where its shells are falling, thus enabling it to get the proper range on the enemy's positions. Some of the subterfuges are so ingenious and executed so cleverly, that detection, because of the act itself, is difficult. For instance, clothes must be washed in war time as well as in days of peace—yet, a clothesline may be made to talk by arranging garments on it by size and color according to a prearranged code. Likewise, the vanes of large windmills, so frequently seen on the Continent, transmit messages merely by turning them to certain positions, a method often used in time of peace to convey information to surrounding neighbors. Such a simple operation as that of washing a window may result in the ultimate defeat of an army. It is readi-

ly seen how a spy thus engaged can signal to a lookout, by means of dots and dashes, for long periods of time, if need be. And the polished interior of a watchcase, a bright spade, a saw, and similar things, all have been used for flashing heliograph messages.

A spy may be anywhere, and often it is almost impossible to tell friend from foe. In the first part of the war, for instance, France was startled to find that several officers and a number of privates in its army were secret agents of the kaiser. During one of the heavy battles along the frontier, a British convoy, hurrying to the front with ammunition, was stopped and told that a detachment of 500 uhlans was along the road ahead. The warning was given by the driver of an English motor car who wore the uniform of a British officer. "Take the road to the left, and after 10 miles bear to the right," he shouted in haste, and then dashed away in the direction he had indicated. Hardly had his words been spoken when 14 British veterans were on their way to rout the uhlans, who, however, were not to be found. A little farther on, the man in the motor car encountered a detachment of British soldiers and was forced to stop. Although his car was English, and he spoke English like a Britisher, he was wearing cavalry breeches with an infantry officer's tunic. He was a German spy. He was shot on the spot. The uhlans were down the left road, whither he had directed the convoy.

Here is a dispatch sent out from the Canadian capital a few weeks ago: "A secret store of arms and ammunition is being searched for on the Isle of Orleans in the St. Lawrence River, just off Quebec. A concrete base upon which a siege gun could be mounted already has been found here. A German, two years ago, bought a tract of land on the Isle of Orleans and established there a plant for the manufacture of concrete blocks. It is upon this property that the concrete foundation has been found. It commands the defenses of Quebec and of the St. Lawrence channel."

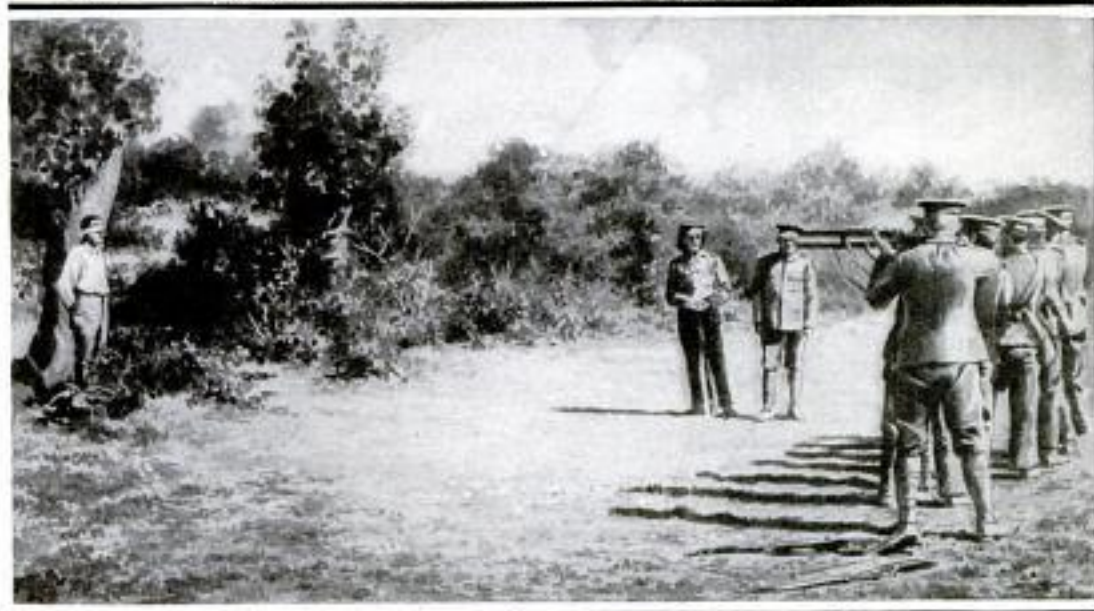

Actual Photograph of the Execution of a German Secret Agent by a British Firing Squad

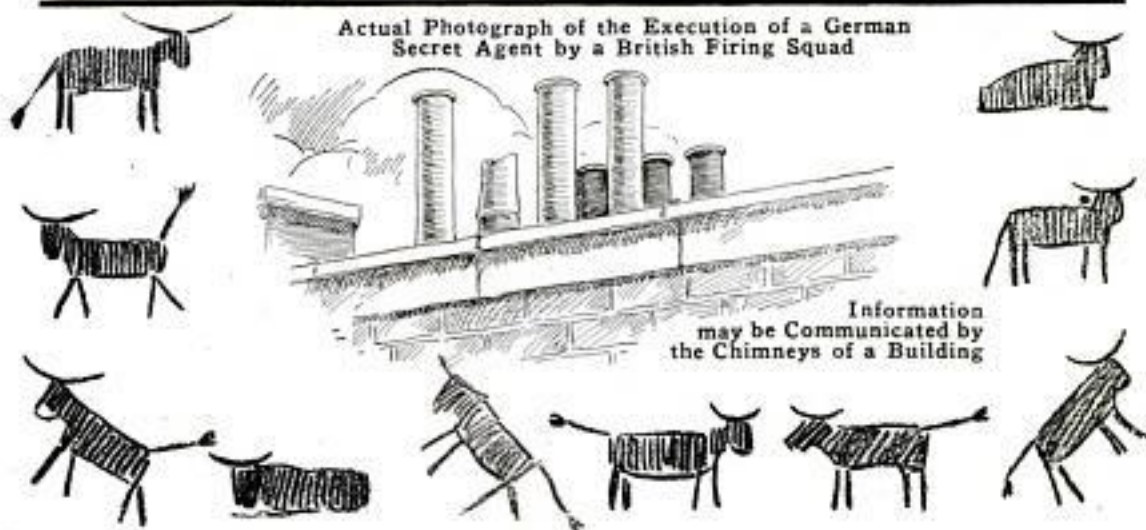

PHOTO COURTESY ILLUSTRATED LONDON NEWS

Each Different Attitude in Which a Cow is Pictured Carries Pertinent Information to German Army

The Liège forts fell before the 42-centimeter guns of the Germans. It is interesting to note, in the reports of correspondents, the accuracy with which the shells from these big German guns were fired. Especially is it interesting when it is remembered that Germany had detailed plans of the Liège fortifications, for German skill helped to build them; and that the massive concrete foundation on which one of these guns was mounted was the site of a German "factory." The range had been predetermined. Therefore, no shells were wasted, nor any time lost in finding the range. It was after this disclosure that the British government discovered that a German "chocolate factory" occupied a position commanding the new naval base at Rosyth, Scotland, while the French government found several "factories" on its own frontier, which covered concrete foundations prepared for the heavy German siege guns.

In America, a spy might operate in comparative freedom, but not so in Europe, where the police system is much different from ours. Because of conditions there, his work must be done delicately. The mere fact that his daily routine is different from that of the people surrounding him, may be sufficient to attach suspicion to him. And all Europe is "spy mad." Therefore, what he says, whom he writes to, and where his letters come from, are all matters which may contribute at any moment to his arrest. His mail possibly is inclosed in an envelope bearing the return address of a German hardware concern and directed to his accomplice, a dealer in London who is in the pay of a foreign government. He may be at Liverpool posing as a physician, and his mail forwarded to him from London in an envelope bearing the address of an English chemical house. Suppose he misses this letter and it is returned to the English factory. Suppose it reads: "Must cancel. Johnson very ill. Lost four days. Shall leave shortly.—Chas. Inglis." There is little of a suspicious nature about its text, yet a dispatch in these very words

was one of the strongest pieces of evidence—a code message to the German authorities—which helped to convict Carl Hans Lody, the German naval lieutenant who was executed at the Tower of London.

This is how a spy works. It is how Lody worked, and how he failed. Incidentally he traveled under the guise of an American citizen, spoke English fluently, was thoroughly familiar with the United States, and even carried an American passport—stolen from a Chicagoan, who had left it at the German foreign office to have it approved. He operated under the name of this man. He visited Forth Bridge, Liverpool, Dublin, and other places. He gained important information concerning the movements of the British navy, noticed that the Houses of Parliament and the Bank of England were protected from Zeppelin bombs by strong wire nets, obtained details of the armament of certain British ships—all of which was admitted in court to be correct—and then communicated the facts to the German admiralty.

Lody, like every secret agent, was a fatalist. He played his game for big stakes against heavy odds, and lost. He was shot at the Tower of London within the shadow of the same buildings where Anne Boleyn, Lady Jane Grey, Thomas More, Sir Walter Raleigh, and others famous in the pages of history, were beheaded. His execution is the first that has occurred within the precincts of the ancient fortress on the Thames since 1747, when Lord Lovat was decapitated, as the most effective means of terminating his claim to the British throne. As a spy—said to be one of the ablest ever trusted by the German intelligence department—Lody died behind the blackened walls of an institution in which more stirring scenes in the political and religious history of the English-speaking people have been enacted, than any other spot in England. But though performing the greatest possible service for his country, he was without assistance from it, unknown, and repudiated by it—a spy.

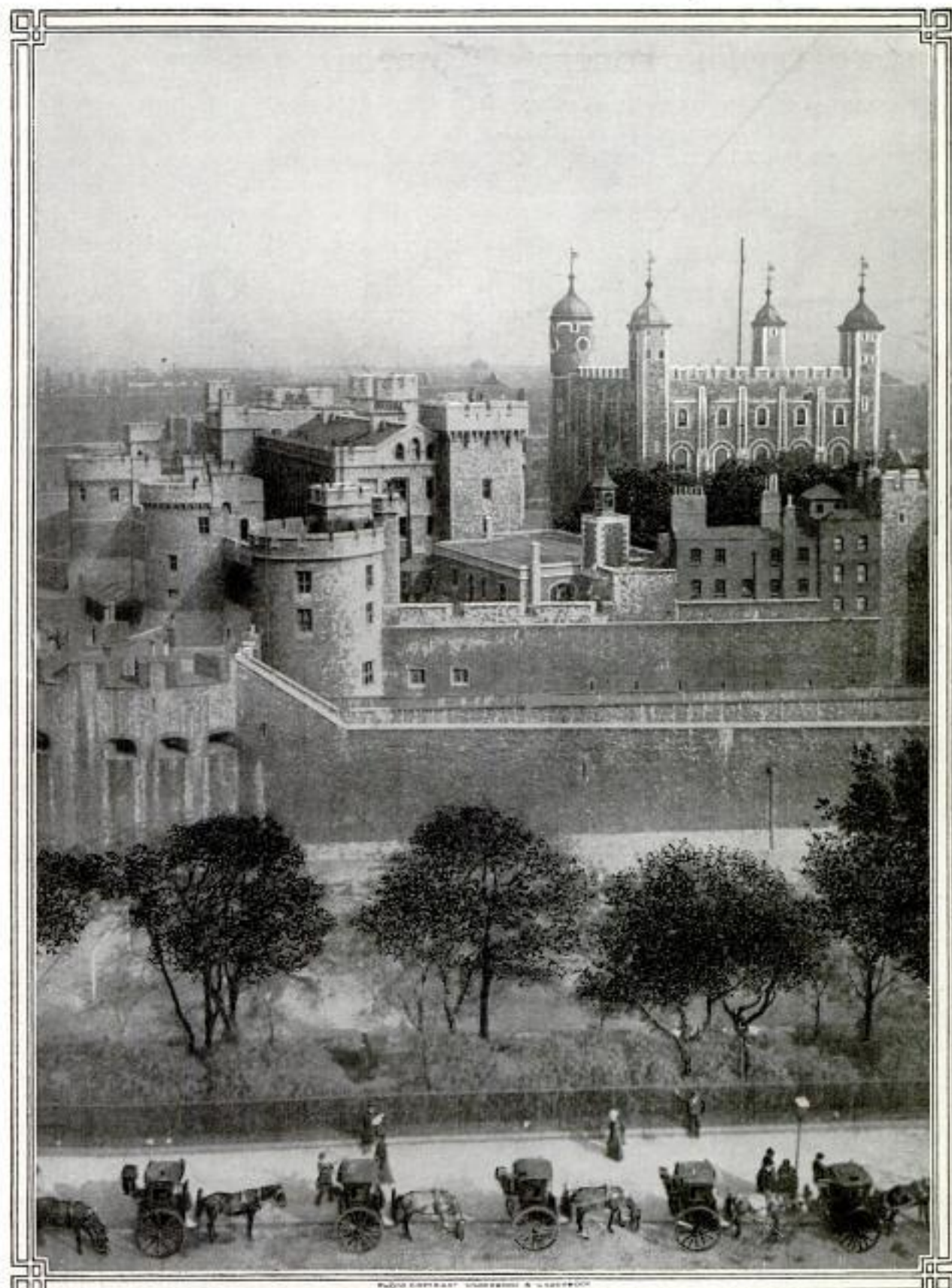

THE Tower of London, Where Carl Hans Lody, a Secret Agent of the German War Office, was Recently Shot. This Execution Is the First That has Occurred within the Walls of the Ancient Fortress Since 1747. From the Days of William the Conqueror, the Builder of the Fortification, Which was Designed to Defend the Maritime Approach to the City, Down Almost to the Present Time, This has been the Stage Where Probably More Stirring Events in English History have been Enacted Than in Any Other Spot in Great Britain. The Institution has Served as a Royal Palace, State Prison, Place of Execution, Government Mint, Depository for the Crown Jewels, and Armory

Frank C. Perkins
Eric Co. Savings Bank

Bldg 232 Buffalo, N.Y. POPULAR MECHANICS

2. W. Davis
411 Jenifer Bldg,
Wash. D. C.

MOTOR SUPPLIES FRESH AIR FOR TELEPHONE BOOTHS

Through the employment of a ventilating apparatus, adequate air circulation has been supplied the telephone

NEW PAPER-MONEY DESIGNS ARTISTIC AND HISTORICAL

The \$250,000,000 issue of Federal-reserve bank notes, which includes \$5, \$10, \$20, \$50, and \$100 notes, is in some ways the most interesting issue ever put out by the government. Each denomination is designed not only to furnish the greatest possible protection against counterfeiting, but to be of artistic and historical value as well. The \$5 note carries a portrait of Lincoln; the \$10 note, a portrait of Jackson; the \$20 note, a portrait of Cleveland; the \$50 note, a portrait of Grant, and the \$100 note, a portrait of Franklin; and it is planned to have these portraits appear on the same notes in all future Federal-reserve issues. The back of the \$5 note carries pictures representing the discovery of America, and the landing of the Pilgrims, while the \$10 note carries typical scenes of agriculture and manufacture. A symbolical picture representing the United States presiding over the Panama Canal occupies the entire back of the \$50 note. On the back of the \$100 note is a picture with a symbolical figure representing America at the center flanked by figures representing Peace, Plenty, Labor, and Mercury, the latter being intended to suggest the distribution of the harvest.



A Complete Change of Air in These Telephone Booths is Made Each Minute

booths in one of the Boston substations. The arrangement consists of a motor-propelled fan which drives currents of fresh air through a duct extending over the top of a line of booths. The air is delivered into each of these through deflectors in such a manner that the occupant is not exposed to draft while using a telephone. As is customary, the doors to the booths are double. Because of this it was possible to arrange openings at the bottom of the inside door and at the top of the outer one, thus providing an exit for the air in such a manner as to eliminate the transmission of sound from the closet to the outside room.

APPLE CIDER CONCENTRATED BY NEW PROCESS

A new process of preserving apple cider produces a condensed liquid that will keep better than raw cider and is easily transformed into sweet cider by the addition of water. The cider is first frozen solid. The ice is then crushed and put into a centrifugal machine such as is used in making cane sugar. The concentrated juice is thrown off by the centrifugal action, while the water remains in the machine as ice. At ordinary refrigerator temperatures this cider will keep for a month or six weeks, and at low temperatures in cold storage it will keep for an indefinite period.

Weekly News Letter

New England Telephone & Telegraph Co.
Car to Boston Sta. Boston, Mass.
E. P. of air. approx. 64 c. f. in booth - person
changing air about once a minute (7 Booths)

Fan 850 R.P.M. - 1650
Changing air about once a minute

HARDWARE COSTUMES SHOW FASHIONS

During a fashion-show week in San Francisco, a hardware merchant took advantage of the opportunity for a novel window display by exhibiting, on wax figures, millinery and feminine apparel made from various articles selected at random from his store. The popular styles in costumes and hats were carefully imitated by an ingenious arrangement of fiber and metal doormats, wire screening, tin pans, hinges, knobs, brushes, garden hose, and other commodities. The setting represented that of a millinery shop, showing a customer engaged with a saleswoman. About them was a large supply of odd creations in head-gear, all of which were made from wastebaskets, mousetraps, cuspidors, molds, and other devices, and trimmed with screening, dusters, and tubing.



This Window Display Appeared in a Hardware Store during Fashion-Show Week at San Francisco

One of the figures was dressed in a coat made of cocoa-fiber mats and a skirt formed of metal doormats over a copper underskirt.

8373 AUTOMATIC GRINDER FOR LATHE-ARBOR CENTERS

A center grinder that is designed to produce an accurate 60° center on a lathe arbor and to do this without the tedious adjustment and trial grinding usually necessary, has been placed on the market. This grinder is equipped with a taper shank which is inserted in the tailstock of the lathe in place of its regular center, and the feature of the tool is that the spindle on which the grinding disk is carried is set at a 30° angle with this shank, so that the center is ground at a 60° angle without further adjustment. In the body of this

device is a small electric motor which furnishes the power for grinding. The feed is regulated by a cross arm carried on the top of the grinder.

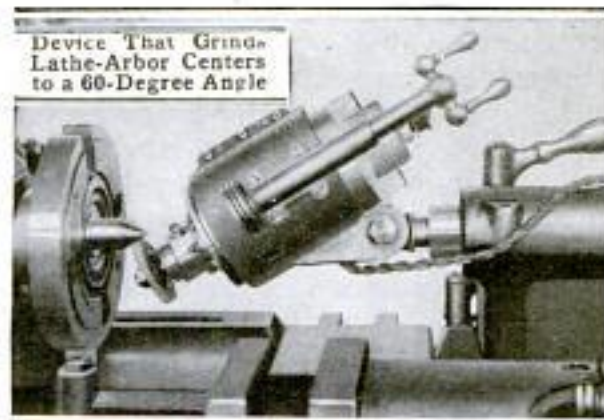

Device That Grinds Lathe-Arbor Centers to a 60-Degree Angle

The Reed & Smith Electric Steel Co.,
Cincinnati, Ohio.

MOTORING ROBE PROTECTS

8785 m ENTIRE BODY

One of the newest of motoring accessories is a robe that is a combination of foot protector, lap robe, and chest



With the Chest Protector in Place and the Feet in the Pockets, the Entire Body is Protected

protector. This robe is made for two or three passengers, as desired. At the bottom are roomy pockets, one for each passenger, which protect the feet from the wind, while attached to the top of the lap-robe section is the chest protector, which is held in place by adjustable straps fastened around the neck. With the chest protector fastened in place and the feet in the pockets, it is impossible for the robe to slip out of position. The greater part of the weight is carried in the lap, so that no appreciable strain is felt on the neck. One of the advantages of the robe is that it does away with the usual necessity for carrying extra wraps.

FOREST-SERVICE STANDARDS

8792 m FOR HICKORY HANDLES

Definite standards for ax, sledge, adz, pick, and other hickory handles have been established by specifications prepared by the United States Forest Service. The Panama Canal authorities have already purchased large quantities of handles made according to these specifications, at one-fourth less than the price formerly paid. The specifications have also been adopted as standard by the war and navy departments, and have been approved by the trade. The new rules are a result of a long study of the subject, covering exhaustive strength tests, investigations of the growth of hickory, processes of manufacture, and market conditions. Handles are selected according to weight as influenced by the density of the wood. Heartwood, known as red hickory and formerly discrim-

inated against in commercial grading, is accepted, since it has been found that weight for weight it is as serviceable as white hickory. Handles which contain small sound knots, or bird pecks so located as not to affect the strength, are also accepted.

NEW EXPLOSIVE IS SAFE

8797 m AND POWERFUL
SABULITE

A new explosive that is 50 per cent more powerful than 45-per-cent dynamite, and is said to be as safe to handle as so much sawdust, is being introduced in the mines of Montana. According to reports, this explosive possesses qualities that make it par-

mining + Engineering
World - Oct. 10, 1914
Invention of a Belgian
Copyrighted material

Auto Comfort Robe Co.,
Gloversville, N.Y.

Forest Service

Managing Asst. *W. J. ...*
Royal Financial Corp. *London, B.C.*

Substanty Dept. *H. W. Johns. Manville Co.*
813 Superior Ave. N.W.

Europe:
Willley Mining Machy Co. Ltd.
Specially suited to mining work. It can only be exploded by a detonator that applies both heat and shock, neither of these alone being capable of exploding it. The product of the explosion is about 60 per cent water vapor, with a little nitrogen and oxygen, and minute quantities of carbon dioxide, silica, and lime.
London, E. C.

POPULAR MECHANICS *Cleveland, Ohio* 235

BURNING MATCHES CAUSE STUBBORN FIRE

8:15 P.M.
A stubborn fire resulted recently when matches stored on the top floor of a wholesale grocery house in Youngstown, Ohio, became ignited. Between two and three carloads of



A Stubborn Fire Resulted When Several Carloads of Matches Stored in This Building were Ignited

bon dioxide, silica, and lime, so that the miners can resume work in the thick smoke following a blast without danger or discomfort. While the exact composition of this explosive has not been given out, it is known that the base consists of ammonium nitrate, and that the principal ingredient is calcium silicate.

matches were carried in storage on this floor and they burned fiercely for over eight hours. The heat was so intense that it was difficult for the fire department to get close enough to the blaze to fight it effectively.

Propellers on many of the European air craft are made from selected ash.

A. M. Wright
 Panama Pacific Exposition
 San Francisco, Calif.
 236

R. F. Lang 8-187 Bridge St
 N. Y. C.
 Sole Agt - U. S. & Canada

POPULAR MECHANICS

BEAUTIFUL LAMP PEDESTAL

6916 W FOR PANAMA FAIR

The Panama-Pacific International Exposition at San Francisco will be



COPYRIGHT BY PANAMA-PACIFIC INTERNATIONAL EXPOSITION COMPANY

conspicuous by the beauty of its lighting arrangements, of which mention has been made in previous numbers of this magazine, but a new design for a pedestal supporting two large globes is of rare artistic merit. The globes will contain the new nitrogenous lights, the latest incandescent lamp, the filament of which in-

stead of glowing in a partial vacuum, is inclosed in nitrogen gas, giving great brilliancy with small consumption of current, and avoiding the discoloration of the globe, so objectionable in the ordinary tungsten lamp.

"Marmor"
 TOURING CAR BREAKS SPEED RECORD

8762 m RECORD

A new speed record for stock touring cars was set at the Indianapolis motor speedway recently when a touring car, carrying five passengers, went 62.89 miles in 60 minutes in an official test. Before this test it was generally believed that no stock car equipped with a motor of less than 50 hp. could average as good as a mile a minute with four passengers. This car had only 41 hp., and made the run with the top and windshield raised.

Machinery, 10/3/14
 BRASS CASTINGS MADE BY

8419 HYDRAULIC PRESSURE

A process for making small brass machine parts, plumbers' brass fittings, and similar products, by hydraulic pressure has been developed in Germany, and it is thought that this method possesses important advantages over the usual method of casting. The high pressure under which the pieces are shaped serves to compress the metal and materially increase its strength, such defects as blowholes are avoided, and the finish of the work is often such that no subsequent machining is required. In addition to these advantages, the process is said to be cheaper than casting where the number of pieces to be made is sufficiently large to warrant the expense of installing the apparatus and making the necessary dies.

8592 m
 BANK BUILDING NO LARGER THAN A HALLWAY

What is probably the smallest bank building in this country, if not in the



world, is located at Raleigh, N. C. The site of the building was originally a hallway. It has a frontage of 7 1/2 ft. and a depth of 25 ft., and in this limited space an important banking business is carried on.

CA large percentage of the popcorn grown

in the United States is shipped out of Odebolt, Ia., and North Loup, Neb.

H. E. Zimmerman
 Int. Morris, Ills.

Analyse Marmor Co
 J. M. Clark's "Poplar"

Chicago Daily News

International News Service

200 Williams St.

New York City

8801

m

SELF-PROPELLED BARGES IN LAKES-TO-GULF TRAFFIC

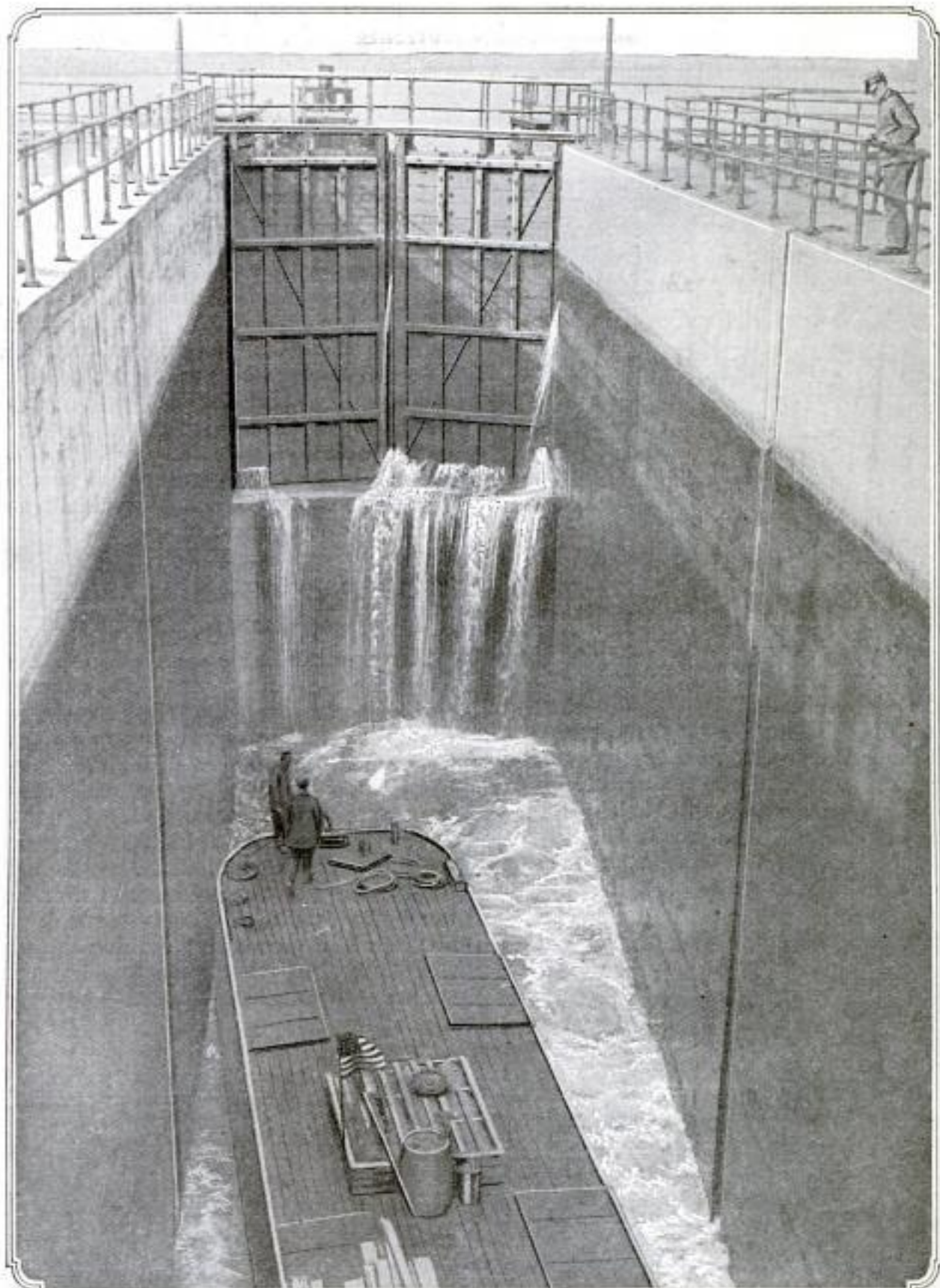

A DECIDED step was taken in the development of water-borne traffic between the Great Lakes and the Gulf of Mexico when a train of self-propelled barges loaded with 600,000 ft. of Louisiana red gum and oak made the trip from New Orleans up the Mississippi and Illinois rivers to the head of river navigation at La Salle, Ill., and then through the old Illinois and Michigan Canal and the Chicago Drainage Canal to Chicago. These 1,000-ton barges are driven by internal-combustion engines using producer gas which is made on the vessels from waste coke as needed.

Data not included
ELECTRIC-LIGHT EQUIPMENT
FOR MOTORCYCLES

8732 H
8749 A combination electric-lighting and ignition system, contained in a single unit, has been devised for motorcycles



Powerful Electric Searchlight Provided for Motorcyclists

and is embodied in one of the late models. A magneto generator, comprising the major part of the plant, is housed compactly in a protected place inside of the cradle and back of the engine cylinders. Adjacent to this is a strong storage battery, which serves as an auxiliary unit for both the ignition

and lighting systems and also furnishes current for a horn. The electric equipment is all controlled by an automatic switch. When the motor is stopped, the horn is cut out so that it cannot be meddled with while the machine is unattended, and at the same time the storage battery is connected in so that the lamps remain lighted. The headlight is fitted with two bulbs, one of low candlepower for city service, and a large one for use when a powerful light is needed, the strength of which is indicated by the accompanying photograph. The tail lamp is so mounted that it is quickly detached for inspection use. Practically all the wiring is incased in metal tubing so that there is little danger of a cross circuit from worn insulation, and small chance of accidentally breaking the connections.

*Kerry Electric Co.
 Anderson, Ind.*

8690 **OPERATING AN ALASKAN RAILWAY IN WINTER**

Keeping the line cleared of snow and ice is the biggest problem in the operation of the railway that runs from Cordova, Alaska, to the Bonanza copper mines. Although snowsheds have been built along the most dangerous places, it is not an uncommon thing for this railway to become blockaded with snow so that trains are stalled for weeks, and on one occasion there were no trains for nearly two months. Rotary snowplows are in almost constant service during the winter, but when the snow drifts to such depths as 40 ft., as it sometimes



Stalled in an Alaskan Snowdrift



Digging Down to the Railroad through 40 Feet of Snow

Rotary Snowplows Like This Are in Almost Constant Use on Alaskan Railroads in Winter for Keeping the Line Open

*E. E. Hurja
 c/o Post-Intelligencer
 Seattle, Wash.*

Lester A. Bargent
 933 1/2 St. N. W.,
 Wash. D. C.

does, even these powerful machines are unable to keep the line open. On one occasion the fuel was used up and the rotary was caught in a snowdrift. The conductor managed to reach a relief telephone and notify the Cordova office of his plight. Oil and several dog teams were sent out on a relief engine. When this engine was stopped by the snow the oil was loaded on the dog sleds and taken over miles of drifts to the stalled rotary. The railway follows a river bank for much of its length, and during seasons when there is alternate freezing and thawing, the overflow from the river forms over the track a solid sheet of ice that can be removed only by dynamite.

gine clutch to the sickle bar, entirely independent of the traction-power



Gasoline Mowing Machine Which may be Used Also for Plowing or Cultivating

**CIGAR LIGHTER HAS CASE
 LIKE SMALL WATCH**

Bearing the appearance of being an ordinary timepiece, a cigar lighter has been invented which is fitted in a case similar to that of a closed-face watch. A pressure of the thumb upon the stem opens the lid, like that of a hunting-case timepiece, while a further depression of the stem ignites the burner. When the stem is pushed down as far as it will go, it pulls a lever which releases the sparking wheel. Because of this arrangement the case may be opened for cleaning or refilling without producing a flame.



transmission shaft. The cutting bar may be removed at will, and a plow, cultivator, drag, or other implement, substituted. The machine is equipped with a 2-cyl., 8-hp. motor.

**HOW LUMBER IS PILED IN
 ENGLISH YARDS**

In English lumber yards it is the custom to keep together all the lumber that has been sawed from one log, so that the purchaser has the advantage of uniformity in his lumber. This custom is followed not only in rough lum-

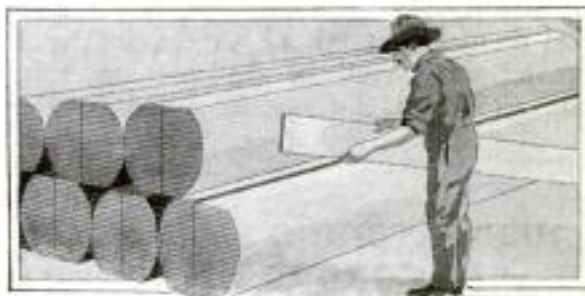

The English Custom in Piling Lumber Is to Keep Together All the Lumber Sawed from One Log

ber, but in that used for cabinetwork, interior trim for buildings, and for other purposes. *The Woodworker* Sept 1914

Coal-tar creosote and zinc chloride are mainly used as wood preservatives.

**NEW "STEEL HORSE" BUILT
 FOR FARM WORK**

One of the recently developed motor-driven implements intended for agricultural purposes is a three-wheeled mower which is capable of being used for various other purposes on a farm. It has a direct chain drive from the en-

Andrews R. B. White
 Newark N. J. (Inventor)

*mower mfd by: Ward
 Tractor Co., Lincoln, Neb.
 Engine made by - Terrahman
 Mantee - 146000 Lincoln Neb.*

John L. Jackson
32 West main St., north,
Chatelet, Ont. Canada

MOTORCYCLE-MADE INTO**8761 m MOTOR SLEIGH**

By an ingenious arrangement of runners a resident of Ontario is able to use his motorcycle with side car with-



Motorcycle with Side Car Equipped with Runners for Operating in Snow

out difficulty during the Canadian winter. In preparing the machine for the winter the rubber tires are taken off the front wheel of the motorcycle and the wheel of the side car, and runners are fitted on and bolted to the rims of these wheels. The rubber tire is left on the rear wheel for driving, and works very well in the rut made in the snow by the runner fixed to the front wheel.

DUST-CATCHING LIQUID FOR**8645 m COAL MINES**

A liquid, composed mainly of glue and a 40-per-cent solution of calcium chloride, is coming into use as a means for catching and keeping down the dust in coal mines. The liquid is carried in a tank which can be taken down the shaft in the cage and then mounted on wheels and moved about the workings, as required. It is then sprayed

Compressed air magazine
Oct. 1914

on the floor, walls and roof with an apparatus that uses compressed air at a pressure of about two atmospheres. The sprayed surfaces look for a short time as if they had been whitewashed, but soon become coated and blackened with the coal dust. Floors treated in this way are slightly springy when walked on, but are not sticky. The liquid is applied about once in three months, and costs about 50 cents per yard a year. In addition to its value as a dust collector, it is said to preserve the rock from erosion and the timber from decay.

**8359 ARTISTIC AND SERVICEABLE
CONCRETE WATER TROUGH**

Standing in a public square at Redlands, Cal., is a concrete water trough which is both substantial and artistic. It is a type of basin which is serviceable as well as inexpensive, and represents a style of work which is being widely adopted throughout the state. In many of the coast cities concrete is being used in the construction of park benches, street-car waiting stations, drinking fountains, and other utilities. The noticeable effect of this is that in

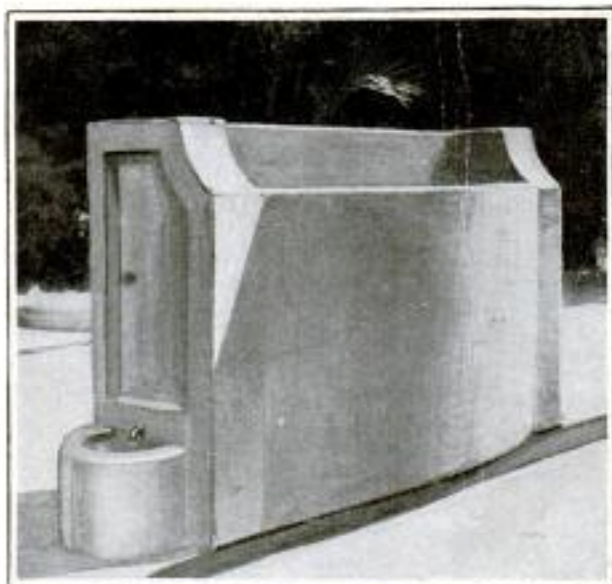

A Rough, Artistic Water Trough Made of Concrete

the majority of cases the device, besides filling the function for which it is intended, adds to the general appearance of the surroundings.

H. S. Marshutz Box 966
Stanford University,
Cal.

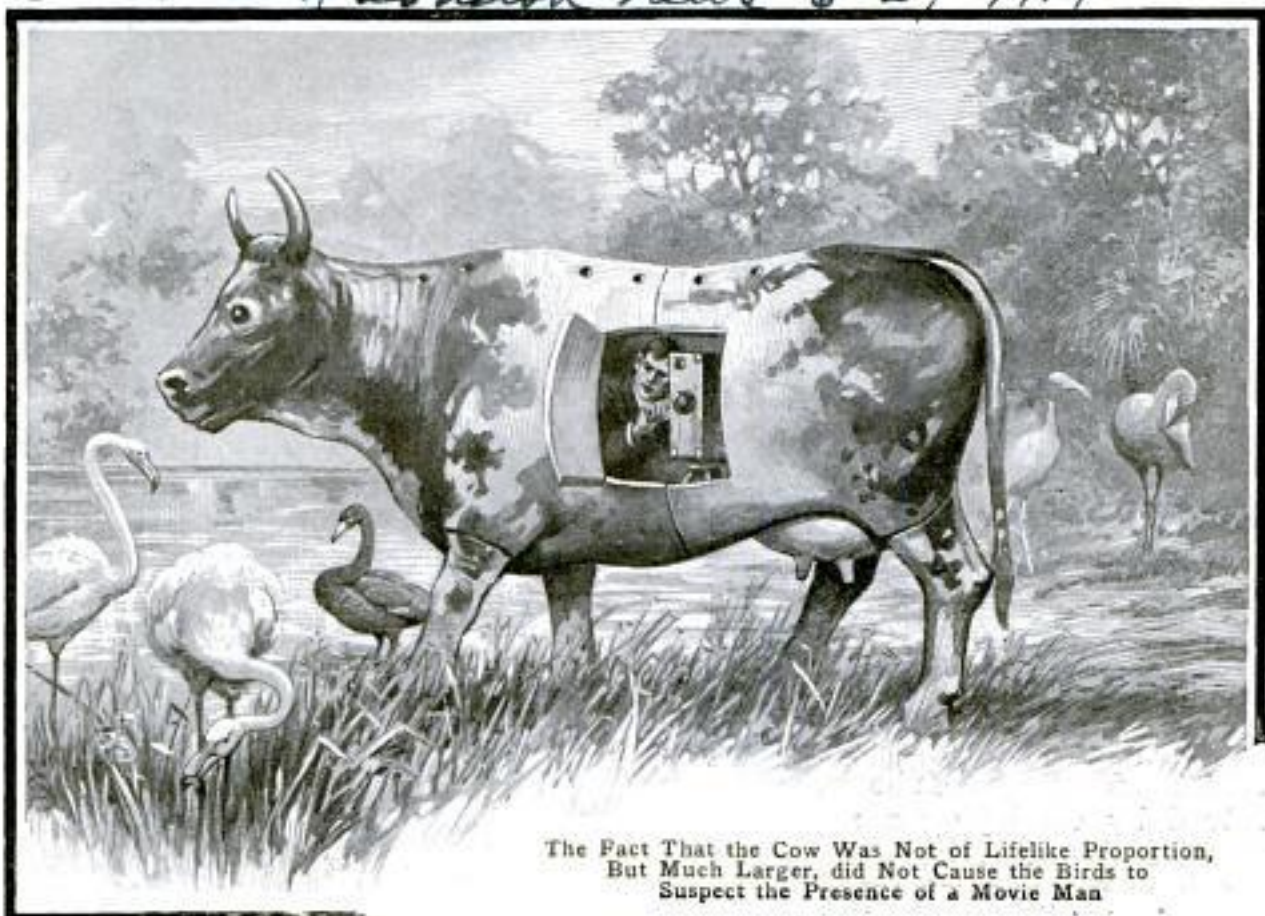

The Fact That the Cow Was Not of Lifelike Proportion, But Much Larger, did Not Cause the Birds to Suspect the Presence of a Movie Man

COURTESY ILLUSTRATED LONDON NEWS

7856 **"COW" SECLUDES MOVIE MAN
 TAKING BIRD PICTURES**

Remarkable studies of tropical bird and animal life were recently made with a motion-picture camera by an operator who was able to lie for hours at a time in artificial blinds within a few feet of rare feathered creatures, leopards, lions, and other animals of the jungle. One of his interesting methods of getting close to the haunts of different birds was the construction of a large cow, which, like the ancient Trojan horse, secreted him and his camera, permitting him to take movies without being discovered or frightening away his subjects. A peculiar thing regarding the cow, and the attitude of birds and certain animals toward it, was that, although it was much larger than life-size, and remained for hours immovable and silent, it did not arouse any suspicion. It was of the form and color of a real cow, and that was sufficient to deceive other animals. Pictures showing intimate glimpses of wild animals springing upon game, playing

with their prey as a cat does, and many other unusual studies were caught by the camera from the interior of rocks made of canvas, and from hiding places in hollow trees.

NEW GAS RANGE SAVES

7744 m **FUEL**

Making two gas burners do the work of five, with a resulting saving in fuel,

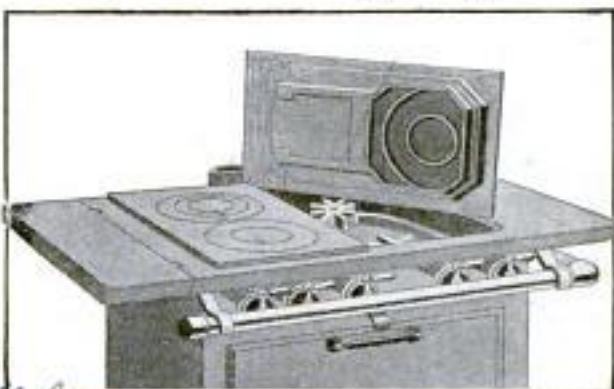

The Front Lid is Heated by the Direct Action of the Flame, and the Hot Gases Pass to the Rear through the Box Flue, Heating the Rear Lid

H. R. Corwin

is the feature of a new gas range that has just been brought out. The top

("The Top Box Flue Heat Distributor") Fireman's Insurance Bldg., Newark, N. J.

*Mrs. Louis Gordon Hotel
 4248 N. Dearborn, Chicago
 (contrib.)*

Prometheus 5/9/14
**BRIDGE IS STRENGTHENED
 BY NOVEL METHOD**

of the range consists of two detachable sections, each heated independently by one burner, and each section has two stove holes, with lids like those of an ordinary stove. Each burner is at the front of the stove and heats the lid over it by the direct action of the flame. The hot gases, instead of escaping as in an ordinary stove, then pass through a shallow flue to an outlet at the rear, heating the remainder of the section.

7881 m
 Using the steel trusses of a railroad span as reinforcing for a new concrete structure built around it was the novel method adopted on a railroad in Sweden for strengthening a bridge that had become too light for the traffic it was required to carry. A reinforced-concrete arch, having a span of about 118 ft., was first erected under the steel span and from this arch concrete columns were erected for supporting the lower chords of the trusses at the panel points. The trusses themselves were then inclosed in concrete so that the entire bridge is in effect a new reinforced-concrete structure. To prevent damage to the setting concrete during the work of construction by vibration from passing trains, the track was raised about 2 ft. and carried on an independent wooden trestle.

8456
**ELEPHANT HAULED ON TRUCK
 THROUGH CITY STREETS**

While a circus was playing at Detroit, an elephant injured one of its legs so seriously that it was nearly impossible for the animal to walk. The problem of carrying the huge beast to the railroad in order that it might accompany the show, was finally solved by employing a motor truck. Considerable scheming was required to get the animal to climb onto the vehicle, but after it had apparently become assured that the truck would not break under its weight, the elephant mounted it and then calmly balanced on three feet while being hauled through the streets of the city.

□ In the event of a war it would be necessary, under present conditions, to enlist 18,000 additional seamen in the United States Navy before its 33 battleships could all be put into commission.

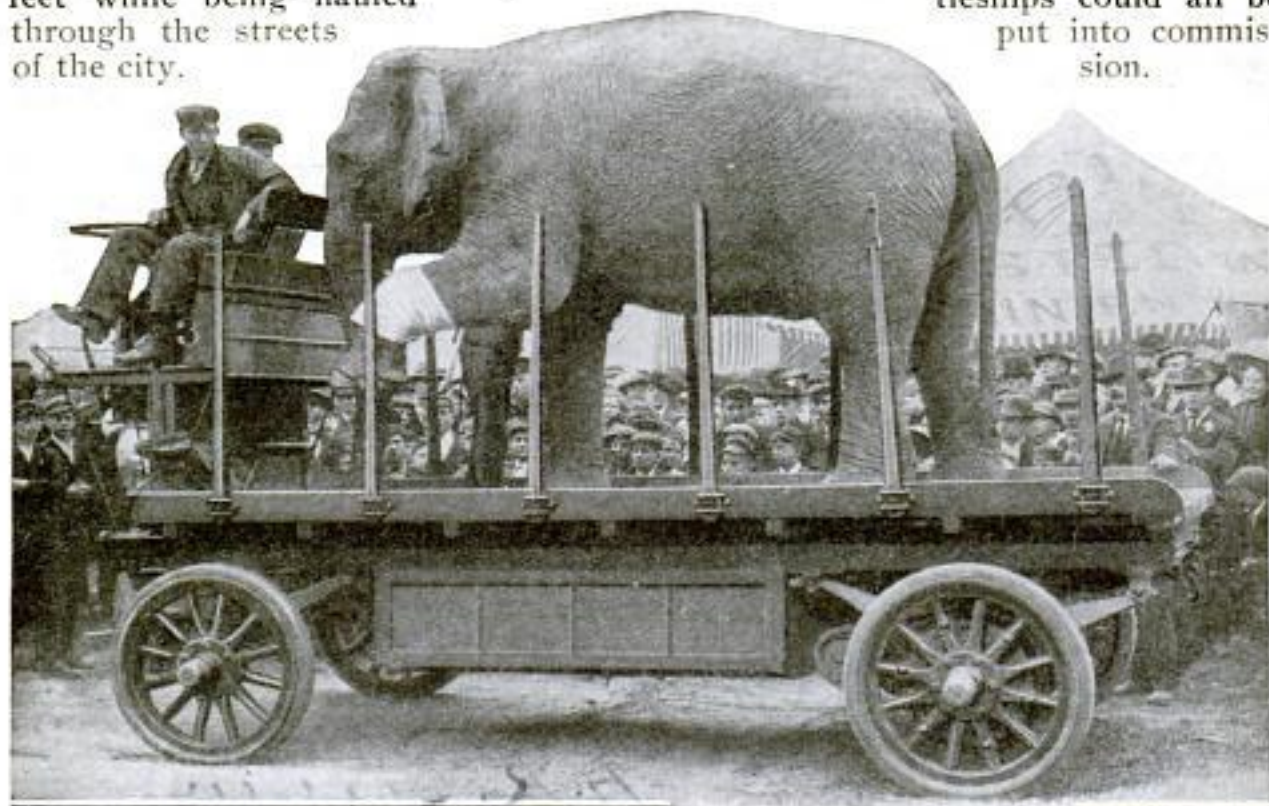

Using a Motor Truck to Carry an Injured Elephant from the Show Grounds to the Railroad

H. E. Zimmerman, Int. Morris, Ills.

SCHOOL BUILDINGS PLANNED BY BOY ARCHITECTS

7641 m BY CHARLTON LAWRENCE EDHOLM



Above: North Front of Arts Building Planned by High-School Boys. In This Building Decorative Effect is Sacrificed to Lighting Requirements

Below: Attractive Corner at the Front of a Stairway in the Arts Building: The Decorative Treatment of the Interior is Simple but Effective

Grammar School in the Old-English, Half-Timbered Style: Not Only Artistic in Design but a Thoroughly Practical Building for School Purposes

the department heads. Its lines are severely plain, the practical requirements of school construction being the thing that is emphasized. The construction is sound and, above all, there is plenty of light. In spite of the sparing use of decoration the building as a whole has a pleasing appearance. On the ground floor is a mechanical and electrical laboratory, 110 ft. long and 35 ft. wide. The upper stories are made up of 10 large classrooms, 14 small classrooms, and six offices for the instructors, with lavatories and other conveniences.

All the details of a \$90,000 arts building recently built in Los Angeles were planned by a class of six boys during their final year in the architectural course of the Polytechnic High School in that city. This building forms a part of the high-school group. The general plan was laid out by the head of the architectural department, and then the boys were turned loose on the job to work out the details. How well they did their work is shown by the resulting structure, which stands as a convincing argument in favor of the modern educational method that brings the practical daily work of a trade or profession into the classroom.

This is not the first building designed by boys in this Los Angeles institution. Other classes, doing the work as part of their classroom study, have designed two of the best grammar-school buildings in the city, both of which are sound examples of good construction for educational institutions. One of these, the grammar school on Avenue Sixty-Second, has the plastered walls and timbers of the Old-English structure. This building was erected at a cost of \$28,000 and is not only artistic in design, but is a thoroughly practical building for school purposes.

The arts building is a structure of reinforced concrete and steel and comprises three stories devoted to classrooms, laboratories, and offices for

CA hospital train is to be installed on a railway in India built for strategic purposes.

OUTDOOR SUBSTATIONS FOR HIGH-VOLTAGE LINES

54
As a result of an extensive series of experiments a full line of electric switches, circuit breakers and lightning

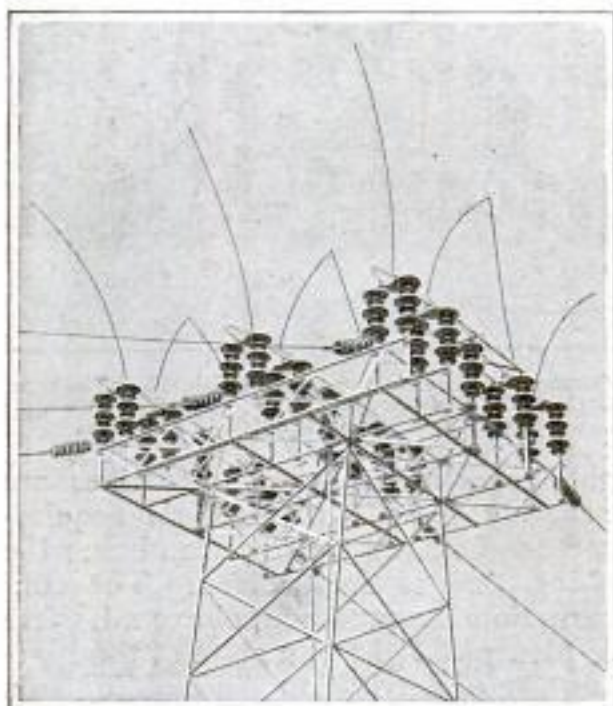

Outdoor Electric Substation That Operates under a Pressure of 150,000 Volts

arresters for outdoor use in any climate, and designed for operating without the protection of any kind of housing, has been developed. An installation of this kind that operates under a pressure of 150,000 volts is shown in the illustration. In

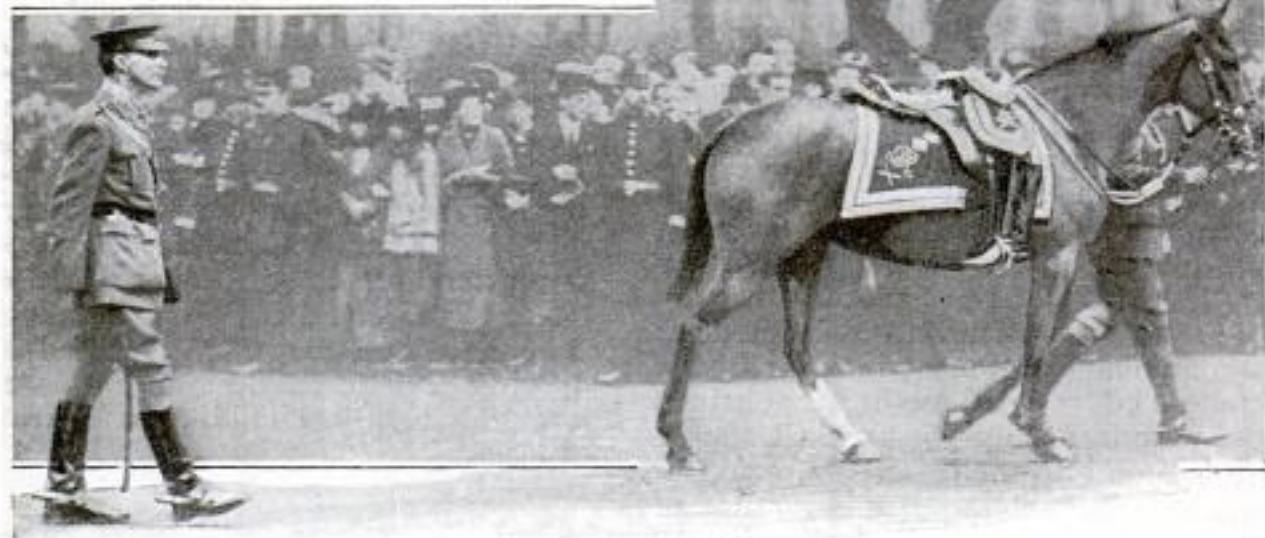

The Funeral of Sir Charles Douglas in London: Carrying the Dead Officer's Boots Turned Backward in the Stirrups on His Riderless Horse Is an Almost Universal Custom at the Funerals of Commanding Officers

this apparatus all bearings are constructed either of bronze or of special babbitt, and are immune from freezing or rusting. One of the interesting features about this installation is the circuit breaker, which works in such a way that the current is materially cut down before the final break occurs, and thus greatly reduces the surging in the electric current which takes place when the current is suddenly shut off, and which corresponds to the water hammer in a water pipe when a valve is suddenly closed.

NO 200 8721 REVERSED BOOTS A FEATURE OF MILITARY FUNERALS

An old custom almost universally observed at the funerals of commanding military officers is that of leading behind the coffin the dead officer's riderless horse, fully equipped with bridle and saddle and carrying the officer's boots turned backward in the stirrups. This custom is illustrated in the photograph of the funeral of Sir Charles Douglas, a British general killed in action in the European war.

COPYRIGHT, UNDERWOOD & UNDERWOOD



Small Frame Dwelling Struck and Pushed 40 Feet from Its Foundations by a Train of Cars That were being Switched in an Industrial District in Chicago

8687 m
**DWELLING CRUSHED BY
RAILROAD CARS**

Through some mistake in throwing a switch, or loss of control by the engineer in handling a string of 40 cars that were being switched in an industrial district in Chicago, a frame dwelling was wrecked and pushed over 40 ft. from its foundations; and of the family of five sleeping in the building, one, a child of four, was killed, and the remainder were injured. The train was being backed by two locomotives.

8765 m
**RUBBER MAY BE MADE FROM
COKE-OVEN GAS**

Recent experiments indicate the possibility of making artificial rubber from coke-oven gases. These gases are known to contain hydrocarbons of various kinds, and efforts are now being made to separate from the gases the particular hydrocarbons found in natural rubber.

Scientific American

8620 m
**REMARKABLE CLUSTER OF
GRAPEFRUIT**

A cluster of grapefruit weighing $18\frac{1}{4}$ lb. and consisting of 18 units of the fruit on one stem, has been produced in an orchard in Alabama. This remarkable cluster was picked from a tree that was three years old, and was a part of the first bearing.



Can official proclamation in Germany prohibits the sale of motor-car tires to private individuals, as all available tires are needed for military purposes.

*J. Harry Hughes
161 S. Warren St.,
Mobile, Ala.
Grown by W. E. Sweet
7-in. l. h. Ala*

Amer. Machinist 7/10/14

Union Caliper Co.,

246

Orange,
Mass

POPULAR MECHANICS

HANDY ATTACHMENT FOR CALIPERS

8434

A new attachment for calipers makes it possible to transfer measurements in cases where the calipers cannot be removed from the object being measured without spreading the points. This consists of a notched bar that can be easily attached or removed. The manner of using the instrument is shown in the illustration, where the thickness between recesses in a casting is being measured. The instrument is set in the usual way and the notched bar adjusted accordingly. The bar is then raised off the pin, the calipers removed, and the bar replaced in the same notch.

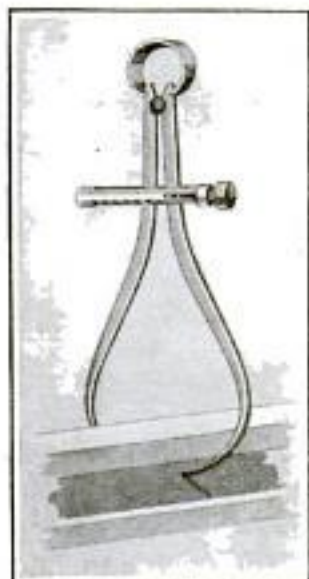

of those made of cast iron. The principal advantages in steel-cylinder motors are their light weight in comparison with cast iron, the possibility of better cooling due to thinner metal, increased efficiency because higher compression is possible with better cooling, and greater accuracy in manufacture.

of those made of cast iron. The principal advantages in steel-cylinder motors are their light weight in comparison with cast iron, the possibility of better cooling due to thinner metal, increased efficiency because higher compression is possible with better cooling, and greater accuracy in manufacture.

ALL FURNITURE OF BEDROOM IN ONE ARTICLE

8561

A bed that combines in one article all the necessary furniture of a sleeping room and which makes a comfortable and attractive-looking couch by day has been patented by a Texas man. Closed up it resembles an ordinary bed with the exception of nine drawers and two cupboards. There is a place for slippers and shoes, another for cuffs, collars, and neckwear, another for underclothing; there are places for silverware, dishes, cooking utensils; a coat hanger and wardrobe for other wearing apparel at the foot of the bed, also a smaller opening just above for magazines and books. A box contains places for clothing, hats, and gloves.

There is a clock in the footboard with an electric light operated by a push button. The bed is also equipped with an electric cooking attachment; a looking glass is under the top panel of the headboard, which is removable. The bed covers are held in position by a patent clamp. The base, head, and foot sections interlock and the whole thing can be taken apart and closed up in box form.

measured. The instrument is set in the usual way and the notched bar adjusted accordingly. The bar is then raised off the pin, the calipers removed, and the bar replaced in the same notch.

STEEL-CYLINDER MOTORS

MADE AT LOW COST

Steel-cylinder motors, while in fairly common use for air craft, have not been adopted to any great extent for automobiles, largely on account of their high cost. A German firm has now succeeded in making such motors at a cost only slightly greater than the cost

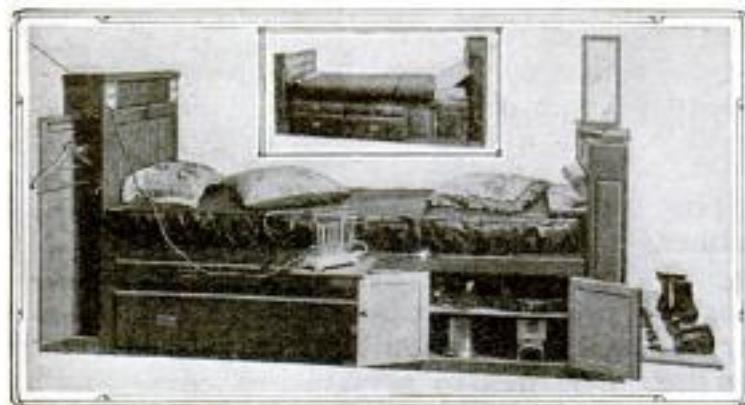

This Novel Bed Contains All the Furniture Required in the Sleeping Room

Lola A Pinchon
Seymour, Ind.

San Antonio, Texas.

Manufacturers of Bird Houses: 103 So. La Salle
1 - J. H. Dodson, 702 S. Security Bldg., Chicago
The Crescent Co., Long River, N.J.

INSECT RAVAGES COST \$500,000,000 EVERY YEAR 8750 H IN DAMAGE TO CROPS

How can this tremendous economic waste be checked?
The Federal Government says: "Protect our native song birds."

THE movement for the protection of American song birds, first stimulated through sentiment, has developed into a nation-wide economic propaganda, backed by the Federal government.

Scientific investigation is responsible for the assertion that were it not for birds, insects would render the entire American continent uninhabitable within a few years. As it is, the annual damage done to trees and growing crops by the ravages of insects represents a loss which has been estimated at more than \$500,000,000, and this mainly because the normal balance between bird life and insect life has been upset by the destruction of song birds. Nearly 90 per cent of the birds of this country, it is estimated, have been exterminated through the various influences of commercialism, sport, ignorance, and cats. Since the preservation of the remainder is necessary from the standpoint of dollars and cents, the government has undertaken to protect the insect-eating birds and assist in their natural increase.

One of the important steps in this direction was the recent bird census, the first enumeration of the kind ever made in this country. It has just been completed, and while the final tabulations are not yet available, estimates indicate that there are, exclusive of sparrows, approximately 2,026,000,000 native birds in the region east of the Mississippi River. The most numerous of these is apparently the robin, of which there are about 100,000,000. Omitting timber land and that planted in crops, there are probably about 1,000 pairs of different kinds of birds to each square mile within the area. Bird life seems to be most prolific in the vicinity of Chevy Chase, Md., where an average of about seven pairs to each acre has been found. Large territories in Arizona and New Mexico, however, are re-

ported not to contain more than one pair to every seven acres.

In spite of their great economic value, song and field birds have always had a hard fight for life in the United States. They have been driven away from many districts, their nests robbed and their young killed by English sparrows. In other sections their nests are destroyed in the spring by the burning over of the fields; millions are killed by poison meant for insects; many are wantonly shot because they are commonly thought to subsist mainly upon grain and fruits, while annually thousands are killed by cats. Certain ornithologists maintain that the average country cat will slaughter as many as 50 insect-destroying birds a year.

An important part of the new movement for bird preservation is the efforts that are being made all over the country to provide nesting places and protection in the breeding season. There are certain principles which must be followed in order to induce birds to nest in a particular spot, but they are simple, and if observed, will often even cause migratory birds to winter in a yard, or on a farm, where they know they will be cared for. The construction of houses, feeding shelters, bathing basins, and similar devices, or even any one of them, if intelligently done, will attract birds. It must be remembered, however, that a bird is just as particular, in many respects, about the place of its abode as is a person, and the requirements of one do not always correspond to those of another. For instance, a bluebird or a wren is content with a tomato can for a nesting place, while this is not true of the chickadee and many other birds. In building houses for birds which ordinarily excavate their nests in tree trunks, the diameter of the entrance and the depth and diameter of the cavity must be made understandingly.

Philip E. Young, D. O. Box 2275, Boston, Mass.

to The Maplewood Biological Laboratory, Stamford, Conn.
Charles E. White, Box 45, Kenilworth, N.J.
The Audubon Bird-House Co., Meriden, N.H.



PURPLE-MARTIN HOUSE WITH 26 ROOMS AND ATTIC



OBSERVATION HOUSE WITH COPPER ROOF



A WREN HOUSE



SUET BASKET ON TREE TRUNK - ALSO A CEMENT BIRD BATH

In all cases, the entrance hole should be in proportion to the size of the bird for which it is intended, and should also be countersunk to exclude rain. Ventilation openings for all bird houses must be placed at least as high as the entrance, and preferably higher, while all nails should be covered with putty and joints made tight. A weathered-wood stain or a natural-green paint is suitable for houses placed in trees or thickets, while a gray or white color is good for those which are put on poles in conspicuous places. In

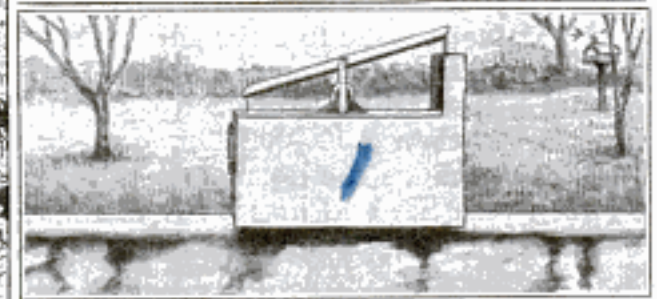

AN EFFICIENT CAT TRAP



A SHALLOW RUSTIC BATHING PAN WHICH WILL DRAW BIRDS TO ALMOST ANY YARD

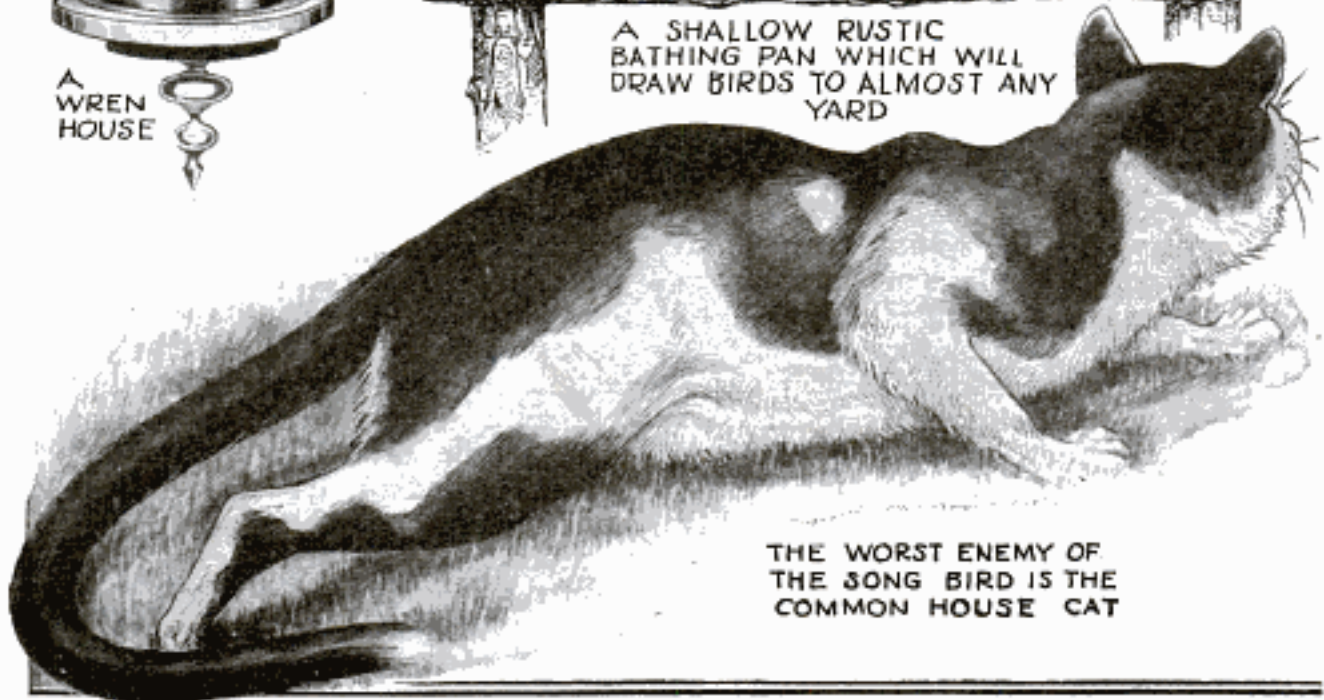

THE WORST ENEMY OF THE SONG BIRD IS THE COMMON HOUSE CAT

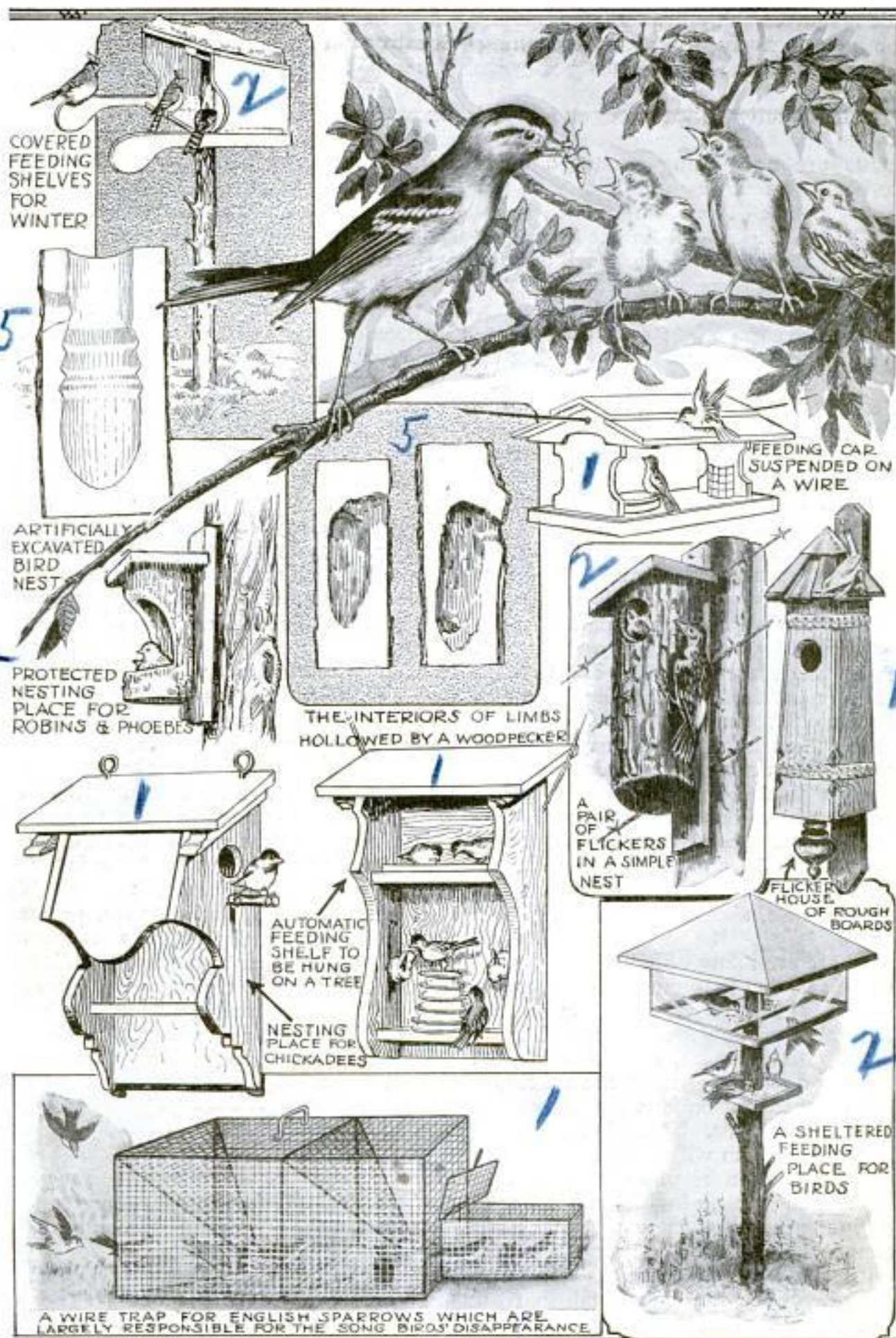

all instances the entrance hole should be placed away from the prevailing direction of the wind during stormy weather.

Scientifically built houses and accessories for the proper care of native birds are now being produced commercially in large numbers. A wren house, shaped like a small cask, is intended to be hung from the limb of a tree. Another house, much like this, but designed to be mounted on a pole, is built for bluebirds. In both cases, the houses are made with four compartments, the reason being that neither a wren nor a bluebird will ordinarily occupy the same nesting place two years in succession, while they are satisfied to take different apartments in the same structure. A single house, made in different sizes, to accommodate wrens, chickadees, tree swallows, bluebirds, flickers, small owls, and woodpeckers, is hollowed from a piece of bark-covered pine. The cavity is shaped much the same as natural nests excavated by woodpeckers and flickers. A nesting place for robins and phœbes is different from most other shelters, and in one form consists of a hollowed limb which is entirely open down the front. Martins rarely live alone, almost always dwelling in colonies. Because of this, their houses are built with connected apartments, ranging in number from 12 to 56, and more. For flickers and golden-winged woodpeckers, a six-sided house, about 26 in. in height, is made.

There are many different feeding devices intended to induce birds to remain in the North throughout the winter, several of which are illustrated herewith. Melted suet, in which ground nuts and scraps of meat are mixed, is the standard ration for the winter feeding of song birds. There is hardly any one thing which will attract birds more quickly than a shallow bathing tray filled with water, of which a number of designs are now available. Song birds cannot be gathered in large numbers until the English sparrows are eliminated. Since the individual sparrow has a very limited range of travel, they

may be exterminated from a specific locality without great trouble. To accomplish this a wire trap has been introduced which will do much toward freeing the neighborhood of the pests. Sparrows thus trapped may be killed by drowning, or by other methods if they are to be used as food, as is becoming more and more the custom in some localities, while song birds, if any are caught, may be removed without injury. Another trap is made in the form of a bird house and has an entrance hole just large enough for a sparrow. It has a false bottom which trips and drops the sparrow into a drawer, that has small holes, through which a wren, if caught, may escape. Aside from sparrows, nothing will keep song birds away more certainly than a cat. A trap made expressly for capturing stray cats acts without injuring the animal, so that if it is merely wished to banish it from the neighborhood, it may be sent to an anticruelty society. The contrivance consists of a rectangular box fitted with a drop door, which is held open by a bar connected with the bait hook inside. A fish head usually serves to attract the cat.

It is important in attempting to attract birds to select properly the sites for their houses. Besides explaining in detail how to construct suitable nesting places for nearly all kinds of birds, the Department of Agriculture is circulating a booklet which treats this subject. Martins, for instance, prefer to breed near dwellings, but not closer than 20 ft. to either a tree or a building. Bluebirds usually choose open places where there are scattered trees. Catbirds, thrashers, and wrens like thick shrubbery, and robins large-trunked trees.

TESTING GUNPOWDER IS A 8727 **DELICATE TASK**

The demand for accuracy and uniformity in the powder used in rifles and shotguns makes it necessary for the makers to test every shipment of powder before it leaves the mills. These tests are made in the "ballistic house,"

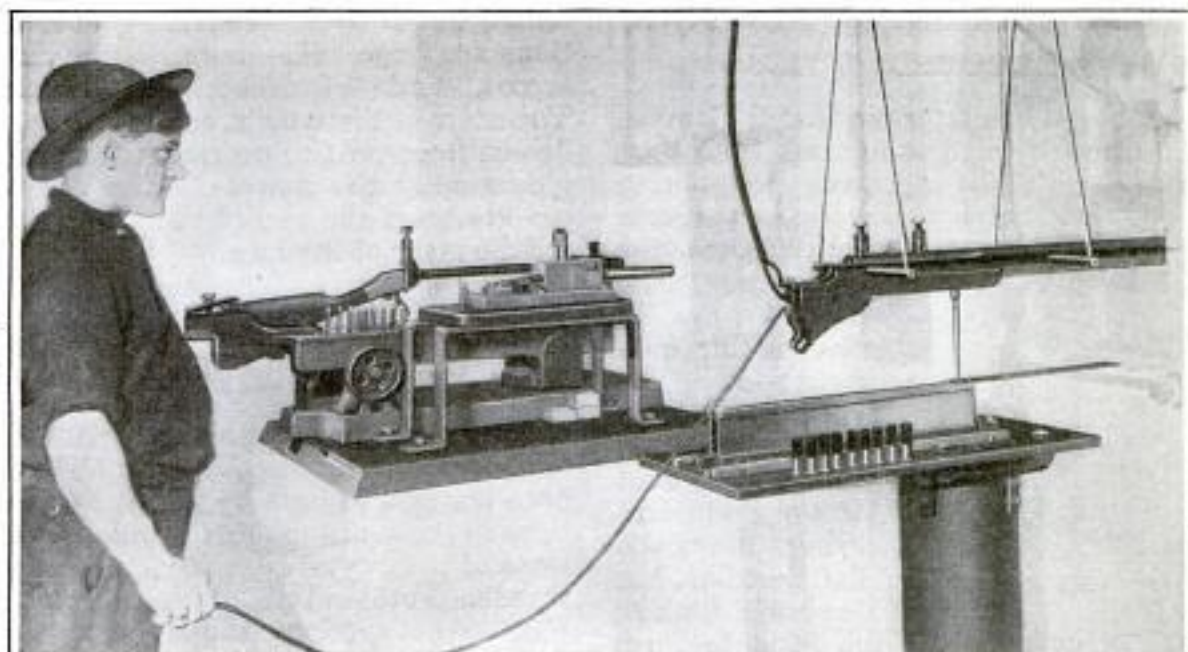

Testing Apparatus in the "Ballistic House" of a Powder Mill: Rifle and Shotgun Mounted for Making Measurements of Recoil, Muzzle Velocity, and Pattern Formed by the Charge

where accurate devices enable the operator to measure the recoil of the test gun under the discharge, the velocity at the muzzle, the velocity at the target, and the pattern made by the charge when fired against a 30-in. circle. The guns used in making the tests are fired as carefully as a camera is exposed, and with the same kind of bulb and tube, in order to avoid giving any jar or movement to the gun at the instant it is fired.

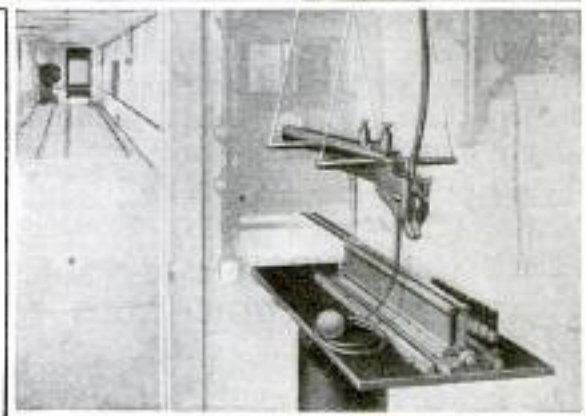

Gun Mounted for Firing against a 30-Inch Circle: The Gun is Fired by Means of a Bulb and Tube

NEW STEAM RADIATOR WITH 7696m NOVEL FEATURES

Tests of a new steam radiator, recently patented, indicate that it has practically six times the radiating efficiency of the ordinary radiator. This radiator is designed to be placed in a horizontal position so that the air will pass up through it, and is made in sections of different sizes to suit the space available. For obtaining a large heating capacity with the use of the smallest possible floor space any number of sections, spaced about 4 in. apart, may be placed one above the other. Between the steam channels are pockets formed by transverse vertical partitions, while a horizontal partition,

pierced with an air hole, divides each pocket into an upper and a lower section, the arrangement being such as to give the air the greatest possible amount of contact with the hot metal as it passes up through the pockets. In



New Type of Steam Radiator of High Efficiency

this way, over 45 sq. ft. of radiating surface is provided for each 10 sq. ft. in the area of the radiator.

The Heating and Ventilating Magazine
June 1914
E. Carl Forster, 448 Soffle Rd., Hawthorne, N.J.

NEW INSULATOR PIN FOR ELECTRIC LINES

8304
m
A metal insulator pin that is clamped in place by a U-bolt and thus does away with the necessity for boring

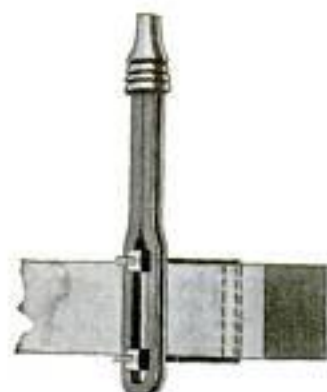

holes, a process that weakens the cross arm, is a new feature in electric-line construction. The pin is made from a galvanized-iron bar which is bent at the middle to bring the ends flat together, but is spread for five or six inches from the bend to form a slot for receiving the U-bolt. The flat end is equipped with a threaded cap, or with coiled wire, for holding the insulator. The U-bolt consists simply of a galvanized-iron strap that clamps around the cross arm.

THE SACRED COWS OF BALI AND THEIR HUGE BELLS

8505
In the island of Bali, one of the Dutch East Indies, near Java, the native New Year's festival, the most important fête of the year, is signaled by a race between the sacred cows. These beasts are decked out for the occasion with ornamental devices attached to their

horns, but their most striking decorations are huge bells, more than a yard across, made of ornamented bronze. The noise of these bells, as the cows are driven from post to post, arouses great glee among the natives. The photograph shows the sacred cows lined up for the start of the race.

PRIMITIVE WATERWORKS OF 8590 OLD NEW YORK

Quaint relics of a water-supply system over one hundred years old have been brought to light by recent excavations in some of the most populous sections of the city of New York. Several wooden gate valves, dating back to 1799—short sections of pine logs bored out axially and fitted with thick iron leaves working in a slot across the opening—have been unearthed; and the recent dismantling of an old building at Reade and Centre streets revealed a cast-iron tank which at one time supplied the entire city with water from a near-by well. The tank was constructed of cast-iron plates, bolted in position. They were imported from England.

The valves and the tank formed part of the water-supply system which was installed in 1799 after a scourge of yellow fever had swept the city. Aaron Burr was instrumental in having this system put in operation. With the desire of averting other epidemics of dis-



Huge Bells Worn by the Sacred Cows of Bali in the New Year's Race

Henry Fuschin
108 Fulton St,
N.Y. City

Geo. F. Worts, 400 West 118 St
N. Y. City

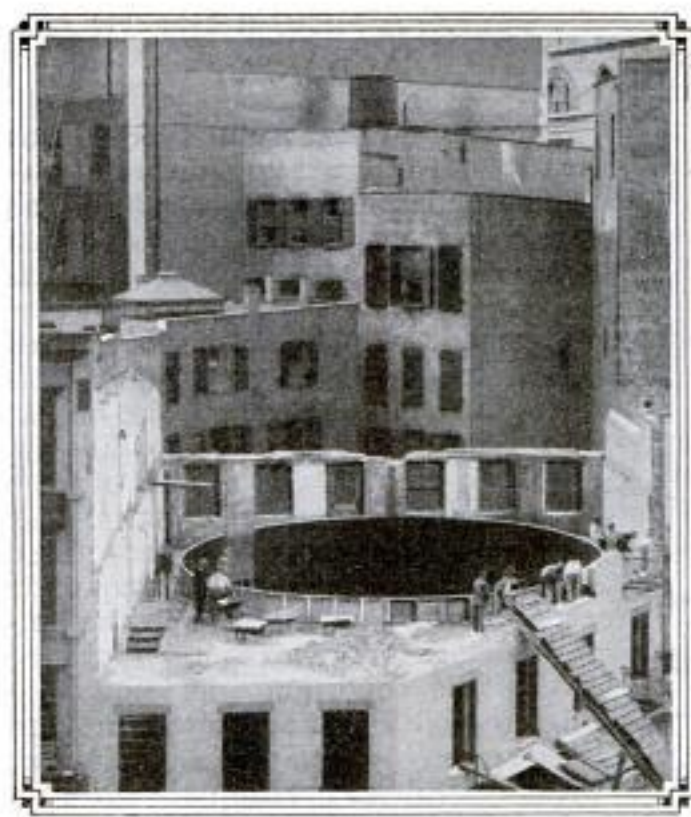

Cast-Iron Tank More Than a Century Old Which Held Water for Old New York



Ancient Wooden Water Pipes with Sheet-Iron Valves

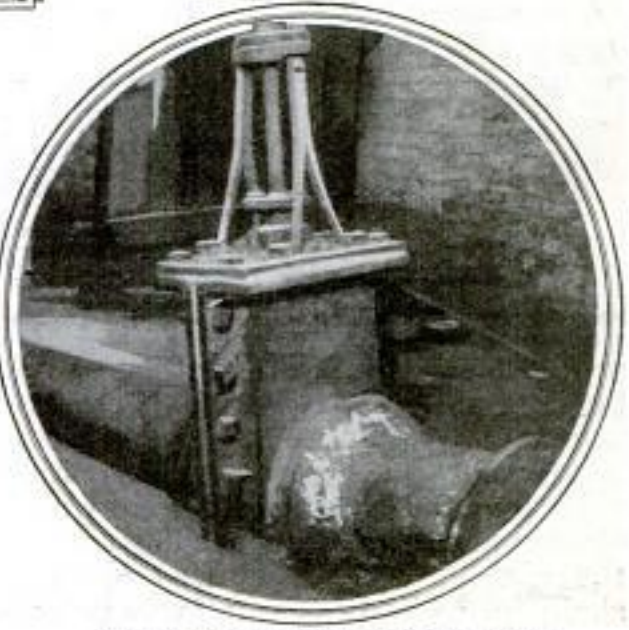

The First Metal Water Pipe and Valve

case, he applied to the New York State Legislature for a charter "For purposes of supplying the City of New York with pure, wholesome water." When the reservoir was torn down, a black, slimy sediment, four or five feet thick, was found on the bottom, eloquently expressing the "pure and wholesome" quality of the water which had been pumped into it.

Two 18-hp. engines pumped 621,000 gal. of water a day into the tank, and, for distribution, hollow pine logs in connection with the wooden gate valves were employed. Twenty-three miles of wooden pipe had been laid by 1823, when the system was superseded by iron-pipe mains. Previous to this time, popular belief held that iron pipes were unhealthful. Only one short stretch of iron pipe and one iron valve were used. The iron pipe was the main conduit from the reservoir to the wooden mains; and the iron valve was connected halfway between the reservoir and the wooden mains. An effort was made to have the valve purchased by some patriotic citizen and placed in a museum, but without success, and

it has been broken up and sold for junk.

An interesting feature of the old pumping system was the charter under which it was operated. Owing to the fact that the installation cost could not be accurately estimated, the legislature, in a "joker clause," gave the Manhattan Company the right to employ all surplus capital in the purchase of public stocks, so that the Manhattan Company in a short time became noth-

ing more nor less than a banking institution with the water-supply system as merely an incidental issue. To this day, in order to hold its charter, the Manhattan Bank, now one of New York's largest financial institutions, must pump a certain amount of water each year.

DIRECTION OF WIND SHOWN BY ELECTRIC INDICATOR

82404 An electric weather vane registering the direction of the wind by illuminating small lenses at the major points of a compass-dial indicator, which may be

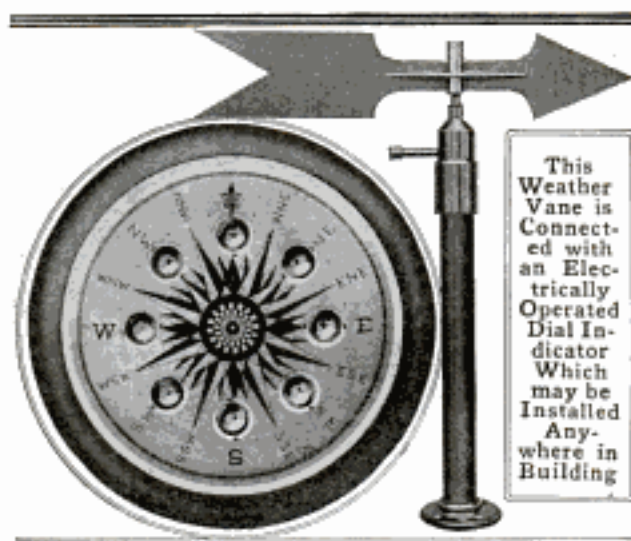

installed in any convenient place in a building or ship, has recently been invented. The purpose of the apparatus is to enable an engineer or navigator to observe the course of the wind without having to take his readings from the vane itself. An incased vertical shaft, on which the vane is mounted, revolves with it and carries a metallic brush which moves over a series of contact points, each of which is in a fixed position corresponding to one of the several points of the compass. As the brush touches one of these members it illuminates the corresponding lens on the indicator, showing that the wind, for instance, has changed from a northerly to a northeasterly direction.

☞Citizens of Philadelphia have shipped 1,900 tons of food to the Belgian war sufferers.

PUTTING A NEW SKIN ON AN OLD BOAT

8532 m A novel and successful process was used for putting a new skin on a government boat, the hull of which had worn thin from rusting and had begun to develop pinholes. This boat was built in 1897, was purchased by the government in 1902, and has been used since that time for inspection and light towing on shallow rivers. The hull as originally built had a length of 65½ ft., a beam of 10½ ft., and a draft of from 20 to 24 in. When the boat was 13 years old, the plates had become so thin from rusting that it was a common occurrence to knock a hole in the bottom during low water and sink the boat. This condition was met by a concrete lining. The inside of the hull was thoroughly scraped and cleaned, chicken wire was spread over the ribs, and cinder concrete to a thickness of from 4 to 5 in. was rammed down through the mesh. This lining, which increased the weight of the hull 8,000 lb., covered the entire bottom and extended up the sides to a level well above the water line. These repairs served the purpose very well for three or four years, but at the end of that time the plates had become so thin that it was feared the concrete lining would drop out through the bottom. A new steel skin was then put on the boat, with the result that the hull is practically as good as new. The boat was put in dry dock, and templates were made to fit the hull at intervals of 2 ft. From these templates a timber frame was built, and on the outside of this frame a new steel skin for the hull was formed, after which the timber frame was removed. The dry dock was then flooded, the boat was floated over the shell and the dock was raised carefully so that the boat was seated accurately in its new skin. After the water had been drained from the space between the hulls, this space was filled with melted paving pitch, and the new skin was securely attached to the old hull. With the removal of most of the old concrete lining, the draft of the boat

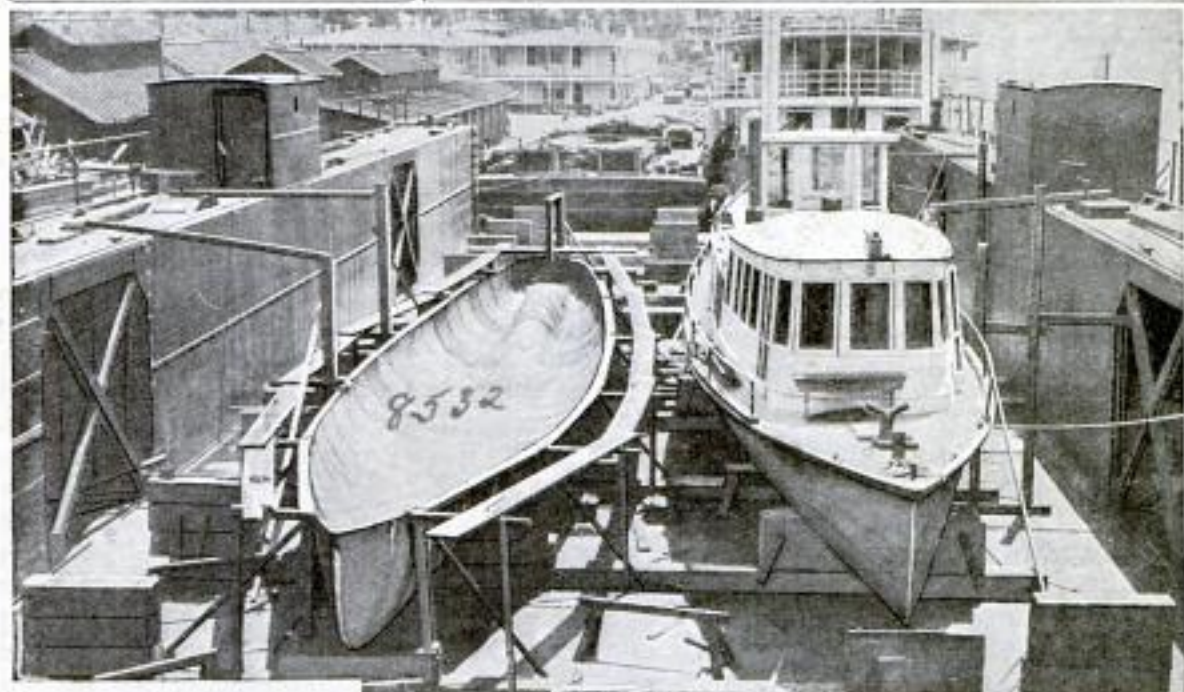

The Boat and Its New Skin in Dry Dock Ready to be Fitted Together

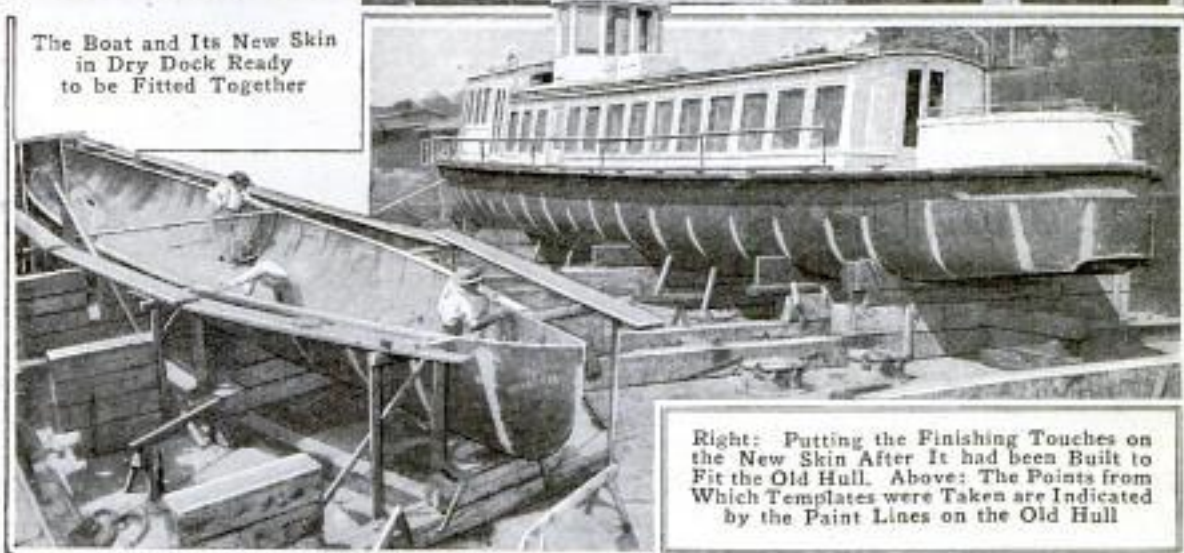

Right: Putting the Finishing Touches on the New Skin After it had been Built to Fit the Old Hull. Above: The Points from Which Templates were Taken are Indicated by the Paint Lines on the Old Hull

Electrical Radiator Co.
 120-102 Commercial St.
 Portland, Maine
 B8/12/16 256

price \$1.00 sold by Henes Sales Corporation, 179 W. Washington St. Chicago

POPULAR MECHANICS

was found to be 18 in. forward and 27 in. aft. The entire work cost about \$850, and it is expected that the new skin will last 12 or 13 years. A new hull would have cost from \$3,000 to \$4,000.

Army & Navy Jour.
DANGER IN INHALING FUMES OF WOOD ALCOHOL

The dangers connected with the handling of wood alcohol and with working where even small quantities of the fumes of this liquid may be inhaled have been brought out prominently as the result of recent scientific investigations, which demonstrated that quantities of wood alcohol as small as .2 of one per cent in the inspired air may lead to the absorption of the product into the body to an injurious extent. With such quantities as this the absorption is slow, but eventually the body becomes "saturated" with it. The greatest danger in inhaling the fumes of wood alcohol is their effect on the optic nerve, which often results in total and incurable blindness.

WATER CIRCULATES HEAT IN ELECTRIC RADIATOR

In an electric radiator that has just been brought out, the heat is distributed through the tubes by water that is

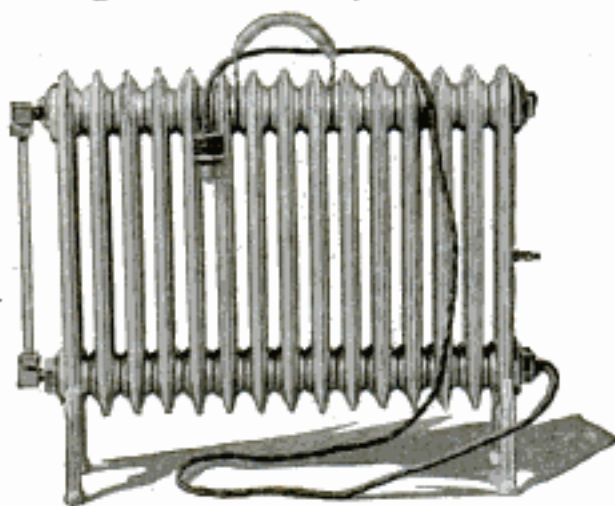

In This Electric Radiator, Water That is Heated by Resistance Coils Distributes the Heat through the Radiator Tubes

heated by resistance coils placed in the base of the radiator. A tube containing the coils runs lengthwise through the bottom of the radiator, and inclosing this is a second tube which is provided with openings for admitting the water. All that is necessary for using is to place a small quantity of water in the radiator and turn on the current. The film of water in contact with the tube containing the coil becomes heated quickly and passes upward in the radiator, and as the heating is continued a circulation of hot water through the radiator tubes is established. Under ordinary conditions the water will boil in from 15 to 25 minutes. One filling with water is sufficient to last for several months.

WRENCHES THAT ARE SELF-ADJUSTING

Two self-adjusting wrenches that work in the same manner, but differ in construction, have been placed on the market. In both of these the jaws are tightened by a transverse push or pull on the handle, and both are so made that the harder the pull in tightening or loosening a nut, the harder the set of the jaws. In each, the base of one of the jaws slides in the base of the other. The tightening is accomplished in one of the wrenches by a ratchet movement, as shown, while in the other wrench the handle is pivoted to the base of one of the

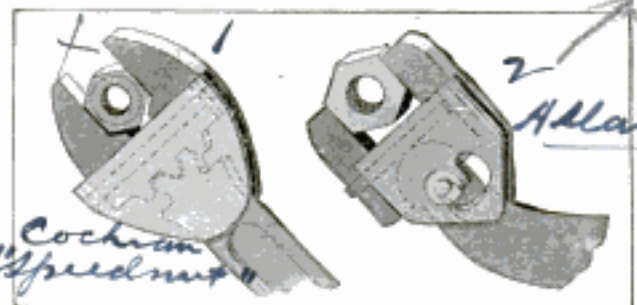

With Either of These Wrenches a Pull on the Handle Automatically Tightens the Jaws against the Nut

Figures compiled before the outbreak of the European war showed Belgium's postal savings deposits to be three times greater than those of this country.

jaws and has a circular bearing that works in a circular recess in the base of the other jaw.

1 Cochran Pipe Wrench
 mfg. Co. 700 Woodlawn St. Chicago
 Sole agents: Henes Sales Corp., 179 W. Washington St. Chicago

2 The Allan self-adjusting wrench, price \$1.00 is invented & sold by A.C. Allan, 420 W. 60th St. Chicago

A.C. Allan & Co., Inc. 715 W. 60th St. Chicago

J. Hawthorne Daniel
11 West 83rd St,
N.Y. City



The White-Pine Shingles on This Maryland Home Are 168 Years Old

8587 **SHINGLES STILL PRESERVED
AFTER FIVE GENERATIONS**

White-pine shingles, 168 years old, are still intact and in a good state of preservation on an old residence at Bladensburg, Md. These, like the ones described in a previous issue of this magazine which served for 121 years on the First Parish Church of Bolton, Mass., were hewed by hand from native logs. So far as is known, the roof never once during the several generations of its exposure has required any attention whatever, and from its present appearance it is safe to assume that re-shingling will not be necessary for a number of years yet to come. The house is of historical interest in that during the battle of Bladensburg in 1813, a battery of British artillery occupied a position on the hill immediately behind it, firing directly over its roof.

8432 m **INSTRUMENT FOR STUDYING
THE AEROPLANE**

The study of the effects of the wind on an aeroplane, which is a part of the science of aerodynamics, is now carried out in a scientific way with models placed in wind tunnels, where any wind

effects that occur in the actual flight of an aeroplane are artificially duplicated on a small scale, and the resulting forces are measured by scientific instruments of the greatest accuracy. One of the most important of these measuring instruments is a new aerodynamic balance, developed in England, with which the amount of lift and drift, and of all forces that affect the lateral or longitudinal stability of an aeroplane under any wind conditions, or at any angle of flight with reference to the direction of the wind, may be accurately measured. Although it is rather complicated in construction, this instrument simply measures the lifting power of the model, the forces acting along the lateral and longitudinal axes of the model, and the turning forces, or moments, about three



Engineering 5-15-14
Mr. Mann

Chicago Tribune
**WATER-COLOR BRUSHES MADE
 FROM HAIR OF COW'S EAR**

axes, one of these axes being vertical, one at right angles to the direction of the wind, and the third parallel with the direction of the wind. These measurements are made by means of three beams, as shown in the illustration, these beams being placed respectively parallel with the three axes. The instrument is mounted underneath the wind tunnel with the vertical beam projecting into the tunnel, and on this beam the aeroplane model is mounted. Each beam is counterweighted and is equipped with measuring devices. With the aid of a handwheel the model can be rotated about two of the beams and thus placed in any position with reference to the direction of the wind. The instrument is so sensitive that the beams are affected by variations as small as .00002 lb. on the model.

8372 An American manufacturer of water colors faced a business crisis when trade relations with Germany were interrupted by the European war, making it impossible to import camel or rabbit-hair brushes from that country. The company has always included one or more of these brushes in each box of its paints, and there was little doubt that the demand for the sets would cease when the brushes could not be furnished. Search for a substitute for rabbit hair resulted in the discovery that the hair in a cow's ears is as soft and strong as is needed for this character of brush material, and that it can be obtained without difficulty at the stockyards.

8466 m **SIGHT-SEEING AUTOMOBILES
 AID IN MOBILIZATION**

Along with every other kind of motor vehicle, the sight-seeing automobiles



COURTESY OF THE SKETCH
 A Sight-Seeing Automobile Used in Transporting Troops from the Interior to the East Coast of England

that form a familiar feature of the tourist's life in England have been pressed into service in connection with the European war, and, owing to their large seating capacity, have proved an invaluable aid in the work of mobilization. A 35-seater is shown in the illustration transporting troops from the interior to the east coast of England.

The sketch

Scientific American
**LOWEST ORGAN TONE EVER
 PRODUCED**

8577 m A tone that is an octave lower than any ever before produced by an organ is given out by a 128-ft. pipe installed in a new pipe organ at Lowell, Mass. This tone is described as "a mighty atmospheric throb of a wesome majesty." The lowest tone heretofore produced by an organ was produced by a combination of stops giving the effect of a 64-ft. pipe. The fundamental tone of a 32-ft. open pipe has 16 vibrations to the second, and this has been regarded as practically the lowest musical tone the human ear can perceive. The new pipe produces only four vibrations to the second, and for this reason it is said that the tone must be felt rather than heard.

Seventy-two kinds of wood are being employed in making umbrella handles, whips, and canes in the United States.

Lara & Co. plmws. Ct.
Chgo.

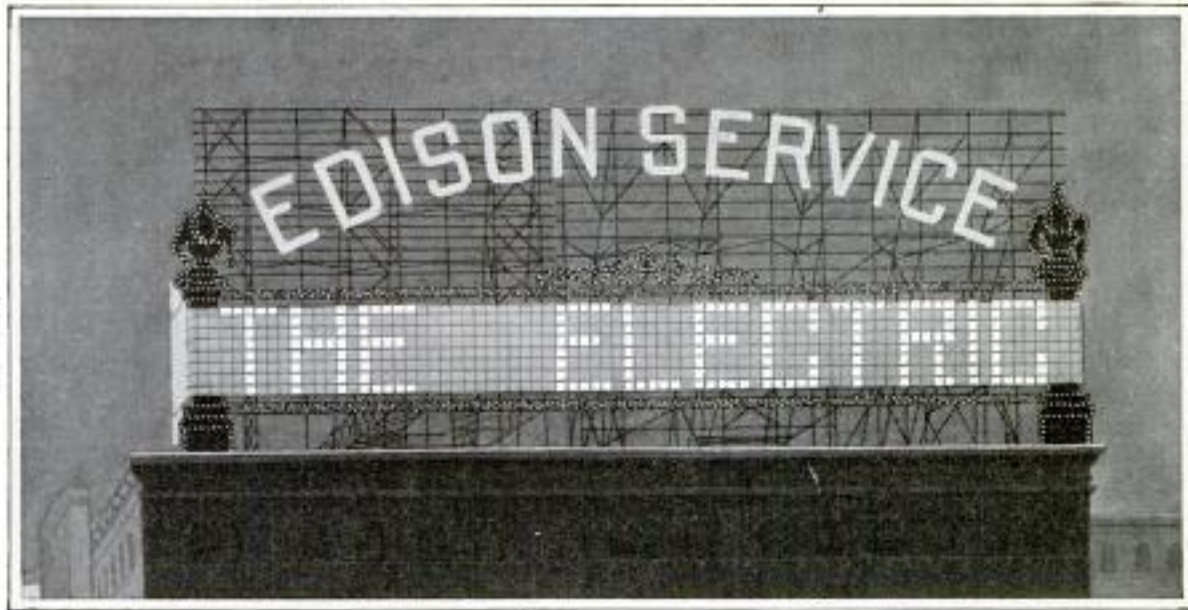

An Electric Sign Which Talks in Letters 12 Feet High While Delivering a 150-Word Advertising Speech

"TALKING" ELECTRIC SIGN

BIG CHEESE FOR EXHIBITION

8242 H **LARGEST OF TYPE**

8694 m **AT SAN FRANCISCO**

The largest electric "talking" sign ever constructed has been erected at a vantage point on Michigan Avenue in Chicago, where it is seen by thousands of persons nightly. The board is 150 ft. long and 50 ft. high, and displays its message in letters 12 ft. in height. Set in regular lines over its face, on a series of perpendicular boards, are more than 7,000 electric-light globes. The feature of the sign which removes it from the ordinary is that it is capable of exhibiting 150 words of text in illuminated letters which may be read blocks away. Each one of the lamps is connected with separate wires, and running between the contact points of these on a control board is a roll of perforated paper. Whenever a hole in this ribbon permits two of the contact points to meet, a circuit is completed and one of the many lamps is lighted. So, as this perforated strip passes over the control board, the letters punched in it are correspondingly shown on the sign and move over it from right to left as the roll crosses the operating board. Since the principle is essentially the same as that of a player piano, it is possible to change the advertisement daily by inserting a new roll.

A cheese that weighs between five and six tons, and is nearly 5 ft. high and more than 6 ft. in diameter, has been made in New York State for exhibition at the Panama-Pacific Exposition. The intake of 25 factories for a day, amounting to about 106,000 lb. of milk, was used in the manufacture of this enormous cheese. It was made in a mold built up of galvanized-steel hoops. At the close of the exposition, the cheese will be cut into pound pieces and sold. This is an unusually large cheese, but

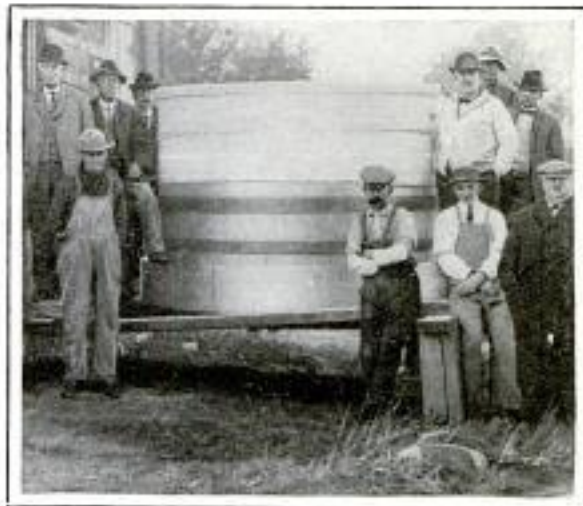

This Cheese, Weighing Between Five and Six Tons, will be Exhibited at the Panama-Pacific Exposition

Elmer E. Laycock
The Syracuse Herald
Syracuse, N.Y.

Made by H. A. Pease, Lowville, N.Y.

Permanentes
Chicago Tribune
ZEPPELIN FACTORY DAMAGED
BY BRITISH AIRMEN

88th
According to newspaper reports the Zeppelin airship factory, located on the shore of Lake Constance, was seriously damaged on Nov. 21, 1914, by bombs dropped from British aeroplanes. In making this raid the British airmen started from French territory and were compelled to make a flight of 250 miles over mountainous country under difficult weather conditions. The raiders penetrated about 120 miles into German territory.

815th
SWEeper COVERS BIG AREA
IN SHORT TIME

A combination street cleaner which sprinkles and sweeps a pavement in one operation, has recently been developed and is now in use at Springfield, Ohio. The machine is built on a three-wheel motor truck which propels it at a moderate rate of speed, sufficient to make it capable of covering 140,000 sq. yd. of street surface in a day's time. It carries a water tank having a capacity of 200 gal. As the sweeper moves along, the pavement in the path of the revolving brush is sprinkled enough to prevent raising a cloud of dust. The dirt is swept by the brush into a conveyor which carries it into a compartment built at the front of the car.

not the largest ever made. A cheese made in Canada and exhibited at the World's Fair in Chicago weighed 11 tons, was 6 ft. high, and nearly 9 ft. in diameter.

31
EIGHT-DAY WATCH PRODUCED
BY BELGIAN MAKER

One of the few real innovations to make its appearance in the watchmaking industry in recent years is an eight-day timepiece which has lately been introduced by a Belgian firm. An advantage claimed for the instrument is that it is so built that it cannot vary in time more than one minute during the period it

runs on a single winding. Pivoted in the center of the dial is a thin hand which splits the seconds into fifths, the same as a stop watch. Another feature of the piece is that it shows the days of the week and month, as did most of the old grandfather clocks of several decades ago.

The straight anchor-escapement type of movement is employed.

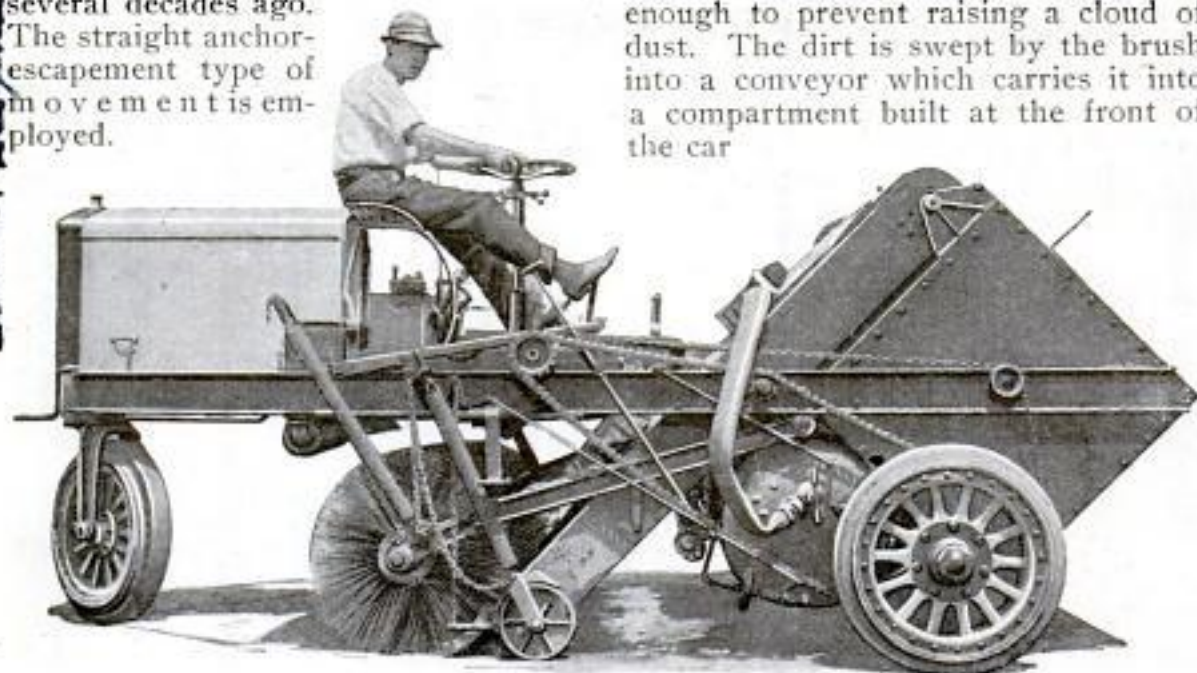

Motor-Driven Sweeper Which Both Sprinkles and Cleans a Pavement in One Operation

Ralph G. Busby
Busby

Review - Sept. 1914
Office International des Revues
de Montreux 8 Jours
de Saint Esprit
90 Rue de

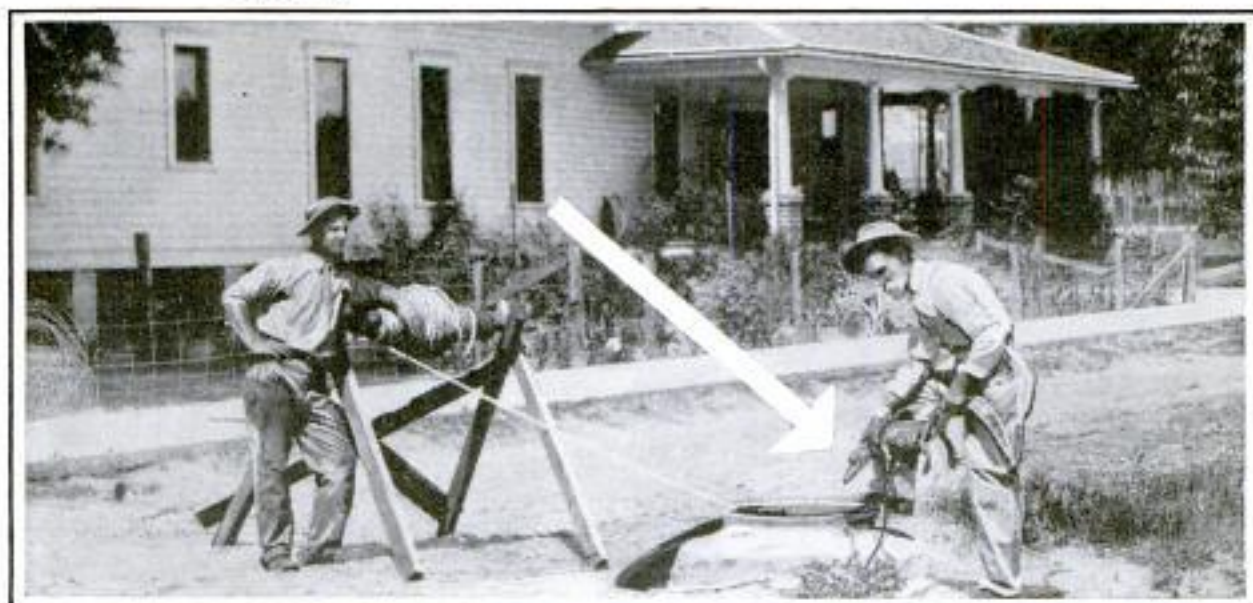

When a Sewer is to be Cleaned in Fort Meade, Florida, an Alligator Carries the Scraper Line Through from One Manhole to the Next

ALLIGATOR AIDS IN SEWER CLEANING

8708 m

The problem of getting a line through sewers that are to be cleaned has been solved at Fort Meade, Fla., by taking into the sewer-cleaning department a tame but very active alligator named "Nick." When a small sewer is to be cleaned, it is first necessary to get a line through from one manhole to the next for pulling a scraper. This is where Nick shows his real worth. The line is simply tied around Nick's body and he is lowered into the manhole and headed in the right direction, and when he reaches the next manhole he is lifted out. The scraper does the rest. It is said that Nick is better for the job than any mechanical crawler, as he never fails to dig his way through.

suspended from the top cross bar, is made to close like a folding chair. A bar which fits across the front of this holds a child so that there is no danger of its falling or being injured when left unattended. The legs are braced firmly



When Not in Use This Swing may be Folded Compactly and Stored in a Small Space

to prevent the device from tipping over, so that it may be used on a lawn as safely as in a sun parlor or room.

CA net revenue of about \$67,000 accrues annually from the town forest of Baden-Baden, Germany.

*made by Brownstown
Lumber Co., Brownstown,*

CHILDREN'S FOLDING SWING ADAPTED FOR CITY FLAT

8365

A child's swing which is particularly designed for use in city apartments and homes where there is a minimum of storage space, has lately been constructed. It may be folded compactly, and although made of light wood, is strong and serviceable. The supporting frame, which is quite similar to that of a stepladder, is approximately 4½ ft. in height, and the swinging seat,

*R. C. Clester
Franceville, Ind.*

W. S. Branch
Orlando, Fla.

Made in Detroit, U. S. A.
Committee
Detroit Board of Commerce
Detroit Mich.

262

POPULAR MECHANICS

Peoples Nat. Bank of Orlando
CLOCK ON DOOR SHOWS WHEN

8x18m BANK IS OPEN

A clock fixed to the front door just below a sign giving the banking hours is the plan adopted by a bank in Orlando,



This Clock is Fixed to the Bank Door just below a Sign Giving the Banking Hours

do, Fla., for indicating that the bank is open, or is closed. This plan was adopted mainly on account of early customers who were inclined to try the door impatiently a few minutes before the opening hour. The clock has an alarm which notifies not only the waiting customers, but the employes as well, when it is time to open the doors.

DESIGN FOR "MADE IN U. S. A." TRADE-MARK WANTED

Mainly as a result of the European war and the consequent radical reduction in imports, a strong movement has taken form having for its object the substitution of goods made in this country for those formerly imported from Europe. One feature of this

movement is the "Made in U. S. A." trade-mark that the Detroit Board of Commerce is preparing to bring out. In order to obtain an appropriate symbol for the purpose, this organization has offered a \$500 prize for the best design. The contest closes Feb. 25, 1915, and any native-born, or naturalized, citizen of the United States is permitted to compete. The design selected is to become the property of the people of the United States, and will be recommended to manufacturers throughout the country. It must be national in character and without any strictly local features. In this contest all drawings must bear the words "Made in Detroit, U. S. A.," with the idea that the names of other cities will be substituted as required after a national trade-mark has been selected.

LONG-STROKE MOTORS COMING INTO FAVOR

The small-bore, long-stroke motor has long been popular with automobilists in Europe, but has only recently begun to attract any considerable attention in this country. The principal advantages ascribed to the long-stroke motor are that it yields more power for a given consumption of gasoline because of the greater expansion of the gases, and that it gives a greater "throw," and therefore a greater leverage on the crankshaft. At the same time these motors have their disadvantages. It is usually necessary to keep the engine speed up, no matter what the car speed, and this calls for a greater use of gears. The small-bore motor also calls for a more careful manipulation of the ignition. These motors also require better materials and more careful workmanship in manufacture. In spite of these drawbacks, however, the small-bore, long-stroke motors seem to be gaining in popularity also in this country.

Of 69 awards recently made by the Carnegie hero-fund commission, 19 went to Ohio.

The Motor, Nov. 1914

8x51
Sent out by Detroit Board of Commerce
see Top 2d col.

FIGHTING IN EVENING DRESS ON EUROPE'S BATTLE FIELDS

How the Soldiers of the Various Warring Nations are Uniformed—The Contrast between the Indistinct Gray Costume of the German Troops and the Flashy Attire of the French—What the Scotch Highlander, the Russian Cossack, the Spahi, the Austrian Jaeger, and the Chasseur d' Afrique Wear to War

WITH the possible exception of the German forces, some part of the soldiers of every one of the warring nations of Europe are fighting in their dress uniforms. Only in one instance was any of the powers prepared at the opening of hostilities to clothe in service uniforms all the men they poured into the field. When war was declared, Germany had four million new service uniforms, that the public had never before seen, ready for its men.

On parade, the British soldier is the most elaborately groomed of any in the world, but in the trenches his regular uniform goes to the extreme of plainness, made of khaki-colored serge. The jacket, or tunic, has large patch pockets and a double collar, with breeches and putties of the same color, a peaked cap, and a greatcoat or mackintosh.



The Scotch Highlander has Never been Persuaded to Substitute the Trousers of the Lowlander for His Kilts

In the different arms of the British service the dress uniforms vary greatly. In the cavalry, the guards and dragoons wear steel helmets, while the dragoon guards wear brass headgear. Scarlet tunics are worn by guards and dragoon guards, while the lancer is distinguished by a double-breasted blue tunic, and a cap fashioned after the

Polish czapka. Hussars wear short blue tunics, elaborately ornamented with rows of gold-braid "frogs" across the breast, with plumed busbies varying in color according to the regiment. Blue trousers and jack-boots are worn by all cavalymen excepting those in the king's guard.



The Dragoon Regiments of the British Cavalry Carry Straight Swords of the "Cut and Thrust" Pattern

The English line, light, and fusilier-infantry uniform consists of a red tunic with pointed cuffs, red shoulder straps, gold buttons, and white piping. The trousers are blue with red stripes. Blue helmets with brass spikes are worn by line infantrymen, while the light infantry has green helmets. Tunics and trousers of dark green are worn by the rifle regiments.

The Scottish Highlander still refuses to exchange his kilts for trousers. With the exception of the Scottish Rifles, who are known by their green doublets and a shako with a black plume, all Lowland and Highland regiments wear scarlet doublets. The latter wear tartan kilts, loose plaids, and ornamental sporrans, checked-topped stockings, and white spats. The Lowlanders wear plaid trousers, and the Kilmarnock bonnet,



One of the Plainest Service Uniforms of Any Foreign Army is the Khaki Costume of the British Soldier

while the Highlanders wear the "feather bonnet." In the service uniforms the kilts are khaki color.

Long-skirted tunics without collars, but with full-length sleeves, trousers, putties, and turban, roughly describes the costume of the Indian troops. Blue is their general color, but the uniforms are not regular in detail, differing according to the various castes.

In the French line infantry a single-breasted blue tunic with its collar, cuff flaps and shoulder straps in red; baggy madder-red trousers, tucked in ankle boots or worn with heavy hobnail shoes and gaiters; red kepi with a tricolor cockade and ball; blue band and brass ornament, and a heavy blue-gray great-coat, cut away from the waist to the knees, constitute the uniform. The same style of tunic is used by the *chasseur* battalions, with different colors of trimmings. The trousers, how-

ever, are blue-gray with yellow piping, and the kepi dark blue with yellow braid. The dress of the French Zouaves is distinctly Moorish in style, having short, dark-blue jacket with red trimmings, extremely baggy, knee-length trousers, white spats and tasseled cap. The Turcos dress similarly, excepting that their trousers are usually either white or blue.

French cuirassiers, hussars, dragoons, and *chasseurs à cheval* have red trousers tucked into boots, and blue tunics. The cuirassiers are protected by heavy steel breast and back plates, and wear a steel helmet with brass ornaments, black horsehair tail and sometimes a red "shaving brush" at the front and side. Dragoons also wear helmets with tails. The red kepi is the service head-dress of the *chasseurs*. A half-open vest of light blue with yellow collar, a red sash and trousers to match, is the attire of the *chasseurs d'Afrique*. The Spahis wear red jackets and baggy blue trousers tucked into red morocco boots. A flowing mantle covers head and shoulders. French artillerymen wear black-braided, blue dolmans, with red shoulder cords and red collar, and trousers of the same color.

Green is the predominating color of Russian uniforms. Double-breasted tunic and knickerbockers, high, black boots, and a flat-topped cap is the customary uniform of the infantry. The heavy grayish-



While the Above Uniform Is a Typical One, the Costume of the Indian Soldier Often Varies According to His Caste



The Turcos, or Members of the Algerian Infantry of the French Army, are Uniformed Essentially the Same as the Zouaves



The Flashy Red and Blue Uniform of the French Infantryman Makes Him a Very Conspicuous Target for the Enemy

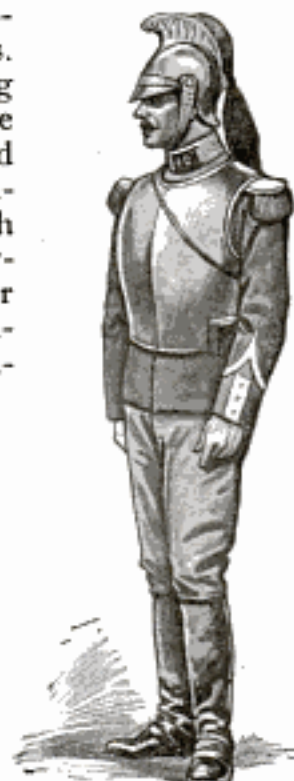

Cuirassiers of the French Cavalry are Always Identified by Ornate Steel Helmets and Heavy Cuirasses

brown, waterproof overcoat is lined with sheepskin and fitted with a head cape. In summer, a light blouse of white linen replaces the tunic. Shoulder straps and cap bands vary according to regiments. The Russian line dragoon wears trousers of blue-gray cloth and a peaked cap. The Russian soldier wears footcloths instead of socks.

Cossacks wear long, loose caftans, dark blue for the troops of three of the divisions, but dark green for the rest. A cloth-topped, conical lambskin cap is worn, except by the Caucasus regiments, which dress in dark-brown caftans and have a full headdress, not a cap. The guard regiments have short tunics, either blue or red. The czar's personal escort dresses in scarlet, gold-braided caftans, white waistcoats and blue trousers. The guard regiments wear spurs, but the other Cossack regiments carry whips instead. They carry curved swords without guards, while some

of the regiments also have daggers. The men of the front rank are armed with 9-ft. cavalry lances.

Dark-green tunics, trousers and caps, with red shoulder straps and piping, is the uniform of the Russian artilleryman. Black collar and cuffs, edged with bright red, distinguish the guard artillery.

The Belgian line infantry is uniformed in blue with double-breasted

coat, loose trousers tucked into high laced boots, and cap of kepi pattern.

Overcoats are the same color. On dress occasions, a bearskin shako is worn by some corps of guards. Belgian cavalrymen wear blue or red tunics, while the headgear varies, the lancers wearing the uhlan czapka, the chasseurs the kepi, and the dragoons a helmet and

occasionally a shako. The light artillery has red trousers, long blue coats, and high boots.

Most of the German troops are fitted with service uniforms of a gray that blends so completely with the landscape that, at a short distance, it is difficult to de-

tect the presence of a body of soldiers. The cut of the uniforms varies in the different arms. Some of the infantry forces, however, are wearing dark-blue tunics, gray trousers piped with red, Wellington boots, black leather helmets, and gray greatcoats. Like the Russians, they wear footcloths



With the Exception of the Guard Regiments, Russian Cossacks Never Wear Spurs, but Instead Carry Long Whips



The Spahis, Forming the Native Algerian Cavalry, Which is Commanded by French Officers, Wear a Red, White and Blue Costume



Dark Green Is the Predominating Color for Both the Dress and Service Uniforms of Nearly All the Russian Land Forces



The Blue Uniforms of the Belgian Soldiers Bear a General Similarity in Cut to Those Worn by the French Forces

instead of socks. The sharpshooters, known as jaegers, are identified by shakos with drooping plumes, green tunics, and gray trousers.



Germany's Gray Uniforms Make Its Soldiers the Most Inconspicuous of Any on the Battle Fields of Europe

Iron and brass cuirasses and high tan boots are worn by the German heavy cavalry, with burgonet-shaped helmet, and blue tunic with gray trousers. The dragoons and

Bavarian heavy cavalry have tunics of light blue, trousers of still lighter blue, and black leather helmets with horsehair tails.

The German hussars are noted for their rich costumes, decked with ornaments and trimmings. They wear tunics of a variety of colors, fur busbies, gray trousers with lace stripes, Hessian boots, and white pouch belts. The color of the braid and lace marks the identity of the regiment. A dark-blue tunic, with girdle and pastron, gray trousers,

and a czapka characterize the uhlan lancers. Lances are carried by all cavalymen. Nearly all of the German artillery regiments wear dark-blue coats and gray trousers.

In the armies of Austria-Hungary, the infantry uniform consists of a dark-blue tunic, cut single-breasted; trousers of a lighter color, and a cap of the same shade patterned after the kepi. A plain blouse with no shoulder straps, or a jacket, replaces the tunic as a service dress, while the cap worn in the field is cylindrical. The differences between the Austrian and Hungarian uniforms



The Hungarian Uniform Differs Only Slightly from the Blue Costume of the Austrian Infantryman, Which is Shown Here

are merely of detail. The jaegers wear broad-brimmed felt hats bearing plumes on the left side, and tunics and trousers of dark green mixed with gray. Austrian dragoons wear blue jackets and red trousers, crest helmets, and a short, fur-trimmed jacket, called a pelisse. The hussars wear dark jacket and pelisse, with gold-braid bars across the chest. The trousers are red and tighter than those of the dragoons. The shako, with a "shaving-brush" plume at the front, is generally worn. The Austrian uhlan wears a uniform not greatly different in appearance from that of the dragoon. The artillerymen wear maroon tunics, light-blue trousers, and a cap of about the same shade.



German, 4 Lb. 1 Oz.

English,
3 Lb. 9 Oz.

French,
3 Lb. 12 Oz.

Servian,
2 Lb. 12 Oz.

Austrian, 4 Lb.

These Military Boots Represent the Types of Footwear Worn in Service by Infantrymen of Europe's Armies



Building the Bridge to Island Mountain Tunnel: The River Takes Eight Miles to Get to the Other Side of the Mountain While the Tunnel Goes Through in 4,300 Feet

RAILROAD TUNNEL THROUGH ISLAND MOUNTAIN

8145 m
A curious phase of railroad construction is the Island Mountain tunnel on a railroad just built in California. This mountain gets its name from the fact that it is almost entirely encircled by a river which takes eight miles to go from one side of the mountain to the other. By means of the tunnel the railroad gets through to the other side in 4,300 ft. The bridge over the river extends up to the precipitous face of the mountain so that a train passes directly from the bridge into the tunnel.

ELECTRIC SIGNAL DEVICE FOR MOTOR CARS

Auto Access
8409 H Rear
For the purpose of informing pedestrians in front of a motor car, as well as traffic at the rear, of the course it is to pursue at a street crossing, an electromagnetic signal has been devised which is operated by a couple of push buttons on the steering wheel. The indicating members of the apparatus consist of two arrows several inches in length, one of which is mounted on the radiator and the other over the tail

lamp of a machine. When the arrows point toward the ground they show that the driver intends continuing straight ahead, but by pressing one of the buttons the two pointers are drawn to the right, or left, as the case may be, announcing that the car is to turn in the direction indicated. The moment pressure on the button is removed, the



These Arrows, Operated Electrically, Indicate the Course to be Taken by a Motor Car at a Street Crossing

arrows drop back to their normal positions. At night time when the signals are being operated they are illuminated by small incandescent lamps.

July 1, 1914, No. 1, Ave. 1, San Francisco, Calif. with view of the car in the background. Changeover 292 of W. J. ...
Copyrighted material

*Editorial Johnson, Editor,
Cement World,
1827 Prairie av., Chicago, Ills*

*Leaflet sent out by Dept. of Interior,
Bureau of Mines. Written by Albert
H. Fay & entitled "Production of Ex-
plosives in the U. S." during the
year 1918*

84915 SNAKES PROVIDED WITH CONCRETE HOUSES

A snake farm where the reptiles are provided with concrete houses is an odd institution maintained by the gov-

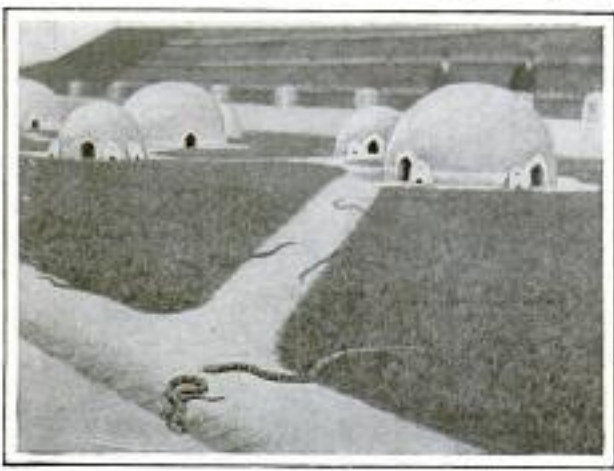

COURTESY CEMENT WORLD
A Brazilian Snake Farm Where the Serpents Live in Concrete Houses

ernment of Brazil at São Paulo. It serves the double purpose of providing a supply of material for the production of serum antidote for snake bites and of educating the public to the fact that all snakes are not venomous. The "farm" is surrounded by a concrete wall high enough to keep the snakes

from crawling out, but low enough for visitors to see over. Inside the wall is a water-filled trench, also lined with concrete, while concrete walks connect the snake houses. At night the snakes are herded into these dome-shaped structures and the doors are closed. In the morning an attendant wakes up the reptiles by prodding them with a stick through a hole in the door, after which the doors are removed and the snakes come out for their morning bath in the trench.

8625 EXPLOSIVES CLASSIFIED BY MINES BUREAU

Under the classification made by the U. S. Bureau of Mines, explosives used in mining and blasting are classified under three heads. Black blasting powder includes all black powder having sodium or potassium nitrate as a constituent. In the class of high explosives are included all dynamite or other high explosives with the exception of permissible explosives. Permissible explosives are those that have passed safety tests specified by the Bureau of Mines.

8321 HOW SHIPS' CABLES ARE MADE AND TESTED

The most important center in the United States for the making of chain cables for seagoing vessels is an inland city, Columbus, Ohio. Curiously enough this industry had its origin in contract work done in the penitentiary. The industry simply spread beyond the prison walls and has flourished under free labor for many years. Large cables are made entirely by hand by expert blacksmiths. Each link is formed from a rod of iron, 32 in. long and nearly 2 1/2 in. in diameter. One of these links weighs 50 lb., and a 90-ft. cable weighs as high as 5,500 lb. Before a cable leaves the factory it is always subjected to a test in which the weakest link in the chain is destroyed. The chain is laid in a long steel trough imbedded in the floor. One end is attached to a powerful testing machine

and the other to an anchorage at the opposite end of the trough. The test consists in pulling on the chain until one of the links snaps and in determining, from an indicator on the testing machine, at what tension this occurs. When the link snaps under the test, fragments are often thrown violently to all parts of the room, and for this reason only the men required for operating the machine are allowed to remain in the room, and these are protected by a heavy wooden barricade. The force registered usually runs from 250 to 375 tons. Following the test, the broken link is replaced and the end links are marked with an iron stamp to show the strain at which the cable parted. The cable is then rolled on an enormous iron spool, dipped in a black coating, and is ready for shipment.

*C. C. Johnston, 1108 Brunson Bldg.,
Columbus, Ohio.*

*Instituto de Oceanografia,
Sao Paulo, Brazil.*



Links for the Chain Cables of Seagoing Vessels are Made by Hand from Iron Rods 32 Inches Long and Nearly $2\frac{1}{4}$ Inches in Diameter



Chain in Steel Trough Ready for the Breaking Test. View of Testing Machine at Left



Scene in the Blacksmith Shop of a Chain-Making Establishment: The Completed Chain Shown in This Picture is Made to Withstand a Breaking Strain of from 250 to 375 Tons

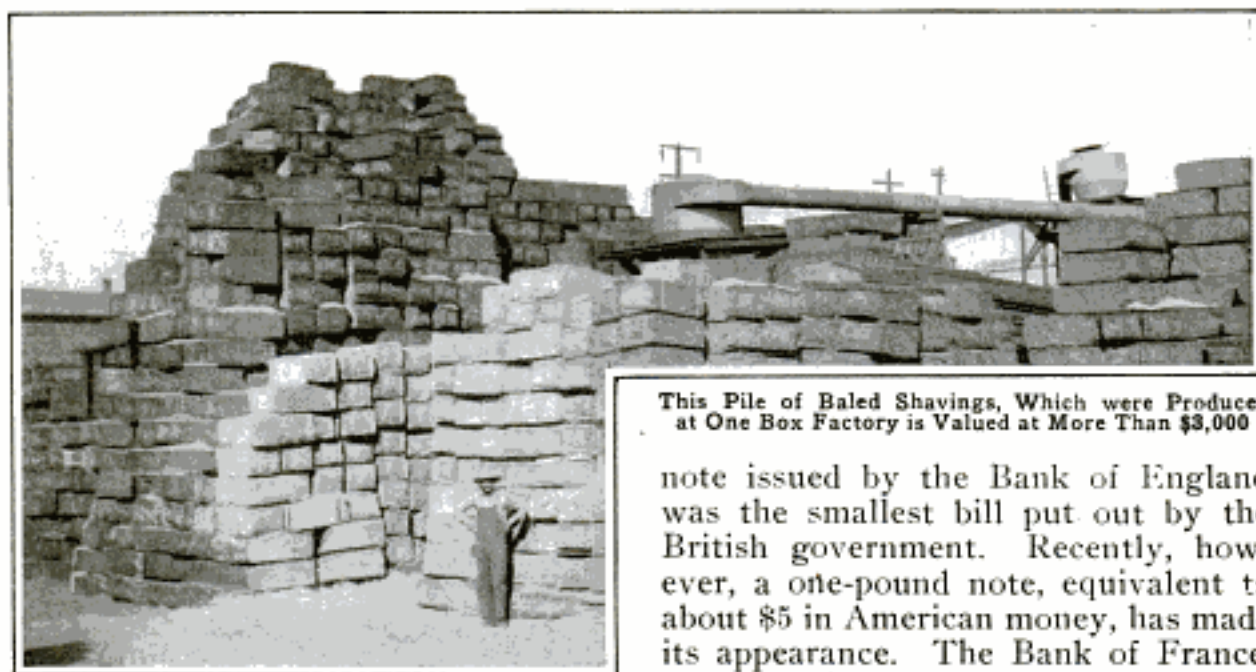

This Pile of Baled Shavings, Which were Produced at One Box Factory is Valued at More Than \$3,000

SHAVINGS A BOX-FACTORY BY-PRODUCT

The shavings which are produced in large quantities at box factories are often regarded as waste material and burned. One large factory in California has turned this waste material into a profitable by-product by baling and selling it. The shavings are used principally as a mulch for orchards, and as bedding for horses and cattle, and there is a ready market for all the shavings produced when they are put in convenient form for handling by baling. They are baled in a specially designed baler somewhat similar to an ordinary hay baler. More than \$3,000 worth of shavings are contained in the piles shown in the illustration.

SMALL BANK NOTES ISSUED IN FRANCE AND ENGLAND

In order to meet the financial crisis caused by the outbreak of the European war, both Great Britain and France have made large issues of emergency currency which is now in general circulation. In each instance paper money of much smaller denominations than that previously in existence in the two countries, has been introduced. Heretofore the five-pound

note issued by the Bank of England was the smallest bill put out by the British government. Recently, however, a one-pound note, equivalent to about \$5 in American money, has made its appearance. The Bank of France, on the other hand, regularly issued nothing smaller than a 20-franc note, which in our money represents \$4. At the opening of the war a five-franc bill was placed in circulation by that institution, while shortly afterward a two-franc note was placed in circulation by the town of St. Quentin. After the Germans had passed through Epernay, France, and taken most of the available money with them, the mayor of that place authorized the issue of notes in denominations as small as 25 and 50 centimes, or five and ten cents.

NEW METHOD OF MENDING BROKEN BONES

A new method that has just been announced for hastening the repair of fractured bones consists in injecting into the fracture a mixture made of granulated bone and petroleum jelly, or petrolatum. A fresh piece of bone is dried, ground to powder, mixed with petrolatum to the consistency of paste and then sterilized. After the fracture is located, a hollow needle is pushed through the flesh to the bone, and the paste is injected between the broken ends by means of a hypodermic syringe.

An Oklahoma oil company is contracting to supply the British government 15,000 barrels of crude oil a day.

Illustrated London News

Chicago Record Herald

See Jerkey 10-67 G. H. Davis, Jr.,
15 Putnam Ave.

Scientific American
POPULAR MECHANICS Braintree, Mass.
LIQUID OXYGEN AS AN
EXPLOSIVE

8700 m
A practical method of making use of the explosive quality of liquid oxygen, a quality it has long been known to have when mixed with certain substances, has recently been discovered. This method consists simply in filling bags with a special form of lampblack and then soaking them thoroughly in the liquid oxygen just before they are required for use. If the soaked bag is lighted with a match, it burns harmlessly, but if detonated, it explodes with the force of dynamite. There is little danger in case of misfire, as the liquid oxygen evaporates in a few minutes.

8376 m
PANAMA CANAL AT NIGHT IS
A BEAUTIFUL SPECTACLE

Striking night effects are produced by the rows of powerful electric lights that line the side and center walls of the Panama Canal locks, as will be seen from the illustration showing the ordinary working illumination of the Pedro Miguel locks. This effect is duplicated at each of the other two sets of locks, while similar lights spaced at greater distances apart serve to mark the channel from end to end of the canal and make navigation as safe by night as by day.



The Pedro Miguel Locks at Night: Effects Like This Form a Striking Feature in a Night Voyage across the Isthmus

Underwood & Co.
12-112 West 37th St., N.Y.C.

8499 m
POSING FOR A PICTURE AT
TOP OF LOFTY SPIRE

Standing with outstretched arms on the ball of a weather vane surmounting a high steeple, was the position selected by a daring steeple jack when asked to pose for his picture. He was at work repairing the tower of the Old South Meeting House in Boston, and the photographer would have been satisfied with a picture showing him at work on the swinging scaffold. This did not seem interesting enough to the steeple jack, so he climbed to the top and took the pose shown.



Can Oregon forest ranger, notified of a forest fire, drove to town, hired 10 men and transported them to the scene of the fire, 12 miles away, all in 48 minutes, thus preventing a serious blaze.

ELECTRICAL SIGNAL POST SUMMONS POLICEMAN

The use of a signal post for calling the patrolman to the telephone for communication with headquarters is an experiment now being tried in New York City. The post is placed at the street corner so that it can be seen down each of the intersecting streets. It is equipped with an electric light having five lenses, one lens being directed along each of the streets and one toward the pavement under the post. In case headquarters wishes to communicate with a patrolman, the light is turned on by means of a connection on the switchboard at headquarters, and is practically certain to be seen by the patrolman as he crosses any one of the intersecting streets in walking his beat. The lamp is so arranged that it is visible by day as well as by night. The signal post is provided with a telephone and also with a "citizen's push button," with which anyone needing a policeman can turn on the light and summon one to his aid.



8322
m

man as he crosses any one of the intersecting streets in walking his beat. The lamp is so arranged that it is visible by day as well as by night. The signal post is provided with a telephone and also with a "citizen's push button," with which anyone needing a policeman can turn on the light and summon one to his aid.

VARIATION OF THE COMPASS OVER HUDSON BAY ROUTE

8672
m

One of the difficult and dangerous features of navigating the new Hudson Bay route is the variation of the magnetic compass on Hudson Bay and out through Hudson Strait and Davis Strait to the Atlantic. On the west shore of Hudson Bay the compass points 10° east of true north, while through the greater part of Hudson Strait it points

from 50° to 55° west of true north. This is due to the fact that the magnetic pole is not the same as the true north pole of the earth, but is located on Boothia Peninsula only a few hundred miles north of Hudson Bay. To overcome the dangers to navigation from this cause, the Canadian government, after a thorough magnetic survey of the route, prepared a chart showing the exact variation of the compass at each point on the route. Since the preparation of this chart there has not been a single mishap, although in 1913 there were several shipwrecks attributed to uncertainties in the compass. As a further aid to navigation, the government has established ten lighthouses which burn eight months day and night without attention, thus doing away with the necessity for an attendant. These lighthouses are supplied with gas and lighted early in the spring, and continue to burn until the close of navigation.

NEW HOLDER WITH SPRING CLAMP

7211
m

A convenience adapted to the home as well as the shop is a new spring holder for umbrellas, brooms, tools, and other articles. The holder is fixed to the wall by a gimlet-pointed screw and has two spring jaws which clamp down on any ordinary handle and hold it securely. It is also provided with several small loops for holding such objects as toothbrushes, button hooks, scissors, and gimlets.



Call the British aeroplanes now operating on the European battle fields flew to the scene of action under their own power.

W. M. Gladish
33 Winerva Ave.
Toronto, Canada

Douglas Mfg. Co.,
1230 Fulton St.,
Brooklyn, N. Y.

Taken from ad of Commonwealth Edison Company

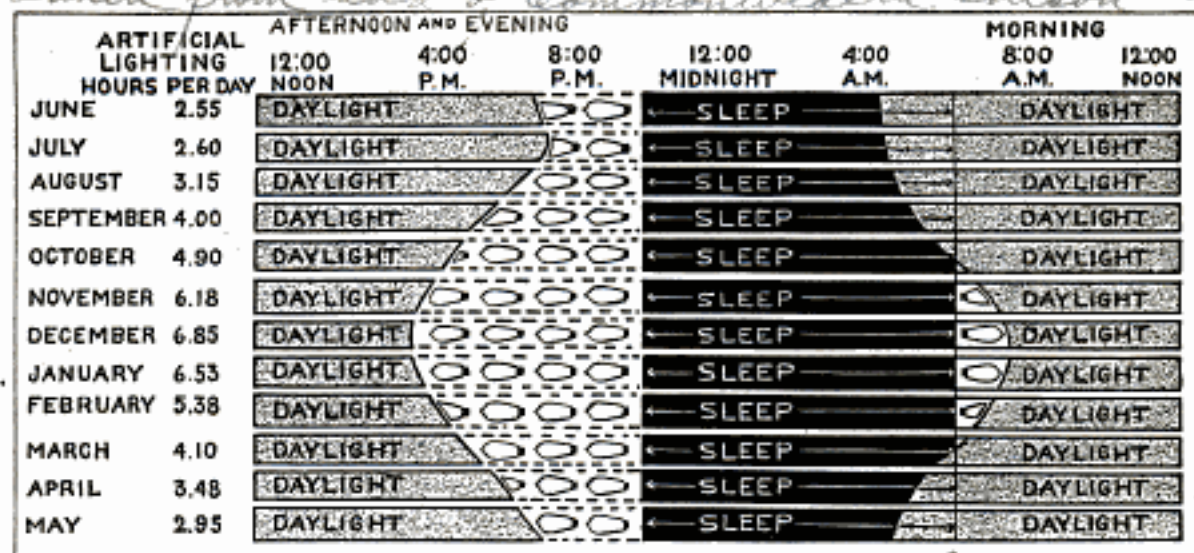

Chicago Examiner 1912

This Diagram Shows the Number of Hours Artificial Light is Used During the Different Months of the Year

LIGHTING BILLS IN WINTER TRIPLE THOSE OF SUMMER

During the winter months people depend upon artificial illumination nearly three times as many hours in each 24, as in the summer. In June, for instance, electric lights, or other mediums of illumination, are used in the average household approximately $2\frac{1}{2}$ hours a day, while in December this period is increased to $6\frac{1}{2}$ hours. The accompanying diagram, showing how the hours of daylight vary throughout the year, explains why lighting bills for the average residence are practically triple in the winter what they are in midsummer.

stated that the cost of production has been reduced to approximately \$25 a ton, which is very much less than it costs to produce it as a by-product. The world's consumption of ammonia sulphate for fertilizing purposes amounts to hundreds of thousands of tons annually.

PADS KEEP FEET FROM SLIPPING OFF PEDALS

In an attempt to overcome the danger of the chauffeur's feet slipping from the clutch or brake pedals of an automobile, which in a tight corner might prove disastrous, a button pad which fits to the plates and secures a firm hold for the feet, has been made. After the pedals have been in use for some time they often wear smooth. This makes it difficult, especially on bad roads where there are bumps, to keep the feet in position. To fit the pads to the plates, it is only necessary to have a small hole bored. The buttons then may be fastened by bolting.

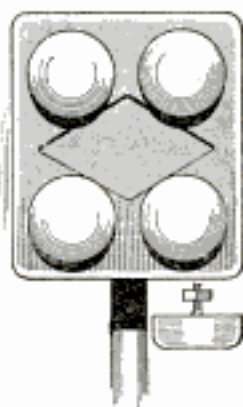

Brown Iron, Ltd. Great Eastern St. 15 Newington Causeway Oxford St., W., London, E.C.

GAS INDUSTRY OF ENGLAND AND SYNTHETIC AMMONIA

Commercial chemists in England have perfected a method for the synthetic production of ammonia from its elements nitrogen and hydrogen, which, it is stated, is less expensive than the making of sulphate of ammonia as a by-product of the gas industry. In the past year the British price of sulphate of ammonia has dropped 20 per cent, which establishes the lowest value for the salt that has been placed upon it in 10 years. While definite figures are not given out, it is

London Times (Engineering Supplement) July 31, 1914

The Car April 8, 1914

NOVEL AND PRACTICAL THINGS FOR DAILY USE



Sandwich Tray Fastens
to Saucer

INTENDED to be used at afternoon teas, or on other occasions when light refreshments are served, a sandwich holder is being made which fastens securely to the edge of a teacup saucer. It is designed in silver in the form of a lily leaf and on its under side is provided with a clasp which fits over the rim of any saucer, enabling wafers or sandwiches to be held with a cup of tea in one hand.



Laundry Bag and
Convenient Fixture

A household laundry bag is being made which is supplied with a metal fixture that holds it open so that soiled linen may be dropped into it without difficulty. The bag itself is of the ordinary type, while the hanger, which is intended to be attached to a wall, consists of a hoop-shaped wire rod open at the middle so that it may be inserted through the draw-string hem of the bag. Capable of being used for an indefinite time, and attached or detached without means of a separate opener, a crown cap for bottles has been invented which seals a flask air-tight when it is in place. A small thumb lever grips the two ends of a wire which is looped around the



Crown-Cap Stopper for
Bottles

base of the cap. When this is turned down it draws the wire together in a groove about the neck of the bottle and fastens the cap in place.



Downward Pressure
Cuts Can

The device is made of heavy steel and has a handle large enough to be gripped firmly. Adjustment is unnecessary when it is being used on different-sized cans.



Simple Holder for Broom
or Mop

A broom and mop holder recently invented consists of a nickelplated forked hook which receives a handle between its open jaws and holds it securely. The two prongs extend out sufficiently far to accommodate also a dust pan and brush.

Adjustable holders for dishes are being made which are intended to be used when highly heated china is placed on a table. They afford handles by which

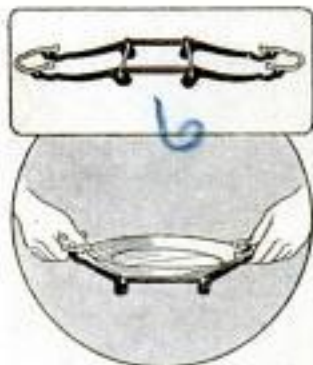

Adjustable Holder for
Hot Dishes

hot dishes may be held without danger of burning the fingers, and also the standards which protect the polished top of a table from being injured by heat.

An individual breakfast service that has recently been shown consists of a metal frame, carrying an egg cup and salt and pepper shakers, which clamps to a plate. Hot toast or biscuits are served on the latter. When it is not in use the frame may be removed from a plate quickly.



Individual Breakfast Service

Designed for opening boxes and crates, a combination tool has been invented which also serves as a hammer, hatchet, box chisel, and nail puller, as well as a cutter for paper and fiber cases. The instrument is substantially made and has a long handle which gives it good leverage in prying.



"Semi-oli"
Box Opener and
Combination Tool

Matches are being packed in a new pasteboard container which, when un-



Match Box Serves as
Wall Fixture

folded, forms a receptacle that may be hung in some convenient position to replace the customary wall match box which requires frequent refilling. The top end of the box pulls out so that it may be suspended from a hook, while the bottom unfolds to form a bin into which the

matches are fed by gravity.

A nutcracker designed for table use is being made which may be used for either large or small nuts. The handles are gracefully curved in such a way that they are easily gripped, while the broad cups in which the nuts are placed, crack a shell over its entire length.

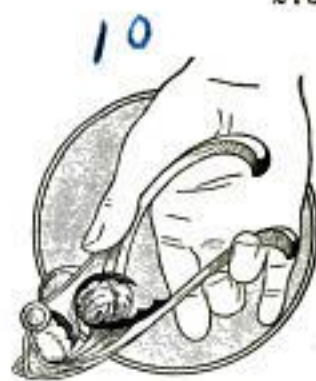

Ornamental Nutcracker
for Table

An electric toaster which by a simple operation may be converted into a small stove and used for numerous purposes, either on the table or in the sick room, has been designed. The coils are held in a frame which is so pivoted to the standard that it may be turned vertically and used for toasting, or horizontally to form a flat heating surface on which dishes may be kept warm, tea or coffee made, or water boiled.



Electric Toaster and
Stovette

Made of polished wood and burnished brass, an open-armed necktie rack which is both serviceable and slightly has been introduced. The rod on which the ties are hung is bent V-shaped in the middle where it fastens to a wooden back, but is open at either end. The device is intended to be attached to a wall. Since the bar is divided into two parts, scarfs of different types may be kept separated.

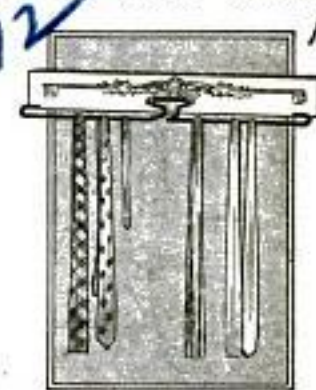

Necktie Rack with
Open Arms

**PENCIL AND POSTAGE SCALE
COMBINED IN ONE**

Combined with a lead pencil, a novel postage scale which registers the number of ounces a letter weighs, has been

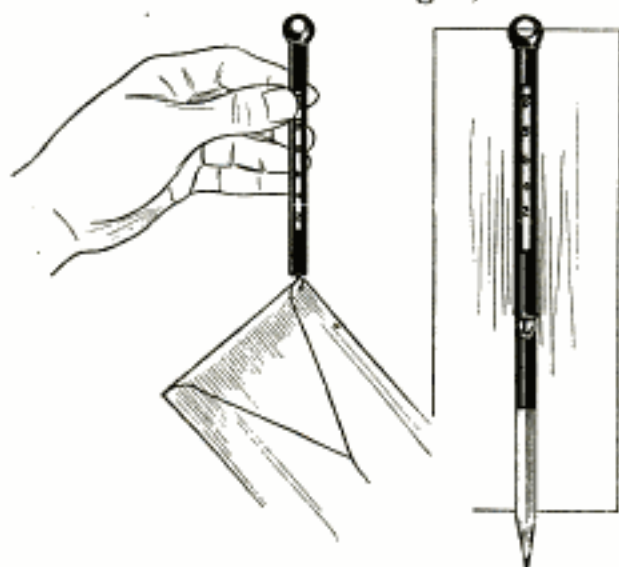

Pencil Fitted with Small Postal Scale

invented. The scale works on a spring which is contained in a small metal tube. At the bottom of this is a hook which may be inserted into the piece of mail to be weighed. The pencil and scale telescope so that the general appearance of the device is the same as that of many pencils. When the scale is not in use the hook is out of the way, being covered by the joining of the two sections.

**TESTING STAND FOR MOTORS
IN AEROPLANE FACTORY**

Ordinarily the stands used in testing aeroplane motors are fixed, and can, therefore, give little authoritative data regarding the behavior of the motor when it is mounted upon the yielding

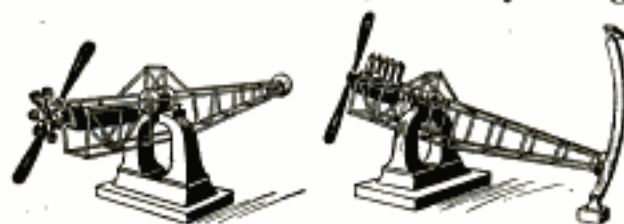

The New Stand Used in Germany for Testing Aeroplane Motors

support afforded by the fuselage, or frame, of the aeroplane. A new testing frame, which has been tried out with

*Berliner Tagblatt
December 18, 1913
Designed by Prof. A. Riedler,
Berlin, & used in the Berlin
Technical High School*

satisfactory results lately, consists of a framework of tubular steel in the shape of an aeroplane fuselage, so pivoted that it permits an up-and-down as well as a limited sidewise motion. A recording device is attached which graphically registers such movements, and from the resulting charts the behavior of the motor is studied. For testing automobile motors the support takes a form similar to a spring-equipped chassis.

**NEW SAW HAS SHIELD FOR
PROTECTING TEETH**

A novel feature in a saw that has just been patented is a shield which protects the teeth when the saw is not in use, but which can be easily folded back into a recess in the handle when the saw is to be used. In addition to this the saw is so made that it comprises a protractor, rule, straightedge and try-square. The shield is of metal and has a longitudinal channel into which the toothed edge of the saw fits, and at the base of the channel is a layer of cork, felt or other soft material, to prevent damage to the teeth. When



This Saw is Equipped with a Folding Shield for Protecting the Teeth, and is So Made That It Comprises a Protractor, Rule, Straightedge, and Try-Square

the saw is to be used, the shield is released by pressure against a spring, and the sections are folded back upon each other and into the recess in the handle. The back of the blade is straight and is perpendicular to the forward edge of the handle, and in this way a try-square and a straightedge of convenient length are provided. Inches are laid off along this edge. The protractor is placed on the side of the blade near the middle, having its center at a V-shaped notch in the back. The zero line is perpendicular to the back and from this line, lines for each 5°, up to

*Chas. H. Shapiro,
Portland, Oregon
(Inventor)*

45°, are laid out in each direction. Each line is provided with V-shaped openings having their points on the line. With this arrangement two points on a line at any angle are easily laid out and the line is then drawn through the points by using the back of the saw as a straightedge.

ORIENTALS USE RAILROADS AS SLEEPING PLACES

In some of the uncivilized parts of the world which are penetrated by common carriers, railroad tracks are said to be favorite slumbering places for many of the natives. In India women and children who are employed in unloading freight cars are not infrequently seen sleeping on a right of way with their heads resting on the rails, often making it necessary for some one to walk ahead of a train and awaken them in order that it may pass. In certain sections of China a similar condition exists and is responsible for a large percentage of the fatalities caused by railroads there. Upon first seeing a locomotive the natives are usually filled with dread, which later gives way to supreme confidence.

COMBINED CRIB AND SCALE FOR THE BABY

A crib for the baby, combined with a simple scale, permitting constant weighing of the infant without removing it from the crib, is a late French novelty.



The crib is suspended on pivoted cross legs, and the scale is so attached that the weight of the

baby tends to push the legs supporting the crib apart. This is resisted by a rod attached to the dial on one of the lower crosspieces of the crib, the baby's weight being thus instantly registered when it is placed in the crib, the pointer moving over a properly calibrated dial.

La Nature
For sale: Jules Thirfan et
Fils, 110 Boul. Sebastopol,
Paris.

FAN BLOWS HOT SUDS THROUGH CLOTHES

In a new washing machine there are neither gears nor belts. A small electric motor fastened beneath the tub is



Washing Machine Operates on New Principle and Subjects the Clothing to No Rubbing Process

connected with a fan or propeller within the tub, and the fan sends a constant stream of hot suds through the soiled clothing, contained in a movable cylinder which is slowly revolved by the action of the stream of hot water upon it. The only manual labor involved is that of placing the soiled clothing in the receptacle, and filling the tub with a sufficient quantity of hot water. When the washing is completed, the cylinder is lifted above the level of the water, and the clothing run through an electric wringer attached to the top of the tub.

SAFETY PLATFORMS BUILT FOR SUBWAY TRAINS

The rush and hurry of passengers entering and leaving subway trains makes careful attention essential, especially where some station platforms have been built on curves, and this attention the hurrying passengers often do not give. On the curved stations either the center or the end doors of the cars must be separated by some distance from the platform edge, making a rather long step unavoidable. To obviate this, a sliding platform sec-

Engineering News

tion has been provided, controlled by pneumatic cylinders, such as are used in many cases to open and close the doors of the cars. As the train comes to a

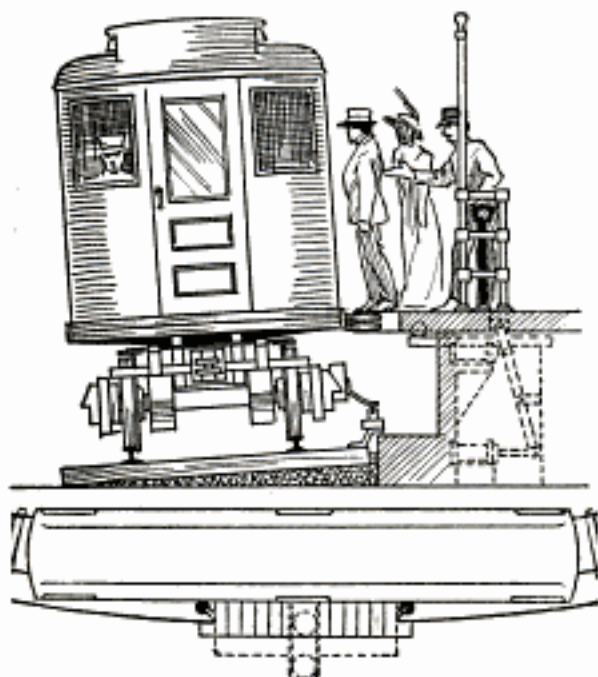

Sliding Platform Section Prevents Accidents in Subway Stations

stop, the platform guard moves a lever, making electrical connections, and the air is admitted, pushing the sliding platform section outward from beneath the main platform, until it engages the guide boards on the side of the car. When the train starts, the swing of the car pushes the platform back, reversing the cylinder control, and the sliding section is withdrawn.

PLAN FOR REORGANIZATION OF STATE MILITIA

Plans contemplating the reorganization of the militia in order to permit its quick mobilization in the event of threatened hostilities are in the course of preparation by the War Department. This step is one of several changes in the different arms of the fighting service as a result of lessons impressed by the European war. In so far as it is possible, it is planned to make the organization of the militia correspond with that of the standing army, which, for one thing, means that the size of the companies will be

Chicago Tribune

increased. As an illustration, the peace strength of a militia company of infantrymen will be raised from 58 to 65, and the war strength placed at 150, conforming with that of the army. When Germany mobilized her army, it was shown that she had equipment ready for every one of her thousands of reserves. The War Department plans to have a stock of equipment sufficient for supplying the militia at its war strength, which in case of trouble might be expressed immediately to the various mobilization points from the national armories.

The adoption of rolling kitchens similar to those in use by the German army is also being considered. One of these would be adequate for a battalion, and would replace the three ranges now carried. The principal feature of the kitchen which has attracted the attention of the War Department is its employment of the fireless cooker, which enables the preparation of food during the course of a march.

HANDY LIGHTING CAP FOR 7113 DRY BATTERIES

For use on ordinary commercial dry batteries, a portable electric light has been conceived which combines the functions of bulb socket, reflector and circuit connector in one piece. Simplicity attends every feature of the idea. The device consists solely of a metal cap, so shaped as to form a reflector, which fits firmly over the top

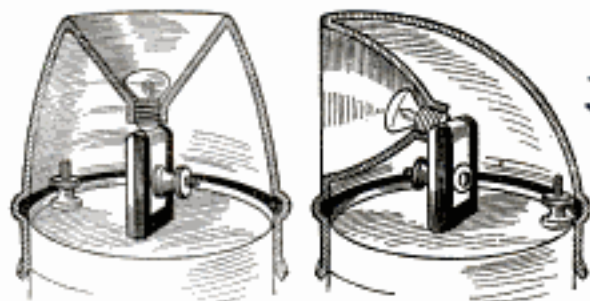

An Electric-Light Attachment for Ordinary Dry Batteries

of the cell. No wires or switches are needed. When put in place the grooved rim of the cap comes in contact with the negative pole of the bat-

Letter to the Editor
716 - 14th St., N.W.
Wash., D.C.

James R. Napp, Los Angeles, Calif.

Milwaukee, Wis.

tery, while the small electric bulb, set in the center of the reflector, makes a connection with the carbon post. As soon as this is done, light is produced. The arrangement is convenient, especially for motorists and others who frequently have need for a long-burning light.

IGNITION DEVICE DESIGNED

8338 H FOR GAS RANGES *Light*

Eliminating the necessity of using matches, a convenient ignition appliance has been devised for gas ranges which makes it possible to light a burner by pressing a button. This is not an electric device, but a pilot lamp which is attached between the burners of a stove in such a position that, when desired, its flame spreads out over each one of them. It is housed in a venti-

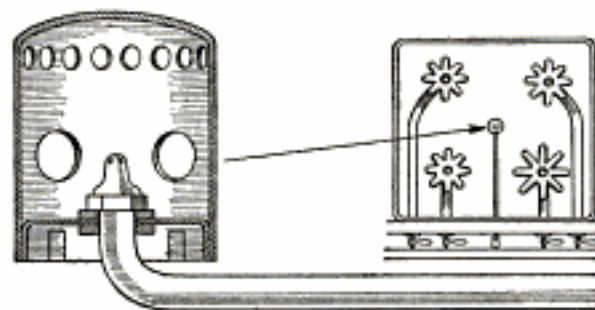

This Lighting Appliance may be Fitted to Any Gas Range in a Few Minutes

lated hood constructed in such a manner that the flame is prevented from being blown out by sudden gusts of wind. At the end of the feed pipe of this auxiliary burner is a button which regulates the flow of gas. When this is pressed down, the flame is increased so that four slender tongues of fire break through holes in the housing and reach the various burners on the range, causing ignition wherever gas is flowing.

SPIRIT LEVEL IS COMBINED WITH POCKET RULE

8267 H A combination folding rule and spirit level is being made which is provided proper alinement and an even bearing surface by specially designed closing pins. The instrument is formed in three 8-in. sections united

Mfg. & Contributor
The Lufkin Rule Co.,
Saginaw, Mich.

by brass joints. The level is depressed in the upper edge of the middle section where it is protected by the two

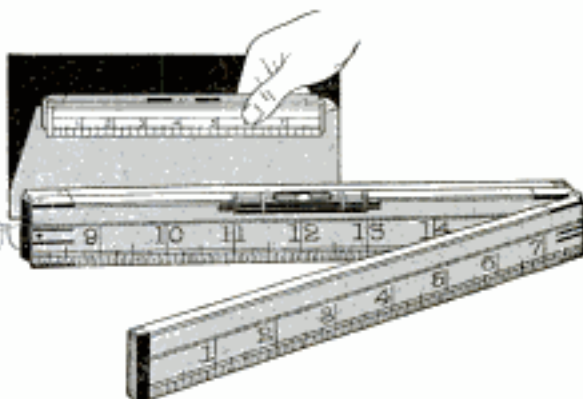

A Combination Tool Which Is Convenient for Both Amateur and Professional Craftsmen

outer sections which inclose it. It offers a convenient tool for many classes of workmen, and is especially serviceable in close places where it is difficult to use the customary level.

MECHANICAL HAMMER DRILL STRIKES RAPID BLOWS

Hand
A recent invention for the use of electrical workers and mechanics eliminates the strain and drudgery of drilling by hand, and substitutes centrifugal force for main strength. It consists of a hand drill, operated by a crank, in which revolving hammers, pivoted to a steel spider, strike the head of the drill rapidly. It is so geared that 13 blows are struck to each

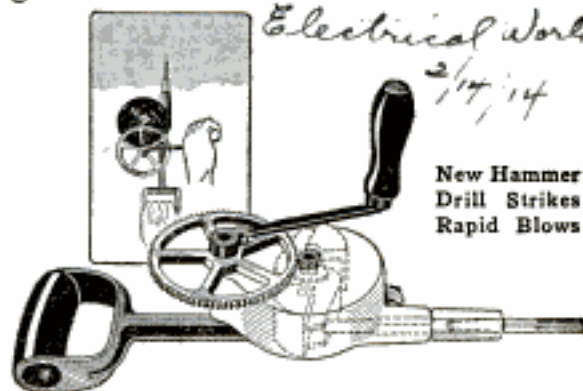

New Hammer Drill Strikes Rapid Blows

Electrical World
2/17/14
revolution of the handle. For drilling holes in concrete, brick, stone and tile, the new device enables the workmen to more than double their efficiency without fatigue.

Orr & Lockett Hardware Co.,
16 W. Randolph St., Chicago
451
Broome St., New York

J. S. Murray
Comptroller Bldg, Suite 711
280 Dallas, Texas

Trackway Review 02-8-14
Mallet Locomotive, made by
Baldwin Loco. Works, + tested on
the Erie R.R.

MOVABLE STEPS THAT WORK LIKE ELEVATOR

70x57m
A novel and ingenious combination of elevator and stairway has been invented for use in places where lack of space prohibits the installation of either

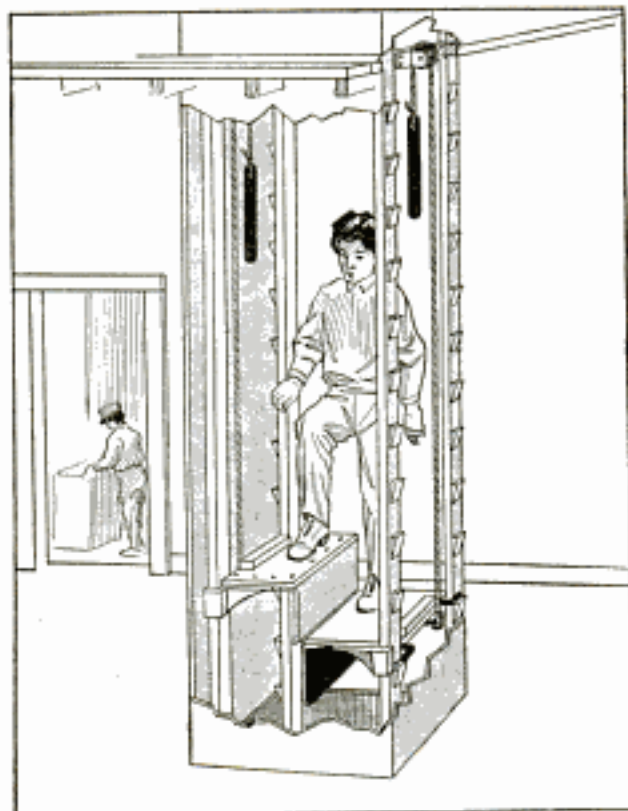

These Steps are Made to Rise or Descend Alternately by Pressure of the Foot

an elevator or a stairway. The apparatus consists of two steps that operate in a small shaft and move up or down alternately under the pressure of the foot. At each corner of the shaft is a post with its outer face provided with spaced teeth, and the front and rear posts are used respectively for supporting the front and rear steps. Each step is provided with a counterweight, and is supported on the posts by means of hinged arms that engage the teeth. In ascending, one stands on one step and allows the other to rise a convenient distance under the action of the counterweight, when the hinged arm engages the teeth in the higher position and holds the step in place. The steps are worked alternately in this fashion until the desired floor is reached. In descending, the steps are released alternately by pressure of the

foot against strips that control the arms, and the steps are forced down to the next lower level. Means for holding the steps stationary at each floor are provided, while ropes suspended from the steps and so arranged as to release the arms from the teeth allow the apparatus to be pulled down readily by a person on a lower floor.

NEW LOCOMOTIVE HAULS RECORD LOAD

4x37m
What is claimed as the world's record for length and weight of train hauled has just been made by the "Matt H. Shay," the gigantic locomotive recently placed in service on the Erie Railroad and described in the July, 1914, number of this magazine. This locomotive made a run of 23 miles at an average speed of 14 miles an hour, hauling 250 loaded 50-ton gondola cars and a dynamometer car. The total weight of the train, exclusive of the locomotive, was 17,912 tons, while the train was over a mile and a half long. The average drawbar pull for the run was about 100,000 lb., and, in order to avoid pulling the train in two, it was necessary to use pusher engines in starting. Telephones were used for communicating between the front and rear ends of the train.

TABLE SIRUP MADE FROM APPLE JUICE

8x59,37m
As the result of a process that has just been developed by the U. S. Department of Agriculture for making table sirup from cider, it is expected that a new and profitable field will be opened to apple growers for disposing of their culls and surplus apples. The raw cider is treated with pure milk of lime to neutralize the natural malic acids. The liquid is then heated, filtered, and evaporated. Another filtering process removes the crystals of calcium malate. One gallon of this sirup is made from about seven gallons of cider. It is of a clear ruby or amber color, and in sealed cans it keeps indefinitely.

Weekly News Letter from
Agricultural Dept.



Homemade Concrete Mixer

By H. B. STRALEY

J. N. XIKIG)
23427

TO mix small portions of concrete for odd jobs with a shovel or a hoe becomes a tedious task, and to have a large mixer would be entirely too expensive for the amount of work required of it. One farmer, with the outlay of only a few dollars, made a small mixer that will do as good work as any power-driven machine, yet it is small and uses very little material for one charge.

An ordinary oil barrel was procured and mounted on a framework of 2 by 4-in. material. A square frame was constructed around the center part of the barrel, which had a steel band without any rough joint fitted on. In the lower corners of this frame two brackets were fastened, each made of two pieces, between which a flat-faced wheel was placed on a shaft run through the pieces. The main portion of the barrel is supported on these wheels, their faces running on the steel band. A little to one side of the center of

this frame two pieces were rigidly attached at right angles so that their ends extended a couple of feet beyond the bottom of the barrel when it was in its place.

Across the diameter of the barrel bottom a piece of metal, or timber, was placed and solidly fastened with bolts. Exactly in the center of the barrel bottom and crosspiece, a hole was bored and a shaft fastened, which was long enough to run through the bearing set in the frame, and to have sufficient end to attach a bevel gear. A cross shaft was provided and supported in a bearing fastened to the extending pieces attached to the square frame.

The square frame was mounted on bearings, centrally located in its sides and connected with brackets, as shown, to the upper ends of vertical pieces, braced and connected to pieces sloping toward the rear, forming a triangular framework for the machine. A band wheel and a sprocket wheel were

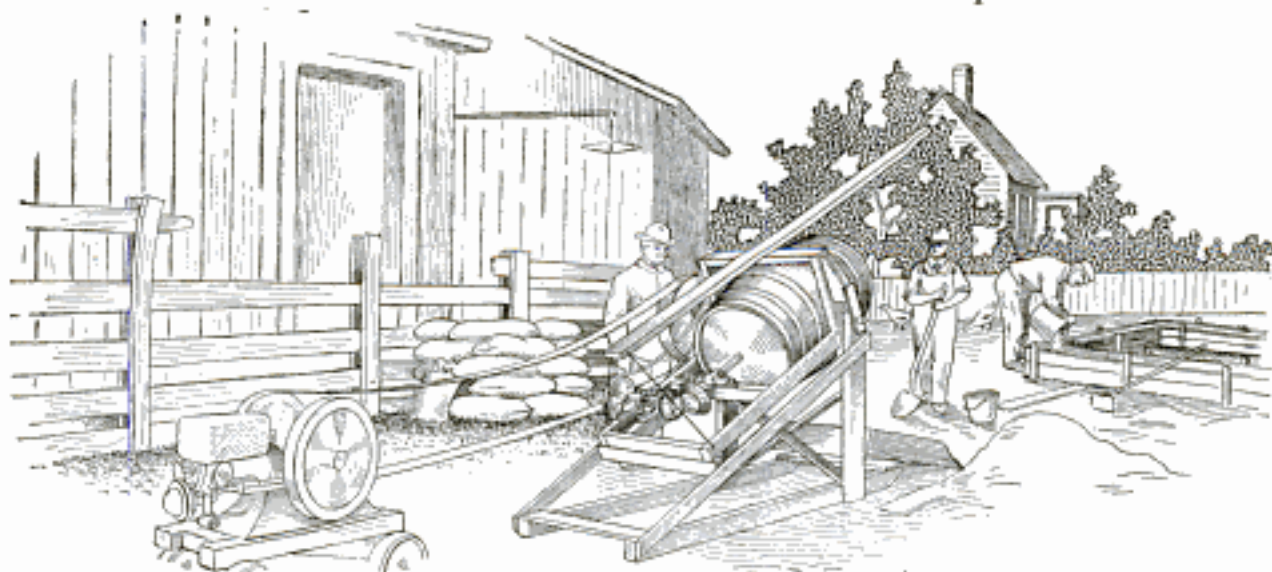

In Making Silos, Foundations, Feeding Floors, Fence Posts, and the Like, It Is Necessary to Have a Mixer for the Concrete, and the One Shown will Serve the Purpose Where There Is No Large Amount of Work

mounted on one shaft that was attached to the outside surface of one upright. A chain connected the two sprocket wheels.

A long lever, fastened to the cross-piece on the upper part of the square frame and wired to the ends of the

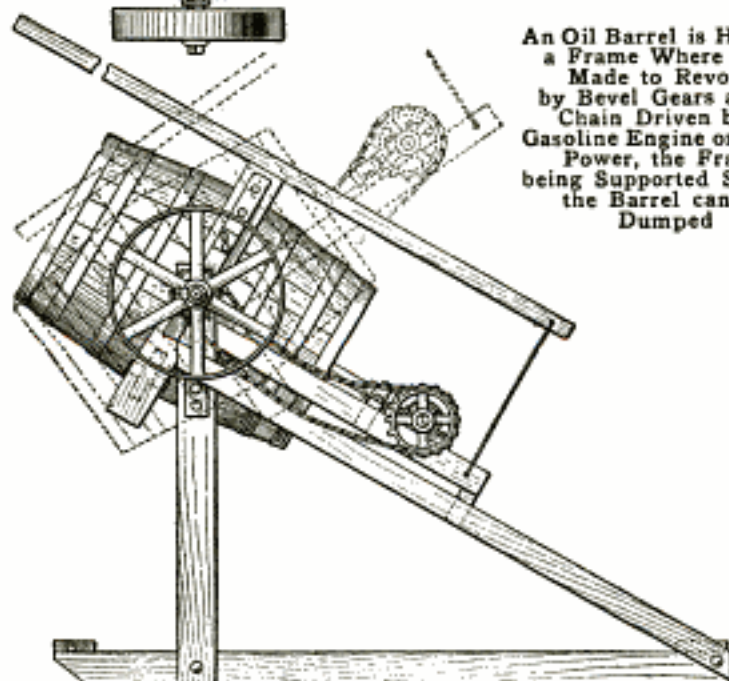
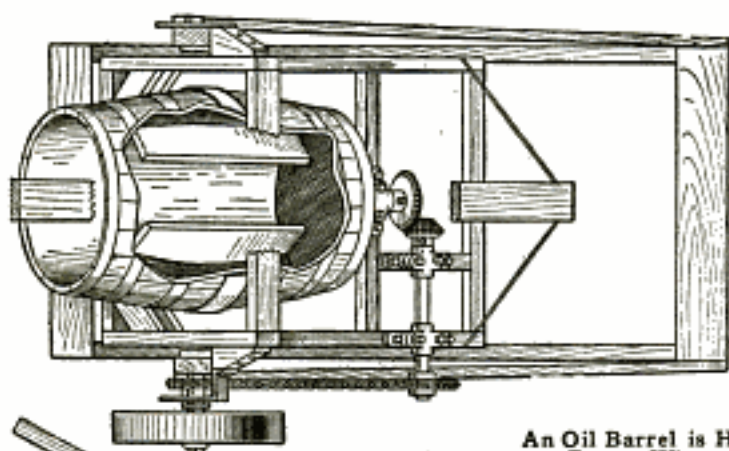

An Oil Barrel is Hung in a Frame Where It is Made to Revolve by Bevel Gears and a Chain Driven by a Gasoline Engine or Other Power, the Frame being Supported So That the Barrel can be Dumped

pieces that extend to the rear of the barrel, provided a means of tilting it, to pour out the contents when the mixture was completed.

On the inside surface of the barrel several pieces were attached, so that they projected and furnished obstructions to catch and spill the aggregate as the barrel revolved. The machine may be driven from any power with a belt.

CA bag made of soft flannel is best to keep inner tubes in, and the mouth should be tied around the projecting stem.

Dividers Used as a Bow Pen and Pencil

Instead of carrying a complete drawing set about in making sketches, a pair of dividers, a 6-in. scale, and a small cork will answer for all purposes.

In one end of the cork, insert one of the divider points, in the other end cut a small, deep slit. Place a pencil lead in the slit, and use it as a bow pencil. To use as a bow pen, remove the lead and place an ordinary pen in its place. The adjustment up and down can be had by moving the lead or pen point in or out of the cork, or by sliding the cork on the divider leg.

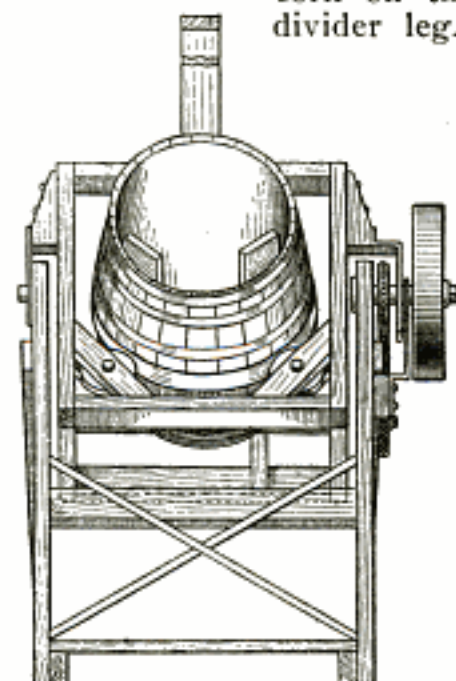

The Use of Waste in an Oil Cup

The general impression that a pad of waste stuffed in an oil cup, or oil recess, will feed out the oil a little at a time and save a lot of attention is absurd, as what oil gets to the bearing will run there in spite of the waste.

In considering the facts, it will be found that in but very few cases does the waste come in contact with the revolving shaft. If it did the shaft would be lubricated as long as that part of the waste was saturated. Suspend the wad of waste above the shaft, and the only oil that will drop is the

excess that filters through by its own weight. The waste may be well saturated, but there is little capillary attraction in the mass, and, contrary to the general idea, it does not act like a wick.

In cases where the bearing does get oil, it is because the waste is sufficiently porous to permit some of the oil to pass through every time any is squirted into the cup. To prove these facts, pour a tablespoonful of oil into an empty ink bottle, and lead a small wick out from it so that the drip will be caught in another vessel. In a couple of hours the bottle will be dry, only a portion of the oil remaining in the wick. Contrast this with the waste. Roll up a ball of the waste, about the size of an ink bottle, saturate it with oil to the same degree as the wick, and suspend it by a wire over a vessel and note the result. A dozen drops will fall in a day's time. Pour on a teaspoonful of oil, and a small percentage of oil drops off. Repeat it, and only a little more falls. If the intervals between the application of oil are long enough and the amount is small, the oil simply dries up in the waste.

Any case in which waste is depended upon to do self-feeding should be carefully investigated. The slow speeds at which the shaft revolves, the loose fits, and the generally oily condition of some machinery on which the waste pad is used, have given credence to its wonderful properties. Liberal quantities of oil will pass through almost any body not solid, but such liberality is not economy. Waste in an oil cellar in contact with a revolving journal will lubricate under the worst of conditions, as is easily shown by the large amount used on car journals, but a wad of it in an oil cup is of no assistance whatever in oiling a bearing.

☞ When riding over sand roads with a motorcycle, let some air out of the tires, especially the front one, which should flatten quite a little. Use just enough pressure to keep the rims from striking the ground.

Eliminating Gas Fumes from a Gas Stove

To eliminate the fumes from a gas stove, make a closed tank, the size of the stove top, and run the pipe into

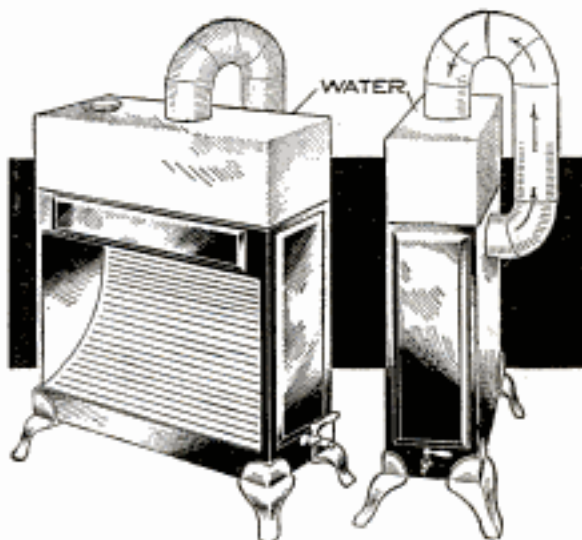

The Fumes of the Gas are Discharged into the Tank of Water on the Stove

it as shown. Fill the tank with water through a hole in the top, which should be provided with a screw-cap cover. With this arrangement, the stove can be taken wherever required, as a chimney is not necessary for a vent.—Contributed by David H. Brook, Dayton, O.

Holding Odd-Shaped Pieces in a Pipe While Drilling Them

In drilling odd-shaped pieces on a drill press, it frequently is necessary to hold them in a vise or some special jig. A piece of suitable-sized pipe can often be used to serve the purpose as well. One end, which should be square with the sides, rests on the drill-press table. The other may be square or suitably cut to fit the irregular piece to be drilled.—Contributed by D. C. Goff, Knoxville, Tenn.



Bookcase for Itinerants

When moving the ordinary bookcase, all books must first be taken out, and moved independently of the case. This

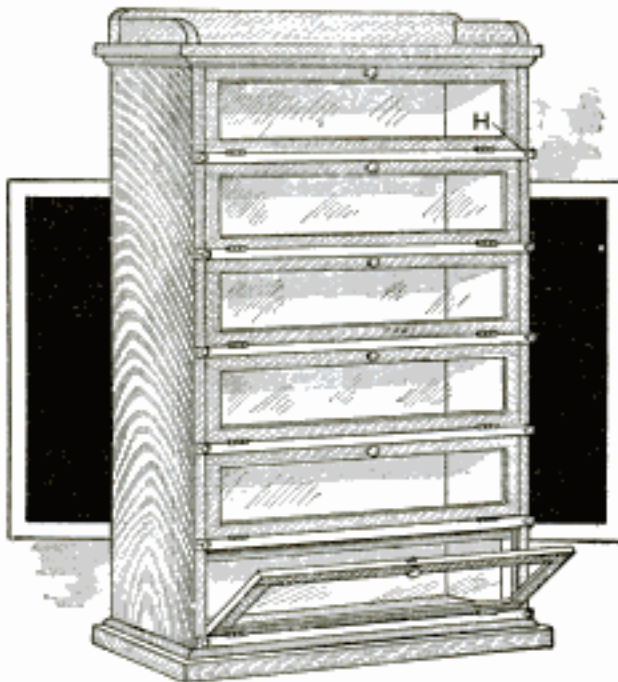

Fig. 1—The Packing Boxes When Assembled Give the Appearance of an Ordinary Sectional Bookcase

not only means much extra work in unpacking, repacking, and final rearranging when destination is reached, but also requires special boxes for the books and a crate for the bookcase—if this is to be shipped from one city to another. The illustration, Fig. 1, shows a new type of case in which the sections form the packing cases for shipment, and Fig. 2 the manner in which they are made up to stack in a case.

The outside frame, made and finished in any suitable manner, consists of four parts: a base, A; top, B, and two sides, C. The various sections for the books consist of open boxes, all of one length. Their height may vary according to the size of books stored in them. Their width must be such that when the doors F, are fastened in place they will come flush with the edges of the sides C. Molding strips, D, are fastened to A, with the two end pieces so located that the section boxes and sides C will fit in between them snugly; the molding

pieces E, on the top B, are likewise so spaced as to hold all parts securely. The glass doors F are made to fit the boxes and completely cover the open side. They are attached by hinges to metal strips, G—or strong wooden molding, if preferred—which are fastened in position to each side by means of thumbscrews H. When opening any particular section, its door is swung down. The bottom and top box should have several strips, K, fastened to the sides facing the bottom A and the top B, corresponding in length to the width of the boxes, and of such a thickness that the edges of those boxes come in line with the edge of the molding. In this way, the top and bottom doors may be fastened like the rest. If the top and bottom boards are of sufficient thickness, they may be mortised to receive the sides C, in which case it would not be necessary to use the molding strips E and D, nor the lining-up strips K.

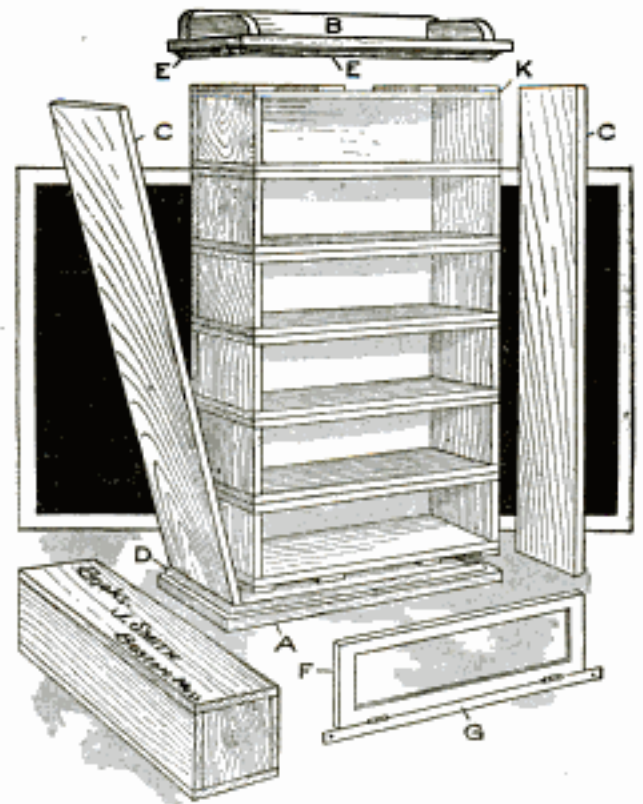

Fig. 2—Case in Sections Ready for Assembling, and a Section Box Closed Ready for Shipment

When necessary to move the case, the doors should first be unscrewed, and then the sides C and top B taken

off. Each box section, with books in it, is then taken off and closed up with an ordinary board cover, after which it is ready to be shipped. The case and doors may be put up in a convenient bundle, or crated. On arriving at the destination, the covers can be readily removed from the boxes and the case assembled as already described. The books being in place, much time and labor is thus saved.—Contributed by E. H. Witman, Danville, Pa.

Protecting the Bed Hammock

Owing to the size and weight of a bed hammock it is generally left outside in all kinds of weather. A good plan is to fasten two awning pulleys to the ceiling of the porch over the hammock so that a rope may be run through them, then attach hooks to the ends of the rope for hooking into the lower part of the hammock. The hammock can then be pulled up close to the ceiling, when not in use, so that it will be out of the sun and rain.

Blocking Attachment for a Shop Truck

In loading heavy pieces on the bed of a common shop truck, it is often necessary to block the wheels to prevent them from rolling back on the floor and spilling or tipping the load as the weight is raised by the front of the truck. I have seen quite a few accidents occur while workmen were attempting to swing the load on the truck without properly blocking the truck wheels. This is often foolishly attempted when there happens to be nothing immediately at hand suitable for use as a block. The sketch shows an arrangement which can be attached to the truck. Just before tipping the truck the blocking piece, or bar, can be kicked out of its hooks with the foot and replaced quickly, when the load is swung up and balanced on the truck. With this arrangement attached, there is no need to look around for a block. The piece of iron with its

chains is so light and so located that it will not interfere with the use of the truck. As a safety device it is hard

Bar Attached with Chains to the Under Side of a Truck to Block the Wheels

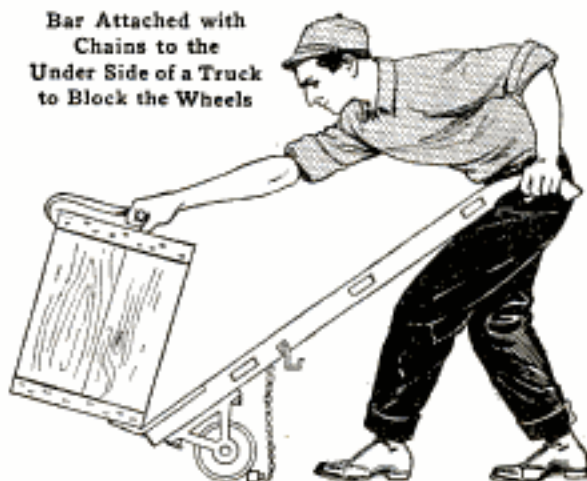

to beat, and will prevent a number of accidents to workmen handling heavy material.—Contributed by F. W. Bentley, Jr., Missouri Valley, Iowa.

Hopper for Measuring Sand Unloaded from Freight Cars

In unloading sand from gondola cars into wagons, it was necessary not only to measure the amount in cubic yards accurately, but also to avoid spilling the sand on the ground. The arrangement shown in the sketch successfully overcame the difficulties. It consists of a hopper, A, of 1-cu.-yd. capacity, with a hinged bottom, B, held shut by means of a catch, C, fastened to the side. Wrought-iron braces, D and E, attach it to the side of the car so it can be slid along as the unloading advances. The hauling wagons can be

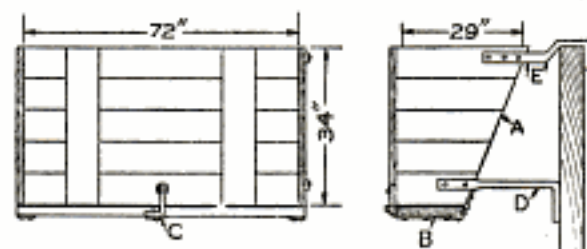

The Hopper is Hooked onto the Side of the Car Where It is Loaded with Shovels

driven under the hopper, and the known amount dumped entirely into them.

Fastening Molding to Automobile Doors

The usual method of attaching a molding on an automobile door is to drill holes and put in screws from the top. A better method is to rabbet the door top as well as the molding so they fit together, and fasten with round-head screws from the inside. Plates can be formed and fastened on either side, with their upper portions bent and placed under the molding, as shown. With this method no screw heads will show on top of the door molding.—Contributed by Frank P. Reidhaar, Connersville, Ind.



To Prevent Down Draft in Chimneys

Procure a 5-gal. can and perforate the sides near the bottom with holes, $\frac{1}{2}$ in. in diameter. The can is then set over the end of the chimney pipe and fastened with brackets. The chimney pipe should extend into the can a short distance. The holes will let out the burnt gases, but a sudden gust of wind will not affect it in the least.—Contributed by P. D. Merrill, Saugatuck, Michigan.

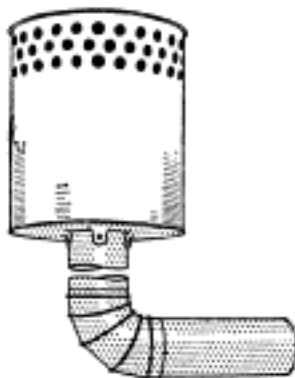

Roach Makes Ground in a Telephone Relay

Being sent out recently by the wire chief to clear up a line which was grounded, I finally located the trouble in the instrument, and when I told the chief the cause he would at first not believe it. A roach had wedged itself

between the frame and the magnet of the relay, thus causing a contact between the springs. The telephone being one of the four-party type, it easily caused a ground.—Contributed by C. W. Elliott, Toronto, Can.

Liquid Spattering Avoided with Fixed Corkscrew

When it is necessary to remove a cork from a bottle it frequently occurs that the corkscrew has been misplaced, and when found and used in the usual manner, part of the contents are often spattered over one's clothing. To avoid these troubles, the corkscrew can be attached to a wall, or shelf, in a convenient place, where it can always be found when needed. In using it, the bottle is screwed onto the puller and gripped with both hands to remove the cork, thereby providing not only a better grip, but also avoiding the otherwise necessary position in line with the contents as they flow or spatter out of the bottle.—Contributed by L. E. Turner, New York, N. Y.

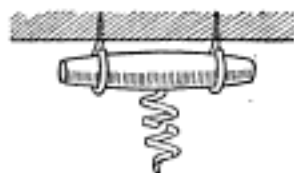

Locating Centers of Pipe Fittings

To locate the center of pipe fittings, such as elbows, tees, and crosses, I made a tool in the shape of a triangle to use in connection with an ordinary pocket rule. The fitting is placed on a bench, or board, and the triangle inserted in the opening of the tee. The rule is then placed against the edge of the triangle. The center line on the triangle gives the dimension wanted. The material required to make the device is a piece of board, $\frac{3}{8}$ in. thick.—Contributed by A. L. Kerbaugh, Allentown, Pa.

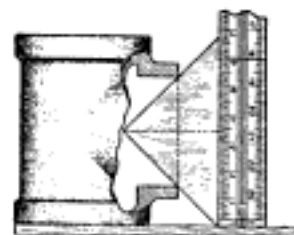

The Making of Distilled Water for Laboratories

By W. M. MILLS

IT is so necessary to have plenty of distilled water on hand in large laboratories, or in buildings where chemical or technical investigations are carried on, that it is imperative to have an arrangement that will give satisfaction along this line. The illustrations show two installations. In the first, distilled water is the main thing sought, and in the second it comes as a by-product from the steam coils of the building or steam otherwise condensed.

In the first sketch the water is distilled from an ordinary laboratory still, thence it is conveyed to a carboy below, from which the water, being protected from dust by a cotton filter, is again drained off through pipes into 1-gal. bottles, as needed. For use in a laboratory where it is made, it is forced from the carboy to the covered jar above by a force pump attached to a tube below. A pipe is fitted from the

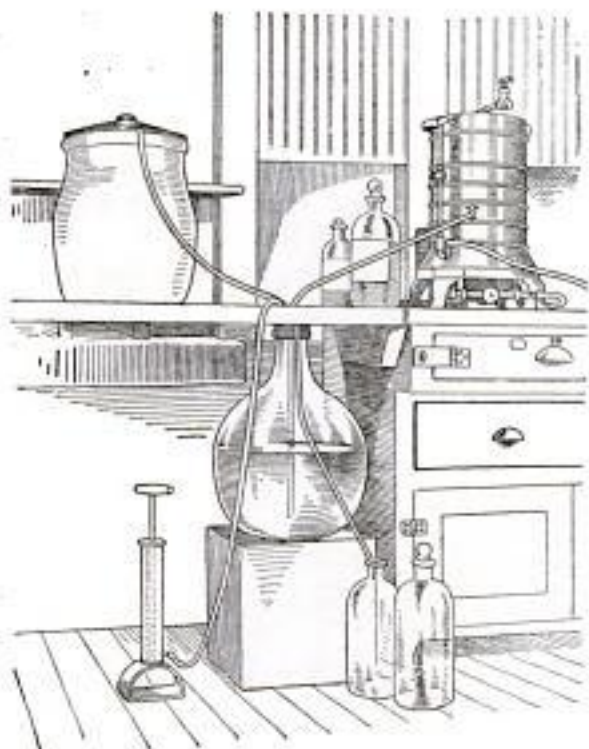

The Arrangement of a Still and Carboy to Produce Distilled Water Free from Contaminations

carboy to the jar above and the water passes up easily till the jar is filled, which is enough to last a large class

in analysis for a few days. The bottles filled from below are for other

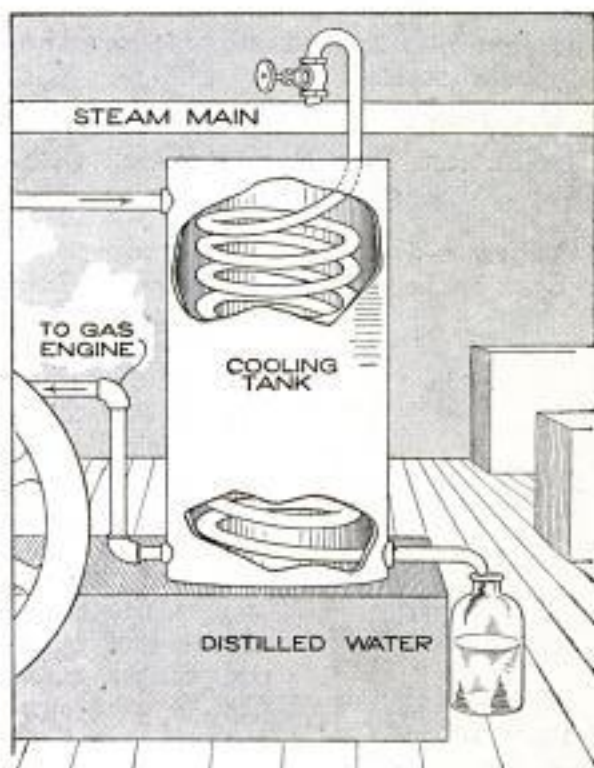

Distilled Water can be Produced from a Steam Main with a Connection and Coil in a Tank

classes in other laboratories about the buildings.

The second method of preparing distilled water is by the condensation of live steam through a copper coil attached to one of the mains of the plant in the building. A hole of the proper size is drilled through the upper side of the main, or if that is impracticable, well up on the side of the main, in order that when the steam or water issues from it there will be no sediment carried with it to contaminate the water. Thread the hole and connect a pipe to it by a threaded connection and globe valve. Lead the copper pipe downward through a water jacket, such as shown in the illustration—in this case the cooling tank of a small gasoline engine. After making several coils in the tank, it is led out through a waste nut fitted at the bottom, and the end is turned down so that 1-gal. bottles can be set under it. After run-

ning some time the valve can be so adjusted that the live steam will all be condensed. This apparatus is well adapted for all northern states where steam is employed in heating, while the first one is best adapted for the southern states.

Flat-Bottom Fire Bucket Fitted with Curved Base

When ordinary flat-bottomed pails are set aside to be used in case of fire only, they are frequently taken—as they are usually found in convenient places—and employed for other uses. If an iron strap be riveted to opposite sides of the pail with the center portion forming an arc, it cannot, without difficulty, be set up straight, and consequently is spoiled for other purposes than fire.—Contributed by George Jaques, Chicago, Ill.

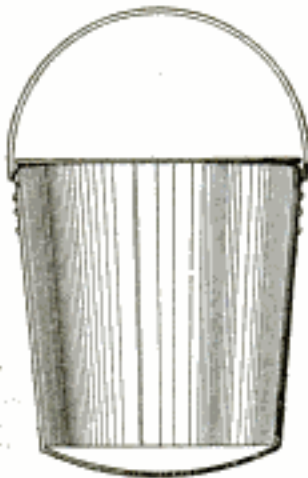

Automatic Valve for Water-Glass Fittings

To make a safety water-glass fitting, provide a ball valve for the valve part that attaches to the boiler, as shown. If the valve end has a very small hole, ream this out tapering, so that a cavity will be made for a steel ball. The large end of the opening is then fitted with a disk, to keep the ball in place. The holes in the disk and into the valve part should be somewhat smaller than the diameter of the ball.



In action, when the gauge glass

breaks, the force of the steam or water will drive the ball into the conical-shaped seat, made by reaming the hole tapering. This will close the hole and prevent the steam, or hot water, from escaping until the valves can be closed. The ball will then drop back into the cavity and allow the steam and water pressure to balance each other in the new glass gauge when it is in place.

Fastening for Rope Ends of Extension Ladders

Painters, and others, using rope extension ladders can very easily save themselves the annoyance of having the end of the extra rope underfoot, as follows: Tie the free end of the rope to the bottom rung of the top section, so that, when it is extended, it will take up the slack automatically, thus doing away with the bother of having it underfoot.—Contributed by C. H. Lockwood, Masonville, N. Y.

Valve-Lifting Tool for Automobile Engines

The simple device illustrated is one that a repairman should have in his kit of tools, or an automobile owner in his tool box.

It compresses the spring so that the washer and key can be easily removed or put in place. It is simple to make and consists of two arms joined together with a rod made adjustable by drilling a number of holes through its diameter. The arms can be forged and swaged to suit the maker. One arm has a fork on its end to fit over the valve stem under the spring, and the end of the other arm has a tapped hole to receive a wing-head screw. Its application is obvious.

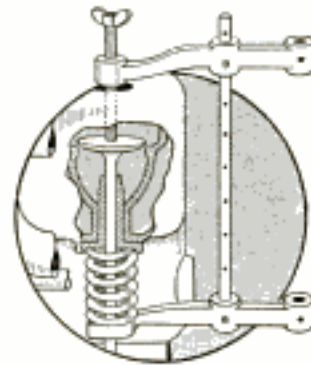

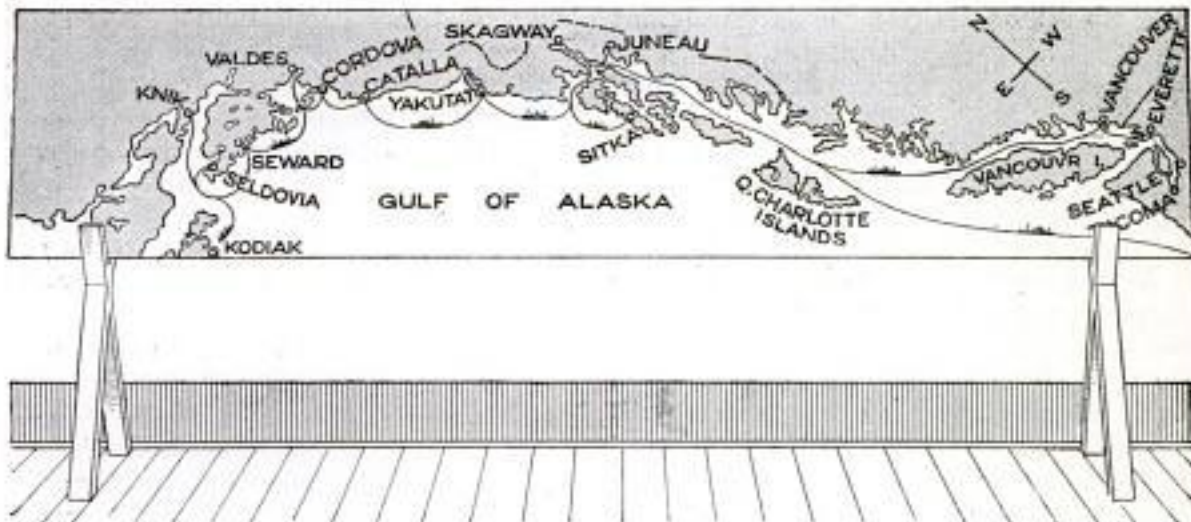

Model Boats are Set in Grooves on the Chart and Placed Each Day According to Wireless So That a Glance will Tell the Movements of All Vessels Entering One Port

Steamship Chart for a Hotel Lobby

As there is always great interest in the shipping in and out of a port in Alaska, I had a frame made, 8 ft. long and 20 in. wide, of material 2 in. square. The frame was then covered with galvanized iron with a small tin groove soldered on it in the channel to hold pieces of wood shaped like boats. The chart was then colored, and the boats were painted in the colors of their respective lines operating in the port. The name of each boat was written on paper with a typewriter and the paper pasted to the boat's bow.

The position of each boat is changed on the chart every day, according to wireless advice received on their location from the time they leave Seattle until they return.—Contributed by Harry F. Cain, Juneau, Alaska.

Multiple-Size Punch

The illustrations show a punch for cutting four different-size holes. The general idea of the tool can be applied for a greater or less number of cutters, as desired and practical. The largest diameter of cutter becomes at the same time the body, or holder, A, Fig. 1. It is bored out to a size slightly larger than the outside diameter of the second largest punch, which, in turn, is

bored out slightly larger than the next size, and so on, down to the last, which is drilled to the size of punch diameter required. The body A is drilled for a pin, B, at such a distance from the cutting edge as to cause the remaining cutters, when resting on B, to assume the positions shown in Fig. 2, each projecting out a little farther than the next larger size. In this way each cutter is held rigidly in place, being braced by those of larger size, and the thrust comes on the pin B. To prevent the cutters from slipping out

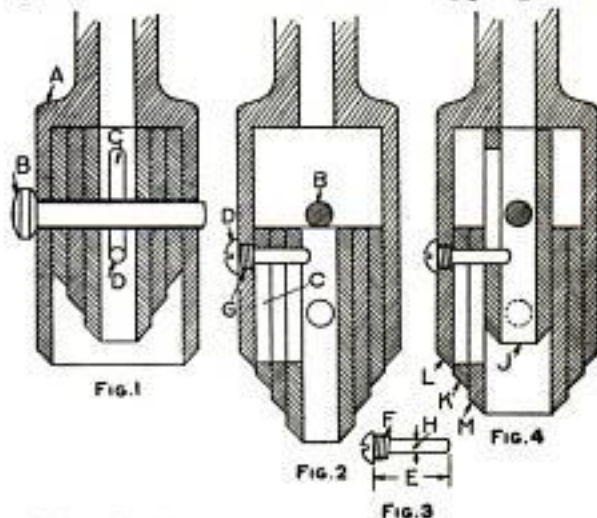

Three Positions of Punch for Using the Largest, Smallest, and Second Cutters, Respectively

when in their extreme position, they are provided with a long slot, C, through which passes a pin, D, securely held in one position in the body

A. This pin, Fig. 3, is of sufficient length, E, to pass through all the cutters on one side. The pin is threaded at the end F, to fit a correspondingly threaded hole, G, in the holder A. The body of the pin is of a diameter, H, slightly smaller than the width of slot in the cutters.

Whenever it is desired to use the largest punch, the pin B is withdrawn, allowing the cutters to drop to the bottom of the holder. In this position, each cutter—having been drilled with a hole slightly larger than pin B—is held in place by putting the pin through the holes. If the smallest cutter is to be used, all the cutters should be put in their extreme outer position, and the pin B put in place as in Fig. 2, the desired cutter being

thereby braced and held on all sides. Supposing it is required to use the second smallest punch, it is necessary to allow the smallest cutter to drop into the holder, after which the pin B is replaced, holding all cutters in the set position. This is shown in Fig. 4, the second cutter M being drawn out, leaving the smallest J in the holder, and the larger cutters K and L supporting the second. Any other combination—within the limits of the tool—can be made, first allowing all cutters larger than the required size to come out in cutting position with the desired cutter; all smaller cutters must remain in the holder. The hole in the body A is for inserting a rod for removing the punching scraps.—Contributed by John Harger, Honolulu, H. I.

A Hand-Power Bench Shaper

By J. B. MURPHY

There is no tool that can take the place of a shaper for certain kinds of work, but the owner of a home workshop usually cannot afford a machine of this kind, so that when it is necessary to do this class of work, it takes hours of time to obtain the results with a file. To provide a tool that can be worked by hand power and take the place of an expensive machine, the one illustrated was designed and most of the parts made of white oak.

The shaper is built on the workbench, where it is attached by means of the bolts A. The general dimensions are omitted, as the machine can be made in length and width to suit the class of work required of it. The lever B—made of hickory, 24 in. long and 2 in. thick—for operating the ram C, is tapering and slotted for the driving stud D.

The ram C is made of a piece of oak, 6 in. square and 40 in. long, and is beveled, as shown in the cross section EE. Adjustment for wear is made by the piece F, which is controlled by the screws G, tapped directly through the wood gib. The ram moves upon a three-piece bed, the center piece being

a little smaller than the two outer pieces that form the ways. This gives the ram proper clearance and avoids unnecessary friction.

In the front, or working, end of the ram, a piece of heavy 1½-in. tubing is driven into a hole bored in the end of the wood, and a pin H is inserted in a hole drilled through both ram and tubing to prevent the latter from turning. In the outer end of the tubing and close to the end of the ram, a ½-in. hole is drilled for the tool J. The tubing tool post is located centrally in the end of the ram, as shown in the cross-section sketch.

The tool can be made of a discarded round file, ground properly and tempered to cut metal. One side of the file is ground flat to make a seat for the setscrew. The setscrew is fitted to the end of the tubing by locating it centrally and pouring babbitt metal around it. A large or coarse thread is necessary, and its bearing should be about 2 in. long.

In the detail of the cross feed, the nut K is recessed in the under side of the platen. The bolt L is turned by hand with the pin M. The bolt, when turned

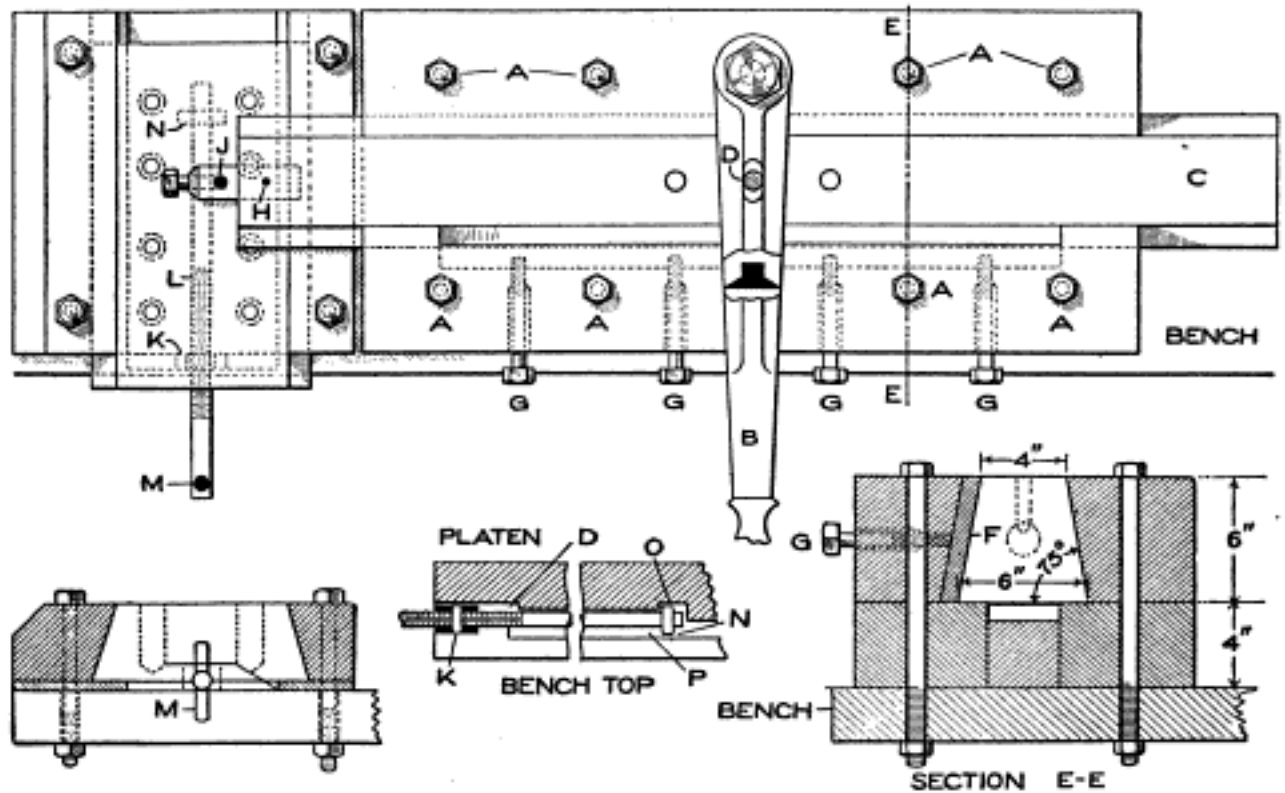

Details Showing Well-Proportioned Parts of a Shaper That will Produce as Good a Grade of Work as an Expensive Machine, Most of Its Parts being Made of Hard Wood

in or out through the fixed nut K, causes the head N to draw the platen either way as the cut is taken. The head N fits into a recess, O, cut in the under side of the platen. A clearance groove, P, is cut in the bench top for the lower part of the bolt head as it travels from end to end.

A good lubricant for the surfaces that slide together is oil and graphite. A cut, $\frac{1}{32}$ in. deep, can be taken with a feed of $\frac{1}{64}$ in. All light planing for experimental work can be done with this planer.

A Gas Water Radiator

The illustration shows a gas water radiator that I constructed from pipe and fittings, using an ordinary gas water heater. Enough $1\frac{1}{4}$ -in. pipe and return bends were used to give about 25 sq. ft. of radiation. The manner of connecting the pipe to the heater is clearly shown. The upright pipe accommodates the rise of the water level due to expansion. A safety valve is placed at the upper end of this pipe.

A small pressure gauge is shown,

but this is not necessary. A pressure of from 1 to 5 lb. makes the radiator much more effective, especially in cold weather. This heater was intended to be used for chilly weather in the spring and fall, but it has been in use every day and night during the entire winter, and keeps an ordinary-sized dining

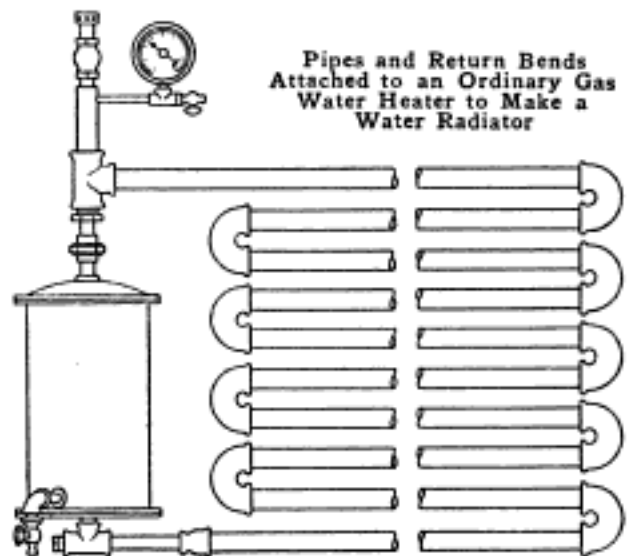

room at a very comfortable temperature with a very small consumption of gas.—Contributed by Claude Swaim, Indianapolis, Ind.

Determining Generator Efficiency by Stray-Power Method

By A. E. ANDREWS

ALL the losses in a direct-current generator or motor may be grouped under one of two main heads, namely, electrical losses and stray-power losses. The electrical losses (I^2R) include all losses in armature winding, commutator segments, brush resistance, resistance of leads to terminals of the machine, and the series and shunt-field windings. The stray-power losses include all friction losses, such as bearing and brush friction, windage, which is the loss due to the fan action of the revolving portion of the machine, and the hysteresis and eddy-current losses, which occur in the armature core, armature inductors, and pole shoes.

The sum of these two groups of losses represents the difference between the input to a machine and its output. The commercial efficiency of a machine is equal to its output expressed as a percentage of its input, so that if it were possible to determine the losses, the commercial efficiency could be determined when the output of the machine is known.

The electrical losses in a machine can be determined by first measuring the resistance of the various circuits after they have reached a temperature corresponding to operating conditions, and then multiplying this resistance by the square of the current the circuit is carrying. The electrical losses in watts will vary directly as the square of the current and resistance to the first power.

When a motor is running without load, all the mechanical power developed in the armature is used in overcoming the stray-power losses, and the value of the mechanical power developed, in electrical units, is equal to the product of the counter electromotive force and the armature current. The stray-power losses in the machine will be practically constant for all loads, since there is a very small change in the field strength, or induction density; speed, friction, and windage losses are also practically constant for all loads.

To determine the stray-power loss of a machine that is operating as a motor is to determine its counter electromotive force, which is equal to the difference between the impressed voltage and the copper drop (current times armature resistance), multiplied by the armature current, when the machine is operating without load, the speed being the same as when loaded.

Example: Suppose a 20-hp., 110-volt motor has an armature resistance of .004 ohm; a shunt-field resistance of 55 ohms, and takes a current of 7 amperes when running without load, and it is desired to determine the commercial efficiency, when the armature current is 120 amperes. The counter electromotive force of the motor, running light, will be

$$110 - 7 \times .004 = 109.972 \text{ volts,}$$

and the stray-power loss will be

$$109.972 \times 7 = 769.804 \text{ watts.}$$

The electrical loss in the field will be equal to the field current times the voltage:

$$(110 \div 55) \times 110 = 220 \text{ watts.}$$

The electrical loss in the armature will be equal to I^2R , or

$$120^2 \times .004 = 57.6 \text{ watts;}$$

total electrical loss:

$$220 + 57.6 = 277.6 \text{ watts;}$$

and total losses:

$$277.6 + 769.8 = 1047.4 \text{ watts.}$$

The total current taken by the machine would be $120 + 2 = 122$ amperes, and the watt input would be

$$122 \times 110 = 13,420 \text{ watts.}$$

The input minus the losses represents the output, which, therefore, is

$$13,420 - 1,047.4 = 12,372.6 \text{ watts.}$$

The commercial efficiency, or the output expressed as a percentage of the input, will thus be found to be

$$\frac{12,372.6}{13,420} \times 100 = 92.2 \text{ per cent.}$$

More exact results may be obtained by operating the machine as a motor with a series of impressed voltages corresponding to the counter electromotive force generated in the machine when operating on various loads as a

motor, and then computing the product of the counter electromotive force and armature current for each particular impressed voltage. The speeds should be the same in both cases. This will give the value of the stray-power loss for each load, but it will be found practically constant for most cases.

In the case of a generator, the stray-power losses are determined by operating the machine as a motor, with impressed voltages corresponding to the generated voltage for various loads when operating as a generator. The speeds should be the same in both cases.

The great advantage of this method of determining the commercial efficiency is the small cost of energy to make the test, and the possibility of testing a large machine with a small generator, or battery, as only the losses need be supplied.

Repairing a Broken Bearing Cap

The following describes a neat repair on the crankshaft bearing cap of an automobile engine. The engine was a very old type, and a new part could not be obtained. The break occurred at the point indicated in the drawing. Two strips, A, of $\frac{1}{8}$ -in. cold-rolled steel were cut in

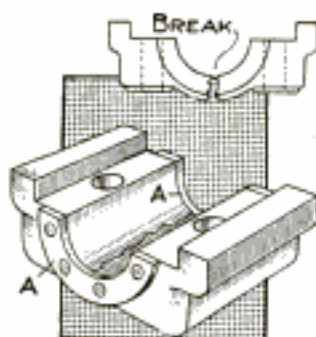

the shape of semicircles. The bearing cap was then planed off $\frac{1}{8}$ in. on each side. The plates were then riveted to the cap by means of $\frac{3}{8}$ -in. rivets. These rivets were of the flat-head type, set into countersunk holes. The heads were finished off flush on the sides. The repair made a neat job and at the same time was inexpensive.—Contributed by Adolph Kline, New York City.

It is quite necessary to examine the oil pump on an automobile engine frequently, as clogging is one of the causes for an overheated motor.

A Cottage Candlestick

A very simple camp and cottage candlestick, that cannot be extinguished in a draft, can be constructed from an ordinary candlestick and lamp chimney. The candle pillar is removed and in its stead a block of wood, 3 by 3 by $\frac{7}{8}$ in., stained with a suitable color, is nailed to the base from underneath. On the four sides of the block pieces of metal are nailed to form clips for holding a No. 2 lamp chimney. Four small finishing nails, driven part way into the upper surface of the block, serve as a candle pillar, or holder.



The candles used are the short kind, or "twelves," with a small wick. These are less apt to smoke up the chimney. Such a candlestick produces a steady flame; can be used on a porch; is safe in passing near portières or curtains, and readily takes the place of an oil lamp on a writing table.

Ventilating Inclosed Automobile Bodies

When an automobile becomes uncomfortably warm for its occupants, one good way of ventilating it is by means of the doors. A hook made of an iron rod can be fastened in holes made in the body and door, as shown, which will cause sufficient draft to readily cool off the car, without danger of the door flying open and being caught or wrenched off.—Contributed by Abner B. Shaw, N. Dartmouth, Massachusetts.

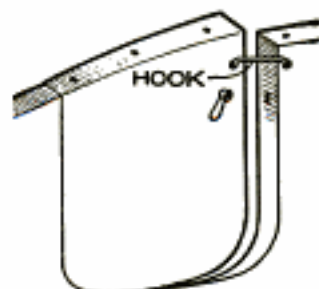

Cam-Cutting Fixture for a Bench Lathe

When it is necessary to cut a large number of cams to the same pattern, quite a little time can be saved, and greater accuracy gained, by using a cam-cutting attachment, one form of which is shown in the sketch. It consists of a base, A, clamped to the bed of the lathe, or milling machine, whichever is used. It is provided with two standards, B and C, bored to fit a cam spindle, D, at a height corresponding to the center of the cam-cutting tool. The spindle D is turned with a shoulder to fit against the work cam blank E, which is secured in a position by the nut F, and screw, at the end of the spindle. The master cam G is fastened to the spindle between the standards, and caused to bear against a guide roller, H—which is fastened to the base A—by means of a compression spring, fitting the spindle between the standard C and the hub of the master cam. If the spring is not desired, a weight can be used, by fastening it to one end of a cord, or wire cable, which passes over a pulley, I, and is attached to the spindle. The cams may be rotated by a handwheel attached to the

spindle. This, although the simplest method, is not very practical where slow feeds are necessary. A better way is to drive the spindle by means of a worm and gear. The gear J is attached to the outer end of the spindle. The worm K is fitted in bearings cast on a bracket, L. This bracket, at its upper end, fits in between the worm gear and a shoulder on the spindle, so that any lengthwise motion of the spindle will carry the bracket with it, thereby keeping the worm and gear in mesh constantly. The bracket is prevented from turning on its bearing by the stud M, fastened to it and made a sliding fit in the base A. The cam outline is cut by an end mill cutter fastened in the headstock spindle. In order to provide for end feed, an adjusting screw, N, and bracket are bolted to the lathe bed and, after slightly loosening the headstock bolts, the screw can be turned, causing the cutter to move for end feed, as required. If the cam-cutting attachment is fastened to the compound rest of the lathe, or on the table of a milling machine, no special adjusting screw is necessary.

In order to dispense with the weight or compression spring for keeping the master cam firmly pressed against the guide roller H, it will be necessary to have a double-faced cam. In this case another roller, O, must be provided which is fastened to the standard C, at a place directly opposite the roller H, the distance between the rollers corresponding to the width of face of the master

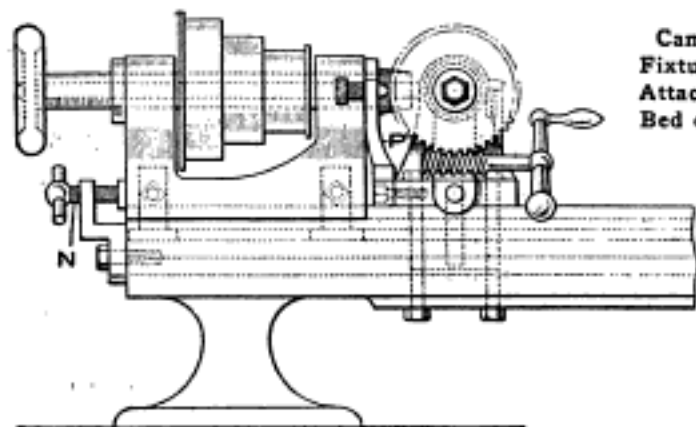
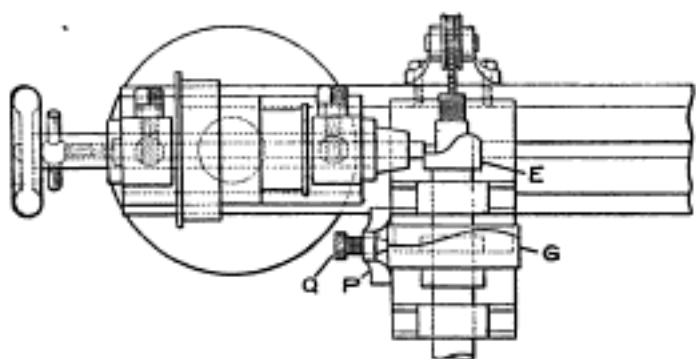

Cam-Cutting Fixture as It is Attached to the Bed of a Bench Lathe

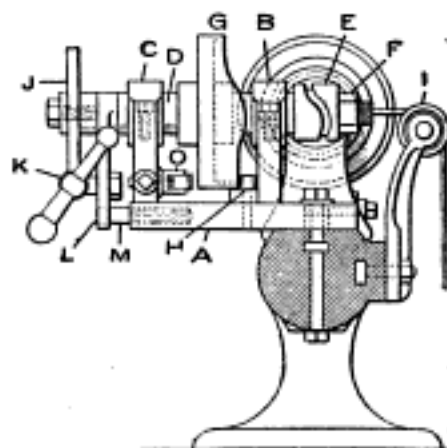

cam. As the two rollers are fixed in place, the cam, fitting between them, should have a radius corresponding approximately to the distance the rollers are from the center of the spindle. If a smaller cam has been developed for the desired motion, its outline must be developed on a blank of the required size, and this formed by the cutter in the usual way. In transferring the outline to the large blank, the small trial cam is put on at the cutter end of the spindle, and rests against a round rod fitted in the tailstock spindle. The master blank is fastened to the spindle in its regular position, the guide rollers being removed to permit the blank to enter. The outline is marked by a scriber attachment, which consists of a bracket, P, fastened to the base A. At a height corresponding to the center of the cam spindle, a hole is drilled and threaded for a tool-steel scriber, Q, adjustable for slightly different diameters of blanks by screwing it in or out. As the master blank slides back and forth, the scriber marks an outline corresponding to that of the small trial cam. If desirable to have a double-faced cam, the scriber bracket should be sufficiently wide so the scriber can be set over a distance corresponding to that between the rollers H and O.—Contributed by E. P. Fickes, Dayton, O.

Cutting Attachment for an Oxyacetylene Welding Torch

For cutting metal with an oxyacetylene welding torch, it is necessary to have a higher pressure of oxygen, at least 40 lb. A separate tank must be provided to produce this pressure, or the gas bought in a high-pressure tube. To make the cutting attachment for the torch, procure a piece of $\frac{1}{8}$ -in. pipe and bend it as shown. Make a tip, or if desired, several of them, with openings from the size of a pin point to $\frac{1}{2}$ in. in diameter. Attach a lever valve just in front of the torch handle, as shown, so that it can be operated with the thumb. Attach the auxiliary pipe to the lower pipe of the torch with

clamps, so that the point of the tip will be within $\frac{1}{4}$ in. of the regular welding tip.

To use, heat the article to be cut with the welding tip, then turn on the

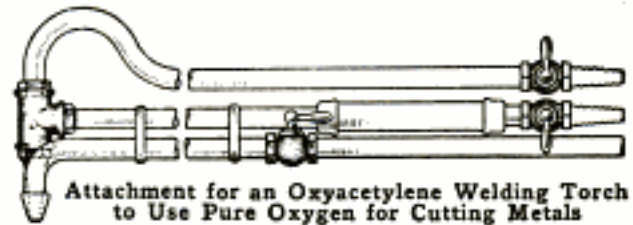

Attachment for an Oxyacetylene Welding Torch to Use Pure Oxygen for Cutting Metals

oxygen through the cutting attachment. With this attachment any kind of metal may be cut quickly and accurately. No changes are made on the welding torch to use this attachment.

A Gambrel Hook

Farmers use a pole to hang the hogs on at slaughtering time in winter. On this pole a gambrel stick is placed, the ends being inserted in the hock of the animal's leg. It is always a hard job to do the hanging and place the gambrel stick at the same time. A better way is to provide a double hook of metal, heavy enough to support the animal, and hang the gambrel stick on this hook, as shown. The metal may be square or round, bent into a U-shape of such dimensions that it will fit over the timber used in hanging the hogs and with a hook formed on each end. It is an easy matter to insert the gambrel while the hog is lying on the work

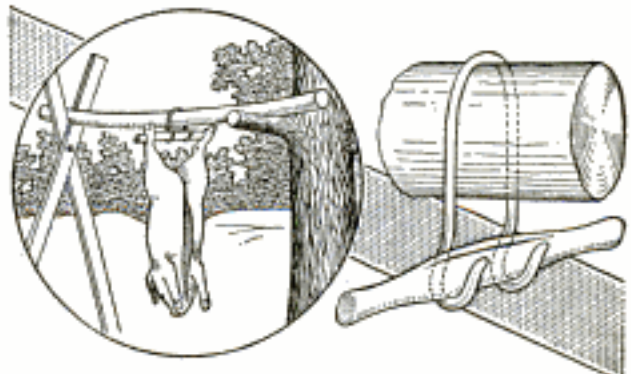

The Hook Provides an Easy Way to Hang a Hog after the Gambrel Is in Place

table, then lift it by the gambrel and place the latter on the hooks.—Contributed by Leslie R. Sutter, Towanda, Illinois.

Gas-Engine Exhaust Water Heater

The heater illustrated utilizes the heat from the exhaust of a gasoline engine, and can be used for heating a small shop, or for washing purposes. To make it, procure a piece of pipe, 12 in. in diameter and 36 in. long. Both ends are closed with caps, or plates. Two openings, one at each end of the pipe, are made for the exhaust to pass through, and a coil of pipe is inserted inside, its ends passing out at the top and bottom. Connect the heater as close to the engine as possible.

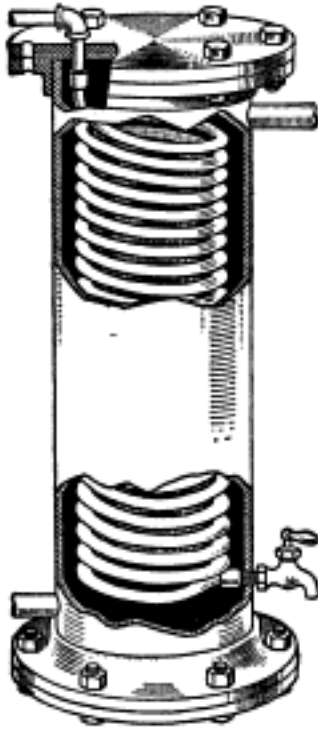

base, about 4 in. high, was built up with the brick in the bottom for the crucible. A crucible, 6 in. in diameter and 8 in. high, was purchased and set on the built-up base, then two walls of fire brick were built up on each side of the crucible to within 4 in. of the top of the shell. These walls should fit snugly against the crucible and the sides of the brick lining of the can. The cover for the top is lined with fire clay which is made to lie on top of the can so that it will form a tight fit.

A hole, 3 in. in diameter, was cut in the shell, on one side, and a 4-in. hole on the other. These holes should be located so that the smaller one enters the side at the center of one compartment formed by the walls and crucible, and the other makes an outlet in the other division, both holes being near the bottom of the can. The flame from a Bunsen burner, A, is directed through the smaller hole against the crucible, and by the walls deflected upward along the side of the crucible and over the top, thence down the opposite side and out. This method utilizes all the heat from the fire and

will melt brass, copper, or aluminum in a very short time.

The type of burner and fuel tank used was the kind used by bicycle repair men in brazing small parts. — Contributed by A. H. Waychoff, Koenig, Col.

CA deep-red stain for woods is made of $\frac{1}{2}$ oz. alkanet root to two fluid ounces of turpentine.

Cracking Prevented in Bending Lead Tubes

When small lead tubing is bent with sharp turns it will frequently crack or break, unless special precautions are used to prevent it. One of the cheapest and simplest methods to overcome the difficulty is to wind the place with several layers of fine flexible wire before trying to make the bend.

Furnace for Metals of Low Fusion Temperatures

Experimenters desiring to make small castings of zinc, brass, copper, and other metals of low fusion point, will find the simple furnace illustrated suitable to their requirements. The body of the furnace was made of an old 10-gal. milk, or cream, can, which was lined on the inside with fire brick, whereupon a

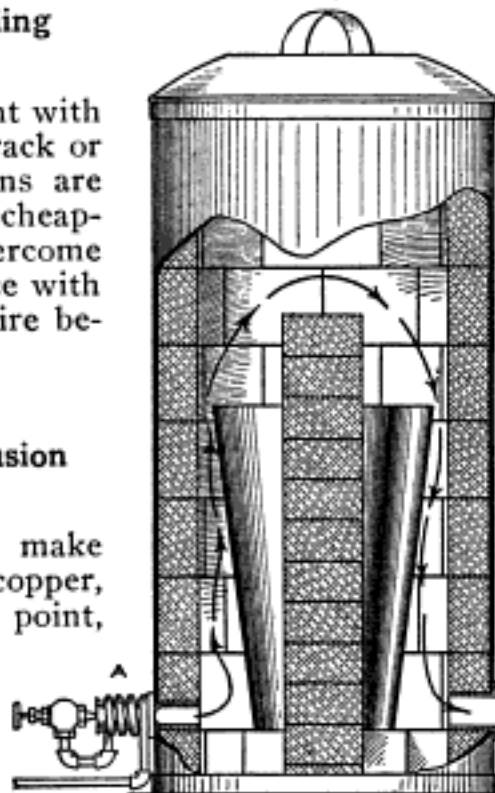

Milk Can Lined with Fire Brick Used as a Furnace to Melt Metals of Low Fusion Temperatures

Silencer for a Rifle

S. N. 12-2443

The silencer is made of a piece of steel tubing, having walls about $\frac{1}{4}$ in. thick, about 5 in. long, and of an inside diameter to fit snugly over the end of the gun barrel. The tube should have a number of holes, $\frac{1}{4}$ in. in diameter, drilled through it.

Another tube, about twice the diameter of the first one and 8 in. long, is drilled with a $\frac{1}{8}$ -in. drill to make it well perforated on the under side. Two pieces of sheet steel are cut or turned to fit the inside diameter of the large tube and holes are drilled in them, off center, the size of the outside diameter of the smaller tube. They are then placed in the ends of the larger tube so that the holes will coincide. The smaller tube is fastened in one end



Rifle Silencer Made of Two Pieces of Perforated Steel Tubing of Different Sizes

only, and at such a place that a small portion of its end will project out of the end of the large tube. After the parts are in place, they are brazed at all joints. A setscrew is placed in the projecting end of the small tube to hold the silencer on the end of the gun barrel.

An Electric Fence Rider

To do away with the necessity of walking or riding around a farm fence to see if it is in repair, the simple device illustrated may be used. A piece of 8-in. board is fitted, as shown in Fig. 1, with battery, push button, call bell, and binding posts, designated by the letters A, B, C, D, E, F, and G. The method of connecting the fence wires is shown in Fig. 2, the letters designating the binding posts to which the end of the wires are attached. Obviously, none of these wires must come in contact with any other wire, and it would, therefore, be better to use insulated wires from the board to the fence. In making a break for

a gate or opening in the fence, the wires must be connected by an underground cable and each one insulated from the others.

To make the test, connect the binding

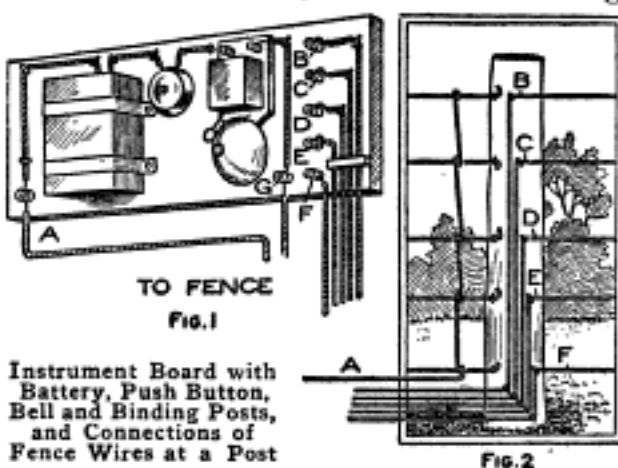

Instrument Board with Battery, Push Button, Bell and Binding Posts, and Connections of Fence Wires at a Post

post G to any one of the other binding posts, B, C, D, E, or F, and press the button. The resulting ring, or silence, of the bell will tell if the strand in the fence is continuous or broken. Reversing the connections to the wires will eliminate, to a great extent, a circuit caused by the fallen end of a broken wire, as it is not often a wire breaks so that both ends will come in contact with the other wires.—Contributed by R. H. Tuttle, Minneapolis, Minnesota.

Oil-Level Gauge for Automobile Crank Case

A smoky exhaust on an automobile can usually be attributed to an excessive amount of oil in the crank case. Oil gauges on the crank cases are frequently omitted, especially in the older types of engines, but simple home-made devices can be made to serve the purpose very well. A hole should be drilled and tapped in the lowest corner of the crank case for $\frac{1}{8}$ -in. pipe thread. Into this is screwed a petcock, having a male thread at one end and a female thread at the other. A piece of $\frac{1}{8}$ -in. pipe is then threaded at



one end and bent so one side will be vertical when the pipe is screwed in position in the petcock. The amount of oil required in the crank case should then be determined, and the vertical pipe cut off at that level. The opening may be flared out to show the oil level more easily. All threaded connections should be white-leaded to insure tight joints. In bending the pipe, hot rosin should first be put in, thereby preventing dents or splits. The petcock should only be open when testing for the oil level or when desirable to add more.

A Distance-Marking Gauge

For gauging lines on a plane surface the ordinary marking gauge answers very well, but if it is necessary to gauge a line parallel with an edge, with a raised portion between the gauging point and the point where the line is desired, the ordinary gauge is useless. It was to overcome this difficulty that the distance-marking gauge was designed, and with it a line may be gauged on the inside of the bottom of a box or drawer, parallel with any of its sides. The scriber bar, being round, can be swung to the right or left and clamped in either position, so that the scriber point can reach places that could not be conveniently reached in any other way.

The head, or stock, is made of hard

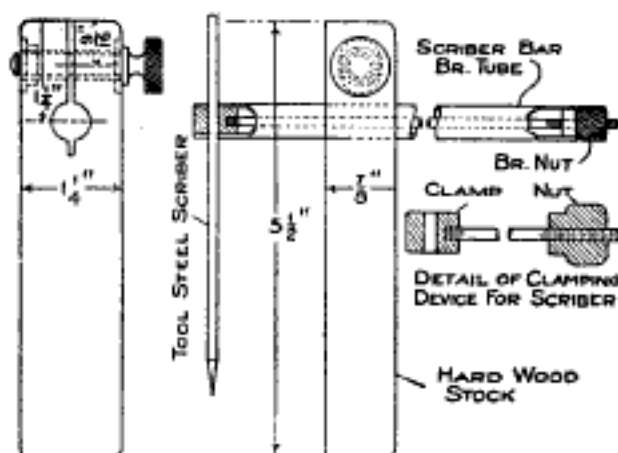

This Gauge will Scribe a Line on Uneven Surfaces over High Parts, as a Drawer Side

wood, and is bored to receive the scriber bar, which is made of brass tubing. This piece of tubing, in the gauge

illustrated, is $\frac{1}{8}$ in. in outside diameter and $\frac{5}{16}$ in. on the inside. The head-clamping device is made as shown, all parts being of brass. The knurled thumbscrew, running completely through the head, is threaded to turn in a plate, let into the side and fastened with two small screws; the same method being used for the plate under the shoulder of the thumbscrew.

The scriber is made of $\frac{1}{8}$ -in. tool steel, hardened at the point. The clamping device for the scriber consists of the knurled nut, turned with a shoulder to fit the inside of the scriber bar and tapped to receive the threaded end of a $\frac{1}{8}$ -in. brass rod that is screwed into the scriber clamp at the opposite end of the bar. This clamp is a short piece of brass rod turned to a sliding fit inside of the tube. The clamping device should be fitted to the tube, and the hole for the scriber drilled through the tube and clamp at the same time.—Contributed by J. A. Shelley, Brooklyn, New York.

Riveting Head for Thin Tubing

The sketch illustrates a very simple, cheap, and effective device for riveting joints in thin tubing, such as rain pipes, stovepipes, furnace pipes, and the like. Instead of merely telescoping them together, making a very insecure and unmechanical connection, this tool will enable all joints to be securely riveted where they cannot be soldered.

The head, Fig. 1, is made of machine steel with slightly countersunk holes drilled in the periphery and then case-hardened. For convenience, the holes are drilled all around and spaced about $\frac{1}{16}$ in. apart, so that the walls will not break out in use. This will make it easy to locate the holes, much more so than if there were only a few.

In construction, a number of disks, about 6 or 8, of varying diameters are turned up and countersunk, and a $\frac{3}{4}$ -in. hole is drilled through their centers, whereupon all are case-hardened. The different diameters are necessary for the different-sized tubes. The disks must be about $\frac{1}{16}$ in. smaller than the

tube diameter, but not more than $\frac{1}{8}$ in. smaller.

A piece of $\frac{5}{8}$ -in. gas pipe, A, is threaded on one end for 2 in.; the remainder is turned down to $\frac{3}{4}$ -in. outside diameter, and a collar, B, is fitted to turn on the pipe threads at the end and fastened there with a rivet, C. The desired head for the size of work at hand is slipped on the pipe against the collar B, and a fixed washer, D, is placed outside on the pipe and held with a hexagon nut.

When in use, the head is inserted in the pipe, and by tapping the outside of the pipe the location of the head can be determined and the holes punched with a tool similar to a belt punch. Place a rivet in the hole, head up, and drive it down. The countersink of the hole in the head will form the rivet head on the inside. The head must be smaller than the tubing in order to clear the rivet head, yet not so small but that the tube will spring back to its original shape when the riveting is finished.

The head can be placed in a straight or curved pipe, around inside of elbows, and all standard angles, with the use of a length of wire-wrapped garden hose attached with a clamp to the free

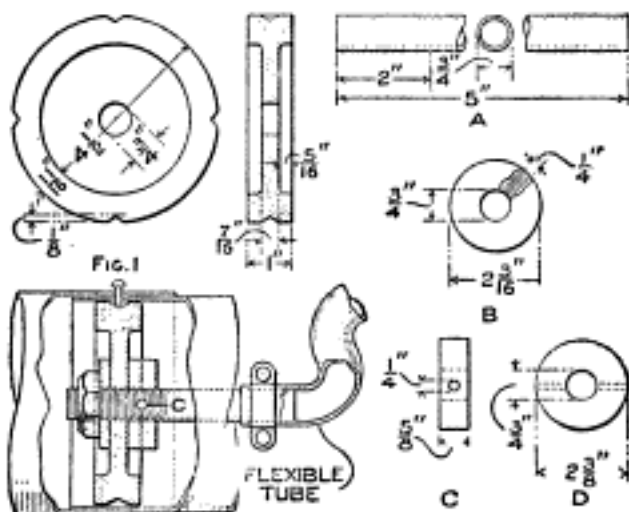
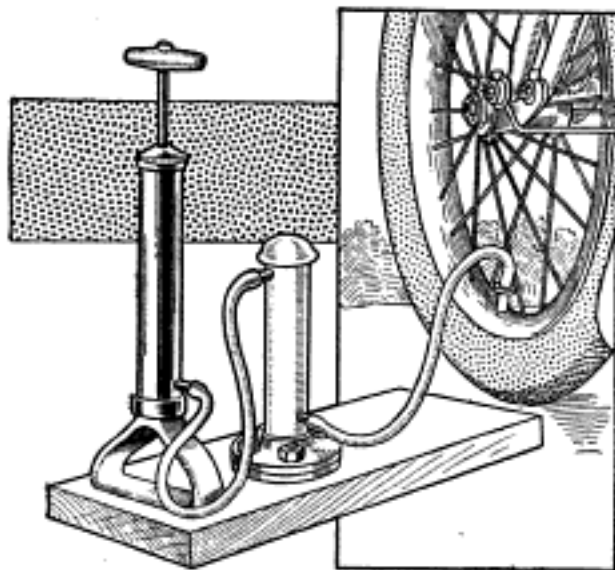

Fig. 2
Head to Insert in a Pipe to Serve as an Anvil in Riveting the Joints

end of the gas pipe, as shown in Fig. 2. This also provides a means of keeping the head straight when it is used in a long pipe.—Contributed by J. B. Murphy, Plainfield, N. J.

Injecting Puncture-Sealing Compound into Tires

The body of the injector consists of a piece of 2-in. pipe, 8 in. long, with a cap screwed on the upper end, and a



Pressure Applied to the Cylinder Forces the Puncture-Sealing Fluid into the Injured Tire

flange on the lower. A tire valve is soldered into a hole drilled in the pipe near the upper end, and a piece of $\frac{1}{8}$ -in. pipe screwed into a tapped hole at the bottom. The cylinder is mounted on a base of hard wood that is large enough for a foot pump also. To fill the cylinder, the upper cap is unscrewed. When the cap is replaced, a pressure is put on the fluid, after attaching a hose between the small outlet pipe and the tire valve.

To Prevent Rust Forming on Tools

Those who desire to use a rust preventive will find that if the tools are wiped with a cloth slightly saturated in mercurial ointment, they will obtain the best results possible. It is not necessary to leave more than a trace of the ointment on the steel. A cloth so impregnated that it will smear a pair of spectacles a little will answer.

This ointment is the very best possible to use on guns, to prevent them from rusting. It will also prevent the barrels from leading and will remove lead from the rifles. It has no action whatever on the metal of the barrel.

Finger Rest for an Oilcan

In places where an oilcan is used very frequently, and especially where it may be covered with oil, making it

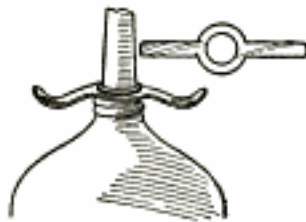

hard to hold, a finger rest can be provided which will serve several purposes. A thin double-winged washer is made and provided with a hole, giving it a tight fit when slipped over the spout to the threaded end. It can then be soldered in place, and the projecting ends bent to conform closely to the finger positions when using the can. This attachment not only prevents slipping of the can when covered with oil or grease, but also provides a good grip for unscrewing the spout.—Contributed by J. J. Kolar, Maywood, Ill.

Holding Collar with a Torn Buttonhole

In the laundry I find a great many collars with the rear buttonhole so badly torn that it is impossible for the collar button to hold it in place.

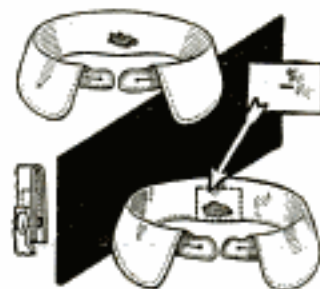

Otherwise the collar is good and can be worn a number of times, but is usually thrown away. To make use of such a collar, take a piece of linen or cardboard and make a hole or slot with a knife point like a buttonhole, and place it in the pocket of the collar over the torn buttonhole. This will aid the button in holding the collar in place.—Contributed by John T. Morrison, Philadelphia, Pa.

☞When an inner tube is immersed in water to discover a leak, make a mark around the hole with an indelible pencil.

Removing Globes from Flash Lamps

Small electric globes in flash lights are very difficult to remove from the socket when it becomes necessary to put in a new one. When in the socket, the outside surface is so smooth that the fingers will not turn it. I have found a very good method which consists in using a piece of rubber tube about $\frac{3}{8}$ in. in diameter and $1\frac{1}{4}$ in. long, and pressing its end against the globe, then turning it. In this manner a globe can be easily removed or replaced. A good place to keep the piece of rubber tubing is in the coil-spring space in the rear of the cap on the flash-lamp casing.

Plugging a Petcock on a Gasoline Tank

If the valve is lost from the petcock on the lower part of the crank case, or gasoline tank, or similar place, do not plug the hole, A, where the valve came out, but unscrew the petcock and fit a wood plug in the upper end. Then there is no danger of the plug losing its hold and causing further leakage.



Erasing Shield for Typewriter Rolls

When erasing a word or letter while the paper is in the typewriter, a much neater job can be done if the shield here illustrated is used. It consists of a piece of thin metal, about $\frac{3}{4}$ in. wide and 2 in. long, with a number of holes cut in it, as shown. The metal plate is then bent to conform to the shape of the roller. In erasing, the plate is laid over the paper on the roller, and the word or letter to be erased is brought under one of the openings. It can then be erased without danger of marring the adjoining letter.





A Photographic Worktable for Small Quarters

By K. V. REED

FLAT dwellers have no space at their disposal for a person to work at photography, and the bathroom must take the place of a dark room. As this was very inconvenient in my case, I constructed a table, that from all appearances was nothing more than a large-size kitchen worktable, and such a table can be used in case the builder does not care to construct it.

The table is turned upside down and the top removed by taking out the screws. The top is made of several pieces glued together and will remain

edge of the rails. If a very neat job is required, these boards should be set inside on strips nailed to the inside surfaces of the rails, at the proper place to make the boards come flush with the under edges of the rails.

At the back side and in the center of the new bottom, a hole is cut, 6 or 7 in. square, and a box fastened beneath it, to form a bottom several inches below the main bottom. In this space bottles filled with solutions are kept. The main bottom should be painted with an acid-proof varnish.

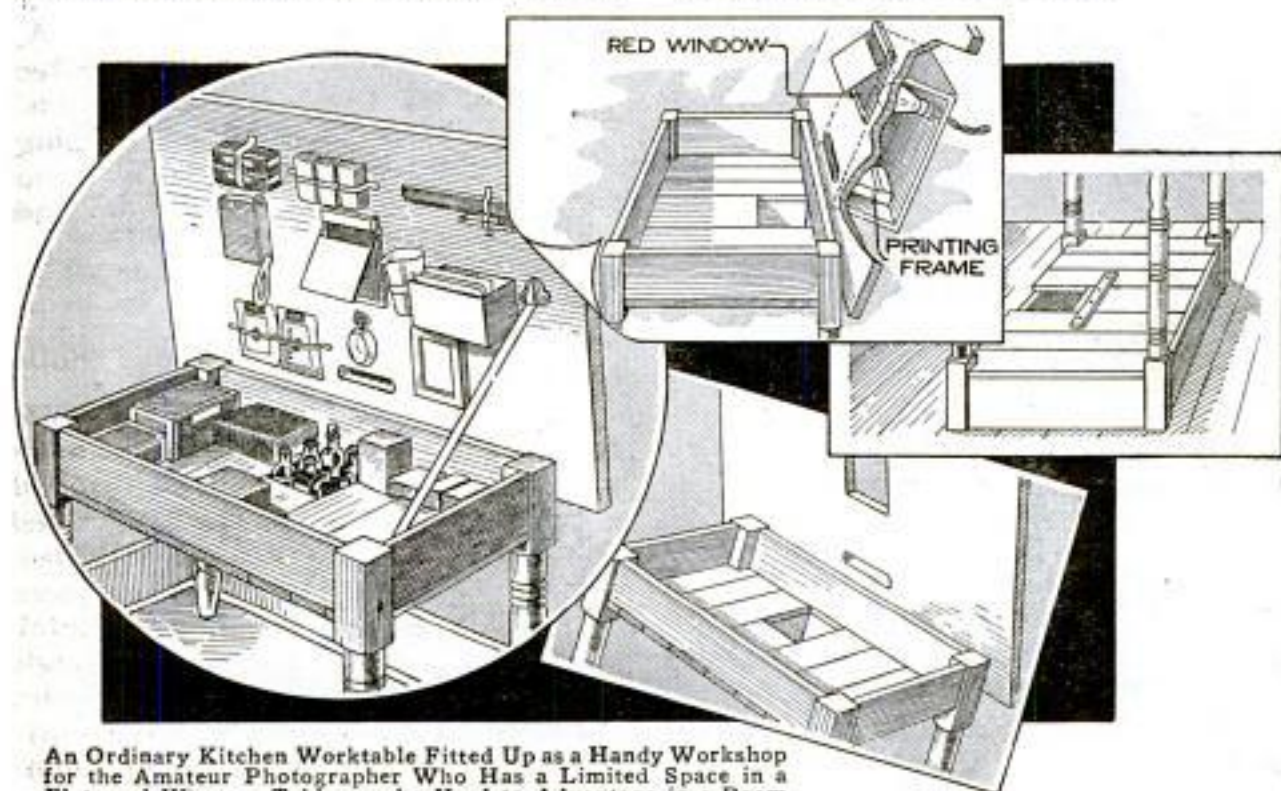

An Ordinary Kitchen Worktable Fitted Up as a Handy Workshop for the Amateur Photographer Who Has a Limited Space in a Flat, and Where a Table can be Used to Advantage in a Room

in one piece. It is then hinged at one side to the top edge of the rail, so that it can be turned back like a trunk, or box, cover.

Boards are then nailed to the under

The space in the table is then divided, and partitions set up, which can be arranged to suit the builder.

Another attachment, which comes in exceedingly handy, is the ruby light.

This consists of a box, large enough to receive a printing frame at the bottom. Two holes are cut in the table top, at the right places to make a window for the light and a slit for the printing frame. When the table top is raised, the box with the light is fastened over the openings with hooks,

the arrangement of which will depend on the size and shape of the box. In closing, the lamp box is removed, and pieces of board are set in the holes. This can be easily arranged, if the holes and blocks are cut on a slight slope, so that the latter when set in will not fall through the openings.

Back Thrust Prevented on Skis

To overcome the difficulty of skis slipping back when walking uphill either of the two devices shown is



Two Methods of Making an Attachment to Prevent the Backward Thrust of a Ski

good, if the attachments are fastened to the rear end of the skis.

The first represents a piece of horsehide, about 4 in. square, tacked on the ski and with the hair slanting backward. This will not interfere with going forward, but will retard any movement backward.

The other consists of a hinged portion that will enter the snow on a back thrust. As the ski end is thin, a block of wood must be attached to it on the upper side, and the projecting piece hinged to the block. The bevel at the end allows it to dig into the snow when the ski starts back. In going forward, it will swing out of the way freely.

Crystallization Shown on a Screen

The formation of chemical crystals can be shown in an interesting manner as follows: Spread a saturated solution of salt on a glass slide, or projection-lantern glass, and allow it to evaporate in the lantern's light or beneath a magnifying glass. The best substances to use are solutions of alum or sodium, alum being preferable. Ordinary table salt gives brilliant crystals which reflect the light to a marked degree. For regular formation, where the shape of the crystal is being studied, use a solution of hyposulphite of soda.

Many startling facts may be learned from the study of crystals in this manner, and watching them "grow" is great sport even to the chemist.—Contributed by L. T. Ward, Des Moines, Iowa.

Furniture Polish for Fine Woods

Boiled olive oil, to which a few drops of vinegar has been added, makes an excellent furniture polish for very fine woods. It will be found to work nicely on highly polished surfaces, and also for automobile bodies. It is applied in moderate quantities, and rubbed to a luster with a flannel cloth.

Paper Glider That Loops the Loop

By C. A. THOMPSON



Fig. 1



Fig. 2

corners of the wings are bent up as in Fig. 2, and, further, the rear corner of the keel is bent at right angles, Fig. 7, whereupon it is thrown in the ordinary manner. It then takes the course shown in Fig. 8.

A Water Filter

A cheap and very effective water filter can be made of a flower pot by plugging the hole in the bottom with a piece of sponge and fitting it as follows: Place powdered charcoal on top of the sponge to a depth of 1 in., then 1 in. of clean silver sand, and lastly 2 in. of small stones and gravel. It is hung with a bail at the top.

The usual paper glider shaped as shown in Fig. 1 can be made to loop the loop and make corkscrew flights if prepared according to sketches herewith. It should be carefully made in the first place so that in its regular form it flies perfectly straight.

To make the glider loop, the rear corners of the wings should be turned up at right angles, as in Fig. 2, and the glider launched with a great deal of force with the nose pointed slightly upward. This will require some practice, but one soon learns the trick. After looping once, as shown in Fig. 3, the glider descends in vol-plane. This form of glider will also right itself, if dropped from a height, nose downward, as shown in Fig. 4.

For a corkscrew flight the glider is prepared as in Fig. 5; one rear corner being bent up and the other down. In this form it flies horizontally, or downward, while rapidly rotating around its longitudinal axis, as shown in Fig. 6.

To make a spiral descent, the rear

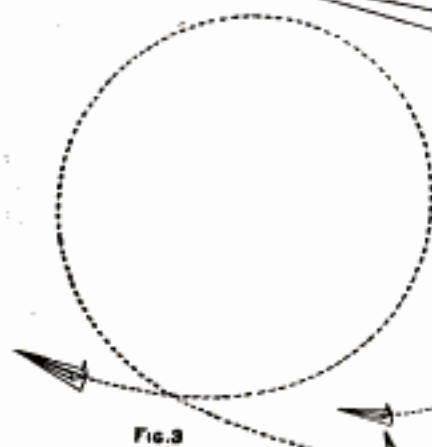

Fig. 3



Fig. 4



Fig. 5

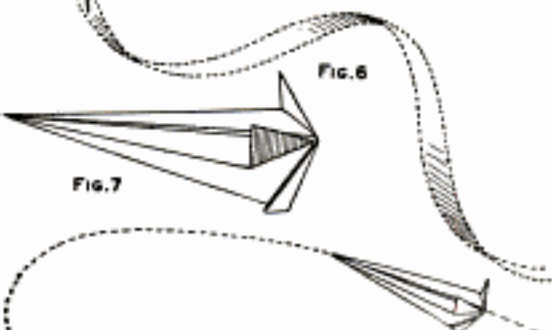

Fig. 6



Fig. 7



Fig. 8



Ordinary Paper Glider and the Manner of Throwing It to Make the Different Flights

An Electric Chime Clock

By JOHN E. MAHLMEISTER.

IN the construction of this clock one perfectly good and accurate alarm clock and the works of an old or discarded one are used. The clock for the accurate time is set into a frame, or casing, made of thin boards which have a circular opening cut in them to fit

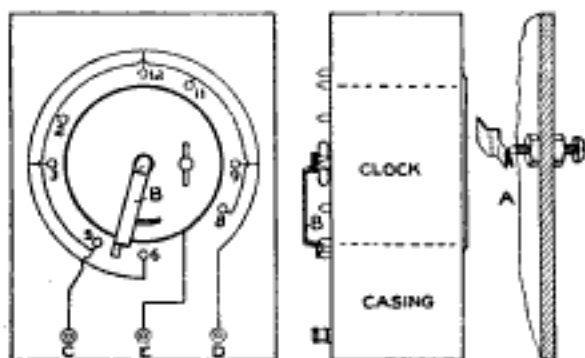

FIG. 1

The Alarm Clock in Its Case and the Location of the Contact Pins and Contact Lever

snugly on the outside casing of the clock. The back of the clock and casing are shown in Fig. 1. A circular line is drawn on the casing, about 1 in. larger in diameter than the clock, and brass machine screws with two nuts clamping on the wood back, as shown at A, are set at intervals so as to be opposite, or just back of, the hour marks 2, 3, 5, 6, 8, 9, 11, and 12. A contact spring, B, is shaped as shown and soldered to the knurled knob on the back

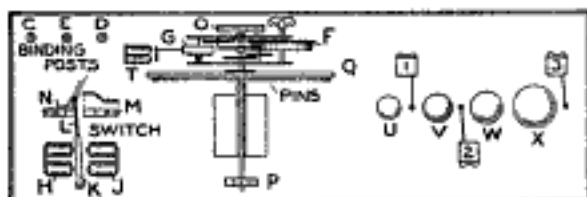

FIG. 2

Location of the Clock Works, Magnets, Binding Posts, Gongs and Strikers on the Baseboard

of the clock used for setting the hands in a position where it will travel or be parallel with the minute hand. The end of the contact spring should be shaped so that it will slide over the points of the screws easily, but in good contact. The ends of the screws should

be filed to a slightly rounding point. The wiring diagram for this part of the apparatus is clearly shown, and the terminals are connected to binding posts C and D. The binding post E is connected to the metal part of the clock.

The chime part is made entirely separate and can be located at any reasonable distance from the clock. It is propelled by the works from an old clock, as shown at F, Fig. 2. The old clock is prepared for use by removing the hands, balance wheel and escapement so that the wheels will turn freely. To prevent the works from running too fast, a piece of sheet brass, G, is soldered to the shaft running at the highest speed. The brass should be as large as the space will admit. It forms a fan to catch the air and retard the speed, and also provides a means of stopping the works by the electric mechanism.

The parts for the gongs and electrical apparatus are supported on a baseboard, $\frac{3}{4}$ in. thick, 6 in. wide, and 18 in. long. The automatic switch is located at one end of the base, and consists of two sets of magnets, H and J, with an armature, K, to which is attached a stiff contact wire, L. This wire is to make contact with the spring M when the armature is drawn by the magnets J, and with N when drawn by the magnets H. The springs M and N are made of thin sheet brass, bent as shown, and mounted on the base.

A piece of wood, O, on which to mount the works of the old clock is mortised into the base. Another standard, P, of the same height as O, is also mortised into the base to provide a bearing for the end of the shaft which carries the wood disk Q, the opposite end of the shaft being connected by means of a ferrule and soldered to the end of the minute-hand shaft. The shaft should be well lined up, so that it will turn freely. The wood disk is $\frac{1}{4}$ in. thick and about 6 in. in diameter.

Mark four circles on the face of the disk, near the outside edge and $\frac{1}{4}$ in. apart. Step off the outside circle into 150 parts and draw a radial line from each mark across the four circular lines with the straight edge on the center of the disk. An arc of the disk is shown in Fig. 3, where trip pins are driven in for making the electric contacts. This part of the arc shows the method of locating the pins for the hour from 3 to 4 o'clock, with the intermediate pins for the quarter, half, and three-quarter-hour contacts. The intermediate pins are arranged in the same manner for all hours, but the hour pins, on the second circle, run from 1 pin to 12 pins consecutively. Ordinary pins, with the heads cut off, are used and should be driven in accurately on the division lines to secure proper results.

The arrangement of the springs is shown in Fig. 4. These springs, when pressed together, will close the circuit for ringing the gongs. They are made of thin sheet brass, bent as shown at R, and fastened to a piece, or block, of hard wood with screws, as shown at S. The springs numbered 3, 5, 7, and 9 are the ones made as shown at R for sliding over the pins in the disk Q, and their ends should clear the face of the disk about $\frac{1}{8}$ in. The springs 1, 2, 4, 6, and 8 are about $\frac{1}{2}$ in. shorter and have their ends bent up at right angles so that they will almost touch the long ones. The spring 1 should be a little shorter than 2. When fastening the

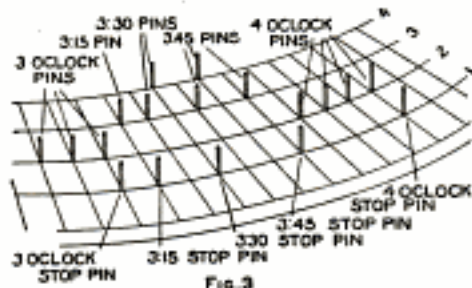

The Pins are Accurately Set in Four Circular Lines and on Radial Lines

springs to the block of wood, be sure that no two springs touch and that each one is separated from the other to form no contact until the pins in the wheel force them together. The block is then fastened to the base under and

parallel with the shaft carrying the disk Q, as shown.

The starting and stopping of the clockwork F is accomplished by means of a set of bell magnets, arranged, as

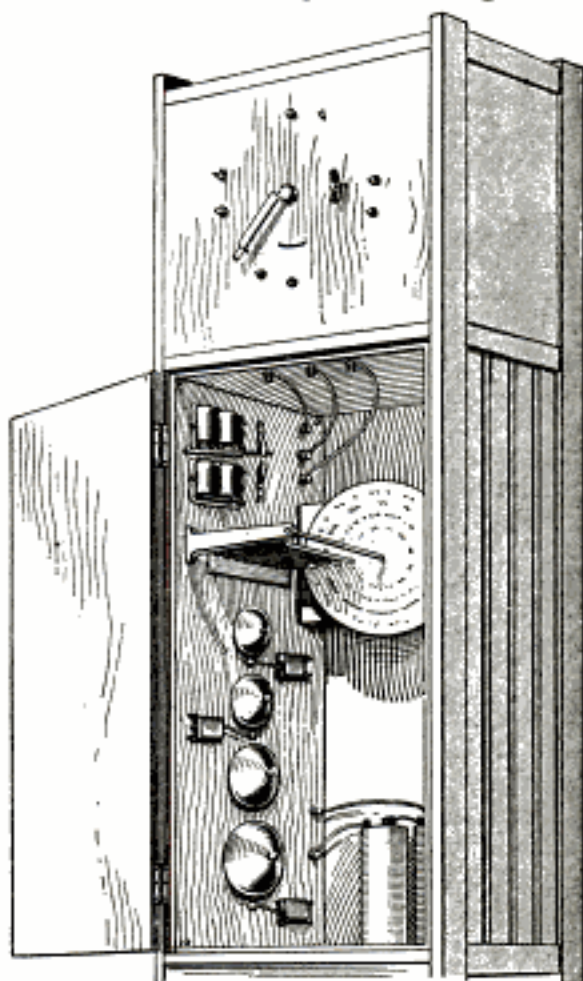

The Parts Constructing the Chime are Placed in the Clock Frame below the Works

shown at T, Fig. 2, with the wire attached to the armature bent to touch the brass wing of the fan G. The armature must not vibrate, but stay against the magnet cores while the current is flowing through them, thus allowing the clock wheels to turn, and as soon as the current is cut off, the armature will spring back and stop the wheels.

Arrange four gongs, U, V, W, and X, as shown in Fig. 2, and also three bell magnets with clappers 1, 2 and 3. These gongs should be selected for tone as in a chime clock. The connections to the bell magnets 1, 2, and 3 should be direct to the binding posts so that the armature will not vibrate,

but give one stroke. For instance, bell magnet 1 should produce one stroke on the gong U when the current is on, and one stroke on the gong V when

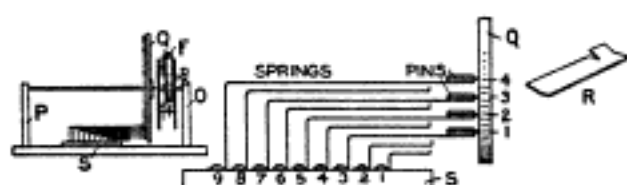

Fig. 4

The Contact Springs are Operated by the Pins on the Disk Wheel

the current breaks. The magnets 2 should cause the clapper to strike once on the gong V when the current is on, and to make one stroke on the gong W when the current is broken. The magnets 3 produce only one stroke on the gong X at a time, which is used to sound the hours.

The parts are connected up electrically as shown in Fig. 5. The lines between the clock, Fig. 1, and the bell-ringing part, Fig. 2, are connected from C to C, D to D, and E, Fig. 1, to the zinc of a battery and from the carbon to E, Fig. 2. Two dry cells will be sufficient for the current.

The working of the mechanism is as follows: Suppose the time is 6 minutes of 3 o'clock and the contact spring on the back is near the 11 pin. As soon as it touches the pin, the armature K of the switch will be drawn in contact with the spring N, then when the contact spring touches the 12 pin, the current will flow into the

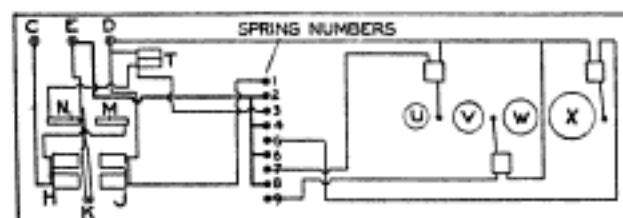

Fig. 5

The Wiring Diagram for the Location of the Wires on the Under Side of the Base

magnets T and release the wheels of the clockwork F, which turns the disk Q, and the three pins in the second row will pass over the spring 5 and press it in contact with the spring 4 three times, causing the gong X to toll out

3 o'clock. As the contact spring B will be on the contact pin 12 for about 1 minute, the wheels of the clockwork F would continue to turn and the bells ring, if it were not for the stop pin located on the outside, or first, circle of the disk Q, which pin is set in line with the last pin in the set of pins for the hour, or, in this instance, in line with the third pin. When the stop pin has passed the spring, the connection through the magnets T is broken and the clockwork F stops instantly. When the spring B strikes the 2 o'clock pin, or 10 minutes after 3 o'clock, the armature K is drawn over to N, and at the 3 pin, or 15 minutes after 3 o'clock, the bells U, V, and W will ring and then the stop pin will break the current, and so on, at every 15 minutes of the 12 hours.

Hinges Used to Substitute Night Bolt

One of the safest devices for bolting, or locking, a door against intruders is to use two sets of hinges. The extra set is fastened to the door and frame in the same way but directly opposite the regular hinges. It may be necessary to file the extra hinges and pins in order to separate and bring the parts together easily. The usual door lock need not be used with this arrangement, as the hinges are exposed only on the inside of the room and cannot be tampered with from without.

Propellers for a Hand Sled

Desiring to propel my hand sled with power transmitted by cranks and wheels, I set about to procure the necessary materials. Two medium-sized buggy wheels were found in the back yard of a blacksmith shop, which were procured for a nominal price. The felloes of these wheels were removed, the tenons cut from the spokes and nails substituted, which were driven in their ends so that about $\frac{1}{2}$ in. of the body with the head projected. The heads were then removed and the nail ends sharpened.

The hubs were plugged with pieces

of wood, whittled to tightly fit the holes. A hole was then bored exactly central through each plug for a $\frac{1}{2}$ -in. rod. This size rod was procured and bent to form a crank, the bearing end being threaded for a distance equal to the length of the hub.

Two pieces or blocks of wood, 2 in. square and 4 in. long, were used as bearings. These were bored centrally through the long way, to receive the $\frac{1}{2}$ -in. rod just loose enough to make a good bearing. These bearings were supported by a pair of braces made of strap iron, about $\frac{1}{4}$ in. thick and $\frac{3}{4}$ in. wide. The length of the iron will depend on the size of the wheels and the height of the sled runner. The braces were shaped as shown. The center of the bearing hole must be as high from the surface of the ground as the distance the spoke ends are from the center of the hub hole.

The crank is then run through the bearing hole and a nut run on the threads and a washer placed against the nut. The wheel is then slipped on the axle, and another washer and nut run on tightly. Both wheels, bearings, cranks, and brackets are

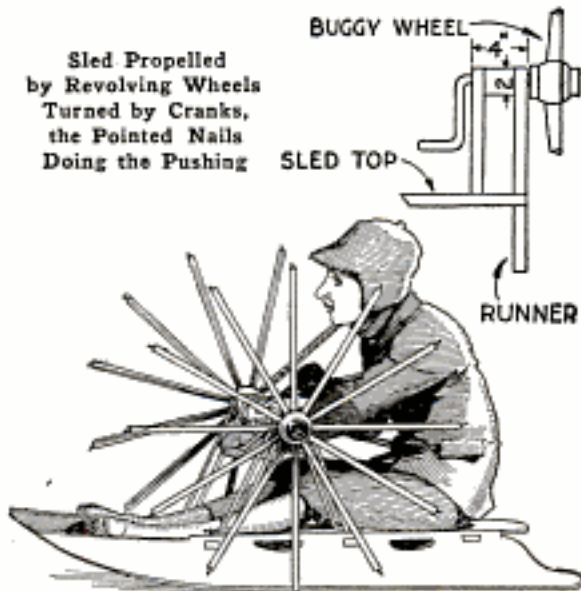

made alike. The brackets are fastened with small bolts to the sled top.—Contributed by Justin Stewart, Wallingford, Conn.

A Self-Feeding Match Box

With the addition of the simple device here illustrated, any match box can be converted into one of the self-

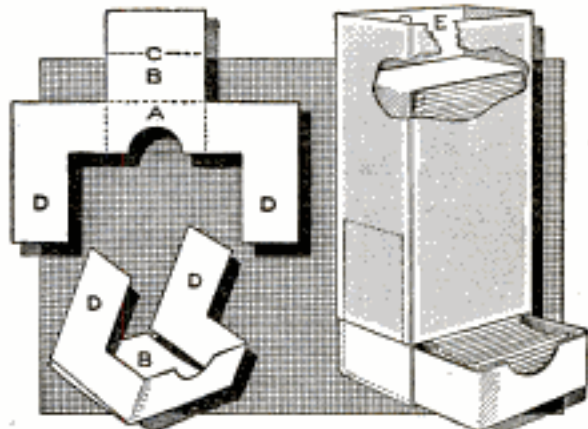

The Attachment Consists of a Receptacle Fitting into the End of a Match Box

feeding type. A piece of tin, or cardboard, is cut, as shown at A, the exact size depending on the match box used. The piece cut out is folded on the dotted lines, the cover on the match box is removed, and the part B pushed into the end of the box beneath the matches. The part B is twice as long as the depth of the box, therefore it enters the box as far as the line C. The flaps D rest against the outside of the box, and are held in place by the box cover. The matches feed into the box formed of the tin or cardboard as fast as used, while the burnt ones can be placed in the upper part E.

Corks-in-a-Box Trick

Procure a pill box and a clean cork. Cut two disks from the cork to fit in the box, and fasten one of the pieces centrally to the inside bottom of the pill box with glue.

To perform the trick, put the loose disk in with the one that is fast, and then open the box to show both corks. Close the box and in doing so turn it over, then open and only one cork will be seen. Be careful not to show the inside of the other part of the box with the cork that is fastened.—Contributed by Fred B. Spoolstra, Yonkers, N. Y.

A Substitute for a Pen

Recently I was hard pressed for a pen, and as none could be found and the hour was late it was necessary to



A Notch Cut in the Tapered Part of a Wood Stick Forms a Substitute Pen

find a substitute. I fashioned a pen from a piece of boxwood, and was agreeably surprised at the excellent results obtained with it. The wood was sharpened like a lead pencil at one end, and a groove was cut out of the tapered part to hold the ink.—Contributed by Richard F. Pohle, Lynn, Massachusetts.

CA very convenient method of keeping shipping tags at hand is to slip them on a desk spindle.

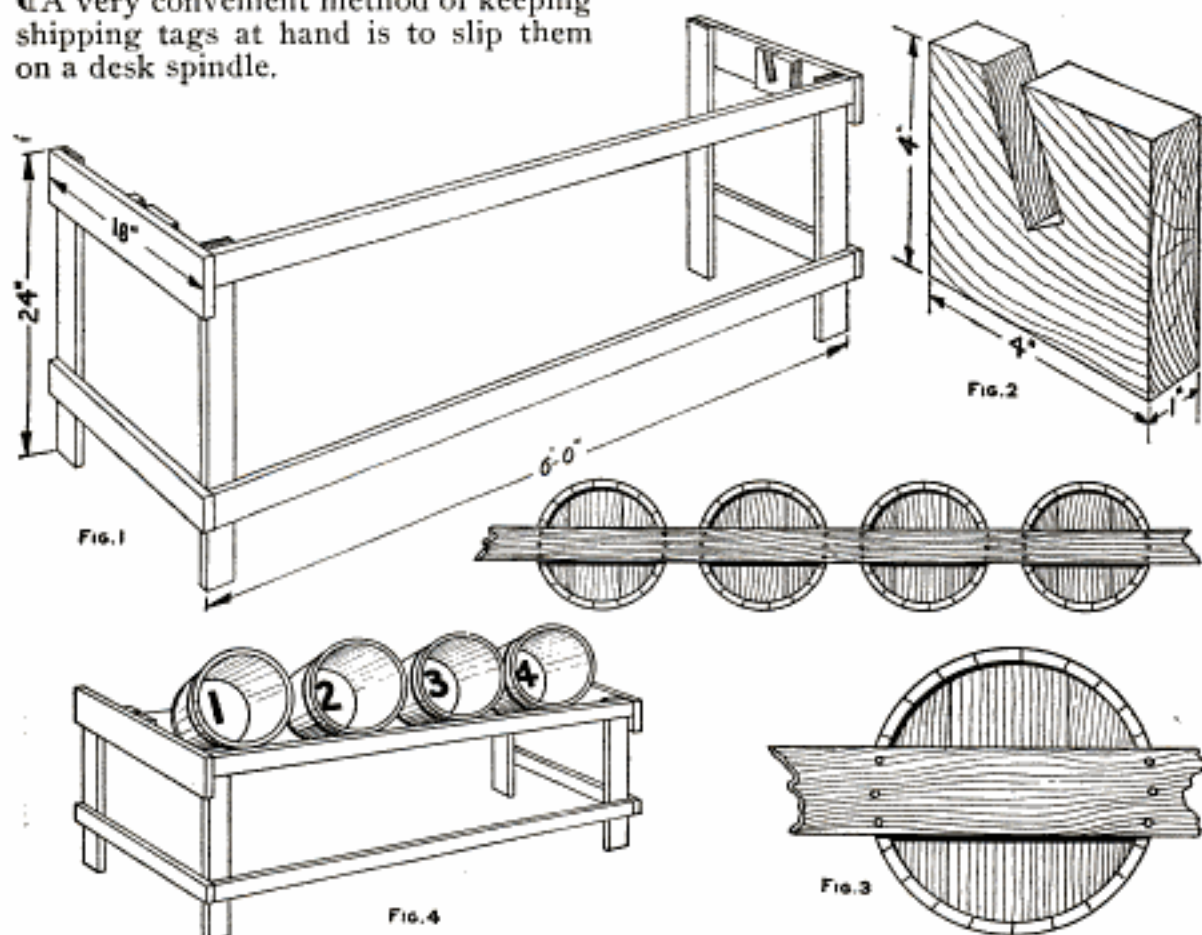

The Frame is Made Up without a Back, to Hold the Buckets at an Angle That Makes It Difficult to Toss the Ball So That It Will Stay in Any One of Them

A Bucket-Ball Game

This is a new indoor game which follows out in principle the regular baseball play. It is an exciting and interesting pastime, and while a certain amount of skill is required to score runs, a person who cannot play the regular game can score as many runs, and as often, as the best players in the national leagues.

Anyone that is just a little handy with tools can make the necessary parts for this game. The tools required are a hammer and a saw, and the materials consist of some finishing nails; three strips of wood, 6 ft. long, 2 in. wide, and 1 in. thick; two strips, 18 in. long, 4 in. wide, and 1 in. thick; four strips, 24 in. long, 2 in. wide, and 1 in. thick; two strips, 18 in. long, 2 in. wide, and 1 in. thick; two blocks, 4 in. square, and 1 in. thick, and four wood buckets.

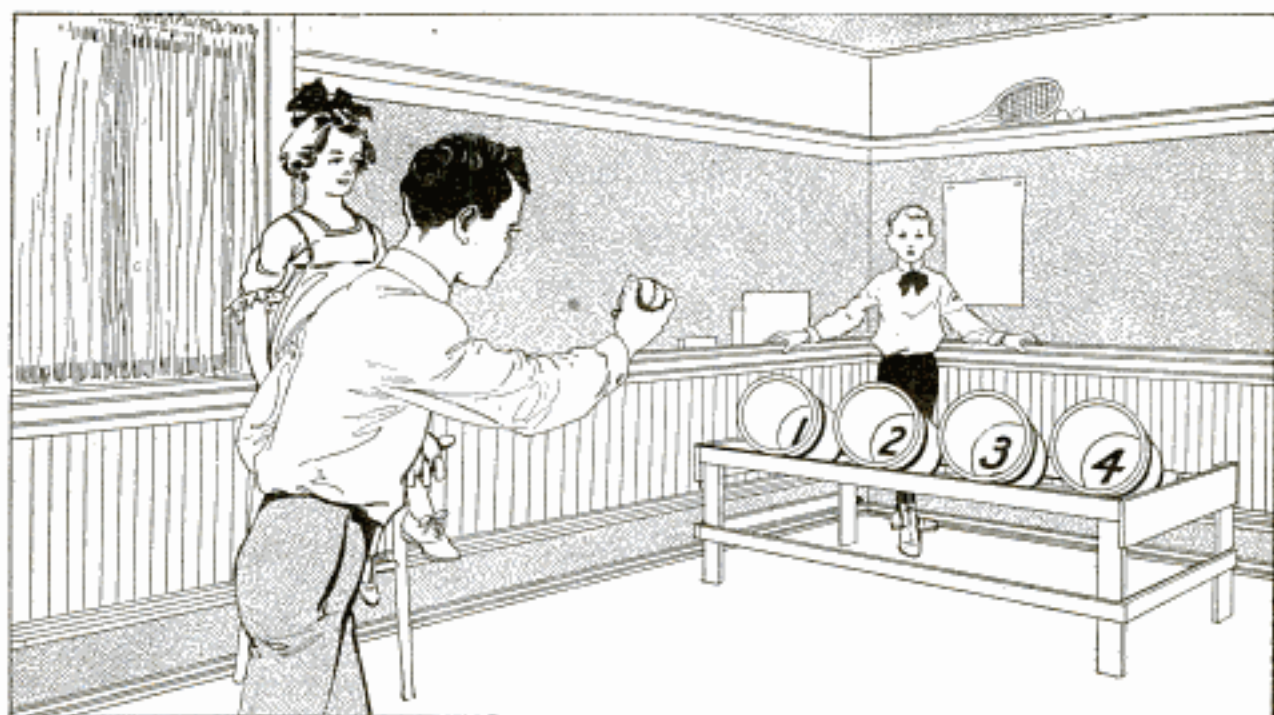

The Player must Throw the Ball So That It will Enter and Stay in One of the Buckets, Which Designates the Base Hits by the Number in Its Bottom

A frame is built up as shown, 6 ft. long, 18 in. wide, and 24 in. high, without a back. One of the long pieces is fastened to the bottoms of the buckets as shown, spacing the latter equally on the length of the piece. This piece is then set in notches cut in the blocks of wood at an angle of 45° . These blocks are fastened to the upper cross-pieces at the ends of the frame. The upper part of the buckets rest on the upper front piece of the frame.

The rules for playing the game are as follows: Three baseballs are used. The players stand about 10 ft. distant and in front of the buckets. Each player, or side, is only permitted to throw three balls an inning, irrespective of the number of runs scored. Any kind of delivery is permitted, but an underhand throw will be found most successful. The buckets are numbered from 1 to 4, and represent, respectively, one, two, and three-base hits, and home runs. The one in which the ball stays designates the run.

Plays are figured as in a regular ball game. For instance, if a ball should stay in bucket No. 2 and the next in bucket No. 3, the first man would be forced home, counting one run, and leaving one man on third base.

If the next ball stays in bucket No. 4, the man on third base is forced home, as well as the one who scored the home run, making three runs for that inning. The runs should be scored as made, to guard against confusion and argument.—Contributed by Walter Talley, Pottsville, Pa.

A Staple Puller

With nothing but ordinary tools the removing of staples is tedious and difficult work. If a suitable-sized wire nail is bent like a fishhook and the hook part driven under the staple, the latter can be easily pulled out by grasping and pulling the nail with a hammer in the usual way.—Contributed by R. Neland, Minneapolis, Minn.



Homemade Water Meter

Where it is necessary to measure water in large quantities the meter illustrated will serve the purpose as well

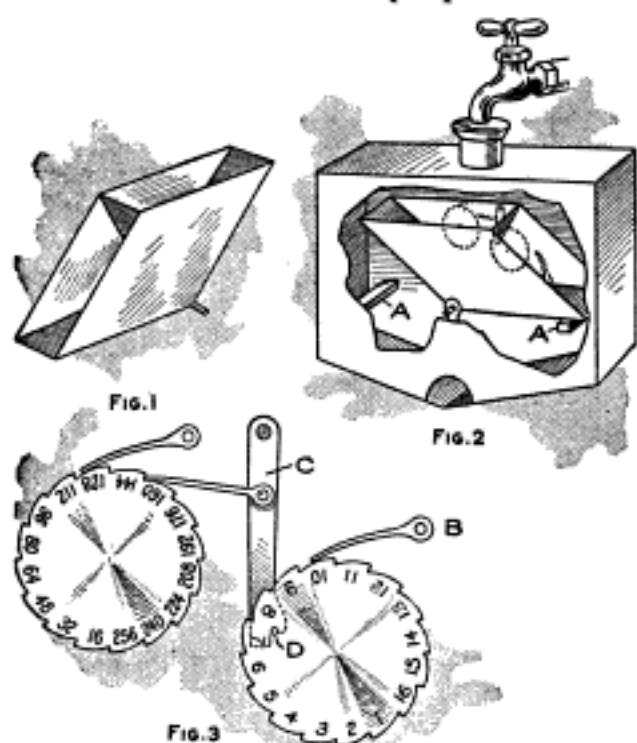

When a Bucket is Filled to the Proper Amount It is Turned Out by the Weight

as an expensive one, and can be made cheaply. The vessel, or bucket, for measuring the water is made diamond-shaped, as shown in Fig. 1, with a partition in the center to make two pockets of a triangular shape, each holding 2 qt., or any amount of sufficient size to take care of the flow of water.

The part forming the pockets is swung on an axis fastened to the lower part, which engages into bearings fastened to the sides of the casing, as shown in Fig. 2. Stops, A, are placed in the casing at the right places for each pocket to spill when exactly 2 qt. of water has run into it. It is obvious that when one pocket is filled, the weight will tip it over and bring the other one up under the flow of water.

The registering device consists of one or more wheels worked with pawls and ratchets, the first wheel being turned a notch at a time by the pawl B, Fig. 3. If each pocket holds 2 qt., the wheel is marked as shown, as each

pocket must discharge to cause the wheel to turn one notch. The second wheel is worked by the lever and pawl C, which is driven with a pin D located in the first wheel. Any number of wheels can be made to turn in a like manner.—Contributed by F. A. Porter, Oderville, Utah.

A Snowball Maker

Snowball making is slow when carried on by hand, and where a thrower is employed in a snow fort it becomes necessary to have a number of assistants in making the snowballs. The time of making these balls can be greatly reduced by the use of the snowball maker shown in the illustration.

The base consists of a board, 24 in. long, 6½ in. wide, and 1 in. thick. A block of wood, A, is hollowed out in the center to make a depression in the shape of a hemisphere, 2½ in. in diameter and 1¼ in. deep. This block is nailed to the base about 1 in. from one end. To make the dimensions come out right, fasten a block, B, 6 in. high, made of one or more pieces, at the other end of the base with its back edge 14½ in. from the center of the hemispherical depression. On top of this block a lever, C, 20 in. long is hinged. Another block, D, is made

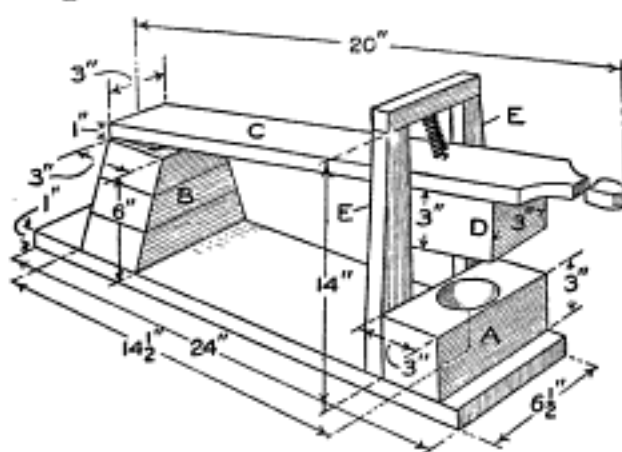

A Device for Making Snowballs Quickly and Perfectly Spherical in Shape

with a hemispherical depression like the block A, and fastened to the under side of the lever, so that the depressions in both blocks will coincide. The lever end is shaped into a handle.

Two uprights, E, are fastened to the back side of the block A as guides for the lever C. A piece is fastened across their tops, and a spring is attached between it and the lever. A curtain-roller spring will be suitable.

In making the balls a bunch of snow is thrown into the lower depression and the lever brought down with considerable force.—Contributed by Abbott W. France, Chester, Pa.

An Inexpensive Bobsled

Any boy who can drive a nail and bore a hole can have a bobsled on short notice. The materials necessary are four good, solid barrel staves; four blocks of wood, 4 in. long, 4 in. wide, and 2 in. thick; two pieces, 12 in. long, 4 in. wide, and 1 in. thick; one piece, 12 in. long, 2 in. wide, and $1\frac{3}{4}$ in.

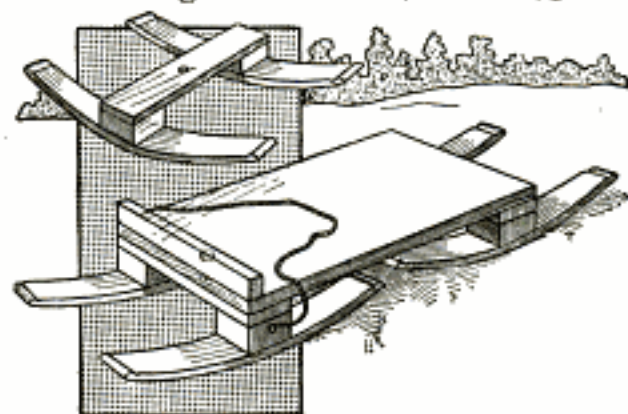

A Bobsled of Simple Construction Using Ordinary Barrel Staves for the Runners

thick; and a good board, 4 ft. long, 12 in. wide, and 1 in. thick.

The crosspieces and knees are made with the blocks and the 1-in. pieces, 12 in. long, as shown; to which the staves are nailed for runners. One of these pieces with the runners is fastened to one end of the board, the other is attached with a bolt in the center. The $1\frac{3}{4}$ by 2-in. piece, 12 in. long, is fastened across the top of the board at the front end. A rope fastened to the knees of the front runners provides a means of steering the sled.

The sled can be quickly made, and it will serve the purpose well when an expensive one cannot be had.—Contributed by H. J. Blackledge, San Rafael, Cal.

Motor Made of Candles

A tube of tin, or cardboard, having an inside diameter to receive a candle snugly, is hung on an axle in the center

Tallow Dripping from the Ends Alternately Lessens the Weight of the Arms and Causes the Tube to Tip

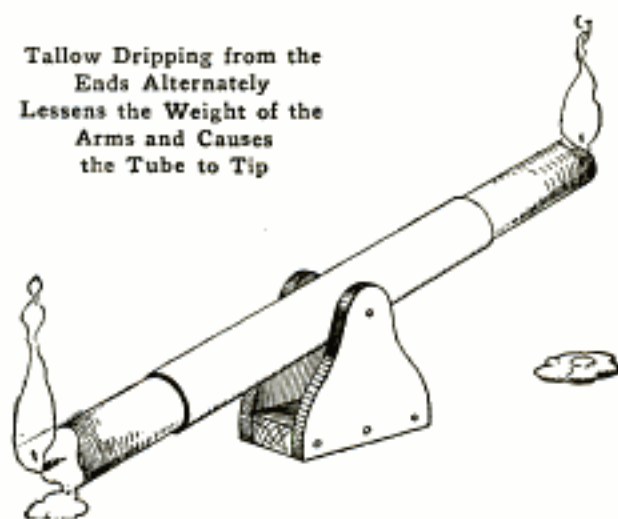

that turns in bearings made of wood. The construction of the bearings is simple, and they can be made from three pieces of wood as shown. The tube should be well balanced. Pieces of candle are then inserted in the ends, also well balanced. If one is heavier than the other, light it and allow the tallow to run off until it rises; then light the other end. The alternate dripping from the candles will cause the tube to tip back and forth like a walking beam. It will keep going automatically until the candles are entirely consumed.—Contributed by Geo. Jaques, Chicago.

Kettle-Handle Support

The handle of a kettle lying on the kettle rim will become so hot that it cannot be held in the bare hand. To keep the handle fairly cool it must be supported in an upright position. To do this, form a piece of spring wire in the shape shown, and slip it over the kettle rim. The shape of the extending end will hold the handle upright and away from the heat.

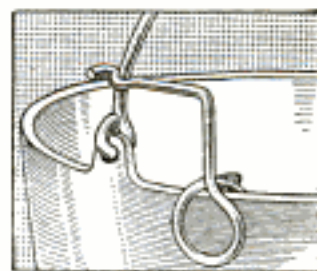

Bicycle Oil Lamp Changed to Electric Light

The desire for an electric light for my bicycle caused me to change a fine oil lamp, too good to be thrown away,

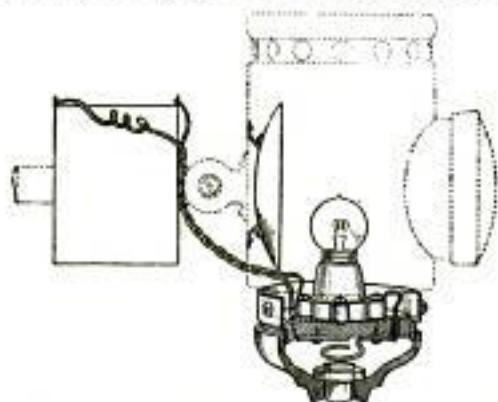

A Push Button with Socket and Miniature Globe Used in an Oil Lamp for Electric Light

so that an electric globe could be used in it. The oil cup of the lamp was removed, and a wood push button fastened in its place with three screws. Before fastening the push button, a porcelain socket was attached to its bottom, and connections were made be-

tween socket and push button, ends being left protruding for connection to the battery. A small flash-light battery was fastened to the lamp bracket. A small rubber washer was placed between the head of the push button on the switch and the cap, so that in screwing the cap up, a permanent connection was made. The lamp can be used as a lantern when removed from the bicycle.—Contributed by Lee Baker, Chicago.

Lifter for Removing Eggs from Hot Water

An improvement over the customary way of removing eggs from hot water with a tablespoon, is to use an old-fashioned coffee strainer. This brings up the eggs without carrying hot water with them.—Contributed by L. E. Turner, New York, N. Y.

☞Genuine oxalic acid may be used for removing stains from all woods except mahogany.

Double Top for a Table

The need of two tables in a kitchen where there was space for only one,



An Extra Top Covers the Table When It is Placed against the Wall

was the cause of devising the arrangement shown in the illustration. An ordinary kitchen table was mounted on trunk casters or domes so that it could be moved easily, whereupon a zinc top was put on it with raised edges. The table was then placed against the wall where it was to be

used, and an extra, plain top fitted to it and hinged to the wall.

When it was desired to wash dishes on the zinc top, the table was pulled out without disturbing the articles on the hinged top. After drying the dishes, they are removed from the zinc top to the hinged part, and the



The Table When Drawn Out Uncovers the Zinc Tray, Fastened on Top

table is pushed back against the wall.—Contributed by Louis Drummond, Philadelphia, Pa.

Electric Heating Apparatus for the Home

By ARTHUR MOORE

PART XII—Electrically Heated Fireless Cooker

THE cooker illustrated differs from the ordinary fireless cooker in the method employed to supply the necessary heat. The heat is supplied to the ordinary cooker with a plate or dish heated on an ordinary stove, and then placed in the bottom of the cooking compartment. The construction of the cooker illustrated is such that practically all the heat is confined in the cooking compartment, and, as a result, the total amount of heat required is a great deal less than would be required

if the same operation were performed on the kitchen stove. The heat is produced by means of an electric current, which flows through a resistance, located directly beneath the bottom of the inner, or cooking, compartment and insulated therefrom. The amount of heat supplied will depend on the rate at which it is being supplied and the duration of the time of supply. The efficiency of the cooker will depend upon the degree to which the heat is confined in the cooking compartment after it is once generated by the electric current. The circuit is not closed continuously, but only for a sufficient length of time to produce the required amount of heat, which can be best determined by experience. The time the circuit is closed may be controlled by a time switch, in which case the cooker will need no attention after the articles have been placed in the cooking compartment, the circuit closed, and the

time switch set to open the circuit after a certain time. Time switches which will perform the above operation may be purchased cheaply and will pay for themselves in a short time in the increased degree of satisfaction obtained in using the cooker.

The cooker really consists of two distinct parts, namely, the box of the cooker, and the heating element. In Fig. 1 is shown the general arrangement of the various parts in cross section. The box of the cooker is nothing

more nor less than a special form of ice box having the walls lined with a material that is not affected by heat nor likely to catch fire. The wall of the inner compartment is made from a good quality of heavy tin, formed into a cylinder, 9 in. in diameter and $8\frac{1}{2}$ in. long. A bottom is attached to one end by crimping the edges of both bottom and cylinder together tightly, so as to make a water-tight joint without using solder, as solder will melt

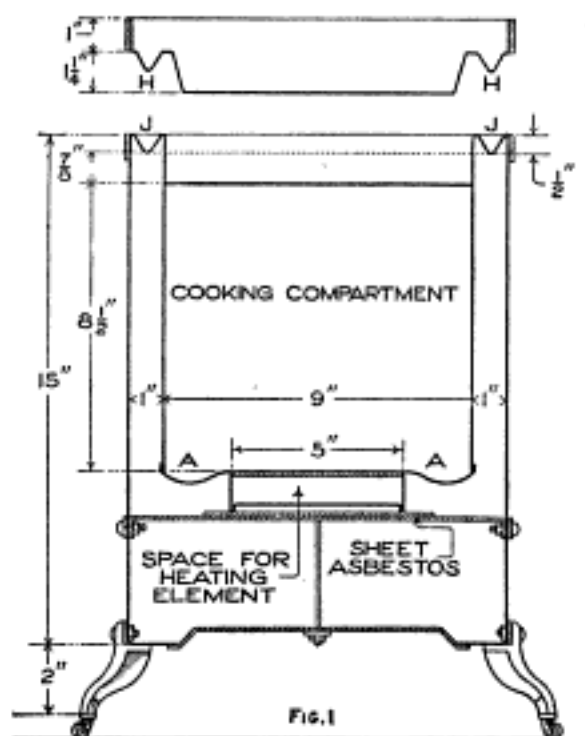

FIG. 1
Cross Section of the Cooker, Showing the Location of the Various Parts, with Dimensions

out. This work can be done by a tinner, who has tools for the work, and before crimping the edges of the bottom and cylinder, a groove should be formed in the disk, as shown at A, for catching any liquid that may collect, and keeping it away from the surface just over the heating element.

Cut from heavy tin a piece having the form and dimensions given in Fig. 2. Bend all four sides up at right angles along the dotted lines B, and then down along the dotted lines C,

also at right angles. Next bend the four sides down, but not at right angles, along the dotted lines D; up, on the dotted lines E; down, on the lines F, and lastly, down, on the lines G.

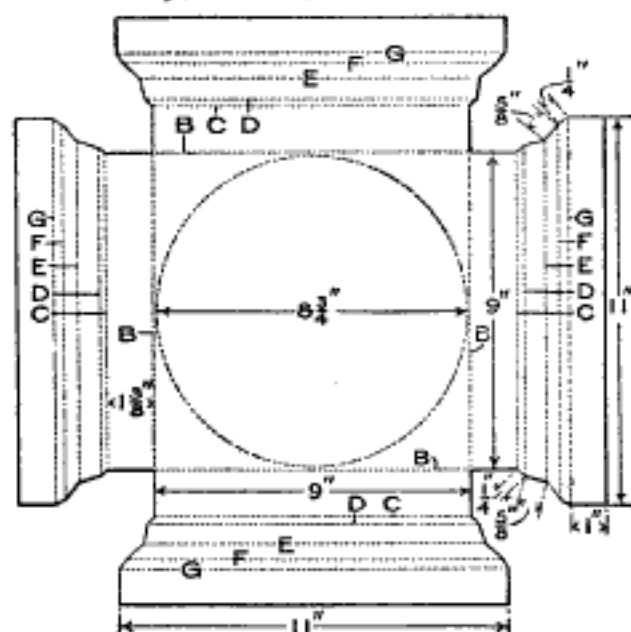

FIG. 2
Manner of Cutting Out the Metal to Form the Top Part of the Cooker

When the four corners are properly cut and the bends properly made, the edges will fit together and make a neat seam. These seams may all be soldered on the under side. A cross section showing the form of the edge when complete is given in Fig. 3. A circular opening is cut in the center of the piece, as indicated. The edge of this opening is turned down so that it will fit snugly in the upper end of the cylindrical vessel first constructed. These two pieces are then soldered together by applying solder from the outside. When through soldering any of the joints, always be sure to remove any trace of soldering flux so as to prevent the possibility of rust, which would soon make a hole in the metal and render the cooker worthless.

The dimensions of the piece forming the under side of the cover are given in Fig. 4. This part of the cover is formed from a piece of heavy tin, with the four edges bent along the dotted lines so that it will have the form shown at the top of Fig. 1. The four corner seams may be soldered on the inside, after the cover is formed so that

it will fit the top on the cylindrical vessel. This piece, or cover, is hinged to the upper portion of the cooker along one edge, and when the cover is raised, the projecting portions H will not rise directly out of the grooves J, but will have a slight side movement, and for this reason they should not fit too tightly.

The outer portion of the cooker is made from sheet iron, such as is used in stovepipes, or galvanized iron will do. The dimensions of the piece for the top of the cover are given in Fig. 5. The four edges are bent down on the dotted lines. This piece, when completed, fits inside of the four edges of the under side of the cover. A rectangle is formed from $\frac{1}{8}$ in. by 1-in. strap iron to fit the outside of the cover. The ends of the piece forming the rectangle may overlap a short distance, and are fastened together with several small rivets. This rectangle must be fastened in place around the outer edge of the cover by means of small round-head bolts, placing at least six of them, evenly spaced, on each of the four edges. The holes for these bolts are drilled while the rectangle is in position, and their positions marked so that it can be taken out and replaced properly. After the holes are all drilled,

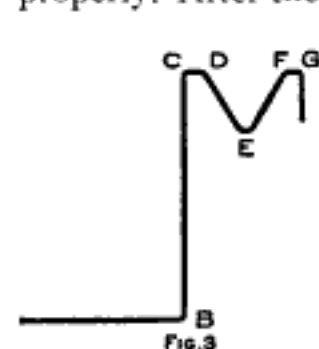

FIG. 3

solder the nuts for the bolts on the inside of the upper portion of the cover, which is inside the tin, their positions being determined by the holes. Fill the space between the upper and lower portions of the cover with asbestos wool, and fasten the cover together by means of the bolts. The appearance will be improved, if the bolts have round heads.

The dimensions and form of the piece for the lower portion of the cooker are given in Fig. 6. Bend the piece along the four vertical dotted lines, and fasten the two edges together by means of an ordinary lap

seam. Bend the four lower projecting portions in, on top of each other, along the horizontal dotted line. Mark out a circle, 7 in. in diameter, on the bottom of the box thus formed, making sure the center of the circle is in the center of the bottom, and cut out the metal inside of the circle. Be sure that the four vertical corners of the box are at right angles, then fasten the four corners of the inwardly projecting pieces with small rivets.

Form three rectangles, from $\frac{1}{8}$ -in. by 1-in. strap iron, that will fit snugly on the outside of the box. The ends of these pieces forming the rectangles are made to overlap and are riveted. The appearance will be improved if all joints in the rectangles are on one side and in line, say, in the center of the side that forms the back of the cooker.

Place the tin cylindrical vessel inside of the sheet-iron box, with the edges of its top outside of the edge of the sheet-iron box, and slip one of the rectangles over it with its upper edge even with the upper edge of the box. Drill six holes in each side of the

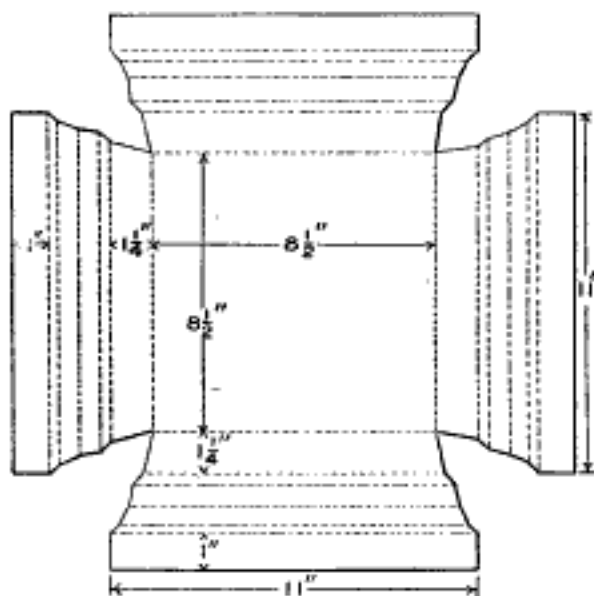

FIG. 4

The Under Part of the Cover is Cut Out the Same as the Cooker Top

rectangle through the tin and the sheet iron. These holes are located directly beneath those that are drilled in the edge of the cover so that all the bolt heads will be in line vertically. Solder

the nuts for the bolts on the inside of the sheet-iron box, using a small portion of solder, so as not to plug up the hole in the nut.

A second rectangle is then fastened

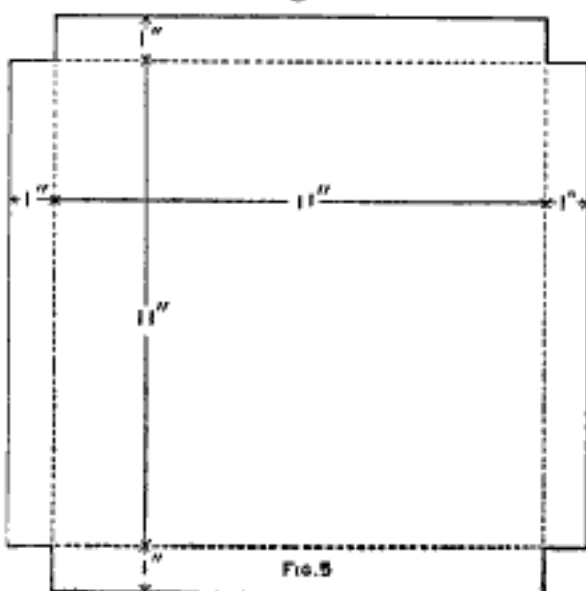

FIG. 5

The Upper Part of the Cover is Cut Out to Make a Flat Surface

around the lower edge of the sheet-iron box with bolts on each side. The position of the third rectangle will depend on the dimensions of the heating element, and it should be put on the box before both rectangles, but not fastened until the heating element is in place.

In constructing this cooker, it is suggested that the builder purchase an ordinary 6-in. disk electric stove rather than make one. One of about 600 watts to operate on the available voltage will do the heating nicely.

The legs, switch, and connecting terminals are carefully removed, and extensions made to the leads so that they are about 10 in. long, and thoroughly insulated with material not affected by heat.

Place the heating element in position, as shown in Fig. 1. Obtain a piece of heavy sheet asbestos, a little larger than the outside dimensions of the bottom of the heating element, and place it in position, as shown. Procure three pieces of strap iron, 13 in. long, 1 in. wide, and $\frac{1}{8}$ in. thick, and bend the ends over at right angles to the main portion, so that they will fit in-

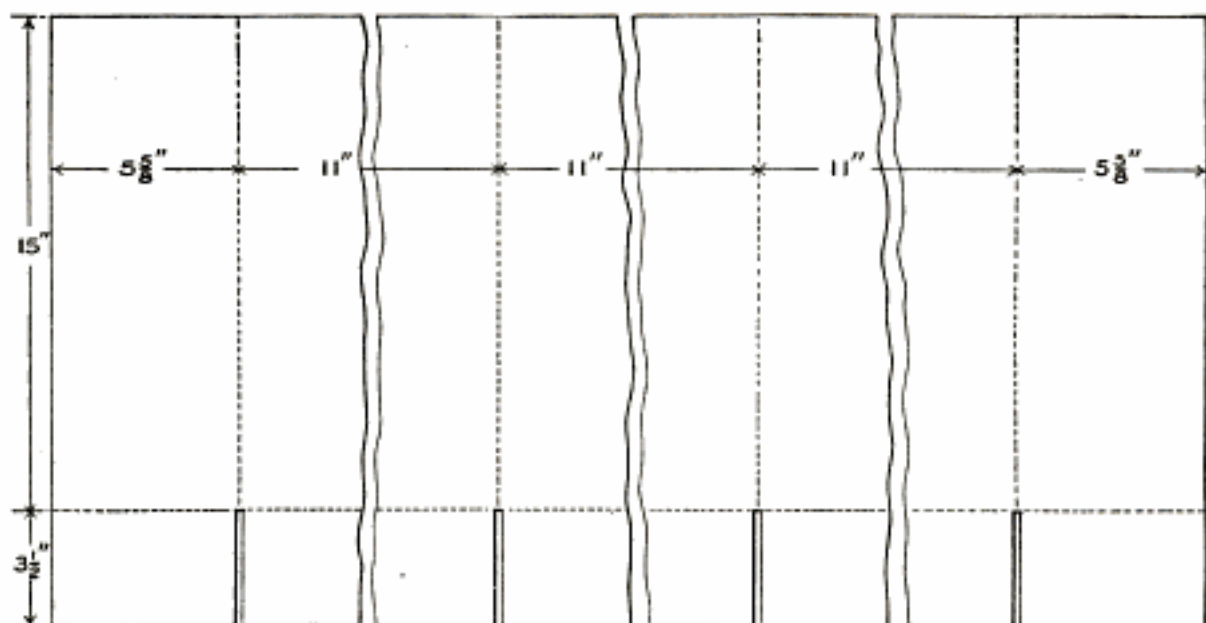

FIG. 6

The Main Outside Body of the Cooker is Made of One Piece of Sheet Metal, with a Portion Cut So That the Projections can be Turned Under, to Form the Bottom

side the sheet-iron box and serve as a support for the heating element. The loose rectangle, outside of the sheet-iron box, is now fastened in position so that some of the bolts used in fastening it may also serve to fasten the three crosspieces. A small rod is fastened in the center of the middle crosspiece, which is to be used in holding the bottom of the cooker in place.

The connecting terminals and switch,

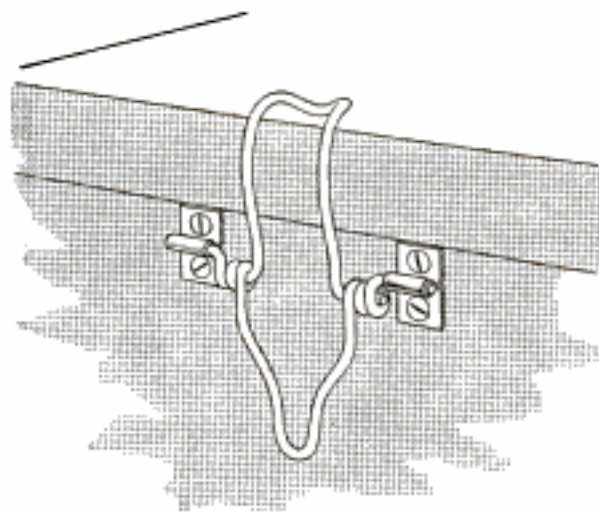

FIG. 7

Two Heavy Wires are Bent to Make a Clip That will Draw the Cover Down Tightly

which were removed from the stove, are mounted on one side of the sheet-iron box, and the necessary electrical

connection made between them and the heating element. A bottom for the cooker is made from a heavy pie pan, fastened as shown. Four legs provided with casters are attached to the corners of the cooker, so that it will be raised at least 3 in. above the surface upon which it is placed.

After all the mechanical work is completed on the lower portion of the cooker, the space between the walls and around the heating-element compartment is filled with asbestos wool. Care should be taken to see that the bottom of the cooking compartment is in contact with the top of the heating element, as any air space between them will greatly reduce the efficiency of the cooker.

A short piece of chain is attached to the cover and main portion of the cooker, to prevent the cover from falling back more than 45 deg. to the vertical. The cover should be held firmly against the upper edge of the cooking compartment to prevent the escape of any heat. A fastener that will serve very well for this purpose is made as shown in Fig. 7. A water seal will be formed around the top of the cooker when enough steam condenses to partly fill the groove J, Fig. 1, in the upper edge.

Skating Merry-Go-Round

By HENRY BURICH

After once making and using the ice merry-go-round as illustrated, no pond will be complete unless it has one or more of these devices.

To construct an amusement device of this kind, select a good pole that will reach to the bottom of the pond. The measurement can be obtained by cutting a hole in the ice at the desired place and dropping in a line weighted on one end. A sufficient length of the pole should be driven into the bottom of the pond to make it solid and allow the upper end to project above the surface of the ice at least 4 feet.

A turning crosspiece for the upper end of the pole is made as follows: First prepare the end of the pole by sawing it off level, then cutting off the bark and making it round for a metal ring which should be driven on tightly. A pin, about $\frac{3}{4}$ in. in diameter, is then driven into a hole bored in the end of the pole. The crosspiece is made of 2 by

6-in. material, at least 18 ft. long. A hole is bored in the center to receive the pin in the pole end.

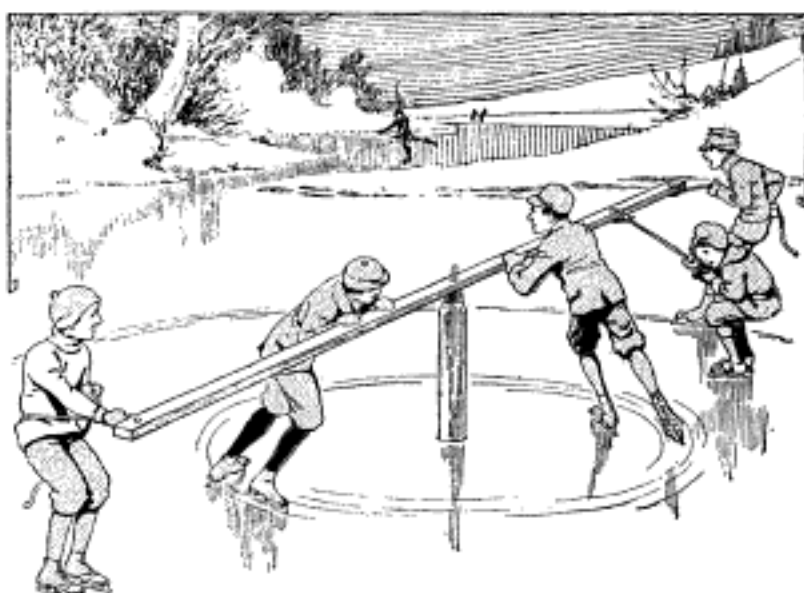

Skaters Holding the Rope Ends are Drawn Around in a Circle Rapidly by the Revolving Crosspiece, Turned near the Center by Other Skaters

The crosspiece is easily pushed around the pole and the faster it goes the closer to the center the pushers can travel. Ropes can be tied to the ends of the crosspiece for the skaters to hold on to as they are propelled around in a circle.

Relieving Air Pressure When Closing Record Boxes

The ordinary pasteboard boxes for holding phonograph records are very hard to close, due to the air pressure on the inside. I overcome this difficulty by making three small holes in the cover with a pin.—Contributed by Robert Bandul, New Orleans, La.

A Steering Sled

An ordinary hand sled can be easily converted into a sled that can be guided like a bobsled by the addition of one extra runner. To attach this runner, a piece of wood is fastened to the under side and in the center at the

front end of the sled top. A runner with a crosspiece on top is pivoted to the extending wood piece, which should be of a length to make the position comfortable when the coaster, sitting on the sled top, has his feet on the ends of the crosspiece. Careful

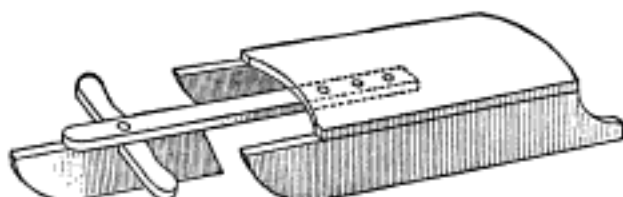

The Extra Runner in Front is Pivoted, and When Turned, Guides the Sled

measurements should be made to have the lower edge of the runner on a level with or a little lower than the sled runners.

INTERESTING NEW PATENTS

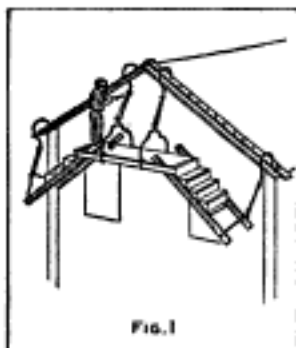

Fig. 1

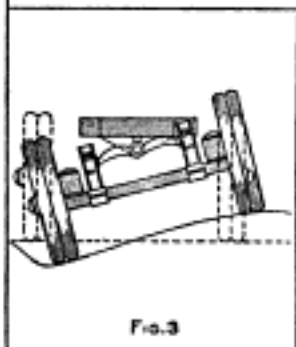

Fig. 3

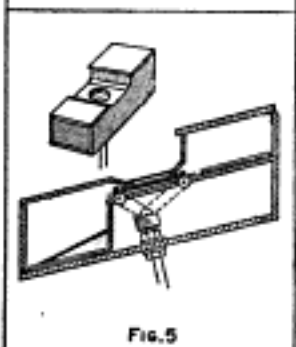

Fig. 5



Fig. 7

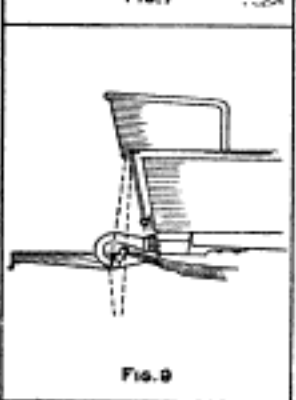

Fig. 9

SWINGING SCAFFOLD (Fig. 1)—This scaffold may be used as a flat platform or as a center platform with steps at the ends. The side pieces of the end sections are hinged to the center section and can be dropped to any angle, while the folding floors of the end sections are easily arranged in the form of steps, as shown.

TRAY-HOLDING ATTACHMENT FOR BED-STEAD (Fig. 2)—The arms that support the tray holders are pivoted to knuckles that are supported on a vertical rod clamped to the bedpost. These knuckles are fixed by setscrews at the proper height for swinging the tray holders over the bed, or may be lowered so the tray holders, when not in use, swing under the bed.

EQUALIZER FOR LOAD ON VEHICLE WHEELS (Fig. 3; British patent)—The purpose of this invention is to permit the wheels to adjust themselves to uneven ground without strain on the frame of the vehicle. The body of the vehicle is rigidly fixed to the rear axle, but has a pivotal connection with the front axle, as shown.

ANTISLIPPING DEVICE FOR SHOES (Fig. 4)—This device consists simply of a chain armor placed under the sole of the shoe, and equipped with means for holding it securely in place. The leather front piece slips over the toe of the shoe, and the heel is secured by a strap that fastens over the instep.

ROUTE INDICATOR (Fig. 5; British patent to a German)—The route map used in this indicator is in the form of cards and shows the road as a continuous line with gradients at one side. The mechanism works in accordance with the distance traveled by the car, and automatically advances the cards in succession from the chamber at the right, past the viewing position at the center, to a storage chamber at the left.

ELECTRIC RAT TRAP (Fig. 6)—The bait trough is at the center and can only be approached over one of the trapdoors, which are pivoted at the trough end and are held in horizontal position by a light spring. An electric current from a battery passes through the trapdoor to the platform at the side of the trap when these are in contact. When the rat has advanced far enough on the trapdoor to spring it down and break the contact, this current passes through the body of the rat, the idea being to stun the rat so that it will fall through the trapdoor into the water tank.

PIVOTED AIRSHIP SHELTER (Fig. 7; British patent to a German)—This shelter is divided longitudinally so that the halves can be swung apart to receive an airship and then swung together to enclose it. One end of each section is pivoted while the other end swings on a circular track. Between the sections is a floor that swings in the same manner as the two sections of the shelter.

SCULLING OAR OPERATED BY ENGINE (Fig. 8; American patent to an Australian)—The oar projects through the stern of the boat above the water line and is mounted on a universal fulcrum that gives it the necessary motions for sculling. Placed around the oar is a rolling shutter that is actuated by a spring, so that it moves with the oar and keeps the opening in the stern of the boat closed.

BAGGAGE RACK FOR MOTOR CARS (Fig. 9)—This rack is pivoted to the hangers of the rear springs of the car, and is easily adjusted to a horizontal or vertical position. It is secured in the horizontal position by a stirrup, as shown. When raised, it furnishes a step for reaching the rear part of the car.

FOOT PADDLE FOR SWIMMING (Fig. 10)—The paddle is pivoted to the frame so that it swings out and catches the water on the backward stroke but lies flat against the ankle when the foot is drawn forward. Stops on the frame prevent the paddle from swinging beyond a position at right angles to the direction of the stroke.

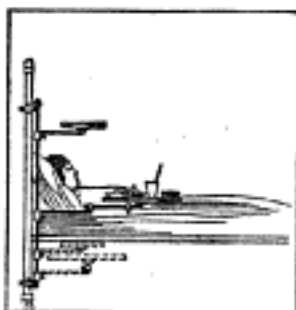

Fig. 2



Fig. 4



Fig. 6



Fig. 8



Fig. 10



Fig. 11

FLYING MACHINE WITH FLAPPING WINGS (Fig. 11)—This airship is a combination of dirigible and aeroplane and is propelled and partially supported by the movement of the swinging wings at the center of the craft. The end planes are fixed rigidly to the frame, which also supports the cockpit. The swinging wings are hinged to the frame of the cockpit and are swung vertically like wings by the engine. Hinged sections in the wings open on the upward stroke and close on the downward stroke. This combined with the shape of the wings gives both a lifting and propelling effect.

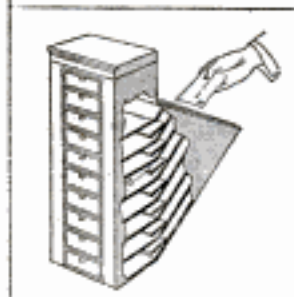

Fig. 12

ALARM SIGNAL OPERATED BY VEHICLES (Fig. 12)—A road box extending across the road so that all vehicles must pass over it has a rocking cover which, through a system of levers and pull wires, actuates an alarm bell located some distance ahead. The device is evidently intended to announce the approach of a vehicle at a road crossing or sharp turn in the road.

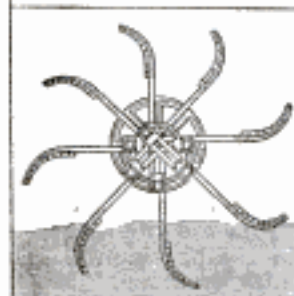

Fig. 13

LETTER-SORTING CABINET (Fig. 13; British patent to a Frenchman)—This device is an auxiliary frame to be used with a letter-sorting cabinet. It consists of a series of inclined chutes each leading to one compartment in the cabinet and each equipped with a ledge at the bottom that deflects the letter to a horizontal position.

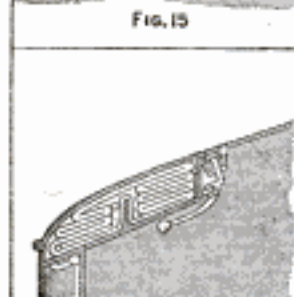

Fig. 14

ANTISKIDDING DEVICE FOR AUTOMOBILE TIRE (Fig. 14)—This device consists of a pair of chains secured to the sides of the tire, to the elongated links of which are fixed metallic clips that bear against the surface of the road and prevent skidding.

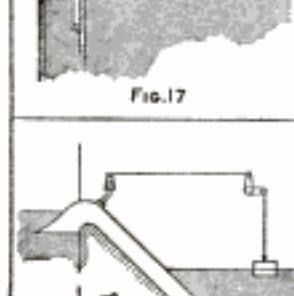

Fig. 15

PADDLE WHEEL (Fig. 15; British patent)—This paddle wheel is equipped with an ingenious mechanism by which each arm is lengthened downward as it enters the water and is shortened as it leaves the water. The arms are made in pairs located on opposite sides of the wheel and are joined by a slotted connection that engages the shaft by means of a star wheel. The shifting of each pair for alternately lengthening and shortening the arms is accomplished by rollers working on a fixed cam, as shown.

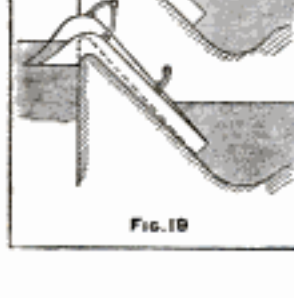

Fig. 16

PARACHUTE (Fig. 16)—The parachute is attached to the body by straps passing around the waist and over the shoulders. The wings as well as the balloon-shaped canopy are ordinarily folded against the body, but unfold automatically and act against the air in case of a fall.



Fig. 17

DEVICE FOR RAISING SUNKEN SUBMARINES (Fig. 17; British patent to a Frenchman)—This is a scheme for raising a submarine by means of balloons permanently carried in the gunwales of the vessel. Each balloon is compactly folded in a compartment which is opened by a handle from the inside when the balloon is to be released. Compressed air or gas generated by a chemical such as calcium carbide may be used for inflating the balloon.

Fig. 18

LEMON SQUEEZER (Fig. 18)—The handle is drawn up out of the way and the lemon is placed in the open end of the channel. When the handle is pressed down the lemon is cut in two and the juice is squeezed from it and drops into the glass through an opening at the bottom of the channel.

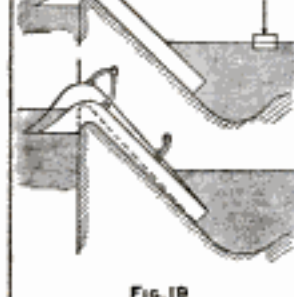

Fig. 19

SIPHON CONTROLLED BY FLOAT (Fig. 19; British patent)—The flow of water through the siphon is regulated by the admission of air to the crown, while the admission of the air is controlled by a float located on either level. The idea of the operation of this apparatus is to admit enough air to reduce the flow but not to stop the siphonic action.



Fig. 20

SHOE FOR WORKING ON ICE (Fig. 20)—This device consists of a metallic plate attached to the shoe and equipped with prongs under the heel and under the ball of the foot. This is secured in place by straps that pass over the instep and around the ankle.

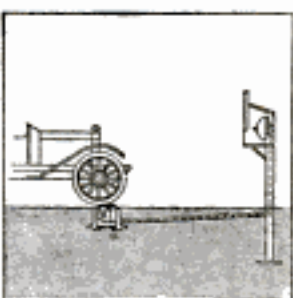

Fig. 12



Fig. 13



Fig. 14



Fig. 15

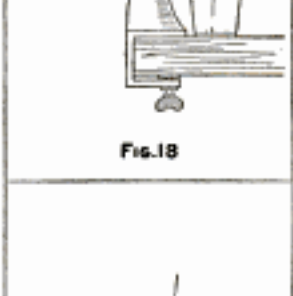

Fig. 16



Fig. 17

Thomas J. Earley
5617 Arch St., Phila., Pa.

House plan

5328
EIGHT-ROOM RESIDENCE BUILT AT LOW COST



THOS. J. EARLY, ARCHITECT, PHILADELPHIA, PA.

THE remarkable feature about this attractive eight-room house is that it was built and equipped at a cost of only \$2,674. The house is of frame construction, plastered on the outside with cement stucco, and has a shingle roof. The finish is stained white pine. One of the features that made it possible to build so large a house at such a low cost is the gambrel roof, by which a considerable amount of wall construction was saved. As the result of an ingenious arrangement only one chimney is necessary. The smoke pipe from the kitchen stove is carried across under the stairway to the chimney, and the heater in the basement is so located that its smoke vent is carried up beside that of the fireplace and kitchen stove.

The general plan is of a type in which a central hallway runs from the front to the rear of the house, dividing it into two distinct parts, but this type has been modified to allow sufficient width for a stairway only on the first floor. Both the living room and kitchen have direct access to the dining room, while the living room and den are so located with reference to the stairway that no member of the family need be marooned on either floor on account of company being entertained in one of these rooms. The hallway on the second floor has the stairway at one end and the bathroom at the other. Ample closet room is provided for each of the four bedrooms on this floor.

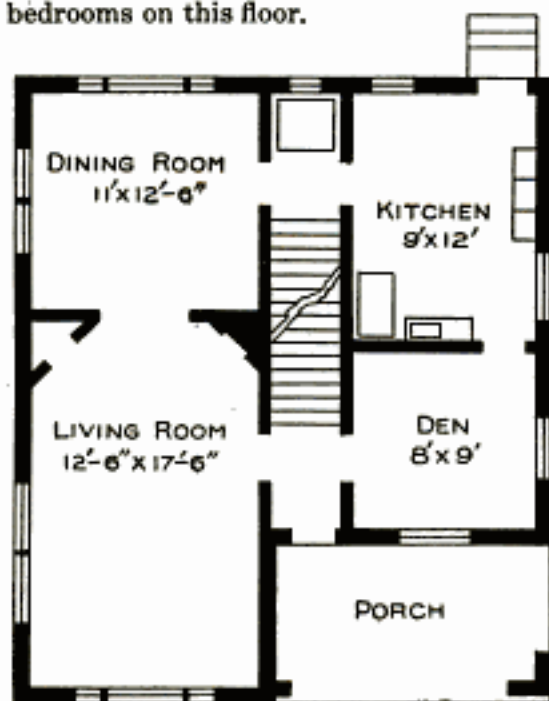

First-Floor Plan

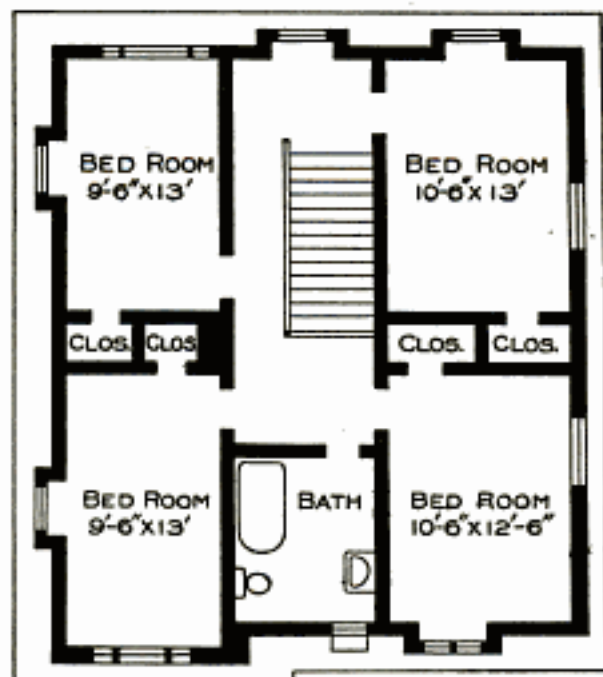

Second-Floor Plan

Dollar-A-Knot

ALADDIN House Guaranty

The strongest guarantee ever made to HOME BUILDERS

The famous 1914 guarantee of \$1 per knot paid for every knot found in Aladdin Red Cedar Siding is continued for 1915, AND we have swept the last knot from Aladdin lumber inside and out. Every Aladdin House in 1915 will be furnished with knotless siding, knotless shingles, knotless outside finish, knotless porch work, knotless flooring, knotless inside finish, knotless door casings, stairwork—knotless inside and outside. Where can you buy as good a home?

The ONLY houses, the ONLY lumber Completely manufactured Readi-Cut—ALADDIN HOUSES



Why should you pay one thousand dollars for a home that you can buy for \$700? Why should you let the contractor add his \$300 profit to your bill? This is plain talk—and meant to be. Middlemen are necessary only when manufacturers won't deal with consumers. You are the consumer—the home builder. We manufacture and produce the goods. We will not sell to middlemen. If we did, you would have to pay thirty cents more on every dollar's worth of our goods. Labor and profit are the biggest parts of the price you pay for any article. That's all the middleman adds to the goods—labor and profit. And you-foot the bill.

5-Room House \$298

A complete 5-Room, year round Aladdin House \$298. This price includes all material—cut to fit—hardware, glass, paints, etc. Aladdin Dollar-a-knot Guaranty allowed on this house—material is same as furnished for larger Aladdin Houses. The average waste of lumber in building a house is 18%. \$18.00 out of every \$100 of your money goes into the waste pile. You pay \$100 and get \$82 value. The Aladdin Readi-Cut System saves you this loss. It puts the \$18 into the house. It gives you a better house for less money. We own and operate the largest mill in the world devoted to the manufacture of Readi-Cut Houses. We ship more complete houses than any manufacturer in the United States. We give the strongest guarantee of satisfaction ever made to the home builder.



ALADDIN READI-CUT HOUSES

Sold by the *Golden Rule*

What you get with each ALADDIN HOUSE

Aladdin houses are complete. You get material absolutely guaranteed to be sufficient for the completion of your house, as follows: Sills, cut to fit; Joists, cut to fit; Studding, cut to fit; Building Paper; Sub-Floor, cut to fit; Rafters, cut to fit; Roof Sheathing, cut to fit; Siding, cut to fit; Outside Finish, cut to fit; Porch Columns, Baluster Rail, Flooring and Frame Work, cut to fit; Lath and Plaster or Plaster Board; Inside Finish, Doors, Casings, Base Board, Windows, Sash, Glass, Nails of all sizes. Locks, Hinges, Tin Flashing, Paints, Oil, Varnishes, Stains, Putty, and Shellac, with complete drawings, illustrations and instructions for erection—The Complete House—also Barns, Poultry Houses, Hog Houses and modern farm buildings. The big Aladdin catalog No. 180 tells all the interesting facts.

NORTH AMERICAN CONSTRUCTION CO.

"Home Builders to the Nation"
960 Aladdin Ave.
BAY CITY, MICH.



NORTH AMERICAN CONSTRUCTION CO.
960 Aladdin Ave., Bay City, Mich.
Send me your catalog No. 180.

NAME
STREET
CITY
STATE



FOR **Ford** CARS
GRAY & DAVIS
STARTING - LIGHTING SYSTEM

Price Complete, \$ **75** (F. O. B. BOSTON)

Long ago we realized the wide demand among Ford owners for electric starting-lighting equipment—providing a system of proved reliability could be obtained at a moderate price.

For nearly two years the Gray & Davis engineers have been engaged in studying the requirements of the Ford car. Exhaustive experiments and months of careful testing were part of the development of this system.

The result is a powerful, dependable starting-lighting device—a typical Gray & Davis System—identical in material and workmanship with systems found on expensive automobiles.

As is well known, Gray & Davis starting-lighting systems are carried as standard equipment on leading American cars in every price class up to \$4,000 and over. These systems have been time-tested and time-proven, and the equipment we now offer Ford owners equals this same high standard.

The Ford system is simple, compact, light in weight, and can quickly and easily be installed on any Model T. A 6-volt



battery, battery box, indicator, switches, wiring and all necessary connections are included. The complete equipment ready for installation is furnished for \$75 (F. O. B. Boston). Any garage, machine shop or owner with mechanical ability, can install the system in a few hours.

How it adds value to your Ford car

You can easily imagine the convenience, safety and intrinsic value this system adds to the present splendid service of your Ford, when you realize that

— it starts the engine by pressing a pedal.

— it eliminates the danger of hand-cranking and back-firing.

— by turning a switch the road is flooded with brilliant, dependable electric light.

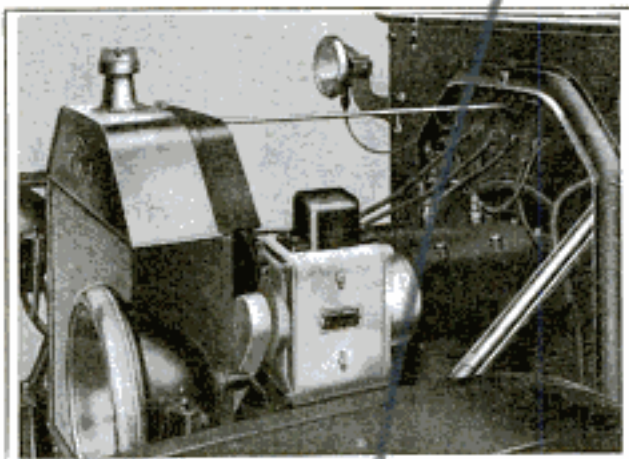

— it spins the "stalled" engine.

— it serves you steadily, quietly, powerfully — asking less than a half hour's care each month.

— it brings the convenient use of your car to your wife and daughters.

In these extra-services the Gray & Davis system quickly repays its cost.

How to Purchase

Below we print a list of our distributors. Your local supply man, dealer or agent can secure delivery for you by ordering from the nearest distributor. If you have any difficulty in obtaining a system, we will see that you are promptly supplied.

Write us *today* for descriptive catalog. You will naturally wish to know all about this equipment.

The Gray & Davis System for Ford cars will be demonstrated at both the New York and Chicago Automobile Shows. If it is possible for you to attend either of these shows, be sure to visit the Gray & Davis section.

DISTRIBUTORS

Atlanta, Ga. Elyen-Austell Company
 Boston, Mass. Mitchell & Smith, Inc.
 Buffalo, N. Y. Jas. G. Barclay, Inc.
 Chicago, Ill. Erwin Greer & Company
 Cincinnati, O. Coughlin & Davis, Inc.
 Columbus, O. Rogers Supply & Tire Co.
 Dallas, Texas Fisk Company of Texas
 Denver, Colo. Auto Equipment Company
 Des Moines, Ia. Herring Motor Co.
 Detroit, Mich. F. E. Holmes Company
 Fresno, Cal. Chanslor & Lyon Company
 Hartford, Conn. R. R. Ashwell
 Houston, Tex. Fisk Company of Texas

Indianapolis, Ind. Gibson Automobile Co.
 Kansas City, Mo. Kansas City Auto Sup. Co.
 Los Angeles, Cal. Chanslor & Lyon Co.
 Louisville, Ky. Roy E. Warner Company
 Minneapolis, Minn. Electric Mfg. Company
 New Orleans, La. Interstate Electric Co.
 New York, N. Y. Gray & Davis Branch,
 245-47-49 West 55th Street
 Oakland, Cal. Chanslor & Lyon Company
 Omaha, Neb. Powell Supply Company
 Philadelphia, Pa. J. H. McCullough & Son

Pittsburgh, Pa. Jos. Woodwell Co.
 Portland, Ore. Chanslor & Lyon Company
 Providence, R. I. Dutee Wilcox Flint
 Richmond, Va. Kaehler Motor Car Co.
 Rochester, N. Y. Barclay-Brown Co., Inc.
 San Antonio, Tex. Fisk Company of Texas
 San Francisco, Cal. Chanslor & Lyon Co.
 Seattle, Wash. Chanslor & Lyon Company
 St. Paul, Minn. Electric Mfg. Company
 Toledo, Ohio. Roberts-Toledo Auto Co.
 Washington, D. C.
 Miller Bros. Auto & Sup. House
 Wellington, N. Z. Colonial Motor Company

GRAY & DAVIS, Inc., BOSTON, MASS.

The Telephone Unites the Nation



AT this time, our country looms large on the world horizon as an example of the popular faith in the underlying principles of the republic.

We are truly one people in all that the forefathers, in their most exalted moments, meant by that phrase.

In making us a homogeneous people, the railroad, the telegraph and the telephone have been important factors. They have facilitated communication and intervisiting, bringing us closer together, giving us a better understanding and promoting more intimate relations.

The telephone has played its part as the situation has required. That it should have been planned for its present usefulness is as wonderful as

that the vision of the forefathers should have beheld the nation as it is today.

At first, the telephone was the voice of the community. As the population increased and its interests grew more varied, the larger task of the telephone was to connect the communities and keep all the people in touch, regardless of local conditions or distance.

The need that the service should be universal was just as great as that there should be a common language. This need defined the duty of the Bell System.

Inspired by this need and repeatedly aided by new inventions and improvements, the Bell System has become the welder of the nation. It has made the continent a community.

**AMERICAN TELEPHONE AND TELEGRAPH COMPANY
AND ASSOCIATED COMPANIES**

One Policy

One System

Universal Service

Please Mention Popular Mechanics

AGENTS WANTED

TO SELL THE Sentinel Burglar Alarm

The only perfect Burglar Door Alarm ever put on the market.

A Most Unusual Opportunity For You

The following are real facts — not an exaggerated advertisement:

First, We want you to know about the wonderful Burglar Alarm which we have just perfected and why homes, offices and stores need one or more. We know by actual sales tests that from two to six alarms will be bought for most homes. The alarm is constructed of the best material, highly nickel plated and polished, attractive in appearance and mechanically perfect. It weighs seven ounces, will fit any sized door knob, is easily attached and taken off in a few seconds. No wires, nails or batteries are used; just a few turns of the thumb screw and it is ready for instant action. With a Sentinel Alarm attached to any door knob, it is impossible for a burglar or anyone else to give the knob the slightest turn or open the door without ringing the bell and alarming the occupants of the house; and when Mr. Burglar hears the alarm, he makes an instant get-away while the going is good.

It guards the home night and day. It provides perfect and cheap burglar insurance, good for a lifetime and all for the small sum of One Dollar. These alarms are splendid for offices and stores

for announcing a caller and for many other purposes. The above are just a few reasons why the Sentinel Alarm is wanted in every home and why it is so easy to sell. In fact, it sells on sight; when people try it, they simply will not be without it. When you see it, you will instantly realize its immense salability.

We are members of the Chicago Association of Commerce, are entirely reliable and mean what we say. We will do our part to help you; the rest is up to you. If you are honest, ambitious and willing to work, write at once for our terms.

MARSHALL DOBBINS & COMPANY
1422 Marquette Bldg., CHICAGO, ILL.
HOUSEHOLD AND OFFICE SPECIALTIES



Second, It will pay you well to become our exclusive agent.

The Sentinel Burglar Alarm is fully covered by patents already issued and applied for, and we shall vigorously prosecute any infringements. Therefore you are thoroughly protected and will have no competition in selling the alarm in your territory, since we will not sell to dealers or anyone except through our regularly appointed agents. You will be your own boss in your territory. A live energetic agent (and we do not want any other kind) can easily earn from \$35.00 to \$90.00 per week in practically any County in the Union. In the more populous Counties, hustling agents will average from \$75.00 to \$175.00 per week. These are conservative figures based on

actual selling tests and mean real live dollars to you. Our proposition to you is so liberal that you will be delighted, but you must act quickly if you want to secure exclusive territory.

MARSHALL DOBBINS & CO.,
1422 Marquette Bldg., Chicago

Without any obligation upon my part, kindly send me full information.

NAME _____
STREET _____
CITY _____
COUNTY _____ STATE _____

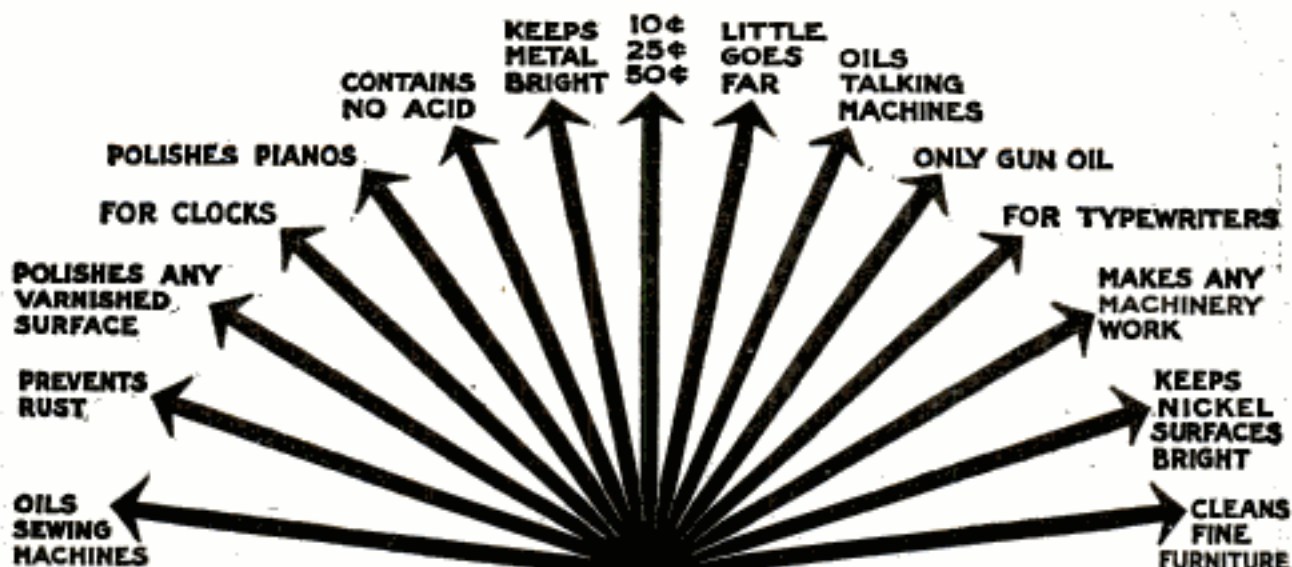

FREE

Try for yourself, without one cent of cost, what this marvelous oil will do. Sign your name and address in the triangle at the lower left hand of this ad—cut out around the black lines—and mail the coupon to us. We will send you immediately a generous sample bottle and full directions—do it now.

FOR PARLOR. 3 in One is the only oil on earth good for every house, cottage or castle. Removes all stains, wear marks, scratches and scars on piano or mahogany furniture. Restores original bright, beautiful finish. No grease—no acid—no varnish odors—helps everything—hurts nothing.

FOR LIVING ROOM. It quickly removes grime of use and time on library table, chairs, davenport, book case, at little cost and no work. Keeps all brass fixtures and chandeliers free from rust and tarnish. Best lubricant for grandfather clocks, alarm clocks.

FOR BEDROOM. Wood and enamel metal beds cleaned and polished with 3 in One last longer and look better. It prevents grate fronts from rusting. Oils hinges and locks just right. For revolvers and guns it oils trigger and action, cleans out residue of burnt powder, prevents metal parts rusting.

**3 in
One Oil Co.**
42CNP Broadway
New York

Please send me, without one cent of expense, a generous sample bottle and 3 in One Dictionary.

Name.....
City..... Street



Try for yourself, without one cent of cost, what this marvelous oil will do. Sign your name and address in the triangle at the lower left hand of this ad—cut out around the black lines—and mail the coupon to us. We will send you immediately a generous sample bottle and full directions—do it now.

FOR KITCHEN 3 in One prevents red rust forming inside oven or anywhere on gas range. Try on wooden surface of kitchen cabinet. Makes ice cream freezer, coffee grinder, washing machine run easily, noiselessly. Prevents rust on refrigerator's metal shelves. Leaves no odor or grease or residue.

FOR DINING ROOM. Wring out soft cloth in cold water. Apply a few drops of 3 in One. Go over surface of dining table, chairs, sideboard, buffet or china cabinet as though washing. Wipe thoroughly. Rub surface briskly with dry cloth. Easiest, cheapest, best method ever discovered for cleaning and polishing all veneered and varnished surfaces.

OTHER USES. Sewing machine repair men "knock" 3 in One because a little of this good oil saves many dollars in repair bills. It makes every part of every machine work smoothly, easily. 3 in One stops hard pumping. Prevents leg ache and "broken backs."

Typewriters work better and last twice as long when oiled with 3 in One. Repair men won't tell you this—they have repairs and cheaper oils to sell. But don't take our word or their word. Just try 3 in One once.

3 SIZES. Small size, 1 oz., 10 cents; large size, 3 oz., 25 cents; Household size, 8 oz., 50c. Also in Handy Oil Cans, 3½ oz., 25c.

3 in One Oil Co.
42CNP Broadway NEW YORK

Save \$200 to \$500 On Your New Home—Shipped Anywhere

Let Us Ship You a \$900 Home Complete for \$681—a \$950 Home for \$690—a \$1200 Home for \$908—a \$1600 Home for \$1178



All lumber, hardware, and painting material including complete plans and specifications. Quality Home Plan No. 157. See plan **\$681** book.



All lumber, hardware, and painting material including complete plans and specifications. Quality Home Plan No. 158. See plan **\$908** book.



All lumber, hardware, and painting material including complete plans and specifications. Quality Home Plan No. 106. See plan **\$1178** book.



All lumber, hardware, and painting material including complete plans and specifications. Quality Home Plan No. 106. See plan **\$690** book.

PROOF On 100 Homes like these, and at all prices and of all most artistic new varieties in handsome architectural effects we have owners' letters telling us they saved as high as \$200 to \$800 or more. Read this: E. J. Sutton of Mass., wrote us Nov. 8th, 1912, "I would like to say the lumber and millwork you sent for House Plan No. 140 (see

Frank Mahannah of Oklahoma says (on Plan No. 106): We are certainly very much pleased with the millwork we got of you. I guess by your figuring we saved \$300 to \$400 in the house. We got everything done very reasonable and your figures in the lumber, also the millwork held out."

above, \$683 shown on page 44 of our Plan Book) was No. 1 in quality and quantity and worked out just as stated by you. We saved \$150 to \$200 by buying from you. A number of contractors have looked the house over and said it could not have been of better lumber." We have thousands of letters like this. Mr. Sutton lives far away. Think what you can save.

Frank Mahannah of Oklahoma says (on Plan No. 106): We are certainly very much pleased with the millwork we got of you. I guess by your figuring we saved \$300 to \$400 in the house. We got everything done very reasonable and your figures in the lumber, also the millwork held out."

Write for Grand Free Millwork Catalog

and \$10,000 Helpful Plan Book Showing 100 "Quality" Homes

BUILD NOW at lowest possible cost. Or remodel, or repair quick before winter. **Saug up everywhere.** Don't delay. Don't hesitate. But don't think of buying a dollar's worth of materials till you get our Grand Offers. See how we have saved **100,000 regular Customers** everywhere in America millions of dollars. All shown in **photographs, colors and descriptions** with our wonderful low wholesale mill prices in our Grand Free Millwork Catalog and Helpful Plan Book. This famous Plan Book costs us \$10,000 to publish. It contains estimates on 100 pictured houses guaranteed to keep cost **within estimates.** No "come-backs." No extras. Generous leeway on all measurements and quantities.

Satisfaction, quality, safe-delivery guaranteed or money back to you anywhere you live on anything you buy of Gordon-Van Tine Co.—Roofing, Storm Sash, Storm Windows, Lumber, Interior Finish, Wallboard, Flooring, Paint, Builder's Hardware, Stair Work, Porch Work, Mouldings, etc., etc. Learn as thousands have that freight costs only a few cents per item. And we save dollars in price for every nickel freight costs. Bargains shown here are duplicated in 5,000 wonderful values offered in Free Catalog. Goods here in this ad or in our Catalogs may be ordered direct under our **Guarantee of Quality, Goods as Represented and Satisfaction or Money Back.** Three Big Banks and the Experience of **100,000 Delighted Customers** Behind This Guarantee.

Estimates and Suggestions Free

TEAR THIS OUT AND MAIL TODAY

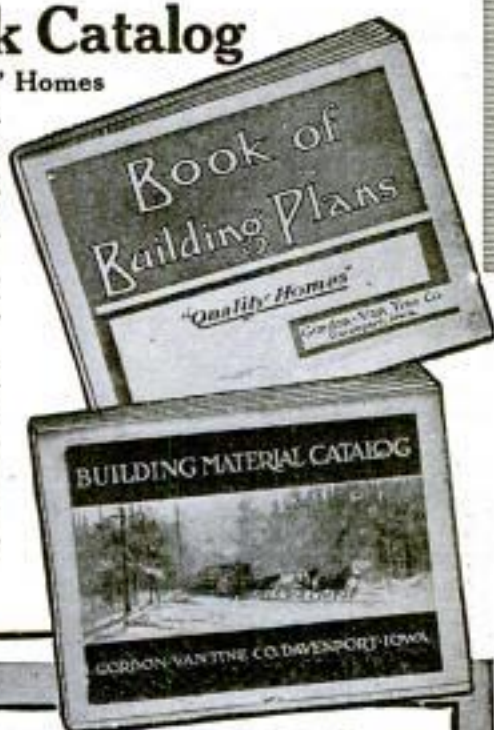

GORDON-VAN TINE CO., 742 Federal St., Davenport, Iowa
Catalog Reminder

Please send me your 5000 Bargain Building Material Catalog Free

NOTE: If you also want our Book of Building Plans, please enclose 10 cents in stamps for postage.

Name.....

Address.....

Please Mention Popular Mechanics

Make your Push Button an Office Telephone for \$8.75

Use the same wires, the same bell or buzzer, the same batteries. Just get these two simple little **Western Electric Inter-phones**, and hook them onto the buzzer wires—one at your desk, the other near the buzzer.

You can then telephone for what you want and get your answer on the instant, without having the office boy or clerk waste his time in coming for your message. This simple arrangement saves time at both ends of the line. Most convenient, and stops the confusion of running back and forth.

We Will Send on Approval
**Western Electric
Company**

Manufacturers of the 8,000,000 "Bell" Telephones
463 West Street, New York
500 S. Clinton Street, Chicago

We will ship you these Inter-phones by parcel post, all ready to hook up, on receipt of \$8.75. Your money back if not satisfied. For particulars and directions for attaching these Inter-phones, write for Booklet No. 42-AW.



Try My *Rapid* FIRELESS COOKER

30 Days in Your Home At My Risk



A big saving in food bills, fuel, work—and food tastes better. I am making

Special Price on 10,000

to introduce cooker into new neighborhoods quick. Cooker is aluminum lined throughout. Complete outfit aluminum utensils free. Write for Free Book and Bargain Prices direct from factory.

WM. CAMPBELL CO.
Dept. 64 DETROIT, MICH.

IF IT ISN'T
AN EASTMAN
IT ISN'T A KODAK

GOOD YIELDS FROM THE "DASHEEN" IN THE SOUTH—The dasheen is a vegetable somewhat resembling the potato, which was introduced into this country a number of years ago by experimenters in the Department of Agriculture from various parts of the Tropics, in the belief that it would prove a valuable root crop for the South. This belief, it is said, is now justified by the outcome of experiments which have been in progress



EVERYTHING in Guaranteed Plumbing and Heating Supplies at wholesale. Our \$200,000 establishment behind our Guarantee.

Send for complete CATALOG 61.

J. HARDIN CO., 30 years at 4533-35-37-39-41-43 Cottage Grove Ave., CHICAGO

1½ to 18
H. P.



34c

**Runs this 6 H. P. Engine for a
10 hour day on KEROSENE**

By means of the patent throttle you can run it as a 4 H. P. engine for 23 cents a day, or as a 2 H. P. for 12 cents a day. Many other strong points; force-feed lubrication; uniform speed; sight-feed fuel supply; automobile muffler; no cranking; runs either way; uses any fuel oil satisfactorily. And it's **Guaranteed for 10 Years.** Write for catalogue and 30 days' free trial.

WE PAY THE FREIGHT

ELLIS ENGINE CO., 2871 East Grand Blvd., Detroit, Mich.

Our collection of rare old violins is one of the largest in America. Write today for special art catalog.



10c a Day

Now Buys This Superb Baader Violin

AN exquisite instrument—perfect in tone and superbly finished. Made by the great violin maker, J. A. Baader, and now offered direct to you at the rock-bottom price. *And you may pay this rock-bottom price at the rate of only 10 cents a day, 10 days' free trial.* Write for special circular.

WURLITZER

200 years of instrument making

It is only because we have mammoth facilities for buying in large quantities that we are able to make this startling offer. Write today for special violin circular. We supply the United States Government.

Scores of Violins to Choose From

Write today for our new violin circular showing handsome illustrations of all the superb instruments to make your selection from. The products of the leading violin makers of the world are yours to choose from—Farny, Baader, Glier, Heberlein, Fiedler, Wurlitzer and many others. Violins of the very highest grade, as well as those of moderate prices—from \$2.70 to \$50, and from \$50 to \$250. Write today for catalog matter that tells you about the instrument in which you are interested. See coupon.

10 Days Free Trial

We will send you any of these superb violins so that you can test them out in your own home for ten full days. You cannot judge a violin by seeing it in a store or by playing upon it once. Play on one of these instruments in your own home, in your own way for ten full days. Then you will be able to decide whether you wish to buy or not. If you are not satisfied send it back at our expense.



10c a Day

now buys this superb Lyric Cornet. Exquisite triple silver-plated horn model Lyric Cornet direct to you on a startling offer. Ten days free trial before you decide to buy. Liberal allowance for old instruments. Write today for 225-page Catalog showing 2561 instruments that you have to choose from.

Send the Coupon

Write today. Send the coupon or a letter or postcard and indicate the catalog matter that you want us to send you. Absolutely no obligations of any kind. Find out about this startling money-saving offer. See handsome illustrations and detailed descriptions of instruments in which you are interested. No obligations of any kind. Send the coupon or a letter or post card.

The Rudolph Wurlitzer Company

4th St., Cincinnati, O. Dept. 1192 S. Wabash Ave., Chicago, Ill.

The Rudolph Wurlitzer Co.

Dept. 1192

S. Wabash Av., Chicago

4th St., Cincinnati

Gentlemen:—Please send me without obligations, free and prepaid the catalog matter checked below:

- The special violin circular.
 Special low priced violins under \$15.00
 Your 225 page illustrated catalog of musical instruments.
 Catalog of music stands, cases and other stringed instrument accessories.
 Art catalog of rare old violins.

Name.....

Address.....

Please Mention Popular Mechanics

How Many Hides Has a Cow?

Sole leather is not adapted to soft, tufted upholstery of automobiles and furniture.

Hides must be split into thin sheets to produce upholstery leather.

The two lower, fleshy, grainless sheets are coated, embossed, and sold as "genuine leather." That is why so much "leather" upholstering cracks, rots and peels so quickly.

Motor Quality
For Automobiles



Craftsman Quality
For Furniture

IS GUARANTEED SUPERIOR TO COATED SPLITS

It averages twice the tensile strength of coated splits, is waterproof, and perfectly parallels the appearance and "feel" of the best quality of grain leather.

For two years several leading makers of automobiles have been upholstering their cars with it, and are entirely satisfied.

Get Acquainted. Small Sample Free. Large Sample (18 x 25 in.) 50c.

DU PONT FABRIKOID CO., Wilmington, Del.

CANADIAN BRANCH, TORONTO, ONTARIO

Craftsman Quality Fabrikoid on Sale by John Wanamaker, Philadelphia; McCreery & Co., Pittsburgh; J. & H. Phillips, Pittsburgh; John Shillito Co., Cincinnati; Stix-Baer-Fuller Co., St. Louis; Du Pont Fabrikoid Co., 621 Broadway, New York.

Red or Black "Vulcan" Ink Pencils

The ONLY perfect, non-leakable ink pencils at moderate prices.

Two Sizes, 4 1/2 and 5 1/2 inches

Extra Size, 8 inches (black only), \$1.25

FREE—Liberal supply of ink with retail orders.

AGENTS WANTED. BIG PROFITS

J. C. ULLRICH & CO., 27 Thames St., NEW YORK

Order today \$1

NOTE THE SIMPLICITY

Of making perfect duplicates with the **Daus' IMPROVED Tip Top Duplicator**

No intricate mechanism. No printer's ink. Always ready. 100 copies from pen-written and 50 copies from type-written original. Useful in any business. Sent on Ten Days' Trial Without Deposit. Complete duplicator, cap ring springs 8-7-13 (shown). Contains roll of Daus' Oil-Proof Parchment Back duplicating surface \$5.00 which can be used over and over again. Circular of larger sizes free on request.

FELIX A. L. DAUS DUPLICATOR CO., Daus Building, 111 John St., New York

EQUIPMENT for BUSINESS

WHAT would you think if a man handed you a piece of brown paper with his name written on it, as his business card? You'd be rather non-pleased wouldn't you? At least you would have a serious doubt as to his desirability as a business connection. In other words his equipment for business does have an effect on you. You do judge him by his equipment—and every man is judging you in the same way. Just remember that!

Just as a card is an advance over a piece of brown paper with written name, so the

Peerless Patent Book Form Card

is an advance over the printed, loose card. You need this peerless card in your business equipment—and you need it because it is the best and cheapest. Cheapest because every card can be used—none to throw away because they have become soiled in the pocket or case—none lost. Every card you pay for is available for the use for which it is intended. Send today for a sample of tab and see what the card is, and how it is detached from the book form with a smooth edge. You will be surprised and pleased.

THE JOHN B. WIGGINS COMPANY
Engraves, Die Embosers, Plate Printers 62-64 East Adams St., Chicago

since 1909. Last year, at the Brooksville station in Florida, an average of 200 bu. per acre was obtained, while with specially favorable conditions this yield may run up to 450 bu. per acre.

Of this quantity approximately one-third consisted of tubers for marketing and about one-fourth of tubers too small to be sold profitably but, nevertheless, large enough for home use. The bulk of the remainder could be disposed of as feed for cattle and hogs or used for

TYPEWRITERS ALL MAKES

Prices \$15.00 up. SOLD or RENTED ANYWHERE at 1/4 to 1/2 MANUFACTURERS' PRICES, allowing RENTAL TO APPLY ON PRICE. Free Trial. Installment payments if desired. Write for Catalog 1.

TYPEWRITER EXPOSITION, 34-36 W. Lake St., Chicago, Ill.

TYPEWRITERS ALL MAKES

Underwoods, Remingtons, Oliviers, Smiths, from \$10 to \$60. Guaranteed 5 years. 500 Typewriters at \$12.50, every one perfect. Write for liberal FREE trial offer at once.

All Makes Typewriter Exchange Co., 148 N. Dearborn St., Chicago, Ill.

WRITE 600 WORDS WITH ONE DIP

Why use ordinary pens with the never ending dip—when One Dip Pens make every penholder virtually a fountain pen? Agents Wanted. Send 10c for Sample Package.

One Dip Pen Co., 34 Daily Record Bldg., Baltimore, Md.

WHITE VALLEY GEMS LOOK LIKE DIAMONDS

Stand acid and fire diamond test. So hard they easily scratch a file and will cut glass. Brilliance guaranteed 25 years. Mounted in 14k solid gold diamond mountings. See them before paying. Will send you any style ring, pin or stud for examination—all charges prepaid. No money in advance. Money refunded if not satisfactory. Write today for free catalog.

WHITE VALLEY GEM CO., 701 Wulsin Bldg., Indianapolis

27 Below Zero and a Winter's Coal Bill of Only \$20



Winters don't come much colder than that. That's when the mercury itself begins to seek shelter. That's when the heating apparatus proves itself either a winner or a failure. But when in addition to keeping the house warm and cosy it also knocks "ill" out of coal bills, then indeed it certainly gives real service.

So, read Mr. Petts' letter, reproduced on this page. Did you ever see a longer list of truly winter conditions? Then read on and learn that the winter's coal bill was only \$20—for a seven room house.

Then remember that we can furnish you with over two thousand just such letters telling of more heat and better heat at a greatly reduced outlay, as a direct result of heating the home with a Williamson New-Feed UNDERFEED Furnace or Boiler.



Cut-Out View of Under-Feed Furnace

The New-Feed UNDERFEED Cuts Coal Bills $\frac{1}{2}$ to $\frac{2}{3}$

This year, even the original UNDERFEED has been improved upon. The New-Feed UNDERFEED requires even less attention, and less effort. If there's a twelve year old boy in the family, he can keep the house warm, and comfortable all the time just as efficiently as a man who tends heaters for a living. The New-Feed is operated from a standing position.

No weary stooping. The wonderful New-Feed principle reduces effort to the minimum. Ashes have to be removed but twice a week.

**WILLIAMSON
NEW-FEED
UNDERFEED
Furnaces and Boilers**

Cut Coal Bills $\frac{1}{2}$ to $\frac{2}{3}$

The UNDERFEED principle is that of feeding coal from below. Clean, hot coals and fire are always on top in direct contact with most effective radiating surfaces. The fire does not have to lose itself struggling with dead coal, smoke, gas or dirt. There is no smoke, no dirt, soot, clinkers or smell. The ashes are fine and white, and few of them. The New-Feed UNDERFEED soon pays for itself in any home, store, church, hall, or

other building. Replaces stoves, grates, or ordinary furnaces or boilers at a great saving. And it burns any size of coal, from soft coal slack and pea or buckwheat anthracite up.

Also, the New-Feed UNDERFEED is adapted to warm air, steam, or hot water. You will be wise and saving if you investigate the New-Feed before deciding on your new heating system.

We Guarantee 50% Saving in Coal Bills That is our real guarantee, made where the UNDERFEED is properly installed and operated. Backed by a million dollar company. You take no risk. It has made good for over 30,000 users. It will surely do the same for you. To learn more about this wonderful money-saving system, sign and mail the attached coupon today. It brings you the free book, "From Overfed to UNDERFEED," which fully explains the wonderful method of combustion and just how the New-Feed UNDERFEED operates. No charge. No obligation.

The Williamson Heater Co.

Formerly The Peck-Williamson Co.

25 Fifth Avenue CINCINNATI, OHIO

Read this Letter

Warren, Mo., March 6, 1915

Gentlemen:—I installed one of your No. 781 UNDERFEED Furnaces in my seven-room dwelling here, last December, and though this has been the most severe winter for the last ten years, my coal bill has been smaller than for years. My house was built this last Fall and Winter, and owing to the severity of the winter, we had to maintain a greater heat, in order to protect the green some plaster from freezing, the soot having been just as just prior to the so last was 50° in January, when the thermometer registered 27 degrees below zero, and we do not see from 10 to 20 degrees below for more than two weeks.

In spite of the cold weather, not a bit of the plaster was frozen. Since we have lived in the house, the furnace has given out a steady heat, free from gas and dirt.

Altogether, we are delighted with the furnace, and would not trade it for any other kind of hot-air furnace, especially an Overfed one. My coal bill has been about \$20 for this winter, from a third to one-half less than any overfed furnace is now in the same sized house.

Yours truly, CHARLES PETTS.

Dealers: The New-Feed UNDERFEED has made a wonderful impression wherever introduced. You can make it a winner in your territory. Write now.

50% Saving Guaranteed

THE WILLIAMSON HEATER CO.

25 Fifth Avenue, Cincinnati, Ohio

Tell me how to cut my coal bills from $\frac{1}{2}$ to $\frac{2}{3}$ with a Williamson New-Feed UNDERFEED.

Warm Air.....Steam or Hot Water.....
(Mark an x after system interested in)

Name.....

Address.....

My Dealer's Name is.....

2c a Week Pays Wash Bill!

Electricity or Water-Power Does the Work

Write for
FREE Book

Just a "Twist of the Wrist" Starts or Stops the Machine!

The 1900 Motor Washers are now at work in thousands of homes. They are doing the work formerly done by women, at a cost of 2c a week for power! Saving thousands upon thousands of dollars in wash bills. Saving worlds of wash-day troubles. Leaving the women free to do other work while the machines are doing the washing.

The 1900 Motor Washer

1900 Water Motor Washer
Can be connected with
any water tap instantly

Washes a Tubful in Six Minutes!

Handles Heavy Blankets or Dainty Laces

The outfit consists of the famous 1900 Washer with either Electric Motor or Water Motor. You turn on the power as easily as you turn on the light, and back and forth goes the tub, washing the clothes for dear life. Then, turn a lever, and the washer does the wringing. All so simple and easy that it is mere child's play.

A Self-Working Wringer Sent With Every Washer!

The motor runs Washer and Wringer. We guarantee the perfect working of both. No extra charge for Wringer, which is one of the finest made. **Write for FREE BOOK and 30 Days' FREE TRIAL OFFER!** Don't doubt! Don't say it can't be done. The free book proves that it can. But we do not ask you to take our word for it. We offer to send a 1900 Motor Washer on absolute Free Trial for an entire month to any responsible person. Not a cent of security—nor a promise to buy. Just your word that you will give it a test. We even agree to pay the freight, and will take it back if it fails to do all we claim for it. A postal card with your name and address sent to us today will bring you the book free by return mail. All correspondence should be addressed to

Doing the wringing with
1900 Electric Motor Washer



1900 WASHER CO., 6173 Court St., BINGHAMTON, N. Y.

OR, IF YOU LIVE IN CANADA, WRITE TO THE CANADIAN WASHER CO., 356 YONGE ST., TORONTO, CANADA.

(22)

Fun and Health

FOR boys and girls from 5 to 15 years of age. Wonderful new mechanical principle. Speed without labor. Rider propelled by his own weight. No pushing. See it. You can't realize the fun and health in this marvelous little car from a picture. Send for a



Skudder Car

It develops the lungs, shoulders and legs. Children never tire of it. Ball bearing, unbreakable steel frame. It will stand the knocks. Write for free circular and our special trial offer.

SKUDDER CO.

Room 510 Straus Bldg., CHICAGO

seed purposes.

The dashen is a staple article of food for millions of people in tropical and subtropical regions, and there seems to be no reason why it should not prove equally

\$1.00 Down 50c a Week

for this high-grade ring set with 1 ct. **Mexican Diamond**



Exactly resembles finest diamond side by side; same rainbow flashes and dazzling brilliancy (guaranteed). Fine 12kt. gold-filled mountings.

We Trust You Send \$1 and we will mail at once (no C. O. D.) either Ladies' or Gent's Tooth Belcher Ring.

Tiff. Ring, price \$4.98, or price \$6.25, set with finest 1st. Gem. If O. K. you pay balance 50c a week. Money back, not pleased. Act quickly; offer limited. Catalogue free. **AGENTS WANTED.**

MEXICAN DIAMOND IMPORTING CO., Dept. ET-2-T, Las Cruces, N. M.

(Exclusive Controllers of the Genuine Mexican Diamond.)

300 Candle Power of Light

AT A COST OF 1/8c PER HOUR

The Kerosene table lamp has one inverted mantle and **MAKES AND BURNS ITS OWN GAS FROM COMMON KEROSENE OR COAL OIL.** It gives a bright and steady white light **TEN TIMES** as **BRILLIANT** as an ordinary kerosene wick lamp.

The "Quicklit" Gasoline table lamp can be **LIT WITH AN ORDINARY MATCH LIKE CITY GAS.**

Both styles equipped with automatic cleaning needle.

No smoke, no smell, no wicks to trim. A splendid proposition for dealers

LIVE AGENTS WANTED

Write today for further particulars, also complete illustrated catalog describing the above kerosene and gasoline lamps and hollow wire systems. **THE NAGEL-CHASE MFG. CO., 144-164 East Erie St., CHICAGO, ILL., U.S.A.**

The largest manufacturers of artificial lighting devices in the world.





Collapsible Go-Cart Bargain

No. MH111. New One-Motion Collapsible Go-Cart equipped with large foot and detachable storm front. 3-bow adjustable hood and foot well. Instantaneous motion folds cart. All steel construction covered with black "Imperial" leather. Half in. rubber tires. Nickel trimmings and fenders. Adjustable back. Price **\$6.98 75c** Per Month
Greatest value ever offered



"Regent" Range Bargain

No. MH112. Complete with high closet. Made of best cast iron in very finest manner. Large oven 13x16x11 ins. in size; duplex grates; 6-hole top; oven thermometer; improved flue system and steel high closet. Trimmed in silver nickel. Cast enclosed reservoir. Price, without reservoir, **\$22.78**. Price, with reservoir, **\$27.78**. **\$1.75** Per Month

Three-Piece Mission Set Bargain

No. MH109. Solid oak, fumed finish, 3-piece Mission Set. Table 34x24 inches, strongly built; convenient book shelf at either end. Rocker and Arm Chair made to match; upper and outside panels upholstered with "Imperial" Spanish leather; seat set on 4 springs, expertly filled and upholstered. Price **\$11.78 75c** Per Month



Complete Bed Outfit Bargain

No. MH113. Consisting of 11-16 in. continuous post iron bed with 5-16 in. slats; 67 1/2 ins. high; all metal steel support spring, and cotton top fibre filled mattress. Outfit comes in full size (4 ft. 6 in.) only. Colors: White, Pea Green or Vernis Martin. Our price only... **\$9.89 75c** Per Month

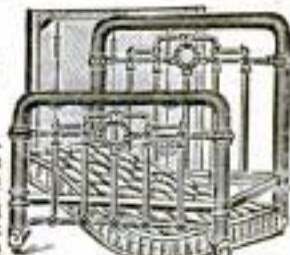

HARTMAN Will Trust You

Hartman's Get-Acquainted Offer

We want you to learn, by testing the remarkable get-acquainted offer in this advertisement, how inexpensive, how satisfying and how easy it is to furnish the entire home or secure odd pieces of Furniture, Carpets, Rugs, Silverware, Draperies, etc., etc., from this mammoth Hartman institution where you can buy on easiest credit terms—and have the goods in your own home before you pay. We alone offer to send you, wherever you live, without sending any money with your order, any one of the remarkable bargains shown here—but we can only afford to send one to each family at these prices.

When you get our mammoth catalog, greatest ever published, you can order anything you wish—any amount—any number of articles you desire. Return anything not satisfactory—we will pay the freight both ways.

Hartman Makes Easiest Terms

We are the originators of the easy payment Credit plan; for 60 years we have extended credit to families everywhere. Our records prove that all housewives are honest, that's why we can give the most liberal credit terms ever made, no matter how small your income—no references required, no embarrassing questions asked, everything strictly confidential, no salesman to bother you, no collectors, no interest to pay, no mortgages, no security asked. Order what you want, make small monthly payments to suit your convenience. Most liberal and most satisfactory plan ever before offered. Millions of homes everywhere beautifully furnished by Hartman's easy payment plan thoroughly prove every claim we make.

Hartman's Mammoth Catalog

FREE Send your name and address today on a postal card and we will send you absolutely free, postpaid, the grandest, most interesting and most beautiful Homefurnishing Goods catalog you ever saw—hundreds of pages done in beautiful colors—you see Rugs and Carpets in exact color reproductions—Furniture, Clocks, Stoves, Refrigerators, Sewing Machines, Jewelry, Washing Machines, Dishes, Bedding, Curtains; all reproductions from photographs. This catalog is like bringing into your home the largest stocks of the largest city stores. Send today for copy.

This is the largest institution of its kind in the world, with a purchasing power of over Ten Million Dollars.

Price **\$12.85**
\$1 Per Month



Refrigerator No. MH 103. Bargain Sanitary Refrigerator. Best cold air circulation, and superior method of insulation works wonders in saving ice. Size: 43 ins. high, 25 1/2 in. wide, 18 1/2 ins. deep; large provision chamber, white enamel lined. Splendid drain. Has ice capacity 75 of lbs.

Kitchen Cabinet Bargain



No. MH104. Selected walnut smoothly sanded finish. Base has white-wood table top 42x25 in. Sliding breadboard, two cutlery drawers, 2 sliding 50lb. flour bins. Top has two cupboard, glass door, tilting sugar bin, shelf space, spice and utility drawers. **\$8.73**

No Reference Is Required

No Money In Advance



Seamless Velvet Rug Bargain

No. MH100. Beautiful Seamless Velvet Rug in an elegant new design, 9x12 ft. Best wearing yarns in a pattern that is sure to please. Rich medallion center and harmonizing border of Tan, Green, Brown, Red and Light colorings. A very choice Rug and one from which lasting service can be had. Price **\$14.75** **\$1** Per Month

Order any one of the items shown in this advertisement. They will prove beyond all argument the true value of the many wonderful bargains in Hartman's Mammoth Catalog.

HARTMAN Furniture and Carpet Co., 3945 Wentworth Ave., Chicago, Ill.



Comfortable Rocker Bargain

No. MH110. A large, comfortable Rocker at a bargain price. Made of solid oak in golden finish in a very choice design. Is upholstered with "Imperial" Spanish brown leather on seat and back. Seat has 4 springs, stuffed with tow and cotton. Front and back posts are handsomely carved. Seat front plaited and back is button tufted. Strong posts and runners. It represents the best rocker value ever offered at the low **\$3.45** price of.....



50c Per Month

A serviceable Flannel Shirt with style!

You've always wanted a good flannel shirt that you could wear for work or pleasure—and here it is—the Signal Flannel Shirt. Built for service—and gives it, yet stylish as a shirt for dress-up service. Guaranteed to wear better than any other flannel shirt you've ever had.

Railroad men especially appreciate a good warm shirt—more and more they are buying Signal Flannel Shirts. Everyone who has worn a Signal Shirt is an ardent booster—you will be, too, after you discover the comfort and wear that these shirts give, without sacrificing style.

SIGNAL Flannel Coatshirts

UNION MADE

Wear well—keep their style—last a long while. Big armholes that will never bind, roomy elbows, extra long sleeves, wide cuffs. Snug-fitting, non-irritating military collar that fits comfortably. Three-inch over-lapping flaps in front. Combination watch and handkerchief pocket, with a flap you can button. Extra button at bottom of breast plait to prevent gapping. Prices \$1.50 and up. Signal Flannel Shirts are also made closed style in a large variety of styles and patterns—military, plain or detachable.

You get in Signal Flannel Shirts the same quality, style and service that made Signal Overalls and Workshirts the universal favorites with railroad men.

Flannel Shirt Free Ask your dealer for Signal Flannel Shirts. If he hasn't them, induce him to send for sample swatches, mentioning your name, and with his first order we will include a shirt for you absolutely without charge.

Hilker-Wiechers Mfg. Co. 1254 Mound Av., Racine, Wis.
Manufacturers of the famous Signal Overalls, Coats and Shirts

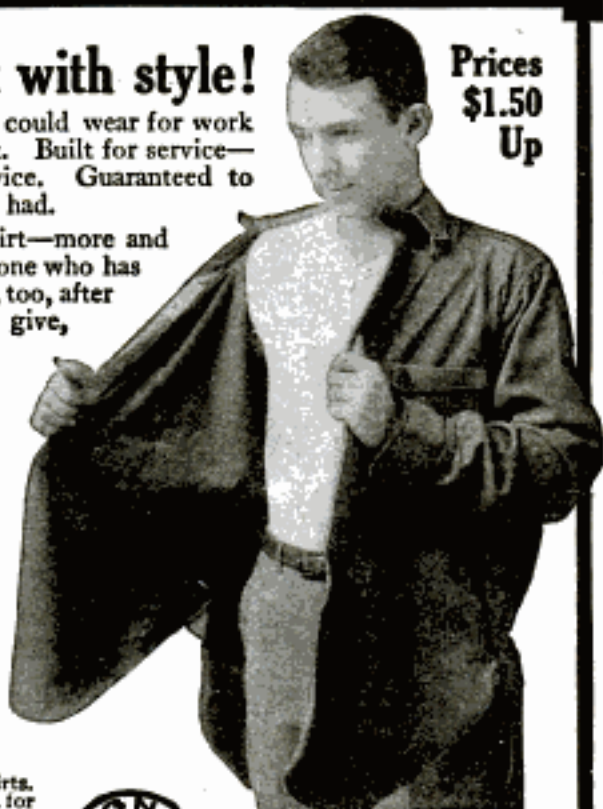

Prices
\$1.50
Up



Always look for this trade-mark—it's the "Safety First" Sign in buying Shirts and Overalls.

AGENTS \$6 A DAY

Should be easily made selling our Concentrated Non-Alcoholic Food Flavors, Soaps, Perfumes and Toilet Preparations. Over 100 kinds, put up in collapsible tubes. Ten times the strength of bottle extracts. Every home in city or country is a possible customer. Entirely new. Quick sellers. Good repeaters. Not sold in stores. No competition. 100 per cent profit to agents. Little or no capital required. Elegant sample case for workers. Start now while it's new. Write today—a post card will do—for full particulars **FREE**



AMERICAN PRODUCTS CO., 171 Third St., CINCINNATI, OHIO



400% to 800% Profit in Popcorn—Crispette and Candy Business

Crowds swarm to buy our Kettle-Popped Popcorn—popped under glass—savored while popping!—GREAT BIG—CRISP—FLUFFY KERNELS! Corn pops 25 per cent bigger with the Dellenbarger machine and 100 per cent better product. Our delicious CRISPETTES melt in your mouth. Wonderful new Automatic Crispette Press is a regular money-mill for extra money in candy!

Course in Candy Making **FREE** with Every Outfit
Write AT ONCE for FREE Catalog, new money-making plans, special prices and sensational easy payment offer. NOW is the time to start. No experience necessary and very little money. Write
C. E. DELLENBARGER CO., 29 Bissel St., JOLIET, ILL.

Please Mention Popular Mechanics

valuable in the southern and southwestern portions of the United States, as a substitute for or supplement to the potato and sweet potato.

Wide Awake AGENTS!

Make
BIG
Money



Be Your
Own
Boss

You need no experience. Our line sells itself. We have the most complete, fully guaranteed, line of knives, razors, strops and cutlery specialties. Golden Rule Knives are hand forged, made of genuine English razor steel. We will put any photo or lodge emblem on one side of the transparent handle and name and address on the other. Write for catalog and terms—exclusive territory.
Golden Rule Cutlery Co., 552 W. Lake St., Dept. 201, Chicago

OVER 65 YEARS'
EXPERIENCE

PATENTS

TRADE MARKS
DESIGNS
COPYRIGHTS, &c.

Anyone sending a sketch and description may quickly ascertain our opinion free whether an invention is probably patentable. Communications strictly confidential. HANDBOOK on Patents sent free. Oldest agency for securing patents. Patents taken through Munn & Co. receive special notice, without charge, in the

Scientific American.

A handsomely illustrated weekly. Largest circulation of any scientific journal. Terms, \$3 a year; four months, \$1. Sold by all newsdealers.

MUNN & CO. 359 Broadway NEW YORK

Washington Office, 625 F St., Washington, D. C.



YOURS FOR 3 CENTS A DAY

© 1915 S. M. S. Co.

Pretty Homes

All Around You are Furnished Here on Credit

No References

One home in nine, the country over, has a charge account here now. Your neighbors have them. Some of the prettiest homes around you are furnished here on credit.

There is no red tape. When you ask for our catalog we open an account. We send a Credit

**Get This Rich Axminster
9x12 Rug—Send only \$1.25**

Order right from this paper to get this handsome bargain. There were not enough to catalog. Try it for 30 days and pay \$1.25 monthly if you keep it.

This Handsome Oriental Design is very rich in tone and will harmonize beautifully with any furniture. The rug is woven in a tan ground and the Oriental figures are brought out in beautiful shades of brown, red, blue, green and old rose colors. Only selected all-wool yarns are used. Rug is neatly finished and has a luxurious high pile.

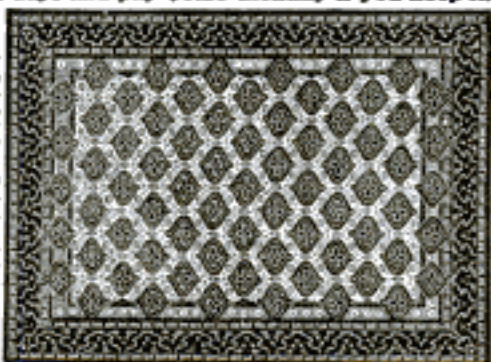

No. F4C203. Size 9 x 12 ft. Price \$12.95

Spiegel, May, Stern & Co.

1201 W. 35th Street, Chicago

Card with the catalog. Then order any time anything you want.

A Year to Pay

We send each article on 30 days' free trial, subject to return. If you like it we charge it to you, allowing a year to pay. Then save up 2 or 3 cents daily. Send us a little each month. And all the time you are using what you pay for.

No contract, no security, no interest, no extra price. It is just as easy as to buy for cash.

Novel Prices

Our prices will astound you. We buy for the millions so we buy very low. We save you five profits by selling direct. Our prices will average one-third less than stores.

New Book Free—Our Spring Bargain Book is just printed. It shows 5,160 things for the home, many in actual colors. It costs us \$1 per copy, but we send it to you free. Send us your name and address. We will mail you then this mammoth book with everything known for the home. And your Credit Card will go with it. You must have it—write today. Cut out coupon now.

Be sure to ask for Book of Spring Styles for Women.

A Dollar Book Picturing 5,160 Things in

Furniture Draperies—Linens Carpenters' Tools
Carpets—Rugs Refrigerators Chinaware—Clocks
Oilcloths, etc. Silverware Sewing Machines
Baby Cabs Kitchen Cabinets Cameras—Pictures

Pay 3 Cents a Day

SPIEGEL, MAY, STERN CO.

1201 W. 35th Street, Chicago

(814)

Mail me your Spring Furniture Book.

Also the books I mark below.

.... Stove Book. Watches and Jewelry.
.... Spring Styles for Women.

Name

Address

Write plainly. Give full address. Check which catalogs you want.

New KEROSENE LIGHT BEATS ELECTRIC OR GASOLINE

10 Days FREE—Send No Money



We don't ask you to pay us a cent until you have used this wonderful modern light in your own home ten days; then you may return it at our expense if not perfectly satisfied. You can't possibly lose a cent. We want to prove to you that it makes an ordinary oil lamp look like a candle; beats electric, gasoline or acetylene. Lights and is put out like old oil lamp. Tests at 14 leading Universities show that it

Burns 50 Hours on One Gallon common coal oil (kerosene), no odor, smoke or noise, simple, clean, won't explode. Three million people already enjoying this powerful, white, steady light, nearest to sunlight. Guaranteed.

\$1,000.00 REWARD

will be given to the person who shows us an oil lamp equal to the new Aladdin in every way (details of offer given in our circular). Would we dare make such a challenge if there were the slightest doubt as to the merits of the Aladdin? **GET ONE FREE.** We want one user in each locality to whom we can refer customers. To that person we have a special introductory offer to make, under which one lamp is given free. Write quick for our 10-Day Absolutely Free Trial Proposition and learn how to get us FREE.

MANTLE LAMP COMPANY, 374 Aladdin Building, Chicago, Ill.
Largest Manufacturers and Distributors of Kerosene Mantle Lamps in the World

Men with Rigs Make \$100 to \$300 Per Mo. Delivering

the ALADDIN on our easy plan. No previous experience necessary. Practically every farm home and small town home will buy after trying. One farmer who had never sold anything in his life before writes: "I sold 51 lamps the first seven days." Another says: "I disposed of 54 lamps out of 81 calls." Thousands who are raising money endorse the Aladdin just as strongly. **No Money Required.** We furnish capital to reliable men to get started. Ask for our distributor's plan, and learn how to make big money in unoccupied territory.

Sunshine Lamp 300 Candle Power FREE!

To Try in Your Own Home

Turns night into day. Gives better light than gas, electricity or 18 ordinary lamps at one tenth the cost. For Homes, Stores, Halls, Churches. A child can carry it. Makes its own light from common gasoline. Absolutely SAFE.

COSTS 1 CENT A NIGHT

We want one person in each locality to whom we can refer new customers. Take advantage of our SPECIAL FREE TRIAL OFFER. Agents Wanted.

SUNSHINE SAFETY LAMP CO.
220 Factory Bldg. Kansas City, Mo.



WHITE FLAME

BURNERS make your old kerosene lamps and lanterns give a brilliant white light better than electricity or gas. Doubles your light. Saves oil. **NO MANTLE TO BREAK.** Guaranteed Safe and Reliable. Delights every user. Send now for complete particulars, 25¢ stamps or coin. \$ for \$1. **MONEY BACK IF NOT SATISFACTORY.** Live Representatives Wanted. Exclusive Territory.

WHITE FLAME LIGHT CO., 68 Clark Bldg., Grand Rapids, Mich.



SAFETY FIRST Yale Electric Lantern

and Combination House Lamp, Search and Flash Light. This is NOT a Toy. Turn a switch and you get a flood of light! The safest, handiest, most simple all-around light for autoists, campers, sportsmen, merchant, farmer, etc. Eliminates filling, matches, oil, grease, smokes, chimneys, trimming of wicks and other troubles. Always ready when wanted. **Introductory Price \$3.50.** A sample will be sent by prepaid parcel post on receipt of remittance of introductory price. Order sample and agents' proposition now—be the first. **Sold on money-back guarantee.** A big money-maker for agents. Agents Wanted Everywhere. **YALE MANUFACTURING CO., 23-22 St. Clifton St., Chicago**



KEROSENE AND GASOLINE LANTERNS

Absolutely bug and wind proof and give 300 candle power of light, at a cost of 1/4c per hour. Suitable for use on farms, watchmen, side shows, circuses, street carnivals, garages, livery barns, summer resorts, warehouses, boat landings, etc.

For complete catalog and agency proposition address
THE NAGEL-CHASE MFG. CO.
150 East Erie St. CHICAGO



BEACON BURNER FREE

FITS YOUR OLD LAMP

100 Candle Power Incandescent pure white light from (kerosene) coal oil. Beats either gas or electricity.

COSTS ONLY 1 CENT FOR 6 HOURS

We want one person in each locality to whom we can refer new customers. Take advantage of our Special Offer to secure a Beacon Burner FREE. Write today. **AGENTS WANTED.**

HOME SUPPLY CO., 111 Home Bldg., Kansas City, Mo.

The total available water powers of the province of Ontario, Canada, it is estimated, are sufficient to produce between 4,000,000 and 5,000,000 hp., of which about 1,000,000 hp. had been developed in 1910. The government proposes to retain control of these immense water powers as far as possible, and to develop them as needed for the benefit of the people.

AGENTS ENORMOUS PROFITS



Great new toilet proposition — country taken by storm. Beautiful line — handsome case — quick sellers. Every woman — every man — sees something to buy. Easy for you to get

This Meximol Sample Case Outfit FREE

by our liberal plan — no money needed. Hustlers given grand opportunity to appoint agents — share in profits of others' work. Exclusive territory. Special offer if you answer quick.

Ask for Free Outfit today
FRANCIS E. LESTER CO., Dept. ET-2-Y, Mesilla Park, N. M.



The BEST LIGHT

A soft, luminous light, which casts no shadow. Brighter than electricity or acetylene. Makes and burns its own gas. **Costs 2c a week.**

No dirt, smoke nor odor. Over 200 styles, ranging from 100 to 2000 candle power.

Absolutely guaranteed. Write for illustrated catalog.

AGENTS WANTED EVERYWHERE
THE BEST LIGHT CO.
324 E. 5th St., Canton, O.



ENGINE QUALITY HIGHER PRICES LOWER

At the very beginning of the gasoline engine business in America, I made my first engine with my own hands. Then, as ever since then, I figured the kerosene or gasoline can—the cost of doing work, and the ease of doing it—

determines engine quality more than the cost of the iron pile. It wasn't so hard to make my engine of the highest quality. But it was hard to get the cost of manufacturing down to the point where I could lead in low prices as well as in high engine quality. A natural gas well which furnishes free power, heat and light, effecting a big saving in manufacturing cost, helped solve the problem. My experience as a practical mechanic and engine designer has made it possible for me to design, build and equip my factory with the latest improved types of labor-saving, cost-reducing machinery—another big saving which I give to my customers. My plant, today, is the largest exclusive engine factory in the world, the entire output of which is sold only direct to engine users.

Gasoline and Naphtha Engine—Stationary Sizes: 2, 4, 6, 8, 12, 16 and 22 H-P. Shown mounted on iron sub-base.

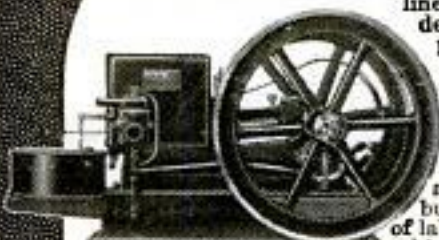

production down to the lowest possible point—using the best of material—selling for one small profit only direct to users—these facts explain my present low prices.

WITTE ENGINES

WITTE Engine—On Skids Sizes: 2, 4, 6, 8 and 12 H-P. Kerosene or Gasoline.



Kerosene, Distillate, Naphtha and Gas

Sold Only Direct From My Factory To Users

Every WITTE Engine is perfectly balanced and properly proportioned in all its parts—no excess friction to overcome—the highest possible percentage of fuel is converted into directly transmittable power. Easy to start—without cranking—and smooth, steady, continuous running, giving its full rated horse-power on minimum fuel consumption, is guaranteed. All have detachable cylinders, 4-ring pistons,

automobile style vertical valves, automatically controlled automobile ignition, double weight, extra sensitive and positive governors and other merits without which no engine can now be really high grade.

Most Valuable Engine Book Ever Published—FREE

This book tells how to judge engine quality—how to decide what size and style engine is best suited for your work—how to be sure in your selection even if you don't pick a WITTE. You'll say this book is worth dollars to you; if you don't think so I'll pay postage to get it back. Mail coupon today.

**ED. H. WITTE, Witte Iron Works Company,
1745 Oakland Ave., Kansas City, Mo.**

**Latest
WITTE
Prices**
**5-Year
Guarantee on
Efficiency and
Durability**
**CASH OR
EASY TERMS**

Stationary	
2 H-P	\$ 34.95
4 "	69.75
6 "	97.75
8 "	139.65
12 "	219.90
16 "	298.80
22 "	399.65

Portable	
2 H-P	\$ 40.95
4 "	82.80
6 "	139.90
8 "	190.40
12 "	279.80
16 "	378.70
22 "	483.15

Saw-Rig	
6 H-P	\$165.40
8 "	227.10
12 "	324.50

You can't buy better engines at any price and none as good as the WITTE for my price. Could you ask my many thousands of old customers I am sure they would tell you, as they have repeatedly told me, that the above claim is a positive fact.

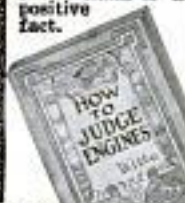

**WITTE
Saw-rig**
Sizes: 6, 8
and 12 H-P.
Kerosene and Gasoline engines furnished in this style.

FREE BOOK COUPON
**ED. H. WITTE, Witte Iron Works Co.,
1745 Oakland Avenue, Kansas City, Mo.**

Without cost to me, and with no obligation on my part, I should like to receive your latest and finest Engine Book, and to investigate your New Liberal Selling Plan.

Name.....
Address.....

Please Mention Popular Mechanics

AGENTS

SALESMEN
MANAGERS
YOUNG OR OLD
NEW BUSINESS

**NEW BUSINESS JUST OUT**

DROP THE DEAD ONES. AWAKE! START WITH THIS NEW INVENTION, THE 20th CENTURY WONDER

Get started in an honest, clean, reliable, permanent, money-making business. Sold on a money-back guarantee

The Blackstone Water Power Vacuum Massage Machine
For the Home. No Cost to Operate. Lasts Life-Time

LISTEN

No Competition, New Field, New Business. Price within reach of all. That's why it's easy to sell. Endorsed by Doctors and Masseurs. Removes Wrinkles, rounds out any part of the face or body, brings back Nature's beauty. Almost instant relief can be given all kinds of pains. A demonstration convinces the most skeptical person. Sales easily made.

Read On! What Others Do, So Can You.

Parker writes, sold eight machines first day. Margwarth says, I am making \$19.00 per day. Schermerhorn, eight dozen machines first month. Shaffer writes, am selling four out of five demonstrations. Vaughn, orders one dozen, four days later wires "ship six dozen by first Express." Lewis, sells four first hour. Men, women, everybody makes money. No experience necessary. Protected territory to active workers. We own all patents. Big book entitled, "The Power and Love of Beauty and Health" Free. Investigate now, today. A postal will do. A big surprise awaits you. Address, BLACKSTONE MFG. CO., 29 Meredith Bldg., Toledo, Ohio

AGENTS

GENERAL AGENTS
ROAD MEN
MAKE MONEY HERE
Start Now - Today



Scientific Device That Does Away With TRUSS-FREE TRIAL



Inner surface is made adhesive to secure the PLAPAO-PAD firmly to the body, keeping the PLAPAO continually applied and the pad from slipping. Nostraps, buckles or springs attached. Soft as velvet—easy to apply.

PATD
APRIL 6
1909

Over 250,000 Now In Use

We have proved to hundreds of thousands of sufferers from hernia (rupture) that to obtain lasting relief and develop a natural process for betterment comes by wearing a Plapao-Pad. This patented mechanico-chemico device can do the same for you. The wearing of an improper support aggravates rather than improves the condition. The Plapao-Pad can and does aid the muscles in giving proper support, thereby rendering efficient aid to Nature in restoring strength to the weakened muscles. Being self-adhesive there is no slipping and shifting of pad with resultant irritation and chafing. No discomfort whatsoever—no delay from work. Awarded Gold Medal at Rome and Grand Prix at Paris.

Send No Money. We will send you a trial of Plapao absolutely FREE, you pay nothing for this trial now or later. Write for it today, also full information.

PLAPAO LABORATORIES, Block 70 St. Louis, Mo.

Deafness



Perfect hearing is now being restored in every condition of deafness or defective hearing from causes such as

Relaxed or Sunken Drums, Roaring or Hissing Sounds, Perforated, Partially Destroyed Drums, etc.

Wilson Common-Sense Ear Drums

"Little Wireless Phones for the Ears"—require no medicine but effectively replace what is lacking or defective in the natural drums. They are simple devices, which the wearer easily fits into the ears where they are invisible. Soft, safe and comfortable to wear at all times.

Write today for our 168 page FREE book on DEAFNESS, giving you full particulars and plenty of testimonials.

WILSON EAR DRUM CO., Incorporated
499 Inter-Southern Building LOUISVILLE, KY.

Please Mention Popular Mechanics

**GEE! WHAT A WAD**

This is STAGE MONEY. Looks like the GENUINE STUFF. Some Green backs, and some Yellow backs. Create a BIG sensation among your friends. The girls will all be after you when they see the wad. BIG roll of 15 pieces by mail 10 cts.

PIKE NOV. CO., Dept. 13, So. Norwalk, Conn.

**CLASS PINS**

FACTORY TO YOU
For College, School or Society

Catalog with attractive prices mailed free upon request. Special offer, either style of pins here illustrated with any three letters and figures, one or two colors of enamel. STERLING SILVER, 30c each; \$3.00 dozen. SILVER PLATE, 15c each; \$1.50 dozen. BASTIAN BROS. CO., 551 Bastian Bldg., ROCHESTER, N. Y.

During the fiscal year ended June 30, 1914, commercial motor vehicles to the number of 249, and 13,108 passenger automobiles were exported from the United States to Europe. Of these, the United Kingdom alone took 203 motor trucks and 6,992 passenger cars.

Erickson Artificial Limb Co., 38 Wash. Av. No., Minneapolis, Minn.
Light Handle Does Not Chafe Overheat or Strain End of Stump



We are
Under
Govt.
Bond

**Amazing Profits
In Mushrooms**

Anybody can add \$8 to \$40 per week to their income, in spare time, entire year growing mushrooms in cellars, sheds, barns, boxes, etc. I tell you where to sell, at highest prices. Free Illustrated Instruction Booklet

HIRAM BARTON
Desk 2, 329 W. 48th St., New York

NO MORE BALD HEADS



When our VACUUM CAP is used a few minutes daily. We accept no pay until you have tried the Cap 60 days and are satisfied. The Vacuum Cap is an appliance that draws the blood to the Hair Roots and starts a new healthy crop of hair. It stops Dandruff, stops the hair from falling out. Bought by Doctors and men who

know that it is the only reasonable HAIR GROWER known to science. No Drugs Used. Write for application blank, testimonials, and booklet on "HAIR," sent sealed in plain envelope, FREE.

THE MODERN VACUUM CAP CO.
O. 559 BARCLAY, DENVER, COLO.



Experienced Smokers Prefer Riz La Croix Cigarette Papers

From the Florida beaches to the California resorts, at all centers of wealth and fashion throughout the world, smokers of experience and discrimination roll their cigarettes with Riz La Croix papers—because Riz La Croix *quality* insures maximum enjoyment and satisfaction.

RIZ LA CROIX

(Pronounced: REE-LAH-KROY)

FAMOUS CIGARETTE PAPERS

5^c

So pure, light and thin, their combustion is perfect. Absolutely no paper-taste in the smoke—nothing but the fresh fragrance of the tobacco. So strong and naturally adhesive, they are rolled easily, without bursting, into perfect cigarettes that hold their shape. Most important of all, entirely healthful, because made exclusively from the best flax linen—a pure, vegetable product.



FREE

Two interesting, illustrated Booklets—one about RIZ LA CROIX Cigarette Papers, the other showing how to "Roll Your Own" cigarettes—sent anywhere in U.S. on request. Address The American Tobacco Co., Room 1184, 111 Fifth Ave., N.Y.

3 Years to Pay — for the — Sweet-Toned Meister Piano



30 Days' Free Trial We Pay the FREIGHT

You are not asked to deposit, or pay or advance a cent in any way until you write us and say that the MEISTER is entirely satisfactory and you wish to keep it. Then these are the terms of sale:

\$1 a Week or \$5 a Month

No Interest On Payments

No cash payment down. No extras of any kind. Piano stool and scarf free.

Sold direct from the maker to you and we guarantee you a saving of \$100.

Send now for our beautiful Free Catalog, which shows eight styles of Meister Pianos. Our resources exceed \$4,000,000.

\$175 Rothschild & Company Dept. 16-B
Chicago, Illinois

\$8,000 to \$10,000 YEARLY



Make Money Out of Others' Fun

Pleasing the Public Pays Big Profits and owners of our famous attractions frequently make from \$8,000 to \$10,000 every year. We make everything in the Kiddie-Gallery and Carouselle line from the smallest to the highest grade. Bring in hundreds of dollars daily. It is a delightful, attractive, big paying, healthful business. Just the thing for the man who can't stand indoor work, or is not fit for heavy work.

Just the business for the man who has some money and wants to invest it to the best advantage. Our goods are finest appearing, easiest running, and most attractive line manufactured. They are simple in construction and require no special knowledge to operate. Our latest new 1915 Carouselle is mounted on trucks to facilitate and reduce cost of moving and shipping. If you want to get into a money-making business write today for catalog and particulars.

HERSCHELL-SPILLMAN COMPANY

PARK AMUSEMENT OUTFITTERS

333 Sweeney St., N. Tonawanda, N. Y., U. S. A.

BUILD

We have accurate scale drawings and knock-down parts of all man-carrying aeroplanes for class-room demonstrations, exhibition purposes, etc.



3 FT. CURTIS FLYING BOAT

Students of aeronautics, everyone with an inquiring turn of mind, should construction of these fascinating models. PRICES—3-FT. MODEL SCALE DRAWINGS—Curtis Flying Boat, 25c; Nieuport Monoplane, 25c; Bleriot Monoplane, 15c; Wright Biplane, 25c; Curtiss Convertible Hydroaeroplane, 35c; Cecil Peeli Champion Racer, 25c. Complete Set of Six \$1.25 Postpaid.

30 pp. Ideal Model Aeroplane Supply Catalog 5c
IDEAL AEROPLANE & SUPPLY CO., 62-68 West 47th St., N.Y.

3 MEN'S SHIRTS - \$2



Fine material, blue, black and lavender stripe, popular coat style, cuffs attached. Sizes 14 to 17 1/2. No catalog or samples. Regular dollar shirt. Money back if not satisfied. Delivered free on receipt of \$2.00. Order today.

GOODSELL & CO., Room 104, 126 E. 34th St., NEW YORK

Make \$30 to \$60 Weekly

Selling our new unequalled gasoline table and hanging lamp for lighting city and rural homes, stores, halls, churches. Most powerful light known. ABSOLUTELY SAFE.

WE LOAN YOU SAMPLE

More brilliant and many times cheaper than gas or electricity. Guaranteed five years. Everyone a possible customer. No experience necessary. Exclusive territory free. Write today.

SUNSHINE SAFETY LAMP CO.
222 Factory Bldg., Kansas City, Mo.



ABOUT MUSHROOMS



How to really make big money in mushrooms is fully explained in the wonderful book, "The Truth About Mushrooms," a great revolutionary improvement, things many growers never knew before. Everything explained from A to Z, at first hand, from the greatest practical authority in America. Add \$10 to \$15 a week to your income. Demand exceeds supply. Grow in cellars, sheds, boxes, etc. Small capital to start. Profit bigger and quicker. Anyone can do it. Women and children too. Now is best time. Send for free book.

BUREAU OF MUSHROOM INDUSTRY, Dept. 161, 1342 N. Clark St., CHICAGO

Marine insurance was practiced in Rome 45 B. C. It was very general in Europe before the discovery of America, and it is altogether probable that the ships of Columbus were insured for their full value.

BUY PLUMBING and HEATING SUPPLIES



at WHOLESALE Will Save You 30%

Don't pay retail prices. Full stock on hand for prompt shipment. Send for free catalog.

B. P. KAROL, 768 to 772 W. Harrison St., CHICAGO

Drink Pure Water

Perfect health demands it. Disease lurks in impure water. Insure purity by installing a

Bohner Self-Cleansing Filter

Gives you constant supply of crystal water, pure as ozone. Inexpensive. Anyone can install without tools. Lasts a lifetime. Full particulars on request.

Bohner Mfg. Co., 10095 So. Wabash Av., CHICAGO, ILL.



Guaranteed to give satisfaction or money back if returned in 15 days.

Regular Price

\$1.25

THE RAPID VACUUM WASHER

Sold on 30 days' trial.



The only Washer with Automatic Suction

Washes everything from blankets to fine laces. Tub of clothes washed in 5 to 10 minutes. A child can operate it.

AGENTS WANTED. Special price on sample postpaid. Write for terms and trial offer.

STEWART-SKINNER CO., 26 Cherry St., Worcester, Mass.

Money in Patents

Manufacturers are always looking for inventions. All patentable ideas should be protected by a patent. (By a Registered United States Patent Attorney.)

The great majority of money making inventions are thought of by persons, I will term amateur inventors, and nearly always are some very small or simple thing, for the reason that a large invention takes too much time and money for the average person to produce. I have inquiries from all over the country, in which manufacturers and business houses are looking for patents in every line of industry. Owing to these inquiries I am about to put inventors in direct touch with manufacturers who want patents, and thereby find a ready sale for their invention, which, for results, is far more practicable than any other mode of assistance to inventors.

A book "How to get your patent and make your profits thereon," which contains general patent information, is free and I would be very glad to have you write me for a copy of it.

MANSSELL F. MILLS
Registered United States Patent Attorney
244 Commercial National Bank Building, WASHINGTON, D. C.

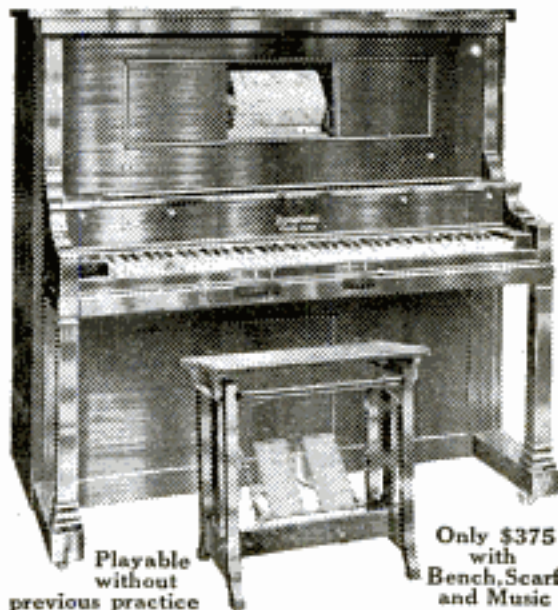

Playable without previous practice

Only \$375 with Bench, Scarf and Music

Have You Too Forgotten How to Play

An Ohio Customer writes: "My wife doesn't play and I have nearly forgotten how, so I want the Symphonic." Perhaps there are similarly situated music lovers of your household who are unable to personally play the many pieces they would like to. The Symphonic, playable with music rolls or by hand, brings to your home the riches of all the world's instrumental music. Hymn, Popular, Patriotic, Classical, Operatic, Dance selections may all be played by any member or friend of your family. Mr. Ernest J. Knabe, Jr., and Mr. Wm Knabe, III., formerly makers of the Wm. Knabe pianos, are the Symphonic's makers.

Symphonic Player-Piano

With Larkin Groceries and Home Supplies

Our offers permit you to reduce your family's living expenses and at the same time save a large sum on the Symphonic Player-Piano at our rock-bottom Factory-to-Family price of \$375. You will save as much as 35c to 50c on the dollar in buying Larkin Products and Larkin Groceries. Flour, Sugar, Coffee, Tea, Canned Goods, Soaps, Toilet Articles are among these 900 household supplies.



Only \$60 Plays Victor and Columbia Records

Symphonola

The Home Entertainer

Larkin Factory-to-Family dealing, proven exceedingly profitable by our two million customers, also brings you this beautiful Symphonola at only \$60—a price far below the usual price for such instruments. A comparison of the Symphonola with other similar instruments will show that you ought at least to try this instrument in your home.

1 to 4 Years to Pay

Take a year, if you desire, to pay for the Symphonola or four years for the Symphonic Piano or Symphonic Player-Piano. No extra interest or rent charge. At the same time you will save large sums in buying Larkin Products or Groceries.

Let us now make known all the details of these offers and send our new book. This illustrates and describes the Symphonic and Symphonola. Send the Coupon now.

SEND TODAY

LARKIN CO., Buffalo, N. Y.
Dept. PM-215

I am interested in the instrument checked. Send your Catalog and offer.

Piano Player-Piano Symphonola

Name.....

Town..... State.....

R. D. or St. Address.....

Piano or Symphonola Book FREE

AGENTS—Make \$100 to \$300



per month easy selling our new Triplicate Sauce Pan. Cooking utensil for 3 different foods on one burner. 400 Specialties — all Whirlwind sellers. Write quick for exclusive territory and large catalogue. **AMERICAN ALUMINUM MFG. CO.** Div. 5 61 LEMONT, ILL.

Please Mention Popular Mechanics

NAVARRE

FIREPROOF

7TH AVENUE & 38TH ST. HOTEL

300 FEET FROM BROADWAY

From GRAND CENTRAL STATION

7 Blocks

PENN. R.R. Sta., 4 Blocks

NEW YORK

CENTRE OF EVERYTHING

350 ROOMS BATHS 200

A room with bath . . . \$1.50

Other rooms with bath \$2.00, \$2.50

Rooms for two persons \$2.50, \$3.00

CUISINE (a la Carte) MUSIC

SEND FOR COLORED MAP OF NEW YORK

EDGAR T. SMITH, Managing Director.

Made-to-Measure

Express Prepaid **\$275**

Pantscut in the latest style. Made-to-your individual measure. Fit, workmanship and wear guaranteed.

No Extra Charge

for peg tops, no matter how extreme you order them.

Agents Wanted

A good live hustler in every town to take orders for our celebrated made-to-measure clothes. Samples of all the latest materials FREE.

We Pay Big Money

to our agents everywhere. Turn your spare time into cash by taking orders for our stylish clothes. Write today for beautiful FREE outfit.

The Progress Tailoring Co.

Dept. 600, CHICAGO, ILL.



Patents

Trade Marks and
Copyrights Secured
or Fee Returned

Special Offer—Free Search of Patent Office Records

Send us a model or sketch and description of your invention, and we will make a *Free Search* of the *Patent Office Records* to ascertain if it is patentable. If we report the invention patentable, we will guarantee to obtain a patent or return our fee, and furnish a certificate of patentability backed by a bonded contract to that effect.

This Certificate of Patentability will protect the inventor and serve as proof of the invention until the case can be filed in the U. S. Patent Office.

Obtaining Assistance for Inventors

Our certificate is of great assistance to inventors who require financial aid to obtain patents.

Our Five Books Mailed Free

(SEE COUPON BELOW)

to any address. Send for these books—the finest publications ever issued for free distribution.

How to Obtain a Patent

Our illustrated eighty-page Guide Book is a book of reference for inventors, and contains 100 mechanical movements illustrated and described.

Money in Patents

Tells how to invent for profit, and gives history of successful inventions.

What to Invent

Contains a valuable **LIST OF INVENTIONS WANTED** and suggestions concerning profitable fields of invention; also information regarding prizes offered for inventions, among which is

Prize of One Million Dollars

offered for one invention, and \$10,000 for others.

Patents That Pay

Contains letters from our clients who have built up profitable enterprises founded upon patents procured by us; also endorsements from prominent inventors, manufacturers, Senators, Congressmen, Governors, etc.

We Advertise Our Clients'

Inventions Free

In a list of Sunday newspapers with two million circulation, in manufacturers' journals and in the *World's Progress*. Sample Copy Free. We save you time and money in securing patents. After the patent is granted we assist you to **SELL YOUR PATENT**.

Foreign Patents

WE HAVE DIRECT AGENCIES IN ALL THE PRINCIPAL FOREIGN COUNTRIES and secure FOREIGN PATENTS in the shortest possible TIME and at the LOWEST COST. Write for our Illustrated Guide Book on Foreign Patents, sent free to any address.



VICTOR BUILDING

Our new \$200,000 building opposite U. S. Patent Office
SPECIALLY ERECTED by us for OUR own use

WANTED NEW IDEAS

Send for **LIST OF PATENT BUYERS** who consult us when purchasing patents. Contains requests from **MANUFACTURERS, MAIL ORDER HOUSES** and **PROMOTERS** for patents secured by us, and suggestions as to New Ideas they wish to purchase. We invite manufacturers and promoters to address our Sales Department regarding the purchase or leasing of a number of meritorious patents secured by us.

REFERENCES

Second National Bank, Washington, D. C.; Union Savings Bank, Washington, D. C.; Chamber of Commerce, Washington, D. C.; Finner Gasoline Lighting Co., Chicago, Ill.; R. G. Dun & Co., Washington, D. C.; Smethport Glass Co., Smethport, Pa.; The Melvin Gauge and Signal Co., Scranton, Pa.; M. Winter Lumber Co., Sheboygan, Wis.; National Savings and Trust Co., Washington, D. C.

FREE COUPON!

VICTOR J. EVANS & CO., Patent Attorneys

NEW YORK OFFICES: 189-191 Broadway

PHILADELPHIA OFFICES: 1429 Chestnut St.

Main Offices: 765 Ninth St., N. W., WASHINGTON, D. C.

GENTLEMEN: Please send me FREE OF CHARGE your FIVE Books as described above.

NAME..... ADDRESS.....

WANTED IDEAS



Inquiries from Manufacturers and Other Buyers of Patents
Who Are Looking for Good Ideas

Protected by Owen Patents

Are constantly being received. Hundreds of ideas are wanted—a market exists for them to-day. YOURS may be one of them. Send for my free books and see for yourself—read the requests for inventions protected by me. Many are simple. You can help supply this demand.

As soon as my clients' rights are protected I aid in every practicable way, **without charge**, to sell. Their applications are advertised free—their patents are called to the attention of the proper prospective buyers—every necessary thing is done. Get my booklets and see.

THESE ARE FREE

You will incur no obligation by writing me. A simple request will bring them to you—the finest, most reliable and instructive patent books published. A postal will do.

"Successful Patents"—a 72 page guide book, tells how to proceed; describes my advantageous business methods; gives references, testimonials, etc.

"Stepping Stones"—gives hundreds of hints of inventions wanted; articles from interviews of noted authorities; tells the truth about prizes for inventions.

"Patent Promotion"—tells you how to sell; why some inventors fail; discusses the value of your idea; how I aid my clients; manufacturing aids furnished you; recent successful patents, etc.

You will also be sent from time to time, as new inventions are wanted, full information concerning them. Only in this way can you keep up to date.

Write for These To-day—Advice costs nothing. All communications confidential. I secure patents or receive no compensation. Your work will receive my personal supervision—but my fees are no higher than others.

Results Speak Loudest—But Here Are Some References

Columbia National Bank,
Washington, D. C.
National Locktile Co.,
Washington, D. C.
The Carnahan Press,
Washington, D. C.
Lightning Gun & Cycle Works,
Oklahoma City, Okla.
Antholene Mfg. Co.,
Hutchinson, Kans.

National Rack Co.,
61 Hannover St.,
Boston, Mass.
The C. J. Loftus Co.,
13 Spring Common,
Youngstown, Ohio
Whitehead Hosiery Mills,
Burlington, N. C.
Dickinson Mfg. Co.,
Des Moines, Iowa.

A LARGE NUMBER OF OTHERS IN MY BOOKLETS.

RICHARD B. OWEN 9-303 OWEN BLDG.
WASHINGTON, D. C.

Inventors submitting their inventions to me are protected in a tangible manner until their applications are filed.



Search of Records

Send sketch or model of your invention for free search of Patent Office Records and report on patentability.

PATENTS THAT PROTECT and PAY

Advice free. Terms reasonable. Highest references. Best results.

Send sketch or model for FREE examination and opinion.

Recommended Patent Lawyer in the Bankers' Register and special list of selected lawyers. Also in Martindale's Law Directory, Sharp and Alleman's Directory of Lawyers, The Gast-Paul Directory of Lawyers, and Kime's International Law Directory.

ALL BUSINESS GIVEN PROMPT AND PROPER ATTENTION

A large list of strong recommendations furnished free

WATSON E. COLEMAN, Patent Lawyer, 622 F St., N.W., Washington, D.C.

A Fortune to the Inventor

who reads and needs it, is the possible worth of the book we send for 6 cents postage. Write us at once.

E. S. & A. B. LACEY, Dept. Y, WASHINGTON, D. C.

PATENTS C. L. PARKER

Formerly Member Examiner
Corps, U. S. Patent Office

PATENT LAWYER

210 MCGILL BLDG.

WASHINGTON, D. C.

Patents, Trade Marks, Copyrights, Patent Litigation

Handbook for Inventors, "Protecting, Exploiting and Selling Inventions" sent free upon request.



BRASS GEARS

Cut by an entirely new process. The most accurate made and at prices that cannot be equalled by others. Every gear has a hub, center painted along black, edges turned true, highest grade red brass, and much heavier than others. We carry the largest stock in the world and every gear listed is always shipped on date of order.

SEND FOR CATALOGUE

CHICAGO STOCK GEAR WORKS
16 S. Fifth Av. Chicago

Active Forces of Inventive Genius



INVENTORS Our Brain Belongs to You. Our Ideas Are Free of Charge.

All we want in return is to build your model, special machinery, dies, tools and rigs to manufacture sheet metal goods, etc. We are expert mechanics, over thirty years' experience and have one of the best equipped shops in the country. Ask for Booklet No. 17. Consultation free. Experimental work strictly confidential.

A. Naecke & Son, J. Urbans, J. Haldrich, Prop's
236-242 S. 9th St., Philadelphia, Pa.

Champion Racer



Our set contains this and 9 other drawings, with instructions for building \$1.00

MODEL AEROPLANES

Send 2c postage for Complete handbook of Models and Supplies.

WADING RIVER MFG. CO.
WADING RIVER, N. Y.



Small Engines

Our $\frac{1}{2}$, 1 and $1\frac{1}{2}$ H. P. Gasoline Engines for Farm and Shop are the best small engines made, because we specialize on them. The "SIEVERKROPP" at \$19.50 will run a washing machine, grinder or any small machine. Buy one for your Boy! Shipped on trial. Send stamp for Booklet and Special Offer.

Sieverkropp Engine Co., 1224 18th St., Racine, Wis.

PATENTS THAT PAY!—

Over \$600,000

made by clients. A Wonderful 127-Page Book: "What and How to Invent—Proof of Fortunes in Patents" that every inventor should have, and can have, FREE. High Class Services.

Across the Street from the Patent Office

E. E. VROOMAN & CO., 871 F St., WASHINGTON, D.C.

Send for FREE BOOK { WHAT TO INVENT
WHAT NOT TO INVENT
HOW TO SELL YOUR PATENT
Copies of nearest Patents and report in every case without charge
H. L. WOODWARD, 9th and G Sts., WASHINGTON, D. C.

PATENTS MASON, FENWICK & LAWRENCE,

Washington, D. C., New York City, Chicago, Ill.

Established over half a century. Booklet Free.

Reference: McLachlan Bank'g Corp., Wash., D. C.

MAP OF ST. LOUIS IN WOOD INLAY WORK—

A woodworker of St. Louis has recently completed a remarkable piece of inlay work in the form of a table and map of that city. The map contains 200,000 wood pieces put together on a scale of about 1,500 ft. to the inch, and is laid on a table, whose base is a copy in miniature of the east end of the old courthouse, from the steps of which slaves were sold before the war. The base is of



Models and Supplies

We make working models of any description and material, also dies, tools and sheet metal stampings. Send your drawing or sample for estimate. Write for catalog of parts and model supplies.

The Pierce Model Works, 3405 Pierce Ave., Chicago, Ill.



MECHANICAL SUPPLIES and MATERIAL of all kinds.

EXPERIMENTAL AND LIGHT MACHINE WORK to order.

132 MILK STREET, BOSTON

STAMPINGS

Metal spinnings and stampings a specialty. All sorts of die work and metal patterns. Manufacturers of patent specialties and novelties. Can get out samples at moderate cost. Experts in black enameling. Prices reasonable. Prompt delivery.

THE STANDARD SPINNING & STAMPING CO., Toledo, O.



MAKE BIG INCOME

Men and Women grow mushrooms all the year at home in cellars, stables, sheds, boxes, etc. Sell as high as \$1.00 a lb. Great demand, markets waiting. Start Now. Big Booklet telling how to do it Free. **Nat'l Spawn Co., Dep. 12, Boston, Mass.**

GO INTO THE MOVING PICTURE BUSINESS

Write For FREE Catalog



ON OUR Easy Payment Plan Make \$20 to \$50 PER NIGHT

With our moving picture outfit. We sell everything—Films, etc.

DEARBORN NOVELTY CO.
Dept. P, 537 S. Dearborn St., Chicago, Ill.

PATENT YOUR IDEAS

*—There is a Constant Demand
for Good Inventions*

Thousands of the biggest money-making inventions have been the "little" things that have made people wonder why they were never thought of before.

"WHAT TO INVENT"

and

"HOW TO OBTAIN A PATENT"

These Books Sent Free

If you have an invention send us a sketch, photograph or model of it. We will give you a report as to its patentability absolutely free. If you have no invention send for our book, "What to Invent." It contains hundreds of valuable suggestions. We are recognized authorities on patent matters and have helped hundreds to find a ready and profitable market for their ideas. We can prove it. If you wish to sell your patent we will advertise it in manufacturers' journals at our expense.

Don't Wait—Find Out NOW!

Your idea will never do you any good if some one else patents it ahead of you. Act quick! Let the other fellow say "he thought of it a long time ago." You reap the profit. Let the others wish they had.

Advice Free—All Matters Confidential

We have secured patents for thousands of inventors and have many letters proving the value of our services. Write us. Send rough drawing or model of your invention for our opinion. We will guard it carefully and report quickly. You are under no obligations to proceed further. Our plan is simply a square deal to all. Our books, "What to Invent" and "How to Obtain a Patent" are the best publications written for the man who has an idea to patent, or who is of an inventive turn of mind. They show just how to proceed with your idea and tell of hundreds of things to invent. We gladly send these books free. The sooner you write for them the sooner you will know all about patents and the many different lines in which new inventions or improvements may be made.

If you have an invention send us a sketch of it for report and ask for the books at the same time.

CHANDLEE & CHANDLEE, 953 F Street, Washington, D. C.

REGISTERED ATTORNEYS

Fresh Water for Stock without effort or expense

It's mighty pleasant to know there's plenty of water for your stock with no tiresome hand pumping or engine troubles ahead of you. That's exactly the situation when you



INSTALL A RIFE RAM ON YOUR FARM

—Any stream having a fall of 3 feet or more and a supply of 3 gallons or more a minute will operate it. Insures a constant, automatic, permanent water supply. No skilled labor required to install. Used with either overhead or air pressure tank. Over 11,000 in daily use. No freezing. No attention. Satisfaction guaranteed.

Tell Us Your Water Supply Conditions and we will estimate on a Ram for your requirements. Write today for catalog and particulars.

RIFE ENGINE COMPANY, 3131 Trinity Building, NEW YORK CITY

"IDEAL" Lawn Mower Grinder



Grinds all makes of Mowers perfectly in 15 minutes without removing wheels, ratchets or reel-knife. Ball-bearing; operated by either hand or power. Skate Sharpener Attachment for sharpening skates.

"You Grind It As You Find It"

Write Today for full information of this great labor-saver and money-maker. Will do the work so much better, quicker and easier you cannot afford to do without it. The only practical machine for sharpening Lawn Mowers on the market. Over 6000 in use. Fully warranted. Sold on easy-payment terms. Write today. Don't delay.

THE ROOT-HEATH MFG. CO., Plymouth, O.

DO YOU HAVE KNIVES TO GRIND, SILVER TO POLISH, SMALL TOOLS TO OPERATE, WASHING MACHINES OR WRINGERS TO RUN?

DO YOUR WORK

Attached to any water faucet will develop up to 3 Horse Power according to size of pipe and water pressure. Only perfect small motor made. Improved bucket wheel construction.

6 in. Motor for Mechanics and Tradesmen. Washing Machines, 3 H. P. on 3 in. pipe, 80 lbs. water pressure; 1 H. P. on 80 lbs. pressure, 2 in. pipe. Net price \$5, cash with order.

No. 1492—4 in. Motor for grinding, polishing, fans, sewing machines; for Doctors, Dentists, Druggists, etc., with emery, buffing wheel, silver polish and pulley, \$3.

No. 1493—4 in. Motor and pulley only \$2.50, cash with order.

Money back for any reason. Order your motor from dealer or from us. Send your water pressure and size of supply pipe. Active Agents wanted. Catalog free.

Only Motor to do this work



DIVINE WATER MOTOR CO. DEPT. P. UTICA, N. Y.

solid cherry wood. Important places in the map are marked by different kinds of wood contrasting in color. The streets are laid in white holly; city blocks, in mahogany; parks, in tulip wood; cemeteries, in bird's-eye maple; the Mississippi River, and other bodies of water, natural and artificial, are outlined in Circassian walnut; street railways are in red cedar; interurban railway lines, in rosewood; steam railroads, municipal buildings, and bridges being also represented by woods in different col-



CRESCENT WOOD WORKING MACHINES

are high in quality and moderate in price. Send today for catalog of hand saws, jointers, saw tables, planers, swing-saws, shapers, planers and matchers, variety wood workers, Universal wood-workers, disk grinders, borers.

The Crescent Machine Co. 93 Columbia St., Lestonia, O.



SEBASTIAN LATHES HIGH QUALITY LOW PRICES

Do you delight in good tools? Then you will delight in a Sebastian Lathe. We have been building Lathes for 25 years. The big factory at Cincinnati is equipped with modern and most improved machinery, and employs skilled labor only. Nothing is built there but Lathes. Specializing on this one tool, together with the larger number manufactured makes Sebastian Lathes

THE STANDARD FOR QUALITY AND LOW IN PRICE

Simple and durable construction makes them accurate and economical. This is proved by many re-orders and voluntary letters, like this one from The Kretschmer Mfg. Co.: "The Lathe we purchased from you 8 months ago is giving us entire satisfaction. We have given it severe work in every way that a Lathe is used, without the least deviation from perfect work. Should we have occasion to purchase another Lathe it certainly would be a Sebastian." Our reputation stands back of every Sebastian Lathe. It has got to be as represented or you get your money back. Ask for our new catalog and look over the lines of Lathes for general repair work, garage and automobile work, etc., and when you buy a Lathe—say "Sebastian." Address,

THE SEBASTIAN LATHE COMPANY, 107 Culvert St., CINCINNATI, OHIO



Sebastian 15-inch Lathe

Ideal for auto builder, garage, repair shop and general jobbing shop. Convenient, rigid, strong—rapid—accurate. Cuts standard threads with furnished gears from 5 to 96. Greatest machine in the world for small and medium sized work.

A Suggestion to Factory Owners

Send for Booklet "How Scotchie Made Good."



Start the New Year right by adding to your equipment this little labor and money saving device. No factory should be without one. A

boy can lace a broken belt in 3 minutes with the

"Clipper" Belt Lacer

TRADE MARK LACES IN THREE MINUTES

Will do the work so much better, quicker and easier you cannot afford to be without one. Let us send you one today on 30 Days' Free Trial; you run no risk whatever, you to be the sole judge. If after 30 days it does not do all we claim and give you entire satisfaction, send it back at our expense. For further information write

CLIPPER BELT LACER CO.
1032 Front Ave. Grand Rapids, Mich.



Print Your Own

Cards, circulars, menus, newspaper, book, &c. PRESS \$5, larger \$15, Rotary \$20. Save money. Big money printing for others. All easy, rules sent. Write factory for illustrated press catalog, TYPE, cards, paper, samples, &c. **THE PRESS CO., Meriden, Conn.**

ors. The foundation of the inlay is of five-ply basswood, making a plate 1 1/4 in. thick. The inlay itself is 3/16 in. thick, so that the top can be refinished many times without obliterating the pattern.

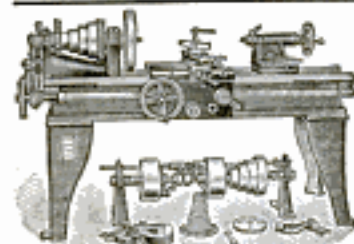

OUR BIGGEST LATHE VALUE

16-inch Lathe with 6-foot bed, \$252.00; other sizes at proportionately low prices. Every lathe guaranteed. Buy your lathe from us and save \$50.00 or more. Machinery Catalog No. 80P139 sent free on request.

SEARS, ROEBUCK AND CO.
CHICAGO

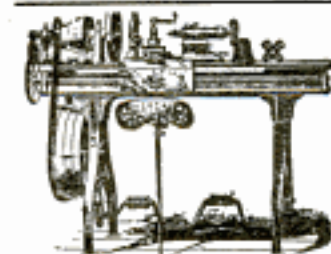

LATHES

9 to 18-inch Swing

List price \$75 and up according to size. When ready to buy send for Lathe Catalog and prices.

W. F. & John Barnes Co.
100 Ruby Street, ROCKFORD, ILL.



South Bend Lathes

For the Machine and Repair Shop

11 inch Lathe Complete,	\$100.00
12 inch Lathe Complete,	125.00
13 inch Lathe Complete,	165.00
15 inch Lathe Complete,	200.00
16 inch Lathe Complete,	250.00
18 inch Lathe Complete,	300.00

Straight or Gap Beds. Send for free catalog giving prices on entire line.
SOUTH BEND MACHINE TOOL CO.
423 Madison St., South Bend, Ind.

How to Run a Lathe

A 50 cent book for 10 cents. Postpaid, stamps accepted

\$2430⁰⁰ IN 90 DAYS

Twenty-seven dollars a day actual clear cash profits is what one man made in just three months with a Helm Press in a little town of 375 inhabitants. He saw a big opportunity in manufacturing pressed cement brick and blocks, was quick to grab it and is realizing big money now.

Look round about you. See how concrete is taking the place above all other materials in building construction. Realize what a chance is yours now to get in this big industry on the ground floor.

Twenty to fifty dollars a day profit is easily made with the Helm Press. You will be turning out a product that is as staple as sugar, as much in demand as the clothes on your back.

Ten Billion Brick are used every year in the United States. Thirty-three and a half million every working day of the year. Consider how enormous the demand, how contractors are crying for more brick. Be the one to supply this demand in your locality. You can start in this business. Be a manufacturer of pressed cement brick and make money from the start. No experience is necessary and as low as \$50.00 starts you.

There Are Big Contracts With Their Big Profits Ready For You

No matter where you are, how little the town or how big the city. Builders are turning to this product because it solves the problem of high cost of building. Concrete must take the place of wood, stone and clay. Here are experiences which you can duplicate in your community:



I landed a \$90,000 government contract with Helm pressed cement brick.

Just landed a contract for 400,000 Helm pressed cement brick.

We are working on a contract for half a million pressed cement brick.

Made a million brick this season on one of your Helm presses.

My daily manufacturing profits on pressed cement blocks average \$25.00.

Working on a contract for a quarter of a million pressed cement brick.

Made 17,000 pressed blocks for one contract in less than a month.

Six weeks behind on Helm pressed cement brick and block orders.

We want you to know more about these manufacturers who are landing the big business and making the big money. We want to show you how they started with but little capital.

Factory Owners are the biggest money makers in America and this machine will place you in their ranks. You can start with little capital and even without experience. This is the machine for you because it makes pressed cement brick and blocks under 80,000 pounds pressure. No tamping and easy work. It makes 1,000 blocks or 10,000 brick daily. No burning required. Ready for the market in a few days' time. Eventually some one will make pressed cement brick and blocks in your community, but now the opportunity is yours. No matter if cement products are now made there—these brick and blocks made by pressure will be demanded.

The possibility of failure in this business is almost eliminated. You can enter it with almost a dead certainty of meeting success. Costs you nothing to learn all about it. Fill in the coupon here, mail it today and receive free, full information of the Helm Press and money to be made in the cement brick business.

Helm Brick Machine Co.

122 Mitchell St., CADILLAC, MICH.

Please send FREE the book on concrete and Helm presses.

Helm Brick Machine Co.

122 Mitchell St., CADILLAC, MICH.

NAME.....

ADDRESS.....



Powerful, Compact, Convenient

This "Yankee" Push Brace No. 75 can be used in tight corners and places where the bit-brace is a clumsy tool.

No. 75 has famous "Yankee" Spiral Ratchet drive, all you do is "push." Quick on boring—holds all usual wood drills and bits with square shanks up to $\frac{1}{2}$ inch. Speedier than any other tool for light drilling in metal, for driving or drawing heavy screws, or running-up nuts on bolts. On automobile or light machinery repair work, and about the garage it is a tool of big usefulness.

"YANKEE" Push Brace No. 75. Price \$2.80

Heavily nickeled. Hardwood polished handle. Drop forged, hardened steel jaws. Length $16\frac{1}{4}$ inches closed— $23\frac{1}{2}$ inches extended. Every detail finished and surfaced with "Yankee" skill that reduces friction to a minimum, and built for strength and long life.

Your Dealer Can Supply You

Write for "Yankee" Tool Book" FREE—for mechanics and amateurs. "Yankee" Tools in the Garage" for Motorists.

North Bros. Mfg. Co.
PHILADELPHIA

"YANKEE" TOOLS
Make Better Mechanics

The Hardware Man has a Carborundum Stone for You



A sharpening stone that cuts fast and clean—that will not fill or glaze, if properly used—a stone that holds its shape and really *CUTS* the edge on the tool.

A Carborundum Sharpening Stone should be in your tool-kit.

Made in many shapes and sizes—and for every sharpening need.

Ask to see the round combination Carborundum Bench Stone.

THE
CARBORUNDUM
COMPANY
NIAGARA FALLS, N. Y.

Please Mention Popular Mechanics

MAKE \$250.00 A MONTH
Repairing AUTO-Tires
MOBILE

Sounds like a lot of money
 —IT IS—A WHOLE LOT of MONEY
 to be earning CLEAR every month—yet it's
 what hundreds of men we have established in the
 Automobile Tire Repair Business are making.

You let down the DRAW BRIDGE for SUCCESS to enter into
 your career by getting into business for yourself. The business for
 you is the one where investment is small—the returns quick and for cash
 —where the margin of profit is large—the demand for your PRODUCT or
 SERVICE constant and ever on the increase.

A Haywood Tire Repair Equipment

answers to all of these requirements of Old Dame Fortune—the certainty of success in this
 business is as sure as anything in this world can be—Each year adds thousands of new
 Automobile Owners—they need YOU to keep their tires in service.

Here Is Your Opportunity!

Be first to enter this new big paying business in your town. Open your pockets. Let the dol-
 lars pour in. Act quick. Every auto sold means more tires to mend. Automobile business is
 growing fast—enormous field for tire repairing. Punctures and blowouts are common. Tires need
 retreading and vulcanizing. Something going wrong all the time. Thousands forced to buy new
 tires because they can't get old ones fixed. Think of the old bicycle days—repair shops on every
 corner—all making money—busy day and night. Autos make same proposition over again—only
 ten times bigger and better. Users of Haywood Tire Repair Plants are making big money. Johnson,
 Tex., writes: "I have made as high as \$18 in a day." Another man who bought a plant Septem-
 ber, 1911, writes he has cleared over \$3000.00. That's going some! Operate a plant as side line
 in connection with auto business—garage or as
 an independent business. Find neighbor-
 hood where there's a bunch of autos—get
 all the steady business besides transient
 work. Experience unnecessary. You learn
 quick. Simply follow directions—practice
 a few days on a couple of old tires and
 you'll be ready to coin money. Business
 comes fast and easy.

The New Money-Making Business—Start Now

This Man is Making
 Money

This
 Bunch
 of Tires
 Will Make
 Several
 Dollars
 Profit

Business
 Keep Coming

Put
 Your-
 self
 Where
 This
 Man
 Is

Repair Tires At Home.

Young men! and boys repair father's tires—get
 money he pays garage man. Get the neighbor's
 work. Make money to attend college or to start
 a garage and repair business. Auto owners—re-
 pair your own tires—save money—pay for your outfit
 in short time. We have outfits for home use. Any-
 how investigate. Send today for catalogue. See the
 wonderful possibilities in this marvelous field. Learn
 of the enormous money-making opportunities in
 this fascinating new business.

Haywood Tire & Equipment Co.
 842 N. Capital Avenue
 Indianapolis, Indiana

Please Mention Popular Mechanics

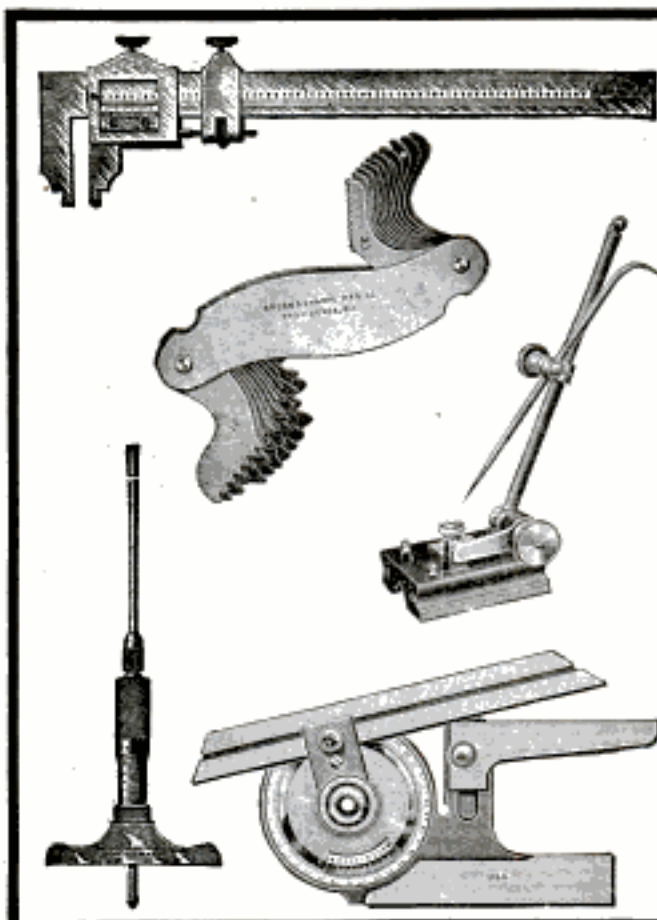

Ever Use Any of These?

If you want a kit that is ready for any job, you need them. But whether you are buying these shown here or others, you want tools that "feel right" in your hand. You want them handy and always to be trusted. It's good tools that make you do your best work.

BROWN & SHARPE Machinists' Tools

are the well finished, reliable kind that every mechanic is proud to own.

There are micrometers, verniers, dividers, protractors, squares, rules, indicators, gauges of every sort; so many kinds and so attractive that you should stop in at the nearest big hardware store and ask for one of our free catalogues, illustrating and describing them all. Or drop us a postal and ask for Catalogue No. 25.

BROWN & SHARPE MFG. CO.
Providence, R. I.

"Fixing to stay!"

Your tools should serve properly and remain in good shape. This thought gives us the opportunity to tell you of the efficiency and satisfactory character to be found in every tool offered by Williams. Goodness was deliberately planned for and we'll "make good" if proved not that way.



"Vulcan" Tool Makers' Clamps
4 sizes, capacity 0 to 4"

Clamps for Every Purpose

NEW (FREE)
CATALOGUE
IN FEBRUARY

J. H. WILLIAMS & CO.
SUPERIOR DROP-FORGINGS
47 Richards St.
Brooklyn, N. Y. City

Western Warehouse
32C So. Clinton St., CHICAGO, ILL.

How to Solder 10c

Solder at home—save money. Solder for others—make money. Send 10c in stamps for complete instructions, fully illustrated. Money back if not satisfied.

THE M. W. DUNTON COMPANY, PROVIDENCE, R. I. IN STAMPS

CHEAP METHOD OF PREVENTING FLY BREEDING—According to a recently made statement by the Department of Agriculture, borax will kill fly eggs,

Searight Compound Lever SNIPS \$1.00 to \$3.50

Made of Crucible Tool Steel. Smallest sizes cut up to 18 gauge, largest cut 16 gauge at the point easily. Just the tool for you to matter what your trade.



7 inch	\$1.00
8 "	1.50
10 "	2.25
12 "	3.00
14 "	3.50

7 inch size pressed, all others drop forged.

Bartlett Manufacturing Company Box 5, Boylston Bldg. DETROIT, MICH.

RED DEVIL No. 50



Drop Forged,
Hand Honed
Side Cutter

New style dentyne milled handles of latest scientific shape.

Red Devil Tools are made by good mechanics for good mechanics. At your dealer's or send 75 cents for sample 6-inch size. Send for booklet of RED DEVIL Tools anyhow.

SMITH & HEMENWAY CO. 161 Chambers Street NEW YORK CITY

Starrett Expansion Pliers

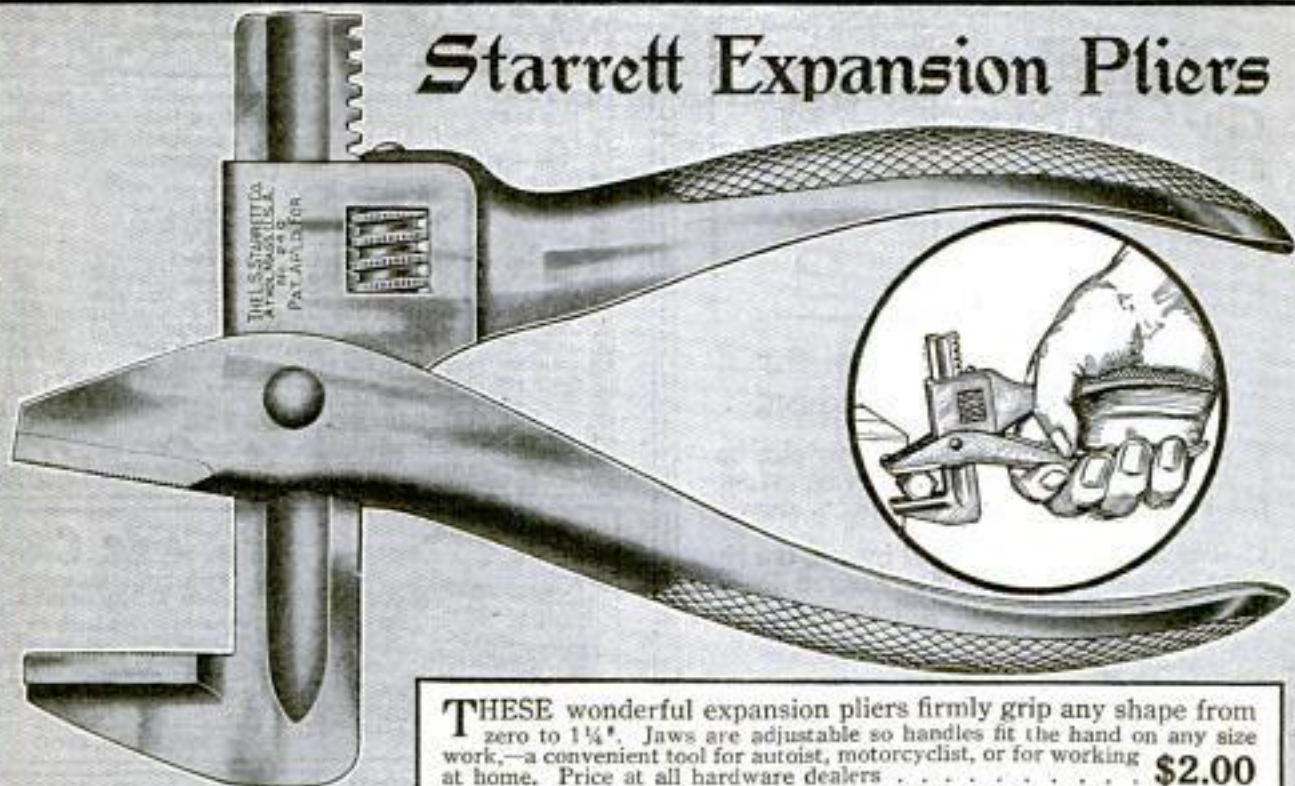

THESE wonderful expansion pliers firmly grip any shape from zero to 1 1/4". Jaws are adjustable so handles fit the hand on any size work.—a convenient tool for autoist, motorcyclist, or for working at home. Price at all hardware dealers **\$2.00**

Send for free catalog No. 20A P.

43-423

The L. S. Starrett Co. Athol, Mass.
World's Greatest Toolmakers

and about 2 oz. per garbage can will prevent flies from breeding. Propagation in stables, garbage piles, rubbish heaps, and in fertilizer can thus be prevented cheaply without lessening the value of the decaying matter for use by the farmer. Borax, to the amount of 2/3 lb., or 3/4 lb. of crude calcium borate, was found to eliminate breeding of flies in eight bushels of fertilizer. This discovery will doubtless assist health authorities in campaigns against the typhoid fly, and contractors should welcome the method as an aid to keep construction camps free from flies.

Union Geared Scroll Chucks

with two sets of jaws



Made in a wide range of sizes

Union Mfg. Co., New Britain, Conn.

\$1.00

Postpaid

Myers' Wonderful Sewing Awl

sews leather, canvas, shoes—anything, heavy or light. Complete repair shop in itself. Saves many trips to town. Mends harness, saddles, wagon covers, blankets, huggy tops, belts, etc. Can't get out of order. Original and only awl with diamond point full grooved needle to protect the thread. BIG MONEY FOR AGENTS.

C. A. MYERS CO., 6339 Lexington Ave., Chicago, Ill.

SIMONDS NO-SET HAND SAW

Cuts Smooth Like a Plane

This new Simonds Saw gives a cut which is almost as smooth as if sand-papered—the sides of the cut are finished by the saw.

It runs with more freedom and ease than the ordinary saw—with great speed and trueness.

For finishing almost any kind of work, for quick cutting any kind of

dry wood, you need this saw, no matter how many saws you now own.

It is a most beautiful and workmanlike tool, with a Simonds special crucible steel blade, straight back, four brass screws and large hand hole in a carved and polished apple-wood handle. Price, \$3 each. If your dealer doesn't have it in stock, we will send it charges prepaid on receipt of price.

Simonds Mfg. Co.
"The Saw Makers"
Fitchburg, Mass.
(Founded 1822)



Stanley Tools

Adjustable Bit Gauge

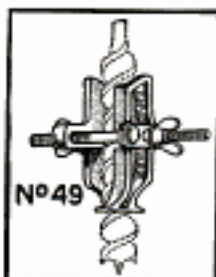

A most convenient tool for Anyone using a Brace and Bit.

It can be attached to bits of any size up to one inch in diameter and can be set for the bit to bore holes of a uniform depth.

It is so constructed that it insures the bit remaining upright when the desired depth is reached, thus preventing the worm being bent or broken.

Price 50c Each

If you cannot procure this tool from your hardware dealer, we will upon receipt of price forward same postage prepaid to any part of the United States. Address—

STANLEY RULE & LEVEL CO.
NEW BRITAIN, CONN. U.S.A.

GASOLINE SOLDERING IRON BLOWTORCH

GUAR on Charcoal and Gasoline Fire Pots
Address Dept. 1, EMMELMANN BROS. MFG. CO., INDIANAPOLIS, IND., U.S.A.

Large Profits from Small Capital



A Business of your own bringing you an income of at least \$10.00 per day with practically no experience or overhead expense.

The Green AUTOMATIC MACHINE

sharpens, hones, and stropps all kinds of safety razor blades, all in one operation, at the rate of 150 to 250 blades per hour, you can readily figure your profits. Let us send you our free booklet explaining everything.

Am. Sharpening Machine Co. (Inc.)
Dept. 2, 184 W. Washington St., Chicago

A Bench like this is just the thing for the home.

OHIO TOOLS



REGISTERED

Planes, Chisels, Auger Bits, etc.
It will pay you to insist upon getting tools of this brand.

CATALOG FREE

OHIO TOOL CO.
Dept. 3 Charleston, W. Va.



YOU CAN DRILL WHERE YOU CANT DIG

There is a big opportunity in every community for a capable man to establish himself in the well drilling business and make money. The right kind of a man with the right kind of equipment can be independent. Let your equipment be

★ DRILLING MACHINES

Equipped with either steam or gasoline power. Thousands of STARS are now in use. The demand for drilled wells is increasing. You can drill where you can't dig. It is a well known fact that there are but few places where water cannot be obtained by drilling. Write us today for catalogs (enclose 5c for receipt) and let us show you the superiority of STARS. Furnished on payments, if desired.

THE STAR DRILLING MACHINE CO.
506 Washington Street Akron, Ohio



Portable Cases

FOR TOOL MAKERS AND MACHINISTS

Twelve styles, felt lined drawers, solid brass trimmings, best of material, beautiful finish, low prices, satisfaction guaranteed. Ask for booklet of cases built for service.

The Pilliod Lumber Co.
SWANTON, OHIO

THE MASTER SLIDE RULE



IMPROVED INTERLOCKING RUST PROOF - POOL PROOF
the only RULE IN THE WORLD whereby inside measurements of doors and windows, etc., can be taken rapidly and accurately. Also superior to any other and closed instantly. MECHANICS, BUILDERS, AND ARCHITECTS, TRY ONE TODAY! DON'T WAIT. Ask hardware dealer for it.
On receipt of 25 cents per linear foot, a 4, 5, 6 or 8 foot rule will be sent to you prepaid. Large profits to agents. Write for circulars and particulars.
DAHL MFG. CO. 51-A East 42nd St. NEW YORK CITY

IMPROVEMENT IN CONCRETE RAILROAD TIES—A process of manufacturing perfectly homogeneous reinforced-concrete ties mechanically has been discovered and practically applied in France. Fine iron turnings are mixed with concrete, and then pressed together to shape under powerful hydraulic presses. Ties of this type have been in use for two years, and are said to be giving complete satisfaction.

YOU OUGHT TO HAVE ONE OF OUR Insured "Vandor" Hammers

—Drop forged from Vanadium Steel, tempered in oil and warranted for a Lifetime. Best Postpaid anywhere on receipt of \$1 and Dealer's Name.

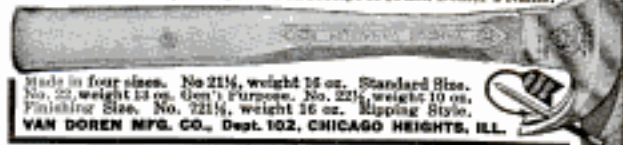

Made in four sizes. No. 21½, weight 16 oz. Standard Size. No. 22, weight 13 oz. Gen's Purpose. No. 22½, weight 10 oz. Finishing Size. No. 22¼, weight 16 oz. Mipping Style.
VAN DOREN MFG. CO., Dept. 102, CHICAGO HEIGHTS, ILL.

MILLERS FALLS TOOLS

Braces Drills Hack Saws Mitre Boxes

Do Better Work and Last Longer

Write for catalog showing complete line.

MILLERS FALLS CO., Millers Falls, Mass.

FREE THIS VALUABLE HAND BOOK

Tells how to help save money for yourself or employer. Just the thing for Mechanics, Electricians, Engineers, Contractors and Executives. Write today for this handbook — FREE.

State your business

VAN EXPANSION BOLT MFG. CO.
1209C Fort Dearborn Bldg., Chicago, Ill.



Freedom
with Fit
Comfort
with
Style



HERE'S a horsehide glove—designed for driving or work, and made as carefully in details as the finest kid. Easy, yet not "baggy," and slips on and off in a jiffy. Allows finger-freedom (almost like bare hands) with perfect fit and style.

Hansen's Dan Patch Glove

cannot scuff, harden, crack or peel, and gives far greater wear than the best kid glove. Cheaper in the end than a dozen flimsy makeshifts.

Send for Free Book of Gloves

At your dealer's or write for information

O. C. Hansen Mfg. Company

291 A. A. Milwaukee St. Milwaukee, Wisconsin

GOETHE'S PROPHECY OF THE PANAMA CANAL—In a book, entitled "Conversations with Goethe," and written by a close companion of the poet's declining years, may be found, according to Office Appliances, the following statement by Goethe, made early in the year 1827, on the subject of a Panama canal:

"If a cut of this kind should prove successful to the extent of making it possible for ships of any cargo and of any size to pass from the Gulf of Mexico into the Pacific Ocean, this would result in incalculable advantages for the entire civilized world. It would surprise me if the United States should allow itself to miss the opportunity of undertaking such a task. It is to be foreseen that this youthful country, in view of its decided tendency toward the West, will have taken possession of, and populated, the vast areas beyond the Rocky Mountains in thirty or forty years' time."

PRINCE ALBERT

the national joy smoke

Book Tells All

Stoves & Ranges



A Kalamazoo
Direct to You

Secrets about ranges—their low cost at factory—and how to get the actual factory price yourself. A genuine glass oven door model put in your kitchen for a long free trial—year's test. \$100,000 backs up guarantee. Postal card may save you \$25. Write today. Ask for catalog No. 473.

Kalamazoo Stove Co.
Manufacturers
Kalamazoo, Michigan

GOODELL PRATT

1500 GOOD TOOLS

You Push—He Twists

Zip—there's a clean, round hole through broom handle or just deep enough to start a screw straight, as you wish.

Mr. Punch will drill through an inch of solid oak in twenty seconds. He's a joy to man and boy; and, for women, takes the terrors out of tinkering.



Curtain fixtures go up quickly and neatly if Mr. Punch first drills the holes.

Mr. Punch



Send for book listing fifteen tools useful in the home

is known to mechanics the world over as G. P. Automatic Drill No. 185. It is built on a spiral principle and rebounds smartly from each stroke. You simply place the drill point and push. Made of brass, nickel plated. Has eight tempered tool-steel drill points in handle, seen through numbered holes. Turning the cap releases the drills.



Lathes Hack-saws
Micrometers Vises
Saw Sets Gauges
Grinders Levels
Calipers Screwdrivers
Punches Drills
Bit Braces Squares

Goodell-Pratt make 1500 good tools with high reputation among mechanics for quality and finish.

Buy Mr. Punch at hardware stores—\$1.50. If your dealer does not have it, Mr. Punch will be shipped direct on receipt of price.

GOODELL-PRATT CO.
Greenfield, Mass.

Toolsmiths

Please Mention Popular Mechanics

Going to Build Remodel or Repair?

YOU can actually save one-third to one-half on your building material bill, so write today for these two free books and see and judge for yourself.

Our Building Material Catalog shows 8,000 price bargains and our Plan Book shows splendid views and floor plans of 50 modern homes and bungalows. You can remodel, repair or build new for much less than you expected.

We ship everywhere everything in the way of high-grade lumber, flooring, roofings, doors, windows, storm sash, mouldings, porch-work, screens, hotbeds, building hardware, paints, wallboard, plumbing, heating and water supply outfits, cement machinery and interior woodwork—**ALL AT WHOLESALE PRICES DIRECT TO YOU.**

Don't plan to build, repair or overhaul until you see these two great books. Quality, safe delivery and satisfaction absolutely guaranteed. Write for them today.

CHICAGO MILLWORK SUPPLY CO.
1444 W. 37th St.
Chicago, Ill.

Material Complete for Houses from **\$398.00** up

Catalog of 8,000 Price Bargains

Beautifully Illustrated PLAN BOOK

Books Are Free

SHOEMAKER'S BOOK ON POULTRY



and Almanac for 1915 has over 200 pages with many colored plates of fowls true to life. It tells all about chickens, their prices, their care, diseases and remedies. All about incubators, their prices and their operation. All about poultry houses and how to build them. It's an encyclopedia of chickendom. You need it. Only 15c.

C. C. SHOEMAKER, Box 1107, Freeport, Ill.

MONEY IN POULTRY Start small. Grow **BIG.**
and SQUABS Get winter eggs. Keep healthy fowls. Save your chicks. **Foy's big book tells how.** Describes largest poultry and pigeon plant. Shows fowls in natural colors, how to feed for eggs, how to select best layers. Mailed Free.

F. FOY, Inc., Box 39, DES MOINES, IOWA

Chickens

And Their Profits!



All told about in latest Old Trusty Book mailed free—gives real A B C of poultry profits. Write quickly for copy—learn how you can make big profits anywhere, any time, in any weather with



\$5.00
Less Than
Anyone
Else Could
Sell It For

Write
for Big
Free Book

OLD TRUSTY

Insures a safe and sure income the whole year around. 630,000 in use—three or four times more than any other. 30 to 90 days' trial—10 years' guarantee—Old Trusty fulfills every promise or we trade back. Less than \$10 buys it. Freight prepaid east of Rockies—just a trifle more delivered clear to Pacific Coast. Write—get chickens making money for you. Address

M. M. JOHNSON CO., Clay Center, Neb.

The Truth About Poultry



Get the Facts by Reading

The One-Man Poultry Plant

Successful Methods of Men on Farms or Small Acreage. Complete in twelve parts; printed in one volume.

By **DR. N. W. SANBORN**

REAL work, with real poultry, on a real New England Farm. This is a simple story of what has been done by a man, at forty-five years of age, town bred and city educated, getting out of practice of medicine, buying a small farm in the hill country, and making a success of the venture. Not only is the rearing of chicks and the management of adult fowl completely covered, but the interesting side issues of fruit growing, grain raising and the production of milk, that cannot be escaped on a real farm. You get rugged facts—rarely found in print. The truth about poultry as found in actual life on a one-man poultry farm.

You Can Do the Same, Book Tells How

OUR SPECIAL OFFER—The One-Man Poultry Plant, in twelve parts (book form), and the American Poultry Advocate, one year, for only 50 cts., book and Advocate, three years, for only \$1.00, if order is sent at once.

Our paper is handsomely illustrated, practical, progressive and up-to-date on poultry matters. Established 1892. 44 to 132 pages monthly. 50 cents a year. 3 months' trial 10 cents. Sample copy free. Catalogue of poultry literature free. Address

AMERICAN POULTRY ADVOCATE, 523 Hodgkins Bldg., Syracuse, N.Y.

"I, therefore, repeat: It is absolutely indispensable for the United States to accomplish a passage from the Gulf of Mexico into the Pacific Ocean, and I am certain that it will come to that."



Greider's Fine Catalogue

and calendar of pure bred poultry; 70 varieties illustrated and described, many in natural colors. A perfect guide to poultry raisers—full of facts. Low prices on stock and eggs for hatching. Incubators and brooders. 22 years in business. You need this noted book. Send 10c for it—today.

B. H. GREIDER, Box 19, Rheems, Pa.

Hatches Every Chick

Poultry raisers ought to follow the simple and easy Buckeye system, which positively hatches every hatchable egg. How to make \$200 a season with one incubator that costs \$7.50 is fully explained in a most interesting book which will be sent absolutely free to any reader who mentions this magazine. Everyone should write today for this valuable free book to

BUCKEYE COMPANY, 635 Euclid Ave., Springfield, O.

Join World's Champions

13 more championships won by owners of Belle City hatching outfits. Makes **21 Times** **Belle City World's Champion** Free Book "Hatching Facts" tells whole story. My \$800 Gold Offers come with Free Book—Money-Back Guaranty. Hatching outfit shown in actual colors. Jim Rohan, Pres. Belle City Incubator Co., Box 164, Racine, Wis.



13 more championships won by owners of Belle City hatching outfits. Makes **21 Times** **Belle City World's Champion** Free Book "Hatching Facts" tells whole story. My \$800 Gold Offers come with Free Book—Money-Back Guaranty. Hatching outfit shown in actual colors. Jim Rohan, Pres. Belle City Incubator Co., Box 164, Racine, Wis.



Values Ripped Wide Open

Big Money in Poultry



My 1915 values are creating a SENSATION. I have the largest incubator factory in the world. My tremendous output is enabling me to rip values wide open. The same high-grade world-beating quality that has made RELIABLE INCUBATORS AND BROODERS the standby of experienced poultrymen all over the world. Don't buy until you get my 1915 price and book of facts. You'll regret it IF YOU DON'T. Write now. **J. W. MYERS, Pres., RELIABLE INCUBATOR & BROODER COMPANY, Box B-81, Quincy, Ill.**

Famous Acousticon

You must not confuse the Acousticon with any other instrument. The Acousticon is the instrument which you regulate instantly to clearly

Hear Every Sound

near or distant—loud or low, indoors or outdoors, under every conceivable condition. The Acousticon receives the sound by our exclusive indirect principle, and transmits it to your hearing in its original tone. Not a word blurred—not a single sound is harsh. The Acousticon covers

48 Degrees of Deafness

Unless "stone deaf" the Acousticon enables you to hear every sound—perfectly. Not a theory—not new or untried—but a world-known success for many years.

NO DEPOSIT

Ten Days Free Trial
Write for special limited offer—no money down—not even a promise to buy. Let us prove the Acousticon is the instrument you must use.

EASY TERMS Learn how to secure an Acousticon on easy monthly payments before special offer expires.

WRITE now for greatest free book of facts for the deaf—testimonials from ministers, judges and hundreds of others everywhere.

General Acoustic Co.,
1327 Candler Bldg., 220 W. 42nd St. New York City
468 Yonge Street, Toronto, Canada

on
free
trial



for
the

DEAF

Now Direct By Mail

THROW YOUR VOICE!



Into the next room, under the bed, down cellar, or anywhere. Fool your teacher, parents or friends. **LOTS OF FUN.**

The Ventrilo is a little instrument that fits the roof of the mouth, out of sight. Boys or Girls can use it. Sample with instructions in the art of **VENTRILLOQUISM**, with our big catalog of **Novelties**, books, games, etc. All by mail for **10cts.**

ROYAL NOV. CO. Desk B So. Norwalk, Conn.

300 C P Triumph Stand Lamp

Besides sunlight there is no other equalling that of the Triumph Lamp. Stand, System or Gravity. Its beams, pure white, brilliant yet mellow, will flood the largest living room with perfect illumination.

PRaised by STUDENTS and MECHANICS as the one perfect light for Home, Office and Work Bench. Excels electricity or gas in brilliancy—safe and gives ten times the light of the old style round wick burning Kerosene Lamps—a menace to the eyesight. You get the light of mid-day for less than 1/10 an hour.

(Agents Wanted) **BRILLIANT GAS LAMP COMPANY**
10095 So. Wabash Ave., Chicago, Ill.



Just Out!

New, wonderful sensation. No experience necessary to operate the **"Mandel-ette"**

A One Minute Camera that takes and finishes pictures in 1 minute

No Plates—No Films—No Dark Room

The "Mandel-ette" weighs 24 ounces. Embodies camera, developing chamber and dark room. Special lens with universal focus. Perfect working shutter. Capacity 50 size 2 1/2 x 3 1/2 inch post cards, loads in daylight. Everything simple—a child can operate it.

SPECIAL INTRODUCTORY OFFER

To introduce the "Mandel-ette" everywhere, we will send you complete outfit for \$5. By parcel post 50 cents extra. Money back if not satisfied. Outfit contains "Mandel-ette" Camera and supplies to make 16 finished post cards. (Additional cards, 25c per package.) Send \$5 with this ad today or write for FREE, descriptive booklet.

THE CHICAGO FERROTYPE COMPANY
4463 Ferrotipe Bldg., Chicago, or Dept. A463, 89 Delaney St., New York

Learn Plumbing!

Start a Business of Your Own

Plumbers are in great demand in all parts of the country. In Chicago Plumbers earn \$6.00 a day for 8 hours work and \$12.00 a day for overtime. In some



parts of the country they receive \$9.00 a day. The plumbing business is growing every year and there are thousands of openings to start a plumbing business in good growing towns and cities. Our course in Plumbing and Sanitary Engineering is by actual practical work. Drawing and estimating is taught with the plumbing course.

Free Employment Bureau is maintained for our students. 1915 will see the biggest year in the building business in the history of Chicago. Now is the time to prepare for the big rush. In order to meet this demand we are making a great special offer. Send today for our "Book of Trades" and full information.

We Teach You in a Short Time —at Small Expense

In order to supply more practical plumbers we are charging a small tuition fee. Your tools and equipment of all kinds are furnished FREE by the School. You may have easy payments if desired. Our course of instruction is clear, simple and thorough. Our Graduates demand handsome salaries. Don't pass up this opportunity.

FREE TOOLS

We will furnish all the material and tools you use in taking our course — **ABSOLUTELY FREE**. All we charge is a very small amount for tuition. Many of our students earn their expenses while taking the course.

Men Wanted for these Trades

Plumbing Electricity
Bricklaying
Moving Picture Operating
Mechanical Drawing

We also teach the trades mentioned above. There are unlimited possibilities in any one of these trades. When you have completed our course you will be in a position to demand from \$5.00 to \$8.00 a day right at the start. Or go in business for yourself and make from \$3,000 to \$5,000 a year.

Send the FREE COUPON for Catalog and Particulars

No obligations on you at all. Just fill out the coupon and mail it today. Take this step towards success. Let us tell you how you can master plumbing or any other profitable trade in a short time—make a bigger success than you ever dreamed of making. Fill out the coupon and mail it at once.

L. L. COOKE, Director

Coyne National Trade Schools
39-51 E. Illinois St.
Dept. 9192
Chicago Ill.

FREE COUPON

L. L. COOKE,
Director

Coyne National Trade Schools
39-51 E. Illinois St.

Dept. 9192, CHICAGO, ILL.

GENTLEMEN: Without any obligations on me whatsoever, please send me your school catalog and full particulars of this offer to men — **ALL FREE.**

NAME

ADDRESS

Please Mention Popular Mechanics

A Real Kerosene Engine

Here's the biggest engine value ever offered in a 1½ H. P. engine. Same cylinder capacity as many 2½ H. P. engines. Throttling governor adjustable while running; crankshaft extends on both sides. Runs either way. Starts without cranking. Equipped with Ellis Patent Fuel Device, guaranteeing successful operation on cheap oils. Beautifully finished in genuine engine enamel.

Runs on 9c a Day Just the engine for pumping, separating, churning, corn-shelling, sawing, shop work, electric lighting and dozens of other light jobs. Sold on 30 days' trial. Guaranteed for 10 years. We make other sizes from 3 to 18 H. P., vertical and horizontal, single and double cylinders.

Ask for our free book, "ENGINE FACTS," telling how to judge and buy an engine.

ELLIS ENGINE CO., 2873 E. Grand Blvd., Detroit, Mich.

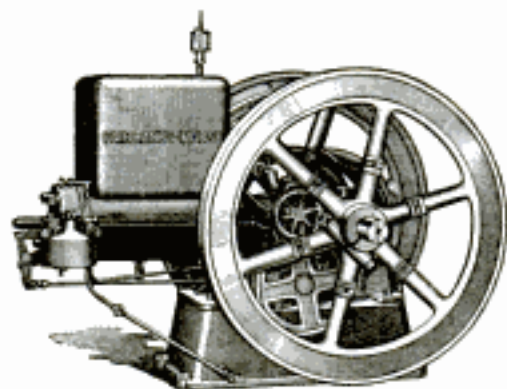
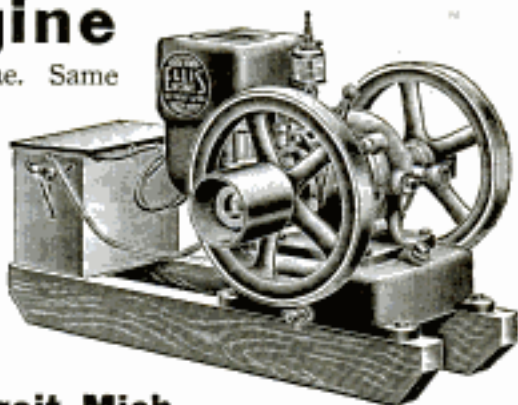

Here's the Engine for Zero Weather

or hottest days because it runs without readjustment under light and heavy loads — in cold or hot weather — on low priced fuels. Let us tell you how the construction of our "Multi-fuel" Oil Engine makes this possible.

Fairbanks, Morse & Co.
Chicago New York San Francisco

(449-207)

More Power For Less Money 6 H.P. \$98.75



The New Galloway Masterpiece "Six" is the most down-to-the-minute engine that mechanical ingenuity can produce. It is perfectly adapted to furnish power to the shop, the mill, the contractor anywhere and where ready, steady, reliable, efficient and economical power is needed.

My New 1915 Proposition is the greatest offer ever made by any manufacturer and is the first time in the history of engine building that an A 1 high-grade engine of this h. p. could be bought for so low a price. Write for particulars and price-reducing sliding scale schedule.

Wm. Galloway, Pres.
The Wm. Galloway Co.
925 Galloway Station, Waterloo, Iowa



WASTE IN METALLURGICAL COKE MANUFACTURE—The coal used in metallurgical coke manufacture in the last five years has averaged about 85,577,000 tons, yielding 43,983,000 tons of coke, valued at \$111,736,000. Of this total, 14,767,000 tons were used in by-product ovens, yielding besides the coke, 54,491,000,000 cu. ft. of gas, 94,300,000 gal. of tar, and \$9,109,000 worth of ammonia. When it is considered that every year over four times these enormous totals of by-products are absolutely wasted through the use of other types of ovens, the importance to the country of a general use of the modern, scientific by-product oven will be appreciated.

"VIM" ENGINE



\$25 COMPLETE

Save money by using a **VIM 1½ HP. Farm Motor** for churning, washing, pumping, separating, spraying, etc. Women operate easily. No valves, cams, gears or complicated parts. Water Cooled, automatic positive lubrication, sensitive governor. Weighs only 75 lbs. Comes ready to run. Fully guaranteed. Get catalog and special agency offer.

THE VIM MOTOR CO., 802 Water St., SANDUSKY, OHIO

FREE TRIAL 30 DAYS BESSEMER NON CRANKING KEROSENE ENGINE

"The Masterpiece of the Largest Manufacturers of 2-Cycle Engines in the World"

It isn't the first cost of an engine—IT'S THE RUNNING COST THAT COUNTS. Economy of fuel and the sureness with which they run have made Bessemer Kerosene Engines the greatest little hustlers in the world. No carburetor troubles because the famous Bessemer Universal Fuel Feeder feeds automatically for a light or heavy load, thus preventing any waste of fuel. Non-cranking, only 3 moving parts, change of speed, etc. 2 to 10 H. P. 30 days' free trial. Immediate shipment. Write for Catalog "R."



BEST FOR WASHING MACHINE

Bessemer Fuel Oil Engine

Lower picture shows the famous Bessemer Fuel Oil Engine. Widely used in irrigation, flour mills, factories, electric light plants, etc. Runs on cheap fuel and crude oils. No batteries or magnets required; ignition is automatic after starting. 15 to 165 H. P. Special Catalog "O" free.

THE BESSEMER GAS ENGINE COMPANY
121 Lincoln Ave. Grove City, Pa.

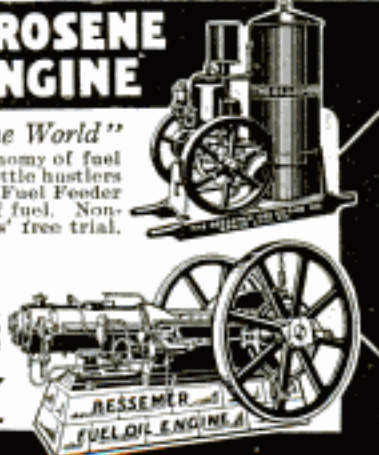

Economy Year after Year



ENGINE buyers who consider the simple, sturdy, efficient construction of I H C engines, and study the great I H C features, know that it is the part of wisdom to buy International Harvester Oil Engines. But not until after several years of steady power delivery will they really appreciate the great economy in I H C quality. They will have spent less than other engine users for fuel and repairs, received steadier power, paid less attention to engine operation—and they will have the soundest engine for future service.

International Harvester Oil Engines

are furnishing the most economical satisfactory power to thousands of users. The engine for your particular need—whether ordinary or unusual—is in the I H C line. I H C engines range in size from 1 to 50 H. P.; styles—vertical, horizontal, stationary, portable, skidded, hopper and tank cooled. They run on any one of a half dozen fuels.

Local dealers everywhere sell I H C engines. Write and we will direct you to the nearest one. Let us send you one of the interesting illustrated catalogues, explaining I H C engines and special I H C features in detail.

International Harvester Company of America
(Incorporated)
16 Harvester Building Chicago U S A

WONDERFUL New Camera



The newest invention in cameras. Scientifically constructed and so easy to operate that errors are practically impossible. Fitted with a genuine Acoustic Lens, automatic focusing device, wide rigid bed to assure accurate optical alignment and new flexible wire release.

Write for the Camera Book. Backed by an unlimited guarantee.

Never before have you been able to get high-grade cameras at anywhere near the low prices at which you can get the great new Ingenios.

Write for "The Camera Book" Send your name and address. No obligations. Write today.
Burke & James Inc. 240-258 E. Ontario St. Dept. 1192, Chicago, Ill.



Building? Get This Free Book

It tells all about the proper method of finishing floors and interior woodwork, and improving furniture. A big help in beautifying the home—new or old.

Johnson's Wood Dye

Comes in 17 harmonious and natural shades. Makes cheap, soft woods as artistic as hard woods. If you are interested in building we will mail you free a Dollar Portfolio of Wood Panels, showing all popular woods finished with Johnson's Wood Finishes. Remember—the Panels and the 25c book Edition PA2 are Free and Postpaid.

Take this ad to your dealer—or write.

S. C. Johnson & Son, Racine, Wis.
"The Wood Finishing Authorities"

FREE TRIAL— 10 to 30 Days



on any strictly high-grade violin in our famous stock of rare instruments. A positively free trial right in your own home. There are no strings to this liberal offer. Send in the coupon for details.

We make and import all our own instruments and sell direct, giving you the benefit of the regular middleman's profits. We have 34 years of expert violin experience.

We will allow you 10 to 30 days' trial free. We insist that you shall be satisfied and we will pay the express charges both ways on any returned instruments. Send the coupon today—now.

Rare Offers Now

Our instruments are all fine hand-made tone violins for professional use, sold at exceptionally low prices for the value given. Some styles are wonderful copies of old violins, owned by the greatest artists. They are far superior in quality and power of tone to the old violin at four times the cost. Test any instrument you choose, right in your own home at our expense. Many wonderful values just now. Easy payments if you prefer not to pay cash.

Free VIOLIN BOOK

Write today for free copy of the new Lewis catalog of Violins, Cellos, Etc. Don't think of buying a Violin, Cello, Viola or other stringed instrument until you have seen this book. War conditions have not affected the price of our violins. A fortunate purchase enables us to make our special offers of rare bargains in high-grade violins at no advance in price. While others ask as much as double their former prices, we still make our special rock-bottom offers on all violins. Write for Violin Book—FREE.

SPECIAL Violin String Offer

As a special offer to introduce our splendid "Allegro" strings, if you will send us the names of two violin players and only 25c we will send you, postpaid, one "Allegro" E string (3 length) always sold for 35c. Or send 65c with the two names and we will send you 3 of these high-grade strings (3 length) absolutely true fifths, regularly sold for \$1.55. You save on this special offer. Seize this opportunity. Order now. Your money refunded if not satisfied after the trial.

Send Coupon Today

Just fill out the coupon and mail to us at once. We will send you free and postpaid full description of our high-grade instruments. Don't delay—send the coupon now for our Free Catalog. If you are a teacher enclose your professional card.

Wm. G. Lewis & Son

(ESTAB. 1869)

Makers and Importers
225 S. Wabash Ave., Dept. 1192
CHICAGO, ILL.

Attention, Violin
Makers—We make
a specialty of
Imported Woods,
Varnishes and
Tools.

COUPON

Wm. G.
Lewis & Son
Dept. 1192
225 S. Wabash Av.
Chicago

GENTLEMEN: With no obligations whatever upon me you may send me free and postpaid one copy of the new Lewis Catalog and full particulars of your great free trial offer on high-grade violins.

Name.....

Address.....

Cut The Cost of Furniture In Two

We can help you do it! Because we are manufacturers. Because we sell direct and save you every cent of the dealers' and jobbers' profits. Government and state institutions, where only the best is considered, buy Brooks famous "Master-Built" Furniture. For years we have been furnishing the Home, Club and Office Furniture for Army and Navy Officers, as well as for hundreds of thousands of homes all over the world.

Buy Direct From Our Factory—Largest Plant of its Kind in the World

Rocker No. 167, Dealers' Price \$24.00—Brooks Factory Price \$12.25
Solid Quartered Oak, 30 in. wide, 20 in. deep, 22 1/2 in. high. Cushion covered with Marquise leather.



order house. Not a jobber or wholesaler. twentieth century method of reducing the side Furniture is

Shipped In Sections—Assembled in Ten Minutes By Anyone

Hundreds of dealers are assembling Brooks "Master-Built" Furniture in their stores and selling it for from 40 to 50 per cent above our prices. They recognize the superior quality.

Our Original Sectional Method Saves 3/4 Packing Costs—2/3 Freight Costs—1/2 the Floor Space Usually Required!

Is it any wonder that we can save you 1/2 the usual cost of furniture? The wonder is why you haven't taken advantage of this money saving plan before. Delay no longer. Get posted. Mail postal for Free Book of all our furniture.

Brooks Manufacturing Co.
2702 Brooks Ave., Saginaw, Mich.

Write for Our Free Book of Finest Furniture



Buffet No. 409, Dealers' Price \$65.00—Brooks Factory Price \$37.75
A beautiful specimen of fine workmanship. Solid Quartered Oak—66 in. long—60 in. high—22 in. deep.

We are simply straight manufacturers—who turn raw materials into finished furniture. Not a Mail Moreover, we have devised a twin-of the package. All "Master-Built"

New HERNIAL Appliance

The Brooks Appliance Holds More Firmly, Comfortably and Surely than Any Truss

Sent on Trial

The new Brooks Appliance for rupture so thoroughly meets every test and requirement that it is ordered by the U. S. War Dept. and is recognized as the most reliable support ever invented. It is fitted with an Automatic Air Cushion which follows every movement of the body and always covers the ruptured spot. The cushion which comes in contact with the skin is soft, pliable gum rubber and clings closely, so that slipping is impossible, and it is cool and comfortable because of the constant circulation of air through it.

This Appliance is sold under a positive guarantee of money refunded if not satisfactory. We do not guarantee to cure any more than any doctor will guarantee to cure his patient. We do guarantee to furnish a perfect fitting Appliance, which will give the wearer solid comfort and retain the protrusion at all times. The purchaser is the sole judge and if for any reason whatever (which does not have to be furnished) it is returned, the price paid will be refunded in full.

Further information regarding the Appliance, rules for self-measurements and catalog sent FREE. Just send your name and address to

BROOKS APPLIANCE COMPANY
1817 State St. Marshall, Michigan

Please Mention Popular Mechanics



C. E. BROOKS, the Inventor

COTTONSEED MEAL FOR BEEF-CATTLE FEED

—Experts of the U. S. Department of Agriculture believe that farmers should take advantage of the abundant supply of cottonseed meal likely to exist in 1915 for feeding beef cattle. Its value as a feed has been recognized by agricultural authorities for some time, and large quantities have been exported to Europe where the farmers are aware of its value.

TYPEWRITERS FACTORY TO YOU

Look at these bargains! Typewriters Rebuilt in our own factories, and guaranteed for one year.

Remingtons \$20 to \$55 Smiths \$18 to \$40
Underwoods \$25 to \$60 Royals \$25 to \$45
L. C. Smiths \$30 to \$50 Oliverts \$20 to \$35

We have others, of course. Send for catalog describing them, and address of nearest branch office.

American Writing Machine Co., Inc., 345 Broadway, N. Y.



A NEW WAY To Get Your Clothes Free

Make Big Money During Spare Time

Something Different, bigger, more liberal than any offer ever made. Lower prices—better clothes—bigger cash profits—Express paid on everything.

Double Pay

FREE clothes and cash besides. We don't ask you to use your cash profits for your own clothes. Ours is a new and better plan. An Extra Present with every order. Not a prize scheme. Choose what you want, work for it and get it besides your Cash Profits. Complete Outfit FREE, 55 real cloth samples, 50 Fashion Plates. Inside wholesale prices. Get the big money. Your name on a post card brings everything FREE.

SPENCER MEAD CO., Dept. 300, Chicago



\$100 a month! net income!

from 20 acres in San Joaquin Valley California

A railroad brakeman, getting along in years, with no prospect of advancement, and guarding against the "blue-envelope" day that might dismiss him, bought a 20-acre farm in the fertile San Joaquin Valley, California, at \$300 per acre (part on time payments). Nine acres each were planted to peaches and raisin grapes. From his 1914 crop he has a net profit above all expenses of \$1,200, 20 per cent on his investment and a living besides. This first year he was new to conditions; next year he expects to do much better. Don't you want to do as well? Our San Joaquin Valley folder, free, tells of the experiences of many others, describes living conditions, crop possibilities, and in general answers the questions a man seeking to better his prospects wants to know about. It's worth money to you. Write for it to-day and tell me the line of farming you prefer, so that I can give you special information.

C. L. Seagraves, Gen'l Colonization Agent
Atchison, Topeka & Santa Fe Ry.
2200 Railway Exchange, Chicago

SUPERIOR SINCE 1904

OVER 100,000 IN USE

Mostly sold through recommendation.
For Personal Desk or General Office
It checks mental calculations.
Buy through your stationer.

Write for 10-Day Trial Offer
E. Ganchar A. A. M. Co., 148 Duane St., New York

Agents Wanted

Golden Gem
PORTABLE
Adding Machine

Multiplies - Subtracts

SURCHARGED "BELGIEN"

War stamps. Just arrived. 3, 5, 10, 20 centime. Belgian Stamps surcharged "Belgien," 3, 5, 10, 25 pfennig, for use of Germans in Belgium. Set of 4, 25c. A rare bargain. Set of 2 varieties 5 and 10 cent Brussels 1896, unused 8c. Approval sheets, 50% discount. Price list and monthly stamp paper free. We publish the Scott Standard Catalogue. Albums 10c to \$55.00.

SCOTT STAMP AND COIN COMPANY
Dept. T, 129 Madison Avenue, New York City. In business since 1860

HERMAN'S U.S. ARMY SHOES



Army Surgeons devoted years to perfecting this shoe. It allows natural freedom to the toes while setting snug at the heel and will not chafe, bind, pinch or blister the tenderest feet under severe tests of climate and service. Every U.S. soldier, sailor, militiaman and thousands of civilians wear this FOOT-EASING, U.S. Army Shoe. Efficiency - Building

Every sportsman ought to wear it. Ask your dealer or send us for catalog and testimonials. The price is \$4.90 a pair; sent prep'd and guaranteed satisfactory

JOS. M. HERMAN SHOE CO.
160 Lincoln St., Dept. 21, Boston, Mass.

Play Billiards at Home! The Cost is Trifling

A few cents a day will soon make you the owner of a handsome Burrowes Table. You can play on the Table while paying for it. No special room is needed. Burrowes Tables can be mounted on dining or library table or on their own legs or folding stand. Put up or taken down in a minute. Sizes range up to 4½ x 9 feet (standard).

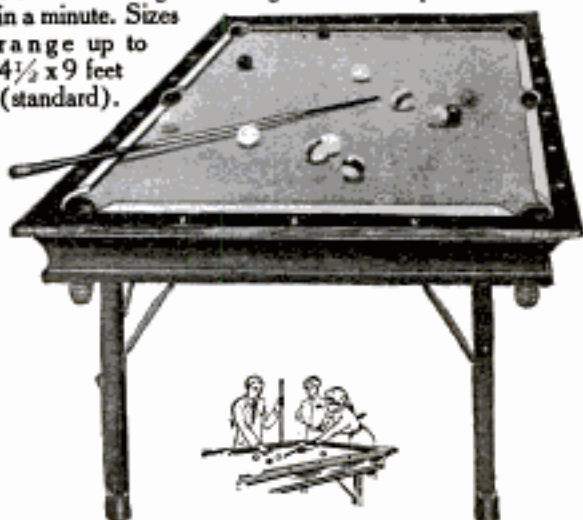

BURROWES

Billiard and Pool Tables

are splendidly made and correct in every detail. The most expert shots, calling for skill of the highest order, can be executed with the utmost precision. Some of the leading professionals use Burrowes Tables for home practice.



\$1.00 DOWN

Terms are very easy—\$1 or more down (depending upon size and style selected), and a small amount each month. Prices from \$15 up. Cues, balls, etc., free.



FREE TRIAL— NO RED TAPE

On receipt of first installment we will ship Table. Play on it one week. If unsatisfactory return it, and on its receipt we will refund your deposit. This ensures you a free trial. Write today or mail this coupon:

THE E. T. BURROWES CO.
164 Spring Street, PORTLAND, ME.

Please send catalog of Billiard Table offers.

Name

Address

BUILD YOUR OWN BOAT



Saw-Plane-Hammer-Screwdriver All the Tools You Need



You can saw straight, drive a nail and a screw. You can assemble a boat by the Brooks System. You need know nothing of designing or of the fine points of boat building—the materials for the boat come to you all ready to put together.

Write for the Brooks Catalog and Learn About the Brooks System —Saves Two-Thirds Boat Builder's Price

The materials alone are all you pay for. Many professional boat builders make use of the Brooks System to get the latest ideas in designs. Why not start now? Build a new "V" bottom model—the popular, speedy model that is so easy to build.

Thousands of people assemble their own boats by the Brooks System every year. Simple directions tell you every move to make. You can't go wrong for all the fitting of parts has been done by our experts, which gives you as good a boat as any professional could make and better than most.

Write for the Brooks Boat Book. See illustrations and descriptions of speed boats, family launches, hunting boats, sail boats, row boats, sailing, paddling and power canoes. Many styles and sizes in each class.

BROOKS MANUFACTURING COMPANY

Largest Plant of its kind in the world. Originators of the Pattern System of Boat Building

8202 Brooks Ave.
SAGINAW,
MICHIGAN



\$37

Buys patterns and knocked down frame for this handsome 23-ft. boat.



Jones Machine Moulded
**PULLEYS
and GEARS**
Clutches, Sprockets
Shafting and Hangers

THE LARGEST LINE OF
Power Transmitting Appliances
IN THE COUNTRY

SEND FOR GENERAL CATALOGUE A18
W. A. JONES FOUNDRY & MACHINE CO.
1400 North Ave. CHICAGO

WATERPROOF SHOES FOR EUROPEAN SOLDIERS—The shoes for some of the European armies are made with the grain side of the leather in. The outward flesh side is filled with grease, effectively keeping the water out.

Cushman Light Weight Engines

Represent a great advance over ordinary Stationary Engines in design, material and workmanship. Highly efficient because of light weight, higher speed, reduced friction and lowered operating cost. 4 Cycle, 4 to 20 H. P. **Throttle Governor** insures fuel consumption and power in proportion to load. Ideal for **electric lighting plants** and other uses where very steady power is required. Equipped with Schebler Carburetor and Friction Clutch Pulley. Not a cheap engine, but cheap in the long run. Engine Book free.

CUSHMAN MOTOR WORKS
892 North 21st St., LINCOLN, NEB.

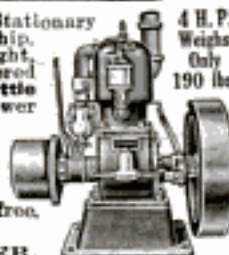

Send for "Old Town" Catalog
4000 canoes ready to ship—an agent in your town. We'll tell you his name—write.

OLD TOWN CANOE CO.
1462 Middle Street Old Town, Maine, U. S. A.



The Woods Beckon You

Vast treasure heaps of sport and health and rest are stored in wooded waterways for you. What you need most to tap them is an

"Old Town Canoe"

It's made in the Maine woods, of seasoned cedar, by seasoned workmen. It won't crack or leak or bulge or act cranky in any way. That's why nearly every knowing guide and trapper owns an "Old Town," and that's why it gives lifetime service; that's why there are more "Old Town Canoes" than all other makes put together, and that's why you should own one.

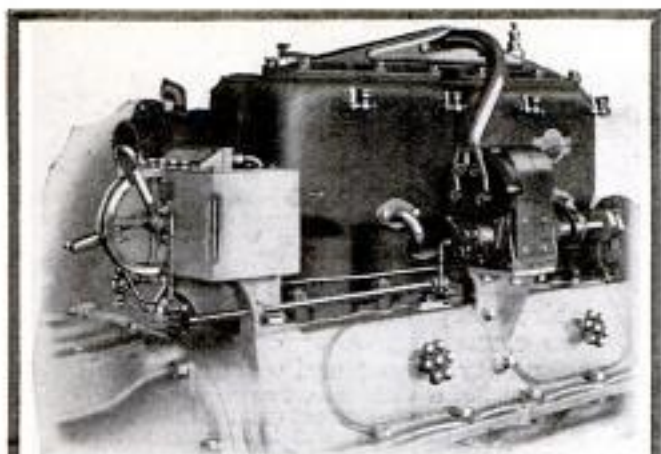

This is New ENCLOSED Scripps Complete Marine Power Plant

The most modern marine motor on the market—equipped with electric self-starter and lighting system. The 1915 Scripps' descriptive catalogue will tell you all about it and 14 other models. Write for your copy today.

SCRIPPS MOTOR COMPANY
637 Lincoln Avenue, Detroit, Mich.

New York, Bowler, Holman & Hoeker Co.,
221 Fulton St.; Chicago, Ill., O. J. Coe-
grove & Co., 215-219 Englewood Ave.;
Philadelphia, W. E. Goehens, 631 Arch
St.; St. Louis, Mo., Chas. J. Pettit, 1800
N. Market St.; Jacksonville, Fla., Gibbs
Gas Engine Co., Foot of Main St.; Seattle,
Wash., S. V. B. Miller, 72 Marion St.;
San Francisco, Cal., Ellery Arms Co.,
525-526 Market St.; Los Angeles, Cal.,
Marine Engines & Supply Co., 831 E. Los
Angeles St.; Duluth, Minn., Kelley Har-
ware Co., 118-120 West Superior St.;
Toronto, Ont., Schofield-Holmes Machine
Co., 2 Carlow Ave.; Montreal, Quebec,
W. H. Baker, Forum Bldg., Atwater St.;
Winnipeg, Man., D. A. Ross; New Orleans,
La., Arthur Durice, 130 Chartres St.
EXPORT OFFICE—17 Battery Place,
New York City.



"The Seal of Safety
at Sea"

GET THIS CATALOG

FULL OF VALUABLE INFORMATION TO EVERY
BOAT OWNER ON

RACING PROPELLER WHEELS,
REVERSE GEARS AND
MARINE ACCESSORIES

LARGE CATALOG FREE. SEND TODAY
MICHIGAN WHEEL CO.

1138 MONROE AVE. GRAND RAPIDS, MICH.



WATKINS' SPECIAL MOTORS

3 H. P. Single Cylinder . . . 30 lbs.
4 H. P. Double Cylinder . . . 48 lbs.
12 H. P. Four Cylinder . . . 100 lbs.

A strictly HIGH GRADE Motor that
will give CONSTANT and EFFICIENT service.
Especially adapted for CANOES and LIGHT
BOATS. Aluminum base, copper water
jacket, steel shaft, bronze bearings.

THE WATKINS MOTOR CO.

837-839 West Sixth Street CINCINNATI, OHIO

Any SIZE **ONLY \$5 DOWN**—One
Year to Pay

\$38 buys the reliable U. S. En-
gine (size 1 1/2 H. P.) direct
from our factory on easy
payments of only \$5 down and \$3 a
month. Free Catalog Folder shows
nine larger sizes all sold at similar
low prices and on very easy terms.
All guaranteed 5 years and
backed by 42 years
manufacturing ex-
perience; all
shipped on
30 days
free
trial.

U.S. ENGINES
Burn Gasoline,
Kerosene or Distillate
—have double the power of other engines of
equal weight—are easiest to move—easy to get at
—take up least space—run smoothest—start easy—
burn less fuel and last longer. Free Catalog Folder
gives 18 reasons for U. S. superiority and quotes low
easy-to-pay factory prices. Write now.

(1) U. S. ENGINE WORKS, 3712 Ogden Ave., CHICAGO



Home Billiards! Royal Sport

This Graphic Book Reveals It—Get One FREE!



Superb Brunswick
"BABY GRAND"
Combination Carom
and Pocket Table

Mail the coupon and learn in this hand-
somerly illustrated book of the winter
reveals that reign around these perfect
tables *right in the homes of thousands!*

While the Storm King rages out-of-doors, the
billiard balls click merrily within. There are
moments of thrilling suspense—and lively re-
partee till bed-time.

Learn how Carom and Pocket Billiards develop
strength, skill and quick decision. How they
teach the young folks the love of home.

And see the famous Brunswick "GRAND,"
"BABY GRAND" and "CONVERTIBLE" tables,
all shown in actual colors.

Brunswick Home Billiard Tables

They are *real* Carom and Pocket Billiard Tables
with life! speed! and accuracy!—not toys or
substitutes for regulation tables. Yet a size for
every home. Have genuine Vermont slate bed,
fast imported billiard cloth and Monarch cushions,
famed for lightning action.

Factory Prices—20c a Day!

Our world-wide sales—requiring nine great
factories—enable us to sell at prices unheard of
ten years ago. You can buy direct, save dealer's
profit—and pay us monthly for a year—terms
as low as 20 cents a day!

30 Days' Trial—Outfit FREE!

Read in this book how we let you try any Bruns-
wick 30 days in your home!

Read how we give a high class Playing Outfit
FREE—Balls, Cues, Rack, Markers, Tips, Cue-
Clamps, expert rules on "How to Play," etc.

Remember, we mail you this valuable book
postpaid, FREE! Send the coupon at once.

Mail For Billiard Book FREE

THE BRUNSWICK-BALKE-COLLENDER CO.
Dept. 10-N, 623-633 S. Wabash Ave., Chicago

Please send me free color-illustrated book—
"BILLIARDS—The Home Magnet"

Name

Address.....(387)

Please Mention Popular Mechanics

Joymotor

For Rowboats and Canoes



Marine
Engine
Dealers
Write for
Agency
Proposition

Joymotor will fit any boat ever made—square stern, pointed stern or decked stern—without additional attachments. Just hook it on or off in a jiffy. Joymotor's unusual bracket takes care of everything. No matter where you take Joymotor you know it will fit the boat you have to use. For Canoes Joymotor special bracket sets motor low down—safety first.

REVERSING PROPELLER

The exclusive patented feature of Joymotor that makes it the safest, most convenient, easiest to handle motor in the world. No more danger of accidents. No drifting or paddling to dock or shore. No more awkward, hurried cranking to reverse the motor. Just move the steering tiller to right or left and Joymotor almost instantly—**Stops your boat and backs it up without reversing the engine**

"Joymotor is rightly named"—
"A joy to own"—"evidently built to enjoy"—that's what owners tell us.

Weights 52 lbs. Runs your boat 7 to 9 miles per hour—cruises 10 to 12. Has real high tension magneto and real carburetor, efficient oiling system and does not have unsightly, tangled up pump hose. Write postal now for catalog and life size picture of Joymotor giving full details of the finest, most satisfying portable motor to be had. Write postal now to

JOY ENGINEERING COMPANY
230 Tribune Bldg., CHICAGO



This picture shows how Joymotor steering tiller swings and reverses position of propeller. Compare this position with large picture.

Unmatched Speed—Extra Power NO VIBRATION

Speed that runs away from any other rowboat motor—power to carry heavier loads—no vibration to shake the boat or mar the pleasure of riding.

2 CYLINDER ROWBOAT KOBAN MOTOR

Is the wise man's choice this year. Last season's records proved its mettle. Absolutely dependable under all conditions—easy to start—reverses while running by simply pressing button—best ignition outfit money can devise.

2 CYLINDER—RACER TYPE

The Koban Motor has 2 opposed cylinders—that's what removes the vibration—3 H. P. nearly double that of other motors—speed line propeller.

Buy now the best constructed rowboat motor on the market.

Write for 1915 catalog Active Agents wanted
KOBAN MFG. CO., 291 South Water St., Milwaukee



3
H. P.

Electric Light for Your Home

This newly invented system enables every rural home to make their own electric current; operates from one to fifty lights; and will drive small electric motor, electric iron, toaster, etc. Everything complete in one compact unit; no batteries or switchboard. Uses standard lamps and fixtures that any dealer can supply. Nothing to watch but the small, high-speed gasoline motor, which requires slight attention once a week.

The ideal electric lighting system for country homes. Nothing like it ever sold before. Costs less than other systems to buy and to operate. Will last for years.

WATERMAN MOTOR COMPANY
282 Mt. Elliott Ave. DETROIT, MICH.

Write today for descriptive literature and prices.

Uni-Lectric
GASOLINE-ELECTRIC UNIT
LIGHTING SYSTEM



A PECULIAR RIVER—The Deschutes River, Oregon, a tributary of the Columbia, has many remarkable features. Its natural flow is almost constant. In times of so-called floods it rises only a few inches, because, for a considerable part of its course, it flows through a region of lava and loose volcanic material which act as a huge sponge. The United States Geological Survey has just issued a comprehensive report discussing the river's possibilities, from which it appears that after allowing for irrigation, a total of 900,000 hp. may be developed.

EVINRUDE

The Evinrude Detachable Rowboat and Canoe Motors embrace the Evinrude Automatic Reverse—Built-in Magnets—and Maxim Silencer, besides all of the characteristics of the 1914 Model.
Prices: \$60.00 to \$80.00
Battery Ignition 55.00 less

12 Beautiful Poster Stamps sent for 4 cents

EVINRUDE MOTOR COMPANY
No. 31 Erie Street, Milwaukee, Wisconsin, U. S. A.



Get the LA Engine Book NOW and Save Money

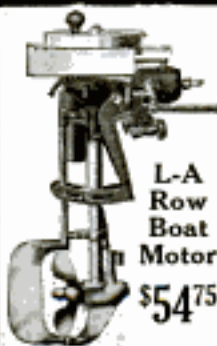

L-A
Row
Boat
Motor
\$54.75

Inevitably, winter will pass. Inevitably summer with the ever alluring joys of motor boating will return. Just as inevitably you will want a staunch, reliable Lockwood-Ash Motor—a motor that's always "on the job." So why not take time by the forelock, and choose your motor NOW?

Post Yourself on How You Can Buy Direct from the Factory and Save the Dealer's Profit

Learn about our 30 days' trial offer which makes it just as safe to buy an L-A Motor on our Direct-from-Factory, Freight-Paid plan, as though you were dealing with your most trusted neighbor. Six models all guaranteed for one year and sold on 30 days' trial. No strings to this offer, no freight to pay. If you're not delighted with the motor, you return it at our expense. The 6 H. P. Motor with Outfit complete, here

illustrated, freight paid, only **\$89.50**—a clear saving of at least 25 per cent. Write today for the L-A Engine book, and take your time in looking over the different models. Why wait? It's worth while to investigate now.

Lockwood-Ash Motor Co., 276 Horton Ave., Jackson, Mich.

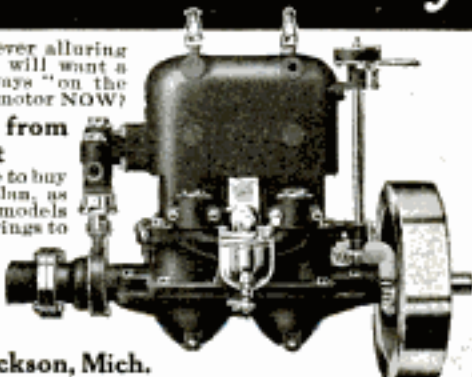

Waterman PORTO Does It

Makes any boat a motor boat. 1914 Model, 3 H. P. Weight 59 lbs. Sold direct from Factory to you, freight paid. Save Agent's profit.



The Waterman PORTO is the original outboard motor. 9th year — 25,000 in use. Guaranteed for life. Fits any shaped stern; has Carburetor — not "mixing valve"; 3 Piston Rings instead of 1; Removable Phosphor Bronze Bearings; Solid Bronze Skeg, protecting 10½ x 16 in. Propeller. Steers by rudder from any part of boat. Water-cooled Exhaust Manifold; Noiseless under-water Exhaust; Bronze Gear Water Pump; Spun-copper Water Jacket; any ignition equipment desired.

DEMAND these essentials in an out-board motor, or you won't get your money's worth.

Write Today for **FREE** Engine Book.

WATERMAN MARINE MOTOR CO., 230 Mt. Elliott Ave., Detroit, Mich.

KERMATH BOAT MOTORS \$180.00

4 Cycle, 4 Cylinder, 12 to 20 H. P.
Highest quality. Silent operation. No vibration. Controls like the finest Motor Car engine. Extremely economical on fuel. Used as standard equipment by over 60% of the world's leading boat builders. Catalogue on request.
\$180 to \$300 depending on equipment.
KERMATH MFG. CO., Dept. P., Detroit, Mich.

VIM MOTORS

5 to 27 h. p.
1, 2 and 3 cylinder
Gasoline or Kerosene
Speed, regular, or heavy
duty. Strong, simple,
accessible—absolutely
dependable. Built for a life-
time. The boat-builder's
stand-by, the boat-owner's
pride. Double ignition.
Non-backfiring. Heavy
brass fittings.

"Only fault with my Vim is that I did not get it sooner. It runs and sounds like an electric fan. Ran it steady last Sunday on 4 gal. gasoline — that's right good for a 10 H. P. engine. My friend says his motor is a gasoline motor and if he can sell it, a Vim goes in his boat." This from S. M. Pratt, Warren, Pa.
VIM MOTOR CO.
102 Water St., Sandusky, Ohio

A refuse incinerator with a total capacity of 300 tons a day is in operation in Milwaukee, Wis. A 6,000-kw. generator is driven by the steam raised in a 200-hp. boiler. The current from the generator is transmitted to a pumping station, some two miles distant, which pumps lake water into the north end of the Milwaukee River for flushing and cleaning purposes.

Set up Your Own Boat



Great Lakes' Sections enable you to build a perfect boat at ¼ the cost of a finished boat. Each section numbered and guaranteed to fit perfectly. Only finest grades lumber used. All boats designed by an experienced naval architect. Write today for Special Low Price on boat you want.

GREAT LAKES BOAT & PATTERN CO.
PIER 15 MILWAUKEE, WIS.

Toledo MARINE MOTORS NONE BETTER

"Nothing Cheap but the Price"

3 H. P. 1 cyl. complete	\$ 65.00
6 H. P. 1 " "	84.00
6 H. P. 2 " "	125.00
12 H. P. 2 " "	160.00
18 H. P. 3 " "	250.00

Fully guaranteed by a responsible concern. 2 cycle, 2 port, 3½x7½ and 4½x8½. Send for free catalog.

THE UNIVERSAL MACHINE CO., Pike Ave., Bowling Green, O.

2½ H. P. \$44.95

Owing to the war, we are disposing of our big stock of engines built for foreign shipment, at factory cost. This stock includes all sizes of high grade, guaranteed farm engines from 1 to 12 H. P. The 2½ H. P. price named in this ad is proportionate with the low prices on our entire line. Send for details and complete price list. Compare our prices with others. See what we save you. Write today.

AMERICAN ENGINE CO.
605 Boston Street Detroit, Mich.



One of the 38 Styles

Superb Wing Piano Shipped on 4 Weeks' Free Trial

Yes, we will ship you on 4 weeks' absolutely free trial a Genuine highest-grade Wing piano or player-piano **DIRECT** from our own factory **freight prepaid**. The most amazing piano offer ever made. We will allow you to use any Wing piano—you choice of 38 superb new styles in any shade of mahogany, walnut or oak—in your own home for 4 full weeks at our expense.

No Money Down—Freight Prepaid

We ask no money down—no security—no bank deposit—no C. O. D.—no obligations. Just choose any Wing from our large catalog. We'll ship the instrument no money down, **freight prepaid**. Use it just as if you owned it. Let your friends play it. At the end of 4 weeks' trial, if you wish, you may return it at our expense. We pay return freight to New York. You alone are the judge. We employ no salesmen to visit and annoy you.

Rock-Bottom DIRECT Offer

You will be amazed at our rock-bottom direct-from-our-factory proposition on the genuine highest-grade Wing, guaranteed 40 years. No other manufacturers dared to meet our baffling offer. Let us quote you prices that local dealers cannot approach. Cash or easiest monthly payments as you prefer—but first four weeks' free trial. Since 1868—for 47 years—we have been building Wing pianos—renowned everywhere for their sweetness of tone and sterling merit. The Wing has all the fine qualities and every improvement of any strictly high-grade piano and superior tone. You pay not a cent for the trial—no deposit.

Valuable Book on Pianos Free

"The Book of Complete Information About Pianos"
The N. Y. World says: "This is a book of educational interest every one should own." Tells you all about pianos, how to judge the fine points of quality and price in buying a piano. You will be astonished at the amount of information about piano quality and piano prices, and how to answer the arguments of piano salesmen. The Coupon brings this 136-page book **FREE**. This magnificent book, a complete encyclopedia on the piano, posts you on the making of a piano from start to finish. Free and prepaid, provided you write at once. With this piano book we will send free our beautiful catalog showing new art styles and full explanation of our Rock-Bottom Prices on the Wing Piano. Just drop a postal or a letter, or mail the coupon—today.

WING & SON, Dept. 1192, (Estab. 1868)

Wing Bldg., 9th Ave. and 13th St.

New York

N. Y.

Piano Book

COUPON

WING & SON (Est. 1868) Wing Bldg.

9th Ave. & 13th St. Dept 1192. New York, N. Y.

Gentlemen:—With the understanding that I am not buying anything, you may send me the 136-page Piano Book containing the ten tests, also your free shipment offer on the Wing Piano.

Name

Address

Please Mention Popular Mechanics

The Simplest, Most Economical and Reliable Portable Electric Light

**SAFETY
REDSEALITE
FIRST**



No. 5337

Redsealite \$1.00
complete with battery

made, for the home, factory, garage, farm; on the automobile, motor boat; when camping or any occasion where an artificial light is required.

Absolutely Safe can be thrown into hay, straw or other inflammable material without danger, as there is no flame to ignite or heat to generate combustion.

Light is Clear, Bright and Steady Not affected by rain or snow. The strongest gale cannot blow it out. Absolutely reliable where a candle, oil lamp or lantern would be valueless.

Economical in the use of current. The RED SEAL DRY BATTERY will give approximately 50 hours of intermittent service. Every up-to-date electrical house, garage or hardware store carries the RED SEAL DRY BATTERY which does not deteriorate when not in use.

It is made of brass, nickel plated with tungsten miniature lamp, reflector and lens. Extremely simple in construction and will fit any standard size battery, so if the Red Seal Dry Battery cannot be had, any standard sized dry battery will answer.

Get your name on file for a copy of our new pocket catalogue, 12s, ready Feb. 1st.

Manhattan Electrical Supply Co.

New York
17 Park Place

Chicago
114 S. 5th Ave.

St. Louis
1106 Pine St.

San Francisco
604 Mission St.

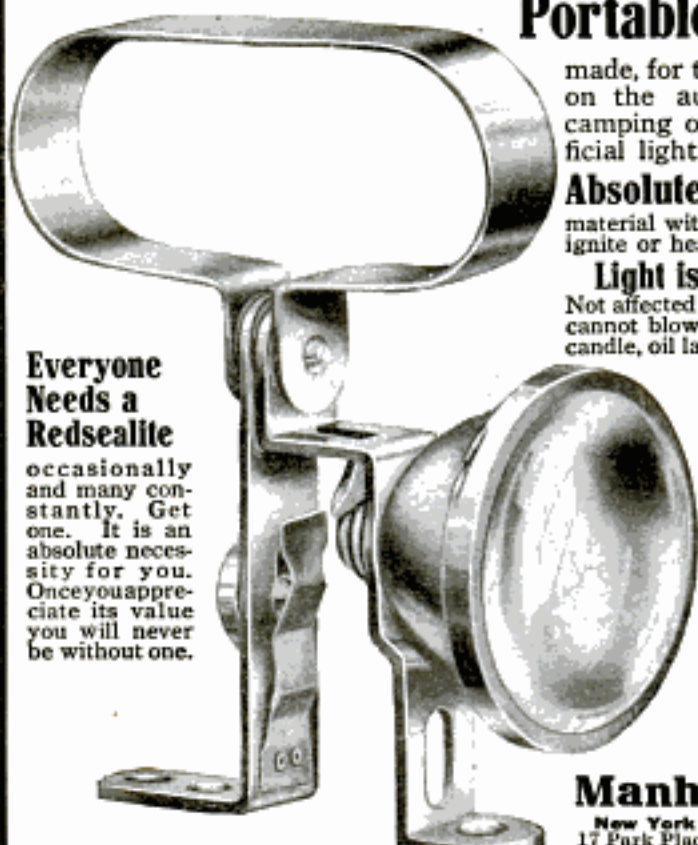

Everyone Needs a Redsealite

occasionally and many constantly. Get one. It is an absolute necessity for you. Once you appreciate its value you will never be without one.

BOYS 10c

A REAL WIRELESS DETECTOR FOR 10 CENTS

We want to acquaint you with "Wireless." Read this astounding and hitherto unattempted offer. For 10c. we will mail you prepaid a complete wireless detector exactly as illustrated, size 2 1/2 x 1 1/2 x 1 1/2. In connection with any telephone receiver and a wire on your roof, this detector is guaranteed to receive messages from 100 to 500 miles. Complete instructions furnished. This detector is not only but does exactly the same work with detector.

FREE Encyclopedia No. 14, containing 400 illustrations and 20 coupons for free Wireless Course, also copy of Magazine "The Electrical Experimenter." If detector is not wanted send 2c. for other books. Electro Importing Co., 233A Fulton St., N.Y. City

BOYS

Labels: GALVANA NICKEL DETECTOR COP AND BRASS POST, HARD RUBBER HANDLE, NICKEL STANDARD AND BRASS POST, SOLID JURY BASE.

FIRE ENGINE MAKES WORK FOR ITSELF—Two fires were started by sparks from a fire engine which was being used to test hose in Spokane, Wash., recently. A wagon load of oranges was ignited by the flying sparks, which were not extinguished until considerable damage had been done to the wagon and contents. The roof of a small building in the vicinity was also burned.

250 "WIRELESS" TRANSFORMER \$9.00
CLOSED-CORE TYPE 14000 VOLTS 3 DIFFERENT POWERS
SELF CONTAINED Shipping Weight 20 Lbs.
Send 2c stamp for catalogue of Wireless Supplies, folders, etc. Wiegner's Telegraph Code Charts free with \$2 orders; otherwise 20 cts. each. Published in "station" or "pocket" sizes, Continental or Morse code; please state which, otherwise Continental "pocket" size will be sent. Wiegner Electric & Mfg. Co., 711 So. Dearborn St., Chicago, Ill.

ELECTRICITY

BOYS—Send today for our new 128-page catalog of everything electrical. Motors, Dynamos, Flashlights, Lamps, Coils, Batteries, Transformers, Magnet and Resistance Wires, Telegraph Outfits, Miniature Electrical Railways and Parts. Catalog with coupon sent only for 6c in stamps or coin. No postals answered.

VOLTAMP ELECTRIC MFG. CO. Voltamp Block, BALTIMORE, MD.

AGENTS SAFETY LANTERN
ELECTRIC TUBO-LITE

JUST OUT—WONDERFUL SELLER—No danger of fire in barns, garages, warehouses, etc. Can be carried anywhere. Use ordinary dry batteries. Refill any place. Selling like wildfire. Agents say stock is sold out before they fairly get started. \$10.00 daily EASY. Write today for terms of **FREE SAMPLE**.

THOMAS LANTERN CO. 4048 Rome St. DAYTON, OHIO



ELECTRIC LIGHT PLANTS Complete gasoline engine, dynamo, switchboard and storage battery \$240.
Agents wanted. American Battery Co., 1129 Fulton St. Chicago (Estab. 1889.)

**For the Clear Winter Nights
GET A PAIR OF
BRANDES WIRELESS RECEIVERS**
and do long distance receiving.
Send stamp for our New Catalog—just out.

C. BRANDES, Inc.
11a Liberty St. NEW YORK



Please Mention Popular Mechanics

DYNAMO-MOTOR

As a dynamo it will operate induction coils, light lamps, charge storage batteries, electroplate, etc., makes an ideal machine for experiment-ing. As motors they will operate heavy models, emery wheels, and other useful appliances.

18 watt dynamo-motor \$3.00
24 " " " 3.85
40 " " " 5.25

Send 2 cent stamp for catalog of wireless apparatus, trains, electrical supplies, novelties, tools and books.
LOOMIS ELECTRIC COMPANY
1427 N. Artesian Ave. Chicago, Ill.

DUCK'S ^{NEW} 325 Page Electrical No. 8 and Wireless Catalog



Contains 100 Pages entirely new

Mailed to anyone upon receipt of 8c in stamps or coin which may be deducted on first dollar purchase. Great cost of catalog and low prices prohibit distribution otherwise.

WHY WASTE TIME AND POSTAGE IN SENDING FOR A DOZEN CATALOGS

when this catalog contains practically everything worth while in wireless and electrical goods, advertised in this and all other magazines,—and in most cases at more attractive prices.

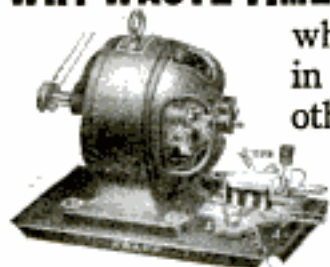

The above motor is a wonderful value. It is representative of our sixty different types of toy motors. It is used extensively in running designs from model builders. Mounted on an enameled metal base, with reversing switch to start, stop or run in either direction. Special price \$1.93. Postage extra. Shipping weight 3½ lbs.

What This Big Catalog Contains

125 pp. Wireless Apparatus for Commercial and Experimental use;	42 pp. Motors and Generators;	10 pp. Ford Automobile Accessories;
10 pp. Wireless Raw Material;	10 pp. Miniature Lamps;	13 pp. Victrolas, on our Easy Payment Purchase Plan;
5 pp. Transformers;	8 pp. Flashlights;	25 pp. Electrical and Mechanical Books;
8 pp. Storage Batteries;	5 pp. Massage Vibrators;	30 pp. General Electrical Supplies.
15 pp. Telegraph Apparatus;	10 pp. Miniature Railways;	
	5 pp. Electric Lighting Plants;	
	10 pp. Ammeters and Voltmeters;	

125 PAGES OF WIRELESS INSTRUMENTS

Our catalog not only contains a wider and bigger selection of wireless instruments than will be found in any other three catalogs published, but everything worth while that may be found in any other catalog. Our large patronage and the supreme confidence of our patrons in everything we offer, impels every manufacturer to seek representation in our catalog. We too, are continually putting out new wireless instruments and are also always on the lookout for the latest and advanced types manufactured by others. All our goods are sold on a money back guarantee. These are a few of the reasons why the overwhelming mass of wireless experimenters have for years adopted the slogan



We carry a complete line of unexcelled lighting plants. Also separate switchboards, generators, ammeters, voltmeters, etc.

**IF DUCK SELLS IT, IT MUST BE GOOD.
IF DUCK DOES NOT SELL IT, THERE'S A REASON.**

ELECTRIC HAND LAMP

for use with the ordinary dry cell battery. Throws a brilliant light over 100 feet. Gives a concentrated light of 65 c. p.

In tests conducted in one of the biggest laboratories in America our lantern was found not only to give a greater concentrated light than any other, but an increase of approximately 400% over another widely advertised lamp for which great claims are made. The difference is in the reflector and the lamp. This hand lamp will last sixty hours on continuous burning and longer if used intermittently. Indispensable to plumbers, automobilists, delivery men, switchmen, housekeepers, etc. Shipping weight, less batteries, 14 oz.

Complete, less battery, in burnished brass finish \$1.90
Complete, less battery, in pressed rolled steel
with hard rubber finish 1.50

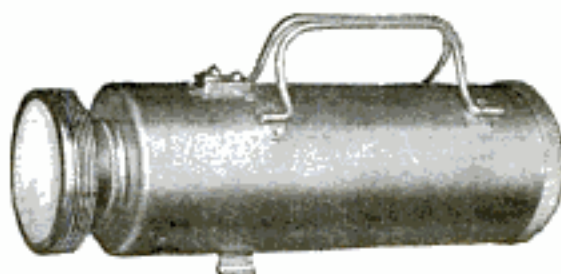

200 PAGES of ELECTRICAL GOODS

We would also like to tell you something about our electrical goods, but it would take pages to adequately do this. Look at the contents of our catalog; then send for the catalog,—the most elaborate, comprehensive, educational and artistic catalog in its line published. Then you will know why we have merited the kindly encomium—

IT MUST BE GOOD, BECAUSE DUCK SELLS IT

THE WILLIAM B. DUCK COMPANY, Empire Arcade Bldg., TOLEDO, OHIO
(OUR FORMER NAME "THE J. J. DUCK COMPANY")

Any Watch You Want ON CREDIT



**WALTHAM
ELGIN
HOWARD
HAMILTON
ILLINOIS**

Sent on **30 Days Free Trial**

No Money Down

Express Prepaid in Advance by Me

You take no chances with me. I am "Square Deal" Miller and I trust the people. That is why I am doing the greatest Credit Watch, Diamond and Jewelry business in the country. Suppose you want any one of the country's best makes of watches? Name any one, I have it for you. No Money Down, Express Prepaid. A full month to carry it in your pocket and the easiest of Long Time Payments. That's the test that tells. All these watches **Guaranteed 25 Years**

I Smash the Terms

No References Demanded

My terms are made to suit you. You get unlimited credit, with no red tape, notes or collectors. All unnecessary detail left out.

An "Open Charge" Account

the same kind of credit you get from your grocer. No matter where you live or what your income is, you can now own the finest watch, a beautiful diamond or any rare jewelry and never miss the money.

Costly Catalog FREE

Send me your name and address so I can mail you. Free and postpaid, the most beautiful catalog of its kind ever printed. I want you to have this book. It's a gem. It illustrates all makes of valuable Watches, Elegant Genuine Diamonds, and a vast assortment of Beautiful Jewelry, all on the easiest and most liberal terms. Write for this book today and get a letter from me that will make you a friend of mine from the start. **Take My Word For It.**

Square Deal MILLER, Pres.

MILLER-HOEFER CO., 420 Miller Bldg., Detroit, Mich.



3 CUSTOM SHIRTS FOR \$5.00

I make shirts that fit you, because I make your shirts from your measurements and guarantee to take them back if they do not satisfy you.

I send you 100 samples to select from

I send you measurement blank with rules. I send you the finished shirts express prepaid. No ready-made shirts in my shop, but facilities for quick delivery of the highest grade of custom work. Write for my samples. (Higher priced fabrics, too.) Spring samples now ready. No agents.

CLARENCE E. HEAD (Master of Shirts), 110 Cayuga Street, ITHACA, N. Y.

Brilliant, Steady Light

—A small Electric Lighting Plant is what the Federal Lamp really is. Touch of switch gives intermittent or steady light. The

Federal Safety Electric Lamp

is wind and rain proof. No smoke—no heat—no oil can to fill and spill. Indispensable to motorists, boatmen, railroadmen, storekeepers, plumbers, electricians, repairmen, janitors, watchmen, photographers and for use in basement and closets of any home. Price complete \$2.00.

Federal Sign System (Electric)
206 N. Desplaines St., Chicago



\$2



Boy Electrician

with 75 illustrations for making Batteries, Dynamos, Motors, Telegraph apparatus, Telephone, Lights, Bells, Alarms, Coils, "Wireless" Current Reverser, Electric Engine, Etc. By Electrical Experts so that anyone can understand it. With Cat. All 10c Postpaid.

J. C. DORN, 705 So. Dearborn St., Dept. 21, Chicago, Ill.



Big Entertainer

320 Jokes and Riddles, 153 Parlor Games and Magic, 15 Tricks with Cards, 73 Toasts, 7 Comic Recitations, 3 Monologues, 22 Funny Readings. Also Checkers, Chess, Dominoes, Fox and Geese, 9 Men Morria. All 10c. postpaid.

J. C. DORN, 709 So. Dearborn Street, Dept. 17, Chicago, Ill.



Boys' Own Toy Maker

Tells how to make a Talking Machine, Camera, Electrical Motor, Bicycle Boat, Canoe, Boomerang, Bobbed, Wind Mill, Microscope, Water Wheel and Motor, Sights, Toboggan, Snow Coaster and Sail Boat, Telephone, Electric Bell, Railroad Wind Mobile, Paddle Raft, Traps, Kites, etc. All 10c. postpaid.

J. C. DORN, 707 So. Dearborn St., Dept. 38, Chicago, Ill.

ELECTRIC HOME, FARM and STORE LIGHT PLANTS. LIGHTS, DYNAMOS, MOTORS, ENGINES. Belts, Books, Rectifiers, Storage & Medical Batteries, Railways, Bicycle, Carriage & Xmas Lights, Massage, Ozone & M.P. Machines. MOTION PICTURE THEATRE Permanent and Traveling Equipments. Big Opportunity. Catalog 3 cts.

OHIO ELECTRIC WORKS, CLEVELAND, OHIO

Working Models

WE MAKE AND SELL



Model Torpedo Destroyers, Warships, Sailing Yachts, Steam Boats, Launches, Steam Engines, Boilers, Locomotives, Turbines, Dynamos, Motors, Flying Machines.

Also we supply all the castings, materials and parts for making and fitting the above working models.

Send for our large copyright Catalogue, 500 illustrations. By mail, 10c. You will then see what we can do for you.

STEVENS'S MODEL DOCKYARD

22Q, ALDGATE, LONDON, ENGLAND

Remit by International Postal Money Order. If coin is sent, letter must be registered.

30 DAYS FREE TRIAL

Total cost only

\$7.50 By Our

7 MONTHS TIME Purchase Plan



to prove to you that this magnificent Royal has the SWEETEST, PUREST, LOUDEST and CLEAREST TONE—

to prove to you that it is as large and handsome as the trust machines that sell at \$25.00—

to prove to you that it has the strongest motor, the best reproducer and tone arm and the most ingenious devices to start, stop and control the music.

Shipped with a supply of 10-inch double disc records of your selection, so you can enjoy the finest entertainments for one whole month. Return the outfit **AT OUR EXPENSE**

if for any reason you do not wish to keep it. Drop a postal for our big list of unsolicited testimonials, record book and other literature—all Free.

Central Distributing House
Dept. D 11 6101-11 Bay St., CHICAGO

FREE



Yes, we will send you a genuine Lachnite Gem for you to wear for 10 full days absolutely free. This is the most astounding jewelry offer ever made. See a genuine Lachnite for yourself. Wear it for 10 days. Then if you can tell it from a genuine diamond send it back at our expense. They are cut by the world renowned diamond cutters of Europe and their dazzling fire last forever. A superb gem set in solid gold. Write today for our big new catalog.

Open An Account

Don't save up your money for months and months before you wear beautiful jewelry. Open an account with us. Have all the genuine Lachnites and other handsome jewelry you want. Write today for the big new catalog. We trust you. No red tape. Your credit is good.

Pay As You Wish

Just a small amount down. Take your time about paying for the rest. Your choice of any of the superb Lachnites and all sorts of other superb, elegant jewelry. All at the rock bottom price. Astounding prices never equalled before. Pay as you are able. The most liberal of terms. Get the free book that tells you all about it. Write today—now.



Free Book—Write Today

Do not delay an instant. Put your name and address on a postal or a letter and send it in to us at once. We'll send you our big new catalogues of elegant jewelry absolutely free. Find out about genuine Lachnites. Find out how you can wear one of these superb gems for 10 days absolutely free. Do not delay an instant. Send in your name and get the big new jewelry book absolutely free.

HAROLD LACHMAN CO.
Dept. 1192 12 N. Michigan Ave., Chicago, Ill.



AETNA-IZE Protect yourself and your family in case of sickness or accident. \$50 a week, and as high as \$10,000 for death. Write for particulars.

AETNA LIFE INSURANCE COMPANY
Drawer 1841 Dept. PM. 2-15 Hartford, Conn.

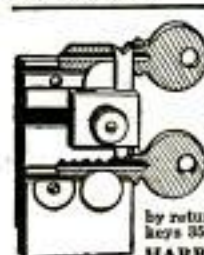

Duplicate Keys for all Pin Tumbler Locks can be made in a minute with **The Harrison M. L. P. Key Filing Machine**

Invaluable for Machinists, Building Superintendents, Hardware and Repair Shops, Locksmiths, Carpenters, Electricians, Garages, etc. Anyone can make a perfect duplicate key without injuring the original. Every machine unconditionally guaranteed. Money refunded if not entirely satisfactory. Price \$3.00 net. Send us P. O. order or N. Y. draft and receive the complete machine by return Parcel Post. Special diamond shaped files for angular keys 35c each or 4 for \$1.00. Send for circular.

HARRISON & COMPANY, 81 NEW ST., NEW YORK

Steel Shoe Book Saves You \$20!

1 Pair Outlasts 3 to 6 Pairs All-Leathers FREE

If you are tired of wet, sore, calloused feet—Rheumatism and Colds—hard, twisted, leaky Leather—Big Doctor and Shoe Bills—loss of time, money, health and comfort—

TRY FREE my Latest Triumph-Leather-Tapped "Steels" Light, Springy, Comfortable, Economical, Waterproof. Warm in winter—Cool in summer—Adjustable Leather Taps, instantly renewed. FREE BOOK tells how you can try "Steels" 10 days FREE and save \$10 to \$20 shoe money.

N. M. Ruthstein—Steel Shoe Man—Dept. 132, Racine, Wis.

30 Days FREE TRIAL

and freight prepaid on the new 1915 "RANGER" bicycle. Write at once and get our big catalog and special offers before buying.

Marvelous improvements. Extraordinary values in our 1915 price offers. You cannot afford to buy without getting our latest propositions. WRITE TODAY.

Boys, be a "Rider Agent" and make big money taking orders for bicycles and supplies. Get our liberal terms on a sample to introduce the new "RANGER."

Tires, equipment, sundries and everything in the bicycle line half usual prices. Auto. and Motorcycle Supplies.

MEAD CYCLE CO., DEPT. C-108, CHICAGO



- | | |
|--|--|
| A. Ball Applicator | J. Soft Rubber Ball |
| B. Button Applicator | K. Soft Rubber Ear Applicator |
| C. Soft Rubber Scalp Applicator | L. Soft Rubber Eye Applicator |
| D. Bust Applicator | M. Spinal Applicator |
| E. Glass Face Applicator | N. Curved Applicator for Throat |
| F. Soft Rubber Face Applicator | and other curved surfaces |
| G. Large Soft Rubber Sponge for eye and other delicate treatment | O. Attachment for Making Vibrating Chair |
| H. Large Hard Disc | P. Round Soft Rubber Sponge |
| | K. Brush Applicator for Scalp |

Power For You

Power from within! Strength that is more than mere muscular strength—the strength of perfect health, abundant nerve force—now within your reach through **Vibration!** Nine people out of every ten are only half alive! Are you? Listen—

All the Joys of Life, Strength, Youth

may be returned to you through Vibration. For *Vibration is life itself!* It will chase away the years like

magic. Every nerve, every fibre in your whole body will fairly tingle with your own awakened power! Stagnation simply cannot exist. You are made over new from head to foot. Your blood is sent humming through every vein, artery, tiny capillary. All the poisonous matters in your system are washed away. Your self-confidence—your self-respect—is increased a hundred fold.

With a White Cross Electric Vibrator you can make a perfect vibrating chair from an ordinary rocker. A few minutes each day in the vibrating chair will do the worn out, tired man or woman more good than hundreds of dollars worth of medicine.



Send the Coupon for the Free Book "Health and Beauty"

Fill out the coupon and send it to us today. Get our splendid big FREE book telling all about the marvels of *Vibration*. No obligation. Send the coupon today—or a postal card or a letter—and get this big book free—but do it today—now.

LINDSTROM-SMITH CO.
1100 S. Wabash Ave.
Dept. 9192, Chicago, Ill.

Without any obligations on my part, please send me free and prepaid your free book on *Vibration* and full particulars of White Cross Vibrator.

Name.....

Lindstrom-Smith Co.

1100 S. Wabash Ave.
Dept. 9192, Chicago, Ill.

We also manufacture
White Cross Electric Irons,
Hair Dryers and Shavers,
Dealers—write.

My Electrical Dealer's Name is.....

Please Mention Popular Mechanics



You and Your Whole Family

AT one time (before typewriters were invented) all business correspondence was written in longhand. But as soon as the typewriter was proven practical, even the smallest offices adopted it.

The same is now true of individuals. Heretofore every man, woman and child wrote in longhand—but now that a typewriter "for personal use" has been perfected, illegible handwriting is becoming a thing of the past.

will find Pleasure and Profit in a

CORONA TYPEWRITER

Let us send you full particulars of this remarkable 6-1/2 machine. Just ask for Booklet No. 11.

CORONA TYPEWRITER COMPANY, Inc., Groton, N. Y.
Salesrooms: 143 W. 42nd St., New York, and
12 S. LaSalle St., Chicago.

Agents in principal cities of the World.

BUT legibility is not the only advantage possessed by the typewriter. One or more exact copies can be made at a single operation and all work is executed more quickly and easily.

You should have a Corona typewriter for personal use in your home and while traveling. It will be a wonderful help to your entire family.

Own a Factory like this You Can

We Built
This Factory
Paid For it
In 3 Years



We will furnish
Equipment Free

Here's a chance for any ambitious man or woman to get into a business that requires no experience and but very little capital (from \$50.00 to \$200.00.) We start you in your own town—furnish the tools free—teach you how to make canvas gloves—show you how to market them.

We do all this for you. Start your factory simply with the understanding that you buy your supplies from us so long as our prices are as low or lower than you can get elsewhere.

The demand for canvas gloves is enormous, everybody everywhere wears them—the farmer—mechanic—doctor—lawyer—laborer. Millions of canvas gloves are required yearly to supply the demand.

Right in Your Own Locality is Your Market

Your surplus can be sold to jobbers and dealers whose names we furnish—you make money from the beginning—profits are immense—we borrowed the money a few years ago to start—beginning with two sewing machines. Today we own the factory pictured above.

You become in reality, a branch of the McCreery Mfg. Co. working independently—we furnish the raw material—you turn out the finished product—reap the big profits. You are not bound by any contract to buy from us—only a man to man agreement. That's all.

We tell you all about the business in our interesting booklet. Costs you nothing to learn about it. Your copy is now ready to mail to you. Write for it. **IT'S FREE.**

Write today for this book. Don't delay it. Only a limited number of equipments will be offered free.

MC CREERY MFG. CO., 1079 Front St., TOLEDO, O.

Please Mention Popular Mechanics

IRWIN BITS

Forged from a single piece of special crucible steel. This steel and IRWIN workmanship are found only in bits made by

THE IRWIN AUGER BIT CO., Wilmington, Ohio

THE SPEEDY STITCHER

SEWS LEATHER LIKE A MACHINE

Price \$1.00



Send for terms to Agents

Automatic Awl Co., 26 Hermas St., Worcester, Mass.

WILL YOU TAKE ORDERS?

Many earn \$30 to \$60 every week demonstrating our 1915 Model Steel Automatic Handi-Tool. Lifting and Pulling Jack, Wire Stretcher, Splicer and Mender, Post and Stump Puller, Tire Tightener, Cable Maker, Press, Vice, Hoist, Wrench, etc. Operates automatically. Has power of 40 men. Guaranteed for life. Spare time or permanent work. Demonstrator loaned. Credit given. Write for factory agency offer.

Chas. E. Benefield Co., 2938 Industrial Bldg., Indianapolis, Ind.



Tool Cases for Toolmakers and Machinists

Keep your tools orderly arranged in a Gerstner Portable Tool Case. There's a place for every tool in one of the felt lined drawers. Every up-to-date mechanic needs one and you'll find our Cases the best built, neatest and most practical on the market. We guarantee to please or refund all money. Write for our free booklet.

Gerstner & Sons

Mfrs. of Mechanics' High Grade Tool Cases
808 Columbia St., DAYTON, OHIO

DRUMMOND 8-inch English Precision self-acting, sliding, boring, screw cutting and milling



LATHE

complete as shown
Forty-two Dollars

Capable of very varied and accurate work.

Our book, "Lathe Work by Home Amateurs," will be sent to you free on request.
W. R. Price, New York

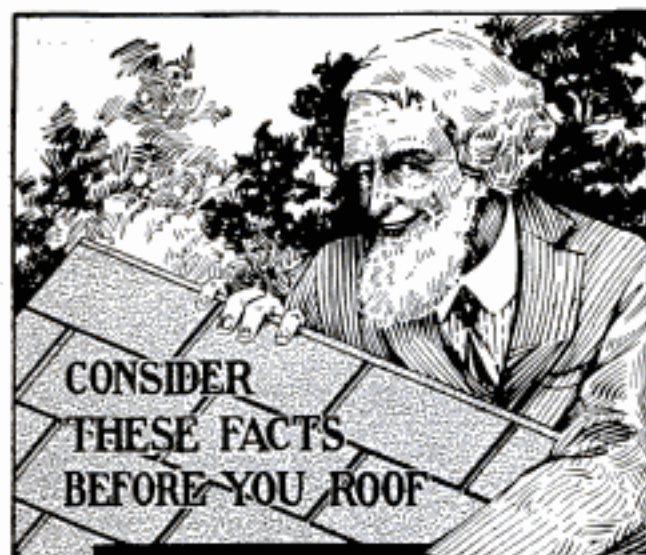

CONSIDER
THESE FACTS
BEFORE YOU ROOF

JUST THINK —
424 FLEX-A-TILES will cover 100 square feet of roof surface. And when you roof with FLEX-A-TILES you don't need the felt underlay that slate shingles demand. And—best of all—you have a roof of permanent beauty for the home. Don't roof until you get the whole FLEX-A-TILE story.

Free Book and Sample

Get a sample of FLEX-A-TILE and the FLEX-A-TILE book that's full of information you need.

THE HEPPES COMPANY

Mfrs. also of Asphalt Paints, Roofing in any flash and Utility Wall Board
1021 So. Kilbourne Avenue, CHICAGO

The Bureau of Soils, according to the latest report of the secretary of agriculture, has surveyed and mapped, since the inauguration of the work, 329,539 square miles of the soil areas of the nation, and, besides, made reconnaissance surveys of 234,000 square miles, or, altogether, 439,000,000 acres.

You should have it



The Drawing Attraction
of the Drawing World

THE CARL J. ESTBY COMPANY
307 Arch St.,
Philadelphia,
U.S.A.

Your dealer should have it

Patented Dec. 13 '04. *None equal*
Line-O-graph

Jr. 112 754 Draftsman Special 183
For use in pencil, ink, or India ink

FLORIDA FARM

\$800.00 buys beautiful 20 acre farm one mile from the rapidly growing town of Volusia on the east coast of Florida; good highly productive soil that will grow profitable crops every month in the year; Corn, oats, cotton, sugar cane, potatoes, celery, tomatoes and all kinds of vegetables thrive, also oranges, grape-fruit, strawberries and other fruits; abundant rainfall, good water, healthful climate, close to rail and water transportation; excellent market facilities; church, school and social advantages; perfect title; easy terms; no interest and no taxes for two years. L. J. NUTTER, Box 14, Volusia, Florida

Boston Garter

Velvet Grip

An essential of
Correct Dress
for Men

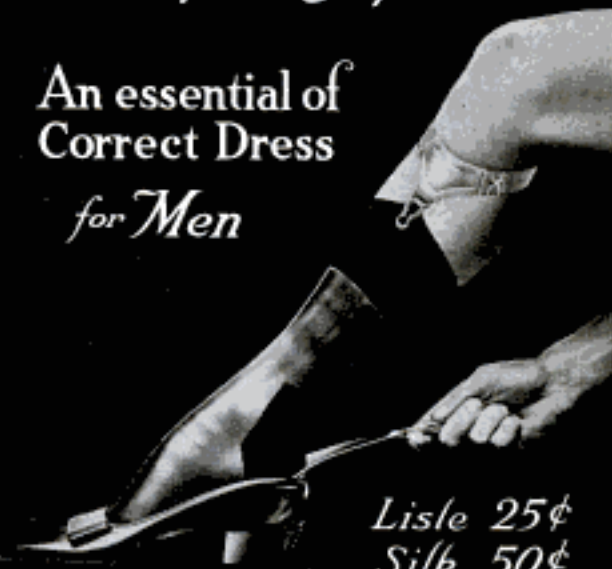

Liste 25¢
Silk 50¢

Holds Your Sock Smooth as Your Skin

GEORGE FROST CO. *Makers* BOSTON

This Catalog FREE

Write for It

J. M. Hanson-Bennett Magazine Agency is the largest in the world.

Save Magazine Money

Our 1916 catalog lists more than 3000 Periodicals and Club Offers. It's a Big Money-Saver. Send us your name and address today.

AGENTS WANTED Write for full particulars.

J. M. HANSON-BENNETT
Magazine Agency
223 W. Jackson Blvd., CHICAGO, ILL.



AGENTS \$10 to \$20 a Day

Easy selling, new, just out.

Aluminum Patent Gem Steam Cooker
Cooks entire meal over one burner. Will not burn or scorch food. Guaranteed 15 years. Thousands will be sold—low price—big profit. Write quick for exclusive territory and large free catalogue of 400 specialties.

American Aluminum Mfg. Co., Div. R 88, Lemont, Ill.

If you shoot you need the Ideal Hand Book.
Tells all about powders, bullets, primers and reloading tools for rifle, pistol and shotgun ammunition. Shows how to cut your ammunition expense in half. 160 pages—sent free to shooters for 3 stamps postage by The Marlin Firearms Co., 65 W. St., New Haven, Conn.

Hand Forged
Razor Steel
Blades. No. 57



This \$2 KNIFE 83¢
DIRECT AT FACTORY PRICE

Handy shaped blade makes this knife best for mechanics, sportsmen and farmers; light but strong; resharpened easily. Stag handle, German silver finish; blades file tested, hand forged from razor steel and warranted. Sample 83c, 3 for \$2 postpaid. Choicest pearl \$2 each. Send for our 80 Page List and "How to use a Razor" FREE

MAHER & GROSH CO., 106 A. St., Toledo, Ohio.



The Economy of Quality

PRICE is the amount of money paid for goods. COST is based on the DURATION OF SERVICE of those goods. WORTH is the combination of quality, durability, service and efficiency that USE proves.

WORTH may exist in the raw materials of which the product is to be made. Worth may be present in the skill of the workmen who are going to make the article. Worth may show in design so distinctively advanced that its greater value cannot be mistaken. At all events, the greater the worth the less the eventual cost.

The REASON there are better things, is because experience taught buyers that they lost money by purchasing the cheaper things. Every wonderful machine has been perfected by improving on what has been tried. If experience taught nothing, men would still live in caves.

EXPERIENCE has taught police departments last year that by paying slightly more for much greater worth their HENDERSONS can be run another season and give perfect satisfaction, instead of purchasing new machines as has been the custom with other types.

This is the economy of quality in your purchase. Secure our new catalog and investigate for yourself.

Have you met "HENDERSON BILL"?
Write for an introduction.

Henderson Motorcycle Company

1160 Cass Ave., Detroit, Michigan



New Motorcycle Type

Remarkable new improvement: make the 1914 "Arrow" a positive wonder for speed, comfort and easy riding. Latest Eagle easy motorcycle saddle—New Departure coaster brake—special motorcycle pedals—motorcycle handlebars with long rubber grips—imported anti-friction chain—reinforced motorcycle frame—beautiful finish. All sizes for boys, men and women.

Wonderful Offer Write today for the low direct offer we are making on the splendid Arrow bicycle. Get our free catalog. A small amount down brings you the Arrow—pay for it while you ride—a little each month. **Write Today** Do it now, and we will send you details of the remarkable new machine and best rock offer. Send today sure. **Arrow Cycle Co.** Dept. 1192 19th St. Chicago, Ill. and California Ave.

Send for Booklet! Boys! SOME CAR! Send for particulars today



The Lad's Car

Send 20c today for Booklet, telling how to build this automobile. Complete instructions and descriptions of parts and sizes, illustrated with diagrams, blue print, cuts made from photographs, and price list of parts.

Boys! We have a wonderful price to offer either on the complete car, or the parts. **SPECIAL INDUCEMENT** to first boy in your town **Niagara Motor Car Corp'n, Dept. A, Niagara Falls, N. Y.**

FIRST SAILING VESSELS PASS THROUGH PANAMA CANAL—The canal was used by sailing vessels for the first time during the last week of November, 1914, when the British schooner "Zeta" and the American yacht "Athene" were put through together, in tow of a tug. The vessels entered the canal on November 28, and arrived at Balboa in the afternoon of November 30.



Convert Your Bicycle into a Motor-Cycle Motor fits any wheel. BEST, MOST RELIABLE. Best hill climber. More STEFFEYS in use than all others. Stamp for circulars. **STEFFEY MFG. CO., 5007 Brown Street, PHILA., PA.**

\$40



MOTORCYCLES!

New and Rebuilt Motorcycles. Largest stock in the world. Lowest Prices. We guarantee to save you from \$25 to \$50. We repair any make of motorcycle. Send us your motorcycle for repairs. Motorcycle tires \$4, best Belg. \$5. Buy direct; save dealer's profits. Send for Catalogue. **DENINGER CYCLE CO., ROCHESTER, N. Y.**

CRIDE a RANGER



bicycle and know you have the best. Buy a machine you can prove before accepting.

DELIVERED FREE ON APPROVAL and 30 days' trial. No expense to you if you do not wish to keep it. **LOW FACTORY COST,** great improvements and values never before equalled in our 1915 models.

WRITE TODAY for our big catalog showing our complete line of 1915 bicycles, **TIRES,** sundries and parts, and learn the wonderful new offers and terms we will give you. Auto and Motorcycle Supplies at factory to user prices. **Do not buy until you know what we can do for you.**

MEAD CYCLE CO. DEPT. C-108, CHICAGO

5 H. P.

1915 Peerless Motorcycle



with Free Engine, Bosch Magneto, together with the best there is in Motorcycle construction, Power, Speed, Silence, Endurance, and those wearing qualities so essential for low cost of maintenance. **5 MILES FOR ONE CENT** Agents Wanted—Liberal Discount!

PEERLESS MOTORCYCLE CO., 179 Hunting Ave., BOSTON, MASS.

MAKE YOUR BIKE A MOTORCYCLE

at a small cost, by using our attachable outfit. Fits any bicycle. Easily attached. No special tools required.

8 Months' Repairs, 30c

Mr. Grabin, of Texas, writes: "I want to write a few lines to you telling you how well pleased I am. Any man or boy can make a good motorcycle with that little 2½ H. F. SHAW motor. It is the simplest and best motor a man can buy for a little money. I can write eight months without repairs, and then it was only 30 cents. It was only half the fuel that other machines use. I can go anywhere with the little SHAW that any other can."

FREE BOOK Write today for bargain list and free booklet, fully describing the SHAW Bicycle Motor Attachment. Motorcycles all makes, new and second-hand, \$35.00 up.

SHAW MANUFACTURING CO.
Dept. 6 GALESBURG, KANSAS



Morgan Gas Lighter

Factory Representatives wanted everywhere to handle our Auto and Hardware Necessities. Unusual Contract. Large Profits. Increasing Demand. Write today, letter—no postals—Exclusive Territory. Samples. **FREE SALES-PLANS!**



Morgan Rolling Wedge Spring Leaf Opener
Only instantaneous spreader on market. For lubricating Wagon, Auto, or any spring. Real Opportunity for Hustlers. Immense field. Popular Prices. Millions will be sold. All our Specialties carry Money-Back Guarantees. Write Now to **MORGAN MFG. CO., Bellevue St., Newport, R. I.**

MAKE \$50 TO \$100 A WEEK

AT THE PANAMA PACIFIC EXPOSITION
Snapping the crowds with a famous **Diamond Post Card Gun** all your expenses there and back and a big daily profit besides. Takes photo post cards and buttons, finished on the spot, in less than a minute. Circulate free. **INTERNATIONAL METAL & FERRO CO., B212, Chicago**



PENNSYLVANIA Oilproof VACUUM CUP TIRES

The Electrically Equipped **Indian Motorcycle**
With Cradle-Spring Frame. Send for Free Catalog.
Hendee Manufacturing Co., 818 State St., Springfield, Mass.

ORBIN Bicycle and Motorcycle
WRITE FOR CATALOGUE.
THE CORBIN SCREW CORP'N
The Amer. Hdqrs. Corp. Succ. New Britain, Conn.

Don't Throw Away Your Worn Tires

For over three years European motorists have been getting from 10,000 to 15,000 miles out of their tires by "half-soiling" them with Steel Studded Treads. In eight months 20,000 American motorists have followed their example and are saving \$50 to \$200 a year in tire expense.

We ship on Approval without a cent deposit, prepay the express and allow you to be the judge.

Durable Treads double the life of your tires and are sold under a signed guarantee for 5,000 miles without puncture. Applied in your own garage in thirty minutes.

Special Discount offered to motorists in new territory on first shipment direct from factory. A postal will get full information and sample within a week. State size of tires. Don't wait—write today. Address nearest factory office.

THE COLORADO TIRE & LEATHER CO.
102 Geitz Bldg., West Austin Ave., CHICAGO, ILL. 102 Geitz Bldg., DENVER, COLO.

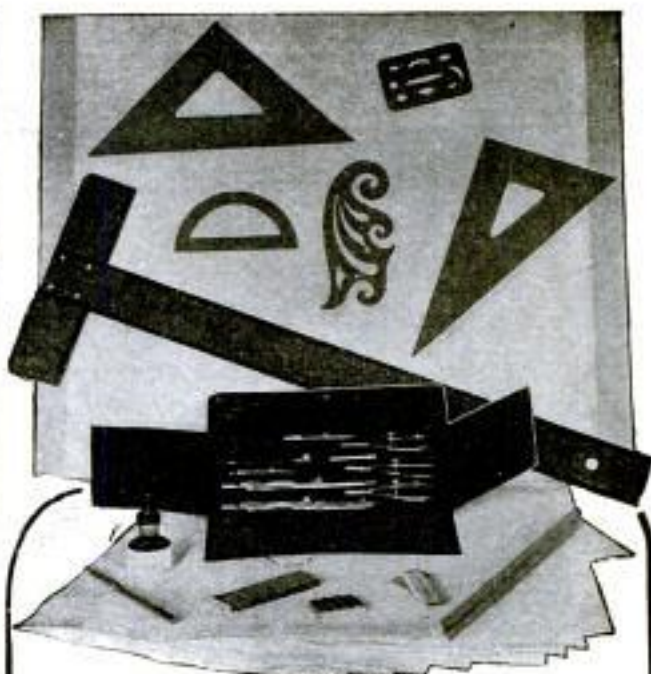

DRAWING LIBRARY FREE

Get the \$20.00 Cyclopedia of Drawing shown below absolutely free. The only work which thoroughly covers **MECHANICAL, STRUCTURAL and ARCHITECTURAL DRAFTING**. Have these books handy for reference at all times—they answer all questions authoritatively and promptly. Just think of it—four big volumes bound in half red morocco, gold stamped, 1,720 pages, 7x10 inches, 1,037 illustrations, page plates, diagrams, designs, etc., furnished free, if you enroll now for our easy drafting course.

Drafting Outfit at Cost

This Draftsman's Outfit consists of imported drawing instruments in morocco case; 20x25 inch drawing board; ebony lined mahogany T-square; transparent triangles; protractor; French curve; triangular scale; ink; pencil; erasers; shield; pencil pointer; drawing paper and thumb-tacks. Instruments made by largest and most reliable manufacturer and guaranteed accurate. The complete outfit, offered by many dealers at from \$15 to \$18, will be furnished you at \$6.40 per set.

Earn \$100 to \$250 a month

Draftsmen earn from \$100 to \$250 per month. The work is pleasant and the hours short—it is the only profession where the demand exceeds the supply. Learn drafting—the foundation of all engineering professions—in your own home and without giving up your work. Our new, practical method will make you an expert draftsman in a short time. Enroll now on this big free offer—prepare yourself in your spare time to enter this well paying profession.

Seize Your Opportunity

Fill in and mail the coupon today—now! Let us tell you how easy it is to fit yourself for a big job and big pay as a draftsman. Remember, we furnish a high grade draftsman's outfit at cost, and send you a \$20 reference work absolutely free when you enroll. Isn't this worth investigating?

AMERICAN SCHOOL OF CORRESPONDENCE
CHICAGO, U. S. A.

Free Offer Coupon

American School of Correspondence, Chicago, U. S. A.

Please send me full information about the course checked below, also further particulars regarding the library sent FREE and the outfit furnished at cost with this course. Pop. Mech. 2-15

... Mechanical Drafting
... Structural Drafting
... Architectural Drafting

NAME.....

ADDRESS.....



Please Mention Popular Mechanics

EARN \$20⁰⁰ TO \$30⁰⁰ A DAY



THERE is no limit to your earning capacity—sounds exaggerated, but it isn't. In small town or large city there's a way for you to earn \$20 to \$30 a day—up to \$3000 a year and more—with one of our B. B. Power Vacuum Cleaners — **30 DAYS' TRIAL**

Try it 30 days—see for yourself. It's a great chance to start a business for yourself—just what you want—the very opening you've been looking for.

Tremendous Profits \$20 to \$30 is easy with one machine—many operate two or three—and profit from others labor. No doubt that is what someone is doing with you. Change this—work for yourself. Get all the profits. Be independent.

Remember how much you can earn daily—\$20 to \$30 is clear profit—**Start a Business of Your Own**

\$500 to \$1000 a month. Profits soon pay for the machine. Business is not overrun—profits steady—thousands and thousands of homes will never own a vacuum cleaner of their own. These will never think of owning them when they can depend on you.

Start with one **You Can Start Small** home on a street—soon half the homes in that neighborhood want regular service. Endless things to be cleaned—rugs, matting, carpets, mattresses, curtains, upholstered furniture, besides walls and floors.

Others Are Doing It—So Can You Churches, lodge rooms, dance halls, hotels—hundreds of places can use your work. No experience necessary—just a little push and courtesy. Clear \$3000 upwards a year.

Mr. Rainbow, writes: "The B. B. does all you claim. I speak out from \$20 to \$25 in six hours easily." Mr. Staley, writes: "It's the greatest dirt puller I ever saw. I make \$20 a day with it." Over all these opportunities—Learn that there is no other business where so small an investment will bring such wonderful returns. In fact we have such implicit confidence in the wonderful money-making possibilities of our "Giant" B. B. House Cleaner—that we will ship one to you on **30 DAYS' TRIAL**.

COME TO SEE US AT OUR EXPENSE

Up to a distance of 300 miles we will pay your traveling expense if you buy. Start now—somewhere—anywhere. Send today for our free book and complete particulars regarding the 30 days' trial. Figure the number of homes in your town—compute how much it costs to clean them each week. You can get part or all of this business. You have scores of friends who would gladly start you with their work—others will surely follow. You can depend upon a nice profitable business from the start.

The McCreery Mfg. Co., 1010 Front St., Toledo, O.



Write postal or letter for Free Book. Tells whole story.

AGENTS—\$5.00 to \$25.00 a Day—It's Easy

Grand Invention. 150% Profit. Great Excitement
Recognized as most phenomenal seller

Experience Unnecessary. Spare time can be devoted if desired

LISTEN: One man's orders \$2,650.00 one month—profit \$1,650.00

Lowry, of Montana, who sold 25 dozen the first two weeks (without previous experience) and made \$187.50, enthusiastically writes: "Why, I could sell this article blindfolded and with a gag in my mouth." Mere boy in Pa. made \$9.00 in 2 1/2 hours. "I do not see how a better seller could be manufactured," reports Parker J. Townsend, Minn. "Started out at 10 a.m., sold 35 by four o'clock," says J. R. Thomas, Colo. "Sold 131 in two days." G. W. Handy, New York. See what a wonderful opportunity. These remarkable reports proven absolutely true by oath-covered evidence—proven to satisfy you beyond a doubt. You can make this money. Work for us and get rich. We want representatives—Agents, Salesmen, Managers—everywhere. Write today. Territory in all sections of the United States, Canada, Mexico and foreign countries to be assigned. The New Easy Wringer Mop tremendously in demand by housewives. Every woman exclaims in delight: "Just what I want!" No more tiresome, back-breaking, miserable mopping days. Drudgery actually transformed into pleasure. The greatest, grandest, most necessary household article ever invented. No need to recite selling arguments. Talking hardly necessary at all. Simply show—order's landed. This is indeed a wonderful opportunity. Establish yourself in this business at once. Send your name and address on a postal now—right now.

The Easy Wringer Mop (Patented) Hands do not touch the water.

Think of It

A Self-Wringing Mop. Two turns of the crank wrings out every drop of water. Mopping is now a pleasure.

U. S. MOP CO., 238 Main St., TOLEDO, OHIO

Please Mention Popular Mechanics

BARODA DIAMONDS

Flash Like the Gem—at 1-50 the cost
SOLID GOLD MOUNTINGS
Stand acid test and expert examination. See them first, then pay. Catalog FREE. Patent Ring Gauge included for 5 two-cent stamps.
The Baroda Co., Dept. U5. 1460 Leland Ave., Chicago



AGENTS STEADY INCOME

Wide Awake Men and Women! You can secure

protected Territory to sell International Portable Lamps and Lighting Systems. Our Self-Heating Rad-Iron is positively the simplest and most practical Iron on the market. We challenge competition. **Your Chance.** Territory is being rapidly taken. If you want a good steady income, write to us TODAY.

International Light, Novelty & Specialty Co.
426 So. Clinton St. Dept. 76 Chicago, Ill.



An Attractive Bungalow Can Be Built for \$900.00

Plan of this bungalow and 117 other plans of bungalows, cottages and other houses in my new book, "Building Plans for Modern Homes," just off the press. One of the most complete and comprehensive books of plans ever published by any Architect. Nearly 300 illustrations of floor plans and elevations, costing from \$250.00 up; gives sizes and cost to build. Sent postpaid for \$1.00.



FREDERICK H. GOWING, Architect, 18 Tremont St., Boston, Mass.

KEITH'S ON HOME BUILDING

20 Cents Copy—Newsstands. (Established 15 Years.)

A beautifully illustrated 80-page monthly magazine devoted to building, decorating and furnishing artistic homes at moderate cost. In each issue are 5 New House Plans by leading architects. Subscription \$2.



Big \$1.00 Offer
Six Big Building Numbers of Keith's showing 60 Unique House Plans, and my Book, "100 Artistic Homes," making a total of 150 Plans, all for \$1.

Any \$1 Plan Book with Keith's 12 Months for \$2

135 Bungalow Plans \$1	175 Homes estg. below \$5,000 \$1
104 Cottages \$1	over \$5,000 \$1
125 Homes estg. below \$4,000 . . . \$1	100 cement and brick \$1
175 \$5,000 \$1	50 Garage and 40 Duplexes \$1

M. L. KEITH, 707 McKnight Bldg., MINNEAPOLIS, MINN.

LET US SET THIS
LEWIS-BUILT HOME
DOWN ON YOUR
LOT



\$433

A Price Possible
Only by the Lewis Method

This beautiful bungalow "Madrid" is only one of over 100 houses shown and priced in our great free book. We supply any house complete, without your bothering with architects, middlemen, lumber dealers and others waiting to have "a finger in your pie."

LEWIS-BUILT CONSTRUCTION means preparing the house at the mills, sawing and working to fit, then shipping direct to you. Accurate working plans furnished; best grade of lumber obtainable; only one small profit to pay.

Send for the "Lewis-Built House Book" — an art gallery of architecture and economy. Contains over 100 original bungalows, cottages, houses of every kind, some as low as \$248.00. Your house, the one you have dreamed of, is there, at a price within your reach. Build now, while building is cheap.

LEWIS MFG. COMPANY
Dept. 278 BAY CITY, MICH.

LEWIS-BUILT HOMES

BAY CITY,

MICHIGAN

More than 4,000,000 tons of iron ore a year are expected to be exported from mines in Algeria by French capitalists who have obtained concessions to work them.

Do Your Own Printing



You can make good money from the start and build up a profitable business by printing cards, letter-heads, circulars, etc. Requires little money.

Write today for our 96 page catalog. It's free. Contains full printing instructions.

ROWELL PRINTERS SUPPLY CO.
75 Main St. (Est. 1865) Louisville, Ky.



BOYS! GIRLS! WONDER OF 20TH CENTURY

Apparently shows bones in fingers, lead, a pencil, etc. You can see through fabrics, even flesh looks transparent and bones can be seen. Think of the FUN you can have. Complete X-RAY shipped prepaid 10 Cents.

NUIDEA CO., Dept. 45, 524 45th St., BROOKLYN, N. Y.

GET IN
BUSINESS
FOR
YOURSELF

Start ice cream cone plant—profits enormous. Business increasing. Start NOW—get in on THIS YEAR'S PROFITS. Own your own factory; sell to trade and public; big money both ways. Or run it with other business, candy store, restaurant, show. Make the sweet sugar cones in demand everywhere. Make the BEST—pure, crisp, the kind that sell fast. Learn before the season starts. Get full particulars. ADDRESS DEPARTMENT B.

LANIER & DRIESBACH MFG. CO., CINCINNATI, OHIO
BIG PROFITS IN CONES



Grow Mushrooms
Add \$5 to \$20 a Week
to Your INCOME

Grown at home, in basements, barns, sheds, etc. Does not interfere with regular employment. Others are making money in this business. Why not you? It costs nothing to find out how to start, how to sell, etc. Send for illustrated booklet. Address

A. V. JACKSON, Falmouth Mushroom Cellars, Inc.
342 Gifford Street, FALMOUTH, MASS.
The Largest Modern Mushroom Farm in the World

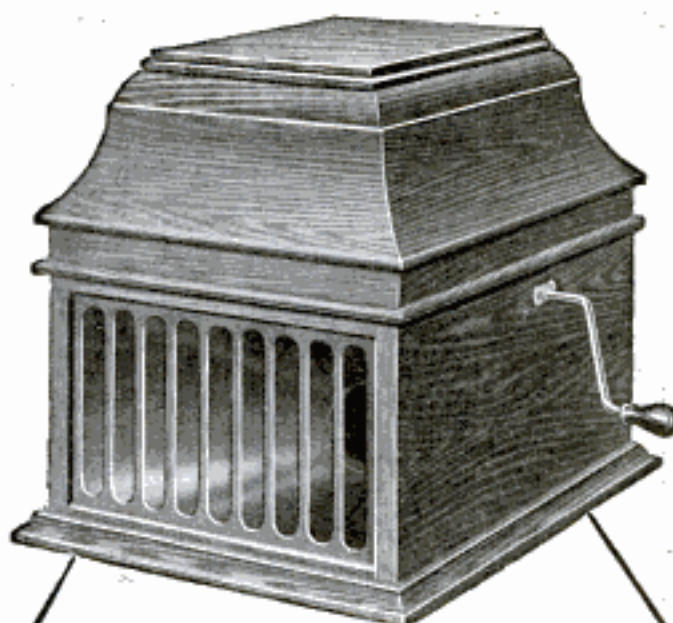

\$100

and You Keep This Superb
New Edison

An astounding offer—the great New Edison with the new Diamond Stylus reproducer and your choice of all the brand new Diamond Amberol Records will be sent to you on free trial without a penny down. The finest, the best that money can buy at one-fourth, yes, one-fifth the price at which imitations of the genuine Edison are offered—a rock-bottom offer direct from us.

Entertain Your Friends

Hear all the latest up-to-date song hits of the big cities. Laugh until the tears stream down your face from laughing at the funniest of minstrel shows. Entertain your family and your friends with everything from Grand Opera to Comic Vaudeville — then if you choose, send the outfit back to us at our expense.

Rock-Bottom Direct Offer

If you wish to keep Mr. Edison's superb new instrument, send us only \$1.00 after the free trial. Pay the balance on the easiest kind of monthly payments.

Think of it — a \$1.00 payment, and a few dollars a month to get this brand new style outfit—the Diamond Stylus reproducer, the musical quality—the same Diamond Amberol Records—all the musical results of the highest price outfits—yes, the greatest value for \$1.00 down, balance on easiest monthly terms. Convince yourself — a free trial first! No money down, no C. O. D., not one cent to pay us unless you choose to keep the instrument.

Our New Edison
Catalog Sent Free

Your name and address on a postal or a letter (or just the coupon) is enough. No obligations in asking for the catalog. Get this offer — while this offer lasts. Fill out coupon today.

F. K. BABSON
Edison Phonograph Distributors
1192 Edison Block
Chicago, Ill.

Canadian Office:
255 Portage Ave.
Winnipeg,
Manitoba.

Name.....

Address.....

To
F. K. Babson
Edison
Phonograph Distributors
1192 Edison Bldg.
Chicago, Ill.

Gentlemen: Please send me your New Edison Catalog and full particulars of your free trial offer on the new model Edison Phonograph.

Please Mention Popular Mechanics



Wouldn't You Like to Own a Store

Like This?

Wouldn't you like to be proprietor of a money making business? Once I was just a struggling candy maker. The profits from Crispettes, the new, delicious popcorn confection, built this big business

for me. The very same proposition that made me, should do the same for you. Start in the Crispette Business for yourself. Build a business of your own as I did. Get a window—a small store—a cozy nook where the rent is low. Keep all the profits. I'll teach you the Crispette business—tell you how to succeed—show you how to make Crispettes by my special secret formula. I'll do it right here in Springfield—personally or by mail. But the thing for you to do is to

Come to See Me At My Expense

Don't say you're coming. Just drop in quietly. Call on any banker or merchant. Ask them about Long—about my store—my crispette business. See if folks think I'll give you a square deal. Then come and see my store—see that it's just like the picture. See the machine. See crispettes made—make a batch yourself. Learn the business. Get my pointers on how to succeed. Up to a distance of 300 miles I'll pay all your traveling expenses, if you buy a machine. You'll see—know—learn everything. It's simple—easy. Won't take you a day. I'll be glad to see you—glad to show you the store and have a good talk with you. You'll go home ready to make more money than you ever made in your life.

Ask them if what I say isn't the truth—right

This is the Money Making Machine



Send for Free Book

Every Nickel You Take in Nets You Almost Four Cents Profit

Think of it! Think of the fortunes made in 5 cent pieces. It's one business in a hundred. Everybody likes crispettes—children—parents—old folks. One sale always means two—two means four. So it goes. It's a great business. I found it so—so should you. Send for my big free book "How to make money in the Crispette Business"—48 pages illustrated—complete information and story of how I built my business. Read it and then come to Springfield.

W. Z. LONG, 1012 High St., SPRINGFIELD, O.



This is a recent picture of the man who made \$1500 in one month with a Long Crispette machine, in a store window.

SET SIX SCREWS And Save \$13.25

SECTIONAL COME-PACK FURNITURE

Sold on a Year's Trial

Our Price only \$11.75 "in the white"

YOU can save from 30% to 60% on the price of your furniture by buying the Come-Pack way.

For instance, this beautiful table, made from quarter-sawn white oak, with rich, deep, natural markings, in the white, only \$11.75; finishing materials, 50c additional.

Usual retail price—about \$25.00. Four Hundred equally attractive designs in our big catalogue. Write for it to-day. Factory prices. The Come-Pack Furniture Company, 201 Derr St., Toledo, O.



No. 300 Library Table
Shipping Weight, 150 lbs.

Height, 30";
Top, 44" x 28"

The world's production of copper is placed at 2,198,732,130 lb. in 1913, as compared with 2,250,101,580 lb. in 1912. In 1913, the output of the United States was 55.6 per cent of the world's production, or 1,417,862,810 tons.



\$4.00 Satin Lining in This Handsome Blue Serge Suit **FREE**

Thousands of men are wearing Bernard-Hewitt tailored-to-measure clothes—they find that our system of tailoring direct saves them big money and enables them to dress better. We want you, too, to become one of our regular customers—that's why we will sell you one of our regular all-wool blue serge suits

Made-to-Measure (\$25 Value) for \$15 and line it with guaranteed satin lining free—also pay shipping charges. We guarantee to please you in tailoring, materials, fit and style or you don't pay us one cent.

Big Spring Catalogue—76 Samples Free Send for it—contains samples of plain and fancy suitings; also lowest prices on men's shoes, furnishings, hats, boys' clothing. Write **BERNARD-HEWITT & CO.,** Desk 22—564 W. Monroe St., CHICAGO

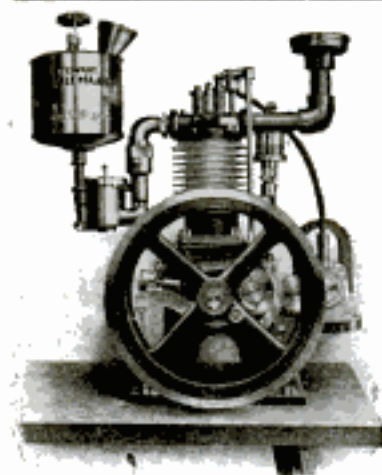

This Marvelous 1/2 H. P. Stewart Engine

is the strongest, sturdiest and easiest to operate of any. Does all work that 1/2 horse power can do.

A half gallon of gasoline runs it a full day

We specialize on 3 sizes only: 1/2, 2 and 3 1/2 H. P. 2 and 3 1/2 operate on kerosene, gasoline or gas. Stewart Engines are superior in quality—they stand up to their work year after year without expensive repair bills. The best is always cheapest in the end. Write for big new 1915 catalogue. Write today.

CHICAGO FLEXIBLE SHAFT COMPANY
105 N. La Salle St., CHICAGO

STOP AGENTS SALEMEN

Just Out—brand new invention—splendid seller—Light Deflector for Auto Headlights. Puts light on the road instead of in other people's eyes. Not a dimmer—increases driving light. Cuts out all the "glare." Needed—wanted on every machine. Simple, easy to put on. No adjustments—no knobs to turn—lasts as long as the car. Fully patented. Low in price—sells like lightning. LISTEN:—You can make

\$45.00 to \$125.00 Weekly

Johnson, Ohio, cleared \$22 first day. Allen, Wash., made \$25.60 one afternoon. Hinkle, Wis., "Best article I ever sold." Walker, Kans., writes, "Double my order and ship C. O. D." Gorman, Iowa, wires, "Ship gross quick, wiring money. Sold 19 today." Profit \$30.40. Hurry, get some of this money yourself. Wiley, Ga., reports 11 sales the first day. Millard, Ohio, says, "Everybody wild over Deflector." This is your chance to make money. Don't hesitate a minute. No charge for territory—sales guaranteed—you can't help but make money. SEND NO MONEY—just write for full details. Address

THE HICKMYER DEFLECTOR CO.
444 S. & B. Bldg. TOLEDO, OHIO



AUTOMATIC TELEPHONE SYSTEM ON OCEAN LINER—The White Star liner "Britannica," now under construction, is to be equipped with a 25-line automatic telephone system. This apparatus is to be used exclusively for administration and executive purposes, and will constitute a part of the navigating mechanism of the ship. This is the first marine installation of automatic equipment to be ordered, and its performance will be watched with interest.

Six hundred thousand sweater coats have been ordered from Canadian factories for the British government.



Diamonds on Credit
20% Down; 10% a Month

Every customer is protected by our written guarantee to refund his money if his dealer can duplicate our diamond at our price. Write for Illustrated Catalog No. 3.

J.M. LYON & CO., 71-73 Nassau St., New York City

The Acetylene Blow Torch

Prest-O-Torch

Costs less to buy than a good gasoline blow torch and costs less to use.

In all soldering and brazing, the Prest-O-Torch avoids the delays and uncertainties of gasoline outfits. Provides a concentrated, intense flame that doesn't blow out even in a high wind. Needs no attention whatever. Used with handy sizes of Prest-O-Lite cylinders—ready-made gas, instantly available.

Style "A" sells for 75c. Used with the small MC size Prest-O-Lite. Will braze up to 3/8 inch round rod. This outfit can be fitted with handle and hook for added convenience in bench and overhead work. Style "C" Prest-O-Torch is recommended for large work. Will braze up to 1/2 inch round rod. Sells for \$2.25. For use with the larger sizes of Prest-O-Lites.

Write for special literature and learn where you can see the Prest-O-Torch in operation.

The Prest-O-Lite Co., Inc. 816 Speedway, Indianapolis, Ind. Exchange Agencies Everywhere

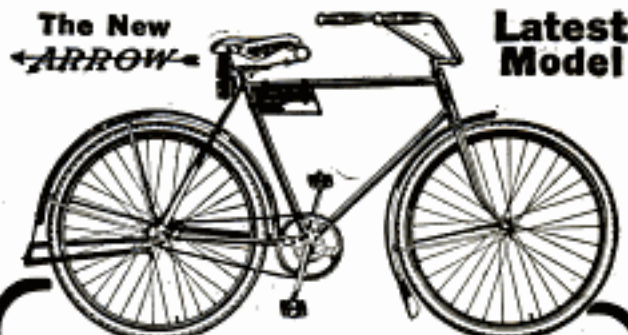

The Wonderful New Motorcycle Type

Remarkable new improvements make the 1915 "Arrow" a positive wonder for speed, comfort, and easy riding. Built just like the highest grade motorcycles. Makes bicycle riding like coasting all the way. Hills are easy with the new "Arrow." Smartest looking bicycle ever built. Cold-drawn, seamless steel tubing frame—latest easy "Arrow" motorcycle saddle—new Lester coaster-brake—special motorcycle pedals—non-vibrating motorcycle handle bars—long rubber grip—imported anti-friction chain—motorcycle mud guards and stand—triple strussed fork crown—long wearing, puncture resisting "Arrow" tires—beautiful finish. All sizes for boys, men and women. Don't fail to learn about this great new motorcycle model. Send coupon today for full details.

Startling Offer

Send the coupon today and we will send you our wonderful low, direct offer on this beautiful "Arrow." Get the special 30-day price offer. We ship the "Arrow" direct to you for your inspection without a penny down. Just pay a small amount monthly. If you are not delighted with this remarkable new machine when you see it—if you do not think it the greatest bicycle bargain you ever saw—send it right back at our expense. You do not risk a cent. Send the coupon today sure.

Pays for Itself!

Get our unparalleled Rider-Agent proposition. Just ride your "Arrow" around. People will admire it. Tell people where you got it. That's all. Just answer questions people ask about your handsome bicycle. You can pay for it and get cash besides. The coupon will bring full details.

Send the Coupon Today

It brings you the handsome "Arrow" Catalogue with announcement of the remarkable new improvements. It also brings you full details of our great Rider-Agent offer and astonishingly low prices. Get your name in early. Don't delay. Send coupon today sure.

ARROW CYCLE COMPANY

Dept. 1192 19th St. & California Ave. Chicago

Special Offer Coupon

Arrow Cycle Co., Dept. 1192
19th St. & California Ave., Chicago, Ill.

Gentlemen:
Please send me—without any obligations on my part—your new catalogue announcing the wonderful new "Arrow" and details of your special 30-day offer and new Rider-Agent proposition.

Name

Address

Please Mention Popular Mechanics



Oxy-Acetylene Welding & Cutting

makes large savings in the repair
and manufacture of all metal parts

Right now, you may be doing work that this process would simplify and cheapen. You owe it to yourself to investigate the actual instances of savings made, and the "on the spot repairs" that have saved money for other manufacturers and shop owners. New uses are being found daily.

Cost of necessary equipment is low. We furnish a thoroughly high grade welding apparatus for \$60.00. The average user will also need gas cylinders, furnished at an additional cost, and about \$10.00 worth of welding supplies. Truck and special equipment for cutting operations at extra cost.

If you are now using the process, by all means secure the added convenience, usefulness, efficiency, portability and simplicity, that is given good welding and cutting equipment, of any make, by

PREST-O-LITE Dissolved Acetylene (Ready made carbide gas)

Prest-O-Lite Acetylene Service furnishes the highest grade of Dissolved Acetylene in portable cylinders, used as conveniently as you use cylinders of oxygen. Saves the large initial outlay and heavy depreciation, trouble and inconvenience of making crude Acetylene in carbide generators. Besides, Prest-O-Lite Dissolved Acetylene is perfectly dried, cleaned and purified — makes better welds and is cheaper to use.

Every user of Acetylene should have full details of the liberal "Prest-O-Lite Service Plan," an ideal arrangement assuring maximum quality and quantity.

A Highly Profitable Business in a New Field

Doing Oxy-Acetylene repair work presents wonderful opportunities for profits to enterprising men seeking a business of their own. Immense and growing demand assures profitable operation from the start. Equipment soon pays for itself. Send for particulars.

Put your problems in welding and cutting up to our Oxy-Acetylene experts. Your name and address on the margin of this page will bring folder full of highly instructive literature.



The Prest-O-Lite Co. Inc.
816 Speedway, Indianapolis, Ind.

Direct factory branches
and charging plants
in principal industrial centers.

WONDER LIGHT OUTFIT

Lots of Fun for Boys
Consists of 3½ volt, 2 C. P. lamp, switch, socket, 20 ft. insulated wire and 3 cells of dry battery all ready to install.

PRICE ONLY 60c.

Post. Extra 15c

May be used to light a dark closet or hall.

LITTLE GIANT MOTOR

Is nearly 3 in. high. Runs at high speed on a single cell of battery. Very powerful and may be used to run small toys, etc. Just the motor every boy has been looking for.

Sent postpaid for only 50 cents

THE SIMPLEX TELEGRAPH



An opportunity for every boy to learn to telegraph and to put up a line with his chum. This is a full sized telegraph set consisting of a fine key and sounder mounted on a polished base. Will work any distance. An excellent Field Telegraph for Boy Scouts.

Sent postpaid for only 98 cents

UPRIGHT STEAM ENGINE

A fine engine, made of the best materials, 9 in. high. The right engine for any boy. Runs at high speed on low pressure. Each engine tested at the factory and fully warranted.

Sent postpaid for only 50 cents

SIMPLEX WIRELESS OUTFIT



Every boy wants a wireless outfit. Get in this interesting game and read the messages flying around you. This outfit is the greatest bargain ever offered. Consists of a large double slide tuner, a sensitive cat whisker detector, condenser, telephone receiver and cord. Size 9x6x4 inches. Wt. 5 lbs.

Special price, complete, \$1.95



EXPERIMENTERS

THIS IS THE **Experimenter's Reference Book**
EVERY BOY NEEDS IT

It's the latest edition of the famous **AMCO Catalog**, nearly 200 pages, fully illustrated. Complete description and prices of the latest Electrical and Experimental Apparatus — Storage Batteries, Rectifiers, Transformers, Induction Coils, Wireless Apparatus, Lamps, Flashlights, Meters, X-Rays, Books, Tools, Electric Railways, Steam Engines, Water Motors, Dynamos, Motors, Telegraphs, Telephones, Electrical Supplies, Model Aeroplanes and parts for building your own apparatus. A treatise on Wireless Telegraphy telling how to put up an aerial, connect apparatus, etc., together with a Call List and Wiring Diagrams, FREE with every catalog. 5c in stamps will bring you this wonderful book. The best catalog of wireless apparatus, etc., published.

ADAMS-MORGAN CO. "THE EXPERIMENTER'S SUPPLY HOUSE"
Dept. M, Upper Montclair, N.J.

The national forests of the United States have an aggregate area of slightly over 165,000,000 acres.

OWN A BUSINESS

WE WILL HELP YOU



"I made \$88.16 first three days," writes Mr. Reed of Ohio. Mr. Woodward earns \$170 a month. Mr. M. L. Smith turned out \$301 in two weeks. Rev. Crawford made \$7.00 first day. See what they have done, judge what you can do.

LET US START YOU

in Gold, Silver, Nickel and metal plating. Prof. Gray's new electromachine plates on watches, jewelry, tableware and metal goods. Prof. Gray's New

Royal Immersion Process latest method. Goods come out instantly with fine, brilliant, beautiful thick plate, guaranteed three to ten years. No polishing or grinding. Every family, hotel and restaurant want goods plated.

PLATERS HAVE ALL THEY CAN DO

People bring it. You can hire boys to do the plating as we do. Men and women gather work for small per cent. Work is fine — no way to do it better. No experience required, we teach you. Recipes, Formulas, Trade Secrets Free. Outfits ready for work when received. Materials cost about ten cents to do \$1.00 worth of plating. Our new plan, testimonials, circulars and **SAMPLE FREE**. Don't wait. Send us your Address anyway.

GRAY & CO., PLATING WORKS
671 Gray Building CINCINNATI, OHIO

DIAMONDS-WATCHES ON CREDIT

This splendid 16 HOWARD WATCH will pass inspection on any railroad, and meets the most exacting requirements where time to the second is demanded. YOU CAN NOW BUY THIS WORLD-RENOWNED HOWARD WATCH OF US AT THE CHEAPEST SPOT CASH PRICE AND PAY FOR IT IN SMALL AMOUNTS EACH MONTH. USE YOUR CREDIT. TERMS ONLY

\$5.00 Per Month

temperature, isochronism and 5 positions; Balance Wheel especially hard tempered; Balance Pivots and Train Pivots made of special steel; double roller escapement; steel escape wheel; 17 selected pigeon-blood Ruby and Oriental Sapphire Jewels; Pallet stones are Oriental sapphires; Case in extra gold filled, screw back, solid back, gwing ring, dust and moisture proof. Guaranteed 25 years. Every Howard Watch is issued at factory, timed and adjusted in its own case. Prices: 16 size, 17 jewels, \$90; Terms, \$5 per mo. 16 size, 19 jewels, \$60; Terms, \$6 per mo. 16 size, 21 jewels, \$65; Terms, \$6.50 per mo. Write for our free Catalog, containing over 2,000 illustrations of Diamonds, Watches, Jewelry, Silverware, etc. It tells all about our easy credit plan.

LOFTIS BROS. & CO., National Credit Jewelers
 Dept. 8894 100 to 108 N. State St. CHICAGO, ILLINOIS
 Stores also in: PITTSBURGH; ST. LOUIS; OMAHA.



Send for Catalog

LOFTIS

Perfection Diamond Ring
 This Diamond Ring No. 659 is our great special. Finest quality pure white diamond. Mounted in our famous Loftis "Perfection" 6-prong ring 14-k solid gold. Special value
\$50 TERMS: \$5.00 A MONTH
 Sent on approval, all charges prepaid. Other sizes and styles at \$25, \$40, \$75, \$100. See our Catalog. Sent Free on request.

Our Big Leader

No Gasoline to Buy; No Fire Risk

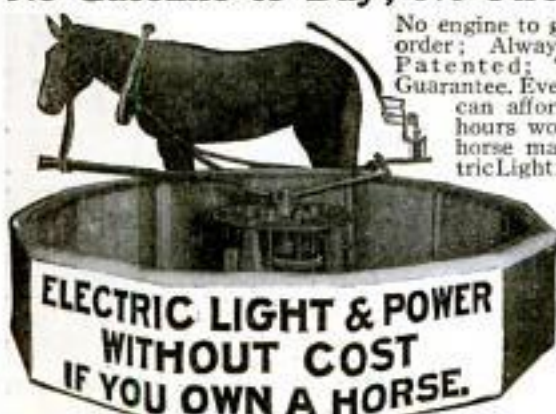

No engine to get out of order; Always ready; Patented; Two year Guarantee. Every farmer can afford it. Six hours work of the horse makes Electric Light for a week or more. Write for prices and circulars. Farmer Agents and Dealers wanted everywhere.

ELECTRIC LIGHT & POWER WITHOUT COST IF YOU OWN A HORSE.

The Electric Horsepowers Co., Mfrs., 906 Elm St., Cincinnati, Ohio

Agents \$60 WEEKLY

Robinson Folding Bath Tub. Big seller. Costs little, no plumbing, little water. Weight 15 pounds, folds into small roll. Full length baths, far better than tin tubs. Guaranteed 10 years. \$10 a day easily made. Write for free tub offer. Robinson Cabinet Mfg. Co., 103 Factory Bldg., Toledo, O.

10 Cents a Day

WURLITZER
 80 years of instrument making
 Pays for This Cornet An astounding offer! Only 10c a day buys this superb Triple Silver Plated Lyric Cornet. **FREE TRIAL** before you decide to buy. Write for our big offer. Write for our big new 250-page Band Catalog. Rock-bottom, direct-from-the-manufacturer's prices on all kinds of instruments. Pay for them at the rate of only a few cents a day. Generous allowance for old instruments. Free Trial. We supply the U.S. Govt. Write now!
Free Band Catalog
 THE RUDOLPH WURLITZER CO., Dept. 9192
 4th St., Cincinnati, Ohio 57 Wabash Ave., Chicago

SEPTEMBER MORN WATCH FOB. SOLID GOLD Finish.

Just like illustration. The bewitching little figure of Miss "September Morn" handsomely embossed on heavy metal, with SOLID GOLD Finish. Size of Fob 1 1/4 x 1 1/4. Genuine black leather strap. Boys, a real work of art. Classy, alluring. **Makes 'em all take notice.** Agents wanted everywhere. Dandy sample fob and our great money proposition to hustlers sent **prepaid 25 cents.** Address, **EMBLEM JEWELRY CO., 401 Morgan Building, Buffalo, N. Y.**



Self-Winding Clock

Marvelous new electric clock—dry cell battery—no wiring—runs anywhere. Winds itself. Clocks complete in many styles. For home, office and factory. No worry or care. Runs in any position. Low price. Special offer to introduce. Movements sold separate for timing devices and experimental work. Book on self-winding clocks and movements postpaid free. Send coupon or write.
American Self-Winding Clock Co., 136 W. Lake St., Dept. 5246, Chicago, Ill.

Economy in Your Pipe-Threading



Die-Stock No. 82
 1/4 in. to 3/4 in. pipe

THE Oster Mfg. Co.
 2100 East 61st Street
 CLEVELAND, OHIO

THE secret of economy is in doing it right the first time. **Oster-Cut Threads** do not eat up dollars in costly repairs. They are always true, perfect threads, easily and quickly made. There are 47 Oster Tools for producing these threads. Learn about them in this attractive booklet. The coupon brings it.



OSTER-CUT THREADS

Kindly send me the Oster catalog by return mail.

Name.....
 Bus.....
 Address.....
 City.....State.....(2100)

SMALLEST GAS ENGINE



in general use. Thousands of powerful little "Redemotors" now in use on washing machines, bench lathes, railway speeders, pumps, separators, fanning mills, generators, etc. Relieve yourself from turning a hand crank or running a foot treadle and get a "Redemotor."

Runs on gasoline, kerosene, also runs fine on gas. Three sizes, 1/2 H.P., 1/4 H.P. and 1 H.P. Low prices. Send for catalog!
ELGIN WHEEL & ENGINE COMPANY, ELGIN, ILL.

Name.....

Address.....

American Self-Winding Clock Co.
 136 W. Lake St., Dept. 5246, Chicago, Ill.

Gentlemen: Send free book on self-winding clocks and movements and special introductory offer. No obligation.

Hello Boys!

MAKE LOTS
OF TOYS

I KNOW
YOU WOULD
LIKE TO WIN THIS
AUTO



\$3000 IN PRIZES **BUILD NEW MODELS FOR ME**

Help me—make some dandy new models different from any yet made. I'll pay you well in prizes to help me show thousands of other boys all over the world what a wonderful toy is

ERECTOR

What are the Prizes?—Auto, motor cycles, bicycles, tents, canoe, camping outfits, skates, camera, Erector sets, air rifles, etc., etc.

300 Prizes—Just think of it!



THIS FOLDER GIVES ALL DETAILS FREE

Ask your dealer for it. If he has no folders, write me and I will supply you. This folder illustrates and describes in great details all the 300 prizes so you'll know exactly what you're working for. It costs nothing to enter contest. Free entry blank is included in folder. Your Toy dealer sells Erector.

Yours for a dandy, good time.

A. C. GILBERT, President

The Mysto Mfg. Co., 253 Foote St., New Haven, Conn.



Lowest Prices on Steel Shingles

Save Money—Save Roofs from Fire, Rot and Rust

But you must act NOW. Offer will soon be gone. Edwards Steel Shingles now cover 135,000 roofs. Cheaper than good wood shingles. Last five times longer. Need no after care. A man with a hammer and nails can quickly apply them. The Edwards patented "Tightcote" process prevents rot, rust, fire. Millions have been saved to Edwards users.

Edwards STEEL Shingles

No raw or exposed edges. Dipped in molten zinc after they are cut. Joints everlastingly watertight through Edwards Patented "Interlocking" Device. An Edwards roof lasts as long as the building. Insurance from lightning free under our \$10,000 guarantee.

Offer Limited

Free Roof Insurance
Factory prices. Direct to you. Freight paid. Have a better roof, every way, and save money by acting now. Offer soon gone. More for your money every way. Quick action important. Costs nothing to find out. No obligation.

Write now—RIGHT NOW

Don't Delay Writing

Give size of roof, if possible, when you write. We will quote prices on entire job. New Bargain Circular contains prices that will make you gasp with wonder at savings they offer.

Write now for
Catalog No. 250

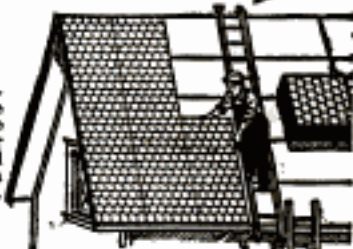

THE EDWARDS MANUFACTURING COMPANY
200-250 Lock Street, CINCINNATI, OHIO

SAFETY FIRST



SAFETY FIRST

AVOID ACCIDENTS AND LAW SUITS BY USING
NUGENT'S FROM-THE-FLOOR SHAFT OILERS
WM. W. NUGENT & CO., CHICAGO, U. S. A.

GRAY MOTORS AND BOATS

50 Leading Boat Builders have joined with the Gray Motor Company in issuing a catalog showing the specialties of each, which includes fishing launches complete from \$125 upward to mahogany finished express launches with self-starting 6-Cylinder 4-Cycle Gray Motors for \$2500. Cruisers from \$450 up. This book helps you select just the model of boat you have been looking for and tells you where to buy it and what it will cost. Send for this big Boat Catalog today. Free. Also Gray Marine Engine Catalog showing full line of 2 and 4 cycle marine motors from \$55 upwards, one to six cylinders. **GRAY MOTOR CO., 294 Gray Motor Bldg., DETROIT, MICH.**

335 Candle Power
Cost 1c 10 hrs. fuel

POWERLIGHT THE HOME LAMP



Winner of the Gold Medal, the highest award at the International Safety Exposition, New York, December, 1914. The only lamp to receive an award. It's the safest, brightest and best: Burns kerosene or gasoline without wick. Can't explode or spill. Plain or art glass dome.

OTHERS LOOK LIKE CANDLES

Must be seen to be appreciated. Don't buy any lamp until you see this one. An ornament to any home. Write for special offer. **AGENTS:** make big money, exclusive territory, samples loaned. Write today.

POWERLIGHT SALES CO.

95 Chambers Street NEW YORK

Ideal

POWER
LAWN MOWER

Combination Mower and Roller

38-INCH CUT

\$400

This newest machine is larger and more powerful than the 1914 model, and carries many improvements that will interest those who have the care of large lawns, golf courses, parks, etc.

A 5 horse-power motor (S. A. E. rating) with 6 adjustable cutter blades, 38 inches wide, and a roller 15 inches in diameter, it cuts 8 acres per day at a speed of one to 4½ miles per hour, at an operating cost of only 30 cents per day. It climbs 35% grades, cuts closely and evenly, is easily guided around walks, trees and shrubbery; and rolls the turf as well as cutting the grass, leaving the lawn in perfect condition. Neither hand-propelled nor horse-drawn mowers can compete with this machine in satisfactory results, economy of operation and all-round efficiency.

The Ideal Junior, a smaller power mower for \$225. Write for catalog and complete description of various sized power mowers.

IDEAL POWER LAWN MOWER CO.

R. E. Olds, Chairman 413 Kalamazoo St.
LANSING, MICHIGAN



Please Mention Popular Mechanics

New Ball Bearing Worm Drive, Hand and Foot Power Tool Grinder for only \$5

YOU'VE never seen as big value before in a grinder at the price. This new type "Best Maide" Tool Grinder operates equally well by either hand or foot power, sharpens all tools speedily, easily and accurately. Only foot power grinder made in which grinding wheel can be used in all positions. Equipped with guide that gives chisels and plane bits exactly the right bevel, either straight edge or hollow ground.

LUTHER "Best Maide" Hand and Foot Power Tool Grinder

Rigid all metal frame. Ball Bearings. Worm Gears cut from solid steel. Tilting Frame. All working parts enclosed and dust-proof. Double faced "Dimo-Grit" Sharpening Wheels—Medium Grit Body for bringing tool quickly to edge and Fine Grit Side Face that puts on finish like a hone. No water needed. Can't draw temper.



New Honing Device \$1.00

This device enables you to hone chisels and plane bits perfectly and give them any desired bevel. Prevents slips and jerks, but allows the free circular movement needed for proper honing. Prepaid for \$1.00—satisfaction guaranteed.



LUTHER GRINDER MFG. CO.

90 Point St. Milwaukee, Wis.

Six
Months
Free
Trial

On receipt of \$5 we will send you this wonderful new grinder with the positive binding agreement that if you are not perfectly satisfied with it, you can return it at any time within six months and we will refund the price. Order direct from this advertisement, or send for descriptive circular and full details of Free Trial Offer. Give dealer's name when you write.



SUMMER IN AMERICA

He could scarcely wait for balmy spring days, to launch his Mullins Boat—now he begrudges every moment spent ashore. That's natural—so many of nature's really delightful spots are accessible only by boat. When you feel the call of the water and the wild places, remember

SAFETY **MULLINS BOATS** **MAKES**

Sturdy craft—and beautiful—designed by America's foremost Naval Architects, manufactured by the most modern methods in the largest boat factory in the world, powered with both 2 and 4 cycle motors.

THE W. H. MULLINS COMPANY, 17 Franklin St., Salem, Ohio
Also manufacturers of the celebrated CHARLES RIVER MODEL CANOES

Mullins catalog, beautifully illustrating in colors, our full line of wood and steel boats, a really fascinating book, is free.

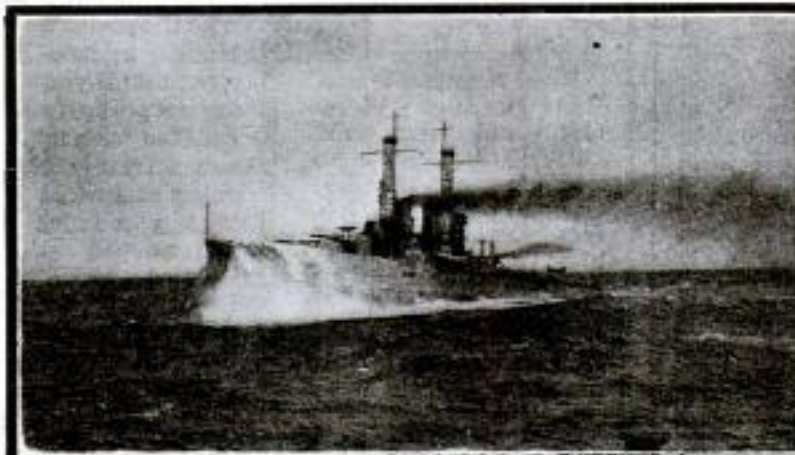

Our Many- Sided Navy

This timely book, just out, is of vital interest to every true American citizen. Mr. Robert W. Neeser, the author, is one of the few landsmen who have accompanied our fleet on its cruises and he *knows* Navy life. His book is a record of everyday life in the Navy and a precise account of the high standard of efficiency it maintains afloat and

ashore. The illustrations are unusual and remarkably fine.

8vo. Cloth. 215 Pages. 40 Illustrations.
Price, \$2.65 Postpaid.

POPULAR MECHANICS BOOK DEPT.
6 N. Michigan Ave., Chicago

WHEN YOU WANT ANYTHING AND DON'T KNOW
WHERE TO FIND IT—WRITE BUREAU OF
INFORMATION, POPULAR MECHANICS, CHICAGO

WHEN YOU WANT ANYTHING AND DON'T KNOW
WHERE TO FIND IT—WRITE BUREAU OF
INFORMATION, POPULAR MECHANICS, CHICAGO

Name.....

Address.....

National Electric Co.,
901 Lytton Bldg.,
Chicago, Ill.

Gentlemen: Enclosed
please find \$2.50 for
which please send
Hold Heet Stove on
10 days' free trial.

My money back if
not satisfied.

Hold Heet Stove \$2.50

Marvelous toaster stove. For toasting, heating, frying. Toasts quicker. New principle for holding the heat. Saves current. Most useful stove for toasting, warming, frying.

Send Coupon

No Metal To Burn You

Made of new patented Hold Heet material. One solid piece, mahogany finish. Lasts a life time. Special limited introductory offer. Now only \$2.50. By parcel post free. Return at our expense if not satisfied. Send for one today. Now.

NATIONAL ELECTRIC CO.

901 Lytton Bldg.

CHICAGO, ILL.



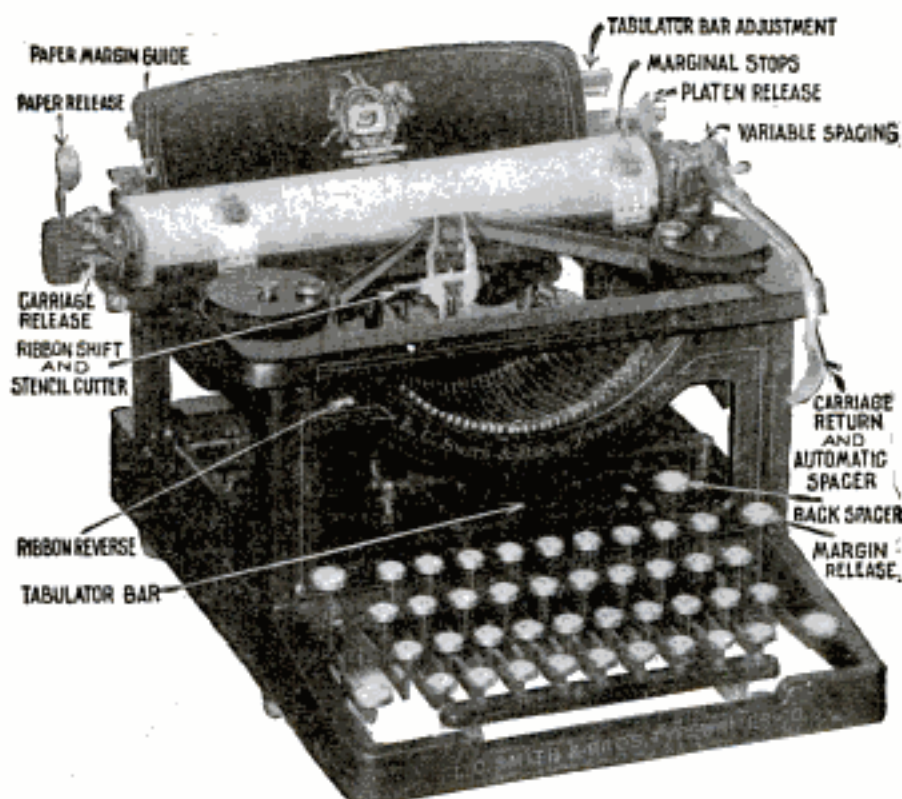

TYPEWRITER SENSATION

Free TRIAL—Use As You Pay

Only \$3.00 a month until the low total price of \$48.30 is paid, and the machine is yours

This is absolutely the most generous typewriter offer ever made. Do not rent a machine when you can pay \$3.00 a month and own one. Think of it—Buying a \$100.00 machine for \$48.30. Cash price, \$45.45. Never before has anything like this been attempted.

Standard Visible L. C. Smith

Perfect machines, Standard size, Keyboard of Standard Universal arrangement writing 76 characters—universally used in teaching the touch system. (Keyboard writing 84 characters \$1.00 extra.) The entire line of writing completely visible at all times, has the tabulator, the two color ribbon with automatic reverse, the Back Spacer, in fact every late style feature and modern operating convenience. Comes to you with everything complete, tools, cover, operating book and instructions, ribbon, practise paper—nothing extra to buy. You cannot imagine the perfection of this beautiful typewriter until you have seen it. I will send it to you F. O. B. Chicago for five days' free trial. It will sell itself, but if you are not satisfied that this is the greatest typewriter you ever saw, you can return it at my expense. You won't want to return it after you try it—you cannot equal this wonderful value anywhere.

You Take No Risk—Put In Your Order Now

When the typewriter arrives deposit with the express agent \$9.30 and take the machine for five days' trial. If you are convinced that it is the best typewriter you ever saw, keep it and send me \$3.00 a month until our bargain price of \$48.30 is paid. If you don't want it, return it to the express agent, receive your \$9.30 and return the machine to me. I will pay the return express charges. This machine is guaranteed just as if you paid \$100.00 for it. It is standard. Over one hundred thousand people own and use these typewriters and think them the best ever manufactured.

The supply at this price is very limited, the price will probably be raised when my next advertisement appears, so don't delay. Fill in the coupon today—mail to me—the typewriter will be shipped promptly. There is no red tape. I employ no solicitors—no collectors—no chattel mortgage. It is simply understood that I retain title to the machine until the full \$48.30 is paid. You cannot lose. It is the greatest typewriter opportunity you will ever have. Do not send me one cent. Get the coupon in the mails today—sure.

HARRY A. SMITH, 231 N. Fifth Ave., CHICAGO

H. A. SMITH
231 N. Fifth Ave.
CHICAGO, ILL.

Ship me a No. 2 L. C. Smith F. O. B. Chicago, as described in this advertisement. I will pay you the \$39.00 balance of the SPECIAL \$48.30 purchase price, at the rate of \$3.00 per month. The title to remain in you until fully paid for. It is understood that I have five days in which to examine and try the typewriter. If I choose not to keep it I will carefully repack it and return it to the express agent. It is understood that you give the standard guarantee for one year.

Name

Address



The Latest and Greatest "X"

Model 15-1—\$225.00

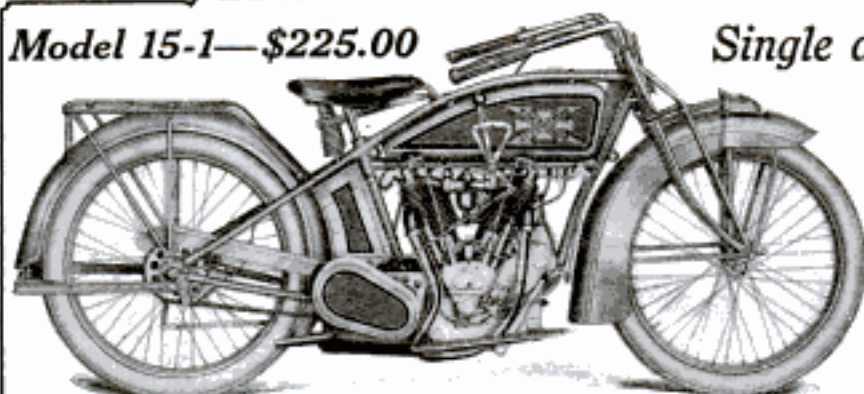

Single and Three Speed

Everything that
Makes a Perfect
Motorcycle,
Brought to the
EXCELSIOR
Standard of
Efficiency

We cannot in this small space, even enumerate the big features that make this not only the Greatest "X", but the most perfect motorcycle ever built. Our new catalog fully describes the

EXCELSIOR AUTOCYCLE

with Single and Twin Motors, One, Two, and Three Speeds, with regular and full electric lighting equipment at prices from \$175.00 to \$275.00. See the Dealer or write for catalog to-day.

Excelsior Motor Manufacturing & Supply Co.
3702 Cortland St., CHICAGO

MAKE FURNITURE LIKE THIS



Shown in the Photograph

ONE of our readers, who is strictly an amateur with tools, experienced no difficulty in making and finishing every piece of furniture, with the exception of the piano, shown in the accompanying picture. It is impossible in a small space to display all the different designs in Mission Furniture which we have published, but this picture shows something of the variety of pieces and how well they go together. The

MISSION FURNITURE SERIES of 3 Volumes

Comprises 98 Attractive Designs, all different

MISSION FURNITURE, Part 1
New Enlarged Edition 128 Pages, 30 Designs
MISSION FURNITURE, Part 2
Recently Issued 128 Pages, 32 Designs
MISSION FURNITURE, Part 3
New Book—Just Out 128 Pages, 36 Designs

Cloth, Size 5x7 inches Price 50 Cents Per Vol., Postpaid

THESE books describe how to make furniture for every room in the house as well as swings for porch and lawn. Whether you need a complete set or only some special article to fill in with here and there, you will find full directions, dimensions and working drawings for making it in these books. The instructions are easy to follow and even the amateur can obtain most satisfactory results as related above. A complete list of the designs in each book will be furnished free upon request.

ASK YOUR BOOK DEALER or address the publishers
POPULAR MECHANICS BOOK DEPARTMENT, 6 N. Michigan Ave., CHICAGO



Evening—

A congenial companion and a Mullins canoe—lights dancing among the ripples—the gentle lapping of the water—the swishing of the dipping paddle—enchantment!

MULLINS CANOES

sweep into the new season with added beauty and refinement. To the grace and lightness of the Indian canoe, we have added expert workmanship, exquisite finish and splendid durability.

Our canoe book is interesting—fascinating—free.

The W. H. Mullins Company
19 Franklin St. SALEM, OHIO

*World's largest manufacturers of
Steel and Wooden Boats.*

A street in Lyons, France—the Rue de la Republic—is paved with glass. The blocks are 8 in. square and so closely fitted that water cannot pass through the pavement.

THE KOBELLE BOTTLE SKIMMER

The Only Perfect
Cream Separator
for Bottled Milk

AGENTS WANTED
Experience Unnecessary

KOBELLE MFG. CO., Box 308, Central Station, Toledo, O.



35c Postpaid

Satisfaction Guaranteed



Make \$15.00 to \$35.00 Per Day

With Our Latest Invention, the Wonderful Ever-Ready Camera. Makes 9 styles single or group pictures direct on postcard or tintypes without film or negative, finished for delivery in less than one minute. **No Experience Necessary.** Get into a good, clean, respectable business of your own and become independent. Big Money at fairs, carnivals, parks, picnics, anywhere. Photos cost you from 1 to 24c; sell at 10, 15 and 25c each. Write Today for Free Proposition and Catalogue.

THE NEW YORK FERROTYPE CO.
Dept. F39, No. 168 Delancey Street, NEW YORK, N. Y.
Dept. F39, No. 1126 S. Halsted Street, CHICAGO, ILL.

50% AGENTS' PROFIT

Selling JIFFY Overall Aprons

Big demand from mechanics, repair-men, printers, carpenters, store clerks, butchers, chauffeurs, automobilists, etc. Side line or spare time—sells on sight. \$1.00 article. Quick action necessary. Territory going fast. Write today.

JIFFY APRON CO., 308 Smith Bldg., DETROIT, MICH.

BUILD YOUR OWN CAR

Send for blueprints and prices on complete parts for one of the best light cars or cyclecar on the market. Side by side seating. It will save you money.

THE B-Z-T CAR COMPANY, Inc.
Owego, Tioga County, NEW YORK

Store Profits

Increased \$3120 Yearly

Confectionery, drug and department stores, theatres, restaurants, news stands, etc., are reaping a year-round harvest of spot-cash sales from this famous BUTTER-KIST Corn Popper.

Hundreds of records to prove that it pays *five times as much profit per square foot as anything else in the store.* Stands anywhere—needs only 26 by 32 inches of space—move a chair and you have room for it. Runs itself.

Proven profits \$25 to \$60 weekly. Small confectioner sells \$5 to \$16 per day. Large department store *netted* \$508.50 in 28 days!

Turns out 1 bag in 48 seconds—\$3.75 per hour. Pops, separates and butters *automatically*—no watching—no work—no stock to carry—no muss.



BUTTER-KIST Pop-Corn

With Butter-Kist Prizes

"Everybody's" asking for the famous BUTTER-KIST—the big, fluffy, white flakes—crisp, crackling and clean—evenly buttered and piping hot—untouched by hands. The finest, flavory, savory treat that ever tantalized a mortal's palate—with a *coaxing fragrance* that makes people hungry for BUTTER-KIST.

Every bag bears pictures of the valuable BUTTER-KIST Kiddies and trademark that thousands are saving and sending to us for handsome prizes. Brings people back to your store for more BUTTER-KIST—throws trade to other departments.

Pay From Your Sales

A small payment down puts the BUTTER-KIST Corn Popper in your store with all privileges included. Then it pays for itself in short order.

Superbly built of plate glass, mahogany, oak or white enamel and metal parts of polished aluminum and nickel. Beautifies your store—motion draws crowds—*starts everybody talking and eating "BUTTER-KIST!"*

"The Little Gold Mine" FREE

Handsome new book, "The Little Gold Mine," gives facts, figures, *proof of profits* and photographs. Valuable to an aggressive dealer. *Sent free postpaid.* Write for it at once—you lose \$5 to \$16 in sales every day you delay.

HOLCOMB & HOKE MFG. CO.
1607 Van Buren St., INDIANAPOLIS, IND.

(6B)



"100 MILES for 10 cents"

Weight only 110 lbs. Price only \$125

Something Entirely New!

It's not a motorcycle, and it's not a bicycle, but a real **motor bicycle**—something that every one of you can enjoy, and afford to own and maintain. It is the lightest, simplest and easiest-handled motor vehicle **in the world**. It places motor travel within the reach of thousands **for the first time**. It appeals alike to all classes—professional and business men, clerks, mechanics, salesmen, farmers, students, boys and girls.



The Miami Motor Bicycle
SAFE - SILENT - CLEAN

You can use it for a quick run to town and back; a trip over into the next county; a run out into the open, or to and from work every day. It is so light you can go anywhere that a heavier vehicle can—and it costs only ten cents a hundred miles.

It is safe for anyone old enough to ride a bicycle because it is so light and easily managed—and it is far superior to a bicycle for business or pleasure. It will take you from 4 up to 25 miles an hour—and the motor does all the work.

Write at Once for Free Booklet

telling all about the Miami Motor Bicycle, how simple in construction and easy to take care of. You can buy one from your cycle Dealer or direct from us.

The Miami Cycle & Mfg. Co.

"AMERICA'S GREATEST CYCLE MAKERS"

600 Mobile Ave.

Middletown, Ohio

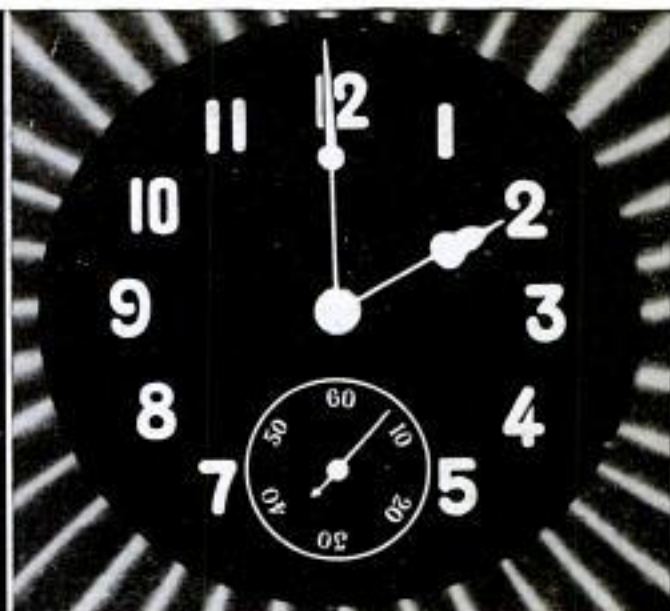

Startling New Ideas in Watches

Send for watch catalog describing, among others, the new radium dials that shine at night—the remarkable discovery enabling you to read time plainly in pitch darkness! The new catalog shows many other novel ideas in Burlington watches. The newest ribbon and enamel monogram designs—exquisite new ideas—your own initials in colors on a rich gold background. Send the coupon today.

On Approval: The new radium dial Burlington or any other Burlington, with your own monogram engraved on the superb gold strata case will be sent to you on approval, prepaid, without a cent in advance. You risk absolutely nothing—you pay nothing—not one cent, unless you want this exceptional offer after seeing and thoroughly inspecting the watch.

If—after examination—you decide to keep it, pay only the direct rock-bottom price—the same price that even the wholesale jeweler must pay. And in order to encourage everybody to secure this watch now we allow this rock-bottom price, either for cash or \$2.50 a month. Remember—we send this watch on approval.

Send the Coupon for New Watch Book

Learn the inside facts about watch prices and the many superior points of the Burlington over double-priced products. Just send the coupon or a letter or a postal. Don't delay—write—get this great offer while it lasts.

Burlington Watch Co., 19th St. & Marshall Blvd., Dept. 1192, Chicago, Ill.

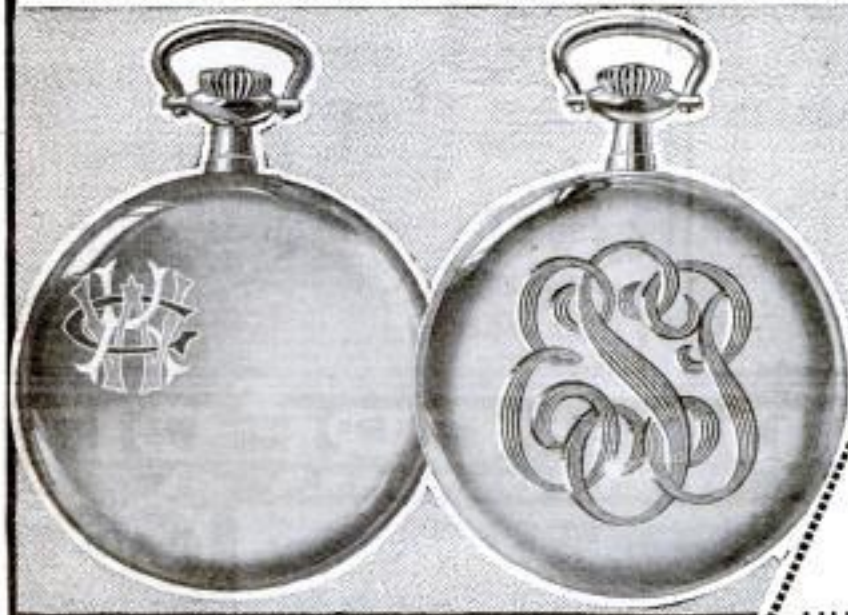

**Burlington Watch Co.
19th St. & Marshall Blvd.
Dept. 1192, CHICAGO, ILL.**

Please send me (without obligations and prepaid) your free book on watches, with full explanation of your cash or \$2.50 a month offer on the Burlington Watches.

Name

Address

Prest-O-Lite For Motorcycles

As Strong and Dependable as the Motorcycle Itself

Be as careful to buy a sturdy, reliable lighting equipment as you are to buy a sturdy, reliable motorcycle. Your safety demands it.

Prest-O-Lite is the only lighting system for motorcycles that has stood the acid test of continued use by experienced riders.

Cold and moisture do not affect it. Prest-O-Lite has nothing to freeze, no delicate wiring to snap

and plunge you into total darkness — no delicate parts that are deranged by jolts and jars, never needs expensive expert repairs or costly replacements. And it costs less to buy and less to operate than any other brilliant light.

The "spills" that are wrecking fragile lighting systems only serve to show the all-year-around value of sturdy, reliable Prest-O-Lite.

30 Days' Free Trial

Prove this on your own machine in your daily riding. Your dealer will give you 30 days in which to prove to yourself every claim made for Prest-O-Lite. If you're not completely sat-

isfied that Prest-O-Lite is everything we claim for it, the test doesn't cost you a cent. Prest-O-Lite is the only motorcycle lighting system sold on such a basis. Think this over.

Insist Upon It

Dealers who know night riding and have your interest at heart, will recommend Prest-O-Lite to you. Any dealer selling "complete equipment" will include Prest-O-Lite. Leading

dealers are making offers like this: "A Prest-O-Lite, an automatic reducing valve, a lamp and a mechanical horn," at very attractive prices.

Get the truth about all motorcycle lighting

Your name and address on the margin of this page will bring you complete information. Sign and send today.

The Prest-O-Lite Co., Inc.

265 Speedway Exchange Agencies Everywhere Indianapolis, Ind.

Secure exclusive sale of this new VACUUM CLEANER

Latest idea; most powerful; low price. Takes place of electric machine in country home.

Big money for hustlers.
THE U. S. MFG. CO.
Warren, Ohio

Write today



The United States Bureau of Mines has begun the collection of a general library of petroleum literature, under the direction of W. A. Williams, chief petroleum technologist. The details of this work have been assigned to Dr. David T. Day, who has recently been transferred from the United States Geological Survey as petroleum technologist, and who will also assist in a thoroughly organized research into the chemistry of oils, which is being developed by the Bureau of Mines. The importance of such a library is so manifest that it is hoped all technologists will aid in the work by exchanging with the bureau all available books and maps on this subject.

POULTRY PROFITS FOR YOU

IS THE TITLE of our 200-page Free Complete Catalogue and Poultry Guide for 1915, which we mail postpaid to any address on request. Illustrates and fully describes our three styles of Incubators, eight different sizes, ranging in price from \$10 to \$38; also our self-regulating, self-ventilating, all-metal Portable and Adaptable Brooding Hovers and nearly 100 other valuable, practical standard articles we manufacture for successful, money-making poultry keepers on any scale of operation. WRITE TODAY for our Complete Catalogue and other valuable free printed matter.

Address our place of business nearest you.

Cyphers Incubator Co., Dept. 161, Buffalo, N. Y.
Boston, New York, Chicago, Kansas City, Dallas, Oakland



Eight Sizes of Incubators



\$4 Per Month! FREE TRIAL!

Nothing Down—Free Trial. Less than Agents' Prices. Shipped on approval. If you want to keep it, send us \$4 a month. Our booklet is worth sending for because it tells you how to save \$48.00. It's FREE. Typewriters Distributing Syndicate, 166-Z-2 N. Michigan Boulevard, Chicago



Learn to be an Expert Wrestler

Be strong, athletic, healthy, handle large men with ease. Farmer Burns, the world's most scientific wrestler, trainer of Frank Gotch, world's champion, will now teach you by mail. Also complete course in Ju-Jitsu self defense and physical culture. Only opportunity ever offered to learn right from champions. For men and boys, (1) ages. A wonderful course. Low cost.

Investigate now. You will be under no obligations whatsoever. **FREE BOOK** Send your name, age and address for free booklet about wrestling and full particulars. Write today. Farmer Burns School of Wrestling, 1122 Range Building, Omaha

DIAMONDS ON CREDIT

20% DOWN 10% MONTHLY

Let us send you any Diamond you may select from our catalogue so you may compare our values with those offered by other dealers; be convinced that our IMPORTER'S PRICES offer you a great saving.

We furnish a guarantee certificate with every Diamond and allow the full purchase price on all exchanges. We will send express prepaid any Diamond or other article, for examination and approval, you to be the sole judge as to whether you keep it or return it at our expense.

Write today for our free catalogue de luxe No. 2, and see how easy it is for you to own and wear a beautiful Diamond. L. W. SWEET & CO., Inc., 2 and 4 MAIDEN LANE, NEW YORK CITY.



The Farm YOU Want

is compact, easy to pay for, and enormously productive
—and it *must* be suburban to a big live city



10 ACRES IN *Lithia*

Here it is—and it's yours for

*3 1/3 cents
per day per acre*

IN OUR NEW LITHIA TRACT SUBURBAN TO TAMPA, the metropolis of South Florida. It is one of the few choice suburban farm tracts left in Hillsboro County, the recognized center of Florida's grape fruit and orange belt.

This is the third great Hillsboro County tract that has been opened to homeseekers and investors by our old established, responsible, thoroughly experienced organization. Over 2,500 families are now rejoicing because they bought at opening prices in our two former tracts. Every family can tell you they got a square and generous deal.

Our new Lithia Tract now offers you the same wonderful opportunity—and more, because of the rapid growth and development on all sides within the past four years.

The visible supply of select Hillsboro County grape fruit land is melting away very fast. Prosperous homes are scattered around the Lithia Tract—grape fruit and orange groves are flourishing on all sides. Already buyers are building homes on our new Lithia Tract, and values are due to rise here just as they have in our two former suburban farm tracts in this same county.

Free—Absolutely Free—100 grape fruit and orange trees to each and every purchaser who reserves one of these farms before March 1st 1915. These trees will be held in our Nurseries until you are ready to plant them. This will give you a splendid start in developing a grove which will bring you an ever increasing income and greatly increase the value of your entire farm. Mail the coupon today.

One judicious investment, remember, means more to your bank account than years and years of labor. Honestly, now, what have you to show for that little 3 1/3 cents per acre per day that might just as well be buying you a beautiful 10-

Get our big new Florida book and look at the map—read the many enthusiastic testimonial letters from settlers now living on the farms they bought from us. Four big railroads intersect these suburban tracts—all the comforts of modern life right at hand! The completion of the Panama Canal throws the spotlight on Tampa, the nearest deep water port, and the traffic of the whole maritime world will pause at Tampa's door.

Think of it—a 10-acre farm suburban to a city like this—a farm big enough to keep you in comfort all your lives, yet one you can pay for at the rate of just 3 1/3 cents per acre per day!

Get the facts now. The coupon brings them to you without cost or obligation. Get your 1915 opportunity clearly before you while prices on this newly opened tract are still low and terms easy. Today \$1.00 per acre per month buys you independence and a future. Tomorrow—who can say?

Tear off the coupon and mail it now and we will lay before you, by return mail, full and complete information showing how you can easily become the owner of one of these beautiful grape fruit and orange groves, and why it is sure to prove the shrewdest, most profitable investment you can possibly make.

North Tampa Land Co.

C. E. THOMAS, President
837 Marquette Building CHICAGO

acre farm? Where else could you put aside a few odd dollars so safely, so securely, and with such surety of seeing your modest savings fund develop into a great big investment?

No use trying to make yourself believe that savings bank interest will ever make you independent, nor 6% loans make you rich. Your money isn't working when you tie it up in such ways—it's LOAFING. Make your money work for YOU; right here in these rich fruit lands is your opportunity—here where a few dollars put to work NOW will reap all the benefit of development work constantly being done by the fast increasing population.

If you do not wish to improve your farm, you can in a few years, cash in on it from the investment standpoint without a stroke of work on your part. Think of it—two or three clears a day, or the cost of a few car fares laid by—and a magnificent grape fruit and orange grove is the result almost before you know it!

You can pay for your land by work. We will sell you ten or more acres and make a contract with you giving you employment clearing land. We will give you enough work to entirely pay for any number of acres you want. All you need is a willingness to work and enough money to pay your fare to Tampa. As clearing is hard work, we can only make such contracts with those who are physically able to do this kind of work. If interested in this special employment agreement be sure to write for information when sending the coupon.

North Tampa Land Co., Pop. Mech. 2-15
837 Marquette Building, Chicago

Please send me, FREE, assortment blank for 100 grape fruit and orange trees, and your latest Illustrated Book on choice Citrus Fruit and Truck Farms suburban to Tampa, Florida.

Name.....

Street No.....

City..... State.....

SAXON "SIX" \$785

Six-cylinder, long stroke motor, 30-35 h. p.; electric lights and starter; three forward speed transmission; 112-inch wheel base; 32 x 3 3/8" tires; demountable rims; stream line 5-passenger body; standard or 60" tread; price \$785, l. o. b. Detroit.

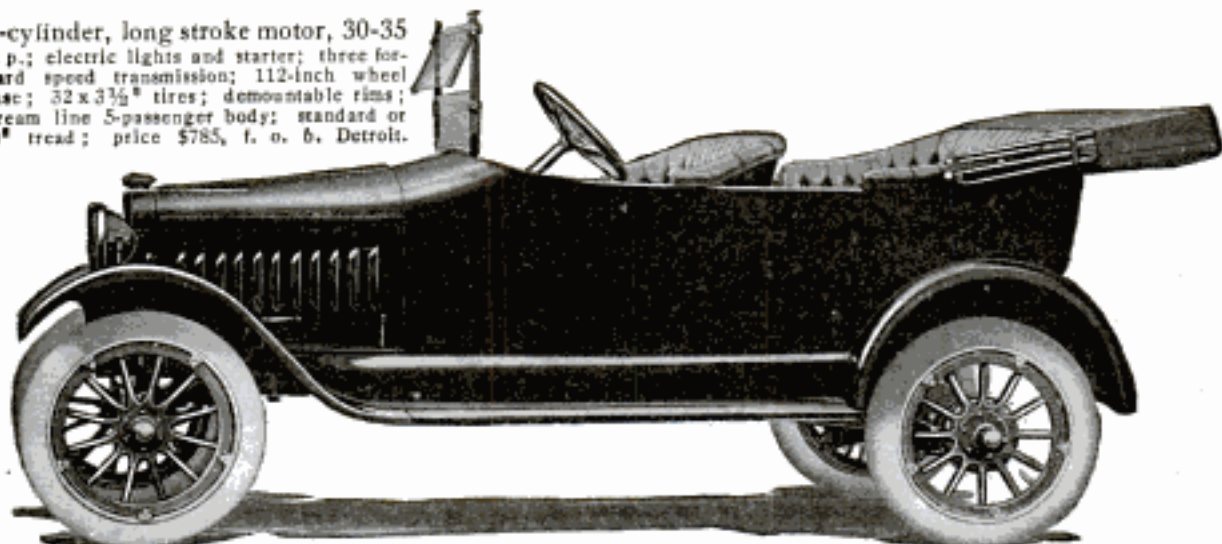

Now a "Six" You Can Afford

Here is positively the most compelling *touring car value* ever offered. That is our claim. We make it unreservedly. And we back it up with these reasons:

The Saxon "Six" is the first "Six" at a price as low as \$785. It answers a question the whole nation has been asking: "Why doesn't someone build a good low-priced six-cylinder car?"

This "Six" is in no sense a small car. It is not to be compared with small cars. It has a long wheelbase — 112 in.; plenty of leg room; plenty of width; seating comfort for five adults. In size — in all-around specifications — it compares with cars selling around \$1250 and above.

Nor is this car "just another automobile." It is a Saxon — stylish, individual. In its distinction of appearance, construction and performance it has been a surprise to every person who has seen it.

Remember, too, the Saxon "Six" is a *fully equipped car*. There is no extra charge for electric starter and lights, or speedometer, or any one of a number of other desirable conveniences. All these are a part of the car — at the price of \$785.

Doubled Output of the 2-Passenger Saxon, \$395

Last year the Saxon Company shipped more cars than any other company ever shipped in its first year.

Therefore, because the two-passenger Saxon has found its market; has made good at it; has proved its rock-bottom economy; has stood the "gaff," and has broken all known records for shipments — production of this popular roadster will be doubled for 1915.

Electric lights and starter (\$70 extra), auxiliary seat (\$10) to accommodate a third passenger, and other features now make the two-passenger Saxon at \$395 even more appealing than before.

WRITE FOR "SAXON DAYS"

Send today for our interesting magazine, "Saxon Days." It gives details of Saxon cars and facts of interest to every owner or prospective owner of an automobile.

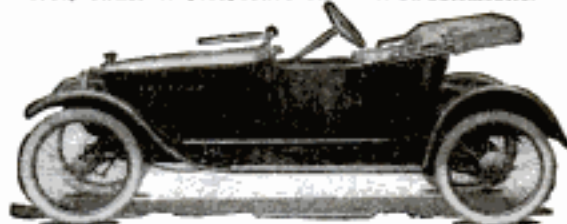

Two-passenger Saxon, \$395. With electric lights and starter, \$70 extra.

Address Dept. J

Saxon Motor Company, Detroit

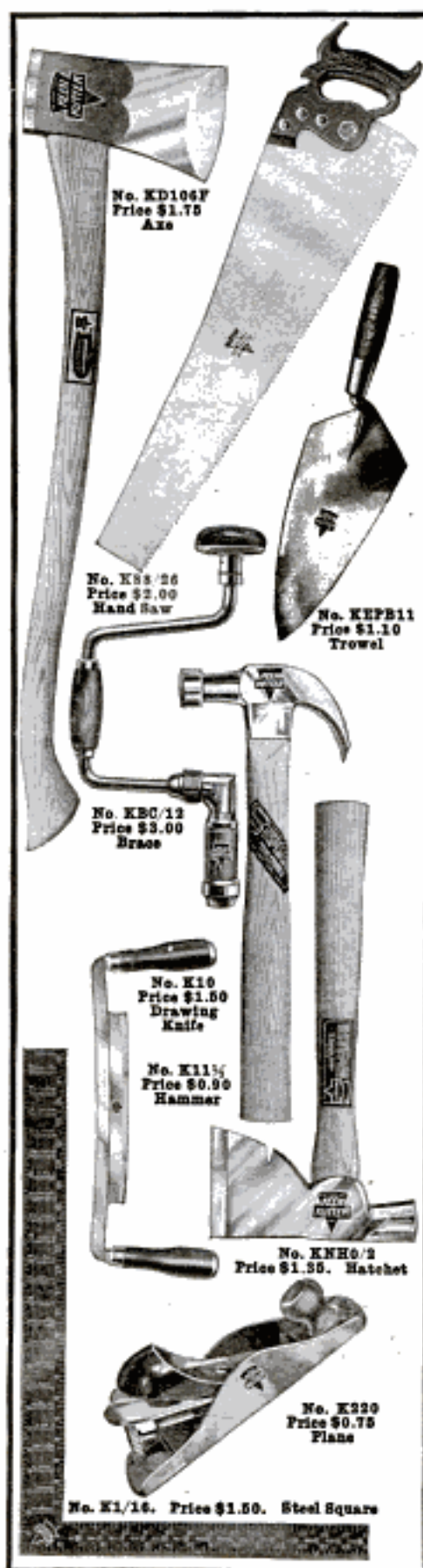

The Only Complete Line of Tools and Cutlery Under One Name

Maybe you buy one kind of hammer, another kind of saw, another make of draw knife. You take a chance on them all. You can't tell that those ordinary tools will prove out by test. Here is the only complete line of bench tools, kitchen tools, garden tools, farming tools and cutlery sold and guaranteed for quality under one name and trade mark.

KEEN KUTTER Tools and Cutlery

are guaranteed to make good or the dealer is authorized to take back any piece bearing the Keen Kutter trade mark that doesn't prove satisfactory. You only have to look for satisfaction in one place and from one maker. But you won't have to look for refunds when you use Keen Kutter tools. You *will* get satisfaction and your full money's worth.

Proof of worth is in the using of Keen Kutter goods of any name, of any description. Quality of materials and of workmanship is the watchword in producing Keen Kutter tools and cutlery.

Send for our Home Furniture Design
Booklet No. D-976.

*"The Recollection of Quality Remains,
Long After the Price is Forgotten"*
Trade Mark Registered. —E. C. SIMMONS.

If not at your dealer's, write us.

Simmons Hardware Company

St. Louis New York Philadelphia
Toledo Minneapolis Sioux City Wichita





Safety on Fast Turns

The motorcyclist takes the turns with confidence when Firestone Non-Skid Tires are gripping the road.

Then on the straightaway, he opens the throttle and "burns up the road" without thought of his tires.

The heavy pure rubber treads with the extra thickness of the raised letter stake the wear, and insulate fabric and inner tube from the heat.

Firestone Motorcycle Tires

are built with Firestone accuracy to meet every tire requirement of the motorcycle.

High speed and the varying angle of the wheels from the perpendicular are provided for in their design.

Firestone reputation for quality, won by actual performance on motor cars, has already extended to Firestone Tires for motorcycles by proving that they give—"Most Miles per Dollar."

Firestone Tire and Rubber Company

"America's Largest Exclusive Tire and Rim Makers"

Akron, Ohio—Branches and Dealers Everywhere

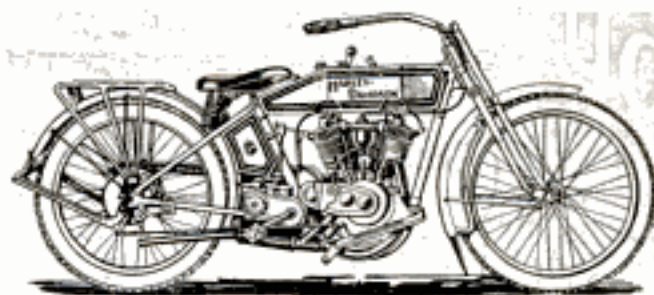

The 1915 Harley-Davidson Three Speed Twin Will Climb a 60% Grade.

THIS powerful machine has taken a Harley-Davidson and sidecar up a 45 per cent grade without a murmur, a grade nearly twice that of the steepest hill to be found in most localities.

The 1915 Harley-Davidson twin motor is guaranteed to develop eleven actual horse power ($37\frac{1}{2}\%$ more than the 1914 Harley-Davidson twin). This exceptional power in conjunction with the new Harley-Davidson three speed gives the rider more power than he really needs. If the going is rough, sandy, snowy or muddy, he can shift into intermediate gear and run mile after mile without overheating the motor.

These three-speed gears are cut so perfectly that they do not make a

sound. The rider will find the Harley-Davidson transmission as silent in low or intermediate gear as in high gear. It is possible to shift from intermediate to high gear or to slam into low gear, any time, anywhere, without fear of clashing or stripping of gears. This is positively prevented by an ingenious device.

There are many other features which add to the comfort, durability and economy of the 1915 Harley-Davidson, fully described in our catalog which will be sent upon request.

More Dealers for 1915

Additions to the Harley-Davidson factories enable us to add more dealers for 1915. If, as a dealer, you are situated in a locality where we are not represented and feel qualified to represent the Harley-Davidson in keeping with the Harley-Davidson name and reputation, get in touch with us at once.

Harley-Davidson Motor Company

Producers of High Grade Motorcycles for Nearly Fourteen Years

407-B Street

MILWAUKEE, WIS., U. S. A.

YOU CAN BE AN ELECTRICAL ENGINEER AT A GOOD SALARY



Earn \$150.00 to \$250.00 a Month

WRITE TODAY! NO EXPERIENCE NECESSARY to enter this wonderfully fascinating, high-salaried work. You should **EARN BIG MONEY IMMEDIATELY**—on completing our Electrical Courses.

The great engineering companies are always searching for practical, trained electrical engineers. Excellent positions open all the time. Decide to fit yourself for one of these well-paid jobs.

Electricity Offers Great Opportunities

Besides the high salaries paid to electrical engineers—the big profits you can make by starting an electrical business of your own—great fortunes are to be made through electrical inventions in the future.

The American School will train you to be an electrical worker or expert in a short time at small expense. You can start right in now and prepare yourself for a better position and more pay.

Earn While Learning No need to give up your present occupation. Just devote your

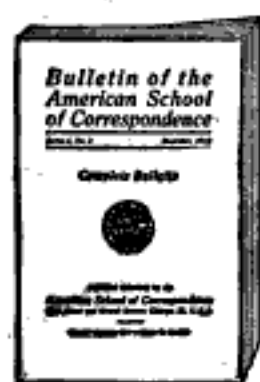

spare time during the day or evening to this interesting work. It is no task to learn Electricity. As you read through the pages of our courses, you will find yourself simply "wrapped up" in the work. And you can draw your present salary while you learn—by means of this home study course.

The only expense will be the nominal charge for our complete tuition.

Pay as You Wish! Don't hold back because of the money. We will arrange for you to pay as best suits your needs.

GUARANTEE:

The world-wide reputation of the American School of Correspondence for integrity and efficiency, together with its thousands of successful graduates, gives you an unqualified guarantee of Success.

FREE SUCCESS COUPON

American School of Correspondence
Chicago, U. S. A.

Without any obligations on me whatsoever, please send me your bulletin and complete information regarding course checked below.

.... Electrical Engineer Hydroelectric Engineer
.... Telephone Engineer Elec. Light and Power Supt.

Pop. Mech. 2-11

NAME.....

ADDRESS.....

This Book Contains Valuable Information—It's Free

Our School Bulletin gives complete information concerning our courses and explains how YOU can become an expert Electrical Engineer.

Send Us This Free "Success" Coupon

—No obligations, no mail at once. It will bring you our School bulletin (catalogue) and complete information. Decide now to take this great step toward Success. Don't be a drudge all your life. Be one of the men who is paid for what he KNOWS, not for the hard work he actually does. No obligations in sending the coupon—**mail today—immediately.**

American School
of Correspondence, Chicago, U.S.A.

In spite of WARS and Higher Tariff BASCH continues their *Import Price* for

Genuine Perfect Cut DIAMONDS

\$97.50
Per Carat

And Here's the Reason: We import *direct*, saving you the waste of needless middlemen; vast sales permit us to add only the smallest profit; and while WAR has stopped all importations and closed down the cutting works at Antwerp and Amsterdam, our million dollar stock enables us to continue our old before-the-war import price, **\$97.50 per carat!**

OUR REAL MONEY BACK GUARANTEE

Contracts to refund to you the full price IN CASH less 10% if for any reason you want to cash-in your diamond anytime within 1 year; allows full price in EXCHANGE, anytime! Certifies legally, carat weight, quality and value, so you know what you get for the money you invest! Stands alone as the only protecting Guarantee in the whole diamond business.

CAUTION: Always buy by Carat Weight

when you buy diamonds. Jewelers buy by carat weight; if they try to sell by the *piece*, its because their *price per carat* is higher by comparison. We've stood nearly alone for *carat weight* pricing for 26 years!

"Heart's Desire" by America's greatest Artist, Penrhyn Stanlaws. Shows the most beautiful type of American girl; paints her desire for love and a Diamond. See below.

SEND NO MONEY! No References. No Deposit!

Simply tell us what diamond and mounting you prefer; we ship it at our expense; permit fullest examination; all without obligating you to buy. This Basch Plan, 36 year-tested enables you to see before paying even one cent!

Never a Time Like NOW to

Buy DIAMONDS

Diamond prices going up every day; importations and cutting in Europe entirely stopped by the War. Here is a *life-time opportunity* for investment at before-the-war import prices; guaranteed only while our stock lasts; You must write *at once!* Do not delay.



14D121
1/2-carat Dia...\$8.25
14K Mounting... 3.75
Price Compl. **\$12.00**

14D122
3/4-carat Dia...\$17.50
14K Mounting... 3.75
Price Compl. **\$21.25**

14D123
3/4-carat Dia...\$31.25
14K Mounting... 3.75
Price Compl. **\$35.00**

14D124
1-carat Dia...\$67.50
14K Mounting... 3.75
Price Compl. **\$71.25**

14D125
3/4-carat Dia...\$31.25
14K Mounting... 5.50
Price Compl. **\$36.76**

14D126
1-carat Dia...\$45.00
14K Mounting... 7.00
Price Compl. **\$52.00**

14D127
10K Solid Gold Cuff
links 2 Dia. pr. **\$1.75**

14D128
14K Ear screws, two
3/4-carat dia. **\$38.00**

14D129 10K Solid gold Tie clasp, 1 Dia. \$4 value...**\$1.00**

14D130 14K Solid 1-car. Dia. value...**\$99.75**



14D131
10K Solid Gold WATCH; full jeweled Hampden movement; extension bracelet and chatelaine pin. In gift case. Engraving Free. Complete **\$15.88**

Watch may be worn with bracelet as complete wrist watch; or on chatelaine, or with chain. Gold or white dial.



1915 DE LUXE BASCH DIAMOND BOOK FREE!

Costliest, most complete book on diamonds ever published. Contains information by recognized experts, most necessary to buy Diamonds intelligently. Thousands of illustrations, styles, suggestions. Full line of Diamonds, Watches, Jewelry—all Standard makes at *factory prices*—startlingly low by comparison. Absolutely FREE—write for it NOW!

MAIL COUPON OR WRITE TO **L. BASCH & CO.**
Dept. B2470 State & Quincy Sts., Chicago, U. S. A.

Please mail me absolutely FREE your De Luxe Diamond Book without obligating me.

Name _____

Address _____

Mail to
L. BASCH & CO., Dept. B2470
State and Quincy Sts., Chicago, Ill.

N.B. If you will send us 4 cents in stamps to pay packing and postage, we will mail you a generous trial size of Colgate's Ribbon Dental Cream and our interesting booklet, "Dental Hygiene." If there are children in the family we will include—on request—"The Jungle Pow-Wow," a funny animal rhyme with colored illustrations.

The
daily use
of



helps to
Good Teeth-Good Health

Your health cannot be at its best without good digestion—nor can your digestion be at its best without good teeth. Clean Teeth is a matter of common sense.

Here is the way to care for your teeth:

When you get up in the morning and just before going to bed at night, brush your teeth with lukewarm water and Ribbon Dental Cream. Your dentist can tell you that this pleasant tasting dentifrice will make your teeth clean and leave your mouth cool and sweet.

Do not brush the teeth straight across. The outside of the upper teeth should be brushed downward from the gums; the lower teeth upward. Clean the inside of your teeth—next to your tongue—in the same way. The part of the teeth used for chewing food (the grinding surfaces) should be brushed in all directions.

After each meal use dental floss or a soft quill tooth-pick to remove bits of food which have become lodged in the crevices between the teeth.

Decay causes the teeth to ache, so by preventing decay you prevent pain. The best way to stop decay is to keep your teeth clean.

Go to the dentist at least once every six months. Have him remove stains, and fill cavities so that decay can no longer continue. The dentist's work will not hurt you so much if you go to him twice a year—and with teeth which you have regularly kept clean.

COLGATE & COMPANY, Dept. 81, 199 Fulton St., New York
Makers of Cashmere Bouquet Toilet Soap—luxurious, lasting, refined.

Copyrighted material