

# POPULAR MECHANICS MAGAZINE

WRITTEN SO YOU CAN UNDERSTAND IT

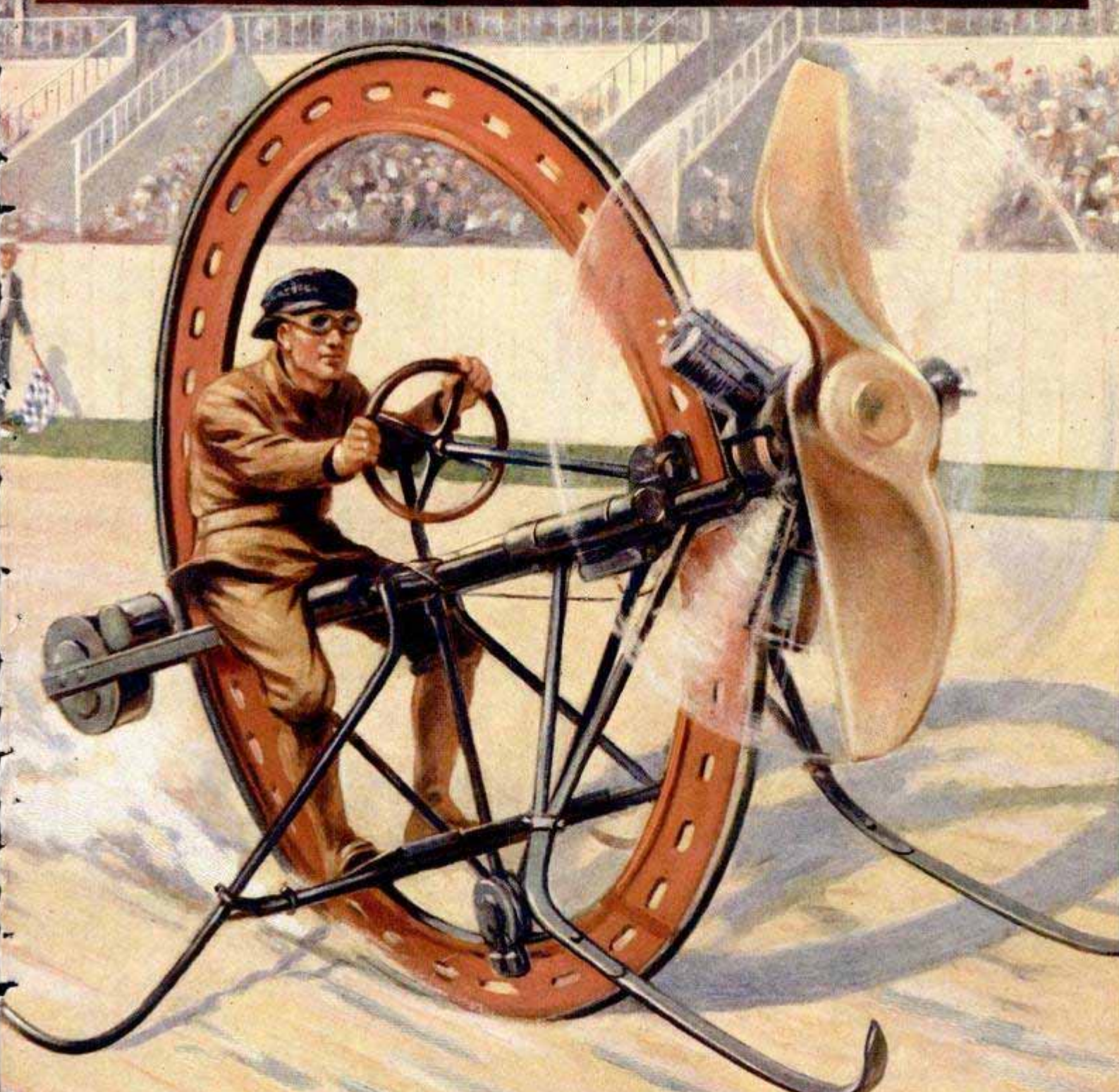



# Material to Build This Home Only \$673



**Design No. 556**  
**\$673** One of our beautiful, modern homes. Six rooms, bath, pantry. Symmetrical exterior—up-to-date interior. Standard construction throughout. Size 21 ft. 6 in. x 28 ft.

**35% to 50% Saved**  
**All Building Material Prices Smashed!**

Never before has there been an epoch-making offer like this to enable every man to own his own home. No matter how limited your means, you can now buy the material to build any one of these beautiful homes at smashed prices that have never before been heard of for absolutely brand new stock backed by our iron-clad guarantee. We actually save you from  $\frac{1}{2}$  to  $\frac{1}{3}$  on complete building—save you middleman's profit.

## Not One Cent Down

**Remarkable Offer** Think of it—we ship you a carload of building material valued anywhere from \$500 to \$1000 **without one cent down**, without a penny in advance—that makes you absolutely safe. We take all the risk and back up every claim and offer with our tremendous \$10,000,000 capitalization and unquestioned reputation for integrity and square dealing. Our stupendous purchasing power for spot cash brings us bargains no one else in the world can duplicate—you get the benefit in wonderful savings. In addition the expert knowledge of our complete Architectural Department enables you to get most practical, up-to-date homes, built without waste to please every taste and every purse. We help you free of charge—give you authentic Blue Print Plans, Specifications,—all this service without a cent of extra charge.



**Design No. 55**  
**\$743** Six Rooms and Bath, all rooms convenient and roomy. Size 22 ft. by 31 ft.

**\$10,000 Book of Plans Free**  
 Mail coupon below at once and get this most wonderful book sent absolutely free anywhere in the United States. Over 100 pages full of modern, beautiful, practical designs that will simply amaze and delight you. A book that every person needs and should have—full of suggestions and valuable information. Sent outside of U.S. upon receipt of 25c.

## Our \$50 Free Plan Offer

We will send a complete set of Blue Print Plans of any design in the above Book or on this page, including Specifications and full Descriptive Material List, giving the size, grades, and catalog numbers of material used in construction upon receipt of a temporary deposit of \$2.00, the entire amount of which is credited you when you order, or if plans do not suit and you return them we will refund you all but 50 cents of your remittance.



**Design No. 50**  
**\$998** Eight Rooms and Bath, very attractive exterior; Five Closets, Airy Balcony. Size 28 ft. by 28 ft.

## We Make Estimates From Your Sketches

In case you have your plans, send us your bill of material, we will quote you guaranteed freight prepaid prices. If you have only rough sketches send them to us, we will name you a guaranteed delivered price. That will cut out all expensive guess work. Our charge will be from \$1.00 to \$3.00, all of which will be refunded on your order.

## Our Guarantee Protects You Free Catalogs

Our guaranteed proposition to you is to furnish material **all brand new stock**, in quantities sufficient to complete design strictly according to plans. Prompt shipment of order. This guarantee is backed by our well known reputation for honest dealing and tremendous capital. You can order from us with positive safety.  
**Capital Stock \$10,000,000**

Send now for Special Building Material Catalog No. 103, Plumbing Catalog No. 137, Heating Catalog No. 140, Furniture and Rugs Catalog No. 134. Latest and best features—absolutely lowest prices.



## High Grade Bathroom Outfits! Hot Water Heating Plants!



Here is an illustration of a bathroom outfit we are selling at \$37.50. Your plumber would ask you about \$60 for this same outfit. It is only one of many other complete outfits that that we are offering at prices from \$35 to \$50.



We make complete plans and instructions and help you every way we can. We loan you tools. Every plant backed by our guarantee bond. Cut out the local dealer's profit and cut cost in half.

## Send this Coupon

**HARRIS BROTHERS COMPANY,**  
 Dept. CW-7 Chicago, Ill.  
 Send me free your \$10,000 Plan Book; full information on  
 Name.....  
 Town.....  
 County.....State.....

**Harris Bros. Co.**  
 Dept. CW-7 35<sup>th</sup> & Iron Sts. Chicago





# SEALED!

## WRIGLEY'S SPEARMINT

is now electrically sealed with  
a "SEAL OF PURITY"  
so *absolute* that it is  
water-proof, damp-  
proof, dust-  
proof — even  
*air*-proof.

It's *clean, pure,*  
*healthful* if it's  
WRIGLEY'S

Give *regular* aid to teeth,  
breath, appetite and digestion.  
It's the *safe* besides *delicious*  
and *beneficial* confection!

### BUY IT BY THE BOX

for 85 cents—at most dealers.

Each box contains twenty 5 cent  
packages. They stay fresh until used.

## Chew it after every meal

Look  
for the  
spear

This One





"You may have *inherited* Repair Bills, but don't *buy* any" — "BUILD OF

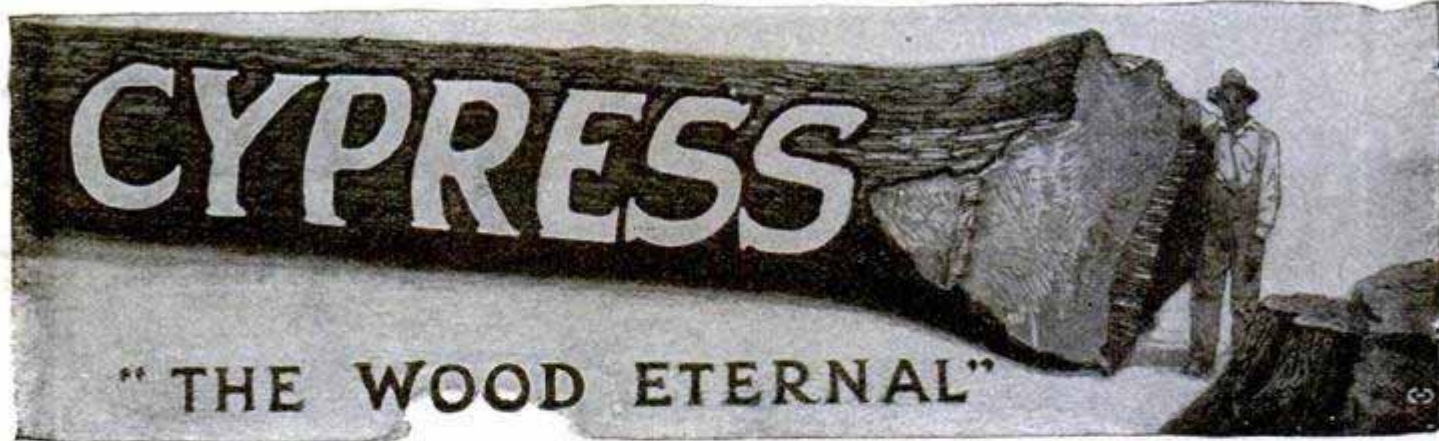

"THE WOOD ETERNAL"

## IT'S YOUR TURN NOW —

We have heretofore supplied several very different types of "homey" Cypress House Plans and Cypress Bungalow Plans to thousands of enthusiastically appreciative people. Perhaps none of these exactly met YOUR tastes or needs. We therefore show here *another one*, totally different in character, and one of the best yet. It is carefully estimated to cost about \$3,900. It is

### CYPRESS SHINGLE HOUSE No. 2

COMPLETE WORKING PLANS AND SPECIFICATIONS, ENOUGH FOR A GOOD CARPENTER TO BUILD FROM, ARE **YOURS** in VOL. 34 of the famous CYPRESS POCKET LIBRARY, **FREE ON REQUEST.**

"When you build, *build for keeps* — **INSIST** on

**CYPRESS**  
OF COURSE."

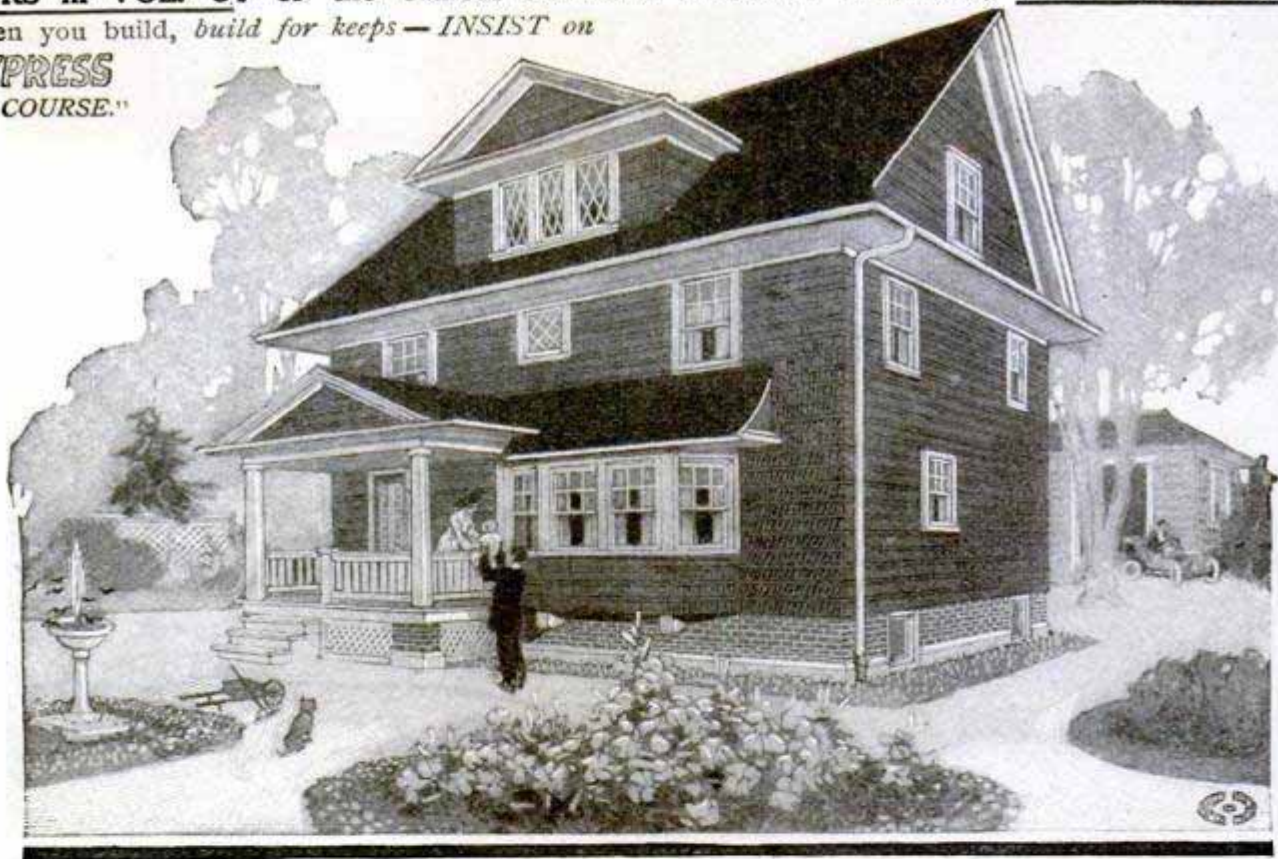

Write TODAY for full particulars of this "New Old Homestead" — in new VOLUME 34, CYPRESS POCKET LIBRARY. Also ask for VOL. 1, with U.S. Govt. Rept. and Complete LIST of OTHER VOLUMES.

ASK our "ALL-ROUND HELPS DEPT." any question about Wood. Our reply will be frank. We recommend CYPRESS *only* where CYPRESS can *prove* itself "the one best wood" for *your* use.

**SOUTHERN CYPRESS MANUFACTURERS' ASSOCIATION**  
1219 HIBERNIA BANK BUILDING, NEW ORLEANS, LA.

We produce CYPRESS but do not retail it. **INSIST ON IT NEAR HOME. WIDE AWAKE** Local Dealers sell CYPRESS; if yours does not, WRITE US, and we will tell you where you CAN get it.



# Popular Mechanics Magazine

318 W. Washington Street, Chicago, U. S. A.

EDITED BY H. H. WINDSOR

ISSUED MONTHLY

SUBSCRIPTION:

SINGLE COPY, 15 CENTS

In United States, and its possessions, Cuba and Mexico, per year, postpaid - - - - \$1.50  
 To Canada - - - - - 1.75  
 To all other countries in the Postal Union - - - - - 2.50

All subscriptions are discontinued at expiration. Please examine the date printed on your wrapper.

Entered as Second Class Matter Sept. 15, 1903, at the Post Office at Chicago, Illinois, under Act of March 3rd, 1879.

Entered as Second Class Matter at the Post Office Department, Canada.

Published monthly by POPULAR MECHANICS CO.

Copyrighted 1914, by H. H. WINDSOR.

The attention of prospective advertisers is called to the policy of this magazine in accordance with which the publisher waives all claim for payment of any advertisement appearing in any issue where the number of copies actually printed and circulated is less than the number printed on the front cover page.

## Contents for April, 1914

Accident, Odd, to French Airman.....	469	Finger-Twisting Machine to Aid Musicians.....	465
Aeroplane Message, Carrier for.....	510	Platiron, Novel, Saves Buttons.....	549
Aeroplane, Mouse Builds Nest in.....	532	Floating on Water with and without Aid.....	522
Aeroplane Passenger Service.....	579	Flying Record, Airman Sets New.....	533
Airman, Long Glide Made by English.....	497	Foreign Languages, System for Teaching.....	468
Airmen to Circumnavigate the Globe.....	489	Furnaces, Public, to Burn Rubbish.....	564
Airmen, What the, are Planning.....	576	Garage on Railroad Car.....	472
Anchor, Stern, on British Warship.....	469	Garden, Japanese, in America.....	568
Antarctic Continent, Across the.....	533	Glass Cooking Utensils Promised Soon.....	571
Armor, Modern Suit of, Advertises Wares.....	575	Glass for Spectacles, Ideal, Sought.....	510
Ash Cans, Rollers for, Facilitate Handling.....	548	Harnessing Science to the Factory.....	474
Australian Capital, New, Construction of Begun.....	582	By Frank Parker Stockbridge	
Automobile, Crippled, Casters for.....	553	Hatrack, A Top for the Top of.....	542
Automobile Road to the Yukon.....	524	High School Heated by Electricity.....	574
Ballot, "Movie" Films Show How to Cast.....	535	Horse Breathes through Brass Tube.....	523
Ballroom on Springs, Hotel Plans.....	581	Horses Stabled in Ice in Greenland.....	471
Boats, Native, of Anam Made without Metal.....	522	Horses, Wild, Make Raids on Canadian Farms.....	484
Bolts, Split, Handy in Cramped Places.....	539	House Plan—An Attractive Cement-Stucco Cot-	
Breeches-Buoy Apparatus, New.....	518	tage.....	616
Bridge Construction, Novel, in Pennsylvania City.....	516	Ink, Phosphorescent, Now Used in Printing.....	553
Building Damaged When Wet Wood Swells.....	562	Interchangeable Blades for Office Knives.....	547
Burglar Alarm, Door-Knob, Something New.....	542	Iron, Cast, Curious Designs Formed in.....	568
Camera, New, Photographs Flying Shell.....	493	Iron, Wrought, Making at Low Cost.....	562
Canal, Carrying a Great, over a Railway Cut.....	575	Irrigation System, Modern, Uses Cement Pipes.....	567
Canal, Columbia River, Completed.....	504	Japanese Picture Brides in America.....	552
Canal, New Welland, Has Only Seven Locks.....	566	Kerosene Motor, France Offers Prize for.....	531
Car Ferry to Havana Planned.....	517	Kitchen, Portable, Used by French Soldiers.....	483
Center of Universe, Altar of Heaven Called.....	536	Lamp-Posts, Temporary Decoration for.....	564
Circus Tent, Pitching by Machinery.....	562	Lamp Standard, Street, Made of Pipe.....	536
Coast Defense by Rail to Solve Problem.....	505	Lamp Which Tells if It has been Used.....	538
Coffin-Shaped Bottles to Hold Poison.....	565	Lantern, Blizzard, Not Affected by Winds.....	541
Collision in Dense Fog Sinks Steamer.....	492	Life Preserver, New, That Covers Whole Body.....	546
Conduits, Threading, by Air Pressure.....	541	Lights, Curious Use of Colored.....	551
Cools House with Air from Deep Well.....	578	Limousine de Luxe for Russian Nobleman.....	572
Culverts, American, in Africa.....	508	Lining Pipes with Wood to Prevent Corrosion.....	543
Curious Vehicles in Use the World Over.....	506	Lock Screw for Furniture Joints.....	551
Dam, Concrete Undermined and Wrecked.....	490	Locomotive Plunges into Coal Mine.....	486
Demonstration Against a Cruel Practice.....	493	Lookout Tower, Forest, Built of Logs.....	519
Derelicts, Finding and Destroying, at Sea.....	488	Lumber Made of Straw Used in Building.....	542
Dish-Washing Machine for Home Use.....	549	Lungmotor Equipment, Sidecar for Carrying.....	491
Dolls, Boarding House for, Built of Logs.....	524	Magnetic-Survey Vessel Sails 80,000 Miles.....	570
Door for Mine, Automatic, Operates Electrically.....	572	Mail Carrier, Swimming, of the Pacific.....	512
Dress Made of Newspaper Printed on Silk.....	481	Military Auto, Six-Bladed Propeller on.....	558
Electric Light, Portable, German Invention.....	571	Milk, Novel Top Protects, When Bottle is Opened.....	544
Electricity, Superheating Molten Metal by.....	544	Miners, Mexican, Weighed with Loads of Ore.....	485
Emery-Wheel Guard, New, Catches Fragments.....	542	Mission Paper Published on Lonely Island.....	469
Employment Bureau, Mechanical.....	464	"Moonshine" Outfit in Use among Eskimos.....	469
Engine, Gasoline, That can be Reversed.....	545	Motion Pictures Show Army in Action.....	481
Eruption, Destructive, of Japanese Volcano.....	500	Motor Car, Three-Wheeled, for Delivery Work.....	574
Excavator, Gravel, Worked by Traction Engine.....	517	Motor-Car Top Folds and Disappears.....	523
Fans, Electric, Used for Disinfectants.....	550	Motor Plow and Tractor for Farm.....	561
Fender, New, Sets Brakes Automatically.....	579	Motor Truck, Bucking, Dumps Load.....	532
Field Gun, New, of U. S. Army.....	499	Motor Trucks, Time-Saving Device Loads.....	569
Files, Curved, Used in Automobile Work.....	579	Motorcycles, Package Carrier for.....	483
Finger Bowls, Individual, of Paper.....	537	"Movie" Tickets Reward Good Conduct.....	508

[Continued on Page 6]

Popular Mechanics offers no premiums; does not join in "clubbing offers," and employs no solicitors to secure subscriptions. It is for sale by nearly every newsdealer in the United States and Canada.







# The "Efficiency" of the Fire-fly

**P** RIMITIVE man once used lanterns holding swarms of fireflies to guide him when he went forth at night. Today, as Waldemar Kaempffert points out in an article on "The Light of Our Descendants" printed by the *Outlook*, the illuminating specialists of two continents are studying the firefly for a solution of one of mankind's greatest problems—artificial light.

To imitate the firefly—to get a great deal of light with but little heat waste—has been the steadfast aim of technical experts in electric lighting since the study of electric light became a science. Step by step science has advanced in its search for this *economy in the fuel of light*.

That is what the much used word "efficiency" means to electric lighting science—*more light without increasing cost*.

The farthest advance in this study of lighting economy has been reached in the work of the famous group of scientists in the Research Laboratories of the General Electric Company at Schenectady. These experts selected and approved the features of a lamp that gives a beautiful light—*three times as much light*, with the same amount of current as you get from the old style carbon lamp.

On the bulb of this lamp is etched the mark "MAZDA."

"MAZDA" is the mark of a Service. It tells you of the great work that these busy men have done for the manufacturers of "MAZDA" lamps. It tells you what they are doing while you are reading this article. It tells you also of what they will be doing tomorrow, and next month, and next year

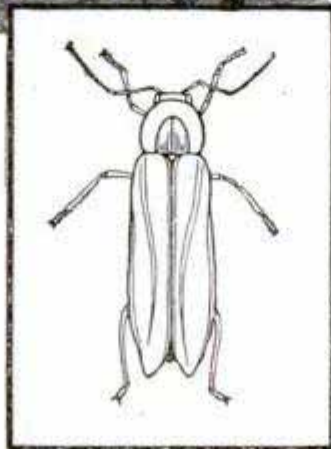

The light produced by the firefly has challenged the lamp experts of two continents.



Not only the volume but the quality of light in experimental lamps is subjected to long and exact study. "MAZDA" Service to the manufacturers of "MAZDA" Lamps enters every detail that might possibly advance manufacturing efficiency and improvement in the product itself.

## Talks about MAZDA-No.2

*"Not the name of a thing,  
but the mark of a Service."*

because it is the trade mark designation of the incessant effort "MAZDA" Service is making toward the ideal light.

On the lamps themselves the mark "MAZDA" means the selection of every "efficiency" discovery these Research Laboratories may find applicable and practical. Not content with wide investigation and experiment in these Research Laboratories, and in the active developing and manufacturing centers at Harrison and Cleveland, there is close touch also with progress that may be made by great experimental laboratories of Europe. From whatever source the new knowledge comes it is impartially considered with reference to its possible value in enabling the manufacturers to produce for you a lamp more "efficient" or adaptable. The proved advances, year after year, are transmitted by this "MAZDA" Service to the General Electric Company factories and the factories of other Companies entitled to receive this Service.

The result is that when you buy a "MAZDA" lamp, today or at any future time, "MAZDA" Service will shine in that lamp. You will know when you see that word "MAZDA" that you have the utmost result of all this indefatigable labor—the summed up successes of these keenest lamp experts in the world. For the lamp so marked will always mean that this Service has been applied, and the manufactured product

backed by this Service will always be marked "MAZDA."

 GENERAL ELECTRIC COMPANY



Let Us SHOW YOU Hundreds of Other Testimonials



## WOULD YOU GIVE 2 DAYS' PAY FOR A GOOD JOB IN THE AUTO TRADE?

THEN READ CAREFULLY

\$50 would not buy my course. After I got through Book 4 of instructions 13 and 14, 15 and 16, I had a job grinding valves. I did the job in four hours. Next day I put on four piston rings, which took six hours. These two jobs paid for my Course. I am now overhauling an engine for a party. I am not afraid to tackle any job now. If I get stuck I am sure I can find the remedy in the instructions. I knew nothing at all about an auto before, and I want to thank you for helping me.—Henry G. Ehredt, 523 E. 8th Ave., Homestead, Pa.

If we prove to you that we have started hundreds of others into the repair business and as chauffeurs—who had no previous experience and who knew no more about an auto than you do right now—you must admit we can do the same for you. Write me today—now—and let me prove it.

- E. Dwyer, 31 N. Willow St., Montclair, N. J., 19 years old, receives \$25 a week and board.
- Harry J. Herbin, Jamestown, Kans., was a farmer, but has doubled his income repairing and selling autos.
- W. R. McClelland, Astoria, Ill., was an auto driver. Became professional chauffeur and more than doubled his salary.
- Donald Stewart, Oakland City, Ind., became a chauffeur at \$25 a week.
- H. M. Fawins and S. T. Slayback, both graduates, are now running a Garage and Repair Shop at Woodbine, Iowa.

And we could continue until we had filled this and several more pages.

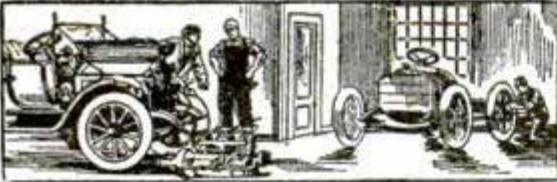

Our book of testimonials, showing photos of students and their shops—free.

### All the Result of the Dyke System

We can thoroughly train you. Open a repair shop or drive a car and make many times more than you are making now. Don't forget, we help you get your start with our *Employment Plan*, if you want it.

### DYKE'S NEW IDEA OF TEACHING BY MAIL WITH WORKING MODELS

is something new. We use *real* working models—not just one, but *five*. On these models you get actual practice, see the actual operation and learn more than you could from the auto itself—it's easy and quick. You don't have to study hard with this system—we teach through the eye—a new idea. We are the originators of the system of teaching by mail with models. We also use charts—268 of them and a 16 page manikin. Our 40 instructions and Repairman's Instructions are simplicity itself—simple as A B C.

### Our Employment Plan for Students

This represents years of work to provide something that no other school had, namely, a way for the graduate to get acquainted with auto and garage owners, to prove his ability and to immediately secure profitable employment. Mr. Dyke has been identified as a pioneer inventor, supply man, etc., with the auto industry since its beginning. He originated the first auto supply co. and published the first book on autos in America. No other man with such experience is to-day teaching others. And all the experience and inside information of the auto business he has thus gained, is embodied in this Employment Plan.

WRITE TO-DAY for Details of Employment Plan and THIS FREE BOOK

It is instructive and interesting—does not cost you a cent and places you under no obligations whatever—You need it for your own sake, not mine. Don't wait—there's no profit in waiting—WRITE NOW and learn how you can obtain all this training for only \$15, if you act immediately.

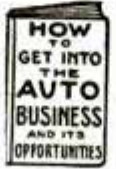

DYKE'S CORRESPONDENCE SCHOOL OF MOTORING  
Box 189, Roe Bldg. ST. LOUIS, MO.

NOTE—Beware of Imitators—Deal with the Originator

Please Mention Popular Mechanics

## DO YOUR OWN Soldering—and Save Money



Send 55c for cloth bound Book "Simple Soldering"—and learn how to join metals, both hard and soft.

**CONTENTS**—Soldering. The Uniting of Metals. Soft Soldering. The Flux. Hard Soldering or Brazing. Soft Soldering. Heating the Work. Flux for Soldering, Etc. Methods of Holding Work. Wiring Work. Silver Solder. Soldering Copper, Etc. Cleaning Up Work. Polishing. Scraping Down. Honing, Etc. Standard Apparatus. The Blow-Pipe. Foot Bellows, Etc. Home Made Apparatus.

SPON & CHAMBERLAIN  
123 P. M. Liberty St. NEW YORK

## 9,059-Word Business Book Free

Simply send us a postal and ask for our free illustrated 9,059-word Business Booklet which tells how priceless Business Experience, squeezed from the lives of 112 big, broad, brainy business men, may be made yours—yours to boost your salary, to increase your profits. This free book deals with—

- How to manage a business
- How to sell goods
- How to get money by mail
- How to buy at rock-bottom
- How to collect money
- How to stop cost leaks
- How to train and handle men
- How to get and hold a position
- How to advertise a business
- How to devise office methods

Sending for this free book binds you to nothing, involves you in no obligation; yet it may be the means of starting you on a broader career. Surely you will not deny yourself this privilege, when it involves only the risk of a postal—a penny! Simply say "Send on your 9,059-word Booklet". Send to SYSTEM, Dept. 81-4 Wabash and Madison Sts., Chicago



## Build Bodily Strength And Mental Vigor

Guaranteed Results in 30 Days

Write for my FREE BOOK "PHYSIOLOGICAL EXERCISES." Tells how exercising with my system ten minutes a day will improve your health and vitality, internally and externally. It tells you how to build a constitution that will defy colds and illness, that will give you muscular power, pure blood, perfect digestion, a strong heart and lungs. Send 4c. in stamps to cover postage.

The Henry Victor System  
14-16 Fourth Ave., Dept. 64 New York



**HERE YOU ARE, BOYS** A medallion pin of Foxy Grandpa. Everyone will notice it on the lapel of your coat and try to get a closer look at it. All you have to do is press the bulb.—Foxy Grandpa will finish the job by squirting a fine stream of water over the inquisitive one. Will squirt 20 feet. Greatest joke out. Order one today and fool your friends. Price 15c. Foxy Grandpa and Hooligan both for 25c. 5 for 50c or 1 doz. for \$1.00. A beautiful fountain pen free with every \$1.00 order.

AMERICAN SUPPLY CO., 918 Union St., St. Paul, Minn.

## BUTTERFLIES

and moths wanted. Summer work. Big prices paid. Beginners get instructions. Send stamp. JAMES SINCLAIR, Entomologist, D.6, Los Angeles, Cal.

## Start a Candy Store

Clear \$1,000 to \$5,000 a year. Capital and experience unnecessary. Ideal business for both men and women. New method home instruction in making and selling all kinds of fine candies. Special low rate now open. Particulars free. Write today.

CANDY MAKERS EXCHANGE, 918 Dwight Bldg., Kansas City, Mo.

DELCO AND OTHER STARTING AND LIGHTING SYSTEMS. EXPLANATIONS SO CLEAR A CHILD CAN UNDERSTAND



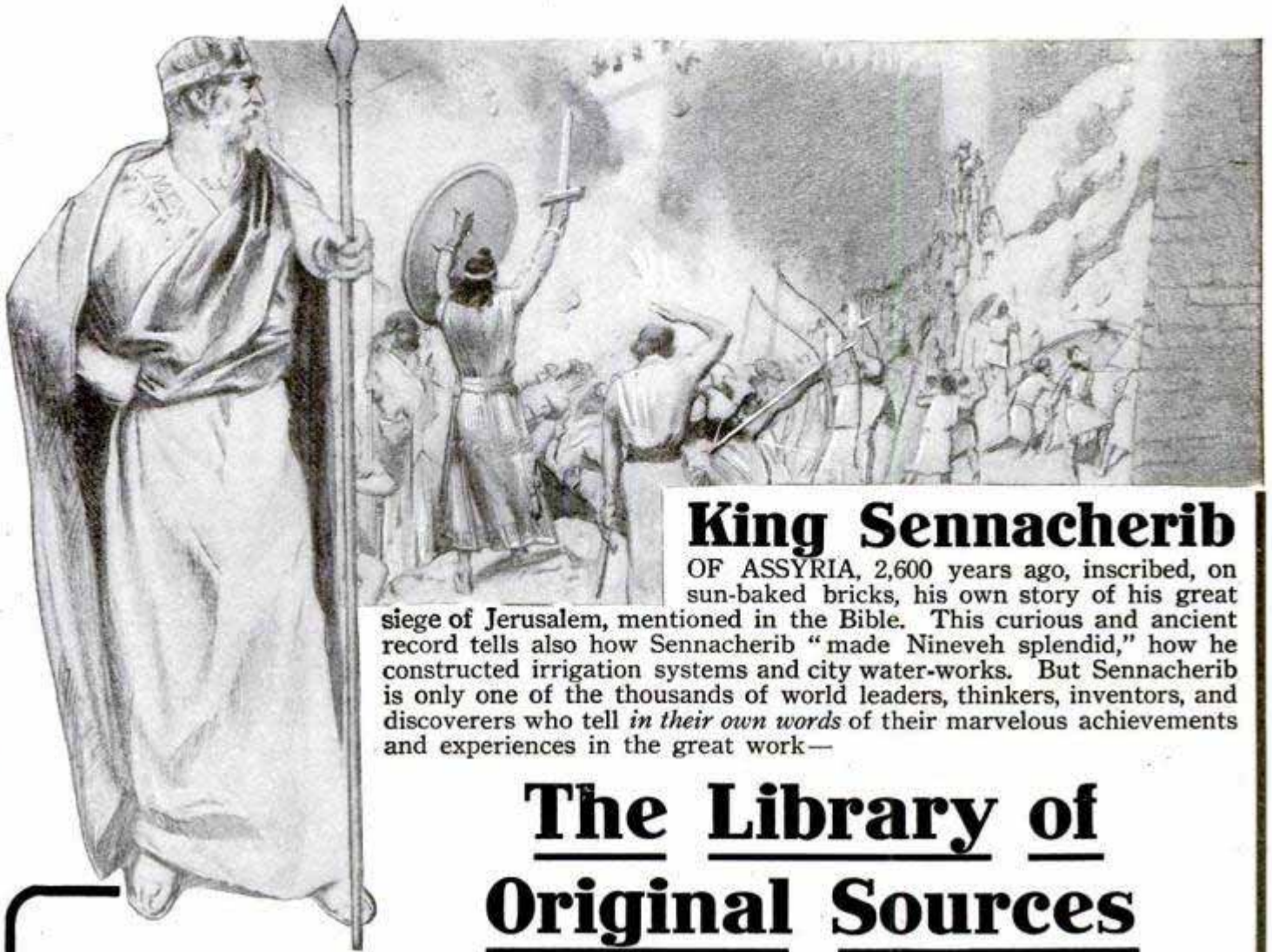

## King Sennacherib

OF ASSYRIA, 2,600 years ago, inscribed, on sun-baked bricks, his own story of his great siege of Jerusalem, mentioned in the Bible. This curious and ancient record tells also how Sennacherib "made Nineveh splendid," how he constructed irrigation systems and city water-works. But Sennacherib is only one of the thousands of world leaders, thinkers, inventors, and discoverers who tell *in their own words* of their marvelous achievements and experiences in the great work—

# The Library of Original Sources

In this wonderful library Tacitus, for example, tells how he *saw* the Christians burned before Nero, Plato tells how he *watched* Socrates drink the death-cup of hemlock, Galileo describes his emotions when looking at the stars through the first crude telescope, and in the same way *thousands of others* give the *inside facts* about themselves and the great events they witnessed and took part in—facts which the ordinary history never even mentions. Every account is in the exact language (translated) of the original manuscript, papyrus, clay tablet or inscribed cylinder; every contribution is from an actual eye-witness or participant.

## An Extraordinary Bargain!

By buying the entire unsold edition from the original publishers we secured it at an unheard of reduction. We offer the remaining sets to Popular Mechanics readers AT LESS THAN HALF of the original price because we sell through the mails only. Note that the attached coupon specifies NO SALESMAN WILL CALL—no agent's commission to pay. Send the coupon AT ONCE and we will mail FREE a book of rare documents and curious inscriptions and tell of our low price offer ON EASY MONTHLY PAYMENTS. Mail the coupon NOW. You assume no obligation. The book is Free.

**THIS MARVELOUS WORK** is revolutionizing modern thought. It's turning upside down old notions and ideas. It gives the authoritative, rock-bottom sources of our knowledge on all subjects of human interest from the earliest civilization down to to-day.

**OVER 100 RESEARCH SPECIALISTS** spent 10 years gathering the contents of this great work. Ancient and remote and forgotten civilizations in all parts of the globe were uncovered, and age-buried hieroglyphics on monuments, tablets, sun-baked bricks and palimpsests yielded their secrets; untiring workers ransacked the hidden literature of every age, ancient, mediæval and modern, to find the "original documents" that shaped the civilizations and influenced the thought and life of the world. Nothing like it has ever been attempted or thought of before. You'll be amazed at the wealth of information this unique library contains.

**YOU'LL FIND EVERYTHING YOU WANT to know** in the Library of Original Sources. 10 sumptuous, massive volumes, bound in rich, deep red leather; full-page illustrations, pure silk head-bands, printed in large, clear type on hand-made paper, gold tops—a triumph of the bookmaker's art.

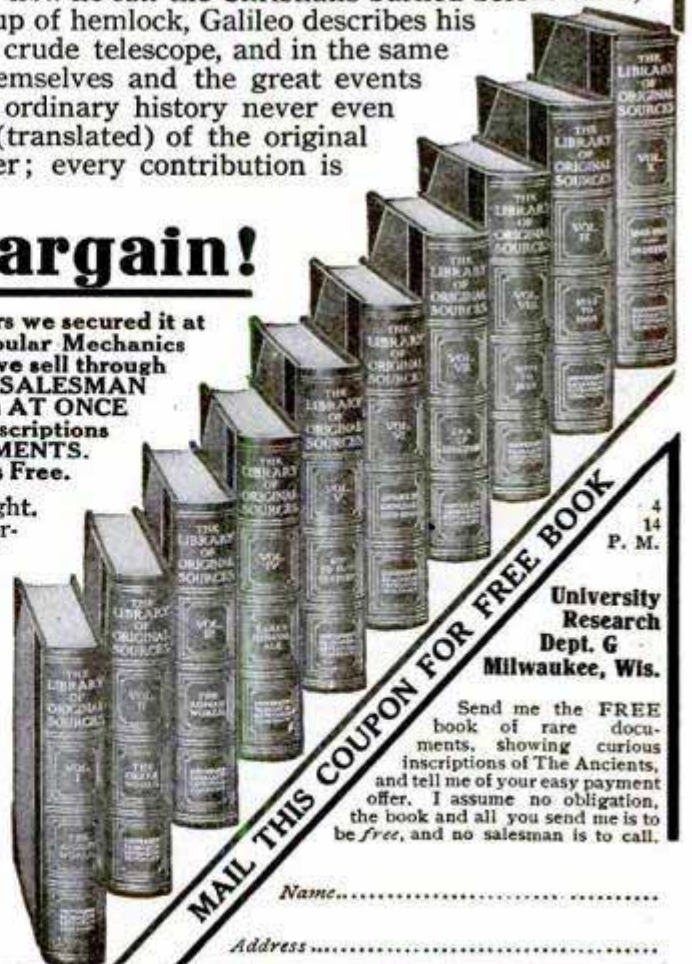

MAIL THIS COUPON FOR FREE BOOK

Name.....  
Address.....

4  
14  
P. M.

University  
Research  
Dept. G  
Milwaukee, Wis.

Send me the FREE book of rare documents, showing curious inscriptions of The Ancients, and tell me of your easy payment offer. I assume no obligation, the book and all you send me is to be free, and no salesman is to call.



The  
Burlington  
Special

19 Jewels  
Fully Adjusted



The  
Burlington  
Special

New Style  
Thin Model

Here  
is an  
Exquisite  
Design

New  
Inlay  
Monogram

The latest idea in watch cases. Superbly beautiful. Your own monogram in handsome enamel design, (many colors to choose from) inlaid in superb gold strata case. The newest thing—just conceived and offered direct to you.

## 1914 Timepiece

"Inlay Enamel" Monogram

### New Ideas in Watch Cases!

Open face or hunting case, ladies' or gentlemen's sizes. These can be had in the newest ideas: *Block and Ribbon Monograms, Diamond Set, Lodge, French Art and Dragon Designs, Etc.* Imagine a beautiful hunting case with your own monogram on one side and the emblem of your lodge or any emblem on the other side. Our catalog shows complete illustrations. See coupon below.

## Special Offer!

The superb Burlington Special now at the **DIRECT** rock-bottom price—the same price that even the wholesale jeweler must pay. You may secure one of these superb timepieces—a watch of the very latest model, the popular new thin design, adjusted to the second—19 jewels—adjusted to positions AND temperature AND isochronism—the most perfect product of the world's most expert watch manufacturers—at the price that even wholesale jewelers must pay—and in order to encourage everybody to secure this watch at once pay this rock-bottom price, either for cash or \$2.50 a month! We send the watch on approval, **prepaid**. You risk absolutely nothing—you pay nothing—not one cent, unless you want this exceptional offer after seeing and thoroughly inspecting the watch. Read the coupon below.

### Write for Free Watch Book

Learn the inside facts about watch prices, and the many superior points of the Burlington over double-priced products. Just send the coupon or a letter or a postal. Get this offer while it lasts.

**Burlington Watch Co.**  
19th Street and  
Marshall Blvd.  
Chicago  
Dept.  
1194

**Burlington Watch Co.**  
19th St. and Marshall Blvd.  
Dept. 1194  
Chicago, Ill.

Please send me (without obligation and prepaid) your free book on watches and a copy of your \$1,000 challenge, with full explanation of your cash or \$2.50 a month offer on the Burlington Watch.

FREE  
Book Coupon

Name.....

Address.....



SHOW CARD WRITERS  
EARN FROM  
\$21 TO \$50  
PER WEEK

## LEARN ABOUT THE BEST COURSE IN SHOW CARD AND SIGN WRITING

IT IS FREE to those purchasing our assortment of "LITHOLIA" Ready-to-Use Colors

A great opportunity for ambitious persons, either sex, to earn \$21 to \$50 weekly, salary or in business for yourself. Our show card course is not a book of alphabets. It's a complete course in lettering compiled by an expert New York show card artist for us. "Litholia" is the only liquid pigment water paint ever made; used the same as cake, distemper or tube colors, but far superior to either. Lasts longer, more brilliant, always ready. Best for show card writers, artists, or interior decorators. Booklet, Circulars and Full Information FREE. LITHOLIA COLOR CO., 73 W. 23rd St., New York City



## BE A BANKER

Splendid opportunities. Pleasant work, short hours, all holidays off, yearly vacation with pay, good salary. Learn at home. Diploma in six months. Catalog free. EDGAR G. ALCORN, Pres. AMERICAN SCHOOL OF BANKING, 119 McLene Bldg., COLUMBUS, OHIO

SEND  
for my  
FREE  
Books



## DO YOU WANT TO KNOW HOW TO DEVELOP VITALITY, ENERGY, ENDURANCE, NERVE STRENGTH, MUSCULAR STRENGTH PERFECT PHYSIQUE?

My FREE BOOKS, "The 'Whys' of Exercise" and "The First and Last Law of Physical Culture," tell you, if you are weak or underdeveloped, how to grow strong; if strong, how to grow stronger. They explain how to develop lungs and muscle, the strong heart and vigorous digestion—in short, how to improve health and strength internally as well as externally. Send TO-DAY-NOW—for these FREE BOOKS. Enclose 4c in stamps to cover postage.

PROF. H. W. TITUS, Department 122, 56 & 58 Cooper Square, New York City



## MAGIC TRICKS AND SUPPLIES

Just Out. New 160 Page Illustrated Catalogue of Wonders.  
PRICE 10 CENTS

Prompt Shipments. Satisfaction Guaranteed.  
Chicago Magic Co., 72 W. Adams St., Chicago, Ill.  
Successors to Read & Covert

## FREE "Linene" COLLAR

Our free sample will prove comfort and economy. Send postal stating size and whether you want high or low collar.  
REVERSIBLE COLLAR CO., Dept. U, Boston, Mass.

**CACHOO!** Make the whole family and all your friends "just sneeze their heads off" without knowing why, with Cachoo, the new long distance harmless snuff. Sent anywhere for 10c, 3 for 25c, 1 doz. and special premium for 90c. AMERICAN SUPPLY CO., St. Paul, Minn.



**PRIZE PACKAGE FREE**  
We will send you FREE a big package of Magic Tricks, Puzzles, Cards, Jokes, Riddles, Money Making Secrets, Splendid Games, Toasts, Card Tricks, Feats in Parlor Magic, all FREE. Just send us 10c to pay for postage and adv. and we will send this trick package free.  
NATIONAL TRICK CO., Dept. E, CHICAGO



## Every Boy His Own Toymaker

Greatest boys' book ever written. Tells how to make a Steam Engine, Telephone, Magic Lantern, Boats, kites, balloons, electrical and mechanical toys, traps, fishing tackle, 200 illustrations; also catalog of 150 puzzles, Keller's Magic Ace Trick Card and "DOUBLE THROAT" warbler and bird call all for only 10c. WESTERN PUZZLE CO., ST. PAUL, MINN.



## DOUBLE THROAT 10c New Invention.

Fits roof of mouth. Greatest thing out. Astonish and mystify your friends. Make dogs or cats talk. Neigh like a horse, sing like a canary. Imitate any Bird or Beast of field or forest. Price 10c; 4 for 25c postpaid.



# Oratory that Made Men Famous in a Day



Copyright, Underwood & Underwood

The brightest thoughts of the world's most famous orators—the wittiest sayings of the wittiest men of the Nineteenth Century—epoch making speeches that moved not only audiences but Nations. They are all here just as they were delivered by these distinguished speakers, and gathered in such form as to instruct and entertain you where and when you will.

## Modern Eloquence

Consists of Ten Beautiful, Richly Bound Volumes

elaborately indexed, beautifully illustrated with over 80 photo-gravures on Japanese vellum; paper, presswork and bindings of very highest quality.

## A Wonderful Bargain

Send us the attached coupon at once, and we will tell you how to get the Library on **Easy Monthly Payments**, and with our terms we will also mail you Henry W. Grady's Great Lecture, "**The Race Problem**"—FREE. Reprinted from the work itself. Champ Clark says—"The most famous after-dinner speech within the memory of any living man." Sending the coupon places you under no obligation to buy. If you are interested tear it off and send in NOW. Don't wait. The offer is limited.

**Are YOU ever asked to respond to a Toast, to Write an Address, or to Make a Speech?** If so you will find these volumes the greatest help imaginable, because they contain nearly every variety of good pattern for the various classes of oratory. And many an inexperienced banquet chairman, toastmaster or honored guest, casting helplessly about him for a good story or appropriate remarks, has found here just the inspiration he needed.

### From the Great Commoner

Hon. Wm. J. Bryan says: "In commending your work, MODERN ELOQUENCE, which I do most heartily, I feel that I am doing a favor, not so much to you as publishers, as to those who may be led to purchase and read the work. It is a valuable addition to any library."

#### 300 After Dinner Speeches

by Joseph H. Choate, Benjamin Disraeli, James G. Blaine, Wm. M. Evarts, John Hay, Oliver Wendell Holmes, Sir Henry Irving, Chauncey M. Depew, Henry Ward Beecher, Mark Twain, Henry W. Grady, Joseph Jefferson, Robt. G. Ingersoll, Seth Low, Albert J. Beveridge, Woodrow Wilson, etc.

#### 150 Great Addresses

by Lyman Abbott, Charles Dudley Warner, William Cullen Bryant, Rufus Choate, Theodore Roosevelt, Arthur J. Balfour, Jonathan P. Doliver, Edward Eggleston, William E. Gladstone, Charles Francis Adams, John L. Spalding, Joseph Chamberlain, Grover Cleveland, Fisher Ames, Lawrence Barrett, Henry Drummond, Hamilton Wright Mable, William J. Bryan, etc.

#### 60 Classic and Popular Lectures

by Charles A. Dana, Robt. J. Burdette, Russell H. Conwell, Canon Farrar, John B. Gough, Andrew Lang, Wendell Phillips, Josh Billings, John Tyndall, Geo. William Curtis, Artemus Ward, Paul DuChaille, John B. Gordon, Newell Dwight Hillis, John Morley, John Ruskin, Henry M. Stanley, Wu Ting Fang, etc.

#### 200 Short Stories and Anecdotes

by Mark Twain, Chauncey M. Depew, Horace Porter, Champ Clark, Joseph H. Choate, John M. Allen, etc.

#### Each Speech, Lecture or Address is COMPLETE.

Everything is of proved value and interest, and is printed in its entirety. Speeches that have been flashed around the world, lectures that have been repeated again and again to never-tiring audiences, "occasional" addresses that have made men famous in a day, masterly orations that have molded public opinion and directed the march of progress—these are brought together for the first time in this remarkable library.

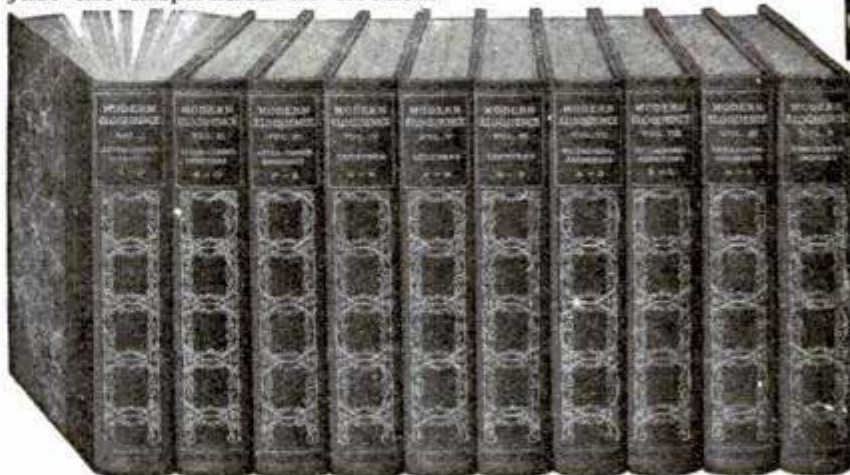

#### Mail This Coupon for FREE Lecture

P. M. 4-14

GEO. L. SHUMAN & CO., Dept. 7, Ohio Building, Chicago

Please send me free lecture and full description of Modern Eloquence with special prices and terms.

Name.....

Address.....



# Making Successful Men

The United States Navy aims to make a successful man of every boy who enlists, and to return him to civil life a useful citizen.

☐ The development of the untrained youth into an efficient man-o'-warsman begins at the time he enlists. The instruction given apprentice seamen at the Navy training stations is continued after the men go on board vessels; and to young men who have the necessary qualifications special instruction is given in the various Navy trade schools.

☐ The great variety of duties in the Navy makes it possible for young men to do the work for which they are best fitted. The pay is graded according to the skill and ability required; and, whether a young man remains in the service after serving one enlistment, or decides to return to civil life, four years' experience in the Navy with an honorable discharge is the most valuable asset he can possess.

Call at the nearest Navy Recruiting Station, and inquire fully about pay, hours, promotion, etc. Or write for pamphlets explaining fully all the advantages offered in the Navy. Free. Talk this over with your parents.

ADDRESS

## BUREAU OF NAVIGATION

Box 69, Navy Department

WASHINGTON, D. C.





# Marie Antoinette

**T**HE illustration herewith shows Marie Antoinette, Queen of France, led to the guillotine. It is said her hair turned white in a single night as a result of the mental anguish to which she was subjected. This scene was the culmination of tragedies during the Reign of Terror of the French Revolution. This period contains more of dramatic interest than any other in the world's history. It was out of this period that the Empire was born, dominated and ruled by Napoleon. It is generally conceded the best account of the French Revolution is by America's Great Historian, Dr. John Clark Ridpath.

## Six Thousand Years of History

Ridpath, the Historian, takes the reader back to the very beginning of civilization and traces man's career down through the long highway of time, through the rise and fall of empires and nations. He covers every race and every nation, and holds the reader spell-bound by his wonderful eloquence. Nothing more interesting or inspiring has ever been written. If you would know the history of mankind, every sacrifice for principle, every struggle for liberty, every conflict and every achievement, then embrace this opportunity to place in your home the world-famed publication—

# Ridpath's History of the World

We will name our special low price and easy terms of payment and mail the beautiful free sample pages to all who mail us the coupon below. Tear off the coupon, write name and address plainly, and mail now before you forget it. Dr. Ridpath is dead, his work is done, but his widow derives her support from the royalty on this History, and to print our low price broadcast for the sake of more quickly selling the sets at our disposal would cause great injury to future sales. **Mail the coupon now.**

### FREE

We will mail free a beautiful 46-page book of sample pages from Ridpath's history to every reader interested in our offer who mails us the coupon, printed for your convenience on the lower corner of this page.



**Nine splendid volumes, 4000 pages, 2000 illustrations. Here are the contents:**

- Volume I.** Egypt, Chaldea, Assyria, Media, Babylonia, Persia. Age of Monarchy.
- Volume II.** Parthia, Greece, Sparta, Macedonia, Alexander the Great. Age of Literature.
- Volume III.** Rome—the Kingdom, the Republic, the Empire. Julius Cæsar, Birth of The Christ. Constantine, Cleopatra. Age of Imperialism.
- Volume IV.** Barbarian Ascendency, Mohammedan Ascendency, Saladin, Charlemagne, Feudal Ascendency, The Crusades. Dark Ages.
- Volume V.** England, Magna Charta, France, Germany, Italy, Spain, Discovery of New World, Thirty Years War, Reformation. Age of Discovery.
- Volume VI.** English Revolution, Oliver Cromwell, Frederick the Great, American Revolution, French Revolution, Napoleon. Age of Revolution.
- Volume VII.** The United States, the Civil War, Mexican War, Great Britain, Sepoy Rebellion, Home Rule, Empire of India. Age of Invention.
- Volume VIII.** United States—Last Decade, Franco-Prussian War, Germany, The Crimean War, Russia, Italy, Turkey, Other European States, Canada, South America, China, Japan and Australia. Age of Industry and Commerce.
- Volume IX.** The Close of the XIX and the Dawn of the XX Century, bringing the History of All Nations down to date. Age of Progress.

**FOLD HERE, TEAR OUT, SIGN AND MAIL**

Name .....

Address .....

4  
14  
**FREE  
COUPON**

Western  
Newspaper  
Association  
**H. E. SEVER**  
President  
140 So. Dearborn St.  
CHICAGO, ILL.

Please mail, free, 46 page sample booklet of Ridpath's History of the World, and write me full particulars of your special offer to Popular Mechanics readers.



# WANTED!

**CHIEF DRAFTSMAN, STRUCTURAL COMPANY,** \$175-\$200; constructor cost accountant, \$100; ornamental iron draftsmen (2) \$20-\$35 per week; salesmen contractors' equipment, Indiana, \$75 plus commission; ornamental iron shop foreman (2), \$125. See MR. WINSLOW.

See the want ads of any big city daily and you will find more good paying positions open for expert Draftsmen and Designers than for any other trade or profession. This is the one profession where the demand exceeds the supply—and the demand is constantly increasing. Never before have salaries been so high—never before such splendid chances for advancement. Why don't you

## Learn Drafting

become an expert Draftsman and enter this interesting, pleasant and extremely profitable line of work? I will give you the benefit of my 20 years' experience as Chief Engineer—give you individual, personal instruction. As my personal student you can easily

## Learn at Home

during your spare moments and without giving up your present occupation. Mind you, my course of instruction does not consist of impractical, stereotyped forms—I send you actual, practical work to do, train you as thoroughly as though you were in the same office with me and fit you to fill a big position—one that will pay you—

**\$125 to \$200 Per Month** Yes, that's what you can earn right at the start as an expert Draftsman and Designer—the kind I can train you to be. My graduates make good. Many have gone into business for themselves and are earning \$3,000 to \$10,000 a year.

**FREE** If you enroll within the next 30 days I will give you, absolutely FREE, this magnificent set of Drawing instruments,



valued at \$17.50—handy size leather bound pocket case—the same as I use in my professional work. Will last a lifetime. But you must act at once to get it FREE!

**My Guarantee** I guarantee to instruct you until in a position paying \$75 to \$200 per month.

## Special Tuition Offer

I can give my personal attention to only a limited number of additional students and for the next 30 days am offering a \$25 Tuition Credit as a special inducement for prompt enrollment. Mail coupon today. And remember, I guarantee to instruct you until you are in a \$75 to \$200 a month position. Let me send you proof that my course is the most thorough and easiest to learn of any similar course. My book "The Road to Success" and full particulars of my limited offer mailed free. Mail coupon or postal today—Sure!

**FREE COUPON**

Chief Engineer,  
**CHICAGO ENGINEERING WORKS,**  
534 Engineering Bldg.,  
**CHICAGO, ILL.**

Dear Sir:—Without any obligation on my part send me your book, "The Road to Success" and full particulars of your limited free offer. Send everything free and prepaid.

NAME.....

Address.....

Chief Engineer,  
**CHICAGO ENGINEERING WORKS,**  
534 Engineering Bldg.,  
**CHICAGO**

## This Auto FREE to New Coey Students



## COEY JUNIOR \$425

We want young men in every community to earn a Coey Junior free and then ride around and take orders for us. Write for information. This is the only Automobile School in the World that really builds automobiles and gives its students an opportunity to help build them and make big money.

## Invest Only \$15

## Make \$100 to \$400 Every Month

A small investment of only \$15.00 will prepare you to earn from \$100 to \$400 per month. Oldest Automobile School in the World, under personal supervision of Mr. C. A. Coey, America's Premier Autoist, holder of the 24 hour automobile world-record.

## Interesting Literature Free

Write today for particulars. You can earn big money the minute you enroll.

**C. A. COEY'S SCHOOL OF MOTORING**  
532 Coey Bldg., 1424-1426 Michigan Ave., CHICAGO, ILL., U. S. A.

## LAW STUDY AT HOME BECOME AN LL.B

Only recognized resident law school in U. S., Conferring Degree of Bachelor of Laws—LL. B.—by correspondence. Only law school in U. S. conducting standard resident school and giving same instruction, by mail. Over 450 class-room lectures. Faculty of over 30 prominent lawyers. Guarantees to prepare graduates to pass bar examination. Only law school giving Complete Course in Oratory and Public Speaking. School highly endorsed and recommended by Gov. Officials, Business Men, Noted Lawyers and Students. Send today for Large Handsomely Illustrated Prospectus. Special courses for Business Men and Bankers.  
**HAMILTON COLLEGE OF LAW, 405 Advertising Bldg., CHICAGO, ILL.**

## LEARN TO PAINT SIGNS and SHOW CARDS

I'll teach you personally by mail. Fourteen years' successful teaching. Big field for men and women. You can **EARN \$18.00 TO \$45.00 A WEEK** Crawford, B. C. writes: "Earned \$300.00 while taking course." Write today for catalog, samples, etc.  
**DETROIT SCHOOL OF LETTERING**  
CHAS. J. STRONG, Founder, Dept. 204 Detroit Mich.



## IF YOU STAMMER



attend no stammering school till you get my large FREE book and special rate. Largest and best school in the world curing by natural method. Write today.

**Lee Wells Millard, Pres., North-Western School, Inc.**  
917 First Street Milwaukee, Wis.

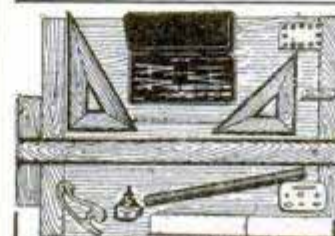

**DRAWING OUTFIT** Consisting of board, T-square, triangles, fine set of instruments, scale, tacks, pencils, rubber, curve, etc.  
**Regular \$8.75, Special now \$3.75**  
The greatest draftsman on earth can use these instruments. If you have any mechanical ability buy this outfit and learn to draw. There are many good positions open all the time for good draftsmen. Better outfits for \$5.80, \$8.75, and \$12.50. If not perfectly satisfied return in ten days and money will be refunded. Send for circular P.M. at once.

**THE T-SQUARE & TRIANGLE CO., 30-32 Clinton St., NEWARK, N. J.**



\$1

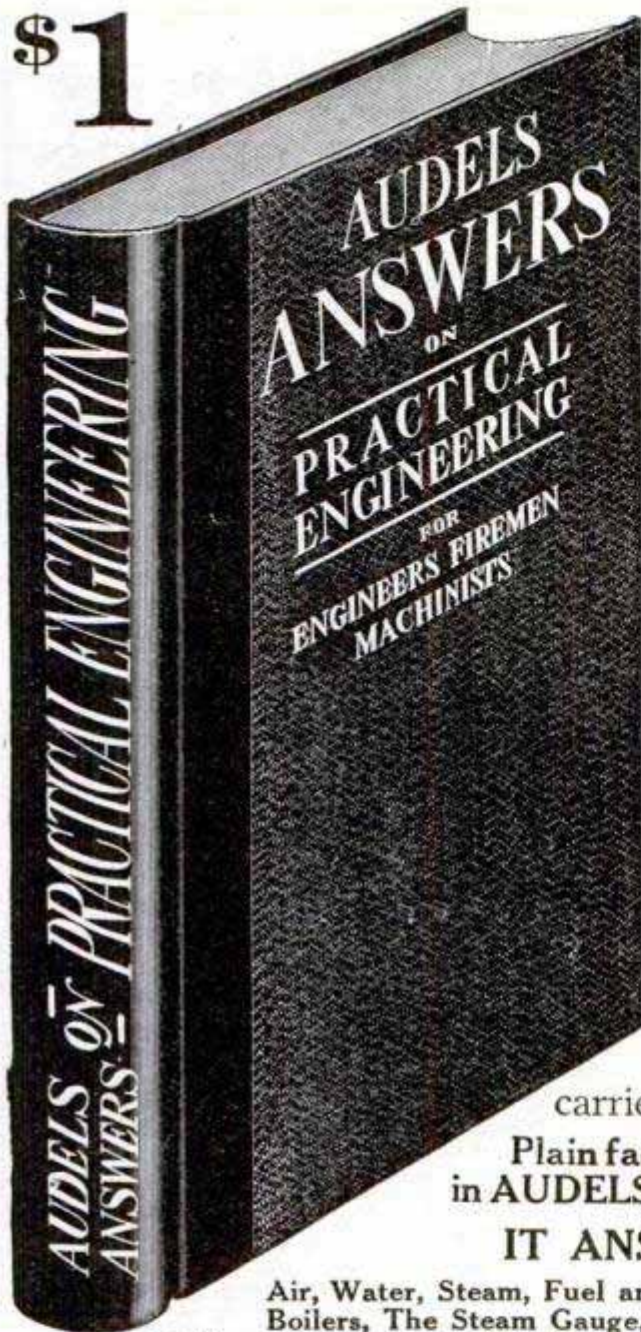

# ENGINEERS

This Book Will Help You

## Audels Answers on Practical Engineering

*When you spend your good hard earned money for books, always make sure that you are going to receive something that will assist you in bettering your position*

**T**HIS book deals largely with the foundation principles which govern the practice of steam engineering. Nothing so soon condemns the applicant as want of knowledge of the every day practice and simple laws relating to the care and management of a steam plant.

No one is expected to know everything, but all are required to be familiar with certain facts which may be called "the beginning of things."

The lack of knowledge of the small things carries conviction of the same lack in the larger.

Plain facts, that you should know, are plainly explained in **AUDELS ANSWERS ON PRACTICAL ENGINEERING.**

### IT ANSWERS YOUR QUESTIONS ON

Air, Water, Steam, Fuel and Heat, Steam Boilers, Boiler Construction, Water Tube Boilers, The Steam Gauge, The Safety Valve, Properties of Steam, Installation of Boilers, Management of Boilers, Engineers' Law, Firemen's Law, Steam Engines, The Valve and Valve Gear, The Corliss Engine, Engine Arithmetic, Lubricators, Installation and Operation of Engines, Steam Pumps, Injectors, Feed Water Heaters, Steam Heating, Steam Traps, Belts, Gears and Pulleys, Steam Turbines, Refrigeration, Practical Electricity, Elevators.

Understand the framework of which your work is but a cross bar. Know something of the cause of which your work is but an effect. Know something of the effect of which your work is the cause. And, above all, know why it is done one way and not another.

**LEARN THE THEORY UNDERLYING THE WORK.** Practical Engineering contains 288 pages fully illustrated, handsomely bound and printed and is in every way a first class book.

## Examination Offer

**If You Are Interested** sign and mail the coupon, and it will bring to your plant a book of sterling merit, for free examination. You can have one week in which to dig out the mine of valuable information contained in its 200 or more pages.

### Carry It in Your Pocket for One Week

and at the end of the time, if you do not think the book is worth one dollar, mail it back to us. If it is, you can mail us \$1.00 in payment for your copy. If you fail to consider this liberal offer you are not dealing fairly with yourself. We take all risk that "Audels Answers on Practical Engineering" is a book you should own. Act now before you forget it.

Please send me for examination one copy  
**Audels Answers on Practical Engineering** \$1

If I keep the book, I promise to send you within 7 days after receiving it ONE DOLLAR, in full payment; if I do not keep it, I will mail it back to you within 7 days.

**THEO. AUDEL & CO., 72 5th Ave., NEW YORK**

Signature.....  
 Occupation.....  
 Address..... P.M. Apr. '14





**THE OLD RELIABLE SCHOOL**  
We have successful graduates in nearly every State in the Union.

## Come to Detroit THE AUTOMOBILE CENTER to learn the automobile business

Sixty-seven out of every one hundred autos in the country are made in Detroit's forty-four automobile factories. There are greater and better opportunities in Detroit than in any other city in the United States. Detroit's prestige is universal. Detroit's products are known the world over.

Automobile men from Detroit are in great demand everywhere. To anyone looking for a position or to anyone starting a garage and repair shop, the very fact that he has learned the business in Detroit, the "Automobile Center," is worth money to him. A Diploma from an auto school in Detroit gives you prestige in the automobile field.

This School is equipped to give you unlimited, practical instruction in construction, repairing and driving of standard makes of cars. Our course also includes thorough instruction on

### ALL LEADING TYPES OF ELECTRIC SELF-STARTERS

such as the Gray & Davis, Delco, Westinghouse, Ward Leonard, Deaco, Jesco, U. S. L., Adams-Westlake, Entz, Aplco, etc.

We actually have a DELCO ignition, lighting and starting system and a Gray & Davis system IN OPERATION ON A MOTOR for the students to work on. We also have the Ward Leonard in ACTUAL OPERATION and expect others any day. We give our students ACTUAL PRACTICAL experience in installing, repairing and maintaining these systems.

In addition to getting actual garage and repairshop experience in overhauling and repairing all kinds of cars, our students ACTUALLY BUILD NEW CARS, right from start to finish, getting regular factory experience in assembling, block-testing, road-testing, etc. We have just purchased Seven New Motors or rather the parts for seven motors. Our students get actual, practical experience in assembling these motors from start to finish after which they are put on the block test.

**Our Block Test Dept.** added two new Six Cylinder Lozier motors, one equipped with Gray & Davis Lighting and Starting System. We now have twelve motors in this department. Here we give our students actual, practical experience in timing motors, adjusting carburetors and magnetos, in adjusting tapets, grinding valves, scraping bearings, etc. Our course covers the automobile thoroughly.

While writing to us, we would ask that you kindly write to several other schools and compare them with ours. Write for our monthly paper, the "Auto School News." It is free. It contains interesting information in regard to the automobile industry and tells you why you should come to Detroit, the automobile center, to learn the automobile business.

**Address Michigan State Automobile School**  
Dept. P THE OLD RELIABLE SCHOOL  
11-13-15-17 Selden Ave., Cor. Woodward, DETROIT, MICH.

### Our Guarantee

We guarantee to qualify you for a position as chauffeur, repairman, tester, salesman or demonstrator in a short time, or we will refund your money.

**And don't forget, we furnish positions, too**

On account of being in the auto center, we can furnish positions that cannot be obtained elsewhere

### WHY NOT BE AN ARTIST?



**STUDY drawing at home under Expert Faculty.** We have successful students in every part of the world. Turn your Talent into money. Our Students are filling high salaried positions. 14 years successful teaching. Endorsed by high authorities. 18 Courses in Commercial and Illustrative Drawing, Teachers' Normal and Applied Art, Profit or Culture.

**Thoroughly Equipped Residence School**

Artist's Outfit FREE to Enrolled Students

SCHOOL OF APPLIED ART, 755 Applied Art Bldg., Battle Creek, Mich.

### LEARN DRAFTING

Be a mechanical, architectural or sheet metal pattern draftsman.

**EARN \$75 TO \$200 PER MONTH**

There is a constant demand for our graduates. Our employment bureau will secure you a good position. Expert instructors. Complete drawing outfit free. Write for free book today.

Colorado Correspondence College, Dept. B-1, Denver, Colo.

**EARN \$20 TO \$50 A WEEK LEARN SHOW CARD WRITING.**

Splendid Opportunities, Big Salaries, Constant Demand for Show Card Writers. I will make you an expert in 14 EASY LESSONS. Learn at home during spare minutes. Valuable illustrated book, "Daily's Self Instructor," describing course, sent free on request.

Room 67 Rauh Bldg.  
**BERT L. DAILY, Dayton, Ohio**

This Book FREE  
Send Today

### STUDY LAW AT HOME

#### Young Man! Crystallize Ambition!

Stop wishing—and act! Law is powerful, honorable and well paid. And our College Law Course is complete, easily mastered and highly endorsed. Write for catalogue and "evidence." Read the testimonies of our hundreds of graduates. Oldest and best. 24 years of biggest success. Write now!

**SPRAGUE CORRESPONDENCE SCHOOL OF LAW**  
359 American Building, Detroit, Mich.

**GET THIS BOOK FIRST.**

**DON'T TRY TO BE A CHAUFFEUR**

or go to ANY SCHOOL to learn, or part with your hard earned dollars until you have read our valuable guide FIRST. It tells what you should PAY and what you should GET. Do not be deceived by schools which claim everything and give you nothing. **YOU CAN'T AFFORD TO SPEND ONE CENT TILL YOU GET OUR GUIDE.** It costs nothing and may save you many dollars. Write now for this FREE BOOK.

**PRACTICAL AUTO SCHOOL, 68 Beaver St., New York**

**BUSINESS LAW**

Bays Miniature Law Library. Only complete work on Commercial Law. Contains Legal Forms of all kinds. Should be in every Library. Fits the pocket; 9 volumes \$12.00. Safe counsellor. Worth its weight in gold. 2000 pages. Order Now. Sent on approval.

**CALLAGHAN & CO., Law Publishers, CHICAGO**

**LEARN SHOW CARD WRITING**

**A FREE OFFER** We have contracted for a limited number of a complete course in Show Card Writing and lettering which we will give absolutely free to purchasers of an assortment of our colors; to introduce. Address: Alpha Color Co., 2050 Amsterdam Ave., N. Y. City

**LEARN JEWELRY ENGRAVING**

in your own home. Earn \$20.00 to \$50.00 Weekly. Personal instructions. Write for free booklet. Chicago Engraving School, 612 Athenaeum Bldg., Chicago

**STOP ST-STU-T-T-TERING**  
and STAMMERING. I did. So can you. At home. Very easy. Let me tell you HOW. **WALTER McDONNELL, Drawer F511, Station F, Washington, D. C.**

**LEARN JEWELERS' ENGRAVING**

A high salaried and easily learned trade, taught thoroughly by mail. We will teach the beginner better engraving than he can gain in years of rigid apprenticeship. We will also improve the skill of any engraver. Send for our catalogue. The Engraving School, 112 Page Bldg., Michigan Ave., Chicago, Ill.

**DRAWING**

Caricature, Cartoon, Comic, Commercial, Fashion, Newspaper and Magazine illustrating taught by mail. Illustrated book 6c in stamps. **THE BOSTON SCHOOL OF DRAWING, 755M Boylston St. BOSTON, MASS.**



# J-M ASBESTOS ROOFING NEVER NEEDS PAINT

## Every Time You Paint a Roof You Repair It!

If you knew you would have to spend \$180.00 every few years to repair your roof to preserve it and make the guarantee good, would you buy it? Painting is repairing, and it will cost \$180.00 at the very lowest price to paint every 100 squares of roofing twice.

Add the cost of painting or gravelling to the original cost of even a cheap roofing for ten years and it will make the cost-per-year of service much higher than the price of J-M Asbestos Roofing.

J-M Asbestos Roofing is a little higher-priced at the beginning than ordinary roofings—but its *first* cost is the *last* cost. It never needs paint, gravel or any other protection. So it saves money in the long run.

This roofing has been in service on hundreds of buildings for more than 25 years without costing a cent for maintenance.

Made of Asbestos (rock) and Trinidad Lake Asphalt—both minerals. Literally a flexible *stone* roofing. Gives perfect fire protection. And is not affected by heat, cold, salt air or acid fumes.

J-M Roofing Cleats, packed in each roll, make joints absolutely water-tight and do away with unsightly black cement.

Furnished in ready-to-lay and built-up form. Suitable for all types of buildings.

Sold direct if your dealer can't supply you. Write our nearest branch for specimen of Asbestos Rock and Book No. 3471.

### H. W. JOHNS-MANVILLE CO.

Albany  
Baltimore  
Boston  
Buffalo

Chicago  
Cincinnati  
Cleveland  
Dallas

Detroit  
Indianapolis  
Kansas City  
Los Angeles

Louisville  
Milwaukee  
Minneapolis  
New Orleans

New York  
Omaha  
Philadelphia  
Pittsburgh

San Francisco  
Seattle  
St. Louis  
Syracuse

THE CANADIAN H. W. JOHNS-MANVILLE CO., LIMITED  
Toronto, Montreal, Winnipeg, Vancouver

2325

RAILWAY EXCHANGE BUILDING, ST. LOUIS, MO.

ROOFED WITH J-M ASBESTOS ROOFING. LARGEST STRUCTURE IN THE WORLD HOUSING A RETAIL STORE AND OFFICE BUILDING. MAURAN, RUSSELL AND CROWELL, ARCHITECTS, WESTLAKE CONSTRUCTION CO. CONTRACTORS.



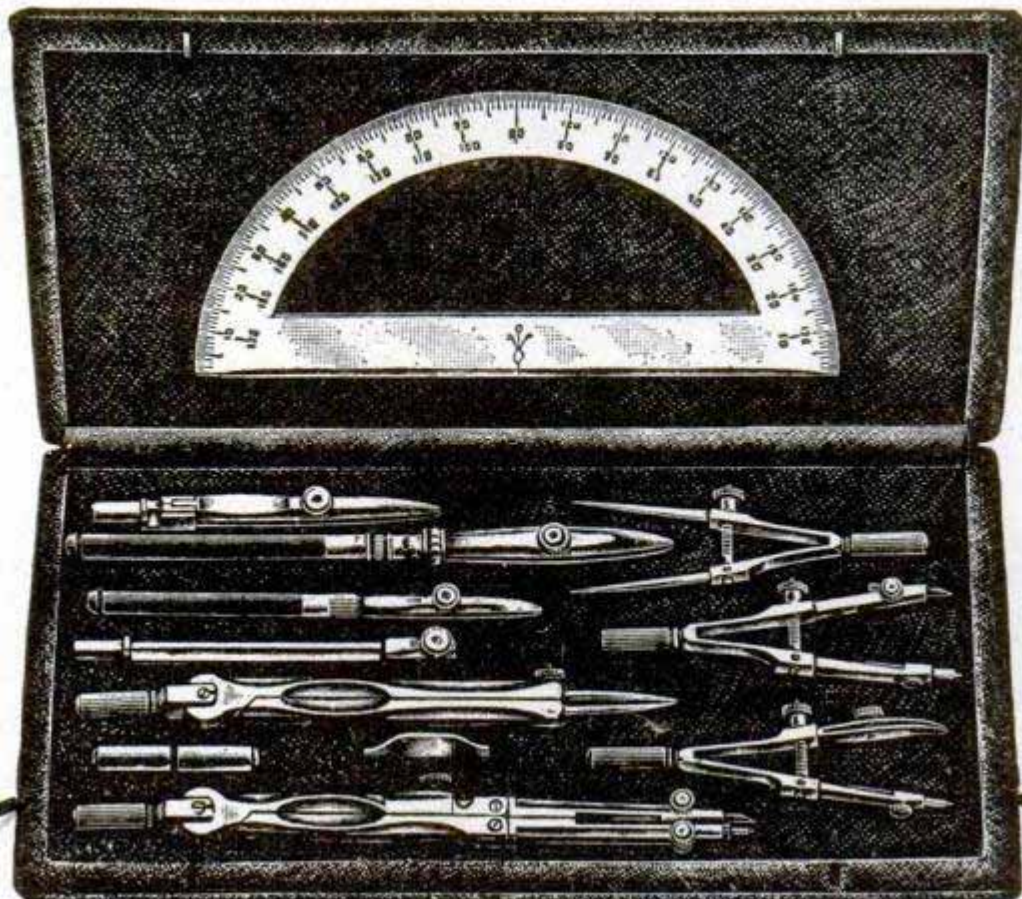

# FREE

## \$15.00 Draftsman's Complete Working Outfit

Yes sir. I will give you a complete draftsman's outfit absolutely free. Besides these German Silver Draftsman's Instruments shown here I also give you absolutely free a 20x25 inch drawing board, a 24 inch T square, 12 inch rule,

supply of drawing paper, 2 triangles and French curve, pencil and eraser, drawing ink and thumb tacks, etc., etc. These are genuine working instruments. Just the kind of an outfit I use myself. You couldn't get this outfit anywhere for less than \$15.00. I give it to you **free**. But you must hurry. Send the free coupon now—today.

## Be a Draftsman

**Earn \$125 to \$175 a Month at Once**

Thousands of positions paying big money are open right along. All over, concerns are constantly wanting trained men. They pay big money. Hundreds of positions open paying from \$75.00 to \$100.00 weekly. A prominent chief draftsman will give you personal instruction, practical training, the kind demanded by firms that pay the biggest salaries. You can learn to become a draftsman in your own home—during your spare time—by mail.

## You Can Earn While Learning

I have perfected a plan that gives you an opportunity to begin earning money as soon as you become my personal student. I want ambitious men. This offer enables ambitious men to pay their way while they are learning. Send me the coupon and get my proposition.

### I Guarantee

To instruct you until competent and in a position at a regular salary paying from \$125.00 to \$175.00 per month and furnish you free \$15.00 Working Outfit at once.

## Chief Draftsman Will Instruct You Personally

For 20 years I have been doing the highest paid expert drafting work. I will train you personally and give you practical training. I will give you this kind of training as long as required during your spare time, in your own home.

### Free Outfit Coupon

#### Chief Draftsman

Div. 1194, Engineer's Equipment Co., Chicago

Please send me your book, "Successful Draftsmanship" and also full particulars of your liberal "Personal Instruction" offer to a few students. It is understood that I am obligated in no way whatever.

### Pay As You Wish

draftsman, don't worry about the money.

Don't bother about the money. If you are ambitious and want to become an expert Write to me now—at once for full particulars.

## Send the Free Coupon NOW

### For Big New Free Book

Just fill out the free coupon and mail it in to me at once. I will send you absolutely free and prepaid a new book, "Successful Draftsmanship." Tells you all about the profession and about the wonderful opportunities that are now open. I'll tell you how you can start earning big money as soon as you enroll. Here is your chance to get into the big money class. The first step is to send the free coupon. Send it **now**.

Name .....

Address .....

## CHIEF DRAFTSMAN

Div. 1194, Engineer's Equipment Co., Chicago, Ill.



# CLASSIFIED ADVERTISEMENTS

Advertisements in this section, 15 cents per word, each insertion, minimum 10 words, payable in advance. To insure ads being inserted under proper classified head in the May issue, copy must reach this office not later than April 1st.

We have records to prove that a classified ad in these columns will find a buyer for almost anything which can be sold. Doubtless you have some article of value to some one else which you no longer need. Why not turn it into money?

## AUTOMOBILES

**AUTOMOBILE model.** Every part shown and named. You can to all intents and purposes take off the wheels, raise the hood and remove the body, exposing to view the vital parts. The only practical method of studying the automobile. Price, 50 cents postpaid. Popular Mechanics Book Dept., 6 No. Michigan Blvd., Chicago.

**BARGAIN—Model 00 five-passenger White Steamer.** Fully equipped; quick action secures this machine at extremely low figure. W. E. Savage, P. O. Box 600, Okolona, Miss.

**AUTOMOBILE Instruction—\$35.25.** Four weeks' course. Best equipped school in the country. Men enrolled from all parts of the U. S. Booklet P. M. on request. West Side Y. M. C. A., 318 West 57th Street, New York.

**2 CYL. Five Passenger, Jackson,** running order \$100. C. V. Andrews, Nova, Ohio.

**PANHARD, seven passenger 35,** like new, cost \$10,000, sacrifice for \$1,200. Ford, 455 Stratford Ave., Bridgeport, Conn.

**GASOLINE Engine Trouble Chart—a sectional view showing clearly all parts of a typical four-cylinder gasoline engine of the four-cycle type and outlining distinctly all parts liable to give trouble.** Also details the derangements apt to interfere with smooth engine operation. Invaluable to motorists. Size, 25x38 inches. Mailed on receipt of 25 cents by Popular Mechanics Book Dept., 6 No. Michigan Blvd., Chicago.

**TWO cylinder five-passenger Reo,** running order; first check for \$135 takes it. Also up-to-date Mitchell for \$275. E. E. Brass, Petersburg, Ill.

**FOR Sale—Chase Truck, 1,500 capacity,** good order, \$275; no trades. Write to Warren F. Blaisdell, York Village, Me.

**MODERN equipped latest Model Steam Car,** using gasoline or kerosene. Charles G. Pape, Fort Wayne, Ind.

**"THE How and Why of the Automobile"**—A 200-page book of practical information for seekers after the fundamental facts regarding the gasoline engine and its application to the motor car. Interesting and instructive to both the beginner and the expert. Bound in full cloth—250 illustrations. Price, \$1 postpaid. Popular Mechanics Book Dept., 6 No. Michigan Blvd., Chicago.

**THE Last Word in Automobile Literature—New Book, "The Modern Gasoline Automobile,"** 700 (6x9 in.) pages, 500 illustrations, is superior to any treatise heretofore published. Deals with every modern improvement. Price, \$2.50 postpaid. Popular Mechanics Book Dept., 6 No. Michigan Blvd., Chicago.

**AUTOMOBILE Instruction.** A complete home study course that shows you exactly what you want to know about the automobile. 220-page book giving definite, thorough, authentic and practical detailed information about every part of the automobile as well as thorough instruction in regard to driving, repairing and general care of the complete car. 190 illustrations, \$1.50 postpaid. Popular Mechanics Book Dept., 6 No. Michigan Blvd., Chicago.

**SMALL Auto Body factory with paint shop, machinery, tools, lumber, hardware,** 3 autos. Address, A. W., 44 Holland Pl., Buffalo, N. Y.

Popular Mechanics Magazine, Chicago, Ill.

Gentlemen:—I wish to advise you that I have always considered the Popular Mechanics Magazine as one of the few best monthlies in their drawing power to get replies to ads in the classified columns. I have carefully kept my ads and find they will bring an average daily mail of five replies throughout the month. My 15-word ad, run in your magazine at the rate of \$2.25 per issue, has netted me a monthly return of about \$50. I consider this pretty good return on money invested, and regret the fact that my business is such that there are but two short seasons when it can be carried on. If it were not for this fact my ad would never disappear from your magazine. Thanking you for past courtesies, I remain

Yours very truly, SHEBOYGAN GINSENG GARDENS.

O. H. Lowe.

\$100 UP. Hudson, Buick, Ford, others. Also tires, bodies, engines. United Motor Sales Co., Dept. 101d, Detroit.

**AUTOISTS,** our 3 formulas for 25c save you money. Auto-shine for trimmings. Varnish for the body, and Clearshield for rain or frost; cheap; no elbow grease. Conneally & Hawthorne, Greenwood, Nebr.

**A WRITTEN guarantee for 5,000 miles without puncture.** French and German motorists are getting 10,000 miles out of their tires by increasing them about one-half inch in size. In eight months 20,000 American motorists have followed their example. It's so easy you can do it in your own garage in thirty minutes, no matter what condition your tires are in. Send for free catalogue, sample and copy of guarantee. Colorado Tire and Leather Co., 1112 Karpen Bldg., Chicago, Ill., 451 Golden Gate Ave., San Francisco, Cal., 1326 Acoma St., Denver, Colo.

**POPE Toledo—racing type, \$175.** 112 Kenton St., Latonia, Ky.

**BUICK F. 5-passenger, reasonable, guaranteed 1 year.** Box 308, St. Anne, Ill.

**ROCK bottom prices on used automobiles, guaranteed in good condition.** Send for big bargain list. Eureka Auto Co., Beavertown, Pa.

**FIRST book out on Automobile Design,** also treats Construction and Repair. By Victor Page, a good authority. Book has 600 (6x9) Pages, 350 illustrations. Right up-to-date. Price \$1.50 postpaid. Popular Mechanics Book Dept., 6 No. Michigan Blvd., Chicago.

**FORD Instruction Book, every part fully explained.** Repair your own car. Sent postpaid \$1. Particulars free. Clark, 308 N. Elizabeth St., Peoria, Ill.

**GET in the Oxy-Acetylene welding business.** Complete new outfit with instructions \$75. I do expert welding at prices that hold the trade. J. M. Shetlin, 340 Elliott Square, Buffalo, N. Y.

**REGRINDING the cylinders, and fitting new pistons and rings, will make your motor as quiet and powerful as it was when new.** The cost is moderate. Advise bore diameter if desire quotation. We also expertly weld broken parts. Send for booklet. Waterbury Welding Corporation, Waterbury, Conn.

**PAINT Your Car Yourself—Save \$25 to \$75 by doing the work at home with the Arsenal system.** Our big free booklet "The Car Beautiful" tells how. Send for it today. Arsenal Varnish Co., Dept. P, Rock Island, Ill.

**BANKRUPT sale 50 new automobiles, \$75 up.** Also parts cheap. Willis Automobile Co., Canal Dover, Ohio.

## AUTOMOBILE SUPPLIES

**REPAIRS on all makes of magnetos and coils.** Estimates furnished. Prices cut 20% on all 1913 magnetos. Send for price list. Pellets Magneto Exchange, 1606 Michigan Ave., Chicago, Ill.

**RECTIFIERS for garages.** All sizes. Charge one to eight batteries, \$12 upwards. American Battery Company, 1129 Fulton St., Chicago.

**GET our plan for monogramming automobiles and motorcycles by special transfer method.** Motorists Accessories Co., Ashland, O.

**TRANSMISSION, 3 speed with rear axle complete.** Running gear. All parts for little 2-cylinder Maxwells. Let me know your wants. Box 62, Chester, N. J.

**45 HORSE 4-cyl. motor \$85.** State your requirements in two and four cylinder air and water-cooled motors. Have some good values. Badger Motor Company, Milwaukee, Wis.

**TIRES—Cut rates new Diamonds, Good-year, Etc.** 30x3, \$7.45; 3 1/2, \$10.85; 32x3 1/2, \$11.60; 34x4, \$17; 4 1/2, \$22.50; 36x4 1/2, \$24.95; 36x5, \$29. Send for list. All sizes. Farwell Bros., Bridgeport, Conn.

**\$500 VULCANIZING Outfit used one season, \$250.** G. H. Jones, Salisbury, Md.

**AUTO engine complete, 4-cylinder, develop 50 hp., almost new, cheap.** J. Steel, 212 E. Fifth St., Cincinnati.

**TIRES—34x4 and 36x4 1/2 Fisk QD Clincher, slightly used, absolutely first—price, casing and tube, \$14 and \$22.** Other great accessory bargains. Get list. Address Automobile Appliance Co., 1436 Michigan Ave., Chicago.

**20 H. P. FLANDERS engine complete.** Good condition, \$60. Lock Box 243, York Village, Maine.

**GEM Gasoline Saver, primer and cleaner saves half gasoline expense.** Fits any automobile. \$5 postpaid. Gemmill Specialty Co., Saginaw, Mich.

**HEADQUARTERS for Ford Specialties.** For Bargain Sheet No. 6, address The Edwards Co., Wapello, Iowa.

**TIRES—3,500 miles guaranteed, and guaranteed tubes.** 28x3, \$8.50, tube, \$1.80; 30x3, \$9.40—\$1.90; 30x1 1/2, \$12.50—\$2.75; 32x3 1/2, \$13.25—\$2.80; 34x4, \$17.50—\$3.90; 36x4, \$18.95—\$4.15; 35x4 1/2, \$23.50—\$4.95. Nonskid 10% more; other sizes, prices accordingly. Write for bargain sheet. 10% with order, balance c. o. d. Examination allowed. Para Auto Tire Co., 1417 Michigan Ave., Chicago, Ill.

**USE an Air-Friction 1914 Model "C."** Increases power and economy of motor one-half. Absolutely impossible to choke or load. Uses distillate, gasoline or half kerosene with finest results. Starts easy in coldest weather. We fit all motors, guaranteeing definite results or refund money. Exclusive county rights. Liberal exchange on other carburetors. The Air-Friction Carburetor Co., Dayton, Ohio.

**CHEAP.** Set of 30x3 1/2 solid tires. Splendid condition, very little used. M. R. Walsh, Nemaha, Iowa.

**FORD license bracket, front 25c, rear 40c, postpaid.** Leggett & Duryea, Princeton, N. J.

**INEXPENSIVE Oxyacetylene Welding Outfit—Complete instructions covering the construction of an inexpensive outfit that will do work equal to the expensive machines are given in our book, Shop Notes for 1914.** Get into this profitable business. Great demand. Price of book only 50 cents, postpaid. Popular Mechanics Book Dept., 6 No. Michigan Blvd., Chicago.

**WE Weld smashed-engine crank cases, cracked cylinders, transmission housings, parts of cast iron, aluminum or brass.** Hobbie's Welding Plant, Hampton, Iowa.

**STORAGE Batteries Repaired and Exchanged.** Meder-Staudt Company, Distributors of Witherbee Batteries, 1876 Broadway, N. Y. City.



**TIRES**—3,500 Miles Guaranteed. Order 2 tires. We deliver. 28x3. \$8.50; 30, \$9.10; 30x3½, \$12.25; 32, \$13.15; 34x4, \$17.60; 35x4½, \$23.95. All sizes. Send 10% with order. Vanderpool, Springfield, O.; Jacksonville, Fla.

**BIG** money vulcanizing at home. Easy learned. Book 50c. Vanderpool's, Springfield, O.

**MAKE** Your Own Welder. We furnish a complete set of bronze castings and parts with blue prints and instructions for making a welding plant. All gauges and needle valves are finished ready for use. Price of entire outfit, \$20.00. We will ship by prepaid express to any part of the U. S., Canada or Mexico upon receipt of \$5.00 to cover packing and express charges. Balance \$15 C. O. D., subject to inspection. Address, Factory Supt., Auto Welding & Mfg. Co., Omaha, Neb., U. S. A.

**SEAT** covers—Ford, Overland, Studebaker, Buick, Hupmobile, Maxwell, Kritt, owners send for samples and money-saving prices. More than 10,000 satisfied customers last year. Globe Seat Cover Co., Dept. 17, Racine, Wis.

**AUTOMOBILE** cylinders reground and fitted with new pistons and rings, for \$7 to \$11 per cylinder. Crown Machine Shop, Crown Point, Ind.

### MOTORCYCLES, BICYCLES & SUPPLIES

**FOR** Sale—Another "5-35" chain drive 1913 Harley-Davidson. Guaranteed first-class condition, \$150. Shipped on \$25 deposit. Marhlon Stevens, Kendall, N. Y.

1 **SLIGHTLY** used 2½ hp. Shaw bicycle motor attachment, complete with high-grade bicycle, price \$75. 1 new 2½ hp. Shaw bicycle motor attachment, complete, price \$40. 1 1911 4 hp. Indian with magneto and clutch, price \$90. 1 1912 4 hp. Pope, with magneto and clutch, price \$95. 1 1912 7 hp. Twin Indian, with presto tank head and tail lamp, speedometer, price \$160. These machines are all in first-class running order and are guaranteed to be good as new. If interested, write at once. Frank Blum, New Washington, Ohio.

1913 7 HP. **TWIN** Indian Motorcycle, perfect order, \$155. Also others. Callwell's Motorcycle Agency, 5 South Water St., Newburgh, N. Y.

**INDIAN**, 1913, 4 hp., new, \$165. Dick Knorr, Lincoln, Ill.

**FOR** Sale—Complete rope-drive transmission with clutch, sheaves, hangers, etc., for use in straight or angle driving. Angsten-Koch Company, Chicago.

1913 H.-D., 8 HP., \$135. 1913 Indian, 4 hp., never used, \$175. 1913 Yale twin, new, \$195. Feagans Bros., Washington, Ind.

1911 **AMERICAN** Twin 8 hp., fully equipped; a beauty. \$125. C. E. Haines, Mansfield, Mass.

1913 **TWIN** Indian, run less than 200 miles, fully equipped, \$175. Nelt Barr, Ashland, Ohio.

**BARGAINS**—1913 twin Excelsior, 1913 twin Harley, 9 hp. Crawford. G. C. Sandruck, 915 N. Howard St., Balto., Md.

**A-B-C** of the Motorcycle—250 page "Show How" book for owners and operators of motorcycles. Fully illustrated, cloth binding. Price \$1, postpaid. Popular Mechanics Book Dept., 6 No. Michigan Blvd., Chicago.

**HAVEFORD** motorcycle, 1912 model, like new, \$45; Merkel, \$35; Heitger Carburetors, \$3.50; motorcycle crankhangers, new, \$2.75; long leather leggings, 98c. Wandersee Company, 129 Gratiot Ave., Detroit, Mich.

**ADVANCE** sale of high-grade, slightly used motorcycles, all standard makes, twins and singles, belt and chain drives. Prices, \$25 up. We have a fine stock to select from. Write for complete list, giving prices and descriptions. Gotham Sporting Goods Company, 57 Warrent St., New York.

**PIERCE** 4-cylinder two-speed free engine, motorcycle, new. C. Aufmkolk, 49 Wall St., New York.

**RIDE** a motorcycle; fascinating, economical and healthy sport. Learn how to select a machine best suited to your requirements, and how to get the most enjoyment out of it. Get a copy of the Motorcycle Manual. Motorcycle construction and operation described; encyclopedia of 400 motorcycle terms; complete trade directory; license regulations of every state; 120 pages, magazine size; 25 cents postpaid. Motorcycle Manual, 51 Chambers St., New York.

**FOR** Sale—Motorcycle, almost new. Neill Struble, Bryan, Ohio.

**BARGAINS** in used guaranteed motorcycles. Save \$25. Write for list. Mueller Cycle Co., Milwaukee, Wis.

1913-14 **CRAWFORD** (De Luxe) 9-13 h.p., rode 250 miles; like new; fully equipped; cost \$335; a bargain, \$230. S. Grams, Box 225, Duluth, Minn.

**BICYCLES** rebuilt \$5, \$7.50, \$10, \$12.50, \$15. Fine tandems \$10. Triplets \$15. McDougald, 1118 N. Clark St., Chicago.

**MOTORCYCLES**; everybody rides them. Why don't you? You're next. We guarantee to save you \$25 to \$50. Kultures, Yales, Readings, Harleys, Excelsiors, Indians, Pierce, Curtiss, Henderson, Thors, Merckels, singles and twins, \$25 to \$100. Tires, \$4; belts, \$5. Buy direct; save dealers' profits. Deninger Cycle Co., Rochester, N. Y.

**REBUILT** motorcycles on monthly payments. Enclose dime to cover mailing expense. Eagle Motor Company, Cedar Falls, Iowa.

**SOME** sacrifice—\$175 buys 1913 two-speed twin Indian. All equipment. Fine condition. Edward F. Hauke, Greenfield, Mass.

**INDIAN** twin, magneto model, speedy, good condition, \$68 cash; worth \$125. Marsh-Metz, magneto, four; big bargain, \$56. Chalmers 30, automobile chassis, make fine delivery truck; good order, \$185. Fox typewriter, \$8.50. Photographs, 3c each. Write R. O. Rubel, Mobile, Ala.

**R-S**, GOOD condition, \$80. Must sell. Wm. Herbst, Twin Falls, Idaho.

**FOR** Sale at a sacrifice, new 1913 Harley-Davidson twin. For information, write Frank Schwab, Vinton, Iowa.

**BARGAINS**—50 of them; don't fail to get our list of used motorcycles, \$40 up. Hall & Gravatt, Atlantic City, N. J.

**FOR** Sale—New 1914 Yale two-speed twin. Absolutely perfect condition. Ray Randolph, Leona, Kans.

**MOTORCYCLES** Cheap. Big clearance sale of new and second hand machines; ask for list "M" just out. American Motor Co., 2724 Michigan Ave., Chicago, Ill.

**FOR** Sale—Thor twin, two-speed gear, fully equipped. Majestic side-car. Cost \$400, condition first-class, \$175—\$25 cash, balance C. O. D. E. S. Case, 3040 Fulton St., Chicago.

1913 **TWIN** Indian, \$145. W. H. Flanagan, 1731 Summit St., Columbus, Ohio.

**POWERFUL** motorcycles in good condition. John Hull, Mt. Hope, Pa.

**BARGAINS**—New and second-hand motorcycles. All makes, \$25 up. Delivered prepaid. Mark McCann, Lowell, Mass.

**HAVE** purchased large stock used motorcycles. Will sacrifice. Machines shipped subject to approval. Send for list. Angsten-Koch Co., Chicago, Ill.

1913 **POPE** twin, used very little, splendid condition, with tandem attachment and new \$90 Majestic side car. Price complete, \$190. Gilbert Harrison, Christopher, Ill.

**USED** motorcycles, all makes. Bargains. Guaranteed to run or money back. C. H. Lang, 1704 Michigan Ave., Chicago, Ill.

**BARGAINS**—Used Harley-Davidson, Yale and Indian motorcycles. Ralph Mount, Marion, Ohio.

**BIG** bargains in second-hand motorcycles, \$25 up. Indians, Harleys, Thors, Excelsiors and Merckels. Write for descriptions. Howard A. French & Co., Baltimore, Md.

**BIG** bargains in good motorcycles we have taken in exchange on new ones. Send for special bargain list. Shaw Mfg. Co., Galesburg, Kansas.

**GUARANTEED** Tires, studded tread, 28x 2½, \$6.80. Delivered. Vanderpool, Springfield, O.

**GUARANTEED** New Bicycle—Used motorcycles. Bargains. List furnished. Advise your wants. Seeber & Hofheins, Buffalo, N. Y.

\$50 **TO** \$150 buys the best Motorcycles, every make and model in our large stock—must be cleared. Half price. Send for list today. Brown Music Co., 9119 Commercial Ave., Chicago, Ill.

200 **MOTORCYCLES**, standard makes, \$50-\$175, guaranteed. Discount to rider agents. Write for list. Chicago Motorcycle Mfg. Co., Dept. 27, Galesburg, Kansas.

**DON'T** buy a Bicycle Motor Attachment until you get our catalog and prices. Shaw Wks., 738 Sheridan Rd., Chicago.

**MERCKELS**, Indians, Excelsiors, overhauled, enameled, nickeled, \$60 to \$160. Write for Bulletin No. 93. Fred Huyck, 1806 Michigan Ave., Chicago, Ill.

**SELL** or exchange, single or twin motorcycle. O'Brien, 6550 State St., Chicago.

**BRAND** new 1913 Indian twin, \$180. Slightly used demonstrator, same kind, \$165. Other Indian bargains. Enclose stamp, R. Swank, Williamsfield, Ill.

### CYCLECARS

\$200 **CYCLECAR**, motor complete, for \$75. Hall & Gravatt, Atlantic City, N. J.

**NEW** four-cylinder Henderson motorcycle motor suitable for cyclecar. Cyclecar material. Circular free. Palmer Bros., Coscob, Conn.

### CYCLECAR MATERIAL

**I HAVE** a cyclecar motor complete. \$40 takes this bargain. Send \$20. Will ship C.O.D. for balance. Ed. F. Leonard, 792 Tremont St., Boston, Mass.

**CYCLECAR** Parts; busted prices. Write for circular. Act at once. Address Motorette, Hartford, Conn., U. S. A.

### AERONAUTICS

**A COMPLETE** set of Bleriot Monoplane blueprints, \$2. The Plan Bureau, 2114 Forest Ave., St. Louis, Mo.

**AEROPLANE**, complete; must sell. J. E. Kingan, New Market, Va.

**NEW** and used balloons and parachutes. Walter Raub, Tampa, Fla.

**ATTENTION**, airmen: Automatic stability under changing pressures of the air. Something new. F. Hollidge, 2714 M St., N. W., Washington, D. C.

**AVIATION** motors, all makes and h. p., from \$250 up. Complete machines, all types, from \$500 up. State your needs. Aero Exchange, 38 Park Row, N. Y. C.

**PROPELLERS** for air, water and land. 5 years of practical propeller production proves perfection. Our products represent the survival of the fittest. Send 3 red stamps for our profusely illustrated propeller catalogue. Heath Aerial Vehicle Co., Chicago.

60 **HORSEPOWER** "Elbridge" aeromotor \$350, C. O. D. for \$25 deposit. Gleason, Bellevue St., Worcester, Mass.

**FOR** Sale—Genuine Curtiss Aeroplane with 80 hp. Curtiss motor—complete, ready to fly. Price \$1,500. G. B. Sault, Erie, Pa.

"**ROBERTS** 50," almost new, perfect; all attachments; \$500. Ford, 455 Stratford Ave., Bridgeport, Conn.

**EVERY** known fact concerning aerial navigation and air vehicles presented in the book "Vehicles of the Air" with working drawings of successful aeroplanes. 550 (6x9) pages—270 illustrations—140 halftone views—500 subject headings—200 terms defined—history of 1,000 flights—comparisons of successful machines. Price \$2.75 postpaid. Popular Mechanics Book Dept., 6 No. Michigan Blvd., Chicago.

**BUILDING** and Flying an Aeroplane—160-page handbook covering the building of small models and full sized gliders and machines. In both biplane and monoplane models the well-known Curtiss and Bleriot types are followed. Fully illustrated with detail drawings. Price, \$1 postpaid. Popular Mechanics Book Dept., 6 No. Michigan Blvd., Chicago.

**HOW** To Make a Biplane Glider—Our book "Amateur Mechanics No. 2" contains a complete detailed description of how to make one. Price of book, 25c postpaid. Popular Mechanics Book Dept., 6 No. Michigan Blvd., Chicago.

**CHICAGO** Aero Works, 143 North Wash Ave. Stamp brings catalog.

**COMPLETE** Plan, drawn to scale, with precise instructions for building a Curtiss 3-foot Model Flying Boat, 25c. Other Plans: Bleriot, 15c; Wright, 25c; Nieuport, 25c; Curtiss Hydro, 35c; "Peoli" Racer, 25c. Set of six, \$1.25. 48-pp. Model Supply catalog, 5c. Ideal Aeroplane Co., 82½ West Broadway, N. Y.

### BOOKS AND PERIODICALS

**FORD** Model T Reference Book. Second edition. Manual on Care, Repair and Operation. Makes you a master and mechanic. Details dismantling and assembling. Troubles located and readily cured by digest index. Circular on request or sent postpaid \$1. Ford Reference Book Co., 57 W. 125th St., New York, N. Y.

**FASCINATING** Books. Sample and catalogue 10c. Taylor Bros., M2129 Clifton Ave., Chicago.

**BOOK** catalog free. S. Mueller, 72 Orchard Street, Malden, Mass.



**30-DAY Offer**—\$1 book for 25c. Valuable mail-order information; buying goods; money-making plans. Money back if unsatisfactory. Order now. King Co., Box 13-P, Little Silver, N. J.

**STAGE Beauties and Play Scenes.** Every issue of new magazine a beauty. Show girls, stars, matinee heroes, 10c a copy. 1 yearly. Trial sub. 25c. Stage Pictorial, 1493 Broadway, New York.

**REAL** fascinating books and pictures, 25 samples and profusely illustrated catalogue, 10c. Normal Specialty Co., L3, Englewood, Chicago.

**WORLD'S** best self-educational books (also periodicals). Agricultural, Electrical, Mechanical, Automobiles, Science, Chemistry, Business, Art; anything technical, common or unusual (any language). Catalogues 5c. Explain subject thoroughly. C. Higene Co., Dept. M4, 2441 Post St., San Francisco.

**MOTION** Picture Making and Exhibiting. 240 Pages, fully illustrated. Cloth \$1. Other practical and reliable mechanical books. Send for complete descriptive list. Charles C. Thompson Co., 1126 Wabash Ave., Chicago.

**AWNINGS** and Tents—Construction and Design, published by Ernest Chandler, 72 Reade St., New York City. Price prepaid \$5. 300 pages, 230 original drawings. A work invaluable to architects and the trade and one that is replete with matters of interest to the purchasing public.

**BOOKS** About Elevators—best published. Morse, Union Place, Yonkers, N. Y.

**BOOKS.** Any kind published. Catalogue free. Reese Publishing House, Mount Pleasant, Pa.

**READ** "Cleopatra," 25c. Catalogue 2c. Paul J. Duff, 2713 Mozart, Chicago.

**MAGAZINES.** Lowest rates guaranteed. Catalog free. American Magazine Agency, Box 1222, Atlanta, Ga.

**BUILD** yourself a boat. A racing cat or speed launch. Send for catalogue. Yacht and Boat Building Books, Rudder Publishing Co., 2 1/2 Hudson St., New York, New York.

**ENGINEERS'** questions and answers for license, by Hobson, for twenty-five cents, postpaid. Send stamps. Reilly's Book Store, Philadelphia, Pa.

**HOW** to Run a Lathe. A 50-cent book for 10 cents postpaid. S. B. Lathe Works, South Bend, Ind.

**EDUCATIONAL AND INSTRUCTION**

**500% PROFIT** in ornamental casting of concrete, artificial marble, plaster, papier-mache, marble dust, imitation wood, soft metals, for manufacturing interior, exterior decorations, garden furniture, statuary, artistic homes, fountains, sanitary marble flooring, tiling, tombstones, cement caskets, stuccoing buildings, life casting, ornament copying, modelling, coloring, gilding, making elastic, rigid moulds, instructions complete \$1. Material furnished free. 200 illustrations beautiful casts (mail address today). Mahler, 117 Russell St., Brooklyn, N. Y.

**WE** teach by mail, Sanitary Engineering, Sanitary Inspection, Plumbing, Hygiene, Booklet free. Anglo-American Sanitary Correspondence College, Ontario Street, Chicago.

**GO** on the stage. Will tell you how! Write for descriptive circular. It's free. Mutual Book Exchange, 319 10th Ave., New York.

**YOUNG** Man! Learn Drafting—one of the most practical subjects of study to-day—indispensable in many occupations—engage in individual study successfully with the aid of our new book, "A Practical Course in Mechanical Drawing," 160 pages, 157 drawings, cloth, 50 cents, postpaid. Popular Mechanics Book Dept., 6 No. Michigan Blvd., Chicago.

**MATHEMATICS** made easy for all by Ropp's Calculator. Figures out, in the twinkling of an eye, every conceivable problem that occurs in the Office, Store, Shop, Bank, Farm or Factory. Greatest time and labor-saving work on figures in the world. Copyright 1912. Price, \$1. Vest pocket size, 50c. Popular Mechanics Book Dept., 6 No. Michigan Blvd., Chicago.

**WOOD**—Working for Amateur Craftsmen—128-page book, profusely illustrated, giving every essential step in wood-working. Valuable for either self-instruction or for use in manual training courses. Cloth, 50 cents, postpaid. Popular Mechanics Book Dept., 6 No. Michigan Blvd., Chicago.

**THE Seven Wonders of the Modern World**—What are they? Do you agree with the selection resulting from the international poll of greatest scientists taken by Popular Mechanics Magazine? The complete result of this vote showing the selection of the wonders together with a historical sketch of each one reprinted in pamphlet form mailed to any address for 10c in stamps. Popular Mechanics Co., 6 No. Michigan Blvd., Chicago.

**CIVIL** Service, Normal, High School, Bookkeeping, Shorthand, Typewriting, Drawing, Agricultural, English, Engineering and Law courses thoroughly taught by mail. Enrollment \$5. Tuition free. For "Free Tuition Scholarship" apply Carnegie College, Rogers, Ohio.

**LEARN** Show Card Writing. Complete course by practical signwriter. Material and brushes free with first lesson. Send \$1 today. Albert Hall, 1 Linwood St., Worcester, Mass.

**SIGNATURE** Experts—Instructs you how to make a good signature in one lesson. Will protect your checks, papers, etc. Free sample pen you should use. Send 15c in stamps. F. Strong School, P. O. Box 328, Anderson, Ind.

**TOPOGRAPHIC** draftsmen, prepare for examination United States departments; demand exceeds supply; next examination next September; good pay, short hours. Apply to Jas. Ballance, Box 86, San Francisco, Cal.

**SHORTHAND** manual for self-instruction by world's greatest court stenographer, \$1.50. Correspondence instruction if desired. Osgoodby School Stenography, Rochester, N. Y.

**BRIEFHAND**, the wonderful new substitute for shorthand, enables you to write 100 words a minute using longhand characters. Complete self-teaching manual containing 2,900 illustrations 50c (stamps). Premier Briefhand School, Washington, D. C.

**YOUR** handwriting improved at home in spare time, small expense. Journal Free. Francis B. Courtney, Box A492, Detroit, Mich.

**YOU** can write 100 words a minute without knowing Shorthand. My new method, Abbreviated Longhand, simpler than the simplest shorthand; tried and approved by thousands. Your money back if not delighted. Sample lesson 20c. Full particulars free. Write today. A. B. Weaver, Court Reporter, Dept. C, Buffalo, N. Y.

**INTERNATIONAL** Correspondence School. Bookkeeping course for \$31. Cost \$62. Frank L. Morris, 132 North Ogden St., Buffalo, N. Y.

**CAN** You Tango? Complete instructions of the new dances, including Tango, Innovation, Walk, One Step, and others. Put up in neat booklet form. One dollar by mail, postpaid. Tango Pub. Co., Dept. 17, P. O. Box 858, Omaha, Nebr.

**TELEGRAPHY**

**TELEGRAPHY**—Morse and Wireless—Railway Accounting (Station Agency) taught quickly. Railroad and Western Union Wires and complete Wireless Stations in school. Big demand. Positions secured. Living expenses low—may be earned. Largest and oldest school—established thirty-nine years. Investment, \$25,000. Correspondence courses, also. Catalogue free. Write today. Dodge's Telegraph Railway and Wireless Institute, 15th Street, Valparaiso, Ind.

**TELEGRAPHY** taught in the shortest possible time. The Omnigraph Automatic Transmitter combined with standard key and sounder. Sends you telegraph messages at any speed just as an expert operator would. Five styles, \$2 up, circular free. Omnigraph Mfg. Co., 41 G, Cortland St., New York.

**TRADE SCHOOLS**

**MAKE** \$5 to \$8 a day as skilled Electrician, Plumber, Draftsman, Bricklayer, Moving Picture Operator. We teach you in short time at small expense, profitable trades. Free employment bureau places graduates in good jobs. Special limited offer now. Write at once for catalogue and full particulars—no obligations. Dept. 8194, Coyne National Trade School, 51 E. Illinois St., Chicago, Ill.

**PATTERN** makers! A book devoted to the principles of pattern and core making and molding. Written by G. H. Willard, a practical pattern maker of years' experience. This book, just published, treats the subject in a much more simple, direct and

effective manner than most books along this line. 224 pages, 312 illustrations. Price \$1, postpaid. Popular Mechanics Book Dept., 6 No. Michigan Blvd., Chicago.

**PAINTING,** Decorating, Paper Hanging taught by actual practice. Free catalogue. Chicago School of Painting, 414 Dearborn Ave., Chicago.

**\$1,000 TO \$2,500 a Year.** Learn automobile repairing, driving, garage management, salesmanship, self starters, machine shop work, steam vulcanizing, oxy-acetylene welding and cutting in the finest and most completely equipped school in America. Unlimited courses at our school, \$20 to \$50. Home study course \$10, sent on trial. Academy of Automobile Engineering, 1454 Michigan Ave., Chicago, Ill.

**PERSONAL**

**TATTOO** marks removed permanently by absorption; wonderful secret formula at last; sure, easy; costs few cents. Big money removing for others. Just send address. Sterling Specialty Co., 231 Blvd. F, Denver, Colo.

**BROTHER**—Accidentally discovered root cures tobacco habit and indigestion. Gladly send particulars. F. Stokes, Mohawk, Florida.

**PICTURES AND POST CARDS**

**20 PRETTY** Postcards 10c. Exchange M24, 3827 N. Kenneth, Chicago.

**FREE**—10 fine Post Cards. Send name and address, no money. Benson, Wayne, Ill.

**20 BEAUTIFUL** Post Cards, all kinds, and list of bargains, 10c. A. C. Kennell, Dept. A, Wellersburg, Pa.

**ARTISTIC** Post Cards, pretty girls. Samples 10c. Exchange, D24, 3827 No. Kenneth, Chicago.

**GREAT** New York Zoo, 4 colors, size 15x27, 15c. Bayne's Panoramic Views, White Plains, N. Y.

**MUSICAL** Post Cards—Can be played on any phonograph. 10c each. Nathan Company, 242 West 148th St., New York City.

**CHALMO-SCOPE**, imported, showing charming beauty poses. Sent sealed, 12c. T. Sullivan, Abbott Ave., S. Fitchburg, Mass.

**JUST** Girls—Postals: 10 poses, 12c. 25, 25c. Assorted postals, 100, 35c. Maple Co., 110, Napanoch, N. Y.

**CINCINNATI** on post cards, complete set 10c. Steding, Jackson St., Cincinnati, O.

**THREE** Artistic Beauty Poses, 10c. Taylor Bros., 2129-M, Clifton, Chicago.

**BETTER** than "September Morn." Two new pictures by same painter. These and "September Morn" for silver quarter. Box 592, Minneapolis, Minn.

**A** PORTLAND View, and your name in Couch's Card Exchange, 10c. Box 871, Portland, Ore.

**3,000 SELECTED** Pictures for \$3. A Panorama of World Events. Political—Industrial—Social—Humorous—Tragic—all of intense human interest. A wonderful collection of 3,000 cartoons reproduced from the newspapers of the United States, Canada, Mexico, Cuba and the cities of the Old World, has been made by Cartoons magazine from more than one hundred fifty thousand published cartoons, and, bound in an artistic and durable cover, are now ready for your library table. Vol. I, Jan.-June, 1912—\$1. Vol. II, July-Dec., 1912—\$1. Vol. III, Jan.-May, 1913—\$1. Cartoons, 6 No. Michigan Blvd., Chicago.

**YOUR** name in gold on 12 Floral Postcards, 10c. The Excelsior Co., 1254 Franklin Ave., Bronx, New York City.

**RECEIVE** pretty postcards from far and near, best club. Membership 10c. Jolly Card Exchange, Box 126, Decatur, Ind.

**IF** you really want to exchange post cards, try our splendid club. Lists circulate in many countries. Membership, 10c. Halcyon Club, Box 133, Erie, Pa.

**JOIN** the Oxford Postcard Exchange and receive cards from faraway lands. Membership, 10c. Keniston, Publisher, South Paris, Maine.

**RECEIVE** pretty postcards from many countries! Membership 10c. Elite Exchange, R24, 3827 North Kenneth, Chicago.

**20 BEAUTIFUL** Postcard Views of Denver, Colo.—25c. Slanker, 524 W. 6 Ave., Denver.

**FIVE** real artistic beauty cards for 25c. J. A. Hulet & Co., 115 Packer Ave., Sayre, Pa.



**POST CARDS** of Irish Scenery, Irish Antiquities, Killarney, Giants Causeway, Dublin, Round Towers, Etc. 50 all different \$1. Lighthouses, foreign and domestic, 50 all different \$1. Famous Liners, Cunard, White Star, etc.; 25 cards and 25 Lighthouse cards \$1. Send U. S. dollar bill or post-office money order. S. H. Strain, Light-house Mission, Belfast, Ireland.

**MEXICAN Revolution Photo Cards**, six for 25c. Pictures of leaders, piles of dead, soldiers executed, cremation and other real war scenes. Robert Runyon, Brownsville, Texas.

**CLASSY**, fascinating, successful social exchange organization; 23,000 members; trial 25c. Round World Club, Dayton, Ohio.

**DANDY Foreign cards** 20c, 12 Indian cards 15c, to introduce monthly edition lists of cards, stamps, typewriters. Drawer F, Fairfield, Neb.

**POSTCARDS** from everywhere. Membership Aurora Postcard Exchange and copy Aurora Postcard Monthly, 10c. 6 months 30c. Ed. Gamble, East Liverpool, O.

**CARDS** exchanged with everybody, 10c. Membership in press immediately. Pacific Card Exchange, Bryn Mawr, Wash.

**PHOTOS**, "Beautiful Women," gems of art. 24 photo miniatures, 10c. Normal Specialty Co., J-7, Englewood, Chicago.

**PHOTOS**—Fascinating subjects, 10 for 25c. Duff, 2713 Mozart, Chicago.

**ART Studies**—Photographs from models; finest collection for artists and art lovers; samples 10c. Westbrook Art Printery, Holyoke, Mass.

**MORE** the merrier, everything cheerier, pastime superior. Exchange postals. "True Blue" has perfect plan. Write E. Ed. Ericson, Elroy, Wis.

**YOU'LL** get cards from everywhere. Membership 10c. Idaho Card Exchange, Dept. K, Box 906, Boise, Idaho.

**STAGE beauties**. Four entrancing full length, richly colored poses, 14 inches high, and twenty life-like illustrations, 10c. Gordon Art Co., New York City.

**POSTCARD Exchangers**—Join our Exchange. We guarantee our members. Membership 10 cents. Solare Club, Box 1342-M, Jacksonville, Fla.

### CAMERAS AND PHOTO SUPPLIES

**PHOTOGRAPHIC Post Cards** made from films. Reasonable prices. Films developed. Enlargements. Write for price list. Moser & Son, 20 Arcade, Cincinnati, Ohio.

**ENLARGEMENTS** from negative or photograph: 8x10, 25c; 11x14, 50c; 16x20, \$1. 16x20 pastel in natural colors, \$1.98; describe colors. Frank Brooks, Box 331, Rush Springs, Okla.

**ART enlargements** from your own negatives. Black and white or hand colored; sample, 50c. We please you or return your money. Kirk Photo Company, 1910 1/2 Mahoning Rd., Canton, Ohio.

**RED, Blue and Green prints** on any material. Chemicals and directions. All three, fifty cents. R. R. Henderson, Madison, Me.

**FREE supplies**, cameras, etc. My book tells all. Fifty cents postpaid. Particulars free. Ames Studios, Sunapee, N. H.

**FOR Sale**—3 1/4 x 4 1/4 Ansco camera, Dagor lens, like new. Costs \$65; price, \$48. Henry A. Berg, Fosston, Minn.

**FILMS** developed, 6c, all sizes. Prints 2 1/4 x 3 1/4, 2c; 2 1/2 x 4 1/4, 3c; 3 1/4 x 4 1/4, 4c; 4c doz. Post cards, 5c. 50c doz. Work guaranteed and returned 24 hours after receiving. Postpaid. Send negatives for samples. Girard's Commercial Photo Shop, 194 High St., Holyoke, Mass.

**LEARN Photo Tinting** and increase your income. Fascinating occupation for spare-time. Anyone with artistic taste can quickly learn to do marketable work. Send for free booklet. Sample hand-colored gift card 25c. Kell-Burr Company, 56 P, Pine St., New York.

**FILMS** developed, any size roll, 10c. Prints 2 1/4 x 3 1/4 to 3 1/4 x 4 1/4, 3c; 3 1/4 x 5 1/4 to 4 1/2 x 5 1/2, 4c. Post cards 4c. 8x10 enlargements 25c. Send two negatives for free sample prints and special offer. Thos. Grove, 1540 East 64th St., Chicago.

**COLOR Photography**. Print your landscape views in colors. Send 2 stamps for circular. Rud. Isenmann, 385 Bergen St., Newark, N. J.

**HAVE** you a camera? Write for samples of my magazines, American Photography and Popular Photography, which tell you how to make better pictures and earn money. F. R. Fraprie, 280 Pope Bldg., Boston.

**MONEY** in Photography. Start at home with your camera. We teach you retouching; portraiture, by mail. Details, with sample pictures, sent free. Wells' Studio, East Liverpool, Ohio.

**RETOUCHING** Taught; we make it easy for you to learn at home. Write the Y. & M. Retouching Company, Marshall, Mich.

**ROLL Films** developed 10 cents. Printing Post Cards 3 cents each. 15 years' experience. Send for complete price list. F. C. Hoyt, Sac City, Iowa.

**TRIAL Offer**—Buy Instanto, the best gas-light developing paper, direct from manufacturer; big saving; better, fresher, quality guaranteed. One full gross 4x6 or smaller and one-half gross postal cards for \$1, for three sample dozen postal cards or 4x6, 25c. The Photo Products Co. (Dept. J), 6100 La Salle Street, Chicago.

**KODAK Films** Developed, 10c per roll, any size. Prompt attention given mail orders. Prints, 2 1/4 x 3 1/4 to 3 1/4 x 4 1/4, 3c; 4x5 to 3 1/4 x 5 1/2, 4c. J. M. Manning, Box B, 1062 Third Ave., New York City.

**FILM** developed 10c a roll. Prints 2, 3 and 4c each. Quick return. Price list free. Kodak Film Finishing Co., 112 Merchants Station, St. Louis.

**QUALITY enlargements** 8x10, 25c. Films developed, any size roll, 10c. Postcards \$2 per 100. Bargains new and second-hand cameras, lenses, Charles H. Loeber, 1147 Broadway, New York.

**SPECIAL**—100 Post Cards printed from one negative \$1.50 prepaid. Films developed 10c roll. Post cards or prints 3c. Enlargements 25c up. Get next to our price and service. Hansen Photo Co., Withee, Wis.

**KORONA and Pixie Cameras** for plates, film packs and roll films, Panoramic View Cameras, Turner-Reich Anastigmat Lenses and other Lenses. Send for complete catalogue and obtain free copy of text book, "Telephotography with a Panoramic Telephoto Lens." Gundlach-Manhattan Optical Co., 839 Clinton Ave., So. Rochester, N. Y.

**GREATEST Photographic Bargain List** ever published. Willoughby, 810 Broadway, N. Y.

We buy, sell and exchange. Bargains in Microscopes, Telescopes, Binoculars, Cameras, etc. Bargain list sent. Kahn & Son, Opticians, No. 54 John St., New York. Established 62 years.

**BIG Money** Saved on Photographic Lenses and Apparatus—goods exchanged; repairing done. Ralph J. Golsen, 65 East 46th St., Chicago, Department F.

### MOTION PICTURES

**BIG money** writing photoplays, spare-time. Complete course \$1. Particulars free. Eureka Supply, B24, 3827 N. Kenneth, Chicago.

**FOR Sale**—New and second-hand moving-picture machines, opera chairs, films, and everything pertaining to picture business. Write for bargain list. Wichita Film & Supply Co., 117 No. Topeka Ave., Wichita, Kans.

**LEARN** to write photoplays. Writing motion-picture plays offers a new, easy and fascinating way to earn money in your spare time. Plot all that is required. Literary training or style not necessary. Easily learned. Great demand. Producers pay \$25 to \$100 each. Our short, fascinating course will teach you how to turn your ideas into dollars. Send for free descriptive catalog. Authors' Motion Picture School, Box 130K, Chicago.

**\$75 WILL** start you in the moving-picture business; no experience needed with our machine. Write today. F. A. Holmes, Brewster, N. Y.

**GO** into the Moving Picture Business. We will start you with complete outfit. Best Machine, Films, and supplies, on the Payment Plan. Want to make Big money? Write for free Catalogue. Dearborn Novelty Co., Dept. P, 537 S. Dearborn St., Chicago.

**\$50 TO \$100** weekly writing moving-picture plays. Send for free booklet, valuable information and special prize offer. Chicago Photoplaywright College, Box 278 MR, Chicago.

**PHOTOPLAY** writing for inexperienced beginners. Booklet, 15 cents. Photoplay Booklet Distributors, Ithaca, N. Y.

**MOTION Picture Work**—A large 618-page book covering every phase of the moving picture, its production and its theatre. Indispensable for reference and instruction to the thousands of workers in the motion picture field. Price \$3, postpaid. Popular Mechanics Book Dept., 6 No. Michigan Blvd., Chicago.

**WRITE Moving Picture Plays**, \$50 each. All or spare time. Correspondence course unnecessary. Details free. Atlas Publishing Co., 304, Cincinnati, Ohio.

**MAKE** a complete Motion Picture Camera and Projector from instructions given in our book Amateur Mechanics No. 4. Full details given. Not hard to construct. Worlds of enjoyment taking and exhibiting subjects dear to the heart. Price of book only 25c postpaid. Popular Mechanics Book Dept., 6 No. Michigan Blvd., Chicago.

**\$35 PROFIT** Nightly—Moving Picture Business—small capital starts you, no experience needed. Teach you—furnish everything. Ralph J. Golsen, 65 E. 46th St., Chicago, Dept. M.

**MOTION picture plays** wanted. You can write them. We teach you. No experience needed. Big demand and good pay. Details free. Asst. M. P. Schools, 601 Sheridan Rd., Chicago.

**BARGAINS**. Best makes of Independent Business with posters for sale from \$4 up. Write for large list. Davenport Film Exchange Co., Davenport, Ia.

**PHOTOPLAYS** successfully placed! Reading, 50c. Includes criticism. Typewriting reasonable. Labberton Co., 1308 Hoe Avenue, New York.

### BUSINESS OPPORTUNITIES

**MAIL Dealers** made a big success on our one exclusive specialty. We have just produced two more that can be sold singly or in combination with this famous seller. Retail price of all, 70c. All dovetail to perfection, making a brand new selling proposition. You are the manufacturer. Profits up to 500%. We furnish wide selection of advertising matter. Invest 20c now for samples and learn all about these real money makers. If on receipt you find our proposition like any other say so, and we'll refund your 20c—you keep the samples. Fair isn't it? Then send today! Eisenberg-Lunke Company, Marquette Building, Chicago.

**REPORT** information, news, names, etc., to us. We have established markets. Particulars free. "Nisco," HDB, Cincinnati.

**MAKE** money working for us, coloring; new process, no experience; write for particulars. The Art Specialty Co., 12 E. Ontario St., Chicago, Ill., Dept. P.

**I WILL** start you in the mail-order business; can make \$100 a week; no canvassing; send for free booklet. Greame, Dept. M, Scranton, Pa.

**START** a mail-order business of your own. Small capital. Spare time. 27 plans. Send for particulars. Mutual Opportunities Exchange, Buffalo, N. Y.

**MAKE** big money opening safes and setting combinations. Wayne Strong, 811 Temple, Los Angeles, Cal.

**YOUR** name on twelve eraser lead pencils, fifty cents. York Pencil Co., York, Pa.

**FREE** information on "How to Succeed in Mail Order Business." No plans, schemes, or outfits. Investigate. P. Newham, Waukegan, Ill.

**YOUR** 12-line advertisement placed in 100 good monthly magazines for only \$4. Write me before placing any syndicate advertising. I'll save you money. F. L. Miller, Dept. A, Syracuse, N. Y.

**\$\$\$! START** profitable business at home; no capital or experience required. Success assured. Fortunes made. Write for particulars. A. R. Kay Co., 401 E. Fifth St., South Boston, Mass.

**MAKE** money putting in rush bottom chair seats. Complete instructions 25c. E. Byron Bayne, White Plains, N. Y.

**BUILD** up an independent business for yourself by manufacturing and selling my metal polishes; saves one-half kitchen work. Send me 25c for formulas and let me tell you how to become independent. H. J. Swarts, Chelsea, Okla.

**MAKE** money by taking orders for sharpening safety-razor blades. Buy Du-Al Safety Razor Sharpener; hones and strops any blades. Guaranteed. Price \$3.50, postpaid. Wm. Bogenberger, 423 Lee St., Milwaukee, Wis.

**CASH** for ideas. Patent News, Dept. 28A, Washington, D. C. Only inventor's paper. 3 months' trial 25c.

**MANUFACTURER** with modern equipped factory, both wood and metal working, wants capable executive business manager, or factory superintendent who can invest from \$5,000 to \$10,000. Unequaled factory line. An independent fortune for right man. E. J. Willeford, 505 Herkimer St., Joliet, Ill.



YOUR advertisement printed on 144 pencils only \$1.90. Pencil Co., Thibodaux, La.

WE start you in business, furnishing everything; men and women, \$30 to \$200 weekly operating our "New System Specialty Candy Factories," home or small room anywhere; no canvassing. Opportunity lifetime; booklet free. W. Ragsdale Co., East Orange, N. J.

MAIL Dealers: Our advertising rate folder gives rates and information. Hundreds of papers. Free. Jukes, 910 Walnut, Philadelphia.

START Candy Business! Original \$15 candy course, 25c. If dissatisfied, we'll return quarter. Morgan Company, 314 Madison, Chicago.

MAKE Money renewing old dry batteries. We guarantee you can at low cost. Formula and instructions, 25c; regular price \$1. If dissatisfied we'll send you quarter back! Northern Supply Co., 154 Randolph, Chicago.

6,000 LIVE bona fide agents' names, \$1. Morgan, 312 Madison, Chicago.

GET into, build up and boss a profitable business of your own. Two issues of timely, money-making information 10c. Agents and Mail Dealers Magazine, Chicago.

"THE Greatest Mail Order Proposition Ever Placed in the Hands of People Desirous of Making Money by Mail"; "The Medical Field"; "Building a Business with Beauty Preparations"; "The Mail Order Book Business"—these and many other excellent plans fully explained in current *Booster Magazine*—the one bona fide publication devoted exclusively to the interests of Agents and all interested in the Mail Order Business. More people read "Booster" than any other trade paper; this alone should convince you that today is the day to learn all about "Booster," its money-making suggestions and principles. Join our ranks now. Let "Booster" put you next to the best money-making propositions—ones that really get you the money! Ten cents brings two copies worth dollars. If you're dissatisfied, will send you dime back. *Booster Magazine*, Northwestern Building, Chicago.

MR. Mail-Order Man: Get quick returns. Established corporation supplies fast mail-order sellers; factory prices. Classy proposition. Beginners or established firms. Copyrighted Prospectus free. Mississippi Valley Co., Inc., Box M629, Pittsburg, Kans.

LEADERS that get the dimes galore! Samples with copies of ads and prices 10c. Rudolph, Manufacturer, Northwestern Building, Chicago.

DON'T start your mail business in too big a hurry. Learn about the Merford Money Back Plan of Merchandising. No stocks to carry. Profits 100%. Salable articles. Big demand! Address Director, The Merford Company, Incorporated, Chicago.

MAIL Dealers: Add a safety razor department; 10c brings samples; imprint circulars. Northwestern Razor Co., Northwestern Bldg., Chicago.

ANYONE earn \$35 weekly making and selling Storm Indicators. Shows weather forecast 24 hours advance. No capital. \$1 tells how. H. W. Willis Co., Hagerstown, Md. Dept. 1.

MAKE more money. "The Popular Advertiser" tells you how. Puts you next to a bona-fide business proposition, enabling you to make \$50 per week, in spare time. Send 10c for four months' trial subscription and receive 24 money-making plans free. Money back if dissatisfied. The Popular Advertiser, 2231 S. Albany Ave., Chicago.

EVEN you can tear away from daily toil and establish a permanent business by mail. I show you how and start you during spare time. Send for free prospectus. Alfred R. McGill, Dept. M, Box 185, Erie, Pa.

BUILD successful business of your own. \$1,500 to \$3,000 yearly profit from small beginning. Whole or part time. My free booklet tells how. G. Merton Meeker, 6159 C. Ellis Ave., Chicago.

I MADE \$50,000 in five years with a small mail order business; began with \$5. Send for free booklet. Tells how. Heacock, 641, Lockport, N. Y.

AN intelligent person may earn \$100 monthly corresponding for newspapers. No canvassing. Send for particulars. Press Syndicate, 700, Lockport, N. Y.

WE manufacture a new, rapid selling mail-order article. Sell to every household, hotel, restaurant, club, drug and jewelry store. Unique selling plan, form letters, envelopes and coin carriers furnished free. Quantity prices and complete sample, 25c coin. Chemo-Plate Manufacturing Co., New England Building, Topeka, Kan.

WHERE, what and how to buy and sell—money making ideas and \$\$\$-getting schemes, plans and suggestions on mail order business, advertising, mailing, canvassing, mixing, in our magazine. 16 to 32 pages each issue. Three big copies, silver dime; satisfaction guaranteed. Mail Order System, 1039 Barry Ave., Room 12, Chicago.

INSTALL the new "Universal" (penny box) match machine. 250% profit on safety matches. Vernon Galster, 507 Prospect Ave., Syracuse, N. Y.

\$5 DAILY easily earned at home, spare-time, silvering mirrors. No capital. Free instructive booklet tells you how to make \$5 daily. Patterson & Co., Dept. 3, Brooksville, Ky.

LEARN to make metallic Sign Letters; \$30 to \$50 per week profit. Experience and capital unnecessary. Particulars free. Cushing, 2715 South Main, Los Angeles, Calif.

MAIL Order business free. Particulars. Norton Supply Co., Minneapolis, Minn.

I MAKE \$5 a day, mail-order business in spare time; I'll send the complete plan and sample free with King's Magazine 3 months, all for 25c. W. E. King, Pub., Box 13-P, Little Silver, N. J.

YOU can have an office in Chicago's highest building. Address privileges, including mail and telephone calls, \$1 monthly. We do shopping and attend to your Chicago business at reasonable rates. Desk room, \$5 monthly, up. A. H. Walker, 1501 the Tower, 6 No. Michigan Boulevard, Chicago, Ill.

SMALL Printing outfit, \$30 takes it. "Friday" Harmon, Girard, Kan.

INCORPORATE. Our lawyers do the work, saving you time, annoyance and money in incorporating under the most liberal laws of Arizona. Laws and forms free. Southwestern Securities & Investment Co., Box D488, Phoenix, Ariz.

WE will start you in the cleaning and dyeing business; little capital needed; big profits. Write for booklet. Ben-Vonde System, Dept. C, Charlotte, N. C.

WAX Carnations. Learn to manufacture. We tell you how. Experience unnecessary. 25c coin brings full instructions. J. M. Gaffney, Dept. A, Hill Station, Harrisburg, Pa.

WE start you in a permanent business with us and furnish everything. We have new, easy-selling plans and seasonable leaders in the mail-order line, to keep our factory busy. Small capital. Large profits. Spare time only required. Personal assistance. Write today for plans, positive proof and sworn statements. Kimo Mfg. Co., 220 Kimo Bldg., Buffalo, N. Y.

BE independent! Start a business of your own. Valuable Formulas. Toilet and Household specialties. 2-cent stamp brings List. Box 282, Tonopah, Nev.

DO you want to own a Wall Paper Cleaning business, be independent, your own boss, or would you manage a shop for me? Full particulars and sample cleaner, 10c. Milliken Co., Davenport, Iowa.

AGENTS—Dealers—We have the best proposition ever placed in your hands. Good chance for agents and jobbers to take a hand. Send 25c for sample and instructions. Cole, 1509 Madison, Chicago.

MINK breeding sideline. \$3,750 from 25 mink yearly. My book tells everything. 50c. George Norton, Pleasantville, N. Y.

BE a Banker. We teach you by mail. Write Fulton System. Dept. E, Murray, Ky.

\$25 TO \$50.00 weekly Resilvering Mirrors. Easily learned. Guaranteed instruction, 25c. Service Bureau, 3311-D, Belleplaine Ave., Chicago.

MONEY in publishing. Quick cash results. Send for free leaflet. "Money Sticking Out." Golden, Hudson, Ohio.

LEARN to collect money—by a sure, easy system. Big income. Quick results. No capital required. Send today for free booklet, "Skillful Collecting." Collectors Assn., 1624 P, Williamson Bldg., Cleveland, Ohio.

CYCO Gold Enamo, on anything. Motorcycles, automobiles, bicycles, enamel beds, picture frames made beautiful. Earn \$5 to \$10 day. Recipe \$1 currency. Beidler, Moneta, Cal.

LEARN to make gold leaf signs—it pays big. We successfully teach through correspondence within sixty days. Modern Method Sign School, 1649 Champa Street, Denver, Colo.

PATENTABLE Ideas wanted—Send for 3 free books. R. B. Owen, 30 Owen Bldg., Washington, D. C.

SILVERING Mirrors, Plating Tableware, auto-brass home. Booklet-plans free. Clarence Sprinkle, East-Grant, Marion, Ind.

MAIL Order Plans and 25 ways to make money with my Book of 50 secret Formulas sent postpaid for 25 cents. C. M. Griffin Sales Company, Dept. 7, Framingham, Mass.

WRITE Moving Picture Plays. \$50 each. All or spare time. Correspondence course unnecessary. Details free. Atlas Publishing Co., 3046, Cincinnati, Ohio.

START a profitable candy business. Secret of success lies in excellence of goods. We sell a complete illustrated book of best candy and ice cream formulas and recipes obtainable. Guaranteed Correct. Prepared by practical expert. 280 candy and 50 ice cream recipes. Price \$4 postpaid. Popular Mechanics Book Dept., 6 No. Michigan Blvd., Chicago.

LEARN electroplating—Practical results may be obtained by following the directions in our book on electroplating. This is a working guide for the beginner written by an old hand at the business. 112 pages, 62 illustrations, cloth, 50 cents, postpaid. Popular Mechanics Book Dept., 6 No. Michigan Blvd., Chicago.

MAKE and Sell Mission Furniture—From our instructions one man who was an amateur made and sold \$400 worth of just one article alone. We give you 93 designs and easily followed directions for making each piece in 3 books at 50 cents each or \$1.50 per set, postpaid. Popular Mechanics Book Dept., 6 No. Michigan Blvd., Chicago.

MONEY-MAKERS. Over 100 ways explained. Complete collection 10c. Service Bureau, 3311-D4 Belleplaine Ave., Chicago.

BLACK Foxes are being bred in captivity in Prince Edward Island, Canada. Government report says, "Thousands of shareholders are receiving 25 per cent to 200 per cent yearly on investments of \$100 to \$1,000 each." A company is now being formed to purchase 3 pairs of P. E. Island registered foxes and to ranch them with the most successful fox breeder in the world, on a percentage basis. A free booklet and prospectus will be sent upon application to Dr. E. A. Randall, Truro, N. S., Canada.

BIG money made. Baseball and football machines. Sullivan Amusement Co., St. Albans, Vt.

YOU will collide with golden money-making Opportunities, Plans and Knowledge by simply sending 10c for two issues of the Agents Magazine, Chicago.

\$3,000 YEARLY in your back yard. No Ginseng, Mushroom dope. New ideas never before published; particulars free. Metz, 306 East 88th St., New York.

ASK Bode! Anything! Especially about Business and Adwriting! Get Particulars "Now"! Bode, 2889p Main, Hartford, Conn.

MAKE \$25 weekly growing mushrooms in cellars, sheds, etc. Booklet free. North Shore Mushroom Farm, Dept. 12, Hubbard Woods, Ill.

EVERY Advertiser Needs our New Advertising Rate Book. Lists 2,000 best advertising mediums in America. Gives circulation and rates. Contains special lists and advertising snaps, including "Ads That Pay," sent prepaid for 10c. Dearborn Advertising Agency, 521 Dearborn St., Chicago.

WOULD you like to own a good-paying mail order business? We have a line that gets repeat orders all the time. You can start in spare time; invest a dollar or two a week and soon own a nice business of your own; write for particulars. Nadico, 1664 Belmont Ave., Chicago.

I WILL start you earning \$4 daily at home in spare time, silvering mirrors; no capital; send for free instructive booklet, giving plans of operations. G. F. Redmond, Dept. 306, Boston, Mass.

INDEPENDENCE and fortune quickly attained in the Manufacturing Mail Order business. I furnish Formulas, Manufacturing Processes and Trade Secrets in all lines. Sold under positive guarantee; 18 years' practical experience. Revision and improvement of Formulas and Processes—reduction of manufacturing cost—utilization of waste materials, etc., a specialty. Booklet, Formula List, and Valuable Information Free. W. L. Cummings, Ph. D., 127 Standard St., Syracuse, N. Y.

FOR recreation and profit raise Buttercups, adapted to any climate. Stamp for particulars. H. V. Meeker, Toledo, O.



**CASH** for your business or property. I bring buyers and sellers together. Write me if you want to buy, sell or exchange any kind of business or property. Established 1881. Frank P. Cleveland, 1308 Adams Express Building, Chicago, Ill.

**YOUR Own Business**—Planned especially for your own needs and circumstances. Let us give you expert service in planning a spare or whole time business for you. Taylor Service, Dept. P P, 220 Broadway, New York.

**WE Sell Patents.** Established 1900. If you wish to add a new product to your line, write us. Charles A. Scott Co., 596 Central Bldg., Rochester, N. Y.

**STOP Here!** Let me start you in a home business that will bring you money every day. Experience unnecessary. Spare time. No canvassing. I furnish everything. Send for proofs. Voorhies, Desk C. R., Omaha, Neb.

**LET** the parcels post help you. Add (\$15 to \$25 weekly) to your present salary or income. Start during spare time and build up a permanent mail-order business of your own. We show you how and help you make good. No canvassing. Experience unnecessary. The Parcels Post makes success doubly sure. Our new ideas and up-to-date plans bring the money. No so-called "Course of Instruction" to sell. We give that free. Write today. Address Pease Mfg. Co., Inc., Dept. A, 70 Broadway, Buffalo, N. Y.

**\$1 STARTS** you in Big Money-Making Business. Men and women. Experience unnecessary. Circulars mailed free. Post Office Box 158, Chicago.

**START** a Chemical Garden. Instructions \$1.00. C. C. White, Hazelhurst, Miss.

**BETTER Business**—Magazine of Opportunity for those interested in Mail Order—Light Manufacturing Business. Trial three months 10c. Better Business, Dept. B P, 220 Broadway, New York.

**WILL** furnish model, instruct how to build and sell an efficient outdoor Fly-Catcher. Reasonable. D. J. Spangler, Elkhart, Ind.

**THIS** beats all the jobs going. A new camera, just out, completely finishes 3 photo post cards of any subject in 5 minutes. No experience necessary to do it. Strong money maker, big profits, simplicity itself; complete outfit, \$3.75. Get a circular quick. Autovac Co., 300 Temple Bldg., St. Louis.

**200% PROFIT.** We trust you and start you in business for yourself. A postal brings particulars. Brown & Hetrick, Franklin, Pa.

**INCORPORATE;** let us tell you why 9/10 big business concerns America organized Delaware and New Jersey instead Arizona, Dakota or elsewhere. America Guarantee and Trust Co., 1530 Chestnut St., Philadelphia, Pa.

**WOULD** you pay \$10.00 to achieve independence in Business? There is an opportunity in the Light Manufacturing Business for you whether you have capital or not. One plan to each city. Write for booklet. Taylor Service Corporation, Dept. I P, 220 Broadway, New York.

**GET** into the Penny Slot Machine Business. Make \$26 to \$50 weekly in your spare time. I made thousands. My free illustrated booklet tells how. Let me start you. Address "Money-Maker Chandler," 326 D Cranston St., Providence, R. I.

#### MAIL ORDER SUPPLIES

**MAIL** Order Dealers. Agents Supply Houses. Get our circulars. Best plated specialty in years. Tremendous demand; or, enclose 25c for two samples; refunded first order. Douglass Mfg. Co., 1230 Fulton St., Brooklyn, N. Y.

**TWO** staple articles for the mail-order dealer and general agent, exclusive territory, few openings; \$200 a month. Address Phelps Specialty Company, Dept. M, Caro, Mich.

**THE** best mail-order proposition on earth. Particulars free. Luther Gordon Co., Chicago.

**INCREASE** your sales. Place your proposition before the readers of "Cartoons Magazine," 23,000 copies every month. Classified rate 2c per word. Mail in a trial ad today. Cartoons Classified Dept., 6 No. Michigan Blvd., Chicago.

**MAIL** Dealers—My joke-novelties are paying big profits. Imprint catalogue supplied at actual printer's cost. Joseph Methieu, 203 Court St., Brockton, Mass.

#### FOR ADVERTISERS

**START** an original mail-order business. Honest, independent, Small Capital, New Methods. Sole rights. Big money. R. Clement Moore, Business Specialist, New Egypt, N. J.

**ADVERTISERS**—Special,—5c per word places your ads in 133 different magazines. Send copy now for next issue. King's Magazine, Box 13-P, Little Silver, N. J.

**YOUR** 70-word display advertisement in 16-page 7x10 magazine reaching 7,000 boys, 40c. Yonths Magazine, Chicago.

**30 WORDS** in our big Postcard Monthly 25c. Display 50c inch. Elite Exchange, 3827 North Kenneth, Chicago.

**ADVERTISERS** to reach boys use Boys' Companion, circulating among 16,000 boys. Special rate, 40 words 50c. Boys' Companion, Chicago.

**YOUR** 125-word ad on 2,000 circulars, 1,000 mailed to interested people and 1,000 sent prepaid (or all mailed) \$1. Meehan's, Gage St., Worcester, Mass.

**BARGAINS**—15-word ad, one year's subscription 25c; extra words one-half cent. Guaranteed 25,000 circulation. Digest, Grand Rapids, Mich.

**I WANT** to send you proof of the wonderful pulling power of Popular Mechanics classified pages. What's your proposition? Write me today. F. W. Johnson, Classified Dept., Popular Mechanics Magazine, 6 No. Michigan Blvd., Chicago.

**ADVERTISERS**—Here's your opportunity. Your proposition placed before the readers of "Cartoons Magazine" for only 2c per word. Circulation 23,000 copies. Send a trial ad for our next issue. Cartoons Classified Dept., 6 No. Michigan Blvd., Chicago.

**THE** Classified ad pages of the Denver Weekly Post will sell or swap anything that the human family uses. Reaches over 115,000 subscribers every week by Uncle Sam. No street or news-stand sales. A circulation not duplicated by any other medium. The largest and newest weekly newspaper between the Missouri River and the Pacific Coast. Classified ads—3c per word. Display—30c per line, \$4.20 per inch. One ad convinces. Write for sample copy. Subscription price 35c the year.

**YOUR** 25 word advertisement in 100 Monthly Magazines, 3 Months, \$1. Bennett, 442 East 184th St., New York.

#### TO MANUFACTURERS

**THOMAS** Camp, 37 Norcross Street, Atlanta, Ga., offers newly patented motor harrow and road machine to manufacturers one year without royalty.

#### AGENTS WANTED

**GENERAL** Agents—Capable of calling on the big trade themselves and handling canvassers for the house to house and office to office business, to sell the newest electric specialty on the market; sold everywhere there is electricity, in the home, office, factory, store, hotel, liberal profits; sales-driving sample; weighs a pound; no experience or knowledge of electricity required; shows how to use one light instead of two and get the same results; sells for \$2.50, \$3.50, \$5.00 and saves the purchaser an investment of \$25.00. Write for particulars. The Handy Light Co., 153 Handy Light Block, Cincinnati, Ohio.

**"BOOSTER"** will show you how to make more money! Why not operate a good, substantial "Income Mail Business?" Every issue of "Booster" contains propositions that can easily be worked evenings. Don't invest any money until you read "Booster"—the magazine that has, for years, actually and accurately placed men like you in business for themselves by publishing money-making propositions that get the dollars. Send 10c today for two months' trial—it's worth cold cash to you. Booster Magazine, Northwestern Bldg., Chicago.

**EVER** hear of selling popular 25c sheet music at 5c? You can, and make big money. Four samples and proposition, 10c. Chicago Book & Music Co., 535 S. Wabash Chicago.

**REPORT** information, news, names, etc., to us. We have established markets. Particulars free. "Nisco"—HDB—Cincinnati.

**MANUFACTURER** of new exclusive linen heel and toe guaranteed hosiery wants agent in every county. Sales enormous. Re-orders insured; permanent, increasing income. Protected territory. Credit. N. Parker Mills, 720 Chestnut St., Philadelphia, Pa.

**DON'T** be an agent—You take the money; be your own master. Dave Crawford, W. Va., writes: "Made \$42.75 first week." Smith, Pa., writes: "\$301 in two weeks." Bostwick, N. Y., writes: "Make an average of \$10 a day." We have started hundreds of others. Gray's outfits, \$15 and up. Plate Gold, Silver, Nickel, Metal, etc. We furnish recipes, formulas, trade secrets and teach you the art; work easy. Royal new dipping process. Every family, hotel, restaurant, shop has tableware, jewelry, metal goods of all kinds to be replated. Every other business overcrowded, few plating shops. Send postal, free sample plating. Gray & Co. Plating Works, 19 Gray Bldg., Cincinnati, O.

**WHITE** Slavery, standing expose of traffic in white women as disclosed by Vice Commissioner of Chicago; 25c sample and agents' prices, 15c. Chicago Book & Music Co., 535 S. Wabash, Chicago.

**AGENTS**—Three new games for Cigar Stores, etc. Retail \$1. Also line of new office specialties. Easy sellers. Particulars free. Poola Co., Dept. PM., Harrisburg, Pa.

**AGENTS** everywhere, join us. Best and neatest ball-bearing nickel-trimmed combination vacuum cleaner on market. Low prices and freight paid. Reliance Specialty Co., 1754 Berneau Ave., Chicago.

**LIVE** Agents Wanted: Universal Polishing Cloth. Sells wherever shown. Full size sample and particulars 25c. Universal Specialty Co., Plainfield, N. J.

**START** a mail-order business of your own. Small capital. Spare time. 27 plans. Send for particulars. Mutual Opportunities Exchange, Buffalo, N. Y.

**ANSWER** this and get our free sample case offer. \$10 a day easy with our complete line of household necessities. Men or women. E. Roberts, 110 Roberts Bldg., St. Louis, Mo.

**YOUR** address on postal brings you the biggest money-making proposition you ever received. Try it. X. L. Products Co., 117 Worth St., New York.

**SCIENTIFIC** Wonder. Gigantic Agents' Success. Millions want quick delivery. Territory now free—means fortune. Brilliant home invention—just out. Mighty labor, drudgery saver. Gives every home advantages of \$75.00 stationary wash tubs, boilers—self-filling, self-emptying—for \$3.75. No plumbing. Works automatically—while you rest. No operating expense. Saves 90% labor, 50% time. New, startling, fascinating. No competition. Field untouched. Investigate quick. Security Mfg. Co., Dept. 11, Toledo, Ohio.

**AGENTS** make \$5 profit daily; Name Plates, House Numbers, Signs. Particulars free. Roscoe Lynch, Bausman, Pa., Dept. B.

**AGENTS** wanted in every city and town, to sell high grade household specialties. Write for particulars. Mutual Sales Co., 1542 McCausland Ave., St. Louis, Mo.

**FOUR** New Household Necessities. One a sure repeater. Easy sellers. Big money-makers. Investigate. The Logan Manufacturing Co., 2314 Lyndale, Chicago.

**PLUCK** the juiciest big cash profit plums selling our superfine products. Brief demonstrations produce sales. 100% profit. "Live wires." Address Box 424 Chicago, Ill.

**PORTRAIT** Agents—Deal direct with the artist; better picture, better terms; send for price list and samples. The Combined Artists, 519 New Era Bldg., Chicago, Ill.

**AGENTS** to take orders for Visiting and Business Cards; large profits; outfit free. Forman Printery, Waterbury, Conn.

**I AM** the manufacturer of Face-O-Clean and want to employ a Sales Manager in every locality, man or woman. Must have \$25 to carry stock. Opportunity to control a big money-making business of your own. Address G. A. Landwehr, Manufacturer, 316 Majestic Bldg., Indianapolis, Ind.

**LISTEN!** You can make \$15 weekly easy selling high-grade Jewelry 50c weekly. Washburn, 417 West 128 St., New York.

**OPPORTUNITIES**—Mail order, agency or local business, write us. Adolph P. Schmitt Co., Seattle, Wash.

**PARCEL** Post and Income Tax mean hundreds government jobs now available. "Pull" unnecessary. \$65 to \$150 month. Write immediately for free list of positions available. Franklin Institute, Dept. E, 22, Rochester, N. Y.

**AGENTS**—500% profit, free sample Gold and Silver Sign Letters for store fronts and office windows. Anyone can put on. Big demand everywhere. Write today for liberal offer to agents. Metallic Letter Co., 406 N. Clark, Chicago, U. S. A.



**AGENTS Wanted**—If you know a chance when you see it you'll see this one now. Big money—stylish, nifty clothes—little work—no experience or capital needed—can you beat that? We want agents everywhere to take care of our business in their localities and to advertise our nobby, nifty suits by wearing them. We furnish everything complete and charge nothing for agents' outfit. The swellest dressers everywhere are our agents and all we ask is that you tell people who inquire about your fine clothes where and how they can get them. You make big money—\$10 a day—without trouble. Just a postal brings you full outfit free. Big, new sample book of up-to-the-minute suitings sent so you can pick out your first suit; also measuring blanks and everything you need. We pay express on everything—not a penny for you to pay. Send quick before some one else gets the agency there—mail postal today to American Woolen Mills Co., Dept. 414, Chicago, Ill.

**AGENTS**—Over 1,000% profit easily made. Formosa, Thibodaux, La.

**HIT of the year.** New invention—Simplex Family Dishwasher. Sell one a day, make \$5 daily; five a day \$600 monthly. Washes, dries, sterilizes dishes, glasses, pots, pans, milk bottles, without wetting the hands, three to five minutes. Saves money, time, labor, temper. Child can run. Not sold in stores; how to demonstrate. Description. Selling plans. Simplex Mfg. Co., Dept. D, Cincinnati, Ohio.

**JUST invented**—Immense money-maker for agents. 2c to mail. Sample furnished. General Supply Co., 212 E. 5th St., Cincinnati.

**LIVE Agents** in every town. Best selling articles. Start now. Big demand for goods. \$25 to \$50 a week. Write today. York Specialty Co., Dept. D, York Village, Maine.

**WE are absolutely making agents** the best proposition of any manufacturer on our new Vacuum Sweepers; largest profit; sell easiest. Act quick. Manufacturers Home Supply Company, Detroit, Mich.

**AGENTS**—\$50 weekly. We manufacture the best needle case made; a wonderful seller; 200% to 500% profit; talking unnecessary; our "Trust Scheme" Envelopes do the work; general agents can make \$100 weekly; particulars free; 25c sample outfit for 10c; buy direct from the factory. Paty Needle Co., 102 Davis Sq., W. Somerville, Mass.

**EARN \$15 to \$25 a week** or more as our mail-order dealer. Right from your own home. Hold your position until entire time is required. We are manufacturers and owners of patented just-in-season, repeat-order specialties. If you are just starting a mail-order business or if already established, you can't afford not to handle our patented money-making getters. We sell exclusively to our mail-order dealers. We carry stock and furnish everything. Small capital. Experience unnecessary. Write today for latest and manufacturers' easy-selling mail-order plan, backed up by the "whole truth," positive proof and sworn statement. Kimo Mfg. Co., 221 Kimo Bldg., Buffalo, N. Y.

**AGENTS**—Men and Women—Big money selling aluminum shake-less salt and pepper sifters. Write today; particulars free. The Oster-Barr Co., Rockford, Ill.

**AGENTS Wanted**—Right here is the one big chance of your life. If you want to make good money—\$10 a day or more, as easy as rolling off a log, and get your swell clothes free besides, you can do it by acting as our agent. We are the biggest people in the business and want our agents to make big money and be nifty, stylish dressers. Send a postal today for free \$10 outfit, including a big book of nobby suiting samples to select your swell agent's suit from. Then take orders from people who admire your nifty clothes. They come to you—not you to them. This is the way to get rich—the sure, easy way. Remember, you need no money—everything is furnished by us free. We pay express on everything. Just send a postal, but do it today. You can't get started too quick, making this big money and wearing these stylish clothes. Address card to Paragon Tailoring Co., Dept. 414, Chicago, Ill.

**AGENTS, make more money.** Handle the Imperial Self-Heating Iron. Oldest and best. Every housewife wants one. Exclusive territory. Write today for interesting proposition. Imperial Brass Mfg. Co., Dept. 734, Chicago.

**200% PROFIT.** You can't beat it. Free pocket sample. Sells everywhere. Everyone buys. Our reputation and big capital back you. Wm. J. Dick, Mgr., Dept H4, 20 W. Lake St., Chicago.

**RAY'S total commissions for 1913** over \$12,000. New Feeny Vacuum Cleaning machine has got all others skinned forty ways. Good men wanted for general agents. Exclusive territory. You risk nothing. If wise, you will write before tomorrow. Feeny Manufacturing Co., Dept. B65, Muncie, Ind.

**AGENTS, earn \$10 per day,** sell three 50c ties \$1. Free Monogram gold cuff links and stick pin. Bowden cleared \$71—5 days. Cooper \$40—4 days. Free samples. Comer Neckwear Co., 2 Eighth St., Dayton, Ohio.

**YOU are looking for me—you are seeking an opportunity to connect with large manufacturing concern,** selling through exclusive agencies, line of goods in big demand; proposition you can make money with right from the start and has unlimited opportunity for future development. I have it; write me, Manager, Dept. 4, 1336 W. Bancroft St., Toledo, O.

**WANTED**—Hustlers to take orders for made-to-measure, high grade men's tailored suits from \$9.00 to \$22.00. Make \$25.00 to \$50.00 weekly. Elegant large book outfit free. Experience unnecessary. No pocket folder affair. Splendid opportunity to make money. Handy Dandy Line, Dept. S, Sangamon St., Chicago.

**IF we had your address we'd send free sample and show you how to make \$25, not one week, but weekly.** G. Mfg. Co., 20H Warren St., N. Y.

**PHOTO Pillow Tops, Portraits, Frames, Sheet Pictures, Photo China Plates.** Rejects credited. Prompt shipments; samples and Cat. free to agents. 30 days' credit. Jas. C. Bailey Co., Desk A1, Chicago, Ill.

**AGENTS—Both Sexes**—We manufacture and control fastest selling household article ever invented. Connolly, 123 Liberty St., New York.

**THEODORE Roosevelt is again writing for Scribner's Magazine** subscription solicitors can earn big commissions. Inquire Desk 15, Scribner's Magazine, 597 Fifth Ave., New York.

**AGENTS sell guaranteed Hosiery, Underwear, and Sweaters** for largest manufacturer in America. Easy work. Big pay. Complete outfit free. Write Madison Mills, Dept. 7A, 590 Broadway, New York City.

**HONEST man wanted** in each town to distribute free advertising premiums; \$15 a week to start; experience unnecessary; references required. Address McLean, Black & Co., 11 S. Beverly St., Boston, Mass.

**TO the agent our perfected acetylene generating and storage system offers** great possibilities. Field includes automobiles, motorcycles, horse-drawn vehicles and motor-boats. The Tank-O-Gas Co., 23 St. Ann St., Forest Hills, Mass.

**FULLER Dustless Floor and Wall Mop,** with adjustable handle, and hand duster, are indispensable to housekeepers. Sells at sight—100% profit to agents. Write today. Fuller Brush Co., 55 Hoadley Place, Hartford, Conn.

**AGENTS**—Just out. Unique invention. World's handiest home massager. No mechanical power required. Small but powerful. Inexpensive; delights both sexes. New business. Big profits. Aztec Remedy Co., Dept. E, Toledo, O.

**AGENTS wanted to call on garages, machine shops, factories, mills, etc.,** selling extensively advertised welding apparatus. Demand already created. Will give exclusive territory together with co-operation to right parties. Exceptional commission. Cox Press Mfg. Co., Albany, N. Y.

**AGENTS and salesmen wanted to sell small hardware article.** Big profit, no competition. P. Slustrop Specialty Co., Cincinnati, O.

**AGENTS wanted to handle remarkable money makers; easy to handle; easy to sell; many repeat orders; write quickly.** H. Warwick, Dept. S, Box 306, Bridgeport, Conn.

**AGENTS, everywhere, sell Penny Gift Gum to stores; big demand; sample box to start, 10c.** Austen Co., Cranston, R. I.

**SELL new patented 120-day guaranteed gas mantles.** Exclusive territory. Large sales. Big profits. Send for particulars and enclose 10 cents for sample. Phoenix Light Co., Manufacturers, Milwaukee, Wis., Est. 1899.

**\$50.00 A WEEK** guaranteed selling Pure Spun Aluminum Cooking Utensils. We are manufacturers of the largest line in the world. First Aluminum Cooking Utensils made bear our trade mark. Wanted live men at once for protected territory. Answer quick. Divn. PM, American Aluminum Mfg. Co., Lemont, Ill.

**WATCH protector sells on sight; 100% profit.** Sample 25c. Worth \$1 to anyone having a watch. N. Appenzeller, 2799 8th Ave., New York City.

**SELL Art Show Cards.** Everybody buys. 400% profits. Catalogue free. Powell Bros., 4150 Madison, Chicago.

**AGENTS**—A free course in General Salesmanship is given to every man of our Sales Organization. This organization is a body of successful men selling the Handy Light; that unique electrical device which cuts the cost of electric lighting in half. Sells for \$3.50, is used in home, office, store, factory; weighs only one pound. Sold by demonstration. All agents furnished with well planned methods for gaining interviews. A high-grade business for a man of ability and standing in his community. General Agents preferred. Inquire for our full proposition by addressing The Handy Light Co., 1101 Handy Light Block, Cincinnati, Ohio.

**MY check protector, the best.** Price fifty cents. Holt Sales Co., Gainesville, Ga.

**MAKE money renewing old dry batteries.** We guarantee you can at cost of one cent each! Send 25c for guaranteed formula and instructions; regular price \$1.00. If dissatisfied we'll send your quarter back! Northern Supply Co., 154 Randolph, Chicago.

**GET in the \$50 a week class; enjoy independence and prosperity.** Two issues of great money-making information, 10c. Agents Magazine, Chicago.

**AGENTS**—Here's a money-maker. New, low-priced portable oil gas stove. Light in weight, compact, practical. Every home a possible customer. Cooks, bakes, heats. Sells both in summer and winter. Write today for our money-making proposition. The World Mfg. Co., 4027 World Bldg., Cincinnati, O.

**AGENTS**—Red hot summer seller. Concentrated soft drinks, orangeade, grape, raspberry, etc. 7 kinds—Small package—enormous demand. Whirlwind sales; astonishing profits. Get it quick, while it's new. Write today for full particulars. American Products Co., 3011 Sycamore St., Cincinnati, Ohio.

**OUR Wonderful Luminous Crucifix.** Shines all night in darkest room. Some territory still open. Pioneer Portrait Co., 1259 W. 63rd St., Chicago.

**VALUABLE Premiums and Big Profits** to Agents selling our order getting line of Guaranteed Pure Aluminum Goods. Our \$200,000 capital backs you. Write today for territory. Wm. J. Dick, Mgr., Dept. 21 (key) 20 W. Lake St., Chicago.

**LET us start you in a permanent business** of your own selling guaranteed Planto-silk Hosiery and Underwear direct from factory to the homes. Capital and experience not necessary. We help you. Our representatives are making \$3,000 to \$5,000 a year. Write for spare time and full time plans. 406 Grandville Ave., Grand Rapids, Mich.

**DAZ-E-LITE patented lamp burners** with wonderful new oil feeder and filler makes great big clear light. Scientifically feeds oil and fills lamp without smearing. Quick seller, \$5 day easily made. Agents' outfit 35c. Internat'l Mfg. Co., Dept. 427, Toledo, Ohio.

**400% PROFIT,** selling our high grade work. Samples free. Gordon Co., Northwestern Bldg., Chicago.

**AGENTS**—High-grade auto necessity. 150% profit. The Perfect Auto License Holder, weighs 8 ounces. Every auto owner a prospect. Placed on car without tools in 2 minutes. 25 sets daily sold easily. Send 25c for agents' sample pair to The Cornelia Auto Sales Co., Toledo, O.

**BIG money selling Automatic Telephone Disinfectors.** Write us. Eucalyptus Parfeno Co., New Bedford, Mass.

**\$15 DAILY** selling \$20 Soda Fountain. Manufacturer, O-1764 Aberdeen, Philadelphia.

**10,000 AGENTS** wanted. New article. Sells on sight. Record-breaking sales everywhere. Sample free. Allen Manufacturing Co., 202 East 99 St., New York City.

**VACUUM Cleaner Agents**—See the U. S. first, new design wheel-operated, nicked extended nozzle, guaranteed five years. Popular price. Large profit. Exclusive territory. U. S. Manufacturing Company, Warren, Ohio.

**\$1.50 SELF-FILLING Fountain Pen.** Never leaks. Gold plated pen. Sample, 25c. Dozen small size, \$1.50; large, \$1.75. Everything postpaid. Money refunded if unsatisfactory. Agents coming money. Rollins Co., Dept. 27, Box 5272, Boston.

**AGENTS Wanted**—Canvas mail box. Good seller. Write for price. Mail Box Man, 1303 N. Fairfield Ave., Chicago, Ill.



**MR. Mail-Order Man:** Get quick returns. Established corporation supplies fast Mail-order sellers; factory prices. Classy proposition. Beginners or established firms. Copyrighted Prospectus free. Mississippi Valley Co., Inc., Box 9629, Pittsburg, Kans.

**AGENTS—New Automatic \$2.00 Adding Machine.** Sell 10 a day easy. Make 100%. Absolutely no competition. Everyone buys. T. Bassett, 5921 Indiana Ave., Chicago.

**AGENTS—Salary or commission.** Greatest seller yet. Every user pen and ink buys on sight. 200 to 500 per cent profit. One agent's sales \$620 in six days; another \$32 in two hours. Monroe Mfg. Co., X 6, La Crosse, Wis.

**\$5,000 YEARLY** for you selling the Universal Telephone Holder. Entirely new invention. Just marketed. Every phone subscriber buys at sight. Nothing similar for sale. Territory going fast. Beautiful copper oxidized sample, 50c prepaid. International Mfg. Co., Dept. 375, Toledo, Ohio.

**IDEAL** trunk strap binds trunk both ways with one turn. Big seller. Send 50c for sample. Union Mail Order Co., Middleboro, Mass.

**AGENTS—Transfer pictures on paper, linen, leather, wood, etc.** Sample bottle 15c prepaid. R. Yost, Watkins, N. Y.

**WANTED—Agent to act as manager in each county.** \$150 month easily made. No canvassing. Success guaranteed. Big, expensive samples. Instructions, plans and starter, all 10c postage. Manager (Dept. 48), Myers & Co., Cambridge, Ohio.

**AGENTS—Repeater; costs 5c; sells for \$1; sample 2c.** Dr. Thornber, Ferris, Ill.

**AGENTS—Attention!** New invention, a quick selling little article that gets the money. Why? Because it's an absolute necessity with every man—enuf sed. 10c brings sample, etc. H. A. Kane, 4317 W. Henderson St., Chicago, Ill.

**AGENTS—Make money sure, quick, easy.** New low-priced self-heating iron. The season is now on. Sells itself. Every home a prospect. Three sales a day means \$40 profit a week for you. Write today for money-making plans. Address C. Brown Mfg. Co., 2017 Brown Bldg., Cincinnati, O.

**AGENTS—To sell the newest electric appliance on the market sold everywhere there is electricity, in the home and office; liberal profits; sales-driving sample, weighs a pound, no experience or knowledge of electricity required; it shows how to use one light instead of two and get the same results; sells for \$3.50 and saves the purchaser an investment of \$25. Write for particulars.** The Handy Light Co., 15 Handy Light Block, Cincinnati, Ohio.

**AGENTS—Streetmen—Eleven New money-makers.** Profits exceed 50%. Latest "Live Wire Bulletin" free. Act quick. United Sales Factory, Newburgh, N. Y.

**AGENTS, big money selling pictures, Abraham Lincoln or Wilson's family, sample postpaid, 15c, (stamps) 15x20%.** Barker's Store, 60 Fulton St., New York City.

**WIDE-AWAKE** agents are coining money with our easily demonstrated specialties; write today for particulars and new catalogue. F. B. Probst, 43 Exchange Pl., New York.

**AGENTS** wanted in every town and city to sell high-grade household specialty. Sells on sight. Write for particulars. Samuels Co., 210 Spring St., Jeffersonville, Ind.

**SELL Metler's Ink Compounds.** Big profits; protected territory. Particulars, samples, three colors, 6c. A. D. Metler, New Brunswick, N. J.

**AGENTS—Here's a whirlwind seller.** Every family needs one. Big profit on every sale. Western Specialty Co., Bismarck, N. D.

**MAKE** and sell your own goods. Formulas by Expert Chemists. We obtain your Government Serial Number. Catalogue for stamp. B. Mystic Company, Washington, D. C.

**AGENTS** wanted—Make \$50.00 to \$100.00 a week selling the Doxameter, the only automatic guaranteed gasoline-saving device for autos and stationary engines. Saves 25% to 40%. Retail price \$5. Send \$3 for sample and particulars. Doxameter Sales Co., 2132 S. Michigan Ave., Chicago.

**FREEMAN** Springs for Letter Carriers. Good article. Fair profit. Freeman Mfg. Co., Long Island City, N. Y.

**AGENTS** wanted—Send us one dollar and we will send you one set of "Sept. Morn" goods, consisting of one pair link cuff buttons, one pin and one watch fob, and also send you sample and full particulars of a good mail-order plan. A. S. Mankin & Co., Alexandria, Va.

**WARREN** cleared \$19.50 in three days with our staple line. Our free booklet tells how. Barker Chem. Co., 20 Center, Auburn, Me.

**AGENTS** Wanted—Agents make 500 per cent profit selling "Novelty Sign Cards." Merchants buy 10 to 100 on sight. 800 varieties. Catalogue free. Sullivan Co., 1234 Van Buren St., Chicago, Ill.

**MEN** Wanted, Handle Branch Agencies paying \$5 day upward. Give references, experience. Modern Specialties, Racine, Wis.

**I NEED** one energetic, dependable, representative in every county to take orders for our new Popular Mechanics book for boys called "The Boy Mechanic." This is not a story book, but a wonderful and interesting collection of 700 things boys love to make and experiment with. A very large attractive book for the price, \$1.50. Every boy's father or mother will want to buy it for their son. It sells itself. Good liberal commission and exclusive territory. You don't have to be a professional agent to be successful with this highly meritorious proposition. Work in and around your home town during spare time only if you cannot devote all your time to it. Write today for full particulars to Manager Book Dept., Popular Mechanics Co., 6 No. Michigan Blvd., Chicago.

**IF** you live in a small town and have a little spare time, get our offer. Easy to make \$100 profit each season; still easier to get your own clothes out of the profit on a few orders. No extra charges for fancy styles, golf bottoms, pearl buttons, etc., makes sales easy. Write for free samples and our new offer. Knickerbocker Tailoring Co., Dept. 56, Chicago.

**GET** in the big income class. Learn how to enjoy Independence and Prosperity. Read the Agents Magazine, 2 issues 10c. Agents Magazine, Chicago.

**AGENTS, Salesmen, Canvassers:** Sell goods put up under your own name; permanent business; 300% profit. Investigate. W. B. Williams, Montclair, N. J.

**AGENTS** in all trades to sell Hygienic hose supporter. Recommended by physicians. Pair 25c. Hygienic Hose Supporter Co., Toledo, Ohio.

**YOUNG** Man, would you accept and wear a fine tailor made suit just for showing it to your friends? Or a Slip-on Raincoat free? Could you use \$5 a day for a little spare time? Perhaps we can offer you a steady job. Write at once and get beautiful samples, styles and this wonderful offer. Banner Tailoring Co., Dept. 703, Chicago.

**AGENTS** in every city to handle our Triplex Folding Handbag; big profits; exclusive territory. Write for terms and free catalog. Other big sellers. S. V. Diamond & Bro., 35 West 21st St., New York City.

**RURAL** Agents write for our "10-day free trial offer to prospective agents" on our New Improved 1914 Model Vacuum Cleaner. We pay all express charges. Best and strongest suction cleaner made. Gets both germs and dirt. Guaranteed 5 years. Postal will bring offer. Warner Vacuum Cleaner Company, Dept. "Z," Muncie, Ind.

**AGENTS** would you take a steady job where you can clear \$20 to \$30 weekly to start and work up to yearly profits of \$3,000 or more? No experience required. Great crew managers' proposition. We manufacture. Middlemen profits saved. Get posted on our 1914 exclusive territory—business-building selling plans. Act quick. E. M. Davis, Pres., R64, Davis Bld., Chicago.

**AGENTS—\$5** daily selling our Handy Tool, 12 articles in one. Lightning seller. Sample free. Thomas Mfg. Company, 462 Third St., Dayton, Ohio.

**WIDE-AWAKE** active agents or crew managers can secure special concession and reap the benefit from the best money-making agency proposition on the market by writing immediately for full particulars. Hugro Manufacturing Co., Chicago, Ill.

**500% PROFIT** selling our wonderful sign letters for office windows, store fronts and glass signs; resembles finest gold leaf; easily applied; samples free. Metallic Letter Co., 406 N. Clark St., Chicago.

**AGENTS—Secure** exclusive territory for Kleenol specialties. Quick repeaters; over 100% profit. Monthly bonus payments extra. Get full information from The Kleenol Co., 65 Taylor St., Springfield, Mass.

**SOAP** and Perfume Agents, write us. Big Profits. Goods Guaranteed. Hopfinger and Roth, 212 N. Second St., St. Louis, Mo.

**WE** are the largest manufacturers of twisted wire brushes in America. Highest grade goods, best service, highest profit. Write for our new catalog. You are sure to win. Fuller Brush Co., 33 Hoadley Place, Hartford, Conn.

**AGENTS—250% profit.** Wonderful little article. Sells like wildfire. Can be carried in pocket. Write at once for free sample. H. Mathews, 1962 Third St., Dayton, Ohio.

**HOUSEHOLD** necessity recently invented sells at 75c. Costs distributors 25c. Nothing like it on the market. Tested and approved by Good Housekeeping Institute. Get your territory now. Hugro Mfg. Co., Chicago, Ill.

**AGENTS—150% Profit on Each Sale.** Show housewives how to do an hour's hard work in a jiffy. Unique household preparation and our original "Entering Wedge" plan makes easy sales and big profits. Excellent opportunity to control this in your territory. Jiffy-Brite Laboratories, Dept. M, Boston, Mass.

**LARGE** income selling Specialty Rugs. Colored illustrations and important information free. Sample rug forwarded prepaid, \$1.00. Reference, Boylston Nat'l Bank, Boston. Dundee Mfg. Co., 46 Chauncey St., Boston, Mass.

**\$1,000.00 OR \$400.00 a month—which?** Agents make \$20.00 a day. Start in small way, grow to big money class. Koehler made \$12.00 first day, \$16.00 second day. "Positive Proof Sales Plan," combined with "Shakit," makes big money certain. Make your friends wonder at your success. Act Quick; particulars for postal. Nat. Dist. Co., 1674 Belmont Ave., Chicago, Ill.

**STAMP** Names and Addresses on Key, Checks, Umbrella Plates, Watch Fobs, etc. We supply blank stock and stamping outfits, sample with name and address, 10c. Hart Mfg. Co., Desk 2, 303 Degraw St., Brooklyn, N. Y.

**AGENTS:** We want, at once, a man or woman, one capable of earning good salary, in every community where we are not represented. Write us. Sun Mfg. Co., 309 Dean Bldg., South Bend, Ind.

**WE** have agents making \$200 weekly, selling our new specialty to merchants. Returns \$7.50, your profit \$3.00. No competition; exclusive territory. Samples and descriptive matter free. Sayers Co., 408 Olive St., St. Louis, Mo.

**MAIL-ORDER** Opportunities; 25 new Propositions. No competition! Make 95c profit on dollar order; complete outfit 10c. Mail Dealers Wholesale House, 521 Franklin Bldg., Chicago.

**STOP** Here! Let me start you in a home business that will bring you money every day. Experience unnecessary. Spare time. No canvassing. I furnish everything. Send for proofs. Voorhies, Desk C. R., Omaha, Neb.

**\$5.00 RAINCOATS—Agents** wanted everywhere. You and many others in your section need Raincoats and would gladly pay Agent \$5.00 for one. Why not be that Agent? Boston Raincoat Company, Sales Dept., Boston, Mass.

**\$35 TO \$100** weekly made easily. Needed in every home and store; enables purchaser to save money and enjoy life. Rapid seller. Profit from \$10 to \$50 each sale. Experience unnecessary; exclusive territory to hustlers. Write for full particulars. C. Hemple, Sales Mgr., 174-C, No. Sangamon, Chicago.

**YOU** can be your own boss with our Key Check Outfit. Good for \$5 a day stamping names on pocket key checks, fobs, etc. Sample check, with your name and address, 15 cents. Pease Die Works, Dept. M, Winchester, N. H.

**AGENTS** make big money and become sales managers for our goods. Fast office sellers. Fine profits. Particulars and samples free. One Dip Pen Company, Dept. 2, Baltimore, Md.

**AGENTS** sell rich-looking imported 35x68 rugs \$1 each. Carter, Tenn., sold 115 in four days, his profit \$57. You can do as well. Write for sample offer and selling plan. Sample rug by Parcel Post, prepaid, 98c. A. Condon, Importer, Stonington, Maine.

**AGENTS** make \$5.00 to \$10.00 a day on the start. Atkinson writes: "The best proposition I have found in my forty years canvassing." Permanent work. Household necessity. Saving 80%. Write today for General or Local Agents terms. Free sample. C. H. Stuart & Co., 16 Union St., Newark, New York.



I WILL start you earning \$4 daily at home in spare time, silvering mirrors; no capital; send for free instructive booklet, giving plans of operation. G. F. Redmond, Dept. 306, Boston, Mass.

300 TO 400% Profit to Agents selling our guaranteed U. S. Fire Extinguishers. Tremendous demand. Orders repeat. Exclusive territory to county and district managers. United Mfg. Co., 1025 Jefferson, Toledo, Ohio.

BIG Profits for You! Manufacture Barley Crisp. New confection. 5c package costs you 1c. Machine, instructions complete \$7.50 prepaid. Send 10c for samples. Barley Crisp Co., 1605 Hyde St., San Francisco.

AGENTS—Handkerchiefs. Dress Goods. Carleton made \$8 one afternoon; Mrs. Bosworth \$25 in two days. Free Samples. Credit. Stamp brings particulars. Freeport Mfg. Company, 59 Main St., Brooklyn, N. Y.

YOU can make \$\$\$\$ as our general or local agent. Household necessity; saves 80 per cent; permanent business; exclusive territory; salary or commission; free sample; credit. J. Pitkin, 113 Redd St., Newark, N. Y.

AGENTS Wanted—Mechanics and shopmen make over \$100 a month in spare time selling transparent handled novelty knives and razors. Big profits. Sales easily made. Write for terms today. Novelty Cutlery Co., 67 Bar St., Canton, O.

MEDALLIONS—300% profit. Make up your own goods and be independent. Catalogue free. Resag Co., 1205 Randolph St., Chicago.

AGENTS—Sell the Primus, genuine Swedish wickless, coal-oil stoves. Smokeless, odorless. Twice the heat of gasoline at one-eighth the cost. No danger of explosion. Big profits. James Anderson & Sons, Sidney, Ohio, American distributors.

AGENTS—Write for prices on Solar, Bromides, Convexed Prints and Pillow Tops. We ship orders back in 24 hours' time. Try us. Horne Copying Co., 113 S. Jefferson St., Chicago.

PERFECTION Pocket Adding Machine. Lightning seller. Agents wanted. Cincinnati Specialty Mfg. Co., Dept. R, Cincinnati, Ohio.

COLLECT Names for business concerns. They buy millions yearly. Some name collectors clear \$100 monthly. Start at home, spare time. Instructive booklet for stamp. Information System, 211, Marietta, Ohio.

LIVE Agents for the Excelsior Brad Set. dispenses with the brad-awl and nail-set. Sells to every carpenter, cabinet maker, pattern maker and picture framer. Send 25c (P. O. Order) for agents' sample. Standard Tool & Supply Co., Torrington, Conn.

SIGNMEN coining money—flashing—electric—changeable letter—sectional unit sign sells for \$10. Sells itself. Flashtrick Sign Works, Chicago.

OUR Agents make good money and get repeat orders easily. Dept. A, Consumers' Direct Supply Co., Boston, Mass.

CASH for ideas. Patent News, Dept. 4A, Washington, D. C. Only inventors' paper published. \$1 year, 25c three months, including complete course of instruction in mechanical drawing.

AGENTS make \$100 month selling kitchen sets, and other trade getting lines. Nice watch free. Write. Pemco, Louisville, Ky.

#### HELP WANTED

BE a detective. Earn big money. Write John J. Gilles, Licensed and Bonded N. Y. State Detective. Retired Member N. Y. Police Dept. 22 years Experience. 254 Huguenot St., New Rochelle, N. Y. Investigation solicited.

\$50 TO \$100 weekly writing moving-picture plays. Send for free booklet, valuable information and special prize offer. Chicago Photoplaywright College, Box 278 MS, Chicago.

FREE illustrated book tells of about 300,000 protected positions in U. S. Service. Thousands of vacancies every year. There is a big chance here for you, sure and generous pay, lifetime employment. Just ask for booklet 8-29. No obligation. Earl Hopkins, Washington, D. C.

BRAKEMEN, Firemen, on all railroads. Wages \$100. Experience unnecessary. Send age, postage. Railway Association, Dept. 298, Brooklyn, N. Y.

ACTIVE persons may earn \$25 weekly corresponding for newspapers. Particulars, News Press Bureau, 33 News Bldg., Medina, N. Y.

BE Detectives—Big pay. Easy work; Travel: Wonderful opportunities; Experience unnecessary. Write, Fidelity Secret Service, Dept. A, Wheeling, W. Va.

WRITE Moving-Picture Plays. \$50 each. All or spare time. Correspondence course unnecessary. Details free. Atlas Publishing Co., 3045, Cincinnati, Ohio.

REPORT information, news, names, etc., to us. We have established markets. Particulars free. "Nisco," HDB, Cincinnati.

START a mail-order business of your own. Small capital. Spare time. 27 plans. Send for particulars. Mutual Opportunities Exchange, Buffalo, N. Y.

PLEASANT Home Work—Ambitious persons wanted for copying, addressing. No mail-order course or trash to sell. Send today addressed, stamped envelope for particulars. Box 17, Station H. G., New York.

GET out of the rut; manufacture goods at home, spare time. Send for free particulars regarding my 24 formulas. All money-makers. Hill, 309 Lincoln, Denver.

ANY intelligent person may earn steady income corresponding for newspapers. No experience required. Press Corresponding Bureau, Washington, D. C.

WANTED—An Ideal Who can think of some simple thing to patent? Protect your ideas; they may bring you wealth. Write for "Needed Inventions" and "How to Get Your Patent and Your Money." Randolph & Co., Patent Attorneys, Dept. 144, Washington, D. C.

WANTED—Men 18 to 35 as Government Railway Mail Clerks. \$75.00 month. Examinations everywhere soon. Schedule and sample questions free. Franklin Institute, Dept. E 21, Rochester, N. Y.

RAILWAY Mail Clerk Examinations everywhere soon. \$75 month. Schedule and sample questions free. Franklin Institute, Dept. E 21, Rochester, N. Y.

MEN and women wanted for government jobs. \$65 to \$150 month. Vacations. Steady work. Parcel post means many appointments. Common education sufficient. "Pull" unnecessary. Write immediately for free list of positions open to you. Franklin Institute, Dept. E 21, Rochester, N. Y.

GOVERNMENT jobs open to men and women. Thousands of appointments coming. List of positions free. Franklin Institute, Dept. E 21, Rochester, N. Y.

WANTED—Railway Mail Clerks. \$75 month. Sample examination questions free. Franklin Institute, Dept. E 21, Rochester, N. Y.

GOVERNMENT wants employes. Positions open; list free. Franklin Institute, Dept. E 21, Rochester, N. Y.

GET a Government Job! See ad on page 42. Write now—today. Patterson Civil Service School, Rochester, N. Y.

A MONEY Proposition—Co-operate with me in a profit-sharing mail-order business. Will place trial advertisement, furnish printed matter, goods to fill orders and divide the profits. Particulars. Desk 153, Hazen A. Horton, Tekonsha, Mich.

SPARE time turned into dollars, conducting profitable mail order or local business at home. Details free. Adolph P. Schmitt Co., Seattle, Wash.

CORPORATION Secretaries wanted each locality. \$1,200-\$8,000. New, uncrowded business. Capital unnecessary. Congenial work. Corporation Service Company, Box 1549, Boston, Mass.

\$3,000 YEARLY in your back yard! No ginseeng, mushroom dope. New industry you never heard of. P. and S. F. Magazine explains; editor helps you. Trial copy with Editor's Special "tip." 10c. Mark Walter, Editor, 42 Hanselman Bldg., Kalamazoo, Mich.

GOVERNMENT Examinations. Most thorough preparation; \$5; returned if not appointed; particulars free. American Civil Service School, Washington, D. C.

YOUNG Man, would you accept and wear a fine tailor made suit just for showing it to your friends? Or a Slip-on Raincoat free? Could you use \$5 a day for a little spare time? Perhaps we can offer you a steady job? Write us at once and get beautiful samples, styles and this wonderful offer. Banner Tailoring Co., Dept. 704, Chicago.

WE will pay you \$120.00 to distribute religious literature in your community. Sixty days' work. Experience not required. Man or woman. Opportunity for promotion. Spare time may be used. International Bible Press, 599 Winston Bldg., Philadelphia.

BE a Detective—Earn \$25 to \$75 weekly; chance to see the world with all expenses paid. Loraine System, Dept. 304, Boston, Mass.

GO on the Stage. Vaudeville career offered you. Experience unnecessary. Managers endorse my method. Instructive vaudeville book free. Write today. Frederic LaDelle, Sta. 10, Jackson, Mich.

WANTED—Distributors, Men and Women—to give away free pkgs. Perfumed Eorax Soap Powders; no money or experience needed; good pay. S. Ward & Company, 218 Institute, Chicago.

STOP Here! Let me start you in a home business that will bring you money every day. Experience unnecessary. Spare time. No canvassing. I furnish everything. Send for proofs. Voorhies, Desk C. R., Omaha, Neb.

BETTER Light for 1/5 Cost of Electricity. Suitable for home or store. Easily installed; no experience necessary, big demand. Write for Free catalogue. Doud Lighting Co., 174-D, N. Sangamon, Chicago.

I WILL start you earning \$4 daily at home in spare time, silvering mirrors; no capital; send for free instructive booklet, giving plans of operations. G. F. Redmond, Dept. 306, Boston, Mass.

LEARN automobile repairing, driving on up-to-date cars; electrical, civil engineering, surveying; methods most practical; room and board while learning; positions secured; satisfaction guaranteed; catalog free. National School of Engineering, 2110 West Seventh, Los Angeles.

BE a Detective. Earn \$200 monthly, positions open. A practical course in Detective Work taught by mail. American School of Criminology, Detroit, Michigan. Dept. F.

WANTED—Several Honest, Industrious people to distribute Patriotic Literature. Salary, \$60 per month. Prof. Nichols, Box C, Naperville, Ill.

MAKE money writing short stories. Big pay. Free booklet tells how. United Press Syndicate, San Francisco.

MACHINISTS: Earn high-grade tool chest in one hour. Plan free. Address with stamp. Art Furn. Co., Grand Rapids, Mich.

#### FOR SALE

FOR Sale—Automatic Card Printing Press. In fine condition. Cost \$165; will sell it very low, as other duties occupy my time. A few hours practice will enable you to make good money. F. G. McNear, Newburgh, N. Y.

NO. 1 STEPTOE Plain Milling Machine. Swivel Vise and Arbor, \$190. 10 1/4" Universal Dividing Head, \$75. Box 216, Soldier, Kan.

VACUUM Cleaners. All makes at half regular prices. Send for list. New York Vacuum Cleaner Exchange, 215 Grand St., New York.

ONE Ohlen inserted tooth saw, 56-in., 4 hp. engine and boiler, good repair. Wood Bros., Glen Haven, Wis.

STANLEY model C power plant complete. Box 65, Osgood, Ohio.

AERO Vacuum Cleaning Wagon complete. Good condition. Might consider trade. Roy Creamer, Jeffersonville, Ohio.

MAGICIANS, big, showy, complete act. Extra quality; practically new; cost \$400; will take \$50. Write. Box 86, Carbondale, Pa.

FOR Sale—Established plumbing and heating business in town of 2,500. Good equipment. Small stock. Good building. Well located. Cheap rent. R. S. Lash, Lexington, Neb.

FOR Sale—Moose and Deer Heads. Reuben Saylor, Taxidermist, 497 S. Broadway, Dayton, O.

#### GUNS, SPORTING GOODS, ETC.

OLD Pistols and Guns Wanted. Will buy or give in exchange almost any sort of modern revolver, rifle or shotgun. Stephen Van Rensselaer, West Orange, N. J.

HAMMERLESS D. B. 12-Gauge Gun and tools. Perfect, \$35. Stainforth, Winthrop, Mass.

#### WANTED

WANTED—Automobile accessory or specialty to manufacture and sell. Something of merit only considered. Submit your proposition. Crum Mfg. Co., Ottawa, Kans.

WANTED—Second-hand stone crusher to crush rock to size walnuts and smaller. Material wanted for building driveway on private estate. Machine must be in first-class condition and preferably in New England, as crusher will be used in Maine. Address with full particulars, "W." care Popular Mechanics Magazine, Chicago.



WE want articles of merit to handle by mail in this country. Kelvin Co., Brandon, Manitoba, Can.

WANTED—Second-hand steam vulcanizing outfit; give full description of same. Address J. G. Council, 108 W. Davie St., Raleigh, N. C.

WANTED to purchase complete file of magazine (Wayside Tales) year 1904. Address W. T. c/o Cartoons, 6 No. Michigan Blvd., Chicago.

#### WANTED—PARTNER

WANTED—Financial partner to obtain foreign patents on Ripping Implement. B. F. Sweeney, Neosho, Mo.

#### MACHINERY, TOOLS AND SUPPLIES

REBUILT Leather Belting. Half the price, equal new in service, excellent appearance, all sizes, satisfaction guaranteed. Also new, 25 per cent under dealer's prices. Freadrich Belting Co., Manufacturer, St. Louis, Mo.

STEAM Engines for sale, 1/2 hp. to 250 hp. What do you want? Stainforth, Winthrop, Mass.

SCREW cutting lathe, five-inch chuck, \$35. Wm. Keck, Princeville, Ills.

YOUR name on steel stamp to mark your tools for \$1. Three initials for 50c. Gideon Pike, Attleboro, Mass.

FOR Sale—Brick machine and hydraulic, twenty-four bricks; practically new; bargain. Joliet Artificial Stone Co., Joliet, Ill.

10 LATHES, millers, shapers, planers, drills, garage equipment and supplies. Bicknell, Janesville, Wis.

FOR Sale or Trade—One 9x14 Atlas automatic engine, \$100. Wanted—1 small air compressor, 1 small geared power pump, 1 pressure tank good for 50 pounds. R. L. Potts & Son, White's Station, Ky.

FOR Sale at low price, 36-in. new Fitchburg triple-gear engine lathes 12, 16 and 18 foot beds. W. H. Savage, Fitchburg, Mass.

PULLEYS, Gears, Sprockets, Shafting, Hangers; see page 132. W. A. Jones Foundry & Machine Co., Chicago.

FOR Sale—Two 250 K.W. Rotary Converters, type E. C., form E, class 6-250-500, 500 r.p.m., 600 volts, d.c.; d.c. amperes 416; a. c. end, 25 cycles, 3 phase, 360 volts. These machines are in A-1 condition and can be delivered at once. Price \$1,400 each f.o.b. cars (Penna. delivery). F. H. Herring, Inc., 30 Church St., New York.

10,000 FT. of belt at 5 cts. per ft. Send for list No. 27. Lucas & Son, Bridgeport, Conn.

HAVE for sale several sizes of lathes, milling machines, drill presses, punch presses, shapers, planers, boilers, steam engines, oil, gas and gasoline engines and wood-working machinery. Pinner, 122 Water St., New York, N. Y.

ENGINE Lathe, swings 9 1/2", takes 25" between centers. Complete set gears cutting all size threads 3" to 40", \$43.50. Grammes & Sons, Allentown, Pa.

HOW to Run a Lathe. A 50-cent book for 10 cents postpaid. S. B. Lathe Works, South Bend, Ind.

FOR Sale—One Bryan Vacuum Molding Machine in first class condition. Price, \$100 f. o. b. Buffalo. Lumen Bearing Company, Sycamore & N. Y. C. Tracks, Buffalo, N. Y.

#### ENGINES AND MOTORS

GUARANTEED 60 cycle motors—Single phase, 1-5 Holtzer-Cabot, \$20; 1/2 Holtzer-Cabot, \$27; 3/4 Century, \$42; 2-hp. Century or Wagner, \$67; three-phase, Westinghouse CCL, 1-hp. \$30; 3-hp. 1120 r.p.m., \$50; Hyre Electric Co., 613 South Dearborn Street, Chicago, Ill.

MARINE Motors—We have fifteen "Liberty" gasoline engines, various sizes, from three to six hp., brand new, complete except mixer. Regular price \$65.00 to \$150.00. Your choice while they last \$27.50 each or two for \$50. Half cash with order, balance C. O. D. Baird-O'Hara Co., 54-56 Jefferson Ave., Detroit, Mich.

FOR Sale—New 8 hp., 2-cyl. Cushman gasoline engine and Rochester generator, complete with all equipment, mounted on truck; guaranteed in perfect running order; first check for \$250 takes it. Plaza Theater, Box 432, Springfield, Minn.

60 HP. OTTO Gasoline Stationary Engine, fine shape, \$750 cash. Stainforth, Winthrop, Mass.

ENGINEERS—Do you want to utilize your exhaust steam for heating or drying purposes, without back pressure on your engine? If so, address Monash Engineering Co., 1403 W. Jackson Blvd., Chicago, Ill.

FOR Sale at a Bargain. New 5x6 four-cylinder, governor-controlled engine, fully equipped with carburetor magneto. Will sell for much less than cost. Fred Hanson, 570 Prior Ave., St. Paul, Minn.

12 STEAM engines each \$12. Send for list 27. Lucas & Son, Bridgeport, Conn.

COMPRESSION restored without rebor-ing. Motor boats, automobiles, pumping and agricultural engines. Willie Adjustable Piston Company, 1534 Fulton St., Brooklyn, N. Y.

REBUILT Engines—We have on hand a number of rebuilt "Buffalo" engines, guaranteed, at greatly reduced prices. Write for bargain list. Buffalo Gasoline Motor Co., 1293-1305 Niagara Street, Buffalo, N. Y.

FOR Sale—25 H. P. Otto Gas Engine 11x16 inch in splendid condition, complete with governor and ignition outfit \$400. Gray-Aldrich Co., 33 Commercial Whf., Boston, Mass.

#### FLOUR & FEED MILLING MACHINERY

SPECIAL bargains in second-hand Attrition mills, burr mills, crushers, corn shellers, bran dusters, dust collectors, purifiers, reels, double, single, 2 and 3-pair high roller mills, sieve bolters, receiving separators, scourers, etc. Write for description and prices. Sprout, Waldron & Co., P. O. Box 429, Muncy, Pa.

#### ENGINE CASTINGS AND BLUE PRINTS

BUILD your own motor. Notched discs, castings and materials for small A. C. motors, instructions for winding. W. C. Houghton, 142 St. Jerome Ave., Holyoke, Mass.

GASOLINE Engine Castings, with drawings. Cheap. Catalog for stamp. Novelty Manufacturing Co., 833 West 6th St., Cincinnati, Ohio.

#### MANUFACTURING

WRITE for our proposition on Blanking and Forming dies and metal press work. Complete equipment for all work in any quantity. S. D. Childs & Company, Chicago.

GAS for power is taking the place of steam for reasons of economy. Learn all about this great change by reading our new non-technical book on this subject, written by a first-class authority for the practical man. 192 pages, profusely illustrated, cloth binding. Price, \$1, postpaid. Popular Mechanics Book Dept., 6 No. Michigan Blvd., Chicago.

WIRE Goods, all kinds, made to order. Cooley Mfg. Co., 553 W. Monroe St., Chicago.

WE are equipped to build anything out of Iron and Brass. Builders' supplies, Structural Steel, Stirrups, Anchors, Iron, Brass, and Aluminum Castings. Practical Gas Engine & Machine Works, North Chicago, Ill.

CLEVELAND Specialty and Manufacturing Company, Cleveland, Ohio, design or make special articles to order. Inventions developed.

#### FACTORIES TO RENT

FACTORY to Rent—Manufacturer with completely equipped woodworking department desires to let same. Privileges to machine shop if desired. American Standard Tool Co., Joliet, Ill.

#### BOATS AND LAUNCHES

4 HP. HEAVY Duty Cooley Engine, good shape, \$35. 1 1/2 hp. jump spark, \$20. Stainforth, Winthrop, Mass.

SALE, sample launch, hulls 16 to 36 ft., family and speed type; second-hand bargains. Send for list. Boat Company, McHenry, Ill., Dept. E.

CHART of a modern submarine boat showing and naming over 200 parts. Size, 14x28 inches. Printed on plate paper. Shows clearly and distinctly all the interior. Mailed in a tube for 25c. Popular Mechanics Book Dept., 6 No. Michigan Blvd., Chicago.

20 HP., 4 Cylinder, 4 Cycle Eagle clutch and propeller outfit. Never used. Cost \$500, sell \$400 f. o. b. Stainforth, Winthrop, Mass.

MOTORCRAFT Encyclopedia—A 150-page book that tells 1000 things every motor boatman should know. How to overcome engine troubles. Price \$1, postpaid. Popular Mechanics Book Dept., 6 No. Michigan Blvd., Chicago.

#### BLACKSMITHS

SHOP Notes—Many valuable kinks for blacksmiths are contained in our series of Shop Notes books, 10 volumes, 50c each, postpaid or \$5 per set prepaid. Popular Mechanics Book Dept., 6 No. Michigan Blvd., Chicago.

BLACKSMITHS — Learn hand-wrought ornamental ironwork. Our 200-page book "Hand Forging" points out clearly all the guiding principles and methods which underlie all forge work. Written by a practical authority. 122 illustrations, cloth, \$1 postpaid. Popular Mechanics Book Dept., 6 No. Michigan Blvd., Chicago.

GOOD blacksmiths are scarce and few learning the trade and the blacksmiths must make the tools for all—from surgeon to the safe blower. Buy Toy's Modern Methods Forging and Welding different kinds of steel solid, and doing all hard jobs easy, also hardening and tempering to a standard by colored charts. Any smith can be an expert that means good jobs and big money. All for one dollar. Send for valuable samples free. W. M. Toy, Sidney, Ohio.

#### CEMENT

CONCRETE Molds, Catalogue free. 5 Market St., St. Louis, Mo.

If you want the best information on cement and concrete construction, subscribe for Concrete-Cement Age, leading cement and concrete monthly. Sample copy, 10 cents. Yearly subscription, \$1.50. Concrete-Cement Age, 135 Newberry Bldg., Detroit, Mich.

#### MECHANICAL ENGINEERS

ALL kinds of Special and Automatic Machinery designed. Inventions developed. Satisfactory results guaranteed. R. D. King, Chicago.

ST. LOUIS Engineering Company. Working drawings, machines, gears, tools, castings to order. Box 737, St. Louis, Mo.

MACHINERY designed by experts to meet your requirements, also patent drawings. American Drafting Bureau, Webster Bldg., Chicago.

CONSULTING Engineer—A. M. American Institute Electrical Engineers. Practical advice. Maximilian Weil, 2 Rector St., New York.

#### WIRELESS

WIRELESS Set. How to Make—96-page book telling how to construct at small cost an outfit suitable for transmitting four or five miles. Price, 50 cents, postpaid. Popular Mechanics Books Dept., 6 No. Michigan Blvd., Chicago.

#### ELECTRICAL

VOLTMETERS and ammeters of switch-board type, encased in a 4 1/4-in. aluminum shell with full glass face for \$1.25 and upwards. They are really serviceable and practicable instruments and must not be judged by price. Circular on request. Progressive Mfg. Co., Box 295A, Reading, Pa.

"AMATEUR Electrician." Shows how to make Batteries, Dynamos, Motors, Telegraph Apparatus, Telephone, Lights, Bells, Alarms, Electric Engine, etc. 75 illustrations 10c. How to renew dry batteries, 3 guaranteed processes. 20c. P. S. Bureau, 3311-D4, Belleplaine Ave., Chicago.

OLD Dry Batteries Renewed cheaply. Instructions, 25c. Crown Chemical Co., Hamilton, Ohio.

#### RARE COINS

WATCH your change! Big money paid for old coins. Right now we offer \$100 for dime 1894, S. Mint; \$50 for 1853 half dollar, no arrows; \$750 for certain \$5 gold, no motto, and lesser amounts for thousands of others. Thousands valuable coins circulating. Get posted. Send only 4c. Get our Large Illustrated Coin Circular. It may mean much profit to you. Send now. Numismatic Bank, Dept. 8, Fort Worth, Texas.



10 VARIETIES Coins 10c. 5 varieties bills 10c. 200 varieties stamps 10c. Postage extra. F. Burgess, 522 Beacon, Toledo, Ohio.

15 COINS, 30 cents per package. Sample coin trays, 25 cents each. C. Johnson, 100 Maiden Lane, N. Y.

50 DIFFERENT foreign coins, including Ceylon, Persia, Egypt, Nigeria, India, Venezuela, Panama, Travancore, Salvador, Africa, etc., \$1. Ancient Roman coin, 1,600 years old, 25c; 3 for 50c. 1,500 mixed stamps—over 500 different, \$1. 200 different stamps, 15c. F. L. Toupal Co., Dept. B9, Chicago Heights, Ill.

\$4.25 EACH Paid for U. S. Flying Eagle Cents dated 1856. We pay cash premiums on hundreds of Old Coins. Send ten cents at once for New Illustrated Coin Value Book 4x7. It may mean your fortune. Clarke & Co., Coin Dealers, Box 15, Le Roy, N. Y.

BARGAINS in Coins, notes, stamps and curious things. Premium catalog. Selling 1st. Pocket Piece and Lucky Seed for 10c. C. J. Carey, New Rochelle, N. Y.

### STAMP COLLECTING

DANDY packet 25 stamps 2c. Approvals. "Hawkins," Raton, N. Mex.

BARGAIN sets 5c each with net approvals. Ten Greece, seven Newfoundland. Palm Stamp Co., Los Angeles, Cal.

STAMPS—108 Japan, etc., for 2c postage. Newport Co., Dept. M, Linden Ave., Brooklyn, N. Y.

FOREIGN Stamps Free; 52 different foreign, including China and Venezuela, to all who apply for our high grade approval selections. Send two cent stamp for return postage. Edgewood Stamp Co., Dept. H, Milford, Conn.

FREE—108 foreign stamps, album and catalogs for 2c postage. Payn Stamp Co., Los Angeles, Cal.

205 DIFFERENT foreign, 101 United States, 20 animal, 25 Canada or 60 Japanese, free with McKele's Stamp Weekly, Boston, Mass., six months 25c.

73 VARIETIES unused Haiti, including inverted surcharges, \$4.25. Immense value. California Stamp Exchange, Ontario, Cal.

PACKET of 23 stamps; no two countries alike, 500 hinges. Set of \$1 and \$2 U. S. Rev., all for 5c. Mention paper. Miami Stamp Co., Toledo, Ohio.

STAMPS Free—100 different for the names of two collectors and two cents postage. 10 different foreign coins 15c; 20 Russian stamps, 10c. Lists free. Toledo Stamp Co., Toledo, Ohio.

STAMPS. 50 different British Colonials, 15c; 25 different, Japan, 15c. Dakota Specialty Co., Watertown, S. Dak.

STAMP Album with 538 Genuine Stamps, including Rhodesia, Congo (tiger), China (dragon) Tasmania (landscape), Jamaica (waterfalls), etc., 10c. 100 diff. Jap., N. Zld., etc., 5c. Big list; coupons, etc. Free! We buy stamps. Hussman Stamp Co., St. Louis, Mo.

WE pay good prices for canceled parcel post stamps. Send dime for price list. Aurora Mail Service Co., Aurora, Ill.

25 DIFFERENT British Colonials to applicants for stamps on approval who send 2c postage. Nickles, Box 2466, Washington, D. C.

STAMPS—105 China, etc., stamp dictionary and list, 2c. Bullard, Sta. A, Boston.

STAMPS, 100, all different, free. Postage 2c. Mention paper. Quaker Stamp Co., Toledo, Ohio.

24 VARIETIES Cuban stamps, 10 cents. List of 6,000 low-priced stamps free. Chambers Stamp Co., 111 P. Nassau St., New York City.

### FORMULAS AND TRADE SECRETS

MECHANICS and Gunmen: \$1 will buy my recipe for bluing or browning steel, iron or guns. Same as manufacturers use. Requires no heating or machinery. Any druggist will furnish material for recipe for 35c, making two quarts. \$1 will buy my recipe for tempering springs making them unbreakable. Recipes guaranteed. Do you know of any gold dust gun powder? Paul Chubb, 341 E. Locust St., York, Pa.

BOOK filled with hundreds of valuable formulas, trade-secrets, 20c. Resilvering mirrors, guaranteed process, 20c. Sneezing and Itch powder 10c each. All postpaid 40c. Formula Bureau, 3311-D, Belleplaine Ave., Chicago.

AGENTS—Make and sell Furniture Polish. Formula \$1. Cole, 1309 Madison, Chicago.

500 VALUABLE formulas and complete encyclopedia of everyday wants. This splendid book, 10c. H. Essex, Box 476, Baltimore, Md.

SECRET of dry cleaning, \$1. Dyer, 818 West Jefferson St., Los Angeles, Cal.

FORTUNES in patent medicines. Formulas for rheumatic cure, pile cure, carbolated salve, \$2; or \$1 each. T. Collins, 22 East 25th St., Baltimore, Maryland.

SILVERING mirror formula (guaranteed) complete working instructions, 20c. Scientific Bureau, W. Lynn, Mass.

GRIT Hand Soap formula for a dime. John Pick, 580 E. Milwaukee, Detroit, Mich.

1,000,000 FORMULAS, trade secrets. \$1.50. Ragtime piano self-instructor, \$1. Ellemm, 667 Ocean, Jersey City.

EGG preserving formula. A new money maker. Gives perfect satisfaction. Complete process, 25c. Unique Novelty Co., Box 354, Springfield, Ill.

"NATURE'S Way" preserving eggs—no waterglass, brine, cold storage, nothing to buy. Complete instructions, 25c, was \$1.00. King Co., Box 13-P, Little Silver, N. J.

FORMULAS with directions for repairing rubber goods, making rubber cement, etching acid, sputterless soldering flux, invisible ink. Send dime in coin. Box 2138, East Bridgeport Conn.

FORMULAS for Anything—Chemical Analyses, tests, duplications. Satisfaction Guaranteed. Taylor Service Corporation, Dept. P.P., 220 Broadway, New York.

10 GUARANTEED formulas, 25c. Jackola, 304 Hancock St., Hancock, Mich.

### SAFETY BLADES SHARPENED

SAFETY Razors Resharpended Right, 2c each. Pay after you try blades. American Tool Co., Columbus, Ohio.

SAFETY razor blades sharpened 2c each. Barber, Box 234, Poughkeepsie, N. Y.

SAFETY razors sharpened; two cents each. Guaranteed. Blade box free. Electro Stropping Co., 134 Shelby St., Detroit, Mich.

SAFETY Blades sharpened, 2c each. Excel Razor House, Box 212, Poughkeepsie, N. Y.

### FOR MEN

FOR Sale—40,000 pounds best leaf tobacco; mail stamps for samples. Anton Wavrin, Franklin, Ky.

CLEAR Havana Cigars, the best cigars. Havana Balsamic Tubes, best short smoke. Direct service. Factory prices. Write today for particulars. A. Ramirez & Co., Factory, 1616 17th St., or Dept. M, Box 998, Tampa, Fla.

TOBACCO, choice natural leaf, 30c lb. delivered. Raymond L. Daniel, Owensboro, Ky.

SEND us your laundry by parcel post. Our specialty, high-class laundering of shirts and collars. We do custom work for stores and shirtmakers. There is a reason. Globe Laundry Co., 222-24-26 So. Morgan St., Chicago.

SAVE money on shoes! Factory to feet. You save retailer's profit and get better shoes. Fit and entire satisfaction guaranteed or money back. Style book free. Pathfinder Shoe Co., Dept. P, Dudley, Mass.

### FOR WOMEN

LADIES free, if you will send us the names of ten lady friends and 5c in stamps, we will send you our novelty catalogue and a handy household specialty absolutely free. Alvin T. Harpole, La Moine, Cal.

### FOR THE HOME

MAGIC cleaner. Clean your carpets and home and save money; make them look new. Send 50c for our cleaner, a wonder. G. B. Rudolph, 5897 Delmar Ave., St. Louis, Mo.

ROACH Powder—Send \$1 for one pound Taylor's O. K. Roach Powder. Guaranteed. O. K. Exterminating Co., 166 Michigan Ave., Detroit, Mich.

WANTED—Million readers try Brazil Ma-Ta. World's best drink; enroll your name today. Woodley Company, Importers, Shamrock, Texas.

BEAUTIFUL arts-crafts lamps—Anyone can make them out of paper, cardboard and wood. 16 designs. Inexpensive yet artistic. Complete book of instructions, Price, 50c, postpaid. Popular Mechanics Book Dept., 6 No. Michigan Blvd., Chicago.

EASY to Make Furniture—100 Modern Designs. Make your own. Save two-thirds cost. Price \$2. Crater & Holt, Grand Rapids, Mich.

LAMP Shade Frames, all descriptions, made to order. Cooley Mfg. Co., 553 W. Monroe St., Chicago.

### GAMES AND ENTERTAINMENTS

PLAY the President Map Game! Entertaining and educating map of U. S. in colors. Price 50c in money order. Circulars free. Agents wanted. Emil Berner, 119—7th St., Calumet, Mich.

CONJURING RECORD, monthly magazine of magical tricks. Sample, 5c. L. T. Bonner, 476 Clinton Ave., Brooklyn, N. Y.

67 TRICKS, 250 jokes—riddles, 73 toasts, 8 fortune telling secrets, 52 money-making secrets, 22 funny readings, 10c. 250 magic tricks with cards, coins, etc., 10c. Greenbacks, big bunch of stage money, 10c. Magic Bureau, 3311-D Belleplaine Ave., Chicago.

13 FUNNY Love letters, (read two ways) 10c. 3 nifty little books, 25c. J. L. Hardway, Normal, Ill.

MAGICIANS—We are headquarters for handcuffs, mail bags, strait jackets, milk cans, and everything in the escape line. Large new catalogue, which also contains a complete line of novelties, tricks, puzzles. Free. Oaks Magical Co., Dept. 50, Oshkosh, Wis.

FREE illustrated catalog. Modern Magic Co., 950 Cromwell Ave., St. Paul, Minn.

SEND dime for large package games. Englewood Trick & Novelty Co., 5716 Elizabeth St., Chicago, Ill.

GRAPEJUICE—A national farce. Latest fun out, 20 cents. Antigo Publishing Co., Antigo, Wis.

MAGIC Tricks, Books and Supplies. Largest line in the world. Large, 160 page, illustrated, professional catalogue, ten cents. See our advertisement on page 10, Chicago Magic Company, successors to Read & Covert, Dept. B, 72 West Adams St., Chicago, Ill.

250 MAGIC Tricks, and 13 Love Letters (reads two ways), 12c. Maple Co., 131 Maple, Napanoch, N. Y.

DOUBLE Throat, 10c. Fits roof of mouth; invisible. Throw your voice, make dogs, cats, horses, etc., talk. Sent postpaid with catalog, 10c. National Co., 307 E. 51st St., Chicago.

"VOICE Throwing"—10 Lessons in Ventriloquism, \$1. Prof. Magill, Rago, Kan.

LEARN to play a harmonica; copy-righted instruction book with concert harmonica for 35c (silver). Book separate, 12c; 5 songs; easy. Peter Montforte, Maritime Building, New York.

TOM Barker Baseball Card Game. The card game New York has gone crazy over. More action than whist, pitch or poker. The only baseball card game ever endorsed by big league players. 52 beautiful picture cards of star players in action. The card game the whole family can play. By mail 50c. National Baseball Playing Card Co., Inc., 18 B. Tremont Street, Boston, Mass. Agents wanted in every City and Town in U. S.

FREE! Free! 15c Card Trick, Ventriloquist's Double Throat, Folder on Magic, and Two New Bargain Catalogs of Latest Tricks, Jokes, etc. Reduced prices on everything. Send 10c postage. Douglas, Kiowa, Okla.

MAGIC Tricks for the stage, Ventriloquist figures, etc. Catalog 2c. Big Bargains, Magic Parlors, 64 Sabin, Providence, R. I.

WONDERFUL Set of Magic Trick Cards—10c. Startling transformations. Mystifies everybody. Walwen Co., 150 Nassau St., New York, Dept. 9.

GREENBACKS! Big bunch 10c. 3, 25c. Exchange, R24, 3827 North Kenneth, Chicago.

MAGIC Cards—Tell Fortunes—Predict Future Events. Entertain your company. Latest parlor amusement. Intensely interesting. Sent postpaid, 25c. Novelty Card Company, Box 1486, St. Louis, Mo.

BEST offer to students, actors, schools. Four hundred toast book, 25 cents. Comic Co., Columbus, Ohio.

TRICKS, jokes and puzzles, catalogs and 25-cent samples, five cents. Gilbert Novelty Co., 1128 Crescent, Morgan Park Station, Chicago.

YOU can be a magician, travel, give shows, earn money. I tell how. Send stamp. Prof. Rapp, Box 1115-F, Madison, Wis.



**MAGIC** pocket trick free. Worth 25c. With illustrated catalog of 250 tricks, puzzles, illusions for 6c. Stamps. Magic Co., Sta. 10, 249 West 38th St., New York.

**CHICKEN** Inspector Badges (latest joke), 10c pp. Percy Ewing, Decatur, Ill.

**PLAYS**, Vaudeville Sketches, Monologues, Dialogues, Speakers, Minstrel Material, Jokes, Recitations, Tableaux, Drills, Musical Pieces, Entertainments for all occasions. Make-Up Goods. Large Catalog free. T. S. Denison & Co., Dept. 11, Chicago.

### MUSIC

**BEGINNERS** can play Piano or Organ selections without teacher, immediately—not next month, by note—figures, or \$1,000 forfeit. Unparalleled in history of inventions. Thousands of grateful patrons. Write, Musician Self-Maker, 2800 Lake, Chicago.

**LEARN** to play piano without notes or teacher. Eliminate needless expense and tiresome practice. For young and old. Surprise yourself and friends. Write today for free particulars. Send 25c and we will mail regular 50c diagram method of playing chords. Elkins Mfg. Co., 2602 Elmwood Ave., Kansas City, Mo.

**LEARN** to play piano without notes or teacher. Only few hours practice required. Play anything. Simple, effective system. Write today for free particulars. James B. Carr, 3921 N. Scott Ave., Chicago.

**ALL** the favorite old songs. Words and music complete in book form with attractive cover. Size 7½x9½ inches; good value. Price 50 cents, postpaid. Popular Mechanics Book Dept., 6 No. Michigan Blvd., Chicago.

### PIANOS AND MUSICAL INSTRUMENTS

**REGINA** coin-operated piano, spring motor model, cost \$500, sell \$75 cash. Condition guaranteed good. Fine instrument for cafe or picture show. Rubel, Mobile, Ala.

**ELECTRIC** Pianos, \$100, terms, catalog. Continental Novelty Co., Omaha, Neb.

### DUPLICATORS AND DEVICES

**WRITER-PRESS**—Perfect typewriter imitation letters, cost \$165, price \$65. General Auto Co., 212 E. 5th St., Cincinnati.

**THE Modern** Duplicator, made without glue or gelatine, is the World's Standard. Fifty to seventy-five exact duplicate copies can be made from each one you write or draw with pen, pencil or typewriter. \$2.40 to \$6.00 according to size. Booklet free. Durkin, Reeves & Co., Mfrs., 339 Fifth Ave., Pittsburgh, Pa.

**HOW** to get a Hektograph that will make 150 copies in 10 minutes; letter size, \$2. Write for circular. Heyer Duplicator Co., 118 No. La Salle St., Chicago.

### MAILING LISTS

**ANY** classification—anywhere. Mention kind wanted. "Nisco"—SDB—Cincinnati. 6,000 LIVE bonafide agents' names, \$1.00. Morgan, 312 Madison, Chicago.

**FREE** to business men, copy of our comprehensive "Silent Salesman." Contains over 2,000 different classifications of mailing lists with number and price of each list, and information every business man needs. Accept this free offer. Trade Circular Addressing Co., G 164½ W. Adams, Chicago.

### TYPEWRITERS AND SUPPLIES

**1c SHEET**—Acme Brand Best Carbon Paper. Constant repeat orders of satisfied customers is the secret of our low price. Sample sheet free. Low Cost Co., 504 Kemper Bldg., Kansas City, Mo.

**UNEQUALLED** values; rebuilt Underwoods, Oliviers, Royals, Foxes, \$24.50; Remingtons, Smiths, \$14.50; binding guarantee; free trial; exchanging, repairing. Consolidated Typewriter Exchange, 243 Broadway, New York.

**TYPEWRITER** Bargains, all makes; slightly used and rebuilt; lowest prices, bar none; satisfaction assured. We save you \$18. Typewriter Sales Co., Ferguson Bldg., Pittsburgh, Pa.

**FOX** Typewriter; all improvements; cost \$102.50; first \$30 takes it. Foxall, Cumberland, Md.

**BENNETT** Typewriter Co. \$18 mailed. Perfect. 6814 Minnesota, St. Louis. Instructions free.

**\$15 TAKES** an elegant, slightly used 100 Typewriter. N. Theim, 3945 Prairie Av., Chicago, Ill.

**DON'T** fail to get our bargain sheet before you buy that typewriter. The M. & M. Typewriter Co., 118-A, No. LaSalle Street, Chicago.

**WRITE** for our special circular "C" for the best offer ever made on typewriters. Young Typewriter Company, 62 West Madison St., Chicago.

**ONE** guaranteed typewriter ribbon 35c or four for \$1 postpaid. Any machine, any color. Mayhim Chemical Company, Cleveland, Ohio.

**GET** our catalogue sixteen, convince yourself our prices of typewriters are lowest. General Office Supply Co., 212 E. 5th St., Cincinnati.

**PICK** out your typewriter and pocket your saving. Typewriters rebuilt in our own factories and guaranteed for one year. Remingtons \$25 to \$65, Smith-Premiers \$23 to \$60, Underwoods \$35 to \$60, L. C. Smiths \$30 to \$50, Royals \$30 to \$46, Oliviers \$30 to \$40. We have all makes. Send for catalog, address of nearest branch office. American Writing Machine Co., Inc., 345 Broadway, New York.

### PRINTING AND ENGRAVING

**1,000 CARDS \$1**; Envelopes \$1.25; Letter Heads \$2. Samples 2c. Artist Press, M 144, W. Superior, Chicago.

**YOUR** name printed on 100 finest quality cards, 30c. Address 10c extra. Script or plain. Owen Dicks, Kenmore, N. Y.

**100 LETTERHEADS** and 100 Envelopes, 90c, postpaid; 1,000 Manila Return Envelopes, \$1.50. Mail Printer, 908 Walnut, Philadelphia.

**GUMMED** Labels, 3,000, \$1. 38p. catalog, 2c. MacTaggart, 1233 Arch, Philadelphia, Pa.

**250 PRINTED** Bond Envelopes and Letter-heads, \$1. 1,000 Bill-heads, Statements, Letter-heads, Envelopes or Cards, \$2. 1,000—100 word Bond Circulars \$1. Samples free. Mercantile Press, 305 East Fifty-first Street, Chicago.

**100 NOTE** Heads and 100 Envelopes 75c. Business Stationery, Cards, \$2 per 1,000. Samples for stamp. The Letterhead Shop, 4107 Colorado Ave., Chicago.

**YOU** wouldn't hire a bum for a salesman. Why use "bum" printing? White Printing Co., Coudersport, Pa.

**50 ENGRAVERS'** style visiting cards, printed 25c (coin) postpaid. Meredith, 296 North St., Rochester, N. Y.

**ATTRACTIVE** printing quick; 100 bond letterheads, envelopes, billheads or business cards, 50c, postpaid. Samples. Race Bros., Hudson, N. Y.

**PRINTED** Envelopes—Buy direct from maker and save money. 3,000 lots \$1.50, per M—5,000 lots \$1.25, per M—10,000 lots \$1 per M. Good white stock; prices include printing. Workmanship guaranteed. N. E. Paper Goods Co., Springfield, Mass.

**PRINTING**—500 either noteheads, envelopes, statements, cards, \$1; 1,000, \$1.50; 1,000 linen finish letterheads or envelopes, \$2.50; 1,000 typewriter letters, \$2. Samples. Model Company, Manchester, Iowa.

**PRESS** and outfit, value \$75, for \$18. United Printing Co., Wilkensburg, Pa.

**1,000 IMITATION** Typewritten Letters, heading black, body purple, \$3. 6x9 Circulars, Envelopes, Statements, Tags, Bill-heads, Cards, \$1.50. Samples free. Good's Printery, Harrisonburg, Va.

**100 FANCY** printed envelopes 50c postpaid. W. Randall, Manna, Sask., Canada.

**EMBOSSD** Letterheads and Envelopes price of Common or Flat Printing. Send for samples. Turner & Dunlap, Wilkesbarre, Pa.

**50 ASSORTED** Comic Cards printed with your name, 25c. Retter, Box 142-P, Tippecanoe City, Ohio.

**125 WHITE** Bond Letterheads and 125 Envelopes, printed, \$1, prepaid. B. Lutz Printing Co., York, Pa.

**GUMMED** Labels—3,000, \$1. 1x2 inches. Catalogue Free. Helmers Company, Hoboken, N. J.

**1,000 LETTERHEADS** or Envelopes, \$2.50; 5,000 or more, \$1.75. Blackledge Specialty Co., 1805 Reed Street, Philadelphia, Pa.

**PRINTING**—100 cards or envelopes, postpaid, 40c. Other work. Good, reasonable, prompt. Get my prices. E. D. Murdock, 183 E. Tioga St., Tunkhannock, Pa.

**YOUR** Name on 200 gummed labels, 10c. Starr Co., Clintonville, Conn.

**DIGNIFY** your correspondence. 100 letterheads and envelopes printed on excellent bond, \$1, prepaid. 500 letterheads or envelopes, \$1.50. 1,000 for \$2.50. Samples free. Proper printing. Robison Printery, Curwensville, Pa.

**PRINTING** Presses, type, supplies. Catalog free. L. M. Carroll & Co., 326 Madison St., Chicago.

**PRINTING** Presses, supplies, second-hand, at bargains. List for stamp. Popular Bargains, Richland, Pa.

**1,000 PURPLE** Multigraphed Letters, black heads printed and stock complete, \$2.75; 500, \$1.85. Specimens free. Perfection Letter Company, Muncie, Ind.

**GOOD** Printing at low prices. 1,000 good letterheads, envelopes, cards, billheads, labels, circulars, \$2.50. Samples free. Catalogues, booklets, and circulars our specialty. Ernest L. Fantus Co., 523 S. Dearborn St., Chicago.

**500 BUSINESS** Cards printed to your order, 75c. Geo. Birt, Russell Ave., Indianapolis, Ind.

**CUT-Rate** Multigraphed Letters. Letterheads. Schwartz Brothers, Congress St., Detroit, Mich.

### PATENT ATTORNEYS

**PATENT** Books Mailed Free—Showing 100 mechanical movements invaluable to inventors and mechanics—and telling what is patentable, how to obtain patent or partner, how to sell, etc. Free on request. Chas. E. Brock, 701 Eighth Street, Washington, District of Columbia.

**PATENT** your invention—Send sketch for free expert search and report as to patentability. Books on inventions and patents, and book of references from congressmen, manufacturers, bankers and inventors sent free. John S. Duffie & Co., 610 F St., N. W., Washington, D. C.

**PATENT** your invention. \$20,000 offered for inventions wanted. Booklet and opinion free. Milo B. Stevens & Co. Established 1864. 685 F St., Washington; 353 Monadnock Block, Chicago.

**PATENT** what you invent. It may be valuable. Write me. No attorney's fee until patent is allowed. Estab. 1882. "Inventor's Guide" free. Franklin H. Hough, 522 Loan & Trust Bldg., Washington, D. C.

**THE PATENTOME** is interesting and instructive. A liberal education in patents and how to get them. Free on request. Established 1865. Anderson and Son, Patent Solicitors, 707 G St., Washington, D. C.

**"PATENTS** and Patent Possibilities," a 72-page treatise sent free upon request; tells what to invent and where to sell it. Write today. H. S. Hill, 905 McLachlen Building, Washington, D. C.

**PATENTABLE** ideas wanted—Send for 3 free books. R. B. Owen, 39 Owen Bldg., Washington, D. C.

**ADVICE**—Best on inventions, free. Write immediately. A. P. Connor, Electrical Mechanical Engineer, Patent Attorney, Lawyer, Washington, D. C. Highest recommendations.

**ADVERTISE** your invention. Why wait until patent is issued before making plans? Let us help you find your market. Direct advertising service. Peyton Annex, Spokane, Wash.

**\$36—INVESTIGATE** special proposition which gives guaranteed patent protection at smallest cost. Inventors' Service Co., Washington, D. C.

**CASH** for Ideas. Patent News, Dept. 29A, Washington, D. C. Only inventor's paper. 3 months' trial 25c.

**PATENTS** procured; prompt, reliable service; terms low; large prizes offered for certain inventions; get my list of inventions wanted; send 4c for new book, "The Last Word on Patents;" send sketch of your invention today. Sanders, 7 Webster Building, Chicago, Ill.

**NO** Attorney fees until patent allowed. Send sketch for free report. Books free. Fuller & Fuller, Washington, D. C.

**PATENTS** and Trade Marks, electrical and mechanical a specialty. Book Free. Joshua R. H. Potts, Patent Lawyer, 8 Dearborn St., Chicago; 805 G St., Washington; 929 Chestnut St., Philadelphia.

**JOHN R. WOODWORTH**, Registered Attorney. Wardur Building, Washington, D. C.

**PATENTS** build fortunes for you. Our free booklets tell how; what to invent, how to choose an attorney. Write today. D. Swift, 317 Seventh St., Washington, D. C. Established 1889.



OFFICIAL Drawings Free. Patents procured or fee refunded. Expert services. Send sketch for free search. The Patent Exchange, Joban Bldg., Washington, D. C.

FOR Honest advice and real patents at Low Cost, consult John O. Seifert, Patent Attorney, 50 Church St., New York.

PATENTS that protect and pay. Advice and books free. Rates reasonable—highest references; best results. Watson E. Coleman, Patent Lawyer, 622 F St., N. W., Washington, D. C.

INVENTIONS Worth Thousands—Their value is governed by the strength of the patent. Get the advantage of our 39 years' experience in procuring your patent. Clients in your state. Write and send sketch. Louis Bagger & Co., 609 Barrister Bldg., Washington, D. C.

C. L. PARKER, Ex-member Examining Corps Patent Office, Patent Attorney, 910 G St., Washington, D. C. Inventor's handbook "Protecting, Exploiting and Selling Inventions," sent free upon request.

PATENTS—Herbert Jenner, patent attorney and mechanical expert, 606 F St., Washington, D. C. I report free of charge if a patent can be had and its exact cost. Send for circular.

PATENTS explained in my free books, telling what you should know—what to invent—what not to invent—how to sell your patent, etc. Write today, H. L. Woodward 902 G St., Washington, D. C.

PATENT secured or fee returned. Send sketch for Free Expert Search and report as to patentability. Books on inventions and patents, and reference book sent free. John S. Duffie & Co., 605 F St., Washington, D. C.

PATENTS Secured—Take advantage of my personal experience; send sketch or model. Get my free book containing 200 mechanical movements. W. N. Roach, Jr., 950 McGill Bldg., Washington, D. C.

#### FOR INVENTORS

WANTED—An Idea! Who can think of some simple thing to patent? Protect your ideas; they may bring you wealth. Write for "Needed Inventions" and "How to Get Your Patent and Your Money." Randolph & Co., Patent Attorneys, 620 F St., Washington, D. C.

PATENTABLE ideas wanted—Send for 3 free books. R. B. Owen, 30 Owen Bldg., Wash., D. C.

INVENTORS—Every known Mechanical Movement, Power, Device and Appliance. \$5. Francis Lightle, Belmont, Iowa.

PATENTS sold on commission. Inventions perfected—Ideas developed. I guarantee utmost satisfaction or no pay. Expert in the development of patents. Legal and technical advice free. R. S. Shelmo-Jacobsen, Consulting Engineer, Dept. C. 452 Peoples Gas Bldg., Chicago, Ill.

EMPLOY those who know. Write for our free advice before procuring a patent. Inventor's Guide, Washington, D. C.

HOW to sell Patents. Our valuable book tells you. Plainly written. \$1 prepaid. Worth \$5.00. Satisfaction guaranteed. Mutual Service Bureau, 3311-DP, Belleplaine Ave., Chicago.

INVENTIONS patented and sold, or manufactured on royalty. Send yours to Adam Fisher Mfg. Co., 61 Fisher Block, St. Louis, Mo.

INVENTORS. If you want help with your invention, or information on Developing, Patenting, Costs, Materials, Drafting, Manufacturing, Selling, etc., send for our "Help Card." Charles A. Scott, 586 Central Bldg., Rochester, N. Y. Established 1900.

PATENTS without advance attorney's fees. Send sketch for free report. Books free. Fuller & Fuller, Washington, D. C.

INVENTORS: My patent made a fortune. Particulars free. Let me sell yours. Eugene Pearl, 23 Union Square, New York.

PATENTS, Trade-Marks and Copyrights. Our handbook on patents will be sent free on request. All patents secured through us are described without cost to the patentee in the Scientific American. Munn & Co., Patent Attorneys, 359 Broadway, New York. Washington, D. C. office, 333 F Street.

PATENTS sold. We do the business—not merely collecting advance fees. If you own a valuable patent send for a free booklet. "How I can get cash for your invention." No charges made for listing. Patent Advertising & Sales Co., Frankford, Phila.

#### PATENTS FOR SALE

FOR Sale—"Patented Invention" that will save the cotton compressors millions of dollars. Investigate. Box 947, Wichita Falls, Texas.

\$1,000 BUYS patent No. 1009014 on water-motor or steam pump; very simple. Cheap to construct. B. J. Baskerville, Joliet, Ill.

VALUABLE Patents for Sale or Royalty. Write for full information. F. C. Luethi, Inventor, Stoughton, Wis.

CATTLE Stanchion Patent No. 1,071,136, self-closing, very simple, good seller; reason for selling, no capital. E. Branschreiber, Zachow, Wis.

SHOCK Absorber, 1,029,478, simple, efficient, cheap; best offer takes. Walter Sturgeon, Sterling, Kan.

FOR Sale or Royalty—Patent portable burglar alarm for homes and travelers' use. A necessity. M. T. Morgan, Anaconda, Mont.

PATENT on grease gun for sale. Andreen, 942 Gates Ave., Brooklyn, N. Y.

BEST cash offer takes improved quick-acting wrench, U. S. and Canadian patent. Paul Natzmer, South Soles St., McKeesport, Pa.

U. S. PATENT No. 1,081,000, Car window cleaner, cleans window while car in motion. Particulars. J. W. Ruben, Portland, Ore.

PATENT for Sale—Adding Pump Counter. Box 635, Marshall, Minn.

FOR Sale—U. S. and Canadian patents (Invisible Shoe Fastener), no lacing or buttons; better investigate; best offer takes them. Hopkins & Woods, Vine Grove, Ky.

FOR Sale, cheap, a new invention, spool holder for crocheting; every woman wants one. Investigate. Ollie Buskohl, Cheyenne, Wyo.

WILL sell reasonable, a good patent watering stock fountain. Will keep water warm in coldest weather. First offer takes it. Emil Odegard, Elkton, S. D.

\$500 CASH buys my patent on Station Indicator; will trade. Carl Duede, Box 144, Stuart, Iowa.

U. S. PATENT, on ink well pen cleaner, needed in every office and home. Copy on request. John L. Diven, Livermore, Pa., R. 2.

HAVE you a Patent to sell? You'll be interested in my proposition. Write now for free particulars. F. W. Johnson, 6 No. Michigan Blvd., Chicago.

WILL sell Patent Roach Exterminator. N. Levi, 2603 Wylie Ave., Pittsburg, Pa.

PATENT for sale, No. 976061, display stand that can be used in any store or store window. A bargain if taken at once. Wm. Gaethje, Rock Island, Ill. Box 38.

TOBACCO pipe patent. Something new. W. T. Kline, Mifflinburg, Pa.

FOR Sale or Trade—all or part of U. S. patent on spark plug, the only plug made having interchangeable electrodes; if interested send \$1 for sample plug. G. O. Terry, 3511 24th Ave. So., Mpls., Minn.

WILL sell 1/2 or entire interest in patent commercially good. C. J. Webster, Osceola, Nebr.

\$1,500 BUYS Pat. No. 1077707 combination Drinking Fountain and Faucet. Box 483, Richmond, Cal.

WILL sell U. S. and Canadian patents Ladies' and Gentlemen's vest-pocket Portable Hat Holder, easily adjusted without marring the support. Fine for public places. Good advertising novelty. E. L. Meyer, Cucamonga, Calif.

WANTED—Partner to finance visible draw stroke safety razor blade stropper. Patented. J. Donahue, 4524 Spruce St., Phila., Pa.

NEWEST creation in automobile life. New type of automobile tire that will do away with troublesome rubber tires. Absolute non-skid. Does not injure pavement. Can be attached to any wheel. Investigate. Edward Jacob, 2349 Cambridge Ave., Chicago, Ill.

HAT Fastener; securely fastens hats on woman's head, without use of hatpins, eliminating all hatpin dangers, and pinholes in hats. Quickly removed from one hat to another. Investigate. Yancey & Dumesnil, General Delivery, Chicago.

#### MODELS AND MODEL SUPPLIES

INVENTIONS perfected and manufactured. Reference, your own banker. Russell Machine Co., Dallas.

INVENTORS: We manufacture metal articles of all kinds, to order. Also, special machinery, tools and dies, punchings, lathe and screw machine work, metal spinnings, castings, plating, wood and metal patterns, etc. Send sample for estimate and expert advice, free. The Eagle Mfg. Co., Dept. B, Cincinnati, O.

FREE catalogue of model supplies. Castings, metal specialties on contract. North Chicago Tool Works, 15 Grove Ave., North Chicago, Ill.

WE make working models for inventors; also dies and stamping of specialties, and carry a complete stock of brass gears and model supplies. Send for catalogue. The Pierce Model Works, 3405 Pierce Ave., Chicago, Ill.

INVENTORS—Our staff of skilled mechanics assist and co-operate with customers to develop and perfect inventions of every description. We build first-class demonstrative models, miniature or regular full-sized machines for inventors, promoters, patentees, salesmen, patent office and manufacturers. Electrical and mechanical experts. Scientific and experimental work a specialty. Write today for further particulars. Regal Model & Tool Works, "Chicago's foremost model works," 122-128 S. Clark St., Chicago.

MODELS made for inventors; general machine work; designing and perfecting; developing automatic devices and machinery. In a position to do all kinds of light tool and machine work. Prices reasonable; estimates cheerfully given. Ideal Machine Works, 62 Ann Street, New York City.

INVENTIONS Perfected: Working Models Made: Dies, Tools, Special Machinery. Free Booklet. Black Diamond Mfg. Co., Cincinnati, O.

FREE catalogue of model supplies. Castings, metal specialties on contract. North Chicago Tool Works, 15 Grove Ave., North Chicago, Ill.

#### REAL ESTATE AND FARM LANDS

FARMS, Business Properties, any kind anywhere; all prices; no commission to buyers; tell us your wants. Interstate Realty Co., Durango, Iowa.

MEN of ambition prosper in the Southeast. Small capital with energy will accomplish wonderful results. Dairy, stock, fruit or poultry will make you independent. Land sells from \$15 an acre up. Growing season from 7 to 10 months' duration. Modern schools, good highways and churches. "The Southern Field" magazine and farm lists on request. M. V. Richards, Land and Ind. Agt., Room 64, Southern Ry., Washington, D. C.

VIRGINIA is the land of performance; farmers live well and make money; short winter, long growing season and abundant rainfall enable two and three crops a year. Write F. H. La Baume, Agri. Agt., Norfolk & Western Ry., Room 250, N. & W. Bldg., Roanoke, Va. Booklets, maps, etc., on request.

ALFALFA Farms with live-stock yield greatest. Surest profits. Pump irrigated. Soft, pure water inexhaustible. Ideal climate. 338 days sunshine 1913. 20 acres means living and \$1,500 yearly. S. W. Alfalfa Farms Co., 707 Fisher Bldg., Chicago.

FOR Sale—Section of good land near big steel plant and railroads in vicinity of Duluth and Superior, in Wisconsin. Snap and liberal terms; 1/2 mile from shipping station. G. H. Rhodes, Iowa Falls, Iowa.

MONEY-Making farms, 21 states, \$10 to \$50 an acre; live stock, tools and crops often included, to settle quickly. Big special bargain list, free. E. A. Strout Farm Agency, Station 3043, 47 West 34th St., New York.

40 ACRES level, rich soil, 10 cleared, house, barn; price \$800. Tom O. Mason, Cumberland, Wis.

BEARING Orange Orchard. Bargain. Good reasons for selling. E. T. Molyneux, Fairhope, Ala.

STOP! Read this, then write for description and photo of my improved 180-acre farm. Gustave Beske, New Rome, Wis.

ATTENTION! Speculators! Investors! \$1.00 down, 50c per week buys a full size city lot in Chicago subdivision. No interest. No taxes. Everyone can save enough to buy a lot on our liberal plan. Double and treble your money in a short time. Real Estate Values steadily increasing. For particulars Address Chas. A. Gray Co., First National Bank Bldg., Chicago.



**CENTRAL Minnesota** — 100 Improved Farms; low prices, easy terms. "A good time always." Write for list. C. D. Baker, Box 15, Fergus Falls, Minn.

**CHICKEN PLACE**—10 acres, Missouri, 19 hens, 3 pigs, incubator-brooder. Sell out \$340. Cash \$12. Weekly \$1.38. Mottaz, 705 Olive, St. Louis, Mo.

WRITE us before you buy or sell. Bargains everywhere. Inquiries daily. "Nisco"—XDB—Cincinnati.

YOU Can Get An Irrigated Farm In Northwest Texas on very favorable terms. Climate, soil, living conditions fine. Our new book, "The Shallow Water Country," tells the story simply, directly. We want you to have this book. A postal to me will bring it. C. L. Seagraves, Gen. Col. Agt., AT&S Ry., 1960 Ry. Ex, Chicago.

\$39,940, TERMS, buys stocked 1065 10/100 operated Missouri Ranch, 66, Lakeworth, Fla.

2,500,000 ACRES of free Government land thrown open this spring. Everyone can get 160 or 320 acres. We furnish revised lists, locating the land; maps, guides and full particulars. Write us to-day. Webb Publishing Company, Dept. 71, Webb Building, St. Paul, Minn.

"DAIRY Farms, fully equipped; Free list, Ellis Bros., Springville, New York.

FERTILE farms, near Philadelphia, mild climate, excellent markets. Catalog. W. M. Stevens, Perkasee, Pa.

WANTED Information. Good farm for sale. Send full description. Western Sales Agency, Minneapolis, Minn.

LANDOLOGY, a magazine giving the facts in regard to the land situation. Three months' trial subscription, free. If for a home, or as an investment you are thinking of buying good farm lands, simply write me a letter marking it personal and say, "Mail me Landology and all particulars free." Address Lloyd M. Skinner, Gen'l Mgr., Skidmore Land Co., 40 Skidmore Bldg., Marinette, Wis.

FREE booklet about farms, homes. State Board of Agriculture, Dover, Del.

FARMS for sale or exchange anywhere in the United States or Canada direct from the owners. Information free. American Investment Association, 37 Palace Bldg., Minneapolis, Minn.

#### DOGS, BIRDS, POULTRY, PETS.

VICTOR Mange Cure for dogs and cats, warranted to cure the most severe cases, or money returned; price, \$5. C. M. Griffin Sales Co., Framingham, Mass.; Dept. 7.

NEWCASTLE Kennels, Brookline, Mass. Scottish terriers. Write us for pamphlet.

THOROUGHbred High Grade White Plymouth Rocks. Eggs \$1.50 setting. Frank H. Stevenot, R. 7, Mt. Sinai, N. Y.

POULTRY band. Latest adjustable. Samples 2c. "Hawkins," Raton, N. Mex.

AIREDALE Puppies. Pedigreed, inexpensive. W. A. Lowber, Burlington, N. J.

ROSE Comb Buff Leghorns and eggs from Chicago winners. Mallard ducks, \$3 pair. Bantams. Frank Morris, Galena Road, Aurora, Ill.

POULTRY paper, 44-124 page periodical, up to date, tells all you want to know about care and management of poultry, for pleasure or profit; four months for 10 cents. Poultry Advocate, Dept. 3, Syracuse, N. Y.

AIREDALE Terriers and Scotch Collies. State wants? Sales list free. Phil Savage, St. Charles, Ill.

#### MISCELLANEOUS

DETECTIVE-PHONE—Make one yourself. You can hear a whisper. Plans and information, 25c. Lobe Mfg. Co., 167 W. 102 St., New York City.

PEARLS bought and sold. Laverne Mapes, Indiana Harbor, Ind.

DO you want to go on the stage? Be a Handcuff King. I will teach you how; for particulars address Box 902, Springfield, Mass.

WE analyze everything. Reliable formulas furnished. Expert chemists. Research Laboratories, 721 East 161 St., New York.

MOTORMAN'S Star Nonmagnetic Watchholder to any address, 35c. W. C. Williamson, Box 85, Wilkesburg, Pa.

FIVE dollars buys Auto Folding Sub Car. Slight pressure of either foot sends you to any desired point under your car. Folds and goes in tool box. Agents wanted. Auto Folding Sub Car Co., Zanesville, Ohio.

RARE Bargain—Calendar Pencil Clip, 10c. Leonard, 1773 Ainslie, Chicago.

BRASS Nameplates, 25—\$1; 100—\$2. Bonnell, 3847 Calumet Ave., Chicago.

MACHINISTS, Patternmakers, Draftsmen, Electricians and Experimenters Standard Gear Charts with formulas 50c. Wire Resistance Charts 25c, 6 in. Static Machine blueprints and instructions 50c. Beginners' Slide Rules 50c, with correspondence instruction. Valuable Blueprints, Formulas, Tables, etc. Winterborne Engineering Works, Dept. 2, San Antonio, Texas.

HOW to Solder Aluminum. How to make the solder, 25c. J. Eaton, 4512 Colorado Ave., Chicago.

RENEW old dry batteries. We guarantee you can at low cost. Formula and instructions 25c; regular price \$1. If dissatisfied we'll send you quarter back! Northern Supply Co., 154 Randolph, Chicago.

MENDALL mends tears in clothing, rubbergoods, Umbrellas, kid gloves, automobile tops. Hundreds of articles mended for 25c, postpaid. Miller Co., 152 Rochester, Pa.

FOUNTAIN Pen, Standard make, 50c, supply limited; send at once. Box 35, Lewistown, Mont.

SINGLE column copper halftones seventy-five cents. Rishell, Engraver, Havana, Ill.

INITIAL pennant watch fob, for silver dime. Wener, Moneta, Cal.

SPEARMINT sprigs sell themselves. Used for garnishing meats, salads, mint juleps. 25 plants \$1. J. E. Timm, Centreville, Mich.

HUNDREDS agents, canvassers, mail-order business opportunities offered in Digest. 25c for one year. Digest, Grand Rapids, Mich.

CURIOS, Photos, Moonstones, Agates, Orchids, Souvenir from Culebra Cut and Panama guide 25 cents silver. Canal Curio Co., Box 65, Ancon, Panama.

LEATHER Pocket-book with seven compartments, your name printed in gold and thirty cards printed, sent prepaid for \$1. Harry A. Jones, Emporia, Kan.

LEARN to braze or hard solder cast iron. We teach you how with each \$1 package of "3A" Cast Iron Brazing Compound. A. A. Allen & Co., 3935 Lake Park Ave., Chicago.

DECORATE your suitcase, six hotel stickers from different sections of country 25c. Elbert Hall, Fitchburg, Mass.

WANTED to handle all kinds of novelties and cheap household articles. B. J. Haley, P. O. Box 559, Denver, Colo.

STACKLAC—The best High Heat Resisting Paint on the market. For smokestacks and hot gas lines. Cliff Schmidt, Aspinwall, Pittsburgh, Pa.

FLEXIBLE rubber stamps, rubber type, steel dies, metal badges, seals, stencils. Catalogue 10c. Buckeye Stamp Works, Market, Dayton, Ohio.

"SEPTEMBER Morn" on a beautiful felt pennant to any address prepaid 50c. Japanese Art Co., 4410 Princeton Ave., Chicago, Ill.

ALASKA Curios, Illustrated catalogue free. Address Standley's Olde Curiosity Shop, Seattle.

FRATERNITY. Solid gold button, 50c worth \$1; any Society with lodge members, money-making proposition. Stanly, Cornhill, Boston.

BASEBALL Fans! A beautiful black leather fob, gilt buckle, metal green finish, set with white brilliant and figure of baseball player in satin gold finish. 25c postpaid. Eagle Co., Box 303, Rochester, N. Y.

BE up-to-date. Have distinctive stationery. Emboss it yourself. Samples and particulars for stamp. Miller Sales Company, Dept. M, Lexington, Ky.

RUBBER stamps are indispensable. Line 15c. Catalogue free. Brabec, 3717 W. 26th Street, Chicago.

INDIAN Baskets and Relics. Price free. Gilham, Highland Springs, Cal.

PATENTS build fortunes for you. Our free booklets tell how; what to invent, how to choose an attorney. Write today. D. Swift, 317 Seventh St., Washington, D. C. Established 1889.

GRANDFATHER'S Clock Works, \$5. Slightly shop-worn, quantity limited, others with chimes, all prices; also several nice Grandfather's Clock cases, exceptional bargains. Clock Company, 1673 Ruffner St., Philadelphia, Pa.

I WILL start you earning \$4 daily at home in spare time, silvering mirrors; no capital; send for free instructive booklet, giving plans of operation. G. F. Redmond, Dept. 306, Boston, Mass.

TOBACCO-CURE—One box cures. Guaranteed or money back. Established 1894. Write for special offer. Allen Distributing Co., 3609H Wabash Ave., Kansas City, Mo.

CUTS anybody can make. Simple Etching Process, \$1. Particulars, specimens, for stamp. M. Day, Windfall, Ind.

**How to Write** and **PHOTO PLAYS**  
No experience needed. New easily mastered method. Indorsed by Jack London and other famous writers.  
Get into the Big Money-Making Profession  
**FREE BOOK "HOW TO WRITE"** tells how famous authors got their start; amounts they earn; how you can succeed. Send today for free book and limited offer.  
Author's Training School, Dept. 1194, Buffalo, N. Y.

## This Suit Yours

To learn how you can have a swell tailored suit without cost (we pay express) make \$10.00 every day; to learn what beautiful tailoring really is; to offer styles that everybody goes wild about; to get all your own clothes easy, do this now—write us and say "Send me your New Wonderful Tailoring Offer," and you will receive a beautiful set of samples and styles to pick from, and an offer so good you can hardly believe it. No money or experience needed. Your spare time will do. Write now—sure. Don't answer unless you live in a small town under 10,000. Address

**BANNER TAILORING CO.**  
Dept. 702 CHICAGO



**LEARN PIANO TUNING AT HOME**  
Our patented TUNE-A-PHONE simplifies learning, removes guesswork, assures accuracy. Musical ear NOT required. We furnish Action Model & tools. Diploma granted. Guaranteed as represented. Write for FREE illustrated book. NILES BRYANT SCHOOL, 216 Art Inst., Battle Creek, Michigan.

**EARN \$5 TO \$15 A DAY**

**To Make The INGERSOLL WATCH**  
finer, more perfect, a greater dollar's worth, is the constant aim of its creator—his every present ideal. Buy "the Watch That Made the Dollar Famous."  
Models at \$1.00, \$1.50, \$2.00 and \$2.50. All Dealers.  
**ROBT. H. INGERSOLL & BRO., 68 Ashland Building, NEW YORK**

**The Boy Mechanic**  
**GREATEST BOYS' BOOK PUBLISHED**  
Describes 700 Things for Boys to Make and has 1,000 Illustrations. Price \$1.50 Prepaid  
**POPULAR MECHANICS BOOK DEPT.**  
6 N. Michigan Blvd., CHICAGO





# "I'll Pay You \$175<sup>00</sup> per Month!"

That's what many a Superintendent or Manager has said to our Graduates. That's what he'll say to YOU. It's not out of the ordinary. It's not impossible. In fact, it's just what **will** happen if you become a trained man. We teach **only the Best Paying Trades. Electricity, Plumbing, Bricklaying, Drafting and Designing and Moving Picture Operating.** No needless theory. The **Actual and Practical** work done in the Schools. Expert Instructors. Complete Equipment. Instructions given with tools, instead of books. No previous training required.

## You Can Earn While You Learn

Everything has been arranged for the benefit and convenience of our students. Day and night classes—whichever you prefer. We assist you in earning your way through School. Employment Bureau places graduates in good paying positions Free.

## 1,000 Young Men Needed

As Electricians, Plumbers, Bricklayers, Draftsmen & Moving Picture Operators

The demand for men skilled in these trades is far greater now than ever before. Glance over the "Help Wanted" columns of the city newspapers and technical magazines and see the hundreds of calls for men trained in these Profitable Trades. They pay \$5.00 to \$8.00 a day all over the country. **Exceptional opportunities for starting a business of your own.** We give you the kind of training necessary and assist you in starting a business of your own.

## Mail Today

Fill in this coupon and mail today. We'll send you our School Catalog "Trades That Pay" and full particulars.

Everything sent to you **FREE AND PREPAID.** Let us tell you how YOU can earn \$175.00 a month—after a short, thorough training in our Schools. Get the facts at once—Mail coupon NOW—while you think of it.

L. L. COOKE, Director  
**COYNE NATIONAL TRADE SCHOOLS**

Dept. 1194  
51 East Illinois St., Chicago  
Oldest, Largest and Best  
Equipped Trade Schools  
in America

Mail  
Today

L. L. COOKE, Director  
**COYNE NATIONAL TRADE SCHOOLS**  
Dept. 1194

51 East Illinois St., Chicago, Ill.

Dear Sir:—Please send me your Catalog "Trades That Pay" and full particulars of how I can become an expert and earn \$175.00 a month. Send everything **FREE AND PREPAID.** I assume no obligations.

Name .....

Address .....



WE OCCUPY ENTIRE BUILDING

COME TO CHICAGO, THE BUSIEST CITY IN THE WORLD



# This Complete Library of **LAW** IN 6 HANDY VOLUMES Only \$1 a Month



**"Ignorance of the law excuses no man"**  
THAT'S LAW. You can't always "guess" the law. You may not have time to "study" law. Lawyers come high—especially some of them. **BUT YOU MUST KNOW LAW.**

**T**HIS splendid little handy LIBRARY OF LAW is prepared for the average man—the business man—the doctor—the teacher—the minister—the man who works for others—the man who works for himself—the man who writes—the man who has money and the man who has not—EVERY MAN. This Library is a work to read at odd times and a reference work combined. The language is simple, direct, plain, and it covers every subject you need to know about. Here are just a few of them: "Wills"—"Mortgages"—"Deeds"—"Farm Laws"—"Landlord and Tenant"—"Leases"—"Copyrights"—"Trade Marks"—"Partnerships"—"Letters of Credit"—"Trustees"—"Corporations"—"Stockholders"—"Dividends"—"Marriage"—"Parental Relation"—"Employer and Employee"—"Assault"—"Defamation"—"Libel"—"Criticism"—"Self Defense"—"Automobile Laws"—"Patents"—"Contracts"—"Fraud"—"Damages"—"Negotiable Paper"—"Indorsements"—"Promissory Notes"—"Checks"—"Bills of Exchange"—"Bonds"—"Agents"—"Banks"—"Bankruptcy," etc.

## HERE IS OUR SPECIAL OFFER

WE can't begin to tell you all about this splendid set of books, so we are not going to try. We want to send you the books themselves—the complete set of 6 handy volumes, measuring 6 3/4 by 4 1/2 by 7/8 inches, so that you can examine all the volumes and decide for yourself if they are just the books you want—and need. If you decide to keep them, just send us \$1 as first payment and \$1 a month thereafter for 8 months. But if you do not wish to keep the books after seeing them, then you may send them back at our expense. That's fair. Isn't it?

Mail coupon below at once.

The Thompson Publishing Co.,  
1127 Pine Street,  
ST. LOUIS, MO.

Send me for examination, one set of your handy LIBRARY OF LAW in six volumes bound in Buckram. If I am satisfied with the books I will send you \$1 as first payment, and \$1 a month thereafter until the special price of \$9 is paid. If I do not wish to keep the books, I will notify you in seven days, and the books are then to be returned at your expense as offered Popular Mechanics Magazine readers.

NAME.....

ADDRESS.....

# Expert Electricians Make Big Money

You can learn all branches of ELECTRICITY at this school—and you will learn them by doing the actual work, step by step, personally guided and coached.

The opportunities open to men who understand ELECTRICITY and have had technical training cannot be exaggerated. Write to-day for our free catalog, or come in and inspect the school at your earliest convenience.

**THE NEW YORK ELECTRICAL SCHOOL**  
44 West 17th Street NEW YORK



## This Book FREE!

**Are You Interested In Automobiles?**  
This book contains vitally important information about the laws governing chauffeurs in every state—How to register—How to get a license—Fees—Driving law regulations—Rights and privileges. This book sells for 50c. But send 10c for a copy of the **American Chauffeur**—the liveliest, illustrated, technical automobile magazine, with educational qualities—the only one published exclusively for the beginner, professional chauffeur and the man who drives his own car—and with it we will send you the Chauffeur's Law Book **absolutely free**. Write now.  
**THE AMERICAN CHAUFFEUR PUBLISHING CO.**  
266 Butler Building, Cincinnati, Ohio

## Improve your Writing

Controlograph "kills" the finger movement. When in use, fingers cannot bend. Muscular movement becomes easy and natural. Made of metal, adjusts to any hand, and fits any round penholder. A boon to the tired, busy writer. Improves your writing from 50 to 100 per cent at once, by making you use correct principles. With it you can become a good penman. Send 50c today for one, or write for circular. Agents Wanted.  
**C. W. RANSOM, 312 Essex Bldg., KANSAS CITY, MISSOURI**

CYLINDER LANGUAGE RECORD

CORTINA PHONE

# LANGUAGES

German—French—English  
Italian—Spanish

or any other language learned quickly and easily by either the Cylinder or Disc Cortinaphone Method at home. Write for Free booklet today: Easy Payment Plan.

**Cortina Academy of Languages.**  
1057 Mecca Building, 1600 B'way, Cor. 46th St., N. Y.

THE ORIGINAL PHONOGRAPHIC METHOD

DISK LANGUAGE RECORD

## DON'T TAKE A COURSE IN Mechanical Drawing

until you have read my proposition. Practical draftsman, regularly employed by the most progressive company in the West, with long experience also as teacher of Mathematics and Drawing, will instruct a few men by mail. **Positively the best way to become a practical well-paid draftsman.** Instruments furnished. Rates reasonable. **Pay a part after in position.** For information write,  
**DRAFTSMAN, 252 South Corona Street, Denver, Colo.**



## Boy Craftsman

10c Tells how to make all kinds of Toys. New Book just printed. How to make Aeroplane, Canoe, Railroad Model, Talking Machine, Telephones, Balloon, Electric Motor, Bicycle Boat, Pocket Flashlight, and hundreds of other things. Fully illustrated. Sent postpaid for 10c. 4 for 25c.  
**NATIONAL CO., 305 E. 51st St., Dept. 83, CHICAGO**



## 200 Kinds Iron, Wood, Wire & Steel Puzzles

Catalog and sample 10c—3 leaders for 25c  
**WESTERN PUZZLE WORKS**  
St. Paul, Minn.



## PRIZE PACKAGE FREE

We will send you **FREE** a big package of Magic Tricks, Puzzles, Cards, Jokes, Riddles, Money Making Secrets, Splendid Games, Toasts, Card Tricks, Feats in Parlor Magic, all **FREE**. Just send us 10c to pay for postage and adv. and we will send this trick package Free.  
**NOVELTY CO., 302 E. 51st St., CHICAGO**





# Strengthen YOUR Will

## Over 18000 People Already Use This Book



### "Power of Will"

By FRANK CHANNING HADDOCK, Ph.D., M.S.

#### Sent on FREE Trial for Five Days

This great work on practical psychology provides a *thorough scientific course in Will-training*, consisting of 28 lessons. Its results have actually bordered on the marvellous.

It has come as a great and vital force into the lives of thousands of men and women, showing them how to *make their brains serve them better*—making them more dominant in their dealings—giving them a sure, masterful grip upon their life problems.

It has proved a veritable well of strength for people afflicted with ill-health and nervous weakness. It has *reawakened ambitions* in men and women who have been turned from their life purposes and has shown its students how to CARRY FORWARD those ambitions into consummation.

#### Helps Everybody

The readers of this book talk of it as a Bible. They range from great captains of industry to clerks. They include physicians, lawyers, artists, writers and advertising men of renown.

It is owned, read, prized and praised by such men as Judge Ben B. Lindsey, Wu Ting Fang, ex-U. S. Chinese Ambassador; Lieut. Governor McKelvie of Nebraska; Asst. Postmaster General Britt; General Manager Christeson of Wells-Fargo Express Co.; E. St. Elmo Lewis of Burroughs Adding Machine Co.—and literally thousands of other men of action and ambition like them, who realize the value of DOMINATING WILL in daily life.

#### How to Develop Indomitable Will

"Power of Will" is not a book of idle essays. It sets forth the *actual methods, plans and principles for training, strengthening and developing Will Power*. These methods are based on the most profound scientific analysis of Will Power ever made.

Modern Psychology has now indisputably established that the Will can be trained INTO WONDERFUL POWER, like any other human faculty, *by intelligent exercise and use*. A man can make what he wills of himself. He can open up slumbering, DORMANT mental powers. He can develop wonderful faculties, now yielding the merest fraction of their powers. He can actually alter the physiological formation of his brain, by means of his Will. This is not a theory, it is a proven fact.

And the unusual value of this great work is that IT SHOWS YOU JUST HOW TO DO THIS FOR YOURSELF—in clear, wonderfully stimulating lessons, which anybody can follow and understand.

#### Is YOUR Will Dormant

Look back upon your life. Once upon a time, no doubt, you weaved great dreams of what you were going to make of yourself. *Are they accomplished now?* Why are they not accomplished? Is it not because you lacked a strong, powerful, dominating, inflexible WILL? You allowed others to control and influence you to their ends, instead of controlling others yourself. You let insignificant daily incidents everlastingly turn you from your purpose. Gradually—like so many of us—you allowed this God-given faculty of will to become scotched and DORMANT in you. Dr. Haddock has a message for you—a *real message of emancipation from the blasting human curse of indecision and blind habit*.

#### Sent FREE for Inspection

The price of "Power of Will" is \$3.00—but we will send it to you at once, without strings and without obligation. Judge for yourself whether you can afford *not* to own it.

Send no money now. Simply send the attached coupon, enclosing your business card, or giving a reference. The book will be sent by return mail, and you can keep it five days. If, at the end of five days, you do not want it—send it back. Cut out the coupon now, before you turn the page and forget.

**Pelton Publishing Co.**  
50 Wilcox Block  
Meriden, Conn.

Hosts of readers of this book have written to us, without solicitation, about its inspiring and helpful character. Below are a few extracts of some of the letters; which make a mass four feet high. These extracts serve, at least, to indicate the tone of intense enthusiasm in which all these absolutely unsolicited testimonials are couched.

#### What Readers Say

"In it I found the rules and principles that make it worth its weight in gold."—Dist. Atty. GOODWIN, Oil City, Pa.

"I have your 'Power of Will' and would not take \$100 for it."—J. A. WAGNER, Sec'y-Treas. Toronto Academy of Music, Edmonton, Can.

"Only wish I had a little of this knowledge years ago."—R. W. OSBORNE; Office of the Sec'y, Gov't Porto Rico.

"Has startled the thinking men all over the world. If you want to know what you are, or can be—get it. It opens up a new world."—JAMES F. ELLS, Pres. National School of Salesmanship, Minneapolis, Minn.

"Better than anything I have met in FORTY YEARS' study of these subjects. I am certainly grateful to secure this book."—REV. WM. HENRY BARNES, 612 N. 43d St., West Philadelphia, Pa.

"I would not willingly separate myself from it."—CHAS. W. MEARS, Adv. Mgr., Winton Motor Car Co., Cleveland, Ohio.

"The five day examination period allowed by you is certainly long enough to convince any one that this is a book one needs. I hardly had it unpacked before I realized I wanted it. I regret I did not know there was a book like this long ago."—ROY S. THARP, Passenger Dept., Southern Pacific R.R. Co., Oakland, Cal.

**Pelton  
Publishing  
Company**  
50 Meriden, Conn.

Gentlemen:

Please send me a copy of "Power of Will" without charge. I agree to remit \$3.00 or return the book in 5 days.

Name .....

Address .....

Frank Channing Haddock, Ph.D., M.S., is one of the most inspiring writers on Practical Psychology now living. His work glows with a deep, splendid, heartening philosophy that ranks him with James, Bergson, Eucken and Royce as a twentieth-century leader of thought. Below is the merest fraction of the long list of studies in this great work.

#### Partial List of Contents

Law of Great Thinking  
Four Factors on Which it Depends  
How to Develop Analytical Power  
How to Think "All Around" a Subject  
How to Concentrate—Detailed Directions  
How to Throw off Worry  
How to Make the Will Supreme  
How to Overcome Indecision  
How Permanent Influence Over Others is Secured  
Fifty-Four Master Rules to Control Other People  
How to Maintain the Central Factors of Bodily Health  
How to Secure Steady Nerves  
First Principles of Success  
How the Will Acts  
How to Test Your Will  
Methods of Developing Will  
Six Grown Principles for Developing Will  
Seven Principles of Drill for Mental Power  
How to Increase Powers of Observation  
How to Develop a Keen Gaze  
How to Train the Senses  
Law of Will Power in Habits  
How to Master Habit  
How to Master Anger and Irritability  
The Mental Law of Habit Cure  
The Principles of Memory  
How to Develop Perfect Memory  
How to Banish Fear  
How to Overcome Hesitation in Speech  
How to Develop Abundance of Thought  
How to Overcome Unhealthy Mind States  
How to Overcome Stage Fright and Embarrassment



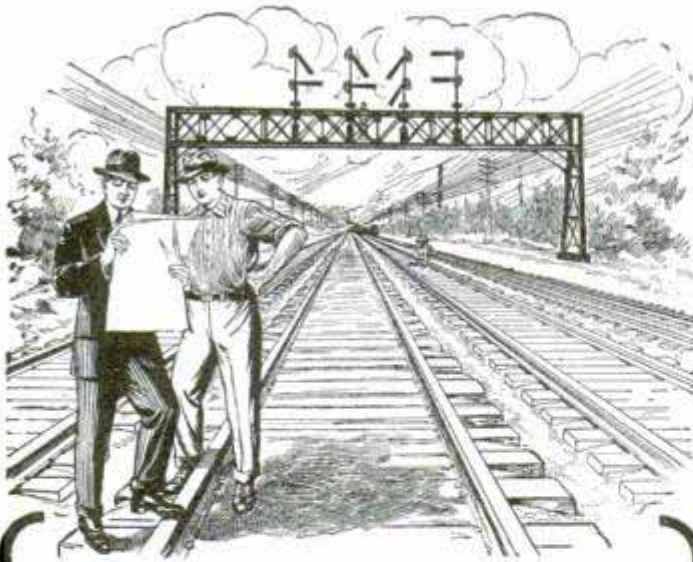

## Be a Signal Engineer

The profession of Signal Engineering is only in its infancy. Thousands of men are needed. At the present time, scarcely more than 25% of the railroads are equipped with automatic electric block signals. We must find more Signal Engineers to superintend the installation of the new systems and the maintenance of the ones that are already installed. **Big money is being paid.** You can get just the kind of instruction you need to hold one of the big jobs in your own home—during your spare time. Send the coupon now for the big new book on Signal Engineering. Find out how you can be the boss and the man who gets the fat pay envelope. Write today.

## Earn \$2,500 a Year

Yes, that is what your salary will be when you are a full fledged Signal Engineer, \$2,500 a year to start. Many men making much more than that. Even while you are learning you can hold one of the positions under a Signal Engineer paying you a handsome salary. Here is your opportunity. Be the man who tells the other fellows what to do. Send in the free coupon for full particulars.

## More Men Needed

Railroads are constantly looking for competent Signal Engineers. There are not enough men to fill the positions. Thousands and thousands of miles of track are now being equipped with automatic signals. More Signal Engineers are needed to superintend the work. Hundreds of new positions will be open. **And there are no men to take them.** Electric Signal Engineering is one of the most fascinating of professions. As a railroad man you travel from coast to coast without it costing you a penny. You can be the man who knows. You can be the man who tells the other fellow what to do. You can be the man who gets the fat pay envelope and free transportation. Here is your chance.

### FREE OUTFIT

If you will write at once we will tell how you can get the big new Signal Engineer's outfit absolutely free. Our students get practical instruction. The kind the railroads demand. If you act at once the outfit is free to you. Send the free coupon for full particulars.

## Send the FREE Coupon for Big New Book

### FREE BOOK COUPON

Department of  
Signaling  
Desk 1194  
491 Cass St.  
Chicago, Ill.

GENTLEMEN: Please send me absolutely free and prepaid your big new Signal book. Also full particulars about your great special free outfit offer. It is distinctly understood that I assume no obligations of any kind.

Just put your name and address on the free coupon and send it in to us at once. Absolutely no obligations of any kind. We will send you the big new Signal book absolutely free. Tells you all about this most fascinating profession. How you can get into the \$2,500 class. The book is free. Get your name and address in at once.

Department of  
Signaling  
Desk 1194  
491 Cass St.  
Chicago  
Ill.

Name.....

Address.....

Age..... Occupation.....

# SHOP NOTES ANNUAL



**FOR 1914  
IS READY**

IT SHOWS  
**519 EASY WAYS TO  
DO HARD THINGS**

224 Pages  
462 illustrations

Price 50 Cents, Postpaid

This is a reprint of all the articles which have been published during the year past in "Shop Notes Dept." of *Popular Mechanics Magazine* and is Vol. X of the series.

That it is one of the best numbers we have ever published is shown by the following list of special feature articles which appear in addition to the hundreds of practical time and labor saving helps our readers are familiar with:

Oxyacetylene Welding Outfit—Tile Sewer Construction—Special Molding Jobs—Electric Soldering Irons—Cost Systems for Small Shops—Motorcycle Garage—How to Build a Greenhouse—Slide Wire Bridge—Methods of Fitting Hinges—Short Cuts in Pattern Shops—A Private Ice House—Fluting Machine for Small Columns—Slide Rule—Homemade Concrete Mixer—Electrical Water Level Indicator—Homemade Ditch Digging Machine.

The seven page index facilitates reference

For Sale by Newsdealers or the Publishers

**POPULAR MECHANICS BOOK DEPT.**  
6 No. Michigan Blvd., Chicago

## DO YOU LIKE TO MAKE THINGS?

This new book

## AMATEUR MECHANICS No. 5

tells how to make scores of interesting and practical devices and is similar in style to Nos. 1, 2, 3 and 4 previously issued.

It contains

**334 Articles—272 Illustrations—128 Pages**

Size 6½ x 9½ in.—Paper

**Price 25 Cents, Postpaid**

These are only a few of the good things:

Aeroplane Kite—Amateur Mechanics' Combination Lathe—Lawn Tennis Marker—Electric Anemometer—Playground Ferris Wheel—Novel Wind Vane—Camp Provision Box—Wind Vane with Electric Indicator—Hand Drill Press—Dry Cell—Picture Frame and Triangle Clamp—Enlarging Photographs—Wet Battery—Electric Furnace—Electric Shaving Mug—Electric Lamp Flasher—Combination Lock—Multiplying Attachment for Camera—Electric Score Board—Galvanometer—Paddle Wheel Boat—Electric Time Light.

For Sale by Newsdealers or the Publishers

**Popular Mechanics Book Dept.**  
6 No. Michigan Blvd., CHICAGO





# The First Result Of Training

More money is not the *only* result of training but it is the *first*.

It makes no difference whether you are training to advance in your present position or to enter some new field, the very first place you feel your new training is in your pocket-book — your pay envelope.

And the only limit to how big your pay will grow is your determination and courage to *make* it grow.

For just as surely as the mercury in a thermometer rises in proportion to the heat, so will your salary go up in exact proportion to your training.

The best of it is, that this sort of training does not necessitate a college education any more.

No matter what education you have missed; what you do; how old you are or where you live, you too can win like all the rest.

The International Correspondence Schools will bring into your own home all the help you need to train you for whatever position you mark on the attached coupon *now*.

**Mail the coupon today.**

## INTERNATIONAL CORRESPONDENCE SCHOOLS

Box 872-S, Scranton, Pa.

Please explain, without further obligation on my part, how I can qualify for a larger salary and advancement to the position, trade, or profession before which I have marked **X**.

Electrical Engineering  
Electric Lighting  
Electric Railways  
Electrician  
Electric Car Running  
Dynamo Foreman  
Wireman  
Mining Engineer  
Telephone Expert  
Surveyor  
Civil Engineer  
Automobile Running  
Agriculture

Mechanical Engineer  
Mechanical Draftsman  
R. R. Construction  
Concrete Construction  
Architect  
Contracting and Build'g  
Architectural Draftsman  
General Illustrating  
Chemist  
Bookkeeper  
Advertising Man  
Civil Service Exams.  
Salesmanship

Name \_\_\_\_\_

St. and No. \_\_\_\_\_

City \_\_\_\_\_ State \_\_\_\_\_

Present Occupation \_\_\_\_\_



# BUY THESE Practical Handbooks FROM YOUR DEALER

## NEW TITLES JUST ADDED TO OUR PRACTICAL HANDBOOK SERIES

Air Brake . . . . .	\$1.00
Applied Electrochemistry . . . . .	1.00
Building Code . . . . .	1.00
Business English and Correspondence . . . . .	1.00
Corporation Law . . . . .	3.00
Dams and Weirs . . . . .	1.00
Fire Insurance Law . . . . .	1.50
Fireproof Construction . . . . .	3.00
Locomotive Boilers and Engines . . . . .	1.00
Machine Drawing . . . . .	1.50
Modern American Homes . . . . .	2.50
Motion Picture Work . . . . .	3.00
Real Property Law (Future Interests) . . . . .	1.50
Standard Legal Forms . . . . .	2.00
Structural Drafting . . . . .	1.00
Switchboards . . . . .	1.00
Underwriters' Requirements for Safe Electrical Installation . . . . .	1.00

If your dealer does not have the particular book of this series that you want, ask him to order it for you or order it direct from us yourself.

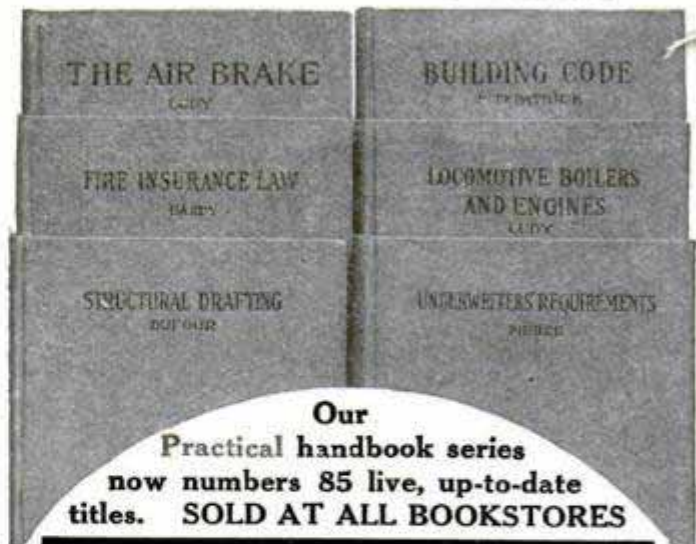

Our Practical handbook series now numbers 85 live, up-to-date titles. SOLD AT ALL BOOKSTORES

## PRACTICAL BOOKS FOR PRACTICAL MEN

These books were written especially for practical self-instruction, by experts whose experience and standing make them authorities.

They are so clear that the beginner can understand them; so thorough that the trained worker can learn from them; so practical that they will give any man a working knowledge of the subjects that they treat, and save him both time and money.

They not only cover the fundamental principles of mechanical science, engineering practice, and business usage, but also present the latest developments and the accepted practice of the most successful men, in those lines.

They give men a practical knowledge of practical things, which enables them to think more accurately and to work more efficiently; and they compose the most helpful, reliable, and comprehensive series of home study books ever put upon the market.

AMERICAN SCHOOL OF CORRESPONDENCE, 58th St. and Drexel Ave. CHICAGO, ILLINOIS

**I Guarantee You \$10**

**For First Photoplay**

you write after taking my few, easy lessons. I don't care who you are, this holds good. Tremendous demand for NEW IDEAS makes this great profession a veritable gold mine for those who start now. As former SCENARIO EDITOR of one of the world's largest producing companies, I speak with authority.

**FREE,** This Booklet explaining everything about learning this most profitable profession. Not many copies left, so send your name on free coupon below at once.

**Learn at Home** to be photoplay writer. Earn \$25 to \$100 weekly turning your "happy thoughts" into photoplays. Special talent or education unnecessary. It's easy by my guaranteed method. For advertising purposes I am just now allowing a reduction of \$5 to those who will enroll with me within 20 days. This reduces the cost of my entire course to very low figures. Don't send a cent now, but obtain the free booklet and facts about the guarantee and reduction immediately. Mail postcard or letter, or use free coupon at once.

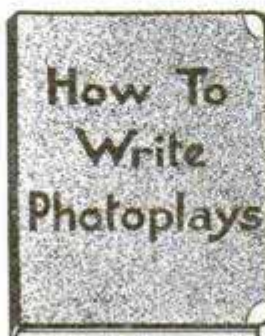

**To Elbert Moore, Box 772, P.D. Chicago**

Send free booklet "How to Write Photoplays" and all facts about guarantee, and special price reduction. No obligation.

NAME.....

ADDRESS.....

## LEARN WATCHMAKING

and become independent. Good-paying positions secured. Easy to learn. Send for FREE CATALOG.

ST. LOUIS WATCHMAKING SCHOOL, Dept. 5, ST. LOUIS, MO.



## Do Not STAMMER

My book, "How to Stop Stammering,"—a treatise of merit on "scientific talking." Price \$1. School literature FREE. M. L. Hatfield, Principal of the Pacific School for Stammerers, 1918 Grove Street, OAKLAND, CALIFORNIA.

## You Can Now Learn SHORTHAND By Mail—in 18 Easy Lessons!

### Stay Right at Home

No need to give up your present work. Earn while you learn. Give us your spare time only. Personal instruction by experts. Surprisingly low cost. Easy Payments. We offer complete stenographic courses by mail—Shorthand, Typewriting, Office Practice, Dictation, Business English, Secretarial Work, Court and General Reporting. Typewriters furnished. Positions everywhere. If you earn less than \$25 a week, write today for

**Free Book on Shorthand** telling of the wonderful opportunities offered those having a knowledge of shorthand and typewriting. Send postal at once and we will send this handsome illustrated booklet free. Get into a fascinating profession that pays big money and leads to the high places. Don't stick to a poorly paid job until too late to change. Any person 15 years of age, with a common school education, can take up our course. A 19-year-old writer of the system we teach established a world's record for speed and accuracy in public contest with the speediest shorthand experts of the world. Send today for list of official court reporters and particulars of remarkable feats young people have accomplished with the shorthand taught by us. Send postal now.

**Chicago University of Commerce**  
Dept. 1034, 800 No. Clark St. (42) Chicago, U. S. A.



# Given Away

**FREE COUPON**

For 30 Days

To American Correspondence School of Law,  
Dept 1194, Manhattan Bldg., Chicago  
Send me free Scholarship Certificate,  
valued at \$100; also your free cata-  
log and full particulars. Send  
everything prepaid and abso-  
lutely without expense or obli-  
gation to me.



**Absolutely FREE to Advertise Our School.**

Fill Out and Mail This Coupon NOW. Get a

**LAW Scholarship Valued at \$100.00 Free!**

You owe it to yourself to investigate this wonderful offer. Send in Coupon at once. HURRY! This offer is limited and may be withdrawn in 30 days. INVESTIGATE NOW! Get your name in before it is too late. Don't wait—do it NOW.

**Hurry Before Time Limit Expires**

Don't throw away \$100.00 by delaying when it costs nothing to investigate. Tear out, sign and mail coupon above at once! We will send you our book on Law, telling how YOU can learn law at home during your spare time, and a \$100.00 Scholarship FREE. No expense or obligation to you. Everything free, postage prepaid. This is your chance. Grab it! Opportunity is at your door—knocking loud. Fill in, tear out and mail coupon NOW before you turn this page.

**\$100 Scholarship FREE to Advertise Our School**

This Scholarship brings the cost of our complete Three Year Course within reach of everybody—less than what you would ordinarily pay for Text Books. People who never before even thought of studying law are grasping this great opportunity—this lifetime chance to obtain a legal education in the largest Law School for Home Study in the world. Our Course covers the same ground as leading resident universities, such as HARVARD, COLUMBIA, MICHIGAN, LELAND STANFORD—distinguished Faculty and Lecturers. We guarantee to coach FREE any graduate failing to pass bar examination.

**American Correspondence School of Law, Dept. 1194 Manhattan Bldg., Chicago, Ill.**

## \$10 to \$100 For Your Ideas

If you turn them into Photoplays. We will show you how. Earn big money right in your own home, in spare time. Let us prove to you that you can sell your ideas. Special education or talent not necessary. Send today for beautiful FREE BOOK of valuable information, and special prize offer. Chicago Photo-Playwright College, Box 278 MU, Chicago



### YOUR SUCCESS!

Depends upon a controlled mind. This is only possible through training. A trained mind will show greater results than a trained body. Think! Money and Power obtained on the basis of Self-Improvement. Correspondence course of Twelve Lessons in Mental-Success-Training will give you a Master Mind. Send for free book, "Masters of Destiny." Frederick W. Foote, The Chicago Institute of Menti-Culture, Dept. F, No. American Bldg., Chicago

## BUILD a BUSINESS OF YOUR OWN



### Make \$5,000 a Year

Reliable, earnest men wanted to join the Merrill Co-operative System. Share in the profits of other people's work. No matter where you live or what your business or profession, I will give you instruction in the Real Estate and Building Business free by mail; and if you qualify, appoint you Special Representative; help you to build up a lifetime business of your own that should yield you an income of \$5,000 a year; great opportunity. Instruction Free I show you every step, in easy lessons, and help you to get others working for you. Write for first lesson and full details, all free. A postal will do. J. J. BUTLER, Mgr. Special Agency Division, 1425 Monon Bldg., Chicago

## Make this car your office—

there is \$900.00 to \$1800.00 a year in it for you



Examinations will likely be held everywhere soon  
Rapid advancement to higher Government Positions. "No layoffs" because of STRIKES, FINANCIAL FLURRIES or the WHIMS OF SOME PETTY BOSS. THE POSITION IS YOURS FOR LIFE.  
Country residents and city residents stand the same chance for immediate appointment. Common-sense education sufficient. Political influence NOT REQUIRED.

We will prepare 25 candidates FREE! Write immediately for schedule showing the places and dates of all SPRING examinations. Don't delay. Every day you lose means the loss of just so much coaching before the rapidly approaching examinations.

**FRANKLIN INSTITUTE, Dept. F 106, Rochester, N.Y.**

Hundreds of Parcel Post Railway Mail Clerks Needed NOW!

**COUPON**  
Franklin Institute (The pathway to plenty), Dept. F 106, Rochester, N.Y.  
The coupon, filled out as directed, entitles the sender to free specimen questions; a free copy of our book, "Government Positions and How to Obtain Them," a list of positions now available, and to consideration for Free Coaching for the examination here checked.  
..... Railway Mail Clerk (\$900 to \$1800) ..... Customs Positions (\$800 to \$1500)  
..... Bookkeeper ..... (\$900 to \$1800) ..... Stenographer ..... (\$800 to \$1500)  
..... Postoffice Clerk ..... (\$800 to \$1200) ..... Internal Revenue ..... (\$700 to \$1800)  
..... Postoffice Carrier ..... (\$800 to \$1200) ..... Clerk in the Departments  
..... Rural Mail Carrier ..... (\$500 to \$1100) ..... at Washington (\$800 to \$1500)  
..... Automobile Chauffeur ..... Canadian Government Positions.....  
Name..... Address..... F 106

Use this before you lose it. Write plainly.





# Next to the Boss

Don't be content with the same small job with its small salary and hopeless future. Don't remain in an occupation that thousands upon thousands of others can fill and are waiting for. If you want independence, prosperity and an assured future you must enter a line that affords possibilities for expansion, prosperity, success. You cannot get success out of a profession or trade if success is not there. You want to get into an occupation that is not already overcrowded—that offers power, large salary and rapid promotion. Be in line for the higher positions—right hand to the Boss.

**\$3,000 to \$10,000 Yearly**

Large firms everywhere need Expert Accountants with La Salle training. They pay \$3,000 to \$10,000 salary yearly for trained experts. This is the vocation that offers remarkable possibilities for unlimited advancement, power and income. If you are ambitious to better your condition, there is not a single reason why you cannot begin at once to become an Expert Accountant and realize a great future. No matter what your present occupation, education or wages

## We Train You By Mail

in your own home, in spare time. Makes no difference where you live. You don't give up your present position. Don't hesitate because of lack of money—we make terms to suit you.

**Present Position Makes no Difference**

It is not necessary that you already understand bookkeeping or work in an office. The LaSalle has devised a general course in bookkeeping that quickly prepares you from the ground up for more advanced work in Higher Accountancy. You can readily master and complete it in a relatively short time. Prepared by some of the world's most noted Expert Accountants—it is thorough, advanced—covering Theory of Accounts, Practical Accounting, Cost Accounting, Auditing, Business Law, etc. The course is administered under the direct personal supervision of William Arthur Chase, a nationally recognized leader, who is Ex-President of the American Association of C. P. A. Examiners, and Ex-Secretary of Illinois State Board of Examiners in Accountancy and prepares you for C. P. A. Examinations in any state.

## The La Salle Shows Results

The La Salle is a strong, reliable, conservative institution, with thousands of successful students. No other home-study course is so thorough and simple—endorsed by America's greatest Experts.

## What Every Bookkeeper Should Know

Write now for free copy of this remarkable book—learn exactly the information you require to become an Expert Accountant, studies, kind of examinations, state regulations, salaries and positions to be had.

## Special Reduced Rates LIMITED OFFER

Write quick and learn how, for a limited time, we are able to offer a special reduced rate scholarship.

## Mail Coupon NOW

Learn about the success of La Salle students and the unusual opportunities awaiting you if you let us qualify you at once. Send coupon now for free book and learn how to earn \$3,000 to \$10,000 yearly.

LA SALLE EXTENSION UNIVERSITY, Chicago, Ill.

La Salle Extension University, Dept. 682, Chicago, Ill.  
 Send at once, your free book, containing What Every Bookkeeper Should Know, and full details of your Course in Higher Accountancy; also advise me about Special Time-Limited Reduced Rate

Name .....

Street No. ....

City.....State.....

Please Mention Popular Mechanics

"EVERYMAN" © G.F.CO., 1912

DOUBLE GRIP      CORD

A STYLE FOR EVERYMAN

# Boston Garter

Fitted with the Famous *Velvet Grip* Rubber Button Clasp

Holds Your Sock Smooth as Your Skin

Lisle, 25c.      EVERYWHERE.      Silk, 50c.

GEORGE FROST COMPANY, MAKERS, BOSTON

## LEARN DECORATIVE ART

or Pictorial and Theatrical Scene Painting at home by mail in your spare time. Make money while you study. Everybody can learn these exclusive, well paid professions and make good money. Start now to become financially independent. Send today for our Free Ill. Catalog and full information about above courses.

Enkeboll Art School, 2700 Ogden St., Omaha, Nebr.

## COPY THIS SKETCH

and let me see what you can do with it. You can earn \$20.00 to \$125.00 or more per week, as illustrator or cartoonist. My practical system of personal individual lessons by mail will develop your talent. Fifteen years successful work for newspapers and magazines qualifies me to teach you. Send me your sketch of President Wilson with 6c in stamps and I will send you a test lesson plate, also collection of drawings showing possibilities for you.

The Landon School of Illustrating and Cartooning  
 1438 Schofield Building, CLEVELAND, O.

# NATIONAL AUTO SCHOOL

June & Reading Rd.  
 Cincinnati, O.

Cut Out Mail Today

GENTLEMEN: Please send FREE Booklet telling how I can become expert Chauffeur or repairman.  
 P. M. 4

NAME.....

ADDRESS.....



# FREE

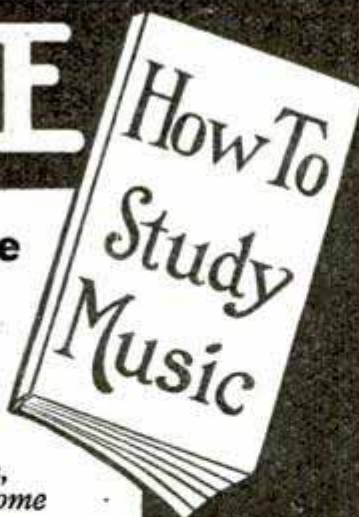

## This Valuable Booklet

explaining how to learn piano-playing 4 times faster — by correspondence, right in your own home

And this certificate

valued at \$60,

both absolutely free, if you write at once. Hurry! this amazing offer expires as soon as our advertising campaign is over.

**Costs Nothing to Investigate**

Dr. Quinn's famous Written Method is endorsed by leading musicians, and by teachers of state universities. It enables the beginner, young or old, to play chords immediately and to play complete pieces, in every key, in first three lessons. Saves three-quarters of time, energy, and money usually required. Send letter or postcard at once for full particulars and for \$60 tuition credit — FREE — **MARCUS LUCIUS QUINN CONSERVATORY OF MUSIC, Box 650 KD, Chicago**



## TELEGRAPHY The Only Trade that is not Crowded.

It insures steady employment and good wages. Promotion is assured for the ambitious. We are official instructors for the Western Union Telegraph Co., and the only school instructing Western Union employes. Largest attendance of any Telegraph school; also authorized school for Illinois Central Railroad Company. Agency course free. Practical instructors; main line wires. Employment furnished to earn expenses if desired. State your age.

**Jones School of Telegraphy, Dept. M, Traders Bldg., Chicago, Ill.**

## ART LESSONS FREE



### SPECIAL INTRODUCTORY OFFER

We are determined to prove the wonderful success of our exclusive methods. Learn Art at home in your spare time. Write for Free Trial Lessons and Special Introductory Offer. This offer is limited to a few in each locality who answer at once. List of Premiums and full particulars FREE. So write today. Address

**FINE ARTS INSTITUTE, Studio 214, Omaha, Nebr.**

## Practical Electrical Education

Electrical Engineering, Installation, Wiring, Draftsmanship and all branches of Electrical Science taught by practical, scientific and thoroughly tested methods in the most completely equipped practical engineering school in America.

**Students Can Enter Any Time** Your education is of no consequence; we start you at the right point and our personal instruction advances you rapidly.

Positions guaranteed competent graduates; spare time work for students helps pay expenses. Write N-O-W for illustrated Booklet — Free.

**SCHOOL OF ENGINEERING OF MILWAUKEE, Division 24, Milwaukee, Wis.**

## FRENCH, GERMAN, SPANISH, ITALIAN

Can be learned quickly, easily and pleasantly at spare moments, in your own home. You hear the living voice of a native professor pronounce each word and phrase. In a surprisingly short time you can speak a new language by the

### LANGUAGE-PHONE METHOD

COMBINED WITH **ROSENTHAL'S PRACTICAL LINGUISTRY**

Disc or Cylinder Records. Can be used on your own talking machine. Send for particulars and booklet.

**THE LANGUAGE-PHONE METHOD 961 Putnam Building, 2 West 45th Street, New York**



# Now \$15.20 Less

This \$35.00 Set—Now \$19.80

This is one of the greatest book offers ever made. Read it carefully—then investigate. Here's your chance to obtain the famous **Steam Engineering Library**, the work of 27 of the biggest and best known engineering experts in America, at a simply phenomenal price. The regular \$35.00 edition for a short time at \$19.80 complete—\$2.00 a month. Not only do you save almost half by getting these books now, but you can buy them on the most liberal of easy payment plans.

Every beginner, as well as the experienced stationary, locomotive or marine engineer, should own these books. Every section, every page, every line, is full of practical, up-to-date information just suited to your needs. This wonderful work will give you a knowledge of steam engineering and gas engine operation that cannot be obtained from any other set of books, and will pave the way to a better job and bigger pay.

## Cyclopedia of Steam Engineering

Contains 3,300 pages, 7 x 10 inches, 2,500 illustrations, full page photographs, plates, folding maps, diagrams, etc.; hundreds of valuable tables and formulas, carefully cross-indexed for quick, easy reference. Printed in large, clear type on special quality paper and bound in half red morocco, gold stamped.

### What These Books Cover

Construction of Boilers—Boiler Accessories—Fuel Economizers—Mechanical Stokers—Steam Pumps—Steam Engines—Indicators—Valve Gears—Steam Turbines—Gas and Oil Engines—Fuels—Automobiles—Carburetors—Locomotive Boilers and Engines—The Air-Brake—Single-Phase Electric Railway—Elevators—Marine Boilers—Marine Engines—Heating and Ventilating—Compressed Air—Transmission—Absorption and Compression—Refrigeration—Ammonia Machines—Direct Current Dynamos and Motors—Management of Dynamos and Motors—Electric Wiring—Electric Lighting, etc.

### Shipped Free

Examine this great work before you send a penny. Merely on receipt of the attached coupon we send you the complete seven volumes, express prepaid. Look them over for a whole week. Test them on some problems that have been bothering you. Then if you decide you want the set, send us \$2 within seven days after receipt and then \$2 a month until you have paid the introductory price of \$24.80. Otherwise tell us and the books come back without a penny of expense to you. But remember—it may be your last opportunity to get these famous books at this specially reduced price.

### Free Consulting Service

Besides the practical value of the library itself, you get a year's Consulting Membership free as a holder of these books. Our staff of expert engineers takes up and solves your problems and special difficulties, absolutely without cost to you. This privilege, which regularly sells for \$12, is yours for a full year free, if you take the Cyclopedia. To find out how useful these books will be to you, you must see them. It costs nothing to look the set over. It does not obligate you in any way. We stand ready to take the books back without expense to you, if you are not pleased with them. Get the books. Examine them. Then make your decision.

### FREE COUPON Worth \$15.20 to You

**American Technical Society, Chicago, U. S. A.**

Please send me Cyclopedia of Steam Engineering for 7 days' free examination. If I decide to buy, will send \$2 in 7 days and balance \$2 a month until \$19.80 has been paid, when \$35 books and \$12 Consulting Membership will be mine. Otherwise will notify you and hold books subject to your order. Title not to pass until fully paid. Pop. Mech. 4-14

NAME.....

ADDRESS.....  
As I have had no previous dealings with you, I refer you to





# Learn to PAINT SIGNS and SHOW CARDS

THERE'S MONEY IN IT

I'll teach you personally by mail. Three courses:  
1—Complete Lettering, Sign and Card Writing; 2—Show Card and Ticket Writing; 3—Lettering. Fourteen years' successful teaching. You will succeed. Wonderful field. Thousands of merchants use window cards, price cards, sale cards, banners and signs in large quantities. They buy new ones weekly. Notice for yourself. Go into business for yourself. Be independent. Gold lettering on glass and wood valuable feature of the course. Our course teaches everything. This knowledge helps you wherever you are. Pay good, work easy and fascinating, hours short.

## Earn \$18.00 to \$45.00 a Week

Many students make big money in business for themselves. Others make excellent salaries. Natural talent unnecessary. Davis, N. Car., writes: "Before taking course I could not make a letter. Today I am doing all the card writing for my firm."

### COMPLETE OUTFIT FREE

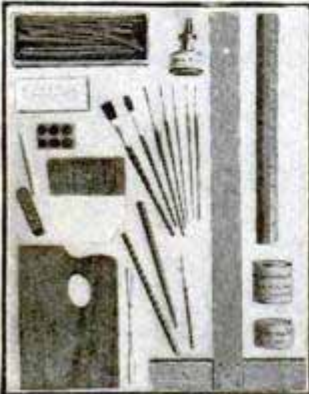

Root, Ill., says: "Wish I had learned of your school years ago. I am now receiving the highest wages paid in our shop." The experience of these men can be yours. Get started.

### FREE—Complete Outfit with Course

I give every student an outfit absolutely free. It is complete and practical. You can do practice work and earn more than enough to pay for course. We give you free all the tools you need, including enough ink, lettering paint, charcoal, etc. (as illustrated) to do the lessons with. With this outfit you can work any place. It is thoroughly practical. You get the outfit when you enroll. Write at once for our big complete school catalog, testimonials, pictures, sample of work and terms. Read them very carefully. The letters above are from men who acted. Don't hesitate.

## DETROIT SCHOOL OF LETTERING

Oldest and Largest School of Its Kind  
Chas. J. Strong, Founder

## Earn You While Learn

Many students begin doing work after one or two lessons and earn many times cost of course. Fritznier, Minn., says: "Did job recently, charged \$10, net profit \$7.05. Did this after taking one lesson." Parrott, Okla., writes: "I have earned several times the cost of the course since enrolling." Crawford, B. C., says: "I have earned nearly \$200.00 since taking up my course." You can do as well as these men.



CHAS. J. STRONG  
Founder

## Guarantee

I GUARANTEE to place my graduates in positions paying \$85.00 to \$175.00 monthly, when they have graduated and are competent. We have constantly more requests for men at good salaries than we can supply.

## I.S.D. DRAWING



Cartoon, caricature, and illustrating taught in BOOK form. Principles of our entire correspondence course with over 125 illustrations. 76 expressions of human face. Write \$1.00 today for book "How to Draw". Sent postpaid \$1.00. INTERNATIONAL SCHOOL OF DRAWING, Washington, D. C. Box 232 L

## PREPARE FOR A

# Government Position

A job with Uncle Sam under Civil Service protection means employment for life with good pay, short hours, pleasant work, annual vacations and the assurance that you will get your pay regularly in spite of panics or hard times.

Post Office, Railway Mail, Rural Carrier, Custom-Internal Revenue and other examinations are being held all the time.

If you're an American citizen 18 or over, we can help you secure one of these good jobs. Our 64 page booklet tells how you can prepare for "exams" under personal supervision of a former U.S. Civil Service Secretary-Examiner—a man who knows and whose knowledge is at your disposal.

Write today for booklet. It's free, without obligation.

**PATTERSON CIVIL SERVICE SCHOOL**  
304 Irving Place ROCHESTER, N. Y.



## I TEACH Penmanship BY MAIL

I won the World's First Prize in Penmanship. By my new system I can make an expert penman of you by mail. I also teach Book-keeping and Shorthand. Am placing my students as instructors in commercial colleges. If you wish to become a better penman, write me. I will send you FREE one of my Favorite Pens and a copy of the Ransomerian Journal.

C. W. RANSOM, 311 Essex Bldg., Kansas City, Missouri



**Sweeney Says:** "I Can Teach You the Automobile Business in Six Weeks by Actually Working on and Driving Cars."

# \$80 PER MONTH UP

**IS EARNED BY TRAINED MEN.** If you drive, repair, sell cars, manage garages, or make yourself a competent mechanic, no business in the world offers greater opportunities. Millionaires like Ford rose from the ranks.

## THE SWEENEY SYSTEM OF PRACTICAL INSTRUCTION

has made this school one of the largest, finest, most completely equipped in the world. WE TEACH EVERY BRANCH OF THE BUSINESS—electric starters, traction engineering, trucks—every new development. We have turned out over 1900 Successful Graduates

THERE IS NOTHING QUITE LIKE THIS SCHOOL IN THE WORLD  
It Makes Young Men Successful. Learn the opportunities before you.



Write Today For full information about this school, many photographs and full details about the opportunities in this business FREE

**SWEENEY AUTO SCHOOL** 1167 Fifteenth St., KANSAS CITY, MO.





# Be the Boss In the New Profession

Thousands of men needed. The New Profession that is paying big money wants you and needs you. Here is your opportunity to get into it. Don't leave your present employment. **Learn at home** during your spare time.

**Be a Meter Engineer** The profession of Electrical Meter Engineering is now in its infancy. The electrical stations must have Meter Engineers. They are paying big money for them. Thousands of positions are now open. A wonderful opportunity for men of all ages.

**A \$3,000 Job for You** Electrical Meter Engineering is one of the best paying professions in the industry. Hundreds of men making \$3,000 and more a year. You can do the same. How would you like to have a \$3,000 job?

**Special**  
For a limited time we are making a special reduced price offer in order to induce men to start the study of Meter Engineering right away. Write for full particulars at once.

**Write Today for 40-page Book Free**  
Just your name and address on a post card is enough. We will send you absolutely free and prepaid our new 40-page book on Electrical Meter Engineering. Tells all about new profession and special offer we are now making. Write now—immediately—while we are making this great special reduced price offer. This offer is limited.  
**FORT WAYNE CORRESPONDENCE SCHOOL, Dept. 1194 Fort Wayne, Ind.**



# BE A TRAVELING SALESMAN

**Earn \$1000 to \$5000 a Year**

You can learn to be a salesman in eight weeks by mail and be earning while you are learning. No former experience required. Write today for particulars, large list of good openings and testimonials from hundreds of our students now earning \$100 to \$500 a month. Address nearest office.

Dept. 29 National Salesmen's Training Association  
Chicago New York Kansas City San Francisco

# DO YOU LIKE TO DRAW?

That's all we want to know  
Now we will not give you any grand prize—or a lot of free stuff if you answer this ad. Nor do we claim to make you rich in a week. But if you are anxious to develop your talent with a successful cartoonist, so you can make money, send a copy of this picture with 6c. in stamps for portfolio of cartoons and sample lesson plate, and let us explain.  
**The W. L. Evans School of Cartooning**  
821 Leader Bldg., Cleveland, O.



# LEARN WATCHMAKING AND ENGRAVING

Earn while learning. Most practical watch school. Individual instructions. Graduates in great demand. Book free.  
**Chicago School of Watchmaking, 63 E. Van Buren St., Chicago**

# LEARN TO WRITE ADVERTISEMENTS EARN \$25 to \$100 A WEEK

We can positively show you by mail how to increase your salary. **BOOK MAILED FREE.**  
**PAGE-DAVIS CO., 112 Page Building, Chicago, Ill., or 150 Nassau St., New York**



# LEARNED BY ALMOST ANYONE AT HOME SMALL COST

**VENTRILOQUISM**  
Send today 2c stamp for particulars and proof.  
**O. A. SMITH, Room D 100, 823 Bigelow St., PEORIA, ILL.**

# LAW FREE BOOK

Tells easiest and best way to acquire a legal training at home.

## New Course — New Text — New Method

Sixty handy pocket size law volumes. The ONLY complete series of law text books EVER PREPARED FOR CORRESPONDENCE INSTRUCTION. Written especially for the American School of Correspondence by 56 of America's greatest legal authorities, including deans and professors in leading resident law schools, judges of federal and state courts, and prominent practicing attorneys. HARVARD, YALE, PENNSYLVANIA, CHICAGO, WISCONSIN, ILLINOIS, MICHIGAN, and other great universities have contributed to this wonderful aggregation of legal talent. No other school can furnish these remarkable law texts. Far superior to studying from a "Law Library" or "Cyclopedia of Law."

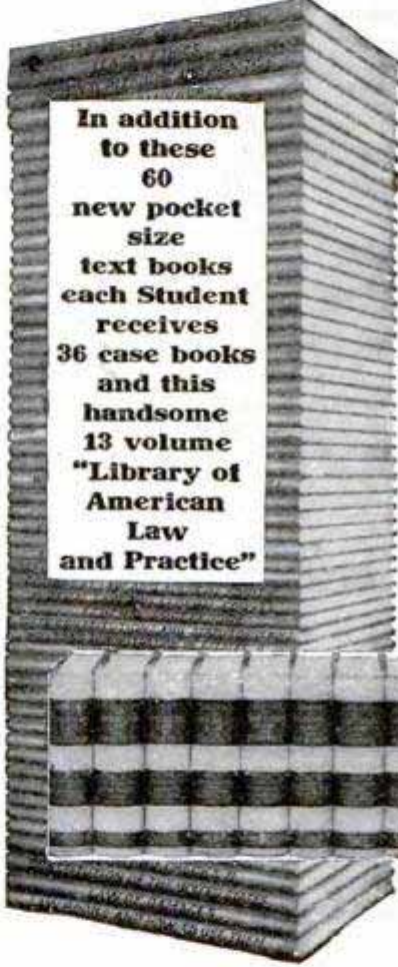

In addition to these 60 new pocket size text books each Student receives 36 case books and this handsome 13 volume "Library of American Law and Practice"

## America's Newest and Best Correspondence Law Course

The last word in American Law and Practice. Every branch of the law thoroughly covered. Stripped of all non-essentials and useless technicalities. Written in plain, simple, easily understood language. All legal terms thoroughly explained and made perfectly clear. 100% efficiency in law instruction. Simplicity of method makes it possible for you to get ALL the knowledge contained in the complete course. Handy pocket size text books enable you to study under any and all con-

ditions. Have your lesson always in your pocket. Take advantage of every spare moment. Saves time. Means quicker admission to the bar.

## The World's Greatest Correspondence School

For sixteen years the American School of Correspondence has stood at the head of all non-resident educational institutions. The only correspondence school in the United States chartered solely as an educational institution for the benefit of its students, not as a commercial enterprise for the benefit of stockholders. Enjoys the proud distinction of having graduated a higher percentage of its students than any other correspondence school in the world. Pre-eminently the best school for YOU.

### FREE BOOK COUPON

**American School**  
of Correspondence, Chicago, USA  
58th St. and Drexel Ave.

Gentlemen: Please send me your FREE Law Book, "How To Acquire a Legal Training," and full particulars regarding your wonderful new system of correspondence law instruction.

NAME.....

ADDRESS.....

**SENT FREE** Special Law Book, "How To Acquire a Legal Training." Explains all about this wonderful new system of law instruction. Send for it today. Get full particulars regarding this great course at once. Eliminate all possibility of failure. Be Sure of Success. Fill in the coupon and mail it today. Better do it RIGHT NOW!!

**American School**  
of Correspondence, Chicago, USA

Pop Mech. 4-14

Please Mention Popular Mechanics



# Your Memory Can Make or Break You

**Prof. Henry Dickson**  
America's foremost authority on Memory Training, Public Speaking, Self-Expression, and Principal of the Dickson Memory School, Auditorium Building, Chicago, Ill.

## I Will Train You To Remember

Thousands of big successful men all over the country are constantly demonstrating my system of memory training is absolutely scientific, correct, and easily mastered.

As I have trained thousands of others in the past 26 years, I will train you to remember practically everything that comes within range of your consciousness, if you will give me ten minutes a day of your spare time. Train you to remember facts, faces, arguments, figures, appointments—to make your brain a classified, systematically filed treasure house of information available for instant use whenever you want it. I will train you to concentrate, to think on your feet, to make impromptu speeches with that natural ease and confidence that overcomes opposition and wins friends.

### Nothing Mysterious About My Method

Your mind can be trained and developed exactly like your muscles. My memory training system is simply a series of brain exercises so graded and arranged that they bring your memory to a state of perfection in the shortest possible time and with the least effort. These exercises can be studied at home in your spare time without interfering with your occupation.

## If You Want to Succeed Don't Overlook This Opportunity

Now is the time to take stock of yourself—be square with yourself. *Are you able to remember—to think on your feet?* If not, and you have any desire to win in the intense competition of today—you must train NOW! The sooner you realize this the sooner you will start on the road to real success. When you start with my system of memory training you will be astonished at your progress—at your ability to think and remember. *You can have a perfect memory*—you can become a dominant personality, a man to reckon with.

## FREE My Valuable Book "How to Remember"

Simply send your name and address on a postal today—you will receive this booklet by return mail—it may be the first step to greater success than you had ever dreamed of.

### How to Get Free Copy of Book "How To Speak In Public"

If you wish to be able to *think on your feet*—to meet emergencies—to express yourself clearly, logically and convincingly whether talking to one person or to a thousand, my book, "How to Speak In Public" will explain how. De Luxe edition handsomely illustrated, richly bound. Price is \$2.00, but I will present a copy absolutely FREE to every student who enrolls for course of memory training within ten days after reading this advertisement.



**Prof. Henry Dickson, Prin.**  
**Dickson School of Memory**

705 Auditorium Building, Chicago, Illinois

What possible hope can *you* have of success if you can't remember facts, faces or names—if you can't remember to do the things you had planned to do—if you are compelled to use that most inexcusable of all excuses, "I forgot"—all the more pitiful because absolutely unnecessary.

Many men of very ordinary ability have risen far above their fellows because consciously or unconsciously they have trained their memories so that they never fail them.

You may dig and grind 'till the crack of doom, but the only learning that will do you any good is that which you *remember*.

There are thousands of readers of this magazine who are now taking various Correspondence School courses in law, electricity, advertising, bookkeeping, accountancy, etc. Every one of

these students would get far more benefit from these courses if each had been trained to remember in the Dickson school of Memory. The college graduate who fails to remember

all that he has been taught is worse off than the poor fellow who never had any chance to learn. The costliest mistake in the social, political or business world—golden opportunities lost—are due directly to forgetfulness.

Are you equipped to make the most of every opportunity—if not it's time to

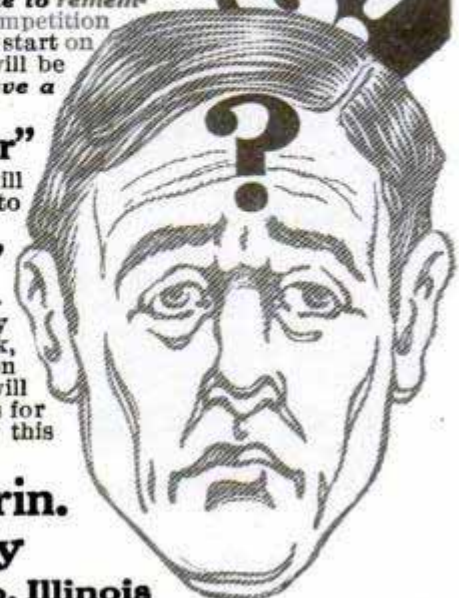



# SHORTHAND IN 30 DAYS

We absolutely guarantee to teach shorthand complete in only thirty days. You can learn in spare time in your own home, no matter where you live. No need to spend months as with old systems. Boyd's Syllabic System is easy to learn—easy to write—easy to read. Simple. Practical. Speedy. Sure. No ruled lines—no positions—no shading as in other systems. No long lists of word signs to confuse. Only nine characters to learn and you have the entire English language at your absolute command. The best system for stenographers, private secretaries, newspaper reporters and railroad men. Lawyers, ministers, teachers, physicians, literary folk and business men and women may now learn shorthand for their own use. Does not take continual daily practice as with other systems. Our graduates hold high grade positions everywhere. Send today for booklets, testimonials, etc.

**Chicago Correspondence Schools**  
969 Chicago Opera House Block, CHICAGO, ILL.



## Learn a Paying Profession

that assures you a good income and position for life. For twenty years we have successfully taught

# PHOTOGRAPHY

Photo-Engraving and Three-Color Work

Our graduates earn \$20 to \$50 a week. We assist them to secure these positions. Learn how you can become successful. Terms easy—living inexpensive. Write for catalogue—NOW!  
ILLINOIS COLLEGE OF PHOTOGRAPHY, 999 Wabash Avenue, Effingham, Ill.

# ELECTRICITY

CONDENSED COURSE IN  
ELECTRICAL ENGINEERING

## Complete in One Year Bliss Electrical School

Studies restricted to theoretical and practical electricity, mechanical drawing and necessary engineering work. Teaches simplicity, concentration, hard work. For young men of energy and character. 21 years of greatest success. Graduates hold first-class positions. **Opens Sept. 23.** Write for new catalog.

104 Takoma Ave., WASHINGTON, D. C.

## EARN TELEGRAPH

Morse or Wireless. Also superior station agency course. Splendid opportunities. Demand greater than supply. Graduates assisted. We own and exclusively occupy two large modern buildings equipped with R. R. and Western Union Wires and Complete \$3000 Marconi Wireless Station. Oldest and largest school—est. 39 years. Investment \$25,000. Endorsed by Railroad, Wireless and Western Union Officials. Expert practical teachers. Living expenses may be earned. Tuition low. Easy payments. Catalogs Free.

Dodge's Telegraph, Railway and Wireless Institute  
8th Street VALPARAISO, IND.

Y

## ADVERTISING WRITERS WANTED

by department stores, merchants, manufacturers. Big demand, small supply. Our graduates earn \$1,500 to \$10,000 yearly. Write TODAY for Free prospectus of our Correspondence System of instruction. **POWELL SCHOOL OF ADVERTISING, Inc. (Est. 1901) 1681 Meyrowitz Building, Fifth Avenue, NEW YORK**

## Learn Watchmaking At Home



You can learn by our modern and original system of instruction every part of the Watchmaker's Trade at home as good or better than at a shop. You can earn money while learning and secure a well paying position or start in business after completing our course of instruction. Good watchmakers are always in demand and earn from \$20 to \$35 per week. For particulars apply to the Wisconsin School of Watchmaking, Stroh Bldg., Milwaukee, Wis.

# YOU Can Learn This NEWEST High Grade Money-Making PROFESSION



—right in your own home, or anywhere—while retaining your present position and salary; and, to do this, you will need to devote but **one or two hours a day** (your spare time) for a few months—to conscientious study, under our guidance.

This new profession of **Physcultopathy**—as successfully practiced by our graduates, by virtue of the Title of

## Doctor of Physcultopathy

which we confer—is firmly established as the coming profession of the age—being founded upon common-sense methods of health treatment, applied with the accurate skill which we instruct you to employ. **Drugless, painless, harmless, and without "operations" of any sort—Physcultopathy is fast becoming**

### RECOGNIZED EVERYWHERE

by intelligent people of every class, as superior to all forms of so-called "medical treatment"—based, as these admittedly are, upon use of poisonous drugs and chemicals. And it supplies to its practitioners (our graduates)

### PLEASANT, DIGNIFIED WORK

of the most honorable, congenial and remunerative character. Why not be a **PROFESSIONAL MAN**—and get away from the tiresome routine of counter, desk, time-clock, and long work-hours? **You can open your own offices**, for professional work in **Physcultopathy**, almost anywhere you may wish to locate. This glorious new profession makes "a place in the world" for YOU—opens before you **unequaled opportunity for personal advancement and large profits.**

Doctors of **Physcultopathy** (graduates of the **Bernarr Macfadden College of Physcultopathy**) easily earn incomes of

### \$5,000 to \$10,000 PER YEAR

—after they have built up a practice in their chosen community—seldom make incomes of less than **\$1,500**, the first year.

YOU can achieve **this same success.** But **START NOW.** Our **THOROUGHLY PRACTICAL Home Study Course in Physcultopathy** is clear, concise, easy of mastery—requires no college education or special training. Course consists of **92 lessons**, test reviews, and unlimited individual, personal, instruction. And to each student enrolling for this great Course, there is **NOW** being given—for a short time only—

## A Great 10-Volume Library FREE

BY **BERNARR MACFADDEN** FREE  
(the recognized authority on Physical Culture)

Tuition for Course, payable in easy installments, to meet your requirements; full **Resident Post-Graduate Course**, without extra expense; your success **ASSURED**, under our expert instruction and guidance. We place every graduate in a **remunerative location**, as soon as he or she has received our **Title and Diploma** conferring the right to practice **Physcultopathy.** We have today, on our "waiting list," **more than 100 good-paying locations** for our Doctors—which we are unable to fill. Let us place YOU in one of these.

### MAIL, TODAY, THIS COUPON

—and we will send you, at once, our **big, handsomely illustrated prospectus, FREE**—telling all about this wonderful, new, established science of health treatment—**Physcultopathy**—its wonderful possibilities—the great successes already won by our graduates—the glorious opportunity awaiting YOU; also our **SPECIAL PLAN.** You do not now know what this opportunity means to YOU. Let us tell you. Mail the coupon, TODAY—no obligation.

**MACFADDEN COLLEGE OF  
PHYSCULTOPATHY,  
4200 Grand Blvd.  
(Box 15)  
CHICAGO, ILL.**

**FREE INFORMATION COUPON**  
Without cost to me, please give further details information concerning your Home Instruction Course, by mail to Physcultopathy, and Special Limited Offer.  
Name \_\_\_\_\_  
Town \_\_\_\_\_ State \_\_\_\_\_



# Become a TRAFFIC EXPERT

## Learn at Home



### UNLIMITED POSSIBILITIES **BIG PAY**

Thousands of large shippers and all Railroads need trained Traffic Experts and Managers—newly created positions are open with salaries of \$35 to \$200 weekly. The demand for trained men is greater than the supply. Recently enacted railroad rate laws and interstate commerce regulations have produced new conditions that necessitate trained specialists—men who know how to route shipments, to obtain shortest mileage, quickest deliveries—lowest rates. With such knowledge you can qualify for an important, big-salaried position with a future—quick.

### WE TRAIN YOU BY MAIL

at home, in spare time, without giving up your position or income. The cost is small—we make the payments to suit you. All you need, to get into this powerful, big paying occupation is our training. No matter where you live, what you work at now, how small your pay, how long your hours—no matter what your age or education—if you can read and write intelligently—our Interstate Commerce Course will train you expertly to handle proficiently a big Traffic job—to merit and retain influence, respect, power and puts you in way to earn \$35.00 to \$200.00 weekly.

### MOST THOROUGH METHOD KNOWN

The LaSalle method is simple, practical, logical—anybody can readily master it. It is the work of some of the greatest Traffic Experts in America. It covers thoroughly every feature of the profession you will ever need to know—it is different and more complete than any other method of home-training in Interstate Commerce ever known. This is the largest home-study Extension University in the world—our graduates are recognized as real experts—they are trained to do the kind of work that commands big positions.

### NEW, UNCROWDED OCCUPATION

This is a new, uncrowded occupation—there's room for you if you prepare at once. Let us train you now for a big future, with power, dignity, respect and a big income, with almost unlimited opportunities. Don't remain in a small job that thousands of men are constantly after—let us make you the master—the big man—a successful leader among men.

### FREE—Wonderful Book

Send the coupon below now and receive free copy of our much-talked-of book "10 Years Promotion in One"—learn more about the opportunities afforded Traffic Experts with our training—learn about the big opportunities now open—learn how easy it is for us to make you a traffic specialist. Remember only trained men can secure the big positions now open—remember that big employers are seeking trained and competent office men. Send the coupon—no money.

La Salle Extension University, Chicago

La Salle Extension University, Dept. 683 Chicago, Ill.

Send at once, without expense to me, FREE copy of your famous book "10 Years Promotion in One"; also book telling how I may, without interfering with my present position, prepare myself as Traffic Expert.

Name .....

Address .....

Occupation .....

Please Mention Popular Mechanics

### THIS \$2.00 BOOK OF Practical Electricity REDUCED TO \$1.00

38,000 engineers, electricians and students of electricity paid \$2.00 for this wonderful volume. You now have the opportunity of buying it at just half that price—\$1.00.

### Good As A School

This book is a school within itself. It contains twenty chapters of valuable information—and teaches the fundamental principles of electricity including designing, operation and care of dynamos and motors.

Practical Electricity was written out of the day's work—the result of our eighteen years' experience, in repairing every possible kind of electrical machinery and apparatus.

This book has helped boost hundreds of men to bigger and more responsible positions. In return for the electrical knowledge they secured from this book they boosted our repair business. We want to line up half a million more boosters—that's why we're cutting the price of the book in two.

### MONEY BACK IF NOT SATISFIED

We couldn't begin to tell all of the points and merits of Practical Electricity. We would rather send you the book and let you see for yourself. Mail us \$1.00 to-day—and if you aren't perfectly satisfied, return it and get your money back. Order it now.

**CLEVELAND ARMATURE WORKS**  
4734 St. Clair Avenue, CLEVELAND, OHIO

America's Greatest Electrical Repair Works

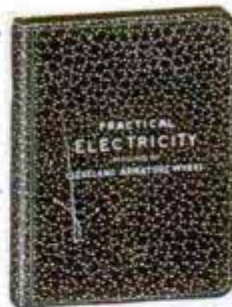

*Learn to Write*

BEGIN TODAY  
WRITE FOR MY  
FREE BOOK

I can make a good penman of you at home during spare time. Write for my free

book, "How to Become a Good Penman."

It contains specimens and tells how others mastered penmanship by the Tamblin System. Your name will be elegantly written on a card if you enclose stamp to pay postage.

F. W. Tamblin, 418 Meyer Bldg. Kansas City, Mo.

FREE  
BOOK

Write for it Today



## A GOOD POSITION

with UNCLE SAM is most desirable. Life positions, pleasant surroundings, good pay, steady work, short hours, promotions on merit. Both sexes. No political pull. Thousands of appointments yearly. Most thorough preparation \$5. Returned if not appointed. Full information and questions used by the Civil Service Commission free

**AMERICAN CIVIL SERVICE SCHOOL**      WASHINGTON, D. C.

## LEARN WATCH REPAIRING

Be a watchmaker—you can learn this profitable trade by correspondence in a few weeks in your own home by the DeSelms Chart System. After you complete the course you will know a watch from A to Z. You will know just what the matter is and how to repair one. When you graduate you will be a practical watchmaker and repairer and competent to fill any position. Positions for our graduates.

Ask for our Free Book. It explains our system and terms.

**THE DeSELMS WATCH SCHOOL**  
23 Perry Street      ATTICA, INDIANA



BE AN ILLUSTRATOR.  
by mail how to draw for magazines and newspapers

Send for Catalog

Learn to draw.

We will teach you  
School of Illustration  
112 Page Bldg.  
Chicago, Ill.



## ARITHMETIC SELF-TAUGHT

A plain, easily understood volume for all who have not had the opportunity of learning this subject thoroughly, or who have forgotten what they once learned. 257 Pages. Requires no teacher. This great little book sent postpaid for 60 CENTS. Stamps accepted, leather binding \$1.

**GEO. A. ZELLER BOOK CO.**  
Est. 1870. 4473 W. Belle Place ST. LOUIS, MO.

SPANGENBERG'S  
PRACTICAL  
ARITHMETIC  
Self-Taught



# Big Money For You In The Mail-Order Business!!



The big-money business of this age—and by far the most interesting and most fascinating business ever known—is the modern business of selling by mail. Here is the one business of great promise which can be started by young and old, experienced or inexperienced, in city, town or country, with only a few dollars or with thousands—and it is a business which offers surer and greater rewards for the time, money and effort invested in its upbuilding than any business I have ever known!

## Sell Anything by Mail—

## New Parcel Post Adds Millions of Mail-Order Buyers Everywhere!

There is practically nothing that cannot be successfully sold by mail. Millions of dollars are sent through the mails every month in the purchase of practically every commodity and every class and kind of professional service. The statement has been made by one of America's great mail-order advertisers that the new Parcel Post has put the mail-order dealer in direct touch with at least 20 million additional buyers. JUST IMAGINE WHAT THIS MEANS TO THE MAIL-ORDER BUSINESS! Right now is the time for you to learn of the great possibilities of the mail-order business and to get ready to launch a business of your own and get your share of the millions that are being made in the business of selling by mail!

## “How To Make Money In FREE! The Mail-Order Business”

If you want to start a mail-order business and start right you should send at once for a copy of my free booklet telling about the great money-making possibilities of the mail-order business and how ambitious men and women anywhere may quickly master the principles of successful selling by mail and build an independent, money-making business. My proposition, my plans, and my methods are absolutely NEW—just what YOU have been wishing for. Don't lose any time in getting YOUR mail-order business started. Write me today. Address

**RANDOLPH ROSE MAIL-ORDER SCHOOL**  
507 Rose Bldg. CHATTANOOGA, TENNESSEE



## HOW TO TRIM SHOW WINDOWS

Shown in this new book. 150 complete windows for every season of the year illustrated by means of over 200 detail drawings and explained in 256 pages of text matter. Shipped prepaid for \$1.50. This is the 10th year for our

## SCHOOL OF WINDOW TRIMMING

**CARD WRITING AND ADVERTISING**  
Best paid and most fascinating professions in the world. A 120page catalog FREE tells you all about it.

COESTER SCHOOL, 306 Jackson Boulevard, CHICAGO

# CIVIL SERVICE

positions are in all parts of the country. Good pay, steady work, life positions, congenial surroundings, promotions on merit, short hours, annual vacation and sick leave with pay. Many thousands appointed yearly. Both sexes. No political pull. Nearly 300,000 classified positions. Common school education sufficient. Full information and questions used by the Civil Service Commission free.

COLUMBIAN CORRESP. COLLEGE, Washington, D. C.

# BE A DETECTIVE

Earn from \$150.00 to \$300.00 per month; travel over the world. Write

C. T. LUDWIG, 133 Westover Bldg., Kansas City, Mo.

# MUSIC TAUGHT FREE AT YOUR HOME

Write Today for our booklet. It tells how to learn to play Piano, Organ, Violin, Mandolin, etc. Beginners or advanced pupils.

AMERICAN SCHOOL OF MUSIC, 50 Lakeside Bldg., Chicago, Ill.

# JEWELRY ENGRAVING

We teach you, by our new and original method of instruction, this clean, fascinating and profitable business right at your home, and furnish you all tools needed absolutely free. Write for free book to the

WISCONSIN SCHOOL OF ENGRAVING, Strah Bldg., MILWAUKEE, WIS.

# Unlimited Possibilities

## FOR YOU

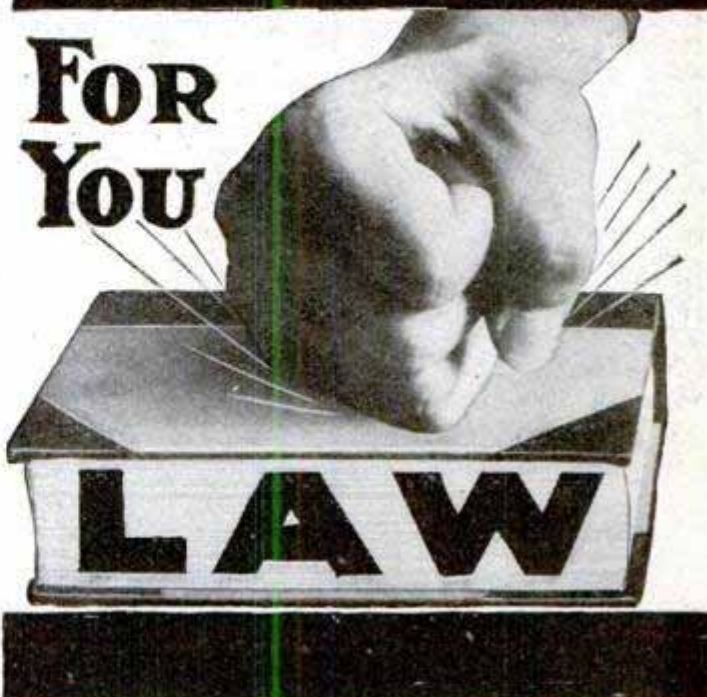

If you expect great success—a prosperous future—choose a calling offering great possibilities. There is a limit to nearly everything. A mechanic, for example, can earn only very small wages, no matter how expert he is. His greatest success must be far below that which his ability and efforts deserve. Look around you—see who are the most successful, the most prosperous, the most powerful men. They are Lawyers! Many of our greatest statesmen, capitalists and business men are Lawyers. Law is the one profession that fits a man for success in almost any line—there is no limit to the possibilities Law offers today. A Lawyer can earn \$5,000 to \$100,000 and more yearly. Let us show you how to

## Become A Lawyer

The demand for Lawyers is increasing—Law is now a vital factor in every business—big firms need competent Lawyers for their regular staffs at large salaries. Don't decide to follow a particular line just because you think you like it best. Look before you leap—determine the possibilities—find out the incomes earned by the majority already in that line. That's the real test. If you have already chosen your life-work—no matter what it is, no matter how far you have entered into it, no matter what your age—it is not too late to start over. The La Salle is founded exactly for that purpose—to help men and women out of wrong occupations and prepare them for success, power and independence. Lack of capital makes no difference—we make terms to suit you.

**Anyone Can Learn** Law is no longer complex—you need not give up your present position and go away to college now. The La Salle Home Study Law Course has revolutionized the study of Law. Present education makes no

**We Train You By MAIL** difference—if you can read and write intelligently, the La Salle can train you to become a successful Lawyer in your own home, in spare time, by mail, as we have done for so many others situated as you are now. The La Salle law text is written in plain language by legal authorities and professors in big resident universities. Recognized as foremost home study Law Course—follows method used in resident universities.

**Guarantee** Our graduates pass bar examinations in any State and attain highest records. We guarantee to coach free and until successful any La Salle student failing to pass bar examination. We are the largest and enroll more students than any other University home study Law School in America.

**Become An LL. B.** The State of Illinois authorizes us to confer on our graduates the Degree of Bachelor of Laws, (LL. B.)

## Law Library Furnished

Enroll now and receive complete, standard Law Library—14 volumes, richly bound, without additional cost.

**This Book Free** Write now for free copy of "Evidence," a remarkable book that shows you how to start right—that puts you on the paths of America's successful lawyers and makes possible the greatest success.

## \$100 Tuition Credit FREE

Write now and learn how, for a short time, to secure \$100 Tuition Credit FREE. Prepare now for this dignified, lucrative profession.

LA SALLE EXTENSION UNIVERSITY, Dept. 684 Chicago

Please Mention Popular Mechanics





**The only solution: Get a better job**

Are you "trying to make both ends meet" on a small, unsatisfactory salary? Are you one of the thousands of energetic, capable men whose days are spent in work not suited to their natural talents?

Then read this great offer of the **American School of Correspondence**, a school in every sense of the word—chartered under the same laws as your state university: The **American School** offers to bring the training you need right into your own home—advise you what studies

to take up to increase your present salary—show you how you can prepare yourself for a better job. After you become one of our students we'll keep on advising and coaching you—then if you can't get a better job yourself, we'll get one for you. Isn't this a wonderful offer? Don't you think it worth while to try? Then sign and mail this coupon.

**Your Opportunity Coupon**  
 Mark the position you want and mail the coupon now

.... Electrical Engineer	.... Lawyer
.... Elec. Light & Power Supt.	.... Bookkeeper
.... Electrical Wireman	.... Stenographer
.... Telephone Expert	.... Private Secretary
.... Architect	.... Accountant
.... Building Contractor	.... Cost Accountant
.... Architectural Draftsman	.... Cert'fd Public Acc't
.... Structural Draftsman	.... Auditor
.... Structural Engineer	.... Business Manager
.... Concrete Engineer	.... Fire Ins. Inspector
.... Civil Engineer	.... Fire Ins. Adjuster
.... Surveyor	.... Fire Ins. Expert
.... Mechanical Engineer	.... Moving Picture Op'r
.... Mechanical Draftsman	.... Sanitary Engineer
.... Steam Engineer	.... Irrigation Engineer
.... Municipal Engineer	.... Textile Boss
.... Gas Engine Engineer	.... College Preparatory
.... Gas Tractor Engineer	.... Auto. Mechanician

**Training solves salary troubles**

The **American School** was established fifteen years ago to help just such men as you—men who want a better education—men who have ambition—men who have brains but cannot afford to leave home to get the training they want and need.

Sign the coupon **now**—get our complete bulletin absolutely free of charge. Even if you don't take a course right away it will pay you to write and find out how much we can help you—how easy it is to get the training and how little it will cost.

**American School**  
 of Correspondence, Chicago, U.S.A.

NAME .....

ADDRESS .....

Pop. Mech., 4-14

**This school has no connection with any other school using the name "American"**



# Popular Mechanics Magazine

WRITTEN SO YOU CAN UNDERSTAND IT

Vol. 21

APRIL, 1914

No. 4

## "Moonshine" Outfit in Use among Eskimos

**T**HAT there are "moonshiners" even among the Alaskan Eskimos is proved by the recent capture by officers of the Revenue Cutter Service of the crude whisky still shown in the illustration. Since the Eskimos are wards of the government, it is against the law for anyone to sell or give them intoxicating liquors. But apparently the more enterprising of the natives are perfectly able to supply the deficiency by making their own "hootch," as whisky is called in the Aleutian tongue. The product of this homemade apparatus was almost pure alcohol, and only an Eskimo stomach could have tolerated it. The natives who operated it were sentenced to 20 days' imprisonment in the Nome

jail. Their still, which was found on one of the Diomedede Islands, was made from a powder can, a wooden keg and a rifle barrel. The distilling was done in the powder can, which was provided with a wire loop for hanging over the fire. The keg was packed with ice and served as a condenser, instead of the usual worm. The distillate passed into the rifle barrel, was chilled and condensed to a liquid as it went

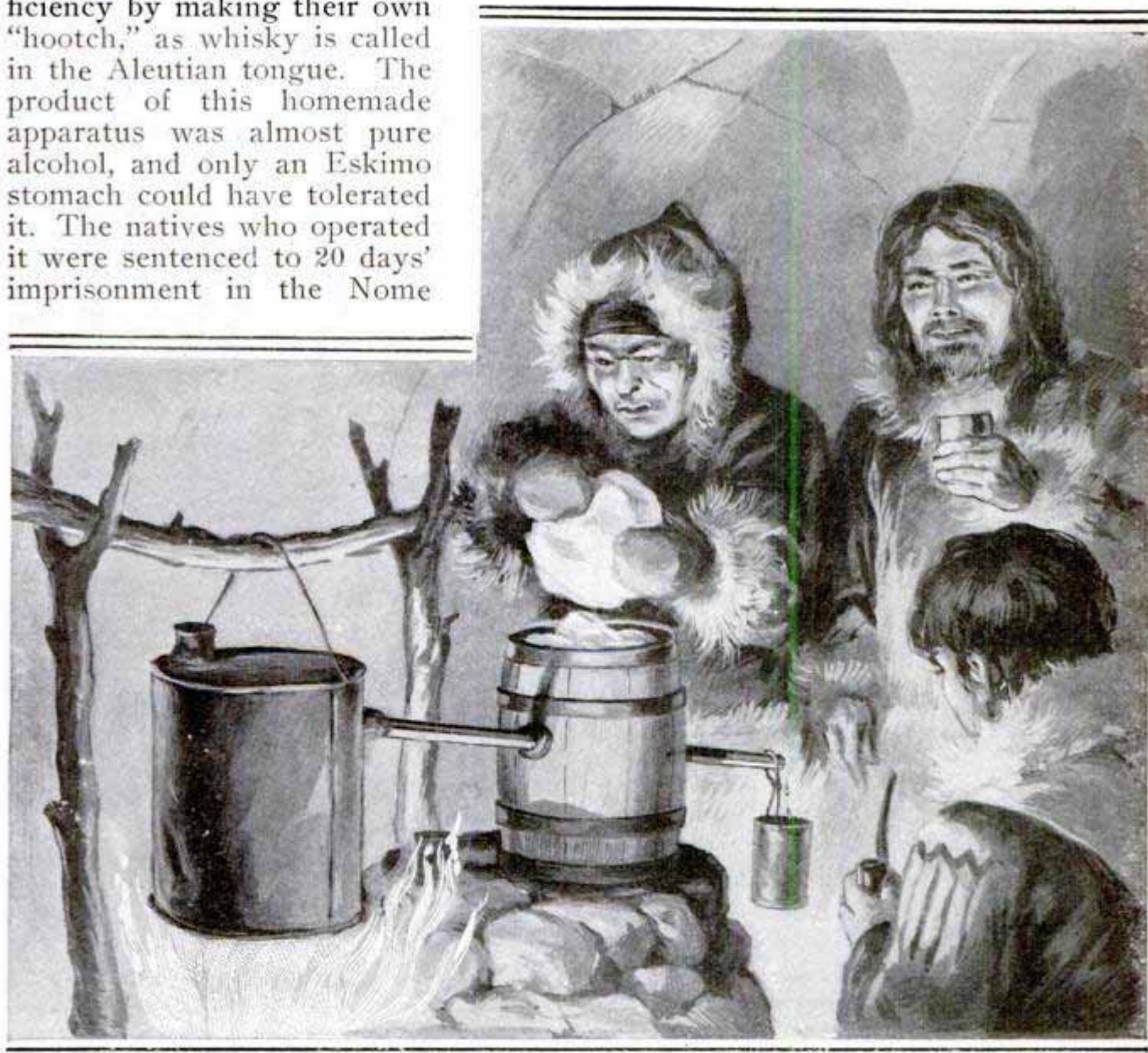

"Moonshine" Still Used by Alaskan Eskimos in Making "Hootch," or Native Whisky



through the packed ice, and then flowed into the can suspended at the lower end of the rifle barrel.

### A MECHANICAL EMPLOYMENT BUREAU

A mechanical device for bringing together the man and the job has been



Slot Machine That Acts as Automatic Employment Agency

invented by a Californian. It consists of an upright cabinet with a number of glass-covered cases, each of which shows a card with an inscription something like this:

"WANTED—A Butcher. Wages \$3.00 a day, German preferred. References."

Enough information is placed on the card, and visible through the glass, so that the applicant can tell if he can fill the requirements. If so, he drops 25 cents in the slot, opens the cabinet and takes out the card, which carries the address upon the reverse. If he obtains the position, he has paid only a quarter instead of the exor-

bitant fee demanded by some agencies, while if he is unsuccessful, he can get his money back by taking the card to the main office. Only one card for each job is placed in the cabinet so there is no crush at the door of the employer, which is a good thing for both parties. The machines are placed in public buildings and on street corners, and in Los Angeles where they have just been installed, the first results are said to be satisfactory.

### OIL WELL PROTECTED BY SHRINELIKE CAP

In order to protect a highly productive Mexican oil well from destruction during the revolutionary period, a solid concrete cap, 15 ft. square and extending about the same distance above and below the surface of the ground, has been built over it. On the top of this block is built a semblance of the usual shrine and chapel, surmounted by a cross, giving it every appearance of being a place of worship. This design was adopted because of the deep reverence the Mexicans entertain toward objects associated with the church, and doubtless affords greater protection than the physical strength of the cap, which, reinforced with steel bars, is calculated to withstand charges of dynamite. An interesting feature of the oil well, aside from this adoption of a religious symbol to preserve property, is the fact that the oil from it, when in operation, is pumped through an 8-in. pipe to the port of Tuxpan, 33 miles distant on



This Oil-Well Cap, of Solid Concrete, was Built in the Form of a Chapel for Protection against Mexican Revolutionists



the Gulf of Mexico. Here the ships lie in the open roadstead, a mile or more off shore, and the oil is piped through submarine lines, the ships receiving it from flexible hose attached to the end of the lines.

### FINGER-TWISTING MACHINE TO AID MUSICIANS

After years of investigation a Russian music teacher has invented a ma-

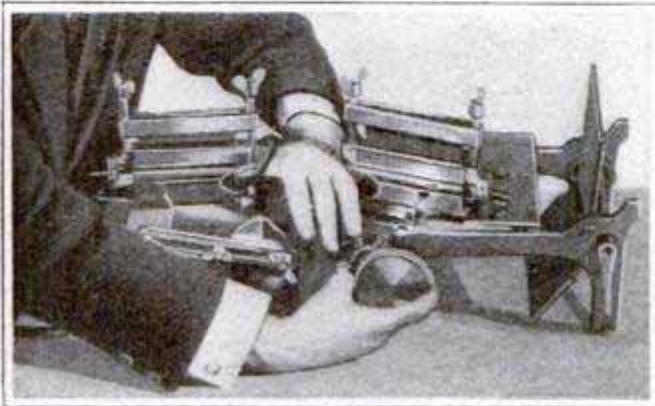

Photo by Underwood & Underwood  
Mechanical Appliance to Increase Manual Dexterity

chine to twist and stretch the finger joints, which he claims will obviate years of practice on the piano or violin. The suppleness and muscular vigor so necessary to proficiency in instrumental music may be obtained through mechanical means, the inventor argues, much more quickly and more certainly through the adoption of this device than by "exercises" on the instrument. The apparatus may be also used to advantage, so it is said, to straighten deformed fingers and to strengthen weak joints.

### MODERN PAPER MILL TO BE ERECTED IN CHINA

Of all the inventions credited to China, none seems more surely the product of that early civilization than paper. For many centuries paper has been made by hand in the Flowery Kingdom, and for excellence of texture and finish their product has not been surpassed by papermakers of any country in the world. Now modern methods have invaded China, and an

up-to-date paper mill has been built at Kongmun, a city on tidewater in the Pearl River delta. The equipment is modern German paper-making machinery, complete. The enterprise is Chinese, a number of orientals living in the United States being interested financially, while Japanese workmen erected the mill. Rice straw is practically unlimited in China, and will form the basis of the paper manufactured.

### PLASTER BLOCKS DIRECT AIR ON WATER JAR

Hollow plaster blocks which permit the wind to blow directly upon the damp surface of a water jar, enable the inhabitants of the Mojave Desert to keep their drinking water cool. The jar is of porous clay, through which some water continually filters, wetting

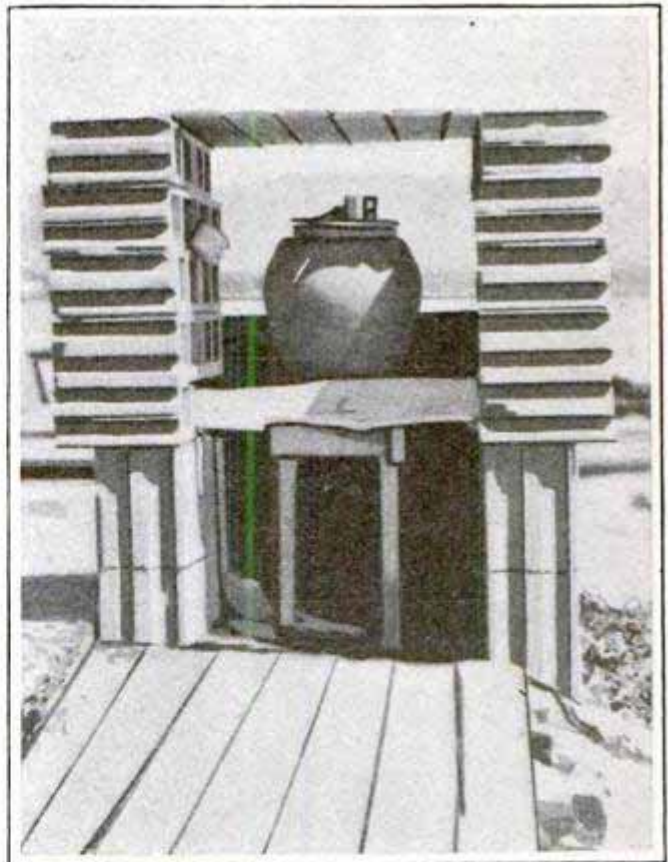

Hollow Tiles Direct Air Currents toward the Olla,  
Cooling the Water More Quickly

the burlap wrapped about it. The air blowing strongly through the holes in the plaster blocks evaporates the water about the jar, lowering the temperature.



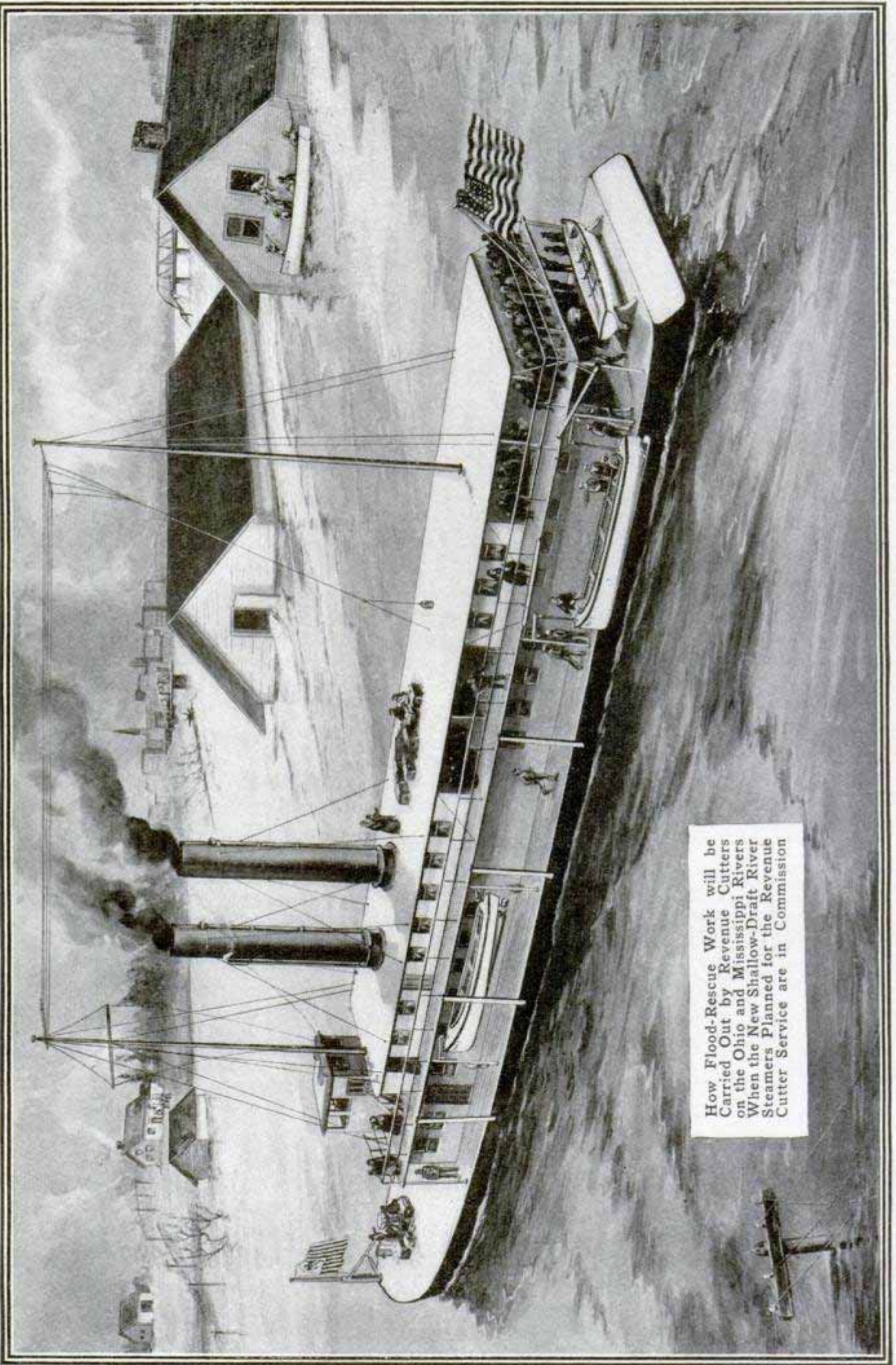

How Flood-Rescue Work will be Carried Out by Revenue Cutters on the Ohio and Mississippi Rivers When the New Shallow-Draft River Steamers Planned for the Revenue Cutter Service are in Commission



## REVENUE CUTTERS FOR OHIO AND MISSISSIPPI RIVERS

Widespread suffering and loss of life, such as occurred in the spring of 1913 when large sections of Ohio and Indiana were submerged by one of the most disastrous floods ever known in the country, will in future be prevented, if the bill now before Congress providing for extending the Revenue Cutter Service to the Ohio and Mississippi Rivers becomes a law. During that flood it was necessary to send from the Great Lakes and Atlantic ports skilled men and life-saving apparatus to aid in saving life in the inundated regions, and in the worst stricken district, the Miami Valley in Ohio, effective relief could not be begun until motorboats had been transported across country in automobiles.

Three powerful, shallow-draft steamers, to be equipped as revenue cutters and estimated to cost about \$80,000 each, have already been designed. Each cutter will have twin screws working in tunnels and will therefore be able to traverse flooded sections without danger to the propellers from wreckage. Each will be equipped with four 30-ft. motorboats carried on davits, and with one or more rowboats,

while cold-storage quarters in the forward part of the hull will enable the cutter to carry large quantities of food for distribution among flood sufferers. Such a vessel as this could probably have gone into the main streets of Dayton while the flood was at its height, could have sent its motorboats to rescue persons marooned in tree tops and crumbling buildings, and could have distributed food to others less perilously situated. During the flood season of each year these cutters will follow the crest of the flood.

Headquarters will be assigned to each of the cutters—one to be located at Louisville or Cincinnati, one at St. Louis and one at Helena, Ark., or Vicksburg, Miss. Under ordinary conditions they will patrol the river just as the revenue cutters now patrol the ocean, enforcing the navigation and motorboat laws, helping vessels in distress, and performing such other duties as may be assigned to them. They will be equipped with wireless apparatus and will therefore be able to respond quickly to any call for help. Each cutter will be 145 ft. long, with a beam of 27 ft. and a draft of 3½ feet.

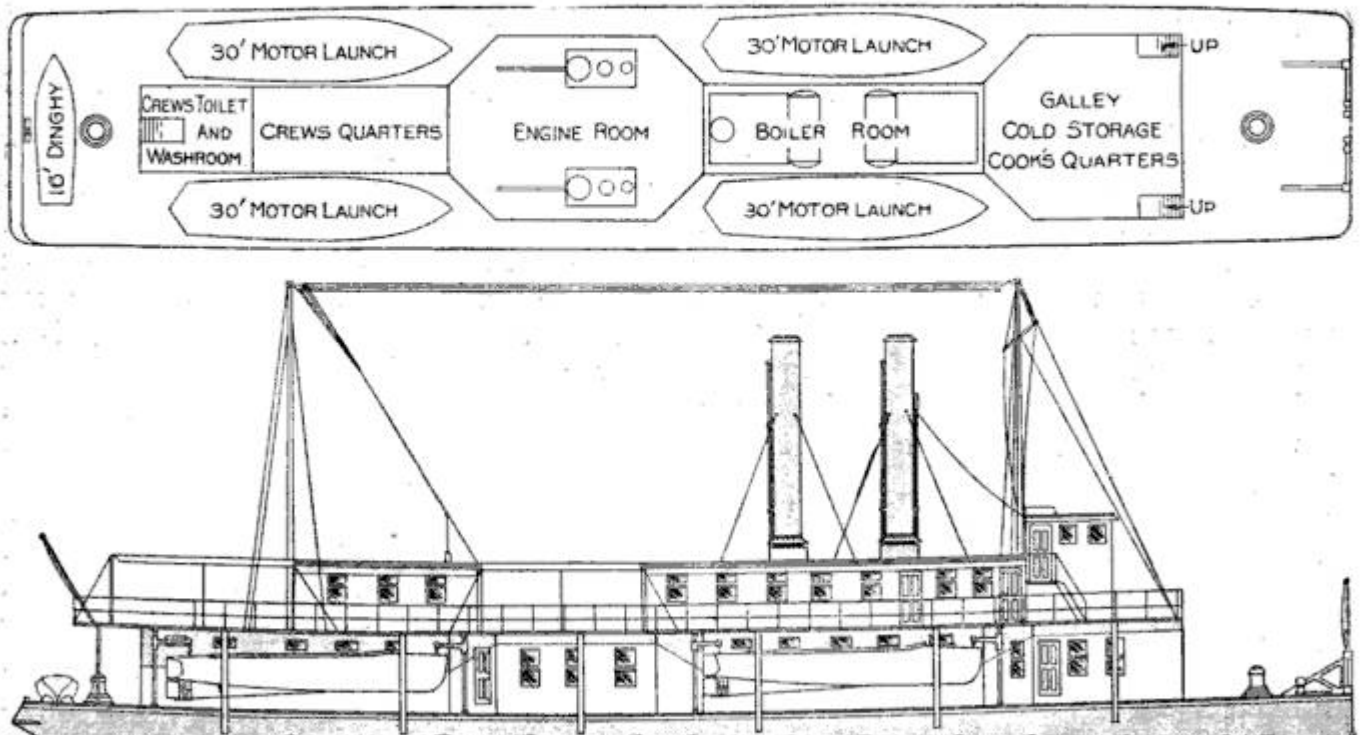

Side View of Proposed Revenue Cutters for Mississippi and Ohio River Service, with Plan of Main Deck



## SYSTEM FOR TEACHING FOREIGN LANGUAGES

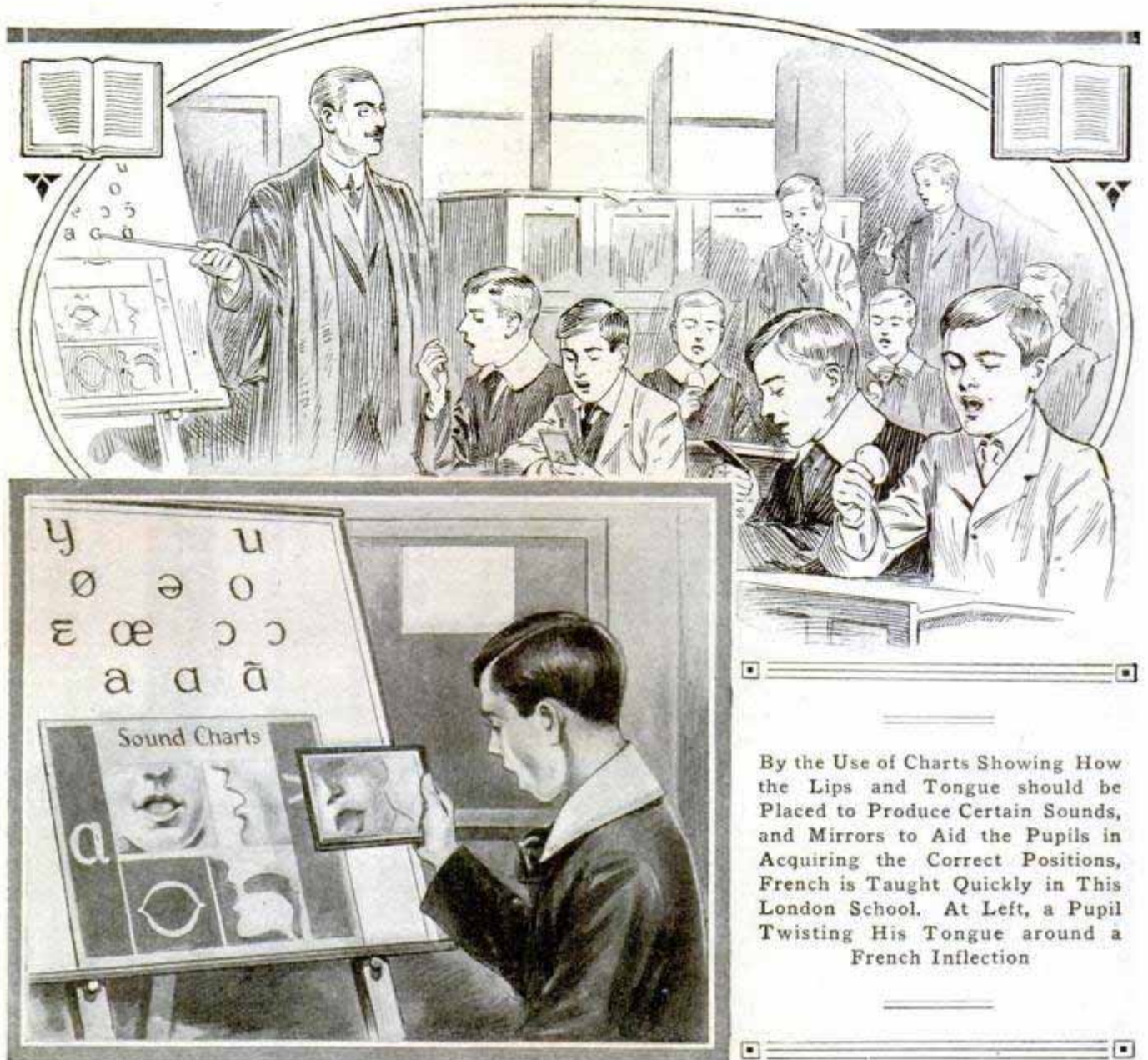

By the Use of Charts Showing How the Lips and Tongue should be Placed to Produce Certain Sounds, and Mirrors to Aid the Pupils in Acquiring the Correct Positions, French is Taught Quickly in This London School. At Left, a Pupil Twisting His Tongue around a French Inflection

In a London school foreign languages are taught by a novel system, using sound charts and mirrors. The charts show, graphically, how the lips and tongue are placed to produce, for example, the vowel "a." The pupil stands before the chart, mirror in hand, and tries to form his mouth and tongue in the manner indicated in the chart.

Lessons in which the whole class simultaneously go through the same exercises are given. In six months, two-thirds of the class could speak French correctly, while in other schools, not using this method, only a few of the scholars, after a similar length of time, could pronounce French in an intelligible manner.

#### MISSION PAPER PUBLISHED ON LONELY ISLAND

Midway between New Zealand and New Caledonia in the southern Pacific Ocean, and nearly 800 miles from the Australian shores, lies the

lonely island of Norfolk, having an extent of but 13.3 square miles. Once a penal colony, it now contains one of the most remarkable printing shops in the world. Here is published a half-yearly mission paper, the "Melanesian Mission Press," and other works in 21



different languages. It is owned by a German-American, formerly employed on a New York newspaper. He is publisher, editor, compositor, proof-reader, printer and binder. He has lived on the island for 32 years.

### STERN ANCHOR ON BRITISH BATTLESHIP

The use of a stern anchor is an innovation introduced on the new British battle cruiser "Queen Mary" which is nearing completion on the Tyne. The accompanying photograph shows how the stern anchor is carried in a hawser hole immediately below the admiral's walk on the stern of the vessel. The staging and ladder below the walk are of course temporary.

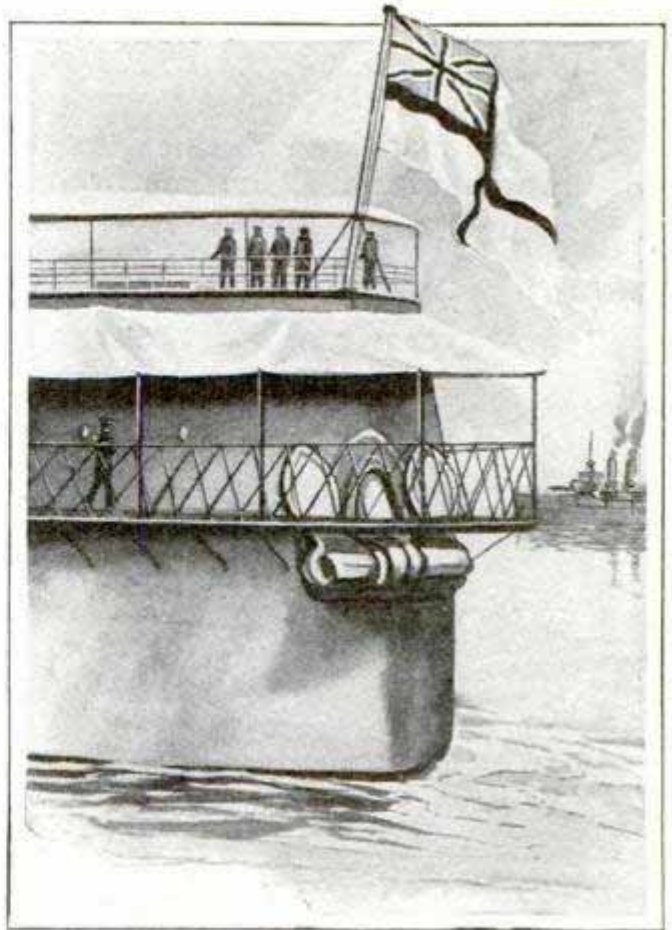

The Stern Anchor Adopted on a New British Warship

CA reproduction of the Yellowstone National Park will be one of the concession features at the Panama-Pacific Exposition.

### ODD ACCIDENT TO FRENCH AIRMAN

When a French airman attempted to make a landing recently, near Paris, his monoplane struck the tiled roof of a building, wrecking the machine and

smashing the tiling. Fortunately, the pilot escaped injury, though it is hard to understand by what miracle he was

An Accident of the Kind All Airmen Dread

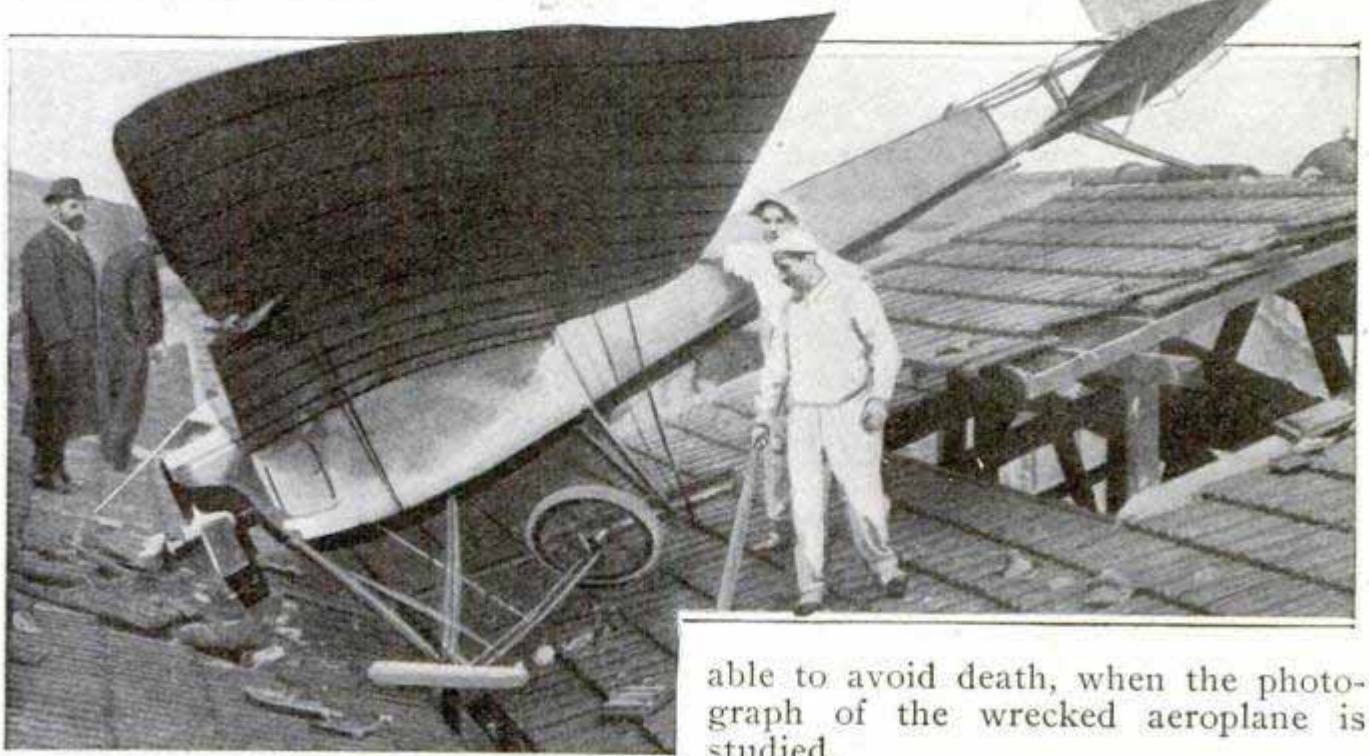

able to avoid death, when the photograph of the wrecked aeroplane is studied.



## AIR-PROPELLED UNICYCLE IS NOVEL VEHICLE

A new machine which upon the boulevards of St. Louis has attained

and oil supplies. The saddle is affixed to the same support, the rider's hands grasping a wheel upon which are mounted the controls, while his feet rest upon a little platform bolted to the

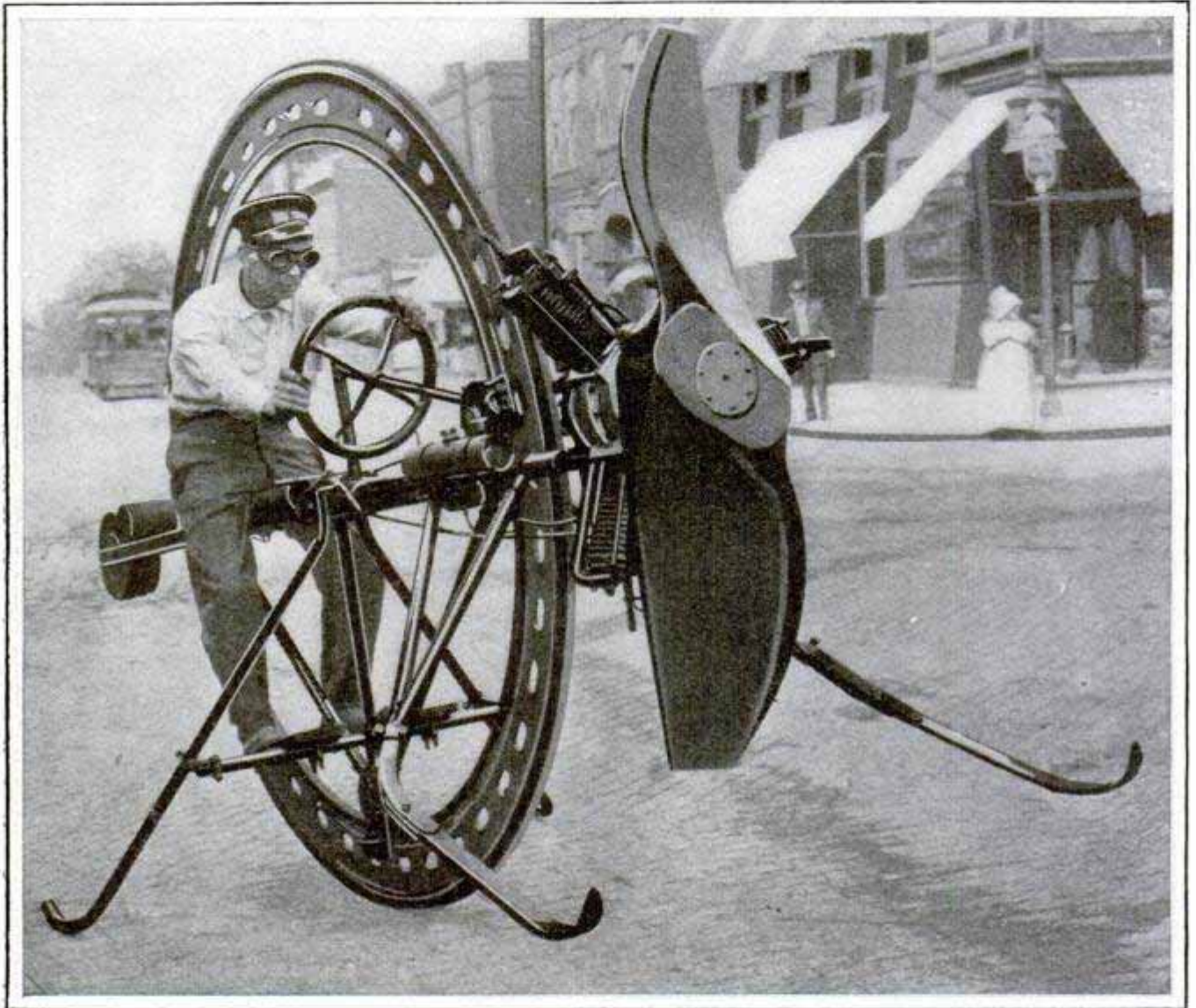

Remarkable Conveyance Which Uses an Aerial Tractor

a speed of 67 miles an hour is built after a novel design. It is a huge wheel or ring of aluminum, 81 in. in diameter, with a 2-in. solid-rubber tire. Within this outer rim is a curious framework of steel tubing so arranged that it remains stationary while the outer wheel or rim revolves. In front of the wheel and projecting from this framework is an air propeller nearly 5 ft. long, its two blades having a 4-ft. pitch and a tractive force of some 150 lb. Just behind the propeller is the three-cylindered engine. Along the principal rib of the framework, and within the wheel, are grouped the batteries, the magneto and the gasoline

lower part of the frame. On either side, and projecting some little distance from the main line of the wheel, are steel prongs or skids, which, when the unicycle is at rest, support it and keep it from falling, while the rearward projection of the frame ends in a small wheel or roller, of aid in starting the machine by giving it stability until enough momentum has been gained to enable the rider, by inclining his body forward, to bring the main rib into a horizontal position, which lifts the roller clear of the ground. The connection between the outer wheel and the frame is found in three jaws supplied with 5-in. fiber roll-



ers, 1 in. thick, which contact the inside rim of the wheel, and are kept from side-slipping by smaller side rollers of the same material. All rollers have ball bearings and lubrication is carefully planned. There is no steering device, the inclination of the body of the rider being sufficient, as in bicycle riding.

### FINDING MISSING PEOPLE BY THE "MOVIES"

A novel use for the motion-picture film has been found by those who are seeking lost friends or relatives. A portrait flashed upon the screen, with a request that anyone knowing the whereabouts of the missing person should communicate with the police, has been the means of locating sons, brothers, fathers and children who have run away or become lost in a large city. That the same means may be used advantageously by army and navy authorities for locating deserters, or by the police for finding men wanted for crimes and misdemeanors, has been suggested and is being favorably considered, as the motion-picture theater serves as the recreation place for hundreds of thousands whose eyes and memories may be enlisted in such search. It would be difficult to hide very long from such publicity.

CA Minnesota cow is credited with having broken the world's record for production of butter fat, her yield for one year being equivalent to 726 lb. of commercial butter.

### HORSES STABLED IN ICE IN GREENLAND

A Danish explorer who has just returned from a journey across the inland ice of Greenland made use of Icelandic ponies, which he found to be well adapted to arctic travel. When stops were made the horses were sheltered in holes cut in the ice. These icy stalls were quite comfortable, and in severe weather were covered with tarpaulins to keep out snow and wind. The small horses gave a good account of themselves, and will doubtless be

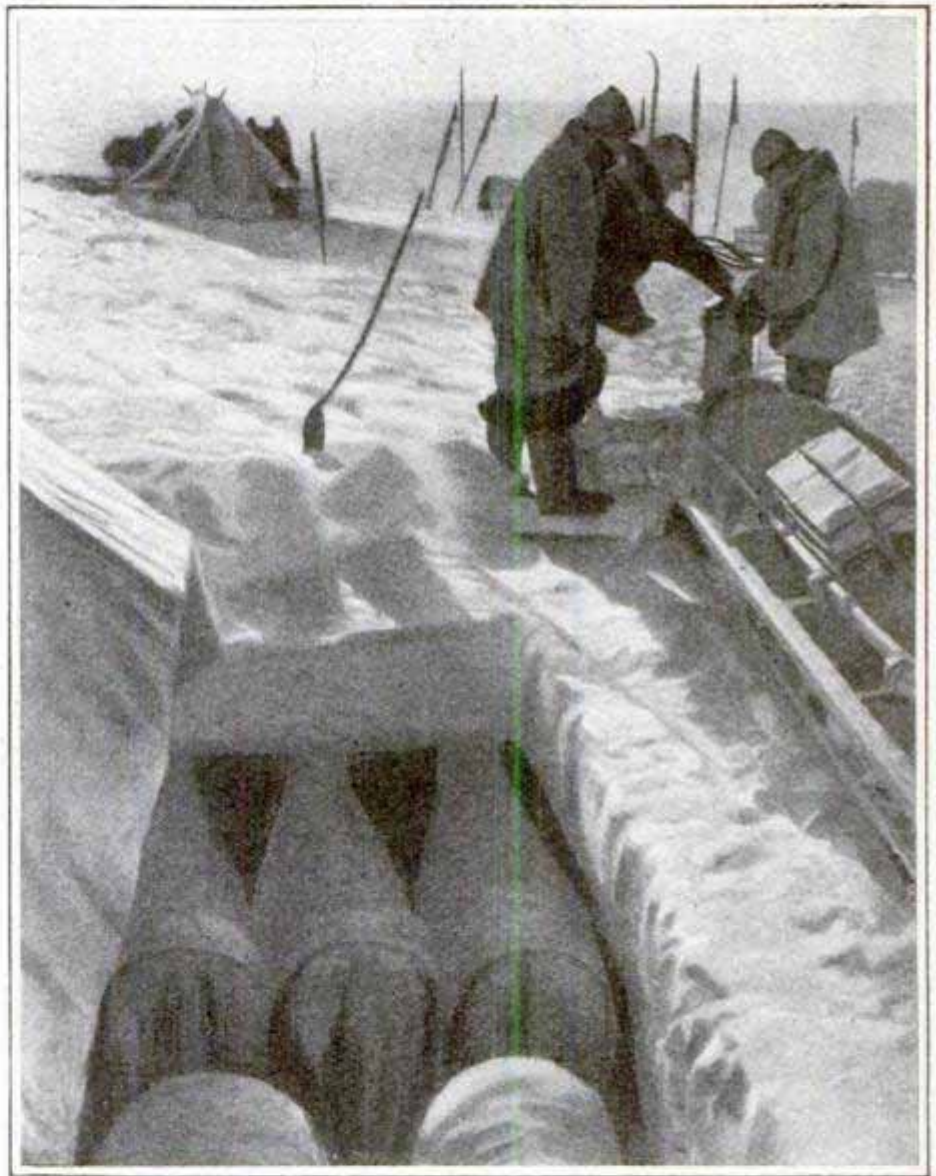

Courtesy Illustrated London News

Five Horses Given Shelter in Hole Dug in the Ice

used extensively in future arctic expeditions.

CA submarine telephone cable, 105 miles long, to cost \$3,000,000, is to connect England and Holland.



## GARAGE ON RAILROAD CAR

A western railroad president who makes many trips of inspection over his lines, is especially interested in

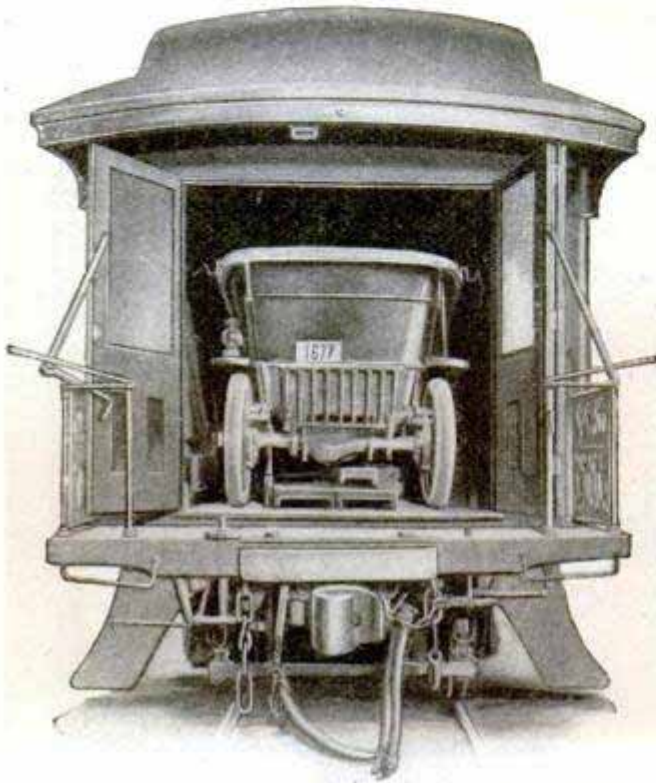

Photo by Underwood & Underwood  
How a Railroad President Carries His Automobile

crop conditions. In order to see at first hand how the farmers in the territory served by his lines are doing, he carries with him his automobile in a garage car attached to his special train. At any stopping point the automobile may be unloaded, and a ride throughout the farming section quickly gives him the information he most desires.

## SUBMARINE FAILS TO RISE AFTER MANEUVERS

Eleven men lost their lives on January 16, last, when the British submarine "A 7," which went out with a flotilla from Portsmouth for instructional evolutions, failed to make its appearance at noon, when the first maneuvers were completed. Six submarines with a tender, comprised the little fleet, which was engaged in carrying out exercises and firing torpedoes in the Channel. The first indication

of an accident came when the officers of the tender observed oily bubbles on the surface of the water.

When the "A 7" failed to appear a buoy was put down, and all available salvage boats summoned, but owing to the increasing rough weather, the buoy was washed away and when the salvage boats arrived, the submarine could not be located. There was sufficient oxygen on board the submerged boat to keep the crew of eleven men alive for only five or six hours beyond the time set for the completion of the evolutions. Several days passed, however, before the missing craft could be found, although an aeroplane was employed as well as a careful combing of the vicinity by submarines and salvage vessels. When at length divers located the "A 7," it was found stuck in the mud, 138 ft. below the surface, with its bow projecting upward at an angle of 30° to 40°, making the task of raising it an extremely difficult one. One theory of the accident is that the craft got so close to the bottom that, when its nose was pointed upward to start for the surface, the stern was thereby depressed so far that the propeller caught in the mud.

The "A 7" was built in 1904, and was one of the oldest submarines in the British navy. It was used only as a training boat, and would have been retired in regular course this year according to the Admiralty rules. It was 150 ft. long, with a displacement of 204 tons, and equipped with gasoline engines of 450 hp., giving a speed of about 14 miles an hour on the surface. When submerged it was operated by electric motors and could make about 8 miles an hour beneath the surface. It was built with air locks and safety helmets, but the pressure of the water at a depth of 140 ft. must have made it impossible to open the conning tower. At the depth the "A 7" is lying, divers can work only with extreme difficulty owing to the pressure of the water, more than 60 lb. to the square inch. Very few divers have ever reached the 140-ft. depth.



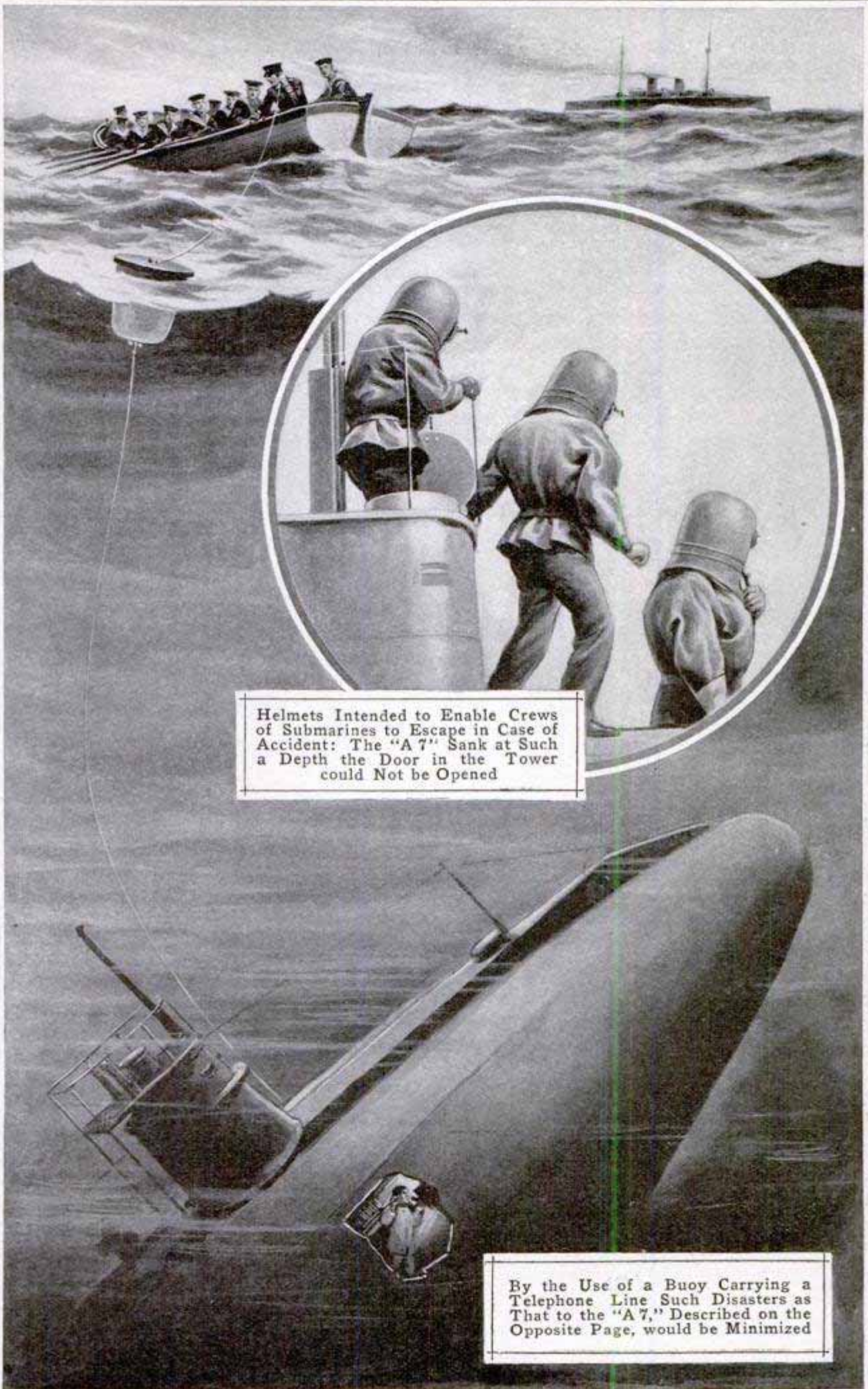

Helmets Intended to Enable Crews of Submarines to Escape in Case of Accident: The "A 7" Sank at Such a Depth the Door in the Tower could Not be Opened

By the Use of a Buoy Carrying a Telephone Line Such Disasters as That to the "A 7," Described on the Opposite Page, would be Minimized



# HARNESSING SCIENCE TO THE FACTORY

By FRANK PARKER STOCKBRIDGE

[ EDITOR'S NOTE—The sudden death of Dr. Robert Kennedy Duncan, which occurred on Feb. 18, 1914, is a distinct and serious loss to the cause of science which he so faithfully served. It is even a greater loss to American industry, to which he was in a very true sense a torchbearer, shedding the light of the new knowledge on its old problems and leading the way toward that industrial efficiency which alone can place American manufacturers on an equal footing with their foreign competitors in the world markets. Doctor Duncan was born in Canada, Nov. 1, 1868, and was educated at the University of Toronto, and at Clark and Columbia Universities in this country. He was the discoverer of several valuable industrial chemical processes and the author of a number of books on scientific subjects. His greatest achievement, however, was his successful attempt to bring manufacturing industries and pure science into closer accord, an achievement which was just reaching its full fruition when he died. It is gratifying to know that the work he so ably began will be continued under the direction of one in whom he had complete confidence and who had long been in touch with his methods and his plans, Dr. Raymond Foss Bacon. "A great deal of the credit for what we have accomplished belongs to Doctor Bacon," said Doctor Duncan in the course of the interview, less than a month before his death, which formed the basis of this article. "I want you to be sure to mention him." The request was characteristic of Doctor Duncan's broad mind and generous nature. And upon the foundation which he laid with so much skill and pains, the new conception of the place of science in industry will stand as his enduring monument.]

**I**N a little wooden building on the grounds of the University of Pittsburgh, 36 young chemists are working at scientific problems, the solution of which will earn millions of dollars for many industries, and eventually add to the happiness and prosperity of everybody in the world.

The little wooden building is the temporary headquarters of the Mellon Institute of Industrial Research of the University of Pittsburgh. A hundred feet away, the walls are going up for a big fireproof building that will house 70 distinct research laboratories, in which a hundred men can work at once on as many different industrial problems. But the walls of the little old wooden building, if they could speak, could tell of discoveries already made, as startling, as valuable and as far-reaching in importance as any that are likely to be made in the institute's new quarters.

Think what it would mean to reduce the nation's bread bill 1 per cent. "Homemade" bread is extinct in this country except in remote rural districts, while the old-fashioned "salt-rising" bread of our grandmothers, which everyone who ever was fortunate enough to taste it will agree was

the best bread ever baked, is practically unknown to the present generation of Americans. We buy our bread from the bakeries—almost \$400,000,000 worth of it every year.

"How can we make better bread?" asked a big baking company of the late Prof. Robert Kennedy Duncan, Director of the Mellon Institute. The first step in finding the answer was to

put a trained chemist at work in one of the institute's laboratories. The baking company paid him a salary of \$750 a year for two years and offered him a prize of \$2,000 if he found a satisfactory answer. Before he had finished his experiments, another baking company asked the same question. They offered \$4,750 a year for two years and a prize of \$10,000 for any practical results.

And the chemists got results—found

not only one answer but a dozen answers—found how to make better bread, while at the same time cutting down the cost of manufacture; found how to make "salt-rising" bread of better quality than the kind grandma used to make; found out, in short, so many interesting and valuable facts about the chemistry of bread making, that the companies which are now

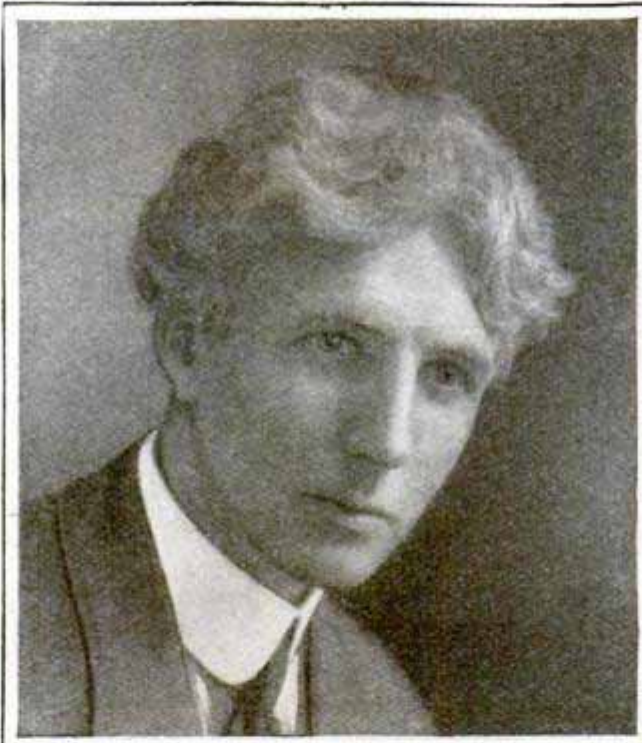

The Late ROBERT KENNEDY DUNCAN, Sc. D.  
Dr. Duncan, the Originator of the Modern Idea  
of Industrial Research in the University,  
Died on Feb. 18, 1914, after This Article  
had been Written and Set in Type



utilizing these facts are already saving probably more than \$250,000 a year in the cost of their product and giving their customers better bread than they have ever had. And that was only a beginning of the research into the chemistry of bread at the Mellon Institute. When I visited it in January I saw three chemists working with masses of dough in one of the little laboratories, trying to work out still more complicated problems in bread making. They are working under a gift of \$6,000 a year for their living expenses, with another \$10,000 prize in view, if they get the answer.

It is almost safe to predict that the poorest bread sold ten years from now will be better than the best on the market today, and cheaper. It is certain that the world's knowledge of chemistry of bread making has been

enormously increased within five years as a result of these men's work.

I have written first of the Mellon Institute's work in bread, because there is no other product of industrial chemistry that enters into the lives of so many people. Baking, after all, is merely a chemical process. But so are thousands of other industrial processes—almost all manufacturing, every branch of farming. Chemistry enters in some degree into every branch of business, into the day's work of everyone engaged in productive labor.

Over in Germany, manufacturers and business men have recognized this direct connection between science and industry for many years, and have been making good use of it. The greatest triumphs of German industry, triumphs that have given them almost a monopoly of the world's markets in

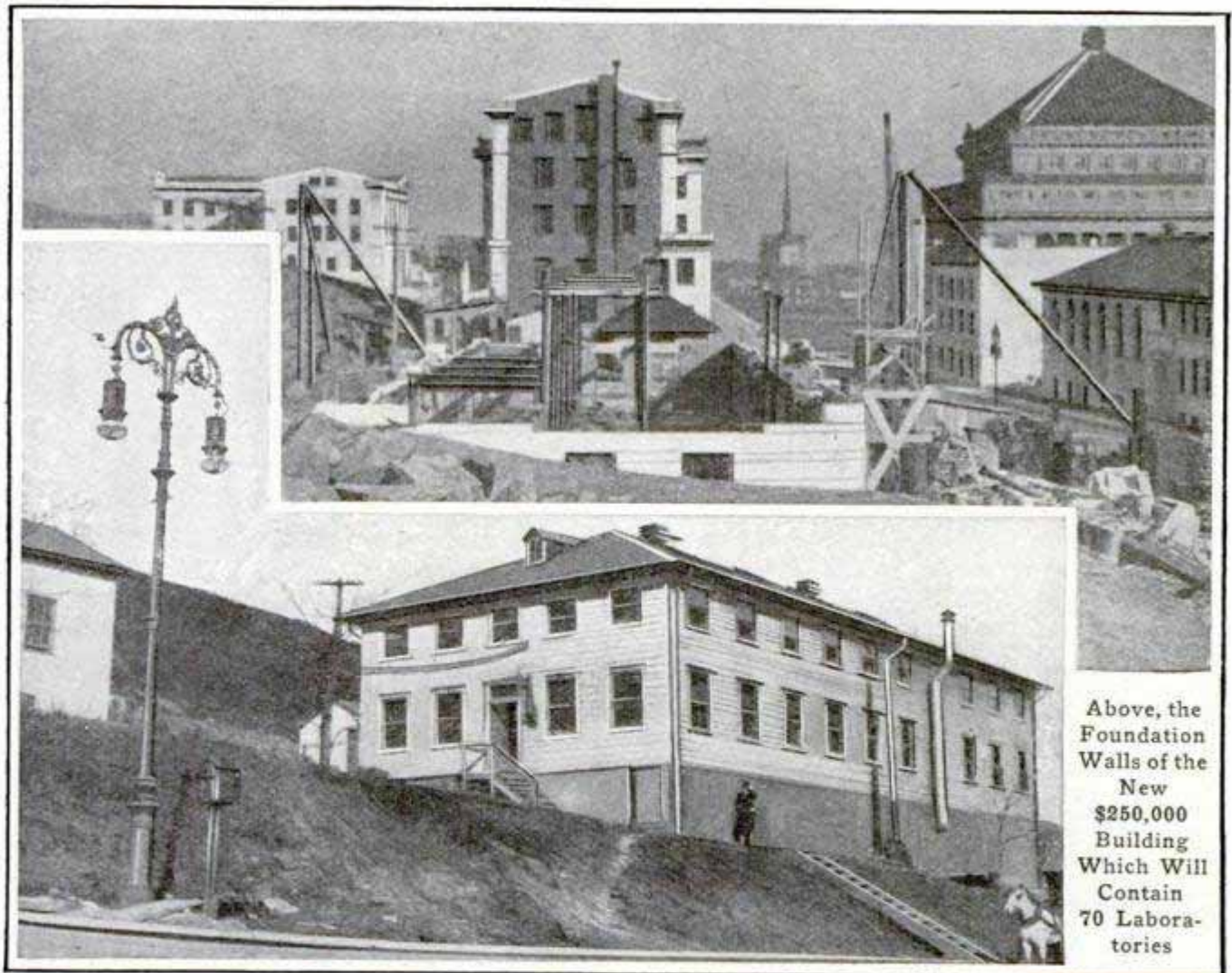

Above, the Foundation Walls of the New \$250,000 Building Which Will Contain 70 Laboratories

The Temporary Wooden Building That Houses the Mellon Institute of Industrial Research, Where Science is Brought to the Assistance of Industry. At the Left is One of the Small "Unit Plants" for Testing Laboratory Results on a Commercial Scale



many lines, have been won through the coöperation of business and science and the application on a commercial scale of the chemists' laboratory discoveries. But while the Germans have been going ahead rapidly, American industries have lagged behind, either refusing to avail themselves of chemical knowledge that would be of immense value to them or at least offering no encouragement to original chemical research, even in lines directly related to their own products. Occasionally an American manufacturer has hired a chemist on about the same basis as he would hire a machine hand, and with about the same expectation of a daily output in return for his wages. But the instances have been as few in America as they have been frequent in Germany where manufacturers have provided adequate laboratory equipment, freedom from restrictions and interference, and reasonable salaries for trained chemists to work out scientifically the vital unsolved problems of a particular industry.

Dr. Robert Kennedy Duncan, at that time professor of industrial chemistry in the University of Kansas, suggested in 1907, in a book on chemical problems, that a practical means of giving American industry the benefit of the best scientific research might be found in the establishment of what he termed "Industrial Fellowships," in some university. He proposed that the manufacturer should lay his particular problem before the university authorities, paying an annual sum sufficient to provide a fair salary for a skilled research worker for a limited time, and offering a prize, either in the form of a cash bonus or an interest in the profits derived from the discovery, if the problem were solved. Several manufacturers took up the idea, and a number of industrial fellowships were established at the University of Kansas. The idea spread, the University of Pittsburgh invited Doctor Duncan to take charge of similar work at that institution, and the Mellon Institute is the result. Doctor Duncan was its first

director, with Raymond Foss Bacon, Ph. D., as associate director.

An interesting and inspiring place, this rough building in which science is teaching industry how to transmute base materials into coined gold. Literally from cellar to garret it is crowded with men and women and apparatus, while the odors of ozone, oxides of nitrogen, yeast, petroleum, sulphuric acid and a hundred other gases and chemicals mingle familiarly in the hallways and provide an "atmosphere" that at once suggests chemistry, even though it does not necessarily imply research. Thirty-two industrial fellowships have so far been established at the Mellon Institute. The work under many of them has been completed, but that still going on represents an annual expenditure by the industrial interests that have endowed the fellowships of \$102,400.

"We can get money for research easier than we can get men qualified to do the highest class of research work," said Doctor Duncan, when I talked with him less than a month before his death. "Two Pittsburgh men, A. W. and R. B. Mellon, have given \$250,000 for the new building, \$60,000 for apparatus, \$20,000 for the purchase of a chemical library, and an endowment of \$40,000 a year for general maintenance. This makes it possible to devote every cent that is paid by a manufacturer for research work to the solution of his particular problem. Our only difficulty now is in getting the best men for research work, but we are getting them from every part of the world."

Secrecy is the rule at the Mellon Institute—the protection of the trade secrets of the manufacturers in whose interests the research work is being done, in order that they may reap the benefits of their investments in the fellowships. Yet every contract between an industrial company and the institute contains a provision insuring the eventual publication, after a reasonable lapse of time, of the results obtained, for the benefit of the whole industrial world. When a process or





Two Interesting Features of the Work of the Mellon Institute: Each Research Worker Tacks His Pennant to This Wall as a Pledge of the Honor of His University for His Loyalty and Fidelity. The Stenographic Corps is Almost as Important as the Chemists, Furnishing the Connecting Link between the Institute and the Scientific Knowledge of the Whole World

product discovered in the laboratory is patentable, it is patented by the research worker discovering it, if the donor of the fellowship so desires, and the patent transferred to the donor. Often, however, the new processes found are kept secret rather than giving to the public, through the medium of a patent, a clue from which others might work out similar results without infringement, as so often happens in commercial enterprises. But since the primary function of the university is to serve the whole people rather than any individual or single interest, even these secrets must in time be disclosed, though not at such time or under such conditions as to affect seriously the business of their original possessors.

With forty or fifty young chemists working in the same building, each on a different problem and each bound to secrecy as to the exact results he obtains and the methods by which he gets them, it is, of course, essential

that a high standard of honor shall prevail throughout the establishment. One of the finest and most inspiring sights at the Mellon Institute is the partition wall in the main office, covered with university pennants. Upon this wall, when he enters the institute to take up research work, each fellow tacks the emblem of his alma mater. It has already become a tradition that in so doing he pledges the honor of his university, not only as to the quality of his work, his enthusiasm and his devotion to it, but by way of an oath to keep his own counsel and never reveal the secrets with which he is intrusted or that he may learn while there. Not once has there been the slightest lapse from this high standard of honor. It is understood that none of the researchers is to question another as to the results he is getting or how he got them. He may—and this is being done continually—ask another who has specialized in a particular



field of chemistry how best to get a certain reaction, for instance, or the meaning of results which are not clear to the inquirer, but as to the bearing of these detailed questions on the main object of research there is no communication and no "prying." In short, the ordinary courteous interchange of information that prevails among scientists is utilized fully, to the advantage of all concerned, without at any time jeopardizing the interests of anyone.

An interesting illustration of the

problems they are to undertake by spending several weeks, or even months, in the factories where the results of their work are to be applied, thus gaining first-hand knowledge of the manufacturing conditions which must be met. Nor does their research work stop with the achievement of mere laboratory results. These once gained, a "unit plant" is constructed, sometimes on the university grounds, sometimes farther away, in order to be beyond the reach of curious outsiders,

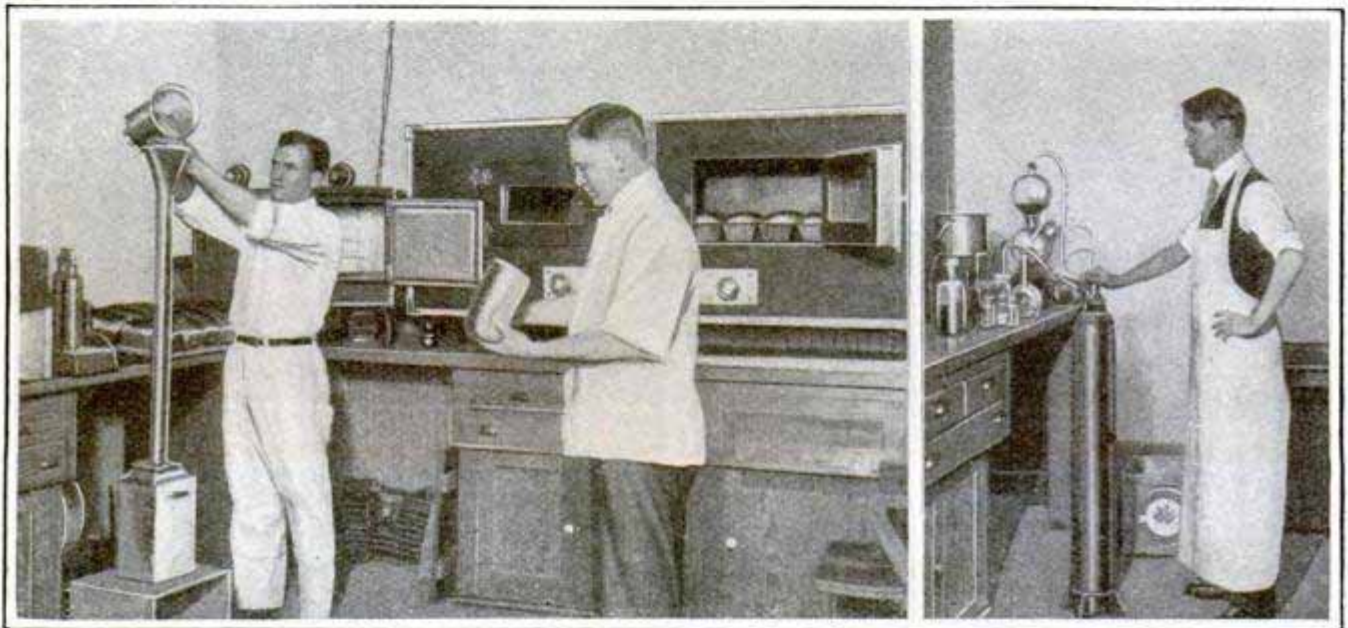

Better and Cheaper Bread for All the World is One of the Most Important Aims of the Research Work of the Mellon Institute: These Views Show Some of the Chemists Engaged in This Work, Which has Already Resulted in Reducing the Cost of Baking

way in which the best available knowledge of specially trained scientists is utilized is found in the organization of the office and the library of the institute. Here, in addition to the books, is a large staff of stenographers. Instead of wasting days or weeks hunting for a special piece of information which may or may not be contained in one of the volumes, if the facts sought are not readily accessible, letters are written to those scientists in every part of the world who stand foremost on the particular questions involved, and thus the fullest available information is brought to bear on the problems.

Before beginning the work in the laboratory, most of the research fellows familiarize themselves with the

and the new process tested or the new product manufactured on a scale large enough to demonstrate its commercial applicability. This "unit plant" demonstration, too, is often followed by a "full-sized" experiment with all the resources of a great manufacturing plant at the investigator's disposal, before the results of his work are finally accepted as satisfactory. Mere theories win no prizes at the Mellon Institute.

While nothing that could affect the interests of the supporters of the industrial fellowships may be made public, yet enough was disclosed to me by Professor Duncan to prove the tremendous value to industry, and so to the public generally, of the work which the Mellon Institute is doing for American manufacturers.



"Here is the result of one of our researches," he said, taking from his desk several objects made of what appeared to be vulcanite or hard rubber. "And here is another specimen of the same substance." This was a rod of material that looked exactly like a fine specimen of clear amber. "Both of those substances are the same," he said. "It is a new product, called amberoid, which was discovered by our industrial fellows. A manufacturer wanted a new finish for wood—an enamel that would be better than anything yet produced. He provided a fund of \$1,500 for the first year and \$4,200 a year for two years more, with a bonus of 25 per cent of the stock of his company for the three scientists engaged in the research. The product which they have evolved is revolutionary. The only enamel now in use which approaches it in quality has to be made and applied under very high pressures and at high temperature. This is produced and readily worked at 60° centigrade, or about 140° F., and without heavy pressures. It is clear and translucent, can be dyed or colored as desired, and is a perfect substitute

for vulcanite in every possible use, both because of its elasticity and its hardness and high insulating power. It is

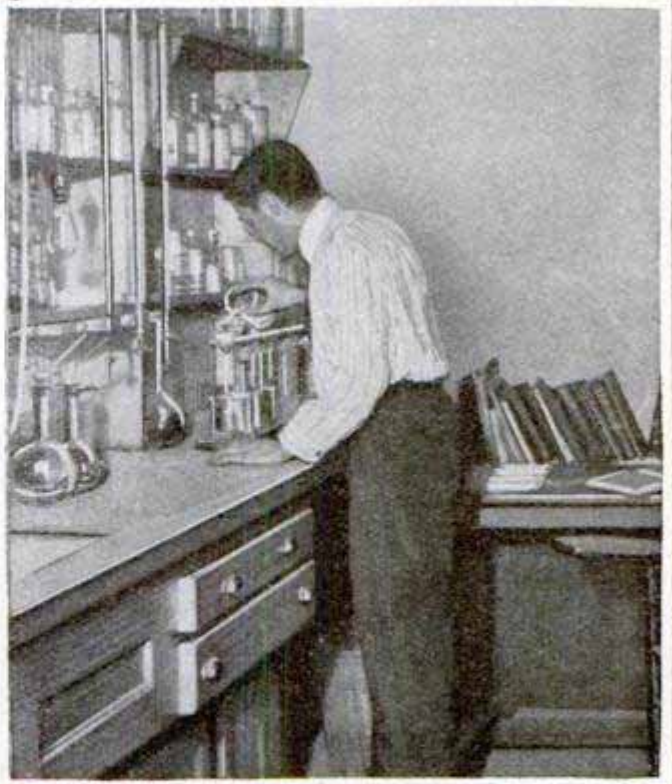
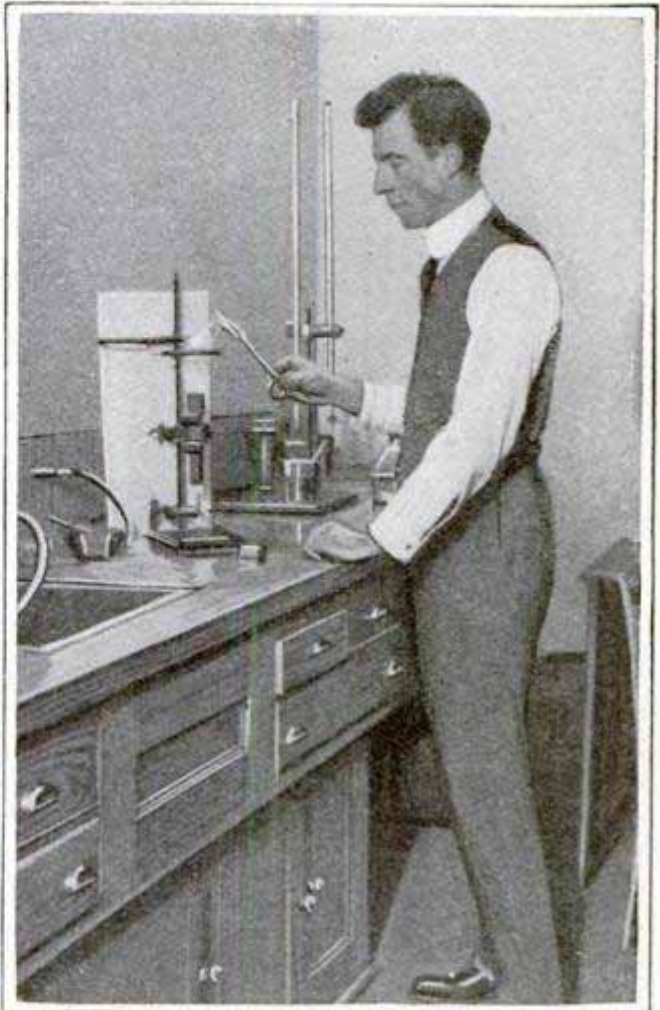

Scenes in the Laboratories at the Mellon Institute, Where Skilled Chemists are Bringing Scientific Knowledge to Bear on the Unsolved Problems of American Industry. There will be Seventy of These Individual Laboratories in the New Building



odorless, insoluble in acids or alkalis, and nonexplosive. It can be used as a binding material, as with sawdust for artificial flooring, or with carborundum for grinding and polishing. I regard it as one of the most important industrial discoveries of recent years.

"Another very important research is one which is now in its third year, in petroleum. There was a variety of problems presented to the nine fellows engaged in this work. The endowment is \$10,000 a year for three years and the bonus a 10-per-cent interest in the discoveries made. One of the most important results so far attained is the discovery of a cheap and practical method of extracting high-grade gasoline from petroleum wastes which have heretofore been thrown away. The importance of this, in view of the tremendous increase in the demand for gasoline, is apparent. These fellows have also discovered a new method of distilling lubricating oils, which gives better results than any process heretofore used.

"Another group of fellows, working under a different endowment, has found new methods of producing hydrogen and new markets for this gas.

"The problem of the preservation of orange juice has puzzled the Florida and California fruit growers for 30 years. No matter what preservatives were used, the preserved juice would eventually turn brown. A practical and cheap method of preserving it would make it possible to utilize a large part of the orange crop which is now wasted. One of our fellows has discovered such a process, whereby orange juice can not only be preserved, but crystallized, so that it can be packed and handled in a dry form; again becoming true orange juice when mixed with water, the only change being that it is slightly less sweet than when first pressed. No artificial preservatives of any kind are used.

"One of our most important lines of research, so far as Pittsburgh is concerned, is the effort to find an effective, yet commercially practical way of abolishing the smoke nuisance. The

sum of \$41,000 was given during a period of three years, and we have now found the answer. The passage of a high-potential current of electricity, of low amperage, through very small wires suspended vertically in a flue, has been found to cause the precipitation of the carbon particles in the smoke. Arrangements are being made to give Pittsburgh the first opportunity to avail itself of this discovery, which was financed from motives of public spirit more than the desire for commercial gain.

"We are now testing, in a unit plant, a new method of extracting copper at a profit from 'tailings' and low-grade ores which were formerly of little or no value. Some of our fellows have made important discoveries relating to the hardening of fats by catalysis.\* An interesting research now under way deals with the purification of sewer grease for use in soap making. The utilization of leather scrap; a method of making glass of a new and distinctive color; the whole subject of the chemistry of glue, of which little is known; methods of coating steel with copper; questions dealing with the utilization of natural gas; the production of cement, and the corrosion of steam radiators—these are among the practical, present-day industrial problems which are being attacked under these industrial fellowships. Most of them will be solved. There have been but two failures so far to get the results sought, and these were such as to reflect no discredit on the institute.

"A particularly interesting problem of far-reaching importance is involved in an industrial fellowship, negotiations for the endowment for which are now under way. The positive results that have been achieved in the use of radium for the treatment of cancer have made the question of the world's radium supply a vital one. Scientists have long known that the Roentgen rays—the ordinary 'X-rays'—are identical with the curative rays of radium

\*A description of this method of converting fluid oils or fats into stable solids was published in Popular Mechanics Magazine for November, 1913, page 622



—the so-called 'gamma' rays—except that the X-rays have much less penetrating power. It has been suggested that if some means could be found to produce by the electric current X-rays having the penetrating power of the gamma rays, the curative powers of radium would be at the command of every physician at a trifling expense. It will require a fund of at least \$7,000 a year for an industrial fellowship having this discovery as its object. It will take some time to find the best-equipped man to undertake this re-

search, for, as I have told you, it is easier to get money than men. But he will be found, and the work will be undertaken. If he succeeds, some arrangement will be made to provide an adequate prize for his discovery and to give the result of his work freely to all the world, for the use of the whole medical profession in the relief of suffering humanity.

"If this discovery shall be made and everything else we have accomplished should be wiped out, our work will have justified the faith of its founders."

### MOTION PICTURES SHOW ARMY IN ACTION

Under orders from the War Department at Washington, an officer of the field artillery is delivering a series of lectures illustrated by about 8,000 ft. of motion pictures showing large bodies of infantry, cavalry and artillery in action. Maneuvers are worked out with perfect technical accuracy. An orderly delivers a message from the commanding officer to assemble one company at once. Call to arms is sounded by the bugler. In a few minutes the company is "on the hike" in the direction of the enemy. The advance guard comes in contact with the enemy. Flankers join the movement. Connecting files inform the main command the preliminary skirmish is on. The entire company goes into action, with rapid fire and bayonet charge. Cavalry supports the rush and field batteries come into action, portraying the most magnificent picture of warfare ever seen. The lectures are well attended and occasion much comment.

### NEW FILLER FOR LIFE PRESERVERS

The Navy Department is considering the adoption of llano silk, or kapok, instead of cork in life-saving appliances. Kapok is the long silky fiber of the bark of a tree which grows freely in tropical America, although

now the product is produced almost exclusively in Java. Kapok, or "silk cotton," as it is also known, is lighter and more easily handled than cork, occupies less space and is better suited in every respect than cork to use in the life-saving apparatus. The fiber is soft, silky and elastic, and maintains its elasticity in use.

DRESS MADE OF  
NEWSPAPER

PRINTED  
ON SILK

Eight Yards of Satin was Run through the Press of a Washington Newspaper Plant Recently. This Garment was Then Made from the Cloth and Formed One of the Most Curious Costumes at a Fancy-Dress Ball. Extreme Care on the Part of the Newspaper Pressmen was Necessary, That the Delicate Material Should Not be Smudged by the Ink, and Caution on the Part of the Modiste and Her Helpers, of Course, in Transforming the Material into a "Creation"



Photo by G. V. Buck



## LARGE SHIPS PROPELLED BY DIESEL MOTORS

After years of experimenting with smaller craft, the Diesel motor is now being applied to merchant vessels of

sels are the "Siam" and the "California." The "Siam" is the largest merchant motor ship afloat and the first to be placed in service on the Pacific. The motors of this ship develop 3,200 hp., while the ship itself is 425 ft.

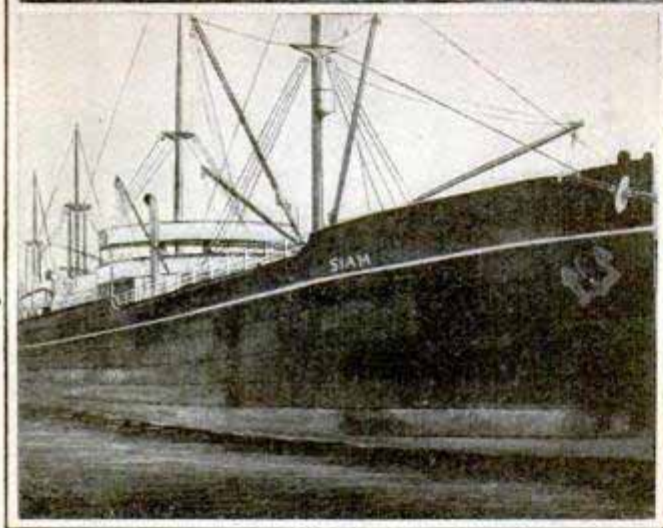
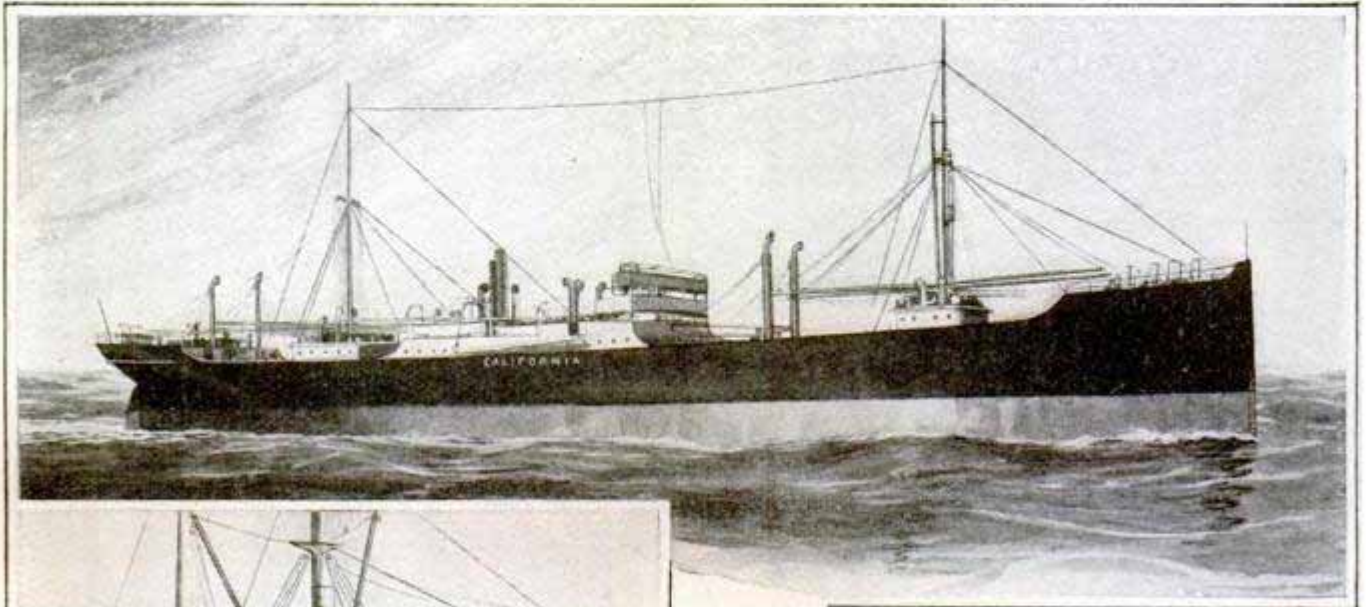

The Stackless Ocean Liner "Siam," All the Machinery of which is Driven by Diesel Motors

The Motor Ship "California" Has Propellers Driven by Diesel Motors and Cargo Winches Driven by Steam

such size as to compare with modern ocean liners. The latest of these ves-

long and has a beam of 55 ft. According to announcements it is the advance guard of a fleet of similar craft to be used for trade by way of the Panama Canal. This ship has a dead-weight capacity of 10,000 tons. The "California" is slightly smaller than the "Siam," having a length of 405 ft., a beam of 54 ft., and a dead-weight capacity of 7,200 tons. The motors are capable of developing 2,700 hp. The cargo winches being steam-driven, it is equipped with a slender funnel.

## AMERICAN TYPEWRITERS IN INDIA

A recent invention permits the adaptation of an American typewriter, in common use in India, so that it may be used for printing the 360 letters and signs of the Bengali alphabet. The standard typewriter keyboard has 42 keys, which, with the one-shift arrangement, permits printing 84 letters and characters. By the addition of four printing keys, each carrying two characters, the whole of the Bengali

alphabet may be written. This is possible from the fact that by the aid of "dead" or non-carriage-operating keys, and the back-spacer key, combined with placing of characters or parts of characters upon the type blocks in certain defined positions, the 360 characters and signs of the alphabet are practically reduced to 92. For example, the triangular character, which is one of two engraved upon a single type block, may be impressed upon the paper by itself, and with the aid of a back-spacer key may be struck a sec-



ond time to form two triangles connected by a dash at the top, forming another and entirely different character. Since the dead keys, when struck, do not cause a movement of the carriage, another character or sign can be impressed upon the paper by an ordinary key at or near the same printing point as that already printed by the dead key. The device is expected to increase the use of typewriters throughout India, where the Bengali language is largely used in commercial affairs.

More than 800,000 hp. has been developed from streams on national forests under government regulation.

### PORTABLE KITCHEN USED BY FRENCH SOLDIERS

In order that his men might have their meals piping hot and without delay, a captain of the French colonial army has invented a portable field kitchen. This unusual contrivance consists of two shafts attached to either side of a portable stove and boiler,

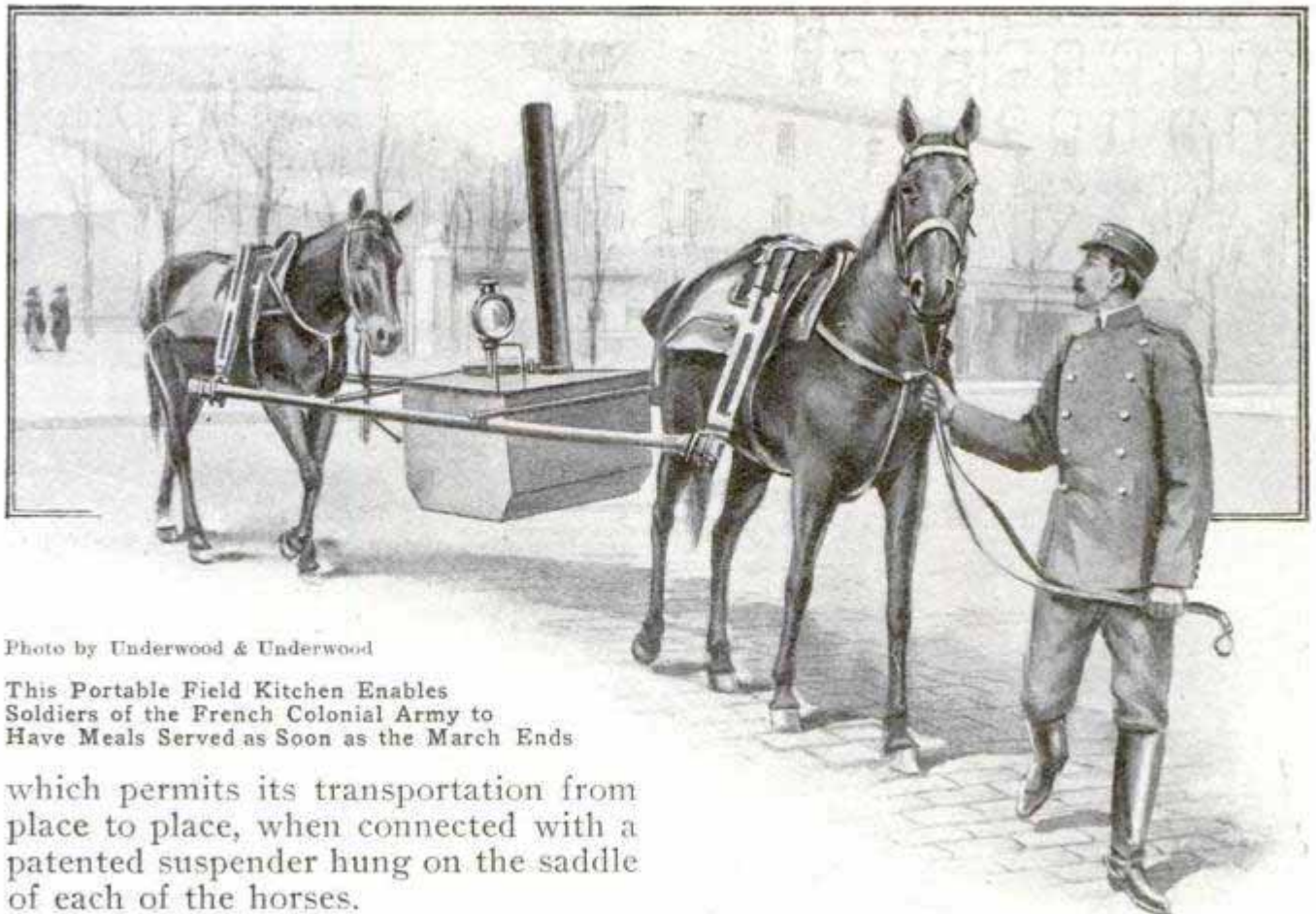

Photo by Underwood & Underwood

This Portable Field Kitchen Enables Soldiers of the French Colonial Army to Have Meals Served as Soon as the March Ends

which permits its transportation from place to place, when connected with a patented suspender hung on the saddle of each of the horses.

### PACKAGE CARRIER FOR MOTORCYCLES

Wire receptacles built over the rear of a motorcycle transform that vehicle

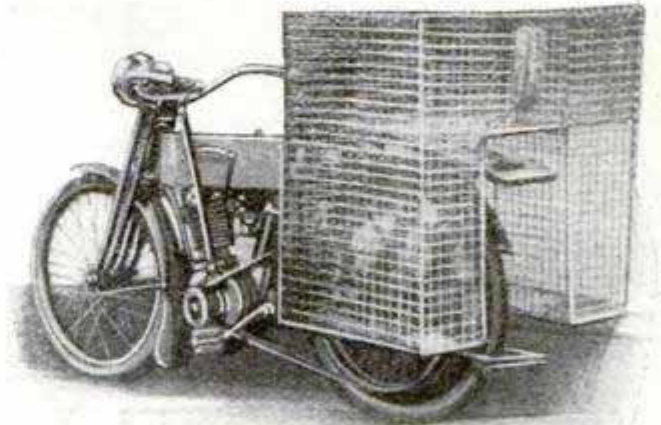

Package Delivery without a Sidecar

into a delivery van for a steam laundry. Heavy woven wire is reinforced at the corners and bottom with stout iron rods, the carrier thus formed being securely fastened to the rear of the saddle and to the frame of the motorcycle. The dimensions on the one pictured are about 30 in. each way, giving it a capacity almost equal to a medium-sized sidecar van.



## AN INTERESTING EXAMPLE OF SNOW SCULPTURE

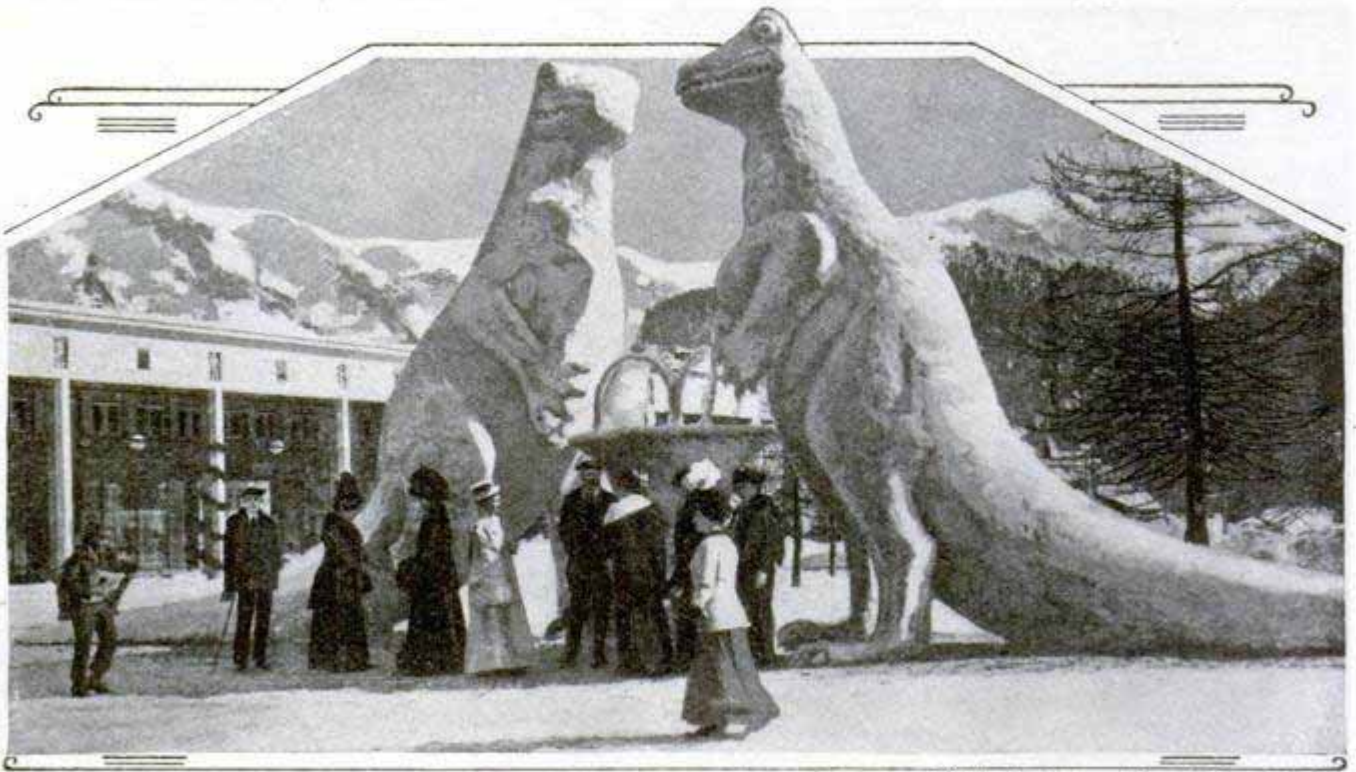
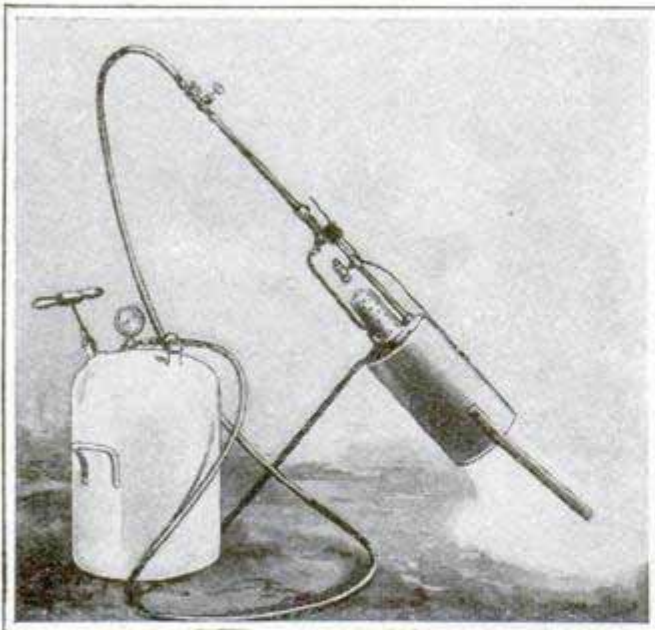

Photo by International News Service

Curious Snow Figures Reproducing Prehistoric-Animal Forms Seen at a Swiss Winter Resort

### KEROSENE HEATER FOR POLE DIGGING

When the ground is frozen the task of digging post holes becomes a heavy one. A new portable heater has been



Banishes Frost When Poles are to be Set

designed, consisting of a kerosene-burner outfit, with tank, hand air pump, pressure gauge and hood of special construction. By means of the

hood the intense flame from the heater is directed to the ground on the spot where the hole is to be dug, and the frost is taken out in a very short time. The earth is thoroughly thawed, so that when tamped back in the hole after the pole has been planted, it sets solidly and no retamping is required.

### WILD HORSES MAKE RAIDS ON CANADIAN FARMS

In the first mad rush for the Yukon gold fields, every available form of transportation was engaged to hurry seekers after the precious yellow dust to their destination. Once the gold camps were reached, many horses, mules and dogs were abandoned, and left to shift for themselves, seeking forage where they might find it. The result is seen today in northern Canada, where herds of wild horses menace the farms of settlers in Alberta and British Columbia, raiding the ranches, stampeding the domestic horses, and leading away into the wilderness numbers of high-bred horses brought to Canada for breeding



purposes. So serious has this condition become that the minister of agriculture for the province of Alberta has applied to the Dominion government for aid in stopping the depredations.

### CEMENT POSTS SUPPORT DECAYED TREE

A large and very old live-oak tree which adorned the lawn of a Pasadena residence had become decayed and broken down. Its picturesque appearance induced the owner to make an effort to save it. Cement posts securely imbedded in the ground, and finished and stained in such a manner as to make them resemble closely the natural bark of the tree, were provided and set in such positions as to support the limbs. One of these posts is as large in diameter as the tree itself, others are 10 or 12 ft. tall, and have stubs which appear to be ends of branches. Few persons looking at the tree and its supports would suppose that the latter were anything but live-oak wood.

### MEXICAN MINERS WEIGHED WITH LOADS OF ORE

To save rehandling, the ore from a Mexican silver mine is weighed as it comes from the mine on the backs of



Weighing Ore and Man  
Together at Mexican  
Silver Mine

the peons. The checker has the weight of each man and his equipment noted in his book, so that the correct number of pounds of the mineral is represented by the difference. This method not only saves considerable time, but also spares the laborers much unnecessary work.

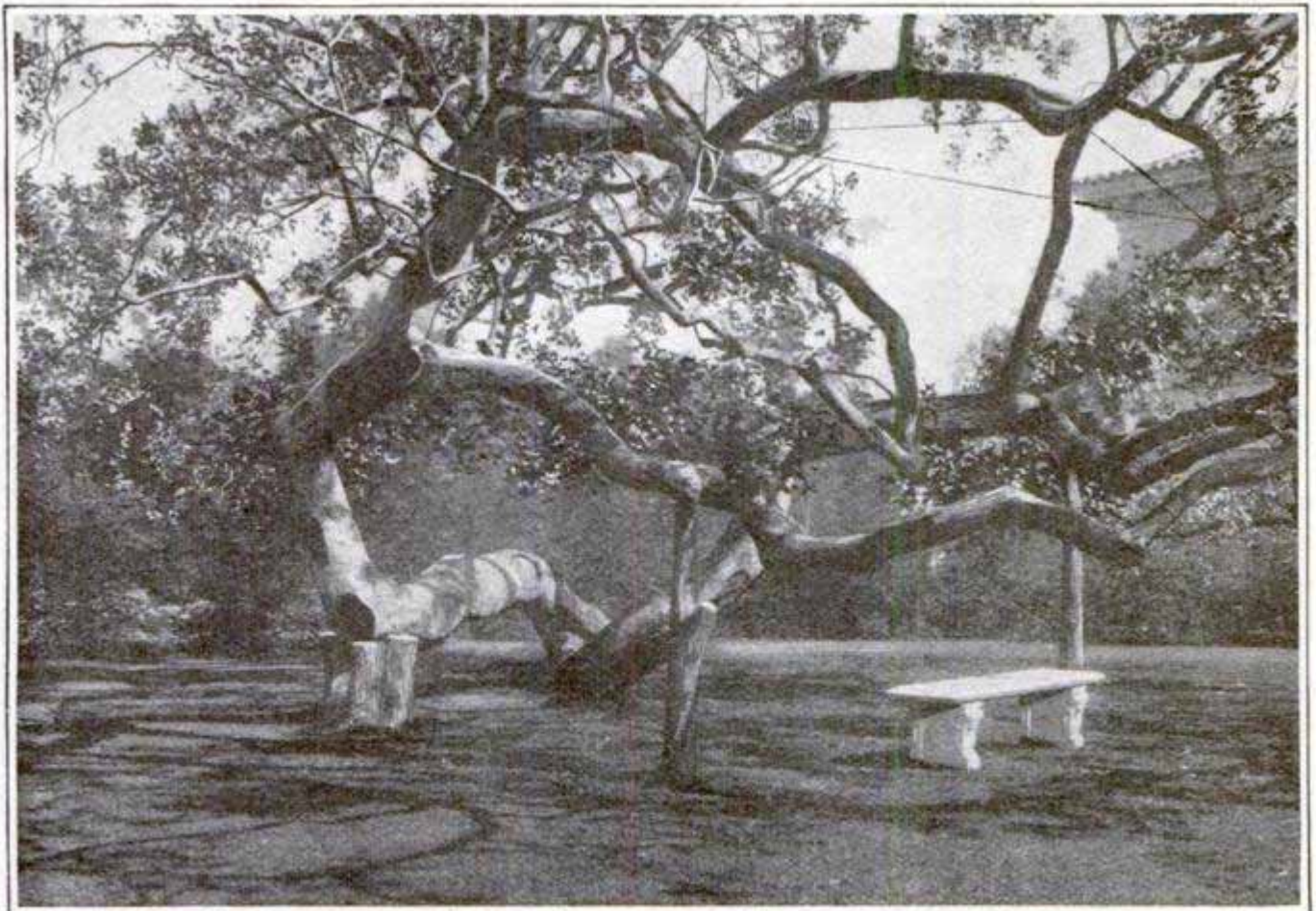

Cement Tree Supports Which Imitate Bark



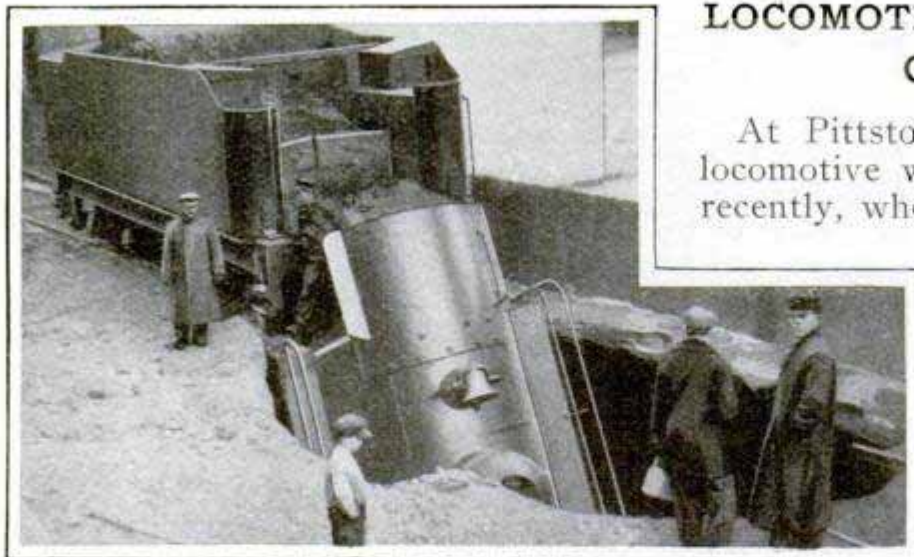

## LOCOMOTIVE PLUNGES INTO COAL MINE

At Pittston, Pa., a Lehigh Valley locomotive was engulfed in a cave-in recently, when the tracks on which it was standing gave way, precipitating the engine into a portion of a coal mine. Fortunately no one was injured, and the engine was pulled out of the hole by the wrecking crew without difficulty.

## IN ARID EGYPT EVERY DROP OF WATER COUNTS

In the land where it rarely rains, all water must be brought from the river Nile, whose sources of supply lie a thousand miles distant. The goatskin bottle and the earthen jar here take the place of water mains and hydrants. The camel and the ox slowly turn the crude wooden gears which lift water from the sluggish river in buckets lashed to a rude water wheel.

Trenches distribute the precious fluid to fields where cotton, sugar cane and rice are grown in the black alluvial soil. True, steam pumps are seen in increasing numbers and irrigation projects of vast impor-



The Boy with the Goatskin Bottle  
Sells Water from Door to Door



A Sakiya, or Geared Water Wheel of Primitive Type,  
Such as is Used in Egypt for Irrigating



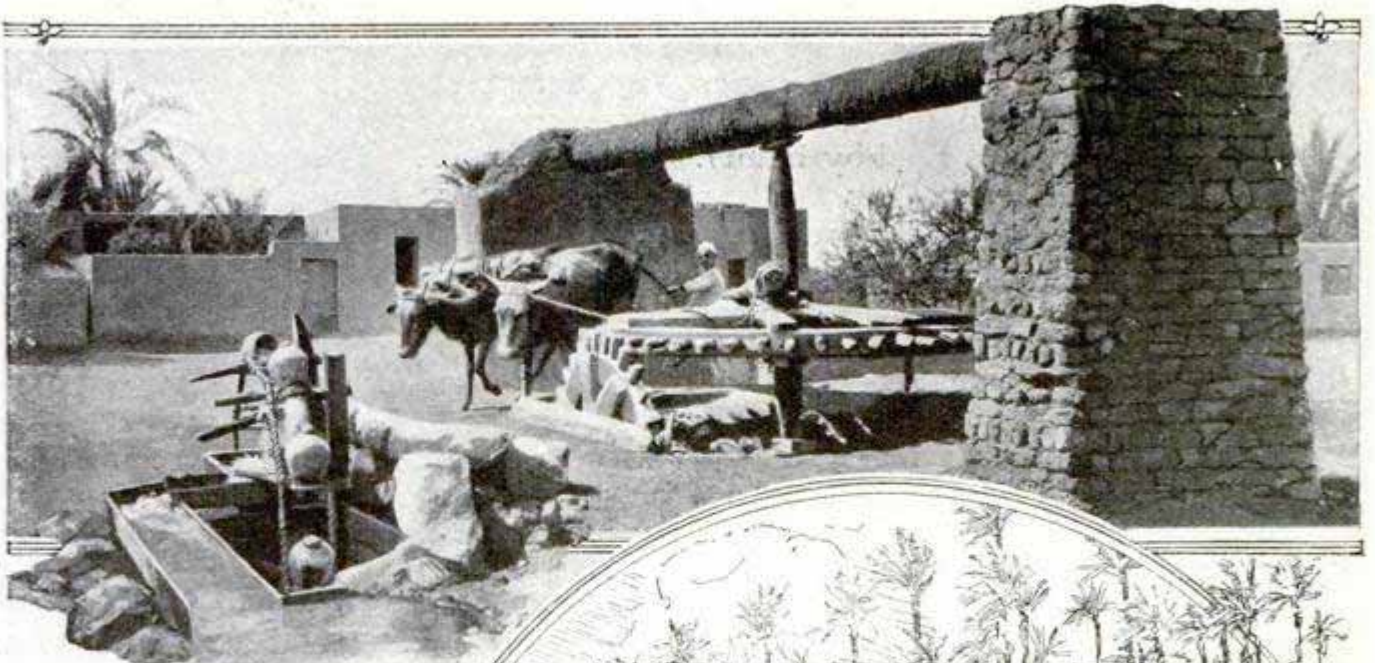

Water Buffaloes Plod Their Daily Round While Earthen Jars Pour Ceaselessly



In Some Sections the Bank of the Irrigating Ditch is the Only Road



A Cairo Water Vender Selling Drinking Water from Earthen Jar



This Form of Screw Pump Dates Back to the Time of Archimedes



tance have been built, but Egypt is essentially the land of the sakias (water wheels worked by oxen) and shadufs (water lifts worked by hand).

### FINDING AND DESTROYING DERELICTS AT SEA

When the "Oklahoma," an oil-tank steamer, suddenly broke in two during a terrific gale which swept the North Atlantic last January, the stern part sank quickly, while the forepart, upheld by the air retained by its bulkheads, floated and, lying in the steamer lanes, formed a serious menace to commerce. The wireless brought six vessels to the rescue, of which the United States revenue cutter "Seneca," known as the "derelict destroyer," was among the first, and after the rescue of the half dozen officers from the wreck, the "Seneca" guns fired solid shot through the derelict's hull until it sank.

Derelicts and disabled vessels always

drift more or less under the influence of wind and wave. The ocean currents are known and their direction and speed charted so that allowance may be made in seeking a lost or helpless ship. But to find quickly a water-logged hulk, in a tract of ocean as large as Texas, Oklahoma, Colorado, and New Mexico combined, is a task which seems to the landsman all but impossible. Yet the Revenue Cutter Service has worked out methods for covering such large areas quickly and thoroughly.

When a derelict is reported to the Revenue Cutter Service, one of its vessels at once speeds to the spot where the abandoned vessel was last seen. Taking the limit of visibility of a derelict from the crow's-nest of the cutter as five miles, a spiral course is laid about the spot where the derelict was last reported. In the course of a day's steaming, amounting to 145 miles, the cutter can survey thoroughly 1,522 square miles.

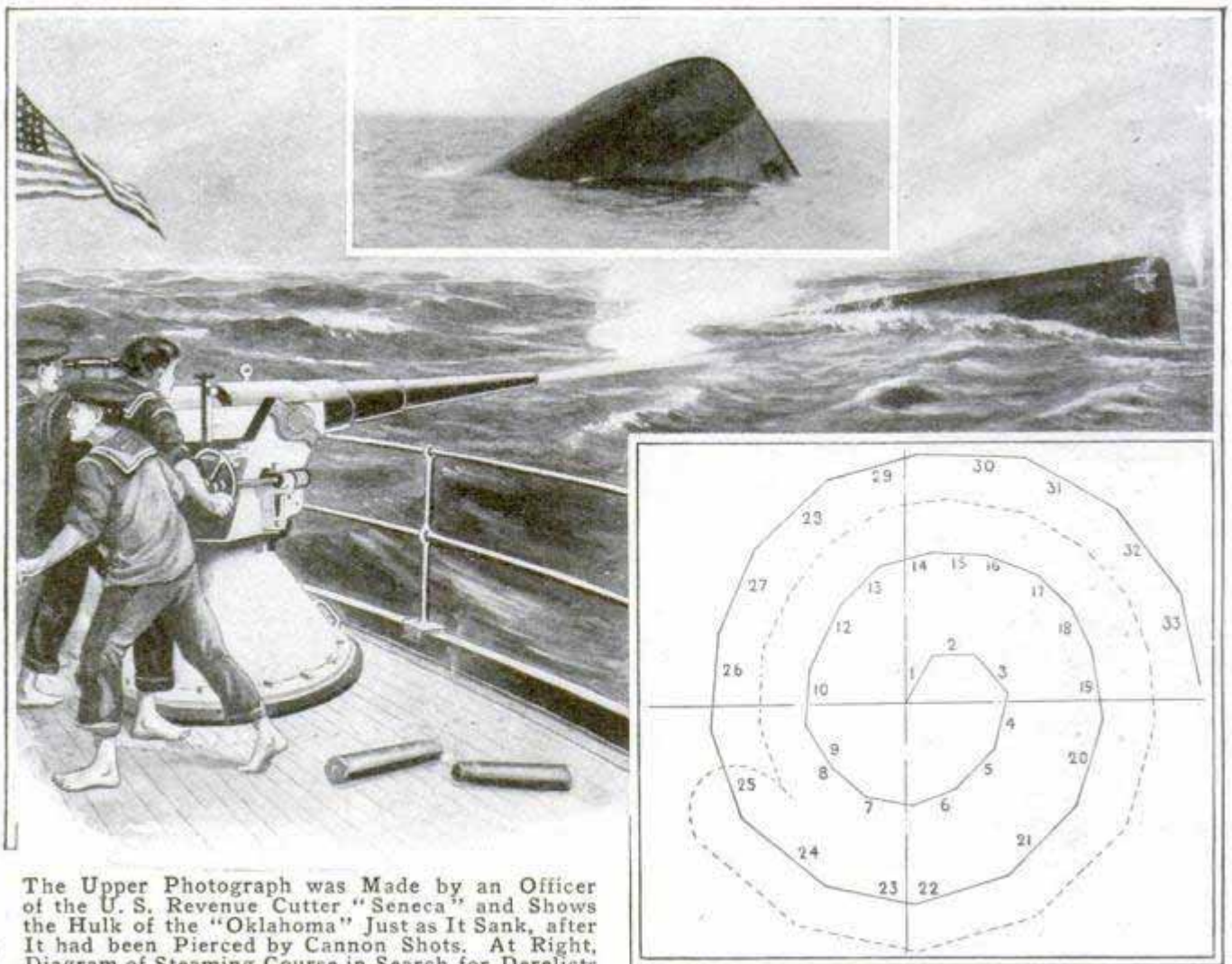

The Upper Photograph was Made by an Officer of the U. S. Revenue Cutter "Seneca" and Shows the Hulk of the "Oklahoma" Just as It Sank, after It had been Pierced by Cannon Shots. At Right, Diagram of Steaming Course in Search for Derelicts



## AIRMEN TO CIRCUMNAVIGATE THE GLOBE

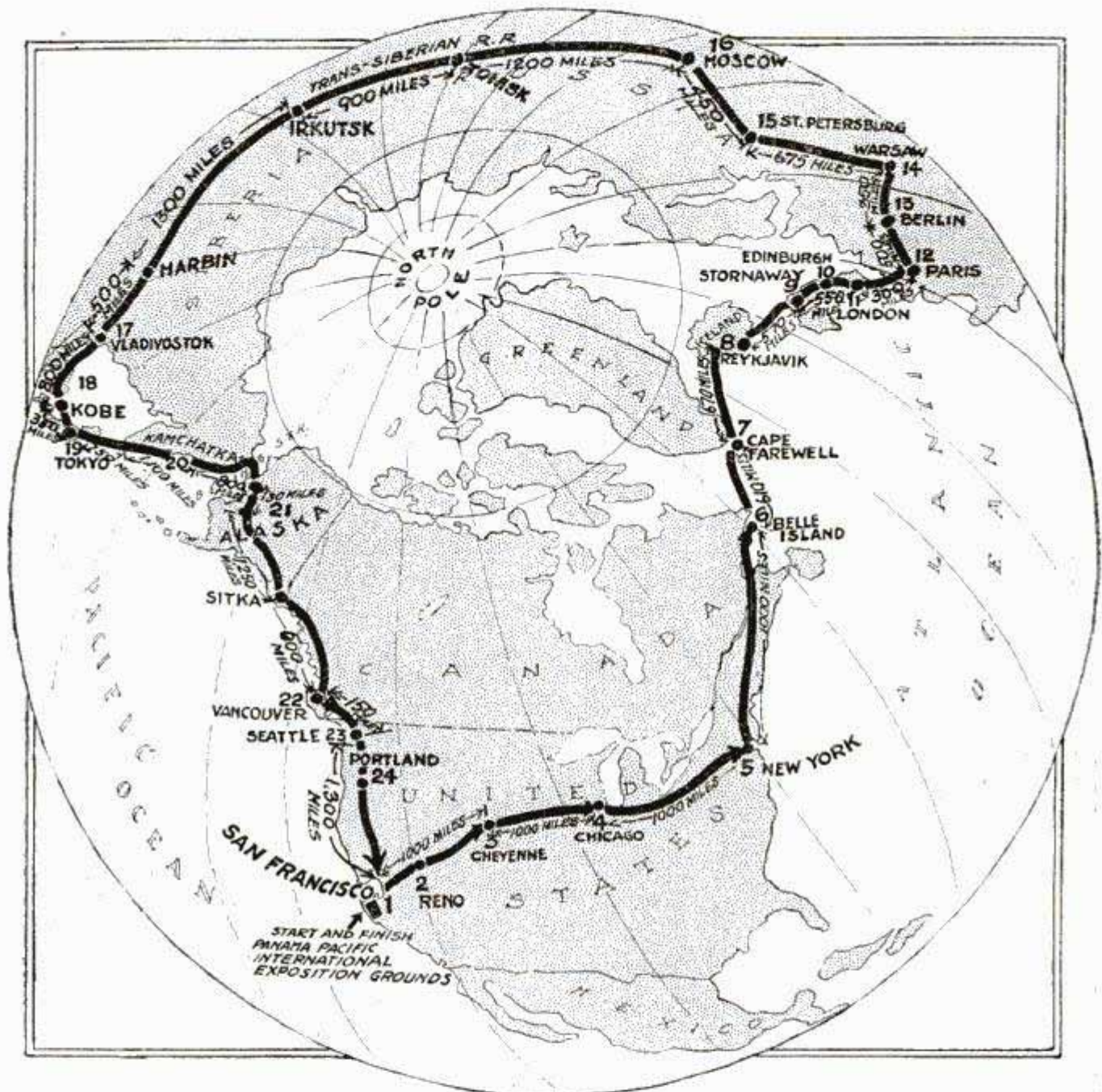

Preparations are under way for a flying race around the world, to start from the exposition grounds at San Francisco in May, 1915, and to end at the same place within 90 days from the time of starting. The flight is to be an international contest, with a prize of about \$300,000 awaiting the airman who completes the journey in the shortest time. The route shown on the map was adopted with the idea of keeping the fliers over land as much as possible. It has a total length of 22,760 miles and is to be followed in an easterly direction. The most dangerous section of the route is considered to be the steppes of Siberia, and the Russian

government will be asked to station troops along this section to give aid to the airmen. All parts of the route that lie over the sea will be patrolled by cruisers.

The longest over-sea flight will be from Cape Farewell, Greenland, to Reykjavik, Iceland, a distance of 670 miles. Twenty-six control stations equipped with supplies and facilities for making repairs will be established at intervals around the world. At each of these controls each airman must check in and have his machine marked with an official stamp. The Fédération Aéronautique Internationale will supervise the contest.



## CONCRETE DAM UNDERMINED AND WRECKED

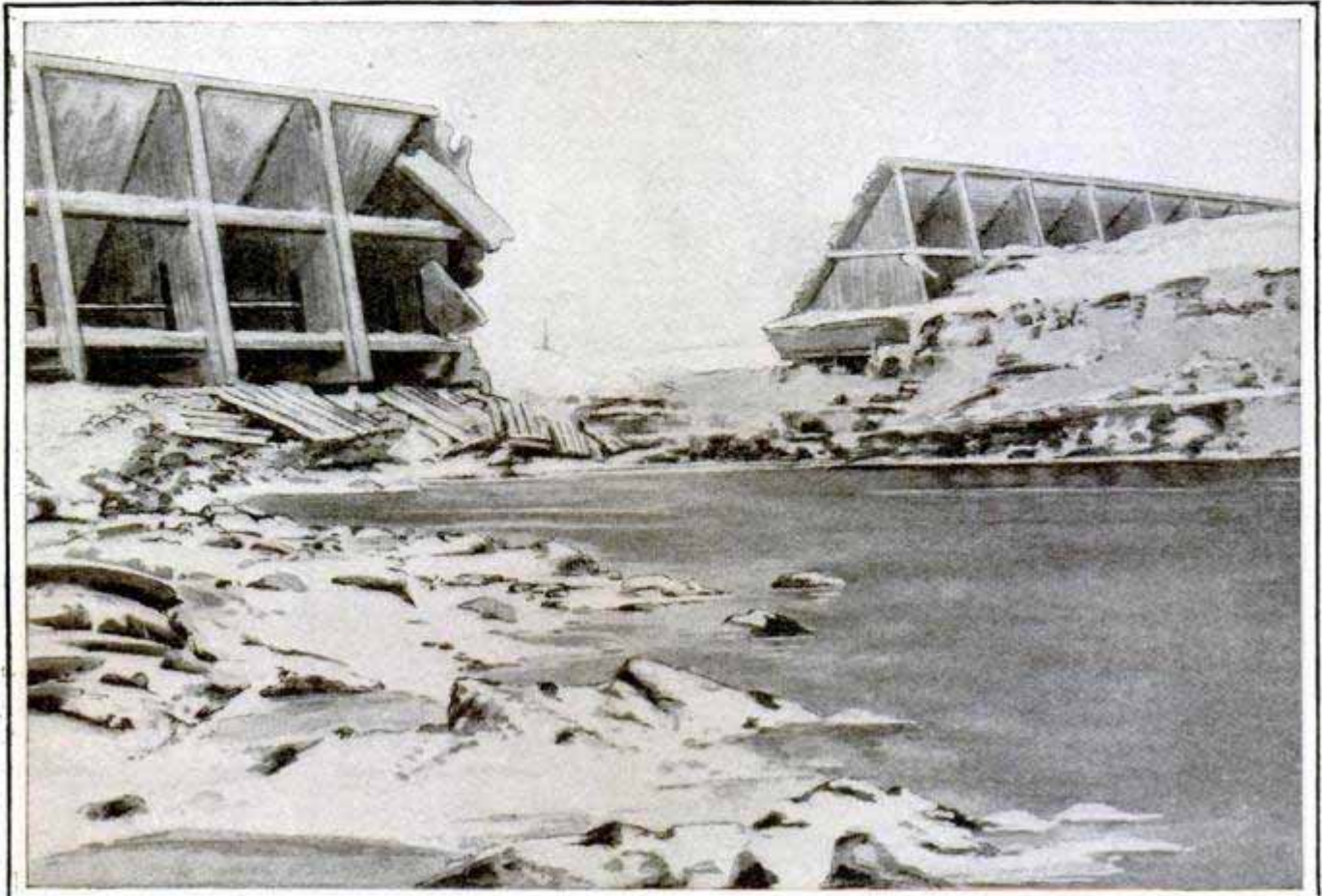

Five bays of a reinforced-concrete dam across the Stony River at Dobbin, W. Va., after being undermined by seepage under the foundations during the high water of last January, collapsed and were carried out under the pressure of the water in the reservoir. The dam is of a cellular type, the sloping surface presented to the water being a comparatively thin reinforced-concrete deck, supported at 15-ft. intervals by slablike buttresses, and was built about six months before the col-

Courtesy Engineering Record

**Breach in the Stony River Dam at Dobbin, W. Va., Seen from Downstream. Left, View Showing Fragments of the Shattered Floor and Deck Slabs Hanging by Their Steel-Reinforcing Rods**

lapse. This superstructure is supported on a concrete foundation. The concrete portion of the dam was 990 ft. long, and had earthwork ends which made the total length about 1,065 ft. The maximum height of the dam was 51 ft., while the storage capacity of the reservoir was 3,000,000,000 gal. The collapse is attributed directly to seams in the footing under the foundations, through which the water was forced under the pressure of the full reservoir. This resulted in a deep cavity and the collapse of the five panels involved. When the dam broke, a wall of water, 8 ft. or more in height, went down the valley, wrecking a number of bridges and other structures. No lives were lost, as the dam is located in a wild and unsettled region.

¶Thirty different wood preservatives are in commercial use in the United States.



## SIDECARS FOR CARRYING LUNGMOTOR EQUIPMENT

Eleven motorcycles with sidecars have been installed in Chicago for enabling police surgeons with lungmotor equipment to reach, in the shortest possible time, victims of asphyxiation, electric shock, drowning, and other classes of accident, in which it is possible to restore life by means of artificial respiration. Motorcycles have been adopted for this service because they are capable of high speed and can be handled in close quarters at a higher speed than would be safe with an automobile. The machines are distributed at police stations in such a way as to cover the city effectively, and each is kept loaded with a lungmotor and other first-aid appliances so that it will be ready to answer a call instantly. These machines are capable of carrying three persons with all equipment at the rate of a mile a minute.

The lungmotor is a comparatively new apparatus, although the pulmotor, which is somewhat similar to it, has been in use for a number of years. The lungmotor bears a pronounced

resemblance to a hand-operated tire pump. It has two cylinders, connected by tubes to a mask that is placed over the mouth of the patient. The pistons of the two cylinders are rigidly connected by the handle at the top and operate in unison. When the handle is drawn up, one cylinder takes in fresh air and oxygen from the reservoir, while the other draws the air from the lungs. When the handle is pressed down the mixture of air and oxygen is forced into the lungs while the used air in the other cylinder is exhausted into the open air. This process of artificial respiration is kept up until natural respiration is restored or the attempt to revive the victim is proved to be hopeless.

☐ An aviation school is to be established in Peru, the government having received contributions amounting to \$30,000 to be used for this purpose.

☐ A course of instruction in apple packing is given each year at North Yakima, Wash., where there is always a demand for expert packers during the fruit harvest.

A Sidecar, Loaded with Lungmotor Equipment, Ready to Make a Life-Saving Run

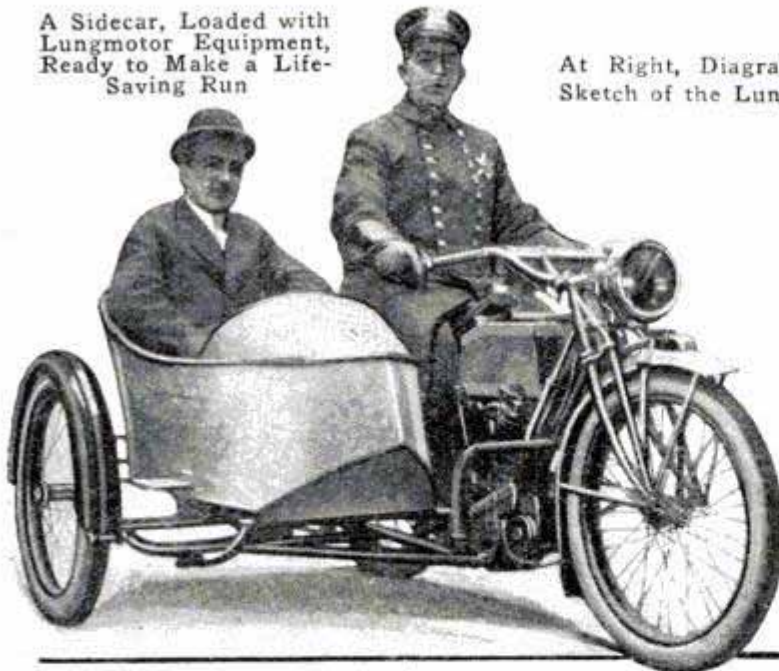

At Right, Diagrammatic Sketch of the Lungmotor

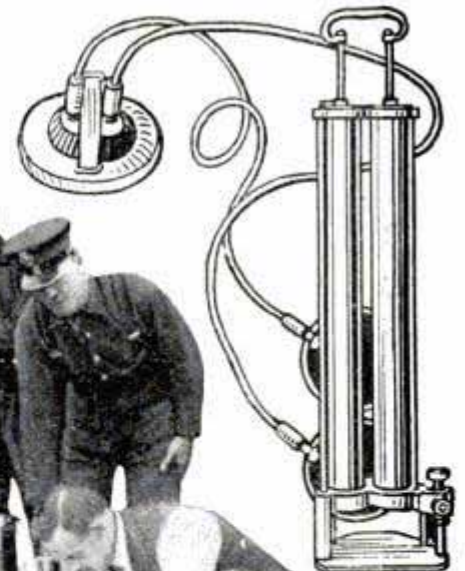

How the Lungmotor is Applied in Reviving the Victim





## COLLISION IN DENSE FOG SINKS STEAMER

In a dense fog off Norfolk, Va., on January 30, last, the steamer "Nantucket," rammed the passenger steamer "Monroe," sending her to the bottom in a few minutes with the loss of 41 lives. A wireless call, sent out by the "Monroe" immediately after the crash, was heard by several vessels, but owing to the heavy fog, the ships in that route could not come to the aid of the stricken boat with any speed. The survivors were taken on board the "Nantucket," which put in to Norfolk,

badly damaged. The terrific shock of the two steamers bent and broke the steel plates, cutting through the sides of the "Monroe," a staunch steel steamer of the Old Dominion line, and smashing the prow of the "Nantucket," even breaking the huge anchor hanging at her bow.

☞ About 175 different kinds of wood are contained in the forests of Florida.

☞ With a population of only a little over 350,000, Stockholm, Sweden, has 80,000 telephones.

Photo by International News Service

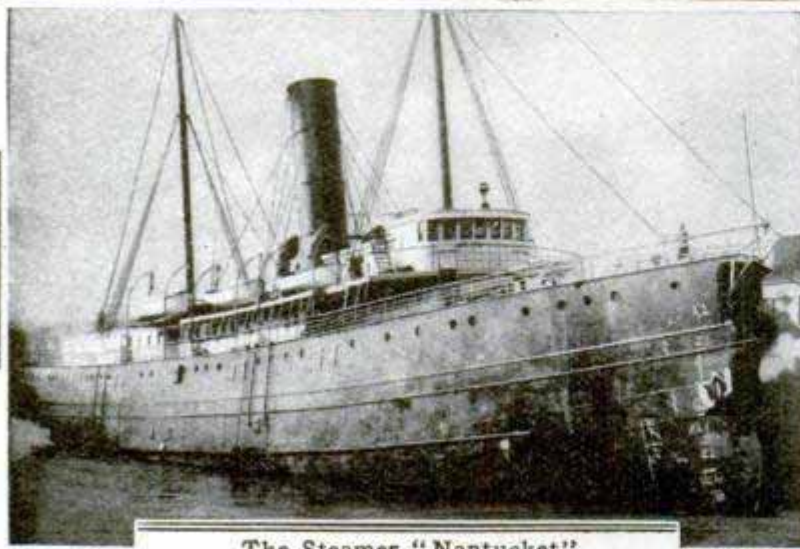

The Steamer "Nantucket" after the Collision

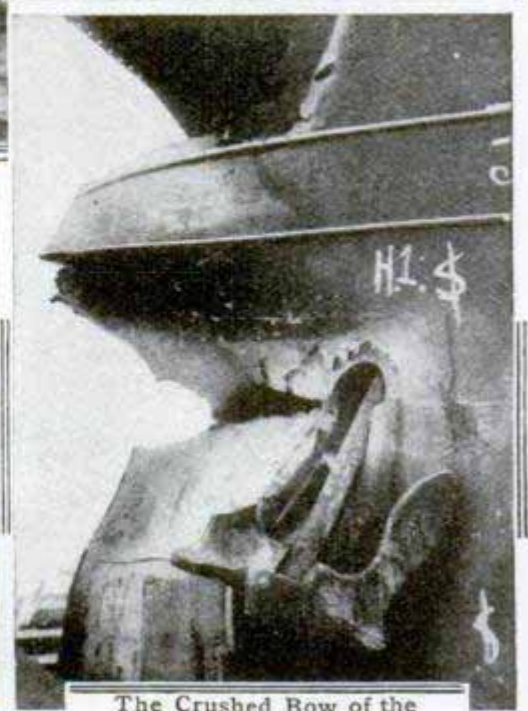

The Crushed Bow of the "Nantucket"

Photos by Underwood & Underwood



## DEMONSTRATION AGAINST A CRUEL PRACTICE

The campaign against the use of the aigrette by milliners has evoked dem-

onstrations in diverse forms, none of which excited more comment than the parade of sandwich men through the streets of London, bearing banners descriptive of the life and death of the mother heron. The aigrette, which was long popular by reason of its filmy daintiness, consists of a bunch of feathers produced by the mother heron, or egret, during nesting time. This bit of plumage could be easiest obtained by killing the parent bird. The young birds thus left without protection perished miserably.



Photo by Underwood & Underwood

Curious Street Demonstration in London Works Change in Millinery Styles

onstrations in diverse forms, none of which excited more comment than the parade of sandwich men through the streets of London, bearing banners descriptive of the life and death of the mother heron. The aigrette, which was long popular by reason of its filmy daintiness, consists of a bunch of feathers produced by the mother heron, or egret, during nesting time. This bit of plumage could be easiest obtained by killing the parent bird. The young birds thus left without protection perished miserably.

## NEW CAMERA PHOTOGRAPHS FLYING SHELL

By means of a novel electrical control for a camera shutter, Engineer James A. Wilson of the Department of Enlisted Specialists, U. S. Coast Artillery Corps, assisted by Capt. Francis J. Behr, of the same branch of the army, has been able to obtain a series of remarkable pictures of the firing of the great coast-defense mortars at Fort Monroe, in which the shell is

seen actually issuing from the mouth of the mortar, and the action of the gases, the formation of the smoke ring and the flight of the shell are all depicted.

The shutter is operated by an electric motor which makes several thousand revolutions per minute. By this device the photographer may determine the exact length of the exposure to be given, even as little as one-five-thousandth of a second, during which almost infinitesimal fraction of time the shell seen in the picture moves a trifle over two inches. At the mouth of the mortar, delicate electrically charged wires form a screen which, broken by the discharge, opens an electric circuit that actuates the shutter, exposing the highly sensitized plate for an instant, thus recording the flight of the projectile, which leaves the muzzle of the gun at the velocity of 900 ft. a second, or more than 617 miles an hour.

The photographs made with this device, shown on the following pages, are pictures of separate shots, each one taken at a slightly different time after the ignition of the powder, so that a progressive picture was obtained which represents the events in the firing of a single shot. Not less interesting than the photograph of the



REMARKABLE PICTURES OF A SHELL IN FLIGHT

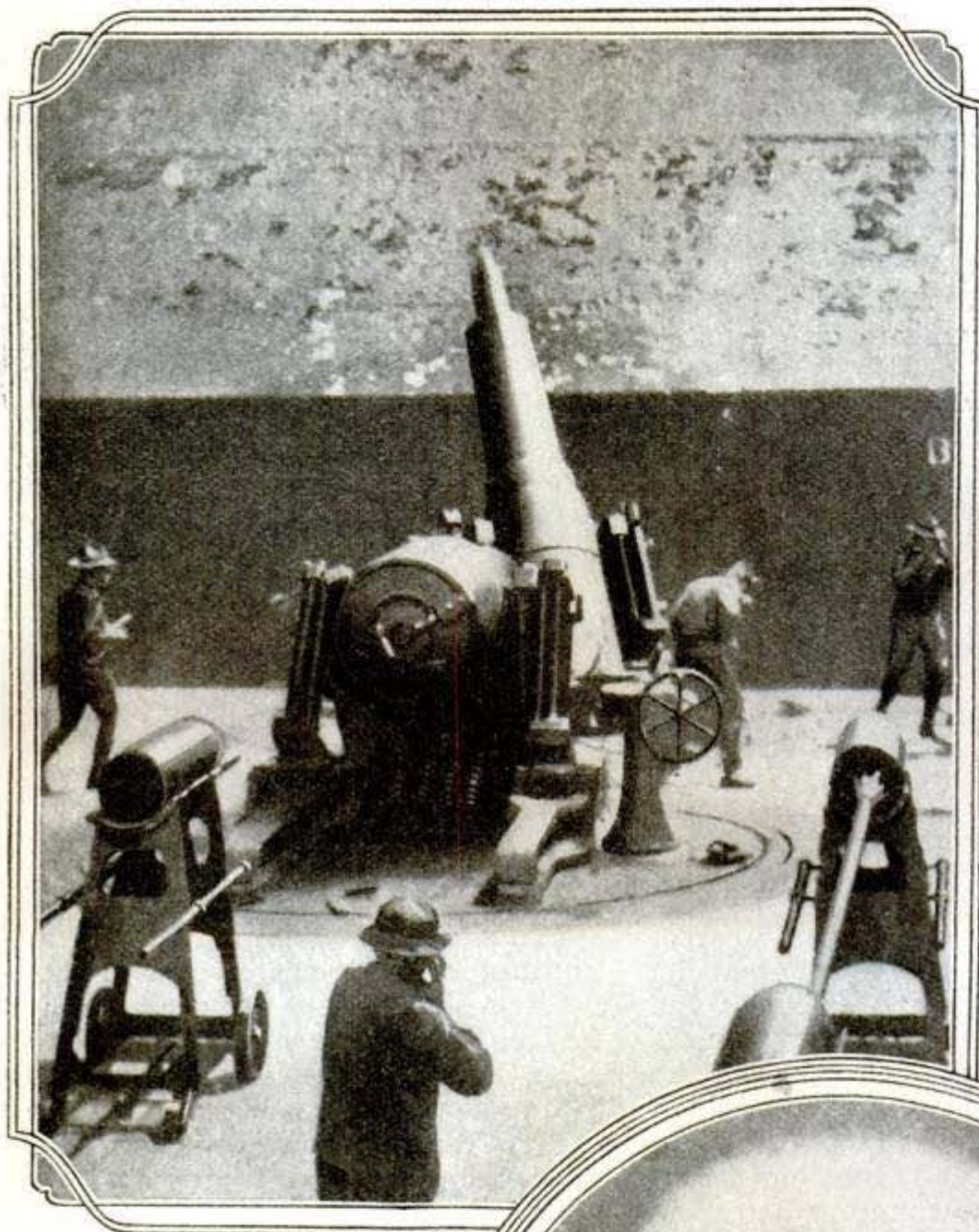

The Beginning of the Shot:  
Shell Emerging from the  
Muzzle of the Mortar



The Luminous Ring  
of Gas Exceeds the  
Shell in Speed, as  
This Photograph  
Clearly Shows



Gas Forced Back,  
Seeking Lines of  
Least Resistance



The Ring of Smoke and  
Gases is of Much Greater  
Density Than the Air It  
Displaces



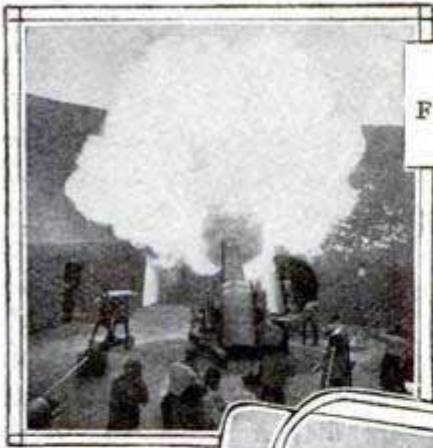

Fifth Stage in the Firing of the Mortar

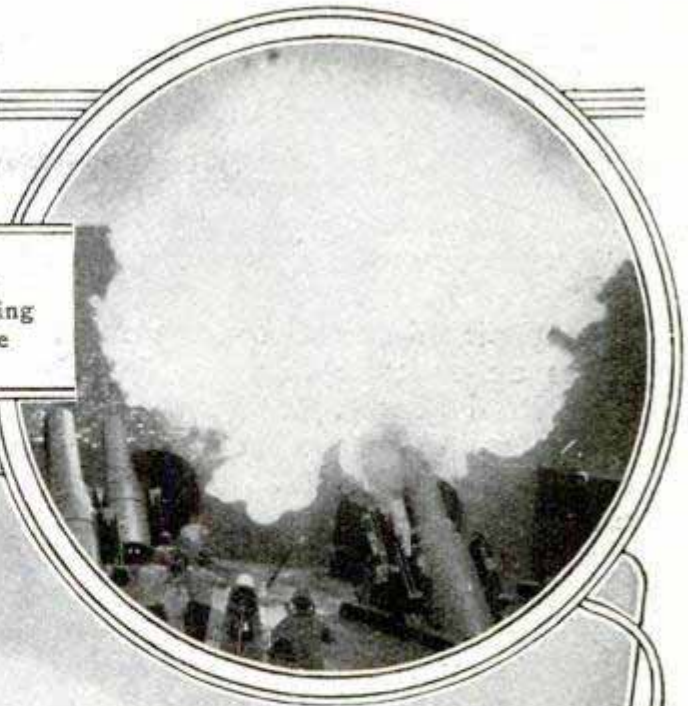

The Discharge:  
The Shell Appearing  
above the Smoke

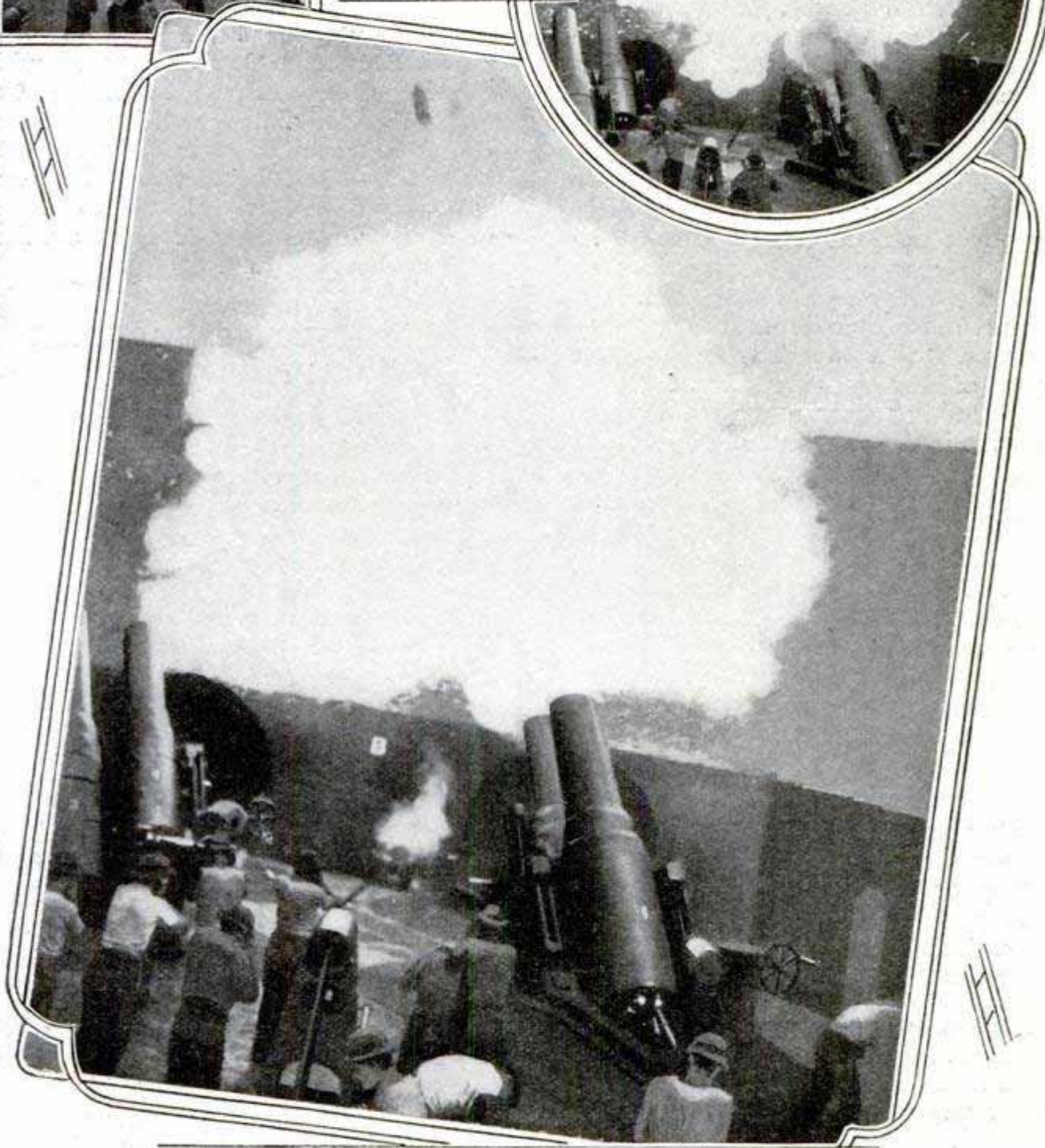

These Remarkable Photographs of the Firing of a Coast-Defense Mortar Show the Seven Stages of the Emergence and Flight of the Shell. They are Fully Described on Page 493



projectile are the pictures showing the formation of the deadly smoke ring immediately following the shell, and which gunners declare to be "as hard as steel," the inconceivably rapid whirling motion of the gases giving it a density comparable to a rigid ring of metal.

The projectile fired by the mortar reaches an altitude of from 5,000 to 20,000 ft. depending upon the range it is desired to reach. It is fired at a moving target towed at a rate of at least six miles an hour. The tug is separated from the target it is towing by only 500 ft. which, considering the distance—often four miles or more—at which target practice takes place, is a small margin. In practice 10 shots are fired, and often companies make 10 hits with the 10 shots fired. To be a hit, the projectile need not strike the target, but if the shell falls within 50 yd. of the moving target a hit is counted. This circle with the 50-yd. radius is the approximate size of a battleship's deck, and a mortar projectile is fired high so as to fall upon the deck of such a target.

A mortar projectile can be seen with the naked eye ascending into the zenith, and a person stationed near where such a projectile falls can see it for some time before it strikes. From the study of these and other photographs of the action of smoke and the flight of shells, officers of the coast artillery hope to discover and remedy faults in mortar construction, in powder making, and in the design of projectiles.

### SUEZ CANAL HAS BEEN DEEPENED

Announcement has just been made that the deepening of the Suez Canal has been completed, and the waterway now has a depth of 29 ft. for its entire length. Originally it was planned to give the canal a depth of  $26\frac{1}{4}$  ft., and for years after it was completed this depth was maintained. Increase in the size of vessels routed through this short cut to the Orient made it necessary to

deepen the cut, and dredging operations, conducted in the early eighties, added 1 ft. to the depth. Six years ago, the now finished undertaking was begun, and throughout the 100 miles of navigation from Port Said to Suez dredges have removed silt and sand, deepening the waterway to 29 ft. Already proposals are being considered for a further dredging, which will make the minimum depth 30 ft. The Panama Canal, while but 50 miles long, cost nearly \$300,000,000, as compared with the Suez expenditure of \$86,500,000 for twice the distance. The Panama Canal, however, is 40 ft. deep and 300 ft. wide, while its eastern rival is considerably narrower, only 200 to 265 ft. in width, and is a sea-level excavation mainly through sand.

### A DIMINUTIVE WIRELESS APPARATUS

A wireless receiving apparatus small enough to be carried in the vest pocket is a recent French invention. While intended mainly for receiving time signals from the Eiffel Tower in Paris, it is suited to a variety of other uses as well. This apparatus consists of a sensitive telephone receiver to which is attached a small but delicately made detector which carries two wires. If no antennae are available, one of the wires is attached with clips to a metal balcony, chimney, or other metal object through which the wireless waves are received, while the other wire is "grounded" by attachment to a gas or water pipe or to a metal rod driven into the ground. Small spools are provided on which the wires are wound up compactly.





## GLASS CASE PROTECTS CAR CHECKER'S RECORD

A handy device recently invented and designed to make the work of



the railroad-car checker easier in bad weather, consists of a glass case in which the book used in making the record is carried. The sides, top and one end are closed with glass, while one end is left open for inserting the book and hand. The book is laid in the case and is used in that position. The case is intended particularly for protecting the

record book in rainy weather, but is handy for use at other times, since it prevents the leaves from blowing in the wind and protects the hand from cold in winter.

## LONG GLIDE MADE BY ENGLISH AIRMAN

With the engine of his biplane shut off, and starting from an elevation of nearly three miles, an English airman recently made a glide of 21 miles across country with a total drop of less than two miles in that distance. This apparently smashes all records for gliding feats. The airman had risen to a height of 15,000 ft., as shown by the recording barograph, when his nose began to bleed. Shutting off his engine, he started gliding with the wind toward a town 21 miles away. When he reached this town he found that he was still more than 5,000 ft. above the ground. Descending into

the town he picked up a passenger and flew back to his original starting point. The flat angle at which this glide was made, the drop being less than 500 ft. to the mile, is an indication of the increased security the fliers are beginning to enjoy through more efficient shaping of the wings and greater skill in handling.

## PICTURESQUE CAR STATIONS BUILT OF FIELD STONES

The residents of a Los Angeles suburb may await the coming street car in comfortable and artistic stations, formed of field stones, cement and rough beams. These attractive little structures were erected at a cost of about \$400 each and are permanent additions to the tract. Vines and flowers will add to the beauty of these remarkable architectural creations, which form a distinctive feature of the scenery.

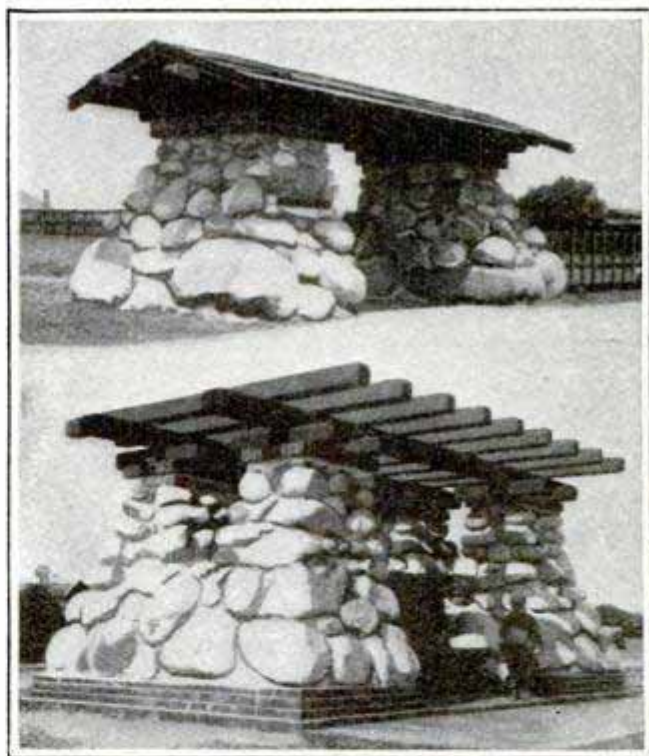

Car Patrons Given Esthetic Stations

A reinforced-concrete building, 200 ft. high, containing a spiral driveway for automobiles to an observation platform on the roof, is planned for Denver.



### DESTROYING OPIUM IN SAN FRANCISCO

An immense amount of opium, together with pipes and other parapher-

### MOTOR SUPPLIES CARRIED IN MOTOR CAR

A complete supply of automobile accessories is carried in the motor car

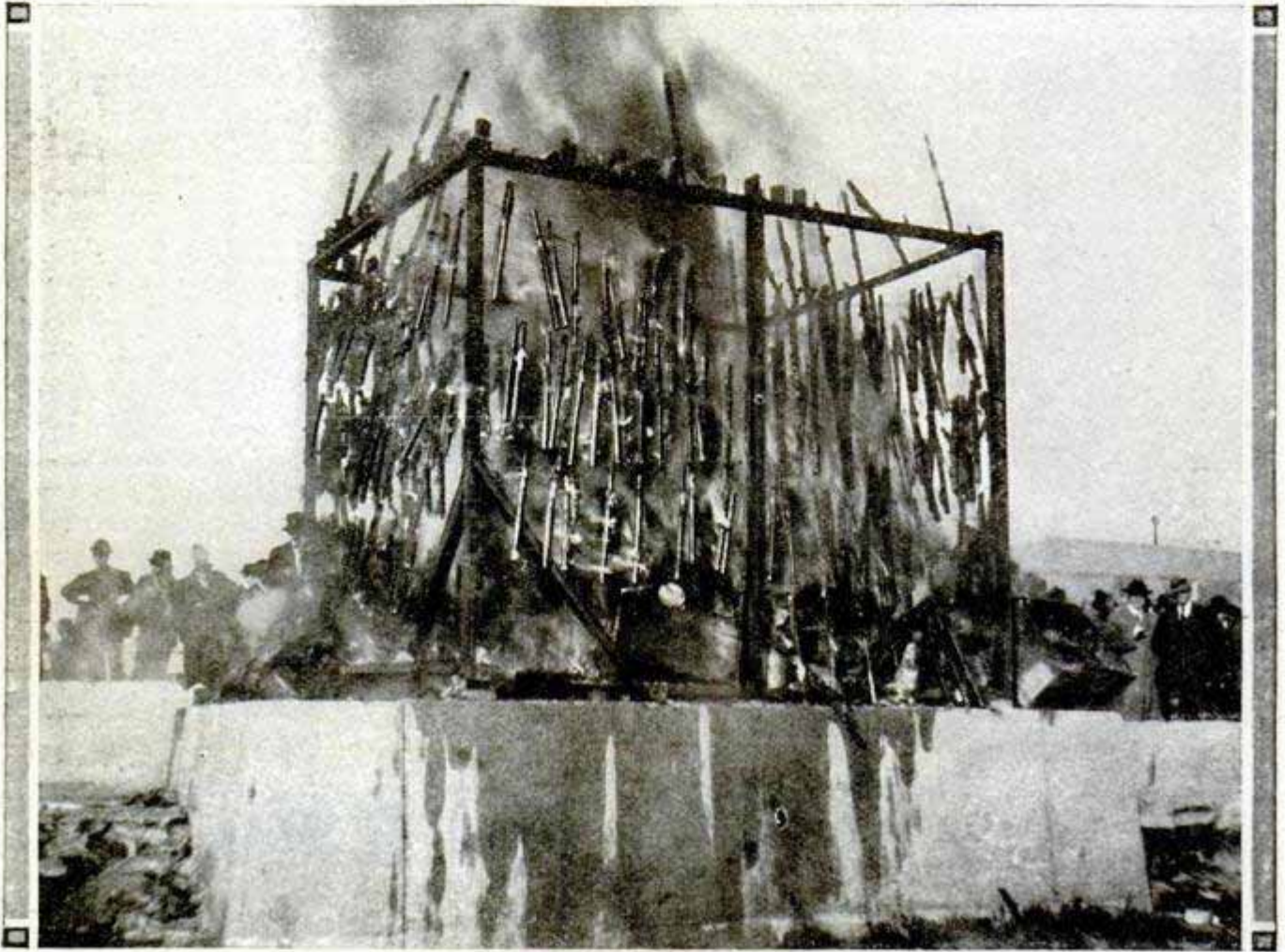

Burning of Opium Layouts by San Francisco Authorities

naliam which had been confiscated by the police of San Francisco, was burned in public recently, on the site of the old city hall. A scaffolding was erected and hundreds of opium pipes, many of them beautifully carved, hypodermic syringes, tins of opium, utensils for the preparation of the drug, bottles, cases and boxes containing opium and other illicit drugs were hung on wires stretched on the scaffold. Kerosene was then poured over the pile and set on fire. Dense smoke, reeking with nauseous fumes, rose from the pile, which contained, it is estimated, over \$20,000 worth of material.

High-pressure direct current is now being used on American electric railways operating 1,946 miles of trackage.

of a Philadelphia salesman, who is thus able to fill small orders without delay. He finds it valuable in introducing novelties, for instead of showing the catalog or photographs of the articles,

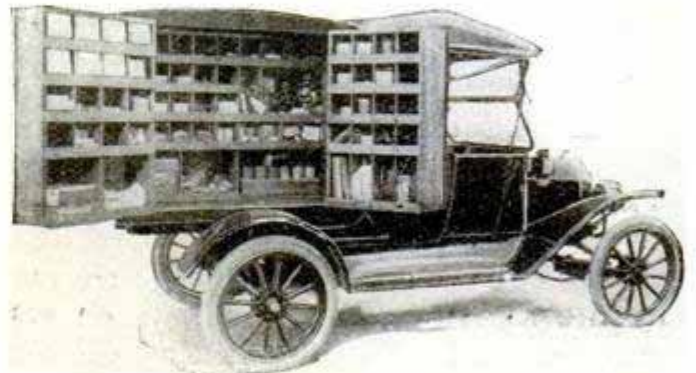

Supply Store on Wheels

the actual samples can be shown, and this might be a difficult matter to handle from an ordinary sample case.



## NEW FIELD GUN OF THE UNITED STATES ARMY

What is thought to be the biggest single improvement made in the artillery service in a decade is comprised in the new field gun recently adopted by the United States government. The carriage of this gun has a double, or split, trail, the word "trail" being used to designate the long beam, or prop, that supports the gun on the ground at the rear. The old-style single trail prevented any great lowering of the gun breech and therefore limited the angle to which the muzzle could be elevated. With the split trail the breech drops down between the halves, and any elevation of the muzzle that is necessary may be secured. By means of a handwheel the gun may be swung quickly and easily in a wide horizontal arc without shifting the trail, which is another great improvement over the old-style carriage. The gunners are thoroughly shielded by steel plates only two-tenths of an inch in thickness, but of such strength and toughness that they cannot be penetrated by a steel-jacketed, needle-nosed bullet fired from a service rifle at a distance of 100 yd. Even the gunner who sights the piece is not exposed. By a system of mirrors and prisms the telescope sight zigzags upward and passes out through a port in the shield a foot or more above the gunner's head. The projectile fired by this gun is 3 in. in diameter and about 1 ft. long, but contains enough explosive and balls to wipe out a whole company.

## ADVENTUROUS BURRO POSES ON GLACIER POINT

Overlooking the deep chasm of the Yosemite Valley is a projecting rock familiar in a thousand photographs as Glacier Point. It is so poised that it will bear a heavy weight upon its outer edge, and tourists for a generation have perched on the point and posed for photographers. A rather unusual model presented itself one day when a burro walked up to the very edge and stood in admiring contemplation of the scene below.



☞ Fuel oil is displacing 20,000,000 to 25,000,000 tons of coal each year, largely in locomotives.

☞ More than a thousand tons of glass will be used in the construction of the buildings of the Panama-Pacific Exposition.

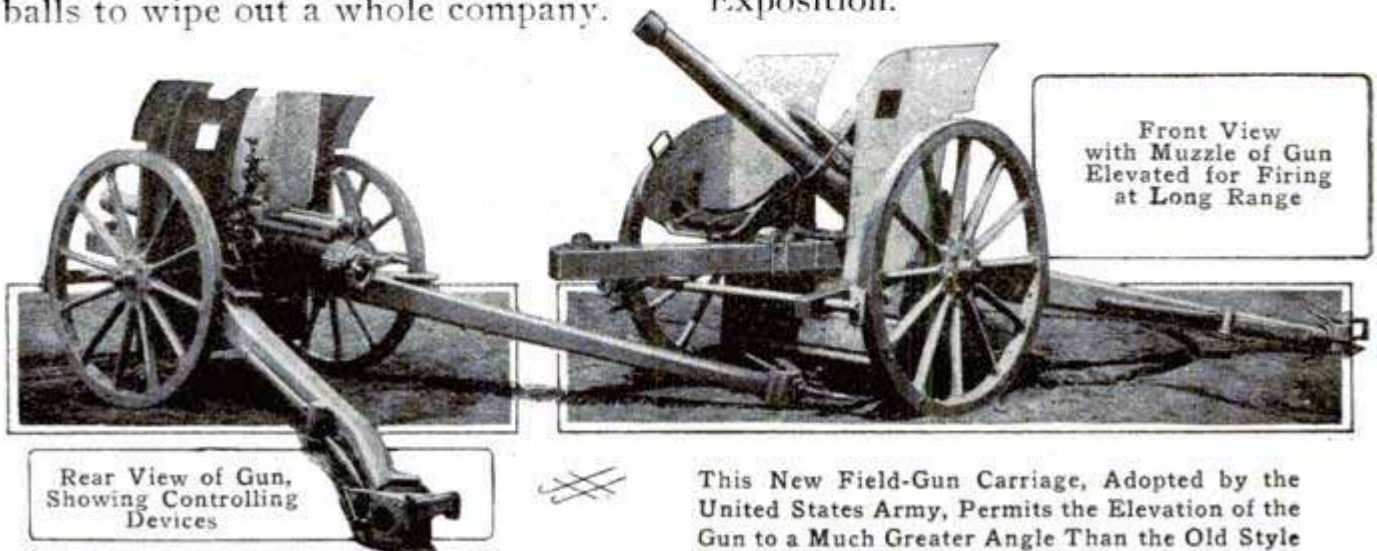

Rear View of Gun, Showing Controlling Devices

Front View with Muzzle of Gun Elevated for Firing at Long Range

This New Field-Gun Carriage, Adopted by the United States Army, Permits the Elevation of the Gun to a Much Greater Angle Than the Old Style



## LONG TELEPHONE POLES ON ELECTRIC TRUCK

An electric truck of unusual size is used by an eastern telephone company

Ninety-Foot Pole on Electric Truck

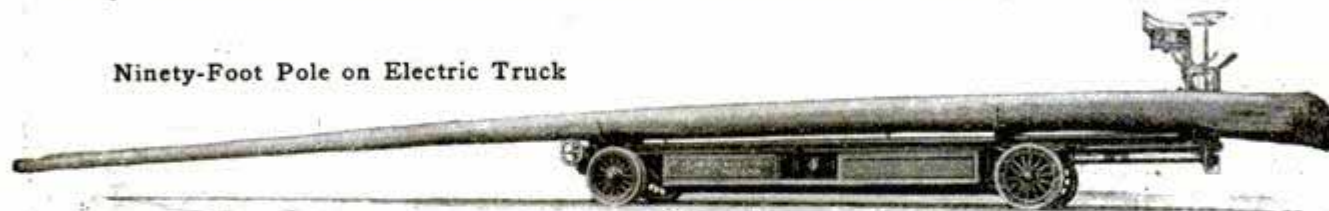

in hauling poles for line installation. It is 31½ ft. long with a 20-ft. wheel base, and has a four-wheel motor drive with four-wheel steering. It has demon-

strated its capacity by hauling 90-ft. poles, a feat seldom considered possible without a trailer. A winch in the center of the car, also operated by electricity, enables two men to load

## DESTRUCTIVE ERUPTION OF JAPANESE VOLCANO

Although the eruption of the Japanese volcano Sakura-Jima, did not result in such great loss of life as was first reported, the destruction that followed in its wake was serious enough to make this rank as one of the most disastrous eruptions of recent times. From official Japanese sources it is learned that 31 persons were killed, that over a hundred were seriously injured, and that from 10,000 to 15,000 were rendered homeless and destitute as a direct result of the eruption itself, while no estimate can be made at the present time of the damage and distress caused by the series of earthquake shocks that accompanied and followed the eruption.

This volcano, which had lain dormant for a period of 135 years, burst into sudden and violent activity on the morning of Jan. 12, 1914. The eruption was preceded, on the day before, by a succession of earthquake shocks, but these were too light to serve as a warning of the approaching calamity. The volcano is located on the small circular island of Sakura-Jima, from which it takes its name. This island lies in the landlocked harbor in front of the important city of Kagoshima, which was also damaged greatly by the eruption and resulting earthquake shocks. The name Sakura-Jima, literally translated, means

these poles easily. The truck carries storage batteries of 42 cells below the body of the car and has a speed of 7 miles an hour with full load.

"Cherry Island," an appropriate name for this, one of the most beautiful and fertile of all the islands of Japan. As a result of the eruption, over two-thirds of its area is now covered with lava and volcanic ashes, and made permanently unfit for habitation. Owing to the suddenness of the eruption and the fact that the boats that went to the rescue could not approach some parts of the shore because of danger from falling stones, thousands of the islanders were unable to escape to the mainland promptly, and it was here that most of the deaths and injuries occurred. The island had a population of 20,000, and the homes of over half of these were obliterated by the eruption.

Kagoshima, which has a population of over 60,000, is situated on the island of Kiusiu, the most southerly of the main islands forming the Japanese empire, and on this island is a range of volcanic mountains known as the Kiusiu Range. Coincident with the eruption of Sakura-Jima, this entire range became active and hundreds of earthquake shocks were felt throughout the island, while ashes from Sakura-Jima fell as far north as Nagasaki, a hundred miles distant. The most severe shocks were felt in Kagoshima, and it seemed for a while that this city would be destroyed. In a few hours the city



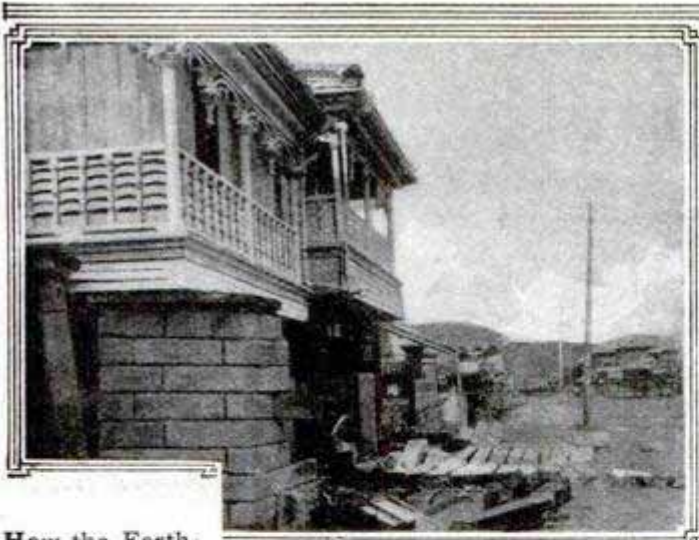

How the Earthquake Damaged Stone Buildings



The Eruption of the Sakura-Jima Volcano, Japan, As Seen from Kagoshima

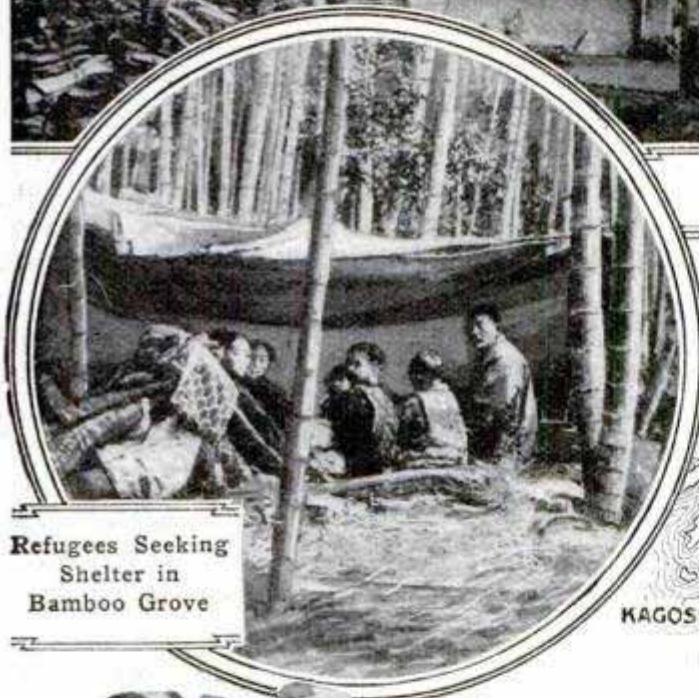
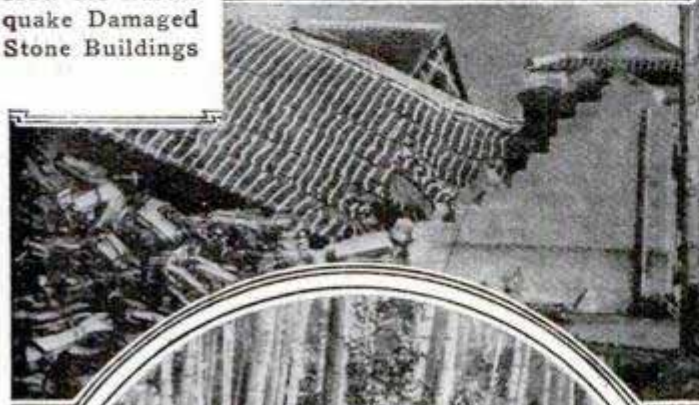

Refugees Seeking Shelter in Bamboo Grove



Effect of Earthquake on a Japanese Dwelling



Refugees Arriving at Kagoshima from Island of Sakura-Jima



was almost entirely emptied of its inhabitants, the panic-stricken refugees escaping by many roads into the interior, but mainly over the railroad that runs north and south along the coast. Thousands took refuge in the first bamboo bush they came to, as the Japanese have learned from long experience that this is the safest shelter from earthquakes. The bamboo trees

are too light to cause much damage if they fall, while the thick interlacing of the roots forms the best protection against the opening of crevices in the earth. As seen from Kagoshima, the eruption of Sakura-Jima, with the mountain glowing from foot to summit with lava, is described as resembling an enormous and terrifying display of fireworks.

### NOVEL ARRANGEMENT OF STREET-CAR SEATS

A novel seating arrangement for street cars that makes it practically unnecessary for passengers to stand

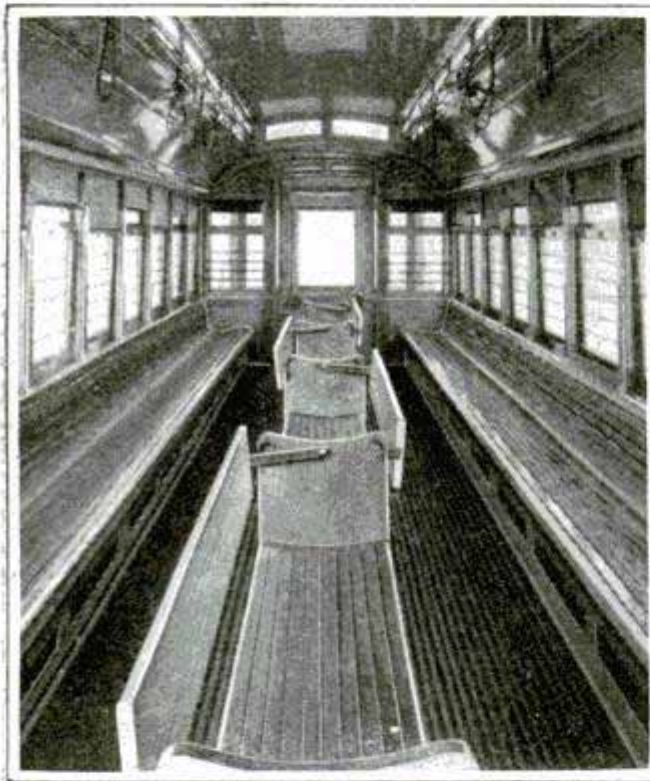

Seating Arrangement Adopted in Spanish-American City for Transportation of Second-Class Passengers

except during periods of unusual congestion has been adopted in a Spanish-American city for the transportation of second-class passengers. The seats along the side of the car are bench seats and through the center of the wide aisle thus provided an additional line of bench seats is placed. These are arranged in sections to face in opposite directions with passageways between the ends of the sections, a plan that enables a passenger, by using first one side and then the other, to

pass along the aisles without the necessity of treading on the toes of seated passengers.

### CURTISS MAKING PLANS FOR TRANSATLANTIC FLIGHT

Interest in transatlantic flight in a heavier-than-air machine has been revived by the announcement that Glenn H. Curtiss, backed by a wealthy Philadelphian, is engaged in the construction of a biplane which it is intended to enter for the Lord Northcliffe prize in the summer of 1914. Other airmen are seriously considering the question, notably Graham-White, the English flier, whose plans, however, have not yet been made public. Lord Northcliffe, the publisher of influential British papers, offered \$50,000 for the first person making the flight across the Atlantic "from one point in the British dominions to another" in a heavier-than-air machine. This means, of course, from Newfoundland to Ireland, or vice versa, a distance of approximately 1,640 miles. A speed of but a trifle over 68 miles an hour would enable an airman to negotiate this distance in 24 hours. It is announced that flight will only be attempted with a strong following wind, when from the weather reports the duration and direction of the wind can be depended upon. Already airmen have made distance flights of over 14 hours without alighting, and it is believed that with a new model biplane which has much larger fuel capacity, the entire distance can be covered successfully. An officer of the U. S. Navy and one of the British navy are expected to be the pilots of the American machine.



## PUTTING THE SMOKESTACKS ON THE LARGEST SHIP

The completion of the steamship "Vaterland," the largest vessel yet built, marks an advance in ship construction, not alone because of its great size, but because of the exceeding care with which the safety of the passengers has been guarded. Some idea of the enormous size of this ship

may be gained from the three funnels which tower 62 ft. above the upper deck. They are oval in shape, measuring 20 by 30 ft., and consist of an outer and inner tube, air space being provided between them. It was found necessary to provide a larger crane for handling these and other great pieces of steel, as the 150-ton traveling crane in use was not considered adequate. So a new revolving crane was built, with a capacity of 250 tons, at a distance of 113 ft. from the center, and 110 tons at the extreme

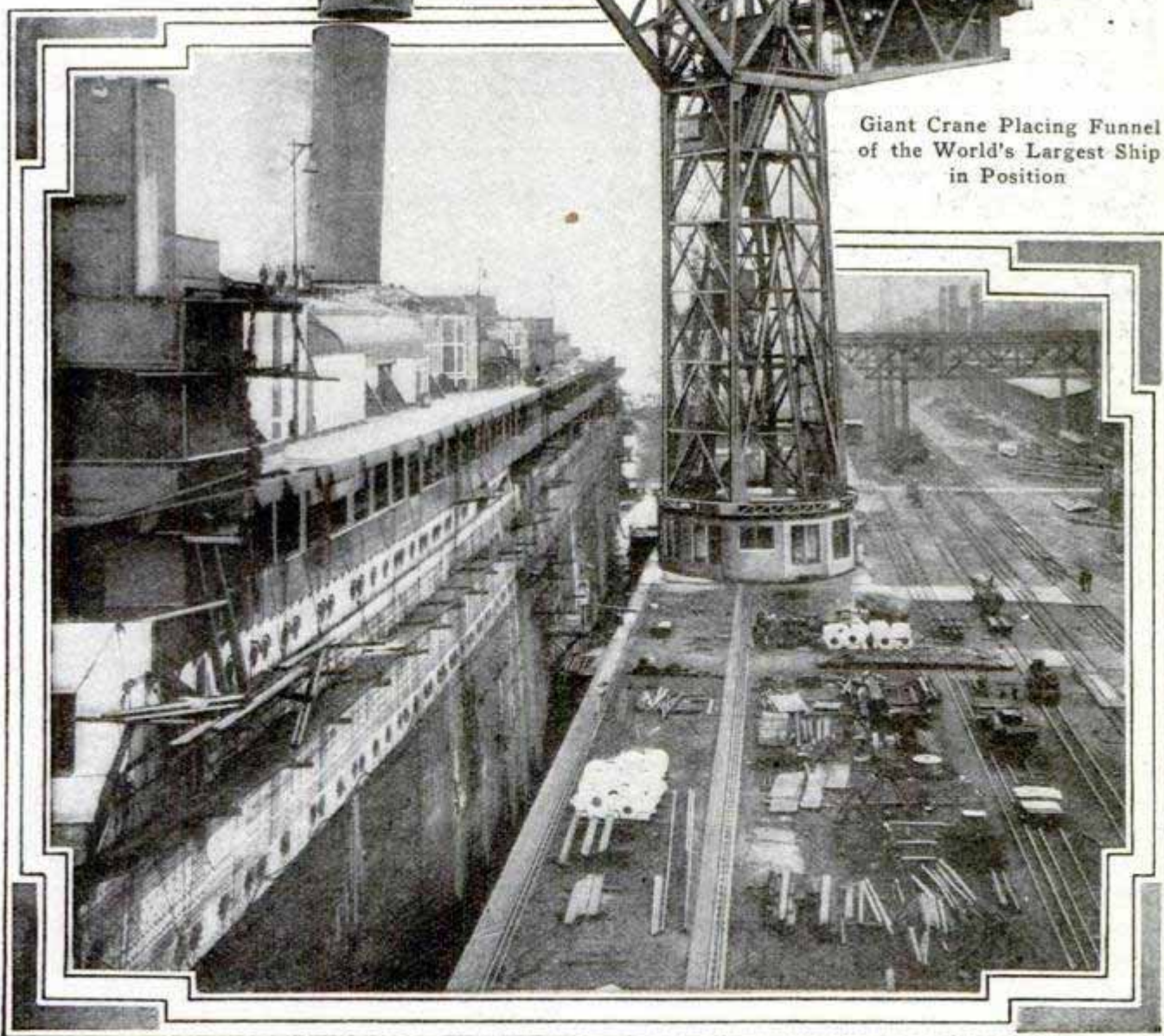

Giant Crane Placing Funnel  
of the World's Largest Ship  
in Position



end, 174 ft. from its support. In addition to the main trolley which runs inside the jib girders, a revolving traveling jib crane of 20 tons capacity at a 33-ft. radius is added. The motors on this giant crane represent 550 hp., but only one man is needed to operate the entire apparatus. His cabin is directly under the hinge of the jib. The picture shows one of the outer funnels being slipped over the inner tube, the big crane dwarfing its burden.

### MEXICAN CANTILEVER BRIDGE

Across the Rio Chico in Mexico, the National Railways have thrown a bridge which is a fine specimen of cantilever construction. It is on a new line between Durango and Llano Grande, and forms part of a projected line to the city of Mazatlan on the west coast, to open up extensive pine-timber resources. It will also serve a mining and cattle country with some agricul-

### COLUMBIA RIVER CANAL COMPLETED

A blast of five tons of giant powder on the afternoon on February 5, last, swept away the remaining obstructions to the free flow of water through the Celilo Canal, and the project which makes the Columbia River navigable for a distance of 400 miles was accomplished. The canal is 8½ miles long, and has been in course of construction for five years. Located midway on the northern border of Oregon, Celilo was the site of obstructions to navigation which hampered the use of that great river which forms so large a portion of the boundary between Oregon and Washington. At a cost of more than \$5,000,000 a canal was dug around the rapids, and a system of locks provided, which, it is anticipated, will afford ready access to the fruit orchards of Idaho, Washington and Oregon, giving the consumer the benefits of low freight rates.

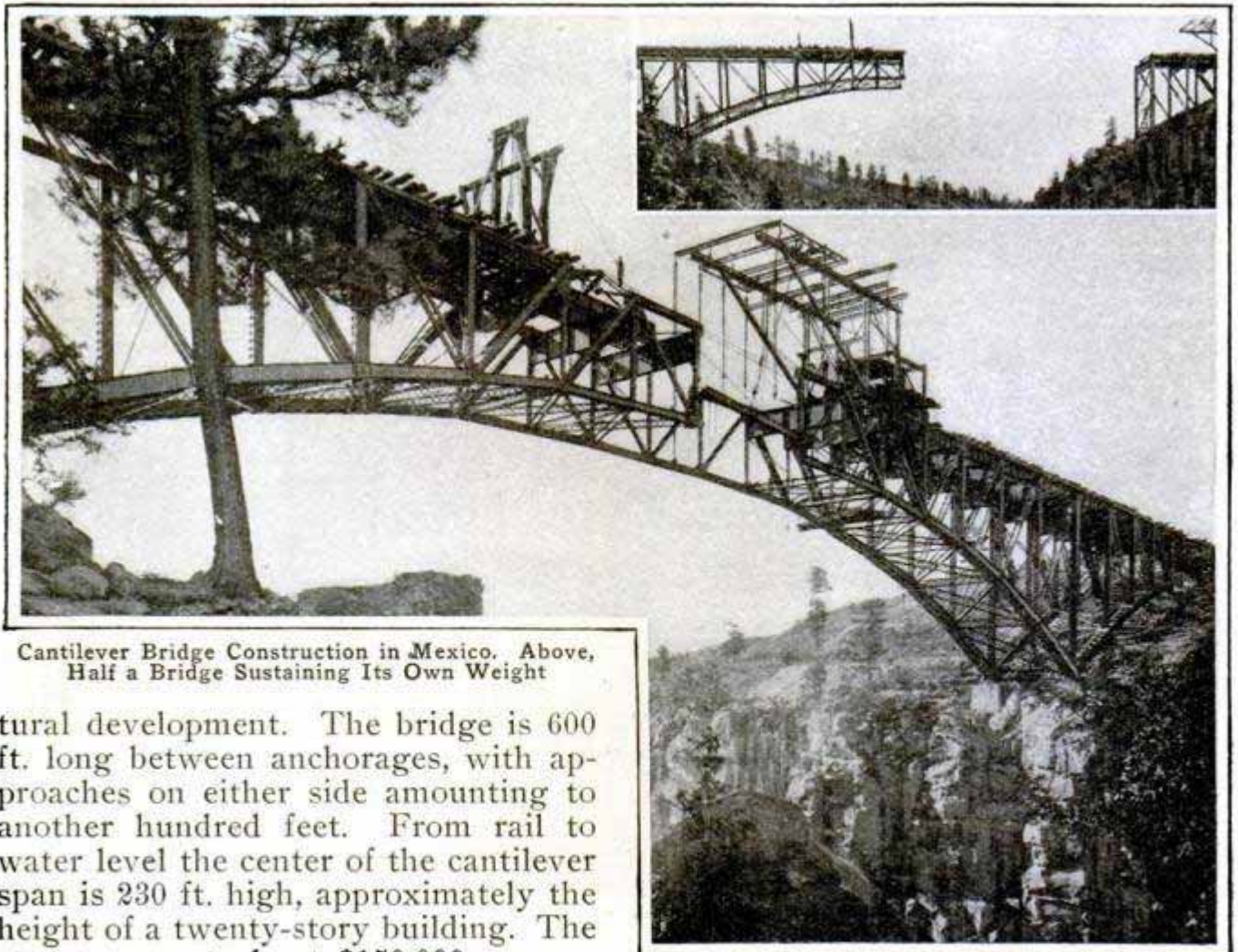

Cantilever Bridge Construction in Mexico. Above, Half a Bridge Sustaining Its Own Weight

tural development. The bridge is 600 ft. long between anchorages, with approaches on either side amounting to another hundred feet. From rail to water level the center of the cantilever span is 230 ft. high, approximately the height of a twenty-story building. The structure cost about \$150,000.

Courtesy Railway Age Gazette



## COAST DEFENSE BY RAIL TO SOLVE PROBLEM

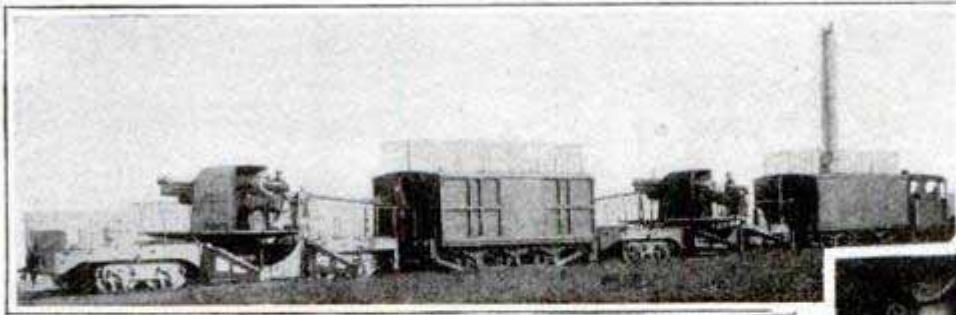

Coast-Defense Train,  
Showing Observation Tower

An entire coast-defense battery mounted on railway trucks is the answer of French military authorities to the question of how to secure positive defense over long coast lines with economy. The advantages claimed for these mobile batteries are the economy in the preparation for the defense of any place, as the batteries on wheels cost less than permanent fixed batteries and can be sent to threatened points from places where they are not needed, the only expense being for laying the rails. Then, too, no coast-defense plans can be sold to the enemy, no photographs or drawings stolen, for no permanent works indicate where the salient points of this defense are located. No special roads need be laid, for military railways may be used in time of peace for commercial purposes, and in war time, peaceful roads utilized for war purposes. The guns so far manufactured for this work are of howitzer pattern, and in 7.87-in., 6-in.,

and 4.7-in. sizes. They are protected by turrets, and the ammunition cars are

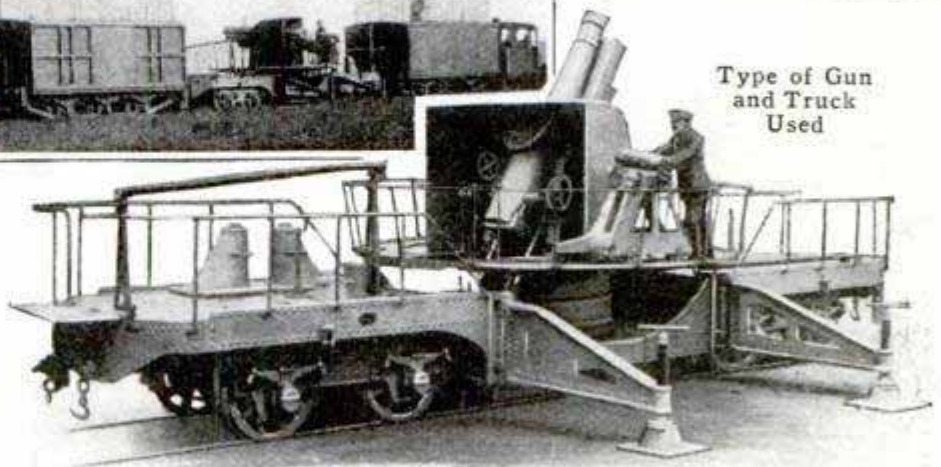

Type of Gun  
and Truck  
Used

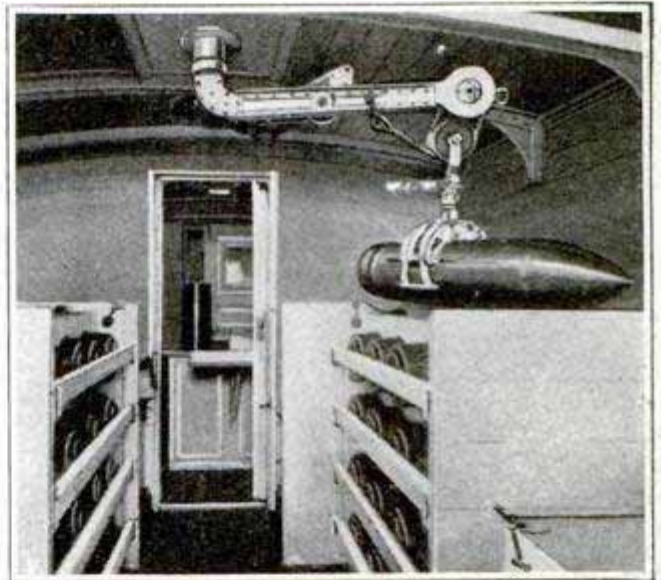

Interior of Ammunition Car

armored. An interesting feature of one car used in the French maneuvers is an observation tower extending some 40 ft. above the rail tops.

### MUTILATING FINGER TIPS FAILS TO SAVE DESERTER

A man who had deserted from the Marine Corps recently attempted to enlist under another name in the navy, and used powerful acids to destroy the ridges on his finger tips, that he might not be identified. The condition of his hands aroused suspicion, as the

skin was scarified except for a little patch the size of a tack on one finger. As impressions of his fingers were not found among the records of enlisted men in the navy, a search was made of the files of the Marine Corps, where he was found under another name. The minute portion of unmutilated skin remaining on one finger was amply sufficient to identify him.



India, the Land of Poverty Far More Appalling Than can be Found Anywhere Else in the World, is Also the Land of Riches in Amounts That Would Stir Many American Millionaires to Envy. Even the Primitive Bullock Carts, Used as Carriages by the Wealthy Classes, Crude as Their Mechanical Construction is, are Often Decorated with Canopies Embroidered in Solid Gold and Hung with Rich Fabrics. These Decorations do Not, However, Completely Compensate for the Absence of Springs and Rubber Tires. The Photograph Shows the Conveyance of a Lady of Rank at Ulwar

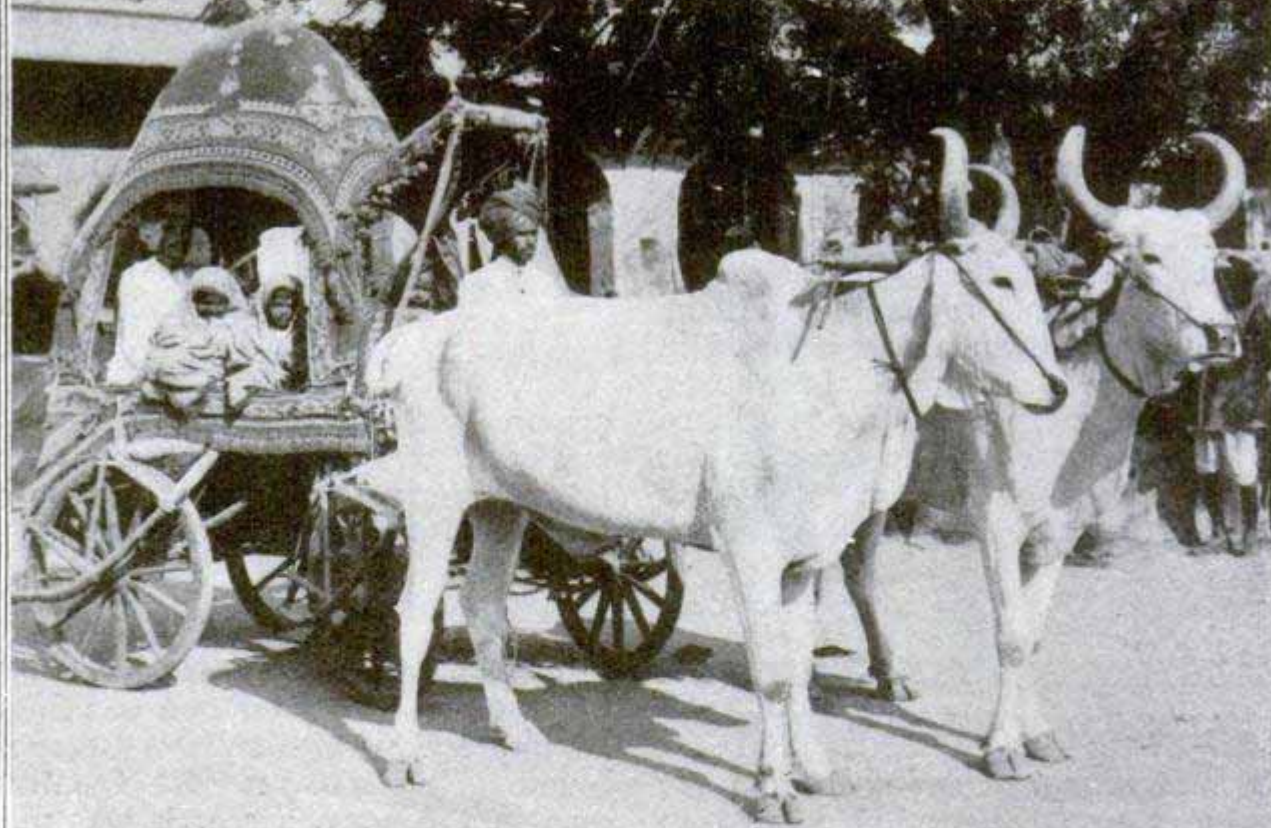



The Custom of Harnessing Three Horses Abreast, Which in America is Confined to Fire Engines and Heavy Trucking, Prevails Quite Generally in Russia for Pleasure Vehicles. This Style of Rig, Known as the "Troika" is Characterized by the High Arch over the Middle Horse. In Winter, Bells are Hung from This Arch. The Beard, Round Cap and Heavy Padded Overcoat are Characteristic of the Typical Russian Coachman. These Men are among the Most Skillful Drivers in the World, and Russia has become Noted for its Fast Trotting Horses. The Photograph was Taken at Sokolnika Park, Moscow





## AMERICAN CULVERTS IN AFRICA

Galvanized, corrugated culverts of American manufacture are being ex-

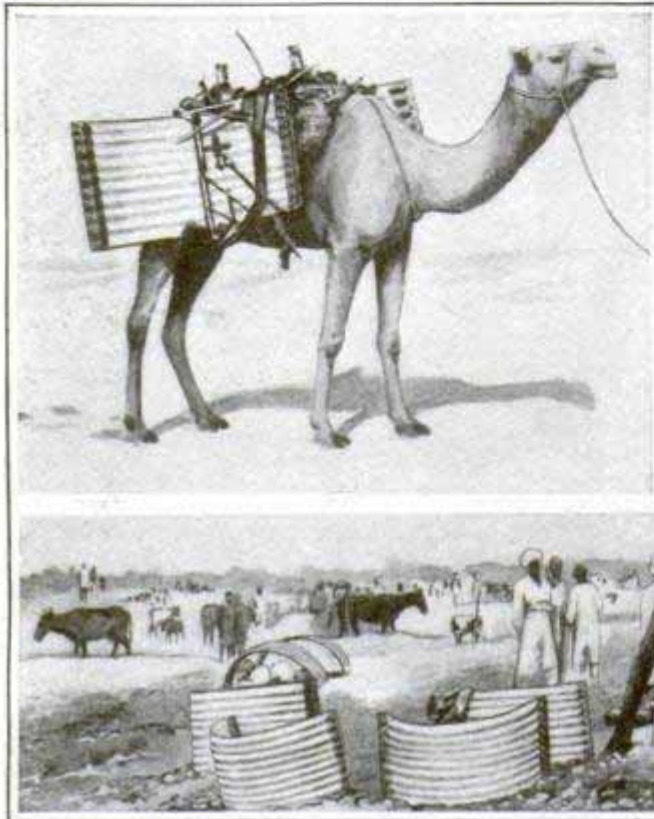

Installing American Corrugated Culvert as Well Casing in Interior of Africa. Above, Bringing in the Culverts on Camel Back

possible from its proper environment when being transported through an African desert on the back of a camel, as shown in the illustration. Nestable culverts of this type, however, are suited to transportation of this kind, because of the possibility of arranging them in small units for shipment. The construction consists of upper and lower half sections of corrugated metal with facing flanges, which are joined together to form a complete culvert by

tensively used in remote parts of Africa and in other sections of the world where the problem of transportation is a difficult one, although it seems, at first sight, that a typically American product such as this is about as far as

means of bolts passing through the flanges of opposite sections. The sections are made in comparatively short lengths and can be packed together compactly for shipment, forming a package easily loaded and handled.

## PARIS SHOWS NEW STYLES IN VEILS

A hint of Constantinople is seen in the newest veils worn on the boulevards of Paris. A heavy border is utilized to mask the lower part of the face, while the eyes are seen clearly through the thinner upper portion of the veiling, giving a peculiarly



Oriental and rather striking effect.

## "MOVIE" TICKETS REWARD GOOD CONDUCT

Officials of the Maryland House of Correction, at Bridewell, four miles from Laurel, have adopted the motion picture as an incentive to good conduct, with results which proved satisfactory. Tickets are given two or three times a week to those inmates who have not violated institutional rules, and these are accompanied by little checks entitling them to admission to the moving-picture shows on designated evenings within the chapel. This, so the officials state, has resulted in raising the department record nearly 50 per cent. Formerly, when certain



department standards were reached, they were rewarded by having their prison clothes taken from them and civilian clothes given. Then, as a further reward for model conduct, white sheets were placed on their beds, but the introduction of the "movies" has had the best effect of any method yet tried, as all the prisoners are anxious not to miss a single entertainment.

### THEATER CHANGES FRONT TO ADVERTISE SHOW

When a mission play was to run at a San Francisco theater, the entire lower front and entrance was changed, as an advertising scheme. A false frame of timber was run up to the marquis in a design to resemble an old Spanish mission. This was covered with canvas and painted in the semblance of stone, giving a realistic impression of heavy arches and hanging bells. Conforming to the style and era of the play, the mission front attracted much attention.

### A NEW VALVE-TRUING DEVICE

It is of great importance that valve and stem shall be concentric, and as the severe conditions under which exhaust valves in gasoline engines have to work tends to warp the stem where it is subjected to the greatest heat, a novel device has been invented which permits grinding of the valve head and at the same time maintaining it true. It contains a cutter to trim the head and a ball adjustment held within cones, supporting two sets of balls. A valve and stem being inserted for grinding, the support holds them concentrically whatever the diameter of the stem, and the valve face will be held evenly.

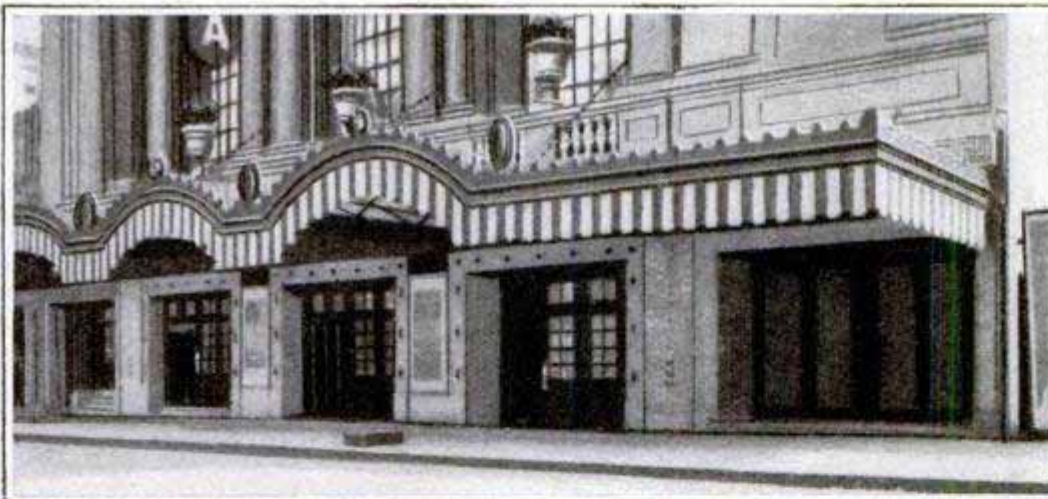
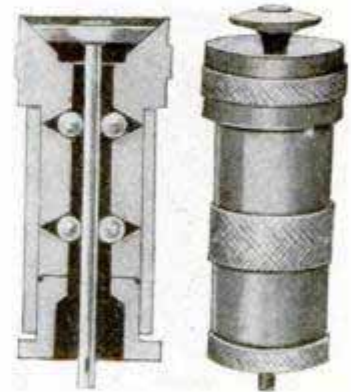

This Playhouse  
with Its  
Artistic Entrance  
is a  
Well-Known  
San Francisco  
Landmark

When a Play  
Representing a  
Spanish Mission  
was Staged,  
the Entire Front  
of  
the Theater was  
Remodeled





### FIRE-INSURANCE PATROL USES SEARCHLIGHT

In Paris the fire-insurance patrols are an important factor in the salvage of goods, both from fire and smoke and

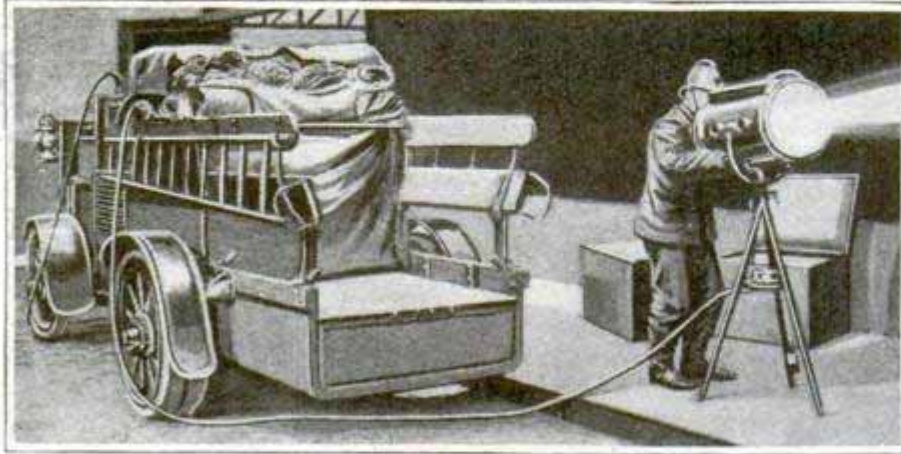

Fire Patrol Carries Searchlight into Burning Building

from damage by water. Their wagons are equipped as are the American apparatus, with tarpaulins, fire axes, and such protective implements, but, in addition, they carry a portable electric searchlight with a long insulated cable, receiving current from a motor-driven dynamo on the wagon. In penetrating remote interior rooms, when gas or electric lighting is cut off by the fire, this portable light is of great value in spreading the tarpaulins, removing goods, rescuing injured firemen or similar work.

### IDEAL GLASS SOUGHT FOR SPECTACLES

Sir William Crookes, the famous English physicist, who has been making researches in the effort to discover a glass which, when used in spectacles, would avoid certain faults, states that he has succeeded in obtaining a glass which cuts off 90 per cent of heat radiation, also glass which is opaque to the invisible ultraviolet rays, and glass which is sufficiently free from color to be used in spectacles. He has not yet, however, been able to combine these three qualities in one piece of glass. The ideal glass should be transparent to all the colors of the spectrum, yet cut off the invisible rays at each end.

### SELLING ROCK AND SAND AS POULTRY

Buyers of poultry in New York City pay for from 150,000 to 300,000 lb. of sand, rock, and other weighty material every week, according to a statement made by a poultry dealers' association, and steps are being taken to have the matter investigated by the United States Department of Agriculture. It is said that this weight-producing material, which adds about half a pound to each fowl, is fed to the chickens on the eve of marketing in a paste that is so palatable that it is devoured eagerly by the birds.

### CARRIER FOR AEROPLANE MESSAGES

Communication between observers scouting in an aeroplane and their military base is difficult, in that messages thrown from aloft are easily lost in grass or on the roadway. A new de-

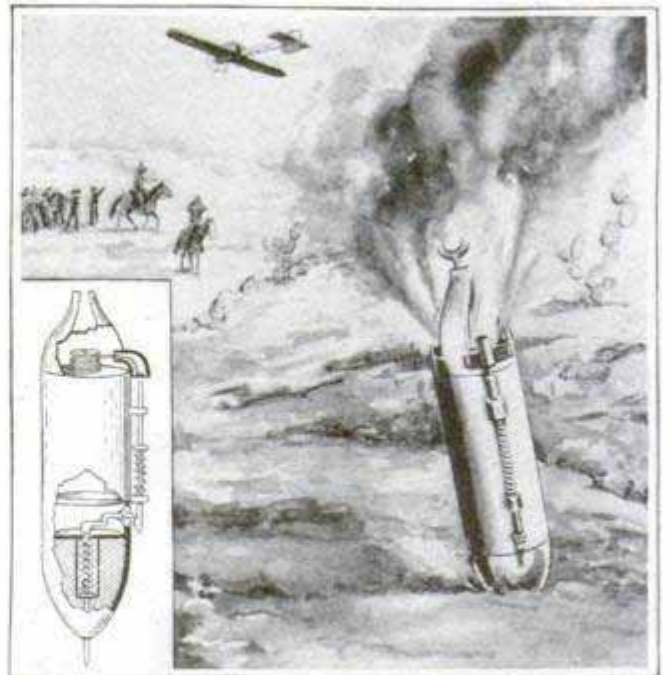

Device Which Enables an Army to Locate Messages Dropped by Air Scouts

vice, by means of a loud report or a blazing torch, announces the location



of the communication. A metallic tube used to inclose the message from the aeroplane is weighted at the lower end, which is fitted with a spike so that it will imbed itself in the ground. At the top a cartridge is fitted with a detonating device which will give a sharp report. If the carrier is used at night, a slow-burning powder is substituted for the detonator. The message, of course, is thoroughly protected from any injury from either detonator or flame.

### WARDROBE ON WHEELS GIVES QUICK DELIVERY

A pressed-metal wardrobe, mounted on a motorcycle sidecar, gives quick

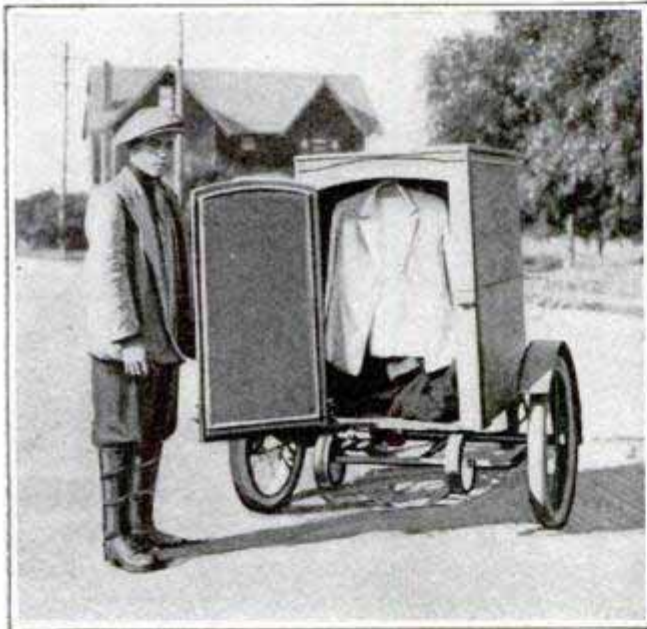

**Traveling Wardrobe a New Wrinkle in Delivery Carts** and safe delivery to the patrons of a cleaning establishment in the West. The interior is equipped with a system of hooks and garment racks, so that newly pressed suits can be taken to customers without folding or creasing. A rod runs through the center of the roof to carry the hanger hooks, and a large number of garments can be carried without crumpling. There is plenty of space below for suits sent to be cleaned, which can be rolled together without damage. The delivery boy can cover a wide radius easily, and when working in town, often makes 50 calls on customers in a single day.

### COIN-CONTROLLED RESERVED SEATS FOR PARKS

In San Diego an inventor has developed a novel seat for use in parks and

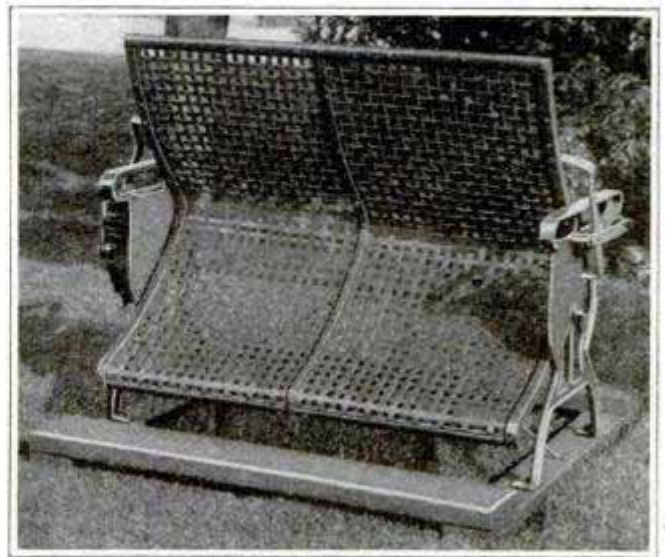

California Park Has Novel Seats

pleasure resorts, which is normally so tipped that it cannot be used. Upon placing a coin in the slot, however, the seat may be tipped back into the usual position, making a comfortable and restful bench. When the occupants rise from the seat it automatically swings forward and locks in a nonusable position, from which it can only be moved by the insertion of another coin.

### AN ELECTRIC-LIGHTED SHAVING GLASS

A novelty which adds to the comfort of an early morning shave, consists of a shaving mirror mounted on a ball joint at the base, with an adjustable reflector and electric lamp attached to the upper rim of the mirror frame. Any desired angle may readily be obtained, and the light directed to fall on the face without the least glare in the eyes.





## A SWIMMING MAIL CARRIER OF THE PACIFIC

The surf is generally so rough at Niuafu, an island in the Tongan group, that there is difficulty in launching the native boats. Once a month the mail steamer passes by, and slows down about a mile from shore. Although sharks abound, a native swimmer plunges through the surf with a long plank, to which is lashed a pole, at the top of which is fastened the letters or other mail to be sent away.

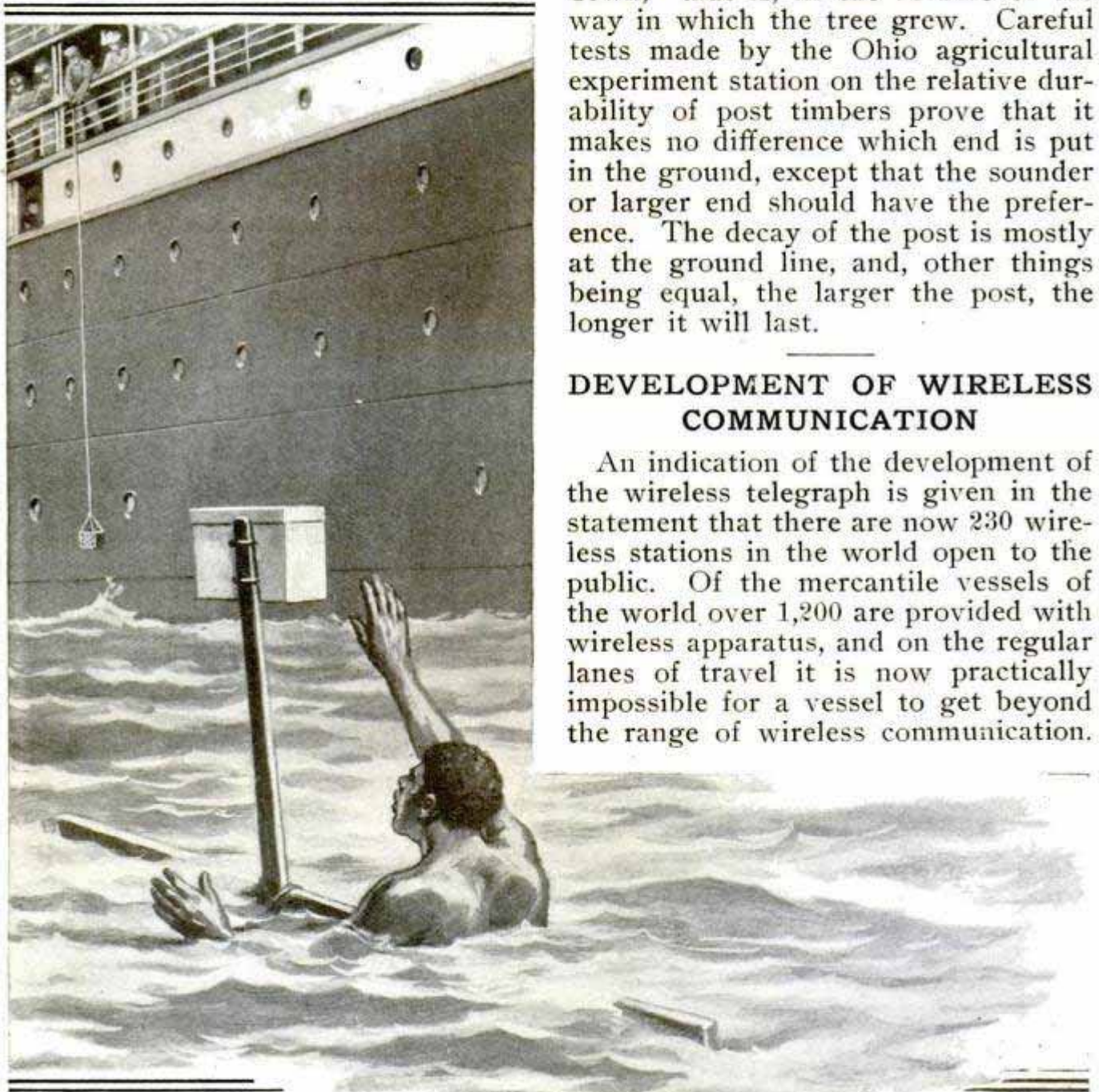

Meeting the  
Mail Steamer Once a Month  
is an Event in the Friendly Islands

This mail is hooked up by a sailor on board the mail steamer, and at the same time the ingoing mail is thrown overboard in a hermetically sealed tin can, and carried by the swarthy swimmer to the shore.

## SETTING FENCE POSTS TO GIVE LONGEST LIFE

In the belief that it is natural for water to flow upward through the cells of wood, farmers for generations have planted their fence posts "upside down," that is, in the reverse of the way in which the tree grew. Careful tests made by the Ohio agricultural experiment station on the relative durability of post timbers prove that it makes no difference which end is put in the ground, except that the sounder or larger end should have the preference. The decay of the post is mostly at the ground line, and, other things being equal, the larger the post, the longer it will last.

## DEVELOPMENT OF WIRELESS COMMUNICATION

An indication of the development of the wireless telegraph is given in the statement that there are now 230 wireless stations in the world open to the public. Of the mercantile vessels of the world over 1,200 are provided with wireless apparatus, and on the regular lanes of travel it is now practically impossible for a vessel to get beyond the range of wireless communication.



## ALPINE TRAVELER USES AERO SLEIGH

Crossing the French Alps in a sleigh, the motive power being furnished by

21 hours. The centrifugal pump is 10 ft. in diameter, and the suction and discharge pipes, 30 in. The "Columbia" is working on the lower Columbia River.

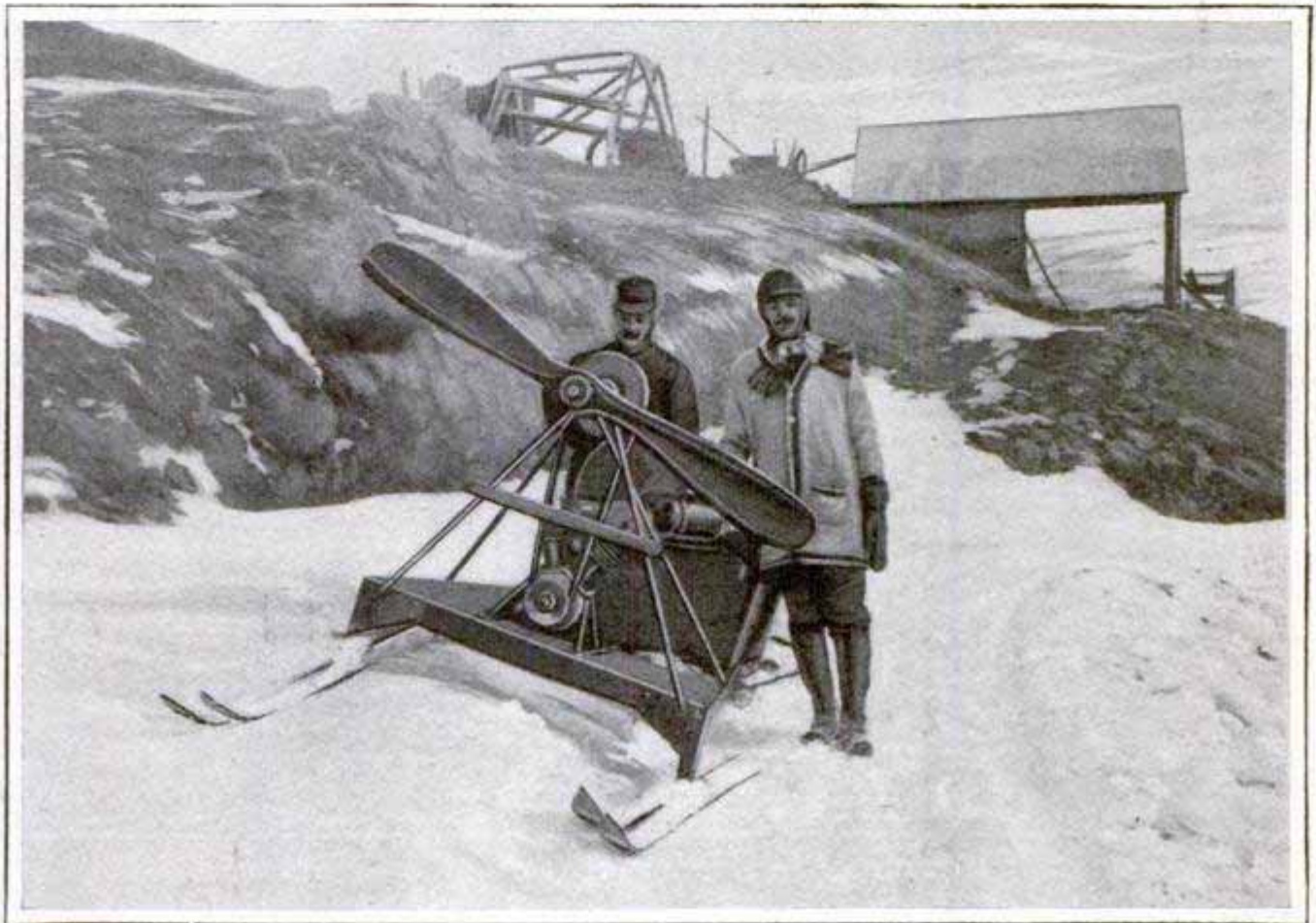

Air-Propellered Auto Sleigh, in Which a Frenchman Crossed the Alps

an air propeller, an inventive and adventurous Frenchman set a new record for scaling snow-clad heights by the aid of gasoline. The motor is set upon a platform which itself is supported by runners formed of skis or ski-shaped boards. The propeller is set in front of the sleigh and consists of two wooden blades.

## LARGE HYDRAULIC DREDGE

The dredge "Columbia," owned by the Port of Portland, Oregon, is 250 ft. long and 65 ft. beam. The main engine is of the marine type and develops 1,500 hp., with four boilers operating on 150 lb. of steam. This dredge, it is stated, will dig 70 ft. below the level of the water, and make a channel 350 ft. wide. Her record is given as 29,000 cu. yd. of solid material in

## SHIELDS THAT FILTER LAMP LIGHT

Lamp shades which filter artificial light and remove the most troublesome rays are among the latest French inventions. As it is the ultraviolet rays that tire the eyes, the circular, transparent screen is made of a fibrous film impregnated with uranium salts, which have the property of intercepting these rays. An opaque shade above the screen can be lowered if the light is still too strong. The wire holders attached to the light filter are arranged to fit gas, electric, and other kinds of lamps.

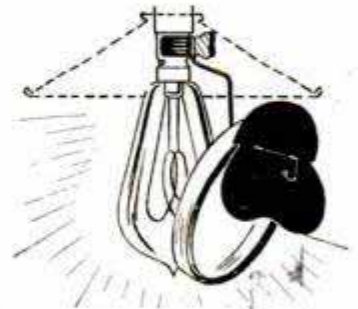



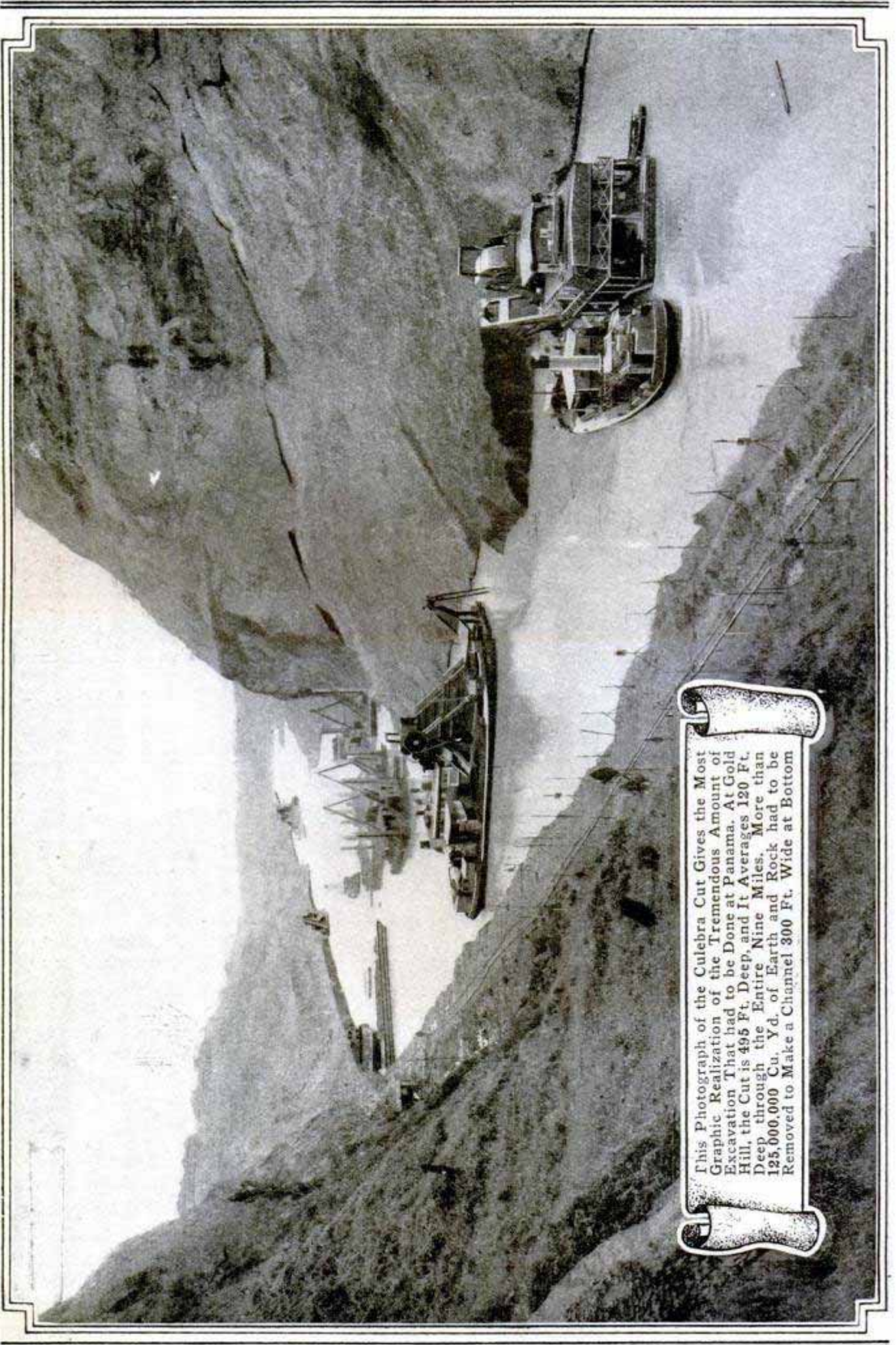

This Photograph of the Culebra Cut Gives the Most Graphic Realization of the Tremendous Amount of Excavation That had to be Done at Panama. At Gold Hill, the Cut is 495 Ft. Deep, and It Averages 120 Ft. Deep through the Entire Nine Miles. More than 125,000,000 Cu. Yd. of Earth and Rock had to be Removed to Make a Channel 300 Ft. Wide at Bottom



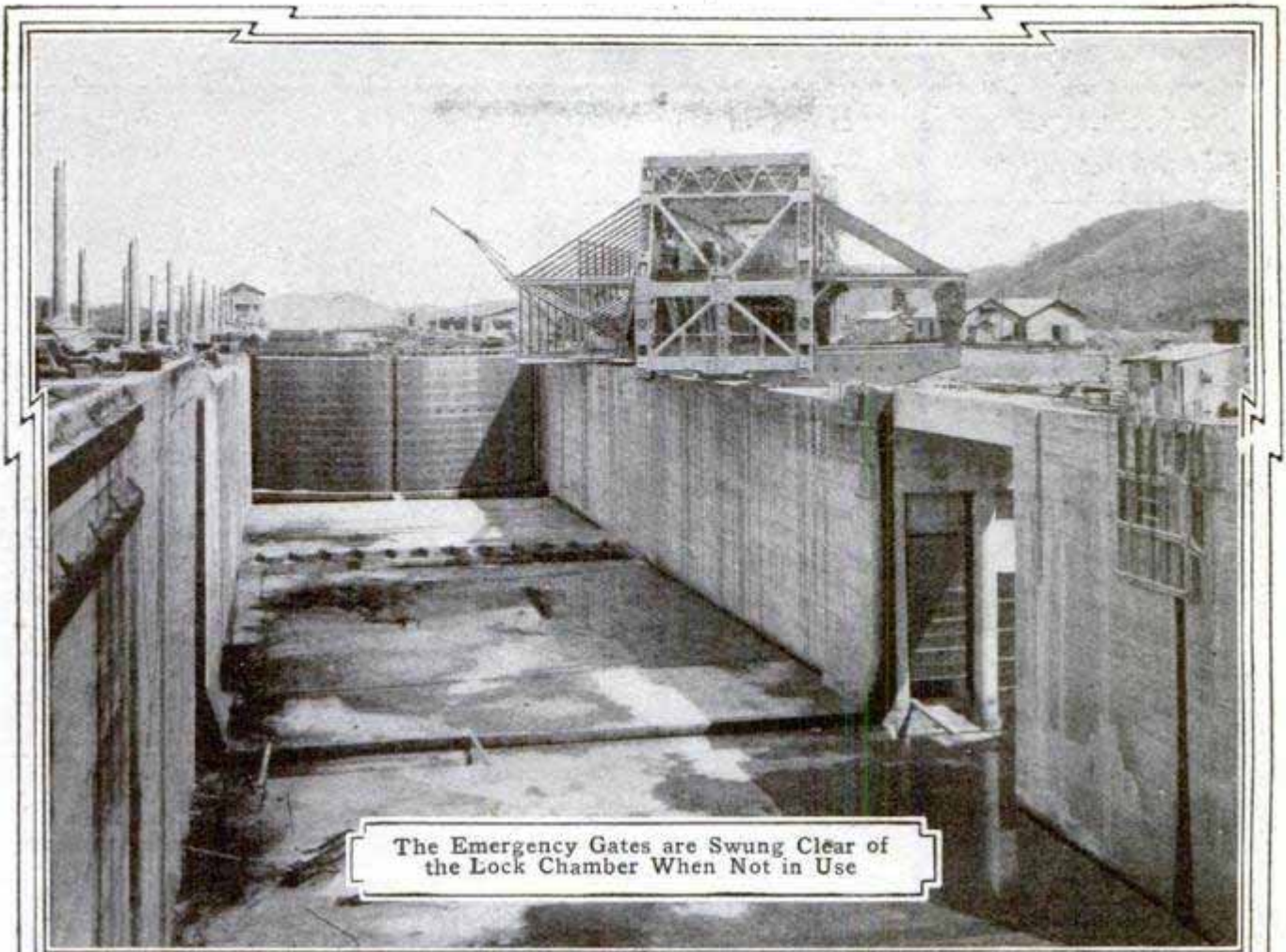

The Emergency Gates are Swung Clear of the Lock Chamber When Not in Use

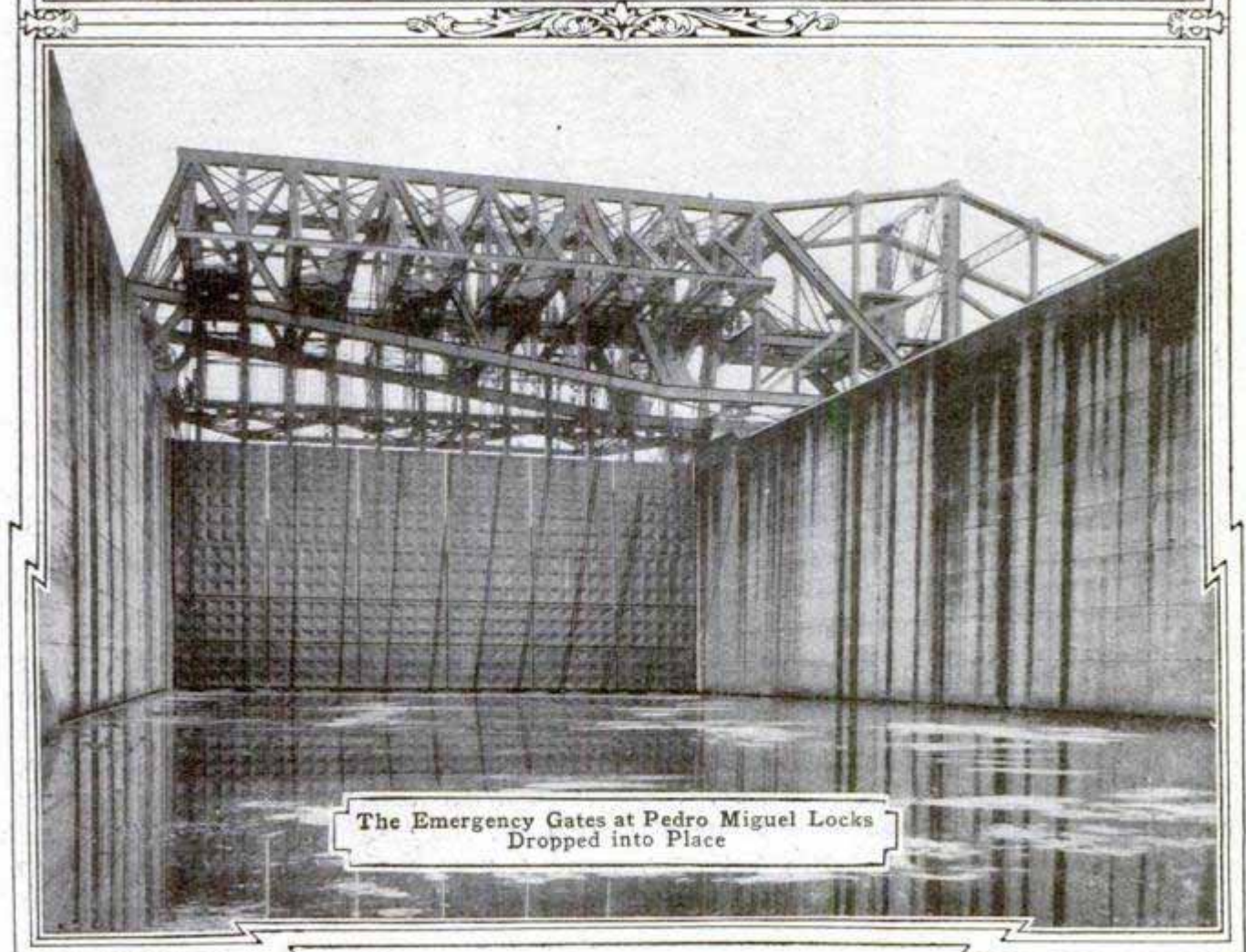

The Emergency Gates at Pedro Miguel Locks Dropped into Place



## NOVEL BRIDGE CONSTRUCTION IN PENNSYLVANIA CITY

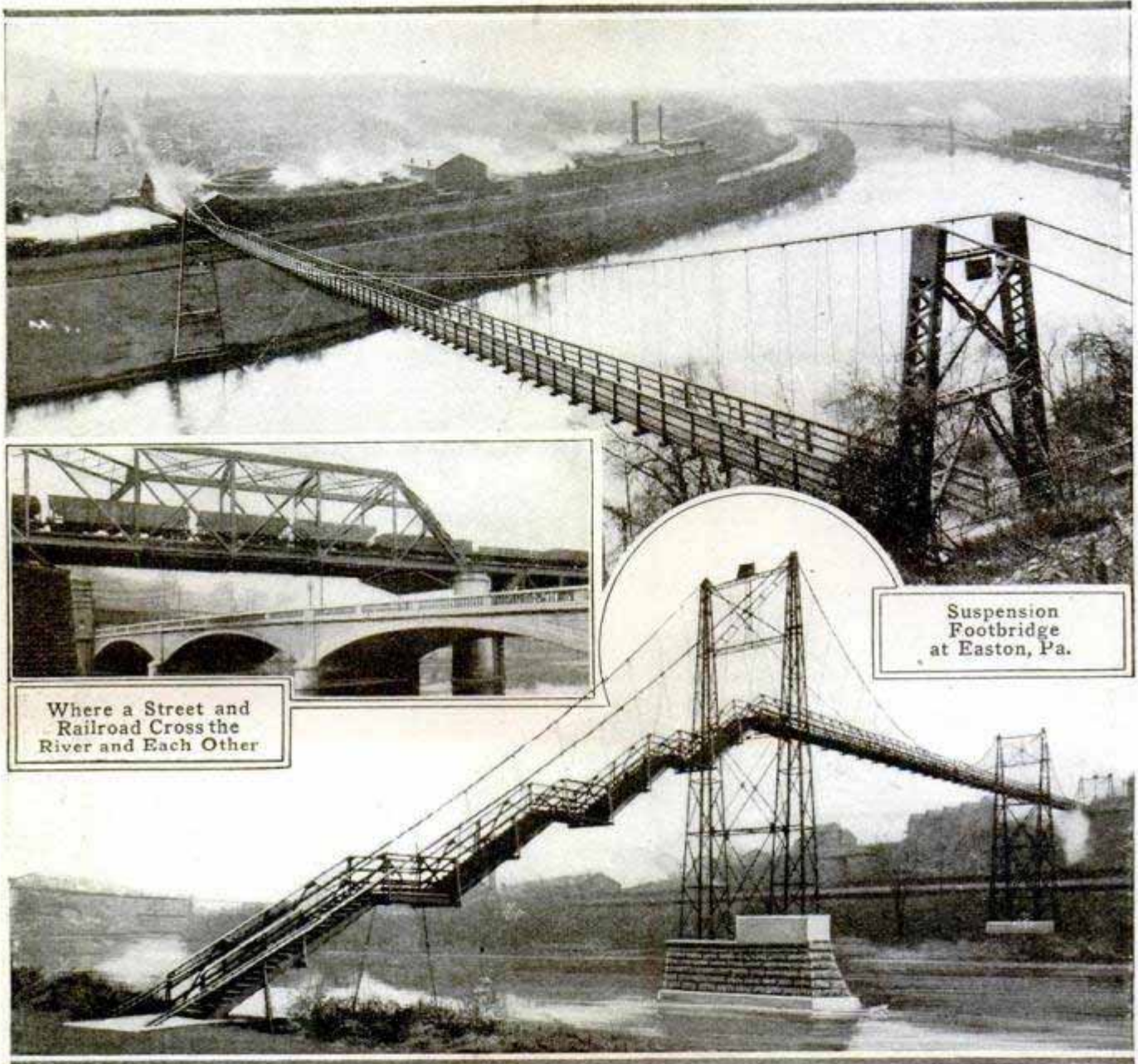

Suspension Approach of Bridge between West Easton and South Easton

Two rivers, the Delaware and the Lehigh, come to a junction at Easton, Pa., the latter cutting the city into two separate sections, and some novel types of bridge arrangement and construction have therefore been necessary in providing convenient communication between the different parts of the city. One of the suspension footbridges, connecting Easton and South Easton, is, perhaps, the highest footbridge in the United States, the floor being 128 ft. above the water. This bridge spans the Lehigh River, the Lehigh Canal, and two railroads, and is 1,020 ft. long. The suspension

footbridge connecting West Easton and South Easton is considered unique among the bridges of this country on account of the construction of the West Easton approach. The north pier of the bridge, where the main span ends, is set out in the river, and from this the approach slopes down to the shore as a series of stairways and landings. This approach, instead of being supported from below in accordance with the usual practice, is suspended from cables which slope from the tower down to anchorages near the foot of the approach. At another point a street and a railroad cross the



river and each other. This necessitated the placing of the railroad bridge at such an elevation as to give adequate clearance to the traffic on the street bridge.

### CAR FERRY TO HAVANA IS PLANNED

A contract has been let for the construction of a large ferryboat, 350 ft. long and 50 ft. beam, which will be used to ferry trains across the Florida Strait from Key West to Havana, a distance of over 100 miles. The vessel will cost \$500,000, and the specifications call for a speed of about 18 miles an hour.

### GRAVEL EXCAVATOR WORKED BY TRACTION ENGINE

A machine has been devised to be used in connection with a traction engine for excavating in sand and gravel pits. A winch, connected with the engine by a belt, carries a steel cable. A bucket of any suitable type is sus-

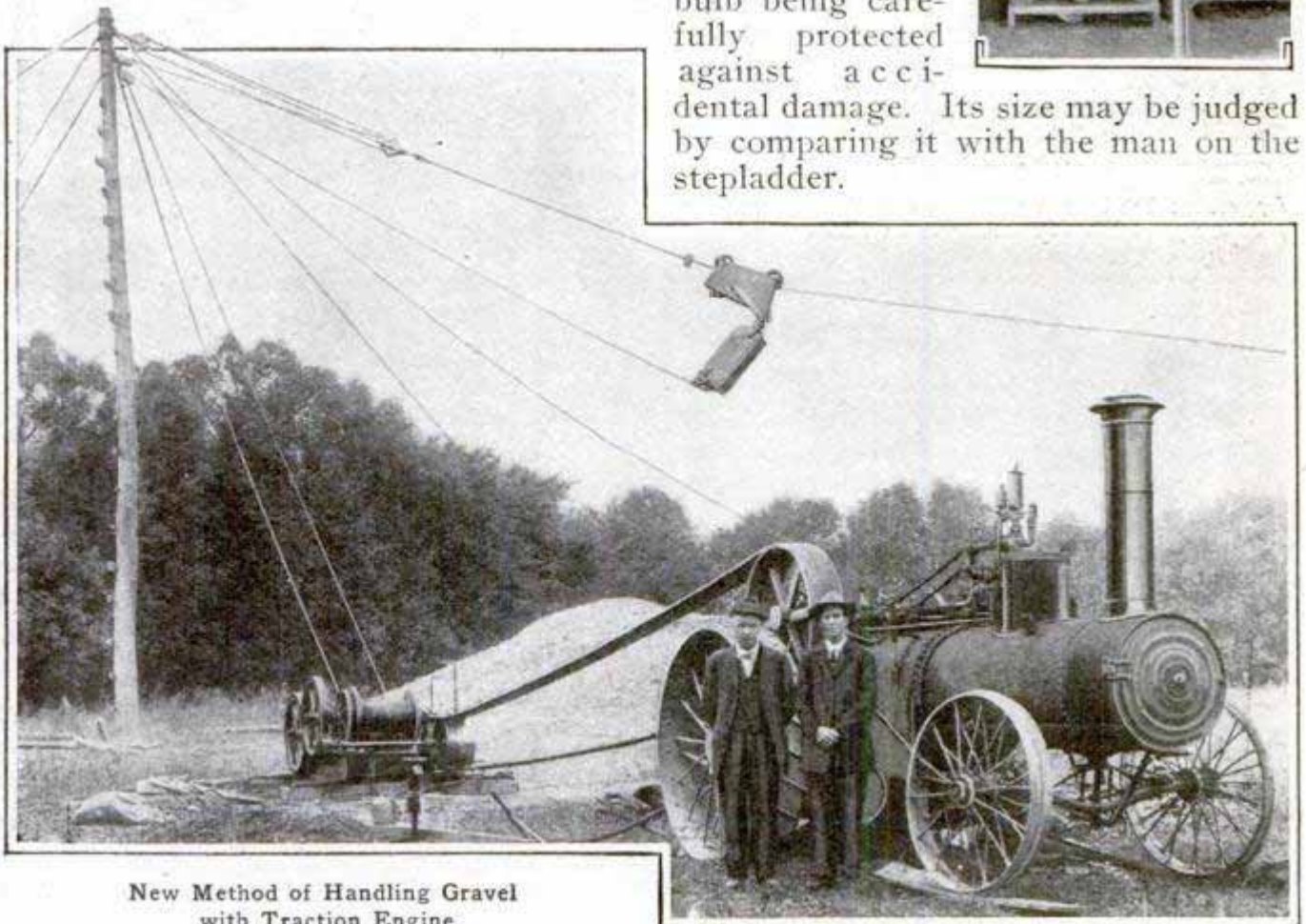

New Method of Handling Gravel with Traction Engine

ended on a guy, moving freely and controlled from the winch by levers. The machine, which is capable of excavating large quantities of material, is designed for use in road making, and to be moved as work progresses.

### A PARK THERMOMETER TEN FEET HIGH

In one of the New Orleans parks a big thermometer has been erected close to the superintendent's office, which measures 10 ft. in height and is plainly visible from a distance, enabling visitors to read the temperature without trouble. A gallon of mercury is used in the tube, the bulb being carefully protected against accidental damage. Its size may be judged by comparing it with the man on the stepladder.

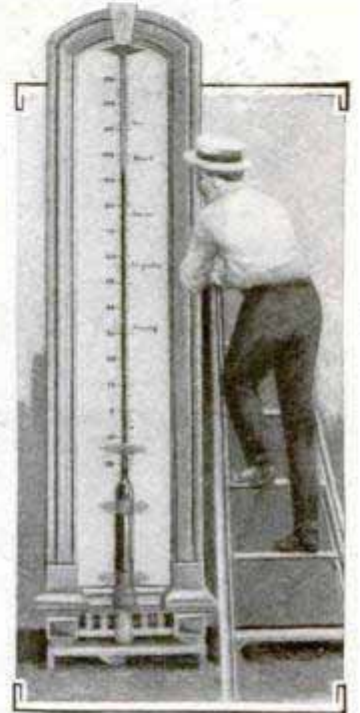



## NEW PORTABLE BREECHES-BUOY APPARATUS

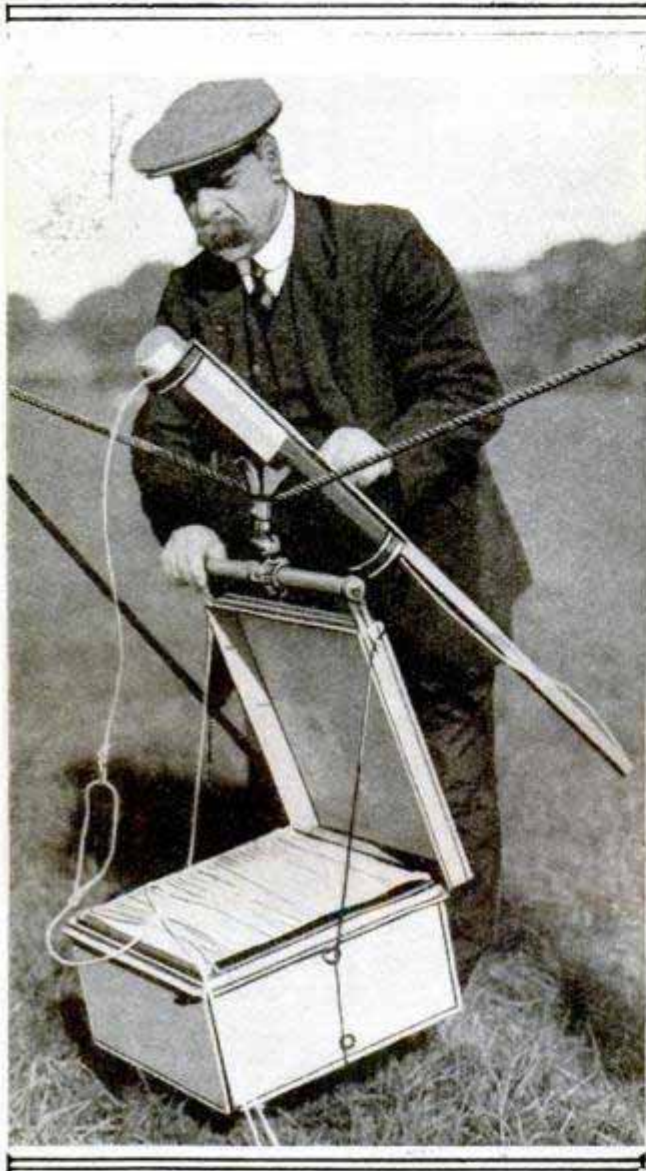

Apparatus Set Up: The Rocket is Connected to the Line and Ready to be Fired

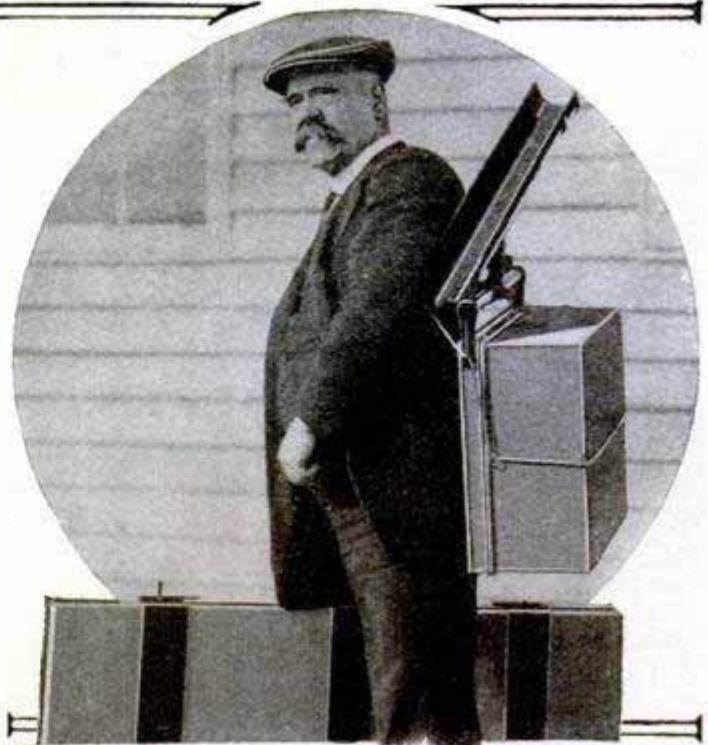

Breeches-Buoy Apparatus Packed and Ready for Transport



Bringing In a Man on the Breeches Buoy: For Test Purposes the Line was Fired over a Point 1,050 Ft. Distant and the Man was Brought In under the Same Conditions as would Prevail at Sea. The Equipment for Firing the Rocket is Shown at the Left

Photos by Paul Thompson

A complete breeches-buoy outfit that can be carried around by one man, and is capable of being operated over a distance of from 450 to 1,200 ft., has been developed by an old English seaman. Each outfit has four lines and four rockets which may be fired in quick

succession, the lines being arranged in the case in such a manner as to run out at high speed without danger of kinking. The apparatus can be readily set up on the ground or the deck of a ship, or may be fired when suspended from ropes or the rigging of a ship, as



it is made to balance automatically. In a recent test with a 6-lb. rocket and 1,050 ft. of line, the line was thrown a distance of 900 ft. against a strong wind.

### FOREST LOOKOUT TOWER BUILT OF LOGS

A lookout station was built in the Sitgreaves National Forest, Alaska, by rangers in the Forestry Service, reaching to the height of 115 ft. and constructed entirely of logs. The first task was to cut and peel the logs, and skid them to the spot selected for the tower. Much care was necessary in selecting the main poles, most of which had to be skidded out of dense thickets. The corner poles average 16 in. in diameter at the butts, and 4 in. at the top. They are spliced at a height of 45 ft. and at 100 ft., each splice being bolted and then bound with telephone wire. The timbers are fastened together with  $\frac{1}{2}$ -in. lag screws. The base of the tower is 30 ft. square, and the platform on the top is 6 ft. square. The time spent in cutting and peeling the logs and constructing the tower amounted to less than 24 working days

of 8 hours each for a crew which averaged 5 in number. Four galvanized wire cables,  $\frac{1}{2}$  in. in diameter, will be added as guys, and a copper cable reaching up and over the top of the tower will follow one leg to the ground and serve as a lightning arrester.

### ARTISTIC STANDARD FOR INVERTED LIGHTS

Artistic effects are obtained in hotels and public halls by the use of standards designed with an electric lamp and reflector in the center of a flower receptacle. The light is thrown on the ceiling and reflected without glare or shadows over the room. Hooks upon the side of the pedestal make it serviceable as a coat and hatrack.

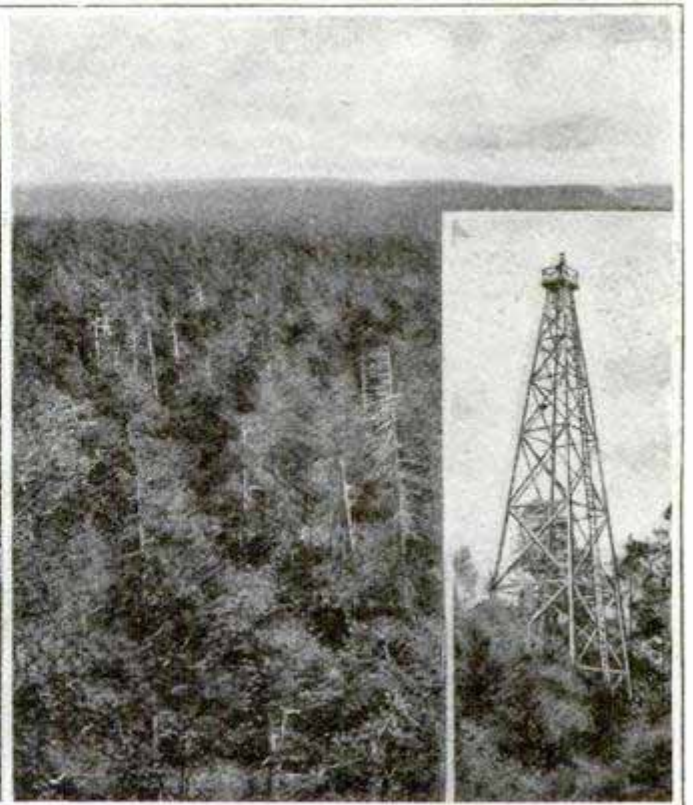
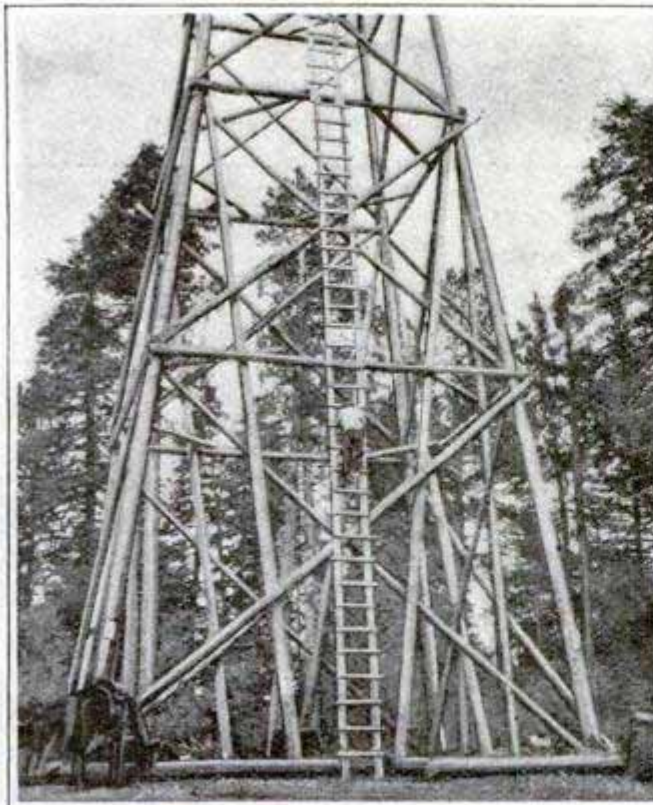

Fire-Lookout Station on Promontory Butte, Alaska: Right, the Tower and View from Its Top; Left, Base of Tower, Showing Log Construction



## PLACER MINING BECOMING MORE EFFICIENT

In the early days of placer mining, the gold-bearing sand and gravel was washed in a shallow pan by the simple expedient of rotating it by a swirling motion, the water and sand being

thrown over the top while the heavier gold remained at the bottom. This was a most inefficient method, and as the pay dirt became scarcer, it was necessary to handle larger quantities of gravel to secure sufficient gold to make the operation profitable. The first step was the use of the "cradle," a roughly pivoted box over which a "grizzly," or coarse sieve, was suspended. Quantities of the sand and gravel are shoveled into the sieve, which keeps out the larger gravel, and the fine sand and grains of gold run through the sieve and into the "rocker," on the bottom of which are strips of wood between which the gold is caught, while the sand is washed away. Bigger quantities of pay dirt are handled when the water is sluiced in, and the bottom of the rocker is composed of plates of copper covered with mercury. The gold sticks to the mercury and is scraped off at the end of the day.

¶ A novel use for the parcel post is reported from Washington, where 400 lb. of ore was shipped for test to a laboratory from a mine in a remote section of the country.

¶ Incense cedar grown in California is now extensively used in the manufacture of pencils by German makers.



Placer Mining with Sluice; Rocker Operated by Wheel

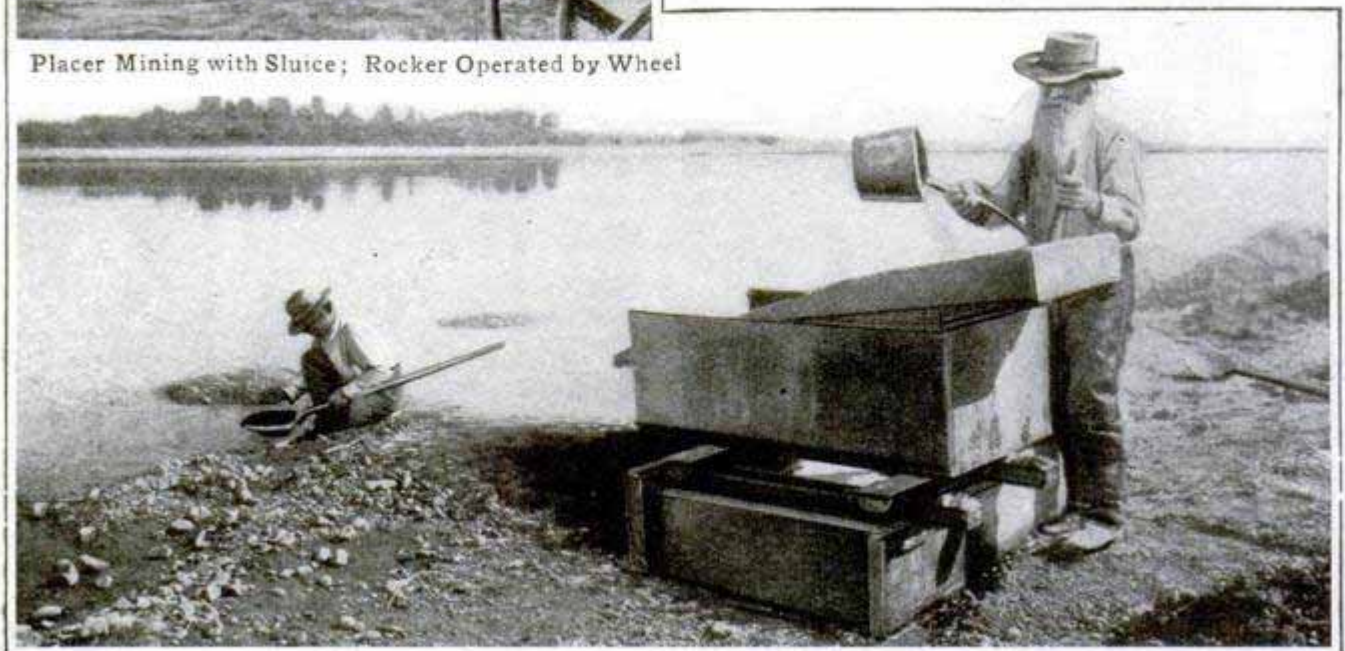

A Primitive Method of Placer Mining: Hand-Washing the Gold-Bearing Sand with a Rocker



## REVOLVING SHADE LESSENS EYESTRAIN

A revolving shade for a portable lamp has recently been invented whereby many diverse positions may be se-

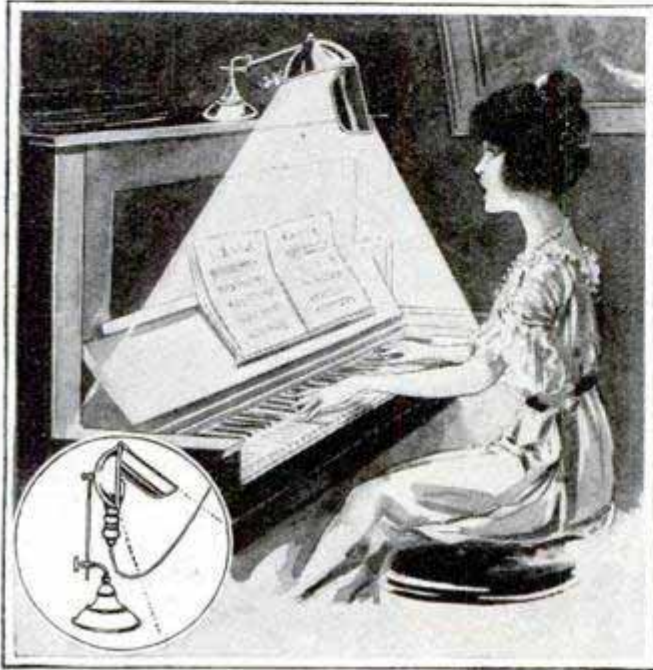

Adjustable Electric Lamp and Shade That Protects the Eyes

cured, throwing a bright beam of light in any direction desired, without attendant eyestrain. An ordinary parabolic reflector attached to an electric incandescent lamp, with an adjustable revolving shade hinged to the brim in such manner that it remains wherever placed, permits the light to be thrown as desired, but all direct rays are cut off from the eyes, preventing glare from injuriously affecting the vision.

CA bill for a canal across New Jersey, to connect the Delaware River with New York harbor and so give Philadelphia a more direct water route to the sea, has been introduced in Congress.

## AFRICAN WAR DRUM MADE FROM TREE TRUNK

What was once the "Dark Continent" has now been so completely explored throughout its length and breadth, that south of a line drawn from Dakar on the coast of Senegal to

Khartum, the modern maps give a fairly accurate idea of territorial divisions, the sources of the principal rivers, and of mountain ranges. There still remain, however, the savage tribes whose mode of life and death show little of the influences of civilization. A recent party, headed by the Duke of Mecklenburg, secured many interesting photographs of savage life under the equator from the Congo and the Niger to the Nile. The war drum of the Sultan of the Niellims is made of a hollowed tree trunk, which, stood on end, is covered with tightly stretched skins, and beaten by two warriors with their open hands. Its reverberations can be heard a long distance.

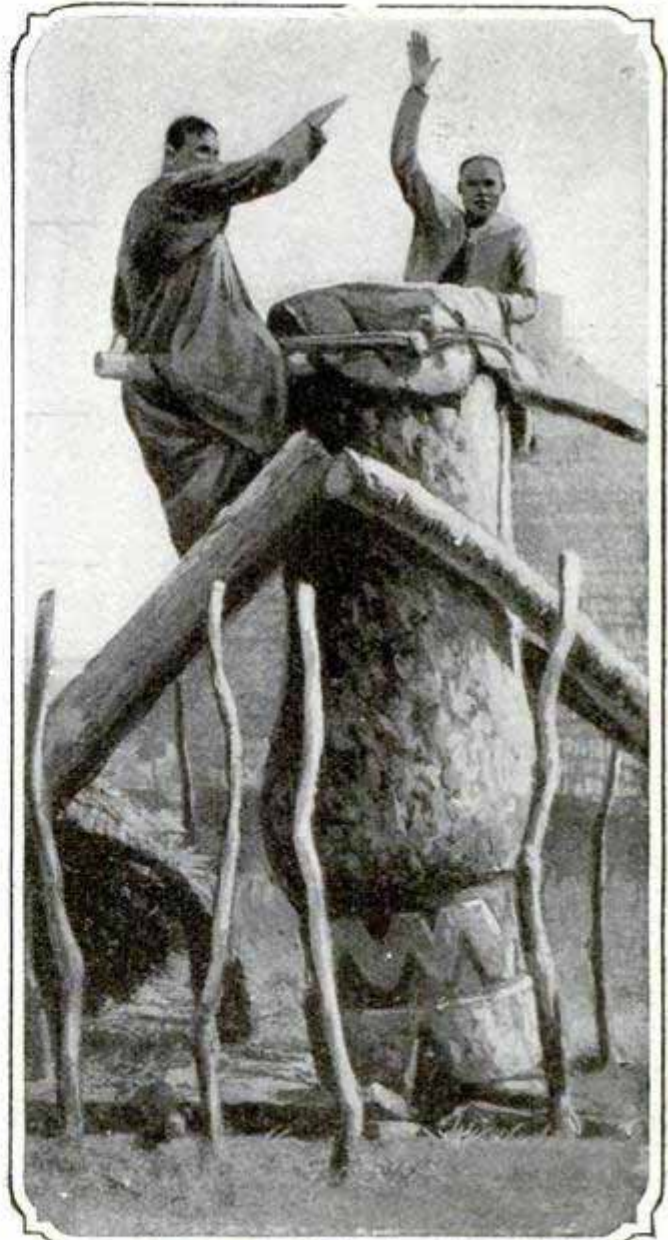

Courtesy Illustrated London News  
Calling Out the Troops in an African Village



## FLOATING ON WATER WITH AND WITHOUT AID

In the waters of the Dead Sea, in Palestine, a bather can lie on the surface in perfect ease and comfort with-

Photo by Underwood & Underwood

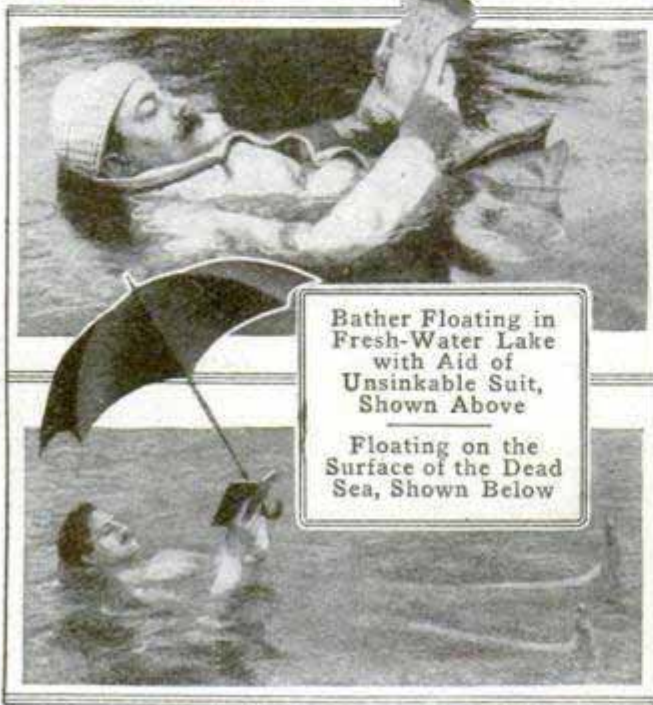

Photo by Wildman Magazine and News Service

out making the slightest effort to keep afloat, since the water contains about six times as much salt as the water of the ocean and is so dense that the body floats only half submerged, as shown in one of the illustrations. A bather may float readily on the surface of the Great Salt Lake in Utah, but on the Dead Sea he can do nothing else but float, and an expert diver can scarcely reach a depth of 6 ft. Quite a different method of floating is shown in the other illustration. Here the bather is floating in fresh water, this feat being made possible through the buoyancy of a special type of suit recently invented in France and made of tissue cloth. The inventor of this suit claims that it is both unsinkable and waterproof, and that it is therefore particularly suitable for use by airmen, steamer passengers, and motorboat enthusiasts.

☐ Direct telephone communication has been established between England and Switzerland.

## NATIVE BOATS OF ANAM MADE WITHOUT METAL

Without nails, screws or bolts, the ingenious natives of Anam, a country lying south of China within the French protectorate, are able to build strong, light boats, some of them of large size, containing no metal of any kind. These sampans, as the native boats are called, are made of five planks, joined together without curving or the use of ribs from one end to the other. The planks used are pierced at intervals of about 8 in. at points directly opposite each other. These perforations form mortises in the shape of double eyelets, through which rattan ropes are passed, tightly binding them together. The joints are calked with vegetable fiber, and over these joints are laid short lengths of board, lapping over one another. These act as stiffeners, strongly reinforcing the boat from end to end and making it water-tight.

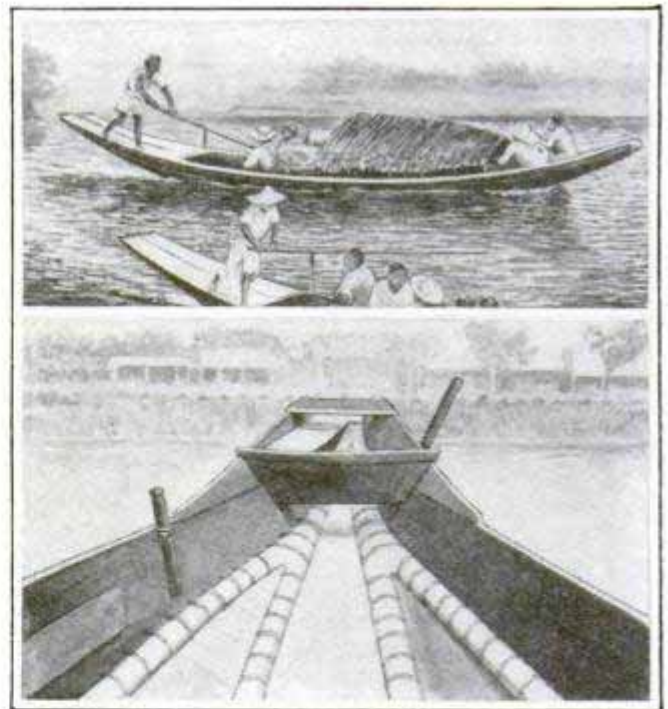

Sampans Made of Five Planks without Nails—Rattan Ropes Hold Boat Together at Joints

## AIR CRAFT TO CO-OPERATE WITH NAVY

One of the most important recommendations of the board of officers recently appointed to draw up a comprehensive plan for the organization of a naval aeronautic service was that for



placing aeroplanes aboard all battleships. All the powers that consider adequate sea power necessary for national defense are developing a strong aerial force to cooperate with their navies and it now looks as if the United States would follow the lead of the other great powers. The organization will ultimately include not only aeroplanes, but dirigibles, captive balloons and kites. If the recommendations of the naval board are carried out, aeroplanes will be provided for every group of ships on scouting duty or detached service. The bulk of the stores and supplies will be carried on fleet auxiliaries so as not to encumber the fighting units, and the use of special ships for carrying air craft is being considered. The purchase of dirigibles at the earliest possible date, with sheds, hydrogen plants and all necessary appliances, was also recommended.

### MOTOR-CAR TOP FOLDS AND DISAPPEARS

A folding top for an automobile, which can easily be raised or lowered by one pair of hands, and, when not in use, is concealed within a chamber formed by the two walls of the tonneau, is a recent novelty offered by a European manufacturer. The top is of full size, but when packed away it is entirely out of sight, and kept free from dust and dirt. This device adds materially to the smart appearance of the car when the top is not in use.

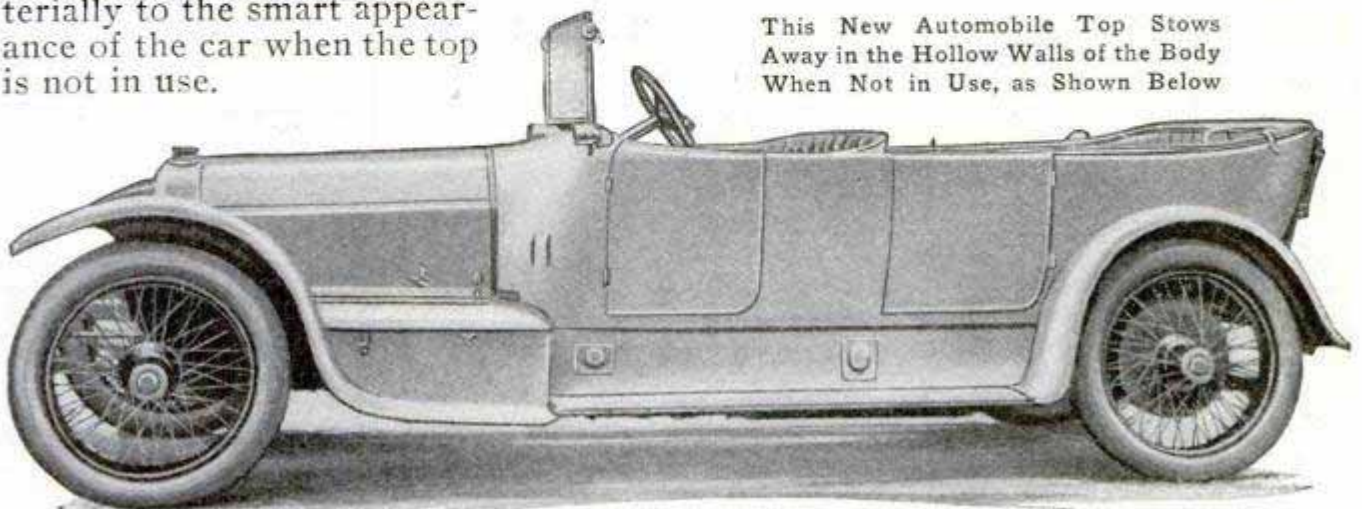

### HORSE BREATHES THROUGH BRASS TUBE

Among the horses employed in the street-cleaning department of Cincinnati is one upon which a surgical oper-



This Horse Breathes through a Tube in Its Throat

ation was performed to save its life. As a result this horse wears a brass tube of special design, penetrating its windpipe. All the air that the horse breathes now goes through this tube.



## BOARDING HOUSE FOR DOLLS BUILT OF LOGS

Asheville, N. C., has long been famous as a resort, and has numerous excellent hotels, but an innovation re-



A "Dolls' Hotel" at a Southern Mountain Resort, Which Adds to the Joy of Juvenile Guests

cently added, equips that city for a branch of entertainment long neglected. A boarding house for dolls has been opened in a little log cabin, 6 by 5 ft. in size, which, while not impressive architecturally, is undeniably cozy. A rifle reposes over the door, a fireplace and chimney of sticks and clay promise comfort, and the clay chinking between the logs makes all warm and dry. A thermometer hung on the side of the cabin calls attention to the salubrity of the North Carolina climate.

☞ An Oregon mill is using in the manufacture of paper the sawmill waste of Douglas fir, of which enormous quantities are to be found in the western forests.

☞ The gathering of acorns to supply eastern nursery firms with material for forest planting is a new industry in Arkansas.

## AUTOMOBILE ROAD TO THE YUKON

A road suitable for the use of automobiles is being planned to run from Vancouver, British Columbia, to Dawson City in the Yukon Territory, and when this is done it is likely that the road will be extended north and west to points in Alaska. Automobiles have already made the 650-mile trip between Vancouver and Hazelton, British Columbia, and the Yukon Territory government is improving the 300-mile sled road between Whitehorse and Dawson so that automobiles will be able to make the trip between these points. This will leave only 400 miles, the stretch between Hazelton and Whitehorse, to be improved.

## NEWSPAPERS DELIVERED BY AEROPLANE

Traversing the distance of 85 miles between Nice and Hyères, a French airman carried a passenger and several packages containing supplements of a daily newspaper published at Nice, and intended for distribution in neighboring cities. Each parcel was attached to a multicolored parachute, and as the aeroplane hovered over some available spot above each city, the parcels were dropped by the passenger, the parachutes unfolding and sinking slowly to the earth. Antibes, Cannes, St. Raphael and Hyères were thus served, and the full distance traveled in less than an hour. After an exhibition of volplaning and banking at the latter place, where the battleships were at anchor, the aeroplane started on its homeward journey, reaching Nice in good order and in record time.



# A TRIP ACROSS THE ATLANTIC

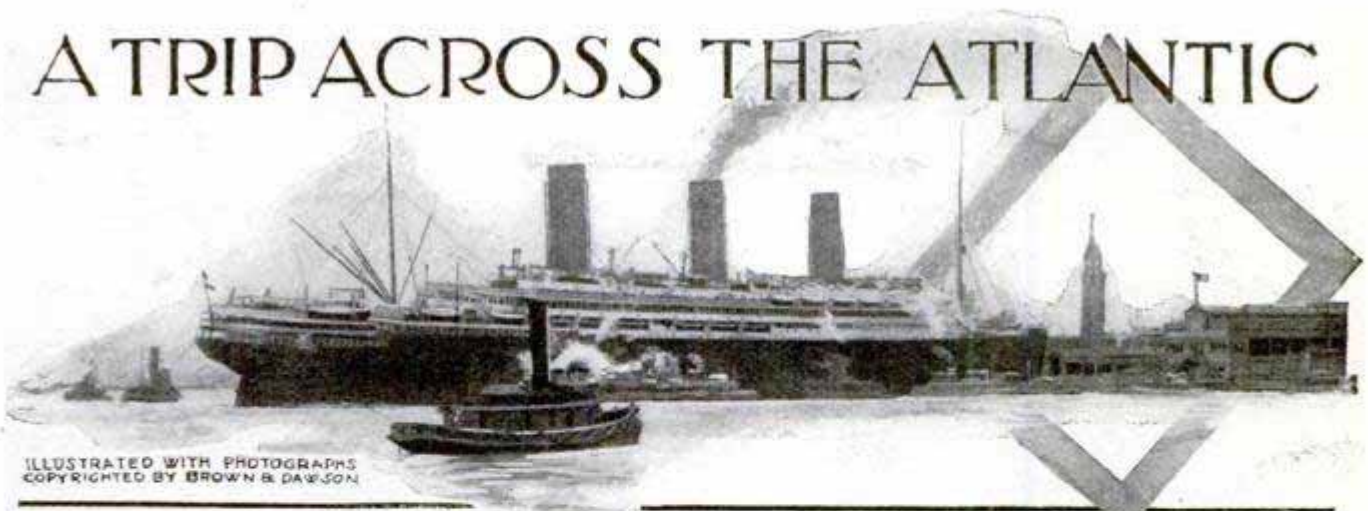

ILLUSTRATED WITH PHOTOGRAPHS  
COPYRIGHTED BY BROWN & DAWSON

THE 'IMPERATOR' LEAVING HER SLIP AT HOBOKEN

**W**HAT happens on a voyage across the Atlantic? How do the passengers amuse themselves through the week or more of life on shipboard? How are they housed and fed and otherwise cared for? What are the novel and interesting things they see on a great modern passenger ship? These are questions that must occur to everyone who has never made an ocean journey.

The best way to answer them is by pictures that tell the whole story. The remarkable series of photographs printed on the following pages give a clearer idea of the daily life and routine of a sea voyage than could be conveyed by any number of words. These photographs were made on board the "Imperator," the largest vessel that has ever sailed the seas. Only half of the story of a voyage in this great ship is told here. The rest of it will appear in picture form in the May issue of this magazine.



Not the Least Interesting Feature of the Ocean Voyage is the Crowd That Gathers on the Pier to Wave a Farewell As the Great Ship Swings Slowly Out into the Stream



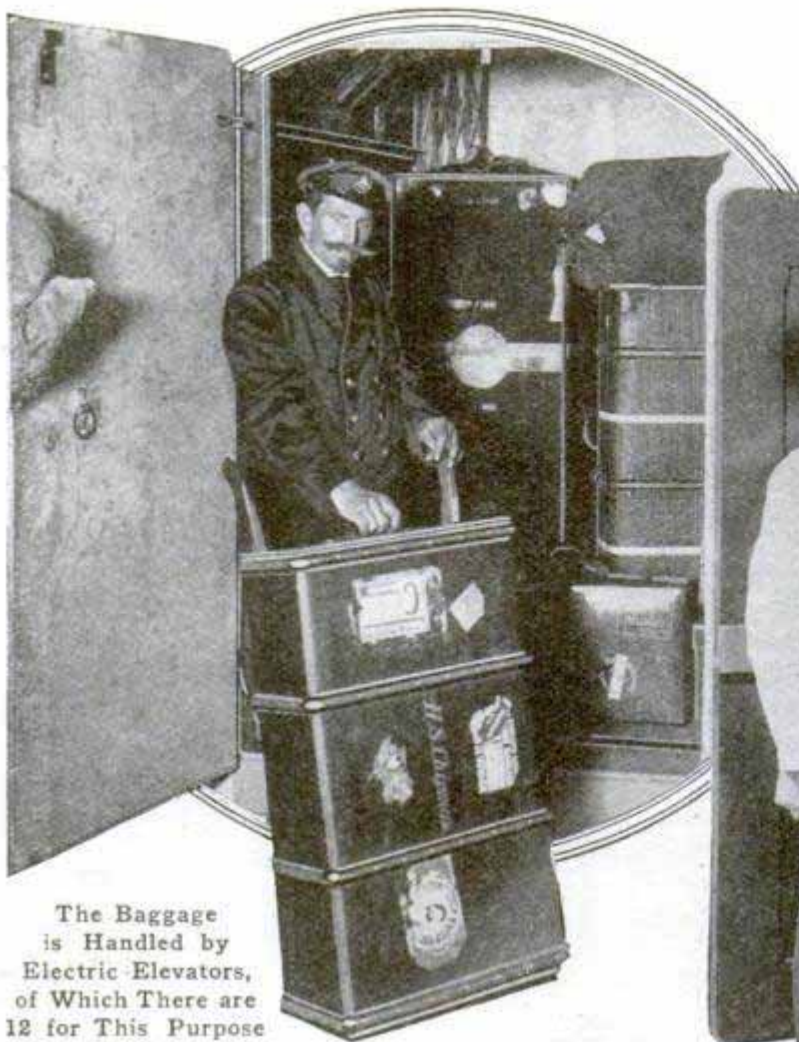

The Baggage  
is Handled by  
Electric Elevators,  
of Which There are  
12 for This Purpose



Special Accommodations  
are Provided for Passengers'  
Pet Dogs, in These Cages

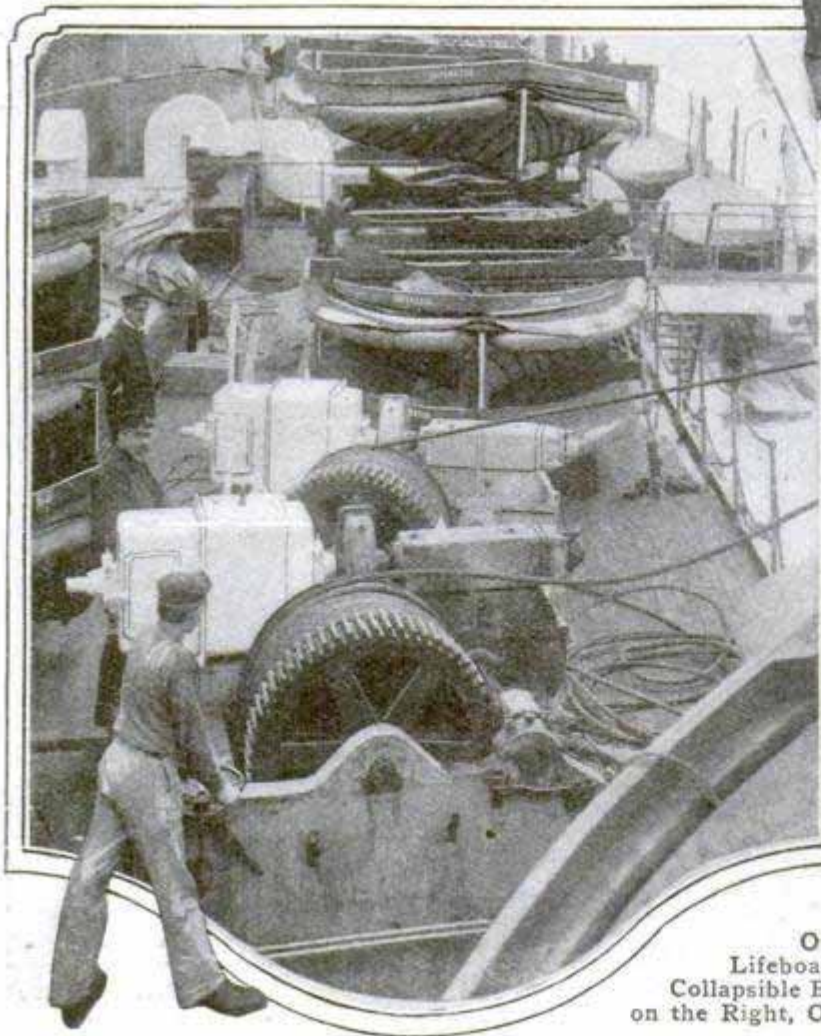

One of the Traveler's First Concerns is the  
Lifeboat Equipment. On the Left are Shown the  
Collapsible Boats and the Winch That Launches Them;  
on the Right, Other Boats, Lowered from Rotating Arms



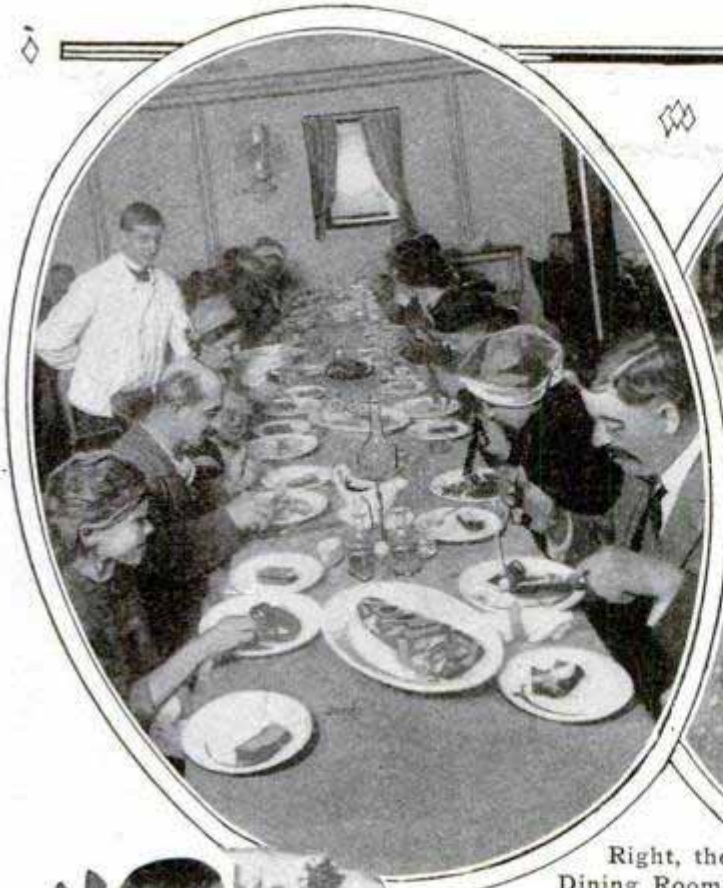

Right, the Dining Room for Steerage Passengers. Left, the Third-Cabin Dining Room

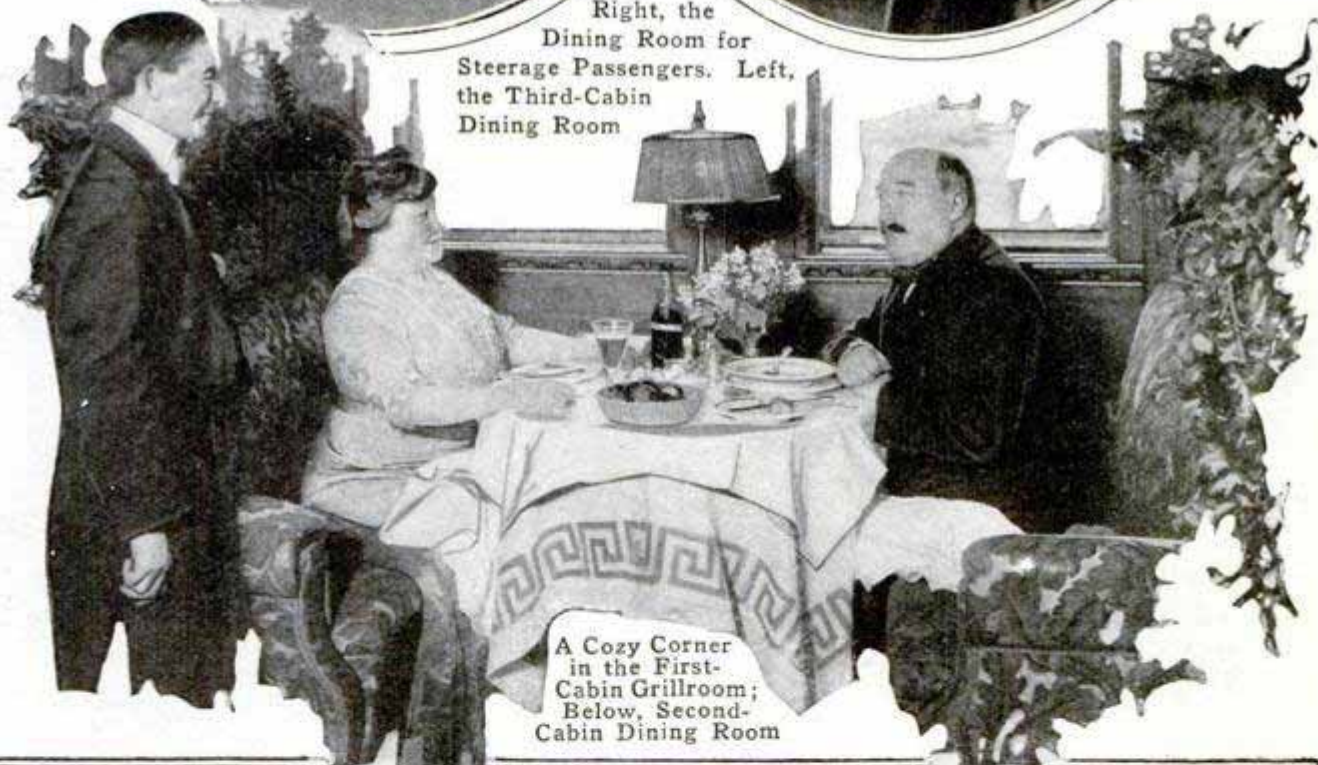

A Cozy Corner in the First-Cabin Grillroom; Below, Second-Cabin Dining Room







For Those Who Love Flowers,  
a Fresh Supply may be Bought  
on Board Every Day



By the Time the First Meal on Board is Over, the Ship has Passed  
Sandy Hook and is Plowing through the Open Sea. Some Join in  
the Deck Sports, Others Take Books from the Ship's Library to Read





In the Children's Dining Room Food Prepared Especially for the Little Ones is Served

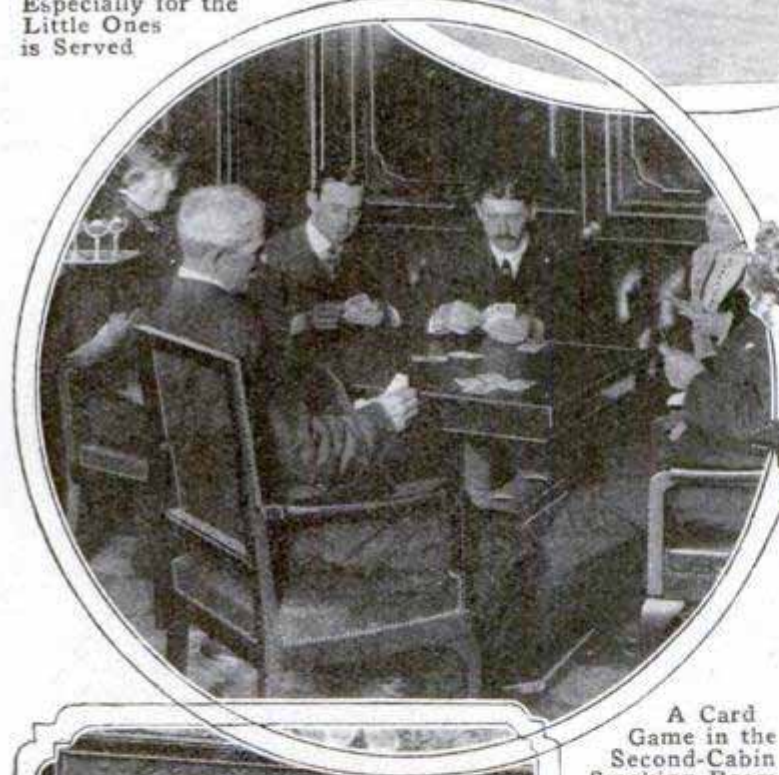

A Card Game in the Second-Cabin Smoking Room



Nurses as well as Physicians Care for the Sick in the Ship's Hospital

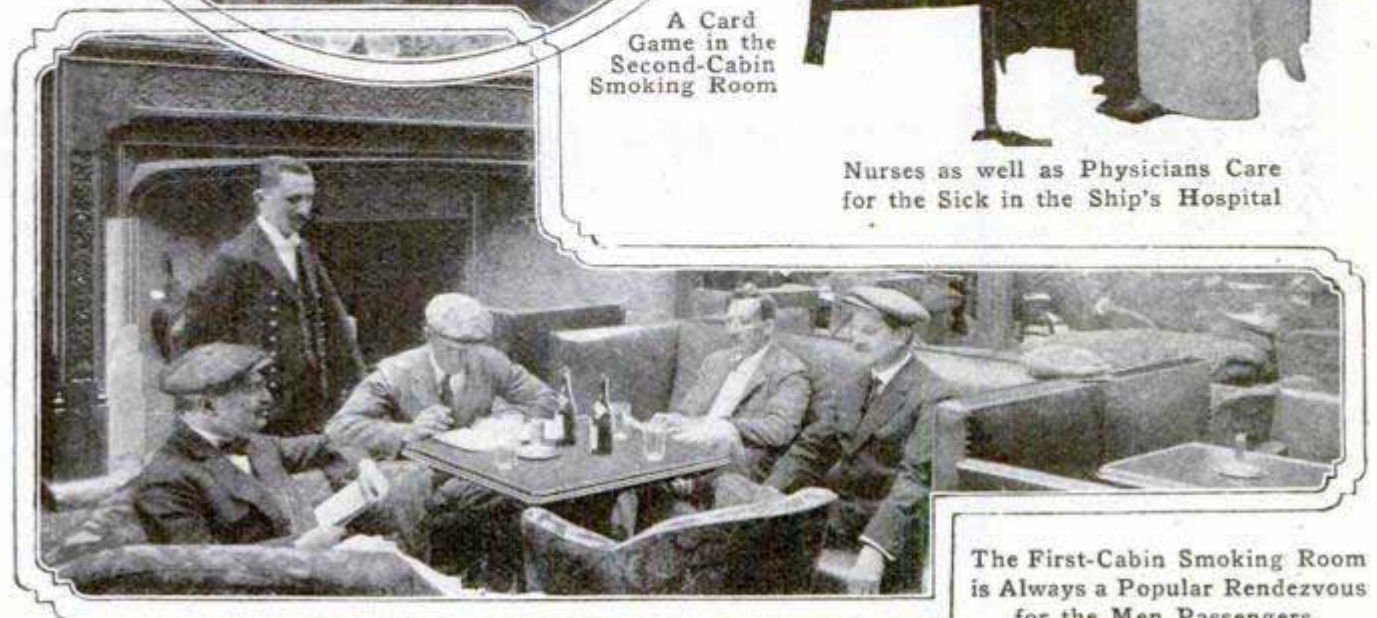

The First-Cabin Smoking Room is Always a Popular Rendezvous for the Men Passengers





Cooking for the Passengers,  
in the Steerage Kitchen

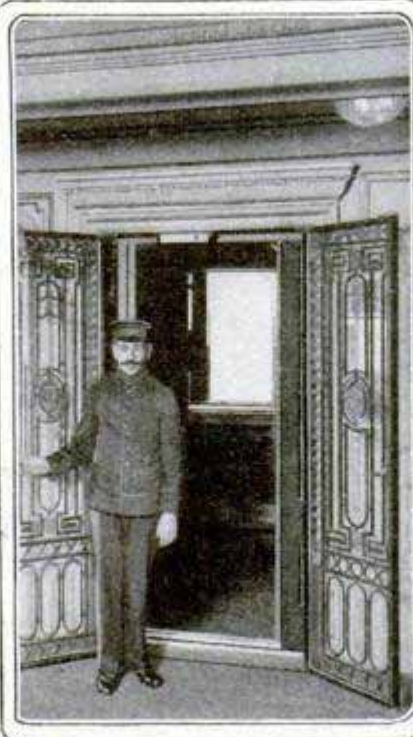

Four Passenger Elevators Save  
Much Time and Many Steps



Electric Dumb Waiters Connect  
All Decks with the Kitchens



Lounging on the Sun Deck is, by Far, the Most Popular Way  
of Passing the Time

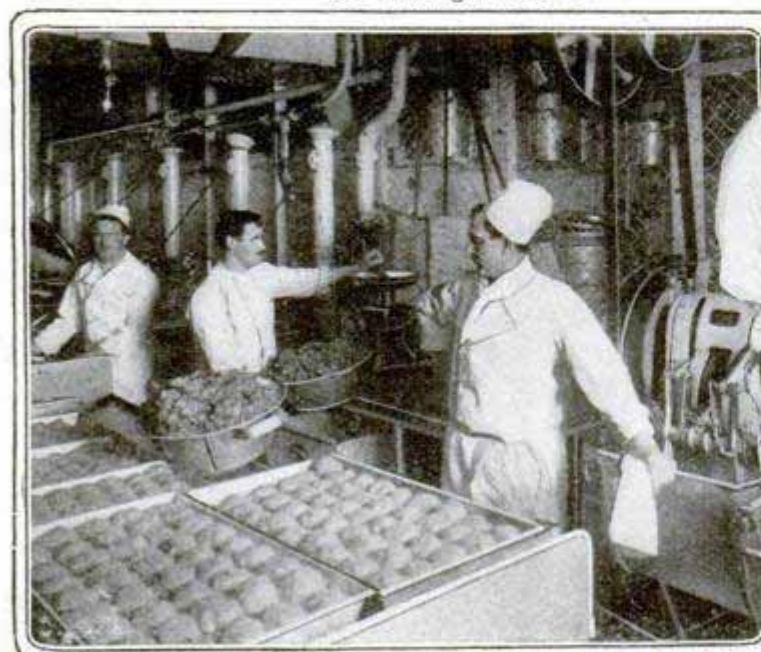

A Visit to the Kitchens Reveals Wonderful Electric Food  
Choppers, Potato Peelers, and Similar Modern Equipment

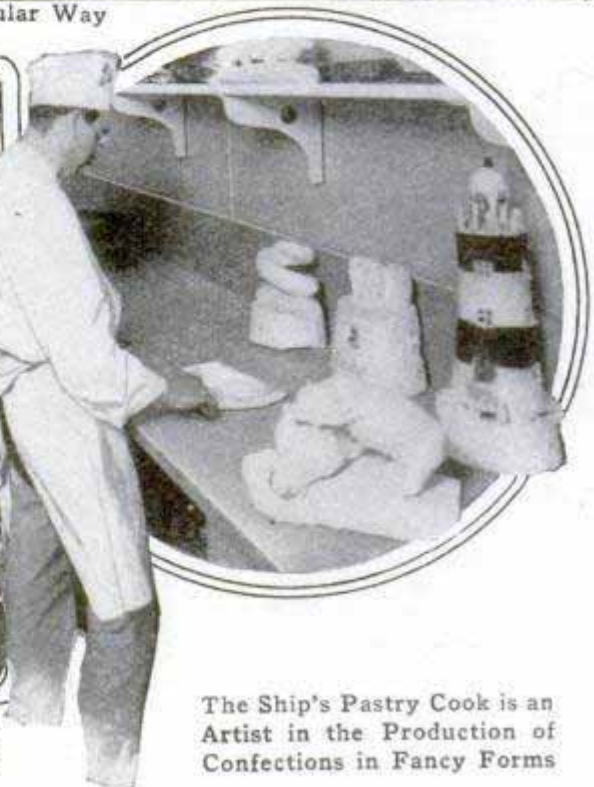

The Ship's Pastry Cook is an  
Artist in the Production of  
Confections in Fancy Forms





A Corner of  
a Typical

First-Class  
Cabin



The Second-Class Cabins of Today are Better  
Than the First-Class of a Few Years Ago



Dinner in the  
Main Dining Room

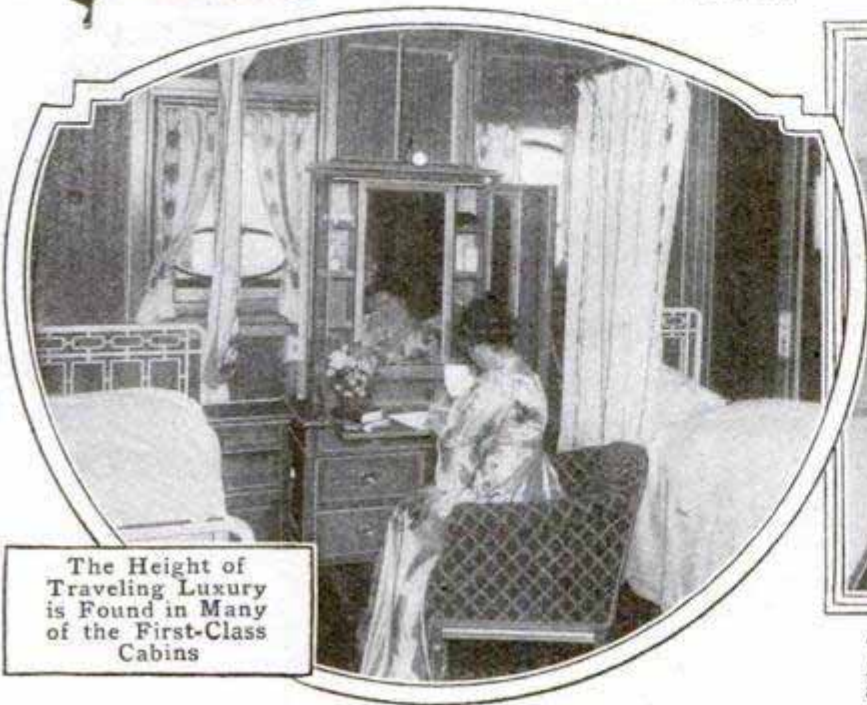

The Height of  
Traveling Luxury  
is Found in Many  
of the First-Class  
Cabins

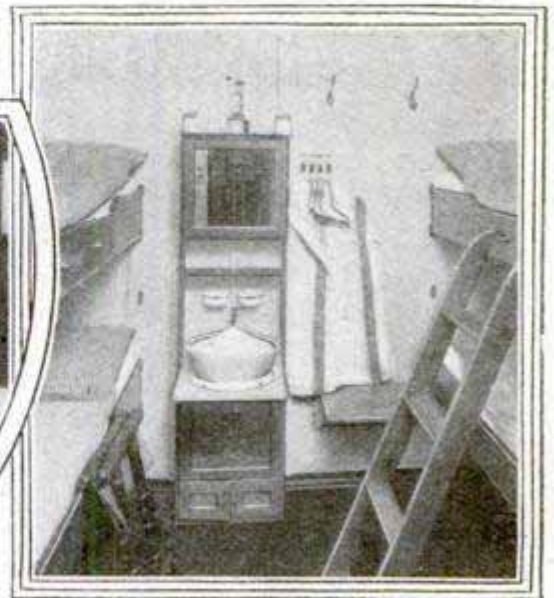

Third-Class Passengers Now Have  
Accommodations That are Clean  
and Comfortable: A Cabin for Four

(To be continued next month)



## BUCKING MOTOR TRUCK DUMPS LOAD

Because the men loading lumber on a motor truck in Tacoma forgot just

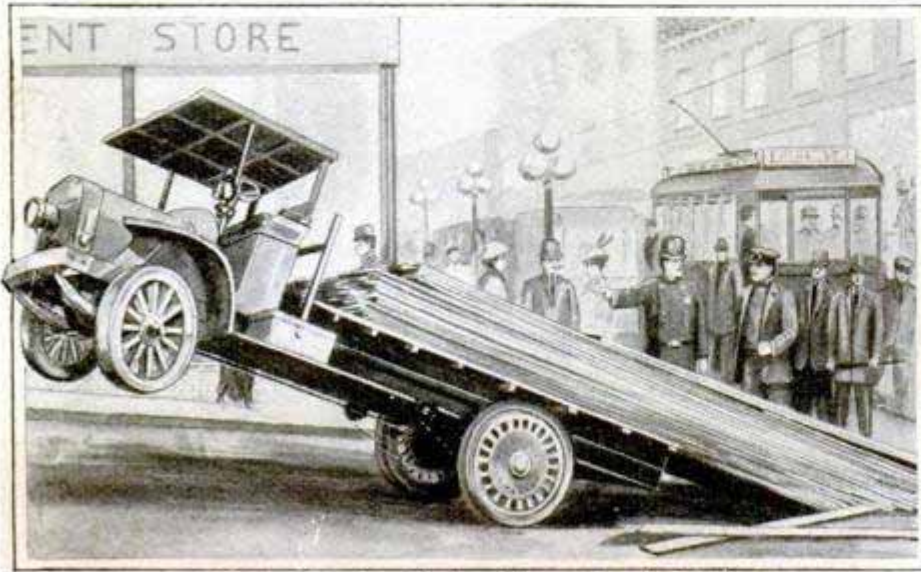

Shifting Lumber Makes Motor Truck Buck

where the center of gravity should be, a most unusual accident occurred when the truck was being driven up a considerable grade in that city. The load shifted suddenly and raised the front wheels nearly 30 in. in the air, while the lumber slid back until it rested on the street. The astonished driver climbed down and summoned help. The load was taken off and rearranged on the truck and the trip completed without further trouble.

## GOVERNMENT BRANDS ON CORD WOOD

Cord wood on which is imprinted the brand of the United States is being sold and burned in North Carolina. The wood comes from government forest reserves in McDowell and other counties in the mountains of North Carolina, where 32,000 acres in the western part of the state are under the control of the United States Forest Service. Wood is sold for 25 cents a cord on the stump, only such wood being allowed to be cut as bears the brand "U. S." deep in the trunk. The government rangers inspect the land, condemn the culls, or undesirable trees, and brand them.

## MOUSE BUILDS NEST IN AN AEROPLANE

An English airman was surprised the other day, after a flight of some 500 miles, to discover a nest of mice in his biplane. The machine had been standing in the hangar for some weeks without being disturbed, and when he suddenly took it out for a flight, the mice evidently did not have an opportunity to escape before the machine rose. Upon landing, the mother mouse fled panic-stricken, abandoning her young to the tender mercies of the airman.

## NOVEL TOWEL SUPPLY HAS SANITARY FEATURES

The abolition of the old-fashioned roller towel on the ground of its disease-spreading proclivities has been accomplished in many states, and a novel cabinet has been devised which retains the convenient and economical features of the roller towel, while preventing the abuses which made the old kind objectionable. A closed cabinet contains geared wheels operating two rollers, upon which several yards of toweling are held, and so arranged that as one portion of the clean towel is pulled down, an equal amount of the used towel is rolled up. Only a pre-determined amount of towel is available at one time.



Only a pre-determined amount of towel is available at one time.



## RATS FORM STAPLE ARTICLE OF FOOD IN MEXICO

The high-cost-of-living problem has been solved in some parts of Mexico by breeding rats for food. A large white variety is raised, which, it is asserted by the market woman who offers them for sale daily, are young, tender and delicious. Whatever objections might be raised to this addition to the menu in America, Mexican epicures pronounce them a distinct and most palatable addition to the meat course.



Whatever objections might be raised to this addition to the menu in America, Mexican epicures pronounce them a distinct and most palatable

addition to the meat course.

## FIRES OF FUTURE TO BE FOUGHT WITH CHEMICALS

That chemicals will entirely take the place of water within the next five years as a means of fighting fire was the prophecy made at a recent convention of fire fighters. In the large cities most of the small fires are now put out with chemicals, and it is not a big step from this to the use of guns for shooting powdered chemicals or chemical bombs into buildings for putting out big blazes. As an argument against the use of water, a case was referred to where in a small fire the fire loss was \$5,000, while the loss due to the water poured on the flames amounted to no less than about \$20,000.

## AIRMAN SETS NEW FLYING RECORD

Remaining in the air for 14 hours and 7 minutes, the airman Bruno Lange set a new record for an endurance flight on February 3d, at Johannesburg. The best previous record for sustained flight was made by Fourny, the French airman, who at Etampes, in September, 1912, covered 625 miles, remaining in the air continuously for 13 hours and 18 minutes.

## ACROSS THE ANTARCTIC CONTINENT

The first serious attempt to cross the Antarctic continent is to be made by Sir Ernest Shackleton, whose South Polar expedition was the subject of an article in a recent number of this magazine. A map of the projected route of the expedition is given herewith, which will aid in understanding the magnitude of the undertaking and the vast difficulties which confront the exploring party. Here no supply stations can be effectively placed for the party, as they will not retrace their steps, and must necessarily carry with them food and fuel sufficient for a journey

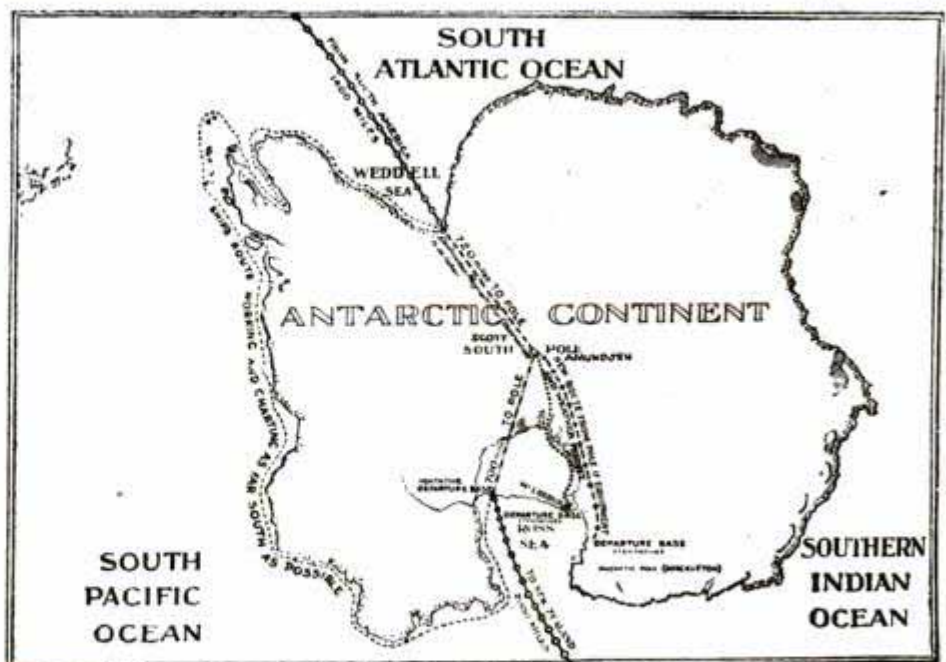

Photo by Paul Thompson

Map Showing Shackleton's Proposed Route across the Antarctic Continent in His Attempt to Reach the South Pole

of over 1,400 miles across trackless wastes of polar snow and ice.



## ENORMOUS SUNFISH CAUGHT OFF CALIFORNIA COAST

A sea sunfish, 10 ft. long and 11 ft. in vertical measurement, was caught with hook and line off the coast of southern California, and is now mounted in the American Museum of Natural History. The sunfish is interesting chiefly because of its absurd shape, "all head," and the abnormal shortness of its spinal cord; thus a sunfish a yard long has a spinal cord less than half an inch in length. One larger specimen has been reported which measured 10 ft. in length and 14 ft. in vertical measurement, weighing 4,400 pounds.

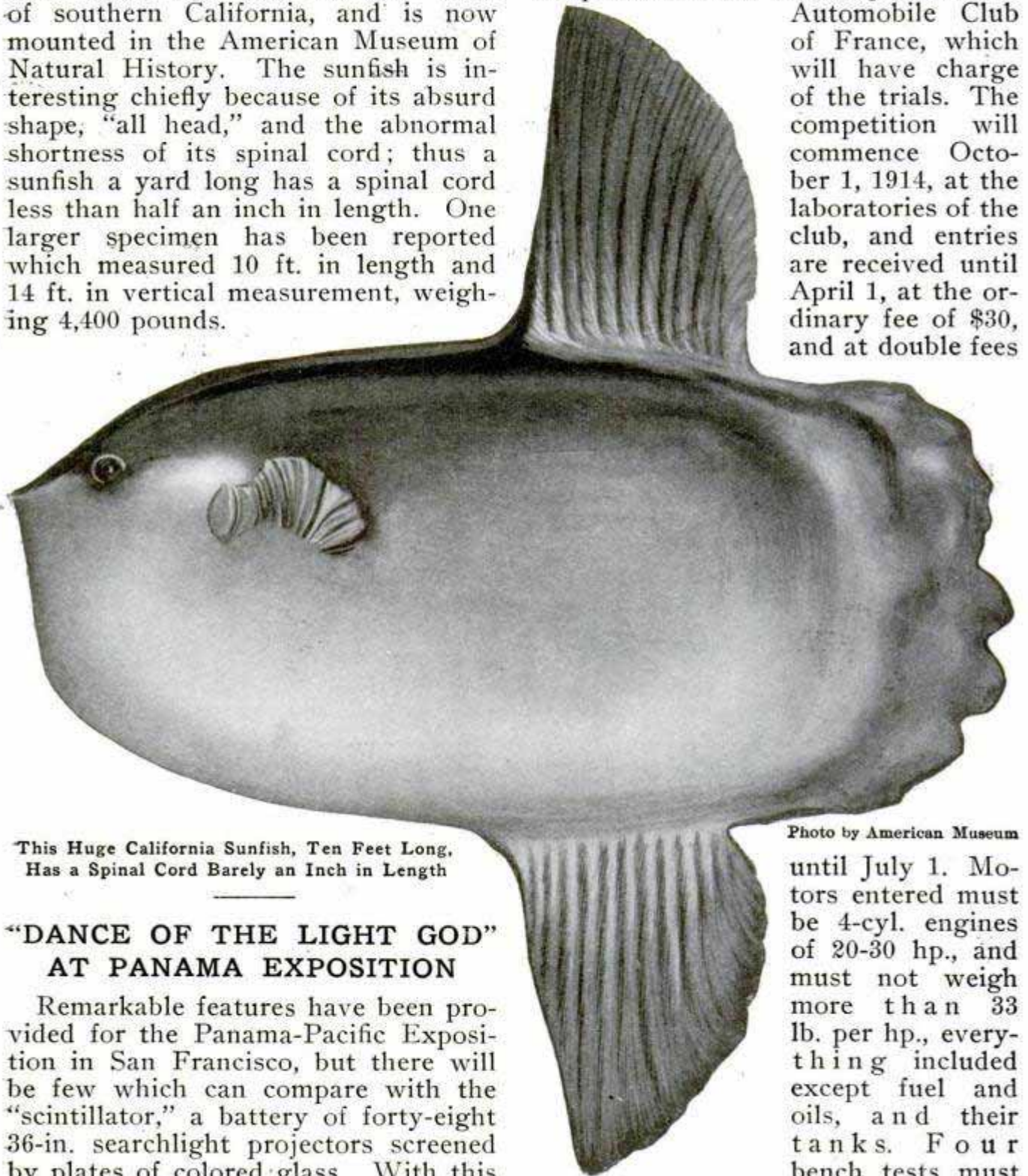

This Huge California Sunfish, Ten Feet Long,  
Has a Spinal Cord Barely an Inch in Length

## "DANCE OF THE LIGHT GOD" AT PANAMA EXPOSITION

Remarkable features have been provided for the Panama-Pacific Exposition in San Francisco, but there will be few which can compare with the "scintillator," a battery of forty-eight 36-in. searchlight projectors screened by plates of colored glass. With this instrument an artist will play a harmonic symphony of light upon the inrolling fog banks, which are incidental to the falling of night in San Francisco. This exhibition has been designated "The Dance of the Light God."

## FRANCE OFFERS PRIZE FOR KEROSENE MOTOR

Prizes for the most efficient kerosene motors are offered in France in a competition under the auspices of the Automobile Club of France, which will have charge of the trials. The competition will commence October 1, 1914, at the laboratories of the club, and entries are received until April 1, at the ordinary fee of \$30, and at double fees

Photo by American Museum

until July 1. Motors entered must be 4-cyl. engines of 20-30 hp., and must not weigh more than 33 lb. per hp., everything included except fuel and oils, and their tanks. Four bench tests must be met, operating under full load, half load, half speed loaded, and half speed light. The amount of fuel burned will be carefully recorded, as well as the amount of gasoline used in starting, and in no case must the time used in



starting exceed 10 minutes. If the motors entered in these preliminary trials show a fuel consumption of less than 350 grams (about  $\frac{3}{4}$  of a pint) per hp.-hour, without repairs, they will be qualified for the road test. Each motor will be mounted on a chassis, the total weight of the vehicle to be not less than 2,645 lb., exclusive of driver, fuel and oil. Four days will be spent on the road, during which time the cars must cover not less than 621 miles at an average speed of 19 miles an hour. The first prize is \$10,000; the second, \$2,000, and the third, \$400.

### "MOVIE" FILMS SHOW HOW TO CAST BALLOT

As the result of a suffrage law that has just gone into effect, the total electorate in Italy has been increased from four millions to eight or nine millions, and the number of qualified voters in one province alone, that of Catania, has advanced from 41,000 to 140,000. The task of educating this large number of new voters in the method of casting their votes properly is a big one, owing to the fact that few if any of them have ever before exercised the suffrage. To meet this condition moving-picture theaters throughout the district, as well as some of the political organizations, are running films showing the procedure to be followed. This means of educating the public has been so favorably received that similar methods are likely to be adopted for teaching the elements of domestic and personal hygiene.

☞ For the tropical garden at the Panama-Pacific Exposition, more than 25,000 cu. yd. of soil have been brought on barges from points on the Sacramento River.

### COLLECT VOLCANIC GASES FROM CRATER'S MOUTH

Scientists connected with the Geophysical Laboratory of the Carnegie Institution of Washington have secured gases from the very crater of Kilauea, on the side of Mauna Loa, the sacred mountain of Hawaii, which, in the ancient mythology of the Kanakas, was the abode of the goddess Pele, whose anger was evinced by earthquakes and eruptions. Equipped with specially devised breathing apparatus, these men traversed the crater, a depression 500 ft. in depth and 3 miles in extent. In the center of this they found a large lava lake, approximately three acres in area, in the middle of which there is constant volcanic activity. A crate of glass tubes, from which the air had been exhausted,

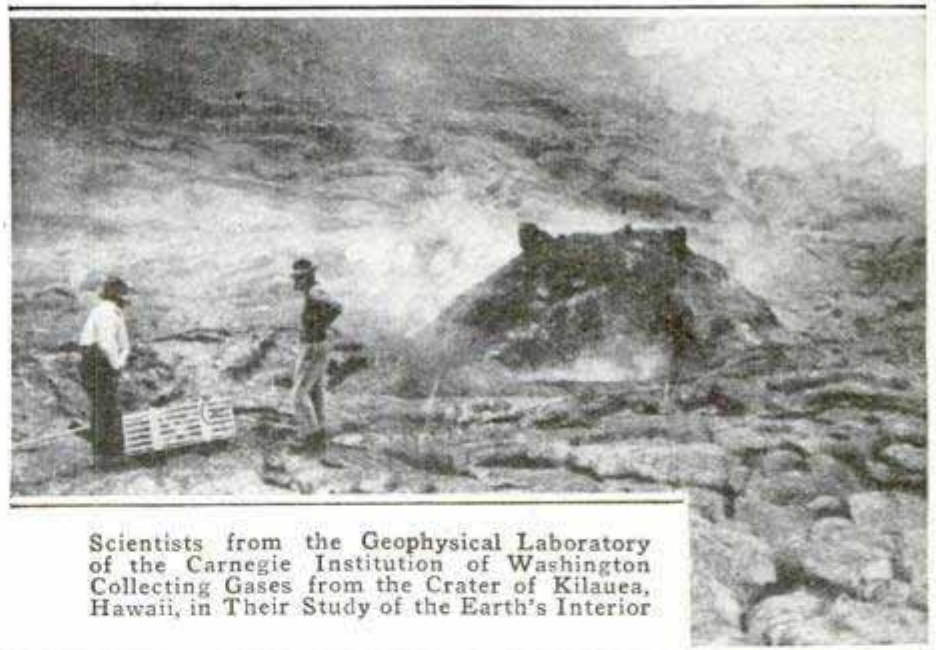

Scientists from the Geophysical Laboratory of the Carnegie Institution of Washington Collecting Gases from the Crater of Kilauea, Hawaii, in Their Study of the Earth's Interior

was carried and devices provided whereby the hot gases could be admitted to separate tubes as desired. One end of a long iron tube was thrust into an active fissure from which gas was being ejected, and by the pressure of a lever a certain amount was admitted into the tube, which was then automatically sealed. The tubes with their precious contents are now being studied in the laboratory at Washington, in the effort to obtain new knowledge of the chemical composition of the earth's interior.



### STREET-LAMP STANDARD MADE OF PIPE



A novel form of standard for street lighting is seen in San Francisco's residential park, Engleside Terrace, which is made of inexpensive water pipe and fittings, the main panel of which is covered with wire netting, against which vines are trained. The lights are incandescent globes and a simple form of

reflector completes this artistic and attractive design, which could be readily duplicated anywhere at a minimum of expense where something out of the ordinary is wanted.

### ALTAR OF HEAVEN CALLED CENTER OF UNIVERSE

When President Yuan Shi Kai of the Chinese republic signed a bill prescribing the worship of Heaven and of Confucius, he made the great Altar of Heaven, located in Peking, once more the religious center of the nation. Built entirely of marble in three terraces, leading to what the Chinese claim to be the center of the universe, it stands near the Temple of Heaven, famed for its blue tiles. To this altar

the emperors of China have repaired for ceremonious worship once a year for centuries. The president of China will worship at the Temple of Heaven annually in the same way as did the Manchu emperors, but without wearing the diadem, which, it is feared, might be taken as an evidence of monarchical tendencies.

### A NAVAL PARTY EXPLORES ALASKAN COAL FIELDS

An expedition into the Bering River coal fields in Alaska was undertaken recently under the direction of a naval officer, to procure sufficient coal for adequate tests as to its efficiency as a fuel for warships. The difficulties met and overcome by the mining party were enormous. There were few trails and, of course, no bridges. When rivers had to be crossed the men would strip and plunge into the icy flood, holding their clothing high above their heads, for they had to have dry clothes to put on after fording the river, otherwise they all would have perished. The parties made sorry spectacles standing in the deep snow on the river banks after crossing the stream, trying to get their clothes over their numbed and bleeding limbs with benumbed fingers, while an arctic wind swept down upon them. In spite of these discomforts the party kept well and thoroughly enjoyed hunting the Alaska brown bears, which are possibly the largest bears in the world and are as cunning as they are wild and fierce. These Kodiak bears are flesh-eaters, extremely powerful, and dangerous customers at all times.

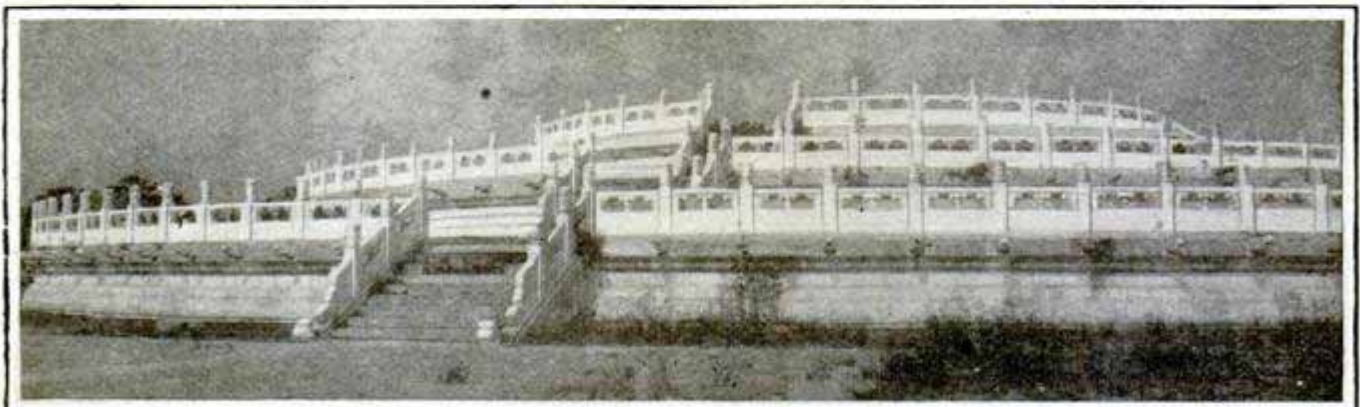

The Chinese "Altar of Heaven," Built of White Marble, is Again the Religious Center of the Nation



## TEAKETTLE CAN BE FILLED WITHOUT SCALDING

To protect a cook's hands from being scalded when she refills her teakettle, a small opening, placed between



the handle and the spout and just large enough to fit over the end of a water faucet, is provided on a 6-qt. aluminum teakettle recently put on the mar-

ket. No matter how much steam there is in the kettle, it cannot reach the hand. An extra large bottom, 10 in. in diameter, gives enough heating surface to heat water very quickly.

## INDIVIDUAL FINGER BOWLS OF PAPER

A very practical advance in sanitation has been adopted by the proprietor of several western hotels and railroad eating houses, by the substitution of individual finger bowls of paraffined paper for the glass bowl used in common with other guests. An ornamental band, sustained by uprights, holds a crimped bowl of paper made impervious by paraffin. This dainty dish



Novel Finger Bowl of Paraffined Paper

may contain the conventional slice of lemon or geranium leaf floating on the water, and when once used, the paper

bowl is thrown away or burned, obviating any possibility of insanitary contact.

## NEW FORM OF BATHING APPARATUS

A bathing apparatus recently invented consists simply of a bag made of rubber or other flexible waterproof material for enveloping the

body of the bather and provided with a collar that can be drawn around the neck in such a way as to be water and airtight. The collar is manipulated by means of cords that hang inside the bag, the whole device being so made that it can be handled by the bather without assistance. Water or steam is admitted through a valve at the front of the bag as shown. This device may be used for medicated

baths of all kinds, but is intended principally for use where ordinary bath conveniences are not available.



## AN IRONLESS CLOTHES-PRESSING MACHINE

The pressing of men's suits and women's tailored garments is made easy by this ironless machine. The operation is simple. The garment to be pressed is placed in the proper position on the "buck," and then the head, or pressing surface, which is covered with fabric, is pushed down on the gar-



ment, and extra pressure is exerted by means of the foot lever. Inside the pressing head are a number of steam

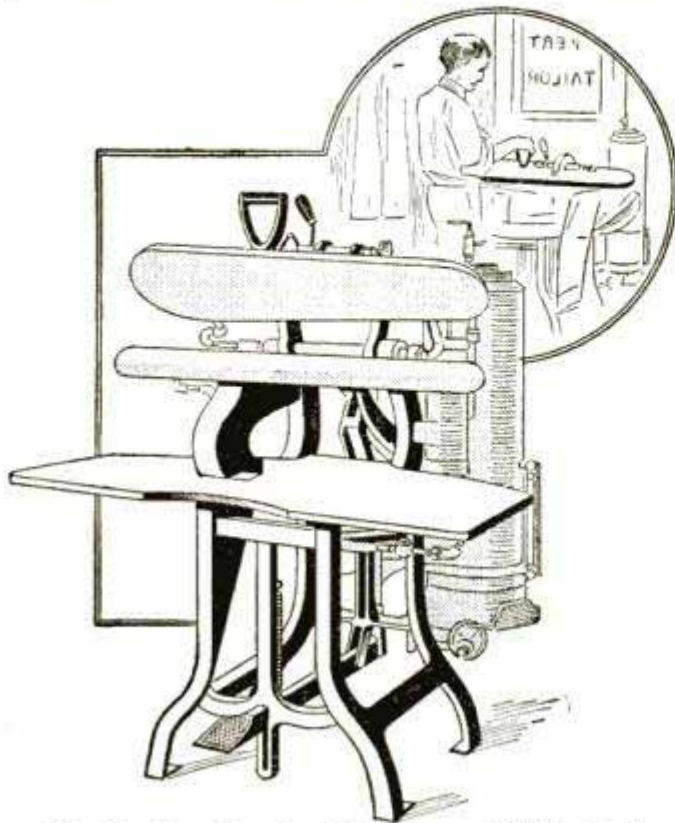

The Ironless Pressing Machine, and Method of Placing the Garments on the "Buck" or Pressing Block

ducts, which moisten and heat the entire pressing surface. The amount of steam to be used is controlled by means of one of the levers shown at the top of the machine. The steam is furnished by a small gas-heated boiler. Live steam is thus brought in direct contact with the material, the garment is pressed uniformly, set, cured, and sterilized at one operation. Scorching is impossible, and the garment may be worn immediately after pressing. All irregular surfaces such as shoulders, tops of trousers and skirts, fronts of ladies' jackets, and the like, are pressed over the rounded end of the buck.

### TRAMP STARTS FIRE WHICH WRECKS TUNNEL LINING

Events happened rapidly when a tramp cooked a meal over a fire near the entrance to Tunnel No. 7, on the coast division of the Southern Pacific Railway. The flames, spreading through the dry grass, reached the entrance of the tunnel and set fire to

the timbers supporting the roof. For 51 days the tunnel was closed to traffic and the cost of extinguishing the fire and rebuilding the tunnel amounted to over \$96,000. A strong wind carried the flames through the tunnel, over 1,000 ft. long. Despite all the efforts of the railroad, which brought fire-fighting apparatus and men from San Francisco, all the timbering of the tunnel was destroyed. The intense heat generated broke down so much rock that it required weeks to remove the debris. Attempts to fight the fire by steam, carbonic-acid gas and water proved unavailing. It was finally decided to let it burn itself out. Restoration work was begun after twelve days, and normal traffic resumed over a month later. Concrete portals and supports for some distance inside the tunnel were constructed, timber being used the remainder of the way.

### A LAMP WHICH TELLS IF IT HAS BEEN USED

A device which is adapted to show if an incandescent lamp has been in use has been invented by a German electrician, and is designed to prevent fraudulent claims being made on manufacturers by dealers and others. At the base of the electric incandescent lamp is a small glass tube through which the wire conductors pass before they are joined to the filaments within the bulb. A substance sensitive to light is placed within this tube. The chemical chosen is not affected by daylight, but is altered by the action of the light from the incandescent filament. When a customer brings back the lamp for exchange or refund, with the statement that the lamp has not been used at all, a glance at the sensitive roll within the tube will proclaim whether

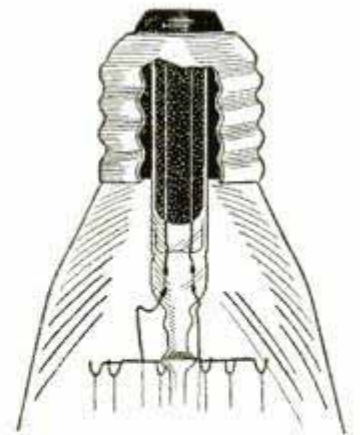



the lamp has been used, and as the color deepens with length of service, an approximation of the amount of use is given the dealer.

### INVISIBLE WARDROBE FITS BENEATH BED

A long box of cedar, or other suitable material, attached by slide rests



Wardrobe Attached to Bed Frame is Off the Floor

to the under side of a bed frame, is the ingenious solution of closet problems recently placed on the market. With an easy pull it rolls out from the framework of the bed, and may be sent back into place and out of sight by a slight shove. Fitted with a tight cover, the box is dust-proof and is of sufficient length to hold long skirts and trousers without folding. A smaller size is made especially for a child's crib.

### ELECTRIC HOT-WATER PLANT

The problem of equalizing the demand on an electric plant over the day and night is being solved by new uses opened for the electric current. The residence of a business man in Tacoma is heated by a hot-water plant, but instead of burning coal he has had electric-heating coils placed in his fire box, and the control switch is placed upstairs. Equipped with a thermostat, he is able to maintain an even temperature all over the house at small cost, and without the dirt, smoke, ashes and trouble attendant upon a furnace.

### SPLIT BOLTS HANDY IN CRAMPED PLACES

Bolts for use when only one side of the plates, or other parts to be assembled, are accessible are now split. They are made in various types to suit different conditions, the split usually running lengthwise, cutting the bolt into two parts, each of which is cut obliquely near the head so they may be turned in relation to each other and the head passed through the perforation made for the bolt and then brought together by means of the nut, which is screwed down as usual.

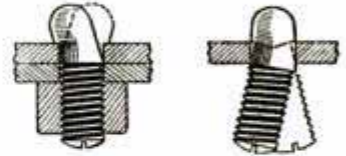

### SPRING SEAT FOR STREET-CAR MOTORMEN

A leather-covered spring seat has been invented which is designed to be secured to the top of the rigid seat usually provided for street-car motormen and relieve the incessant jar to which they are subjected. This seat

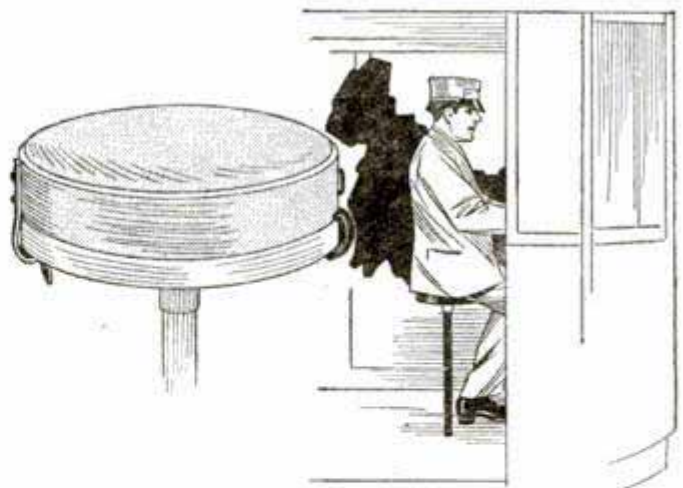

Spring Seat Adds to Comfort of Street-Car Motormen

is secured in place by means of a fixed hook and a spring snap which hook under opposite sides of the ordinary seat. It is easily removed when not in use, and is provided with a sliding hook by which it may be hung on a window rail, or other convenient object.



## NEW FIREPROOF FLOORING AND PLASTERED CEILING

A gypsum-plaster block, so shaped that it forms on one side a flat surface, and on the other a dome-shaped hump, is used in reinforced-concrete flooring to form a fireproof floor and at the same time a fully plastered ceiling

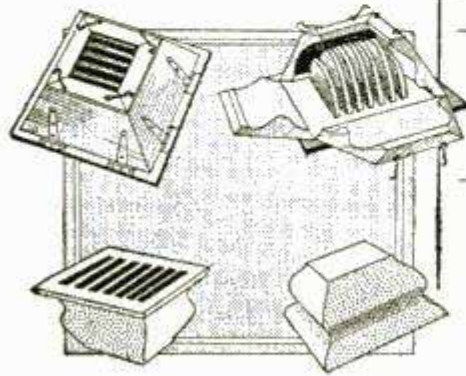

Saving Time, Space, and Money  
in Building Fireproof Floors

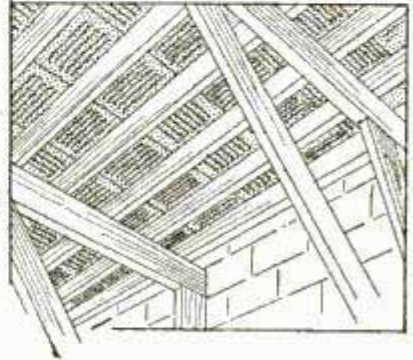

forms, flat side down, have the steel reinforcing laid along their sides, and concrete is poured in even with top of the block. Flooring can be nailed direct to the top of the plaster blocks, resulting in the saving of much space, while the floor is fireproof, and when the open forms are removed the ceiling is finished

ing which needs only a finishing coat. The blocks, which are laid on open

ished except for the white coat, the process thus being very economical.

## PHILIPPINE NATIVES MAKE HATS FROM BURRI PALM

Four straws are obtained from the "buri," which is one of the most valuable of the many varieties of the palms in the Philippine Islands. These straws are raffia, buri straw, kalasiao straw, and buntal. The production of the buri straw is the most widespread. The unopened buri leaf is whitened, washed, and cut to size for weaving, and is then known as buri straw. The hats made from buri straw are loosely woven and cheap and do not wear very well, hence are rarely exported, but supply most of the local market. Kalasiao hats are produced from the midribs of the unopened buri leaf, the finest-grade hats requiring from six weeks to two months to complete. Buntal straw is extracted from the leaf stem of the buri leaf, and it takes considerable dexterity to get the fibers out in good shape. The buntal hats are made with an "over and under" weave, and after weaving, are turned over to a finisher for completion. Dealers keep these hats unironed until ready for sale, since ironing is impor-

tant to give the hats the proper finish. Buntal hats are light and silky and are said to be more pliable, and longer-lived than those from Panama.

## SAFETY TIRE VALVE KEEPS PRESSURE UNIFORM

Improper inflation, due to pumping by guess, inaccurate pressure gauges and failure to notice the extra inflation caused by the heat of the road, by friction or other conditions, is responsible for about 90 per cent of all pneumatic tire trouble. A little contrivance has been patented which prevents overinflation, and warns the motorist when his tires need more air. It consists of an air valve with

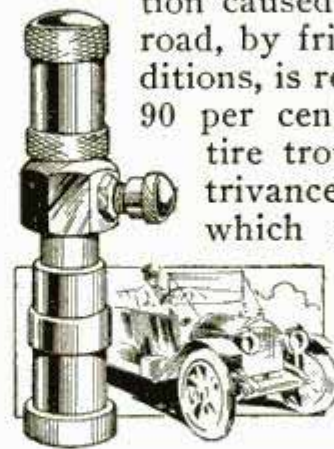

adjustable pressure gauge to be set at the figure the tires are rated for. Any excess pressure is automatically released, and a plunger, which at normal pressure protrudes from the top of the valve, disappears when the pres-



sure sinks 15 lb. below normal, thus giving a positive warning that the tires need refilling. Uniform pressure being assured, the life of the tires is lengthened, and easy riding made certain, as well as freedom from blow-outs.

### WHERE THE NAVY'S SAILORS COME FROM

Enlistments at navy recruiting stations in the past year have demonstrated that the great farming and manufacturing districts of the Middle West furnish nearly one-third of all the naval recruits. The Central and Middle Western states sent 31 per cent of all the men received in the navy, while New England furnished but 8½ per cent; the Middle Eastern states, 28 per cent; the Far Western states, 16 per cent, and the Southern states 12 per cent.

### BLIZZARD LANTERN NOT AFFECTED BY WINDS

A convenient light for outdoor use, which is not affected by winds nor extreme cold, is now on the market, in which a hooded globe contains the burner, to which gasoline is supplied from a lower res-

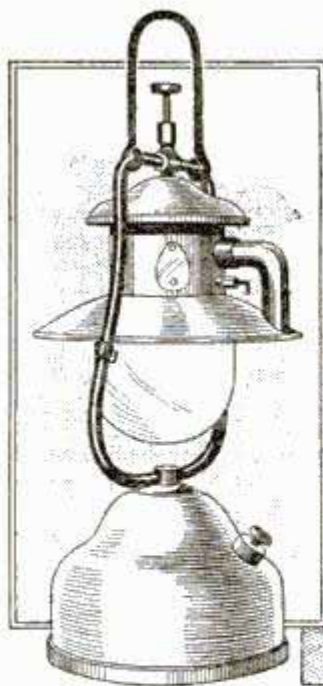

Gasoline Lantern That cannot Blow Out

ervoir by air pressure. Wood alcohol is used to start the light, which after starting burns with a powerful, steady flame.



### THREADING CONDUITS BY AIR PRESSURE

The pneumatic conduit threader is a device for placing wires through a conduit, usually a difficult process by the ordinary methods. The equipment consists of an air tank and hand pump, as shown in the illustration. "Travelers" consisting of a series of washers, loosely fitting the interior diameter of the pipe, are forced through the conduit by the air pressure from the tank. Attached to the travelers is a string, by means of which wires as required may be threaded into the conduit.

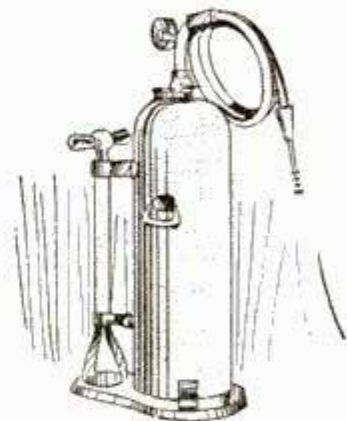

### PURE OXYGEN OBTAINED BY ELECTROLYSIS

In the distillation of liquid air for the purpose of securing oxygen, present methods do not eliminate all the nitrogen, often more than 1½ per cent of the latter gas remaining, lowering the efficiency of the oxygen in delicate scientific experiments very considerably. So, too, pure oxygen cannot be obtained from well-known chemical reactions without the admixture of more or less impurities. The electrolytic method of disintegrating water into oxygen and hydrogen gases has, therefore, come more and more into use. The crude oxygen obtained from electrolysis contains from 2 to 4 per cent of hydrogen, but the gas is easily rectified by passing it

through a silver tube in which a platinum spiral is heated to redness by electricity. The tube also contains pumice stone treated with palladium.



### A TOP FOR THE TOP OF A HATRACK

Having had some complaints that ordinary wire hatracks broke and cut the hats placed upon them by check-room

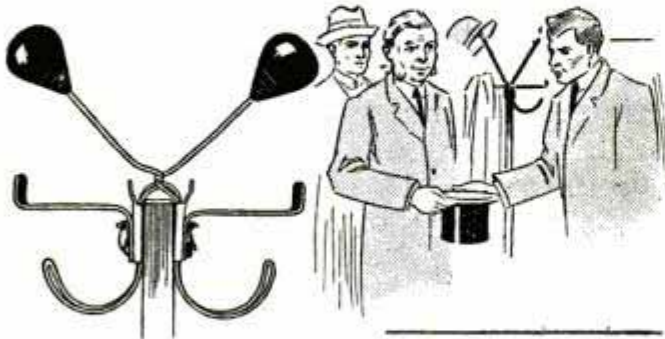

Novel Adaptation of Spinning Tops to the Hatrack

employes, the manager of the cloak-room of the Chicago Post Office obtained a thousand tops such as are sold to schoolboys for a penny apiece, and fastened them on the ends of the wire holders. The tops present a smooth, rounded surface and do not cut, scratch or mar the hats in any way.

### NEW EMERY-WHEEL GUARD CATCHES FRAGMENTS

An elastic steel guard for emery wheels has been brought out in Germany. It is designed, primarily, to resist the shock, and to hold the fragments, of a bursting wheel. The guard

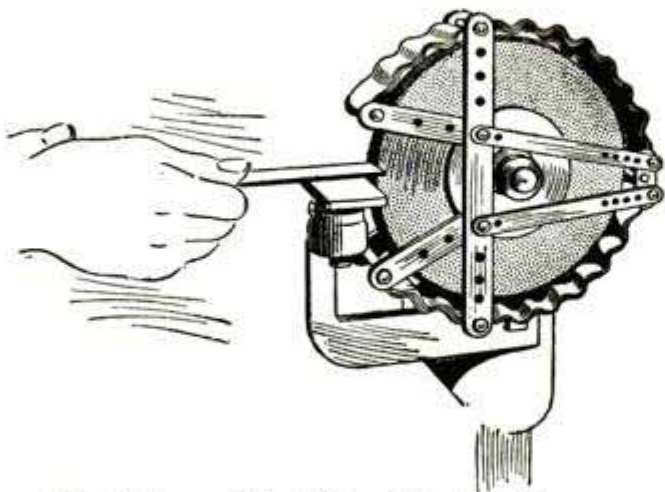

Elastic Emery-Wheel Guard Used in Germany

is made up of bands of corrugated sheet steel which are bound together in an elastic framework of crossbars.

### LUMBER MADE OF STRAW USED IN BUILDING

A French inventor has patented a process whereby straw is converted into an artificial wood. Beams, lath, plank and molding can be made of it, and it can be sawed, planed and polished as readily as natural wood. To make this artificial wood, straw is chopped and boiled until it is reduced to a paste, and certain chemicals added. When mixed into a homogeneous mass it is placed in hydraulic presses, and lumber of all sizes is thus made to order. It is also suitable for match sticks, as when burned it gives a bright flame with little smoke.

### DOOR-KNOB BURGLAR ALARM SOMETHING NEW

Based upon the idea that noise is the best weapon against midnight prowlers, a device has been patented which, when attached to any door, rings a bell when the door knob is turned. A key retainer is part of the device, and holds the key in the lock, preventing anyone from turning the key or pushing it out so as to introduce another key in the lock. The device uses a rotary push button for actuating the bell, which gives a continuous ring when the knob is turned. It may be left on the door permanently, and if it is not desired to ring, a thumb-screw may be loosened and the bell is silent.

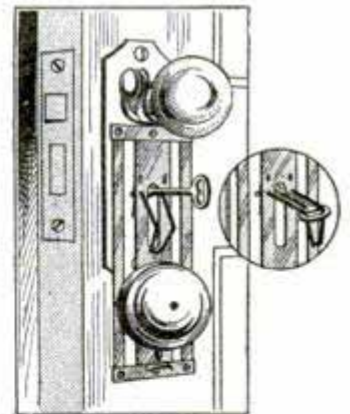

Removing an old steel bridge and replacing it with another within five minutes is the record made by a bridge gang on the Lehigh Valley Railroad, near Victor, N. Y.



## LINING PIPES WITH WOOD TO PREVENT CORROSION

A new form of wooden pipe for the conveyance of fluids which corrode metal, through direct chemical action or through electrolysis, has been brought out in Germany. The tubing is lined with dovetailed staves under pressure and the completed lining shows little trace of joints.

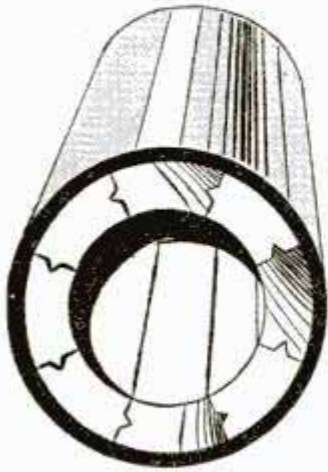

The pipe does not sweat, and interior shocks are taken up by the elastic wood, preventing the bursting of the metal shell. Another advantage is that the wood does not flavor the liquids.

## MOTOR TRUCK REDUCES COST IN RAISING POLES

An electric-power company is using a heavy motor truck in raising the heavy poles for overhead wires with a resulting decrease of cost. A gin pole, snatch block and tackle is the only equipment necessary for this purpose. With the gin pole in place and securely anchored by guy ropes, a sling is fixed near the center of gravity of the pole to be raised and connected with the cable run through the blocks. Attachment is made with the rear axle of the motor truck, and the pole is raised and then dropped into the hole.

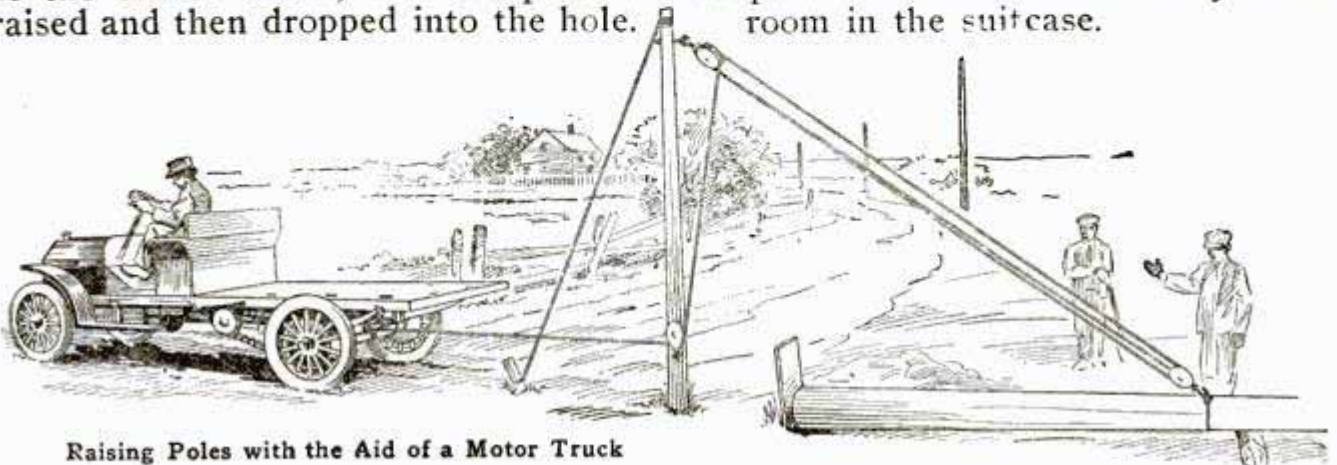

Raising Poles with the Aid of a Motor Truck

## FOLDING WARDROBE FOR TRAVELERS

A travelers' portable wardrobe, patented recently, can be folded small enough to be carried in a suitcase. It is intended especially for traveling men who may have to stop at hotels where no wardrobes are provided. A light framework of wood that can be hung from a nail or a picture molding forms the top of the portable wardrobe, and a curtain attached to the four sides and opening in front, hangs from the framework to the floor. The cross-

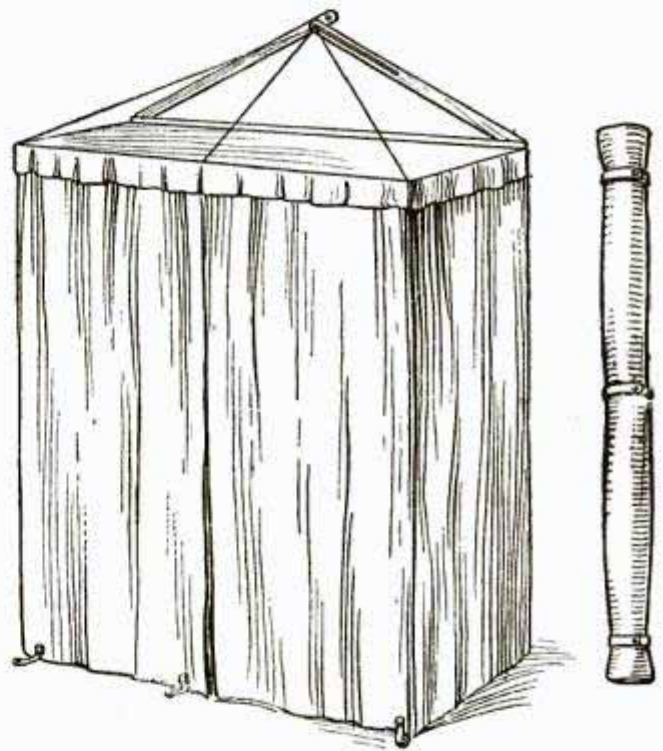

A Wardrobe That can be Folded Up and Carried in a Suitcase

pieces of the framework are hinged so that it can be folded flat and rolled up in the curtain, thus reducing it into a compact bundle that takes very little room in the suitcase.



## NEW KEROSENE CARBURETOR REQUIRES NO HEAT

A novel system for carbureting kerosene has been devised in France which does away with the application of

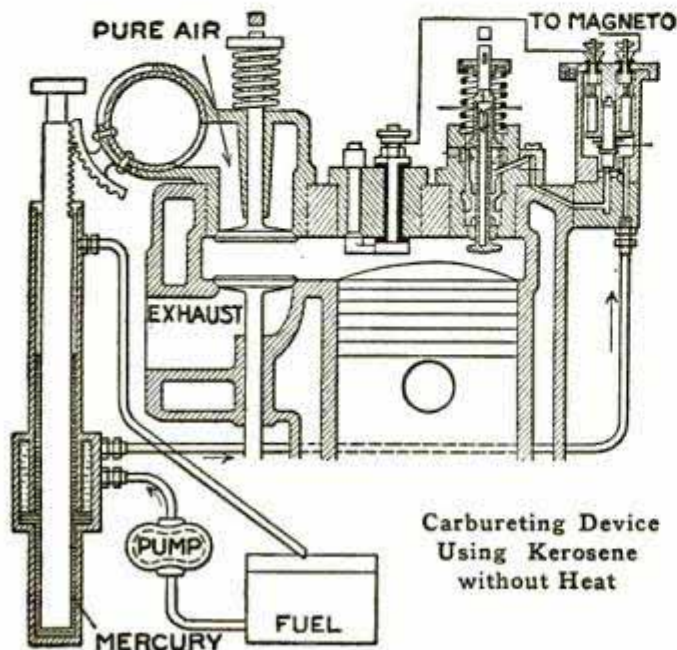

heat, either to the oil or to the atomized mixture, permitting the starting of an engine so equipped when cold as easily as if gasoline were used. The first point of difference in the new method is that air only is admitted through the inlet valve. The kerosene is sprayed under pressure by an atomizer, located in the cylinder nearly over the head of the piston, directly into the combustion space and mixed with the proper amount of air entering through the inlet valve and immediately compressed. There can be no opportunity for condensation, as the atomization has taken place within the cylinder itself. The admission of the raw kerosene is controlled by a needle valve, of which the needle itself is the plunger of a solenoid and is drawn into the interior of the hollow coil whenever the coil is excited. A spring prevents the passage of oil when the engine is not running. An electric-circuit breaker, geared to the crankshaft of the motor, regulates the excitations of the coil and the fuel supply is thus at all times exactly proportioned to the different requirements of the engine at varying loads.

## NOVEL TOP PROTECTS MILK WHEN BOTTLE IS OPENED

A metal top which may be slipped on a milk bottle after it has been opened in the kitchen has been patented. It has a flanged sleeve, clamping the top of the bottle, and a hinged lid with a counterweight which holds it normally closed. When the bottle is tilted, the lid opens automatically, permitting the milk to be poured freely.



## SUPERHEATING MOLTEN METAL BY ELECTRICITY

Taking advantage of the fact that refractory linings of ladles or melting pots, used in foundries, become good conductors of electricity at high temperatures, a Pennsylvania inventor has secured a patent on a method of superheating molten metal by passing a current of electricity through it while being poured. Two pots or ladles are made the terminals of the circuit, the metal in one being fluid. When the contents are poured into the other, an electric circuit is established through the restricted stream, the passage of the current raising the temperature as required. The method is adapted to the

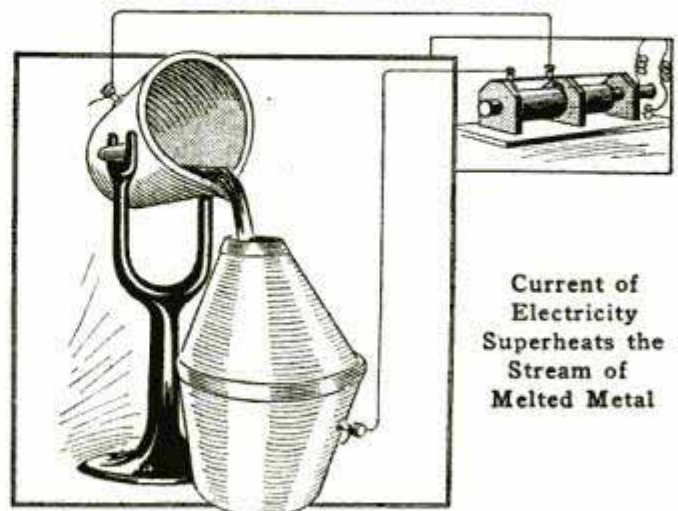

treatment of platinum or other metals where very high temperatures are necessary.



## CONVENIENT DESK BLOTTER AND SUPPLY HOLDER

A readily accessible supply of ink, pens, erasers, stationery, stamps, ruler,

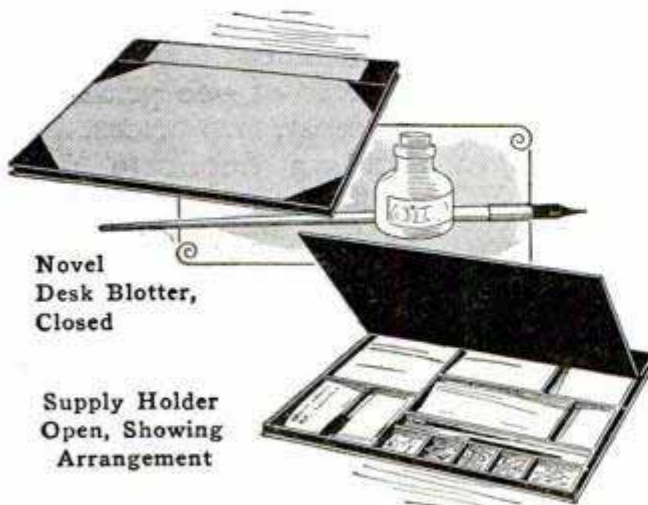

Novel  
Desk Blotter,  
Closed

Supply Holder  
Open, Showing  
Arrangement

scissors, rubber bands, etc., is found in a combination desk blotter and pad just placed on the market. The inkwells rest on the strip of blotting paper, and the cover may be raised without disturbing the ink. Interior compartments are fitted in convenient system to hold all necessary supplies for either the office desk or the home secretary. The pads come in various sizes and are cloth bound with large seal-grain-leather corners.

## HOLDFAST MATCH SAFE FASTENS ON WALL

A simple and convenient device has just been patented which locks the box of safety matches and keeps them in

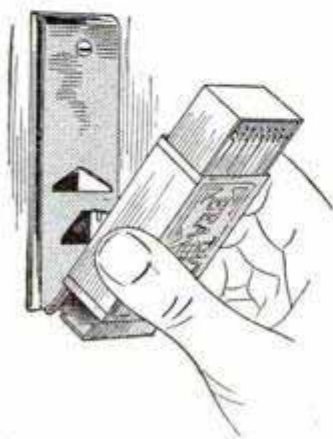

lock it securely in position.

their place. It consists of a metal back, with screw holes, so that it may be fixed permanently against the wall, desk, or elsewhere, and two protruding sharp points which pierce the wooden box and

## A GASOLINE ENGINE THAT CAN BE REVERSED

A reversible gasoline engine has just been patented which gets its reversibility from the fact that in design it is a cross between a steam engine and an internal-combustion engine. In construction it is more like a steam or pressure engine and can be run with steam, compressed air or gas, as well as with gasoline or kerosene. The valves of the engine are in a valve chest and operated by eccentrics and reciprocating links, like those on a steam engine. Back of the chest is a cut-out valve which admits either pressure fluid from a tank or boiler, or gas mixture from a carburetor. With this valve in one position, the engine runs like an ordinary double-acting steam engine; with the valve in the other position, it runs as a two-cycle explosive engine. The burned gas instead of escaping is taken from the exhaust valve into a storage tank to be used in starting. To reverse the engine, when it is running as an explosive

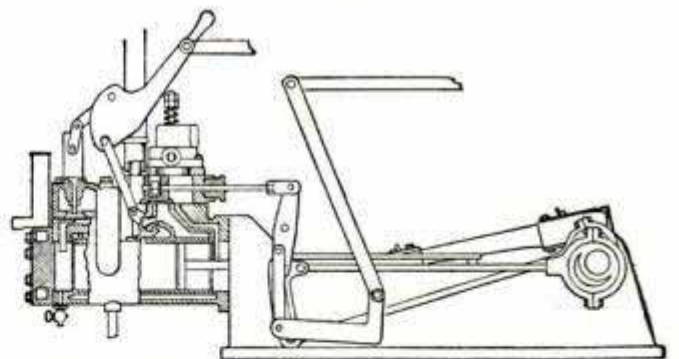

A Reversible Gas Engine Which Has a Valve Chest and Reciprocating Gear Like a Steam Engine, and is Run Like a Double-Acting Steam Engine While It is being Started

engine, it is necessary merely to reverse the link mechanism just as in reversing a steam engine. After the valves have been reversed, the cut-out valve is opened and gas under pressure is admitted from the tank long enough to start the engine.

☐The German imperial war flag, which has heretofore been permitted only to men-of-war, naval forts and naval offices, will in future be flown on the army airships of the German empire.



## NEW LIFE PRESERVER THAT COVERS WHOLE BODY

A new form of life preserver consists of a rubber suit that envelops the whole body and is provided with a rub-



Life Preserver Consisting of Rubber Suit That Covers the Head and Body and Has a Tube through Which the Wearer Breathes

ber cap or helmet that serves to inclose and protect the head. The helmet is made large enough to provide an air space, which not only enables the wearer to breathe for a limited time under the water, but furnishes buoyancy for the upper part of the body. Communication with the outside air is through a tube in the front of the helmet, which the wearer holds in the mouth and which is closed with the tongue when under water, while the wearer is able to see by means of two small windows placed opposite the eyes. The garment is fastened around the ankles with straps, and the opening at the top of the helmet is closed by pulling a strap that hangs inside in convenient reach. This life preserver is so designed that it may be used either for floating or swimming.

CA series of experiments recently conducted in England indicated that the receiving intensity of a wireless station is not influenced by the height of the sun during the day, but is increased in the night during a cold season.

## AUTOMATIC TICKET-SELLING MACHINE

An automatic ticket-selling machine recently brought out is designed particularly for motion-picture theaters and other places of amusement, where tickets of one price, or at most, two prices, are sold, a duplicate machine being used in the latter case. The machine delivers from one to five tickets at a time and registers the sale automatically. The operator simply presses a button corresponding to the number of tickets called for, depresses a foot lever, and the tickets appear at the top of the machine in convenient reach of the customer, an arrangement that relieves the

operator of the necessity of handling the tickets. The machine is inclosed in a small cabinet which rests on a counter, and occupies a space about 10 in. square.

## FLY SWATTER WITH RUBBER EDGE

One of the new "fly swatters" has a circular rubber rim around the wire-mesh blade to increase its effectiveness. The patented rubber edge is intended to give the blade enough weight to kill bees and hornets, as well as flies, and the flexible rubber connection between the blade and the handle makes a flat blow possible on any surface. The blade can be removed from the wooden handle for cleansing in boiling water or in an antiseptic solution.

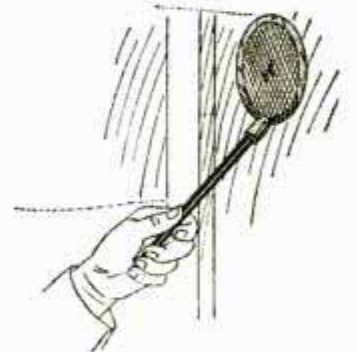



## INTERCHANGEABLE BLADES FOR OFFICE KNIVES

An office knife which serves the purposes of pencil sharpener, eraser and paper cutter is being manufactured with interchangeable blades, the purpose being that the blade may be removed while it is being sharpened and another used in its place. With this device one may use the aluminum holder indefinitely by supplying a new blade when necessary. A slight pressure on the catch spring disengages the blade, which may then be removed and another slipped easily into place.

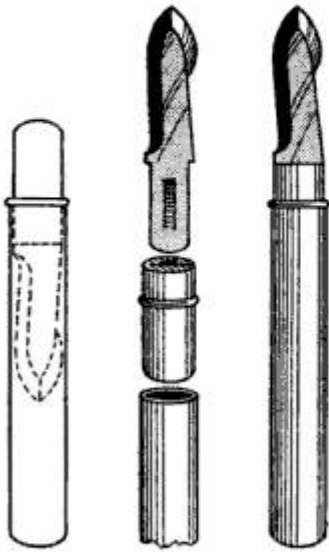

## WASTE OF NATURAL GAS IS TREMENDOUS

The loss of gas from flowing oil wells in one district in Oklahoma, according to government statistics, equals in value the oil that is secured. Millions of dollars worth of this almost perfect fuel is wasted each year through negligence and indifference. A hundred million cubic feet of gas escapes into the air every day in Oklahoma alone, worth \$20,000 a day, or \$7,300,000 a year. This equals in heating power one and a quarter million tons of the best bituminous coal. The loss of gas in California and Louisiana is no less extensive, and practically all of it unnecessary. Modern methods of drilling make such tremendous drains upon natural resources avoidable, and gas wells may be closed by proper precautions. The gasoline content in the wasted natural gas would go a long way toward keeping the cost of motor fuel down.

## NEW WIRELESS CORPS AID TO SIGNAL EFFICIENCY

It is proposed to organize radio companies to act with the aero sections of the Signal Corps of the United States army, which shall be completely equipped with wireless apparatus, capable of hard service in the field. The field companies consist of telegraph and buzzer outfits with a radio section. The aero section will carry four aeroplanes with necessary equipment, and each company will consist of eight airmen and 40 enlisted men. By combining the activities of the telegraph and aero sections with a complete wireless outfit, the efficiency of the Signal Corps will be vastly increased.

## NEW RAILWAY CLOCK SHOWS MINUTES AT A GLANCE

The minutes on a novel dial, arranged for the use of railroads, are big and plain, because they are so very important to trainmen and others in the transportation and mechanical departments. The idea is not new, but the adaptation is ingenious, and the time is easily read in poor light or at a distance. Lengthening the minute



Novel Dial Which Makes It Easy to See the Minutes hand, and showing the hours in different color are the features of this interesting clock.



## EASY-EMPTYING VACUUM FLASK

A vacuum container for liquefied gases, designed for easy emptying, was recently patented by a German inventor.

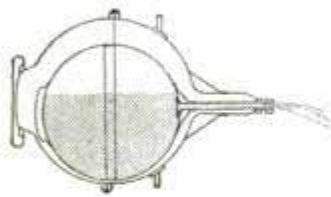

The container is composed of two metal vessels, one inside the other, with a vacuum between —like the ordinary vacuum bottle. Easy emptying is made possible by the fact that the inside flask is suspended from the mouth of the container by a long narrow neck. When the container is placed upon its side, the inside flask rests against the outer vessel, allowing heat to pass to its contents. The resulting vaporizing of part of the liquefied gas quickly forces out the contents. A perforated receptacle filled with magnesium carbonate absorbs any gas that escapes into the vacuum.

## HYDRAULIC TRANSMISSION FOR MOTOR CARS

A new type of hydraulic transmission for motor cars is being introduced which combines a pump running at constant speed with a motor of varying speed,

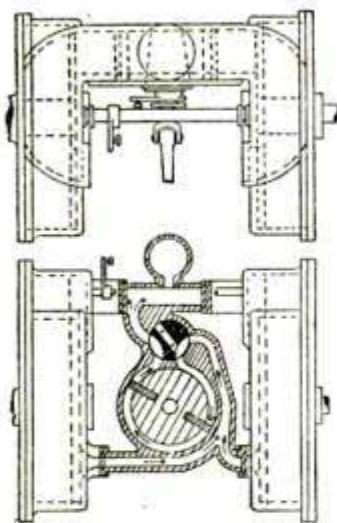

Courtesy The Horseless Age

being due to the varying surface of the pistons subjected to the action of the fluid. The locations of the rotary pump and controlling valve, as well as the circulation of the liquid, are shown in the illustration. The three positions of the valve enable the driver to move forward or backward, or to stop the car without change in the direction or speed of the pump motion. The liquid

is driven through two motors, one on each side of the car, each controlling one of the rear wheels. The circulation is self-equalizing, and no gear differential is required.

## ROLLERS FOR ASH CANS FACILITATE HANDLING

A loaded ash can or garbage receptacle is an unwieldy object. A recent invention seeks to lighten the labor attendant upon handling such unhandy affairs by placing small adjustable wheels beneath the edge of the can in such a manner that they will carry the loaded can when desired or may be thrown up and out of the way when the can is in place. A small wrought-iron wheel is hinged to a clamp fastening easily on either side of the bottom of the ordinary galvanized ash can, making a two-wheel truck convenient to handle the loaded can.



Patent Rollers Attached to Ash Can Transform It into Truck

When not in use, the wheels are simply pushed up out of the way and the can is then resting solidly on its base.

⌈The production of natural gas in California, in 1912, amounted to 9,354,428,000 cubic feet.



## NOVEL FLATIRON SAVES BUTTONS

The modern song of the shirt is punctuated by missing buttons, the bane of hurried laundresses. A new

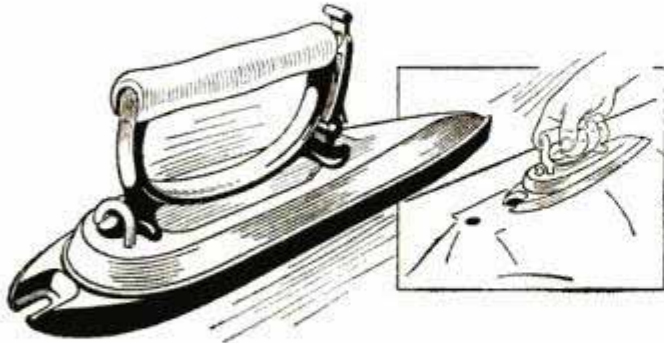

New Device Irons All Around the Button

flatiron has been patented which enables the ironer to give a smooth finish all about the buttons on dress or shirt without tearing them from the garment. A recess within one end of the iron, just big enough to permit the entrance of the button, is the feature of the invention. It readily lends itself to easy handling by even unskilled labor. The handle is removable.

## BUILD ICE ROADS FOR HAULING LOGS

Hauling heavy logs from the forest where they grow to the railroad is facilitated by the building of ice roads. After the roadway has first been prepared by removing timber, stumps and brush, watercarts equipped with two-hose sprinklers are run over the roads when the temperature is at zero or below, and the water dripped in two streams. It freezes as it falls, forming ice-covered ridges and as the cart is kept traveling back and forth, these ridges increase to the depth of several inches. Heavy ruts or grooves are then cut in this ice, to keep the heavily loaded sleighs from running off the ice onto the bare ground. A curious steam engine is used to haul the logs, the front part resting on runners and the rear wheels traveling in a caterpillar belt, with spikes to catch the ice surface.

## DISH-WASHING MACHINE FOR HOME USE

Designed to relieve the housewife of a disagreeable task, the dishwasher shown in the picture is simple in construction and operation. A hollow drum divided into two parts just above the middle line, opens to receive a semi-circular basket of strong wire with suitable racks for holding the dishes. The drum, which revolves, is equipped with several T-shaped elevators, extending the whole length, and these serve to pour the soapy water upon the dishes in the basket, which remains stationary. A gallon of water is sufficient to wash an entire set of dishes, and the basket may be removed to the rinsing pan by lifting it out of the drum.



## NEW SHOCK ABSORBER FOR AEROPLANES



Designed to minimize the terrific jar with which an aeroplane sometimes strikes the ground, a patent recently issued has for its basic principle a hollow cylinder pivoted to the base of the frame and open at its lower end to receive a piston, the rod of which is connected with the axle of the wheelbase. It thus seeks to interpose an air cushion in such manner that when an aeroplane strikes the ground it will first impinge upon the wheelbase, causing the piston rod to operate the piston within the cylinder, absorbing the shock and relieving the machine of unnecessary jar.



## RUBBER TOOTHBRUSH THAT SLIPS OVER FINGER

A rubber toothbrush which slips over the first joint of the index finger, and which is provided with fine rubber spines for cleansing the teeth, is a novelty on the market. This brush has no bristles to be lost. The claim is made that it is more sanitary than the ordinary type of brush, and that it can be used for massaging the gums without danger of injury.



## AUTOMATIC DANGER SIGNAL AND TRAIN CONTROL

The prevention of accidents on railways is engaging the attention of many minds. A device for which a patent was recently issued is automatic in operation and inexpensive in construction. It consists of an insulated rail laid between the tracks, upon which a shoe with sliding contact actuates electrical mechanisms in the cab. A warning bell is sounded when another train enters the block, a light

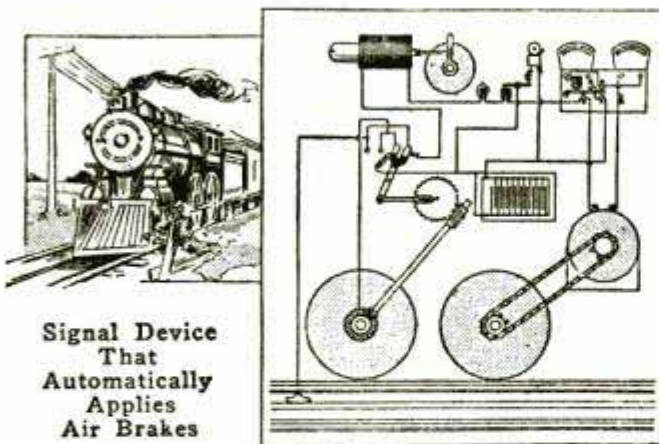

Signal Device That Automatically Applies Air Brakes

in the cab increases in brilliancy as the trains approach, and at a predetermined distance the air brake is applied automatically, bringing the trains to a standstill. A storage battery supplies the current, a gear on any wheel of the engine entrains a mechanism

for reversing the polarity of the shoe, and the resistance between the rails and the shoe controls the warning signals. When the track is clear, the circuit through the apparatus will at no time be closed, while the approach of another train or trains will intermittently change the polarity of the shoe, increasing the resistance until at last it will impel the warning signal.

## ELECTRIC FANS USED FOR DISINFECTANTS

A device which may be attached to any electric fan, for the purpose of automatically disinfecting the room in which the fan is operating, has been patented. The attachment consists of a metal container from which projects a wide-mouthed spout. The lower end of a wick extending from this spout lies in the disinfecting liquid, and capillary attraction brings a fresh supply of disinfectant constantly up to the blast of the fan, which blows the disinfecting medium to all parts of the room.

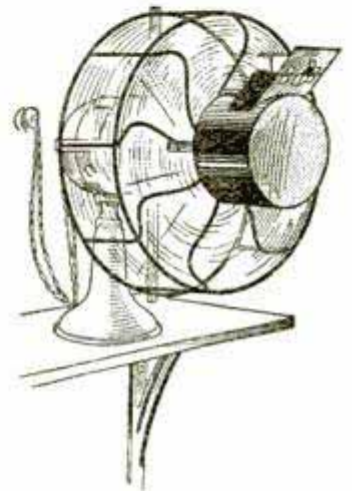

## NEW YORK STREET CARS USE NOVEL MOTOR

A new street-car line at Great Neck, L. I., will use a novel form of propulsion, for although the cars run on rails and have every appearance of electric cars, they will be independently operating units, without overhead wires, third rails or central power station. A flash boiler on one platform, heated either by gasoline or kerosene, supplies a steam turbine under the body of the car, the normal speed being from 3,000 to 4,000 revolutions per minute. A herringbone gear set connects the turbine to a hydraulic trans-



mission, running at 600 revolutions, which delivers power to all four wheels. Twenty-five horsepower is developed by the turbine.

### CURIOUS USE OF COLORED LIGHTS

Color is the result of the reflection of certain rays from the surface of a body, and if the light thrown upon it does not contain such rays, the body will appear dark or black. At the New York Electrical Show a novel application of this principle was shown, where a series of placards on a dark background were illuminated by light reflected from colored lamps placed in front and at the sides of the cards. A switch connected to the lamp circuits alternately lighted lamps of different colors. When each kind of light was in turn thrown upon these colored placards, portions of the picture seemed to disappear, owing to the neutralizing influence of the colored lights employed.

### UNUSUAL SHOCK ABSORBER WITH COIL SPRINGS

Flat steel springs 9 ft. long, coiled, consisting of four sets, two for each leaf spring of the car, have made their

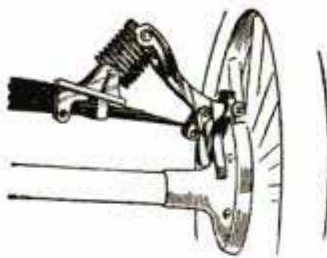

appearance, which work under compression at all times. Rebound is checked when the leaf spring rises above a certain point, the main lever of the shock absorber is held stationary, and the coil springs are again compressed, so that both upward and downward movements actuate the coil. This novel shock absorber has been found so sensitive that when the car is unoccupied the pressure of the hand will move the car body on the coils. Spring perches are used to attach the absorber, being reversed on the front axles, while on the rear they are bolted to the brake housings.

### PIVOTED TEAPOT SWINGS FOR BREWING

A practical novelty is a pivoted teapot with an upper compartment to hold the tea leaves, and an alcohol

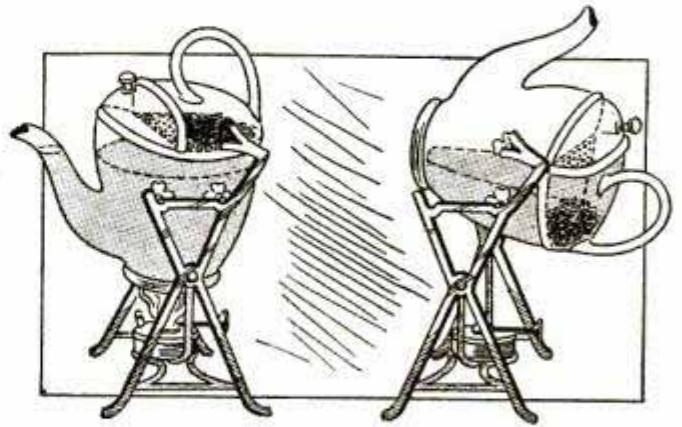

French Teapot Which Does Away with Troublesome Details in Brewing Tea

lamp beneath the pot with which the water is boiled. At the instant of boiling, the flame is extinguished, and the teapot tilted backward until the water covers the tea leaves. The teapot is left in this position as long as may be necessary, and when returned to its normal position the tea is ready for drinking, and is not further affected by contact with the tea leaves.

### LOCK SCREW FOR FURNITURE JOINTS

To take the place of glue and wood-dowel joints in furniture construction and to give greater strength and rigidity is the purpose of a furniture-locking screw that has recently been patented. It is simply a bolt and nut made in such shape as to be imbedded in the wood about the joint entirely out of sight. A small plate, working like

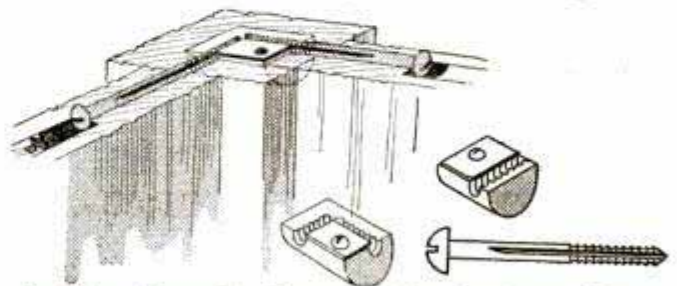

Locking Screw for Strengthening Furniture Joints a ratchet in four channels in the screw, locks the bolt automatically at each quarter turn as it is driven into place.



## ELECTRIC FAN FOR CLOSED AUTOMOBILES

A diminutive electric fan, especially designed to ventilate the interior of a closed automobile, is a French novelty.

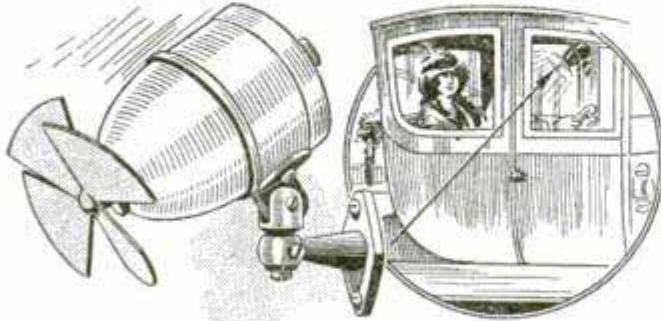

Self-Contained Automobile Ventilator

The double-jointed mounting provided with the fan permits one to direct the air current toward any part of the car. The motor is completely inclosed, so there is no leakage of lubricant and the fan is self-contained in an aluminum body. It uses but little energy and takes up very little room.

## ADJUSTABLE CONDUIT BENDER

An ingenious adjustable bender for the conduits used in wiring is here shown. It will bend either  $\frac{1}{2}$ -in. or  $\frac{3}{4}$ -in. conduit without crushing or kinking it. The weight of the bender is a little over 10 pounds.



¶The variations of pressure in water mains are utilized by a French inventor for the operation of a self-winding clock.

## JAPANESE PICTURE BRIDES IN AMERICA

Each steamer from Japan which lands its passengers at an American port brings over a number of young women from the "Land of the Cherry

Blossoms" who are coming to claim husbands they have never seen, but whose photographs they cherish and to whom by Japanese statute they have been lawfully wedded. In the past five years the number of Japanese women in America has doubled, and the increase is due to the "picture brides" as they are called. Japanese bachelors coming to this country as laborers have had their pictures taken and have sent photographs back to parents or friends at home, asking that brides be secured for them. Consent of the girls' parents and registration before the proper official suffices to make the marriage valid according to Japanese law. America, however, requires that another wedding be celebrated and at one time the immigration officer married these couples upon the pier. This was the "pier marriage," but it was so lacking in romance that now the official visits the couple at their hotel and performs the ceremony, and the honeymoon begins with the journey to the new home. In Japan the young couple meet for the first time before the matchmaker and ratify the arrangements. Here, on the pier in a new world, the young bride stands with the photograph of her husband in her hand, seeking to identify him among the hundreds of crowding Japanese. The girl whose dream of America has painted a land of gold, her life one of aristocratic ease, the wife of a wealthy man, may find herself condemned to hard work in the camp or on the farm, if her husband is but a laborer. Many disappointments come to the picture bride, but on the other hand the number of Japanese women in America is steadily increasing, the divorce evil does not touch them, and race suicide is unknown.

¶An eastern railroad is experimenting with "coke breeze" as a locomotive fuel. This fuel, formerly regarded as waste, consists of granular and other particles of coke that are too small to be used in smelting furnaces.



## WASTE TWINE SAVED FOR FOUR YEARS

For years and years the clerks at the post office at Pleasant Ridge, Ohio, threw the short pieces of twine which come wrapped around the bundles of letters into the waste basket. Four years ago the superintendent began saving the pieces and today he has a big ball of twine, 29 in. in diameter, which weighs 75 lb. He calculates



Thirty Miles of String in Ohio Post Office

that there is 30 miles of twine in that ball, and he is still saving the pieces, day by day.

## PHOSPHORESCENT INK NOW USED IN PRINTING

Printers' ink containing a radium preparation has been manufactured in Germany, by means of which newspapers can be printed that can be read in the dark without other illumination than that contained in the ink itself. The so-called radium colors produce light in tints of green, violet, blue, red, and yellow. The inventor claims that these colors will retain their phosphorescent qualities for 10 to 12 years, may be used for signs, wall decorations, illuminating stairways, as well as for painting ships, boats and aeroplanes. All sorts of materials have been treated with the preparation.

## WATCH THAT SHOWS LAST TIME WOUND

A watch that accurately indicates the exact time elapsed since the last time it was wound has recently been placed on the market. The face of the timekeeper is provided with a small dial near the top of the regular dial, which has a small hand that shows when the mainspring was last wound and also records the progress of its unwinding, thus showing, at a glance, when the watch needs rewinding.



## CASTERS FOR CRIPPLED AUTOMOBILE

A very present help in time of trouble has been invented by an Illinois garage man, consisting of a wrecking truck for towing automobiles which have lost a wheel. The device can be carried in the relief car and readily slipped under the front or rear axle of the damaged car, and as the small wheels operate like casters, there is

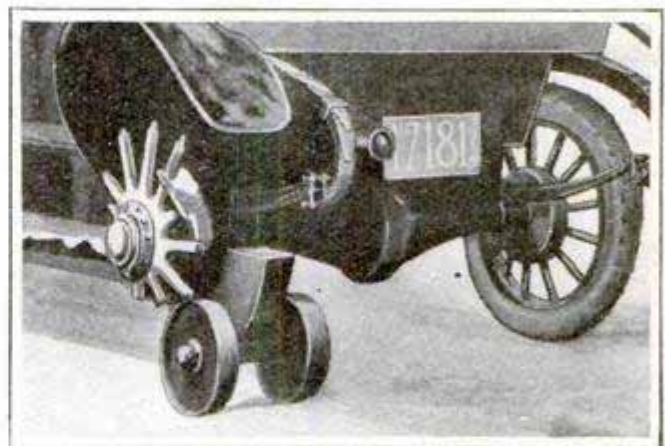

Handy Device for Relief of Injured Automobiles

no trouble in steering. This appliance does away with the former method of setting a heavy beam under the axle and dragging the car to the repair shop.



## ARTIFICIAL WATERWAYS IN MANY LANDS

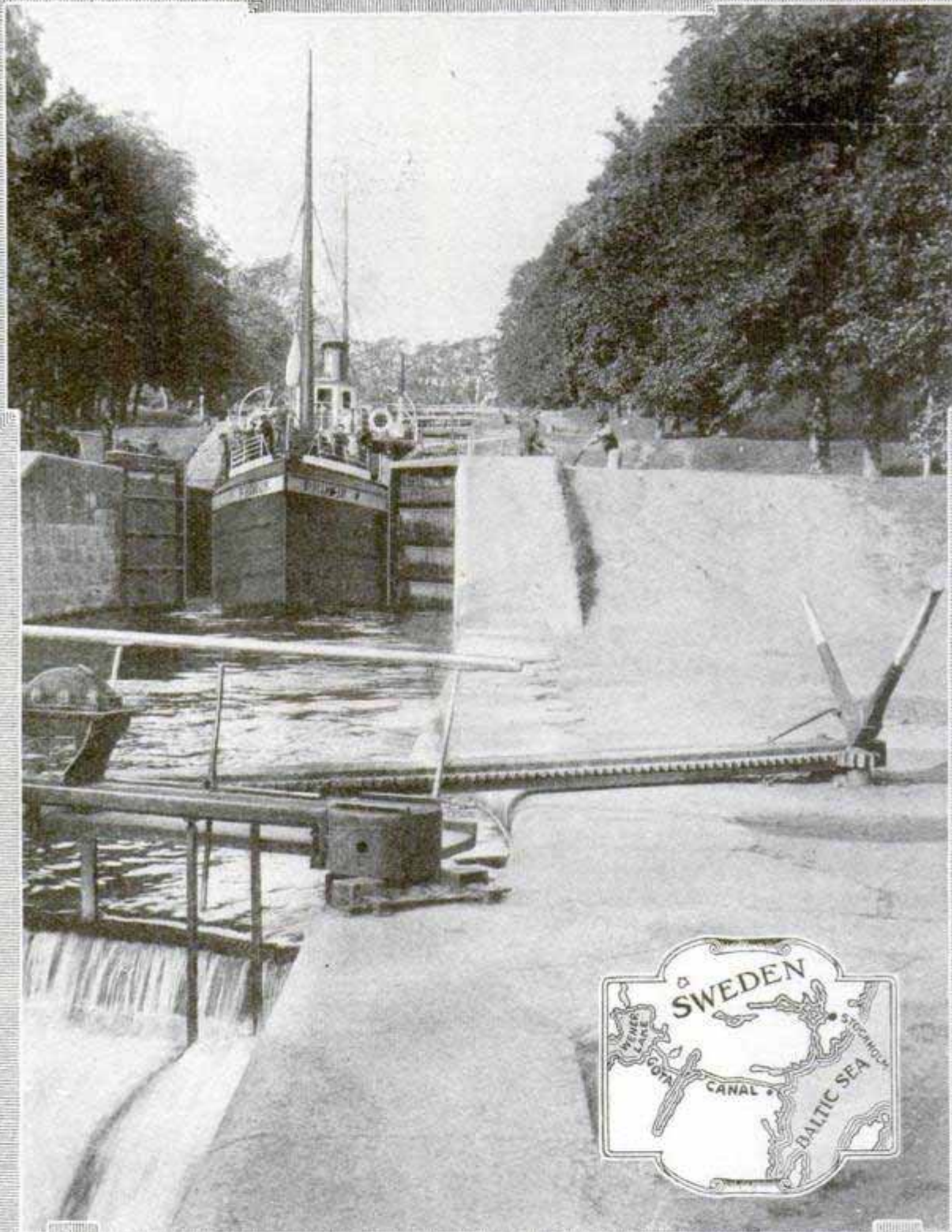

The Göta Canal is the Longest and Most Important Artificial Waterway in Sweden. Connecting Wener Lake with the Baltic Sea, It Enables Vessels of Light Draft to Pass Entirely across the Country, from the North Sea to the Baltic. The Göta River Connects Wener Lake with the North Sea. The Photograph Shows the Locks at Borensult. The Enlargement of This Canal to Permit the Passage of Ocean-Going Vessels is being Agitated in Sweden



# ARTIFICIAL WATERWAYS IN MANY LANDS

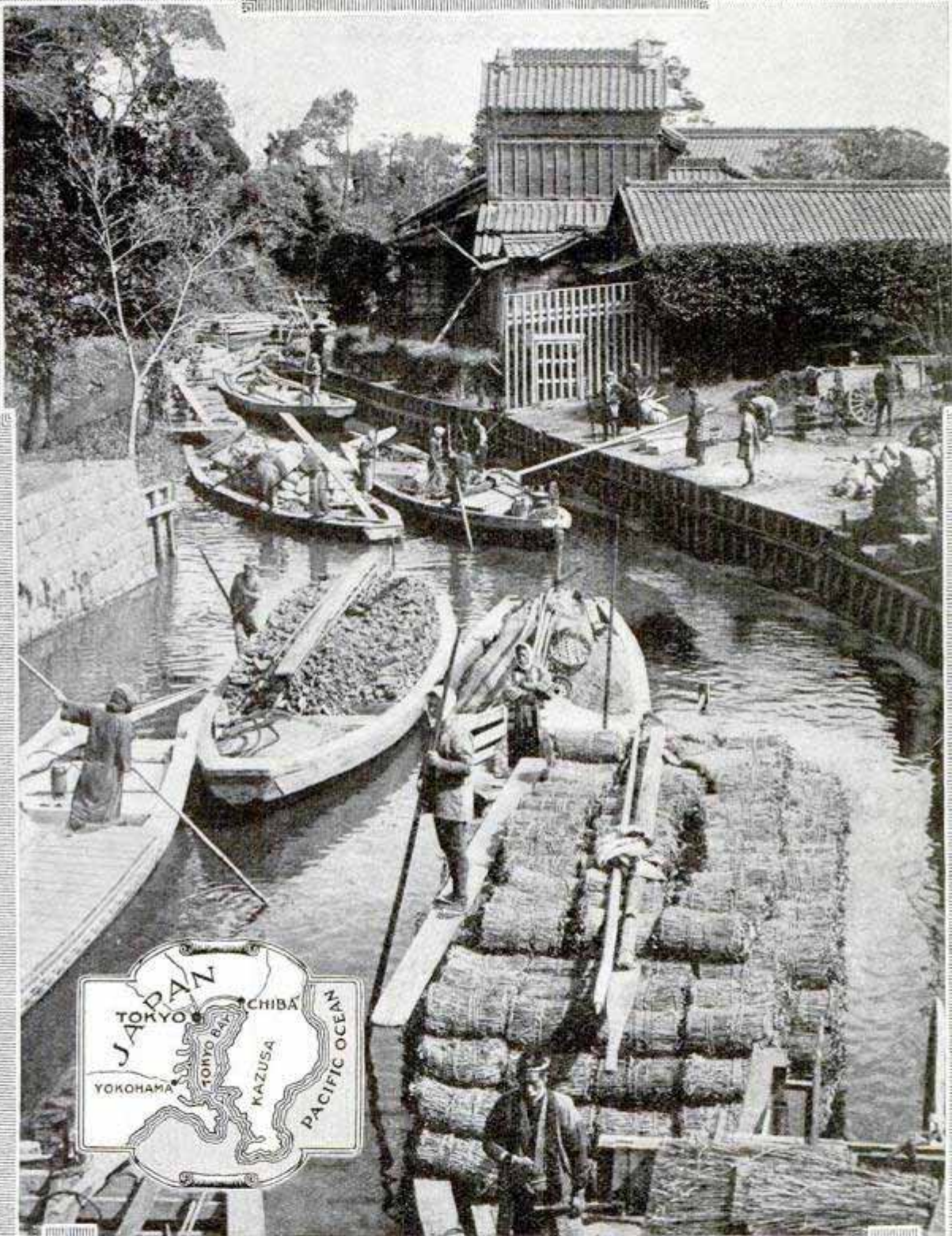

Probably No Other Country is so Completely Covered by a Network of Streams, Lakes and Canals as is Japan. The Rivers being Small and Shallow, Canals Provided the Principal Means of Inland Intercourse before the Railroads were Built. The Lower Part of the City of Tokyo, the Capital of Japan, is Intersected by Many Canals, Connecting Various Parts of the City and Adjacent Districts with the Sumida River and the Bay. The Photograph Shows a Scene on the Chiba Canal, One of the Most Important of These Watercourses



# ARTIFICIAL WATERWAYS IN MANY LANDS

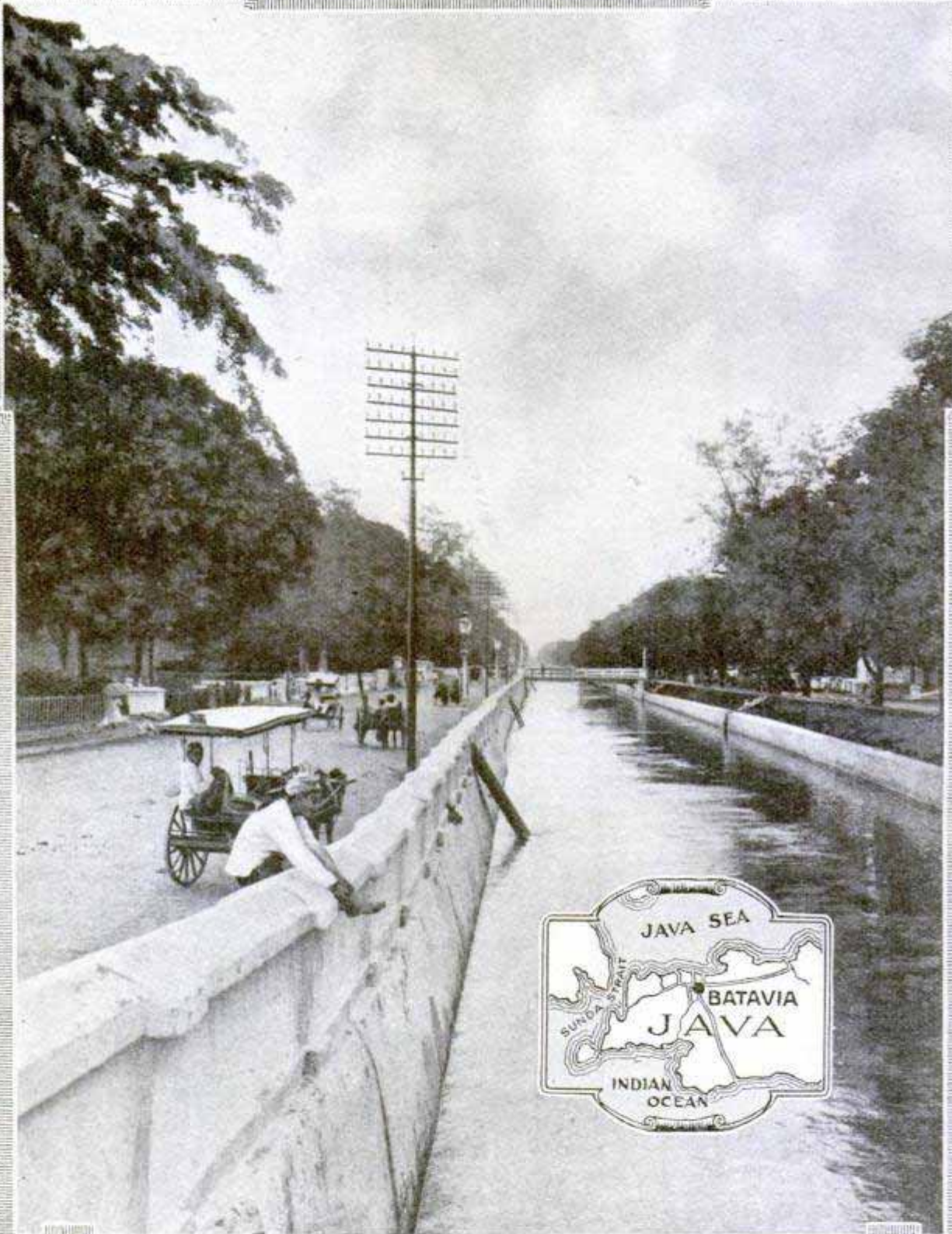

When the Dutch East India Company Settled in Java, in 1610, They Brought with Them Many of the Traditions of Holland. The Swampy Plain at the Mouth of the Jacatra River on Which the Town of Batavia is Located Bears a Certain Resemblance to the Lowlands of the North Sea, and Quite Naturally Canals Similar to Those of Holland were Excavated to Provide both Drainage and Means of Communication. The Photograph Shows One of These, Connecting Two Sections of the City Which are Known as Molenvliet (Mill Stream) and Noordwijk (North Town). This Canal Gives Communication by Water from the City to the Harbor



# ARTIFICIAL WATERWAYS IN MANY LANDS

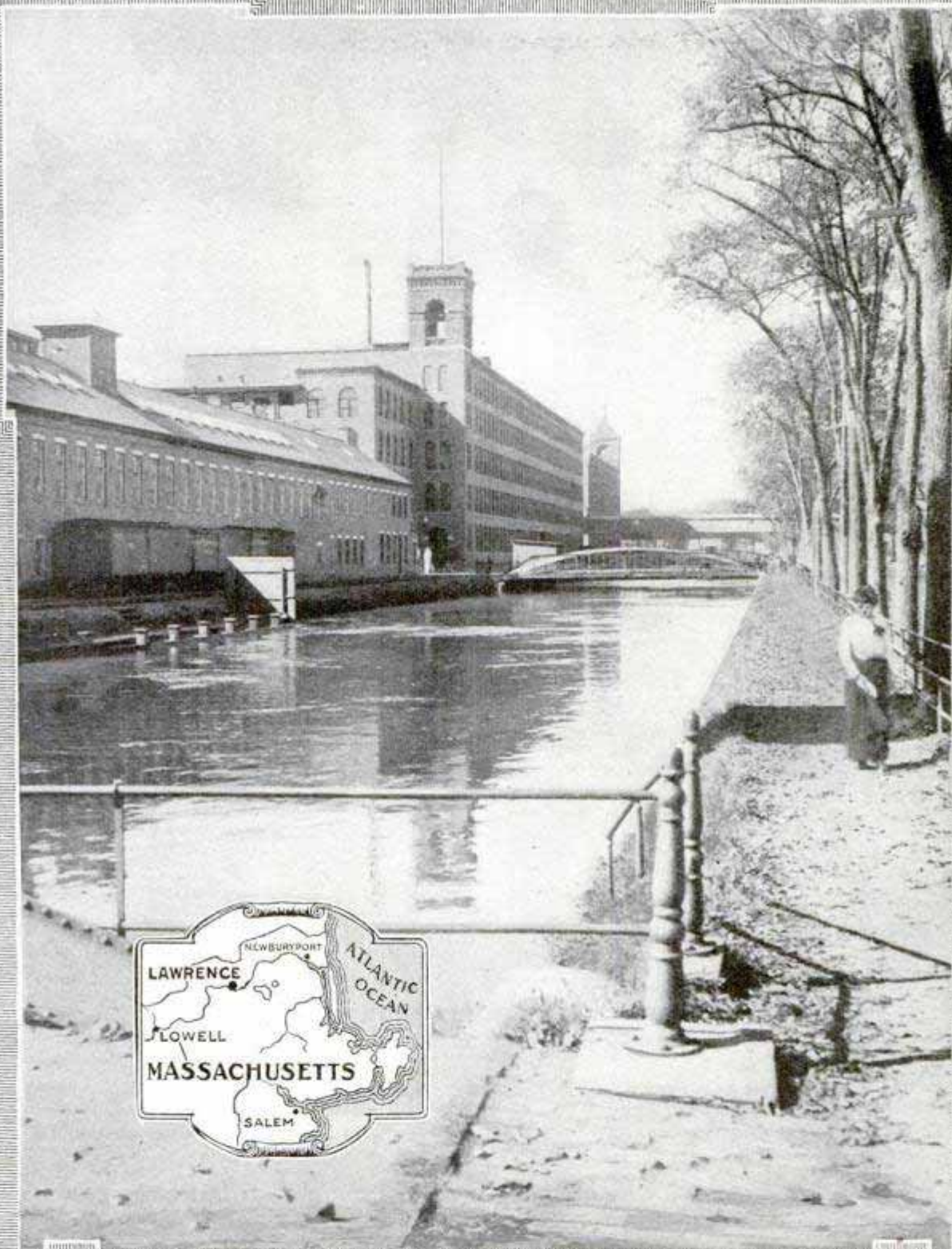

The "Great Canal" at Lawrence, Mass., Although Not a Navigable Body of Water, is Nevertheless Important among the Canals of the World. It Carries the Water of the Merrimac River a Distance of One Mile, and in Falling Back into the River Bed Below, the Falls Develop 12,000 hp., to Operate the Great Woolen and Cotton Mills. A Stone Dam, 900 Ft. Long, Holds the River Back and Diverts It into This Canal and a Shorter One on the South Side of the River. The Total Fall is 28 Feet



## RUBBERS FOR DANCING THE TANGO

The pace prescribed for dancing the tango is so rapid that the old-style dancing pump cannot be used on a slippery floor with safety. Modifications were introduced, such as a rubber patch in the leather sole near the toe of the pump, or near the ball of the foot. At last a Massachusetts shoe firm has produced a rubber sole which may be slipped on over the sole of the ordinary dancing pump, converting it into a "tango slipper" which gives a firm grip upon the dancing floor and at the same time is scarcely noticeable on the foot.



## STRUCTURE OF HUMAN HAIR TELLS RACIAL ORIGIN

Scientists are able, by the use of the microscope, to tell from a single human hair to what great racial division the original wearer belonged. If a cross section of the hair is elliptical, the man was black; if round, the man was yellow or red; while the white man's hair is oval. The Australian native has hair with the least diameter, the Bushman of Africa, the next, then the American Indian, the Chinese, the white races of Europe, and lastly the Japanese, the coarsest of all. The beard of a white man is 50 per cent thicker than his hair, and is almost identically the size of the hair of the chimpanzee. The strength of human hair is, as a rule, in direct proportion to its thickness.

## SIX-BLADED PROPELLER ON MILITARY AUTO

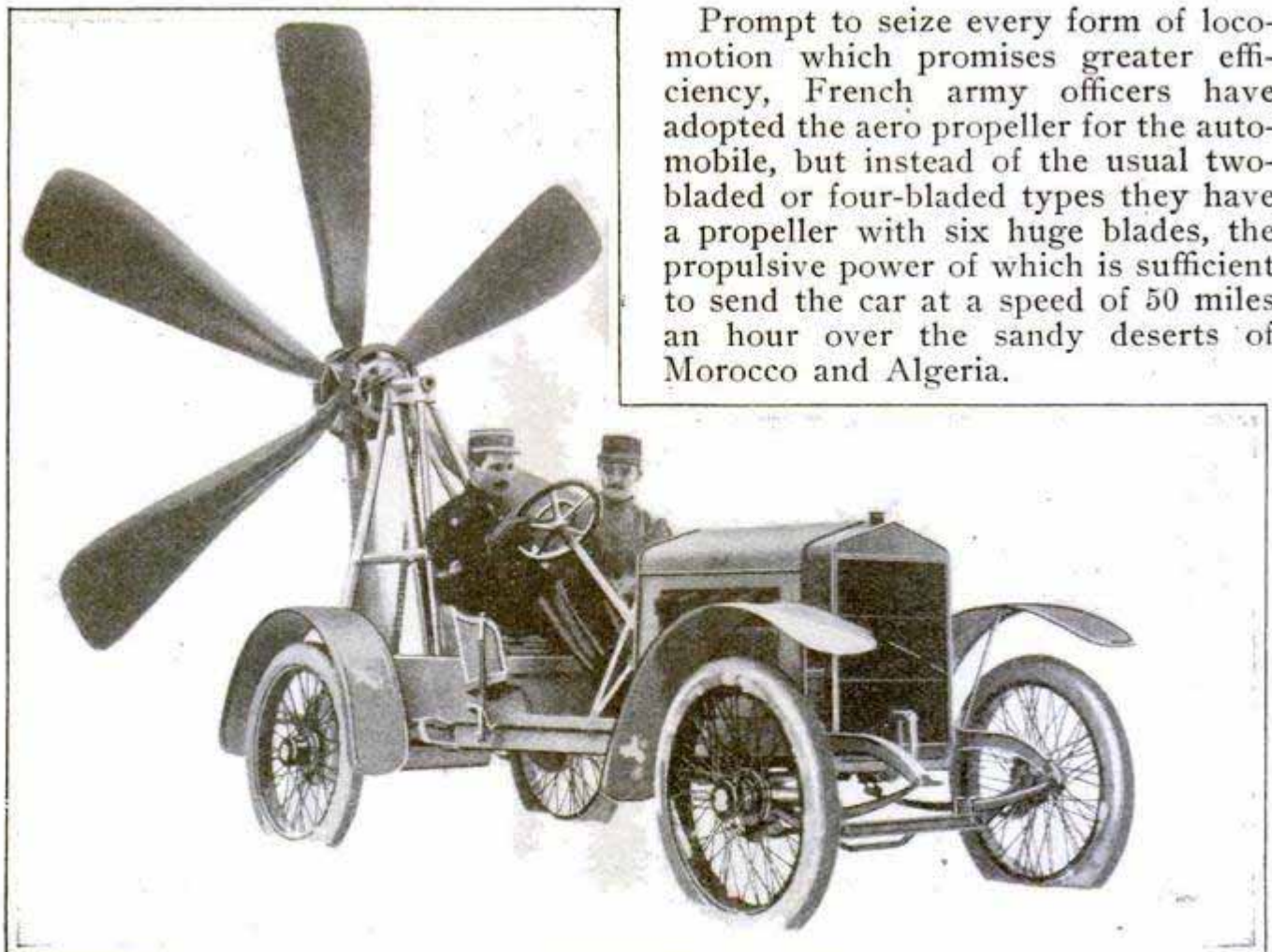

Prompt to seize every form of locomotion which promises greater efficiency, French army officers have adopted the aero propeller for the automobile, but instead of the usual two-bladed or four-bladed types they have a propeller with six huge blades, the propulsive power of which is sufficient to send the car at a speed of 50 miles an hour over the sandy deserts of Morocco and Algeria.

Speedy Flying Auto Adopted by Military Authorities in French Colonial Possessions  
Photo by Underwood & Underwood



## ORNAMENTAL BAND STAND OF CONCRETE

A band stand of unusual design, in which concrete forms the main mate-

## OPTICAL ILLUSIONS PUZZLE THE EYE

Who has not remarked on the large disk of the rising moon, seemingly so

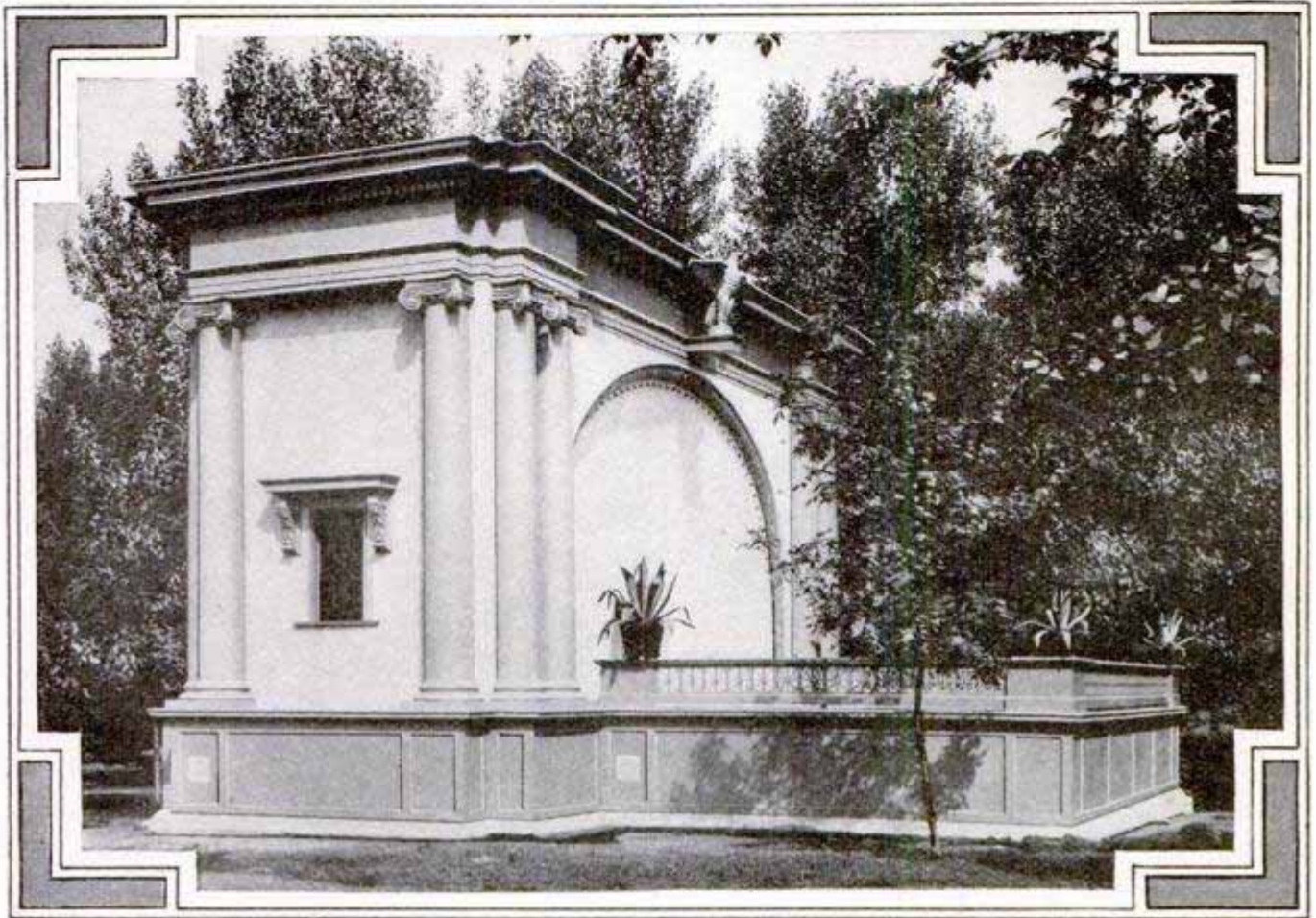

A Concrete Band Stand in Salt Lake City Which Adds Greatly to the Beauty of Liberty Park

rial, has recently been built in Liberty Park, Salt Lake City. The foundations are 12 in. thick and sunk 2 ft. below the surface of the ground. Care was exercised in placing the forms and in tamping the concrete so that the finished structure should be true to line and of proper dimensions. The outside walls and convex sounding board were lathed with expanded metal, tightly stretched, and three coats of cement mortar applied.

Carpet manufacturers in Europe, who formerly had to send samples of their product to southern countries to test their sun-resisting qualities, now use the mercury-vapor quartz lamp for that purpose, its ultraviolet rays having even greater power to fade dye-stuffs than the sun.

much bigger at the horizon than when it floats in midsky? An Italian psychologist explains this optical illusion by means of two diagrams which are reproduced herewith. Two circles of equal area drawn within the angle made by two intersecting lines appear of different size, the one nearest the vertex of the angle seeming the larger. The moon upon rising is seen in the angle formed by the plane of the visible horizon and the slanting vault of the heavens, and thus appears to be of greater diameter than when at a higher altitude.

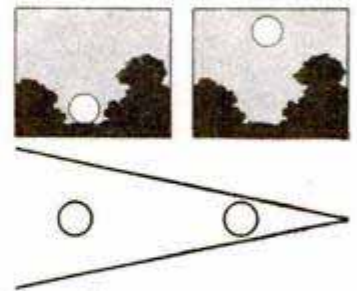



### TREE-GRAFTING DEVICE FOR FARMERS

A farmer has designed a tool for use in tree grafting, by which scientific

of a broken cable, an adjustable friction clutch between the drum and the worm gear is provided, which is designed to transmit just sufficient power to give the braking effect desired,

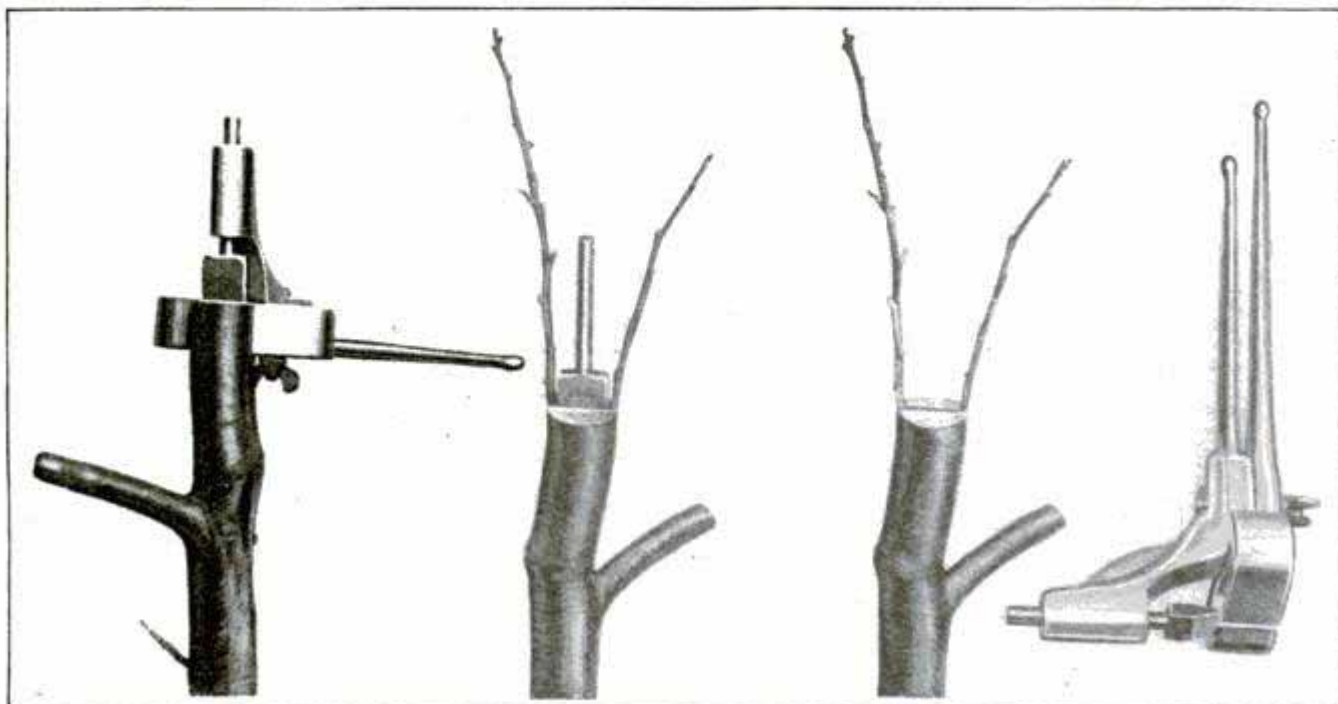

Grafting Tool Which Eliminates Damage to the Bark

grafts can be obtained without expert assistance. Specially devised tongs and a knife are operated by levers so that the bark is cut cleanly, preventing tearing and shredding. The splitting knife is adjusted so that it cuts a straight line between the cuts made by the tongs. The scions are then put in place, the knife removed and the wax applied. A very high percentage of perfect grafts are possible with this improved appliance.

### ELECTRIC BRAKE LATEST AUTOMOBILE AID

A recent innovation in motor-car construction is an electric brake, which takes away from the driver the actual labor of applying the brakes. A very small motor, operating at high speed and supplied from a storage battery, furnishes the power for the braking mechanism. A drum at one end of the transverse shaft carries a steel cable to the brake levers, displacing the usual rod. To prevent the possibility

beyond which the clutch will slip, preserving the cable. Stops govern the position of the lever controlling the operation of the braking motor. When applying the brakes, the lever is moved to the first position, enough current passing to the motor to rotate the drum a certain distance, winding up the cable a predetermined amount, when an

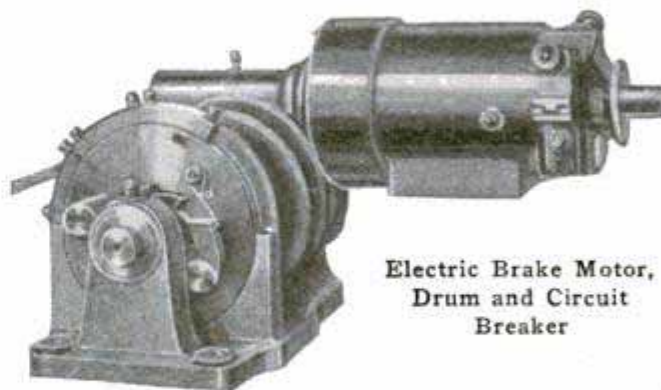

Electric Brake Motor,  
Drum and Circuit  
Breaker

automatic circuit breaker switches off the current. By this means the brake is lightly applied as in ordinary stops. To increase the pressure, it is merely necessary to open and close the circuit again with the finger lever, and the drum makes a further revolution,



and the operation may be repeated as desired. An emergency stop is made by pushing the lever as far as it will go, when the full power of the cable is exercised immediately.

### CHARTING THE APPROACHES TO THE PANAMA CANAL

With the opening of the Panama Canal reliable charts of the Yucatan Channel, the Caribbean Sea, and the coasts bordering on these waters will become a necessity for the heavy shipping approaching and leaving the Atlantic terminus of the canal as well as for vessels engaged in coastwise trade. With this in view the United States government is already engaged in making extensive surveys of these waters, and as a result of the work carried on by the survey ship "Hannibal," the hydrographic office will be able to supply fruit steamers and other trading vessels with correct charts of the sea off the coast of Yucatan and the east coast of Central America. The "Leonidas" is now being fitted up to take part in the work of surveying, which is to be prosecuted more vigorously than ever this year in preparation for the opening of the canal.

### MOTOR PLOW AND TRACTOR FOR FARM

A former number of this magazine contained a description of a motor plow adapted for farm use, and a recent development permits its use as a tractor. A lever is provided for lifting the plow, which is hinged and thus may be folded out of the way. The frame now rests on four wheels, and the tractor may be "hitched" to other farm implements, such as disk harrows, rakes or weeders, or used as a light truck for hauling farm products or

### FACTORIES FOR MAKING MOVING-PICTURE FILMS

The importance of the motion-picture industry has become such that many of the larger film companies have erected buildings specially designed to serve as film factories. A typical illustration of this class of building is shown in the accompanying view of a film factory at Tempelhofen, Germany. Except where there are



A German Film Factory: Plays are Produced and Photographed in the Glass-Covered Upper Story

some special requirements, the exposures for all films are made in the glass-covered upper story of this building, suitable scenery being arranged to produce a realistic effect. A number of plays are often enacted at one time in each building, only enough separation being necessary to avoid interference.

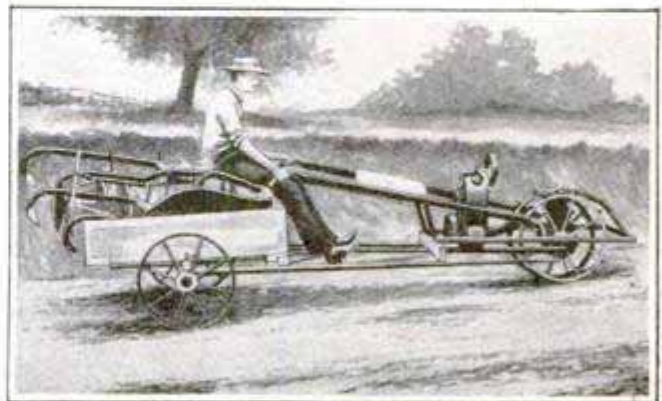

Motor Plow Which can be Used as Truck merchandise, or taking the tools necessary for work out to the fields or back to the farm buildings.



## BUILDING DAMAGED WHEN WET WOOD SWELLS

A pile of dashboards, made of oak veneered with maple, was stacked in the basement of an automobile factory. The top of the pile came within one inch of the bottom of a reinforced-concrete beam, forming the framing of the lower floor of the plant. During a flood the basement was filled with

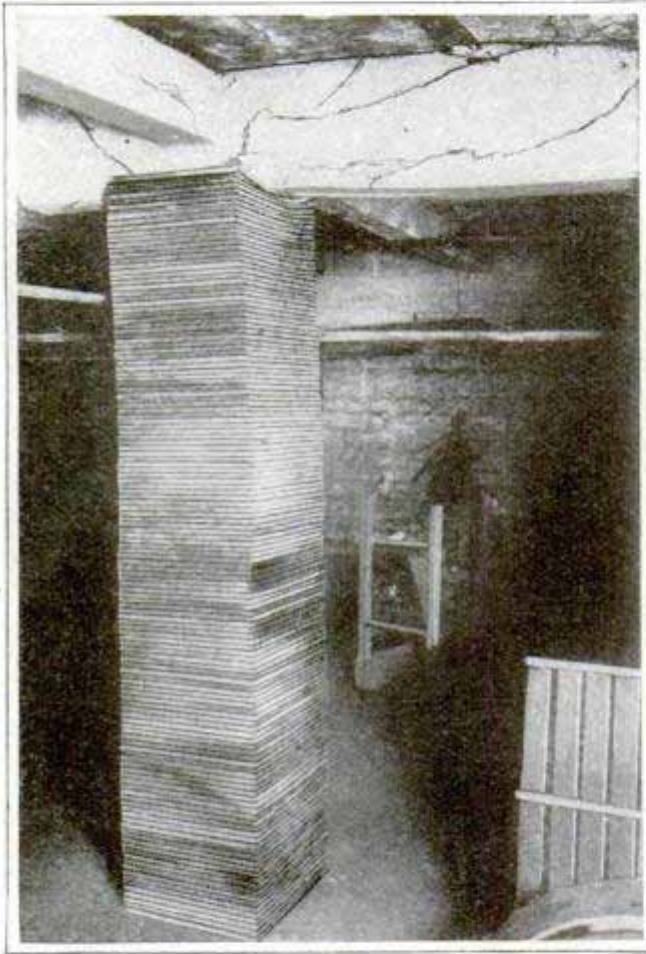

Water-Soaked Pile of Boards Which Broke  
Concrete Beam

water and the wooden plates became soaked. They swelled to such an extent that they lifted the girder 3 in. above the level, cracking it so seriously that it had to be replaced.

## MAKING WROUGHT IRON AT LOW COST

Wrought iron made by hand is costly because of the necessarily small amount which one puddler can handle, about 200 lb. being considered the maximum. A mechanical device has been patented whereby much larger quantities can be handled, the pud-

dling being done in a rotating furnace, and the resulting metal has the low carbon content and other general properties of wrought iron. The process is simple, the pig iron being first blown in a Bessemer converter until most of the carbon is oxidized and just enough iron oxide formed to convert the remaining carbon when puddled or thoroughly worked. Then the iron with a small quantity of slag is transferred to a rotating balling furnace where, under a reverberatory flame, the iron oxide reacts on the remaining carbon and the iron gradually becomes purified. In this process as high as four tons may be worked at once, greatly lessening the cost of production and largely increasing the output of wrought iron. Another slightly modified process patented by the same inventor permits the use of cheap pig iron of high silicon or phosphorous content in the making of wrought iron.

## PITCHING A CIRCUS TENT BY MACHINERY

The great canvas tents so familiar to the circus-going population are enormously heavy, weighing often five tons or more, and handling them quickly is a task that formerly taxed 50 men for two hours, and then was accomplished only indifferently well. By a new device a big wagon is equipped with a long roller, operated by a gasoline engine, which winds up the big canvas as quickly and easily as a clothes wringer handles a sheet. Indeed, the resemblance is something more than fanciful, for this appliance wrings the canvas perfectly dry, even on a rainy night, so that the tent may be transported without fear of rotting or mildew. Reversing the process, and pulling the big canvas off the rollers by horses, the entire tent may be raised quickly, the roller on the wagon being utilized to pull up the ropes which raise the poles, saving an immense amount of hard work and hours of time. The gasoline engine is used only for operating the roller, the wagon being hauled by eight horses.



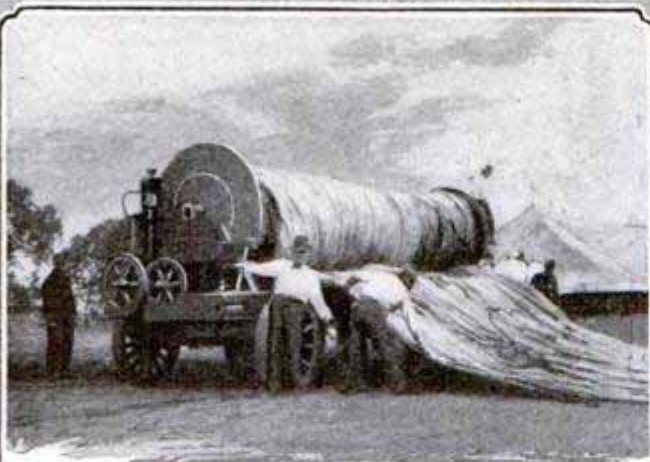

Winding Up the Big Tent by Gasoline Engine.  
This Formerly Took the Efforts of Fifty Men

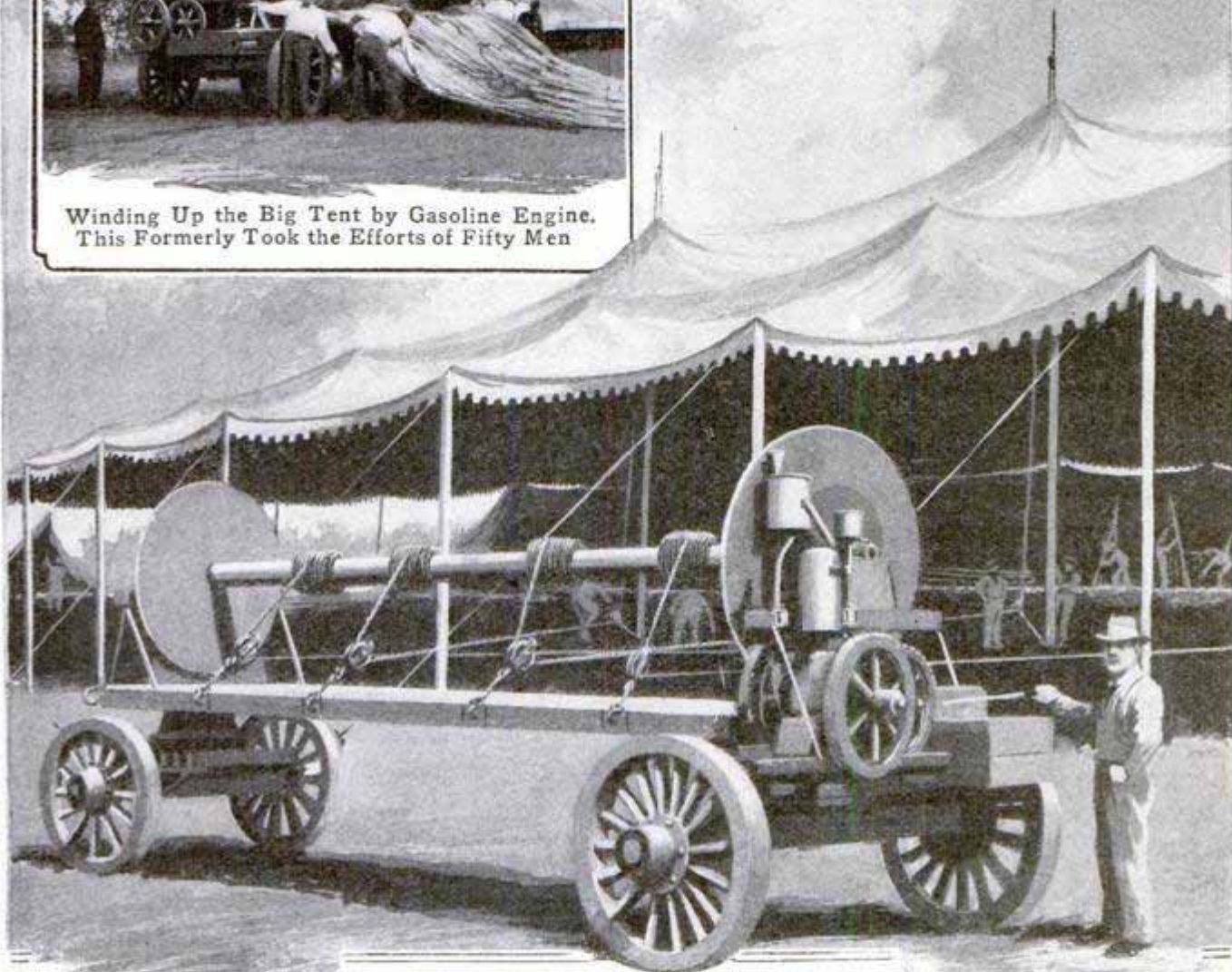

Great Truck, Showing Reel and Engine  
Which Reduces a Task of Hours to a Matter of Minutes

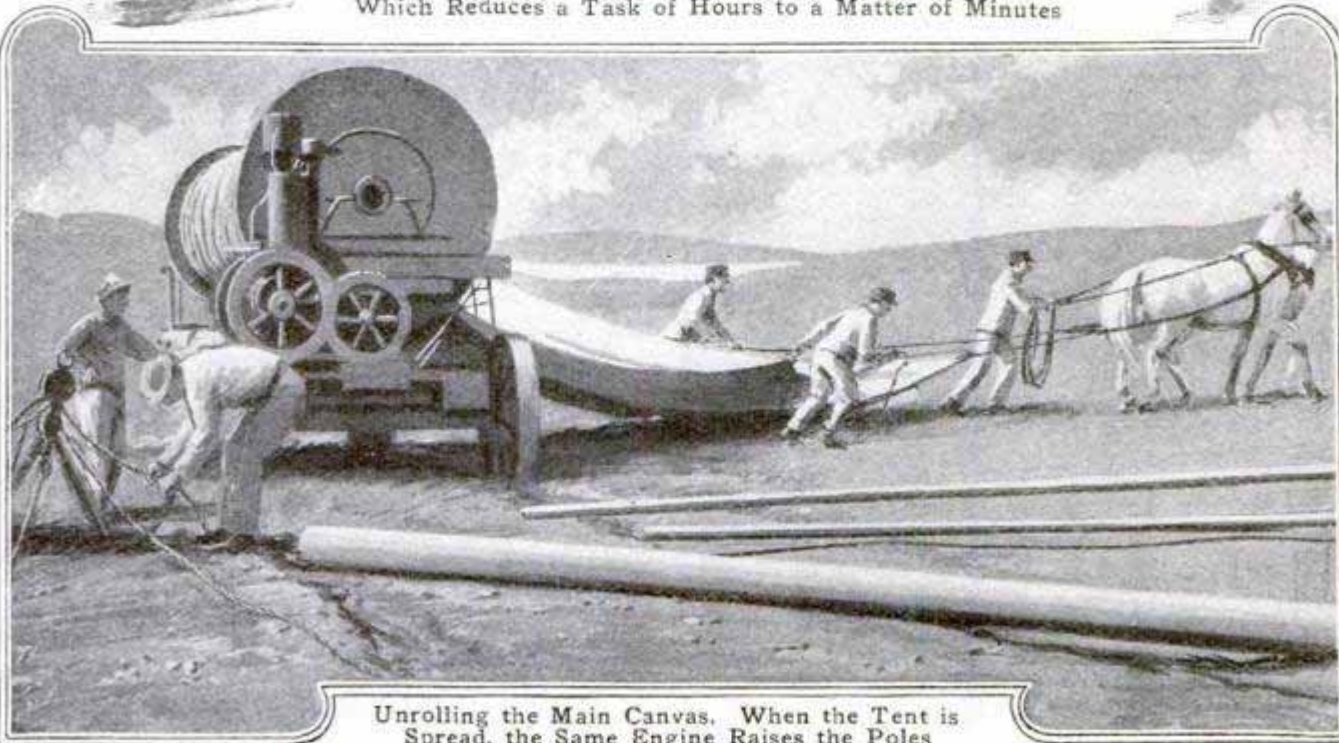

Unrolling the Main Canvas. When the Tent is  
Spread, the Same Engine Raises the Poles



## NEW OIL-CUSHION INSERT LUBRICATES SPRINGS

A perforated strip of special antifriction metal, designed to be placed between the leaves of automobile springs,

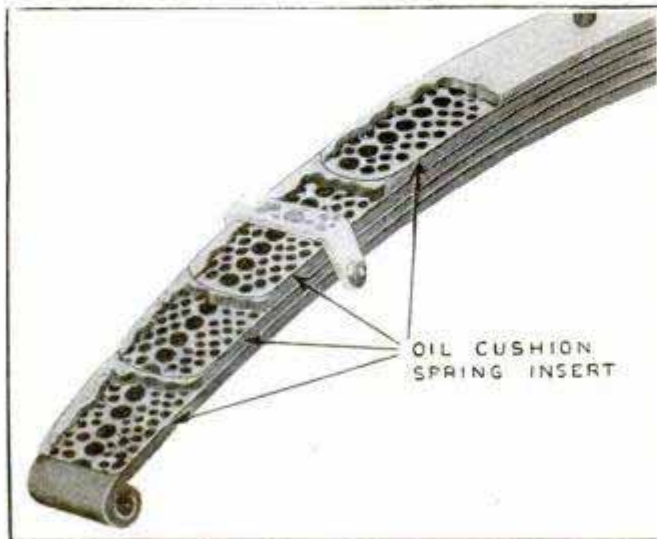

Lubricant is Held between Leaves of Spring

is now being placed on the market, which holds the lubricant in place and prevents squeaking and rusting. The oil-cushion insert is a steel alloy, the perforations being filled with a special heavy grease, having a tendency to stay in the holes. After the perforated strips have been placed between the leaves and the spring drawn together by the bolts and clips, the pockets in the cushions are sealed.

## PORTABLE TRACK CRANE FOR HANDLING RAILS

In replacing worn-out rails by hand, many men are required, and the work

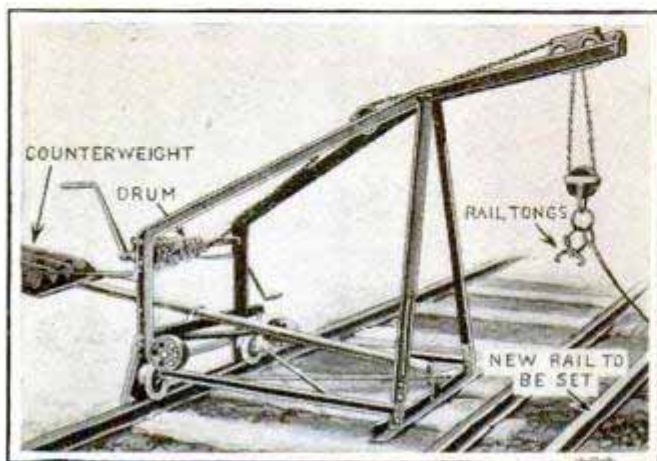

Machine Which Reduces Labor Cost  
in Track Laying

is slow because of the difficulty of getting the men organized to work together systematically. A light rail-handling machine for picking up new rails and laying them in position has been invented, by which three men can do as much work as the ordinary rail-handling crew of from 12 to 20 men. The appliance consists of a hand crane, equipped with two wheels with double flanges to ride on one rail, while an inclined boom, supported by an A-frame, rests on the ties. A winding drum carries a chain by which the rails are lifted.

## TEMPORARY DECORATION FOR LAMP-POSTS

During the Shriners' convention in Atlanta recently, a novel ornament was designed for use on the top of city lamp-posts. Over the top light on a five-light post, was set a metal lantern, inscribed with appropriate words and symbols, so placed that the device was illuminated at night. Over 2,000 of these artistic decorations were used, adding much to the appearance of the city's streets both by day and by night.



## PUBLIC FURNACES TO BURN RUBBISH

To keep its streets free from waste paper and rubbish, Glendale, a small city near Los Angeles, has built public incinerators or catch-all furnaces in the alleys back of its business blocks. Four of these, paid for by an assessment levied on the merchants, have



not only solved the rubbish problem, but have reduced the danger of fire from promiscuous bonfires. The fur-

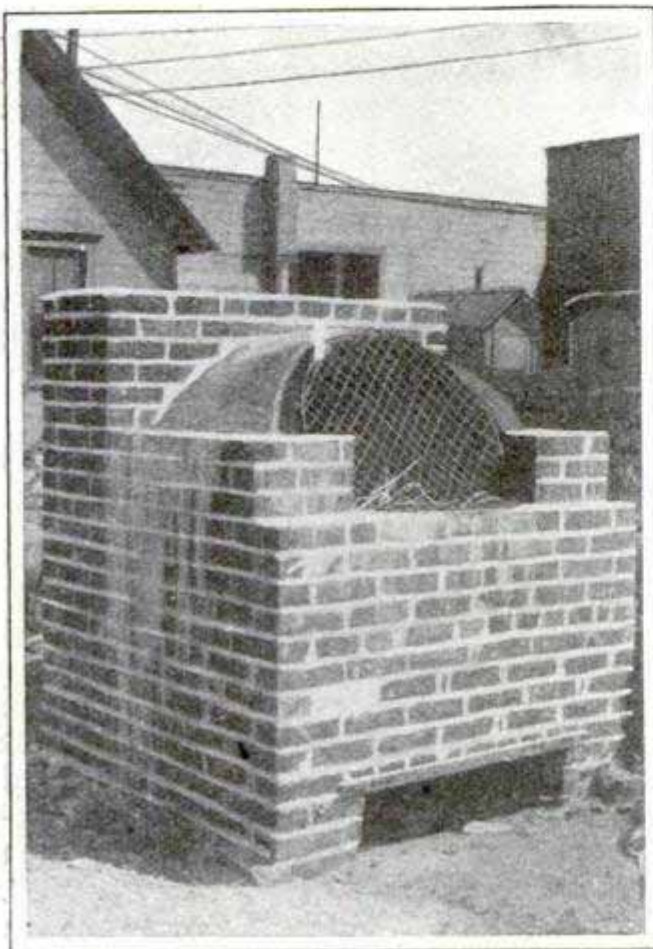

A Public Incinerator Built by a California Town to Take Care of Rubbish

naces are built of brick and do not need watching while a fire is burning inside. They are 4 ft. high with a chimney portion extending 1 ft. above the main furnace. Rubbish to be burned is dumped into the furnace through a 27-in. hole, covered with a 2-in. wire screen, in the top. A good draft is secured by a draft hole, 8 in. by 27 in., at the bottom, and the chimney flue, 6 in. by 27 in., is covered with a 1/2-in. wire screen. The chief advantage of the furnaces is that they are always ready for use and are practically fool-proof.

Out of a total of about 20,000,000,000 pieces of mail matter handled in a year by the Post Office Department, a trifle over 13,000,000, equivalent to one piece in about 1,500, are without address or are improperly addressed.

## COFFIN-SHAPED BOTTLES TO HOLD POISON

Coffin-shaped poison tablets in coffin-shaped bottles is a late design aimed to prevent avoidable accidents in handling dangerous substances by the drug clerk, or in the medicine cabinet at home. Sharp points protrude from the bottle, which may also be colored a distinctive shade. In addition to the word "Poison" on one side of each tablet, a skull and crossbones appear on the reverse.



## ELECTRIC SPOT WELDING SUPERSEDES RIVETS

A "spot welding" machine has been invented which promises to supersede riveting. The objection to rivets is that punching holes in the metal plates weakens them. No matter how carefully the rivets are driven in and how tightly they may be hammered down, the seam has inherent weakness. With the electric welder, however, plates are superimposed and welded by the electric current without a trace of weakness. The labor involved is small, the cost of the current but a trifle, and

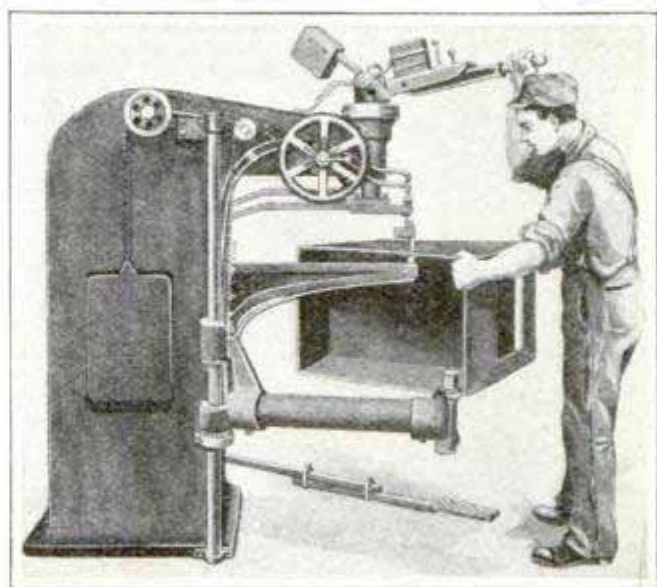

One Man with Electric Spot Welder Accomplishes More Than Nine Men Riveting by Hand

the operation far quicker than any of the older methods of riveting.



## NEW WELLAND SHIP CANAL HAS ONLY SEVEN LOCKS

That Montreal may have more shipping, the Canadian authorities are about to build a new canal through the Welland route, which materially shortens the passage between Lakes Erie and Ontario, and has 19 fewer locks than the old Welland Canal. A difference in lake levels of 326 ft. gives rise to the magnificent spectacle of Niagara, but offered tremendous engineering difficulties when the first Welland Canal was dug 90 years ago. In 1872, the second canal was dug, practically along the same route as the first, with 27 locks. The canal was deepened and enlarged. Now, by straightening the course,  $2\frac{1}{2}$  miles will be saved, and only seven locks are needed to negotiate the fall of over 300 ft. in 25 miles. A new port on Lake Ontario is being built which will bear the name of Port Weller, after the engineer in charge of construction. The bottom of the canal will be 200 ft. wide and the minimum depth over the sills of each lock will be 30 ft. The locks are longer

and will accommodate larger boats, while decreasing the number of locks shortens the time required to traverse the canal by three hours. The new waterway will cost \$50,000,000 to complete, and years must elapse before it can be put in use. Many freighters from Lake Superior, which now discharge their cargoes at Cleveland and Buffalo, can, when the new Welland Ship Canal is completed, take their cargoes direct to the docks of Montreal, there to be reloaded into ocean-going steamers awaiting them.

## TIME-SAVING DEVICE LOADS MOTOR TRUCKS

A loading device used in a lumber yard in the West is designed to save the time of the motor truck and driver. A metal framework, fitting both the motor-truck chassis and the running gear of the wagon, is first placed on the wagon, which is loaded with lumber to fill the order from different parts of the yard. It is then driven beneath a small traveling crane, and the load lifted so the wagon can

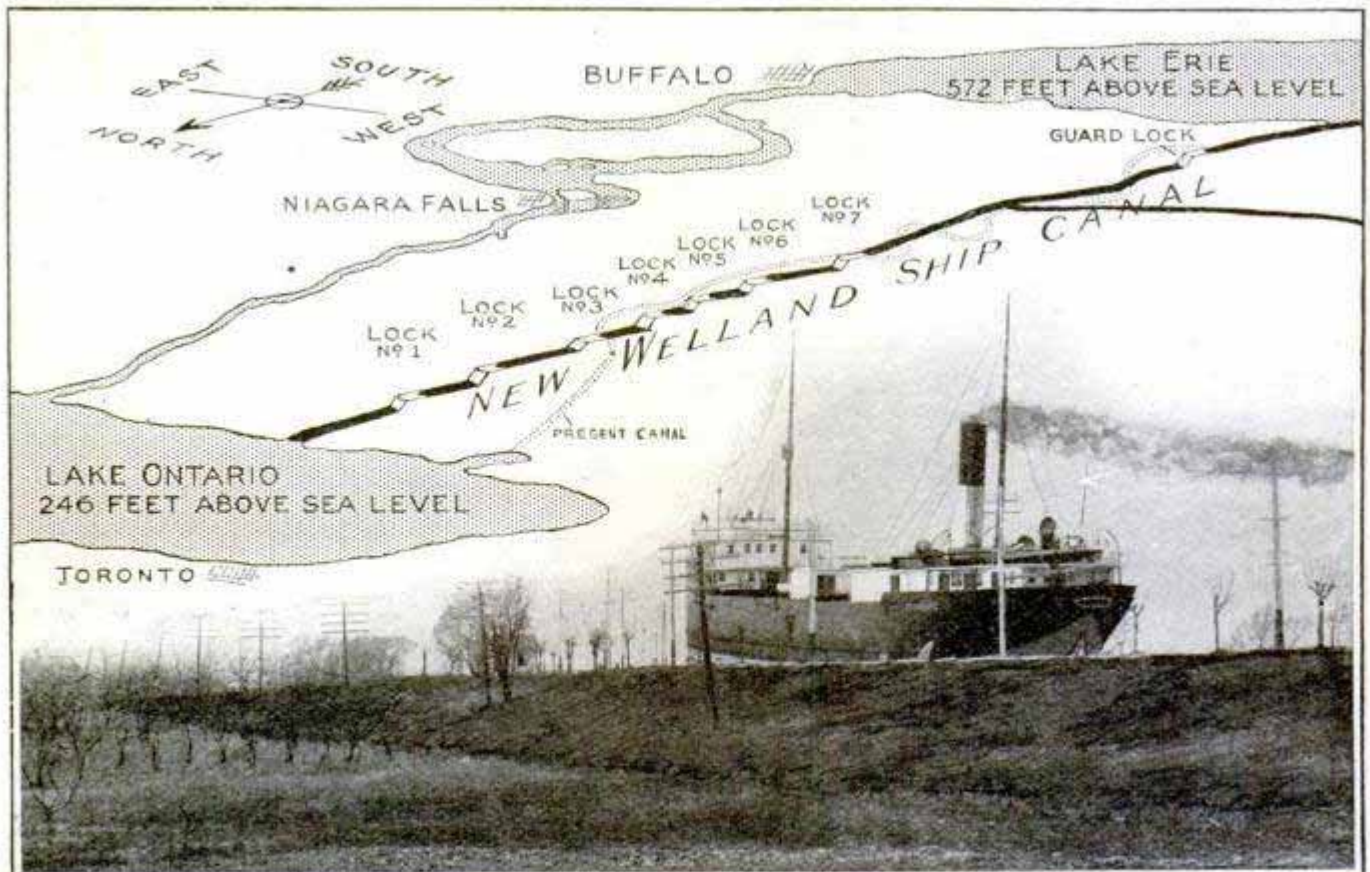

Photograph of a Ship Steaming Overland in the Welland Canal—Map of Present and New Canadian Ship Canals



be driven out. The load is left suspended at the proper height for the motor truck, which is driven under it

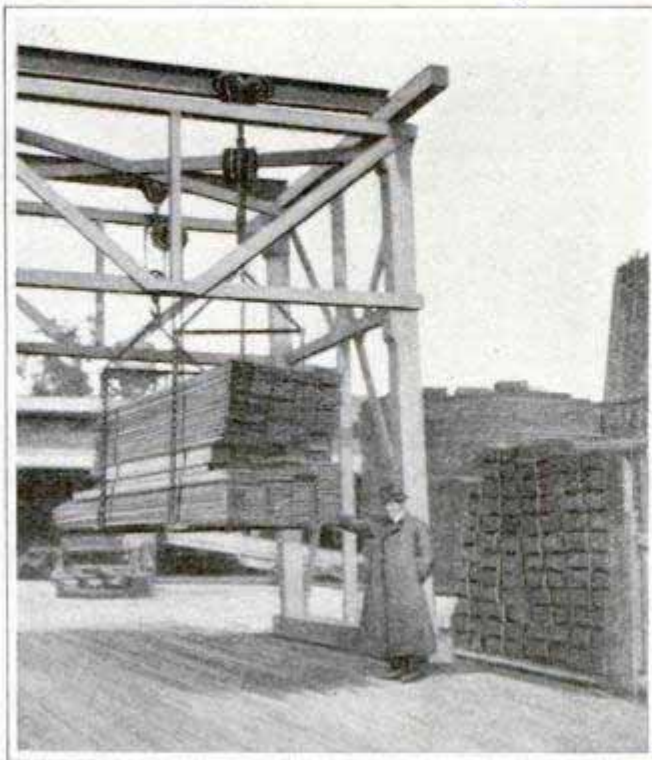

Device That Saves Time in Lumber Yard

as soon as it arrives in the yard, and the load at once lowered on the chassis. This obviates rehandling the lumber and saves nearly half an hour for each load that is sent out.

### MODERN IRRIGATION SYSTEM USES CEMENT PIPES

The citrus growers of California have adopted a modern irrigating system which, once installed, avoids the yearly ditch digging which, with repeated hoeings to keep down rank weed growths, was the bugbear of the old irrigation ditch. The system consists of a pressure box and a series of cement stations, one of which is located at the head of each row of trees. The pressure box is used to measure the water with which the orchard is irrigated. It is a cement box,  $3\frac{1}{2}$  ft. long and 30 in. wide, rising over 4 ft. from the ground, and reaching down to the water main, some  $3\frac{1}{2}$  ft. below the surface. Inside the box there is a partition which is pierced by a hole 1 ft. square. When the pressure box is full, water is passing through this opening

at a constant rate so that the rancher or orchardist knows exactly how many hour-feet of water he has used during a certain irrigating period.

From the pressure box cement pipes, 8 in. in diameter, conduct the water to the stations, which are 15 in. across, and equipped with a patent shut-off by which the flow of water from the main may be closed at any time. Thus the old basin system gives way to an underground system, which puts the water just where the feeders of the tree can reach it best, and keeps the water away from the surface, where it produced rank growths of weeds. The new system is more efficient than the old ditch or wooden flume, and needs little or no repairs or renewals. Little water is lost by evaporation and the orchards look more sightly than under any of the older methods of irrigation.

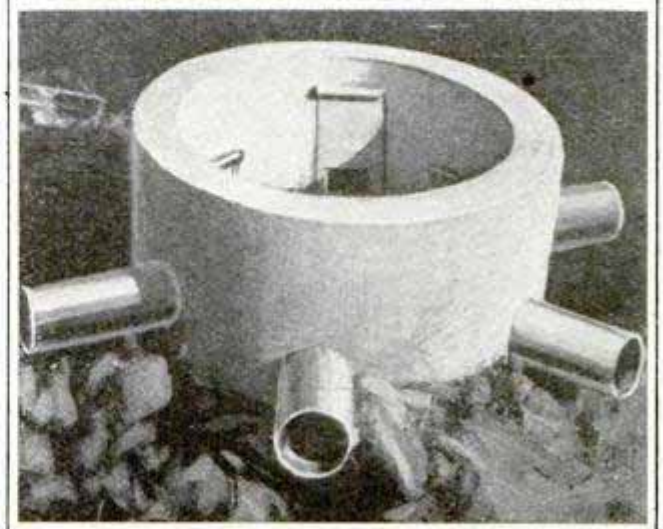
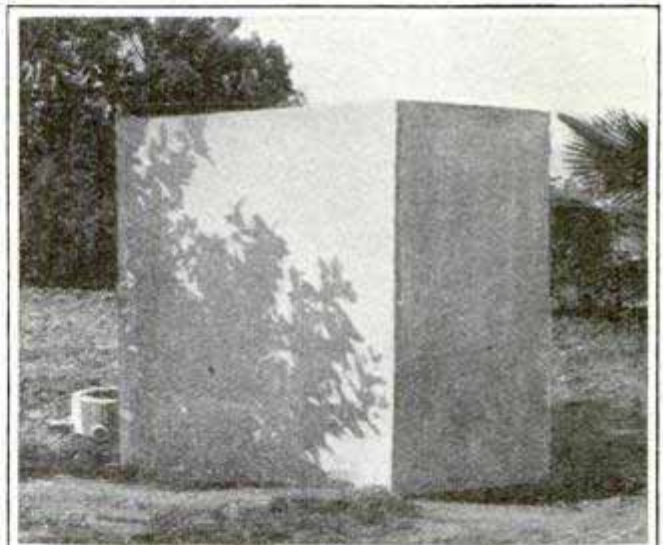

Concrete Apparatus Used in Underground Irrigation System in California Orchards



## CURIOUS DESIGNS FORMED IN CAST IRON

A metallurgist amused himself by pouring the dregs remaining in ladles

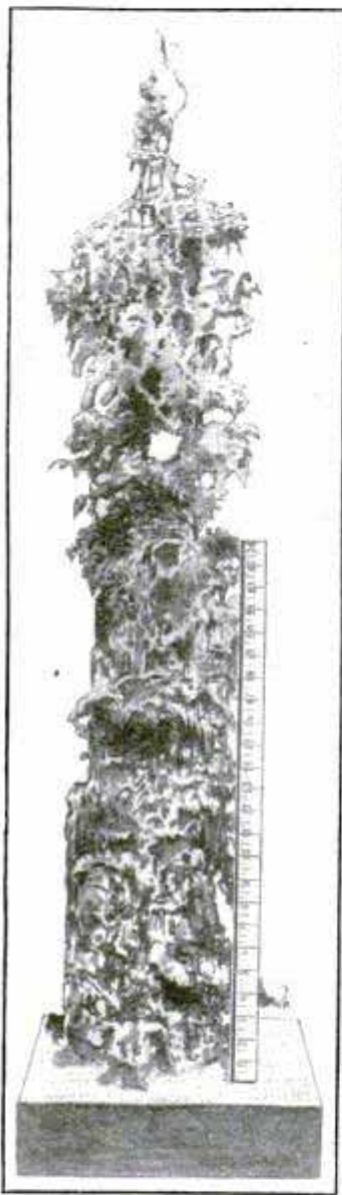

of common foundry iron into a rough wooden box, in which he had piled charcoal. The resulting forms puzzled metal workers, for the treelike shapes with their slender tendrils vibrated, if touched, for minutes at a time. It seemed impossible that such delicate objects could have been removed from the mold without breaking. The explanation is that after the molten metal had been poured, the box, which rested on sand, was removed and the charcoal allowed to burn

slowly away. It is noticeable that the treelike forms have shapes resembling birds, perched upon the branches. There are no duplicates and the varying lumps of charcoal and the finer granulations produce an infinite variety of shapes.

## NAVY OPERATES ITS OWN DINING-CAR SERVICE

The navy department has been experimenting with the plan of operating its own dining-car service when transporting drafts of men by rail, and

with such satisfactory results that this plan will be followed hereafter for large bodies of men and over considerable distances. It has been found that the department can feed its own men better than was the case under the old arrangement with the railroads, and at considerably less cost. The food is prepared in a tourist kitchen car, which is simply a regular tourist sleeper with two sections removed and a large coal range installed in their place. The remainder of the kitchen car is used as a sleeper. A table is provided for each sleeping section on the train and the bluejackets are fed in their own sections. Between meals the tables are removed or may be used by the men in reading, writing or card playing. With this arrangement the regular seagoing routine can be followed. When a meal is to be served, the mess call is sounded by the bugler. At 6:30 in the morning the reveille is sounded, while taps is sounded at 8 o'clock at night.

## A JAPANESE GARDEN IN AMERICA

Near Philadelphia, one of the finest Japanese gardens in America has recently been completed. For two years Japanese gardeners have been at work making this a perfect reproduction of the garden so familiar to tourists in the Kingdom of the Cherry Blossoms. A stone with symbolic markings is always placed at the entrance to ward off evil spirits, hence its name "Protective Stone." The sacred crane and other animals all have a part in the mythology or folklore of ancient Japan. The gardens are illuminated at night by real Japanese lanterns. The stones, plants and even the sacred lions from the temple gardens were all brought from Japan and are set in accordance with Nipponese customs and with due regard to the esthetic ideals of the Orient. The result is picturesque in the extreme, and the contrast with adjoining gardens impressive.





Symbolical  
Stone Piece  
from Korea



Stone Lions  
from Sacred  
Temple  
Gardens



Lantern in Form  
of Pagoda

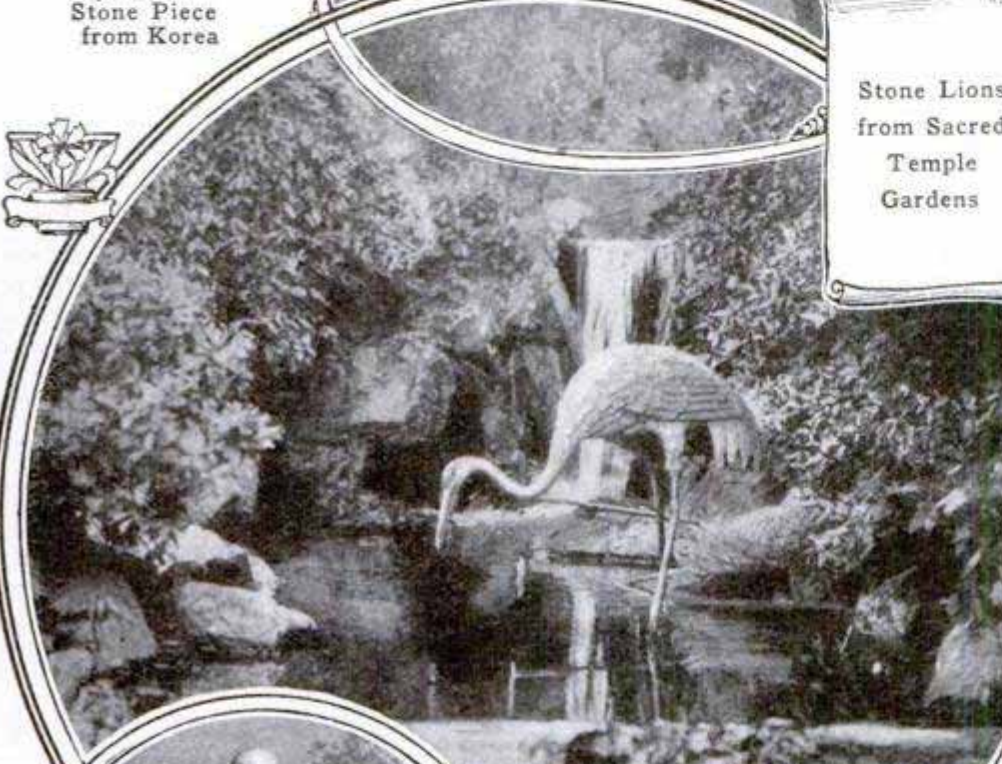

Sacred Crane  
beside  
Pool



Japanese Lantern  
with Crescent



Protective Stone at the Entrance of a Curious  
Japanese Garden Built near Philadelphia



### NEW SMOKE-PROOF HELMET FOR FIREMEN

A light helmet designed to protect firemen in dense smoke, poisonous gas or ammoniacal fumes has been adopted



French Fire Brigade Equipped with Self-Breathing Helmets

by Paris fire brigades, and might also be used to advantage in mine-rescue work. It is termed a "self-breathing" helmet from the fact that it is hermetically sealed about the head and shoulders of the wearer, whose breath is purified by chemicals, and the oxygen content replenished from compressed-oxygen bottles strapped to his back. Thus the firemen breathe perfectly pure air and are at the same time wholly cut off from the smoke or fumes which may fill the apartment.

### AUSTRALIAN BEEF AT LOW COST FOR OUR NAVY

The Secretary of the Navy recently authorized the purchase of 285,000 lb. of Australian beef at \$11.90 per 100 lb., as compared with \$12.49 per hundred asked by American packers. Canned corned beef was bought for the navy at a price of \$15.37 per hundred for Australian beef, as against \$23.31 per hundred for American corned beef. The purchases followed the passage of the tariff bill permitting the free importation of foreign meats.

### MAGNETIC-SURVEY VESSEL SAILS 80,000 MILES

Accurate reading of the mariner's compass on board modern steel ships is accomplished only after involved calculations, in which allowance is made for error due to aberration of the needle by reason of the immense amount of steel and iron used in the ship's construction. In addition to this, known variations of the needle in the same localities at different seasons of the year make navigation difficult. To determine the absolute magnetic north and to correct the inaccuracies of regular navigation compass points, the Car-

negie Institution built and equipped a nonmagnetic ship, in which brass, bronze and composition metals were used instead of iron or steel, and sent her out four years ago to make a magnetic survey of the world. This remarkable vessel has just returned, after a cruise of more than 80,000 miles, and the mass of data gathered is in the hands of hydrographers. New maps will show definitely the magnetic variations at intervals of 200 miles on all the important shipping lanes of the sea. The "Carnegie" is a wooden ship, 155 ft. long, with a beam of 33 ft. No nails or screws of iron or steel were used, and even the small auxiliary engine carried contains less than 600 lb. of steel. Sails were mainly relied on to give propulsion, and the auxiliary engine was used only in cases of emergency and for maneuvering in port.

It is estimated that the combined cost of replacing wooden cars with steel cars and installing suitable signal service on all railroads of the United States will amount to about \$1,000,000,000.



## GLASS COOKING UTENSILS PROMISED SOON

A New York glass manufacturer is experimenting with the making of cooking utensils of glass. Already glass percolators and stewpans have been made which, although they rest on the flames, give no evidence of cracking, and have proved heat-resisting and nonexpansive. These utensils are apparently not affected in any way by the intense heat under them or by the contrasting temperatures of the articles which they contain. Glass is for many reasons superior to either enamel or aluminum, being affected by none of the acids or alkalis formed or used in cooking and not subject to the insanitary cracking which is characteristic of most enameled ware.

## PORTABLE ELECTRIC LIGHT GERMAN INVENTION

A hand lamp has been invented in Germany which is adapted to a large variety of uses where either alternating or direct electric current is available. An electric arc, giving 6,000 cp., is contained in a lamp only 9 in. wide and 7 in. high. The lamp is particularly useful in confined spaces.

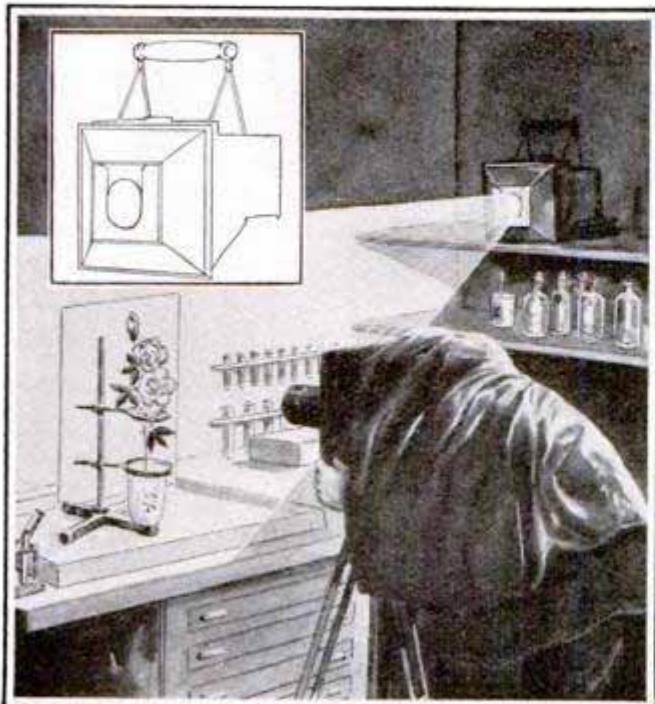

Small Electric Hand Lamp of High Power

## TOWER FOR COOLING WATER IN CONDENSER

An unusual cooling tower which has been built on the roof of a Philadelphia dairy company's building to cool the

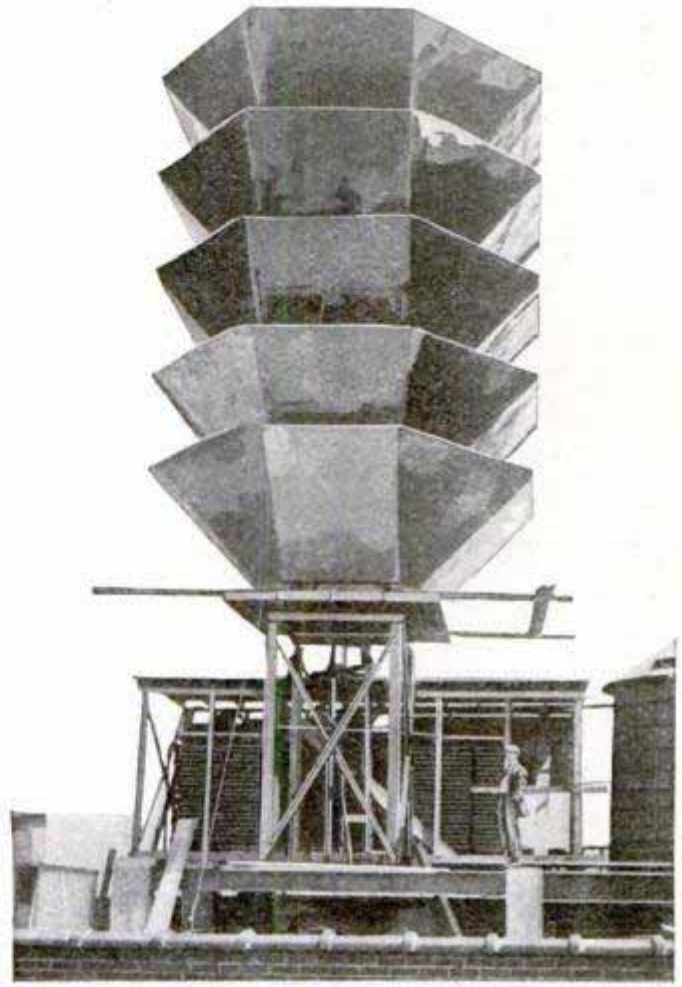

This Tower is Used to Cool the Condenser Water of a Refrigeration Plant

water used in the condenser of an ammonia refrigeration plant is shown in the accompanying picture. After the water has passed through the condenser coils in the background it is circulated through the cones of the tower and used over again instead of being run off. The ammonia tanks are at the right of the tower.

CA French airman recently ascended in a monoplane to a height of 20,295 ft., in 1 hour and 35 minutes, breaking the world's altitude record of 19,300 ft.

CA An economical process for extracting pure radium salts from carnotite ore has been discovered by a German scientist.



## LIMOUSINE DE LUXE FOR A RUSSIAN NOBLEMAN

A German automobile concern has manufactured a car for a member of the Russian nobility which is a model

proaches and passes through. The door is built of yellow pine, and is 7 ft. high by 8 ft. wide. Attached to the ribs in the passageway, 300 ft. on either side of the door, are switches, operated by the motorman in passing,

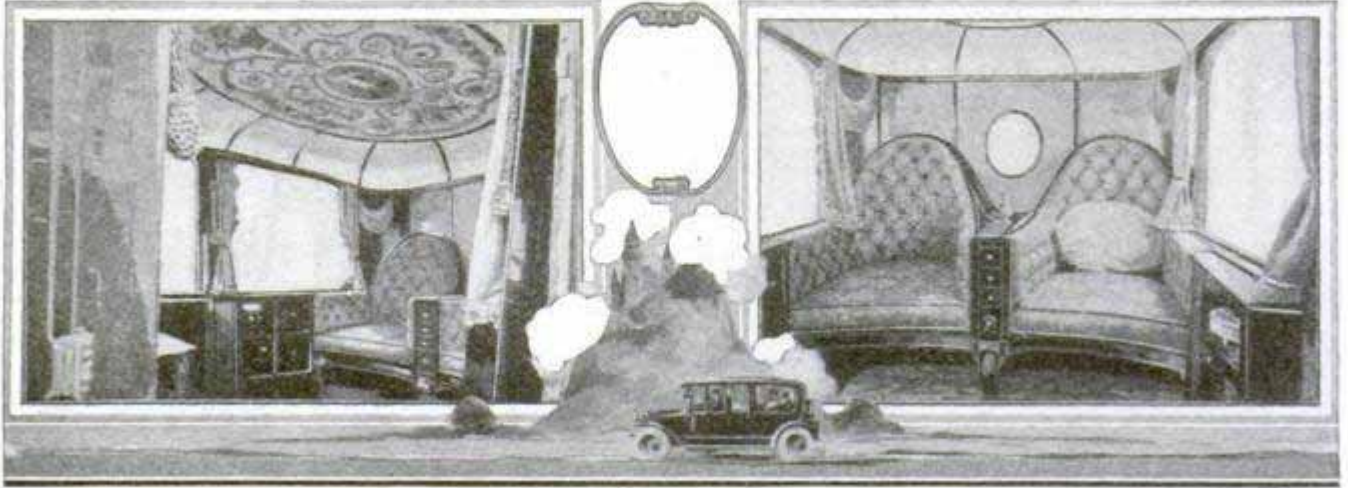

Luxurious Interior of Automobile, with Side Cabinets and Tapestried Ceiling. At Right, Comfortable Cushioned Seats with Nest of Drawers between Chairs

of elegant comfort in transportation. It is the interior rather than the exterior which attracts attention, for both art and ingenuity have been combined in the luxurious arrangement of seats, cabinets and lighting effects, while the upholstery on ceiling and seats is tapestry of special design.

which throw the current on a small motor situated near the door. A spur gear on the end of the armature shaft drives cylindrical drums which wind up the cable attached to the door, swinging it open. When the motor passes, the operation of the opposite switch reverses the motor and the door swings shut.

## AUTOMATIC DOOR FOR MINE OPERATES ELECTRICALLY

A door in a Pennsylvania coal mine is equipped with an electrical mechan-

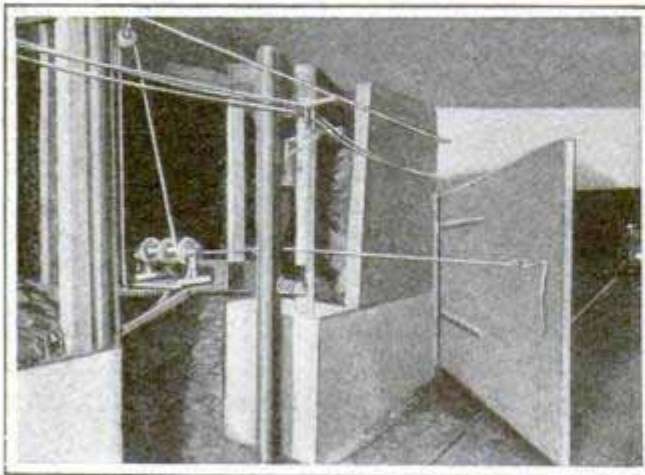

Electrically Operated Door Requires No Tender

ism by which it opens and closes when the small motor trolley car which hauls the coal out of the mine ap-

## PHOTOGRAPHIC TELESCOPE LONG IN MAKING

Seventeen years ago an order was placed in France for the glass from which a lens was to be ground for the largest photographic telescope in the world, which a wealthy Pittsburgh manufacturer gave to the Allegheny observatory. It was not until 10 years later that the piece of glass was shipped, owing to the difficulty of getting a perfectly homogeneous cast. When an American firm attempted to grind the lens, a flaw developed, and all the work was lost. A German firm then prepared another piece of glass, and after six years it is now on its way to America, and it is expected to be ground and in place before the end of 1914. The mechanism of the telescope has long been completed, and comprises a movable dome and floor, oper-



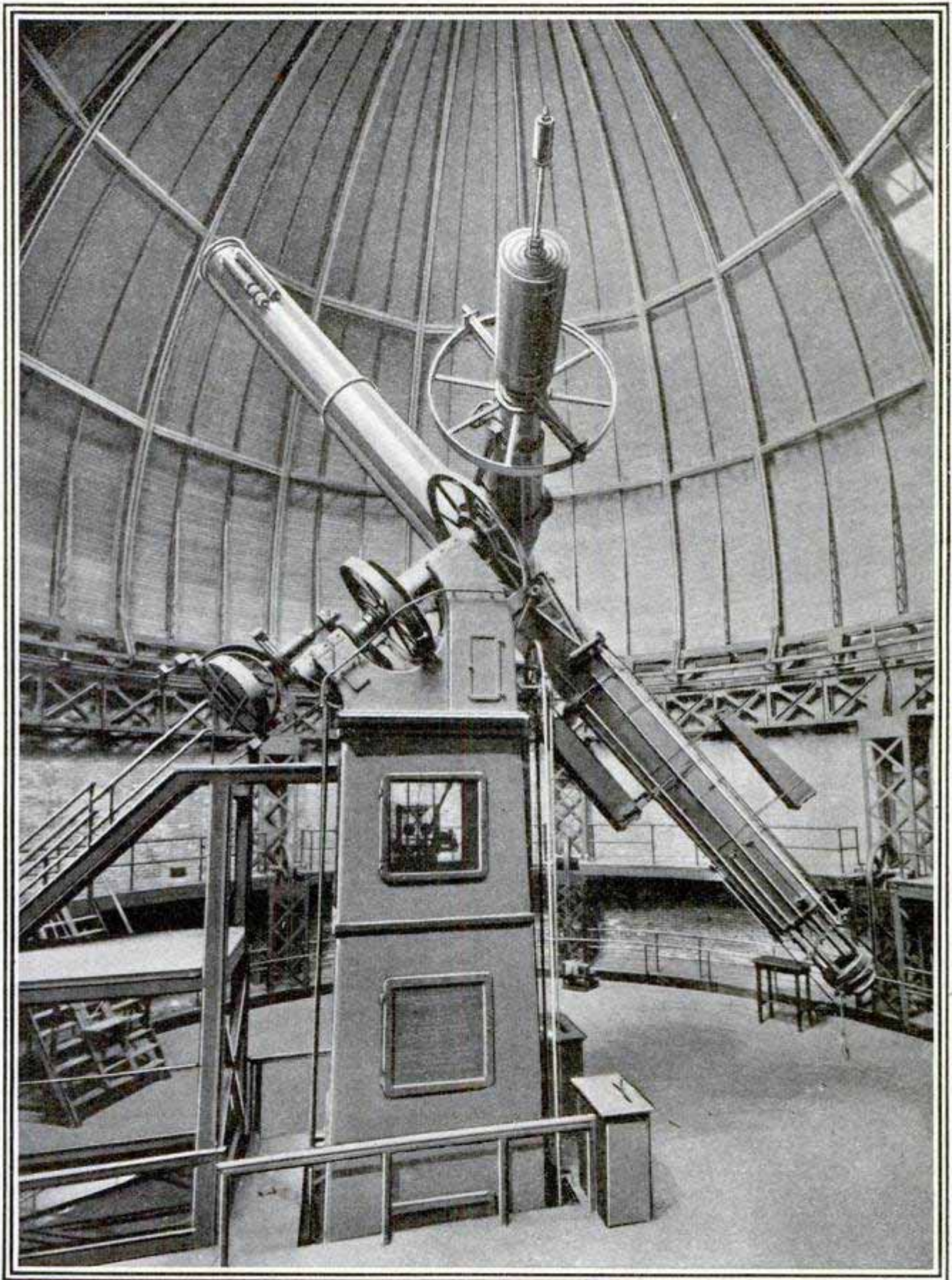

For 17 Years Glass Makers have been Trying to Produce a Perfect Lens  
for This Photographic Telescope

ated by electricity, controlled by clock-work. The pier supporting the telescope is sunk independently of the observatory walls, giving a minimum of

vibration. The diameter of the lens is to be 30 in., and the length of the tube is 50 ft. It will be used exclusively for photographic work.



### THREE-WHEELED MOTOR CAR FOR DELIVERY WORK

Three-wheeled motor trucks with two wheels at the front and one at the rear are the latest thing in the way of vehicles for delivery purposes. The body of the truck is so built that

Three-Wheeled Motor Truck Specially  
Designed for Delivery Work

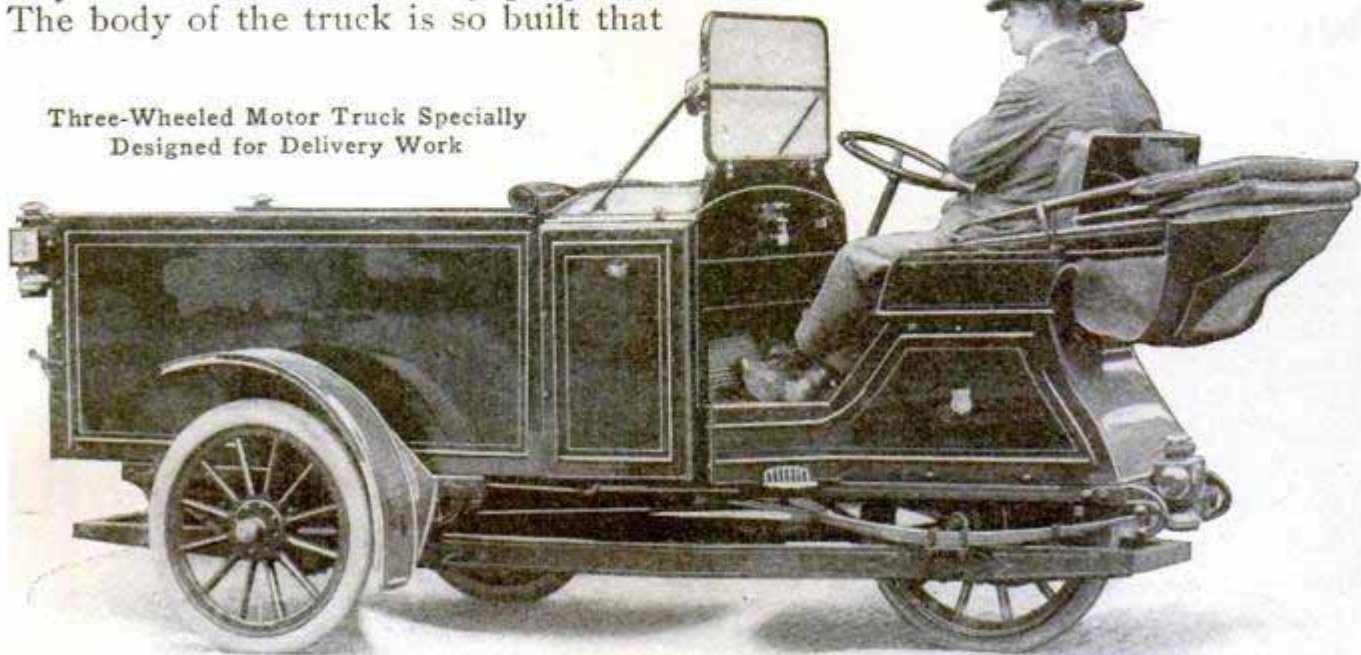

the greater part of the load is carried on the front wheels, and the vehicle is also steered with these wheels. Power is applied through the rear wheel and one of the advantages claimed for this type of car in addition to its lightness, is that by using one power-driven wheel the necessity for complicated differential gear is done away with. The car shown in the illustration weighs 1,800 lb. and is capable of carrying a load of 800 pounds.

### HIGH SCHOOL HEATED BY ELECTRICITY

The first instance of a large building being heated electrically at a cost below that of other systems is the new high school at Rupert, Idaho, in the center of the Minidoka irrigation project. The power is furnished by the government power house connected with the irrigation system, situated 14 miles above Rupert, at a cost low enough to compete successfully with coal.

Hot-air heating is adopted, and the

usual arrangement of hot-air pipes, flues and ducts is adhered to, but instead of a furnace or boiler, a battery of electric-heating units, similar to those used in electric bake ovens, pro-

vides the heat. Twenty 18-kw. units are installed in pairs, each pair separately controlled from a switchboard in the office of the principal. An emergency switch makes it possible to cut out all current—heat, light and power—from the entire building, so, in case of accident or fire, the lives of the students may be protected.

Electricity, besides heating the building, lights it, ventilates it and runs the machinery of the manual-training department. In the chemistry department, hot plates and small electric furnaces supplant the familiar Bunsen burner; in the domestic-science rooms, each girl of a class of 20 has her individual electric-disk stove and all necessary cooking utensils. An electric water heater supplies shower baths, lavatories and science rooms with an abundance of hot water, and the cafeteria is equipped with an electric range and other equipment for serving meals on a large scale.

It is estimated that the cost of heating the high school by electricity will amount to \$1,760 per year. Enough coal to heat the building would cost



\$1,000, but the use of electricity saves the wages of a fireman at \$75 per month, and the cost of installing the electric system was \$3,000 less than for any other system of heating that was under consideration.

### GOVERNMENT SELLS TIMBER FROM FOREST RESERVES

More than 2,000,000,000 board feet of timber was sold by the forest service last year with a value of \$4,500,000 on the stump, according to the annual report of the Department of Agriculture. The forest service aims first to prevent fire losses, and also to utilize the ripe timber which can be marketed. In this way forest permanence and restocking is assured, speculative monopolies discouraged, and the cost of administration and production paid. Already the Alaskan forests more than pay the costs of their supervision, and several national forests are paying their operating expenses. Twenty-five per cent of the receipts from the sale of timber in national reserve forests go to the particular states in which such reserves happen to be situated.

### MODERN SUIT OF ARMOR ADVERTISES WARES

An advertising novelty seen in a parade in an Illinois town consisted of a complete suit of armor made of galvanized sheet steel. The upper part of the suit was lipped on over the head of the man inside, resting on his shoulders, and bringing his eyes on a level with the white screen used as the shirt front of the giant, permitting him to see where he was going. The trousers were made in movable sections allowing free locomotion, and his shoes were painted to correspond with the galvanizing of the armor. The effect was fully as spectacular as a suit of genuine antique armor would have been.



### CARRYING A GREAT CANAL OVER A RAILWAY CUT

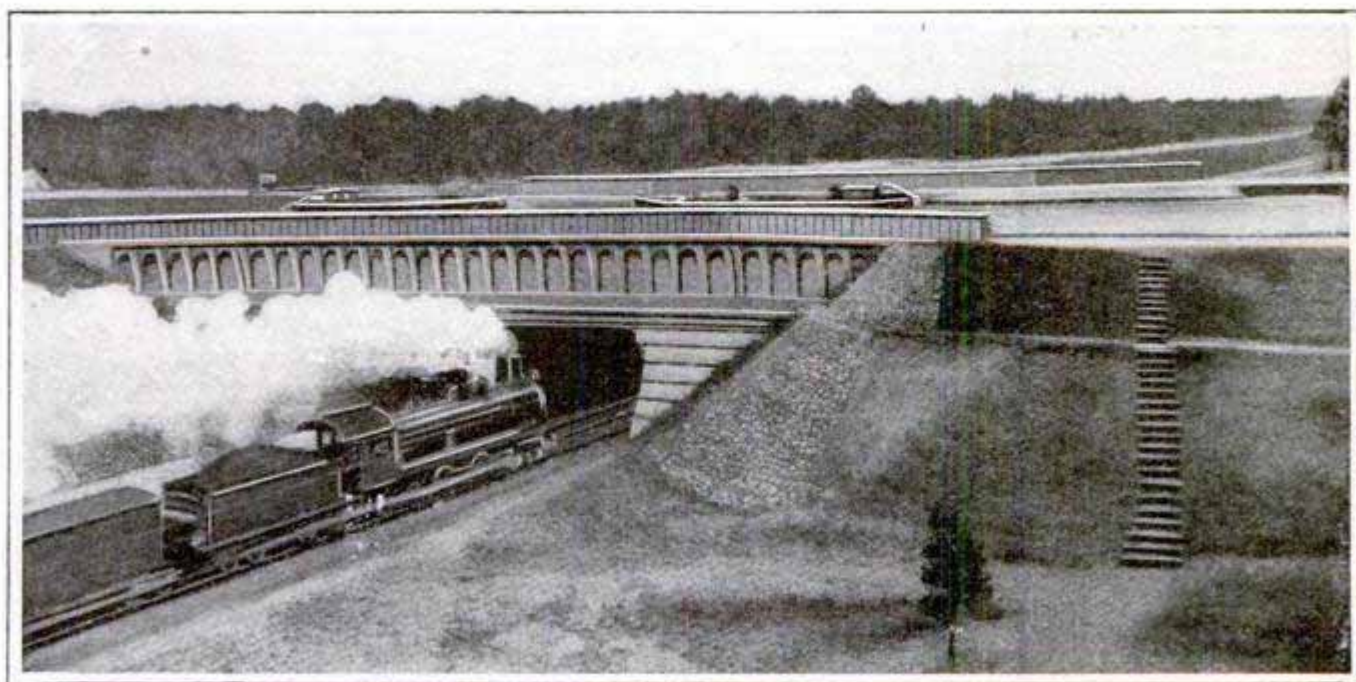

The Great Berlin-Stettin Canal Passes through Some of the Richest Farming Lands of Germany. It is Here Shown Carried across a Railroad on a Handsome Stone Viaduct



## NOVEL SIDECAR ADVERTISES WARES

A merchant of Paris who deals in sporting goods has designed an in-

Delivery Car  
in the Shape of a  
Boxing Glove



genious method of advertising his specialties, by constructing a delivery

van, built like a sidecar, in the shape of an enormous boxing glove, which bears his name and address prominently on the side. The curiously shaped car attracts much attention.

## ELECTRIC REGULATOR FOR STREET TRAFFIC

The traffic squad of Cleveland will control the movements of vehicles and pedestrians at street crossings by the use of an electric traffic regulator. Patrolmen stationed on slight elevations at street intersections operate the system, causing red lights to flash when the warning to stop is given, and white lights signal "proceed." An automatic bell takes the place of the whistle.

## WHAT THE AIRMEN ARE PLANNING

By L. J. LESH

The recent feats of Pegoud and Beachey, the new automatic stabilizer, the troubles of the dirigibles and the ever-present possibility of transatlantic flight are the constant subjects of conversation among airmen, and he who would forecast the future of aviation may obtain his best lead by talking with the airmen themselves.

At Hammondsport, N. Y., there is a boarding house known as "the aviators' roost." Here 15 or 20 airmen and inventors of aeroplanes gather daily, and after dinner, under the soothing influence of good tobacco, the imagination of the most alert and practical men in the game is given free play.

Transatlantic flight is the center of interest, and among the problems considered is that of transferring gasoline from one aeroplane to another during flight. An ingenious solution was offered by one airman, which is illustrated in the accompanying picture. The upper machine has sailed up from the supply boat, and is letting gasoline down through a tube to the speedy monoplane which is winging its way

across the ocean. Thus there will be no time lost and no necessity to risk a stop on the sea. No difficulty is anticipated in accomplishing this feat, and all admit that under certain conditions it would be the only possible way of supplying the cross-ocean flier with fuel to continue on his trip. It was suggested that the tube must be equipped with a valve on its lower end so that no gasoline could be spilled when the tube is disconnected from the lower machine.

The possibility of launching an aeroplane from the top of a dirigible is much discussed, and we may expect to see this feat accomplished in the near future. As shown in the sketch, the plane might be launched from the broad back of a dirigible with little difficulty. It is pointed out that the speed of a Zeppelin is frequently 45 miles an hour, which would give the aeroplane sufficient speed for support without a preliminary run. The machine would simply be clamped down to the dirigible and then released to spring in the air. When it was suggested that eddy currents, developed



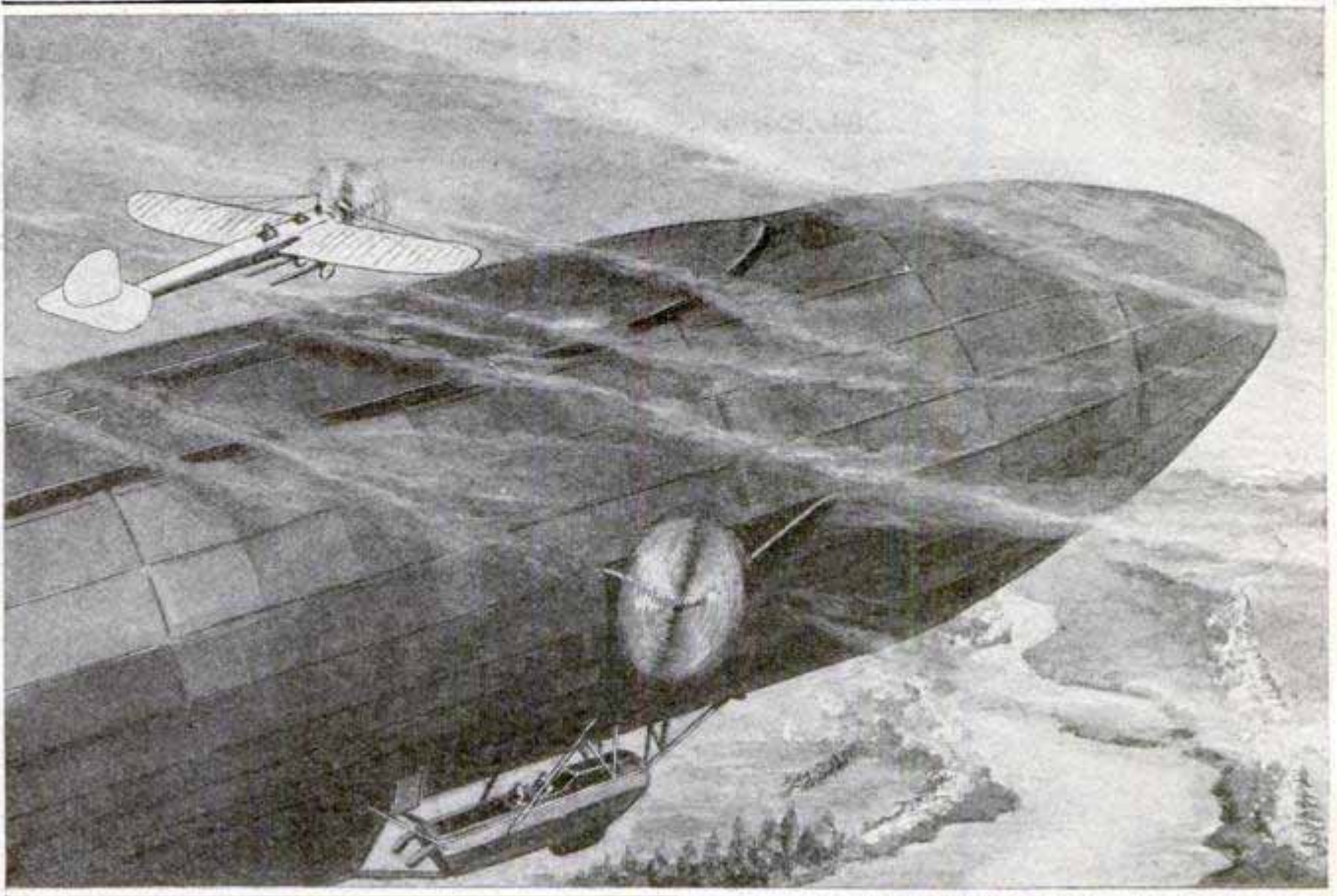

Monoplane Rising from the Broad Top of a Dirigible.  
Below, Proposed Method of Supplying Air Boat  
with Gasoline in Transatlantic Flight

around the body of the balloon, might present difficulties for the airman, an alternative was proposed. The dirigible, it is urged, might slow down, floating with little speed relative to the air, and then be pointed downward, so that the aeroplane could speed up and obtain a good start in undisturbed air.

In landing on the back of a dirigible, both aeroplane and balloon would maintain the same speed, and the plane would drop slowly down and be held in place by half a dozen men until it could be securely fastened to the landing platform. The value of folding wings for the aeroplane, such as developed recently by foreign inventors, will be appreciated when it is desired to carry planes on the back of dirigibles, for it is apparent that an aeroplane with wings outspread would present a large item of resistance with the dirigible traveling at 45 miles per hour. That the motor of the aeroplane could be kept running and thus help the dirigible to speed was another suggestion received with enthusiasm.

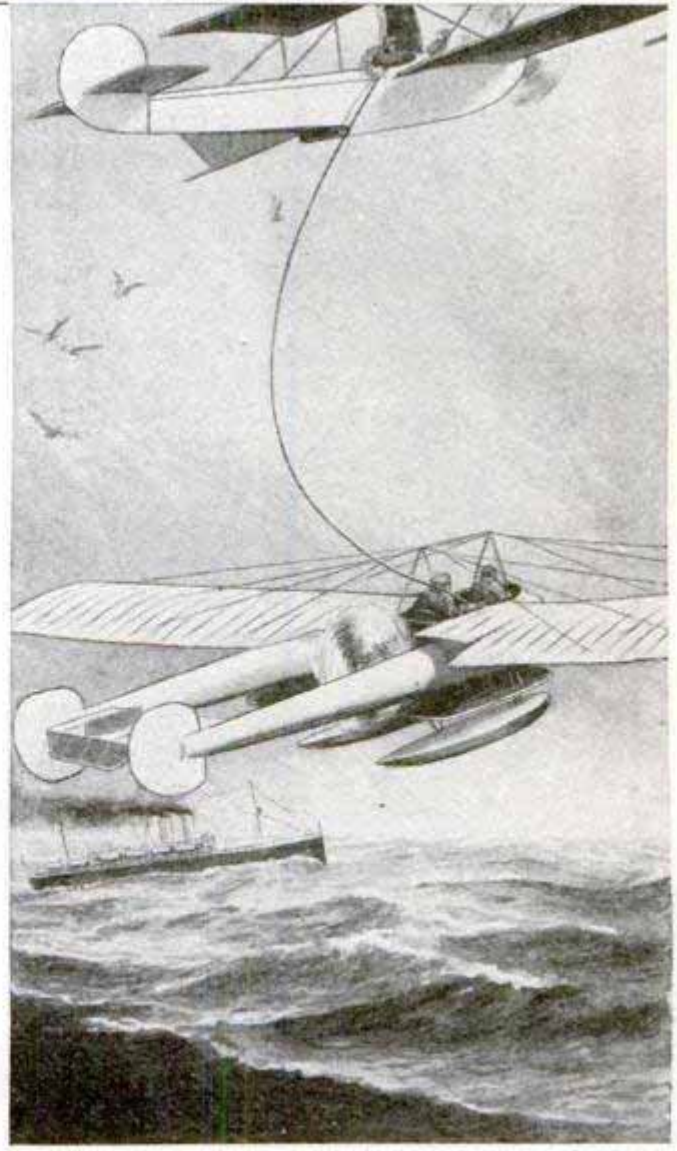



## TALL STEEL STACK WITHOUT GUY WIRES

A steel smokestack, over 204 ft. high, which stands firmly without the support of guy wires has been built for an electric-light company in Louisville. The diameter of the stack at the bottom is 20 ft., gradually decreasing to 13 ft., which is maintained to the top. The stack is built of soft-steel plates, lined with fire brick, and is surmounted by a cast-iron cap, and also has an exterior circular Z-shaped bar, which forms a track for a painter's trolley. The space between the brick lining and the steel shell is completely filled with cement grout.

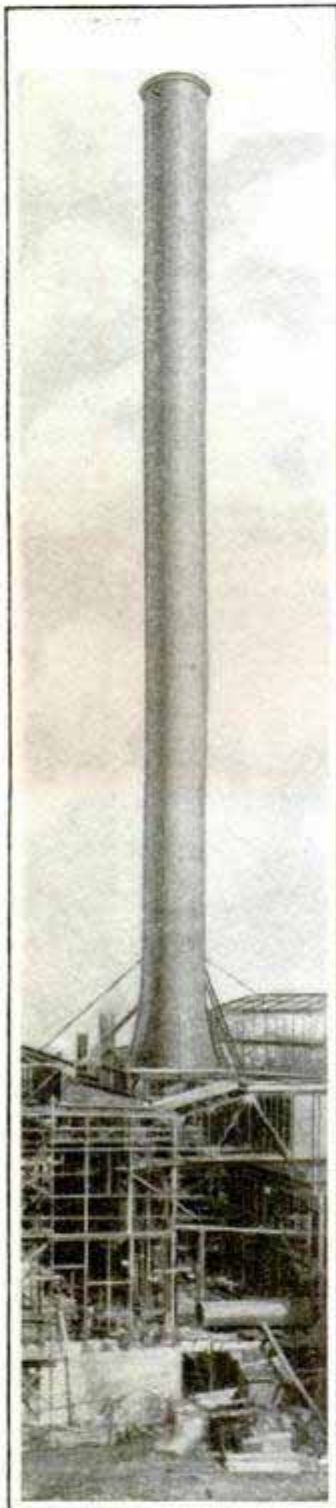

## COOLS HOUSE WITH AIR FROM DEEP WELL

An Oklahoma well digger who had sunk a shaft to a depth of 50 ft. was surprised when the bottom dropped out, revealing a cavern of considerable extent, from which there was a strong flow of ice-cold air. Upon sounding the cavern, an abundance of cold water of good quality was found, which affords an inexhaustible source of supply for house and farm. The top of

the well was sealed with a concrete cap, through which pipes lead from the well to the house. One pipe brings water for household use and the other carries cold air that is piped through every room of his residence. This reduces the temperature many degrees even on the hottest days.

## PORTUGUESE BLACKSMITHS SHOE OXEN

The ox is largely used in Portugal as a transport animal, and is shod in the same manner as a horse or mule, except that the cloven hoof of the ox necessitates the use of two shoes, in the form of semicircular plates, on each foot. To the tourist the sight is a strange one, for owing to the ability of the ox to administer a very swift and powerful kick, extraordinary precautions are adopted to protect the blacksmith while performing the operation. A ponderous wooden frame is provided, from which the ox is suspended by means of straps over rollers. Once in position and hoisted clear of the

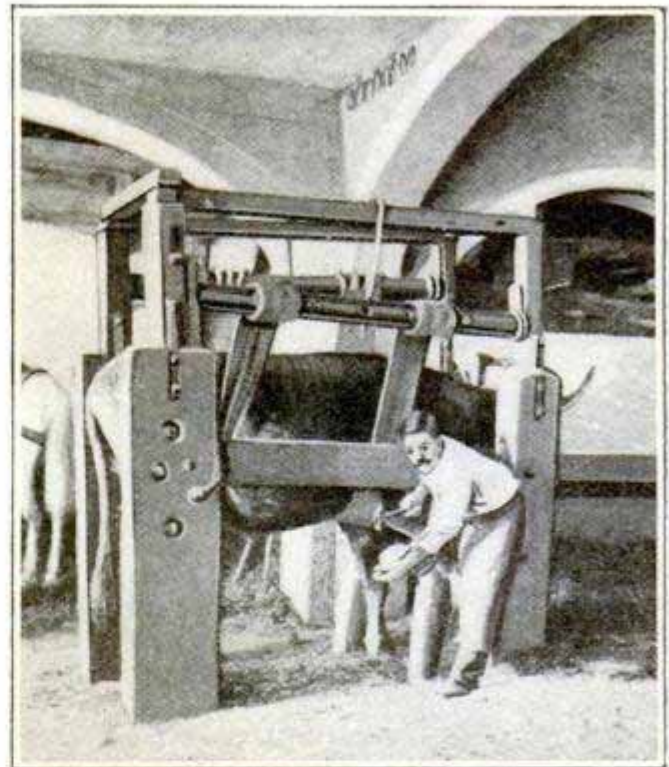

Scene in a Portuguese Blacksmith Shop

ground, there is no opportunity for movement until the curious job of farriery has been completed.



## CURVED FILES USED IN AUTOMOBILE WORK

Considerable filing has to be done in making up the sheet-metal bodies

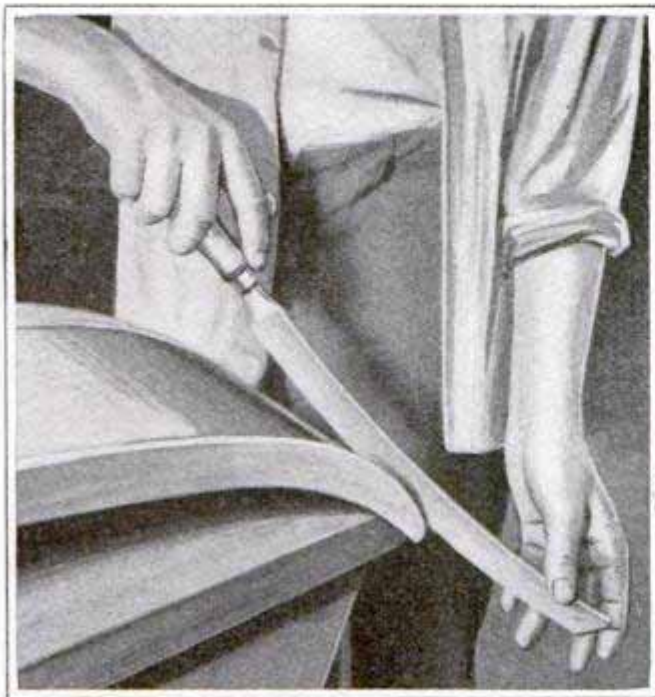

Curved Holder for Flexible File Blades

for automobiles, such as in cleaning up the joints which have been brazed, and curved files have been found to give the best results. The latest file brought out to meet this demand consists of a curved base, upon which a file blade is mounted, made of steel which will withstand bending in a cold state. When the file wears out, it is easily removed, and a new one may be mounted in its place.

## NEW FENDER SETS BRAKES AUTOMATICALLY

A patent has recently been issued for a safety appliance for vehicles consisting of a fender connected with the air-brake mechanism of street cars, by which a quick stop is made when any object is struck by the fender. The brakes are ordinarily set by hand control, as in common practice, but the automatic stop is independent of this manual control, and becomes a positive emergency brake upon impact on the fender. It is claimed the slightest obstruction will operate the device.

## AEROPLANE PASSENGER SERVICE

An aerial suburban passenger service is to be established in Chicago. Two flying boats are to be run from Grant Park, the down-town lake front, to the fashionable suburbs on the north shore. It is expected that the line will start May 15, 1914, and the advance time-table shows all suburban stops northward as far as Lake Forest, 28 miles distant. The speed planned will exceed a mile a minute, and a flat rate of 50 cents a mile will be charged. On Sundays the regular suburban trips will be cut, and excursions to other points on Lake Michigan are contemplated by the promoters.

## INDIAN MAKES RAZOR OUT OF OLD FILE

Among the Osage Indians it is a custom to shave the heads of warriors, leaving only a narrow strip for a scalp lock, running from the forehead to the back of the neck. A traveler saw in the Indian village of Pawhuska, in Oklahoma, a razor used by the Osages for ten years, which had been hand made from an old file. The work was done by a member of the tribe, now nearly a hundred years old, and his only tools were a hand bellows, a flint hammer and an emery rock. The razor is a demonstration of his skill, for it is nearly as perfect as if made by machinery, the edge of the blade being sharp and straight, while the handle is but the old file unchanged. The Osage Indians are wealthy on account of the royalties paid on oil lands owned by the tribe. Despite this, however, they maintain many tribal characteristics, and to this day the scalp lock is preserved, especially by the elder men.

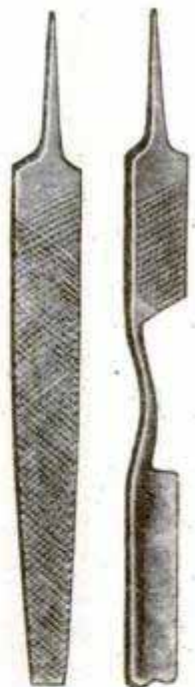



## SOLDIERS' MONUMENT BUILT OF CONCRETE BLOCKS

The monumental shaft to the memory of the soldiers who fought during the Civil War, erected by citizens of Casey, Illinois, is constructed of concrete blocks after a design by an 80-year-old veteran. It is 60 ft. high and 18 ft. square at the base. There is a stairway inside by which the top of the pile may be reached, and a flagpole surmounts the monument, which is located in the village cemetery. The monument cost about \$1,600.

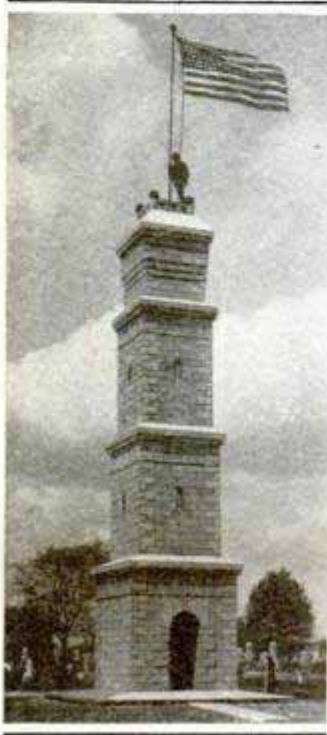

mounts the monument, which is located in the village cemetery. The monument cost about \$1,600.

## REINDEER HERD IN ALASKA THRIVES IN NEW HOME

Only a few years ago the Department of Agriculture sent a herd of

reindeer into Alaska as an experiment to solve a troublesome transportation problem. The animals have flourished and the herd now comprises over 2,500 head. The illustration shows some hundreds of these beautiful animals at a boat landing. The white, or albino, reindeer in the foreground is of unusual interest, as these specimens occur only rarely.

## PRECAUTIONS TAKEN IN POWDER MANUFACTURE

Powder manufacturers are constantly on the alert for methods and means to minimize factory explosions. So far as practicable, they maintain a large number of small factories scattered over a dozen states. Each of these plants is built with an eye to possible explosions, the foundation and three walls of each building being substantial, while the roof and the remaining wall are of the flimsiest character. When the accidental explosion occurs, the roof and weak walls readily give way before the charge, the remainder of the building standing practically uninjured. Semiautomatic machinery is also used wherever possible, designed so that it may be operated largely from points outside the structure in which it is housed. This combination of explosion-proof buildings



Where Santa Claus Recruits His Stable: One of the Reindeer Herds of Alaska

Courtesy The Valve World



and long-distance operation is steadily cutting down the losses due to explosions, if not their number.

### MIRROR MAKES WIRELESS FLASHES VISIBLE

A new wireless receiver, intended particularly for use on aeroplanes, is



equipped with a mirror which reflects the wireless flashes so that the operator sees the message instead of hearing it. This device serves to overcome one of the awkward and often dangerous features connected with the use of wireless apparatus by an airman. Heretofore the airman has been compelled to strap the receivers over his ears. This interferes with his hearing the engine distinctly, a thing of the utmost importance in the operation of air craft. Yet, without the earpieces, the noise of the engine interferes greatly with the sound of the wireless.

### HOTEL PLANS BALLROOM ON SPRINGS

A new hotel in Spokane is having a ballroom built which will lend a buoyancy to dancing that is impossible on the rigidly fixed floor. The novel dancing floor is suspended on resilient steel cables, and is constructed on the principle of a suspension bridge, to allow of "give" under the swaying of the dancers. It is stated that while this new construction has been used in private houses, this is the first instance of its adaptation on so large a scale for a public ballroom.

### CRUDE OIL AS LOCOMOTIVE FUEL

During the last few years crude oil has replaced coal as a locomotive fuel on many of the railroads of Texas, Oklahoma and Louisiana, and, in less degree, in some of the other states. More than 1,200 oil-burning locomotives are in use on the Southern Pacific and more than 800 on the Santa Fe. It is estimated that about 32,000,000 gal. of oil was used for fuel by the railroads of the United States in 1912, and that the total mileage of railroads operated with oil is now in the neighborhood of 30,000.

### METHOD OF SMOOTHING OLD ASPHALT PAVEMENTS

A smoothing treatment for asphalt pavements that is being successfully applied in some of the larger cities does away with the necessity of cutting out and replacing sections of pavement that have become rough through a combination of heavy traffic and hot weather. The asphalt surface is first heated to a semifluid state, this being accomplished by oil flames confined under a steel hood that is lowered over the section to be treated. The hood is carried at the front of a traction engine and is rigged in such a way that it can be easily raised and lowered. When the asphalt is heated to the proper working degree, the hood is raised and the machine is backed off to another position, leaving the hot pavement to be raked and leveled by hand, and surfaced by a light steam roller or with hand irons.





## CONSTRUCTION OF NEW AUSTRALIAN CAPITAL BEGUN

The biggest of problems in government and in national development are being worked out in Australia on an independent basis, without the interference of native or transplanted standards that have so much force in other countries. One of the most important enterprises now under way in that country is the building of a Federal capital city in a mountain valley that until recently was practically a wilderness.

Renewed interest in this project and in Australian affairs generally has been aroused in this country by the return of Walter Burley Griffin, the American architect who won the first prize for a plan of the new city and who has since been placed in full charge of the work as director of design and construction. This plan, which was described in the September, 1912, issue of *Popular Mechanics Magazine*, embodies the biggest city-building project of modern times. Although it was worked out in a period of only six weeks, the plan as a whole has been adopted with only such minor modifications as would naturally occur after a minute adjustment to site and other local conditions. Mr. Griffin expects to be back in Australia early in May.

In an interview with a representative of *Popular Mechanics Magazine*, Mr. Griffin said: "The city of Canberra is not to be built hurriedly, but in accordance with a carefully arranged schedule extending over a period of about eight years. For carrying out this schedule, appropriations are being made from year to year as required. For the fiscal year ended June 30, 1913, an appropriation of £145,000 was made, while an appropriation of £285,000 was made to cover the work of the fiscal year ending June 30, 1914. All the money so far has been used in buying construction material and equipment and in building construction plants, including a brick plant, a water plant, roads, and one unit of a steam-power plant for generating electric current." Mr. Griffin then ex-

plained that in Australia, public utilities, including railroads, are owned either by the commonwealth or by the individual states, and that in accordance with this practice the commonwealth will own and operate all public utilities in the capital and the Federal district in which it is located. The commonwealth now owns the land in the Federal district and will retain that ownership permanently, the plan being to lease the land required for private uses. The parliament building will be the first of the government group to be built, and the plans for this, like the plans for the city, will be obtained through an international competition open to all practicing architects.

There is now no railroad communication with the capital, the usual method of reaching the site being by automobile from a station on the railroad 40 miles to the east. This is a handicap that will soon be removed, as a railroad is now being graded north through the capital from Queanbeyan while a line is soon to be built from Canberra east to Jarvis Bay on the Pacific coast.

Speaking of conditions generally in Australia, Mr. Griffin said: "The rainfall is ample and the summers, from November to March, are quite hot, the climate appearing to be quite like that of southern California. Business is very active and prospects are particularly good. There appears to be a good opening for expert architects. The profession has not been commercialized there as it has been in the states. The architects in Melbourne and Sydney employ small staffs and are therefore able to give close personal supervision to the work." Heretofore, the architecture of Australia has been mainly British. Mr. Griffin believes that the conditions are now ripe for the development of a representative architecture, one free from historical precedents and adapted specifically to the social and climatic conditions of the country.





### Tool for Cutting Square Holes in Metals

A special tool for cutting square holes in iron, or other metals, is shown in the sketch. It is made of the best grade of tool steel with the body square and tapering and teeth cut, as shown, the top one being the size of the required hole. As accuracy in graduating the thickness and pitch of the teeth is of great value, it is advisable to cut them in a machine, although it can be done by hand with a file. In tempering the tool, be careful to secure an even hardness throughout.

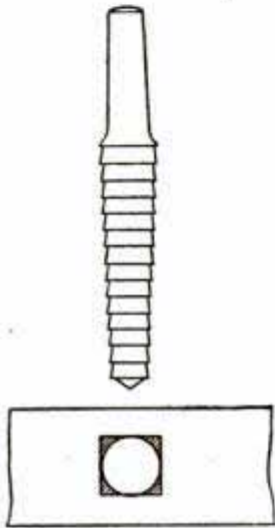

To cut the square hole, first drill a hole of the same diameter as the sides of the square hole desired. Hold the iron over the open jaws of a solid box vise, an anvil hole or a dressing plate, and insert the cutter, then, with a few blows of a hammer, start the cutter, which takes the corners out gradually as the tool penetrates the hole, the material removed dropping from the hole until finally the cutter passes through, giving it the desired dimensions.

In order to prevent the cutter from heating and to insure a smooth cut, it is advisable to dip the cutter in oil before using it. To protect it from striking the hardened surfaces of the vise jaws, pieces of hardwood should be used on the jaws.

With a properly made tool, round holes in iron,  $\frac{1}{2}$  in. thick, can be made perfectly square quickly. Holes of other shapes, oval, triangular, pentahedral, hexagonal, etc., can be cut successfully by using a tool made on this principle.—Contributed by Pierre Wagner, Indianapolis, Ind.

### Drill Press Used to Cut Spiral in a Shaft

Having a long spiral to cut in a shaft that was too long for the lathe or milling machine, I did the job very successfully in a drill press. After it was finished, mechanics who had varied experiences would not believe that such a good job could be done on a drill press. As the lead had to be four turns per foot, a piece of  $\frac{1}{4}$  by 1-in. bar iron of suitable length was cut and placed within a 1-in. pipe, 12 in. long. One end of the flat iron was gripped in a vise, while the other end was turned with a strong wrench to make four complete turns. The spiral thus formed served as a lead screw for the work. The spiral and stock were

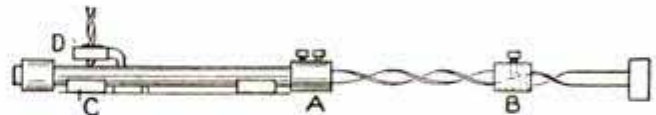

The Spiral Thrust Gave the Proper Turns to the Shaft under the Drill Point

fastened together with a coupling, at A, and a guide block, B, was clamped to the table, while the work was resting on V-blocks, C. The drill was guided with a jig, D, which was fastened to the platen of the machine.—Contributed by Albin P. Swaidmark, Orlando, Florida.



### A Basement Hotbed

What might be termed a greenhouse in miniature may be easily constructed in one side of the basement of the

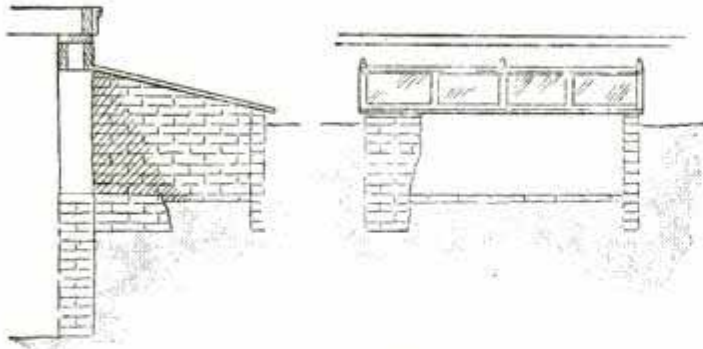

The Hotbed is Merely an Extension of the House Wall and is Covered with Double-Glazed Sash, the Entrance Being from the Basement of the House, so That the Bed is Kept Warm by the Furnace and the Sun's Rays

average house at very small expense. If the hotbed is to be built in a new house it will be an easy matter for the workmen to build up the walls, as shown in the sketch, leaving the side open into the basement. As there is practically no weight to support, the walls need not be any thicker than 4 in. or the width of one course of brick.

The bottom of the bed should be at such a height that it may be easily reached while standing on the basement floor, yet not so deep that the outside walls will interfere with the rays of the sun striking the bed.

The walls are built up a trifle higher than the surface of the ground on the outside and the ends slope up to the house until they are 1 ft. higher than the front. Make the surface of the sloping ends smooth with mortar so that a close joint will be made when the sash is laid on it.

Timbers, 2 by 8 in., are placed over the opening in the wall between the hotbed and the basement, so that their upper edges are level with the top of the wall for the house. The sash that cover the hotbed are hinged to the outside timber. If they do not fit on the walls snugly, pieces of felt may be cut in narrow strips and glued to the underside of the sash where they strike the upper surface of the walls.

The sash should be double-glazed, that is, have two pieces of glass with an air space between them. However,

if the hotbed is built at the side of a room containing a furnace, sufficient heat will be provided by the furnace to enable one to raise tender crops even though the glass is only one thickness.

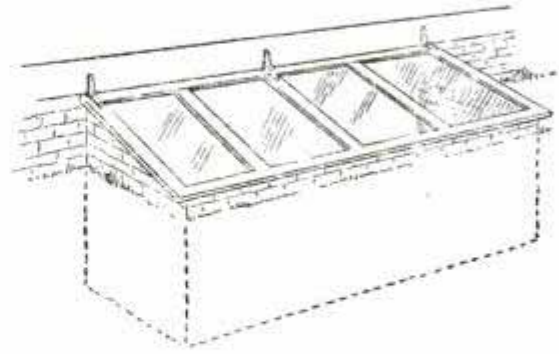

The bed is filled in with rich soil and fertilizer to a depth of 10 or 12 in. Such a hotbed will produce all the early lettuce, radishes, etc., required for the average table before the ground in the garden has thawed sufficiently to work it. It also provides an excellent place to force tender plants in the spring and to have them started and vigorous by the time they can be safely set out in the garden.—Contributed by O. J. Thompson, Petersburg, Ill.

### Starting a Tap in a Pulley Hub

It is not an easy matter to start a short tap in a hole drilled in the hub of a small pulley. Having a number

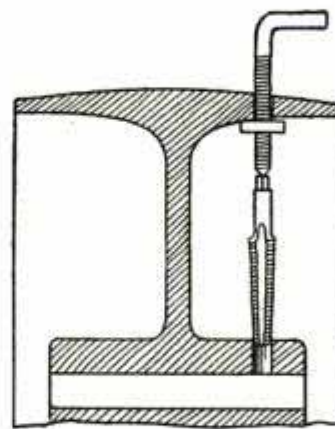

of these to tap for setscrews, I devised the tap starter shown. It consists of an ordinary bolt, of a size to pass through the drilled hole in the pulley face, and with its nut placed on the inner surface. If

the bolt does not have a square or octagon head, it can be turned at right angles, as shown, to make a handle. The tap can be easily started straight with the bolt.—Contributed by J. W. Madison, Oshkosh, Wis.



**Locking a Cork in a Bottle**

The sketch shows a bottle cork which will not slip out and spill the contents of the bottle while carried in the pocket, suitcase or grip, if bounced or jolted. I have found this a very efficient method and by using glass-headed steel pins a neat appearance is presented.

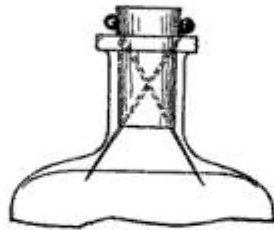

The pins are run through the cork so that their lower ends, or points, extend under the shoulders of the bottle neck.—Contributed by M. C. Erwin, Gallup, New Mexico.

**Inserting Rod in a Lace Curtain**

To put a rod through a sash or window lace curtain usually is a rather trying matter, as the rod often catches in the material, which is easily torn. To avoid this, place a thimble or a glove finger tip on the end of the rod before pushing it through the hem of the curtain. The result will be found satisfactory and the job done with little difficulty.—Contributed by Freda Nehls, New York City.

**Plummet-Cord Adjuster on a Transit**

In using a transit, I have tried many different methods of adjusting the length of the cord supporting the plummet without perfect satisfaction, but I have now adopted a device of my own that I like best of all and which is as follows: A loop, about 3 in. long, is made on one end of a small silk or linen cord, having a length of about 10 in. This I suspended, loop down, from the leveling head. On the cord which suspends the plummet I tie single overhand knots, about 1 in. apart, for almost its entire length. By passing the end of the cord through the loop, I can use whatever length is needed, and a knot will prevent it from slipping when suspended.—Contributed by J. L. Bayley, Ione, Wash.

**Pipe-Thread Lubricant**

A lubricant for the threads on large pipe fittings is a mixture of 1/2 pt. black machine oil, 2 oz. white lead, 8 oz. graphite, and about half a teaspoonful of flour of emery. The emery will smooth the threads, and the oil and lead will make a fine lubricant of enough body to stop any leak.

**Location Board for Employees**

The whereabouts of any employe, regardless of the number of floors and departments, may be easily kept track of on a board similar to that shown in the illustration. The board and spaces can be of any size. A check is used for each employe with his or her name as well as the department lettered on it.

The board is placed at the doorway of each floor, or at the desk of the foreman in charge. If an employe works most of the time on the fourth floor, the check is kept as designated in the lower row, but on leaving to go to the second floor in the department employed, he hangs his check on the second-floor row of that department column.

PLACE CHECK IN RIGHT SPACE BEFORE LEAVING								
OUT	DEPT. 1	DEPT. 2	DEPT. 3	SMITH	DEPT. 5	DEPT. 6	DEPT. 7	DEPT. 8
1 <sup>st</sup> Floor								
2 <sup>d</sup> Floor							JONES	
3 <sup>d</sup> Floor								
4 <sup>th</sup> Floor			BROWN					

A Board on Which to Hang Checks to Designate the Place Where an Employe is at Work

Then, if the foreman should have a call over the telephone for anyone, he would only have to look at the board to know where to find that person. When anyone leaves the building his check would be placed on the space designating the department in which he is employed.—Contributed by Milton Pilhashy, San Francisco, Cal.



### Entrance Signal for a Garage

One ingenious garage owner rigged up an electric bell to ring when an automobile was entering the runway



Trip Bar in an Entrance Runway to Make Connections for an Inside Electric Bell

on the outside, so that the assistant could be called to open the doors. This is an especially handy device for winter, or when the doors of the garage are kept closed. The device consists of the ordinary electric-bell connections with the wires running underground to the curbing on the runway, where they are connected to the switch. The runway has a trip bar, set in the paving with the end extending into the curb, where it works the switch when pressure is applied by the automobile wheels. A coil spring is placed under the curb end of the bar to keep it in its upper position and the electric contact broken. The runway end of the bar is hinged.

The electric switch, which is well protected from the weather by being boxed over, is a simple arrangement of two springs pressed together by a projection on the end of the bar.—Contributed by F. H. Tillotson, Chicago.

### Removing a Stuck Shank from a Drill Spindle

The usual method of removing drills or drill chucks from the end of a drill-press spindle is to use a tapered drift.

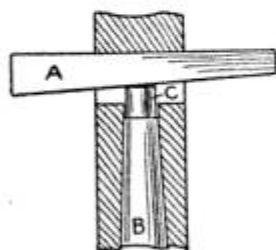

Occasionally, however, some one drives a drill in that has a short stem or shank, which does not reach up to the drift slot so that it can be driven out. The illustration shows such a condition. The drift A cannot touch the end of the drill shank B. Instead of pounding and twisting to get the drill out, procure a short piece of round rod, C, slightly smaller than the

drill shank and of such length that, when dropped in on the end of the drill, the drift may be entered in its slot. A little oil on the edges of the drift will be of assistance in either case.—Contributed by Donald A. Hampson, Middletown, N. Y.

### A Garden Cultivator

The cultivator can be constructed of ordinary materials found about any farm, but the stock can be purchased

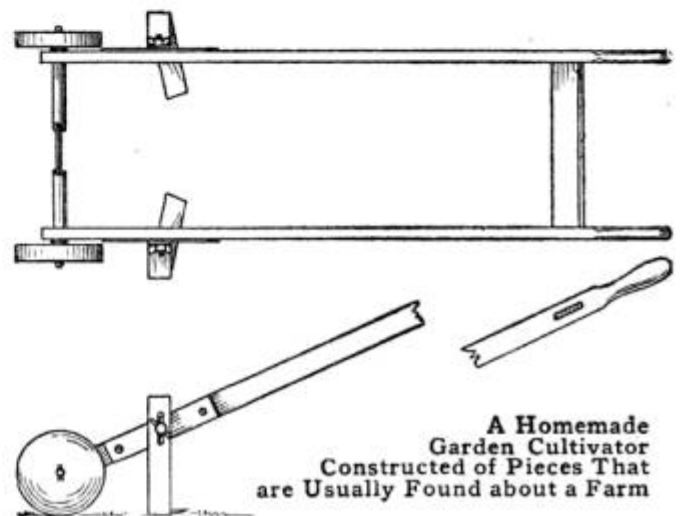

A Homemade Garden Cultivator Constructed of Pieces That are Usually Found about a Farm

and the amount required does not make the cost very great. The width of the cultivator will depend on the width of the planted rows of seeds.

The wheels and handles are wood, the axle is a  $\frac{3}{8}$ -in. steel rod with  $\frac{1}{8}$ -in. holes drilled near each end for cot- ters. Two washers are used on each side of a wheel. A piece of  $\frac{1}{2}$ -in. pipe is placed on the axle to keep the handles apart at the lower end, and a tenoned crossbar, mortised in the upper part of the handles, separates them in a like manner.

The blades are made of suitable steel, bent as shown and sharpened on the edge where they touch the ground. The upper ends of the blades are slotted and fastened to the handles with a bolt having a thumb nut.—Contributed by W. E. Crane, Cleveland.

☞Heat together 10 parts lime, 12 parts resin and 1 part linseed oil, and when thoroughly dissolved and hot, apply to a wood surface. This will make a coating almost as hard as stone.



### A Homemade Solar Heater

People living in sections having a goodly proportion of sun every day realize the value of a solar heater both in convenience and the saving of fuel. A heater equal in all respects to any factory-made can be built at less than one-fifth their cost by using an ordinary cylindrical range boiler or hot-water tank for the heater part. Select one of suitable size for all requirements, either new or second-hand. Make a box, into which the tank will fit, with about 1 in. space between the sides of the tank and box, leaving one side open for the glass. Nail narrow molding of door-size stop around the inside of the box and about  $\frac{3}{8}$  in. from the open edge, to form a rest for the glass, which must be set in with putty.

Bore holes in the box for the pipe connections, and any extra holes in the tank should be plugged. Paint both tank and the inside of the box with two coats of lampblack.

After placing the tank in the box and connecting the service pipes, stop all holes and joints with putty, fasten the glass on the face, just as a window pane, and the heater is ready for service. If pressure water is used, it can be placed near the ground and it will give as good service as if placed on the roof. The box should be placed in a horizontal position, the length running due east and west, with the face at such an angle as will expose it to the direct rays of the sun.—Contributed by E. C. Knopf, San Ysidro, Cal.

### Flexible Sandpaper Block

Plane a number of strips, 1 in. wide, and taper them from  $\frac{3}{16}$  in. at one

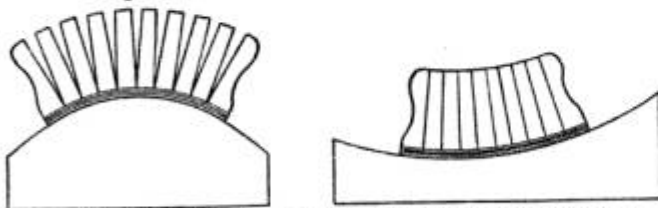

The Flexible Sandpaper Block will Shape Itself to Fit and Smooth an Uneven Surface

edge down to  $\frac{1}{8}$  in. at the other. If desired, the outside strips can be made thicker, to permit a groove to be cut

for the finger tips. After giving them a coat of shellac, assemble the strips to make the size of block wanted. A convenient-size block is one made 8 in. long by 2 in. wide. Obtain a piece of single-ply belting, the older the better, and stick it to the broad surface of the block with thick shellac.

When it is dry, drive some brads through the leather into the strips to securely fasten it in place. The sandpaper is glued to the leather, or held on with the ends extending under the grip of the fingers. This block is very handy, as it can be used on both flat, and convex or concave surfaces.—Contributed by C. White, Brooklyn, N. Y.

### A Bag Holder

The bag holder shown in the sketch is designed to hang on a barrel, bin, truck, or any other convenient place. The parts are made of strap iron and shaped as shown, requiring no exact lengths. The yoke should be the size of the bag top. The U-shaped pieces at the sides permit the top of the sack to be turned over the yoke. Two clips are riveted to the moving part, projecting over and catching on the yoke sides to prevent it from dropping too far down. The hooks and vertically extending parts are used to hold it on a box or barrel.

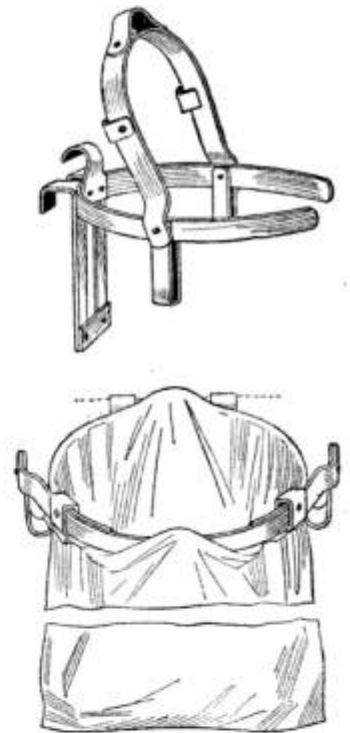

To fill the bag, place its upper edge over the hook at the back and between the yoke, so that the edge overhangs. The clamping band is drawn down over the bag top where it holds the cloth securely without injury.—Contributed by J. F. Reed, Johnstown, Pa.



### Line-Shaft Polisher

Nothing makes a better impression in a well-appointed and tidy shop than to see the line shafts free from rust and oil, and at the same time polished. A little attention each day with the polisher illustrated will keep a shaft in such a condition. The polisher is made of a piece of soft wood, about 4 in. thick, 5 in. wide, and 12 in. long, to which a hardwood handle, 8 ft. long, is

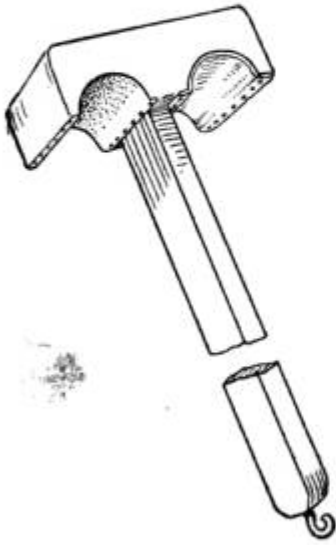

attached. A semicircular groove is cut on each side, as shown, a little larger than the diameter of the largest shaft in the shop. One groove is lined with several thicknesses of heavy cotton cloth, and the other, with a sheet of coarse emery cloth, both tacked securely in place.

Apply the emery side first, then use the cloth side, moving the polisher along slowly back and forth on the shaft while it is turning. This will produce the desired result. A hook is provided so that on long stretches of shaft a weight of 10 or 15 lb. may be hung on it, thereby making the operation easier.—Contributed by A. Dane, Pottstown, Pa.

### Calculating Pipe Size to Take Flow from Two Pipes

To ascertain the proper diameter of a pipe to take the flow of water from two pipes of any given diameter, lay out a right-angled triangle with the base equal to the diameter of one pipe and the height equal to the other. The length of the hypotenuse will be the desired diameter. A carpenter's steel square is handy for this problem within its limits.—Contributed by J. A. Shelley, Brooklyn, N. Y.

### Cleaning Marble Floors

A good way to clean marble or mosaic floors when the dirt clings in the crevices is as follows: Apply powdered table soda over the floor or the dirty spots. Then apply a 5-per-cent solution of acetic acid. This solution may be purchased at any drug store. There will be considerable foaming for a few seconds. As soon as this stops, the solution should be removed at once and the floors washed with clean soapsuds. The articles mentioned are harmless to the hands. The acetic acid should not be left where small children might drink it.—Contributed by Loren Ward, Des Moines, Iowa.

### A Feeding Trough

The feeding of hogs in a trough is always a troublesome task, as the hogs will get in the way of the food if it is in a liquid form, and prevent the trough from filling evenly. One farmer overcame this difficulty by setting the trough on the outside of the fence and hinging a panel of the fence so that the bottom would swing outward. A stop is placed at each end to hold the panel in place while the food is poured in the trough. The stops are also used to prevent the panel from being pushed farther than the outside of the trough. The food is placed in the trough evenly and then the stops

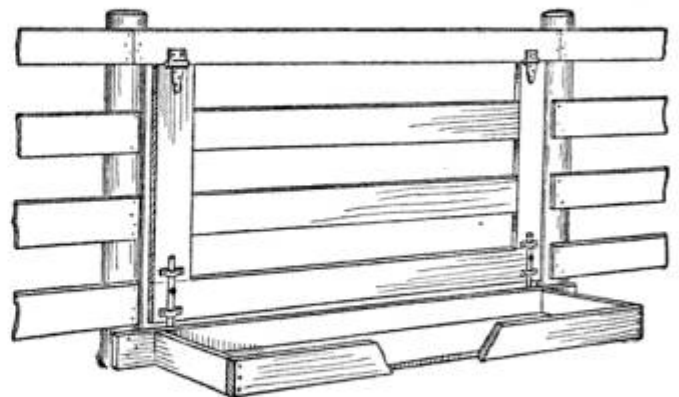

A Feed Trough on the Outside of a Fence to Prevent Swine from Getting in the Food

are raised and lowered to catch on the outside edge of the trough. The trough should be secured to the fence post at each end.



### Reinforced Babbitt Bearings

The sketch illustrates a valuable and easily applied improvement for pillow-block and all forms of bearings that are babbitted. The coiled soft-brass or copper wire prolongs the life of the bearing, makes a better fit, and will be found specially valuable in the upkeep of high-speed and heavy machinery.

The application is as follows: Before pouring the babbitt take a piece of soft, not hard, brass or copper wire

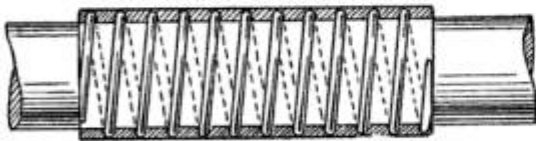

A Babbitt Reinforcement of Coiled Brass Wire to Make a Harder-Wearing Surface for Bearings

of such gauge that it will just fill the space allotted for the babbitt and make surface contact with the shaft, and prepare the coil by winding the wire around a piece of shaft or wood having the same diameter as the machine shaft, the coils to be  $\frac{1}{4}$  in. apart for the entire length of the bearing. Remove the arbor and place the coiled wire in the bore to be babbitted and pour the babbitt around the wire, then scrape to a fit.

Hard wire should not be used because of the extra care required in fitting, and, besides, the soft wire is better in many other ways. This is an easy and cheap way of producing bearings that will last, and also gives a chance to utilize the scrap wire about a shop or factory. Furthermore, it is a good method to use in constructing models or machines in the home workshop.

### Packing between Storage Cells and the Case

A toy hollow rubber ball forced into the space between a storage battery and its case is an effective means of keeping it from jostling around and also absorbs all jolts and jars. These balls can be purchased cheaply in various sizes suitable for the space to be filled.

### Drawing Brass Tubes by Hand

Small tubes of light brass or copper are easily drawn by hand with a pair of pliers through a hole drilled in a piece of  $\frac{1}{4}$ -in. iron or steel held in a vise. The flat strip of metal should be exactly as wide as the circumference of the hole through which it is to be drawn, and it should be pointed on one end sufficiently to start it through the hole. Then it is grasped in a pair of pliers and drawn through with a good steady pull. If the metal has been cut the proper width, the resulting tube will be tight enough to convey oil without soldering.

### Ferrule for Straight-Shank Tools

The ordinary ferrule, as applied to file and chisel handles, is all right as long as the article to be held has a tapered shank, or tang, so that it can be tightened when becoming loose. When the shank is straight, it is not easy to tighten the tool in the handle. In order to cause a handle to grip a straight shank, I use a special ferrule as shown in the sketch.

This ferrule is made of brass or steel tubing and is tapered on the inside. The taper is formed with a taper reamer. The ferrule seat on the handle is given approximately the same taper as the inside of the ferrule. After drilling the hole for the shank, the handle is sawed lengthwise, two cuts being taken at right angles to each other, as the sketch clearly shows. The saw cuts form the handle into a four-jawed chuck, so that when the shank is placed in the handle and the ferrule driven down on the seat, the jaws will grip the shank tightly. If the tool works loose, a few taps of a hammer on the ferrule will close the jaws and tighten it again.—Contributed by Clyde L. Adams, La Grange, Ill.

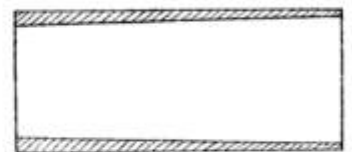



### Anchors for Babbitt Bearings

Usually designers of machinery give the patternmaker a great deal of trouble in allowing for babbitt anchors

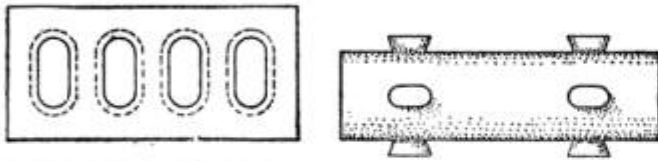

Box for Molding Cores to Make Holes in Machinery-Bearing Boxes for Babbitt Anchors

in bearings. With my method this is simplified. In making a bearing core box, only show some spots with red shellac and make a core box for the core maker, as shown to the left in the sketch. These cores can be kept as a standard by the foundry and used always for bearings. This will eventually save many dollars, as complicated core boxes are often needed. The manner of pasting and nailing sand anchors on the ordinary stock cores is shown at the right. If the bearings are cast in green-sand molds, the anchors will be placed on the green-sand mold.—Contributed by J. C. Hansen, Maywood, Ill.

### Supports for Reinforcing Rods

A support for reinforcing rods, used in concrete-floor construction, is shown in the sketch. The supports are made

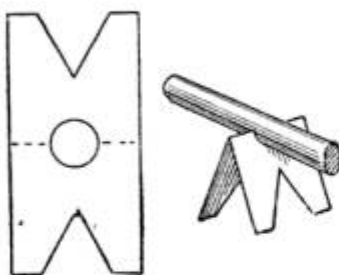

of heavy galvanized sheet metal, about 2 in. wide and 4 in. long. A hole is punched in the center for the size of the rods used, and

notches are cut in the ends to facilitate the flow of concrete. The metal is then bent on the center line, leaving the ends 1 in., or more, apart, so that the support can stand alone. They are placed at proper intervals under the rods, to support the latter above the floor forms and allow the concrete to flow under them. Their cost is slight and they answer the purpose in every way.—Contributed by C. W. Thomas.

### Under-Inflation of Automobile Tires

Many automobile owners do not realize the importance of properly inflating their tires. This is mainly due to ignorance of the real nature of the tires. Two things must be considered in the construction of a tire, the envelope and the air cushion. The casing cannot support the weight; that is the function of the air cushion. Then it is evident that the greater the weight, the larger the air cushion must be, and as the air cushion increases in size the more pressure is required, hence there must be a certain pressure for a certain size tire.

If the air pressure is insufficient the tire itself must support some of the weight. The result of this is a flattened tire at the point in contact with the ground, and when the wheel is turning, every part of the casing is forced into this unnatural shape, then resumes its original size, so that each side of the casing bends out and springs back again at every revolution of the tire.

The casing is made up of several layers of rubberized canvas, vulcanized together. With a sufficient air cushion these layers all work together as one unit, but in the case of a flattened tire the working of the sides causes them to pull apart. This, in time, will result in the separation of the layers and then the working will cause them to chafe and heat so that the fabric becomes too weak to sustain the weight and a "blow-out" occurs.

There are several kinds of tire abuse, but under-inflation is the worst of all. The statistics of the leading tire manufacturers show that 75 per cent of the tires go out of service prematurely on account of insufficient inflation. Under-inflation not only wears out the various layers, but it also loosens the tread. The flattened condition of the tires, when the pressure is low, causes a little roll of rubber right in front of the point of contact of the tire with the ground. This tends to loosen the tread. In case of the clincher tire, under-inflation usually causes the tire



to rim-cut before the fabric gives way. The continual working in and out over the hook of the rim soon cuts the tire.

The standard rule for right pressure is 20 lb. to every 1 in. of width. The following table is adopted by the leading tire manufacturers for correct pressures as applied to tires:

2½-in. tire, 50 lb.	4½-in. tire, 90 lb.
3-in. tire, 60 lb.	5-in. tire, 100 lb.
3½-in. tire, 70 lb.	5½-in. tire, 110 lb.
4-in. tire, 80 lb.	6-in. tire, 120 lb.

To pump a tire up to the right pressure and then take for granted that it will stay at that pressure, will result in a flattened tire, sooner or later. No tire is absolutely air-tight; each one should be tested at least twice a week, and if possible, every day, and air added as required. It is surprising how quickly the pressure will be reduced although there is no visible leak.—Contributed by W. A. Yoakam, Granville, O.

### Care of Eyeglasses

To prevent glasses from covering with a veil of steam when one enters a warm room, rub them with some moist soap of any kind—not a sand soap—and polish while the soap is moist. If an accident should happen to the lens and cause it to break, a temporary repair can be made by pasting the parts together with liquid shellac. The shellac dries quickly and the mended lens will give good service until a new one can be procured.—Contributed by H. Martine Warner, E. Orange, N. J.

### Clarinet-Reed Trimmer

Clarinet players will find a very cheap and efficient substitute for a reed trimmer in the ordinary fingernail clip. A perfectly new reed is sometimes useless on account of being too soft, but it can be used by clipping, or trimming, the end in the same manner as finger nails are clipped.—Contributed by Wm. H. Patten, Belleville, New Jersey.

### To Fill an Engineer's Torch with Wicking

Pass the end of the lamp wick down through the sleeve in the usual way, then bring the end up and tie it, at A, so that in pulling on the wick, at B, it will increase in size until the hole is filled tightly. Cut the wick off at the top and assemble the torch parts. This will save the wicking, and the hole can be easily filled as tightly as desired.—Contributed by C. G. Green, Toronto, Canada.

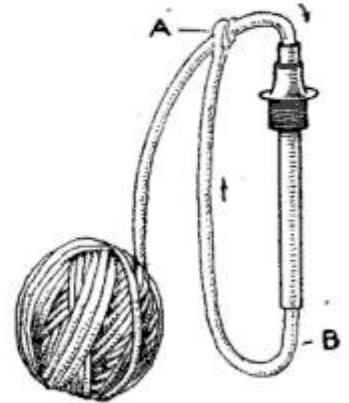

### A Street-Gutter Cleaner

The superintendent of streets in a suburban city did not have a large number of street cleaners, and to quickly accomplish the work with a few hands, he devised the gutter cleaner shown in the sketch. The cleaner is made like a large hoe with shafts instead of a tongue or handle, and a horse is hitched to it. Two handles for the operator are attached to the rear part as on a plow. The scraping edge has a steel bar attached, and the scraper part can be set straight or at an angle as desired. The refuse

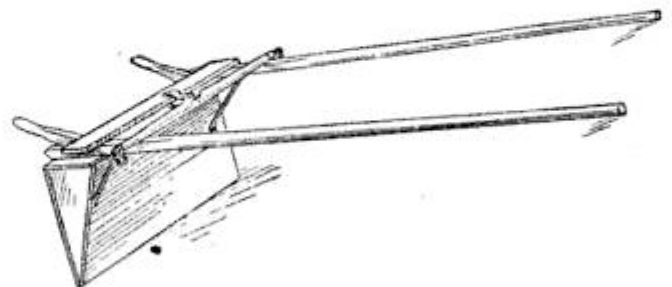

A Cleaner for Removing Dirt That Collects in the Gutters of a Street

falling into the gutter is thus easily and quickly scraped into piles and gathered into wagons.—Contributed by H. H. Sherer, Evanston, Ill.



### Automobile Windshield for the Baby

It is almost impossible to keep a pair of goggles on a baby and dust out of its eyes while taking a ride in an open

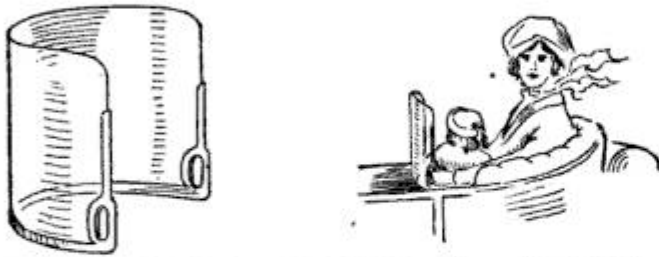

A Windshield Made of Celluloid with a Metal Edge to Hold in Front of the Baby

automobile not having a windshield. The illustration shows a simple device made of sheet metal, preferably brass, and a piece of celluloid. The metal may be of double thickness riveted together over the edge of the celluloid to keep it in place. The shield is held in front of the baby in a very comfortable position.—Contributed by R. F. Pohle, E. Lynn, Mass.

### Setting Difficult Work in a Chuck

In setting difficult work in a chuck to a finished surface that must not be marred by adjusting to the sound of a tool; where the part to be set true is out of reach to take a chalk mark; or where it cannot be seen, I find the appliance shown in the sketch to be indispensable.

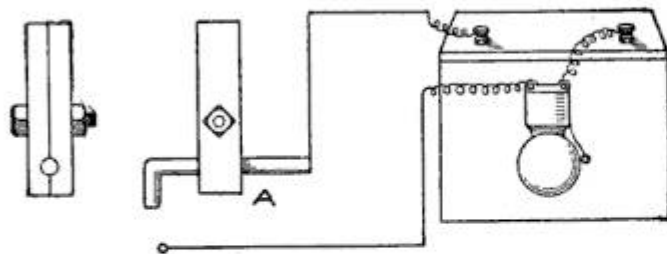

The Work must be Set True to Make a Perfect Electrical Contact during the Entire Revolution

The apparatus is made of a square box, just large enough to contain one dry cell of battery, and a bell attached on one side of the box, the connections being made as shown. This makes an outfit of convenient size for the tool kit.

In use, one terminal is connected to the lathe or boring bar, and the other,

which is set in an insulated clamp, A, is used in the slot for the tool in the boring bar. Proceed to true up the piece in the same manner as if setting with a tool, and when the bell rings for the entire revolution of the piece, it is set absolutely true. On work in sight, this device in many cases produces quicker results than when setting to chalk marks.—Contributed by Ross Williams, St. Louis, Missouri.

### Tying Horses to a Hitching Post

The illustration shows a way of tying horses to a hitching post so that the tie can be easily loosened. Double up the lines and insert the loop thus formed through the ring of the post. Then also double up the remaining end and pull this loop through the first one. This tie will hold the horses securely, and is very quickly loosened by a quick pull on one end.—Contributed by C. H. Thomas, Norristown, Pa.

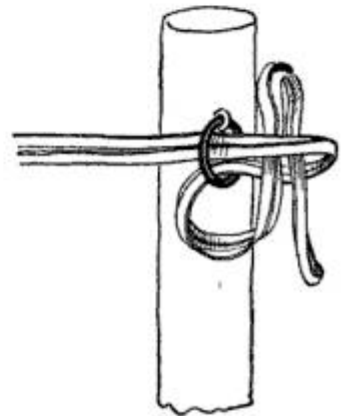

### To Prevent Mucilage Accumulating on the Receptacle Edge

In our office a quantity of mucilage is kept in open pots. These pots soon gather an accumulation of hardened mucilage on their upper edges, and the brush handles become covered with it. This causes great inconvenience on account of the brushes sticking to the pot edges.

This trouble was avoided by applying a thin coat of paraffin on the edge of the pots and on the brushes above the bristles. The paraffin was melted in a tin can over a gas jet and was applied by "painting" it on with an old brush. This treatment is very effective, as the mucilage will not stick to the paraffin.—Contributed by Jas. A. Hart.



### Hoisting with a Concrete Mixer

The problem of getting material out of an excavation for a reinforced-concrete job was solved in an unusual way by one contractor. The electrically driven concrete mixer was rigged up so it would do the lifting of the earth from the excavation. The mixer, which was of the cylindrical type, had a rope, leading out of the hole and fastened to the drum after passing over a set of sheaves. To hoist, the motor was run and the rope wound up on the drum of the mixer. For lowering, the weight of the empty bucket was usually sufficient and when it was not, or a braking action was required, the motor was reversed.—Contributed by Sidney K. Eastwood, Germantown, Pa.

### Inserting a Fiber Gasket

A round gasket, cut from sheet packing, leaves some waste, and if a small portion of this waste is left attached,



as shown, it can be used as a handle for inserting the gasket in place. Where flanges cannot be spread very far apart without removing a piece of the pipe, put one bolt through a hole in the gasket, and then it can be turned either way by the aid of the attached piece to locate the other holes. The piece can be cut off after the joint is tightened up.—Contributed by J. B. Bedore, Crivitz, Wis.

### A Planer Clamp

There is a certain amount of work done on metal planers that cannot be bolted down directly to the bed or held in vises on it. Such work is held by what might be called compression; that is, a block, rib or plate is fastened to the planer bed, the work is placed against this fixed piece and by means

of fingers, setscrew posts, etc., the work is pressed against the fixed piece hard enough to enable a cut to be taken on it. A holding or clamping

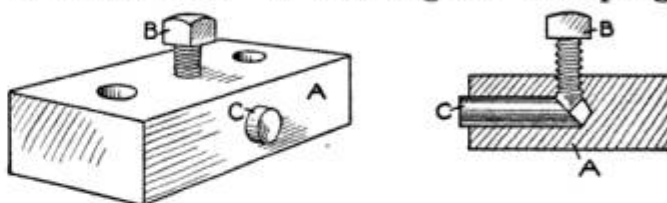

A Clamping Block Having a Laterally Sliding Pin Forced Out by a Vertical Screw

device for producing this lateral pressure is easily made as shown in the sketch. A block of steel, A, is drilled and tapped for a cone-pointed setscrew, B. At right angles to this hole, another hole is drilled in the block and a pin, C, fitted so that it will slide. The end of the pin on the inside is beveled to an angle of 45 deg., the same as the point of the setscrew. It is obvious that turning the screw downward drives the pin out of the side at the same rate. As many of the blocks as may be necessary or convenient may be grouped about a piece of work, or the device may be put in a long strip, in series. It is neat, simple and inexpensive, and should take the place of the various devices kept for the same kind of work.

### Large Hand-Ladle Supports

Large and heavy hand ladles, filled with melted metal, are just a little more than a person can handle, especially when slow, steady pouring is required after carrying the metal quite a distance. If a support is placed on the handle, it holds the entire weight and the operator merely steadies and turns the handle. When walking and carrying the ladle, the support is held against the handle, and when ready to

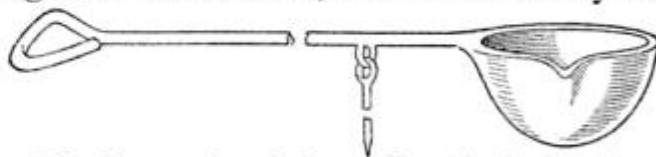

The Support Attached to a Hand-Ladle Handle Carries the Load for Steady Pouring

pour it is released. The pointed end prevents any slipping on wood or earthen surfaces.—Contributed by Bert Verne, San Diego, Cal.



### Instruments for Taking Foreign Matter from the Eye

The sketch shows two very handy instruments for the shop "eye doctor." The loop, formed of  $\frac{1}{8}$ -in. soft-iron wire, is pressed firmly over the outside

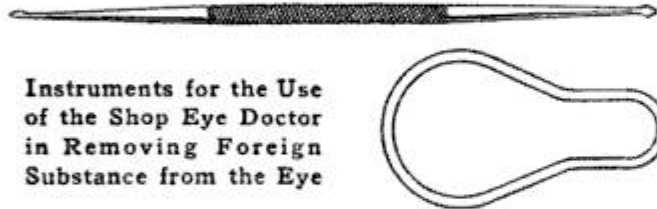

Instruments for the Use of the Shop Eye Doctor in Removing Foreign Substance from the Eye

of the eye. This loop holds the eye steady and the eyelid well down, thereby giving the operator a much better chance to remove the foreign substance.

The "pick" can be made of an old 6-in. round file, with the ends ground as shown. They should be stropped to a razor edge, and used only by one having a perfectly steady hand. These two articles have been in use for several years and have given complete satisfaction.—Contributed by A. Dane, Pottstown, Pa.

### Cutting Keyways in a Lathe

Few of the small garages or the amateur workmen have other facilities for making keyways than chipping them in the pieces. This is slow work, requires considerable skill and is never satisfactory. The ever-present lathe, the king of tools, may be made to do the work very nicely.

If the keyway is to be cut in a shaft, place the shaft between the centers of a lathe, then put a tool of the proper size and shape in the tool post—preferably a tool of the gooseneck or spring type, but turned one-quarter way around from the normal position of the lathe tools. Block the gears of the lathe so that the spindle cannot revolve, run the tool up against the work and move it lengthwise of the lathe by turning the carriage wheel. This will make the first cut for the keyway. At each succeeding travel of the carriage, move the tool in a little deeper, and soon a very creditable keyway will be produced. This may seem to be hard

work, but it is a better way and easier to do than chipping out one with a chisel.

To cut an internal keyway, the principle is the same. Forge or grind a boring tool so that it will cut when moved lengthwise of the lathe. It is better to have the tool cut when it is being pulled out, as it is less apt to dig in when so operated. By this method a gear or pulley may be bored and key-seated at one setting.—Contributed by Donald A. Hampson.

### How to Repair a Cylinder Lock for Worn Keys

Remove the cylinder from the lock, insert the key and turn it  $\frac{1}{4}$  in.; loosen the screws in the cam on the back end of the cylinder and remove the cam, as shown at A. The plug is removed by placing the end of a  $\frac{1}{2}$ -in. rod against the end of it, as shown at B. Push the plug out of the cylinder and follow it closely with the rod to hold the driving pins and springs in place.

When the plug is removed from the cylinder, as shown at C, the ends of the pins will be below the surface, due to the worn condition of the key. Smooth the plug down flush with the ends of the pins to overcome the catching of the pins in turning the cylinder. Replace the plug in the cylinder, in the same manner as it was taken out. Be

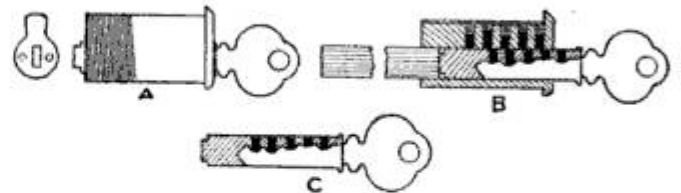

The Cylinder is Removed and the Surface Filed Down to the Level of the Pin Ends

sure to fasten the cam in place securely, and the cylinder will work as well as a new one.—Contributed by Wm. J. Tolson, Lyons, Iowa.

### Substitute for a Demijohn

A handy demijohn for carrying drinking water in the fields, to laborers, on picnics, or to store liquids can be easily made of three large bottles



of uniform size. The bottles are held together with several thicknesses of burlap drawn tightly around them and sewed in place. The contents can be kept cool by wetting the burlap.

### To Make a Taper Hole with a Straight Reamer

If no taper reamer is at hand, a taper hole can be cut with a straight reamer by the method shown in the illustration, which is described by a correspondent of the American Machinist. A hole, the size of the small end of the taper hole wanted, is drilled into the work and a flat bottom cut, allowing a small portion of the drill-point depression to remain, which is drilled out slightly with a small drill to admit a steel ball halfway.



A Straight Reamer, the Shank of Which is Offset with the Tailstock, will Cut a Taper Hole

The center hole of the straight reamer is set on the ball as shown. The lathe tailstock is clamped to the ways solidly, and the holding-down bolt is loosened so that it can be crowded over with the adjusting screws to the taper required.

### Coat Hanger in Coaches

The top or overcoat is a bothersome garment on a rail trip. There is no place provided for one to keep it from becoming wrinkled. One traveler suspends his extra coat by inserting the hanging strap through the bars of the package shelf, as shown, then putting a lead pencil through the loop. The pencil resting on the bars will hold the coat firmly in place, no matter how long or rough the journey may be.—Contributed by Wm. N. Robson, Pittsburgh, Pa.

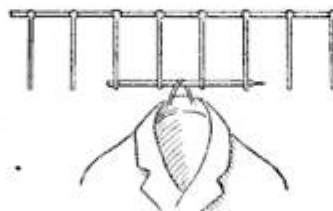

### Towing an Automobile with a Broken Rear Wheel

An accident left me several miles from a garage with a rear wheel brok-

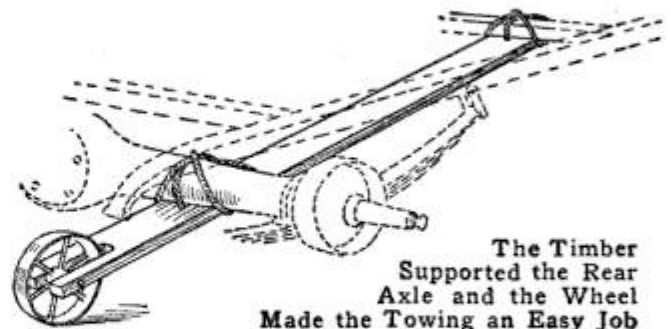

The Timber Supported the Rear Axle and the Wheel Made the Towing an Easy Job

en off from my automobile. A timber, 3 in. thick, 6 in. wide, and 12 ft. long, was lashed to one of the transverse angle irons under the front seat and extended under the rear axle, the end resting on the ground, but a team of horses could not start the machine. I finally hit upon the scheme of inserting a cultivator wheel in the end of the timber, as shown in the sketch. A slot was sawed in the timber end as wide as the wheel hub was long, and the wheel was held in place with a bolt inserted in a hole bored through the extending ends.—Contributed by L. L. Llewellyn, Hayward, Cal.

### Oiling Piston Rings

It is necessary to use a sufficient amount of oil on piston rings, or they will score the cylinder bore. The neglect of this one thing often results in having to equip an engine with an entire new set of rings, and, in many cases, where the scoring is deep and reboring is necessary, new piston rings and piston also will be required to fit the new size.

### Ground Colors for Paint

For vehicle painting it is found that while the very pale yellows, such as straw, light primrose, chamois, and canary appear best placed over a white groundwork, some of the deeper tones of yellow, such as primrose, sulphur, and deep chrome yellow, are at their best on an ivory-white ground.



### Ink-Bottle and Print Holders on a Drawing Board

Sometimes it is required to incline the drawing board more than the

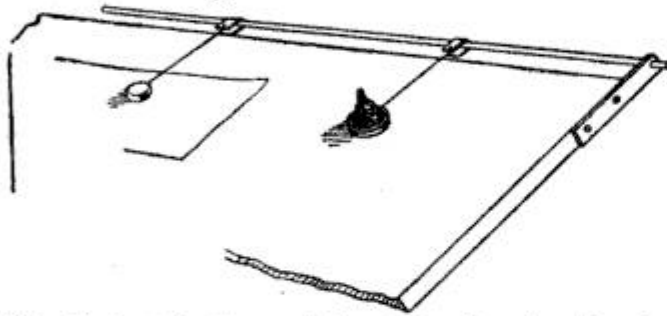

The Rod at the Upper Edge of the Drawing Board Has Holders for Ink Bottle and Prints

usual angle and it is then impossible to hold the ink bottle or the reference prints on its sloping surface. An attachment for this emergency, simple to make and also very effective, is shown in the sketch. A rod,  $\frac{1}{4}$  in. in diameter, is held to the top of the board by means of supports at each side. U-shaped holders of sheet metal, with holes drilled through their ends, slide on the rod and provide means of attaching cords for holding a weight or the ink bottle.

The weight, which is made of  $1\frac{1}{2}$ -in. cold-rolled stock, about 1 in. thick, is placed on the reference print to hold it in position. The ink bottle is held in a wood base and is connected to the rod with a cord. Thus they can be moved to any part of the board without trouble, and the device will prove helpful to those who do not possess other means to attain the same results.—Contributed by H. P. Reston, Rochester, N. Y.

### How to Set a Lathe Steady Rest

There is quite a variety of lathe work that demands the steady rest to support one end of the work, while drilling, boring, centering and special turning are some of the jobs in which the tailstock is removed and the steady rest used. It is a well-known fact that a piece of work, held by the chuck and supported by the steady rest, will work out of the chuck if the steady-rest jaws are not set to bring the work in a true center line of the lathe.

Many mechanics can set the jaws of a chuck near enough central by eye, but there are some that cannot do this quickly. Of course, a piece of work can be put in true in the jaws and laboriously measured to center it, but a much quicker method is as follows: Place an arbor of the same diameter as the piece to be worked, between the centers of the lathe. Set the steady-rest jaws to the arbor with the fingers and tighten the binder screws. Put away the arbor and slide the tailstock out of the way. It is assumed that the steady rest is made with one or two V-shaped projections on the bottom and that, in setting it up, these projections are placed in position on the ways, or guides, of the lathe. The steady rest can be pushed along on the ways to the point where it is needed, and the work will be truly centered. The rest can be removed from the lathe and, if later on it is desired to do more of the same work, it will center as truly as before when replaced.

### A Small Engine-Room Water Heater

In a boiler room, not having up-to-date conveniences, it is difficult to secure easily and quickly water of the right temperature to wash

with at the termination of the shift or the day's work. The sketch is descriptive of a small water heater that can be constructed of old pipe fittings, and from which steam and water are very easily

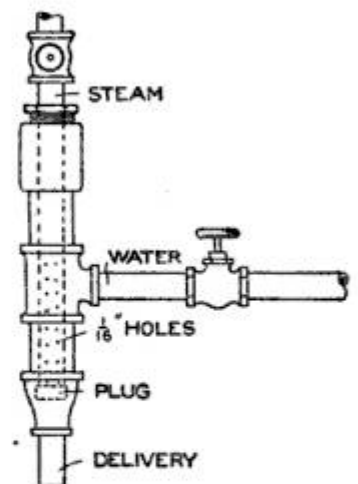

tapped so as to supply hot water whenever such is required. A little experimenting with the two valves will enable anyone to get a stream of water instantly of the exact temperature desired from the delivery.—Contributed by J. W. Bently, Jr., Milwaukee, Wis.



### Oiler on a Diestock

Plumbers always do most of their work on the job wherever it happens to be, and it is, therefore, difficult to keep

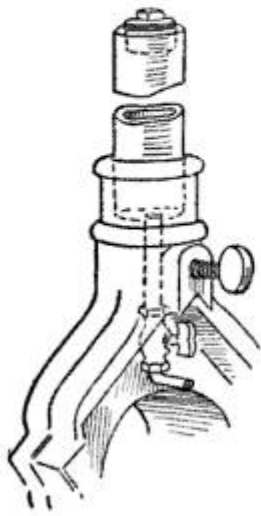

an oil can handy and filled with oil for lubricating the threads of the die. For this reason I provided an oil reservoir in one of the handles on my diestock, with  $\frac{1}{8}$ -in. pipe connections at the end near the die and a petcock fitted in it for regulating the flow of oil. The illustration shows the connection. Only

a few parts are required to have this oil supply always at hand, and one filling will last a long time.—Contributed by E. I. Beicher, Marion, Ohio.

### Inserting Wires in Gas Pipes

Inserting electric wires in gas pipe is very difficult, especially if the pipe has any bends in it. A contractor having one of these pipes in a newel post that had three 90-deg. turns easily overcame the trouble by inserting a line for drawing in the wire with the use of a vacuum cleaner. A string was made into a ball almost as large as the inside diameter of the pipe and, fastening one end, the ball was started in the pipe at one end and the smallest nozzle of the cleaner placed over the other end. The ball was quickly sucked through the pipe, leaving a line that was used to draw in the wire.

### Resilvering an Old Mirror

Clean the glass with powdered chalk, being careful not to scratch the glass. Dampen the chalk with a little alcohol and rub it dry with tissue paper. Make a liquid preparation by melting, in a porcelain vessel, 1 dr. of lead, 1 dr. of tin, and 1 dr. of bismuth. When these are melted together add 10 dr. of quick-

silver before the mass cools. This will cool it sufficiently for use. Lay the glass flat, with the cleaned side up, and pour the liquid over it, completely covering the surface. Raise the glass to almost a perpendicular position and let the amalgam drain off quickly. When the coating has become perfectly hard and dry, coat it with drop black, ground in japan and then thinned with turpentine.

### Fireproof Base for a Laundry Stove

To eliminate all danger of fire resulting from a laundry stove in the basement, I made a concrete base or shelf, as shown in the sketch. A form was made and set against the wall, the back being 6 in. lower than the front, with a border, 3 in. high, on the two outer sides. A hole was bored in the projecting corner large enough to admit a piece of 1-in. pipe, which was fitted with a floor flange on the bottom and set up in the hole, the top extending into the form about half as high as the edge. The wall and side of the chimney were cleaned and plastered with a rich mixture of cement to make it binding, then the form was filled to the top with cement. The form was removed after the setting of the cement, and it left a hard stone shelf firmly cemented to the wall with an iron leg in the outer corner fastened

A Fireproof Base Made of Cement for a Basement Laundry Stove

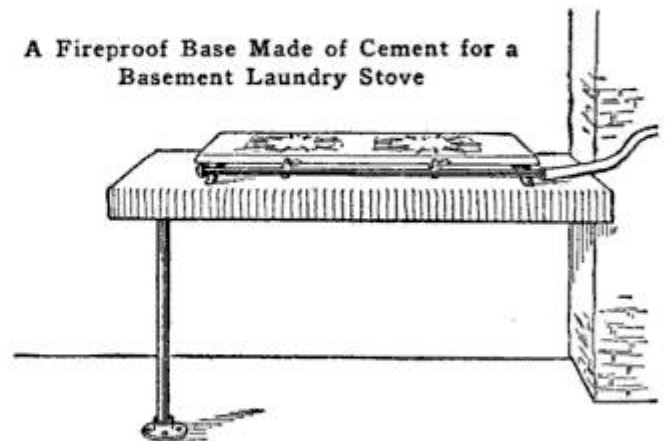

solidly in the cement. The shelf is 30 in. long by 24 in. deep, 3 in. thick in front, and 9 in. thick at the back.—Contributed by L. M. Johnson, Emsworth, Pa.



### A Homemade Whip Socket

A whip socket can be made quickly from a length of pipe flattened on one end and bent at right angles, as shown. Two holes are drilled and countersunk in the flattened end for screws, to hold it in a convenient place. — Contributed by F. H. Tillotson, Chicago.

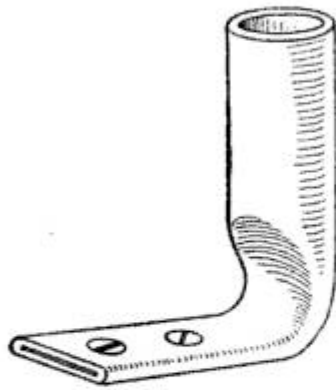

### To Straighten a Miter Saw

In using a miter saw on wood with a spring to it, the saw is apt to stick so that a warp or uneven cutting edge is produced, which can be seen by sighting lengthwise of the teeth.

This warp can be removed by striking the top of the metal flange on the back of the saw, directly opposite the warp or kink, a sharp blow with a hammer. The necessary force can be determined by beginning with a light blow and increasing the force until the edge is straight.—Contributed by E. C. Knopf, San Ysidro, Cal.

### Stiffening the Legs of a Bow Pencil

It is very common that a bow pencil has a tendency to run from its previous mark on account of its being weak, or having lost its rigidity. This can be easily remedied by placing a small piece of soft rubber, A—a piece cut from an old eraser will answer the purpose well—between the

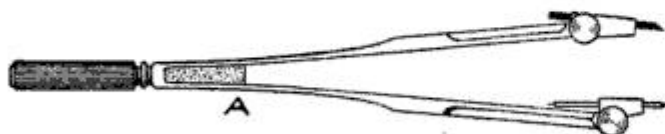

A Piece of Soft Rubber Placed in the Crotch of the Bow Pencil Makes It More Rigid

springs. The stiffness can be varied by the thickness of the rubber.—Contributed by Ralph D. Curtis, South Bend, Ind.

### A Wax-Fillet Machine

The construction of the machine shown in the illustration allows it to be fastened with screws to the bench, or it can be attached to a block and the block gripped in a vise. The machine consists of a cylinder, A, cap, B, and a plunger, C, all of brass; and the screw D, T-handle, E, and screws of steel.

The wax should not be mixed too hard. It should be of such consistency that it can be easily inserted through

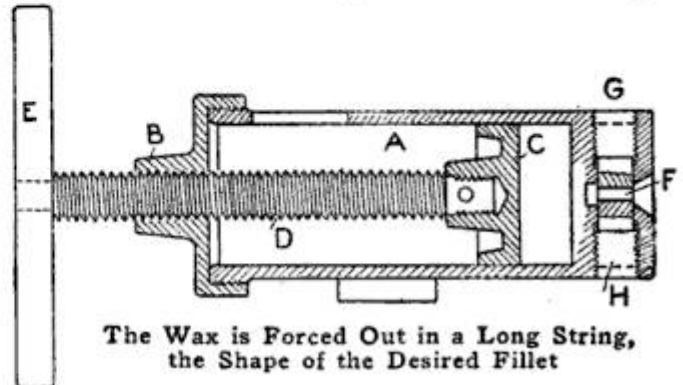

The Wax is Forced Out in a Long String, the Shape of the Desired Fillet

the hole in the side of the cylinder A, then the plunger C is screwed down to compress the wax and force it through the opening F, formed by the screws G and H. The opening in these screws can be made in any shape desired. The forming hole should be cut into the end of the screw G, the other screw H acting as a lock screw.—Contributed by E. W. Voss, Cincinnati, Ohio.

### Boring Catcher on a Bit for Ceiling Work

Having some wiring to do in an office, several holes had to be bored in the ceiling. To accomplish this without covering the rosewood desks and tables with plaster dust seemed to be unavoidable, but a paper cone or funnel, about 8 in. deep and 5 in. in diameter at the top, was fastened firmly around the bit to catch the borings. After boring the holes not a particle of plaster could be found on the furniture; the funnel had caught it all.—Contributed by F. E. Searl.

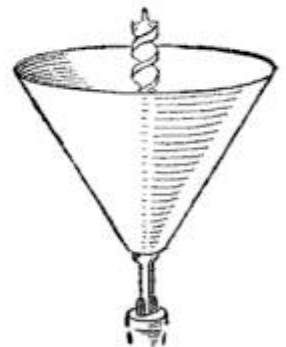



### Calking Tool for Elbow Fittings

Finding it a hard job to properly calk the lead into soil-pipe connections where the fittings have a close bend, such as a short-sweep elbow or a Y-fitting, with ordinary tools, I designed one as shown in the illustration. The tool is made of  $\frac{3}{4}$ -in. octagon steel. The part, or anvil, A, is made as shown,

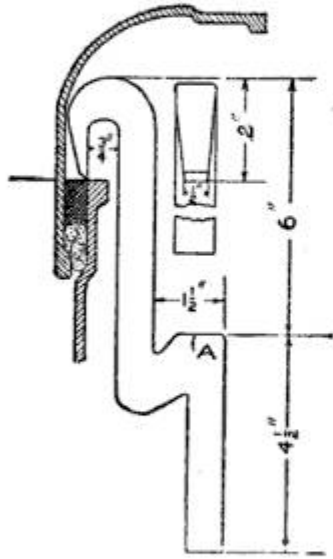

to provide a striking surface. This tool will be found very useful to stop a leak in a fitting near a ceiling.—Contributed by O. F. Germaine, Mansfield, Ohio.

### Cover for a Stair

A very convenient contrivance for moving heavy articles up and down stairs consists of a door of hard wood, so hinged that it will fit down snugly over the steps when in use. When not in use, it is turned up against the cellar wall and held there by means of a catch. Barrels, bags, machinery, etc., may be lowered into a basement or elevated to upper floors with comparative ease in this manner.—Contributed by J. G. Allshouse, Avonsmore, Pa.

### Draining an Automobile Radiator

Never open the petcock at the bottom of an automobile radiator and then go away supposing that the cooling system will be drained. Scale, rust or any foreign matter may clog the mouth of the petcock, and a frozen and burst radiator will be the result. Always wait and dislodge any particles that may stop the flow, or, better still, dilute the water in the radiator with alcohol and glycerin, about half and half.—Contributed by D. C. Goff, Knoxville, Tenn.

### Tying Strings on Tools

A wrench, dropped accidentally into the gear case of an automobile, caused the workman to spend about one hour's time trying to fish it out with a piece of wire. This could have been avoided, if one end of a length of string had been tied to the wrench and the other to his wrist. It is always best to tie a string to any tool and fasten it to the person, if the tool is to be used where dropping it would cause trouble.

### A Homemade Block Signal

A homemade block signal, like the one shown in the illustration, has been in use for some time in a freight yard of an Ohio railroad. An upright pole holds in place a horizontal arm which is fastened in the center, and on each end of the arm is suspended a trainman's lantern of appropriate color. The device is operated by a rope, fastened to either end of the arm, by means of which the arm can be held at any angle desired, the rope being fastened like an ordinary awning rope. The crosspiece is called a target, and the device is stationed where one road crosses another. When the target is in

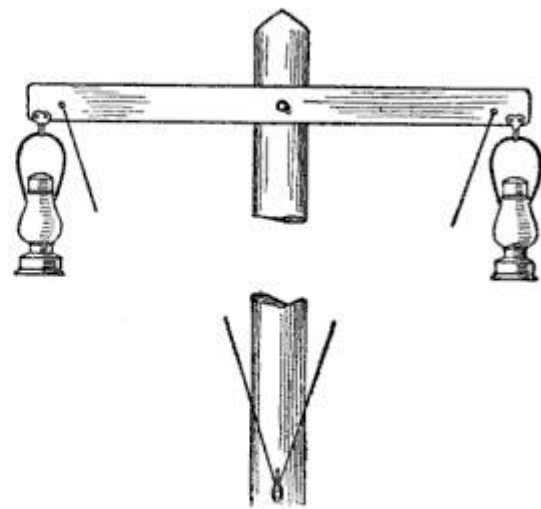

The Target with Two Lanterns Used for a Block Signal on Railroad Crossings

one position the track is clear for one road, and when in the other position the road is clear for the other line.—Contributed by Wm. N. Robson, Pittsburgh, Pa.



### Displaying Hosiery on the Ends of Stock Boxes

The usual way of keeping hosiery in stock boxes on shelves is to allow a part of the top pair to extend out and



Showing How to Exhibit the Color and Kind of Hose Contained in a Stock Box

over the end as in the first illustration to show the kind and color contained within. In selling hosiery from the box the top pair is taken out or displaced in getting out a pair below. Instead of allowing a part of the top pair to extend out, place the bottom pair in the box as shown in the second illustration, so that a part of it will lie on the inside of the box against the end and a portion overhang on the outside. Then, in selling a pair from the box, the pair used for display need not be disturbed and the trouble of rearranging the contents is lessened.—Contributed by Miss J. Schwartzberg, Shreveport, Louisiana.

### Guard for the Sliding Jaw of a Vise

There is no member of the bench vise more abused by the careless workman than the screw of the sliding-jaw part. It affords a ready but costly means of cutting wire and other small stuff with a hammer, to the destruction of this part of the vise and its roughing so that it will not pass freely through the slot in the guide-jaw head.

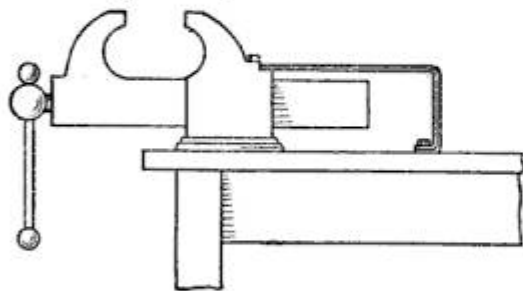

A Guard to Protect the Sliding-Jaw Part of a Bench Vise

The sketch shows a guard strip securely bolted to the bench over this portion of the vise, to afford a permanent and lasting protection for it. In a large shop, where laborers of all kinds

are allowed access to vises, this safety device would reduce repair expenses to a great extent.—Contributed by F. W. Bently, Jr., Milwaukee, Wis.

### Commutator Lubricating Stick

A very simple little device that can be made by anyone, and yet serves the purpose very well, is shown in the illustration. Select

a cylindrical piece of wood, about 4 in. long and 1 in. in diameter. Bore



a  $\frac{1}{2}$ -in. hole through the center longitudinally, then saw one end off diagonally, to fit the surface of the commutator. A piece of fine muslin is tacked over the sloping end. The hole is kept filled with vaseline, which is a good commutator dressing.—Contributed by Stanley Radcliffe, Laurel, Maryland.

### Refitting an Automobile-Engine Wrist Pin

In a great many automobile engines, the wrist pins are made a tight fit in the pistons and are held in place by a setscrew and lock nut, or a pin and cotter, on the inside of the piston. With such a construction the rod turns on the wrist pin. Generally the rod end is solid and is bronze-bushed. When the wear in the bushing and on the pin becomes great enough, a "knock" develops in the engine. As the thrust of the engine's work is all one way, the bushing will soon be worn out of round, the wear being on the side toward the cylinder head, and the pin will be flattened on the side next to the crankshaft. Where such damage has been done, the best kind of repair is, of course, to supply new bushings and pins.

Sometimes, however, for reasons of economy or because the automobile's condition will not warrant the new parts, the repair is made without them. One of the best ways of doing this is as follows: Mark the position of the



bushing in the rod, remove the bushing and turn it 90 deg., then replace it. This will place the short diameter on the thrust. Remove the wrist pin, after marking the position, turn it also 90 deg. and replace it, then "spot" the pin for the setscrew in its new position, or drill it through for the cotter, as the case may be. With a little scraping, the fit of the rod and pin may be made as good as when new in the direction of the engine's thrust. The play sideways, of course, is as great as it was endways, but this will not cause any knocking of the engine. This will make a cheap but good and satisfactory repair.—Contributed by Donald A. Hampson, Middletown, N. Y.

### A Nonspilling Soldering-Acid Can

Soldering fluid can be conveniently kept and carried in a small copper receptacle to which a cover has been soldered. A hole is cut in the center of the top and a  $\frac{3}{8}$ -in. tube soldered to it, the tube being long enough to extend almost to the bottom. Should the holder tip, the acid will not be spilled. When carried in a tool bag where it is liable to be roughly handled, a cork can be put into the tube as an extra precaution.—Contributed by Gertrude M. Bender, Utica, N. Y.

### Umbrella Hanger for Day Coaches

An umbrella is a friend in need, when it is raining, but usually a nuisance at other times, especially when traveling by rail.

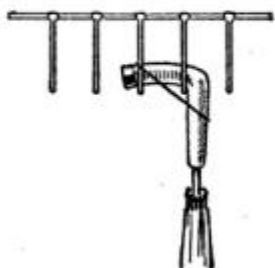

There is no convenient place to put it, and if laid in the package shelf it is often forgotten. Then, too, the shelf is generally filled with parcels. Simply

hook the handle through the bars of the package shelf and secure it with a rubber band, as shown, and the umbrella will remain where it cannot be broken or forgotten.—Contributed by Wm. N. Robson, Pittsburgh, Pa.

### Automobile Guide Rail in a Narrow Passage

A narrow passage that requires careful driving, to keep from scratching the body of an automobile, can be fitted

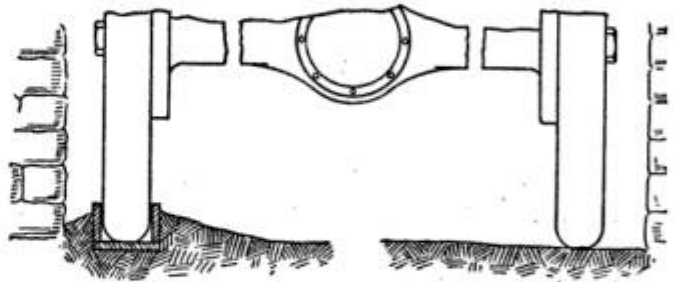

The Rail Guides the Automobile in the Passage so That Neither Side will Strike

with a guide rail that will make the driving easy. The rail consists of three pieces of lumber, one for the bottom of the rail, which is 1 in. thick and 6 in. wide, and two for the sides, each 1 in. thick and 5 in. wide. These are nailed or screwed securely together, as shown, in the form of a miter box. The rail should be somewhat longer than the passageway and if possible the sides should spread out a little to enable the driver to start the wheel into it without difficulty.

When ready to set the rail, drive the automobile into the passage, carefully centering it, and mark the location. Remove a sufficient amount of earth to permit the rail to be sunk to within 1 in. of the top and tamp the dirt in solidly on both sides.—Contributed by James W. York, Ottawa, Can.

### Testing Rollers for Straightness

A mechanic was asked to straighten some long rollers of a printing press that had been bent, and having no lathe long enough to take in the rollers, he was momentarily at a loss how to test them after in part straightening them. However, he hit upon a plan that was as good as it was simple. It is illustrated in the sketch.

The workbench was supplied with two vises about 8 ft. apart. In each of these was placed a large center used on the planer. When they were tightly gripped by the vise jaws and approximately lined up they were as



good as the lathe centers for the work. A block on the bench brought up close to the roll showed exactly the high

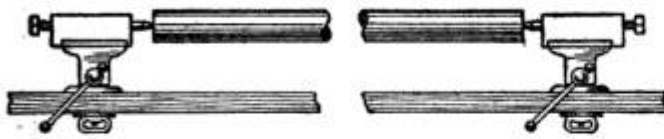

Testing Long Rollers for Straightness by Placing Them between Centers Clamped in Vises

spot when the roll was turned by hand. Repeated bendings at the high spots, followed by checking or testing between centers, produced a most satisfactory job.

### A Deaf-Mute and a Blind Man Conversing

For a time I was employed in a private sanitarium and while there I noticed two men who were very fond of each other, but had no means of communication whatever, one being a deaf-mute, the other having become blind by accident some time after having made the mute's acquaintance. I was called on several times to transmit messages between them, which led to the following idea: I purchased two telegraph keys, a sounder and a small green electric bulb, and wired them in the same way as two sounders, the deaf-mute using the light and the blind man the sounder. Both being very intelligent men, they soon learned the Morse code and made very rapid progress; in fact they became nearly expert telegraphers and were both very much delighted with the result of the idea.—Contributed by Joseph C. Laackmann, Philadelphia, Pa.

### A Holder for Loose Papers

One of the most convenient methods of holding loose papers, which are very apt to be thrown around and blown off a desk, consists of a piece of fiber board with clips at one end. All papers which are sent to the different departments in a large factory are always put on these boards with clips, and by means of them any additional sheets can be easily attached with red tags on

the clips to designate rush work. Two sizes of this board are used, one  $5\frac{1}{2}$  by  $8\frac{1}{2}$  in., and the other  $8\frac{1}{2}$  by  $11\frac{1}{2}$  in., made of fiber,  $\frac{1}{32}$  in. thick. These boards accommodate practically every size of paper ordinarily found in an office.—Contributed by Geo. L. Colburn, Norfolk Downs, Mass.

### Reducing Gearing Noise

The space, on each side, between the rim and the boss of the hub is fitted with disks of sheet metal, and the spaces between the disks, with sawdust and small shot. This will eliminate vibrations. Wheels with a diameter greater than  $1\frac{1}{2}$  ft. should be fitted with wooden instead of sheet-metal disks. A packing should be used between the disks and the metal of the wheel so that the sawdust will not sift out when the wheels are in motion.

The disks with the sawdust-filled space will not only prevent much of the noise, but will also make it impossible for a workman to get his arm or tools caught in the wheel.

### Soldering Irons for Rivet Heads

Where a large number of rivet heads are to be soldered to make them air or water-tight for tanks or blower pipes, a pair of coppers, shaped as shown at A and B, will do neat and quick work. The irons are shaped by heating them red hot, clamping each in a vise, C, and driving a rivet head into the end.

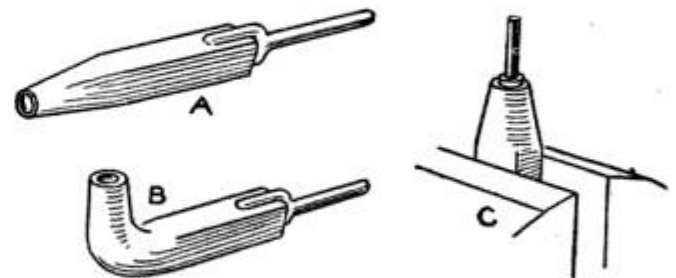

Soldering Coppers Having a Cup-Shaped End to Fit the Heads of Rivets

The edges are then filed to the right shape and tinned in the same manner as an ordinary soldering copper.—Contributed by Lorin A. Brown, Washington, D. C.



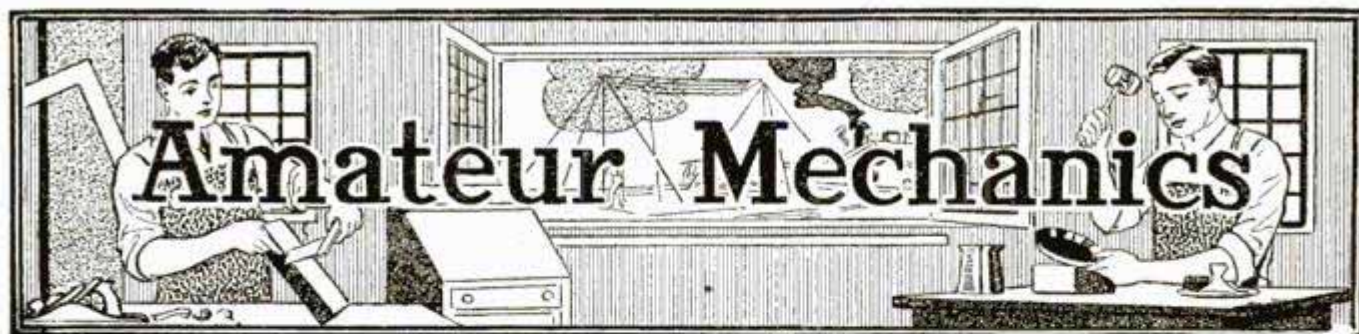

### A Telescoping Support for a Hinged Shelf

The supporting arm of the hinged shelf is constructed of a piece of gas pipe and a length of iron rod which



When the Shelf is Lowered the Support Telescopes and is Out of the Way

slides snugly into the pipe. A spring catch is set in the pipe at the proper height to engage the end of the iron rod when the shelf is up. This spring must be of good size, as it holds

the entire weight of the shelf. A large clock spring is suitable. One end of the spring is bent outward and upward to form a releasing handle. The other end is drilled for the two machine screws which hold it to the pipe. The spring works in a rectangular slot, cut lengthwise of the pipe. The pipe must extend 8 or 10 in. beyond the spring. The ends of the rod and of the pipe are pivoted with screws or rivets on angle pieces screwed to the shelf and wall.—Contributed by Donald A. Price, Wilmington, Del.

### A Bug Powder

To secure a nonpoisonous roach and bug powder mix dry 3 lb. plaster of Paris with 2 lb. of sugar, then add 1 oz. of pulverized aniseed. The addition of a little corn meal will help to draw the pests.—Contributed by Loren Ward, Des Moines, Iowa.

### How the Capacity of an Incubator may be Doubled

About 10 days after setting the incubator one may easily start another hatch by placing more eggs on top of the incubator in the following manner: Make a pad about 1 in. thick of any cotton material and place it on top of the incubator. Cut four pieces of boards, 1 by 4 in., and fit them around the top of the incubator. Nail them together as in making the sides and ends of a box. Pad the inside of this frame about 1 in. thick and tack it on top of the incubator, being careful that none of the material comes too close to the lamp. Place the eggs inside of this tray and cover them with a pad about 3 in. thick. Turn the eggs the same as those on the inside. When the first hatch comes out, place the eggs kept on top in the incubator after having cleaned it with a solution of carbolic acid.—Contributed by Hattie J. Day.

### Homemade Rivet Set

Desiring to rivet some pieces of leather together and having no rivet set, I hastily made one from a strip of heavy sheet tin,  $\frac{3}{4}$  in. wide. This was rolled at one end, as shown in the sketch, and the other end notched to fit over the rivet end. The rolled



A Strip of Tin Shaped to Take the Place of a Rivet Set

end formed the part for setting the washer and the slotted end held the washer down while the first blows of the hammer were struck.



## How to Make a Small Vertical Drill

A small hand drill with a three-jaw chuck that will take the smallest drill can be purchased very reasonably.

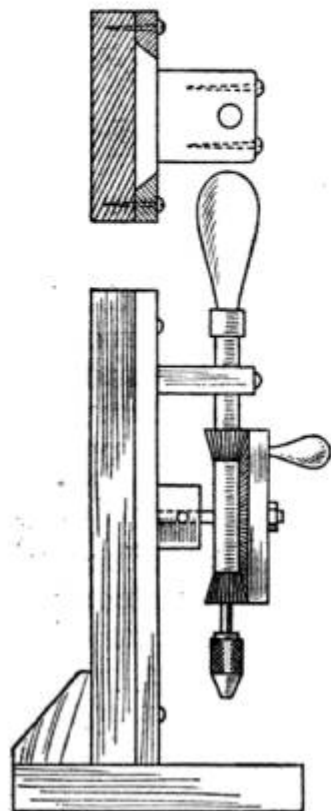

For ordinary work these drills do very well, but for comparatively deep holes, or when using long, slender drills, some sort of a stand should be made, if for no other reason, to avoid breaking the drills, which is almost invariably due to the side motion of the hand. There are other reasons, however, for making such a stand, and

these lie in the fact that it is impossible to drill by hand at right angles with the surface of the metal, or to hold such a drill sufficiently steady to avoid widening the hole around the top.

As each make of hand drill will require a somewhat different form of stand, no detailed description need be given of the one illustrated. The principal point is to have the base and standard securely set at right angles to each other, and then provide a smoothly sliding piece to which the hand drill may be clamped. The edges on this slide and the corresponding guides should be planed off to an angle of 45 deg. One of the guides should be adjustable, which may be arranged by elongating the screw holes and placing small washers under the heads of the screws that hold this guide to the main standard.

A neat little hand drill, arranged in this manner and firmly secured to the bench, may also be used for finishing the ends of small shafts, either flat or pointed, for polishing screw heads,

etc., to all of which it gives that workmanlike appearance that can only be had when things are polished with a true rotary motion.—Contributed by John D. Adams, Phoenix, Ariz.

## Decorating Candles

Candles can be easily decorated by the following method: The designs can be selected from paper prints which are tightly wrapped around the candle with the design in contact with the wax. Strike a match and play the flame over the back of the paper. Allow time enough for the melted wax to harden and then remove the paper. The print will be transferred to the wax.

Select designs that are not larger than the circumference of the candle. A good impression of ink on thin paper works best.—Contributed by J. J. Kolar, Maywood, Ill.

## Homemade Hacksaw Frame

A home workshop not having a complete set of tools may be supplied in many ways with tools made by the owner. The hacksaw frame illustrated is one of these. The frame is made of hard wood. The saw end is inserted in a slot sawed in the handle end, and a screw or small bolt holds it in place. The other end is equipped with a bolt having a sheet-metal head, as shown at A. The blade is kept from turning

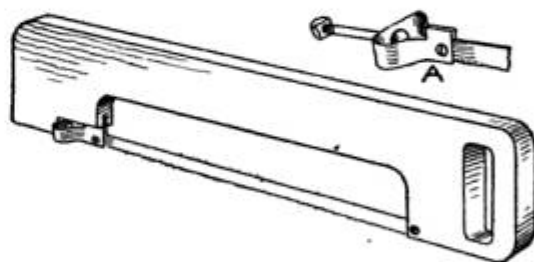

Hacksaw Frame, Cut from Hard Wood, with Fittings Attached to Draw the Blade Taut

by a projection of the sheet metal which fits in a saw cut made in the frame.—Contributed by W. A. Henry, Galesburg, Ill.



### A Homemade Cradle

The cradle shown in the sketch can be made quickly and easily at home and will be found far more serviceable than, and possessing several advantages over, the ones purchased. It is made of a clothes basket, an iron rod and two ordinary chairs. It can be

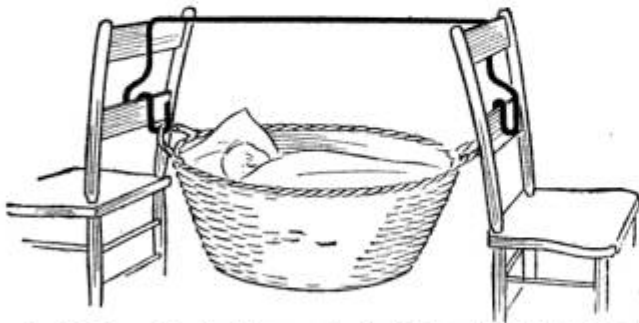

A Clothes Basket Supported with a Rod between Two Chairs Makes a Good Cradle

taken down and the parts used for other purposes. The upper portion of the rod prevents the chairs from slipping. A light cloth can be placed over the rod, in tent fashion, to keep flies out, while at the same time permitting air for ventilation.—Contributed by Bert Verne, San Diego, Cal.

### A Removable Post

It is often desirable to have football and baseball grounds in public parks roped in during the game, but after the game the ropes and stakes must be removed. To drive in iron stakes and then remove them is hard work and requires considerable time. The sketch shows a much better way. A

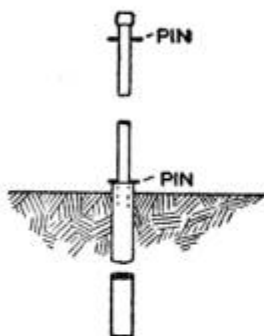

piece of 2-in. pipe, about 18 in. long, is sunk level with the ground in the right location for a post. The post is made of 1½-in. pipe of the length desired. This will just fit inside of the 2-in. pipe. A wood plug is fitted in the upper end of the pipe in the ground to keep out dirt when the post is removed.—Contributed by Abner B. Shaw, N. Dartmouth, Mass.

### String-and-Ball Trick

The stopping of a ball on a string at any desired point is understood by almost every person, but to make one that can be worked only when the operator so desires is a mysterious trick. Procure a wooden ball, about 2 in. in diameter, and cut it into two equal parts. Insert a small peg in the flat surface of one half, a little to one side of the center, as shown, and allow the end to project about  $\frac{3}{16}$  in. The flat surface of the other half is cut out concave, as shown, to make it  $\frac{1}{2}$  in. deep. The two halves are then glued together, and a hole is drilled centrally on the division line for a string to pass through.

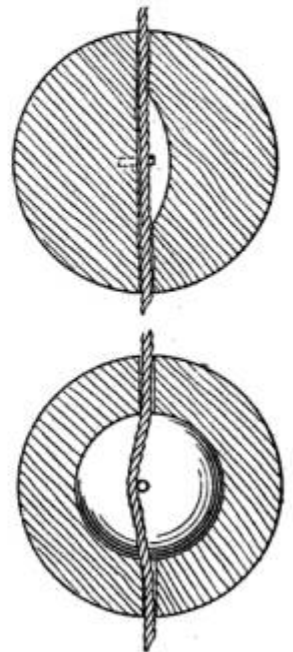

To do the trick, hold an end of the string in each hand tightly and draw it taut with the ball at the top, then slacken the string enough to allow the ball to slide down the string. To stop the ball at any point, pull the string taut.

Before handing the ball and string out for inspection, push the string from each side of the ball and turn it slightly to throw it off the peg. This will allow the string to pass freely through the ball, and it cannot be stopped at will. To replace the string reverse the operation.—Contributed by Wm. O. Swett, Chicago.

### Wall-Paper Cleaner

The following mixture I have used with the best results for years. Thoroughly mix together 3 pt. of wheat flour and 1 pt. of powdered whiting, then add sufficient water to make a dough. To clean a dirty papered wall, take a piece of the dough that can be easily grasped in the hand, press it



against the surface and make a long stroke downward. During the process of cleaning, keep kneading the dirt into the dough. The preparation can be mixed in any amount desired by using the proportions named.—Contributed by C. W. Bause, Jr., E. Troy, Wis.

### Revolving Shaft without Power

The device illustrated seems paradoxical for it apparently works without any power being applied to it, making from two to three revolutions per hour, which, though slow, is nevertheless motion, requiring energy.

The shaft A is supported on the edges, in the bearings B and C, of a tank, D. A disk, E, having a central hole larger in diameter than the shaft, is located at the middle of the latter. The disk is supported by 12 or more cotton ropes, F. The tank is filled to the level G with water. The lower ropes, being immersed in the water, shrink and lift the disk slightly above the center in the position of an eccentric, as shown by the dotted lines in the sketch. The center of gravity of the disk in this position, being higher and slightly to one side of the shaft, the disk has a tendency to turn around. The motion drives the next rope into the water where it becomes soaked and shrinkage takes place again, lifting the disk to a higher position, while the rope coming out of the water dries

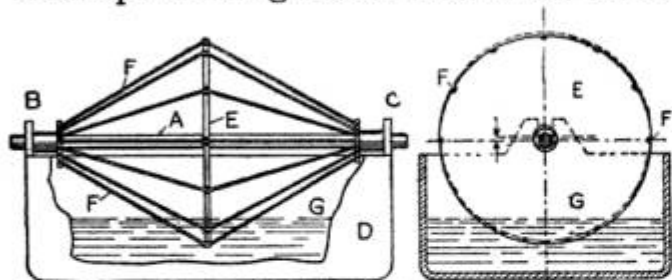

The Expansion and Contraction of the Ropes Keep the Disk Up and to One Side of the Center

out. The ropes emerging from the water but not yet thoroughly dry cause the upper part of the disk to be in an eccentric position laterally with reference to the center of the shaft, thus causing the center of gravity to be not only above but also slightly to one side.—Contributed by Charles Roberts, Brooklyn, N. Y.

### A Paper-Bag Holder

A holder, to accommodate the different-sized bags used in a store, can be easily made of a board, 6 in. wide and 30 in. long. One edge of the board is cut with notches similar to the teeth of a rip saw and their back-sloping edges are drilled to admit a nail point. A sufficient quantity of bags is placed in a pile and a nail is driven through the edge near their upper ends, and the projecting point of the nail is stuck into one of the holes. Proceed in the same manner with bags of other sizes. To remove a bag, take hold of the lower end of the outermost one and tear it from the nail. Be sure to drive the nails through the bags close to the top.—Contributed by Abner B. Shaw, N. Dartmouth, Mass.

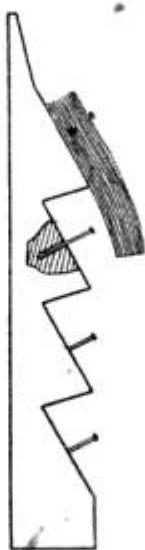

### Covering for Chalk Trays

The chalk trays fitted at the lower edge of blackboards soon collect considerable chalk dust and the chalk sticks dropped into it are, therefore, disagreeable to handle. A simple way of keeping the sticks clean is to cover the trays with wire mesh which is shaped like a tray but not so deep as the chalk tray. Thus the chalk dust will fall through this screen and be out of the way of the sticks.

### A Curtain Hanger

A close-coiled spring, about  $\frac{1}{4}$  in. in diameter, makes a much better hanger for a short curtain than a small rod. The spring should be about 1 in. shorter than the width of the window and fastened with screwhooks. The spring is preferable not only because it is less apt to tear the fabric, as it will give some if the curtain is pulled, but also for the reason that it is much easier to put it through the hem than the rod.—Contributed by Walter Ramm, New York City.



## Electrical Heating Apparatus for the Home

By ARTHUR MOORE

## Part II—An Electric Toaster

The frame and base of the electric toaster described in this article are made from sheet brass, approximately  $\frac{3}{64}$  in. thick. Five pieces will be required having the following dimensions: 11 by 8 in., 6 by  $1\frac{1}{2}$  in., 15 by  $3\frac{1}{4}$  in., 8 by 7 in., and 16 by 3 in., respectively. Some parts of the toaster, such as the doors and outer portion of the containing case, may be made from

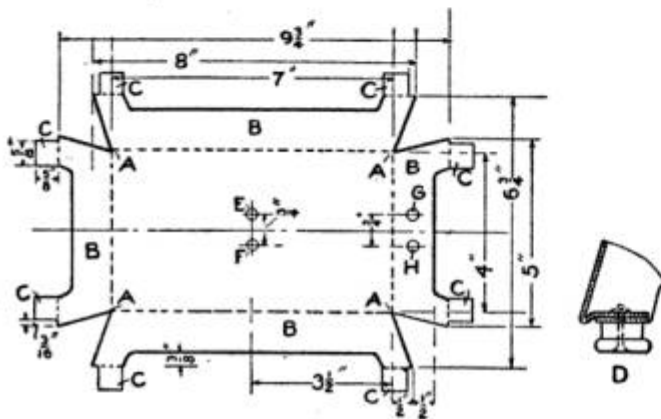

FIG. 1

Shape and Size of the Metal Which Forms the Base, and Manner of Attaching the Feet

lighter metal, but the selection of the proper thickness will be left to the builder.

Lay out on the largest piece of sheet brass, which is to form the base, an outline of the dimensions and shape given in Fig. 1. Drill four  $\frac{1}{16}$ -in. holes, one in each of the four corners A, and then cut away all metal outside of the full line. The four parts, B, are to be bent down along the dotted lines so as to form the sides and ends of the base, respectively. Before doing this, however, the edges along the ends of these parts should be beveled by means of a file so as to fit neatly together when bent into place. The eight projections, C, are bent under at the four corners along the dotted lines, and the two in each corner will overlap each other, thus affording a means of fastening the ends and sides together. One of these pieces in each corner should

be given an extra bend, as shown at D, to improve the appearance. Four small legs are then made from some insulating material that is not affected by heat, and fastened to the overlapping projections by means of a small bolt or rivet through a counter-sunk hole in each leg, as shown at D. This bolt or rivet thus serves the double purpose of fastening the legs and holding the sides and ends of the base together.

Two  $\frac{3}{8}$ -in. holes, E and F, are drilled in the central portion of the base for the leads to the heating element. Two other holes, G and H, are drilled in one of the end pieces to be used in mounting the terminal clips; these holes should be at least  $\frac{1}{4}$  in. in diameter and exactly  $\frac{3}{4}$  in. apart.

The main support for the heating element is made from the 15 by  $3\frac{1}{4}$ -in. piece of brass and should have the dimensions and shape shown in Fig. 2. Saw four slots, J, in the sides of this piece to a depth of  $\frac{1}{4}$  in. In each end of the piece drill two  $\frac{1}{8}$ -in. holes, K, for mounting it on the base. The centers of these holes should be  $\frac{3}{8}$  in. from the end. Next drill four  $\frac{5}{32}$ -in. holes, L,  $\frac{3}{4}$  in. from the ends and  $\frac{1}{2}$  in. on either side of the center line. The holes M and N are not drilled until the heating element is ready to be put in place, as their position will depend upon its dimensions. Four  $\frac{1}{8}$ -in. holes, O, are drilled in the four corners,  $\frac{1}{4}$  in. inside of the horizontal and vertical dotted lines respectively. The 20 holes laid out between the dotted lines near the center are drilled  $\frac{1}{16}$  in. in diameter; the rows should be  $\frac{3}{4}$  in. above and below the center line, and the holes in each row should be  $\frac{1}{2}$  in. apart, the odd spaces being at the ends.

Bend the  $\frac{1}{4}$ -in. side projections of the central part up at right angles on the dotted lines; the end projections containing the holes K are next bent



up at right angles; and finally the side pieces, containing the holes L, M, N and O, are bent down at right angles to the center portion on the vertical dotted lines.

The 16 by 3-in. piece of brass is bent

Procure two pieces of  $\frac{5}{8}$ -in. square brass rod,  $5\frac{3}{4}$  in. long; two pieces of  $\frac{1}{8}$ -in. rod,  $5\frac{3}{4}$  in. long, and a piece of  $\frac{1}{16}$ -in. brass wire,  $7\frac{1}{2}$  ft. long. Turn the ends of the square brass rods, for a distance of  $\frac{1}{8}$  in., down to a  $\frac{5}{8}$ -in.

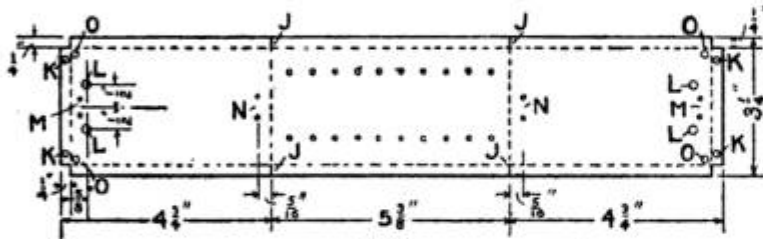

FIG 2



FIG 3

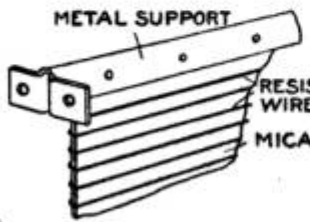

FIG. 4

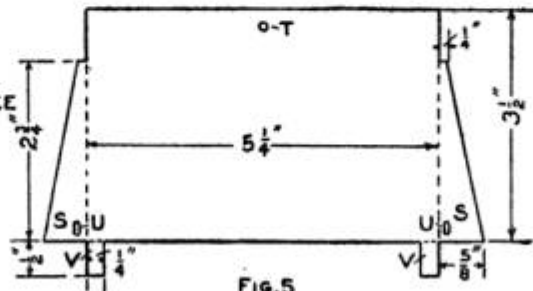

FIG. 5

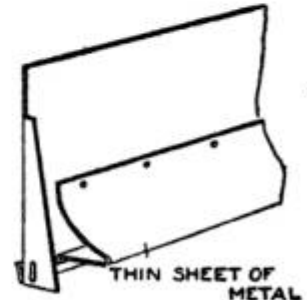

FIG 6

Patterns, with Dimensions, for Making the Supports for the Heating Element; and the Method of Attaching the Resistance Wire on the Insulator. The Door Dimensions and a Sheet-Metal Strip for Keeping the Bread Close to the Heat

into such a shape that it will fit snugly over the outside of the piece just completed. This piece is to form the outside of the case for the heating element, there being an air space of approximately  $\frac{1}{4}$  in. between it and the main support, which is quite an advantage in that it protects the outside of the case from the extreme heat, and also serves as an insulator, confining the heat better than a single piece.

Holes are now drilled in the top of the base to correspond to the holes K in the ends of the main support for the heating element. In locating these holes, divide the space at the ends and sides equally, and make sure the vertical portions of the support are the same distance apart at both top and bottom; in other words, parallel. Next locate and drill the holes for mounting the outer portion of the containing case. The piece forming the outer part of the containing case will extend beyond the piece forming the inner part, and this extension should be the same on both sides. Both these pieces should be fastened by means of small bolts, as it may be necessary to remove them to make repairs in the heating element.

diameter, and then drill ten  $\frac{1}{16}$ -in. holes in one side of each of them, not quite through,  $\frac{1}{2}$  in. apart, or so they correspond to the holes in the center portion of the piece shown in Fig. 2. These pieces are to be supported in the holes L, Fig. 2; and pieces should be cut from the  $\frac{1}{16}$ -in. wire of such a length that they extend from the holes in the  $\frac{5}{8}$ -in. square rods through the  $\frac{1}{16}$ -in. holes in the upper portion of the support and protrude  $\frac{1}{4}$  in. The pieces of  $\frac{1}{8}$ -in. rod are to support the doors and are to be placed in the  $\frac{1}{8}$ -in. holes, O, Fig. 2. After these pieces of wire and rods are all in place, they will be held by the outer portion of the case when it is fastened to the base.

Cut from the 6 by  $1\frac{1}{2}$ -in. piece of brass two pieces, each  $\frac{5}{8}$  in. wide and  $5\frac{7}{8}$  in. long, like the one shown in Fig. 3. Two  $\frac{1}{16}$ -in. holes, Q, are drilled in each end of each of these pieces. A slot, R, is cut in the center of each end to a depth of  $\frac{1}{4}$  in., and the four perforated pieces are bent up on the dotted lines at right angles. Then bend the main portion of the piece along the dotted line in the center, forming a piece like that shown in Fig.



4, with a space of  $\frac{1}{2}$  in. between the two sides. The  $\frac{1}{16}$ -in. holes in the main portion of the piece, indicated in Fig. 3, may now be laid out and drilled.

Obtain two pieces of good sheet mica,  $\frac{3}{8}$  in. thick,  $2\frac{1}{4}$  in. wide and  $4\frac{1}{8}$  in. long. The  $2\frac{1}{4}$ -in. sides of the mica pieces are inserted in the space between the sides of the metal pieces just described and the parts riveted together, as shown in Fig. 4, the mica pieces being so placed that their inside edges are  $\frac{3}{8}$  in. apart and the outside space at the ends is the same on both sides. Two terminals should be provided near the inside edges and as close to the lower end of the pieces of mica as possible, which may be made by drilling a small hole in the mica and placing a small brass bolt, provided with several washers, in each hole. These terminals should be as near the holes E and F in the base, Fig. 1, as possible, and for this reason it might be best to drill the holes in the base to the right and left of the vertical center line instead of as indicated.

Procure 15 ft. of No. 23 gauge "Nichrome" resistance wire and proceed to wind it on the pieces of mica. One end of the wire is fastened under one of the terminals; 19 turns are taken about one mica piece and then across to the top of the other piece on which 19 turns are also made, ending at the other terminal. The turns should be placed a little closer together at the bottom of the element than at the top, as this will give a somewhat better distribution of the heat, which naturally rises, making the upper part hotter.

The heating element may now be mounted in the previously made frame as follows: Place the heating element inside the U-shaped frame with its upper edge  $\frac{1}{8}$  in. from the upper surface of the frame and the ends of the metal strips in the center of the sides of the frame and then mark the location of the holes M and N, Fig. 2. These holes should correspond in size with those in the ends of the pieces shown in Fig. 3, and after they are drilled the heating element may be fastened by means of small rivets, or the holes may be

threaded and small screens used instead. Two doors for the sides of the toaster are cut from the 8 by 7-in. piece of brass to the dimensions given in Fig. 5. The projections S in the lower corners are bent over at right angles to the main portion of the piece: A small handle of insulation material is attached to each door at the point T. Two slots, U,  $\frac{1}{4}$  in. long and  $\frac{1}{8}$  in. wide, are cut in the projections S. These slots should be  $\frac{1}{8}$  in. from the dotted lines and  $\frac{1}{8}$  in. from the lower edge of the door. The projections V, Fig. 5, are bent back, as shown in Fig. 6, so as to form a stop to prevent the door from dropping too far. A piece of thin metal is riveted to the inside of each door, as shown in Fig. 6.

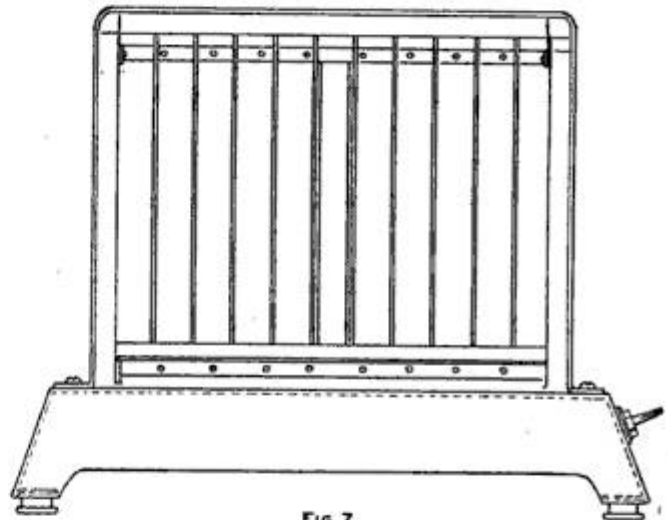

FIG. 7  
The Parts Assembled, Showing the Appearance of the Completed Toaster without the Doors

The bread is placed upon this piece and, as it is sloping, the bread slides over against the vertical wires.

A side view of the assembled toaster with the door removed, is given in Fig. 7.

The terminals of the toaster may be made as shown in Fig. 8, and consist of two pieces of  $\frac{1}{8}$ -in. brass, about  $1\frac{1}{4}$  in. long, mounted in the end of the base. Each of these pieces are threaded on one end, for a distance of  $\frac{5}{8}$  in., and the other end is rounded off and slotted with a hacksaw, as shown. Three brass nuts and two washers should be provided for each piece. Procure two pieces of thin mica, about  $\frac{5}{8}$  by  $1\frac{1}{4}$  in., and drill two  $\frac{1}{8}$ -in. holes in each piece,  $\frac{3}{4}$  in. apart, so that they



will center with the holes G and H, Fig. 1, in the end of the base. Mount the terminals on the base, first placing a sheet of mica on either side and a

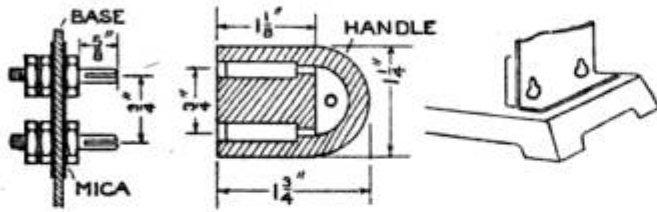

FIG. 8

FIG. 9

FIG. 10

Method of Insulating the Terminals; the Flexible-Cord End, and Covering for the Door-Rod Ends

washer outside of the mica; then draw the inside nuts up good and tight. Two pieces of asbestos-insulated copper wire, about No. 14 gauge and long enough to reach from the terminals of the heating element to the terminals on the end of the base, are then fastened by bending small eyes in their ends and placing them under the nuts provided on the respective terminals.

A special plug should be made from a piece of insulating material, and connected to a cord leading from the source of electrical energy. A cross section through a suitable plug is given in Fig. 9. It is made from a piece of composition insulation,  $\frac{1}{2}$  in. thick,  $1\frac{3}{8}$  in. wide and  $1\frac{3}{4}$  in. long. One end of the piece is rounded off, and an opening is cut to form a handle as shown in Fig. 9. Procure two pieces of thin brass tubing,  $\frac{3}{4}$  in. long and of sufficient inside diameter to just slip onto the terminals on the end of the base. Cut two slots in the end of each tubing with a fine hacksaw to a depth of  $\frac{3}{8}$  in., ream out the end, and spring the sides of the tube inward so that it will fit snugly on the terminals. Two holes,  $\frac{7}{8}$  in. deep, are drilled in the end of the piece of insulation, with their centers  $\frac{3}{4}$  in. apart and of such diameter that the brass tubes will just slip into them. Continue these holes with a smaller drill into the opening under the handle. Two small holes are now drilled through the side of the piece of insulation and through one wall of each tube, near the back end. Remove the tubes and thread the holes in them to take a small brass screw.

Countersink the holes in the insulation and increase their size so as to take the threaded screws.

The ends of the cord are now tied about the handle, so as to take care of the strain, and the ends are passed through the holes and fastened under the two screws, which also serve to hold the brass tubes in place.

The doors may be made removable by drilling two  $\frac{5}{32}$ -in. holes in one end of the outer part of the containing case opposite two of the holes O in the piece shown in Fig. 2, through which the  $\frac{1}{8}$ -in. rods may be removed. Two metal drops, as shown in Fig. 10, should be placed over these holes to prevent the rods from working out. Two handles of insulating material may be attached to the ends of the containing case, so that it can be handled or moved while hot. A collapsible wire rack may be arranged on top, upon which the toasted bread is placed to keep it warm.

The appearance of the completed toaster may be greatly improved, if desired, by having it nickelplated.

### How to Make a High Stool

The cast-off handles of four old brooms, three pieces of board, cut as shown, and a few screws will make

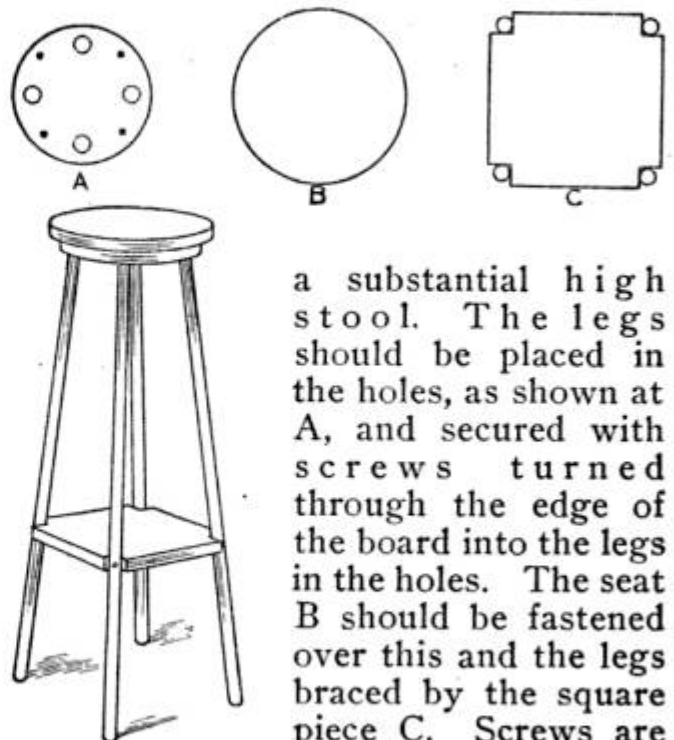

a substantial high stool. The legs should be placed in the holes, as shown at A, and secured with screws turned through the edge of the board into the legs in the holes. The seat B should be fastened over this and the legs braced by the square piece C. Screws are turned through the legs and into the square piece to keep it in position.



### A Homemade Blowtorch

The torch shown in the sketch requires no air pump. Instead of forcing a small stream of gasoline into a heated

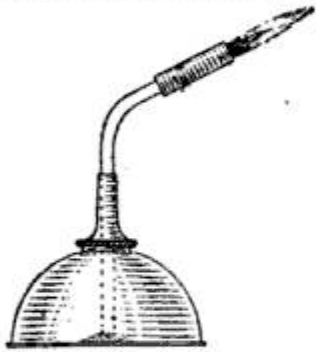

burner it converts the gasoline into gas in the chamber and blows a small jet of it through a very small hole into the combustion chamber.

A medium-sized and strong oil can is used for the reservoir, the spout being cut off close to the screw part and a steel or brass tube, about  $\frac{5}{16}$  in. in diameter, soldered to the stub end. The tube is bent as shown. A piece of wicking is drawn into the tube so that the upper end is within  $\frac{1}{4}$  in. of the tube end. The end of the tube is then fitted with a piece of brass rod with a very small hole in the center. The hole is made in the following manner: Before the piece is cut from the rod, it is held in a vise and the sharp end of a scriber is carefully driven into the center. A little oil placed on the scriber point will keep it from sticking in the metal. Measure the depth of the hole and cut the rod off just above the point. File the end of the piece cut off with a fine file until the point of the hole is reached. This hole must be so small that light can be barely seen through it.

The combustion chamber is made of a piece of brass tubing driven over the end of the smaller tube on the spout. About  $\frac{1}{2}$  in. from the back end of the larger tube four or more holes are drilled to admit air to the gas.

Fill the can about three-fourths full of gasoline and allow time for the wick to become saturated to the upper end. Hold a lighted match to the rear of the burner, and the heat will convert the gasoline into gas which will then burn with a nice white flame about 1 in. long. The success of the torch depends altogether on the fineness of the hole in the end of the tube and the tight soldering of all the joints.

### A Rule Gauge

The method of using the thumb as a gauge on a rule in scribing long boards is not always satisfactory, especially if the board has a rough edge. It is always best to have a regular gauge, but in the absence of one, an attachment for an ordinary carpenter's rule can be quickly made from a piece of tin, although one made of sheet brass is better, in appearance as well as for service. Cut out the metal, as shown by the dimensions, and roll the two sides up, stopping at the dotted lines. The ends A and B are turned out slightly so that they will slide easily along the edge of the board. The gauge will snap on a rule easily and

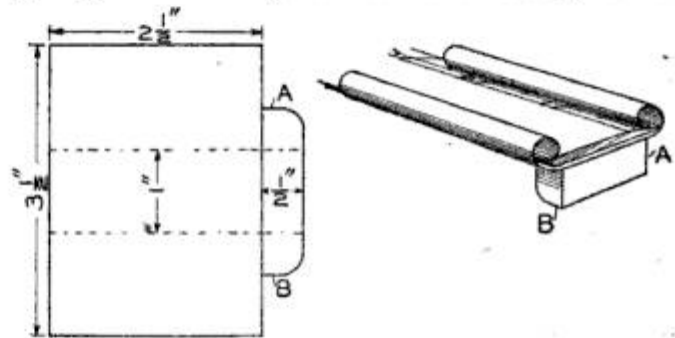

Gauge Made of Sheet Metal Which will Easily Snap on a Carpenter's Rule

will stay where it is placed.—Contributed by H. J. Blackledge, San Rafael, Cal.

### A Match Holder

The holder consists of a small box, the same size as a match box, with a sloping spring bottom and spring wires covering the lower part of the front side. One end of the match box is removed and the contents dumped into the holder. The matches fall to the lower sloping edge, where one match at a time can be easily removed.

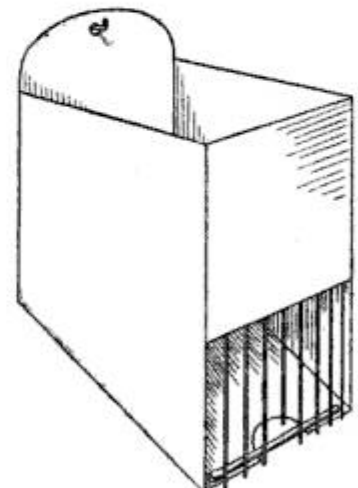

—Contributed by Bert Verne, San Diego, Cal.



### A Homemade Hydrometer

The hydrometer is an instrument used in determining the specific gravity of a liquid, such as acids, etc. The specific gravity of any material is the ratio of the weights of equal volumes of the material and water. Thus if a pint of acid weighs 1.2 times a pint of water, its specific gravity is said to be 1.2.



A very simple and inexpensive hydrometer, similar to the one shown in the sketch, may be easily constructed, and will give quite satisfactory results, if the scale on the instrument is carefully marked when it is calibrated.

Purchase from the local druggist or doctor two test tubes, one large enough to contain the other, as shown. The smaller tube is to form the hydrometer proper, while the larger one is to serve as a containing vessel in which the liquid to be tested is placed. The large tube should be mounted in a vertical position, by placing it in a hole bored in a small block of wood, or a suitable metal or wooden frame may be made that will accommodate one or more tubes.

The small tube is loaded at the lower end with a quantity of shot, or other heavy metal, in such a way that it will stand in a vertical position when it is placed in a vessel of water. The amount of the loading will depend upon whether the hydrometer is to be used in determining the specific gravity of liquids heavier or lighter than water. If the liquids are heavier than water, the loading should be such that the tube is almost entirely immersed when placed in water; if lighter, only sufficient loading should be used to make the tube stand upright in water. After the amount of loading has been determined it should be fastened in place by means of a small

quantity of calcined plaster. A small cork should now be placed in the open end of the tube, and the tube sealed by coating the end with shellac, or melting a small quantity of resin or sealing wax over the top of the cork with a hot soldering iron.

Now place in the large tube a quantity of as pure water as can be obtained—fresh rain water will answer very well and distilled water still better. Immerse the small tube in the water in the large tube and allow it to come to rest. Make a small mark on the small tube with a file, level with the surface of the water in the large tube. If the hydrometer is placed in a liquid lighter than water and allowed to float, the mark made on the tube will always be below the surface of the liquid in which the instrument is placed, and the mark will be above the surface of the liquid when the liquid is heavier than water.

The hydrometer may be calibrated by making use of a hydrometer borrowed from the druggist or doctor. The two hydrometers should be immersed in the same liquid and the tube of the newly made instrument marked to correspond with the markings on the borrowed instrument. If the liquid is heavier than water to start with, its specific gravity can be reduced by adding water, and as the water is added the hydrometers will both rise.

### A Stirring Stick

The stirring, or mixing, stick shown in the sketch deserves its name, as it will stir evenly all the way around. It consists of two flat sticks, one two-thirds the width of the other, which

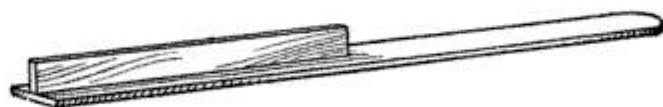

A Flat Surface Strikes the Liquid No Matter Which Way the Stick is Moved

are nailed together as shown. The narrow one is only long enough to enter the depth of the liquid.—Contributed by Frank J. Rempe, Oakland, California.



### A Pea-Shooting Gun

The gun consists of only two parts. The barrel may be either a piece of bamboo fishing pole or a section of sweet alder. The spring is a piece



A Pea-Shooting Gun Made of a Piece of Alder and a Corset String

of corset steel, such as can be usually found about the home.

Sweet alder can be found in the summer growing along the fences in the country almost anywhere. Find a stalk, about 1 in. in diameter, which is good and straight, and cut it off to a length of 6 or 7 in. Make a ram rod of wood and use it to punch out the pith of the alder, rendering the bore as smooth as possible. An old bamboo pole of like dimensions may be used instead.

Cut out a section of the wood,  $2\frac{1}{2}$  in. long, beginning  $1\frac{1}{2}$  in. from one end of the tube. The depth of this cut should be almost halfway through the piece. The corset steel is then inserted into the short end of the tube and bent over so that its other end will touch the bottom of the open part of the bore. A nick is made with a knife across the bottom of the bore at this point, to let the spring catch a little. The ammunition is placed before the caught end of the spring, as shown, and discharged by hooking the forefinger over the spring at the point A and pulling backward as when pulling the trigger of a gun.

It is necessary to keep the muzzle elevated a little after the ammunition is placed in position, otherwise the pea will roll out before the spring has a chance to strike it.

### Coloring Electric-Light Globes

Often it is desired to produce certain effects in lighting which demand a different-colored light than that given by the modern tungsten lamp. As an example, a soft, mellow light is some-

times desired similar to that given by the old carbon-filament lamp. In such cases it is a great mistake to install the carbon lamps on account of their exceedingly poor efficiency.

The ordinary tungsten lamp has an average efficiency of about 1.2 watts per candlepower, while the carbon-filament lamp requires about 3 watts per candlepower. Therefore, it is much more economical to color the globe of the tungsten lamp so as to produce the required color than to use the carbon lamp. Of course, both lamps must be colored when any color other than a soft, yellow light is desired.

A cheap coloring solution may be made as follows: Soak a small amount of gelatin in cold water for several hours, then boil it and strain it through a piece of fine cloth. While the solution is still hot, add a small quantity of aniline dye of the desired color that has been previously mixed in a small quantity of cold water. The lamps are dipped in the solution and then allowed to cool in a vertical position so that the coating will be more uniform.

A more satisfactory coloring solution may be made from celluloid. Obtain quite a number of old photographic films and remove all the gelatin by washing them in hot water. Then dissolve them in a solution of equal parts of ether and alcohol. Add the coloring solution and dip the lamps. The coating produced by this method is impervious to water.

### Support for an Open Book

When a book is laid on a table for reading the pages at the beginning or end, it will not stay open flat on account of the difference in the thickness of the open parts. One person, doing a great deal of reading, uses a small card, with the corner cut out, which is placed under the side of the book having the smallest number of leaves, as shown.

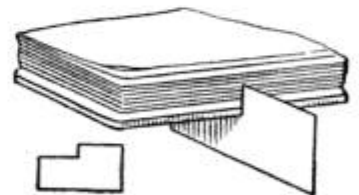



## INTERESTING NEW PATENTS



FIG. 1



FIG. 3



FIG. 5



FIG. 7

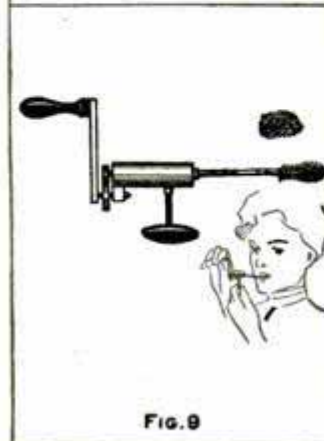

FIG. 9

**TRAVELING ELECTRIC FAN** (Fig. 1)—This apparatus, which is intended to distribute the effect of a fan over a room, consists of an ordinary electric fan hung from a carriage which travels back and forth on a horizontal wire track. The fan is propelled by the lateral force of the air current, since it is so mounted as to rotate alternately in two planes that are slightly inclined to the horizontal. When the fan has run the length of the cable in one direction, the impact with a metal disk inclines the motor in the opposite direction and the fan propels itself back to the other end.

**WEED PULLER** (Fig. 2)—This device consists of a hollow tube terminating at its lower end in a blade having straight teeth and provided with a pivoted arm for grappling the weed, the pivoted arm having curved teeth that engage the teeth in the blade. The pivoted arm is operated by a lever arm to which is connected a rod that runs up the side of the hollow tube and through the top to a connection with the lower or movable handle, by which it is controlled.

**COMBINED EYE SHADE AND FAN** (Fig. 3)—The fan is held to the hat by a clamp which is attached securely to the brim and which draws into position a spring tongue which bears against the lower side of the fan. In order to use the clamp it is necessary to make a notch in the edge of the fan.

**FAN ATTACHMENT FOR ROCKING CHAIR** (Fig. 4; British patent by an American)—With this apparatus two motions are imparted to the fan when the chair is rocked. The rockers are mounted on a base, and through the gearing, as shown, and the shaft on the back of the chair, an up-and-down motion is given to the shaft that carries the fan. A wire that passes over a grooved roller on the fan shaft and is attached to the lower part of the chair gives the fan shaft a rotary motion as it is raised and lowered, a spring bringing the shaft back to its original position after each movement.

**FUNNEL WITH DUCTS FOR ESCAPE OF AIR** (Fig. 5; British patent)—The outer walls of the funnel are provided with spiral grooves which permit the air to escape while the vessel is being filled, and, forming corrugations on the inside, also give a swirling motion to the liquid.

**LAWN TRIMMER** (Fig. 6)—This trimmer is made of a single sheet of metal which is bent to a channel shape and formed to a sharp point at each end and to a sharp blade on the side which forms the cutter of the device. A handle is attached to the other or vertical side of the channel.

**EQUILIBRATOR FOR BOAT** (Fig. 7)—This device is designed for stabilizing a small boat in a rough sea or for equilibrating under uneven loading, and consists simply of an adjustable weight suspended under the boat as shown. Chains running from the bow and stern make it possible to shift the weight to a position under any part of the boat.

**MOISTENING BELL** (Fig. 8; British patent by a Hungarian)—This bell or cover is intended to be placed over foods, plants, flowers, tobacco or other substances which it is desired to keep moist. The recesses in the wall extend around the cover, and when the cover is dipped into water and withdrawn the recesses remain filled.

**ROTARY TOOTHBRUSH** (Fig. 9; British patent by an American)—The shaft that carries the brush is rotated by a crank handle that is geared to the shaft in such a way that a moderate speed of turning gives a rapid rotation to the brush. The brush is held in place by friction and is easily detachable.

**RAILWAY MOTOR CAR** (Fig. 10; British patent)—The purpose of this curious construction is to provide room for the motors under the center of the car. The motorman's compartment is at the center of the car, over the motors, and has windows that project above the roof.



FIG. 2



FIG. 4

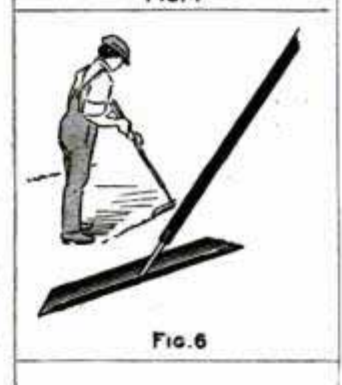

FIG. 6

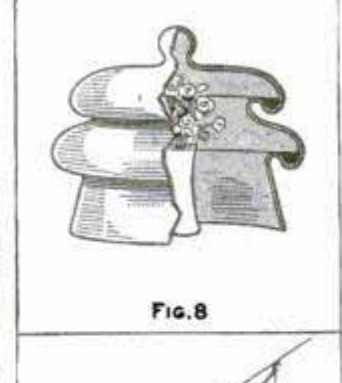

FIG. 8

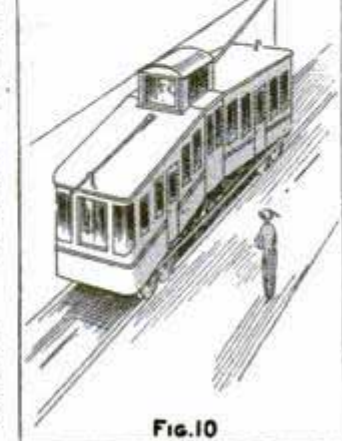

FIG. 10



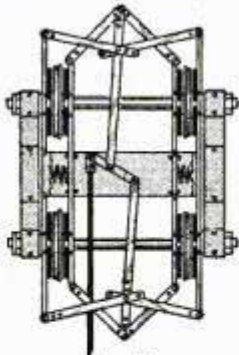

Fig. 11

**BRAKE FOR RAILWAY TRUCKS (Fig. 11)**—In this novel apparatus the brake shoes bear against the sides of the wheel and not against the tread, and it is claimed that by this arrangement all danger of lifting the wheels by the force of the brakes is eliminated. The brake shoes work in pairs, one bearing against each side of the wheel. They are set by a system of levers, as shown, and are returned to their original position by springs as soon as released.

**EXTRA HANDLE FOR SHOVEL (Fig. 12)**—This extra handle, intended to give a more convenient hold in handling a shovel, is attached by means of a clamp which is secured in place with a setscrew. To give the utmost freedom of movement the handle has a pivotal connection with the clamp.

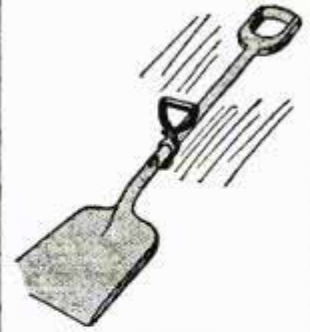

Fig. 12

**COMBINED KNIFE AND SCISSORS (Fig. 13; British patent)**—This implement is designed principally as a fruit knife and grape cutter. The long prong comprises the knife, while the short prong, or grape cutter, has a ledge which projects over the back of the knife blade and is adapted to hold the stalks of the grapes as they are severed.

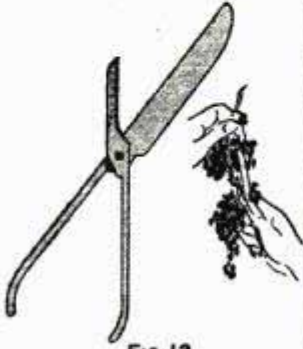

Fig. 13

**HORN ATTACHMENT FOR VIOLIN (Fig. 14; British patent)**—A hole is cut in the back of the violin, and this is closed with a dish-shaped sounding board on which the sound post of the instrument rests. The horn is attached to an elbow which is pivoted to the instrument, and can therefore be turned to direct the sound in any direction. This device is particularly suited to making graphophone or similar records.



Fig. 14

**SOIL PULVERIZER (Fig. 15; American patent by a Canadian)**—This simple device, designed to pulverize and level the soil, consists of three beams rigidly attached to a frame at right angles to the direction of movement. The crushing is done by the two forward inclined beams, and the leveling by the rear beam, which has one face resting flat on the ground.



Fig. 15

**CLOTHESLINE REEL (Fig. 16)**—This reel consists of cross arms which have brackets for carrying the clothesline and are pivoted by a stub shaft to a straight supporting bar. The supporting bar has a handle on one end and a guide for the clothesline on the other. The reel portion is turned by a small handle placed just inside one of the brackets.



Fig. 16

**LIFE-SAVING BUOY (Fig. 17; British patent by a Russian)**—The sides of this buoy have double walls, between which are air spaces for securing buoyancy. Water is kept out of the vessel by a water-tight jacket which is attached to the top of the buoy and is strapped around the waist of the user. A weight is attached to the bottom of the vessel to add to its stability, and a small force pump is provided for pumping air into the air spaces.



Fig. 17

**ROLLER SKATE WITH BRAKE ROLLER (Fig. 18; British patent by a German)**—The drawings accompanying this patent show a type of skate that is uncommon in this country, since it has only one supporting wheel. The essential features of the patent are the mounting of the wheel on a spring and the provision of a brake roller at the rear of the skate.

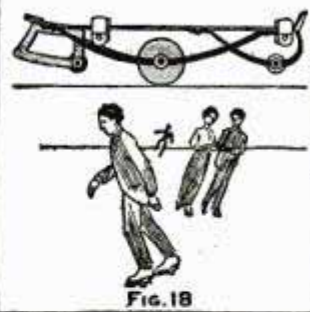

Fig. 18

**CLOTHES-WASHING APPARATUS (Fig. 19; British patent)**—This apparatus is designed for permitting the clothes to be effectively stirred while they are being boiled. It consists of a cage with slatted sides and a perforated bottom, that is set into the wash boiler. A lid fits closely over the cage, and through a hole in the center of this lid there projects a stem which is used in turning the stirring device.



Fig. 19

**ROAD-IRONING MACHINE (Fig. 20; British patent by a German)**—The plate at the bottom of the machine is heated by the combustion of gas in the closed chamber above it and is rotated on the section of pavement to be treated, melting the asphalt and ironing it to a smooth surface. The shaft is hollow, and through it the gas is admitted to the chamber. A compact engine for rotating the chamber and plate is contained in the upper and stationary part of the machine.

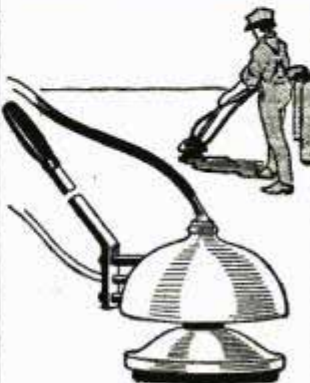
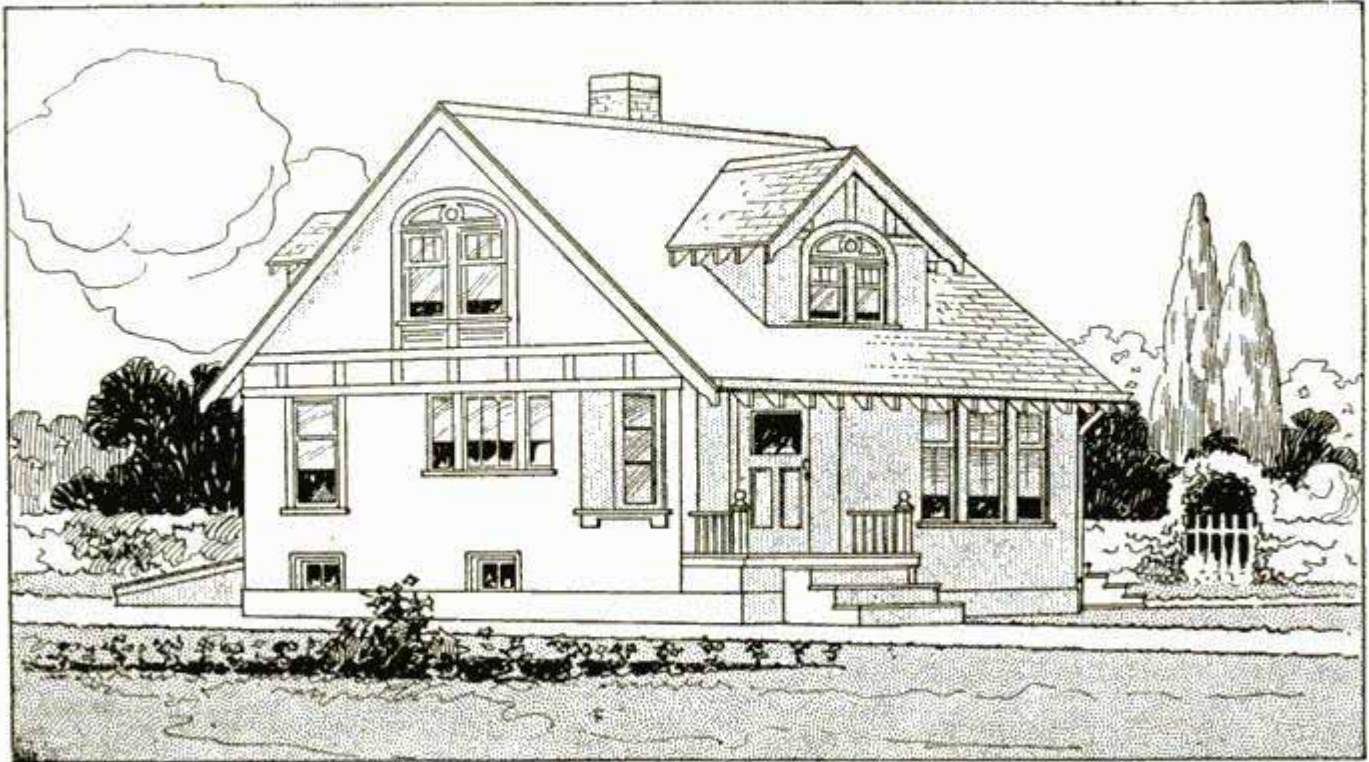

Fig. 20



## AN ATTRACTIVE CEMENT-STUCCO COTTAGE

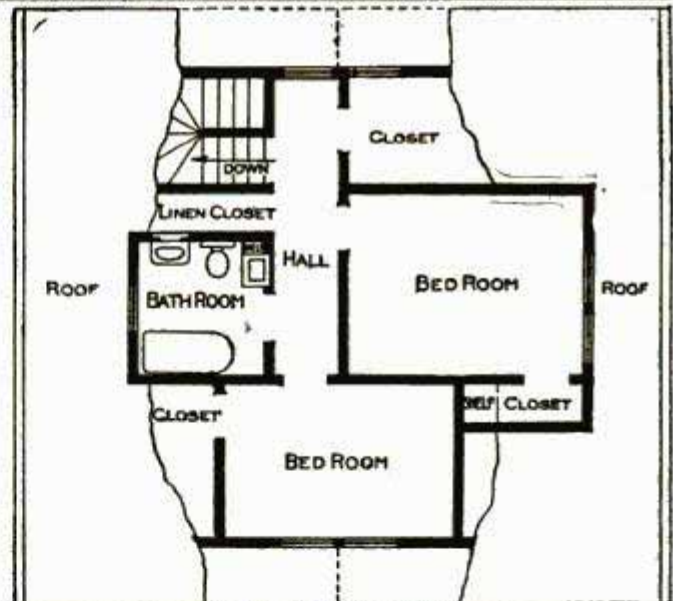

First-Floor Plan

W. A. Abell & Sons, Architects, Elgin, Ill.  
Second-Floor Plan

The exterior of this compact six-room cottage consists of cement plaster laid on metal lath, with a roof of stained shingles. Although of the simplest form of construction, the building as a whole produces a picturesque effect, owing mainly to the treatment of the dormers, the spacing and form of the windows and the suggestion of half-timber construction at the ends of the building.

The plan of the first floor is of a rather unusual type. The dining room has an outlook on the street, with a window opening on the front porch, while the living room overlooks a garden at the opposite side of the building. The living room is entered through a vestibule, and from this room an archway leads into the dining room, there being no outside entrance to the latter. The front porch is partly under roof, but is open on two sides. A feature worthy of note as being unusual in buildings of this class is the dressing room, placed adjoining the dining room. This room is provided with a closet and with a cupboard under which a sliding bed may be placed, an arrangement that makes the room available as a spare bedroom when required. The dining room opens directly into the kitchen, a recessed sideboard being located at the side of the doorway. The stairways are arranged in what appears to be the most convenient way, the stairway to the basement leading from the kitchen and that to the second floor leading from the dining room.

The second floor contains two bedrooms and bathroom, with a hallway that gives direct access from each room to the stairway. Each bedroom is furnished with a closet of ordinary size, while there is one large closet for general storage, that is independent of the bedrooms, having its entrance opening into the hallway. The building was erected and equipped at a cost of about \$2,600.





Mishkin



Broothorn

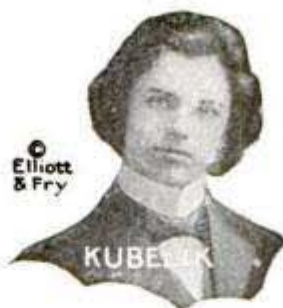

Elliott & Fry



Devis & Sanford

## The Victrola gives everybody the kind of music they like best

Its mission is to bring to you the best music of every kind—and just as it presents to you the beautiful voices of the world's greatest opera stars and the superb art of the most celebrated instrumentalists, so in the lighter forms of music it offers you entertainment by the most noted talent.

With a Victrola you can change at will from the classical to the mirth-provoking—one moment you are in fancy transported to the Metropolitan Opera House and hear Caruso and other famous artists, the next you can be in any of the myriad of theatres along Broadway listening to the "song hits" of the latest musical successes.

And as you sit and enjoy all this wonderful variety of music on the Victrola, your enjoyment is all the greater because of the knowledge that the music you are hearing, you can hear again and again, whenever, and as often as you wish.

There are Victors and Victrolas in great variety of styles from \$10 to \$200, and any Victor dealer will gladly demonstrate them and play any music you wish to hear.

**Victor Talking Machine Co., Camden, N. J., U. S. A.**

Berliner Gramophone Co., Montreal, Canadian Distributors

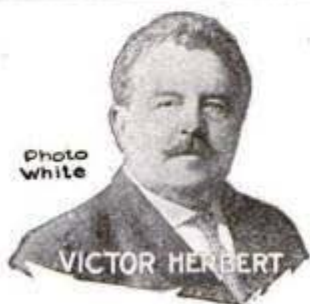

Photo White

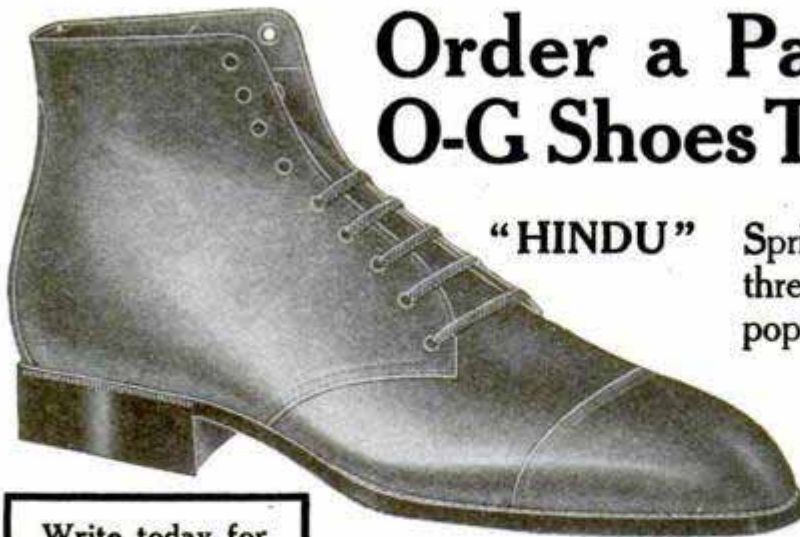

Photo White



**New Victor Records demonstrated at all dealers on the 28th of each month**





# Order a Pair of O-G Shoes Today



**"HINDU"** Spring style starter—blucher cut, thread lace to top, stitched tip, popular flat last, in black and tan.

## \$4.50

Sent anywhere, prepaid, upon receipt of price.

Write today for book of the O-G BOOTERIES, showing spring and summer styles. It is FREE.

O-G Shoes are worn wherever originality is appreciated. We've created more smart, snappy styles in men's and women's footwear than any other house in America. O-G shoes are first in style, first in quality—first in everything.



## O'CONNOR & GOLDBERG

Mail Order Address:

Dept. A, 205 S. State St. (Republic Bldg.), Chicago, Illinois

# WONDERFUL NEW FOUNTAIN PEN

Self-Filling **"THE CHICAGO"** Non-Leakable

## \$1

### SPECIAL OFFER

### Beautiful—Economical—Reliable

At last, a perfect fountain pen. Throw away your old style pen and dropper. THE CHICAGO has come to stay. It is the greatest and simplest fountain pen ever put on the market. So easy to fill. Simply turn the cap and you can regulate the flow of ink just as you want it.

### THE ONLY FOUNTAIN PEN THAT REGULATES THE FLOW OF INK

Automatic Self-filler—no dropper needed. Just put the pen in ink, turn the cap and it can be filled in four seconds' time. The biggest improvement ever put into a fountain pen. You cannot soil your hands or clothing; no danger of blotting the paper; will not leak when upside down. It is a beautiful pen, equipped with 14 karat plated gold pen point. Everybody will want one when they see it. Writes in a nice, smooth, steady, easy manner.

Regular Price \$2.50

Here's what we're going to do. In order to let the people quickly learn the merits of this remarkable pen, we are going to give away a thousand of them to the readers of this paper for practically the cost of packing, postage and advertising; \$1.00. Remember, only a thousand at this low price. They will be snatched up in no time. Get yours today. We make this unusual price because we have no dealers or agents to split our profit with. We sell direct only.

**SEND US YOUR ORDER TODAY.**

CHICAGO FOUNTAIN PEN CO.,  
Dickey Bldg., Chicago, Ill.

Gentlemen: Enclosed find one dollar. Send me the wonderful "CHICAGO PEN" as advertised in the Popular Mechanics.

Name.....

Address.....

### THIS COUPON SAVES YOU \$1.50

Clip it out, mail it at once and we will send you this wonderful pen by return mail. You absolutely take no risk. When you see it, if you do not think it is the best pen you ever saw send it back and we will instantly refund your money. Send 2c stamps, money order or currency. Add 5c to personal checks for exchange. Order today, save \$1.50.





# A jimmy pipe is bully fine

just jammed full of delicious Prince Albert—tobacco that's pleasing and fresh and fragrant. *You get yours*, and know yourself what it means to grow smiles where grouches used to sprout! Now, listen:

## PRINCE ALBERT

*the national joy smoke*

can't bite your tongue, because the bite's cut out by a patented process that just gives you the best smoke any man ever put a match to.

*And you can smoke P. A. all day and all night and just feel fine and dandy and most cheerful, because it's tobacco without a comeback!* And that's why men go to it, natural-like. *Change your brand!*

Buy Prince Albert in the first store you hit. Tippy red bag, 5c; tidy red tin, 10c; also in handsome pound and half-pound humidors. You can now get P. A. all over the civilized world.

**R. J. REYNOLDS  
TOBACCO CO.**  
Winston-Salem, N. C.

Copyright  
1914 by  
R. J. Reynolds  
Tobacco Co.



*Please Mention Popular Mechanics*





## The Out-of-door Life!

**M**OUNTED on a sturdy, fast Indian you are in command of everything that's going on, far and near. Shore and country—short trips or long trips—the whole out-of-doors is yours when you own a motorcycle. The zest of riding, with its rush of pure air—as you roll off mile after mile—gives a new exhilaration, just makes life hum with fresh delight!

What point of interest do you want to reach quickly? Throw a leg over an Indian—give a "twist of the wrist"—and off you go.

# Indian MOTOCYCLES FOR 1914

are powerful and swift red beauties. All have Footboards, the famous comfort feature, the Cradle Spring Frame and 38 Betterments. Some have electric equipment, consisting of electric head light, electric tail light, electric signal, two sets of storage batteries. Also Corbin-Brown rear drive speedometer.

Prices have been revised downward—mechanical values increased—so that almost every young man can own an Indian with a little effort.

And remember this: All Indian riders have a world-wide service always on call, provided by 2,700 Indian Dealers and Service Stations.

### The 1914 Line of Indian Motorcycles

4 H. P. Single, Service Model .....	\$200.00
7 H. P. Twin Two-Twenty-Five, Regular Model.....	225.00
7 H. P. Twin Two-Sixty, Standard Model.....	260.00
7 H. P. Twin Light Roadster Model .....	260.00
7 H. P. Twin Two-Speed, Regular Model.....	275.00
7 H. P. Twin Two-Speed, Tourist Standard Model.....	300.00
7 H. P. Twin Hendee Special Model (with Electric Starter)	325.00

*Ask the nearest Indian dealer for a free demonstration. He'll be glad to talk the Indian over with you. Send for the new 32-page catalog.*

**HENDEE MANUFACTURING CO.** (Largest Motorcycle Manufacturers in the World) 816 State St., Springfield, Mass.

Branches and Service Stations—Chicago, Dallas, Kansas City, Minneapolis, San Francisco, Atlanta, Denver, Toronto, Melbourne, London





United States Tire Enthusiasts at a "Motorcycle Picnic," Williamsport, Pa.

## For pleasure and for business the motorcycle is a safe, speedy means of transportation, and United States Tires make it dependable.

Today the motorcycle is an efficient, economical, perfected piece of mechanism.

It has passed the experimental stage—the motorcycle has "arrived."

We, the makers of United States Tires, have done much to make the motorcycle dependable.

We have concentrated our great resources to improve our product as the motorcycle has improved.

We have kept pace with the motorcycle makers.

We have each year equipped better motorcycles with better tires.

We have solved the motorcycle tire problem.

Today United States Motorcycle Tires stand alone in a class absolutely by themselves and are acknowledged to be the standard motorcycle tires of the world.

Their overwhelming popularity is a known fact.

**In one year—1913—the sales of UNITED STATES MOTORCYCLE TIRES increased 139 per cent.—an increase that is without a parallel in motorcycle history**

**NOTE THIS:—Dealers who sell UNITED STATES MOTORCYCLE TIRES sell the best of everything**

# United States Motorcycle Tires

Made by the

Largest Rubber Company in the World



**MAKE \$250.00 A MONTH**

**Repairing AUTO-TIRES  
MOBILE**

Sounds like a lot of money  
**—IT IS—A WHOLE LOT of MONEY**  
 to be earning CLEAR every month—yet it's  
 what hundreds of men we have established in the  
 Automobile Tire Repair Business are making.

You let down the DRAW BRIDGE for SUCCESS to enter into  
 your career by getting into business for yourself. The business for  
 you is the one where investment is small—the returns quick and for cash  
 —where the margin of profit is large—the demand for your PRODUCT or  
 SERVICE constant and ever on the increase.

**A Haywood Tire Repair Equipment**

answers to all of these requirements of Old Dame Fortune—the certainty of success in this  
 business is as sure as anything in this world can be—Each year adds thousands of new  
 Automobile Owners—they need YOU to keep their tires in service.

**Here Is Your Opportunity!**

Be first to enter this new big paying business in your town. Open your pockets. Let the dol-  
 lars pour in. Act quick. Every auto sold means more tires to mend. Automobile business is  
 growing fast—enormous field for tire repairing. Punctures and blowouts are common. Tires need  
 retreading and vulcanizing. Something going wrong all the time. Thousands forced to buy new  
 tires because they can't get old ones fixed. Think of the old bicycle days—repair shops on every  
 corner—all making money—busy day and night. Autos make same proposition over again—only  
 ten times bigger and better. Users of Haywood Tire Repair Plants are making big money. Johnson,  
 Tex., writes: "I have made as high as \$18 in a day." Another man who bought a plant Septem-  
 ber, 1911, writes he has cleared over \$3000.00. That's going some! Operate a plant as side line  
 in connection with auto business—garage or as  
 an independent business. Find neighbor-  
 hood where there's a bunch of autos—get  
 all the steady business besides transient  
 work. Experience unnecessary. You learn  
 quick. Simply follow directions—practice  
 a few days on a couple of old tires and  
 you'll be ready to coin money Business  
 comes fast and easy.

**Repair Tires At Home.**

Young men! and boys repair father's tires—get  
 money he pays garage man. Get the neighbor's  
 work. Make money to attend college or to start  
 a garage and repair business. Auto owners—re-  
 pair your own tires—save money—pay for your outfit  
 in short time. We have outfits for home use. Any-  
 how investigate. Send today for catalogue. See the  
 wonderful possibilities in this marvelous field. Learn  
 of the enormous money-making opportunities in  
 this fascinating new business.

**Haywood Tire & Equipment Co.**  
 688 N. Capital Avenue  
 Indianapolis, Indiana

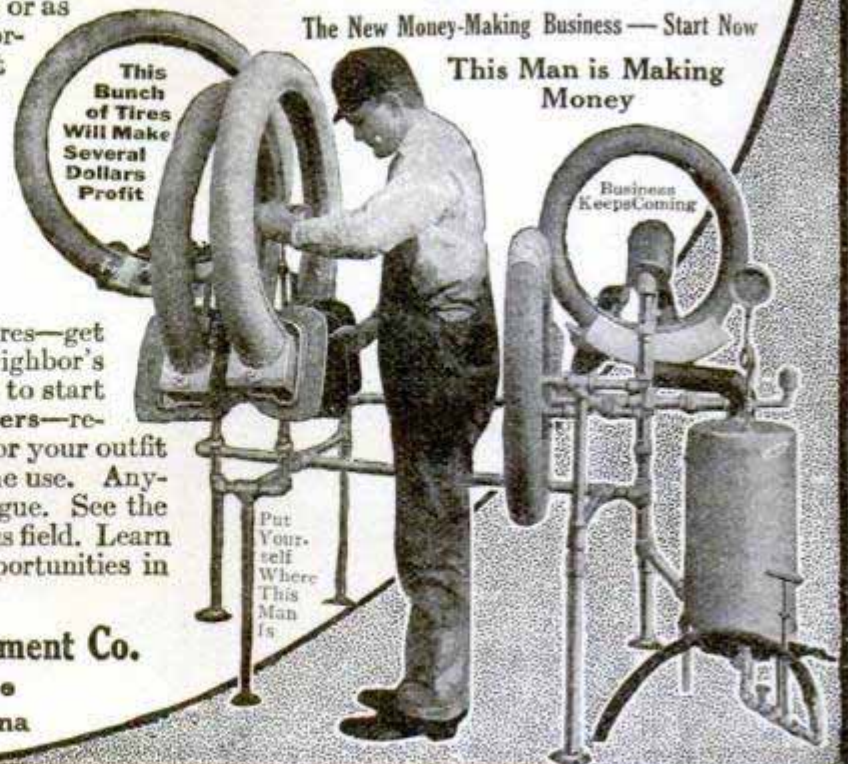

This  
 Bunch  
 of Tires  
 Will Make  
 Several  
 Dollars  
 Profit

The New Money-Making Business — Start Now

This Man is Making  
 Money

Business  
 Keeps Coming

Put  
 Your-  
 self  
 Where  
 This  
 Man  
 Is



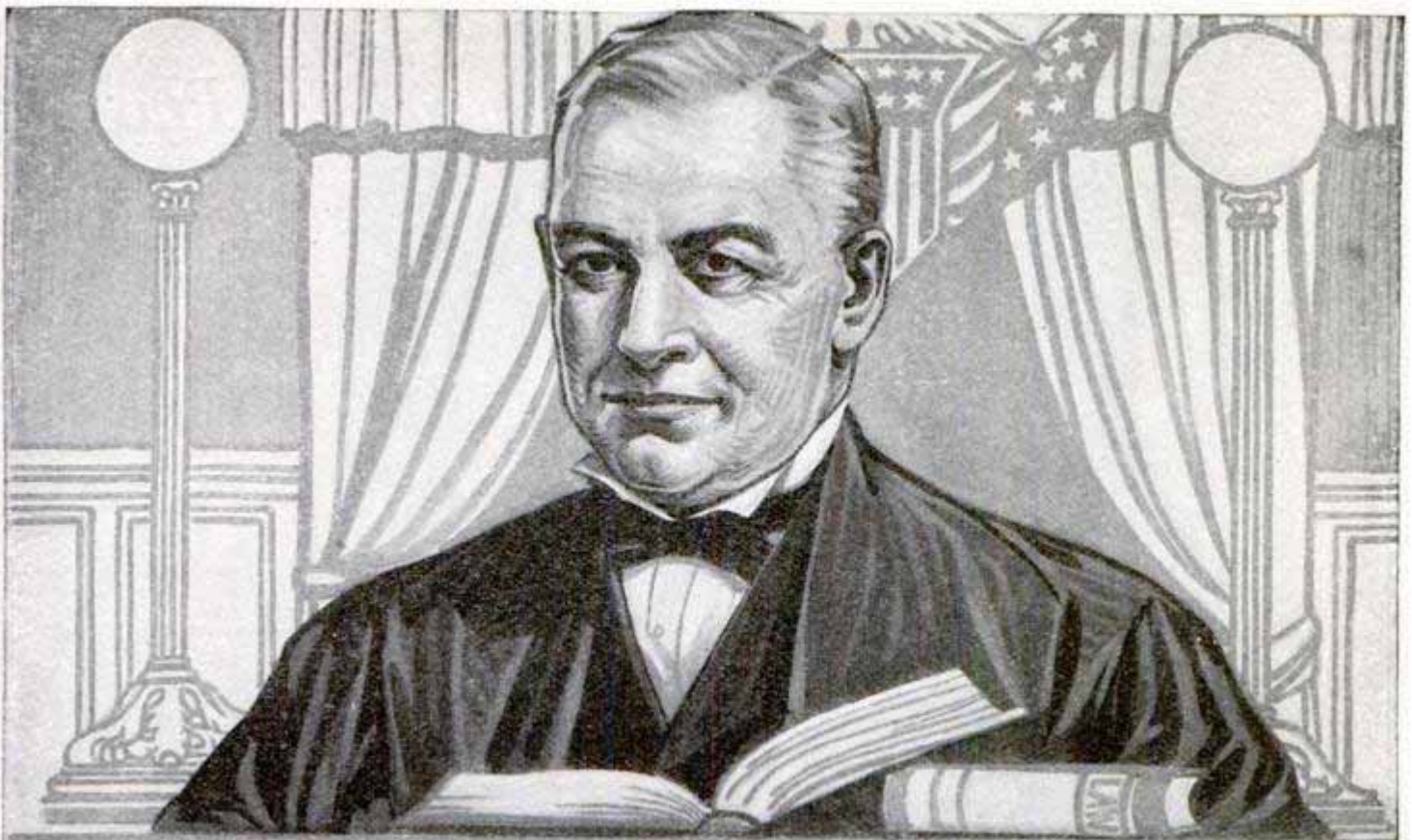

## A Judge Can't Smoke

in the courtroom—but he's going to enjoy his tobacco just the same. He gets a good, juicy chew of "PIPER"—that's the tobacco—*real* tobacco—rich and mellow—and chewing it gives him calmness—"the poise that comes from rumination"! When you chew

# PIPER Heidsieck

CHEWING TOBACCO—Champagne Flavor

you get the epicure's delight. The taste of "PIPER" carries with it that wonderfully wine-like flavor which has made the brand so justly famous. It combines with all the natural richness of splendid tobacco the mellow tang of ripe champagne.

Try "PIPER" just one week. You'll

see why thousands and thousands of American men of brains and eminence have used "PIPER" for years.

Only finest leaves of choicest tobacco go into the making of "PIPER." We go to the utmost expense to keep this superb tobacco clear up above all others, in a class by itself.

**FREE** Send 10 cents and we will send a full-size 10-cent cut of "PIPER" and a handsome leather pouch **FREE**. The tobacco, the pouch and mailing expenses will cost us 20 cents and we are glad to spend the money to get you to try "PIPER." We know that once you have started, you will become a permanent friend of this wonderfully wholesome, healthful and satisfying tobacco. In writing us please tell us the name of the dealer of whom you buy your tobacco.

*This offer applies to U. S. only.*

Sold by dealers everywhere, in all size cuts from 5c up—also in handy 10c tin boxes

**THE AMERICAN TOBACCO COMPANY, Room 1168, 111 Fifth Avenue, New York City**



*Efficiency Plus*

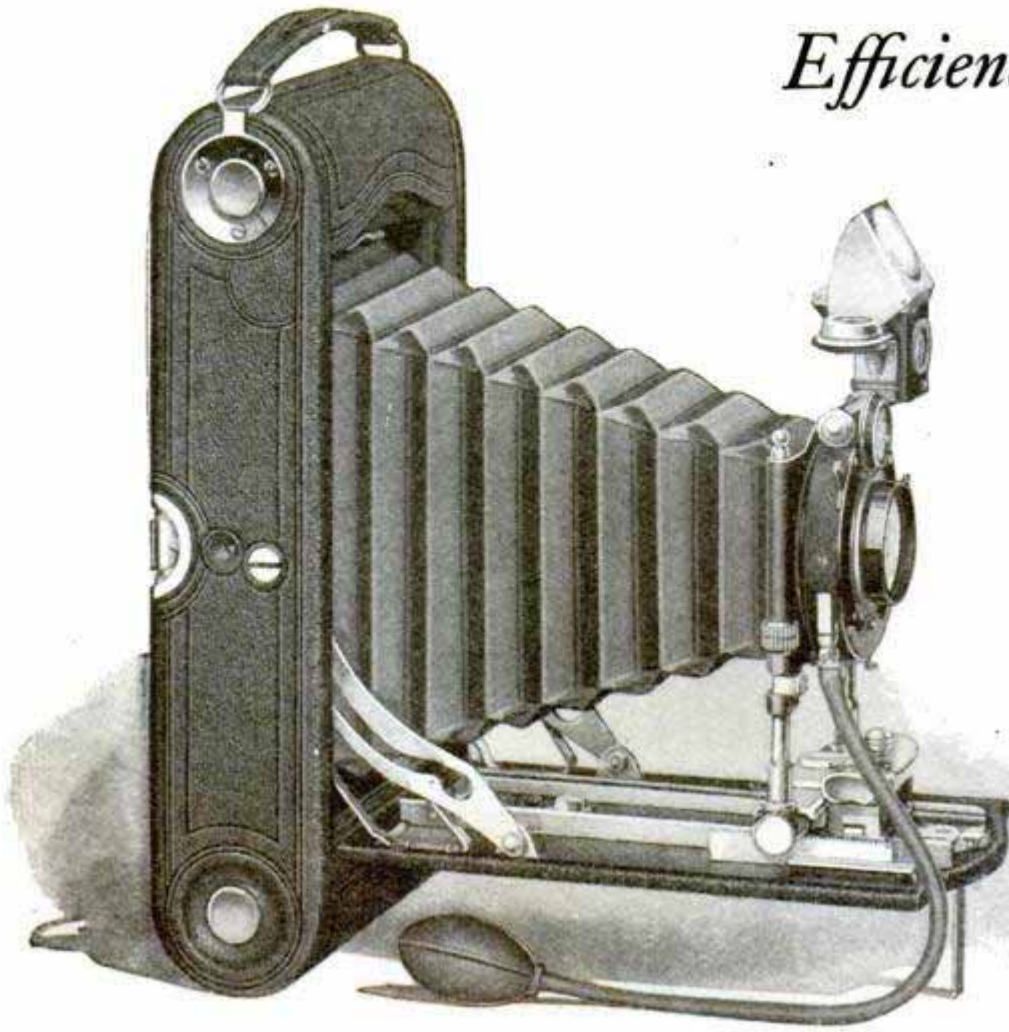

## The *Special* Kodaks

*Combining:* Anastigmat lens speed, Compound Shutter precision, perfection in the minutest detail of construction and finish, every feature that is desired by the most expert hand camera worker—all this in pocket cameras that retain the *Kodak Simplicity*.

No. 1A, pictures	2½ x 4¼ inches,	-	-	-	\$46.00
No. 3,	“ 3¼ x 4¼ inches,	-	-	-	48.00
No. 3A,	“ 3¼ x 5½ inches,	-	-	-	60.00

EASTMAN KODAK COMPANY,

*Catalogue free at your dealers  
or by mail.*

ROCHESTER, N. Y., *The Kodak City.*



# \$1400 Heated This Twelve Room House An Entire Winter!

## With an Underfeed Furnace

How does this compare with your coal bills?

Mr. Williams' experience, as given below, is similar to that of over 25,000 other users of Peck-Williamson heaters. A saving of *one-half to two-thirds* of your coal bills is the positive result with the Underfeed.

## What Six Out of 25,000 Users Say

- "Coal bill \$16.22 for seven rooms."  
Mrs. Carrie See, Trenton, Ill.
- "\$5.40 to heat four rooms."  
Simon Kocher, Breeze, Ill.
- "Reduced coal bill from \$109 to \$53."  
Geo. J. Pfeiler, 6322 Halsted St., Chicago, Ill.
- "Heats two flats for \$30 per year."  
M. Tinnis, 3848 Robey St., Chicago, Ill.
- "Heats ten-room house for \$25."  
I. A. Ruess, Grand Rapids, Mich.
- "Saved \$122 a season."  
Howard Weiss, Siegfried, Pa.



### Read this Remarkable Letter

Back in 1906, W. L. Williams of Belknap, Ill., whose 12-room house is shown above, wrote us that he had comfortably heated his home the entire winter with \$14 worth of slack. Recently he wrote us again, saying, "My Underfeed, after eight years, is just as good as new and has been in use throughout each winter since it was installed." Could there be stronger evidence of merit than this? Think it over. We'll send you copies of the original letters if you wish.

We'll send you the names and addresses of over 2,000 Underfeed users—some right in your vicinity—who know by experience that clean, even, economical heat is obtainable only with the Underfeed.

Clean,  
Economical,  
Even Heat

**WILLIAMSON  
UNDERFEED  
FURNACES and BOILERS**

The  
Guaranteed  
Heating System

Cut Coal Bills  $\frac{1}{2}$  to  $\frac{2}{3}$

With the Underfeed coal is fed from below. All the fire is on top. Smoke and gases are burned up, making more heat. You can use cheapest slack and soft coal or pea and buckwheat sizes of hard coal and secure same heat as highest priced coal with no smoke, smell and dirt. No other furnace or boiler made can do this. Underfeed heaters slash coal bills 1-2 to 2-3 in 25,000 homes, stores, churches and other buildings. Soon pays

for itself. Adds to renting and selling value of any building. Adapted to warm air, steam and hot water. A saving of 50% in coal bills guaranteed with an Underfeed, when properly installed and operated. If you are going to build or want to cut down your high cost of heating, send the coupon for full information. Underfeeds have saved millions of dollars for coal buyers. Why not save your share? Write today—NOW.

The **WILLIAMSON Co.**  
Peck-

41 W. Fifth St.  
Cincinnati, Ohio

### Mail This Money-Saving Coupon Now!

**THE PECK-WILLIAMSON COMPANY** (4)  
41 W. Fifth Street, Cincinnati, Ohio

I would like to know how to cut my coal bills from one-half to two-thirds with an Underfeed.

Warm Air..... Steam or Hot Water.....  
(Mark an X after System interested in)

Name .....

Address .....

My Dealer's Name is .....



Coal Goes in Here

Out-out View of Underfeed Furnace

### To Dealers!

Thousands of keen minded people are buying Underfeeds because they cut coal bills 1-2 to 2-3. Furnace Dealers, Plumbers and Hardware Dealers, send for exclusive sale proposition. A small amount of territory still open. Act!



# Unseen Forces Behind Your Telephone

THE telephone instrument is a common sight, but it affords no idea of the magnitude of the mechanical equipment by which it is made effective.

To give you some conception of the great number of persons and the enormous quantity of materials required to maintain an always-efficient service, various comparisons are here presented.

**The cost of these materials unassembled is only 45% of the cost of constructing the telephone plant.**



## Poles

enough to build a stockade around California—12,480,000 of them, worth in the lumber yard about \$40,000,000.



## Telephones

enough to string around Lake Erie—8,000,000 of them, 5,000,000 Bell-owned, which, with equipment, cost at the factory \$45,000,000.



## Wire

to coil around the earth 621 times—15,460,000 miles of it, worth about \$100,000,000, including 260,000 tons of copper, worth \$88,000,000.

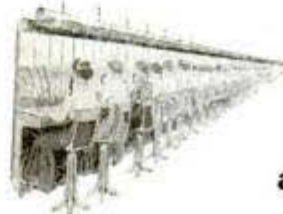

## Switchboards

in a line would extend thirty-six miles—55,000 of them, which cost, unassembled, \$90,000,000.



## Lead and Tin

to load 6,600 coal cars—being 659,960,000 pounds, worth more than \$37,000,000.



## Buildings

sufficient to house a city of 150,000—more than a thousand buildings, which, unfurnished, and without land, cost \$44,000,000.



## Conduits

to go five times through the earth from pole to pole—225,778,000 feet, worth in the warehouse \$9,000,000.



## People

equal in numbers to the entire population of Wyoming—150,000 Bell System employees, not including those of connecting companies.

The poles are set all over this country, and strung with wires and cables; the conduits are buried under the great cities; the telephones are installed in separate homes and offices; the switchboards housed, connected and supplemented with other machinery, and the whole Bell System kept in running order so that each subscriber may talk at any time, anywhere.



**AMERICAN TELEPHONE AND TELEGRAPH COMPANY  
AND ASSOCIATED COMPANIES**

**One Policy**

**One System**

**Universal Service**

*Please Mention Popular Mechanics*





## Johnson's Wood Dye

In 17 shades—for the  
artistic coloring of wood  
—*soft and hard.*

## Johnson's Prepared Wax

A complete finish and polish for  
all wood—*floors, woodwork and  
furniture.*

### Use This Coupon

for Free trial packages and Instruction  
Book, "*The Proper Treatment for  
Floors, Woodwork and Furniture.*"

S. C. Johnson & Son

"The Wood Finishing  
Authorities"

Racine,  
Wis.



PRESENT THIS COUPON TO YOUR DEALER IN PAINTS

**45c—Value FREE—45c**

To Paint, Hardware or Drug Dealer: Furnish the  
bearer, free of all expense, with

- 1—25c Instruction Book
- 1—10c Bottle Johnson's Wood Dye
- 1—10c Can Johnson's Prepared Wax

S. C. Johnson & Son, Racine, Wis.

(Must be presented by an adult.)

PA4



# TYPEWRITER SENSATION!

## 2 DOLLARS A MONTH

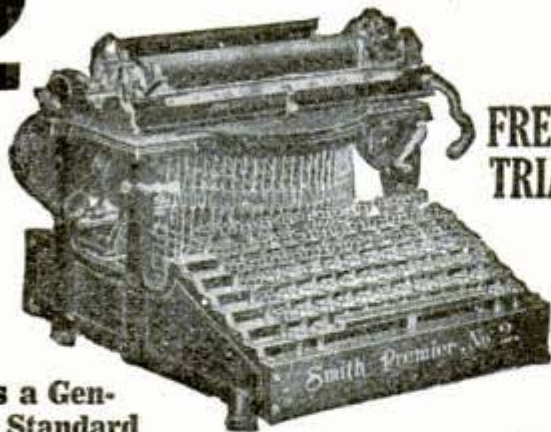

**FREE TRIAL**

**Buys a Genuine Standard No. 2 SMITH-PREMIER Typewriter and at \$71.20 less than the original price.**

Never before has anything like this been attempted. Dealers get \$3.00 a month rent for this make of machine, not nearly as perfect as the one we will send you, and you pay only **TWO DOLLARS A MONTH AND OWN IT.**

### A Guaranteed Typewriter \$28<sup>80</sup>

Perfect machines only, complete outfit, nothing extra to buy, no strings of any kind to this offer. Just think of buying such a typewriter for \$8.80 down and \$2.00 a month. Cash price \$27.40. Thousands of people have paid \$100.00 cash for Smith-Premiers. It's standard, by many considered the best typewriter ever built. A key for each character, so each character is always the same, a type brush for cleaning the type built into the machine; the tilting carriage throws all previous writing in plain sight of the operator. Comes to you with two color ribbon, complete operating instructions, tools, waterproof cover, practice paper, everything, ready. It runs beautifully. Writes as perfect and clean cut a letter as quickly and easily as any machine bought for \$100.00. It's wonderfully simple, a child can operate it with half an hour's practice and rapidly attain speed. It's strongly built and will give you years and years of honest service and complete satisfaction.

### Send the Coupon and We Will Ship You this Smith-Premier Typewriter

When the typewriter arrives, deposit with the express agent \$8.80 and take the typewriter three days and try it. If you find it to be the best typewriter you ever saw, satisfactory in every respect, keep it and send us \$2.00 each month, until our special price of \$2.80 is paid. If you don't want to keep it, return it to the express agent, and he will give you back your \$8.80, and return the typewriter to us. We will pay the return express charges.

You won't want to send this machine back after you have seen it and tried it. You can't imagine the perfection of these machines till you see one, and the price is \$71.20 less than the catalogue price, and it is guaranteed just as if you paid \$100.

**Only 200 orders will be filled on this offer. Act today to be sure**

This coupon states the terms. Fill it out, send it now, today. You can't lose, and it's the greatest economical typewriter opportunity you will ever have.

#### COUPON

**HARRY A. SMITH, No. 180 N. Dearborn St., Chicago.**

Ship me a No. 2 Smith-Premier, f.o.b. Chicago, as described in this advertisement. I will pay you the \$20.00 balance of the special \$28.80 purchase price, at the rate of \$2.00 per month. The title to remain in you until fully paid for. It is understood that I have three days in which to examine and try the typewriter. If I choose not to keep it I will carefully repack it and return it to the express agent. It is understood that you give the standard guarantee for one year.

Name .....

Address .....

Pop. Mech. Apt.

Please Mention Popular Mechanics

## Easiest Ironing with a Saving of Money



**I**N the past eight years, thousands of homes have installed the Simplex Ironer because it does the ironing better, quicker, easier and with far less expense than any other method. It will iron a large table cloth in 3 minutes that would require 20 minutes to do by hand.

## SIMPLEX IRONER

"THE BEST IRONER"

produces a uniform beautiful finish with no wear on the goods ironed. Two to four cents expense will do an average ironing with no tired feeling or back ache. It soon saves its cost in labor, time, health and satisfaction.

Write for name of our local dealer, 30 Day FREE TRIAL Offer and Catalog.

**American Ironing Machine Co.**  
562, 168 No. Michigan Ave., CHICAGO, ILL.

## Bausch and Lomb BALOPTICON

THE PERFECT STEREOPTICON

Bausch & Lomb Optical Co., 576 St. Paul St., Rochester, N. Y.

**CAUTION**—Complaints are reaching Popular Mechanics that solicitors are taking subscriptions for this magazine, representing themselves as the agents of the "American Advertisers Association." Popular Mechanics Magazine offers no premiums, does not join in any clubbing offers and has no solicitors to secure subscriptions.

# SKAT

Quickly removes grime, grease, dust, etc., from hands, leaving white and soft. Needed in every household, garage, office and factory. A great cleanser—injures nothing. 10c cans everywhere; but if your dealer hasn't it, send his name for free sample.

**THE SKAT COMPANY, DEPT. P, HARTFORD, CONN.**  
AGENTS AND DEALERS write for liberal terms.

## Shipped FREE! Superb Wing Piano

Yes, we will ship absolutely free to you a highest grade Wing Piano or Player-Piano DIRECT from our own factory all freight prepaid. Your choice of 38 new art styles on four full weeks' Free Trial in your own home. At the end of 4 weeks, if you wish you may return it at our expense. You alone are the judge. No money down—no security—no obligations whatever.



One of 38 Styles

**Rock-Bottom Offer** You will be amazed at our direct-from-our-factory price on the famous Wing, guaranteed for 40 years. Small monthly payments or cash if you prefer, but first 4 weeks absolute free trial.

**Write Now** For "Book of Complete Information About Pianos" sent free and postpaid. It tells all the secrets of piano making and piano selling. Its 136 pages show you how to judge piano quality and prices. We will also send our catalog of newest art styles in Wing Pianos. Write Now.

**WING & SON (Established 1868)**  
Wing Bldg., 13th St. & 9th Av., Dept. 1194, New York, N. Y.





## MORNING IN THE BOIS

with scent of violet and tang of fresh young leaves in the air is always enhanced by an after-breakfast cigarette. And the cigarette is hand-made. For your true Parisian is a lover-of-living; his cigarette is a part of his *joie-de-vivre*. And for that cigarette to be perfect he puts his favorite tobacco into his favorite paper.

# RIZ LA CROIX.

(Pronounced: REE-LAH-KROY)

## FAMOUS CIGARETTE PAPERS

are being used the world over by fashionable men. In any company — ladies not excepted — it has become the *mode* to make up your own cigarettes, using Riz La Croix papers.

These papers are supreme because they are the perfect product of decade after decade of experimentation by the manufacturers of the La Croix family. Craftsmanship cannot form a lighter, stronger, purer, more satisfactory paper than Riz La Croix.

In cigarette papers Riz La Croix is *premier* — and all the world comes after.



An interesting illustrated booklet about RIZ LA CROIX Cigarette Papers, together with a booklet showing the best way to roll a cigarette, will be sent anywhere in U. S. on request. Address AMERICAN TOBACCO CO., 111 Fifth Ave., N. Y.



# 2c a Week Pays Wash Bill!

## Electricity or Water-Power Does the Work

Write for  
**FREE Book**

Just a "Twist of the Wrist" Starts or Stops the Machine!

The 1900 Motor Washers are now at work in thousands of homes. They are doing the work formerly done by women, at a cost of 2c a week for power! Saving thousands upon thousands of dollars in wash bills. Saving worlds of wash-day troubles. Leaving the women free to do other work while the machines are doing the washing.

# The 1900 Motor Washer

1900 Water Motor Washer  
Can be connected with  
any water tap instantly

Washes a Tubful in Six Minutes!

Handles Heavy Blankets or Dainty Laces

The outfit consists of the famous 1900 Washer with either Electric Motor or Water Motor. You turn on the power as easily as you turn on the light, and back and forth goes the tub, washing the clothes for dear life. Then, turn a lever, and the washer does the wringing. All so simple and easy that it is mere child's play.

**A Self-Working Wringer Sent With Every Washer!**

The motor runs the washer and wringer. We guarantee the perfect working of both. No extra charge for wringer, which is one of the finest made. **Write for FREE BOOK and 30 Days' FREE TRIAL OFFER!** Don't doubt! Don't say it can't be done. The free book proves that it can. But we do not ask you to take our word for it. We offer to send a 1900 Motor Washer on absolute Free Trial for an entire month to any responsible person. Not a cent of security—nor a promise to buy. Just your word that you will give it a test. We even agree to pay the freight, and will take it back if it fails to do all we claim for it. A postal card with your name and address sent to us today will bring you the book free by return mail. All correspondence should be addressed to

Doing the wringing with  
1900 Electric Motor Washer



**1900 WASHER CO., 6144 Court St., BINGHAMTON, N. Y.**  
OR, IF YOU LIVE IN CANADA, WRITE TO THE CANADIAN WASHER CO., 355 YONGE ST., TORONTO, CANADA. (23)

**DWIGGINS  
LAST LONGER  
FENCES  
COST LESS**

Greatest values ever offered in fences and gates for lawn and cemetery, farm, field and poultry yard. WRITE TODAY FOR FREE CATALOG AND PRICE LIST  
**DWIGGINS WIRE FENCE CO., 237 Dwiggins Ave., Anderson, Ind.**

**NEW SOUTH AFRICAN RAILWAY**—A connecting link between Oudtshoorn and George, Cape Colony, was opened recently. This 45-mile branch reduces the distance by rail from Fort Elizabeth to Cape Town from 839 miles to 664 miles, with a saving in time of seven hours, and from Oudtshoorn to Cape Town from 910 to 387 miles.

**FACTORY TO YOU CLASS PINS**  
For College, School or Society  
NO. 1671

Catalog with attractive prices mailed free upon request. Special offer, either style of pins here illustrated with any three letters and figures, one or two colors of enamel. **STERLING SILVER, 30c each, \$3.00 dozen; SILVER PLATE, 15c each, \$1.50 dozen.**

**BASTIAN BROS. CO., 278 Bastian Bldg., ROCHESTER, N. Y.**

**DO YOU NEED MONEY?**

To educate your children, support a family, pay off a mortgage, buy a home or dress better. Then do as thousands of others are doing. Make money selling **World's Star Hosiery and Klean Knit Underwear** in your home town.

No previous experience is necessary. We show you how to make money in an **easy, congenial and profitable way.** Two lady agents began in their home town in California and each made over **\$3000 First Year**

We sell direct from the mill to the home, eliminating the middleman's profit, thereby giving better value for the money. Our lines for men, women and children are famous the world over. We have in 18 years grown to be the **largest concern in the world** manufacturing and selling knit goods direct to the consumer.

Agents wanted in every town. It is a permanent, pleasant and profitable business. Write today for our free catalog. We protect agents in territory and make prompt delivery.

**WORLD'S STAR KNITTING CO.**  
Dept. 142 BAY CITY, MICH.

**OVER 65 YEARS' EXPERIENCE**

# PATENTS

**TRADE MARKS  
DESIGNS  
COPYRIGHTS, &c.**

Anyone sending a sketch and description may quickly ascertain our opinion free whether an invention is probably patentable. Communications strictly confidential. **HANDBOOK on Patents** sent free. Oldest agency for securing patents. Patents taken through Munn & Co. receive *special notice*, without charge, in the

## Scientific American.

A handsomely illustrated weekly. Largest circulation of any scientific journal. Terms, \$3 a year; four months, \$1. Sold by all newsdealers.

**MUNN & CO. 359 Broadway NEW YORK**  
Washington Office, 625 F St., Washington, D. C.



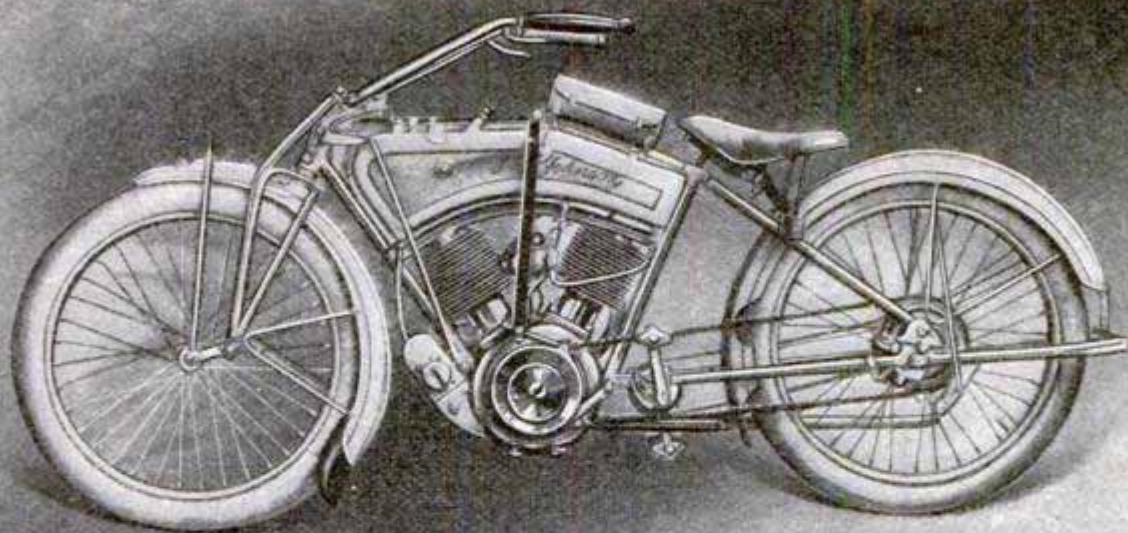

# IVER JOHNSON

## Worth a Million

You are one of several million people who believe that "Iver Johnson" stands for good quality in firearms, bicycles and motorcycles. We could trade on that faith and use inferior steel and cheap labor—for a year or two. No doubt in that time we could clean up a million dollars extra profit. So figuring it that way the name "Iver Johnson" is doubtless worth at least a million.

But think how much more profitable it will be for us to justify and foster your confidence—to hold the confidence of generation after generation—by maintaining the high quality and reputation of our product.

Just as a matter of investment it pays us to use the finest steel, the most accurate machine processes, the most exact methods of tempering; and to command the services of the ablest designers and engineers.

Our 82-page book, bound in board covers, tells in a simple and convincing way why the Iver Johnson Revolver is the standard side arm of the world; why the Iver Johnson Champion Shot Gun is accurate and dependable; why the Iver Johnson Bicycle is the choice of nearly all of America's crack riders; why the Iver Johnson Motorcycle has been pronounced by prominent engineers to be a mechanical masterpiece.

### Send for this Valuable Book

#### IVER JOHNSON'S ARMS & CYCLE WORKS

307 River Street, Fitchburg, Mass.

99 Chambers St., New York  
717 Market St., San Francisco







# Would You Accept This 30-Day Offer?

Standard of the World. Endorsed by Government and Railway Officials. Harris-Goar's enlarged Easy Credit Plan now enables you to own one of these superb Elgin Watches without missing the money. Write for Free Catalog.

## 17-Jewel Elgin

Guaranteed 25 years, hand engraved, plain polished or with your own monogram, and our startling offer is to send you this celebrated 1914 Model free of charge for your approval

## No Money Down

Because we want to prove to you that the great volume of our business actually enables us to do better by you than any other Watch or Diamond House in the World, and that on this particular watch, we save you nearly half for it sells regularly at \$20 to \$22, while our

**Special Price is only \$12<sup>75</sup>**

25-Year Gold Case 17 Ruby Jewels

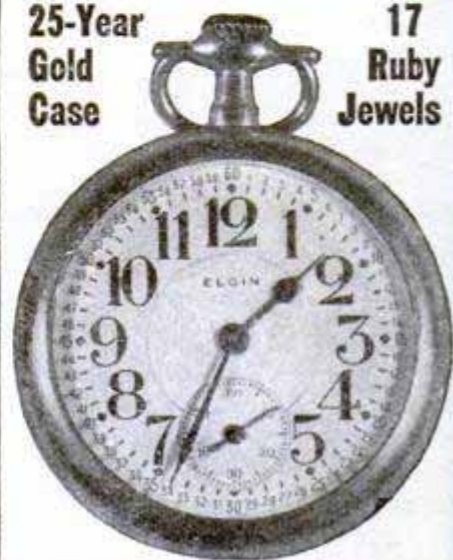

### 3 Fine BOOKS FREE

MR. HARRIS wants to send you his three latest Books FREE—one the story of "The Diamond," its discovery, where and how mined, cut and marketed, the other, "Facts vs Bunc," or all about the Watch Business, both at home and abroad, also our Big Free Watch and Diamond Book.

We don't want you to send us one cent—not a penny. Merely give us your full name and address that we may send you this superb 17-Jewel Elgin on approval, and if after you receive it and want to keep it, then pay us the sum of

**Only \$2.00 a Month**

But if after you have worn it 30 days FREE and don't want to keep it, send it back at our expense.

You assume no risk whatever. You do not buy or pay a cent until we have placed the watch right in your own hands for your decision. We want no security, no interest, no red tape—just common honesty among men. Write for our BIG FREE WATCH AND DIAMOND BOOK today. Do it now!

**HARRIS-GOAR CO., Dept. 1211, KANSAS CITY, MO.**

The House That Sells More Elgin Watches Than Any Other Firm in the World.

**Natural Hen Incubator \$3.** No freight. Actual hen contains everything. No lamps, no costly mistakes. Over 600,000 sold. Agents wanted. Free catalog. Special Introductory Offer. **Natural Hen Inc. Co., Sta. H, Dept. 27, Los Angeles, Cal.**

Approximately \$20,000,000 worth of canned goods passed out of the United States during the year 1913. Meats, fruits, vegetables, dairy products, and fish are the principal articles forming this class of exports, and they are distributed to all parts of the world, especially the tropics.



### Greider's Fine Catalogue

and calendar of pure-bred poultry for 1914, large, many pages of poultry facts, different breeds in natural colors, 70 varieties illustrated and described. Incubators and brooders, low price of stock and eggs for hatching. A perfect guide to all poultry raisers. Send 10c for this noted book.

**B. H. GREIDER Box 19, RHEEMS, PA.**

### MONEY IN POULTRY and SQUABS

Start small. Grow big. Get winter eggs. Keep healthy fowls. Save your chicks. Foy's big book tells how. Describes largest poultry and pigeon farm. Mailed Free.

**F. FOY, Box 39, DES MOINES, IA.**



## Shirley President Suspenders

You hardly know you have them on

50¢

"Satisfaction or money back"

Be sure "SHIRLEY PRESIDENT" is on buckles  
**The C. A. Edgerton Mfg. Co., Shirley, Mass.**

# 555 New Songs and Music—10c

Oh Mr. Dream Man  
On Moonlight Bay  
Everybody's Doin' It  
After the Honey-moon  
Someone Loves You—  
For You Dear Heart  
While You Are Mine  
Anywhere With You  
Love's Young Dream  
Every Little Movement  
Bird on Nellie's Hat  
Temptation Rag  
I Wish I Had a Girl  
Dream On Dear Heart  
Garden of Dreams  
Sweet Italian Love  
Somebody Else Is Getting It  
If You Talk In Your Sleep  
Let Me Call You Sweetheart  
When I Get You Alone Tonight  
Sail On Silvery Moon  
Green Grass Grew All Around

If I Had a Home Sweet Home  
Who Are You With Tonight?  
They Always Pick On Me  
All That I Ask of You is Love  
When Moon Plays Peek-a-Boo  
The Sweetest Girl in Dixie  
Put On Your Old Grey Bonnet  
By Light of the Silvery Moon  
Will the Angels Let Me Play  
Let Me Call You Sweetheart  
Roses Bring Dreams of You  
Lemon in the Garden of Love  
Call Me Some Rainy Afternoon  
Wonder Who's Kissing Her Now  
If I Only Had the Nerve  
You'll Do the Same Thing Over

Waiting for the Robert E. Lee  
O You Saturday Night  
I Want to Be in Dixie  
You for Me When Sweet 16  
Because I'm in Love With You  
Be My Little Baby Bumble Bee

Kentucky Days  
Hold Up Rag  
My Dixie Rose  
In Georgia Land  
Little Boy Blue  
A Little Cozy Flat  
O, Say, Doctor  
Red Rose Rag  
School Days  
Way Down South  
Casey Jones  
Steamboat Bill  
O You Circus Day  
Kentucky Rag  
Rag Time Violin  
Grizzly Bear

I'd Love to Live in Loveland  
Oh You Beautiful Doll  
Alexander's Ragtime Band  
I Long for You Tonight  
Rag Time Soldier Man  
Silver Bell  
Pony Boy

There's a Mother Old and Gray  
Just for a Brown Eyed Girl  
Silver Threads Among the Gold  
Till Sands of Desert Grow Cold  
On a Beautiful Night with  
Beautiful Girl



**FREE**

Send 10 cents for our New Song Album with the latest songs and music and get FREE our Chart of Chords which teaches you how to play piano quickly, also illustrations how to dance all the latest dances, The Tango, The One Step, The Turkey Trot, etc., so plain you can easily learn. **TANGO MUSIC CO., 1103 Monroe St., CHICAGO**



# Clip This Coupon!

It Saves You  
**\$41.50**

On Genuine No. 3 Model  
Visible Oliver Typewriter

**TYPEWRITERS DISTRIBUTING SYNDICATE**  
166-P99 N. Michigan Blvd., Chicago, Ill.

Date.....

Gentlemen: Ship me an Oliver Typewriter, Model No. 3, for examination. If satisfactory, I agree to remit \$4.00 after five days from the date I receive the machine, as full payment for one month's rental, and \$4.00 each month thereafter, as rental for the use of the typewriter. When I have paid you \$56.00 in this manner, the typewriter is to become mine. Until then the title is to remain in you. Otherwise I will return the typewriter to you at your expense.

Name.....

Address.....

References.....

The regular catalog price of the No. 3 Oliver is \$97.50.

By purchasing in wholesale quantities and selling to you direct, without agents, salesmen or branch houses, we are able to make the astonishingly low price of \$56. And we allow you to pay for it like typewriter rent—\$4 per month. No deposit—no collectors—no interest—no red tape. 13 cents a day for a few months, and this splendid No. 3 Oliver is yours!

## Use It FREE at Our Risk

If you mail the coupon in this advertisement, we will place this machine in your home or office on free trial.

Don't rent or buy any typewriter—don't pay \$10 or \$100 or anything in between—until you get this genuine No. 3 Oliver and see what a tremendous bargain it is. Examine the machine. Practice on it. Use it in your work for five days. Then, if you decide not to keep it, we will take it back and pay transportation charges both ways. The trial will cost you nothing.

### Complete Oliver Equipment

This is the genuine Oliver No. 3 model, shipped to you in the same box it leaves factory of the maker. Visible writing; universal keyboard; downward stroke type-bar, giving light action; light running carriage; automatic line spacer; double type-bar, insuring perfect alignment; left-hand carriage return; finger release key; writes on ruled lines; makes 20 carbons at a time; easiest running machine in the world. Equipped with

every device regularly furnished with this Oliver model. Guaranteed for full life of machine.

### Rent Money Buys It

For the same sum you would ordinarily pay for some obsolete, inferior machine, you can own a real No. 3 Oliver. You really rent this machine for 14 months at \$4 per month. Then it's yours. Nothing further to pay. No complicated documents to fuss with. All you sign is coupon attached hereto. Fill it out and mail to us to-day.

### Send No Money Now

We ask no payment until you decide to keep the machine. And after that no collectors will bother you. We can make this low price of \$56 only by letting you be your own salesman. That is our plan. And we invite you to take advantage of it. With the machine we send everything—metal carrying case, cleaning and oiling outfit, ribbon, practice paper, carbon paper and complete illustrated instruction book. You can begin using the typewriter the moment you unpack it.

### 18,000 Machines Sold Under This Plan

Our customers are scattered all over the United States. Some perhaps, in your own vicinity. We sell even in foreign countries. For this plan has a universal appeal. It is made from the buyer's standpoint. It means that you can now buy a genuine No. 3 Oliver Typewriter at almost half catalog price, and pay for it as convenient.

But let us send you the machine itself. Let it do its own talking. By mailing the coupon today you save \$41.50. It is the only way of getting this famous No. 3 Oliver at the present low price on Rental Purchase plan, and on five days Free Trial. Fill out and mail the coupon today.

**Typewriters Distributing Syndicate**  
166-P99 N. Michigan Blvd. CHICAGO  
(209)

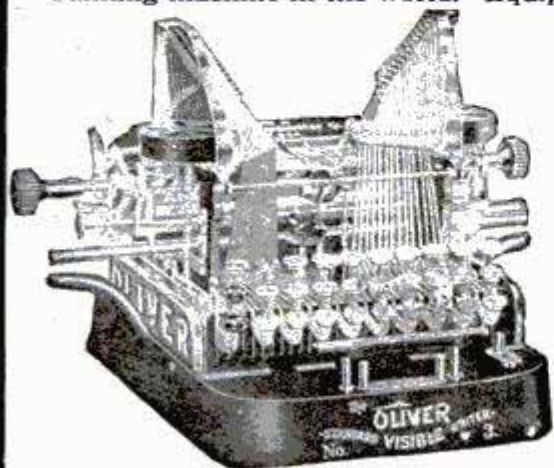



# Like a clean china dish

Copyright, 1914, by Grand Rapids Refrigerator Co.

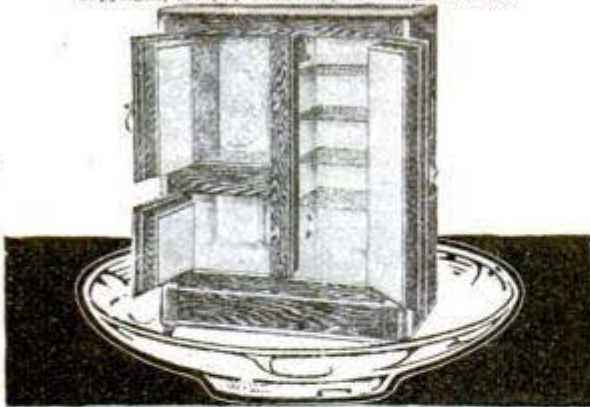

Superb Porcelain Lined—the delight of every woman's heart—the pride of every housekeeper. Here's that famous Refrigerator with the seamless, scratchless, dish-like lining, the genuine

## Leonard Cleanable

Don't confuse this wonderful sanitary lining with paint or enamel. I will mail you—free—a sample of Leonard Porcelain that will quickly show you the difference. You can't scratch it even with a knife. It's everlasting—easily kept beautifully sweet and clean. You'll never be satisfied with anything else.

Style shown is No. 4, in polished oak case, Size 35x21x45 . . . **\$35.00**

**50 Styles, \$15.00 up; Freight Paid**

to Ohio and Mississippi Rivers. I take the risk; send for catalog today. Money returned if you are not perfectly satisfied. Ask for sample of porcelain and I'll mail my booklet, "Care of Refrigerators." Every woman should have a copy of this valuable book.

**C. H. LEONARD, President**

**GRAND RAPIDS REFRIGERATOR COMPANY**  
157 Clyde Park Ave., Grand Rapids, Mich. (1)

# Let Us Figure On Your Furnace

**Our Free Plans and Direct Factory Prices Will Help You Greatly No Matter Where You Decide To Buy.**

Expert heating engineers will draw detail plans to your special needs and quote exact cost on furnace with fittings—no obligation.

## Customers Everywhere To Refer You To

No Delay—No Freight to Pay—Satisfaction Guaranteed. And \$25 to \$75 saved. Cash or easy terms.

**WRITE for Catalog**

Ask for No. 936

See the simple, practical, economical plan that is winning favor everywhere.

**KALAMAZOO STOVE CO.**  
Mfrs., Kalamazoo, Mich.

We make a full line of Ranges, Stoves, Furnaces, Metal Kitchen Cabinets and Gas Stoves. Mention catalog wanted.



This Book Saves You From \$25 to \$75

**"A Kalamazoo Direct to You"** And Gas Stoves Too  
Trade Mark Registered

**SWINGING OF LOCK-GATE LEAVES IN PANAMA CANAL**—The swinging of a leaf means the completion of its erection, sheathing, and most of the riveting and reaming, and is only a step toward final adjustment. The work of lining up and babbitting the nickel-steel bearing plates at both ends of a leaf can

# Hello Boys!

Do You Know thousands of boys like you are having barrels of fun with this toy? Parents give some, many boys "save up" and buy themselves. Can't you get in on this good time? Get now

## The Mysto ERECTOR

**FREE BOOK** My free, 24 page book, in two colors, describes this wonderful toy, its NEW MOTOR, girders, wheels, etc. **HURRY!** Send postal now. Ask about prize contest. Give dealer's name. Address A. C. Gilbert, Pres.,

**MYSTO MFG. CO.**  
53 Foote Street, New Haven, Conn.



**BUY YOUR FURNACE \$10 DOWN \$10 A MONTH**



This No. 1 Jahant Down-Draft Furnace (weight over 1000 lbs.) as it stands \$48.00 cash, delivered east of Omaha and north of Ohio River.

Our monthly payment plan of selling direct saves you the dealer's profits and charges for installation. The

## Jahant Furnace

with the patented "Down Draft System" is best for residences, schools, hotels, churches, etc., because it delivers plenty of heat wherever and whenever desired at a saving of 1-3 to 1-2 in fuel bills. Install the Jahant yourself. We send complete outfit, freight prepaid with special plans, detailed instructions and all necessary tools for installation. Satisfaction guaranteed or money refunded.

Write for free illustrated book.

**THE JAHANT HEATING CO.**

20 Main Street

Akron, Ohio

**Save 1/3 to 1/2 on Fuel Bills**

# Rapid Fireless Get My Cooker 1914 Special

A big saving in Price Offer  
food bills, fuel, work—and food tastes better.



**30 Days FREE Trial**

Complete outfit aluminum utensils free. Covers and cooking compartments lined with pure aluminum. Dust-proof, odorless. Write for Free Book and direct-from-factory prices.

**WM. CAMPBELL CO.**  
Dept. 64 DETROIT, MICH.

# The "BEST" LIGHT



gives a clearer, cleaner, brighter illumination, at less cost, than any other lighting system possible to install in the private home. Every house has its own lighting plant—safe, sure and economical.

Agents Wanted

Write for Catalogue of 200 styles.

**THE BEST LIGHT CO.**  
324 East 5th St., Canton, O.



# Hartman Will Trust You Requires No References Asks No Advance Payment

## No. 7D286—Hartman's Refrigerator Bargain

A Model Sanitary Refrigerator, Gray Enamel Exterior, White Enamel Interior. Easily kept clean. Rounded corners, lift-out ice chamber, splendid drain, best cooling radiation. Best hard wood veneers, trimmed with real nickel. Guaranteed. Size 43 in. high 24 in. wide 16 ins. deep. Holds 65 lbs. ice. Price only



**\$1**  
Holds  
**\$12.75** Monthly

## No. 7F513—Go-Cart

New one-motion collapsible go-cart. Instantaneous motion easily folds cart as shown. All steel construction covered with Imperial Leather. Has 3 bow hood, half in. rubber tires. Most remarkable bargain



**\$4.95**  
**50c**

## Per Month

## No. 7F460—Hartman's Ball Bearing Washer

Tub of eight quart capacity, bottom and sides corrugated, made of selected cyprus, known to withstand effect of lye, soap and acids. Heavily varnished. Lid has detachable hinges, easily removed. Tub supported on heavy legs, strongly braced. Improved wringer or attachment securely fastened. Ball bearing connections make the work easy. Four-pronged dasher, large and strong, can't split or crack. Remarkable value



**50c**  
Monthly

## No. 1F426—Imperial Spanish Leather Mission Rocker

Large, comfortable rocker, made of finest solid oak, elegant fumed finish. Double panel back and seat are upholstered with Spanish Imperial leather, while seat is set over "Monarch" steel spring construction. Has broad arms, strong posts, heavy runners and arm slats. A bargain for the money. Price only



**50c**  
Per Month

## Every Hartman Bargain Sent 30 Days Approval and Fully Guaranteed

Not only has the great Hartman establishment brought the necessities—Guaranteed Dependable Quality Home Furnishings—the comforts and even luxuries, heretofore found only in the homes of the rich and prosperous, within the reach of even those of very limited means by these remarkably low prices and most liberal Easy Payment Plan, but guarantees every article shown in the Big Free Hartman Credit Bargain Book. Read every word of Guarantee printed opposite. It is backed by our 59 years' reputation for square and liberal dealings, and our entire resources of over \$10,000,000. Every article must actually sell itself on its own merit, after you see it in your own home. At the end of a month you may return articles ordered if

not found perfectly satisfactory. Hartman refunds your money including freight.

## Our \$10,000,000 Purchasing Power Makes Rock Bottom Prices

We are the largest Home Furnishing Establishment in the world. Our purchasing power is immense—we buy goods in such vast quantities—that we not only secure the best the market offers, but we secure better prices than would be possible for smaller concerns. Our immense volume of sales enables us to be satisfied with a very small profit from each sale. We allow no factory, store or mail order house to undersell us. Old customers—over a million of them—know the wonderful money saving afforded by our remarkable bargain prices; new customers, find it out with their very first order.

## Send Today for HARTMAN'S Big Credit Bargain Book—It's FREE

Now is your chance to furnish your home, because the opportunity is remarkable. You should send today for the Big, Special FREE Hartman Credit Bargain Book, showing everything in Guaranteed, Dependable Quality Home Furnishings, in colors, patterns and designs photographed from the originals. It will be like bringing into your own home an enormous stock of home furnishings many times the size of the largest city store including—

- Furniture, Stoves, Ranges, Sewing Machines,
- Dishes, Carpets, Clocks, Washing Machines,
- Rugs, Bedding, Tinware, Lace Curtains,
- Jewelry, Portieres, Silverware, Refrigerators,
- Go-Carts, Springs, Mattresses, Carpet Sweepers, etc.

During this big sale you can order any of these special advertised bargains without sending us any advance payment.

## Makes Easiest Terms

Hartman trusts everyone—asks no references—no advance payment. No mortgage—no interest—no red tape—no matter who you are or where you live. There are no extra charges, no mortgage to sign, nor do we ask for security. Hartman's transactions with you are strictly confidential—no references asked—no embarrassment. You'll like the Hartman plan. With longtime credit,

free from ALL objectionable features, as easy to get as it is from Hartman there is no reason for anyone to live in a meagerly furnished home.

Now Send Address on Postal for Hartman's Big FREE Credit Bargain Catalog

# HARTMAN

Furniture and Carpet Co.  
3945 Wentworth Ave., Chicago, Ill.

**HARTMAN'S Legal Guarantee**  
We Unreservedly Guarantee every article sold by us to be exactly as represented and described in our catalog.  
We Guarantee our prices to be lower than those of any other concern for goods of equal quality.  
We Guarantee to ship each and every article on approval, and if within 30 days from receipt of the goods, anything is not perfectly satisfactory, FOR ANY REASON WHATEVER, we will accept their return and when the goods are returned to us, we will refund all moneys paid on them including payment of freight charges both ways.

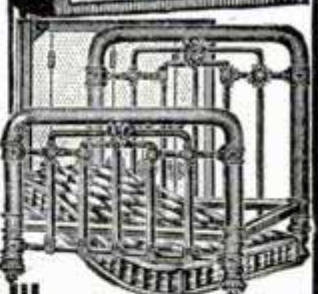

## No. 3F714—Complete Bed Outfit Bargain

Consisting of massive iron bed, 4 ft. 6 in. wide; 40 lb. elastic top fibre filled mattress, durable ticking, and all angle iron springs, spiral spring supports. Bed has 1 1/8 in. continuous posts and heavy fillers. White or pea green enamel or Vernis Martin. Price 3 pieces

**\$8.75**

**75c** Per Month

## No. 1F722—Hartman's Lawn Swing Bargain

This delightful hardwood law Swing holds four passengers and is exceptionally well made and durable. Posts are painted red and swing operation is easy and noiseless. Remarkable Bargain at Our Price

**\$4.65**

**50c** Per Month





# Brooks Buffet No. 412



Dealers' Price \$65.00  
Brooks' Factory Price \$33

A buffet that will adorn any home. Fashioned from solid Quartered Oak—57 in. long—56 in. high—23 in. wide. Bevel Plate Mirror 8 x 48 in.

## Finest of Furniture at Half Retail Price

Our unique merchandising plan saves you at least  $\frac{1}{2}$ . When you deal with us you are dealing with the manufacturer—not a mail order house or jobber or wholesaler. We save you all the dealers' and jobbers' profits.

## Buy Direct From Our Factory

Another thing—our original sectional method saves  $\frac{1}{4}$  the packing costs,  $\frac{1}{4}$  the freight costs and  $\frac{1}{2}$  the factory floor space we would require if our furniture was sent assembled. All additional reasons why you save  $\frac{1}{2}$  when you buy "Master-Built" Furniture, which is

## Shipped in Sections that Anyone Can Assemble in 20 Minutes

Army and Navy Quarters are equipped with this furniture in preference to all others. Dealers even are buying it and assembling it in their own stores and selling it for from 40 to 50 per cent more than you can buy it direct. Get more information. Get our book. It's Free. Send a postal for it today.

Brooks Manufacturing Co.  
2704 Rust Ave., Saginaw, Michigan

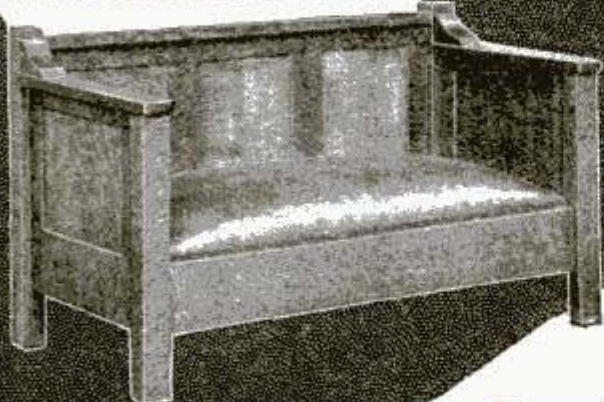

Send Postal For  
**FREE**  
Furniture  
Book

## Brooks Settee No. 109

Dealers' Price \$40.00  
Brooks Factory Price \$18.50

Solidly made of Quartered Oak—54 in. long—29 in. deep—33 $\frac{1}{2}$  in. high. Cushion covered with Marokene Leather.

Please Mention Popular Mechanics

# WE TRUST YOU \$2.95 Brings You This Suit BE WELL DRESSED

Thousands of men have charge accounts with us and take six months to pay. You, too, can have a credit account with us and we want you for a new customer—your credit is good—we'll trust you.

## We Give You 6 Months to Pay

Guarantee Satisfaction

Remember, we save you big money on made-to-order clothes that are better in quality than can be bought elsewhere. No matter who you are or where you live, we'll sell you order made clothes on credit.

**Stanley-Rogers Show You How to Take Your Own Measurements—Don't Hesitate—It's Easy—Order Blank Shows All.**

We have the easiest special system of taking measurements ever used. You'll like it when you see the simple instructions.

## \$2.95 Brings You This Suit

This elegant all-wool suit, made in latest style as shown, of fine brown fabric. Sent to you—made to your order—upon receipt of \$2.95 and measurements. Order by No. 799 S.

Price \$12.95. Balance \$2.00 Monthly

No References Asked—No Red Tape

## Free STYLE BOOK and SAMPLES

Write for book showing latest styles and fabrics being worn by swell dressers all over the country. Get your copy now. It's Free. Send a postal for it today. Write to

**STANLEY-ROGERS COMPANY**

526 536 South Clark Street

CHICAGO, ILL.

be completed only after the leaf is swinging in operating position, and the leaves are yet to be tested, painted inside and out, and fitted with footwalk and handrail. The last of the 92 leaves for the miter gates of the Panama Canal locks was lowered into place on its hinge pintle on October 30, 1913.

Mineral water produced and sold in the United States in 1912 totaled 62,281,201 gal., having an average value of 10 $\frac{1}{2}$  cents.

## BUY PLUMBING and HEATING SUPPLIES



at WHOLESALE Will Save You 30%

Don't pay retail prices. Full stock on hand for prompt shipment. Send for free catalog.

B. P. KAROL, 768 to 772 W. Harrison St., CHICAGO

## DISHWASHING DRUDGERY GONE FOREVER



The Kitchenette Family Dishwasher takes the place of the old dishcloth, dishpan way. Washes and sterilizes in a few minutes. Will not break the most delicate china. Hands do not touch the water. No red, rough, chapped, dishwater hands. Approved by Good Housekeeping Institute of N. Y. and guaranteed by us. Send no money. 30 days free trial and easy payment plan. All freight prepaid. Address CARY-DAVIS CO., INC., Dept. P-A2, 42 Pearl St., Buffalo, N. Y.

## THE IMPROVED MONITOR

AGENTS \$10 A DAY



MAKES ironing easy and a pleasure. Pronounced "The World's Best" by over 575,000 satisfied customers. No hot stove. Easy to operate. Heat regulated instantly. Satisfaction guaranteed. Highest in Quality, Lowest in Price. Highly polished and nickel plated. Quick, easy sales. Exclusive rights and territory free. Write for illustrated circular; explains everything.

The Monitor Sad Iron Co.  
400 Wayne St. Big Prairie, O.



# Become An Expert Draftsman

## Learn Mechanical, Structural or Architectural Drafting by Mail

Absolutely the greatest drafting offer ever made. Read it carefully. Then investigate. Sign and mail the coupon at once. Here is your opportunity to get the training you need to hold down a good job and earn big money—\$100.00 to \$250.00 per month paid to expert draftsmen. Our easy, practical method will teach you ARCHITECTURAL DRAFTING, STRUCTURAL DRAFTING or MECHANICAL DRAFTING in a few months. You will receive expert individual instruction in the course you select. All drafting instruments and materials supplied absolutely free of charge. Also big four volume Cyclopedic of Drawing sent free if you enroll now. Drafting is the foundation of all engineering professions—Learn drafting if you are ambitious to be an engineer. Prepare yourself for a real man's work. And remember—this great special offer is made by the greatest non-resident educational institution in the world—a school whose guarantee is backed by sixteen years of successful teaching by correspondence.

# FREE

This \$20.00 Cyclopedic of Drawing also included absolutely free in this special limited offer. Four big volumes as illustrated below. The only work which thoroughly covers MECHANICAL, STRUCTURAL and ARCHITECTURAL DRAFTING. Worth many times \$20.00 to any drafting student. Not only will you receive the best expert instruction, but you will have these books handy for reference at all times—they will answer all your questions authoritatively and promptly. Just think of it—four big volumes bound in half red morocco, gold stamped, 1,720 pages, 7x10 inches, 1,037 illustrations, page plates, diagrams, designs, etc., and the handsome \$20.00 Draftsman's Outfit. All free if you enroll now under this special limited offer.

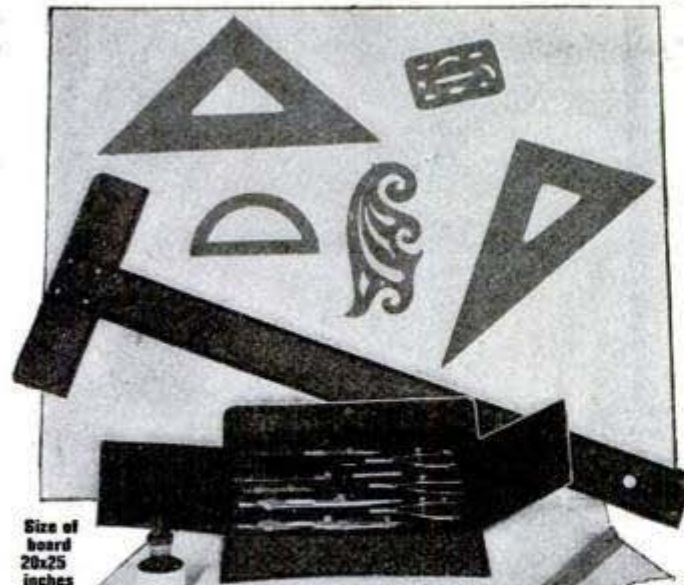

Size of board 20x25 inches

**FREE \$20 Outfit**  
**FREE \$20 Library**

This \$20 Draftsman's Outfit as illustrated. Imported German silver drawing instruments in morocco case; 20 x 25 inch drawing board; ebony lined mahogany T-square; transparent triangles; German silver protractor; French curve; triangular boxwood scale; waterproof ink; pencil; erasers; shield; pencil pointer; handmade drawing paper and thumbtacks. Instruments guaranteed accurate—made by largest and most reliable manufacturer. This handsome, expensive outfit free to you if you enroll now!

### SALARY GUARANTEE

THE AMERICAN SCHOOL OF CORRESPONDENCE GUARANTEES that you will receive an increase of fifty per cent over your present salary within three years from the date of your enrollment; or, failing in this, the School guarantees to refund to you the full amount paid for your course. Back of this guarantee stands the American School—for more than fifteen years the foremost educational institution of its kind in the world. A school that has succeeded because it has been true to its principles of giving its students the instruction for which they enrolled.

### Just Mail the Coupon

Accept this great offer now—today! It never has and never will be equalled. You get the \$20 Drafting Outfit and the \$20 Cyclopedic of Drawing absolutely free of charge. Don't miss this opportunity. Your future success may depend upon whether you fill in and mail the coupon. It will only cost you a stamp to investigate. It may mean success and a big future for you.

**American School**  
of Correspondence. Chicago. U.S.A.



### FREE OFFER COUPON

A. S. of C.

Gentlemen:—Please send me full information about the course checked below, also further particulars regarding the drafting outfit and library sent FREE with this course.

- ... Mechanical Drafting
- ... Structural Drafting
- ... Architectural Drafting

Pop. Mech. 4-14

NAME.....

ADDRESS.....



# READY Our Big Book of Spring Fashions and Woolens FREE

"We Have No Agents"

Just off the press! Our Big Book of Spring Fashions, a complete guide to correct dress; handsomely illustrated in colors. Contains dozens of samples of newest spring and summer woolens—foreign and domestic fabrics in plain and fancy suitings, explains our new tailoring system, tells how we can make you an

## All Wool Made-to-Measure \$15 Blue Serge Suit for Only \$15

Yes, individually tailored to your measure, that for real style, fit, tailoring and material cannot be duplicated in the ordinary way for less than \$25. Why pay \$25 to \$30 for merely ordinary "ready-made" garments when you can get our classy, made-to-measure, all wool worsted serge suit for only \$15, in light blue, dark blue, gray or black. Up-to-the-minute in style; guaranteed perfect fitting. We satisfy you or you don't pay us one cent.

## \$4 Satin Lining Free

We want your business and in order to get it we are going to line the first suit you order with our regular \$4 Satin Lining, fully guaranteed, without 1 cent extra charge. Be a tailor-made man.

## Spend 1c — Save \$10

Send now, today, for your copy of our Big Book. Contains most wonderful tailoring values ever offered. Mail that postal this minute, right now before you forget it. Your copy of our Big Fashion Book will come by return mail.

**BERNARD, HEWITT & COMPANY**

Desk 24, 564-6-8 W. Monroe St., Chicago

Send for the big book to-day.



Shipping Charges We Pay



MONEY IN MUSHROOMS

## MAKE BIG INCOME

Men and Women can do this all the year at home growing mushrooms in cellars, stables, sheds, boxes, etc. Crop sells for \$3.50 to \$1.00 a lb. \$20.00 a week easily made. Great demand, markets waiting. Start Now. Write for big 32 page Free Illustrated Booklet and learn how to do it. NAT'L SPAWN CO., Dept. 12, BOSTON, MASS.



**EVERYTHING** in Guaranteed Plumbing and Heating Supplies at wholesale. Our \$200,000 establishment behind our Guarantee. Send 20c for complete CATALOG 61, to be refunded on 1st order. J. HARDIN CO., 30 years at 4533-35-37-39-41-43 Cottage Grove Ave., CHICAGO

## Caementum (Pronounced Sementum) The Cement which Repairs Everything



Caementum is a liquid porcelain cement which sets rapidly and becomes absolutely insoluble. It is impervious to steam, water, heat or acids. It repairs everything from the finest china and glass to steam pipes and automobile radiators. With it you can build missing parts of china articles, stop leaks in pots and pans, repair woodenware or metals. Its uses are almost unlimited. It is made in France and is the only preparation of its kind on sale in America.

At dealers or by mail postpaid 25c

**STANDARD GLUE CO.** Dept. A BALTIMORE, MD.

Sole Agents for U. S. and Canada

## A BOOK THAT EVERY SHOOTER SHOULD OWN

"A New Chapter in an Old Story"—an intensely dramatic recital of man's development of his means of defense and offense from the stone age to the present day. A temptingly readable volume. Price 50c prepaid. Address

**Remington Arms-Union Metallic Cartridge Co., 299 Broadway, NEW YORK**

Canada cuts about 2,000,000 cords of pulp wood annually, about half of which is exported for manufacture in the United States.

## MAGIC FISH LURE!



Best bait for attracting all kinds of fish ever discovered. It sure does get 'em! Seems as though they just can't keep away from it. Will keep you busy hauling in the finny beauties. Makes fishing a REAL pleasure. Use Magic Fish Lure and you'll catch a big string every time while the other fellows go home empty-handed marveling at your "luck." Good any season. Won't spoil. Not unlawful to use. Send 25c for box containing enough for 500 baits. Money back if not satisfied. Valuable catalog sent FREE. Write for it today.

Lotz Bros. 155 N. Main St., St. Louis, Mo.

## HILDEBRANDT BAITES HOOK AND LAND 'EM

The choice of experienced anglers. A small outfit, interchangeable, catches any fresh water game fish. "Standard", "Slim Fish", "Idaho" shapes—nickle, copper, brass, aluminum, black and gold finishes suitable for bright or dull days. Ball bearing "spin so easy" blades—reversible. FREE NEW 1914 CATALOG. Actual sized illustrations, new flies, spinners, rods, lines, etc. 2c stamp brings it. The John J. Hildebrandt Co. 1314 High St. Logansport, Ind., U.S.A.

## Agents Make \$3 to \$10 a Day!



## NO-KEY PADLOCK

Biggest, quickest seller ever offered agents. Sells on sight. Nothing else like it. No keys to lose, no knobs to turn, no clicks to count. Simply press buttons and lock flies open. 40,000 different combinations. 100,000 in use. Operated as easily in dark as daylight. Big demand. Agents making 100% profit. No competition. Write quick for terms of free sample. Get this big easy money now. A postal will do. THE EDWARDS MFG. CO., Factory No. 8, CINCINNATI, O.

Please Mention Popular Mechanics





With a White Cross Electric Vibrator you can make a vibrating chair from an ordinary rocker.

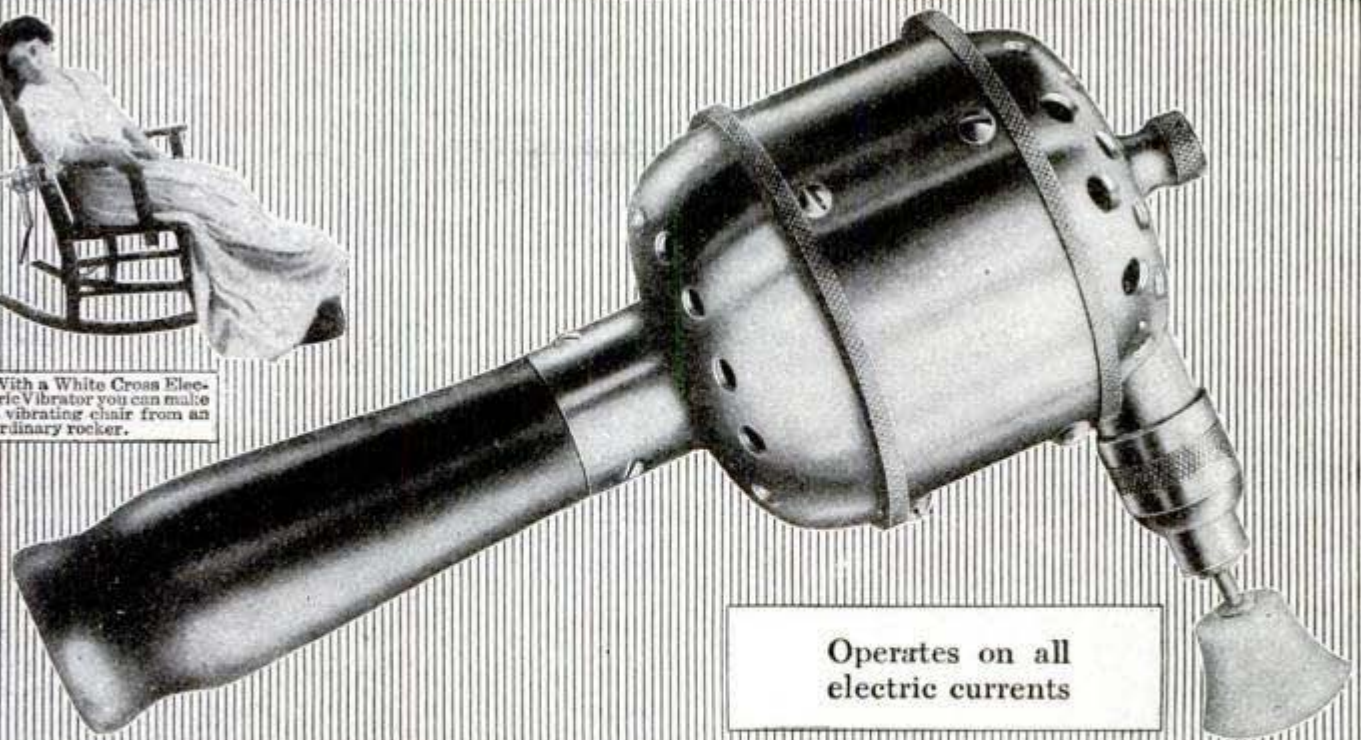

Operates on all electric currents

# \$750 For Our New Model No. 10. White Cross Electric Vibrator

The marvelous instrument that has been such a boon to the medical and scientific world. Endorsed by prominent physicians everywhere. Used by physicians in their practice and can be used by an individual himself. The greatest aid to health and beauty known to man. Nature's own remedy, perfected by man's ingenuity. On a great special offer you may now get this superb new model No. 10 for only \$7.50. Send the coupon now for the free book that tells you all about it. We have over a dozen different types of vibrators for you to choose from and our prices are from 25 to 50 per cent lower than our competitors'. Write today—send coupon.

*The only vibrator that can make a vibrating chair from any chair*

## Power and Health For All—For You

Power from within. Strength that is more than mere muscular strength—the strength of the perfect man now within your reach through vibration. Do you feel "tuned up" all the time? Aren't there times when something is wrong—just a little something that takes the edge off things—takes away the keenness of appetite and enjoyment. Usually there is just one thing wrong—circulation. If you only knew how much vibration would do, you would not allow yourself to go another day without trying it. Send the coupon for the free book that tells you all about it.

## White Cross Combination Vibrator

This superb instrument operates on direct or alternating current, or on its own powerful batteries. It gives mechanical vibration, galvanic and faradic electricity. Combined vibratory and electrical treatments can be taken at the same time or separately. It has an electric lamp for examining all cavities of the body. It furnishes current for operating the electric needle for removing superfluous hair and all kinds of facial blemishes. Attachments are furnished for treating the eye, ear, face, scalp and all parts of the body. It is complete with electric brush, sponges, foot plates, etc., etc., so that every member of the family can take any kind of treatments they wish.



Model No. 18

## Send the Coupon for New Book "Health and Beauty"

absolutely free and postpaid. It tells you how the earliest man turned to vibration (common rubbing) as a relief, through instinct. Send the free coupon today and find out about vibration and what it will do for you. It is so easy to use—so simple for you to find out how good it is. The book, "Health and Beauty," tells about our great offer. Send free coupon now or a letter or postal card. We'll send you the book free and prepaid. Do it NOW.

Get the book (also our Special Reduced Price offer). We are mailing out this great book

### FREE COUPON

Lindstrom-Smith Co.  
1100 So. Wabash Avenue  
Dept. 1194 Chicago, Illinois

Without any obligation to me, please send me free and prepaid, your new book "Health and Beauty." Also send me full particulars of your Special Offer on the White Cross Electric Vibrator.

Name.....

Address.....

**Lindstrom-Smith Company**  
1100 So. Wabash Ave. Dept. 1194 Chicago, Ill.

We manufacture White Cross electric irons, hair driers, stoves. Dealers write.

My Electrical Dealer's Name is.....



# Send for Copy of Our New Wireless Manual P1

It contains 96 pages and tells how to erect and maintain wireless telegraph stations. Shows a number of diagrams. Has the Morse and Continental Telegraph Codes. Illustrates the best instruments to use; tells what they are for and how to use them. Do not wait until some other time, but sit down now and send your name and address, and get one. It costs you nothing.



# Send for Our Pocket Catalog P26

It contains 212 pages, with over 1,000 illustrations and describes in plain, clear language all about Bells, Push Buttons, Batteries, Telephone and Telegraph Material, Electric Toys, Burglar and Fire Alarm Contrivances, Electric Call Bells, Electric Alarm Clocks, Medical Batteries, Motor Boat Horns, Electrically Heated Apparatus, Battery Connectors, Switches, Battery Gauges, Wireless Telegraph Instruments, Ignition Supplies, etc.

**It Means Money Saved to You** to have our Manual and our Catalog when you want to buy

**MANHATTAN ELECTRICAL SUPPLY CO.**

NEW YORK, 17 Park Place CHICAGO, 114 S. Fifth Ave. ST. LOUIS, 1106 Pine St. SAN FRANCISCO, 604 Mission St.



Nine Inch Search Light. Gives 20,000 flashes. Best make \$0.70



75 Ohm Telephone Receiver. \$0.40



6 Volt, 6 Ampere Dynamo. Lights 12 Tungsten Lamps. Weight 6 1/2 lbs. \$3.70

## WIRELESS

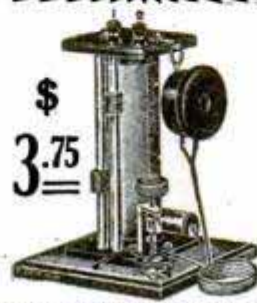

\$  
3.75

The "Interstate" Wireless Outfit, receives accurate messages 300 miles distant. Has Tuning coil, Galena Detector, 75 ohm Receiver, Condenser, etc., ALL WIRED ready for use. Greatest bargain ever offered. Satisfaction guaranteed. Complete \$3.75

The above goods represent only a few articles from our famous comprehensive electrical cyclopedia, No. 12, containing over 450 illustrations and over 1600 electrical apparatus and supplies.

Send to-day 3c. postage for this wonderful book, the greatest money saver in the United States. With this book is furnished free 16 page "Treatise on Wireless Telegraphy," also a 16 page copy of the new magazine "THE ELECTRICAL EXPERIMENTER." ASK FOR OUR FREE 160 PAGE "WIRELESS COURSE" IN TWENTY LESSONS. The Electro Importing Co., 233A Fulton St., N. Y. C. "Everything for the Experimenter."

**ELECTRIC LIGHT PLANTS** Complete gasoline engine, dynamo, switchboard and storage battery \$240. Agents wanted. American Battery Co., 1139 Fulton St. Chicago (Estab. 1889.)

**SUPPLIES FOR THE WIRELESS EXPERIMENTER** This little ad is just to catch your Eye. Our Catalogue "B" is sure to catch your Fancy. A 2 cent stamp brings it by return mail. Send for it NOW. WINGER ELECTRIC & MANFG. CO., 711 So. Dearborn St., CHICAGO, ILL. Successors to Dawson & Winger Electric Co.

## DUCK'S BIG 325 PP. ELECTRICAL AND WIRELESS CATALOG

Mailed for 8c. stamps or coin, which you may deduct on first order of \$1.00. Great cost of catalog and low prices prohibit distribution except to those really interested. Most elaborate catalog of its kind published. Catalog contains more valuable information on wireless and electricity than many text books. Contains 125 pages wireless insts. and raw material for making insts., numerous diagrams, hookups, etc. 15 pages telegraph insts., 42 pages motors and dynamos. 150 pages flashlights, lamps, lighting plants, ammeters, guns, radiotrans, miniature railways and mechanical books.

Our lighting plants possess exclusive advantages over all other types. They cannot be surpassed in quality, and are absolutely fool proof, requiring less attention than any other plant on the market. They are also very reasonable in price.



**Complete Home Electric Lighting Plants.**

If interested in lighting plants ask for special literature.



THE J. J. DUCK COMPANY, Arcade Bldg., TOLEDO, OHIO

## BOYS \$1.00 Pocket Electric Flash Light FREE

To introduce "Flexo" Pull Chain Key Socket attachments we will give FREE our nickel plated powerful electric Pocket Flash Light.

"Flexo" is a new device that transforms key sockets of electric lights into pull chain fixtures. They are put on in a minute and every family needs from 6 to 12.

You earn \$1.50 in cash and get the Flash Light FREE. Send ten cents for sample and full information. Don't delay.



**PEERLESS LIGHT CO.**

Dept. P., 813 W. Adams St., Chicago, Ill.

## A Complete Wireless Station

\$985

Receives 1200 Miles  
Sends 12 to 15 Miles

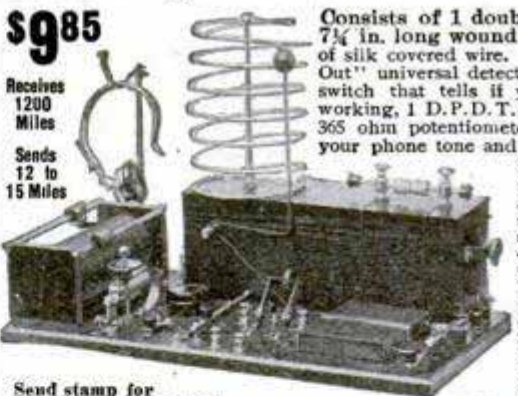

Consists of 1 double slide tuner 7 1/4 in. long wound with 160 feet of silk covered wire. Our "Don't Jar Out" universal detector, 1 buzzer and switch that tells if your detector is working, 1 D.P.D.T. aerial switch, 1-365 ohm potentiometer — it increases your phone tone and distance 30%. 1 fixed condenser. 1 standard wireless key, 1 spark coil guaranteed to give 1 1/2 inch spark, 1 helix & cord, 1 machine turned spark gap, 1 flat 8-plate condenser, 1-1000-ohm double pole receiver and cord, 1 nickleed headband, 6 insulators & diagram.

Send stamp for bulletin "P" for other remarkable values.

Nichols Electric Co., 35 Frankfort St., N. Y.

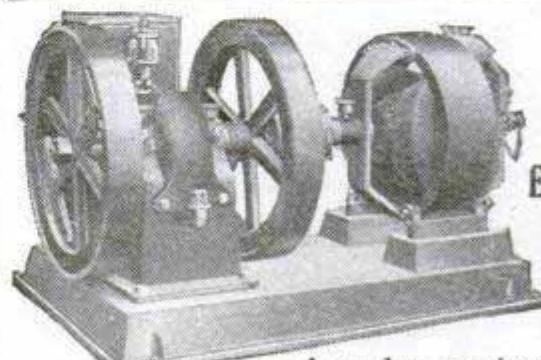

**LIGHT YOUR HOUSE WITH ELECTRICITY**

Put in a Direct Connected Gasoline Engine and Dynamo.

A modern equipment at small cost for farm and house lighting and small isolated plants. Dynamo has an output of 42 volts, charges the battery during the day, and 32 volt lamps are used to light the house. Operation steady and quiet. Write for circular.

THE CARLISLE & FINCH CO., 244 East Clifton Ave., CINCINNATI, OHIO



**\$8,000 to \$10,000  
YEARLY**



**Make Money Out of Others' Fun**

Pleasing the Public Pays Big Profits and owners of our famous attractions frequently make from \$8,000 to \$10,000 every year. We make everything in the Riding Gallery line from a hand-power Merry-Go-Round to the highest grade Carouselles. Bring in hundreds of dollars daily. It is a delightful, attractive, big paying, healthful business. Just the thing for the man who can't stand indoor work, or is not fit for heavy work.

Just the business for the man who has some money and wants to invest it to the best advantage. Our goods are the finest appearing, easiest running, and most attractive line manufactured. They are simple in construction and require no special knowledge to operate. If you want to get into a money-making business write today for catalog and particulars.

**HERSCHELL-SPILLMAN CO.**

Park Amusement Outfitters  
333 Sweeney St., N. Tonawanda, N. Y., U.S.A.

There are 216,000 farms in New York state averaging a little more than 100 acres each. Of this total, 49,000 are tenant farms.

**ELECTRIC HOME, FARM, STORE, THEATRE & TOWN LIGHTING PLANTS. Water Wheels Engines Fan & Power Motors. Dynamos. Batteries. Ozone & Massage Machines Carriage, Bicycle, Hunting, Fishing, Flash & Motorcycle Lights MOTION PICTURE THEATRE COMPLETE EQUIPMENTS START YOU with BIG PROFITS. Cat. 3 cents OHIO ELECTRIC WORKS, CLEVELAND, OHIO**

**Electric Flashlight Pistol**

Complete with tungsten lamp and battery. Gun metal finish, handy to carry, never in the way. Size 3x3 1/2. It's no toy, but a neat, handy flashlight. Protect yourself in the dark.



Price, prepaid, \$1.45  
SEND FOR CIRCULAR. Agents Wanted  
**MOHR BROS., 2809 N. Halsted St., CHICAGO**

**ELECTRICITY**

This is your "elbow book." It's the latest edition of the **VOLTAMP ELECTRIC Catalog**—128 pages full of cuts, complete description and prices of latest experimental apparatus—Dynamos, Motors, Rheostats, Transformers, Wireless Coils—Electrical Repair Material; Raw Materials; Telephone, Telegraph and Wireless Outfits; Handbooks; **Miniature Electric Railways** and parts, Toys, etc. 6c in stamps or coin will bring you this book (with valuable coupon)—you'll find it worth dollars. (No postals answered.)  
**VOLTAMP ELECTRIC MFG. CO. Voltamp Block, BALTIMORE, MD.**

**BING'S CONSTRUCTOR**



Most fascinating building toy. No screws or rivets. Build anything you want—Machinery, bridges, towers, wagons, machine shops, etc. Outfits \$2, \$4, \$6, up to \$60. Ask your dealer about them, or write to us for full particulars.

Made with Bing's Constructor **BING BROTHERS, Manufacturers JOHN BING, Sole Representative, 382 Fourth Ave., N. Y.**



**Come "Evinrude" With Us**

Do you know what "Evinruding" is? It is not a *new* sport because too many thousands are "Evinruding" to call it new. Dictionaries should describe it as making a motor-boat of any row-boat in less than one minute—of realizing all the pleasures of motor-boating with any rowboat or canoe. The



is vibrationless, quiet and smooth running; weighs about fifty pounds; may be carried anywhere like a suit case.

**You Don't Need to Own a Boat**

if you have an "Evinrude" because the "Evinrude" will attach to any boat whether rented or owned and its simplicity of operation enables women and children to enjoy the pleasures of "Evinruding" everywhere. In designing our 1914 models we have installed a

**Built-In Reversible Magneto**

which eliminates the carrying of fifteen or twenty pounds of batteries necessary with similar motors. This magneto starts the motor with one-twelfth turn of the fly-wheel in either direction; is not affected by rain, waves or even complete submersion.

The motor drives the average rowboat eight miles an hour or may be slowed down for trolling. Speed with the average canoe, twelve miles an hour.

Call at your Hardware or Sporting Goods Dealer to see the "Evinrude" or write for large illustrated catalog sent free

**EVINRUDE MOTOR COMPANY**

235-M STREET MILWAUKEE, WISCONSIN  
BRANCH OFFICES  
San Francisco, 423 Market St. Portland Ore., 106 Fourth St.  
Jacksonville, Fla., Foot of Main St. Boston, 218 State St.  
New York, 69 Cortlandt Street



# Wanted—Inventors —or Men with the Inventive Turn

The whole world wants the inventor. To the intelligent inventor it gives its richest prizes. Westinghouse, Marconi, Edison, were all once beginners, like you. The average man of their time thought everything had been invented that could be invented. If you have an inventive mind, their success may be yours. The world wants your work.

To meet the demand for a square, fair deal for small inventors, two young men, G. H. and H. C. Chandlee opened a little office twenty years ago in the Stead Building in Washington. They believed that thousands of men were being shut out from big opportunities because of the huge fees charged by most patent attorneys.

They said: "We will stand by the

small inventor. We will keep faith with him. We will advertise, secure a large volume of business, charge small fees and make our money through the greater number of cases we handle."

The plan succeeded. Now Chandlee & Chandlee give employment to nearly 100 people, including many registered attorneys, and large manufacturing concerns, knowing that they have secured valuable and well-protected patents for their clients, solicit their services, both in the obtaining of patents and in the purchase of patents, to be manufactured on a royalty or bought outright.

Chandlee & Chandlee have built their business in the very shadow of the patent office. They have learned by long practice not only

## How to Obtain Patent Protection at Small Cost

but also how to assist their clients in the sale of their inventions—a double service. Hosts of successful inventors owe their start to the good work done for them by Chandlee & Chandlee. These young men, now grown to middle age, to knowledge and to success, are serving splendidly the men who are beginners, as they were once beginners.

### The Big Thought

And the big thought back of Chandlee & Chandlee is that they want to make inventors. They want inventors to work intelligently along right lines. They believe that the field for great and even startling successes and profits is greater now than ever.

And so out of their knowledge of what succeeds and what makes money, they have prepared two books—

**"What to Invent"**  
and

**"How to Obtain a Patent"**

These two books cover the field. They tell just what inventions are wanted and just what must be done to obtain patent protection. They have started many inventors on the right track and have made inventors of many men who had simply the untrained inventive faculty.

## You May Have These Books Free

Write your name and address in a letter or on a postal card and they will be sent you free. Or, if you have already invented something, send a rough sketch and description of it for a free report as to patentability. Do it now.  
Address

**CHANDLEE & CHANDLEE**  
1009 F. Street, Washington, D. C.





# Patents

Trade Marks and  
Copyrights Secured  
or Fee Returned

## Special Offer—Free Search of Patent Office Records

Send us a model or sketch and description of your invention, and we will make a *Free Search* of the *Patent Office Records* to ascertain if it is patentable. If we report the invention patentable, we will guarantee to obtain a patent or return our fee, and furnish a certificate of patentability backed by a bonded contract to that effect. **This Certificate of Patentability will protect the inventor and serve as proof of the invention until the case can be filed in the U. S. Patent Office.**

### Obtaining Assistance for Inventors

Our certificate is of great assistance to inventors who require financial aid to obtain patents.

### Our Five Books Mailed Free

(SEE COUPON BELOW)

to any address. Send for these books—the finest publications ever issued for free distribution.

#### How to Obtain a Patent

Our illustrated eighty-page Guide Book is a book of reference for inventors, and contains 100 mechanical movements illustrated and described.

#### Money in Patents

Tells how to invent for profit, and gives history of successful inventions.

#### What to Invent

Contains a valuable **LIST OF INVENTIONS WANTED** and suggestions concerning profitable fields of invention; also information regarding prizes offered for inventions, among which is

#### Prize of One Million Dollars

offered for one invention, and \$10,000 for others.

#### Patents That Pay

Contains letters from our clients who have built up profitable enterprises founded upon patents procured by us; also endorsements from prominent inventors, manufacturers, Senators, Congressmen, Governors, etc.

#### We Advertise Our Clients'

#### Inventions Free

In a list of Sunday newspapers with two million circulation, in manufacturers' journals and in the *World's Progress*. Sample Copy Free. We save you time and money in securing patents. After the patent is granted we assist you **TO SELL YOUR PATENT.**

#### Foreign Patents

WE HAVE DIRECT AGENCIES IN ALL THE PRINCIPAL FOREIGN COUNTRIES and secure FOREIGN PATENTS in the shortest possible TIME and at the LOWEST COST. Write for our Illustrated Guide Book on Foreign Patents, sent free to any address.

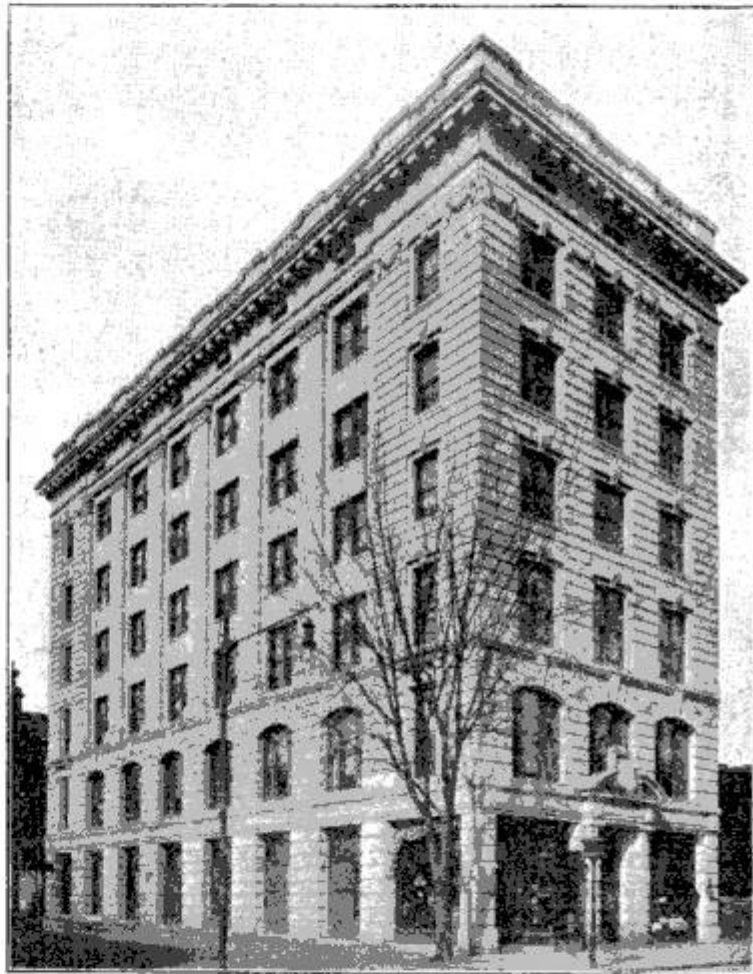

**VICTOR BUILDING**

Our new \$200,000 building opposite U. S. Patent Office  
SPECIALLY ERECTED by us for OUR own use

## WANTED NEW IDEAS

Send for **LIST OF PATENT BUYERS** who consult us when purchasing patents. Contains requests from **MANUFACTURERS, MAIL ORDER HOUSES and PROMOTERS** for patents secured by us, and suggestions as to New Ideas they wish to purchase. We invite manufacturers and promoters to address our Sales Department regarding the purchase or leasing of a number of meritorious patents secured by us.

### REFERENCES

Second National Bank, Washington, D. C.; Union Savings Bank, Washington, D. C.; Chamber of Commerce, Washington, D. C.; Pitner Gasoline Lighting Co., Chicago, Ill.; R. G. Dun & Co., Washington, D. C.; Smethport Glass Co., Smethport, Pa.; The Melvin Gauge and Signal Co., Scranton, Pa.; M. Winter Lumber Co., Sheboygan, Wis.; National Savings and Trust Co., Washington, D. C.

### FREE COUPON!

**VICTOR J. EVANS & CO., Patent Attorneys**

NEW YORK OFFICES: 132 Nassau St.

PHILADELPHIA OFFICES: 1429 Chestnut St.

Main Offices: 724-726 9th St., N. W., WASHINGTON, D. C.

GENTLEMEN: Please send me FREE OF CHARGE your FIVE Books as described above.

NAME..... ADDRESS.....



# WANTED-IDEAS

Manufacturers are constantly writing me for patents procured through me. The demand for good ideas

## Protected by Owen Patents

is greater than ever before. Send for my free books and read the letters from the greatest manufacturers in this country. Read their requests for Owen Patents and see for yourself what ideas they want. You can help supply the unceasing demand for good inventions.

My clients are provided with manufacturing facilities, and I aid them in **many ways, without charge**, to sell their patents. **Applications** filed through me advertised free.

You will get a strong patent or I will get no compensation. Your interests are my interests.

# FREE!

A simple request will bring you the following three finest patent books published **absolutely** free—you will incur no obligation by writing me.

**"SUCCESSFUL PATENTS"**—a new 72 page guide book; tells how to proceed to be successful; describes my advantageous business methods.

**"STEPPING STONES"**—gives lists of over 200 inventions wanted; gives forecasts from interviews of Edison and many other authorities; tells the plain truth about prizes of millions of dollars for inventions.

**"PATENT PROMOTION"**—tells you how to promote your invention; why some inventors fail; the value of your rights, etc.



**Write for these books today—NOW! Advice costs nothing**

### VERY HIGHEST REFERENCES

Columbia National Bank,  
Washington, D. C.

National Locktile Co.,  
Washington, D. C.

The Carnahan Press,  
Washington, D. C.

Lightning Gun & Cycle Works  
Oklahoma City, Okla.

Antholene Mfg. Co.,  
Hutchinson, Kans.

National Rack Co.,  
61 Hannoter St.,  
Boston, Mass.

The C. J. Loftus Co.,  
13 Spring Common,  
Youngstown, Ohio

Whitehead Hosiery Mills,  
Burlington, N. C.

Dickinson Mfg. Co.,  
Des Moines, Iowa.

And an immense number of others whose letters are printed in my booklets.

## SPECIAL!

Send me a sketch or model of your invention and I will make a search of the U. S. Patent Office Records **FREE OF CHARGE** and report to you concerning patentability, practicability, etc.

Your work will receive my **PERSONAL** supervision—but my fees are no higher than others.

**RICHARD B. OWEN** 9-303 OWEN BLDG.  
WASHINGTON, D. C.

Inventors submitting their inventions to me are protected in a tangible manner until their applications are filed.



# Inventors! Send for these Remarkable FREE BOOKS, Today

Complete and full information about patents, everything the inventor or manufacturer should know, has been included in these books. Never before has such an inexhaustible fund of valuable information been at the inventor's disposal. Regardless of the fact that the compilation of this information cost us thousands of dollars, we will send to all interested persons, any or all of these books, entirely without charge or obligation.

## "Millions In Patents"

This volume, 192 pages, tells the story of the romance of invention. The brain of the inventor is the magician that has made the ancient fairy tales come true. Millions have been paid for a hook, fortunes have come from a toy. Read "Millions In Patents," and you will realize that this country and all the nations of the world are ready to enrich you beyond your wildest dreams if you can contribute one useful or amusing thing.

## "What Is a Trademark?"

It is not an exaggeration to say that billions of dollars have been made out of trademarks, labels and copyrights. He who can fashion a trademark or design a label which will make a product stand out above all similar products, is indisputably a genius for whose brains the world offers almost unlimited money.

## "Foreign Patents"

A good invention is bought not by one country but by the world. "Foreign Patents" shows you how the inventor may be paid by other countries and other peoples, as well as by this nation, for his ideas and his inventions. It explains how we, through our representatives in the capitals of the world, maintain for your benefit an endless chain of opportunities which, if you take advantage of them, will girdle the earth and make of your product an agent that may bring back to you rich rewards.

## "Inventions Needed"

This book, 256 pages, lays before you a description of the active and profitable field of invention. It tells you the inventions the world needs today, the devices manufacturers are seeking for their business, the ideas for which the public will pay big money. It gives great men's ideas of the most important things needed in inventions now. Science is the key to wealth, and this key can be turned best by the inventor. This book tells you why.

## "How to Get Your Patent and Your Money"

The man who invents needs the co-operation of the man who invests. This book, 132 pages, is a guide to the inventor. It describes, according to the teachings of our experience and the lessons of men made rich by patents, how the inventor may secure money, the right amount of money, for the device which his brain has constructed. If you have invented something and desire to learn what it will cost you to get your patent and what you must do to find your market, read this book.

## "Special Bulletin of Patent Buyers"

This bulletin, 64 pages, contains copies of hundreds of letters from wealthy men who are seeking to purchase patents. Next to the idea of the invention itself, the most valuable thing to the inventor is a hint of where there is a man ready to buy the invention or to finance the inventor so that his device can be readily marketed. We act as intermediary, **without one cent of charge**, between the man who invents and the man who invests.

**We Secure Reliable Patents, Trade Marks, Copyrights, On Most Liberal Terms Ever Offered**

**Send Model or Sketch and description of your invention for Free Search of the United States Patents**

**Rejected and Difficult Cases are Our Specialty**

**RANDOLPH & CO.**  
600 F St., N.W., Washington, D.C.

**RANDOLPH & CO.,**  
WASHINGTON, D. C.

Gentlemen: Please send me, without obligation on my part, the books indicated on margin of this coupon. (Write on margin of coupon, names of books desired.)

NAME .....

STREET .....

CITY .....

STATE .....

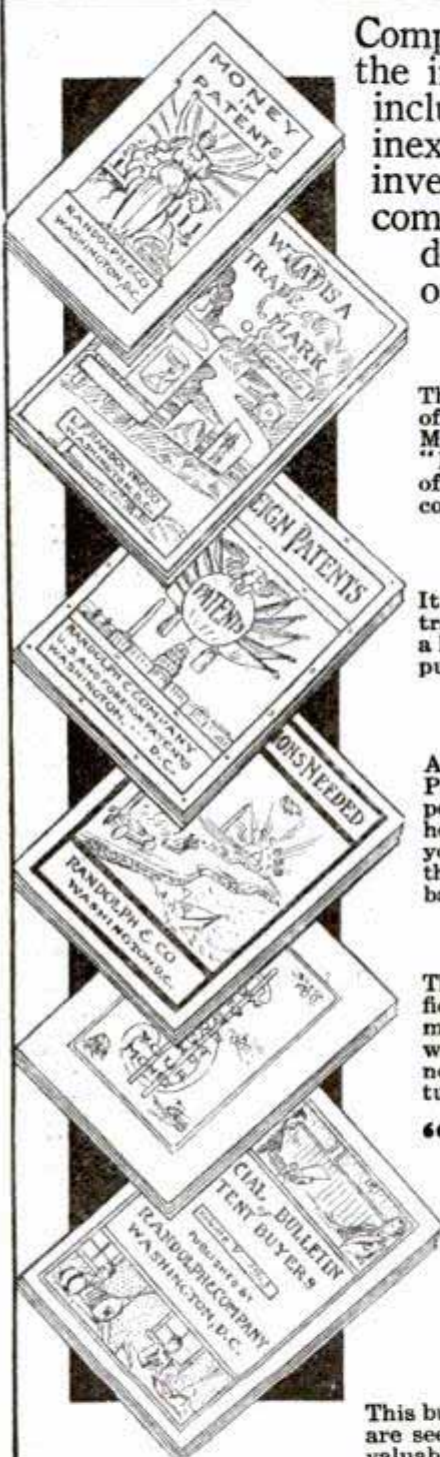



# PATENTS THAT PROTECT and PAY

Advice free. Terms reasonable. Highest references. Best results.

Send sketch or model for FREE examination and opinion.

Recommended Patent Lawyer in the Bankers' Register and special list of selected lawyers. Also in Martindale's Law Directory, Sharp and Alleman's Directory of Lawyers, The Gast-Paul Directory of Lawyers, and Kime's International Law Directory.

**ALL BUSINESS GIVEN PROMPT AND PROPER ATTENTION**

A large list of strong recommendations furnished free

**WATSON E. COLEMAN, Patent Lawyer, 622 F St., N.W., Washington, D.C.**

## PATENTS

**C. L. PARKER**  
Formerly Member Examining  
Corps, U. S. Patent Office  
**PATENT LAWYER**  
210 MCGILL BLDG.  
WASHINGTON, D. C.

Patents, Trade Marks, Copyrights, Patent Litigation

Handbook for Inventors, "Protecting, Exploiting and Selling Inventions" sent free upon request.

For Interesting and Valuable Information about  
**PATENTS WANTED**  
and bought by Manufacturers, send 6 cents postage for large Illustrated paper *Visible Results and Terms Book*.  
E. S. & A. B. Lacey, Dept. Y, Washington, D. C. Estab. 1869.

Active Powers of Inventive Genius



**INVENTORS** Our Brain Belongs to You. Our Ideas Are Free of Charge.

All we want in return is to build your model, special machinery, dies, tools and jigs to manufacture sheet metal goods, etc. We are expert mechanics, over thirty years experience and have one of the best equipped shops in the country. Ask for Booklet No. 17. Consultation free. Experimental work strictly confidential.

**A. NACKE & SON**  
236-242 S. 9th St., Philadelphia, Pa.



## BRASS GEARS

Cut by an entirely new process. The most accurate made and at prices that cannot be equalled by others. Every gear has a hub, center painted ebony black, edges turned true, highest grade red brass, and much heavier than others. We carry the largest stock in the world and every gear listed is always shipped on date of order.

SEND FOR CIRCULARS  
**CHICAGO STOCK GEAR WORKS**  
16 S. Fifth Av. Chicago

## PATENTS THAT PAY—\$561,530 Made

by my clients. List Free of PRIZES OFFERED. 127 Page Patent Book—"What and How to Invent—Proof of Fortunes in Patents"—FREE. Opposite Patent Office.  
**E. E. VROOMAN, Pat. Atty., 871 F St., WASHINGTON, D. C.**

Send for FREE BOOK { WHAT TO INVENT  
WHAT NOT TO INVENT  
HOW TO SELL YOUR PATENT  
Copies of nearest Patents and report in every case without charge  
**H. L. WOODWARD, 900 G St., Washington, D. C.**

**CASH FOR IDEAS** Given by NEWS, Dept. P, Washington, D. C. Only inventor's paper on earth; three months' trial, 25 cents. \$1.00 a year.

**FIVE NEW PAPERS A DAY**—The forty-sixth annual census of the publications of the United States and Canada, shows that an average of five new publications were started every working day during 1913. The suspensions and consolidations make the net gain only three a week. The total number of publications is 24,527. There are 2,640 dailies and 572 Sunday papers.



## Models and Supplies

We make working models of any description and material, also dies, tools and sheet metal stampings. Send your drawing or sample for estimate. Write for catalog of gears and model supplies.  
**The Pierce Model Works, 3405 Pierce Ave., Chicago, Ill.**



**MECHANICAL SUPPLIES AND MATERIAL** of all kinds. EXPERIMENTAL AND LIGHT MACHINE WORK to order.  
132 MILK STREET. BOSTON

## STAMPINGS

Metal spinnings and stampings a specialty. All sorts of die work and metal patterns. Manufacturers of patent specialties and novelties. Can get out samples at moderate cost. Experts in black enameling. Prices reasonable. Prompt delivery.  
**THE STANDARD SPINNING & STAMPING CO., Toledo, O.**

## PATENT POINTERS

Things to know before applying for a patent:

1. Is my invention perfected or complete?
2. Is it new and patentable? If so, what will a patent cost?
3. Does it infringe any patent?
4. Is there a demand for such an invention?
5. Can a demand be created at reasonable expense?
6. What will it cost to demonstrate the utility of and demand for my invention?
7. Who are likely to be interested in the manufacture and sale of such inventions?
8. Where can I get reliable information and advice on the above points?

We will be glad to demonstrate to your satisfaction that we can render the service required to fully post you upon the above points.

**BENJAMIN AND BASSETT**  
Patent Attorneys and Mechanical Experts  
Provident Savings Bank Bldg., WASHINGTON, D. C.



# Money-Saving Prices on STEEL Shingles!

Why fool with wood shingles that *burn* and *rot* when 135,000 people have found Edwards "Interlocking" Steel Shingles far and away superior?

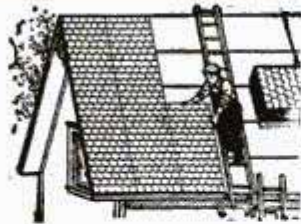

They are fire-proof, lightning-proof, and rust-proof (made so by Edwards famous "Tightcote" Process) and *cost less than wood!* You can lay them yourself with hammer and nails. Come in big sheets easy to handle. Put on over old roof or sheathing if you like.

## Edwards STEEL Shingles Factory Prices—Freight Paid

No expert workmen, no special tools, no painting. And the handsomest roof you ever saw. Your neighbors are struck dumb with admiration. They'll all want roofs like yours.

**EDWARDS OFFER** Write Edwards today and get his astounding low price, with freight prepaid to your station. (148)

Ask for Book No. 450 and give size of roof if possible.

**THE EDWARDS MFG. CO.**  
400-450 Lock Street CINCINNATI, OHIO

The longest stretch of straight railroad in the world is found in New Zealand, the tracks extending for 136 miles in a perfectly straight line.



## TYPEWRITERS ALL MAKES

All the Standard Machines SOLD or RENTED ANYWHERE at  $\frac{1}{2}$  to  $\frac{3}{4}$  MFR'S PRICES, allowing RENTAL TO APPLY ON PRICE. Shipped with privilege of examination. Write for Illustrated Catalog L.  
TYPEWRITER EMPORIUM, 34-36 W. Lake St., CHICAGO



Agents Wanted

## WRITE 600 WORDS WITH ONE DIP

Why use ordinary pens with the never ending dip — when One Dip Pens make every penholder virtually a fountain pen?

Send 10c for Sample Package

One Dip Pen Co., 34 Daily Record Bldg., Baltimore, Md.

## TRY IT YOUR SELF FOR 10 DAYS WITHOUT DEPOSIT



If not satisfactory, return it and no questions asked. DAUS IMPROVED TIP TOP DUPLICATOR with "Dausco" Oiled Parchment Back negative roll is the result of 25 years' experience and is used and endorsed by thousands of business houses and individuals. 100 copies from pen-written and 50 copies from typewritten original — Clear, Clean, Perfect. Complete Duplicator, Cap size (prints 8 3/4 x 13 in.), price **\$5.00**

FELIX A. L. DAUS DUPLICATOR CO., Daus Building, 111 John St., New York

## Over 80,000 in Use

Mostly sold by recommendation. For Personal Desk or General Office.

It checks mental calculations. Handsome Morocco case free. Buy Thru Your Stationer.

Write for 10 day trial offer. E. Ganther, A. A. M. Co., 119 W. Broadway, New York City.

## Golden Gem \$10 Adding Machine

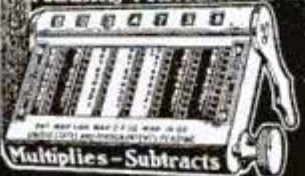

Multiplies - Subtracts

Agents Wanted

# FREE Plan Book and Consulting Service

**Carpenters!** Make big money in the construction field. This business getting combination yours without cost. A year's Consulting Membership, entitling you to the unlimited advice of a staff of experts, and our big Plan Book absolutely free. Contains 224 pages, 9 1/2 by 12 1/4 inches, and 426 illustrations. Covers completely 168 structures, from city and country homes to apartment houses and public buildings, including plans and specifications, exterior and interior views, and detailed estimates.

The advice of our experts, which alone may be worth more than the entire cost of the books, together with the Plan Book and our **Cyclopedia of Architecture, Carpentry and Building**, will enable you to figure on any job, no matter how large. Your ability to save the usual architect's fee will get you the business.

## The Cyclopedia of ARCHITECTURE, CARPENTRY AND BUILDING

consists of ten massive volumes; 4,760 pages, 7x10 inches; 4,000 illustrations, full page plates, building plans, diagrams, etc.; hundreds of valuable tables and formulas; carefully cross-indexed for quick, easy reference.

This great work covers everything in the building professions, from the first rough sketch of the architect to the acceptance of the finished structure. It includes wood, stone, steel, and reinforced concrete construction; estimating and contracting; a study of the Greek and Roman Orders; interior finishing and decorating, and modern house lighting and sanitation.

**Now offered at half price and on the easiest of easy payment plans.**

### Partial Table of Contents

Mechanical, Freehand, Perspective and Architectural Drawing, Lettering, Pen and Ink Rendering, The Orders, Superintendence, Strength of Materials, Masonry, Reinforced Concrete, Carpentry, Steel Square, Stair-Building, Hardware, Steel Construction, Roof Trusses, Practical Problems, Estimating, Contracts, Specifications, Building Law, Sanitation, Sheet Metal Work, Electric Wiring and Lighting.

With every order for a Cyclopedia we will include the Plan Book and a year's Consulting Membership absolutely free of charge, and send you the Cyclopedia and the Plan Book, express prepaid, for seven days' free examination. You keep the books a full week — examine them thoroughly at your leisure — and if they don't meet with your expectations they may be returned at our expense. Remember — the complete set, Cyclopedia and Plan Book, are sent free upon receipt of the coupon below and we pay express charges both ways if they are not satisfactory.

Don't wait. This means money saved if you act now. You take no chances whatever — it costs nothing to inspect and you are nothing out if you do not care to buy. Isn't this offer worth investigating? It may mean your success, so mail the coupon today — now — before you turn the page.

### COMBINATION OFFER COUPON

American Technical Society,  
Chicago, U. S. A.

Please send Free Plan Book, also Cyclopedia of Architecture, Carpentry and Building for seven days' examination. I will send \$2.00 within seven days and \$2.00 a month until I have paid \$24.80 for Cyclopedia (Plan Book and Consulting Membership included free), or notify you and hold books subject to your order. Title not to pass until fully paid. POP. MECH. 4-14

NAME.....

ADDRESS.....  
As I have had no previous dealings with you, I refer you to

Free Plan Book

Please Mention Popular Mechanics



## Coin Money MAKING CEMENT PIPE



Increase Your Income and be Independent

Making cement pipe offers big opportunities. We started over 3000 men and firms in business last year making cement Sewer Pipe and Drain Tile. Every community uses pipe for sewers, land drainage, irrigation, road culverts, well casing or other purposes. 24 inch Bell mouth pipe can be made for 35 cents a foot with sand and cement at ordinary prices. Vitri-fied clay pipe, the closest competitor, sells up to \$1.25 per foot depending on distance from factory. Attractive profits in every size. This proposition is well suited to the smaller cities and country towns, and every village can support a cement pipe plant. Cement is getting cheaper every year; sand and gravel are found everywhere.

**How to Start at the Business**

Our catalog tells all about the manufacture of cement sewer pipe and drain tile and gives data on cost of manufacture. Sent free on request.

Send now and get started early for the big summer trade. We also make a complete line of mixers and concrete machinery for building blocks, brick, burial vaults, sidewalk, tile, fence posts, etc. Write today.



**LANSING CO., 724 Cedar St., LANSING, MICH.**  
Agents everywhere

## A SAFE LATHE TO BUY

*"The Best at the Lowest Price"*

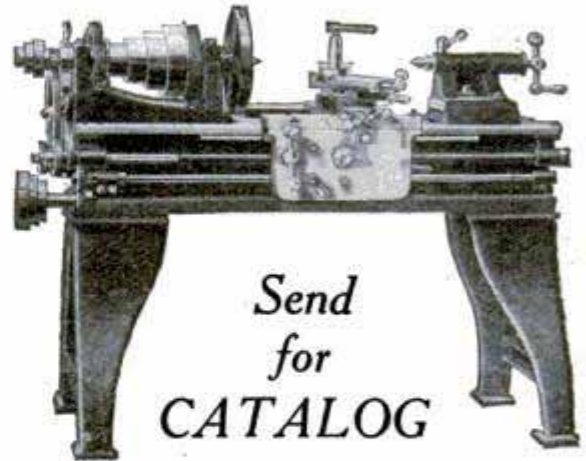

Send  
for  
**CATALOG**

If you have **Garage and Automobile** work to do or operate a shop for **General Repair Work**, you want a Lathe you can depend on—the best Lathe to be had at the lowest price. Answer—the "SEBASTIAN" Lathe, made of high grade materials by skilled workmen. Drop us a card for our new catalog.

**The Sebastian Lathe Co.**

107 Culvert Street

CINCINNATI, OHIO

## Superior Woodworking Machinery

A modern line of woodworking machinery for Furniture Factories—Piano Factories—Box Factories—Cabinet Shops—Pattern Shops—Carpenter Shops—Wagon Shops—Repair Shops—Contractors—Manual Training Schools, etc. If interested write for our catalogue and net prices.

Largest manufacturers  
of woodworking machinery  
in Chicago.

**Jones Superior Machine Co.**  
1266 W. North Ave., CHICAGO

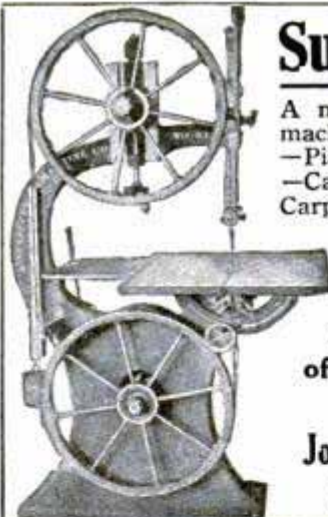

Jones Machine Moulded  
**PULLEYS**  
and **GEARS**  
Clutches, Sprockets  
Shafting and Hangers

THE LARGEST LINE OF  
**Power Transmitting Appliances**  
IN THE COUNTRY

SEND FOR GENERAL CATALOGUE A18

**W. A. JONES FOUNDRY & MACHINE CO.**  
1400 North Ave. CHICAGO

**WOMAN HAD TO BORROW OWN TEETH—**  
There was an amusing incident recently at an English police court when a peddler was charged with theft from a house. Among the stolen property was a double set of false teeth. As the man was remanded for a week, their owner, a woman, found herself in a difficulty, all stolen property having to remain with the police until the case is completed. The magistrate, however, granted her the loan of her own teeth for a week on the understanding that she would produce them when the case came up for hearing.

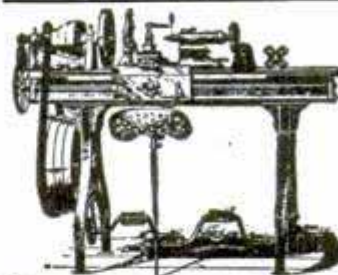

## LATHES

9 to 13-inch Swing

List price \$75 and up according to size. When ready to buy send for Lathe Catalog and prices.

**W. F. & John Barnes Co.**  
100 Ruby Street, ROCKFORD, ILL.

DO YOU HAVE KNIVES TO GRIND, SILVER TO POLISH, SMALL TOOLS TO OPERATE, WASHING MACHINES OR WRINGERS TO RUN? LET THE RED DEVIL

DO YOUR WORK

Attached to any water faucet will develop up to 3 Horse Power according to size of pipe and water pressure. Only perfect small motor made. Improved bucket wheel construction.

6 in. Motor for Mechanics and Tradesmen. Washing Machine, 1/2 H. P. on 1/2 in. pipe, 60 lbs. water pressure; 1 H. P. on 60 lbs. pressure, 2 in. pipe. Net price \$55, cash with order.

No. 1492—4 in. Motor for grinding, polishing, fans, sewing machines; for Doctors, Dentists, Druggists, etc., with emery, buffing wheel, silver polish and pulley, \$3.

No. 1493—4 in. Motor and pulley only \$2.50, cash with order. Money back for any reason. Order your motor from dealer or from us. Send your water pressure and size of supply pipe. Active Agents wanted. Catalog free.

Only Motor to do this work



6 in. Motor

**DIVINE WATER MOTOR CO.**  
DEPT P. UTICA, N.Y.



**\$300<sup>00</sup> IN ONE SEASON**

Make it sharpening Lawn-mowers on the "Ideal" Lawn-mower Grinder.

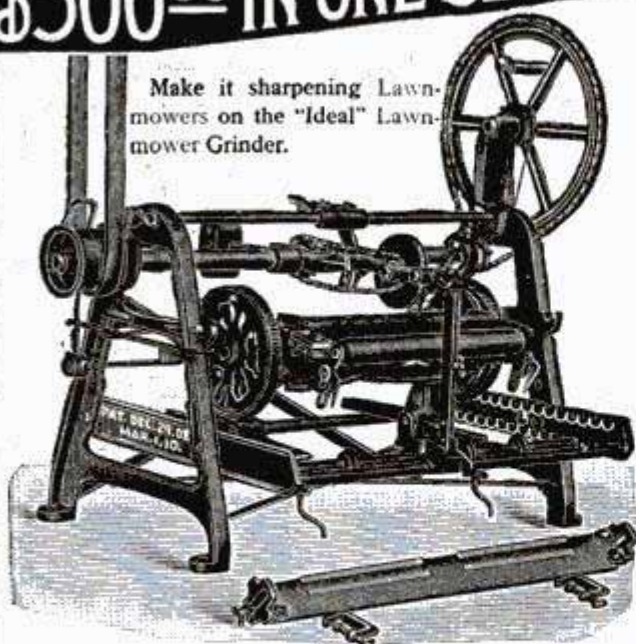

"You Grind It As You Find It"

Many have done better. Mr. Zabst, Mich., writes: "I sharpened 2178 mowers in 3 seasons at 75c to \$1.50 each." Mr. Stoy Ia., writes: "I ground over 500 mowers this season and expect to do better next year." Sharpens skates in winter, too. The best money maker you can have in your shop. Nothing like it on the market. Sharpens all makes of mowers perfectly in fifteen minutes. Over 6000 in use. Fully warranted. Write today for catalog and full information.

The ROOT-HEATH MFG. CO., Plymouth, O.



**LEIMAN BROS. ROTARY VACUUM-PUMPS AND BLOWERS**  
for Vacuum Cleaning, Melting, Forging, Soldering, Sand Blasting. Take up their own wear.  
LEIMAN BROS., 62P John St., New York

**VACUUM PUMPS**  
Tools, Hose and Parts

for cleaners at wholesale. Electric or gasoline power. For stationary, house or flat machine or wagon outfit. Our pumps rugged, will stand any wear. Assemble your own machine. Saves half. Dept. E.

VACUUM SUPPLY CO., Ann Arbor, Mich.

**CRESCENT QUALITY**  
can be had only in the Crescent line of wood working machinery

Price is moderate. Ask for our catalog of band saws, jointers, saw tables, planers, swing saws, shapers, planers and matchers, disk grinders, variety wood workers, Universal wood workers.

THE CRESCENT MACHINE COMPANY, 93 Columbia St., LEETONIA, O.

**VELVATONE WOOD NEEDLES**

**FOR DISK TALKING MACHINES**

New Idea in Talking Machine Needles. Made of hard wood chemically treated. No fiber. Preserve and improve records with continued use. Give softer, smoother and much sweeter tone to the music. Self-sharpening. A single needle has played 30 records. Send name of your Talking Machine dealer for Free Sample, or 50c for full size package, enough to play over 1000 records.

VELVATONE WOOD NEEDLE CO.  
DEPT. 1 KANSAS CITY, MO.

**Now Ready**

Mailed Free

Send Coupon Today



**1914 Camp Guide**

**Free**

Find out all about camping. Get ready for your vacation. The new 1914 Camp Guide gives you all the latest information about camps and camping—tells you how to prepare for trips—how to locate your camps and pitch your tents—what to take along—clothing, provisions, cooking, etc.—also expert advice on hunting and fishing.

You can also get full information about tents, canvas specialties and outfits—everything you need for the camping trip. Tells you how you can make a big saving on the purchase of your outfit and everything needed. You get the rock-bottom prices on everything, the direct factory price from the largest manufacturer in the United States. Everything that you buy is covered by a strong guarantee. Get the 1914 Camp Guide now and prepare for your trip.



**Special Offer!**

**Complete Outfit**

Send the coupon today and learn about the great special offer being made to readers of this magazine. Learn how you can get a complete camping outfit. Everything you need—at a remarkably low reduced price. Do not fail to learn about this great offer at once.

**\$5.90** Special Price for this splendid tent, Size 7x7. Genuine full weight 8-oz. Duck.

**Send Coupon Today**

Don't delay. Get the free Camp Guide and full information about camps and camping. Get ready for your vacation. Send the coupon today sure for this valuable FREE Book.

**H. Channon Company**

Dept. 1194 150 Market Street, Chicago

**FREE Camp Guide Coupon**  
H. Channon Company

Dept. 1194, 150 Market St., Chicago

Gentlemen:—Without any obligations on my part please send me your 1914 Camp Guide and Catalog, and full information about tents and camp outfittings—also about your special outfit offer.

Name .....

Address .....



**Just the thing for the  
Little Shop  
Carborundum  
Grinder Head**



**C**OMPACT, serviceable, well balanced and constructed upon the right mechanical lines. The grinder head has a crucible steel shaft, real babbited bearings, and the main casting is of the best grade of grey iron, nicely finished. Each grinder head is fitted with two genuine

**CARBORUNDUM  
GRINDING WHEELS**

the fastest, cleanest, coolest cutting wheels for general grinding—it's a great machine for the small shop where power is available.

From your hardware dealer or direct.  
Price, complete with two wheels, one coarse, one fine, . . . \$12.50

**THE CARBORUNDUM  
COMPANY**  
NIAGARA FALLS, N. Y.

Please Mention Popular Mechanics

**Unusual Service Value!**

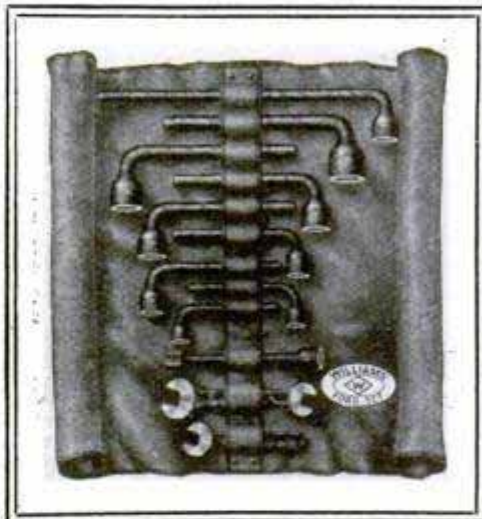

**Williams' Ford Wrench Set**

Drop-forged from special steel and designed for extreme and convenient service upon the Bolts and Screws common to the "Ford" construction, the Williams' Superior Drop-forged Wrench Set is without an equal for this service—barring none!

Every tool illustrated in the set is a guarantee of better service and of a longer life of mechanical comfort and usefulness than has ever before been offered for the purpose—an investment in which you must have the utmost of satisfaction.

With Williams' "Ford" Wrench Set and an adjustable wrench you will be prepared for any mechanical emergency which may develop from the use of the popular "Ford" machines. Send for catalog of dependable tools.

**J. H. Williams & Co., Superior Drop-forgings**  
47 Richards St., Brooklyn, N. Y. City, 32E S. Clinton St., Chicago, Ill.

**LAUNDERING IN INDIA**—For washing clothes the better-class native families in India generally use English soap. A vast amount of washing, however, is done outside of the home by a class of natives called dhobies.

**SOLDERING IRON ALWAYS READY**

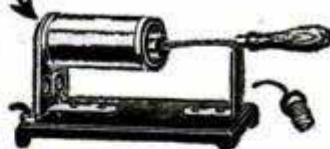

With the use of the Current Electric Furnace, any voltage, comes in three sizes complete. Cost of operation very low, cheaper and by far superior than any other known method. No more expensive delays and dangers caused by the use of gas, oil, gasoline, etc. Furnace absolutely guaranteed, money refunded if not

satisfactory. Price very low. WRITE FOR PRICES AND CIRCULAR.  
CURRENT ELECTRIC COMPANY, 18 E. Kinzie St., Dept. E19, Chicago, Ill.



**Tool Cases** for Toolmakers and Machinists

Keep your tools orderly arranged in a Gerstner's Portable Tool Case. There's a place for every tool in one of the felt lined drawers. Every up-to-date mechanic needs one and you'll find our Cases the best built, neatest and most practical on the market. We guarantee to please or refund all money.

*Gerstner Sons*

Write for our free booklet

Mfrs. of Mechanics' High Grade Tool Cases  
818 Columbia St. DAYTON, OHIO

**GROBET SWISS FILES**



Are the standard of excellence in files, and have been for over 100 years. We send post paid as an introducer 48 files especially adapted for tool makers and machinists on receipt of \$5.00. This is a chance to get a set of files you'll appreciate and we'll get future orders.

**MONTGOMERY & CO.**  
111 Fulton Street NEW YORK CITY



# Starrett Hack Saws

Every man who has use for a hack saw, is glad to know that he can buy a saw of the same high quality as the well-known STARRETT TOOLS.

No matter whether you require hack saws in the course of your day's work or only for an "odd job" about the house, you will find there is a Starrett hack-

saw blade and frame suited to your requirements. Starrett hack saws are made of the best tungsten steel, tempered by our secret process, and the teeth are evenly milled.

Send for our big, new, free 320-page catalog No. 20AP describing more than 2100 styles and sizes of tools and hack saws.

42-310

The L. S. Starrett Co., Athol, Mass.  
World's Greatest Toolmakers



## This Ratchet Wrench SAVES TIME AND DOLLARS

The thousands who are using U. S. Ratchet Wrenches find them wonderful time and money savers. **STRONG—DURABLE.** Last a lifetime. Write for Free Circular and Special Introductory price.

**U. S. RATCHET WRENCH CO.**  
217 Masonic Temple, Peoria, Ill.

## You ought to have one of our Insured - "VANDOR" - Hammers



"VANDOR" - Hammers are drop forged from Vanadium Steel, tempered in oil and are **Warranted Against All Defects for a Lifetime**

Attached to every "VANDOR" - hammer is a numbered guarantee certificate, insuring lifetime service.

A "VANDOR" - will bite and draw a headless nail that defies the claw of an ordinary hammer.

**Sent by Parcel Post Anywhere** - "VANDOR" -

Send us \$1 and your dealer's name. We'll ship the postpaid by return mail. Please state whether wanted for light, medium or heavy work.

**VAN DOREN MFG. CO., Dept. 104, CHICAGO HEIGHTS, ILL.**  
Reference 1st Nat. Bank, CHICAGO

\$1.00



## Postpaid Myers' Wonderful Sewing Awl

sews leather, canvas, shoes—anything, heavy or light. Complete repair shop in itself. Saves many trips to town. Mends harness, saddles, wagon covers, blankets, buggy tops, belts, etc. Can't get out of order. Original and only awl with diamond point full grooved needle to protect the thread. **HIG MONEY FOR AGENTS.**

**C. A. MYERS CO., 6339 Lexington Ave., Chicago, Ill.**

## NEW SLIDE RULE—ADDS—SUBTRACTS—MULTIPLIES—DIVIDES

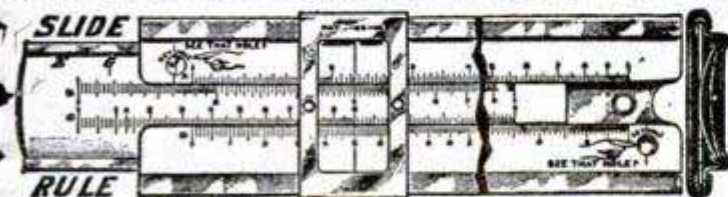

For years the Slide Rule was considered so complicated an instrument that it was used only by Technical men, and there are people today who still have this opinion. The **Richardson Direct Reading Slide Rule** has put an end to the mystery surrounding this machine, and my 52 p. book, **The Slide Rule Simplified**, shows the actual setting of the rule by 90 full size engravings, for problems which confront men in any vocation. It is written so that you can understand it, and makes the use of the Slide Rule possible for everyone. The examples selected are those which frequently come up for solution by the **Banker, Broker, Auditor, Inventory and Insurance**

**Man, Cost Estimator, Manufacturer, Contractor, Salesman, Manual Training Teacher, Time-Keeper, Book-keeper, Lumber, Land, Marine, and other merchants** too numerous to mention.

This Simple Instrument multiplies, divides, adds, subtracts, solves proportion, extracts the square and cube roots, changes fractions to decimals and vice versa, calculates interest, discount, percentage, mensuration of superficies, the rule of three, etc., and performs almost any other kind of calculation almost instantly. For Engineers, Draftsmen, Master Mechanics—all technical men—it is indispensable. For Electricians it is a complete wire table. The operation with the use of the key and keyhole is very simple, and the answer is given direct for such problems as, Horse Power of Engines, Pumps, Belts, etc., size of duct for ventilating, radiation and size grate and steam main, change gear and pulley problems, area, circumference and diameter of circles, etc. My new 1914 rule is made in two sizes, coat and vest pocket, 10x1 1/2 x 1/4" and 5 1/2 x 1 1/2 x 1/4". 10" has Sine, Log and Tangent scales on the face of rule always in plain sight. No wood in their construction, scales white celluloid, printed from engine divided plates in two colors, washable, and secured by an improved locking device in non-corrodible Monel Metal framing.

Price 10" Rule, Add, Subtract, Multiply and Divide, \$3.00; 10" Rule (non-Add and Subt.) \$2.50; leather case, 50c extra; 5" Rule (non-Add and Subt.), leather case, \$2.50. 10" Dummy Rule bristol board scales, \$1.00. Postage prepaid. If ordered now the book, **The Slide Rule Simplified**, goes Free with each rule. If interested in forming clubs, write for large list of tools GIVEN FREE.

**GEO. W. RICHARDSON, 4218 24th Place, CHICAGO, U. S. A.**



# Machinists!—Toolmakers!

Here is the handiest and most practical tool you can buy for use in drilling, fitting, and laying out work on a surface plate. It is drop-forged and case-hardened; also light and convenient to handle. Each vise is furnished with two steel jaws, as shown in cut, that slip on and off end of screw.

Ask your hardware dealer to show you one. He will also give you our latest catalogue for the asking.

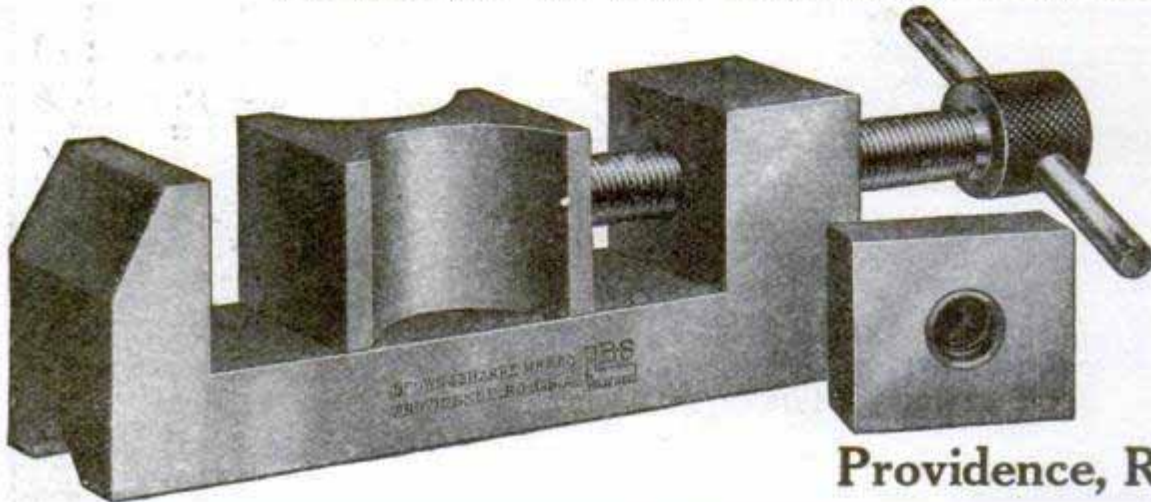

**BROWN  
&  
SHARPE  
MFG. CO.**

Providence, R. I., U. S. A.



## The New Britain Drill Chuck

Ball Bearing

Hand Operated Wrenchless

This chuck gives the tightest gripping power of any Drill Chuck now on the market. The greater the pressure on the drill, the tighter it grips.

SAVES DRILLS—SAVES TIME

**UNION MANUFACTURING CO.**

Makers of a Complete Line of Chucks

26 Cortlandt St., New York

New Britain, Conn.

(which means washermen). Their usual charge for washing varies from 1 cent to 2 cents per piece. They depend more on physical effort in beating, pounding, and rubbing the clothes than they do upon soap. A small amount of very cheap soap of native manufacture, in which sand is the important constituent and which is sold in large balls for about 2 cents apiece, is applied to the clothes. Most municipalities in India set apart certain small ponds, lakes, and parts of rivers where the dobbies are permitted to do their washing. Fre-



## Portable Cases

FOR TOOL MAKERS  
AND MACHINISTS

Twelve styles, felt-lined drawers, solid brass trimmings, best of material, beautiful finish, low prices, satisfaction guaranteed. Ask for booklet of cases built for service.

**The Pilliod Lumber Co.**  
SWANTON, OHIO



"AMERICAN"  
Key Cutter

## A Steady Income—Independence—for You!

\$5.00 to \$10.00 a day with little effort and small investment. Others are doing it—so can you.

Why not establish yourself in this immensely profitable business? We show you how and supply everything — everything but a little enterprise; that's up to you! Our two unique machines do the trick. The "American" is the only machine that sharpens, hones, and stropps razors, and all kinds razor blades, scissors, clippers, pocket knives, surgical instruments, etc. No previous experience necessary. The "American" Key Cutter is a little wonder, cuts any shape slot. Booklet of information furnished FREE.

State Agents wanted

**AMERICAN SHARPENING MACHINE CO., Inc.**  
Dept. 4, 184 W. Washington St. CHICAGO

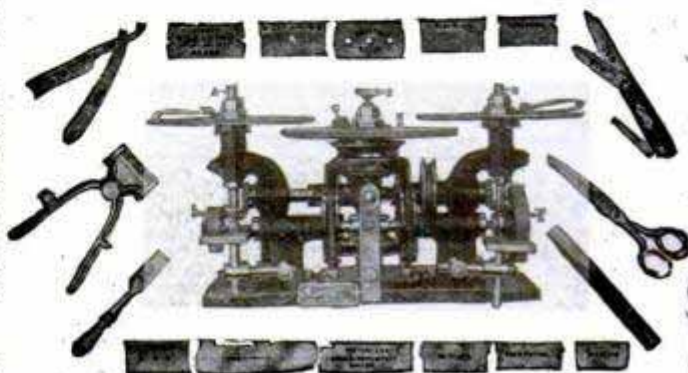



# What this Bolt Will do—



It fastens heavy fixtures, electrical and otherwise, with a vise-like grip, to hard surfaced walls, floors and ceilings so they cannot break loose nor wobble, as they are sure to do sooner or later by the wood plugging or leading in method. The fixture sets neatly and tightly to the wall and cannot be pulled down.

## SEBCO

The most dependable fastener known for fixtures, push buttons, lamp brackets, telephones, chandeliers, heaters, motors, etc.

*Write for Catalog and Samples—look them over and you will never use any other.*

**STAR EXPANSION BOLT CO.**  
147-149 Cedar St. NEW YORK

quently the conditions are quite insanitary, and "dho-bies' itch," caused by washing clothes in unclean water, is a prevalent disease of the skin in India. The lowest class of people in India all wash their own clothes.

## THE SPEEDY STITCHER

SEWS LEATHER LIKE A MACHINE

Price \$1.00

Send for terms to Agents

Automatic Awl Co., 26 Hermon St., Worcester, Mass.



## THE MASTER SLIDE RULE,



Improved Interlocking Rust Proof Fool Proof

the only RULE IN THE WORLD whereby inside measurements of doors and windows, etc., can be taken rapidly and accurately. Also superior to any other rule for outside measurements of walls and ceilings, etc., as it can be extended and closed instantly. **MECHANICS, BUILDERS, AND ARCHITECTS, TRY ONE TODAY! DON'T WAIT.** Ask hardware dealer for it.

On receipt of 15 cents per lineal foot, a 4, 5, 6 or 8 foot rule will be sent to you prepaid. Large profits to agents. Write for circulars and particulars.

**DAHL MFG. CO. 51-A East 42nd St. NEW YORK CITY**

## "Ohio" Edge Tools



REGISTERED

Insist on "Ohio" Tools when buying Planes, Chisels, Drawing Knives, Auger Bits, Screw Drivers, etc.

CATALOGUE FREE

**OHIO TOOL CO.** (Dept. 3) Charleston, W. Va.



# The "spring" gives it the Quick Return

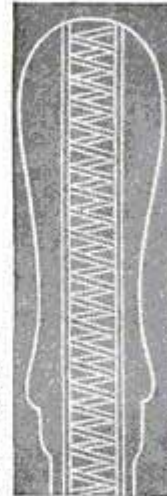

The quick acting spring in the handle of this "Yankee" Spiral Ratchet Screw-driver brings back the handle in position each time, for the next drive. You can drive or draw screws, one handed in deep narrow places, or way above your head where you can't use both hands. The spring pressure keeps the bit in the slot. A big time saver—where you have many screws to drive. No pulling or twisting with hand or wrist—"just push."—They're accurate workers, every one of these—

## "YANKEE" TOOLS

*Make Better Mechanics*

There is a right, a left hand ratchet and rigid adjustment. Supplied with 3 sizes of bits. Attachments obtainable for drilling, counter-sinking, etc.

## "YANKEE" QUICK RETURN Spiral Ratchet Screw-driver No. 130 price \$1.85

Your Dealer Can Supply You

"Yankee" Tool Book "free— for the mechanic or householder. "Yankee" Tools in the Garage"—for the automobilist.

**NORTH BROS. MFG. CO. PHILADELPHIA**

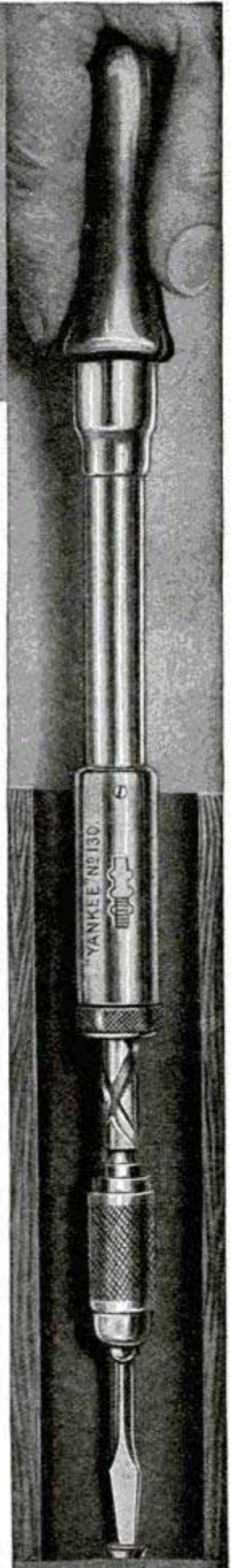



# Stanley Tools

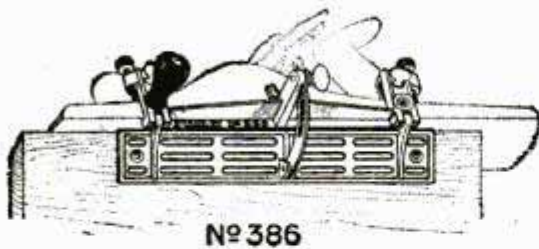

No. 386

## Stanley Jointer Gauge Can be Attached to Any Iron Plane

¶ A new STANLEY TOOL that will enable you to plane bevels of any angle between 30 and 90 degrees, or to square up the edges of boards with extreme accuracy.

¶ All parts except the knob are of metal—nickel plated and all the joints and bearing surfaces are machined.

**PRICE \$1.75 EACH**

¶ If you cannot procure this tool from your Hardware Dealer, we will upon receipt of price send same postage prepaid to any part of the United States.

Address \_\_\_\_\_

**STANLEY RULE & LEVEL CO.**  
NEW BRITAIN, CONN. U.S.A.

## Core Box Plane

An  
Absolutely  
Accurate  
Core Plane

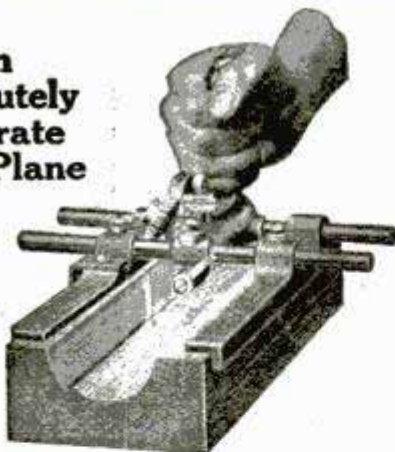

EVERY patternmaker realizes the need of a plane that will cut half circle  $\frac{3}{4}$  to 6 inches. This is the only tool ever devised that will do it. Mechanics who are using this tool tell us it is worth one hundred dollars. Sold on a guarantee—your money back if dissatisfied in any way.

**Price \$10.00**

**Economy Manufacturing Company**  
COLUMBUS, O.

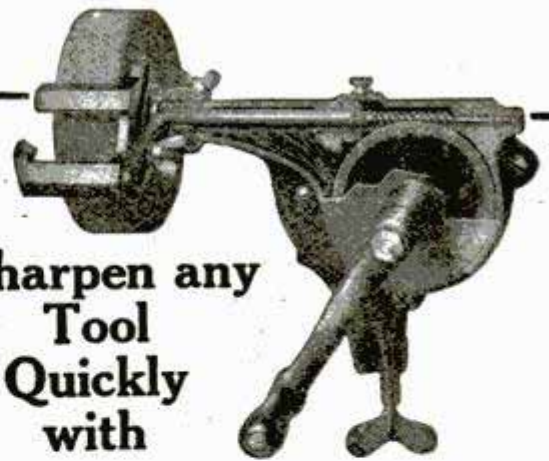

Sharpen any  
Tool  
Quickly  
with

## LUTHER "Best Maide" TOOL GRINDERS

Handy, light running, accurate—easily the best of all hand-power tool sharpeners. Ball-bearings, worm gear, steel shaft, improved tilting frame, dust-proof parts, oil bath. Runs true and without vibration. Special attachments for drill sharpening, drilling, etc.

### Double-Faced Sharpening Wheels of DIMO-GRIT

Bring tool to an edge on the medium grit body; then smooth off and finish it on the fine-grit side face. Dimo-Grut cuts hardest steel as easily as emery does copper. No water needed, cannot draw temper. Guaranteed for five years.

Ask your dealer to show you the Luther "Best Maide" Grinder. If he cannot, write for descriptive folder and we will tell you how to get a handy DIMO-GRIT Pocket Home FREE.

LUTHER GRINDER MFG. CO., 895 Point St., Milwaukee, Wis.

## Rent This Level 9 Months— Then It's Yours

### BUILDERS—CONTRACTORS—ARCHITECTS

High price and cash payments are eliminated. For the first time it is possible to obtain a high grade Level on terms so easy that you can not afford to be without one.

### Convertible Level

Besides its use as a Level it can also be used for running straight lines, getting angles, taking vertical sights, etc. for which ordinarily a Transit is required.



For more than fifty years Aloe's surveying instruments have been recognized as standard instruments. This Level is offered to you with an absolute guarantee that is backed by a ten day free trial offer.

### FULL PARTICULARS

and details of our extraordinary selling plan will be sent on request.

**A. S. Aloe Co., 515 Olive St., St. Louis, Mo.**

## You Can Always Tell

a Good Mechanic by his Tools and the **best** Mechanic because he is sure to have our

### Hand Drill No. 5

A Drill unequalled in strength, durability, easy action and all-around excellence. Has cut gears, ball thrust bearing, and carries 8 wood boring points ranging from  $\frac{1}{16}$ " to  $\frac{11}{64}$ ". The way this tool is made insures long and satisfactory service—try one. Write us for a copy of our Catalog.

**MILLERS FALLS CO.**  
28 Warren St.  
NEW YORK





## Quick Drilling Where You Want It —by Electricity



Attaches to any Electric Light Socket.

Saves time and labor. It doubles efficiency.

### A Portable Machine Shop

Handiest device ever known for drilling, tapping, grinding valves, sharpening tools, etc.—quickly and easily. Does away with tiring hand work.

# TEMCO Electric Portable Drill

Weighs only 11 pounds. Perfect balance between handles makes it seem doubly light and free to place and hold. Has famous Temco motor. Connect with any lamp socket (A. C. or D. C.) Costs only 1 cent per hour to run. Reverses instantly on full speed. Changes tap to drill in one minute. Has multitude of uses. Saves cost quickly in time and hard work. Guaranteed not to burn out.

**Ten Days' FREE Trial**

Mail postal or letter quick—get descriptive CATALOG FREE. Address

**The Temco Electric Motor Co.**  
477 Sugar St., Leipsic, Ohio

Special Designers and Mfrs. of 1-50 to 1-6 H.P. Motors.

The northernmost national forest is the Chugach, in Alaska; the southernmost is the Luquillo in Porto Rico.



### THE BEST AND MOST PERFECT SELF-FILLING FOUNTAIN PEN

ever produced. 14 kt. gold pen mailed to any address on receipt of price 25c. AGENTS WANTED.

**BIRKBECK & SON** Dept. P, 629 Centre Street  
FREELAND, PA.

### BUILD A

We have accurate scale drawings and knock-down parts of all man-carrying aeroplanes for class-room demonstrations, exhibition purposes, etc. Students of aeronautics, everyone with an inquiring turn of mind, should construct one of these fascinating models.

PRICES OF 3-FT. MODEL SCALE DRAWINGS—Curtiss Flying Boat, 25c; Nieuport Monoplane, 25c; Bleriot Monoplane, 15c; Wright Biplane, 25c; Curtiss Convertible Hydroaeroplane, 35c; Cecil Peoli Champion Racer, 25c

Complete Set of Six \$1.25 Postpaid  
50 pp. Ideal Model Aeroplane Supply Catalog 5c.  
**IDEAL AEROPLANE & SUPPLY CO., 82-88 West 87th St., N.Y.**

## Furniture On Credit

Write for Mammoth Bargain Book picturing 4,918 articles

**SPIEGEL, MAY, STERN CO.**  
1089 West 35th Street, Chicago



### DON'T DRINK GERMS

Avoid Typhoid, dysentery and kindred ills by using the

### Crystal Water Filter

Anyone can instantly attach it to the ordinary kitchen faucet without expense. The most expensive is not better. Will last a life time. Agents Wanted, Men or Women, wherever city water systems are established. No experience or talking needed, will sell as fast as demonstrated; has no competitor. **CRYSTAL FILTER CO., 1009 S. S. Wabash Ave., Chicago, Ill.**



# 1500 Styles and Sizes of TOOLS



For Carpenters  
Mechanics and  
Householders

Our complete pocket catalog No. 11 will be sent Free to any address

**Goodell-Pratt Company**  
*Toolsmiths* GREENFIELD,  
MASS., U.S.A.

## MATCHLESS—the thoroughbred of all pipe-threading tools

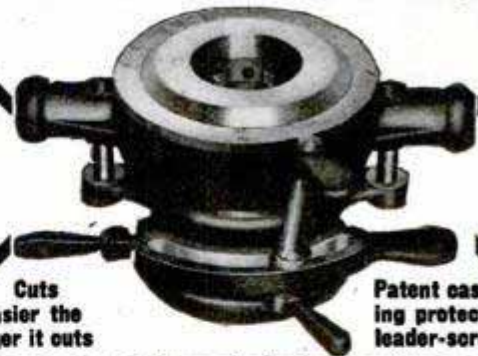

Cuts easier the longer it cuts

Patent casing protects leader-screw

You have never threaded pipe—quite so easily, quickly, cleanly as you will with a self-contained

## OSTER "MATCHLESS" DIE-STOCK

No one has discovered how to make a better die-stock than the OSTER MATCHLESS. We honestly believe there is no better way. Use the coupon now, and we will show you what makes the OSTER MATCHLESS the "big" die-stock in the field.

**THE OSTER MFG. CO., 2100 E. 61st, CLEVELAND, O.**

Name.....  
Business.....  
Address.....  
City..... State..... (2100)

Please Mention Popular Mechanics



MAKE MONEY HERE

**AGENTS! DROP DEAD ONES. AWAKE! GRAB THIS NEW INVENTION! THE 20th CENTURY WONDER AGENTS!**

LEARN the NEW WAY

Get started in an honest, clean, reliable, money-making business. Sold on a money-back guarantee

World's magical gift realized by this new invention. The **BLACKSTONE WATER POWER VACUUM MASSAGE MACHINE** for the home. No cost to operate. Lasts life-time. Price within reach of all. No competition. New field. **New business.** That's why it's easy. Removes blackheads, wrinkles, rounds out any part of the face or body and brings back Nature's beauty. Endorsed by leading doctors and masseurs. Listen: Parker, Okla., says, "8 orders first day." Margwarth, Pa., writes, "I am making \$19.00 per day." Shea, "First order 12, second 36, third 72. Schermerhorn, Ia., orders eight dozen machines first month. Shaffer, Va., "selling 4 out of 5 demonstrations." Vaughn, Wash., orders one dozen. Four days later wires "Ship 6 dozen by first express." Spain, Tenn., started with sample. Orders one dozen, then 2 dozen, next 3 dozen. Lewis, Ind., sells 3 machines first hour. Says "Best article he ever saw for merit and money-making." No experience necessary. Territory with protection given free to active workers. Nothing in the world like it. Best agent's article ever invented.

We own all U. S. and foreign patents. Big book entitled, "The Power and the Love of Beauty and Health" Free. Investigate now, today. A Postal will do. A big surprise awaits you. Address **BLACKSTONE MFG. CO.** 889 Meredith Bldg. TOLEDO, O.



**\$20 SUIT to order \$13.50**

**STYLE BOOK FREE 64 SAMPLES**

**THOUSANDS** of particular dressers, men who want the smartest New York style and best possible fit and tailoring in made-to-measure clothes, have been sending us their orders for thirty-five years.

We sell direct, entirely by mail, through our big **FREE style book and samples.**

Our direct method, cutting out all in-between selling costs, such as agents or local representatives, enables us to produce the highest type of custom tailoring in a \$20 suit made to measure for \$13.50.

We guarantee this: Any member of your family can take your measure with the simple measuring outfit we send, and we guarantee to fit you perfectly.

**Free Style Book and Samples**  
Send for them today. You have nothing to lose and lots to learn.

**Bell Tailors of New York**  
126-128 Walker Street New York

# Deafness



Perfect hearing is now being restored in every condition of deafness or defective hearing from causes such as

Relaxed or Sunken Drums, Roaring or Hissing Sounds, Perforated, Partially Destroyed Drums, etc.

## Wilson Common-Sense Ear Drums

"Little Wireless Phones for the Ears"—

require no medicine but effectively replace what is lacking or defective in the natural drums. They are simple devices, which the wearer easily fits into the ears where they are invisible. Soft, safe and comfortable to wear at all times.

Write today for our 168 page **FREE** book on **DEAFNESS**, giving you full particulars and plenty of testimonials.

**WILSON EAR DRUM CO., Incorporated**

914 Inter-Southern Building

LOUISVILLE, KY.

# TOBACCO HABIT BANISHED

**In 48 to 72 Hours** Yes, positively permanently banished almost before you know it. Pleasant, easy to take. Results quick, sure, lasting. No craving for tobacco in any form after first dose. Not a substitute. Harmless, no poisonous habit forming drugs. Satisfactory results guaranteed in every case or money refunded. *Tobacco Redeemer* is the only absolutely scientific and thoroughly dependable tobacco remedy ever discovered. Write for free booklet and positive proof.

**NEWELL PHARMACAL CO., Dept. 25, ST. LOUIS, MO.**



## ART STUDIES

### DEN PICTURES IN BEWITCHING POSES

Genuine photos from living models on double-weight stock. 3 swell cabinets, 25c; 6 for 50c. with fine 6 1/2 x 8 1/2 photo **FREE** with order for 6. **Our Dollar Special:** 6 cabinets, two 6 1/2 x 8 1/2, and over 50 small photos, all for \$1.00. 10c extra for sealed postage. Money back if not as represented.

**KING CO., 2807 P. M., ANDOVER, OHIO**

I will send as long as they last my 25c. book

## "STRONG ARMS"

for 10c. in stamps or coin

Illustrated with 20 full-page half-tone cuts showing exercises that will **quickly develop, beautify, and gain great strength in your shoulders, arms, and hands** without any apparatus.

## NULIFE

shoulder brace, straightens round shoulders instantly, expands your chest, makes you breathe deeply at all times, and compels you to stand, sit and walk erect. For men, women and children. Special price—\$2.00 postpaid. Send height, weight and chest measure.

**PROF. ANTHONY BARKER**  
640 Barker Bldg. 110 West 42nd Street, NEW YORK

# NO MORE BALD HEADS



When our **VACUUM CAP** is used a few minutes daily. We accept no pay until you have tried the Cap 60 days and are satisfied. The Vacuum Cap is an appliance that draws the blood to the Hair Roots and starts a new healthy crop of hair. It stops Dandruff, stops the hair from falling out. Bought by Doctors and men who

know that it is the only reasonable **HAIR GROWER** known to science. No Drugs Used. Write for application blank, testimonials, and booklet on "HAIR," sent sealed in plain envelope, **FREE.**

## THE MODERN VACUUM CAP CO.

E. 559 BARCLAY, DENVER, COLO.



## Electric Light for Farms, Churches and Towns



Any sized plants from 15 to 1000 lights. With each order we send an electrical expert to install the plant and wire your building. Turned over in complete working order. Price \$265 and up.

**ABSOLUTELY** { No danger  
Nothing complicated  
Any one can operate them

*Our booklet explains everything*

**The Universal Lighting System**  
is the simplest and best

**UNIVERSAL BATTERY CO.**

Dept. 1194 301 N. Peoria St., Chicago

We manufacture all kinds of batteries for the trade

**PRICES OF RARE ANIMALS**—In the latest catalogue of a well-known animal dealer a pair of East

# I WILL START YOU

earning \$4 daily at home in spare time, silvering mirrors; no capital; send for free instructive booklet, giving plans of operation. G. F. REDMOND, Dept. 306-A, BOSTON, MASS.



## WE TRUST YOU!

Pay Us From Your Profits

We start you in a business all your own—where you are sole Boss! We furnish everything necessary—you pay us later. **The Filmless Post Card Camera** takes 5 sizes of post cards; also photo buttons. A complete photographic studio in itself. Takes, develops, tones, and finishes right on the spot! No Films, Plates or Dark-room.

**You Make \$50 to \$100 a Week Easy** At Bathing Beaches, Parks, Fairs, Carnivals, etc. **No experience needed.** Nets you 8c profit on every dime. Send today for **FREE** particulars and get started at once.

**FILMLESS POST CARD CAMERA WORKS**  
2203C, W. 12th St., CHICAGO, ILL.

A Dazzling  
Pure Blue  
White Gem  
—Not an  
Imitation.

# Maztec Gems

**Brilliance** guaranteed forever. Set in solid 14k gold mtgs. Ladies' Tiff, style Ring with ½ Kt. Gem \$8.50. Gents Heavy Belcher Ring with 1 Kt. Gem \$16—sent C.O.D. for examination, 10% disc. for cash. State ring size. Our booklet on genuine native gems, Mex. Fire Opals and The Story of the wonderful "Maztec Gem" is free to you—write today.

Francis E. Lester Co., Dept. ET4G, Mesilla Pk., N. Mexico



## Use This Camera 10 Days FREE

Do not send us a penny, merely send your name, address, etc. on coupon below, and the genuine Folding Naco 3-A, the camera with a national reputation, will be sent to you Parcel Post prepaid. Try it for ten days, see how splendidly it works, note the high grade rapid symmetrical lens, Naco automatic shutter, brilliant reversible finder that works either horizontally or vertically, two tripod sockets, and improved spool holder—for either six or ten exposure films. This is an ideal camera, high grade, post card size— $3\frac{1}{4} \times 5\frac{1}{2}$ ; use it for pleasure or profit; take pictures for making money, or take pictures for fun or study. It is a great pastime and a liberal education.

If at the end of ten days, you find that it's just the camera you want, send us \$2.00, and thereafter \$2.00 a month for nine months—\$20.00 in all. If you do not want it, simply return the camera at our expense. You take no risk.

## This is the Greatest Camera Offer Ever Made in America

This celebrated Naco 3-A Folding Camera sells for \$20.00 cash everywhere in the world, that's the standard price—we offer it to you at the same price on the easy-payment plan, only \$2.00 a month. This is the first time you have ever had the opportunity to buy a standard high grade camera on the easy-payment plan.

**Special Film Offer** You will need one or more rolls of film to try out this camera, and we are making a special offer: Send us 50c and we will send you a roll of films that will take 6 pictures; after you have taken the pictures, send the roll to us and we will develop and print them and send them to you without any additional charge.

**Fill Out This Coupon Today** and try the wonderful Naco 3-A for 10 days, free. We will send it to you prepaid. You take no risk.

**National Camera Company**

1415 Chestnut Street  
St. Louis Mo.

AGE.....OCCUPATION.....

Please Mention Popular Mechanics

**National Camera Company**  
1415 Chestnut St.  
St. Louis, Mo.

Send me for ten days' free trial the Naco 3-A Camera. If I am satisfied with it, I will send you \$2.00 as first payment, and then \$2.00 per month for nine months. If I do not wish to keep the camera, I will return it to you within ten days at your expense. (I enclose 50c for your special film offer.)

NAME .....

STREET .....

CITY .....



# \$1200.00 IN COLD CASH

Made, Paid and Banked in 30 Days, by  
Stoneman—\$1500.00 To Date

Reader, this offer is open to you—this money—the cold cash—can be yours. You and you alone by waiting too long can lose it. Investigate today—get the proof. Send your name and address—but NO MONEY—this very minute.

## \$1000.00 PER MAN PER COUNTY

Don't worry—don't find excuses—no experience is necessary—business supplies the capital. You don't have to wait a month not even a week—payments can start the first day—and continue daily up to \$1,000.00 per month, per county. For years we have been quietly picking men from all walks of life, ministers, clerks, farmers, preachers, doctors, lawyers, teachers and so on—enabling them with our co-operation and \$50,000.00 appropriation to get what we here offer and can do for you—\$1,000.00 per man, per county. Some of these men you may know—possibly have envied without understanding the reason of their prosperity.



**INVESTIGATE AND BE AMAZED** Demand absolute proof—accept no other kind. Either we have the best thing that ever happened or we're colossal liars. Ask Schleicher, minister, whether it's true that he received

## \$195 TWELVE HOURS AFTER APPOINTMENT

Langley, liveryman, \$115 first day; Rasp, agent, \$1,685 in 73 days; Beem, solicitor, \$164.25 weekly for 12 weeks; Korstad, farmer, \$2,212 in a few weeks; Zimmerman, farmer, \$3,856 in 30 days; Juell, clerk, \$6,800; Hart, farmer, \$5,000; Wilson, cashier, \$3,000 in 30 days. Let us refer you to these men, to the U. S. government, to banks, business houses, noted people at home and abroad. Heed this caution from Chas. Starr, of Mich., who writes: "Sorry this field is closed. Should have acted sooner but was skeptical. Your local man's great success has set everybody talking and proves I was a chump. Wonderful what a man can do with a real opportunity." Then read this from Lodewick who acted quickly: "Lucky I answered ad. It's great. Money coming fast." Which will you be, Starr, a victim of "neglected opportunities," or Lodewick, the "early bird." To escape Starr's fate, send your postal this very minute—

## SPEND ONE CENT TO MAKE THOUSANDS

Strange invention startles world. Gives every home that long-desired blessing, a modern bathroom with hot and cold running water facilities for only \$6.50. No plumbing—no water works—self-heating. Only ten minutes to install. Gives cleansing plus friction, massage and shower baths in any room. Equivalent to any \$200 bathroom. Over 200,000 delighted users. Used by U. S. government.

More remarkable than this invention is our startling plan of universal distribution through special representatives who become virtually profit sharing partners in a business that's immense—exciting—fascinating—dignified—and above all, has enabled them, will enable you, to get \$1,000.00 per month, per county. Asking to be shown doesn't obligate you one bit. Investigate today by all means.

ALLEN MFG. CO., 3893 Allen Bldg., TOLEDO, O.



## MONEY! MONEY! MONEY!

Make lots of it, selling our Electric Lanterns. No Matches! No Oil! Safe and convenient. Household necessity. Everyone buys. No competition! Lift Lantern by the bail, and light is on. Sample prepaid \$3.75. Circular Free.

AMERICAN MINUTE PHOTO CO., Lantern Dept. No. 5  
2214 Ogden Ave. CHICAGO, ILL.

When you want anything and don't know where to find it—write Bureau of Information, Popular Mechanics, Chicago



## Only \$36.00 The Wonderful ILLUSTRATOR LANTERN

With our improved famous ALCO RADIANT LIGHT.

This new 1912 Model has many improvements and double brilliancy. Write for illustrated circular of this and Lanterns of all styles and lights at bottom prices. IF YOU OWN A LANTERN we should have your name to mail to you our regular announcements of new slides and lecture sets. 75,000 Lantern Slides to rent. POST CARD MAGIC LANTERN reflects image of postcard or any other picture or object. Prices, \$2.75, \$12.50, \$25.00, \$60.00, express paid.

WILLIAMS, BROWN & EARLE, Inc., 918 Chestnut St., Philadelphia, Pa., Lantern Dept. 20  
Engineering, Microscope, Optical, Scientific, Photo Lantern Slide Supplies

## Can You Stand Prosperity?

Post-card photography with a Daydark is an easy road to a good income.

Engesser writes: "I have just returned from a mill town 'Glenn' and in eight hours made \$42.50." With a

**PLATELESS DAYDARK PHOTO POST-CARD MACHINE**

Earn big money at home, traveling, at fairs, on streets, taking, finishing and delivering 3 photo post-cards a minute—all done with the Daydark. NO EXPERIENCE NECESSARY.

**FREE TRIAL — 10 DAYS CHARGES PREPAID**

Be independent—be prosperous. Write postal to-day for Free Catalogue and sample post-card showing fine work this machine does.

**DAYDARK SPECIALTY CO.**  
402 Daydark Building  
St. Louis, Mo.

MADE \$42.50 IN 8 HOURS

## You Can Make \$75 a Week

Yes!—You'll make that and MORE, easily, if you start AT ONCE with a

**DIAMOND Post Card Gun**

A new invention—takes full size Post Cards and Button Photos, 4 shapes, without films, plates or darkroom. Turns out 6 to 8 a minute; you net 8c profit on every click of the bulb.

**POSITIVELY NO EXPERIENCE NEEDED** to make this big, easy money at Fairs, Parks, Carnivals, etc., all year round. Send for FREE Illustrated Book at once.

**International Metal & Ferrotyping Co.**  
2223 W. 12th St., D. 412, CHICAGO, ILL.

## Go into THE MOVING PICTURE BUSINESS.

Write for FREE Catalog

**Earn \$30-\$50 Per Night No Experience Necessary**

A small investment will start you in this great money making business. We furnish Machine, Film, Lighting Equipment and complete traveling and stationary outfits.

**ACORN MOVING PICTURE CO.**  
173 N. Green St. Dept. C, Chicago

African rhinos is offered at \$16,000. A number of elephants are offered at prices ranging from \$1,500 to \$5,000. The highest price asked for any lion on the list

## HONEST MAN WANTED

In each town for special advertising work; \$15 a week to start; experience unnecessary; references required.  
McLEAN, BLACK & CO., 18 E. Beverly St., BOSTON, MASS.

## Your Picture in a Postal Card IN ONE MINUTE

The pictures are developed, toned and finished in a single developing solution. No experience is necessary. Price of machines \$7.50 and \$15.00—circulars describing our machines sent free. We are also headquarters for supplies for all minute picture machines.

**AMERICAN MINUTE PHOTO COMPANY**  
Desk A 96, 2214 Ogden Ave., Chicago, Illinois  
The largest manufacturers and distributors of minute picture machines and supplies in the world.

## WE START YOU IN MOTION PICTURE BUSINESS

A Postal Card or Letter is all that it costs to learn how we do it. Many of our clients whom we started

**WITH SMALL CAPITAL**

are among the most successful exhibitors in the country. The business is just at the height of its prosperity—its profits are now the greatest—you can't fail to get your share if you start at once. \$35 to \$50 and More Daily Profit. Write today for our Plan & full details.

**ATLAS MOVING PICTURE CO.**  
Room 230, 508 South Dearborn Street, Chicago, Illinois



# Young Man! Your greatest opportunity

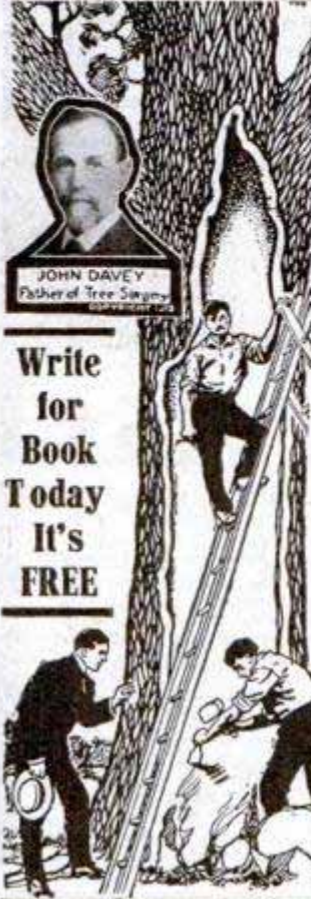

To the man who wants to improve his condition in life—to increase his earning capacity—to get away from the monotony, grind, and low wages of ordinary occupations—to elevate his social standing, the new profession of Tree Surgery, which is not overcrowded, offers the young man of today his greatest opportunity. The Extension Course given by The Davey Institute of Tree Surgery, will fit you to practice this profitable profession.

## Learn TREE SURGERY and Fruit Growing By Mail

You can become proficient in this work without interfering with your present occupation. An hour or so a day will give you a training that will make your future bright and prosperous. The work of a Tree Surgeon is healthful, fascinating and remunerative. The call for men in this profession is far greater than the supply, and the demand is growing. There are positions open at good salary and opportunities everywhere to establish a paying business of your own—Why work for others at small pay when you can be your own boss? Write today for our book "Adventures in Success." Read what others have done, and learn how easily and quickly you can improve your condition in life.

THE DAVEY INSTITUTE OF TREE SURGERY  
416 Oak Street KENT, OHIO

Write for Book Today It's FREE

is \$1,600. A pair of tigers is quoted at \$2,200, and a pair of polar bears can be obtained for \$1,300. The market is somewhat overfull of zebras and they can be obtained for \$650 each. Two-humped dromedaries from Asia are quoted at only \$350. Deer can be obtained for prices varying from \$50 to \$500, and antelope, from

## AGENTS—200% PROFIT

**Foot Scraper and Cleaner—**  
Needed on every porch and outside door-step. Right now is the time to sell it—A winner. C. P. Draper, Mass., first order for 200. C. A. Johnson sold 40 in 1½ days. W. W. Harpster, Pa., made \$27.45 in 4 evenings, spare time work. Write quick for terms of free sample. A postal will do.  
THOMAS CO., 3048 West St., DAYTON, OHIO

**THE RAPID VACUUM WASHER**  
Regular Price \$1.25  
Sold on 30 days' trial.  
The only Washer with Automatic Suction  
Washes everything from blankets to fine laces. Tub of clothes washed in 5 to 10 minutes. A child can operate it.  
AGENTS WANTED. Special price on sample postpaid. Write for terms and trial offer.  
STEWART-SKINNER CO., 26 Cherry St., Worcester, Mass.

## Wide Awake AGENTS!

Make BIG Money Be Your Own Boss

You need no experience. Our line sells itself. We have the most complete, fully guaranteed, line of knives, razors, strops and cutlery specialties. Golden Rule Knives are hand forged, made of genuine English razor steel. We will put any photo or lodge emblem on one side of the transparent handle and name and address on the other. Write for catalog and terms—exclusive territory.  
Golden Rule Cutlery Co., 552 W. Lake St., Dept. 113, Chicago



Cut your finger \_\_\_\_\_?

Don't risk infection. Use

# New-Skin

It kills germs and protects the skin. Always have it handy.

New-Skin comes only in glass. 10c. and 25c., at druggists. Look for our name on the box. Home Size by Parcel Post for 25c. in stamps. Address Dept. L, Newskin Co., New York.



When you need it, you need it badly



## TWO Phonographs For ONE

Have you a Victor Victrola or a Columbia Graphophone? If so, these wonderful new quick-attachable UNION Reproducers (with diamond points) will enable you to play the beautiful new EDISON Disc Records—the sweetest music of their kind—without altering your machine. They give you Two Phonographs for One. Order one on trial—there's no risk—your money refunded, if desired, any time within two weeks.

UNION Reproducer for Victor or Columbia  
**PRICES** Gold-plated . . . . \$9.00  
Nickel . . . . \$8.00  
Sapphire points, \$1.50 less

For descriptive folders write THE UNION SPECIALTY & PLATING CO. 411 Prospect Ave., N.W. Cleveland, Ohio  
Or ask your dealer

NAME .....  
ADDRESS .....  
CITY..... STATE ..... (411)  
Use the coupon to get descriptive folders  
Please Mention Popular Mechanics



# Say "Good-bye" to shingle trouble

Rot, rust and unsightliness *simply can't happen* if you use Flex-a-Tile Asphalt Shingles. You use *fewer* shingles and you can lay them right over old roof boards — weather and water-proof, fire-resisting.

## FLEX-A-TILE

**Asphalt Shingles** give such splendid satisfaction because they are *made* to do it. We use a high-quality wool felt base and a rubbery, special asphalt coating. The outer finish of slate or granite is compressed *under tons of pressure*. The beautiful natural colors of these mineral surfacings are permanent and get richer with age. In red, garnet, greenish gray, emerald and brown.

Write for handsome Flex-a-Tile book and specimen shingles.

### THE HEPPEES CO.

Mfgs. also of Asphalt Paint, Asphalt Roofing in any finish and Utility Wall Board

1021 S. Kilbourne Ave., Chicago, Ill.

WEAR

Trade Mark Registered

**B.V.D.** U. S. Patent Office and Foreign Countries

UNDERWEAR



## There's Money in Agricultural Blasting

WE TEACH YOU FREE

Our extensive national advertising yields thousands of inquiries from farmers, orchardists, etc., who need blasters to clear land, blast ditches, holes for tree planting, tight subsoils, etc. More than twenty million pounds of agricultural dynamite used in 1913. We refer all inquirers to nearest blaster, supply free advertising matter and help you get the business. We want to start in this independent business, reliable men who have \$200 capital for tools, magazine, and running expenses. Write for free booklet No. 248-B.

Agricultural Division, Du Pont Powder Company, Wilmington, Del.

Mounted in exquisite solid gold settings. Their dazzling fire lasts forever.

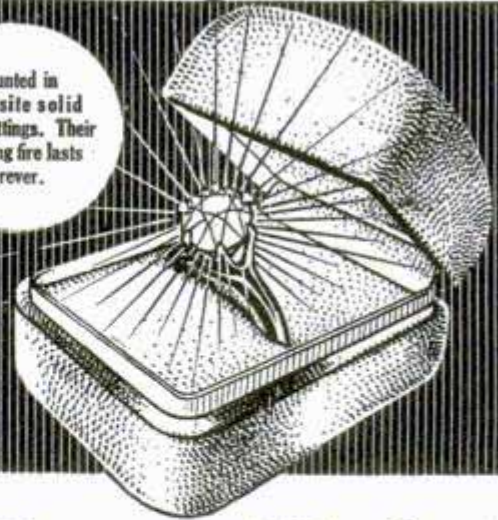

## Free Trial

Wear a dazzling, sparkling Lachnite gem for ten full days **absolutely free**. Its dazzling fire is excelled only by the Sun itself. Cut by world-renowned diamond cutters — their scintillating splendor lasts forever. **Set in solid gold**. Will stand acid tests and cut glass like mined diamonds. Pick out just the gem you want. Wear it for 10 days. Put it alongside of a real diamond, then if you can tell the difference send it back at our expense.

### Pay Only a Few Cents a Day

You get a genuine Lachnite at the rock-bottom price — direct from us. Pay for it at the rate of only a few cents a day. You do not risk a cent. No red tape. Wear the gem while paying.

### Write for Free Jewelry Book

Our big new jewelry book shows you all the exquisite Lachnite Gems and other jewelry that you have to select from. No obligations. It's FREE. Send your name and address.

HAROLD LACHMAN CO., Dept. 1194, 12 N. Michigan Av., Chicago

\$400 to \$1,000. Ostriches are quoted at \$400 per bird, while white peafowl may be obtained at \$100 a pair. A particularly choice snake will be thrown on the market this year by Hagenbeck. It is a python 27 ft. long. This charming companion can be had for \$600.



### Your Choice, 3000 Typewriters

Underwoods, \$30; Oliviers, \$25; L. C. Smiths, \$15; Remingtons, \$12; Royals, \$24; and other makes as low as \$10. Every one perfect and guaranteed two years. Expert repairing. Free trial. ALL MAKES TYPEWRITER COMPANY, 150 Ashland Block, CHICAGO

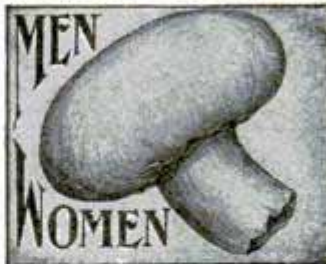

### Amazing Profits In Mushrooms

Anybody can add \$8 to \$40 per week to their income, in spare time, entire year growing mushrooms in cellars, sheds, barns, boxes, etc. I tell you where to sell, at highest prices.

Free Illustrated Instruction Booklet

**HIRAM BARTON**

Desk 2, 329 W. 48th St., New York





Sears, Roebuck and Co.'s  
Masterpiece of Value

# THE HARRIS VISIBLE TYPEWRITER

The Harris Visible Typewriter is beyond question the greatest merchandising victory we have ever won. **\$39<sup>80</sup>**

The Harris is standard in size and shape—is equipped with Universal keyboard, two sets of shift keys, shift lock, release key, tabulator, back spacer, marginal release, 11-inch carriage, writes a line 9 inches long.

Hundreds of Harris Visible Typewriters have replaced other standard makes throughout our plants.

At \$39.80 we believe it is the greatest typewriter value in America.

Compare it with any other make, regardless of price, and judge the value we are offering.

Write today, requesting Typewriter Catalog No. 80P92, which describes every detail and quotes liberal time payment terms.

**Sears, Roebuck and Co., Chicago**

We will gladly send you a Harris for 30-day trial and return your money if you are not satisfied with your purchase.

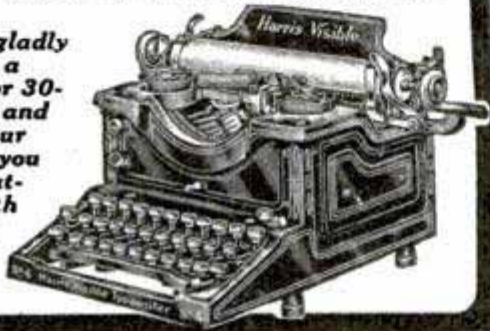

**EARLY OIL DAYS**—One of our readers in describing the early development of oil in Pennsylvania writes: "My father drove to the Drake well when it was about

## ERICKSON LEG

Arms, Braces, Wheel Chairs, Stockings.  
**SOLD ON EASY TERMS**

E. H. ERICKSON ARTIFICIAL LIMB CO.,  
17 Wash. Av. N., MINNEAPOLIS, MINN.



Largest Limb Factory in World.

**Boy Electrician** with 75 illustrations for making Batteries, Dynamors, Motors, Telegraph apparatus, Telephone, Lights, Bells, Alarms, Coils, "Wireless" Current Reverser, Electric Engine, Etc. By Electrical Experts so that anyone can understand it. With Cat. All 10c Ppd.  
**J. C. DORN, 705 So. Dearborn St., Dept. 21, Chicago, Ill.**

**Big Entertainer** 220 Jokes and Riddles, 153 Parlor Games' and Magic, 15 Tricks with Cards, 73 Toasts, 7 Comic Recitations, 3 Monologues, 22 Funny Readings. Also Checkers, Chess, Dominoes, Fox and Geese, 9 Men Morris. All 10c. postpaid.  
**J. C. DORN, 709 So. Dearborn Street, Dept. 17, Chicago, Ill.**

**Boys' Own Toy Maker**  
Tells how to make a Talking Machine, Camera, Electrical Motor, Bicycle Boat, Canoe, Boomerang, Bobbed, Wind Mill, Microscope, Water Wheel and Motor, Stilts, Toboggan, Snow Coaster and Sail Boat, Telephone, Electric Bell, Railroad Wind Mobile, Paddle Raft, Traps, Kites, etc. All 10c, postpaid.  
**J. C. DORN, 707 So. Dearborn St., Dept. 38, Chicago, Ill.**

## RANGER BICYCLES

Have imported roller chains, sprockets and pedals; New Departure Coaster-Brakes and Hubs; Puncture Proof Tires; highest grade equipment and many advanced features possessed by no other wheels. Guaranteed 5 yrs. direct to you are less than others ask for cheap wheels. Other reliable models from \$12 up. A few good second-hand machines \$3 to \$5.

**10 DAYS' FREE TRIAL** We ship on approval, freight prepaid, anywhere in U.S., without a cent in advance. **DO NOT BUY** a bicycle or a pair of tires from anyone at any price until you get our big new catalog and special prices and a marvelous new offer. A postal brings everything. Write it now. **TIRES, Coaster-Brake Rear Wheels, lamps, parts, sundries, half usual prices.** Rider Agents everywhere are coining money selling our bicycles, tires and sundries. Write today.  
**MEAD CYCLE CO., Dept. T108, CHICAGO**

# Almost 1/2 Price

This \$35.00 Set—Now \$19.80

If you have anything to do with metals, tools or machines—get these books. Get them today, now, at a saving of over fifteen dollars and on the easiest of easy payment plans. This great work was planned especially for the use of the mechanic. It covers the design, construction and operation of steam and gasoline engines, and of machines in general; and the manufacture and working of all metals used in the mechanical trades. Contains hundreds of practical ideas on the management and operation of the Modern Shop. Get these books now—have them ready when you need them. They'll solve every shop problem quickly and correctly—nowaiting—no asking—just a little time and study will make you the expert man on the job.

## Cyclopedia of Mechanical Engineering Gas Engine Operation and Modern Shop Practice

Contains 3,092 pages, 7x10 inches; 2,327 illustrations, full page plates, diagrams, etc.; hundreds of valuable tables and formulas; carefully cross-indexed for quick, easy reference. Printed in large, clear type on special quality paper and bound in half red morocco.

### Subjects Thoroughly Covered

Machine Shop Work—Vertical Milling Machine—Motor-Driven Shops—Shop Lighting—Forging—Electric Welding—Tool Making—Metallurgy—Manufacture of Iron and Steel—High-Speed Steel—Flaws in Castings—Electric Lifting Magnets—Magnetic Clutches—Making a Machinist—The Ideal Foreman—Pattern Making—Foundry Work—Automatic Coal and Ore Handling Appliances—Machine Parts—Construction of Boilers—Types of Boilers—Boiler Accessories—Steam Pumps—Air Compressors—The Steam Engine—The Steam Turbine—Indicators—Valve Gears—Refrigeration—Gas Producers—Gas Engines—Automobiles—Elevators—Sheet Metal Work—Practical Problems in Measurement—Mechanical Drawing—Drafting Room Organization—Machine Design, Etc.

**Shipped Free** Seven volumes, not will be sent, express prepaid, for seven days' free examination. If you keep them pay \$2.00 seven days after receipt and then \$2.00 a month until you have paid the special introductory price of \$19.80. Remember, you save almost half by buying the set now. Examine these great books at your leisure and in your own home. It won't cost you a cent and the books may be returned if they do not meet with your expectations.

## Free Consulting Service

Every man who takes advantage of this offer now gets absolutely free a complete Consulting Membership, under which our entire staff of experts answers all questions and solves all engineering and shop problems a whole year absolutely free. One question answered may be worth more than the entire cost of the books. Usual price—\$12.00—now free with this set. Fill out and mail us the coupon. Books go to you at once, express paid. Our liberal offer protects you. You take no chances. You are not bothered. If the books cannot sell themselves to you strictly on merit, don't keep them. But first inspect them. Mail the coupon today.

## FREE COUPON Worth \$15.20 to You

**American Technical Society,  
Chicago, U. S. A.**

Please send me Cyclopedia of Mechanical Engineering for seven days' free examination. If I decide to buy, will send \$2.00 in seven days and balance \$2.00 a month until \$19.80 has been paid, when \$35.00 books and \$12.00 Consulting Membership will be mine. Otherwise will notify you and hold books subject to your order. Title not to pass until fully paid.  
Pop. Mech. 4-14

NAME .....

ADDRESS .....

As I have had no previous dealings with you, I refer you to .....





## \$2 and you keep this SUPERB TYPEWRITER

Think of it! Only \$2.00 on this great offer and we ship this marvelous, visible typewriter direct from the factory to you without any jobber's, dealer's or middlemen's profits of any kind. We allow full 10 days' free trial. Use it all you want to. Try it for speed, durability, all around excellency. Notice its exclusive patented features, its new line space regulator, bronze carrying bearings, patent eraser plate, patented envelope addressing plate, self interchangeable type reels, printing 90 letters and characters—then, if you don't want it, send it back at our expense. If you find it the greatest bargain you have ever seen or heard of anywhere and decide that you want to keep it, you can make settlement on the easiest monthly payments.

## FREE Use for 10 Days

That you may test the excellent qualities of this typewriter, we will place one in your home or office for ten days' free use. Don't pay the enormous profits asked by the local dealers. Buy direct from us, the manufacturers, and save from \$50 to \$65 on the purchase of your typewriter. Every sale is backed by our 10-year, ironclad guarantee.

## Easy Payment

Never mind the money. Our low, wholesale price and easy payment terms are so liberal that you never think of the money. We want you to see for yourself that "The Chicago" is equal to any other typewriter that costs more than twice its price. It is the only typewriter good enough to put out on a 10-year, ironclad guarantee and easy payment plan, such as we offer you here.

## Limited Offer

To all who write promptly, we will include free, one of our handsome leatherette carrying cases with fine brass lock and trimmings. Just send your name and address for full particulars of this special, limited, wholesale offer and it will be sent to you postpaid free. Write today—now! Address

**Galesburg Writing Machine Co.**  
Department 163 GALESBURG, ILL.

Please Mention Popular Mechanics

# RISE UP Become A Leader.



## MAKE OTHERS ENVY YOU

We want men and women, 18 to 50 years of age, in every locality to act as Deputies or Preferred Members. NO EXPERIENCE NEEDED. We teach you in a few days and give you a big FREE OUTFIT. Grand opportunity to make big money in an honorable way. The work is inspiring, dignified, pleasant and highly profitable. This big powerful organization will back you up and help you. You can begin at once—the sooner the better—either SPARE or WHOLE TIME.

**\$50 to \$100 Monthly — SPARE TIME**  
**\$100 to \$500 Monthly — WHOLE TIME**

New Members are easy to introduce into the Order because no other Society gives as much protection for as little money. Everyone likes the I-L-U. It gives GUARANTEED protection with

Fraternal features. All promises are faithfully and promptly fulfilled. Sick, injury and death Benefit Protection for the whole family at ACTUAL COST. You will gain the respect of all and your standing in your community will be strengthened. Your Influence Means Big Money for You. Success Means Promotion and More Money. Only one Deputy or Preferred Member appointed in each locality. Be the First!

### SPECIAL FREE WATCH OFFER

This Famous I-L-U Compass Watch, with Leather Fob and Enamelled Emblem Charm will be given, absolutely Free to the first man or woman to join the Order from your locality. Only one appointment is made in each locality and only one Watch goes Free with each appointment. Full particulars sent to the first applicant. Be the First from Your Locality. Be Quick—Write Today—Now—before someone else gets ahead of you.



Address **THE I-L-U OF THE WORLD**  
1241 I-L-U Building COVINGTON, KY.

20 ft. deep, accompanied by Mr. R. D. Fletcher, now of Titusville, and after viewing the well, father began almost immediately to have a well going down for himself. He used the old gin-pole drilling outfit (kicking



## 10 Cents a Day

Pays for This Cornet An astounding offer! Only 10c a day buys this superb Triple Silver Plated Lyric Cornet. FREE TRIAL before you decide to buy. Write for our big offer.

**WURLITZER**  
80 years of instrument making

Carrying Case Free with this superb triple silver plated Lyric Cornet.

Free Band Catalog Write for our big new 250-page Band Catalog.

Rock-bottom, direct-from-the-manufacturer's prices on all kinds of instruments. Pay for them at the rate of only a few cents a day. Generous allowance for old instruments. Free Trial. We supply the U.S. Gov't. Write now. THE RUDOLPH WURLITZER CO., Dept. 1192, 4th St., Cincinnati, Ohio S. Wabash Ave., Chicago



## Don't Drug Your Hair

My rational treatment does what tonics cannot do. It prevents and cures Dandruff, Baldness, Falling Hair and all other hair and scalp troubles.

No Drugs. No Diet. No Apparatus Not necessary to discard the hat Results guaranteed. Testimonials on request. Full personal Course, which includes all cost . . . . . \$2

Chas. E. Smith, H.D. Box 9148, 1708 Warren Ave. CHICAGO, ILL.



## Small Engines Our Specialty

Our gasoline engines— $\frac{1}{2}$ , 1 and  $1\frac{1}{2}$  H. P.—for farm, shop and home use are the best small engine values in America, because we specialize on them. The

high quality, "SIEVERKROPP" dependable at \$19.50 (factory price) will run a washing machine, small cream separator, grinder or any small machine. Buy one for your boy and watch him grow! Shipped on trial. Booklet and Special Offer on request. Write today to

**SIEVERKROPP ENGINE CO.**  
1222 18th St., RACINE, WIS.



**MAKE \$10 to \$25 a Week EXTRA**



Don't be an under-paid, over worked clerk. Get out of the wage earner's class and into the big field of business. Be Somebody. REALIZE the best that is in you. Show the world what you can really do. It's easy, if you but know how to seize an opportunity when it presents itself. Here is your chance. The Mail Order business is the greatest field today for the man of limited means to strike out for himself. Get out of the rut and

**MAKE \$25 TO \$100 A WEEK**

We are manufacturers and market our Patented Specialties exclusively through our dealers. We furnish everything. Big profits. Small capital. No experience necessary. Begin at your own home. Spare time. Grasp YOUR opportunity. Write us right now for full particulars; Plan, sworn statements and positive proof.

**KIMO MFG. CO., 222 Kimo Bldg., Buffalo, N. Y.**

**Writing is a Pleasure**

If you use a smooth, easy writing

**"VULCAN" Ink-Pencil**

Red or Black  
4 1/4 or 5 1/2 in.  
Order one to-day.

**FREE** Liberal supply of ink with retail orders.

**AGENTS WANTED**

**J. C. ULLRICH & CO., 27 Thames Street, NEW YORK**

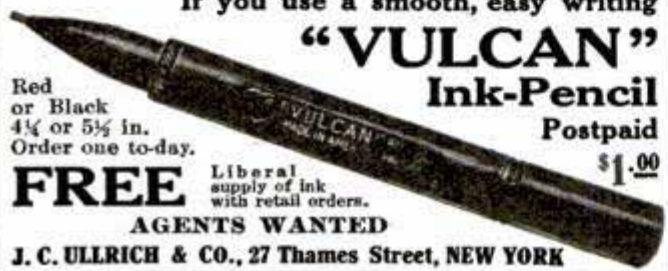

down a well by foot power). He was in it when oil was absorbed by woolen blankets being thrown over oil sump holes or seepages, and the blankets wrung out into troughs and the oil run into barrels, which were shipped down the Allegheny River on rafts to Pittsburgh. He built the third refinery in the state at Mead-

**BUYS THIS PRINTING PRESS**

The "Ideal" is an absolutely practical printing press, suitable for store, office or home. It's a wonder—always ready for work. Save dealers' profits. Write for a copy of our free catalog of printing presses and supplies.

**IDEAL PRESS CO., 2011 N. Lawndale Ave., Chicago, Ill.**



**Guaranteed Used Pianos**

A large number of fine instruments at exceptional bargain prices, many like new, exchanged for Kimball Player Pianos, thoroughly overhauled and guaranteed to be in splendid condition in every way.

Examples:	Schaefer Upright \$140	Hallet & Davis \$190
Briggs Upright \$ 70	Hinze Upright . . 145	Kimball Upright . 220
Colby Upright . 90	Fisher Upright . 165	Steinway Upright 275
Emerson Upright 110	Whitney Upright 185	Kimball Upright . 275
Decker Bros. Upr't 135	Chickering Upright 175	Knabe Upright . 175

We ship anywhere to reliable people on easy payment terms. Write Today For Complete List, Prices, and Terms and Beautiful Illustrated Musical Herald **FREE**, and catalogue New Kimball Pianos.

**W. W. KIMBALL COMPANY, 1294 Kimball Hall, Chicago, Ill.**

**Get a Broader View of Life in Bitter Root Valley**

Arrange with us to join one of our coming low rate, first-class excursions and see with your own eyes the money making, health making and home making opportunities in this famous scenic environment, with good roads, hunting, fishing, and mountain climbing. Learn on the ground how you can obtain a return of \$200 an acre or more annually from a Bitter Root Valley fruit orchard. For excursion dates and particulars, address

**BITTER ROOT VALLEY IRRIGATION COMPANY**  
849-855 First National Bank Building, CHICAGO, ILL.

No. 57  
**83c**

**El Diablo**

**RAZOR STEEL**



Why Not Carry **THIS SPLENDID**  
**Guaranteed WATCH?**



The best BONA-FIDE WATCH OFFER yet. Standard seven-jewel Elgin or Waltham movement—stem wind and set—choice of beautifully engraved or plain engine-turned **GENUINE** 20-year gold filled hunting case—thin model—size 6 to 18—at about 1/2 the regular price; **ONLY \$7.95.** Case and works fully guaranteed for 20 years. You will positively

**20 YEAR GUARANTEE**

**SAVE 12 DOLLARS**

—if you order one of these watches today—and you'll have a better watch than you ever had before, no matter what you paid for it. This is a special introductory offer—and special stock allotted will not last long. BEAR IN MIND—you can't get EVERY DAY—a \$20 value—best-known guaranteed watch-movement made, in genuine 20-year gold-filled case—choice of size and style—for \$7.95. Don't ask for more "information"—don't "consider" until OTHERS get them all. Order this watch TODAY (sending One Dollar—to cover express charges and packing)—and ask for big free catalog—listing surprising bargains in watches and all jewelry. We send you one of these SPECIAL VALUE Elgin or Waltham watches subject to your inspection; if it isn't just as represented—if you're not pleased with it—SEND IT BACK, and GET YOUR DOLLAR.

ORDER TODAY—under our unqualified 20-year guaranty of case and movement. Satisfaction—or you RETURN THE WATCH. (Only one watch to each purchaser.)

**CHARLES CUMMINGS CO., 420 S. Dearborn St., CHICAGO**

*(Cut Shows Exact Thickness of This Watch)*



**Do Your Printing!**

Cards, circulars, books, newspaper. Press \$5. Larger, \$18, Rotary \$60. Save money. Big profit printing for others. All easy, rules sent. Write factory for press catalog. TYPE, cards, paper, outfits, samples. **THE PRESS CO., Meriden, Conn.**



**BRASS AND STRINGED INSTRUMENTS**

Biggest line of band and orchestra instruments for band and home use. Cornets, trombones, clarinets, drums, violins, guitars and all wind and stringed instruments. Send for a free catalog of any instrument you may want—we can save you money. We give you a fifty lesson certificate **FREE** with each instrument. Write today mentioning instrument in which you are interested.

**JENKINS MUSIC HOUSE, 40 Jenkins Bldg., Kansas City, Mo.**



**FREE TRIAL**

**Automatic Electric Floor Surfacer**

Money saver for Contractors. Big opportunities for carpenter or a hustler. You can earn from \$10.00 to \$20.00 per day by purchasing one of these Wonderful Self-Propelling Machines, made in three sizes, 12", 15" and 18" Cylinder Roller. We also manufacture the well known Stone Floor Surfacers in three sizes. Write us for circulars and complete information.

**M. L. SCHLUETER, 103-105 No. Canal St., CHICAGO, ILL.**



**A Genuine \$2 Knife for 83c**

**THIS KNIFE HAS BRAINS IN IT.** Equally good in the Shop, the Farm, or Forest; light but extra strong; resharpened easily. Stag handle, German silver finish; blades file tested, hand forged razor steel and warranted. Sample 83c, 3 for \$2, postpaid. Choicest Pearl, \$2 each.

Send for 80-page Free List and "How to Use a Razor"

**MAHER & GROSH CO., 106 A St., Toledo, Ohio**



## WATERLOO BOY TRACTORS GASOLINE ENGINES CREAM SEPARATORS



Waterloo Boy Farm Tractors, Engines and Separators are the best for the money the world has ever produced. Any one of these machines will increase the production of your farm at a big saving in labor.

Our light Farm Tractor is a wonder. It turns short and will go anywhere you can work with a team. Our tractors sell at such reasonable prices that you cannot afford to be without one.

All Our Machines are Sold Under Our Strong Five-Year Guarantee

Write today for our catalog and let us tell you about our tractors, engines and separators.

Waterloo Gasoline Engine Company

Waterloo,  
Iowa

This Marvelous  
Tractor and  
Plows only  
\$1,050.00.

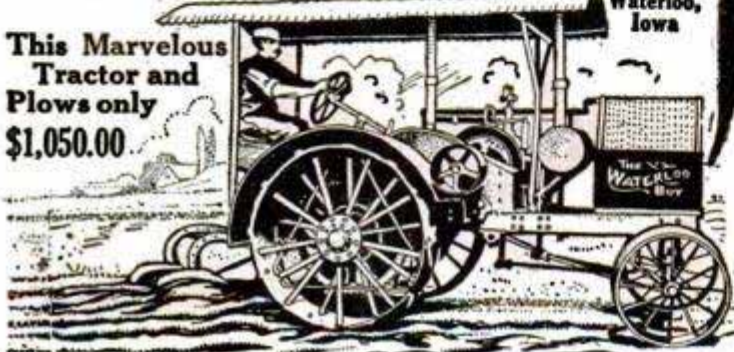

## Small Gas and Gasoline Engines

Air and Water Cooled.  $\frac{1}{4}$ ,  $\frac{1}{2}$  and 1 H. P.

Electric light plants from 6 to 50 lights. All prices. All kinds of electrical apparatus. Motors, Dynamos and Batteries. Gas, Gasoline and Steam engines from  $\frac{1}{4}$  h. p. up. Get our No. 12 Toy and Engine or No. 20 Engines and General Catalogs. Ten cents each. (Coin preferred.) Refunded on first order.

AMATEUR MECHANICS SUPPLY CO.

860 G, Monadnock Block, CHICAGO

FREE TRIAL 30 DAYS

BESSEMER  
KEROSENE  
ENGINE

Success with cheap kerosene or coal oil absolutely guaranteed. Try before you buy. Most economical, reliable and durable engine made. So simple and easy the wife or boy can start and run it. People everywhere throwing away their old engines, buying Bessemers and making money by it. Get one for yourself. Be ahead of your neighbors. Runs fast or slow. Will do a dozen things at once. Wonderful beyond belief. Pays for itself in fuel saved. For special discount write at once. The Bessemer Gas Engine Co., 121 Lincoln Ave., Grove City, Pa.



\$50  
to  
\$300  
SAVED  
Just Write!

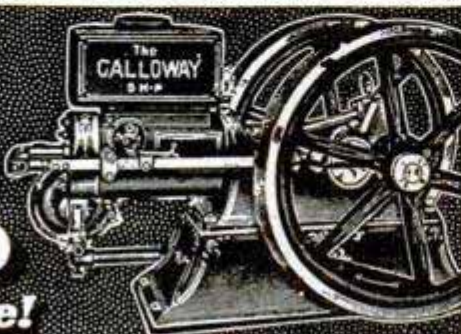

Get my prices—my new offers—get them right away. If you're going to buy an engine I'll put \$50 to \$300 in your pocket sure. All the dealers' profits cut off—you get them. You buy direct from my big factory.

30 Days' Free Trial Satisfaction guaranteed or your money back without a word. Any size from 1-4 to 15 H.P. Galloway Engines will run on gasoline, kerosene, naphtha, distillate, natural gas or motor spirits. Write for my Big Engine Book and Special Offers today.

William Galloway, Pres., WILLIAM GALLOWAY CO.  
965 Galloway Station, Waterloo, Iowa

668

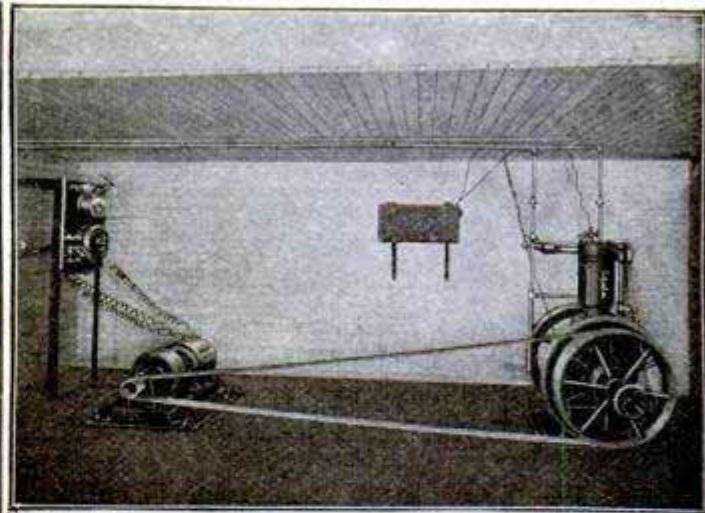

## International Harvester Oil and Gas Engines

Buy an International Harvester engine. Take care of it as any machine should be cared for, and a dozen years or more from now it will still be working for you.

Here are reasons why the engine you buy should be an International. They last longer, burn less fuel, are simpler, and give you most power. Consider that they have: Offset cylinder heads, large exhaust and intake valves, accurately ground pistons and rings, heavy drop forged crank shafts and connecting rods. Best material and construction mean the best engine. International engines are built in all styles, and in all sizes from 1 to 50 H. P. They operate on low and high grade fuels. Our catalogues telling all about International Harvester engines, will be sent on request. Write for them.

International Harvester Company of America

(INCORPORATED)

16 Harvester Building

CHICAGO U S A

ville, Pa. He got a patent for oil burners to be used under boilers in 1865, and he experimented with his fire under a boiler by giving exhibitions in a vacant lot in Boston, and on the Battery, New York City, in 1865 and 1866, and kept at it until he got capitalists interested, Mr. Stillman B. Allen and his brother, Frank A. Allen, the latter now living in Boston. Through these gentlemen and these experiments, he got the government interested, and the government gave an appropriation of \$10,000 (at that time a large amount of money) and also loaned an iron-clad gunboat of 350 tons to father,

## Simple, Safe, Sure and Serviceable

—the four principal features of the speedy little REDEMOTOR Engine. No experience in operating gas engines necessary.

Runs on almost any adjustment of the carburetor. Easy for a woman or child to start, the

### REDEMOTOR ENGINE

is absolutely safe and sure. Uses gas, gasoline, kerosene or alcohol. Runs fine on city gas. Made in 3 sizes,  $\frac{1}{4}$ ,  $\frac{1}{2}$  and 1 horse power. Silent running—as noiseless as an electric motor—and much cheaper to operate. Positive satisfaction guaranteed or your money back. Write today for FREE booklet 144.

ELGIN WHEEL & ENGINE CO.  
ELGIN, ILLINOIS



## Don't Buy an Engine

until you investigate the famous TEMPLE Gasoline-Kerosene, slow speed, heavy duty, all-purpose engines. Bulk and weight less than horizontal engines; cylinders built low, close to base, eliminating shock and vibration, increasing strength and durability, and giving scientifically correct distribution of strain. Pay for themselves in fuel saving alone. Have won five 1st premiums for low operating cost, stability and steady power. Old reliable pioneer concern (manufacturers for 61 years) guarantees these engines. Write today for catalog and particulars of 30-day trial offer.

TEMPLE MANUFACTURING CO., 2100 So. 54th Ave., Cicero, Ill.

Please Mention Popular Mechanics



## Put an "Eclipse" on Your Pump and Watch it Work

You will be surprised at the amount of water it can pump with **1 cent's worth** of gasoline. 1000 gallons of water to a pint of fuel, against an 80 foot head, is an ordinary performance for it.

### There's Quality in these Little Four-Cycle Engines

and they are the best engine bargain to be found—**quality considered**. Easily detached from pump. Can be used to run churn, washer and other light machinery. Cylinder and piston ground to fit—make and break ignition—frost proof cooling jacket.

Write now for  
Catalog 9M449

## Fairbanks, Morse & Co.

Chicago New York San Francisco  
and many other cities

## Run your Binder with a Cushman Engine

### and Save a Team

Quickly attached to any binder. Does all the operating. Horses merely draw machine. Weight only 167 lbs. Clutch pulley control with chain drive.

**THE ORIGINAL BINDER ENGINE** is easily detached for all farm power work. Runs any speed. Also larger 2-cylinder specialty farm engines. Throttle governor, Schebler carburetor. Get catalog.

**CUSHMAN MOTOR WORKS**  
800 N. 21st St., Lincoln, Neb.

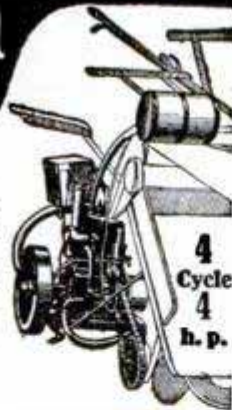

4  
Cycle  
4  
h. p.



## MULLINS CANOES CAN'T SINK

Enjoy the delights of canoeing without fear for **MULLINS CANOES** when equipped with patented buoyancy pads, steadied by special keel construction—are the most stable and safest canoes afloat—graceful in design—elegant in appearance—made from carefully selected cedar—Open gunwale construction—one-piece canvas covering that cannot crack or wrinkle—polished brass and copper fastenings—special broad flat bottoms. Two thousand canoes of assorted lengths, grades and colors in stock for immediate shipment.

Write for beautiful Canoe catalog illustrated in color.  
**THE W. H. MULLINS CO.** Salem, Ohio, U.S.A.  
362 Franklin Street The World's Largest Boat Builders

**STEEL MOTOR, DUCK & ROWBOATS**

# Famous Acousticon For the DEAF

You have heard about the famous Acousticon—you have needed one—you've wanted one. You can secure it from our factory at the factory price wherever you live

## NOW DIRECT BY MAIL

The Acousticon is the instrument everyone knows will positively enable you to hear the slightest sound. It makes no difference what you have tried without satisfaction, you have never used anything like the Acousticon. There is nothing else like it—it must not be confused with any other instrument. The Acousticon is the instrument which you easily regulate instantly to enable you to clearly

## Hear Every Sound

near or distant  
—loud or low,  
indoors or  
outdoors,  
under every  
conceivable  
condition  
One of the  
advantages that  
make the  
Acousticon

the great hearing device of today is the patent that transmits every sound, not only clearly, but absolutely natural. The Acousticon retains and transmits to you the original quality, or tone, of every sound. Not a word blurred—not a single sound is harsh. This remarkable quality of sound is possible only by our patented transmitter, which receives the sound on the indirect principle. The Acousticon is the instrument that covers

## 48 Degrees of Deafness

and defective hearing. It makes absolutely no difference what the cause of deafness, unless you are "stone deaf" or born deaf, the Acousticon will positively enable you to hear every sound—perfectly. We claim this—thousands of people know it—and we prove it.

The Acousticon is not a theory—not a new, untried device—but a world-known success for years. Why is it installed in hundreds of churches, theatres, banks and other public institutions? Why is it used all over the world by thousands?

## NO DEPOSIT Ten Days FREE TRIAL

Write for our special offer—10 days free trial—no deposit—no promise to buy—let us prove the Acousticon is the instrument you must use.

**EASY TERMS** Learn how to secure an Acousticon on easy monthly payments before special offer expires.

**WRITE** now for free copy of the greatest book of facts for the deaf ever printed, with testimonials from ministers, judges and others.

**General Acoustic Co.,**  
1322 Candler Bldg., 220 W. 42nd Street, New York City





# Motor Boat Catalog

FREE  
ON  
REQUEST

## Send for this Valuable Boat Buyer's Guide

Here is a book that will prove a great help in selecting the **right** motor boat. Nothing like it ever before published.

The foremost boat builders from all sections of the country are represented. Stock models and special designs are illustrated and described and prices are quoted on complete outfits with Gray Motors installed. Family pleasure launches, hunting and fishing boats, power canoes, hydroplanes, speed boats, runabouts, work boats and cruisers.

Boats  
from  
**\$142.50**  
Upwards

The book contains a truly wonderful fund of information that will prove of equal value to the man wanting a low priced outfit for inland lakes and rivers or the man wanting a luxurious cruising yacht.

With every request for this book we also send a copy of our Big Engine Book "M," which will give you a lot of general information about marine engines and shows the complete line of **Gray Motors** from 3 to 30-45 H.P. in one, two, three, four and six-cylinder models. Tells you how they are made. The books are absolutely free—no obligations—write for copies today.

GRAY MOTOR CO., 46 Gray Motor Bldg., Detroit, Mich.

# GRAY MOTORS

3 H.P. Complete \$55

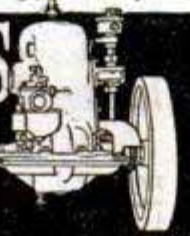

## Only 2 Cylinder Rowboat Motor

MORE POWER  
GREATER SPEED

Here's the latest and finest thing in detachable rowboat motors—the **only 2-cylinder detachable rowboat motor** made. Beats anything on the market. It's a real engine. Powerful and fast—quiet and smooth running, vibrationless. Has full 3 H. P. and reverses easily.

## KOBAN Rowboat Motor

The Koban Motor overcomes vibration, which has been the biggest objection against rowboat motoring. All revolving and reciprocating parts are perfectly balanced. Fits any rowboat—can be attached or detached in a jiffy—absolutely weedless rudder and propeller—sure and easy starter—can be steered when engine is shut off. Costs less per horse power than anything on the market. If you are going to buy a rowboat motor, this is the one you want. Write at once for full particulars and illustrated pamphlet. Agents wanted.

KOBAN MANUFACTURING CO.  
255 South Water St., Milwaukee, Wis.

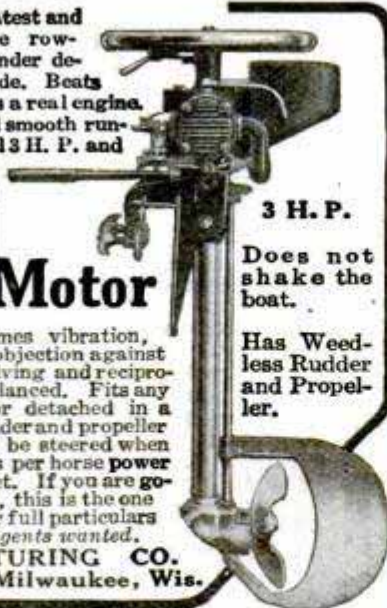

3 H. P.

Does not  
shake the  
boat.

Has Weed-  
less Rudder  
and Propel-  
ler.

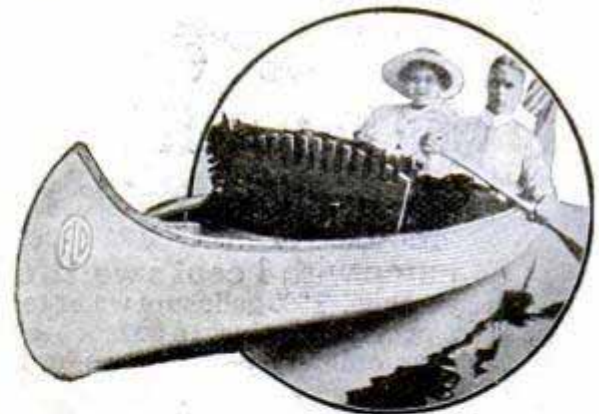

## Make This a Canoe Summer

Warm days and moonlit nights are coming, with picturesque streams and placid lakes for you to explore. Get the prettiest of nature's views—get solitude, exercise and rest—get an

## "Old Town Canoe"

Staunch, swift, safe—graceful designs. Hulls are oiled and canvased to prevent absorption of water and leaking. "Old Town 'Sponson' Canoes" cannot sink.

Send for our catalogue and learn all about canoes. 4,000 in stock. Agents everywhere.

OLD TOWN CANOE CO., 1364 Middle Street  
Old Town, Maine, U. S. A.



which was fitted up with his apparatus, using oil as fuel, and made several trips to sea, and ran the boat for 72

## VIM MOTORS

5 to 55 h. p. 3 kinds  
Speed—Regular—  
Heavy Duty

Strong, neat, simple—absolutely dependable. Wins your enthusiastic confidence. Accessible. Built to last a life time. Heavy brass fittings. Non-back-firing. Double ignition.

VIM MOTOR CO.



1, 2, 3 and 4 Cylinder  
Use Gasoline or  
Kerosene

Your boat will provide exhilarating and healthful recreation—equipped with a VIM. It's the old boatman's choice. Read 27 reasons why in "Boating Facts"—our new free book.

104 Water Street,  
SANDUSKY, OHIO

## HUNTERS—TRAPPERS

If you want an ideal lamp for night fishing, trapping, hunting or for work about farm or machinery, send to-day for a



## BALDWIN LAMP

Projects a 14 candle power light 150 feet. Burns Acetylene Gas. Weight 6 oz. Height 3 1/2 in. Can be carried in hand or worn on cap or belt, leaving both hands free. No oil, soot or glass. Absolutely safe and simple. Fifty hours' bright light costs 25c. Useful as well during Automobile repairing. Catalogue free and instructive booklet. "Knots and How to Tie Them" mailed on request.

At all dealers or by  
mail prepaid, \$1.00

JOHN SIMMONS CO., 162 Leonard St., NEW YORK CITY

## MULLINS STEEL BOATS CAN'T SINK

Never Need  
Calking



Safe as a life boat—Practically impossible to capsize—Airtight compartments—The lightest, cleanest, easiest to row boat that floats—No bottom faults to retard progress—**Absolutely Guaranteed Against Leaks or Punctures**—No seams to caulk—No cracks to leak—No bad odors as from water-logged wooden boats—A dry boat always. **MULLINS Steel Row Boats** can't dry out or rot out—Cost but a coat of paint to keep in commission. Beautiful in appearance—Always ready for use, they are the ideal all-around row boat for Recreation and Livery. Over 35,000 now in use. Write today for beautifully illustrated catalog of Row Boats, Hunting and Fishing Boats, Motor Boats and Canoes.

THE W. H. MULLINS CO.

410 Franklin St., Salem, Ohio, U.S.A.

The World's Largest Boat Builders

COST LESS LAST LONGER THAN WOOD BOATS





## On the Threshold

of the new season, every up-to-date Naval Architect, Boat Builder, and Motorboat Enthusiast is eagerly scanning the new designs for improvements and desirable refinements. Scripps Motors will be found to be worthy of careful examination for several reasons—"Simplification of design, Improvements in the ignition system, Refinements in details, and Accuracy of workmanship."

The 1914 catalog explains this all in detail. It is just off the press. Send for your copy, today. Scripps motors are made in 17 different models, including 1-2-4 and 6-cylinder sizes, semi-speed, medium duty and extra heavy duty types.

**SCRIPPS MOTOR COMPANY, 637 Lincoln Ave., Detroit, Mich.**

Scripps Motors are carried in stock by

New York, Bowler, Holmes & Hecker Co., 141 Liberty St. Chicago, Ill., O. L. Cosgrove & Co., 215-219 Englewood Ave. Philadelphia, W. E. Gochenaur, 631 Arch St. St. Louis, Mo., Chas. J. Pettit, 1860 No. Market St. Jacksonville, Fla., Gibbs Gas Engine Co., Foot of Main St. Seattle, Wash., S. H. V. Miller, 72 Marion St. San Francisco, Cal., Ellery Arms Co., 583-5 Market St. Los Angeles, Cal., Marine Engine & Supply Co., 832 S. Los Angeles St. Duluth, Minn., Kelley Hardware Co., 118-120 West Superior St. Toronto, Ont., Schofield-Holden Machine Co., 2 Carlow Ave. Winnipeg, Man., D. A. Ross. New Orleans, La., Arthur Duvic, 130 Chartres St. Export Office, 17 Battery Place, New York City.

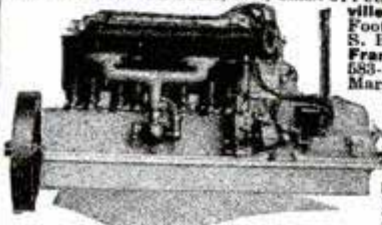

## Americanize Your Boat

Why not be patriotic in practice as well as in principle—even tho you don't carry a "big" gun you can drive your boat with an AMERICAN Motor and fly the American flag. If you install an AMERICAN, you are sure to be a true AMERICAN booster. Starts without cranking, uses Kerosene (coal oil), also gasoline, benzine, petrol, alcohol, distillate or naphtha without change of equipment. Our new Kerosene Carburetor cuts fuel cost in half. Every AMERICAN motor is fully guaranteed.

Send for our handsome new catalog, showing our complete line of AMERICAN motors—all sizes from 2 to 30 H. P.—at lowest prices. Catalog is free to any address. Live Agents and Dealers wanted. Some good territory still open. Write for our liberal proposition.



2 H.P.  
\$38

American Engine Co.,  
412 Boston St., Detroit, Mich.

MARINE AERIAL

# ROBERTS

AUTOMOBILE STATIONARY

The Motors That Never Backfire

In Which Motor Are You Interested?

The Roberts Motor Co., 419 Columbus Ave. SANDUSKY, OHIO

# Was Deaf— Now Hears!



Read This Good News:

Mears Ear Phone Co., New York City.  
Gentlemen:—For 34 years I was deaf and was greatly handicapped in my business. Since using your Mears Ear Phone I have had no difficulty in carrying on my business to better advantage and profit, and also in being able to enjoy Plays, Sermons, Lectures and Music. Until I commenced using the Mears Ear Phone my hearing was gradually growing worse. But since using it my hearing has greatly improved so that in time, I am sure I will be able to discard it entirely and hear as well as any person. I wish everybody could know what a wonderful instrument is the Mears Ear Phone.  
Very sincerely yours,  
CHAS. McCAUSLAND,

267 Dickerson St., Newark, N. J.

You, Too, May Hear Unless the congested hearing organs are completely paralyzed, there is every chance for the Mears 8-Tone Ear Phone to do for you what it has done for this man and 40,000 other satisfied users. Read below and write for our liberal direct free trial offer on the

## Latest 8-Tone Mears Ear Phone

A scientific aid to the hearing. Eight Tones! Eight different sound strengths, eight separate adjustments that you may instantly set by the touch of a finger for any possible variation of sound. Your ear hears normally all manner of sound, music or conversation.

The wearer of the Mears 8-Tone Ear Phone is never embarrassed—never annoyed. The instrument is always less prominent than eye glasses.



### Our Offer

Write today for our new offer direct from the laboratory—the lowest net price.

But don't make up your mind to keep the instrument on any terms until you have first tested and tried it thoroughly at our risk. Then, if you are satisfied, you can pay the laboratory price in small monthly payments if desired. Don't miss this opportunity. Take advantage of it today. Write for free booklet. Already 40,000 Mears Ear Phones have been sold.

## Sent on Free Trial

The Mears Ear Phone is sold only on trial. Test it and prove its power to do for you what it is doing for others. Make the test at our expense. Try it for 15 days in your own home, under every condition of actual service. If it does not please you, send it back, and the trial will cost you nothing. Remember, the Mears Eight-Tone Ear Phone is not an experiment.

## Booklet Request Coupon

If you live in New York call at our office for free demonstration.

The Mears Ear Phone book explains all the causes of deafness; tells how to stop the progress of the malady, and gives the names and addresses of hundreds of satisfied patrons to whom you can write. Send the coupon at once for Free Book and our Special Introductory Offer.

Mears Ear Phone Co.  
Dept. 1194  
45 W. 34th St., New York.  
Gentlemen: Please mail me, free and postpaid, your Mears Ear Phone Booklet and particulars of your Special Introductory Offer on your new model Eight-Tone Mears Ear Phone and Free Trial Offer.

Name.....

Address.....

Mears Ear Phone Co.  
45 W. 34th St., Dept. 1194  
New York, N. Y.



# MULLINS

## STEEL BOATS CAN'T SINK



A constant source of pleasure not an expense—The first cost is the last cost—No expense to put in commission or maintain, outside the slight cost of painting—**Mullins Boats** are built like Government Torpedo Boats of tough, heavily galvanized steel plates with air-tight compartments like Life Boats—**Absolutely Guaranteed Against Puncture**—Never require calking or repair—Never waterlog—Never warp—Never dry out—No seams to open and leak—Designed by Whittelsey the famous New York Naval Architect—Equipped with Sterling 4 Cycle and Pierce-Budd and Ferro 2 Cycle Motors—Light—Powerful—Simple—Can be operated by the beginner—Never stall—Never balk at any speed—Silent under water exhaust. **Free Book** beautifully illustrated in color will tell you all about these boats and their wonderful construction. **Write For It.**



Mullins Cedar Canoes Can't Sink  
Famous Yale and Harvard models

**THE W. H. MULLINS CO.**

The World's Largest Boat Builders

151 Franklin Street

Salem, Ohio

**Cost Less - Last Longer than Wood Boats**

AMERICA'S STANDARD 12-H.P. MARINE MOTOR

# KERMATH

4  
Cycle  
4  
Cylinder

\$180 to  
\$260, de-  
pending on  
equipment

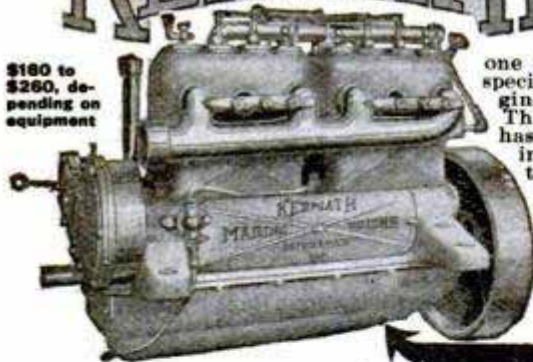

Made in one size only by specialists in engine building. The Kermath hasn't an equal in this size and type, absolutely regardless of price. Catalog request

**KERMATH MFG. CO.**  
Dept. P  
DETROIT, MICH.

## Make A Family Launch Of Your Row Boat



**E**NJOY all the pleasures of a launch at a mere fraction of the cost. Make your summer one long vacation—chuck full of boating pleasures. Go anywhere over river and lake—to the camp, summer home, hunting or fishing grounds without touching your hand to an oar. Leave all the rowing to a

### Caille Portable Boat Motor

Can be instantly attached to any row boat by simply turning two thumb screws and will drive it seven to nine miles an hour or slow enough to troll. Develops 2 H.P. Weighs but 55 lbs. Is steered by a rudder like a launch. Pivoted rudder (Pat. applied for) slides over stones and obstructions. Motor is adjustable to any angle or depth of stern. A turn of the fly wheel starts it. Can be run in salt or fresh water. Made in the largest two cycle engine plant in the world. A postal brings our beautiful catalog.

#### For Larger Launches

we build motors from 2 to 30 H.P. If interested, ask for our free Marine Motor Blue Book.

**The Caille Perfection Motor Co.,**  
1418 Caille St., Detroit, Mich.



consecutive hours. On one of these trips, June 24, 1867, the President of the United States, and many naval engineers and scientific men and newspaper men were taken along. The press of the country gave long articles about this new and wonderful fuel without smoke, and steamers that could not be discovered at sea by the smoke sign."

Japan exports to the United States annually copper to the approximate value of \$3,000,000.

#### GET THIS CATALOG

FULL OF VALUABLE INFORMATION TO EVERY BOAT OWNER ON

RACING PROPELLER WHEELS,  
REVERSE GEARS AND  
MARINE ACCESSORIES

LARGE CATALOG FREE. SEND TODAY

**MICHIGAN WHEEL CO.**

1139 MONROE AVE., GRAND RAPIDS, MICH.



# WATKINS - 1914 - SPECIALS

LIGHT WEIGHT—HIGH SPEED  
CLASS B—ALL IRON

A MOTOR FOR THE PEOPLE  
AND A PRICE TO SUIT

3 Sizes—3, 6 and 12 HP.

ALSO MANUFACTURE

THE FAMOUS 3 HP. 30 LB. COPPER  
JACKET MOTOR

CATALOGUE FREE

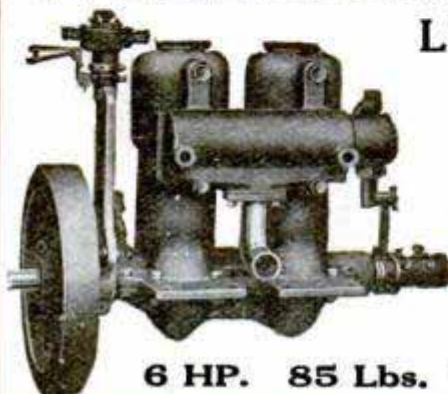

6 HP. 85 Lbs.

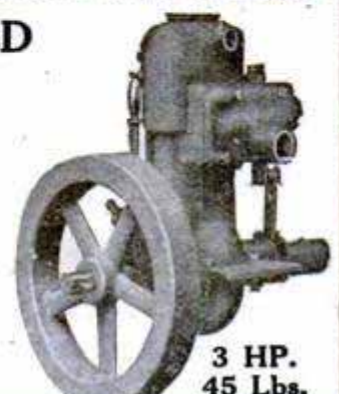

3 HP.  
45 Lbs.

**THE WATKINS MOTOR CO.** 839 W. 6th St.  
CINCINNATI, O.



# SWEET Detachable Rowboat MOTOR

Long Stroke 4 Horse Power

Fits any boat. Weight 55 pounds. 4 HP. Long Stroke, Ball Bearing. 10½ inch Weedless Propeller—sends 18 foot boat 8 to 9 miles per hour—35 miles on one gallon of gasoline and oil, mixed. Honestly made on principles proven right by experience. 9 years' efficient management assures quality and your satisfaction. Guaranteed for life. Write for special 30-day price and free catalog. Better be safe than sorry. Write to-day.



SWEET MANUFACTURING CO., 61 Griswold St., Detroit, Mich.

# WATERMAN "PORTO" MOTOR

2½ to 3 H.P. Weight 59 lbs.

Makes Any Boat a Motor Boat The original outboard motor. 9th year—25,000 in use. Guaranteed for life. Fits any shaped stern. Drives rowboat 8 miles an hour on quart of gasoline.

BUY DIRECT FROM FACTORY Freight Paid. Save Agent's Profit

Insist upon getting these essentials: Carburetor, not "mixing valve"; 3 Piston Rings; Removable Phosphor Bronze Bearings; Bronze Skeg; 10½ x 16" Propeller; Rudder; Noiseless, Underwater Exhaust; Spun Copper Water Jacket, highly polished.

Postal brings Free Engine Book

WATERMAN MARINE MOTOR CO., 430 Mt. Elliott Ave., Detroit, Mich.



## DUNPHY K. D. FRAMES

Makes it possible for any one to build a classy up-to-date model—all of the particular work done by expert mechanics—every piece fitted together, numbered and marked. Full line of complete boats carried in stock. Beautiful illustrated catalog sent on request.

DUNPHY BOAT MFG. CO. Eau Claire, Wis. BOX 19

**DO YOU KNOW—**

That we have brought out a new High Speed "Buffalo" Model—Four cylinder, 16-20 h.p.; bore, 3¼"; stroke, 5"; speed, 800 R.P.M.; weight, 525 lbs.; all working parts enclosed; constant level splash lubrication. Write for details.

**BUFFALO GASOLENE MOTOR CO.**  
1293-1305 Niagara St. BUFFALO, N. Y.

**MOTORGO Row Boat Engine**

Let the Motorgo row for you. Doubles the pleasure of fishing, hunting, boating. Our price saves you \$20.00. Guaranteed equal to any row boat engine, regardless of price. Write us.

Complete, ready to run. Converts any row boat into an efficient motor boat in one minute. Guaranteed to please you in every way or money returned. Write us a postal card now for "Motorgo Folder No. 801P."

Sears, Roebuck and Co., Chicago

PRICE \$49<sup>95</sup> =

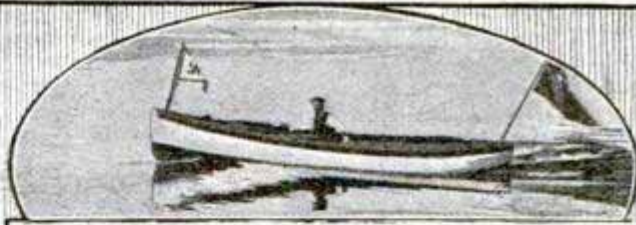

J. P. Brittan, Grenfell, Sask., Can., writes: "I'm still running my 210 I built two years ago and if anything else is better now than ever. I installed a 6 H. P. and have beaten everything on the lake. Before I started making boats by your system I couldn't saw a straight line and in this boat everything was saved out by hand except ribs and I had those cut out with a machine."



M. E. Steele, Ft. Wayne, Ind., writes: "The patterns I got from you on the Boat No. 232 with the frame were certainly O. K. and I can say that I am well pleased. I am sending you a photo of the boat making 12½ miles an hour with a 6 H. P. engine."



D. H. Dargin, Blue Creek, Wash., writes: "I made this boat pay me \$516.00 in 63 days and then sold it for \$250.00. I built it after a Brooks pattern 16 foot transom stern launch and cost with motor \$96.25."

**They Saved Money Through The Brooks System. Why Don't You?**

You cannot realize how easily you can build a beautiful, seaworthy boat and save a big share of the boat builders' price until you get the Brooks Boat Book. Read the letter of Mr. Brittan, who says he couldn't saw a straight line, yet he built the fastest boat on a popular lake. You can do as well. Send for the Brooks Boat Book and see how you can

## Save at Least 2/3 and Have Greater Confidence In Your Boat

All the parts come to you cut, shaped and fitted. Illustrated instructions show you how to put them together. You know where every piece—even every nail and screw is to go. You know that the very best material goes into your boat and you can always have the feeling that it is designed right and built right. All the technical or skilled work is done here in the factory. We build a complete, full size boat—then take actual size patterns of every piece in the boat, marking each pattern to show you where it belongs. Difficult work is taken care of, too. Erect the frame, put on the plank and your boat is ready for painting, finishing, etc.

## Write Today for the Brooks Boat Book—Mailed Free Learn About Popular "V" Bottom Model

Get this book and see illustrations of fine cruisers, motor boats, speed boats, family launches, sail boats, row boats and canoes, boats of all kinds that you can build easily in spare time. Try the popular "V" Bottom Model—so simple and easy to build and so speedy and seaworthy in service. Write today for our Boat Book—it's free—Address

**BROOKS MFG. CO.**  
8204 Rust Ave., Saginaw, Mich.  
Largest Plant of its kind in the world. Originators of the Pattern System of Boat Building.

Only \$33.00 Buys the complete frame for this fine 23 ft. launch, including full size patterns and illustrated instructions to finish. Speed 9½ to 14 miles an hour—12 passengers. This and other models in Free Boat Book. Write for it.

**\$2 and up**  
Buys full size patterns and full instructions for building any model.







# EXCELSIOR

Model 7-C. 7-10 H.P.  
Chain Drive  
Price \$225

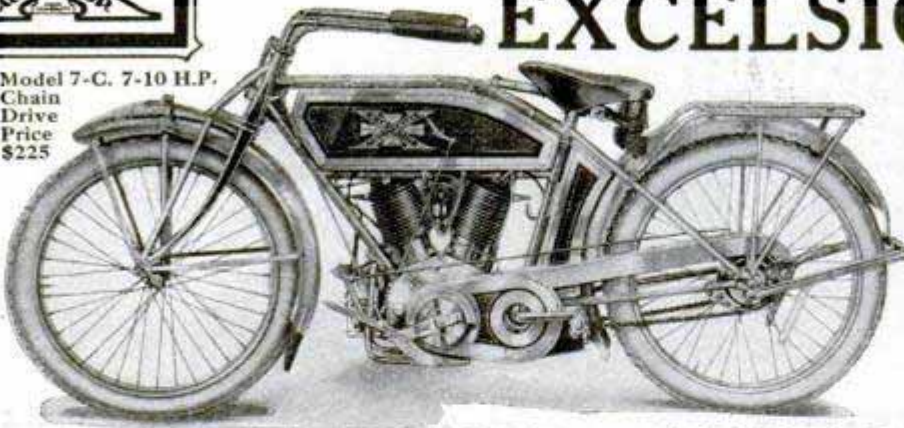

**SAFETY and CERTAINTY of EXCELSIOR CONTROL**

The grip control of all functions of the

## EXCELSIOR AUTOCYCLE

is the greatest assurance of safety to the rider that is found in any motorcycle on the market. Throttle, Spark, Compression and Clutch are all controlled by the handle bar grips without removing the hands or in any way interfering with the steering or other details of operation. This simplicity and Certainty of control is of equal value to the beginner and the experienced rider, as it enables you to get through crowded streets and bad roads with every part of the machine under absolute control. One hand governing the speed, the other the clutch, and as on no other motorcycle built. 100% Efficiency in control is only one of the great features of the EXCELSIOR. Our catalog or the nearest dealer will tell you the rest. Get Wise — get an "X" and be Satisfied.

both hands in positive control of the steering, insures safety and gives the rider a degree of confidence that enables him to go through sand or mud holes that would be absolutely impassable were the rider compelled to lose control of either of these important functions to attend to something else. The experienced rider fully appreciates this and a moment's consideration will convince the novice that his life and safety are assured on an EXCELSIOR AUTOCYCLE

**Excelsior Motor Manufacturing & Supply Co.**  
2202-2250 South Union St., CHICAGO

### NORTHWESTERN "GIANT" MARINE ENGINES

For Fishermen, Guides and Boat Liveries and those who want absolute reliability.

The Most Compact Marine Engines in Existence of medium weight, moderate speed and a very modest price. The standard 2 cycle engine of the world. Planhard carburetor, spark and waterproof commutator. Patented gas-tight bearings, flange couplings, magneto with storage battery, sight feed oilers, etc. 2, 4, 7, 10 and 18 H. P.—Prices \$50 and up. New 1914 catalog in colors. Hundreds of engines on hand for immediate shipment. Get the agency in your town.

NORTHWESTERN MOTOR CO., 774 Spring St., Eau Claire, Wis., U. S. A.



7 H.P. develops actual 9 H.P.

### GRAY GEARLESS DETACHABLE BOAT MOTOR

Attaches to any row boat or canoe. Just the motor for your vacation. Has several superior mechanical features found on no other outboard motor. You will find the Gray Gearless Boat Motor is

#### Mechanically Better

and you get more power, less weight, fewer parts, greater simplicity, easier steering and longer life at a remarkably low price—\$65 complete. Guaranteed by a responsible concern. Write for full details—ask a Gray agent—your nearest hardware or sporting goods dealer, or get immediate deliveries from factory. GRAY MOTOR CO., 4806 Gray Motor Bldg., Detroit, Mich.



**LA**  
Marine Motors  
Direct from Factory  
to You



### Save the Dealer's Profit

It won't cost you as much as you thought to enjoy the pleasure of motor boating this summer. The old, reliable, "keep-going" Lockwood-Ash motors are sold direct from factory to you at a big saving. No dealer's profits to pay. **Immediate Delivery**—Six models, all guaranteed for one year, and sold on 30 days' trial. No strings to this offer, no freight to pay. Just send for one of our complete outfits, and if it doesn't delight you send it back at our expense.

The 6 H.P. Motor with Outfit complete, shown in illustration, freight paid, only..... **\$96.00** — a clear saving of at least \$29.00. Post yourself on motor boating and the safest, cheapest way to buy by writing today for our 1914 catalog. It's soon time to start — get busy.

LOCKWOOD-ASH MOTOR CO., 436 Horton Ave., Jackson, Mich.

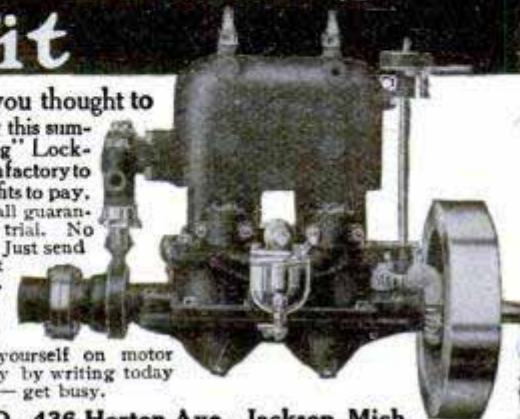





## Don't Pay Rent

Only \$80.00 buys a garage 12 feet wide by 15 feet deep. Shipped to you in sections. Put it up yourself with a wrench and screwdriver.

WRITE FOR READY MADE BUILDING CATALOG.

Illustrates and describes the above and other ready made portable garages; also houses, barns, chicken houses, boat houses, summer cottages, from \$62.00 up. Write for Ready Made Building Catalog No. 80P94. SEARS, ROEBUCK AND CO., CHICAGO.

# MOTORCYCLES

State Distributor for **EVERYTHING FOR THE MOTORCYCLE**  
**Excelsiors**  
 Motorcycle Co-operative Corporation  
 471-473 Woodward Ave. DETROIT, MICH.

## 5 H. P. 1914 Peerless Motorcycle

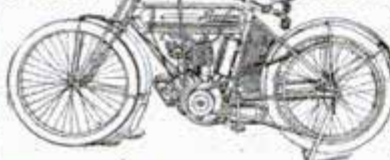

With Free Engine Idler and Bosch Magneto, together with the best there is in motorcycle construction—Power, Silence, Endurance, and those Wearing Qualities so essential for low cost of maintenance.  
 5 MILES FOR ONE CENT  
 Agents Wanted—Liberal Discounts

PEERLESS MOTORCYCLE CO., 179 Huntington Ave., BOSTON, MASS.



**Convert Your Wheel Into a Motor-Cycle** Motor fits any wheel. BEST. MOST RELIABLE. Best Hill Climber. More STEFFEYS in use than any others. Send stamp for circulars. STEFFEY MFG. CO., Girard Ave. and 30th St., Phila., Pa.

## AUTO HEEL REST



USED ON ALL CARS FOR BRAKE, CLUTCH AND GAS PEDALS.

Four Heights, 1/2, 1, 1 1/2, 2 in.  
 75 CTS. POSTPAID  
 LUCAS & SON, Bridgeport, Conn.

## Solar Motorcycle Lamps

are the neatest looking, strongest and most efficient lamps made. The product of light specialists, makers of 90% of the automobile lamps used on the high grade cars of America. Catalog shows many styles—gas, oil and electric. Write for it today.

**BADGER BRASS MFG. CO.**

Kenosha, Wis. New York City, N. Y.

## Ten Days' Free Trial

allowed on every bicycle we sell. We **Ship on Approval** and trial to anyone in the U. S. and *prepay the freight*. If you are not satisfied with the bicycle after using it ten days, ship it back and *don't pay a cent*.

**FACTORY PRICES** Do not buy a bicycle or a pair of tires from anyone at any price until you receive our latest Art Catalog—of high grade bicycles and sundries and learn our unheard-of prices and marvelous new special offers.

**IT ONLY COSTS** a cent to write a postal and **FREE** by return mail. You will get much valuable information. **Do Not Wait; write it NOW!**

**TIRES, Coaster-Brake, rear wheels, lamps,**

parts, repairs and sundries of all kinds at *half usual prices*.  
**MEAD CYCLE CO. Dept. T108 CHICAGO**

# Prest-O-Lite

for  
**Motorcycles**

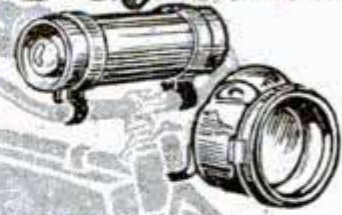

## Safety First

There is but one practical light for motorcycles—Prest-O-Lite!

It is simple and sturdy. It stands the vibration and the jolts. It is safe and dependable under all conditions. You don't risk your safety on a delicate electrical connection or a toy storage battery.

The first cost is small. The operating cost is one-third to one-fifth that of electric light, and usually no greater than the cost of operating a carbide generator. When you consider its freedom from trouble, repairs, and attention, Prest-O-Lite is the *most convenient* system you can use.

## 30 Days FREE Trial

You can prove Prest-O-Lite on your motorcycle for thirty days by our liberal trial offer. Insist upon a similar trial before you buy any other lighting system.

## Get Prest-O-Lite

Some dealers are now offering combinations of equipment at attractive prices. In any such combinations, you can get Prest-O-Lite. If necessary, insist upon it.

Get our booklet giving ALL the facts about motorcycle lighting before you buy. It will save you time, money and trouble. Tear off below the dotted line, write your name and address below and mail it for complete information.

**The Prest-O-Lite Co., Inc.**

265 Speedway, Indianapolis, Ind.

(Contributor to Lincoln Highway)

Please send facts on ALL Lighting Systems to



## The Champion X Is the Spark Plug The



Special  $\frac{1}{2}$  in.  
75c

## Ford Motor Co. Puts on The Ford Cars

The Ford Manual, which is issued for the guidance of Ford agents, says: "The make of plugs with which Ford engines are equipped when they leave the factory, are best adapted to the requirements of our motor, notwithstanding the opinion of various garage men to the contrary."

The spark plug referred to is the Special  $\frac{1}{2}$  inch **Champion X**.

But it isn't only The Ford Motor Company that endorses **Champion Spark Plugs**.

Seventy-five per cent. of all the cars made in America today are factory equipped with Champions.

This includes not only the Ford, Overland, Metz and Maxwell, but over forty other of the best known motor cars in the world. All replacements should, of course, be made with Champions. Insist upon them.

**Champion Spark Plugs** do not show deflection at their points as the result of hard service.

Their high quality is based not only on the superior materials used, but upon our manufacturing processes.

There is a **Champion Spark Plug** for every type of Motor Car, Motor Truck, Motorcycle, Motor Boat, Aeroplane or Stationary Motor.

**Special  $\frac{1}{2}$  inch Champion X  
sells for 75c everywhere**

Consult with your dealer as to the "Champion" which will give your motor its highest efficiency.

(Licensed under the Canfield Patent No. 612,701, October 18, 1898)

**Champion Spark Plug Company**  
F. D. STRANAHAN, Treasurer R. A. STRANAHAN, President  
406 Avondale Ave. Toledo, Ohio

Please Mention Popular Mechanics

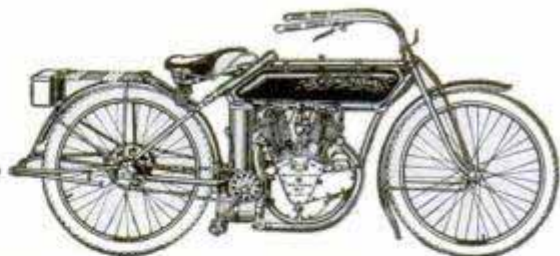

There are nearly one hundred reasons why the **FLYING MERKEL** is the world's best motorcycle. Fully explained in our 1914 Art Catalog. Write to-day for your copy. We have room for a few more live agents. Write to-day.

**THE MIAMI CYCLE & MFG. CO.**  
280 Hanover Street Middletown, Ohio

Send 10 Cents in Stamps for Sample Copy

Monthly  
\$1.00 Per Year

*The American*  
**Cyclecar** *America's First*  
*Cyclecar Journal*

2202 MICHIGAN AVE., CHICAGO

The Journal of Motoring for the Masses  
Have Splendid Opportunity  
for LIVE Subscription Agents



### Morgan Gas Lighter

Factory Representatives wanted everywhere to handle our Auto and Hardware **Necessities**. Unusual Contract. Large Profits. Increasing Demand. Write today, letter — no postals — Exclusive Territory. Samples.

**Morgan Rolling Wedge Spring Leaf Opener**  
Only instantaneous spreader on market. For lubricating Wagon, Auto, or any spring. Real Opportunity for Hustlers. Immense field. Popular Prices. Millions will be sold. All our Specialties. Money-Back Guarantee. Write Now to  
**MORGAN MFG. CO., Bellevue St., Newport, R. I.**



YOU CAN NOW GET

### Diamond Automobile Squeegee Tread Tires

ON YOUR MOTORCYCLE OR BICYCLE

You have exactly the same tire problems as the automobilist. Realizing this, we have built for you a tire made of the same Vitalized Rubber, the same fabric, the same principle of construction, and built in exactly the same manner as the automobile tire. Diamond Vitalized Rubber Motorcycle Tires are made with the Squeegee or Studded Tread and Perfect 3-Point Rim Contact; also the "More Mileage" Strip on the tread, an exclusive Diamond feature. They "won't slip — won't slide — won't skid — but grip and hold."

YOUR DEALER CAN SUPPLY YOU



### \$40 Motorcycle

We have the largest line of new and used Motorcycles in the country at the lowest prices. We also have a thoroughly equipped repair department and are in position to furnish repairs for any machine. Send us your machine to be overhauled. We pay cash for second hand motorcycles. Send for Catalog.  
**HARRY R. GEER CO., 888 McLaran Ave., ST. LOUIS, MO.**



Send your name on a Postal for 1914 Bargain sheet of FLYERS.

**RICK CYCLE WORKS**  
DESK P BUFFALO, N. Y.



### We Ship on Approval

without a cent deposit, prepay the freight and allow 10 DAYS FREE TRIAL on every bicycle. IT ONLY COSTS one cent to learn our unheard of prices and marvelous offers on highest grade 1914 models.

**FACTORY PRICES** Do not buy a bicycle or a pair of tires from anyone at any price until you write for our new large Art Catalog and learn our wonderful proposition on the first sample bicycle going to your town.

**RIDER AGENTS** everywhere are making big money exhibiting and selling our bicycles. We Sell cheaper than any other factory.

**TIRES, Coaster-Brake rear wheels, lamps, repairs and sundries at half usual prices. Do Not Wait; write today for our latest special offer on "Ranger" bicycle.**

**MEAD CYCLE CO. Dept. T108 CHICAGO**





**The Racycle** is the world's easiest running bicycle because there is 27% less pressure on the bearings than on any other bicycle in the world. It has always been the world's leader in many ways. Fully explained in our 1914 Art Catalog. Write today for your copy.

**The Miami Cycle & Mfg. Co.** 420 Grand Ave. MIDDLETOWN, OHIO

**DIRECT FACTORY SALE**

**THE WARREN MOTOR CAR COMPANY** are closing out all surplus stock of new auto parts at prices that demand quick sale:—

\$ 1.00 Spark Plugs.....	\$ .19	<b>Any-thing else? We have it.</b>
150.00 Full Floating Rear Axles.....	50.00	
30.00 Front Axles.....	12.50	
50.00 Pressed Steel Frames—all sizes...	10.00	
100.00 Auto Bodies.....	30.00	
60.00 Radiator—many sizes and styles	15.00	
100.00 Magnetos.....	35.00	
8.00 Iron Vises.....	3.19	
15.00 Electric Horns.....	3.98	
5.00 Complete Tool Kits.....	1.09	
50.00 Steering Gears.....	12.19	
10.00 Gasoline Tanks—square.....	1.00	
18.00 Oval and Round Tanks.....	3.00	

Send for a Big Bargain list of new goods being sold at this sale. Get on our mailing list. Hundreds of other automobile parts and accessories are shown on our Big Bargain Sheet of goods sold at this sale. Write for this quick.

**WARREN MOTOR CAR CO.,** 64 TENTH STREET DETROIT, MICH.

**THE MOTOR-BOB 1914 MODEL**



Very latest design, classy looking, simple in construction. Boys! here's a real little auto that you can build yourself. Send 25 cts. for a set of our easy to understand plans, instructions and list of parts, telling you just how to build the 1914 model Motor-Bob.

**THE IDEA SHOP, Dept. I, BUFFALO, N. Y.**



Rider, be our representative in your town. **EARN \$40.00 PER WEEK.** Get our **FREE CATALOG** and compare prices with your local dealer. Introduce our electric bicycles and our wonderfully improved everlasting puncture proof tires \$10.00; Sample pair \$5.00. Guaranteed one year. **Park Row Motorcycle Co., Dept. A31, No. 36 Vesey St., New York** Largest Eastern Supply House

**Garage \$49.50**



Genuine "Edwards." Ready-made, fire-proof garages. Quickly set up any place. Direct-from-factory prices — \$49.50 and up. Postal brings illustrated 64-page catalog.

**THE EDWARDS MFG. CO.,** 320-370 Eggleston Ave., Cincinnati, Ohio

**MONEY IN MUSHROOMS**

**Add \$10 to \$50 a Week to Your Income**  
**Grow Mushrooms** at home in your basements, barns, sheds, etc., without interfering with your regular occupation. Small beds, 5 x 10 ft., costing practically nothing to start, often produce 60 to 100 lbs., selling at 50c to \$2.00 a lb. Your whole family can help in raising them. Others are making money growing mushrooms. Why don't you? My illustrated booklet telling how to start, how to sell, etc., sent free. Write today.

**A. Y. JACKSON, Falmouth Mushroom Cellars, Inc., 196 Gifford Street, Falmouth, Mass.** The largest modern mushroom farm in the world.

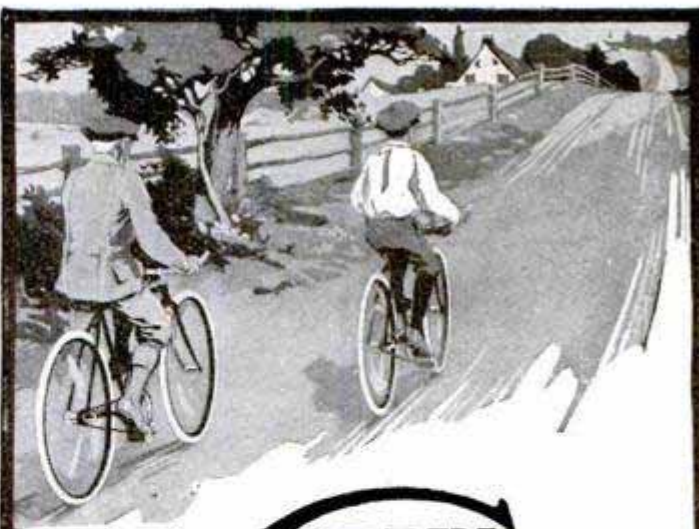

**Coaster Brakes**

*Save Energy — Insure Safety*

**Corbin Duplex Coaster Brake—**

The most popular of all brakes for use by boys and girls. You coast at will and save



your energy. You stop the wheel gradually or instantly as the occasion demands.

**Corbin Two-Speed Coaster Brake — Preferred by elderly**



men and women. Levels the hills. Makes it easy to

ride in the face of a stiff wind. Two gears always at your command. Change made from high to low by change in foot pressure.

**"Corbin Control Means Safety Assured"**

Sold and equipped by bicycle and hardware dealers everywhere.

Write for new 1914 Catalog

**The Corbin Screw Corporation**

The American Hardware Corporation, Successors  
201 High Street - New Britain, Conn.



# BIG PROFITS

## In One Minute Photography No Experience Required

A new, live profession, offering to red blooded, ambitious men and women, a real chance to make money. Now, as you read, you are facing an opportunity that may be a turning point in your life. Strike out for yourself! What's a mere job? What kind of future do the time clock and pay envelope promise? Invest your brains! Better your position! Double your income! **Do Something.** You want opportunity—don't you? Listen!

### \$28.50 PROFIT IN ONE DAY

That's what John Hancock, of Lamoni, Iowa, earned. Rev. J. W. White, Okla., made \$3.50 in 3 hours. Miller, Ia., says: "I made \$13.65 in one afternoon." Shearer, Mont., made \$22.35 in 5 hrs. Hundreds of letters like these show the stupendous possibilities—the enormous money-making power of

## THE "MANDEL" POST CARD MACHINE

A new one minute picture machine, taking and finishing original photographs on post cards and buttons at the rate of 3 per minute. Five different styles of pictures made with the same machine. **No films, plates or dark room required.** The pictures are taken and finished right within the machine in less than a minute's time. No waiting. No delays. You collect your money right away.

## World-Wide Market For One Minute Photographers

Here's a business that gives you an unlimited money-making market. Fairs, carnivals, picnics, circus grounds, aviation fields, busy corners, in small towns and large cities—all that, and more is your field for profit. You can travel and see life and make money besides expenses. Or you can work right in and around your own town—all or spare time. There are a thousand chances, a thousand advantages the "Mandel" Machine gives you to turn hours into cash.

### Small Capital Starts You

Write today! Let us show you what big opportunities this **Portable Post Card Gallery** offers you. Costs nothing to write us—and it may mean the starting of a successful business career for you. Address either office—**TODAY.**

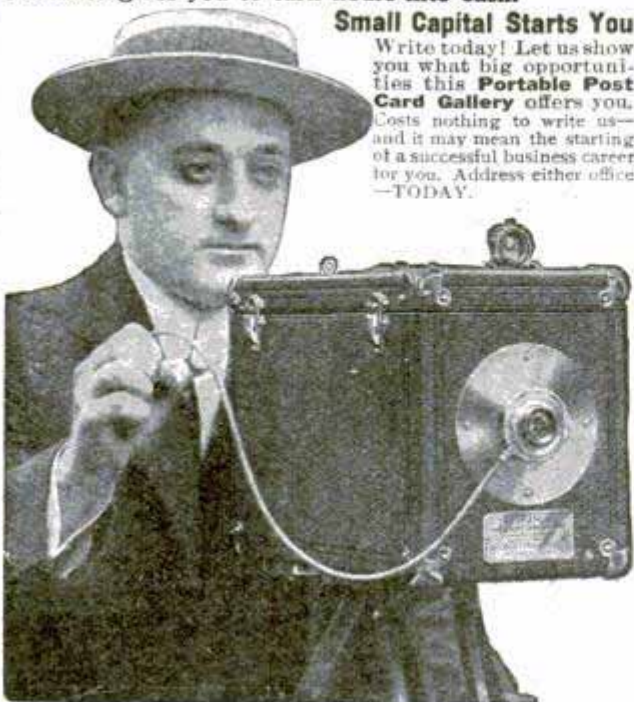

## The Chicago Ferrottype Co.

307 Ferrottype Bldg., OR Dept. 307, Public Bk. Bldg.,  
CHICAGO, ILL. OR 89-91 Delancey St., NEW YORK, N.Y.

Please Mention Popular Mechanics

**3-in-One** oils, cleans, polishes, prevents rust. Lubricates sewing machines and all light machinery. Restores new look to time-worn furniture. Keeps bathroom fixtures bright. Makes the finest dustless duster in the world.

### 3-in-One oil

does scores of useful things which can't be mentioned here. Sold by hardware, drug, grocery, housefurnishing and general stores: 1 oz. bottle, 10c; 3 oz. 25c; 8 oz. (1-2 pt.), 60c. Also in Handy Oil Cans, 3 1/2 oz. 25c. If your dealer hasn't these cans, we will send one by parcel post, full of 3-in-One for 30c. A Library Slip with every bottle.

**FREE**—Write for a generous free sample and the 3-in-One Dictionary.

**Three-in-One Oil Co.**  
42 CNF, Broadway  
New York

## KEYLESS PADLOCK

No more lost-key troubles. No buttons to fumble. Just turn knob as directed. 40,000 combinations possible. No one can open yours but you. Operated as easily in dark as in light.

**AGENTS MAKING 100 PER CENT PROFIT.** Sells on sight in city or country. Write today for terms of free samples. A postal card will do. Address, **Victor Specialty Co., 63 Cook St., Canton, Ohio**

## I WANT GOOD MEN

Would you take a steady job where you can clear \$30.00 weekly with opportunity to be district manager at \$3000 yearly? No experience required. Great crew managers proposition. We manufacture—middlemen's profit saved. Write for our 1914 exclusive territory-business-building plans. I'm an old agent myself—made my six-story factory by hustling. If you want to also earn big money, write and I'll tell you how I did it. E. M. Davis, President, E. M. Davis Company, D 14, Davis Bldg., Chicago

## Health? Take Turkish Bath at Home—Only 2 Cents



Physicians are abandoning drugs for this new treatment. If your mind or body is tired, open your pores and feel the rapid change in your condition, at cost of 2c a bath. The **Robinson Bath Cabinet** is the only scientifically constructed bath cabinet ever made for the home. **Great \$2 Book Sent Free**—"The Philosophy of Health and Beauty." Write today. Agents Wanted. **ROBINSON MFG. CO., 650 Robinson Bldg., Toledo, O.**

## RIDER AGENTS WANTED

in each town to ride and exhibit sample 1914 model. Write for Special Offer. Finest **\$10 to \$27** Guaranteed 1914 Models with Coaster-Brakes and Puncture-Proof Tires. 1912 and 1913 MODELS ALL OF BEST MAKES..... **\$7 to \$12**

**100 Second-Hand Wheels**  
All makes and models, good as new  
Great Factory Clearing Sale. **\$3 to \$8**  
We Ship on Approval without a cent deposit, pay the **10 Days' Free Trial** freight & allow

**TIRES** coaster-brake wheels, lamps, and sundries, half usual prices. **DO NOT BUY** till you get our catalogue and offer. Write now.  
**MEAD CYCLE CO. Dept. 7108 CHICAGO**





is doubled—your home made more cozy and attractive—your electric bills cut down—by

### The D'LIGHT

This small portable electric lamp will stick to a mirror. Has an invisible spring clamp that holds it to the back of a chair, head of a bed—anywhere you want the light—an adjustable shade CONCENTRATES THE LIGHT, bringing it directly upon any object. For shaving, dressing, sewing and reading—saves your eyes and light bills—is a COMFORT in homes, offices and stores; a JOY TO TRAVELERS—can be packed in your grip. At dealers. Sent prepaid complete for \$5.00.

WIZARD ELECTRIC LAMP CO.

143 New Mont'ry San Francisco, Cal.

Agents Wanted

Positive guarantee of money back if not satisfactory.



**VACUUM CONVEYOR FOR COAL**—An Austrian power plant is handling all its coal by vacuum pipes. Coal, graded as dust coal and nut coal, is delivered in car loads to the plant, and a suction pipe, dropped into the car, conveys the coal to the storage bin.

One standard of lather excellence whichever method you prefer—

## Colgate's Shaving Lather

STICK—POWDER—CREAM

A rich, luxurious lather that softens the beard without being rubbed in with the fingers. Send 4c in stamps for trial size of your favorite method.

Colgate & Co., Dept. 81, 199 Fulton St., N. Y.

## Chauffeur's Law Book FREE!

The first and only book of its kind ever compiled. Contains vitally important information about the laws governing chauffeurs in every state—When and how to register—How to get a license in each state—What the fees are for the first year and renewals—Driving laws and regulations—Rights and privileges of the chauffeur—And scores of valuable facts every chauffeur should know. This book, at any book store, would sell for 50c. But send us 10c for a copy of the **American Chauffeur** and with it we will send you this book free.

This offer is made for a limited time to get you acquainted with the **American Chauffeur**—the liveliest magazine in the automobile field and the only one published exclusively in the interest of the beginner, the professional chauffeur, and the man who drives his own car. Every issue crammed with valuable articles that will make you a better chauffeur and help you make more money. Write your name on the margin of this page and send it with 10c in stamps or coin, and we will forward the **Chauffeur's Law Book** and a current copy of the **American Chauffeur** by return mail.

THE AMERICAN CHAUFFEUR PUBLISHING CO.  
251 Butler Building CINCINNATI, OHIO

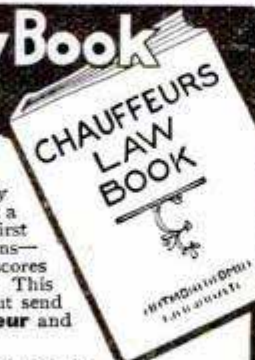

# Over 1/3 Off

This \$40.00 Set—Now \$24.80

Are you interested in Civil Engineering? Then take advantage of this great opportunity. Save over fifteen dollars on this complete and extensive work—the only books ever published covering the entire "Civil" field. These eight volumes cover the four great branches of municipal, structural, railroad and reclamation engineering, and constitute in themselves an engineering reference library which has found favor with colleges, technical schools, libraries, engineers and students throughout the country. From these books the beginner can fit himself to make a successful start in this field; the experienced engineer and the consulting expert will find them invaluable for ready reference.

## Cyclopedia of Civil Engineering

Contains 3,900 pages, 7 x 10 inches, 3,000 illustrations, full page photographs, plates, folding maps, diagrams, etc.; hundreds of valuable tables and formulas, carefully cross-indexed for quick, easy reference. Printed in large, clear type on special quality paper and bound in half red morocco, gold stamped.

### What These Books Cover

Plane Surveying—Mechanical Drawing—Plotting and Topography—Railroad Engineering—Statics—Strength of Materials—Roof Trusses—Mill Building Construction—Cost Analysis in Relation to Engineering—Masonry and Reinforced Concrete—Steel Construction—Practical Problems in Construction—Bridge Engineering—Highway Construction—Hydraulics—Water Supply—Irrigation Engineering—Water Power Development—Sewers and Drains—House Drainage and Sanitation—River and Harbor Improvements, etc., etc.

**Shipped Free** Examine this great work before you send a penny. We want the books themselves, not what we say, to help you decide whether you need them. Merely on receipt of the attached coupon we send you the complete set, express prepaid. Take a whole week to look them over. Test them on some problems that have been bothering you. Then if you decide you want the set, send us \$2 within seven days after receipt and then \$2 a month until you have paid the introductory price of \$24.80. Otherwise tell us and the books come back without a penny of expense to you. But remember—it may be your last opportunity to get these famous books at this specially reduced price.

### Free Consulting Service

Besides the practical value of the library itself, you get a year's Consulting Membership free as a holder of these books. Our staff of civil engineers takes up and solves your problems and special difficulties, absolutely without cost to you. This privilege, which regularly sells for \$12, is yours for a full year free, if you take the cyclopedia. To find out how useful these books will be to you, you must see them. It costs nothing to look the set over. It does not obligate you in any way. We stand ready to take the books back without expense to you, if you are not pleased with them. Get the books. Examine them. Then make your decision.

### FREE COUPON Worth \$15.20 to You

American Technical Society, Chicago, U. S. A.

Please send me Cyclopedia of Civil Engineering for 7 days' free examination. If I decide to buy, will send \$2 in 7 days and balance \$2 a month until \$24.80 has been paid, when \$40 books and \$12 Consulting Membership will be mine. Otherwise will notify you and hold books subject to your order. Title not to pass until fully paid. Pop. Mech. 4-14

NAME .....

ADDRESS .....

As I have had no previous dealings with you, I refer you to





SECTIONAL  
**COME-PACKT**  
FURNITURESECTIONAL  
**COME-PACKT**  
FURNITURE

# Why Pay \$89.50?

## You Can Buy These Pieces Direct From Our Factory—In Sections—For LESS THAN HALF Retail Store Price

### The New Idea That Reduces Price and Guarantees Quality

We build Come-Packt furniture in sections—ship direct from our factory to you in compact crates, at knock-down freight rates—you set it up in your own home in a few spare moments—you save over half what you would pay at a retail store. Furthermore, your protection in quality is absolute—you see each section separately before it is finished or assembled. Nothing can be covered up—no flaws could escape notice—you get full 100% quality. Three such pieces at any retail store would cost you \$89.50—our price, only.....

### Each Piece Is of World's Finest Genuine Quartered White Oak

Not red oak, or any other cheap grade of oak, or imitation. Any cabinet maker will confirm the fact that there is but one oak of quality—Genuine Quartered WHITE oak. Years of hard usage will enhance the beauty of Come-Packt furniture—it is solid worth and character throughout. Built in modern designs with the care and skill of the old master cabinet makers—possessing an individuality and charm befitting the home of quality. We ship to you at actual factory price of lumber and mill work. All you need is a screw driver and a few moments of spare time. Eight different shades of finish from which to select. Every piece sold on a full year's guarantee. If you are not satisfied, your money will be immediately returned, including freight.

**New 1914 Catalog FREE** Shows over 400 other beautiful examples of Come-Packt craftsmanship in living, dining, bedroom and den furniture—in sections—at a saving in some instances of even 60%. Color plates showing exquisite finish and upholstery. Sent free—postpaid. Write for it today. A postal will bring it.

**COME-PACKT FURNITURE CO.**  
401 Dorr Street Toledo, Ohio

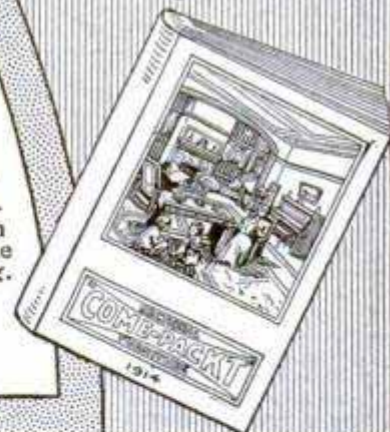

6034-\$50.      Only 20% down      and 10% a month      6038-\$75.      6258 \$25.

## DIAMONDS ON CREDIT

Buying a high grade Diamond is saving money, *not* spending it. The "Lyon Method" makes it easy for you to save. Lyon Diamonds are Blue-white and perfect. A written Guarantee Certificate with each Diamond. All goods sent prepaid for inspection. No security required. Write now for Catalog No. 3.      10% discount for cash.

**J. M. Lyon & Co.,**      71-73 Nassau Street  
NEW YORK

6226 \$35.

6211 \$100.

16026 \$175.

6188 \$175.

6261 \$35.



# \$300.00 in 30 Days

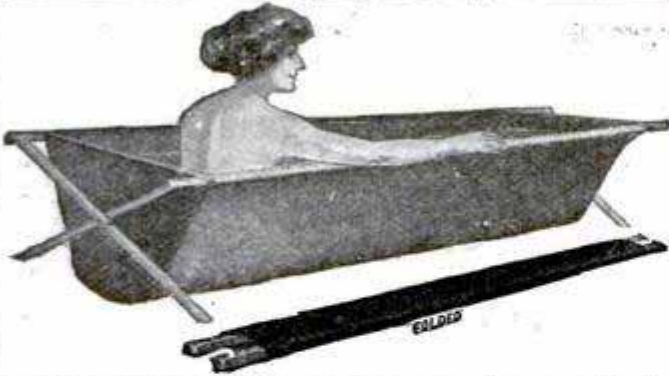

Made by one Robinson salesman. You—yourself—can positively make \$60 and expenses every week. I want men like you, hustling, energetic, ambitious fellows, anxious to make money, who are willing to work with me. Not for me, but with me. I want you to advertise, sell, and appoint local agents for the **biggest, most sensational seller in 50 years—the ROBINSON FOLDING BATH TUB.** Here's an absolutely new invention that has taken the entire country by storm. Nothing else like it. Gives every home a modern up-to-date bathroom in any part of the house. No plumbing, no waterworks needed. Folds in small roll, handy as an umbrella. Self-emptying and positively un-leakable. Absolutely guaranteed for 5 years. Hustlers, east, north, west, south,—coining money. Orders orders everywhere. Badly wanted, eagerly bought, for remember, **fully 70% of homes have no bathrooms.** Immense profits for you. Two sales a day means \$300 a month. Here's proof—real proof. Will Gunckel, Ohio, got \$240 worth of orders first week. A. Bernider, Kansas, made \$30 in four hours. Hamlington, of Wyo., made \$60 first two days. Hundreds like that. Pleasant, permanent, fascinating work. This is not idle talk. Make me prove it. Write a postcard. Let me write you a long letter. Then decide. No experience needed, no capital. Your credit is good if you mean business. But you **must be ambitious**, you must want to **make money.** That's all. Write a postcard **now.** I want to pay you sixty dollars every week.

Sales Mgr., **THE ROBINSON MFG. CO.**  
312 Vance Street TOLEDO, OHIO

**ENDLESS NECKTIE** All the rage. Newest style. Ties in different place each time. A wonder. Girl makes \$87 one week; man \$20 one day. **FREE SAMPLE** and amazing offer. Write quick.  
**ENDLESS NECKTIE COMPANY, Dept. 10, Kansas City, Mo.**



The rapid development of **Double Your Income ON YOUR SAVINGS**  
Wyoming makes it safe for us to pay 6 per cent—because Wyoming legal int. rate is 8 to 12 per cent. Our stringent banking laws give you the same protection you get at home. Why be content with 3 to 4 per cent when we will pay you 6 per cent. Resources over \$100,000. Write today for booklet.  
**PIONEER TRUST and SAVINGS BANK** 12 Pioneer Street, Basin, Wyo.



**3 YEARS TO PAY**  
**Meister Piano** 30 days free trial in your own home  
**\$1 A WEEK or \$5 A MONTH Price \$175.00**  
No cash payment down. No interest—no extras. Piano stool and scarf free.  
**ROTHSCHILD & COMPANY**  
Dept. P16 CHICAGO, ILL.



**NEXT to DIAMONDS OUTSHINE ALL OTHERS.**

They not only represent diamonds to perfection (in white and canary brilliancy) but also rubies (in oriental pigeon blood red) and sapphires (in rich oriental blue) all so beautiful in color and sparkle as genuine oriental gems, and guaranteed everlasting. Considering the opportunity offered and desire for personal adornment at a very low cost, Lapid should be given the first thought. They pass all test and defy all criticism. See them first, then buy. All goods sent for examination, C.O.D. Ins. Policy with all Lapid, insuring against fire, breakage or loss of stone. If you have a ring, pin or heirloom for re-setting, use a Lapid. Jewel book free. Engel's patent Ring Gauge included for five 2c stamps, which assures exact size when you order ring.

**ALBERT W. ENGEL, Gem Expert Since 1879**

Maker of Engel's Famous 75c Gem Cleaning Outfit. Buy it at special price, 50c. Use it often and retain the sparkle of your jewels.

Address Desk 10 D

1456 Leland, Chicago, Ill.

The Burlington Special

19 Jewels Fully Adjusted

The Burlington Special

New Style Thin Model



Here is an Exquisite Design

Inlay Enamel Monogram

# Just Out!

*New Ideas in Watches*

Block and Ribbon Monograms, Diamond Set, Lodge, French Art and Dragon Designs. See catalog for complete set of color illustrations.

## Special Offer

You may secure one of these superb time-pieces—a watch of the very latest model, the popular new thin design, adjusted to the second—19 jewels—adjusted to positions AND temperature AND isochronism—at the same price that even wholesale jewelers must pay—and in order to encourage everybody to secure this watch at once pay this rock bottom price, either for cash or \$2.50 a month! We send the watch on approval, **prepaid**. You risk absolutely nothing—you pay nothing—not one cent, unless you want this **exceptional offer** after seeing and thoroughly inspecting the watch.

## Write for New Watch Book

Learn the inside facts about watch prices, and the many superior points of the Burlington over double-priced products. Just send the coupon or a letter or a postcard. Get this offer while it lasts.

**Burlington Watch Co.**  
19th Street and Marshall Blvd.  
Chicago  
Dept. 9194

Watch Book Coupon  
**Burlington Watch Co.**  
Dept. 9194  
19th Street and Marshall Blvd.  
Chicago, Ill.

Please send me (without obligation and prepaid) your free book on watches with full explanation of your rock-bottom DIRECT offer for cash or \$2.50 a month, on the Burlington Watch

Name .....

Address .....

Please Mention Popular Mechanics



# Stewart Motorcycle Speedometer

MAGNETIC PRINCIPLE

## Front Fork Jars Cannot Injure This Front Wheel Drive Model

Before this Stewart Front Wheel Drive Motorcycle Speedometer was put on the market, you had to choose between two evils—

You had to accept a front drive motorcycle speedometer *with drive through flexible tube*, which soon whipped itself to pieces, or—

Content yourself with a rear wheel drive model which constantly registered false mileage through rear wheel slippage and whenever the motor was tuned up on the stand.

But this Stewart *Front Wheel Drive Motorcycle Speedometer* solves all difficulties. Its drive chain operates through a *solid, rigid tube*. The tube supports the bracket which holds the angle joint and fibre pinion. This bracket swivels freely on the front wheel axle. Thus all the vicious front fork shock, jar and twist is taken up without the slightest injury to any part. The pinion simply moves up and down on the sprocket with each up-and-down movement of the wheel.

# \$12

Complete and Fully Guaranteed

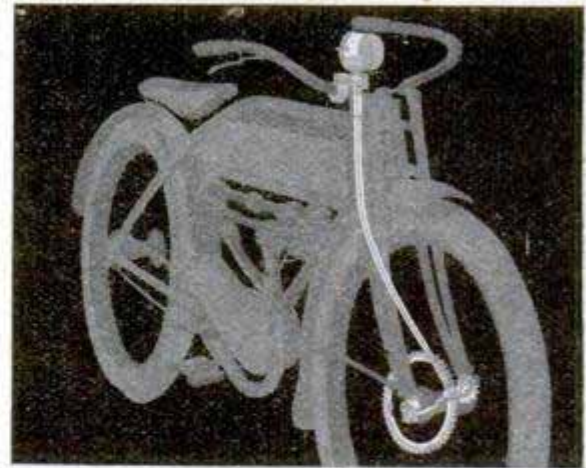

We also make the best *rear wheel drive* motorcycle speedometer on the market, but in spite of this we recommend the Stewart *Front Drive* instrument because it will give you better, longer, safer, more accurate service. The instrument itself is our famous *magnetic* type, and the price is only \$12 complete and fully guaranteed. For sale by dealers everywhere. Accept no other.

Stewart-Warner Speedometer Corporation,

Factories: Chicago, Ill., and Beloit, Wis.

17 Branches, also Service Stations in all cities and large towns.

## 15 Days Free Use

Moth Proof Red Cedar Chest

15 DAYS FREE TRIAL



A Piedmont Southern Red Cedar Chest protects furs, woollens and plumes from moths, mice, dust and damp. Charms the home with the romance of colonial days. Makes the finest birthday, wedding or graduation gift. Shipped direct from factory at factory prices. Write for 84-page catalog showing designs, sizes and prices of Piedmont Chests. Piedmont Red Cedar Chest Co., Dept. 67 Statesville, N.C.

Write for Catalog



## Made-to-Measure Express Prepaid \$275

Pants cut in the latest style. Made to your individual measure. Fit, workmanship and wear guaranteed.

**No Extra Charge** for peg tops, no matter how extreme you order them.

**Agents Wanted**  
A good live hustler in every town to take orders for our celebrated made-to-measure clothes. Samples of all the latest materials **FREE**.

**We Pay Big Money** to our agents everywhere. Turn your spare time into cash by taking orders for our stylish clothes. Write today for beautiful **FREE** outfit.

The Progress Tailoring Co., Dept. 604, Chicago

## I WANT 200 SALES AGENTS AT \$1200 TO \$3600 A YEAR

To introduce my new **Compress and Vacuum Washing Machine** to every home in the country, I want 200 additional representatives to begin work at once in their home counties. I consider this machine the most brilliant inventive achievement of the age in household necessities. It is selling faster than anything I have ever heard of—**going like wildfire**.

### PROFITS START FIRST DAY

No waiting or guessing. The price of only \$1.50 makes a sale at every house—**cash business at 200 per cent profit to you**. The biggest opportunity ever offered. I want hustlers—men and women who want to make money quick and fast. No large investment needed—**business supplies the capital**.

**NO EXPERIENCE REQUIRED** Just follow instructions. Failure impossible. **Success assured**. Frank Greene sold 45 first three days—profit \$45. Mrs. L. C. MARRICK made \$90 first three weeks in spare time only. J. H. Goddard took 18 orders first three hours. **No talking necessary**. Just show it—the order is yours right on the spot.

H. F. WENDELL, Pres., Wendell Vacuum Washer Co., 202 Oak St., Leipsic, Ohio



**\$1.50**  
Selling Price

Every machine sold on money-back guarantee. **A child can use it**. Abolishes labor of wash day. Women discard \$15 and \$20 machines for it.

### MAIL YOUR APPLICATION TODAY

**Don't delay**. Get your county under contract. **No charge for territory**. To wait means to lose. Write me a letter or a postal card today. If you are honest and willing to work I will give you the position. **Do not let someone else get in ahead of you**. I want agents, general agents and managers. Write today—then you will have done your part. **Do it right now**. Address



**A Lacing more pliant than the belt**

**Reduce Your Time Loss**

Don't consume from 10 to 20 minutes of a high-priced expert's time lacing your belts by hand. Get a

**"Clipper"**  
TRADE MARK  
**BELT LACER**

It will lace your belt in 3 minutes and do it better. Your cheapest man or stout boy can handle it. No skill necessary.

Try the "Clipper" 30 days at our risk.

**Clipper Belt Lacer Co.**  
1032 Front Ave. GRAND RAPIDS, MICH

**GASOLINE SOLDERING IRON BLOW TORCH**

**HERE IT IS**



Address Dept. 1. EMMELMANN BROS. MFG. CO., INDIANAPOLIS, IND., U.S.A.

**MAKE MONEY AT HOME**

Increase the family income. Making canvas gloves offers the opportunity. Start in spare time on your sewing machine. Add more machines as business grows. Large factories have developed from a modest beginning like this. We started that way. Let us start you. The work is easy—no skill needed. The demand for canvas gloves is big. Send no money. Write today for our free book that explains the business.



**McCREERY MFG. CO.**  
713 Dorr St. TOLEDO, O.

**PUT A LITTLE CALIFORNIA IN YOUR HOME**

**BUILD A GENUINE Stillwell-California BUNGALOW**

—having style, comfort and distinction; right for any climate.

STILLWELL PLANS pay big dividends on their cost; are practical, economical; provide labor-saving built-in conveniences; make building a certainty and selling easy.



**Photos - Plans - Costs of 129 Model Homes**  
"REPRESENTATIVE CALIFORNIA HOMES" ALL 3 BOOKS FOR \$1  
50 ideal homes, \$1600 to \$6000—Price 50c  
"WEST COAST BUNGALOWS"  
51 inexpensive homes, \$600 to \$2000—Price 50c  
"LITTLE BUNGALOWS"  
28 perfect little homes, \$300 to \$1400—Price 25c (POSTPAID)  
We Sell Books and Blue Prints on a Money-Back Guarantee  
**E. W. STILLWELL & CO., ARCHITECTS**  
4167 HENNE BLDG., LOS ANGELES

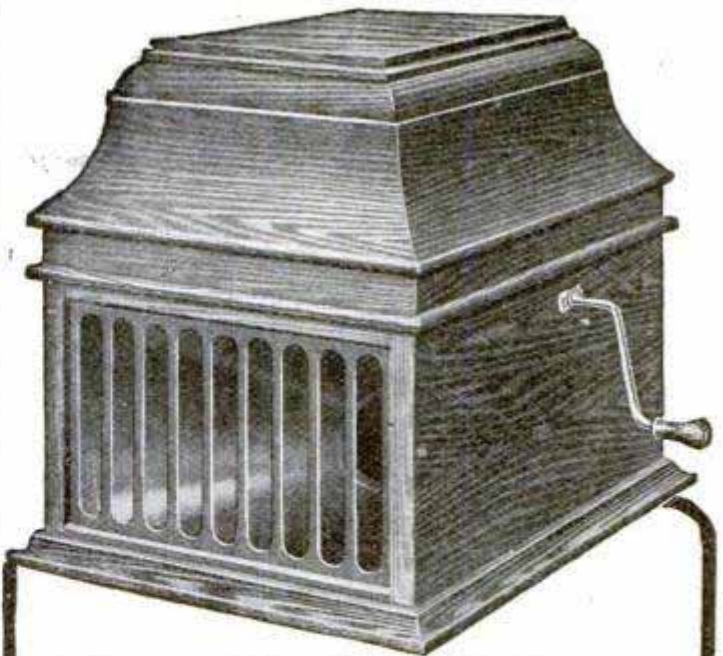

**New Edison Phonograph** (Mr. Edison's LATEST invention) **Now Shipped Free**

Write *today* for our new Edison Catalog — that tells about the superb new model Edison with Mr. Edison's new diamond stylus reproducer and our **NEW Edison offer**. Now read:

**The Offer:** We will send you the new model Edison and your choice of all the brand new records on an absolutely free loan. Entertain your family and your friends. Then, when you are through with the outfit you may send it back at our expense.

**The Reason:** We are tremendously proud of this magnificent new instrument. When you get it in your town we know everybody will say that nothing like it has ever been heard before, so we are sure that someone will want to buy one of these new style Edison's, especially as they are being offered now at the most astounding rock-bottom price and on easy terms as low as \$2.00 a month.

*REMEMBER, not a penny down—no deposit—no guarantee—no C.O.D. to us—no obligation to buy—A FULL FREE TRIAL in your own home—DIRECT from us—DIRECT to you. Returnable at our expense or payable (if you want to keep it) at the actual rock-bottom price direct from us.*

**Our NEW Edison Catalog Sent FREE!**

Your name and address on a postal or in a letter, (or just the coupon) is enough. No obligations in asking for the catalog. Get this offer—while this offer lasts. Fill out the coupon today.

**F. K. BABSON**  
Edison Phonograph Distributors  
1194 Edison Bldg., CHICAGO, ILL.  
Canadian Office  
355 Portage Ave. WINNIPEG, MAN.

To **F. K. Babson**  
Edison Phonograph Distributors  
Dept. 1194 Edison Bldg. CHICAGO, ILL.

**GENTLEMEN:**—Please send me your New Edison Catalog and full particulars of your free trial offer on the new model Edison Phonograph.

NAME.....

ADDRESS.....





# You'll like this coat-shirt

Every railroad man who has worn a Signal Shirt will have no other. You'll make it a point to try the Signal, too, when you have seen how stylish and well-made it is, and the many exclusive features it has.

## SIGNAL Coat-Shirts

# \$1.00

(\$1.25 West of Mo. River)

**UNION MADE**

Has all these improvements; Easy-on, easy-off coat style. Extra big armholes that give plenty of arm movement. Specially cut skirts overlapping 3 inches in front and with extra button at bottom to prevent gapping. Two detached or attached collars; cuffs made with both button and extra buttonhole so they can be buttoned or used with detachable cuffs. Double needle machine stitching (prevents rips), buttons sewed on extra strong; 2 pockets, one a triple combination pencil, watch and handkerchief pocket. Signal Shirts are made from fast color percales that won't shrink or fade. Big variety of neat patterns. Only expert union labor employed.

**Sent at our risk** Ask your dealer. If he hasn't them, tell us his name and your size, and we will express you a couple C. O. D. If not delighted with them on examination, return at our expense, without paying us a cent. Be sure and write for folder showing a big variety of other styles and sample swatches.

**HILKER-WIECHERS MFG. CO., 1254 Mound Ave., Racine, Wis.**  
*Also manufacturers of the famous Signal Overalls and Coats*



### Don't Throw Away Your Worn Tires

For over three years French and German motorists have been getting from 10,000 to 15,000 miles out of their tires by "half-soling" them with steel studded Treads. In eight months 20,000 American motorists have taken advantage of this opportunity to **save one half their tire expense.**

**We ship on approval** without a cent deposit, **prepay the express** and allow the user to be the judge.

**Durable Treads** double the life of your tires and are sold under a **signed guarantee for 5000 miles without puncture.** Applied in your own garage in thirty minutes.

**Special Discount** offered to motorists in new territory on first shipment **direct from factory.** A postal will get full information and sample within a week, **Don't wait—write today.**

**The Colorado Tire & Leather Co.**  
1153 Karpen Bldg. CHICAGO, ILL.

**START A MAIL ORDER BUSINESS**

30 new propositions. No competition. Make 95c profit on dollar orders. Complete plans, 10 cts.

**MAIL DEALERS WHOLESALE HOUSE**  
541 Franklin Bldg. CHICAGO



### OWN A BUSINESS WHERE THE CROWDS ARE ALWAYS WAITING TO HAND YOU MONEY

**The Motion Picture Business is the Business.** It's the greatest Money making business of the times, and our free book "How to Make Money in the Moving Picture Business" tells you how you can start with a very small capital, and begin making money from the very start.

**ABSOLUTELY NO EXPERIENCE NEEDED**

This book is a guide for the inexperienced; it tells everything pertaining to the business and how to conduct it profitably. Don't wait, send for **your copy today.** It's free.

**P. & W. SALES COMPANY, 731 Como Bldg., Chicago, Ill.**

**\$54.75** Freight Paid



## L. A. Rowboat Motor

—a brand new member of the famous L. A. family. The fruit of 8 years' marine motor experience and sold direct from factory on

**—30 DAYS' FREE TRIAL—**

The popular outboard style of motor is now, for the first time, offered for sale at a popular price. You can enjoy all the pleasures of motor-boating this summer — such a summer as you never had before. The L. A. is light as the lightest, strong as the strongest, with many exclusive refinements. It drives a rowboat 8 miles an hour, or slow enough to troll. Instantly attachable — instantly removable.

**Order Today,** sending \$54.75, and motor will be sent back at our expense if unsatisfactory. Fully guaranteed.

Send for L. A. catalog and post yourself on this popular motor at a popular price.

**LOCKWOOD-ASH MOTOR CO.**  
476 Horton St., Jackson, Mich.

**Save The Dealer's Profit**



# Any Watch Made Sold on Credit

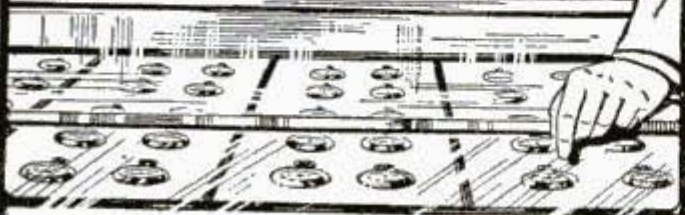

## FROM 7 TO 23 JEWELS

and in all sizes from the small ladies' sizes to the popular 12 size gentleman's watch and up to the larger size Railroad Watch. I have them all, in any make you want: cased in 14K solid gold cases, solid silver or double strata gold filled cases.

## GUARANTEED FOR 25 YEARS

The maker's name is stamped on every watch and case I sell, and back of these guarantees I give my own personal guarantee, to sell any make of watch on easy terms as low as

## \$1.50 A MONTH AND UP

depending upon the grade, quality, and make of watch that you may desire to purchase, and remember that all watches are SENT ON APPROVAL subject to your inspection without one cent of cost to you, as I even prepay the express or mail charges and the watch is not considered sold until you have had

## THIRTY DAYS' TRIAL

and if within thirty days you are not perfectly satisfied with your purchase, return the goods to us at our expense and we will promptly refund you every penny of expense that you have been put to.

## FREE CATALOG

Write today for this wonderful jewelry catalog. It is "Square Deal" Miller's own book, illustrating and describing the choicest lines of watches, sparkling diamonds, and jewelry of all kinds sold on easy monthly terms.

NO REFERENCES DEMANDED, no notes, no interest, no red-tape, but a square deal from start to finish from the Original "Square Deal" Miller. Write today for our catalog—a post card will do. Address mail to

**"Square Deal" MILLER, President**

MILLER - HOFER CO. 274 Miller Building, Detroit, Mich.



# Make \$15.00 to \$35.00

## Per Day With Our Latest Invention, The Wonderful Ever-Ready Camera

Makes 9 styles single or group pictures direct on post cards or tints without use of films or negative. NO EXPERIENCE NECESSARY. Complete picture finished, toned and fixed in 30 seconds. HERE'S AN OPPORTUNITY TO GET

into a DIGNIFIED, RESPECTABLE BUSINESS OF YOUR OWN with a VERY SMALL INVESTMENT and BECOME INDEPENDENT. BIG MONEY. At carnivals, summer resorts, parks, picnics, anywhere. BIGGEST MONEY-MAKING PROPOSITION in the WORLD. Photos cost you from 1 to 2 1/2 cts. and sell for 10, 15 and 25 cts. each. WRITE TO-DAY FOR FREE PROPOSITION & CATALOGUE.

**THE NEW YORK FERROTYPE CO.**

Dept. A29, No. 168 Delancey St., NEW YORK, N. Y. Dept. A39, No. 1113 Halsted St., CHICAGO, ILL.  
Largest Manufacturers and Distributors of One Minute Picture Machines and Supplies in the World. Established 1902.

# FREE—Grape Fruit and Orange Trees—FREE

TO ALL WHO USE THE ATTACHED COUPON



In Reserving One of These Choice Citrus Fruit and Truck Farms on Our Special Terms of Only

**We are giving 100 fine, sturdy Citrus Fruit Trees FREE to each purchaser of one of these Florida farms—a full assortment of 100 Citrus Fruit Trees ABSOLUTELY FREE.**

These trees, when delivered, will be from one and a half to two years old, budded on strong, hardy, rough lemon and sour orange stock—good, sturdy, healthy young trees that compare favorably with those sold by the reliable nurseries at 45 to 85 cents apiece.

There are no strings to this exceedingly liberal offer. Every new purchaser who mails this coupon promptly, receives 100 sturdy Citrus Fruit trees of such an assortment as he may select. During 1914 your trees will be cultivated, budded and cared for by first class nurserymen without charge.

**To Get Your FREE Fruit Trees, Mail Coupon Today**  
OUR NEW LITHIA TRACT is suburban to Tampa, the metropolis of South Florida, and is one of the few choice citrus fruit tracts left in Hillsboro County, the recognized center of Florida's grape fruit and orange belt.

This is the third great Hillsboro County tract subdivided by our old established, responsible, thoroughly experienced organization. Over 2,500 families are now rejoicing because they bought at opening prices in our two former tracts. Every family can tell you they got a square and generous deal.

Our New Lithia Tract now offers you the same wonderful opportunity—better still, because of the rapid growth and development on all sides within the past four years. Our surveyors have completed their work of subdividing the New Lithia tract into 10, 20 and 40-acre Citrus Fruit and Truck Farms, and it is now being thrown open to home-seekers and investors.

Hillsboro County is building ONE MILLION DOLLARS' WORTH OF NEW BRICK COUNTRY ROADS—the first county in the U. S. to vote such an appropriation. Improvements of all kinds are going rapidly forward. Already buyers are building homes on our new Lithia Tract, and values are due to rise here just as they have in our two former suburban farm tracts in this same county.

The visible supply of select Hillsboro County grape fruit land is fast melting away. Prosperous homes are scattered around the new Lithia Tract—grape fruit and orange groves are flourishing on all sides.

One judicious investment beats years of labor. If you do not wish to improve your farm, you can cash in on it from the investment standpoint in a few years without a stroke of work on your part.

Get our big new Florida book and look at the map—four big railroads intersect our suburban farms—all the comforts of modern life right at hand! The completion of the Panama Canal throws the spotlight on Tampa, the nearest deep water port, and now the traffic of the whole maritime world will pause at Tampa's door.

Think of it—a 10-acre farm near a great city like this—a farm big enough to keep you in comfort all your lives, yet yours for just 3 1/2 cents per acre per day!

Get the facts now. The coupon brings them to you without cost or obligation—now, while prices on this newly opened tract are still low and terms easy. Today \$1.00 per acre per month buys you independence and a future. Tomorrow—who knows?

We have prepared a special bulletin and a large illustrated book which we will gladly send you free on receipt of the coupon. Tear it off and mail it NOW and we will lay before you, by return mail, full and complete information showing how you can easily become the owner of one of these beautiful suburban farms, and why it is sure to prove the shrewdest, most profitable investment you can ever make.

## North Tampa Land Co.

C. E. THOMAS, President  
1128 Commercial National Bank Bldg., CHICAGO

**CHICAGO**  
NORTH TAMPA LAND CO., 1128 Commercial National Bank Bldg., CHICAGO  
Please send me FREE assortment blank for 100 Sturdy Citrus Fruit Trees, also your latest and best illustrated Book on choice Citrus Fruit and Truck Farms suburban to Tampa, Florida.  
Name ..... Street No. .... City ..... State .....



# Do You Know a Boy Who is Waiting for this Book?

**H**E may have the few tools and materials to be found in every household, or he may possess his own complete chest of tools and well-equipped workshop, but something is lacking—He needs ideas—suggestions of things to make or do. He is tired of all the things that he and his companions have been able to think of. Now there are hundreds of other boys scattered all over this big country who have many new and interesting ideas he has never thought of, but how can this one boy ever get in touch with all these others? In just one way—through the pages of

## The Boy Mechanic

The Great Book of 700 Things For Boys To Do

These original, practical suggestions have been furnished by hundreds of boys who have actually built and experimented with the devices they are now telling other boys how to build. In no other way could a book containing such a wide and interesting variety of contents have been prepared, for no one author or staff of writers, for that matter, could have possibly gleaned such a wealth of ideas from their own observation and experience.

### THE BOY MECHANIC

Represents the Best Accomplishments of the Mechanical Genius of Young America

for the material used in the book is a careful selection of only those articles which are new, practical and of more than ordinary interest; the selection having been made by mechanical experts who still have active recollections of their boyhood interests. It gives complete directions for making all the things boys love to build and experiment with in the fields of electricity, mechanics, sports, arts and crafts work, magic, etc., such as

Electrical Appliances—Steam and Gas Engines—Turbines—Motors—Wireless and Morse Telegraph—Self-Propelled Vehicles—Toboggans—Ice Boats—Canoes—Paddle Boats—Punts—Camping Outfits—Tents—Fishing Tackle—Magic Lanterns—Searchlights—Cameras—Telescopes—Gliders, Kites and Ballons—Electric Furnaces—Lathes—Pottery Kilns.

A boy would be an old man before he could make half the things described in this wonderful book. It is entirely different from any other published and has

**700 Articles—480 Pages—800 Illustrations**  
(7 x 10)

**Price \$1.50 Postpaid**

It is clearly printed on high-grade book paper and durably bound in cloth. The cover is of an attractive design in four colors showing a boy building a small boat. There are ten solid pages of index alone. Neither care nor expense have been spared to make this the greatest boys' book published, and to enable as many boys as possible to have one, the price has been made absolutely as low as possible. It would be difficult to think of a way of investing \$1.50 that would benefit a boy as much as through the purchase of one of these books.

Sent postpaid to any address upon receipt of price by the publishers

**POPULAR MECHANICS  
BOOK DEPARTMENT**

6 North Michigan Blvd.  
**CHICAGO**



#### A Few Practical Features:

☑ A large number of the things described may be made from old cast-off articles which the average boy has at his disposal.

☑ Many articles involving the purchase of only a few cents worth of material will be found fully as serviceable as similar ones costing several dollars.

☑ Scores of handy things the family can use in the home are described.

☑ Finally, this book will develop and interest the boy along mechanical lines and educate him at his play.

“Wish I  
knew what  
to make”





**Special BARGAIN SALE**

**"EVERYBODY'S DOING IT"—BUYING DIAMONDS, WATCHES, JEWELRY, on CREDIT YOU SAVE ONE-THIRD**

**Diamonds Watches on credit**

Send for FREE Jewelry Catalog

(Established 1858) STORES ALSO IN: PITTSBURGH ST. LOUIS OMAHA

These are our Big Leaders—always fashionable, always worn by lovers of artistic jewelry. Let us send you any of these handsome pieces, or any article shown in our Catalog, for your examination and approval, all delivery charges prepaid by us. If satisfactory, send us one-fifth of purchase price as first payment, balance in eight equal amounts, payable monthly. No. 520-Diamond Ring, "The Young Man's Favorite," 6-prong "Tooth" mounting, 14k solid gold \$65 No. 521-Diamond Ring, the famous Loftis "Perfection" mounting, 14k solid gold \$50 No. 625-LaValiere, solid gold, 1 Diamond, 4 whole Pearls, 2 Sapphires; with 15 in. chain. Our best seller, \$25

Our handsome 116-page Catalog, illustrating over 2,000 bargains, is sent free on request. All the new, popular styles in Jewelry—gorgeously beautiful Diamonds, Artistic solid gold and platinum mountings—exquisite things—that sell in some cash stores at almost double our prices. Our Easy Credit Plan is fully explained in Catalog. Send for it today. IT IS FREE.

**LOFTIS BROS. & CO., Diamonds, Watches, etc.**  
Dept. M 894, 100 to 108 N. State Street, CHICAGO, ILL.



**Cannot Rot, Split, Curl-up or Burn**



Group of Metal Slates

Spring building and repairs revive that old sleep disturber "What kind of a roof shall I put on?"

Wood shingles are short-lived, leaky, a fire menace, and are constantly growing scarcer and higher in price; slate is heavy, fragile, often dangerous.

**Cortright Metal Shingles**

have none of these disadvantages. They're fireproof, stormproof, last indefinitely and never need repairs.

Our free book, "Concerning that Roof" should be in your hands. Write for it today.

Group of Victoria Shingles

**CORTRIGHT METAL ROOFING COMPANY**  
Inquiry Dept. 210 S. 7th St., Philadelphia, Pa.

**BIGGER MONEY FROM MUSHROOMS**



There never was a time when such big, quick, easy and sure profits could be made in growing mushrooms, as today. Learn the great revolutionary improvement in mushroom culture, "The Truth About Mushrooms," from the greatest practical authority in America. Grow mushrooms now if you never thought of doing it before. Present occupation will not interfere. Add \$10 to \$70 to your weekly income.

Small capital to start. Profits now bigger, quicker, easier. Demand exceeds supply. Grow in cellars, sheds, boxes, etc. Any one can do it. Women and children, too. Now is best time. Send for this book today; it's Free.

**BUREAU OF MUSHROOM INDUSTRY, Dept. 152, 1342 N. Clark St., CHICAGO**

**A pocket KNIFE SHARPENER FREE**

The tough, sharp crystals of a Pike India Oilstone just eat steel. It's fun to see how quickly they put a dandy, keen edge on carvers, kitchen knives, tools, etc. No other stone cuts so fast without losing its shape.

Adopted now by manual training schools, big machine shops, etc. Nothing like it. This is only one of the famous

**PIKE SHARPENING STONES**

"The only line that includes every sharpening substance—natural or artificial—each the best for some sharpening need."

Every home needs one. Hardware and tool stores everywhere sell them.

Let us mail you a Pike India Vest Pocket Stone for pocket knives, office use, etc. Just send your dealer's name and 4c. for packing and mailing. We'll include "How to Sharpen"—greatest book ever written on sharpening and how to select and care for oilstones. You'll be pleased. Write today.

**Pike Manufacturing Co.**  
101 Main St., Pike, N. H.

**Make this car your office—**

there is \$900.00 to \$1800.00 a year in it for you

Examinations will likely be held everywhere soon

Rapid advancement to higher Government Positions. "No layoffs" because of STRIKES, FINANCIAL FLURRIES or the WHIMS OF SOME PETTY BOSS. THE POSITION IS YOURS FOR LIFE.

Country residents and city residents stand the same chance for immediate appointment. Common-sense education sufficient. Political influence NOT REQUIRED.

We will prepare 25 candidates FREE! Write immediately for schedule showing the places and dates of all SPRING examinations. Don't delay. Every day you lose means the loss of just so much coaching before the rapidly approaching examinations.

**FRANKLIN INSTITUTE, Dept. F 174, Rochester, N.Y.**

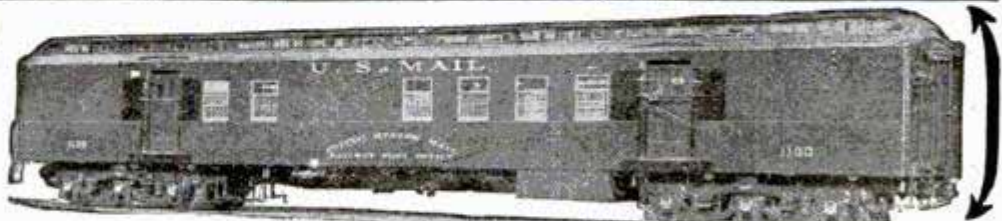

Hundreds of Parcels Post Railway Mail Clerks Needed NOW!

Franklin Institute (The pathway to plenty), Dept. F174, Rochester, N. Y.

The coupon, filled out as directed, entitles the sender to free specimen questions; a free copy of our book, "Government Positions and How to Obtain Them," a list of positions now available, and to consideration for Free Coaching for the examination here checked.

- ... Railway Mail Clerk (\$900 to \$1800) .... Customs Positions (\$800 to \$1500)
- ... Bookkeeper ..... (\$900 to \$1800) .... Stenographer .... (\$800 to \$1500)
- ... Postoffice Clerk ..... (\$800 to \$1200) .... Internal Revenue .. (\$700 to \$1800)
- ... Postoffice Carrier ..... (\$800 to \$1200) .... Clerk in the Departments
- ... Rural Mail Carrier ..... (\$500 to \$1100) .... at Washington (\$800 to \$1500)
- ... Automobile Chauffeur ..... Canadian Government Positions .....

Name..... Address..... F174

Use this before you lose it. Write plainly.



# The Motor that's Better Built Wisconsin

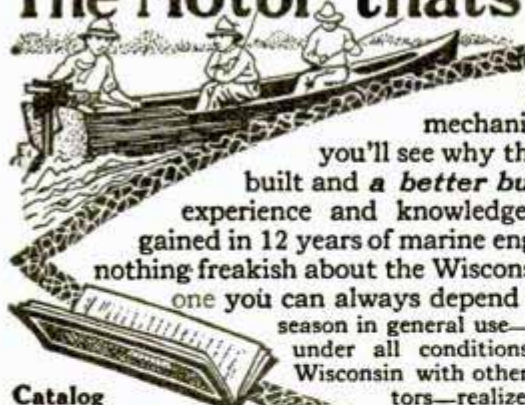

Look at it from the mechanical viewpoint and you'll see why the Wisconsin is better built and a *better buy*. Back of it is the experience and knowledge - of - what's - needed gained in 12 years of marine engine building. There's nothing freakish about the Wisconsin—it's a *real motor*, one you can always depend on. This is its third season in general use—it has made good under all conditions. Compare the Wisconsin with other detachable motors—realize what we mean by *better built*.



## Detachable Row Boat Motor

Size up these specifications:—  
 Reversible *High-Tension* Magneto—no missing even at slowest speeds; Rudder Steering—complete control even when motor is still; Improved Carburetor—20% more power on less fuel; Nickel Aluminum Crankcase, Nickel Babbitt Bearings, Phosphor Bronze Connecting Rod and Gearhousing. Isn't *this* the class of motor you want?  
**WISCONSIN MACHINERY & MFG. CO.**  
 989 Canal Street  
 Milwaukee, Wis.

Catalog  
**FREE**

Write today for our 1914 Catalog—  
 —for the facts you ought to have  
 about the Wisconsin and how it's built.

## Hand-Forging and Wrought-Iron Ornamental Work

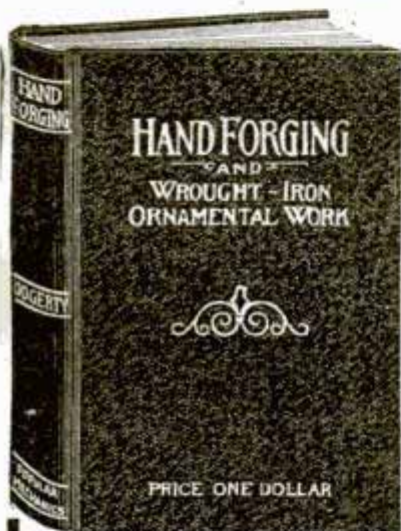

### Brief Outline of Contents

Introductory—The Spirit of Decorating—Correct Principles in Designing—Equipment—How to Draw the Iron Working at the Forge—Various Processes described—Various Forms of Welding—Brazing—Twisting—Banding—Riveting—Scrollwork—Grilles—Welded Scrollwork—Box Forging—Embossing—Forms in Relief—Raised Forms—Special Designs—Drawer Pulls and Hinges, etc.—Door Plates—Iron Lamps.

A New Book on a Fascinating Handicraft  
 By **THOS. F. GOOGERTY**

208 pages. 122 illustrations. 12mo. Printed on a special grade of book paper and bound durably in extra cloth. Special quotations to schools ordering in quantities. **Price \$1 Postpaid**

**POPULAR MECHANICS BOOK DEPT.**  
 318 W. Washington St., CHICAGO

Ask about our  
 \$,000 R. D. Tools

### "Red Devil" Glass Cutters

*"It's all in the wheel"*

For 3 2c. stamps we will send any glazier 1 No. 024 Glass Cutter.  
**SMITH & HEMENWAY CO.**  
 150 - 152 Chambers Street, New York, N. Y., U. S. A.

The director of the Deutsche Bank has recently completed a report of the wealth of the German and other nations, showing an aggregate of \$75,000,000,000 to \$78,000,000,000 for Germany. The wealth of France is placed at \$60,000,000,000; England, \$57,000,000,000 to \$65,000,000,000, and the United States, \$124,000,000,000. German per-capita wealth is placed at from \$1,100 to \$1,200; France, \$1,425; England, \$1,250 to \$1,385; and United States, \$1,360. The annual income of the German people is estimated at between \$9,000,000,000 and \$10,000,000,000, of which about one-sixth is used for public purposes.

### \$1 SELF FILLING FOUNTAIN PEN 25c

Every Man, Woman and Child should take advantage of this offer. To advertise our specialties we will send this Guaranteed Self-Filling Fountain Pen postpaid to any address on receipt of the cost of packing and postage. Guaranteed not to leak. Each pen nicely packed in separate box. Send 25c in stamps or coin; with clip 5c additional.  
**ROYAL SPECIALTY CO., Dept. B, 4054-3rd Ave., Bronx, NEW YORK**

# "I'll Pay \$1.00 For Every Knot"



That's my 1914 challenge to every man who buys or sells lumber. I'll pay \$1.00 per knot for every knot any customer can find in our Red Cedar Siding shipped from Bay City. I stand ready to prove to you in this way that the lumber in Aladdin houses is higher in grade throughout than is regularly carried by any seller of lumber in America.  
**O. E. Sovereign, Gen. Mgr.**

## Dwellings, Bungalows, Summer Cottages, Garages

Besides having the best of lumber, Aladdin houses have character, distinction and beauty. You can save \$200 to \$300 on the cost. Aladdin lumber comes direct from the forest, no middlemen's profits, material cut to fit, saving one-half the expense for labor. They are warmer and stronger. Price includes Clear Siding, Clear Flooring, Clear Interior Finish and Clear Shingles, framing lumber and sheathing, all cut to fit; outside and inside finish, windows, frames, stairways, hardware, nails, paints and varnishes, shingles, lath and plaster or plaster board, in short everything to complete the house. Send today for catalog 180.

**North American Can. Branch: C. P. Construction Co.**  
 R. Bldg., Toronto - 183 Aladdin Ave.

**5-Room House \$298**  
 This Warm, Snug Winter Home with five cozy rooms only \$298. Price includes all material cut-to-fit, all hardware, nails, paints—in short everything to complete the house. Can be shipped same day order is received.  
 Bay City, Mich.



# Genuine Latest Models Victrola

and 6 double-faced records  
(12 pieces to play) sent  
direct to you for



## FREE TRIAL

No Money Down    No Deposit    No Obligation

Don't send me one cent. Just select from my handsome free catalogue the Victor or Victrola you want and the 6 records (12 pieces to play) and I will send them to you for free trial. Then if you decide to keep the outfit, you can buy on **Easy Payments**—so small you'll never notice them. No interest—no premium.

**As Little as \$2.00 per Month**

will buy a genuine Victrola and records.  
On some instruments you have as long as

## ONE YEAR TO PAY

If after the trial you decide you don't want the outfit, just send it back at my expense.

**My Free Book**—Complete and beautifully illustrated. Contains details of free trial and easy payment plan with detailed descriptions of all machines and lists of records. Write to-day. NOW.

PETER GOODWIN, President

**PETER GOODWIN MERCANTILE CO.**

Distributors of Victors  
and Victrolas

422 Syndicate Trust Bldg.  
ST. LOUIS, MO.

There are 36,500,000 young trees in the government's forest nurseries.

**Save \$10.00  
Lawyer's Fees**

**PROVIDE FOR YOUR  
WIFE AND CHILDREN  
Make Your Will NOW!**

Our blank form, guaranteed legal in every State, sent postpaid with full instructions for **ONLY 50c stamps or coin.** Money back if you want it. **Don't Take Risks! SAVE \$10.00** by sending this ad and 50c to **HUSE PUBLISHING COMPANY, Box 5, NORFOLK, NEBR.**

## Get Your Canadian Home From The Canadian Pacific

One-twentieth down—the balance in 19 equal annual payments. **Good land** in Western Canada—every kind of farming—\$11 to \$30 an acre.

### \$2,000 Improvement Loan

20 years to pay—only 6% interest. Best livestock supplied, actual cost. Expert demonstration work at your service. **FREE BOOKLETS** on Manitoba, Alberta-Saskatchewan, Irrigation Farming. Write today.

**G. E. THORNTON, Colonization Agent, 112 W. Adams St. CHICAGO**

## ZIG ZAG AUTOMATIC STROPPER

### A SHARP BLADE FOR EVERY SHAVE

How would you like to have your first safety razor blade stay new for months? If you use up a brand new blade every two or three days to insure comfortable, clean shaves, then here is a device that will give you more personal satisfaction than any dollar's worth you ever bought before. Sharpens any standard safety razor blade; simple and strong, it will last for years; nothing to get out of order. At your dealer's or sent prepaid for \$1.00, complete with strop. Money-back guarantee.

**ZIG ZAG SALES CO.**  
407 Union Street,  
Plymouth, Mich.

**\$1.00**  
**COMPLETE  
WITH STROP**



## Does the Joy of Outdoor Life Mean Anything to You?

Is it not the short jaunt into the country; the week-end fishing trip, or the pleasure of a ride in your parks that makes life hum with sincere delight?

Has the need of a conveyance, within your means, been depriving you of these essentials to health and happiness?

## THE

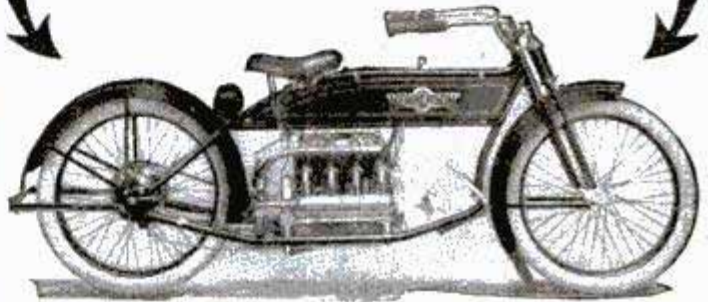

## HENDERSON

Will make those favorite haunts in the country easily accessible to you and your companion—

Will give you the bracing air at intervals during your working day as no other vehicle can.

A quiet running, four-cylinder motor, lowest center of gravity, longest wheelbase, most comfortable saddle position and greatest adaptability to tandem and side car, are distinctions of note.

A beautiful illustrated catalog describes how these

### Exclusive Henderson Features

will give you maximum efficiency and comfort at the lowest upkeep cost.

**"We Mail It on Request"**

**Henderson Motorcycle Co.**

**Detroit, Michigan**



# They Show and Name Every Part

Cut Shows Auto Model Partly Unfolded

Actual Size  
9½x25  
Inches

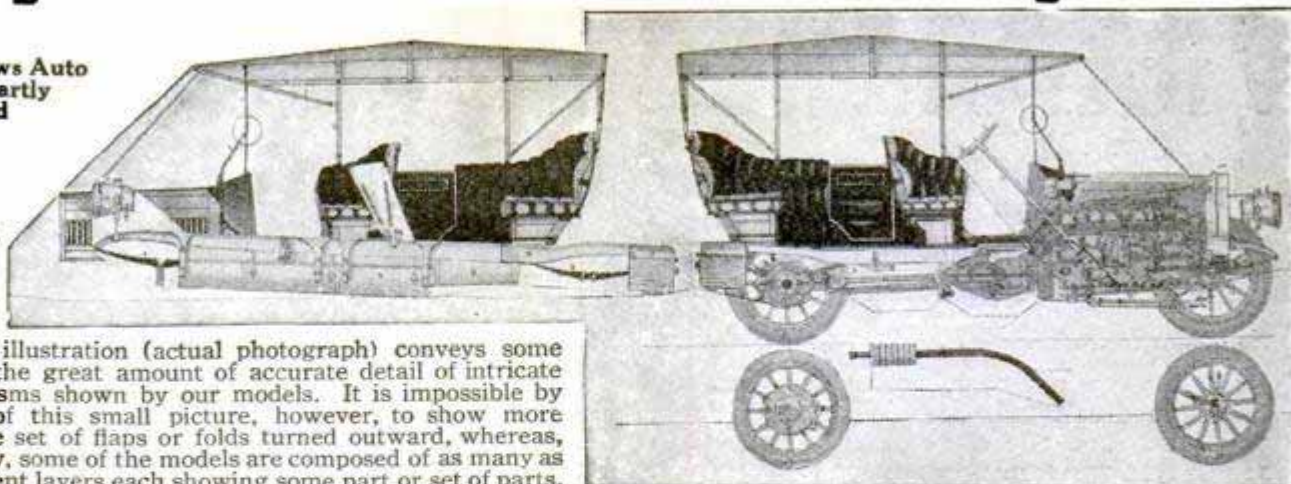

The illustration (actual photograph) conveys some idea of the great amount of accurate detail of intricate mechanisms shown by our models. It is impossible by means of this small picture, however, to show more than one set of flaps or folds turned outward, whereas, in reality, some of the models are composed of as many as 14 different layers each showing some part or set of parts.

## Series of Eight Lithographic Models

Price 50c Each. Complete Set of Eight Models, \$3.50 Postpaid

Automobile  
Locomotive  
Steamship (Ocean Liner)  
Wireless Telegraph  
Steam Turbine  
Steam Engine  
Gas Engine  
Dynamo

The ingenious way in which all the interrelated mechanism is thus clearly shown can only be appreciated by seeing and examining the models themselves. The ease with which the detail may be studied will be readily understood as by turning the flaps the models can be practically disassembled and put together again. Each part is numbered to correspond with its name found on a printed key.

You can get more information about the construction and operation of these machines by use of the models than in any other way. No detail is omitted. Everything is accurate and in true proportion and they have the approval of the manufacturers of the machines represented. They are not toys in any sense but are educational in character and worth many times their cost. Invaluable for individual study or supplementary to school courses.

**POPULAR MECHANICS BOOK DEPARTMENT**  
SOLE AGENTS 6 No. MICHIGAN BLVD. CHICAGO

## YOUNG MAN! LEARN DRAFTING

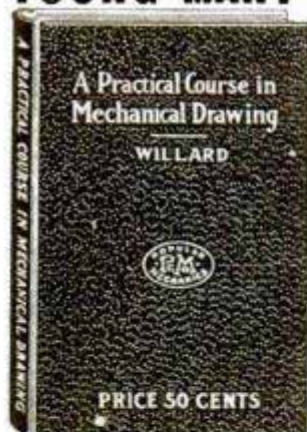

ONE of the most practical subjects of study today; an essential in most lines of engineering; indispensable in many occupations and often the secret of successful advancement; of no less importance to the farmer than the mechanic. There is bound to come a time when you will feel the need of the ability to "lay out" something in accordance with the rules and conventions used in the drafting profession.

### Individual Study

may be successfully engaged in with the aid of our new enlarged edition of the book

## A Practical Course in Mechanical Drawing

By WM. F. WILLARD

(For several years instructor in Mechanical Drawing at Armour Institute of Technology, Chicago)

160 PAGES — SIZE 5x7 — 157 DRAWINGS — CLOTH COVER

Price 50 Cents, Postpaid

There has been a real need for a book of this kind, as it clinches each problem in the mind of the student by giving the practical application of that problem to every day practice in some phase of the world's work. It meets every modern requirement and is in advance of any other work on the subject. Excellent for use in shop classes, trade or high schools. A complete detailed description of the contents of this book sent free upon request.

Order of your Book Dealer or direct from the publishers

**POPULAR MECHANICS BOOK DEPT.**  
6 No. Michigan Blvd., CHICAGO

## Pattern-Making

BY C. H. WILLARD

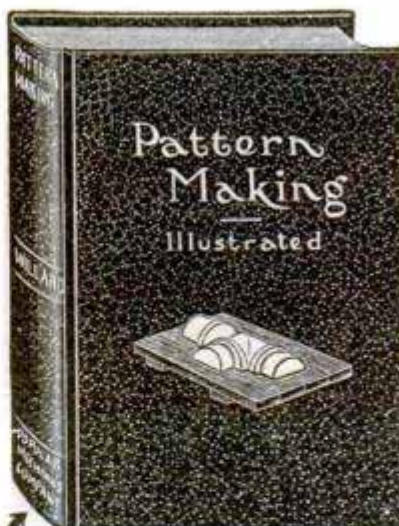

With Additional Chapters on  
Core-Making  
and Molding

224 Pages  
312 Illustrations  
Cloth Cover  
Price \$1.00 Postpaid

"Written So You Can Understand It"

A book for the man who has to do the work. Written by a practical pattern-maker of many years' experience.

**CHAPTER HEADINGS.** I. Pattern-Making as a Trade. II. The Tools. III. Woods. IV. Joints. V. Turning. VI. Turning (Continued). VII. Turning (Continued). VIII. Turning (Continued). IX. The Circular Saw. X. The Circular Saw (Continued). XI. Machine Tools. XII. Machine Tools (Continued). XIII. Simple Patterns. XIV. Simple Patterns (Continued). XV. Simple Patterns (Continued). XVI. Crooked Patterns. XVII. Large Pattern Work. XVIII. Large Pattern Work (Continued). XIX. Crosshead Guide Patterns. XX. Sweep Work. XXI. Pipe Work. XXII. Stove Pattern Work. XXIII. Molding—Machine Work. XXIV. Molding Pattern Work.

**PART II—Core-Making and Molding.** Chapter I. Core-Making, Simple and Complex. II. Principles in Molding. III. Loam Patterns and Loam Molds.

Every one following this trade, or intending to learn it, should have a copy of this valuable book.

**POPULAR MECHANICS BOOK DEPT.**  
6 No. Michigan Blvd., CHICAGO



## ARE YOU INTERESTED IN

## Cheaper Power?

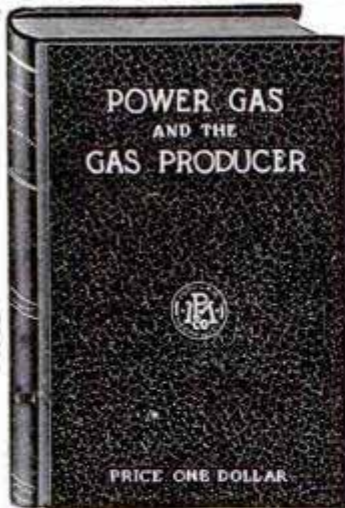

Under certain conditions the gas producer makes a startling saving in the cost of power and it is worth every power user's time to know whether or not his present system is the best.

To meet a demand for information which has not been hitherto available except by the employment of an expert, we have been fortunate in securing the services of an eminent

gas power engineer, Mr. J. C. Miller, M. E., who has written a book on this subject which we have recently published. It gives just the information a man wants to have, comparing the first cost of steam engines and boilers with the gas producer and gas engine, and the comparative cost of maintenance and operation. It tells all about the advantages and troubles of gas producers, and gives full details of how to run them. It is written in an absolutely impartial manner, and not with a view to increase the sale of gas plants, leaving the decision as to the advisability to the individual reader. It will also enable the Steam Engineer to understand thoroughly the working of the new system if the change is made, and to handle a plant competently and with confidence.

## POWER GAS AND THE GAS PRODUCER

has 200 pages, is printed on the best book paper, profusely illustrated with half-tones from photographs, diagrams, etc., and durably bound in extra cloth.

SENT POSTPAID TO ANY ADDRESS FOR \$1

Popular Mechanics Book Dept., 318 W. Washington St., CHICAGO

## WARNING

From widely separated parts of the country come reports of the operation of subscription swindlers. These are young men who represent themselves as students working their way through college, and who are offering Popular Mechanics Magazine as a "trial offer" at 49 cents for a full year. Usually one, and sometimes two other magazines are included, all for the 49 cents.

Popular Mechanics Magazine has no subscription solicitors and prints a notice to that effect on its front cover every month, and never offers its subscription at less than the regular price of \$1.50.

POPULAR MECHANICS COMPANY  
H. H. WINDSOR, Pres.

# SAVES

## A MESSAGE TO FORD OWNERS

Big-Car-Luxury is now a reality for owners of Ford Cars. E. Z. Rider Shock Absorbers give that smooth, floating restfulness.

If you would enjoy your FORD to the utmost, learn about these E. Z. Rider Shock Absorbers— and learn what they SAVE you and your Ford

- SAVES**—the bumps, jumps, vibrations and irritations of rough roads and pavements. The sensitive coiled springs make all roads seem smooth.
- SAVES**—wear and tear on your Ford by absorbing the shock and vibrations. E. Z. more than save their cost, by saving car repairs.
- SAVES**—engine trouble by protecting the delicate mechanism from ruinous jar and vibration. Saves you delay, trouble and expense, and E. Z. Rider saves tires by easing the traction strain and preventing bound and rebound.

### Try E. Z. Rider Shock Absorbers 10 Days

We want to send every Ford Car Owner a set of E. Z. Rider on 10 days trial. If not pleased, return E. Z. and receive your money back. Once you know E. Z., you'll never drive without them.

Dust proof, trouble proof, long wearing, fully guaranteed. Set weighs only 20 pounds. Easily and quickly installed—you can do it, we send all instructions.

\$15 set of four (front and rear) F. O. B. Cleveland

Order a set today for your Ford

**The Forest City Electric Co.**  
5008 Windsor Avenue CLEVELAND, O.  
Reference—Bradstreets

## MECHANICS' COMPUTING DEVICE



By rotating cap on end this Thread and Tap Gauge shows at a glance the size of drill to use for taps; also number of threads per inch. 4 Types—U. S. S.  $\frac{1}{8}$ " to 2"—Pipe,  $\frac{1}{8}$ " to 3 $\frac{1}{2}$ "—A. L. A. M. to 1"—S. A. E.  $\frac{1}{8}$ " to 1 $\frac{1}{2}$ ". Price of any type 50c postpaid. Please avoid sending stamps if possible. AGENTS WANTED. Patented. Made and sold only by WM. J. RAINEY, Box 135, GROVE CITY, PA.



## South Bend Lathes

9 to 18' Swing  
Foot Power, Steam Power  
Electric Motor Drive  
Straight or Gap Bed

\$7500  
and up

Write for Catalog and Price  
SOUTH BEND MACHINE TOOL CO.  
423 Madison St., South Bend, Ind.

## 80c Profit on Each Dollar

selling one minute pictures at fairs, carnivals, picnics, busy street corners, and everywhere you can think of. I positively show you how to make this money. You need no experience. You can start at once. I want ambitious men and women to take advantage of my most amazing offer.

## \$12.00 ONE MINUTE CAMERA AND COMPLETE OUTFIT

Yes, only \$12.00 sets you up in the liveliest, quickest money-getting business of today. This wonderful camera makes pictures on post-cards and buttons without films or plates. Pictures are finished, ready to sell, in one minute. They sell for 10c each—cost you 1 $\frac{1}{2}$ c. Over 8c profit on a sale—80c on each dollar.

I offer you this great chance to earn \$50 a week. Begin now. You can't lose. My \$12 outfit includes the One Minute Camera, tripod and material to make 50 finished 2 $\frac{3}{4}$  x 3 $\frac{1}{4}$  inch pictures. First sales bring \$5. Your only expense after that will be the small cost of supplies. Write me today for FREE PARTICULARS.

M. Cowan, Mgr., ONE MINUTE CAMERA CO., Dept. 429, 536 S. Clark St., CHICAGO





# ANDREWS STEEL BOILER FOR HOT-WATER HEATING

THE boiler is the heart of any hot-water plant. On its heating efficiency, durability and ease of operation, your whole heating system must depend. The Andrews Steel Boilers are made of plate steel like large power boilers. No interior castings except the grate. Almost double the fire travel of other boilers, obtaining quick heating. Burns any grade fuel. Can be used for hot water or steam.

**We Sell Complete Plants or Just the Boiler**

Any man handy with tools can install them



Shipped  
Freight  
Prepaid  
To Your  
Nearest  
Depot

Andrews Locomotive  
Steel Boiler. Most  
Durable. Heats very  
quickly on little fuel  
of any grade. Easily  
cleaned.

**360 DAYS FREE TRIAL.**  
guaranteed by bond, given on our steel  
boilers and on our complete heating plants.

## Big 72-Page Heating Book FREE

This book should be in the hands of everyone building a new home or contemplating the changing of heating plants in old homes. It describes the Andrews Systems and Boilers completely, tells how they are sold and gives valuable information on other features to modernize the home.

WRITE TODAY—

**Andrews Heating Co., 1423 Heating Building  
MINNEAPOLIS, MINN.**

**Lightest Motorcycle Built in America**  
None More Efficient. Most Economical Means for Rapid Transit.

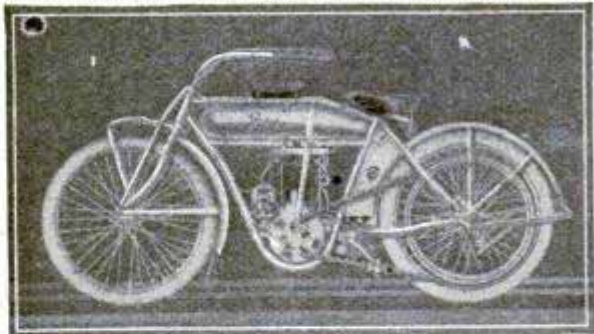

**Model H-14. Price \$150.00** Easy to drive as a horse, but with four times the power. Splendidly equipped. Imported magneto; "V" belt drive; Eclipse clutch; spring seat post; large separate gasoline and oil tanks. Send for Catalog. **THE POPE MANUFACTURING CO., 16 Cycle Street, Westfield, Mass., U.S.A.**

## New Typewriter \$18

in U.S.A.

*A Remarkable Typewriter, Carried in Grip or in Overcoat Pocket. Standard Keyboard. Does Work of \$100 Machine. Over 34,000 in Daily Use.*

Bennett Portable Typewriter has less than 250 parts, against 1700 to 3700 in others. That's the secret of our \$18 price. It's built in the famous Elliott-Fisher Billing Machine Factory, sold on a money-back-unless-satisfied guaranty. Wt. 4½ lbs. You can carry for home use, business or trips. Send for catalog and



**Agents' Proposition.**

**CHARLES M. BENNETT CO., 1304 Cedar Street, Harrisburg, Pa.**

## \$200 A MONTH

operating the **New Model Combination Camera**. It takes and instantly develops eleven entirely different styles of pictures, including two sizes and four styles **Paper Postcards**, six styles of Tintype Pictures, and Brooch Pictures. Requires no experience whatever. Everybody wants pictures. Five hundred per cent. profit. **The World's Biggest Money-maker**. Small investment secures complete outfit, including Camera, Tripod, and material for 150 pictures. Make money the first day, no matter where you live or what you are doing. **WE TRUST YOU**. Write today for free information, including letters from prosperous operators everywhere.

**L. LASCELLE, 627 W. 43d St., Dept. 1214, New York**

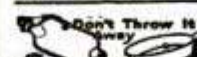

**MENDETS**  
A GREAT DISCOVERY

Mend leaks instantly in all utensils, graniteware, aluminum, tin, brass, hot water bags, etc. No solder, cement or rivet. Any one can use them. Send for sample box, **10c**; large box, all sizes, **25c**, postpaid. **Agents Wanted. Collette Mfg. Co., Box 404, Amsterdam, N. Y.**

**WHEN YOU WANT ANYTHING AND DON'T KNOW WHERE TO FIND IT  
WRITE BUREAU OF INFORMATION,  
POPULAR MECHANICS CHICAGO**

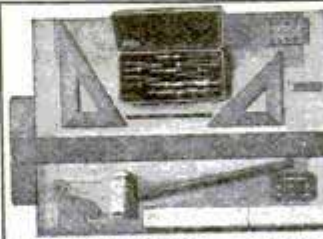

**DRAWING OUTFIT \$3.80**  
COMPLETE. Special

Outfit consists of Board, T-Square, Triangles, Fine Set of Instruments, Scale, Tacks, Pencils, Rubber, Curve, etc. Buy your boy this outfit and start him off to become an Edison or Westinghouse. Don't waste your good money on instruction, unless you yourself can see that the boy has mechanical ability. Better outfits for \$5.80, \$8.75 and \$12.00. Sent on receipt of price. Send for circular. Agents wanted in every town to represent us. **E. G. RUEHLE & CO.**

Largest Manufacturers. 119 Fulton St., New York, N. Y., Branch, Newark, N. J.

## Chart of a Modern Submarine

Price 25c Postpaid

Showing and naming over 200 parts. Size 14x28 inches. Printed on Plate Paper.

**POPULAR MECHANICS BOOK DEPT.  
318 W. Washington St. Chicago**

# Speedaway

Detachable

## Rowboat Motor

**Speedaway Is the King of  
Detachable Rowboat Motors**

Just look into it and I'll bet you can't resist buying one. I couldn't.

I get a speed of 8 to 10 miles an hour out of my boat. The two-cycle, air-cooled engine develops full 2 h. p. at 1200 r. p. m.

My hands are free except when I change the course. The tiller sets in any direction and automatically holds the boat on its course.

I never have any trouble with weeds. The bronze propeller is surrounded and protected by a large and efficient rudder.

It's got noiseless underwater exhaust, too. And, say, but it sure is handy. Weighs only 50 lbs. and fits snugly in a special satchel-like case. I can put it on my boat or take it off in two minutes.

**You ought to get yourself a  
SPEEDAWAY  
IT'S IMMENSE!**

Write for handsome illustrated Catalog.

**SPEEDAWAY BOAT MOTOR CO.**  
(Owned and controlled by the Hofer Mfg. Co.)

165  
Chicago  
Street  
FREERPORT  
ILL.

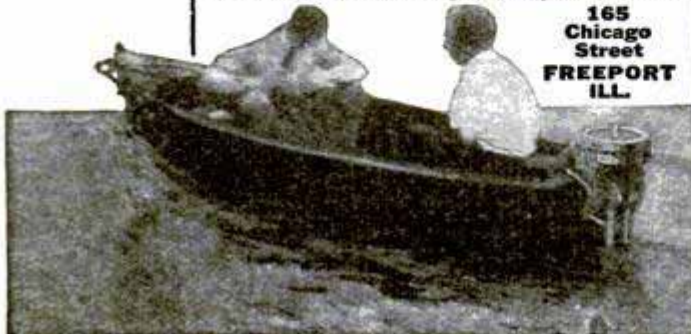



# A 6 lb. Typewriter

For Personal Use.



Carrying Case  
2 3/4 lbs



**\$50**

**CORONA**

**A complete high grade standard writing machine**

that you can carry with you on your trips, use at home, or in your place of business.

The only portable typewriter with all of these features: visible writing, two color ribbon, front stroke, type bar, back spacer and stencil cutting device.

A booklet describing the Corona, the lightest and most compact standard typewriter ever made, will be sent free. Ask for "Corona 6 lb. Booklet No. 8"

**Standard Typewriter Co., Groton, N. Y.**

New York office, 1493 Broadway

Agencies in principal cities of the world.

## PORTABLE SUMMER CAMP



Complete plans, specifications and full directions for building, including complete bill of all necessary material.

Address **By Mail \$1**  
P. M. BURGESS,  
1063 Balmoral Ave.  
CHICAGO, ILL.

## Toledo MARINE MOTORS

"Nothing Cheap but the Price"

3 H. P. 1 cyl. complete	\$ 65.00
6 H. P. 1 " "	84.00
6 H. P. 2 " "	125.00
12 H. P. 2 " "	160.00
18 H. P. 3 " "	250.00

Fully guaranteed by a responsible concern. 2 cycle, 2 port, 3 1/2x3 1/4 and 4 1/2x4 1/4. Send for free catalog "C."

THE UNIVERSAL MACHINE CO., Pike Ave., Bowling Green, O.

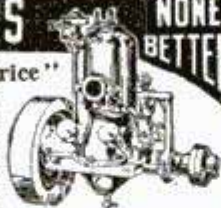

NONE BETTER

## Why Did It Sell Quick?



Build your house so other people want it. You can do it at no greater cost if your plan is right. We can show you first. Accept this

**BIG \$1 OFFER**  
**KEITH'S**  
**PLAN BOOK, 100**  
**Artistic Homes**

Keith's 1610—Built in Fall, 1913

And 6 numbers of Keith's 80-page monthly Magazine on Home Building (established 14 years), and recognized a leading authority. Each issue contains 8 House Plans by leading architects. Many beautifully illustrated articles on building and interior decoration. Practical articles on construction and materials. Subscription, \$2 a year. News-stands.

**KEITH'S Will Help You "DO IT RIGHT!"**

M. L. KEITH, 507 McKnight Bldg., Minneapolis, Minn.

# Yours for \$2

a month. This \$35.00 set now only \$19.80!

Here's a real opportunity! You can buy at almost half price, the most complete and comprehensive work on electricity ever published — the world's greatest electrical library is now offered to you on the easiest of monthly payments. This plan brings these great books within the reach of all. Take advantage of this opportunity. Be an Electrician — start now. These books and our wonderful consulting privilege will give you a complete electrical education. Whether worker, engineer or expert, these books will add to your knowledge, add to your job and add to your salary.

## Cyclopedia of Applied Electricity

Contains 3,200 pages, 7x10 inches; 2,600 illustrations, full page plates, diagrams, etc.; hundreds of valuable tables and formulas; carefully cross-indexed for quick, easy reference. Printed in large, clear type on special quality paper and bound in half red morocco, gold stamped.

### Read These Subjects Carefully

Theory, Calculation, Design and Construction of Generators and Motors—Electrical Measurements—Electric Wiring—Electric Welding—Types of Generators and Motors—Management of Generators and Motors—Storage Batteries—Electric Lighting—Alternating Current Machinery—Station Appliances—Power Stations—Power Transmission—Central Station Engineering—Electric Railways, Including Single-Phase—The Electric Telegraph—Telephone Equipment, Systems and Operation—Wireless Telegraph and Telephone—Telautograph, Telephonograph, etc., etc.

**Shipped Free** The complete seven volumes, not a sample volume, will be sent, express prepaid, for seven days' free examination; returnable at our expense if they fail to meet with your expectations. If you keep them, pay \$2.00 seven days after receipt and then \$2.00 a month until you have paid the introductory price of \$19.80. Fill in and mail the coupon — today. It won't cost you a cent to examine the books, so get them into your home and look them over at your leisure. Remember, if you don't like them they may be returned at our expense.

## Consulting Service Free

With every set is included a year's Consulting Membership, regular value \$12.00, entitling you to the free advice of a staff of electrical experts. This will give you practical help in handling your difficult working problems. There will be no limit to this service — ask as many questions as you wish for an entire year. This service alone may be worth more than the first cost of the books. Don't wait. This means \$15.20 saved if you act now. You take no chances whatever. It costs nothing to inspect and you are nothing out if you do not care to buy. Mail the coupon today.

**FREE COUPON** Worth \$15.20 to You

**American Technical Society, Chicago, U. S. A.**

Please send me Cyclopedia of Applied Electricity for 7 days' free examination. If I decide to buy, will send \$2 in 7 days and balance \$2 a month until \$19.80 has been paid, when \$35 books and \$12 Consulting Membership will be mine. Otherwise will notify you and hold books subject to your order. Title not to pass until fully paid. Pop. Mech. 4-14

NAME.....

ADDRESS.....

As I have had no previous dealings with you, I refer you to



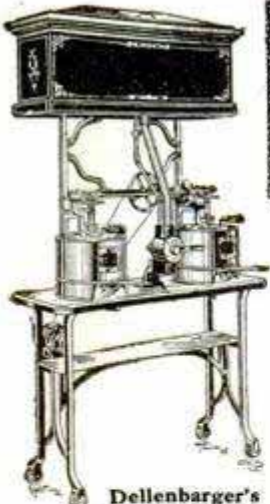

Dellenbarger's Kettle-Popped Pop Corn Machine made in several sizes.

**NOTE!**  
We also make Complete Wagon Outfits for Transit purposes. Our booklet describes them.



# Get Into The Pop-Corn, Crispette And Candy Business

## We Will Start You!

and teach you the business FREE. Tell you how to make the most money with the least effort—how to get the crowds—how to cash in BIG from the very start! We'll help locate you, too, if you wish, and make it so easy that you can start at once and

## Pay Us Later From Your Profits

Hundreds of men and women everywhere are making BIG money in the ever-popular Pop Corn, Crispette and Candy Business. We will gladly do for you what we have done for hundreds before you. We make the terms so easy that a very small amount is sufficient to start you.

**\$600.00 in 3 days** that's what one man took in at Braidwood, Ill. Another made \$225 in one day. A young woman in St. Louis took in \$50 in 1½ hours. Think of it! Did you ever hear of such a wonderful business? Yet, you, too, can do as well in this easy business of BIG PROFITS. Now then, don't wait—don't think you haven't enough money, for with our easy payment plan very little is needed.

## Dellenbarger's Kettle-Popped Pop Corn

a new process, means—large, light, fluffy and tender kernels that melt in your mouth. Makes Crispettes wonderfully rich and delicious—the kind that "wins" the "Come-back-to-get-more" crowds.

### Start at Once—NOW!

Send for our big, generous co-operation offer. FREE catalogues and full particulars explaining how we start you on easy payments. *Don't put this opportunity off another minute.*

**Write Today, SURE!** before you forget it. Our big offer sent by return mail. It's up to you NOW to act—DO SO! Address

**C. T. DELLENBARGER & CO.**  
617 W. Jackson Boul.  
CHICAGO, ILL.

We Teach You the Business FREE

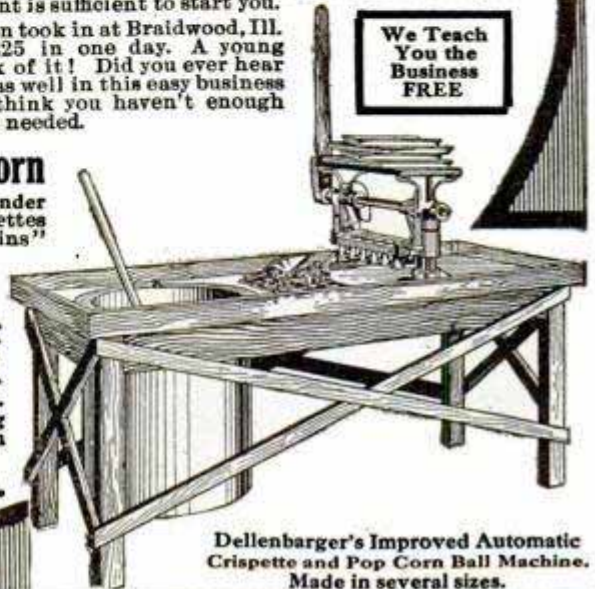

Dellenbarger's Improved Automatic Crispette and Pop Corn Ball Machine. Made in several sizes.

## WHEN YOU BUILD YOUR HOME

### Plan for It; Don't Guess

Study Saxton's wonderful book of plans. Will give you hundreds of practical ideas. May keep you from making mistakes that cost money and regrets. Contains

## 310 PLANS and PICTURES

with complete and interesting description of each. Not like other plan books. Price \$1.00. Also book of 80 photos, showing how rooms will look. \$1.50. Money back if you ask for it. Send now.

**GLENN D. SAXTON**

Architect

Plymouth Bldg., Minneapolis, Minn.



## THIS BUNGALOW \$900 CAN BE BUILT FOR

This and many others in my new book, Building Plans for Modern Homes, will save you hundreds of dollars. One of the most complete and comprehensive books of plans ever published by any architect. Fifth edition just off the press. One hundred and fifty floor plans and photographs of bungalows, etc., costing from \$250 up; gives sizes and cost to build. Sent postpaid for \$1.00



**FREDERICK H. GOWING**  
ARCHITECT  
18 Tremont St., BOSTON, MASS.

## TO-DAY I MADE \$35.23

With My Camera Taking Pictures—A. I. Shinnbaum. You can do even better. Write for our New Proposition and Catalogue, explaining fully how, without any former knowledge or experience, hundreds of young men everywhere are making big money. Don't Miss This Opportunity of Becoming Independent Financially. Send today for Full Particulars.



Jamestown Ferrottype Co., Dept. A40, 1113 S. Halsted St., Chicago, Ill.

3 to 12  
H. P.

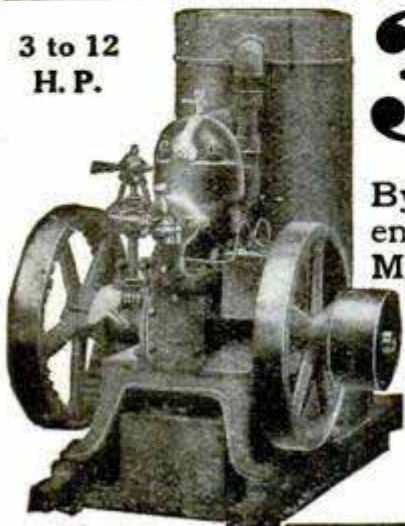

# 34c

## Runs this 6 H. P. Engine for a 10 hour day on KEROSENE

By means of the patent throttle you can run it as a 4 H. P. engine for 23 cents a day, or as a 2 H. P. for 12 cents a day. Many other strong points; force-feed lubrication; uniform speed; sight-feed fuel supply; automobile muffler; no cranking; runs either way; uses any fuel oil satisfactorily. And it's Guaranteed for 10 Years. Write for catalogue and 30 days' free trial.

WE PAY THE FREIGHT

**ELLIS ENGINE CO., 65 Mullett St., Detroit, Mich.**



# A HOME BENCH

MADE BY  
Grand Rapids Hand Screw Co.



HERE IS  
THE ONE  
THING I  
REALLY  
NEED

(Cash with the Order) No. 97—\$8.85 Delivered

In U. S. within 300 miles of Grand Rapids, Mich.  
To points beyond add \$1.00 for excess freight.

Made from Michigan white maple. Has two vises, backboard, tool rack. Top is double tongue and groove construction. Size 46 in. long, 18 in. wide, 32 in. high. Just the thing for household repairs. Instructive, entertaining and profitable to boys taking manual training.

OUR BOOK "HOME BENCHES" IS FREE

GRAND RAPIDS HAND SCREW CO.  
1622 Front Av., N. W., GRAND RAPIDS, MICH.

## MONEY FOR SLOW ACCOUNTS

Send your slow accounts to us. We cover the country and collect for big firms everywhere. Prompt, efficient service at minimum charge. No results, no pay. Members Chicago Association of Commerce; Wiley & Mack, General Counsel. Save this ad and write us today.

CONIE W. MACK & CO., COLLECTORS  
1407 Otis Bldg. CHICAGO, ILL.

## Gas and Gasoline Engines



1/4, 1/2 and 1 H. P. Air and Water Cooled  
They certainly can't be beat; that is what they are all telling us of the wonderful ability of our Engines. We sell them with a trial privilege and absolutely guarantee them. We can furnish castings and blue prints of our Steam, Gas and Gasoline Engines at reasonable prices. Write us for further information and prices.

UNIQUE ENGINE & MANUFACTURING CO., Sycamore, ILL.

## Get a pair of these great Grinnell RESISTOL Gloves

They'll stand harder wear than any glove you ever had on your hands—yet they're soft and pliable. Wash them in soap and water or gasoline—they come out like new. Ask your dealer. If he doesn't carry Grinnell Gloves, send us his name. We will send your selection on approval. On request, handsome glove book and leather samples.

Morrison-Ricker Mfg. Co.  
153 Broad Street, Grinnell, Iowa



Style 4315 P. R. F.  
Electric-current  
resisting work-glove

# \$2430<sup>00</sup> IN 90 DAYS

Twenty-seven dollars a day actual clear cash profits is what one man made in just three months with a Helm Press in a little town of 375 inhabitants. He saw a big opportunity in manufacturing pressed cement brick and blocks, was quick to grab it and is realizing big money now.

Look round about you. See how concrete is taking the place above all other materials in building construction. Realize what a chance is yours now to get in this big industry on the ground floor.

Twenty to fifty dollars a day profit is easily made with the Helm Press. You will be turning out a product that is as staple as sugar, as much in demand as the clothes on your back.

Ten Billion Brick are used every year in the United States. Thirty-three and a half million every working day of the year. Consider how enormous the demand, how contractors are crying for more brick. Be the one to supply this demand in your locality. You can start in this business. Be a manufacturer of pressed cement brick and make money from the start. No experience is necessary and very little capital needed.

## There Are Big Contracts With Their Big Profits

Ready  
For You



No matter where you are, how little the town or how big the city. Builders are turning to this product because it solves the problem of high cost of building. Concrete must take the place of wood, stone and clay. Here are experiences which you can duplicate in your community:

I landed a \$90,000 government contract with Helm pressed cement brick.

Just landed a contract for 400,000 Helm pressed cement brick.

We are working on a contract for half a million pressed cement brick.

Made a million brick this season on one of your Helm presses.

My daily manufacturing profits on pressed cement blocks average \$25.00.

Working on a contract for a quarter of a million pressed cement brick.

Made 17,000 pressed blocks for one contract in less than a month.

Six weeks behind on Helm pressed cement brick and block orders.

We want you to know more about these manufacturers who are landing the big business and making the big money. We want to show you how they started with but little capital.

Factory Owners are the biggest money makers in America and this machine will place you in their ranks. You can start with little capital and even without experience. This is the machine for you because it makes pressed cement brick and blocks under 80,000 pounds pressure. No tamping, and easy work. It makes 1,000 blocks or 10,000 brick daily. No burning required. Ready for the market in a few days' time. Eventually some one will make pressed cement brick and blocks in your community, but now the opportunity is yours. No matter if cement products are now made there—these brick and blocks made by pressure will be demanded.

The possibility of failure in this business is almost eliminated. You can enter it with almost a dead certainty of meeting success. Costs you nothing to learn all about it. Fill in the coupon here, mail it today and receive free, full information of the Helm Press and money to be made in the cement brick business.

Helm Brick  
Machine Co.

124 Bank Building  
TRAVERSE CITY, MICH.

Helm  
Brick Machine Co.

124 Bank Building  
TRAVERSE CITY, MICH.

Please send FREE the  
book on concrete and Helm  
presses.

NAME.....

ADDRESS.....



FOR THE OFFICE— **UHL ART STEEL** —FOR THE HOME

# Typewriter Table and Cabinet

**15 DAYS FREE TRIAL IN YOUR OFFICE OR HOME**



Closed

Last word in typewriter efficiency. Thousands in use in offices, homes, public buildings, etc. Among mechanics, business men, authors, writers, ministers, traveling salesmen, students, etc. Time, space and money saver. Occupies only four square feet as compared with ten square feet taken by old style desks. Deep, roomy compartments, ample for week's supply of stationery. No drawers to act as "catch-all."

**Clean and Sanitary** Stands firm and rigid when on its feet. Simple turn of lever places leather castors for silently moving to any desired position. Frame is indestructible steel with built-up wood platform, noiseless under operation. Sides fold up—steel top rolls down and locks securely. **Guaranteed 100% efficient.** Write us on business stationery for the 15 days' trial. If not satisfactory we will buy it back at full price. Orders filled through our dealers, or through yours, if we have none, providing you will give us his name. Write us today. You will be delighted with the trial.

Cut Down Your Office Expenses

Saves 6 sq. feet space any place.

Portable here — there — anywhere



Note the Lever

Open

X-Rayview right end, showing depth and roominess of stationery compartments



Beware of imitations! The Uhl is the original and always

bears the above mark. Look for it

**THE TOLEDO METAL FURNITURE CO., 2410 Dorr St., TOLEDO, OHIO**

## See Yourself in Motion Pictures

A new invention enables you to make and show Motion Pictures of yourself, family, friends, sports, travels, or anything that interests you. **FOR PLEASURE OR PROFIT.**

**AS EASY TO WORK AS A KODAK**

Send for descriptive catalogue No. 5

A 400-page book, 80 illustrations, free with each camera

**MOTION PICTURE CAMERA CO., Inc.**

5 WEST 14th STREET, NEW YORK

Importers and Mfrs. of Motion Picture Apparatus

## Your Old Camera Taken in Trade

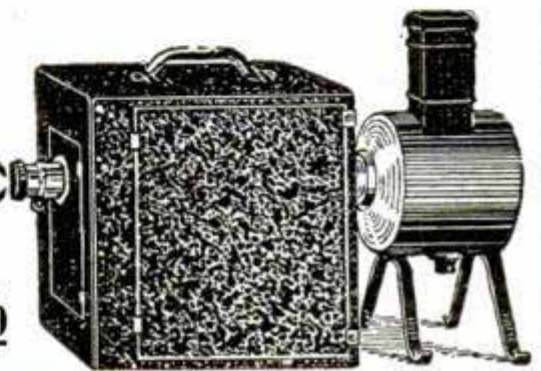

Price **\$39.00**

Cash or Easy Payments

# AGENTS WANTED \$50 to \$75 PER WEEK

ALL—OR—SPARE TIME Selling **Easy Wringer Mops**



**150% PROFIT—Start—Now**

Two turns of crank wrings out every drop of water. Simple, practical, reliable, durable, never wears out. Every home buys. No talking necessary. Show it, take the order. Get started now, don't wait. We will help you.

We want Agents, Salesmen, Managers in every county to fill orders, appoint, supply, control sub-agents. **150 per cent profit.** No investment required. Sample free with first order. New catalog, Instructions, sworn-to evidence, all free.

**U. S. MOP CO., 190 MAIN STREET, TOLEDO, OHIO**



This mop on floor. It spreads out and is held down to floor at all points.

## Factory Price Saves You \$25

Every style of vehicle and harness for every purpose of pleasure and business. Many new styles and big improvements in 1914 line. 40 years of success selling direct proves quality and big savings.

**Large New Book — FREE**

Handsomely illustrated. Let us send you a copy and quote prices that will surprise and please.

**ELKHART CARRIAGE & HARNESS MFG. CO., Elkhart, Indiana**





## THE COMPLETION OF THE GRAND TRUNK PACIFIC Brings Your Chance

You still have one ground-floor chance left. The building of the Grand Trunk Pacific's great transcontinental line across Western Canada has built cities and brought wealth to thousands of wise investors who bought choice lots, cheap, before the railroads came and sold them later at handsome profits. You have the same chance NOW at

# VANDERHOOF

(Location of the railway station site approved by the Board of Railway Commissioners, April 9, 1912. Order number 16,278.)

The key to a whole new empire—that's Vanderhoof. Think of 1,000 square miles of the richest soil waiting for market places. Think of 800 miles of navigable waterway waiting for towns to link its traffic with the railroad. Grasp the fact that the last spike in the wonderful new transcontinental line will soon be driven near Vanderhoof. THESE ARE FORTUNE FACTS FOR YOU.



## Towns Grow Quick—Profits Multiply Fast In WESTERN CANADA

### Get Your Share of the Wealth Without Leaving Home

One day the shack of the pioneer merchant. The next day, the handsome brick blocks of a modern city. Western Canada towns grow like magic. This means quick money for shrewd investors. Millions of dollars have been made here buying choice, down-town lots in new towns before the railroads came and holding for the inevitable rise in value. Many a man has had one little investment of a few dollars down and a few dollars a month start him on the road to fortune. Today your chance is at Vanderhoof, a new townsite in the last west on the Grand Trunk Pacific's main line through new British Columbia.

### A Strategic Distributing Center

Vanderhoof is the center of the rich Nechaco Valley. Government investigators say: "The Nechaco Valley is the greatest connected area of lands susceptible to cultivation in the whole province of British Columbia." Vanderhoof is the heart of this great agricultural region. It has the combined transportation advantages of the greatest transcontinental railway

and an 800-mile navigable waterway. It is only 400 miles from the Pacific Ocean and direct steamship lines to the Orient. Short route via Panama to European markets. Vast timber and mineral wealth are easily accessible by both rail and water. Grain, fruits, dairy products, poultry, fish, vegetables, cattle, timber and minerals will come by rail, road and river to Vanderhoof. So Vanderhoof is bound to be an important supply center. Today you can cash in on this knowledge.

Either start in business there and supply the settlers with what they need at big profits or, if you can't leave home or don't want to, simply buy business-center lots at present low first-sale prices and hold for the rise in values after the railroad is completed in the spring.

That's your big chance at Vanderhoof. But you must act quickly. This advertisement may never appear again, so keen are those who know the possibilities of British Columbia to invest and settle there. Anyone can take advantage of this chance. The prices are low. The terms are easy. We are authorized to take applications for a short time at low figures in order to encourage quick development. It makes no difference whether you wish to invest big money or only a few dollars a month.

### A Few Dollars Down and a Few Dollars a Month May Mean the Beginning of Your Fortune

We're ready this instant to take your application for business center lots. Get ahead of everyone by telegraphing us to reserve the best business lot for you—easy terms—subject to your acceptance. You take no chances. The Grand Trunk Pacific Station Site has been approved by the Board of Railway Commissioners. Grading is already completed for the railway yards. At least investigate. Get our proof of profit possibilities. Find out the big chances that await you at Vanderhoof. Mail the Coupon Now.

Clear and Perfect Title Direct from the Land Department of the

## Grand Trunk Pacific Railway

N. T. MacMILLAN COMPANY, Ltd., Authorized General  
Selling Agents

316 McArthur Building, WINNIPEG, MAN., CANADA

### COUPON

N. T. MacMillan Company, Ltd.  
316 McArthur Building,  
Winnipeg, Manitoba, Canada

Send me your illustrated descriptive matter of VANDERHOOF, British Columbia, in the heart of the rich Nechaco Valley; also maps of the town and transcontinental railway, and full information for the investor or prospective business builder. This does not obligate me in any way.

Name.....

Address.....

Town..... State.....



# MAKE FURNITURE LIKE THIS

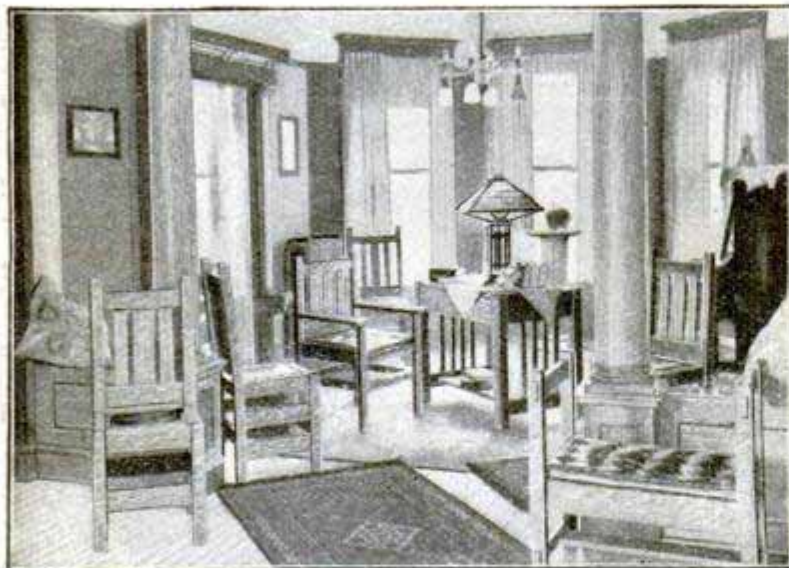

## Shown in the Photograph

ONE of our readers, who is strictly an amateur with tools, experienced no difficulty in making and finishing every piece of furniture, with the exception of the piano, shown in the accompanying picture. It is impossible in a small space to display all the different designs in Mission Furniture which we have published, but this picture shows something of the variety of pieces and how well they go together. The

## MISSION FURNITURE SERIES of 3 Volumes

Comprises 98 Attractive Designs, all different

**MISSION FURNITURE, Part 1**  
New Enlarged Edition 128 Pages, 30 Designs  
**MISSION FURNITURE, Part 2**  
Recently Issued 128 Pages, 32 Designs  
**MISSION FURNITURE, Part 3**  
New Book—Just Out 128 Pages, 36 Designs

Cloth, Size 5x7 inches Price 50 Cents Per Vol., Postpaid

THESE books describe how to make furniture for every room in the house as well as swings for porch and lawn. Whether you need a complete set or only some special article to fill in with here and there, you will find full directions, dimensions and working drawings for making it in these books. The instructions are easy to follow and even the amateur can obtain most satisfactory results as related above. A complete list of the designs in each book will be furnished free upon request.

ASK YOUR BOOK DEALER or address the publishers

**POPULAR MECHANICS BOOK DEPARTMENT, 6 No. Michigan Blvd., CHICAGO**

The Pictorial Review of Current Events

# Cartoons

Magazine

15 Cents a Copy

\$1.50 per Year

[By H. H. WINDSOR, Editor Popular Mechanics Magazine]

Get the APRIL Number

And keep up with the events of this busy world without wasting hours of your time.

In Its New Garb the Cartoons Magazine Becomes the Magazine for Everybody

Its pages are crowded with the best work of the cartoonists of the world and these clever drawings are accompanied by comment gleaned from the columns of editorials penned by newspaper writers trained to follow the questions of the day.

Cartoons Magazine has become the ready reference book of the up to date man. It is not a mere collection of clever pictures but is a magazine that improves and educates.

Ask your newsdealer to show you the April number, or

Send your order to **CARTOONS, 6 No. Michigan Blvd., Chicago, Ill.**

Bound Volumes  
One, Two and Three  
NOW READY

These bound volumes contain more than 3,000 reproductions of the very best cartoons that have been printed during 1912 and 1913. A collection of more than 120,000 cartoons was made in order to secure them. Bound in the three volumes they make an "instant history" of the past months, for they are a pictorial record of the events of the world.

These three books, artistically and durably bound, are now ready for distribution and will be sent all express charges prepaid to any address in the United States or its possessions upon receipt of **One Dollar Each**



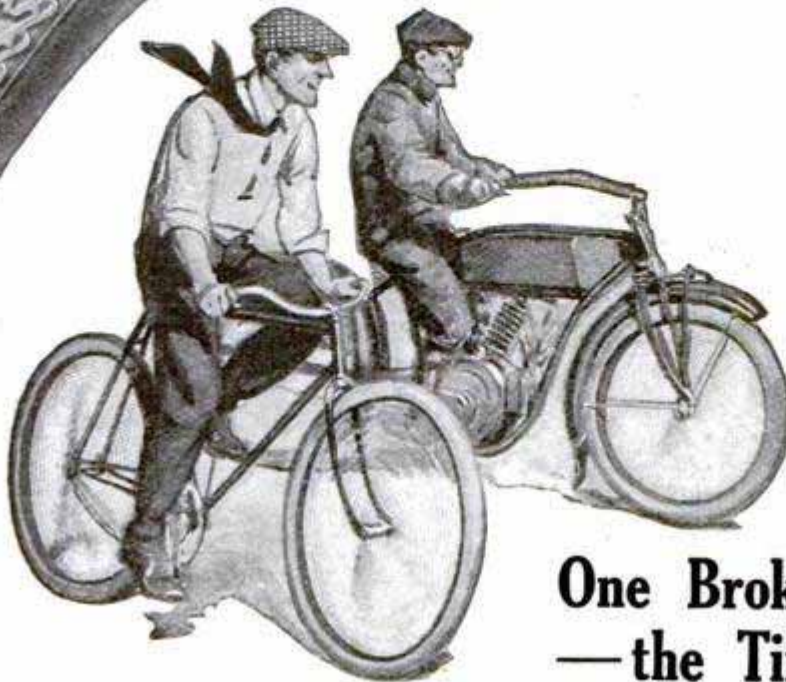

## One Broken Thread —the Tire is Gone

**T**HE strength of a tire is all in the fabric—the layers of tire fabric which are built into the tire. Without this fabric the tire would blow up like a toy balloon. It is the fabric that withstands road shocks and strains. Let one little thread of the fabric break and your tire is gone. The tremendous strain widens the break—the air begins to seep out—worming its way in between layers until it has reached the surface.

The thread of a good tire fabric must be *unbreakable* after it's in the tire—literally unbreakable. The triumph of Vitalic Tires is really the triumph of Vitalic Triply Twisted Thread. This thread is made of the finest Sea Island Cotton with tough, silky fibres fully two inches long.

The thread is twisted—not once like ordinary thread—but again and still again until it has almost the tensile strength of wire. The bicycle rim itself will break before a thread in Vitalic Tires will.

Into this indestructible fabric foundation we force by tremendous pressure the finest, toughest, most enduring rubber that can be compounded.

**The Continental Rubber Works**  
19th and Plum Sts. Erie, Pa.

Largest Single Makers of Bicycle and Motorcycle Tires  
in the World

After the tire is vulcanized it is tested three times—the test is so drastic that no imperfect tire can escape.

### *Satisfaction or a New Tire*

Now you know why Vitalic Tires are *Guaranteed*—why we say to you, "If a

Vitalic Tire in any way fails to satisfy you, take it back to your dealer and get a new tire or your money."

We have told the whole Vitalic story in a book, "The Truth from Tube

to Tread"; send for it and for a free cross section of the tire itself.

Then look up the dealer who shows the Vitalic Sign.

**Guaranteed**  
**VITALIC**  
**TIRES**  
TRADE MARK

**Bicycles and Motorcycles**

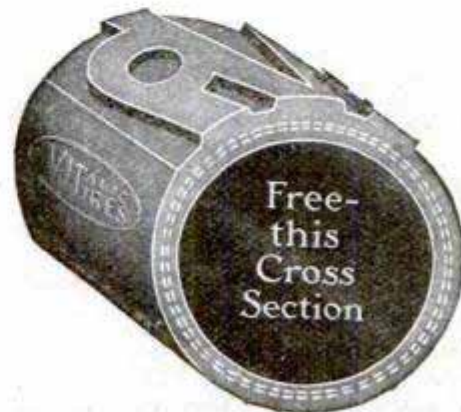



**5,000 ONLY AT \$1.00 - THEN REGULAR PRICE - \$2.40**

**SPECIAL INTRODUCTORY OFFER TO PROVE THEIR MERIT TO EVERY MAN, WOMAN AND BOY.**

The minute the first 5,000 go the price returns to the regular retail price--\$2.40. **NOT A TOY.** 8 in. long--

projects a strong, penetrating beam 200 feet. A practical, safe searchlight with intermittent or continuous flash. First all-metal searchlight--no fibre or pasteboard used. Flashes under water--cannot be short-circuited.



**NIAGARA ELECTRIC SEARCHLIGHT WITH MAZDA BATTERY AND DRAWN WIRE LAMP \$1.00 PREPAID**

Below Manufacturer's Cost.

If not among first 5,000, your money returned. **ACT QUICK.**

**GUARANTEE.**

If not, in every respect, the finest electric hand-searchlight in the world, bar none, return lamp and get money back.

Adopted by U. S. Gov't for Battleships and Army Posts. Unlimited Usefulness for The Home, Boy Scouts, Women, Policemen, Deliverymen, Messengers, Hunters, Mechanics, Auto-Repair Men, Farmers, Reporters, Motorists.

**NIAGARA SEARCHLIGHT CO., NIAGARA FALLS, N.Y. MANUFACTURERS OF THE WORLDS HIGHEST CLASS SEARCHLIGHTS**



**300 Candle Power of Light AT A COST OF 1/8c PER HOUR**

The Kerosene table lamp has one inverted mantle and **MAKES AND BURNS ITS OWN GAS FROM COMMON KEROSENE OR COAL OIL.** It gives a bright and steady white light **TEN TIMES** as **BRILLIANT** as an ordinary kerosene wick lamp.

**The "Quicklit"** Gasoline table lamp can be **LIT WITH AN ORDINARY MATCH LIKE CITY GAS.**

*Both styles equipped with automatic cleaning needle.*

**NO smoke, no smell, no wicks to trim. A splendid proposition for dealers**

**LIVE AGENTS WANTED** Write today for further particulars, also complete illustrated catalog describing the above kerosene and gasoline lamps and hollow wire systems. **THE NAGEL-CHASE MFG. CO., 146-168 East Erie St., CHICAGO, ILL., U.S.A.**

*The largest manufacturers of artificial lighting devices in the world.*

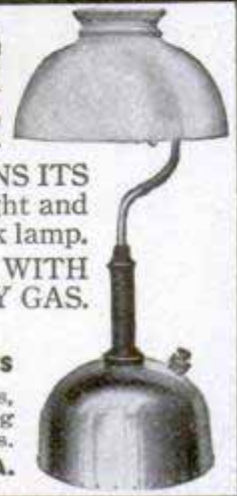

**AGENTS-WANTED-**

**\$45 TO \$95 PER WEEK**

**Salesmen-Gen'l Agents-Managers HURRY--BE ALIVE--ACT AT ONCE**

An ounce of decision is worth a ton of delay. Be alive--get away from ordinary propositions--get your share of the big money. One million Washers will be sold.

**200% PROFIT**

**ACCEPT THIS FINE OFFER NOW** While the time is ripe--while the article is new; while the demand is so enormous; while possibilities are so good for you. Get details of the money-making opportunity offered to you through this absolutely new guaranteed

**MARVELOUS INVENTION THAT MAKES THE OLD FASHIONED WASH-BOARD USELESS!**

We challenge the World to make a better Washing Machine for the price we ask! Think of it--a machine that retails for only \$1.50--that does the work of heavy, cumbersome outfits that cost \$10, \$15 and \$25. No power needed--costs nothing to operate--lasts a lifetime--strong and powerful, yet so light that a child can use it and do a whole washing in ten minutes. The Air Cell puts an end to back-breaking, youth-destroying, health-wrecking drudgery. No more wash-day slavery for women. Sold on absolute guarantee of money back if dissatisfied. Can you beat it? Agents, General Agents Wanted At Once. Territory free. 200 per cent profit. Enormous demand. \$45 to \$95 per week to hustlers. Get in the band wagon and head the parade to success. Act now, get full particulars about this wonderful invention. Be alive--don't delay--send a postal today.



**THE AIR CELL WASHER CO., 464 Valentine Bldg., TOLEDO, OHIO**



**Own Your Own Home--**



"Make Dreams of a Home of Your Own Come True."

It's easy--easier than you ever dreamed--if you will enlist the services of the Standard Home Company. Thousands of families are enjoying the pleasures of homes all their own, paid for the Standard Way.

**BE A HOME OWNER--\$6 STARTS YOU**

Don't say you can't do it--you can. No matter what your income you can lay aside the few dollars necessary each month to become a home owner the Standard Way. Don't pay rent to the landlord--pay it to yourself.

**THE STANDARD MAKES IT EASY**

The Standard plan is so simple, so plain, so easy, you'll be delighted with it.

**WRITE TODAY for valuable book and complete information** of the Standard Home Company plan--it's yours for the asking. Make up your mind now, today, this minute, to become a home owner--take the first step by addressing

**W. E. WHITEHEAD & CO., Dept. B, 1410 American Trust Bldg., Chicago, Ill.**

Thousands of Families Live in Homes Made Their Own Through The Standard Way. Over 2,400,000 Dollars to Home Owners.



**100% Safety**  
**200% Service**

## Automobile Tires in Motorcycle Sizes

that's what you get in V. C.'s. The only tires heavy enough and strong enough to *stand up* under "Motorcycling unlimited".

## PENNSYLVANIA Oilproof VACUUM CUP TIRES

There's a new sense of speed and power and security in V. C. positive non-skid traction. For the quick turn or the sudden check on the skiddy pavement there's the sure safety of the suction cup tread, with its live, elastic V. C. grip.

Service guaranteed—for 5,000 miles. Average mileage is easily twice the guaranteed distance—200% service.

Oilproof through and through. You drive right down the middle of the oiled road.

*File your order with your dealer now  
and start the season on V. C.'s*

**Pennsylvania Rubber Co., Jeannette, Pa.**

New York  
Pittsburgh  
St. Paul

Boston  
Detroit  
Seattle

Los Angeles  
Omaha  
Dallas

Minneapolis  
Cleveland  
Atlanta

Chicago  
San Francisco  
Kansas City, Mo.



*An Independent Company with an independent selling policy*



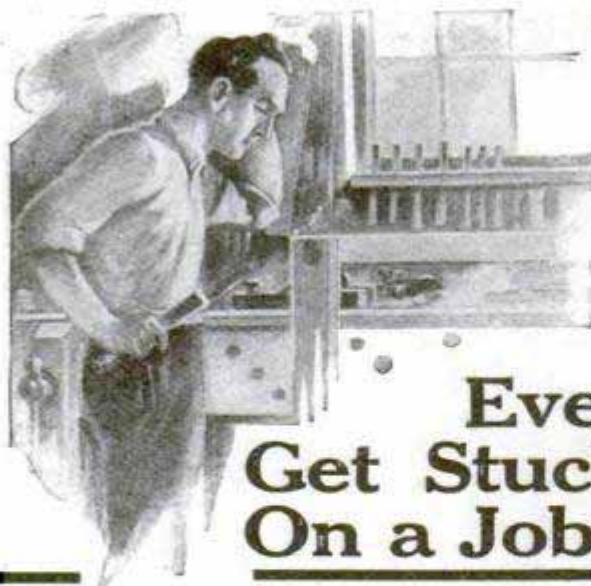

## Ever Get Stuck On a Job?

WERE you ever confronted with an emergency job where something unusual had to be done quickly with the few tools at hand or no tools at all? You could have done that unfamiliar job in a jiffy if only some one could have informed you how he did it.

¶ Has it occurred to you that every day, everywhere, men in every department of mechanics, engineers, firemen, carpenters, machinists, plumbers, painters, iron and wood workers, electricians, masons and in fact men in all the trades are meeting and solving these problems in economical, time and labor saving ways?

¶ If a collection of all this useful experience of years, of hundreds of the most successful mechanics could be made, "boiled down" and written so it could be readily understood by anyone who uses tools, would it not be of priceless value to the owner?

¶ This is just what **Popular Mechanics Magazine** has been doing for years, and now our

### Series of Shop Notes Year Books

constitutes a veritable encyclopedia of

### Easy Ways to Do Hard Things

¶ Naturally these books must be handy of reference to be of value and this feature has not been overlooked as each volume is indexed fully and with great care, so that any subject may be turned to at once.

¶ Why not save yourself the trouble of puzzling out the "kinks" and "short-cuts" when some one has already done it for you? Some one little suggestion may be worth more to you than the price of the entire set of books.

### Shop Notes Year Books

VOLS. I TO X INCLUSIVE  
CONTAIN

5114 Articles—2212 Pages—4965 Illustrations  
Size 6 x 9 in. Bristol Covers.

PRICE  
**50c** PER VOLUME **\$5.00** PER SET of  
Postpaid ten Books in  
Handsome Case Prepaid

Order or complete your set to-day

**Popular Mechanics Book Dept.**  
318 W. Washington St. CHICAGO

# Farming with Power

"Written So You Can Understand It"

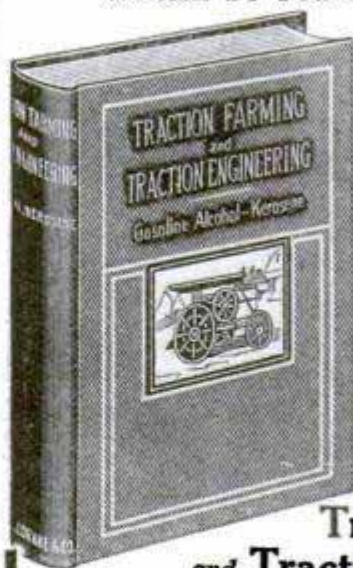

The development and use of machinery as one of the most important factors in modern farming is too well known to require comment. What we want to emphasize is that a proper understanding of how to run, care for and repair this machinery is a requisite for every farmer who would be up with the times. An urgent demand for such information has prompted the publication of

## Traction Farming and Traction Engineering

GASOLINE — KEROSENE — ALCOHOL

A book that shows the how and tells the why of power farming  
PART I—Farm Tractors. PART II—Water Supply and Electric Lighting System for Farm Homes. PART III—The Science of Threshing and Types of Threshing Machines.

This book treats in a thoroughly practical manner all there is to know of Traction Engineering and was written by practical men.

336 Pages — 151 Illustrations and Working Diagrams  
Cloth—Price \$1.50, Postpaid

**POPULAR MECHANICS BOOK DEPT.**  
318 W. Washington St. CHICAGO

# The Story of the Panama Canal

By LOGAN MARSHALL

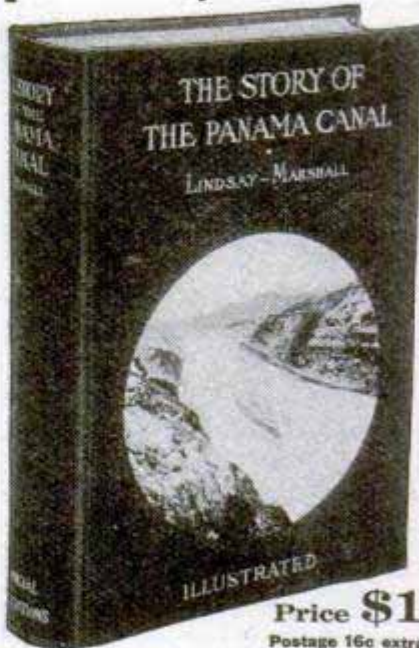

THE authoritative book. Panama, picturesque and historic. This fascinating volume relates the story of the Panama Canal from the earliest explorations to the completion of the Canal. The author is the best informed writer on the subject, and this is his best work on the greatest enterprise ever undertaken by the American people.

The Latest Message  
from the Canal Zone  
320 pages

Price \$1  
Postage 16c extra

Illustrated with many colored plates, half-tones, text cuts, maps, etc. 12mo. Cloth, \$1.00.

ADDRESS  
**POPULAR MECHANICS BOOK DEPT.**  
318 W. Washington St. CHICAGO



# The Help of The Hartford

**W**HEN the home has burned and plans for rebuilding are discussed it gives great satisfaction to know that there is a policy in the

## Hartford Fire Insurance Company

This great company has in 104 years paid over 167 millions to policy holders to help them replace property destroyed by fire. Its settlements are prompt and fair and its commercial honor unquestioned. When you need fire insurance



**INSIST on the HARTFORD  
AGENTS EVERYWHERE**



**HARTFORD FIRE INSURANCE COMPANY, Hartford, Conn.**

Pop. Mech.

Tear off

Send for our Booklet "Structural Safeguards for Dwellings." It will be sent free.  
My name and address is written below.





## Stops Tire Troubles

A four-ounce tube of Neverleak injected into each of your tires will save you aggravating, expensive tire troubles for the entire season. It will practically double the life of your tires.

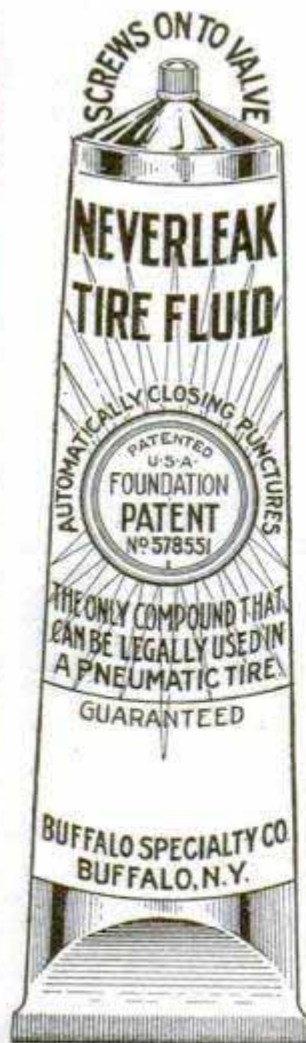

# NEVERLEAK

is a preservative of both the fabric and rubber of which bicycle tires are made and keeps them in the best of condition. It makes tires wear for months after they would otherwise have to be thrown away; it stops all trouble on account of tires getting porous; stops thread leaks and those caused by previous defective repairs. It instantly heals all punctures within the bounds of reason; does away entirely with plugging and patching except in the most severe accidents.

Neverleak is a thoroughly reliable article that has been selling and constantly increasing in popularity for eighteen years. It is used by thousands of bicycle riders; by the largest tire manufacturers and by repairmen everywhere. The sooner you treat your tires with Neverleak the better. It will greatly reduce the cost of keeping your wheel. You can buy it of any bicycle dealer or repairman at 25 cents a tube. Accept no substitute.

**BUFFALO SPECIALTY COMPANY, Buffalo, N. Y.**



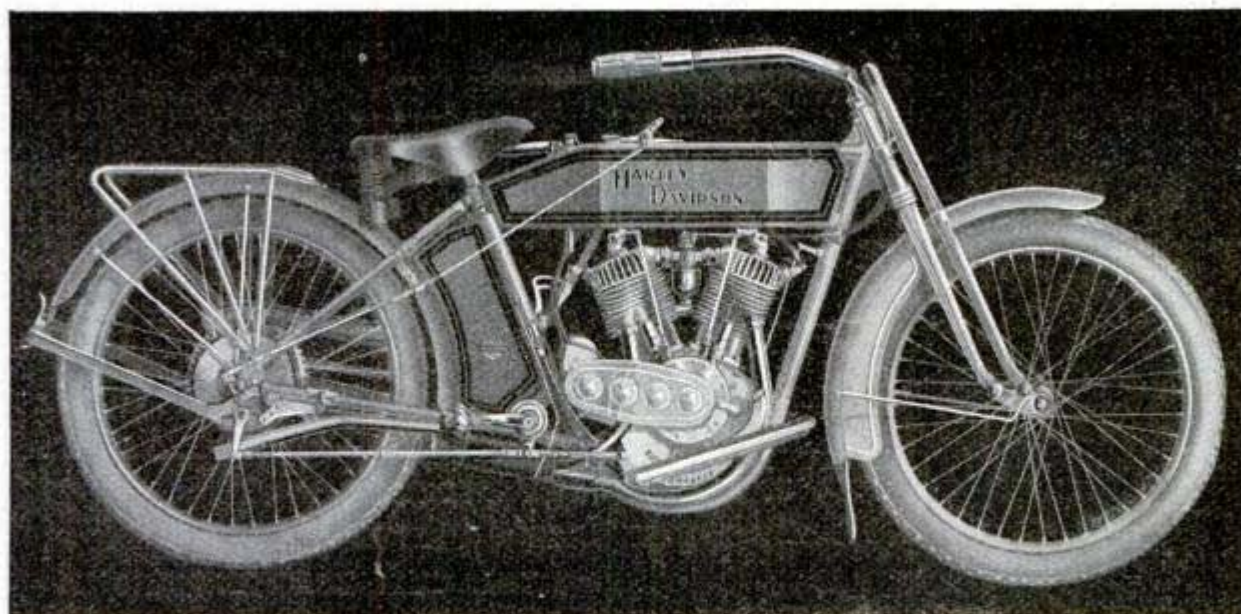

## Harley-Davidson Two-Speed Twin With Starter \$285

Other features are Double Brake Control, Double Clutch Control, Folding Foot Boards, Ful-Floteing Seat and Substantial Luggage Carrier

### Protected Selective Type of Two-Speed

The simple, compact and efficient patented Harley-Davidson two-speed gear is located in the rear hub out of the way. High gear and low gear are both controlled by a small lever conveniently located on top of the tank. The two-speed Harley-Davidson models are particularly adapted for use in rough, hilly or sandy countries or for use with the Harley-Davidson side car.

### A Simple Effective Starter

The patented Harley-Davidson step-starter makes it possible to start the motor without dismounting. It is no longer necessary to get off in the mud and find a level spot on which to drag the machine onto the stand in order to start the motor, if it is accidentally stalled. Instead a simple downward push on either pedal and the motor again begins to throb. The step-starter has no heavy complicated mechanism liable to derangement nor has it any tiny delicate parts to break. It is an extremely simple and sturdy device to be depended on at all times to serve its purpose—that of starting the motor.

### OTHER IMPORTANT FEATURES

#### Double Clutch Control

The patented Harley-Davidson clutch can be operated either by a foot lever on the left foot board or by a hand lever. This foot control does away with the necessity of taking either hand off the handle-bars.

#### Ful-Floteing Seat

For the third successive year the

Ful-Floteing Seat is standard on all Harley-Davidsons. This patented device floats the weight of the rider between two concealed springs, assimilating all jars and vibrations due to rough roads.

#### Double Brake Control

The new Harley-Davidson Band Brake can be operated either by a foot lever on the right foot board or by back pedaling on either pedal.

#### Folding Foot Boards

All models this year are equipped with folding foot boards in addition to the regular pedals. These foot boards accommodating themselves to a rider of any height permit of a variety of positions when touring. This does away entirely with the necessity for assuming one cramped riding position.

*Complete catalog describing all models of the 1914 Harley-Davidson motorcycles and the Harley-Davidson sidecar will be mailed on request together with the name of the nearest Harley-Davidson dealer.*

## HARLEY-DAVIDSON MOTOR COMPANY

Producers of High Grade Motorcycles For More Than Twelve Years

379 B Street

Milwaukee, Wisconsin



# \$1500<sup>00</sup> MADE IN ONE MONTH with a "Long" Crispette Machine

That's what Mr. Eakins made—paid his last \$10 for rent of a store window—at the end of 30 days had \$1500 in the bank—today he is independent. A Crispette machine and Crispettes did it.

**By This Man**

Mr. Perrin, Cal., took in \$380 in one day—every nickel brought him almost 4c profit. What are you going to do in the future? Just barely earn a living—keep wishing for something to turn up? Don't do it.



LISTEN—take that money you have saved up against the day of opportunity—invest it in a Long Popcorn Crispette Machine, and make fortune smile on you—build up a big paying business. Think of the fortunes made of 5c pieces—street cars—moving picture shows—5 and 10c stores. Everyone will spend a nickel—everyone likes Crispettes—children—parents—old folks. You don't need any experience—you can start anywhere—in a store window, a small store room where rent is cheap, or the kitchen of your home. The Crispette machine and Long's secret formula to the man of limited means is a Gold Mine—a sure way to independence and fortune—to make money from the start.

## ALMOST 400% PROFIT

Every 20c invested returns \$1.00 cash—not theory—not guesswork—not imagination, but the actual bona fide proven record of profits from Crispette machines from Coney Island to Oregon—from Canada to Argentine Republic.

STOP! You have followed the rut too long—received only what others cared to give. Get on the other side—take only what you want.

F. C. Thompson, Ore., took in \$575 in 27 days. E. H. H., Pa., sold over 12,000 rolls in two weeks—just records from letters from Crispette merchants in all parts of the country.

The money barons began with much less advantage than I offer you today. Write NOW for my handsomely illustrated 48 page free booklet "How to Make Money In The Crispette Business," or

**Come To See Me At My Expense**

It's unnecessary to write that you are coming—just drop in any time. It will pay your travel expenses within a 300 mile radius if you buy a machine. I will give you reference after reference from responsible merchants, bankers, citizens—satisfy yourself and then go over the Crispette business with me.

**Go Into This Business Now—**

The big spring and summer trade is waiting for you right in your own city. Send for my free booklet "Dollars & Sense In The Crispette Business." It tells the whole story—how and where to start—how to succeed, proved by the experience of others. It's worth reading even if you don't start. If you are looking for a good thing and easy money, send for this book—TODAY.

**W. Z. LONG, 859 High St., Springfield, O.**

**Popcorn Crispettes**

**Built this Big Business for me**



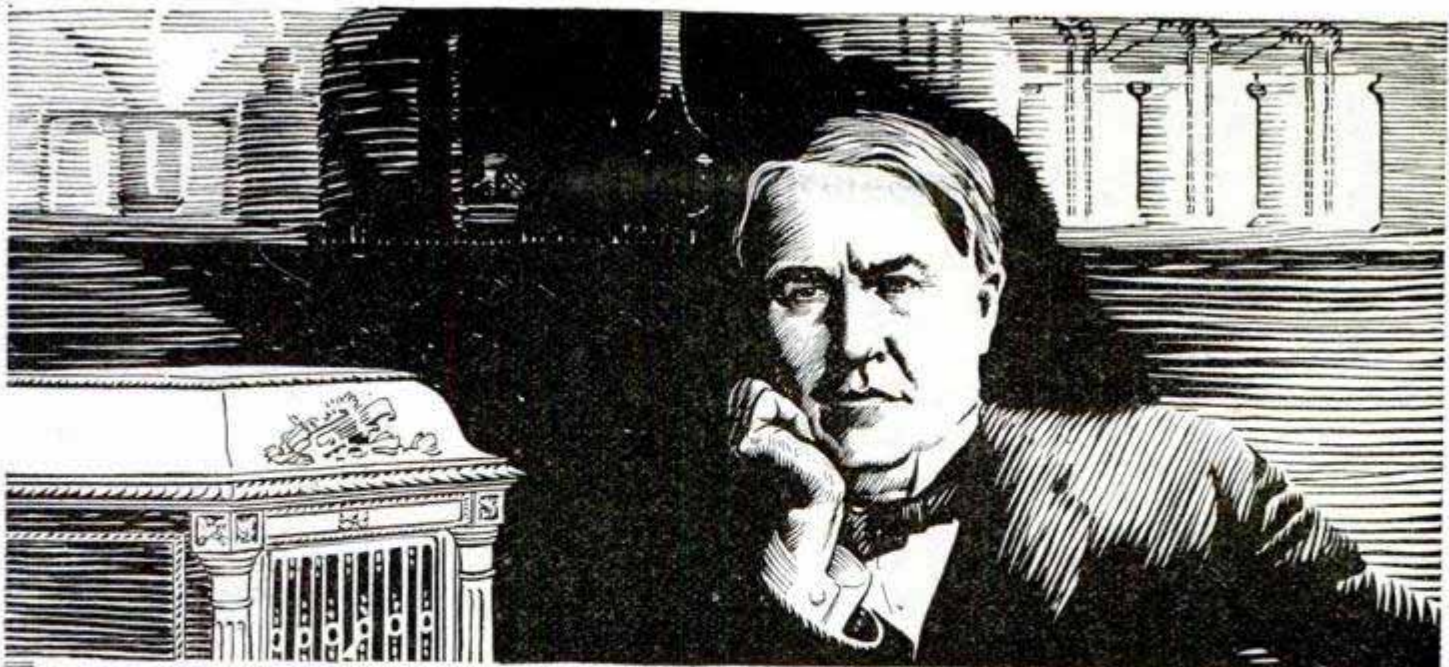

## Success Crowns Labors of Edison

Four years of continuous application—four years of infinitely patient labor on his hobby—has brought the result:

The *Perfected Phonograph*.

The instrument that produces with *absolute* fidelity the human voice and every instrument—solos, operas, concerts.

Perfect reproduction now in every detail.

To quote the inventor: "REAL music at last."

When Mr. Edison, four years ago, announced that he had decided to perfect his favorite invention, to make it not only the *best* of phonographs but absolutely perfect in every detail, those who were acquainted with him knew that there was only one calamity that could stop him—his death. He lived and he worked, and *now he has announced* that the phonograph is indeed perfected.

The new instruments are sent out on Mr. Edison's personal statement vouching for their superiority.

## Free Loan Offer

We will send you the *new* model Edison and your choice of all the brand new records on an *absolutely free loan*. Hear all the waltzes, two-steps, v. audevilles, minstrels, grand operas, old sacred hymns, every kind of comic and popular music, also your choice of the highest grade concerts and operas, as rendered by the world's greatest artists. Entertain your family and your friends. Then, when you are through with the outfit, you may send it back at our expense.

Send for our new Edison Catalog.

**REMEMBER**, not a penny down—no deposit—no guarantee—no C.O.D. to us—no obligation to buy—a full *free trial* in your own home—*direct* from us—*direct* to you. Returnable at our expense or payable (if you want to keep it) at the actual rock-bottom price direct from us.

**The Reason:** Why should we make such an ultra-liberal offer? Well, we'll tell you:—we are tremendously proud of this magnificent new instrument. When you get it in your town we know everybody will say that nothing like it has ever been heard—so wonderful, so grand, so beautiful, such a king of entertainers—so we are sure that at least some one, if not you, then somebody else, will want to buy one of these new style Edison's especially as they are being offered now at the most astounding rock-bottom price and on easy terms as low as \$2.00 a month.

## Our *New* Edison Catalog Sent *FREE!*

Your name and address on a postal or in a letter (or just the coupon) is enough. No obligations in asking for the catalog. Get this offer—*while this offer lasts*. Fill out the coupon today.

**F. K. Babson, Edison Phonograph Distributors**  
9194 Edison Block, Chicago, Ill.

Canadian Office: 355 Portage Avenue, Winnipeg, Man.

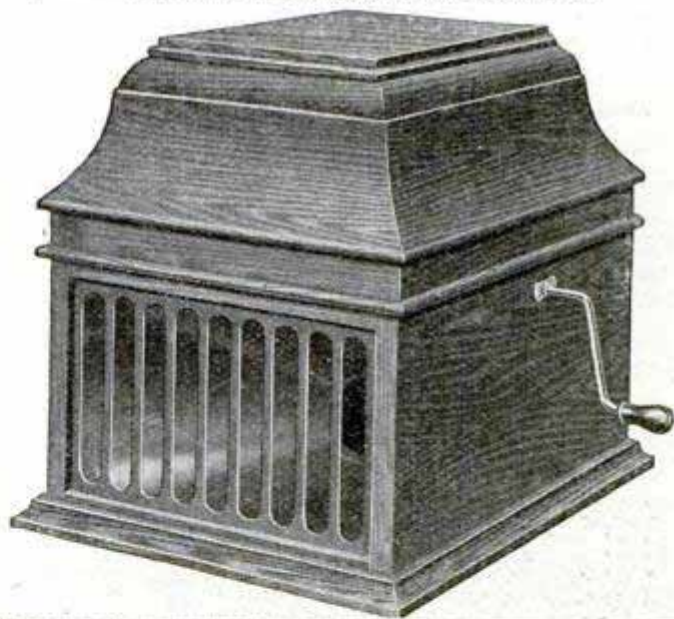

To  
**F. K. BABSON,**

Edison Phonograph Distributors,  
Dept. 9194, Edison Block, Chicago, Ill.

Gentlemen:—Please send me your New Edison Catalog and full particulars of your free trial offer on the new model Edison Phonograph.

Name .....

Address .....



# PHOTOGRAPH YOURSELF

## BIG, NEW, MONEY-MAKING PROPOSITION—JUST OUT



Marvelous invention—perfected after years of experiment by famous mechanical and chemical experts. Wonder of the age. Biggest novelty ever invented—**gold mine money-maker**. Instantly gathers crowd anywhere—everywhere. \$20 to \$40 a day net profit.

### A Photo—A Minute—A Dime

Nothing like it. Customers amazed—delighted—try it over and over. Think of it! You do not need to be there to operate or watch it. Customer just drops dime in slot—**machine automatically takes, develops, frames and delivers complete, perfect medallion photo all in sixty seconds**. Takes post card photos also. Write today. Get complete information. Within a week you can have one of these machines dropping dimes for you at the rate of

### \$6.00 An Hour—75% Profit

One man at Atlantic City averaged 400 to 650 pictures per day. Another at Brighton Beach, with two machines took in \$134.00 a day. No experience required. No knowledge of photography needed. Machine is entirely automatic. Absolutely guaranteed. A child can take a picture. Act now. Write at once—today. Make \$5,000 to \$10,000 this year. Send post card or letter for free complete information. Address

**The United Vending Machine Co., Inc., Dept. 3, 840 E. 93rd CLEVELAND, O.**

WHEN YOU WANT ANYTHING AND DON'T KNOW WHERE TO FIND IT—WRITE BUREAU OF INFORMATION, POPULAR MECHANICS, CHICAGO

Thirty thousand tons of tin plate are required in the manufacture of tops for bottles; over 4,000 tons of sheets are required in the manufacture of eyeclets and hoops for shoes in New England.

REG. TRADE MARK  
**DESKAID**  
PATENTED IN U.S. & FOREIGN COUNTRIES

ONE INSTRUMENT WITH A DOZEN USES  
GERMAN SILVER NOVELTY—THE CURVE CUTS IT  
Envelope Opener, String Cutter,  
News Clipper, Paper Cutter,  
Cigar Box Opener, Book  
Mark, Erasing Shield,  
Scales, Tack  
Lifter, Ruler,  
etc.

YOUR DEALER 50c OR POSTPAID THE DE SKAID CO. 105 W. 40. NEW YORK



\$2.95



Solid Nickel Silver

### American Thin Model 20 YEAR Watch \$2.95

Special Closing-out Sale of American made watches. Send your name and address and we will send you by parcel post or express C.O.D. \$2.95 this elegant thin model 18 size for geats, 16 size for boys, open face, solid nickel silver screw back and bezel case, dust proof, with lever movement, jeweled expansion balance, hard enamel dial, stem wind and pendant set, will keep time equal to a \$15.00 watch, case and works guaranteed 20 years. **ORDER AT ONCE.** This sale for a short time only. Satisfaction guaranteed. Pay your postman or expressman. Address  
**DIAMOND JEWELRY CO., K8, 189 W. Madison St., Chicago, Ill.**

## Salesmen Wanted

We want 750 five-thousand-dollar a year salesmen. Experience unnecessary. Do not delay. No charge for territory. Exclusive field. Success assured. 150 per cent. profit. Remarkable opportunity. Harvest of real money-making.

We are appointing men every day to manage our business in local territories. We need good, honest, willing workers, and we offer you this opportunity to represent us.

### YOU Can Make \$5,000 This Year

introducing **THE SWEDISH RHYTHMIC VIBRATOR**, the most amazing seller ever invented. An instrument for home vibratory massage treatment. Needed by every man, woman and family. Endorsed by the highest medical authorities in the world. Produces 30,000 thrilling, invigorating, penetrating, revitalizing vibrations per minute. A masterpiece of mechanical and electrical genius. Sells to the home, to physicians, masseurs, osteopaths, chiropractors, barbers, beauty parlors—unlimited market.

**Investigate** Get free literature and complete information at once. Send just your name and address on a postal card and all will be mailed FREE immediately. Agent's sample furnished at wholesale price. Investigate. Territory being rapidly assigned. But one man allowed in a field. Give the name of your county. Send your name and address today. This is a brilliant opportunity. Do not put it off. **Act immediately.** Address

**SWEDISH RHYTHMIC VIBRATOR CO. 119 Vibrator Bldg. 211-215 Schiller St. Chicago, Ill.**







**T**HESE are assured factors in "CONSERVATION." If, in an investment, you require **safety**—Fire Insurance Stock will bear the most searching scrutiny. If **unusual returns**, again it will meet your utmost requirements. **Unequaled**; for its **stringent legal safeguards**—for its positive, prolific dividends—it surpasses, in **market value** and **earning power**, every other legitimate investment. And

# 30% to 250% Now Being Earned

by large Eastern fire insurance companies, proves these statements. Last year, twenty-five stock fire insurance companies earned 30% to 250% (the latter in one instance) on **original capital**; while average **dividends** for all in the United States, for the past six years, has been 34%. Can it be disputed, then, that for **stability**, fire insurance stock measures up to the highest conservative standard—while for **profitable returns**, it easily outclasses every other safeguarded investment?

## Extraordinary Legal Safeguards

—afford "CONSERVATION" absolute protection. Fire Insurance Stock investments (under control of Illinois law) are safeguarded by the **highest-grade securities**—**gilt-edged bonds and mortgages**. Every dollar invested (save **5%** legitimately set aside for organization) is therefore, always remain **intact**, and **merely earning** basis. Unlike ordinary **common fire-insurance** shareholdings, not so carefully controlled. Who need **not** see capital cannot be depleted, or **mortgage** satisfied with ordinary bank **rentals**—to interest, or real-estate **rentals**—when 30%, or more, may be had—as **surely**, as **steadily**, and as **surely**, in "CONSERVATION!"

## One Hundred Per Cent Efficiency

**Negotiability** is one of the many desirable characteristics that distinguish Fire Insurance Stock. Any time the fortunate shareholder in an established company wishes to realize on his stock, he has but to **endorse it at bank**. But this he seldom does—because good Fire Insurance Stock is **better than cash**. This convertibility can be easily confirmed by writing to any leading Eastern bank, as to opportunity of purchasing old-line stock. Because fire insurance investments are **100% efficient and convertible, legally safe and double-earning**, they are highly prized by astute financiers. They are consequently next to impossible to purchase.

**SUBSCRIBE NOW;**  
**KEEP YOUR MONEY**  
TILL  
**\$200,000**  
IS  
**RAISED**

## Perfect Control

Equality of ownership rights and simplicity of organization make shareholdings in progressive fire insurance companies an incomparable investment. There are none of the usual discriminations as to preferred and common stocks—for stock is **all one kind and non-assessable**. Shareholders will control the Company in perfect **equity**. Their rights cannot be subordinated to other holding obligations. Since in control, therefore, they can elect officers and mould the policy of the Company, in a way to conserve their own interests. Returns must, consequently, bountifully vindicate investors' judgment.

## You Don't Pay Now

Ordinary business projects ask immediate cash remittance from subscribers. The "CONSERVATION" does not. **Subscribe TO-DAY—pay when success is assured.** THE GREAT ADVANTAGE to you, under our plan, is clear. You can send in your application for "CONSERVATION" stock—little or much—fully assured you are assuming **no obligation whatever**, for payment, until the full amount necessary to organize (\$200,000) is subscribed. Even then, you have 5 months to complete payments. Reliable Bank holds funds pending organization.

# The Conservation Fire Insurance Company

—now organizing—offers **Westerners** their first equable opportunity in this rich investment field, hitherto all but monopolized by wealthy Easterners and Europeans. While full capital and surplus will reach near **\$2,000,000**, Company will begin **actual operation** when **\$200,000** is subscribed—assuring generous **earnings** long before capital is fully paid in. And, remember—**not a cent to pay, until this \$200,000 has been raised**. This removes every shadow of risk. Get the facts on this superlative investment. **Mail Coupon, secure full evidence.** No obligation—and the biggest and best **opportunity you'll ever have**.

ADDRESS

**State Sales Corporation,**  
 318-25 S. Sixth St., SPRINGFIELD, ILL.

**STATES SALES CORPORATION, 318-25 S. Sixth St., SPRINGFIELD, ILLINOIS**  
 Gentlemen—Without any obligation or cost to me, send information regarding First-issue investment in "CONSERVATION."  
 Name.....  
 Street.....  
 Town.....  
 State.....  
 Pop. Mech.



# It's Easy Now to Own a WITTE ENGINE

Kerosene, Distillate, Gasoline, Naphtha & Gas

WITTE Engine power is cheaper than muscle or brute power, for any work that can be hitched to a belt. No need to let any such work go undone, for lack of dependable hired man, or team, help. Let me send you a WITTE Engine to earn its own cost, while being paid for.

## Look at These New Prices

Direct from Factory to User

2 H.P. \$39.45; 4 H.P. \$75.50; 6 H.P. \$99.35  
8 H.P. 139.65; 11 H.P. 208.90; 20 H.P. 389.50

Other Sizes up to 40 H. P. Proportionately Low

For 27 years the WITTE has set the standard of engine quality. It has **always** proved itself **dependable**—so simple

in construction that you can easily understand, start, and run it, whether you are experienced with any engine or not. Guaranteed steady power with small fuel consumption. No gas or oil engine has outlasted the WITTE, and few, **ve** few, of them work for an equally low fuel cost.

## 60 Days' Free Trial Five Year Guarantee

I don't consider any sale closed until the engine has made good—sold itself under actual test in the user's hands. Under my New Plan, you are sure of knowing what any engine **ought** to do, besides knowing what my engine **can** do, before you finally decide to buy.

I am the only man in the U. S. who makes his own engines, in his own debt-free factory, from his own designs, using his own special machinery and selling his output **under his own name, direct from factory to user.**

I don't owe any money for stock, bonds, notes, or mortgages, or for anything else. My entire plant and every other dollar I have—a total of over half a million—is behind my **five year guarantee.** I have never done anything else but make WITTE Engines. When I started making WITTE Engines, 27 years ago, the gasoline engine business was new. Today, I am the only man in the business, who started when I did and my factory is the only one which has come through successfully under the continuous management of the man under whom it was started and who made his own first engine. WITTE Engine-quality is the only thing that did it. I challenge anyone to show stronger proof of reliable engine-quality.

Mail this  
Coupon  
Today

ED. H. WITTE,  
Witte Iron Works Co.,  
1749 Oakland Ave., Kansas City, Mo.

Get My Complete New Offer and  
Copy of My New Book FREE

You should have a copy of my new Engine Book—the finest in the business. Explains fully my liberal easy terms and sales plans—tells how to judge an engine—how little it costs—how to start it and keep it running. Mail coupon today and I will send you the whole WITTE story by return mail.

ED. H. WITTE, WITTE IRON WORKS CO.  
1749 Oakland Avenue Kansas City, Mo.

With no obligation on my part, I should like to receive your latest and finest Engine Book, with your new liberal Selling Plan.

NAME.....

ADDRESS.....



**WITTE  
Gasoline  
and  
Naphtha  
Engine  
Stationary**

Shown mounted on iron sub-base which makes a permanent foundation where it is impractical to use masonry construction.

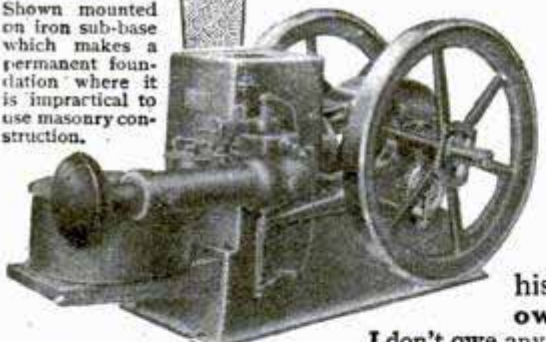

**WITTE  
Kerosene  
Engine—  
Stationary**

Burns Kerosene, Distillate, Solar Oil, Toppings and all fuels of like grades. Also Gasoline, Naphtha and Gas.





## SAFETY

**T**HE famous Disability Clause embodied in the Guaranteed Low Cost Life Insurance policies of The Travelers protects the policyholder as a breakwater does a disabled ship in a storm.

In case you become permanently and totally disabled from accident or disease before age sixty, the policy immediately matures for the full value by the payment to you of a guaranteed yearly income.

In the Monthly Income Policy the payments will be made to you, and at your death to your wife for life.

The Travelers' Disability provision is the greatest benefit added to life insurance in many years. Let us tell you what it has done for others. It will do the same for you. No Life Insurance is complete without The Travelers Disability Clause.



**Moral: Insure in The Travelers**

The Travelers Insurance Co., Hartford, Conn.

Pop. Mech. E.

Tear Off

Please send me particulars regarding your policies with the Disability Clause.  
My name, address, occupation and date of birth are written below:



# Make Your "Bike" a Motorcycle

Yes, thousands of others have turned their old-fashioned bicycles into up-to-date, swift, sure, easy riding, high power motorcycles with the easily attached, inexpensive **Shaw motorcycle attachment!**

Fits bicycles of any make or size. Everything is complete and we send it to you all ready to attach to your bicycle in just a few minutes without the aid of an expert mechanic and without any special tools—just an ordinary wrench and screwdriver. Built of highest grade, most serviceable materials; every part guaranteed; plain easily understood directions sent with each equipment. Thousands of enthusiastic owners everywhere. Here is your chance to get a powerful, dependable, durable, fine looking and speedy motorcycle at a price so small you will wonder how you ever got along with the old-fashioned "leg power" machine.

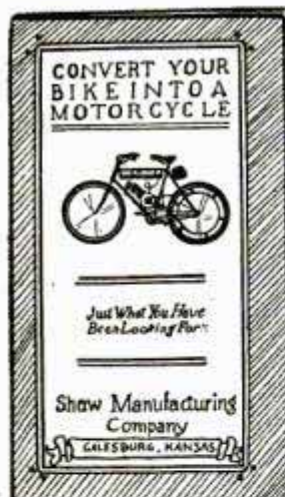

## Read What These Users Say of Shaw Motorcycle Attachment

### "300 Miles for 40 Cents"

The SHAW Motor which I purchased of you about a month ago, is doing excellent work. I have ridden it about 300 miles with about 40 cents expense. It is certainly the cheapest and best running machine I ever saw. Having ridden several makes of motorcycles, I find it the simplest and easiest controlled of any of them.

W. N. HARMISON, Blockton, Iowa.

### "Climbs Hills in Canada"

I have climbed hills with your motor that large motor cars get stalled on; the sand is several inches deep.

ERNEST PEDEN, Carleton Place, Ont., Canada.

### "Power, Speed and Reliability"

I received my attachment from you in first-class condition. The motor was easily attached and runs fine. It does not take an experienced person to run the SHAW. I recommend it to anyone desiring, at small cost, a motorcycle for power, speed and reliability.

PEARL BLACKETER, Ayshire, Ind.

### "Very Useful"

I have found your motor attachment to be all you claim. Have been using the one I bought for six months, have bought no repairs for engine at all. I find it very speedy and powerful, and very useful in many ways.

L. E. RICKMAN, Ferda, Ark.

### "Perfectly Reliable Outfit"

The motor which I ordered of you in the summer of 1910 has proved to be a perfectly reliable outfit. I have had no trouble whatever with the engine. The cam and gears show no wear, and I have probably ridden it 2000 miles. I can honestly recommend the SHAW Motor to anyone that wants a motorcycle at a small cost and have a satisfactory motor.

OSCAR L. THOMPSON, Cedar Lake, Iowa.

**SHAW**  
Manufacturing Co.  
Dept. F, GALESBURG, KANSAS

Thousands In Use All  
Over America and  
Europe

Please send me, free and postpaid, copy of your book illustrating and describing the SHAW Motorcycle Attachment as advertised in the April issue of POPULAR MECHANICS. Quote me your lowest net cash, factory price.

NAME .....

ADDRESS .....

## Write For FREE BOOK!

We want to send you, free and postpaid, a copy of our booklet illustrating and fully describing the SHAW Motorcycle Attachment. When you read about the simplicity and the low cost of the SHAW attachment you will no longer be satisfied with your old-fashioned, slow-going, tiresome bicycle, but will want to send and join forces with the thousands of other go-getters who are now hitting the high speed trail with a SHAW!

Send name on the coupon or postal card for the free booklet today

**Shaw Manufacturing Co.**  
Department F  
Galesburg, Kans.



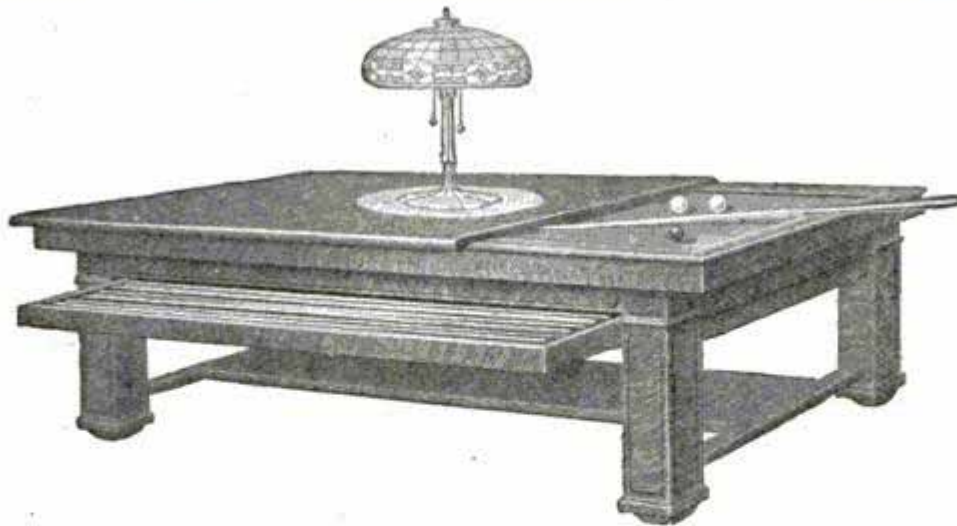

# Billiard-Library Table

## —20 Cents a Day

The trifling sum of 20 cents a day will pay for this beautiful Brunswick "Convertible" Billiard-Library Table, including complete Playing Outfit.

The table is made of finest Quarter-sawed Golden Oak, handsomely finished. Equal in playing qualities to the famous "Baby Grand."

Concealed Cue Rack and Accessory Drawer hold entire playing equipment. Adapted for use in library, living room or den—no extra room required.

## Brunswick "Baby Grand" Home Billiard or Pocket-Billiard Table



### The Home Magnet

No indoor game has such charm for the young folks as billiards or pocket-billiards. It is a refined and innocent pastime which keeps them contentedly at home, away from harmful influences. Endorsed by eminent educators and trainers of young men. Ask for a little book entitled, "Our Boy Now Lives at Home."

### Send for Free Book

The De Luxe book, "Billiards—The Home Magnet," shows these superb tables in actual colors. Gives descriptions, prices, easy terms, etc. Write for it.

**THE BRUNSWICK-BALKE-COLLENDER CO.**  
Dept. V. H. — 623-633 S. Wabash Ave., Chicago

The Brunswick "Baby Grand" is a masterpiece in Mahogany. Fitted with a genuine Slate Bed, the celebrated Monarch Quick-Acting Cushions and Accessory Drawer to hold entire playing equipment. Sizes 3x6, 3½x7, 4x8. Furnished as a Carom, Pocket-Billiard or Combination Carom and Pocket-Billiard Table. Attractive prices and easy terms.

### A Year to Pay

#### Complete Playing Outfit Free

We offer these beautiful tables at very moderate prices, and on wonderfully attractive terms, as low as 20 cents a day. A year to pay if desired.

Complete Playing Outfit goes with table, including Cues, Balls, Bridge, Rack, Markers, Chalk, Cover, Billiard Brush, Book on "How to Play," etc., etc.

**The Brunswick-Balke-Collender Co.** (240)  
Dept. V. H. — 623-633 S. Wabash Avenue, Chicago

Please send me the free color-illustrated book —

**"Billiards — The Home Magnet"**

Name .....

Address .....



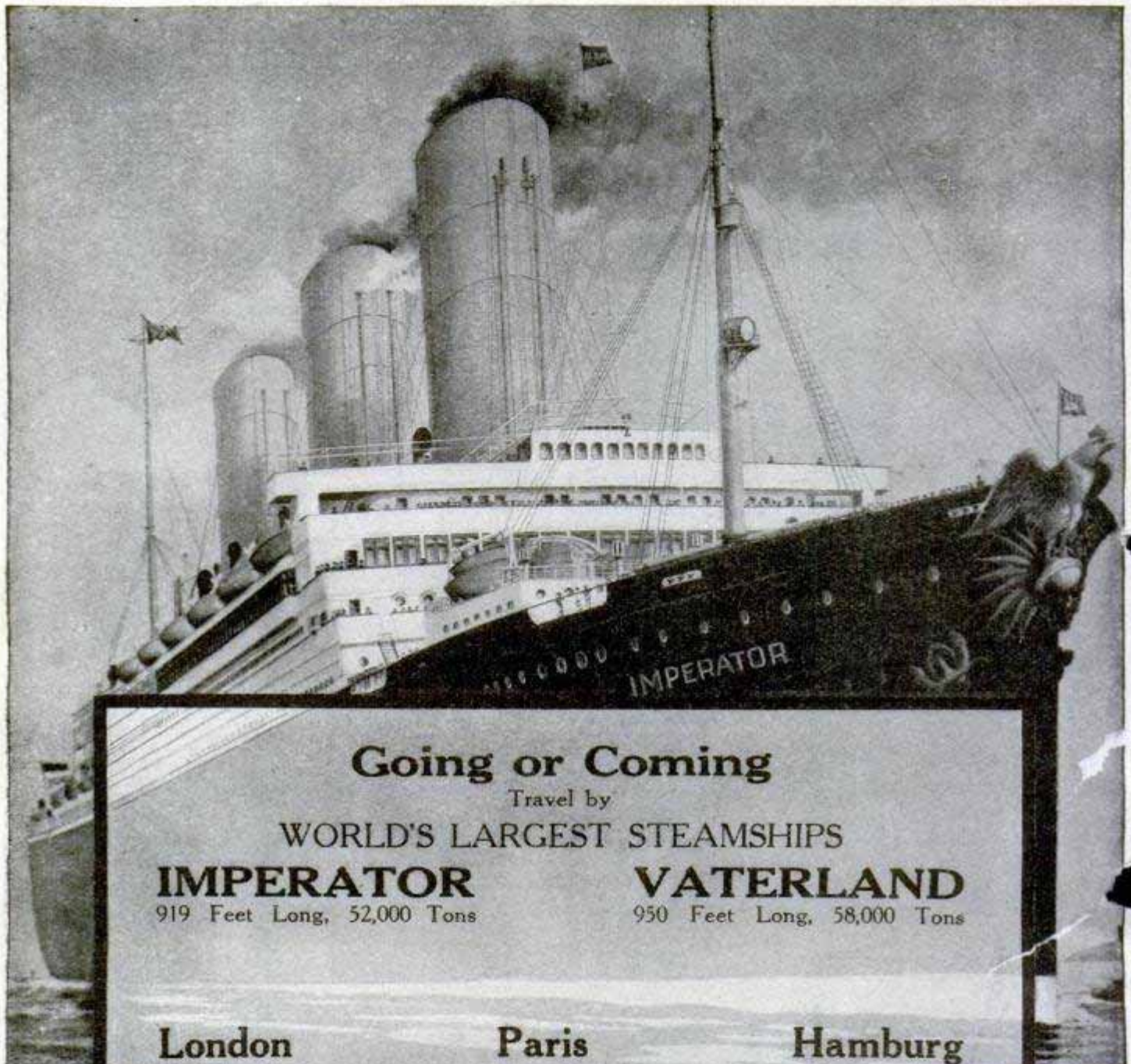

## Going or Coming

Travel by

WORLD'S LARGEST STEAMSHIPS

**IMPERATOR**

919 Feet Long, 52,000 Tons

**VATERLAND**

950 Feet Long, 58,000 Tons

**London**

**Paris**

**Hamburg**

March 21 | April 15 | June 16 | July 7  
 May 16 | June 6 | August 1 | August 22

**Cruises from Hamburg**

During June, July and August  
 to the

**Land of the Midnight Sun**

Great Cruise of 1915

**AROUND THE WORLD**

Through the PANAMA CANAL

reaching San Francisco at the opening of the  
 Panama-Pacific Exposition

**DURATION 135 DAYS, COST \$900 UP**

*Send for Illustrated Booklet*



**HAMBURG-AMERICAN LINE** 41-45 Broadway New York  
 Philadelphia Boston Pittsburgh Chicago New Orleans Minneapolis St. Louis San Francisco





## On the Firing Line

in every walk of life you'll find good old "Bull" Durham. Men of action, men with red blood in their veins, who do the world's work, and do it well, learn to appreciate things at their *real worth*. They are not fooled by frills—they demand *honest value*.

These are the millions of men all over the earth who find complete, healthful enjoyment and lasting satisfaction in "Bull" Durham hand-made cigarettes! There is a fresh, peculiar fragrance—produced by the original and exclusive "Bull" process—which gives a special pleasure to "Bull" Durham in a handmade cigarette.

# GENUINE "BULL" DURHAM SMOKING TOBACCO

(Enough for forty hand-made cigarettes in each 5-cent muslin sack)

Ask for **FREE**  
book of "papers"  
with each 5c sack



Note that unique aroma! It gives a greater relish and savor to your cigarette. "Roll your own" and learn this *distinctive form* of tobacco enjoyment.

An Illustrated Booklet, showing how to "Roll Your Own," and a Book of cigarette papers, will both be mailed, **FREE**, to any address in U. S. on postal request. Address "Bull" Durham, Durham, N. C. Room 1124

THE AMERICAN TOBACCO COMPANY



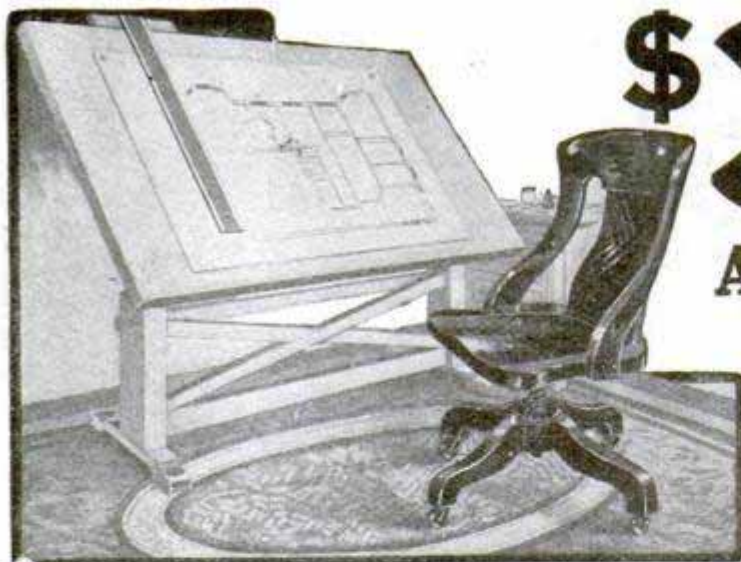

# \$3,000

## A Year to Fill This Chair

There's many a vacant chair like this waiting for you. I am training young men to fill them. Will you send your name to me? Many a man who has written to me now earns \$3,000 or more. The draftsman's training they got from me gave them the power to demand this price. There will be no obligations on you if you send me your name. Then I'll tell you just exactly how I train you personally.

# Drafting

**I'll teach you drafting in your own home. I'll teach you personally—**

give you private instruction. This instruction is given to you by me. I make you see how I do it. For 20 years I have been doing the highest paid expert drafting work as Chief Draftsman of a large and well known Company. One day the manager said to me, "Why is it that there are not more high quality men like you? *I would pay thousands of dollars a year if I could get them.*" Right there I made up my mind that I would give to ambitious men the highest quality, personal instruction in the very things which had enabled me to earn my big salary. So the kind of training I will give you is the **practical** kind. The kind you need to hold one of the big paying positions.



I know what the big firms demand and this is what I teach you. I do it all during your spare time in your own home. Remember you get my personal training. Don't hesitate about sending me your name—just cut out the coupon below—write in your name and you'll hear from me at once.

## Positions Open Right Now

Right now—this very minute—there are many positions open which pay \$3,000 and more per year to the right men who have learned drafting. There is lots of room at the top. I got there myself but have found all around incompetent men holding poor positions. They had not been trained right. The thing I want to do is to train you in the practical way you ought to be trained; to show you what to avoid and how to do things right. **YOU** can get into one of these chairs soon if you will merely send me your name on the free coupon below.

## You Can Earn While Learning

I have even perfected a plan which gives you an opportunity to begin earning money as soon as you have enrolled as one of my personal and private students. This enables a few young men or older men who could not otherwise take up this practical, personal training which I give, to pay their way as they go along. Write for this plan today. Put your name on the coupon at the bottom and get it in to me right away. If you have been one of those who have dreamed of the future of greatness and power, send the coupon.

### I Guarantee

To instruct you until competent and in a position at a regular salary, paying from \$125.00 to \$175.00 per month and furnish you free \$15 Working Outfit at once.

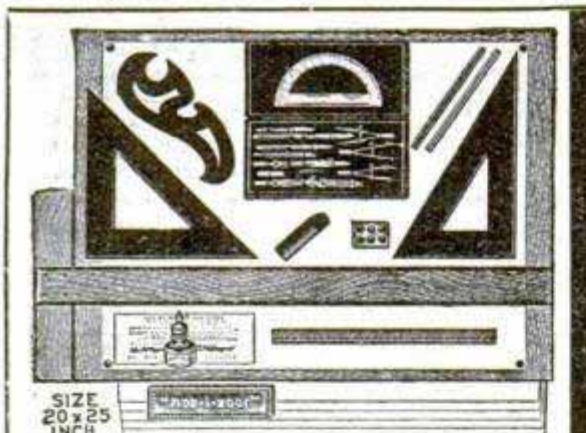

SIZE 20 x 25 INCH

**This \$15.00 Draftsman's Working Outfit FREE**

## Tear Off This Coupon and Mail Today

It will positively help you to find out all about the things which I can do for you. I will tell you what I have done for other men. Then you can make up your own mind about what I can do for you. I say I can put you into a chair paying a big salary. If you want to sit in this chair

## Put Your Name Right Here

There are no obligations in your sending your name and address to me on this free coupon. Send it today. I will mail you absolutely free and prepaid my new book, "Successful Draftsmanship." This tells you about the wonderful opportunities there are in this great profession. About the big jobs that are open. The big future ahead for the man who gets in now and knows what to do. Now, the first thing to do. Send the coupon. Do it today.

**Address CHIEF DRAFTSMAN**

Div. 9194, Engineer's Equipment Co., (Inc.) CHICAGO, ILL.

**\$3000 SALARY EARNING OFFER COUPON**

**CHIEF DRAFTSMAN, Engineer's Equipment Co. (Inc.) Div. 9194 CHICAGO, ILL.**

Without any obligation to me whatsoever, please mail your book, "Successful Draftsmanship" and full particulars of your liberal "Personal Instruction" offer to a few students. It is understood that I am obligated in no way whatever.

Name .....

Address .....



10%  
Increase in Tariff  
Oct. 1913

**GENUINE  
PERFECT CUT  
DIAMONDS**  
**\$97.50**  
PER CARAT

25%  
Increase in Diamond  
Prices in 12  
Months

## Fixed as the Sun! Our Old Price \$97.50 Per Carat!

In spite of increased tariff on diamonds; in spite of a general advance of 25% in diamond prices and values—we continue to offer Genuine Perfect Cut Diamonds at the old price—**\$97.50 per carat**. Diamonds of richest brilliancy, full \$160 per carat quality at a saving of more than one-third! Made possible by direct importing, cash methods which require no advance payment, low expenses and small profit. Read the wonderful features of the Basch Plan.

### What our Money Back Guarantee means to you

You can buy and wear a diamond with the **absolute certainty** that you can return it to us for a **cash refund**. We legally guarantee in writing to refund the full price **IN CASH** less 10% any time within 2 years; and also to allow the full price in exchange at any time. We legally certify the carat weight, quality and value of every diamond.



### A Few Examples of Basch Values

	Price Complete		Price Complete
<b>\$101</b> —Two $\frac{1}{8}$ c. dia.	<b>\$19.50</b>	<b>\$108</b> — $\frac{1}{2}$ carat dia.	<b>\$48.75</b>
<b>\$102</b> — $\frac{3}{8}$ carat dia.	<b>\$36.75</b>	<b>\$109</b> — $\frac{3}{8}$ carat dia.	<b>\$71.25</b>
<b>\$103</b> — $\frac{1}{2}$ carat dia.	<b>\$63.25</b>	<b>\$110</b> — $\frac{1}{2}$ carat dia.	<b>\$10.50</b>
<b>\$104</b> —Two $\frac{1}{8}$ c. dia.	<b>\$65.50</b>	<b>\$111</b> — $\frac{1}{2}$ carat dia.	<b>\$22.50</b>
<b>\$105</b> — $\frac{1}{2}$ carat dia.	<b>\$12.00</b>	<b>\$112</b> — $\frac{1}{2}$ carat dia.	<b>\$33.50</b>
<b>\$106</b> — $\frac{1}{2}$ carat dia.	<b>\$21.25</b>	<b>\$113</b> — $\frac{1}{2}$ carat dia.	<b>\$50.00</b>
<b>\$107</b> — $\frac{3}{8}$ carat dia.	<b>\$35.00</b>	<b>\$114</b> — $\frac{1}{2}$ carat dia.	<b>\$69.75</b>
		<b>\$115</b> —1 carat dia.	<b>\$102.50</b>

### Free Examination

Send no money! Select any diamond, any one of the thousands of mountings we illustrate in our De Luxe Diamond Book. We ship to your City, care of any express office or bank—allow free and complete examination—all at our expense and without obligating you to buy! You will find our prices  $\frac{1}{3}$  less than jewelers ask;  $\frac{1}{2}$  less than time payment prices—20% less than wholesale,

## 128 page De Luxe Basch Diamond Book **FREE!**

Clip the coupon—fill in your address—to secure a 30% dividend on your diamond investment! For this coupon will bring you our De Luxe Diamond Book—considered by experts the most complete, beautiful and authoritative catalog of Diamonds and Jewelry ever produced. 10,000 illustrations, facts about diamonds acquired by our experts through a life-time of study; particularly how the Basch Plan enables us to assure you a saving of at least 30% on any diamond. You will appreciate the helpful information in our book which will enable you to buy your diamond intelligently—to judge qualities and compare values.

MAIL COUPON OR WRITE TO

**L. BASCH & CO.**

Dept. N247, State & Quincy Sts., CHICAGO

**Clip this Coupon to save 30%**

Please mail me free your 128 page De Luxe Basch Diamond Book explaining the Basch Plan and Importers' Prices. It is understood I am not obligated in any way in making this request.

Name .....

Address .....

Dept. N247, State & Quincy Sts., CHICAGO

THE BASCH DIAMOND BOOK



Jewelry ever produced. 10,000 illustrations, facts about diamonds acquired by our experts through a life-time of study; particularly how the Basch Plan enables us to assure you a saving of at least 30% on any diamond. You will appreciate the helpful information in our book which will enable you to buy your diamond intelligently—to judge qualities and compare values.





# Williams'

## PATENTED Holder Top Shaving Stick

Greater Convenience—Greater Satisfaction

Your fingers do not touch the soap. You grasp it by the metal cap in which the stick is firmly fastened, rub it gently over the face, which has previously been moistened, and then return the Shaving Stick to its nickeled container.

The Holder-Top permits you to use the stick down to the last available bit with perfect ease and convenience.

THREE OTHER FORMS OF THE SAME GOOD QUALITY



Williams' Shaving Stick Hinged-Cover  
Nickeled Box  
Williams' Shaving Powder Hinged-Cover  
Nickeled Box  
Williams' Shaving Cream (in tubes)

A sample of any one of these four shaving preparations will be sent postpaid for 4c. in stamps.

THE J. B. WILLIAMS COMPANY  
Dept. A, Glastonbury, Conn.

WILLIAMS' JERSEY CREAM SOAP

and our extensive line of *Toilet* soaps have the same softening, creamy emollient qualities that have made Williams' *Shaving* Soaps so famous. Ask your dealer for them.

