

# Popular Mechanics Magazine

318 W. Washington Street, Chicago, U. S. A.

EDITED BY H. H. WINDSOR

ISSUED MONTHLY

SUBSCRIPTION:

SINGLE COPY, 15 CENTS

In United States, and its possessions, Cuba and Mexico, per year, postpaid . . . . . \$1.50  
To Canada . . . . . 1.75  
To all other countries in the Postal Union . . . . . 2.50

All subscriptions are discontinued at expiration. Please examine the date printed on your wrapper.

Entered as Second Class Matter Sept. 15, 1903, at the Post Office at Chicago, Illinois, under Act of March 3rd, 1879.

Entered as Second Class Matter at the Post Office Department, Canada.

Published monthly by POPULAR MECHANICS CO.

Copyrighted 1914, by H. H. WINDSOR.

The attention of prospective advertisers is called to the policy of this magazine in accordance with which the publisher waives all claim for payment of any advertisement appearing in any issue where the number of copies actually printed and circulated is less than the number printed on the front cover page.

## Contents for March, 1914

Accident to a Street Car, Strange.....	420	Dirigible Operated by Wireless.....	346
Aerial Ropeway for Transporting Game.....	317	Dirigibles Carry Many Passengers.....	369
Aeronautics, Technical School Teaches.....	420	Dock, Floating, Tow Great from Holland to Java.....	361
Aeroplane Engine, Ten-Cylinder.....	417	Door Key Turns Lights On and Off.....	392
Aeroplane, Stabilizer for, Called "Pancake".....	406	Drawing Board, Tackless, for Draftsmen.....	412
Airman, American, Loops the Loop.....	376	Drier, Mechanical, Operates Rapidly.....	343
Airman Seeks to Fly Around the World.....	349	Electric-Fixture Extension, Novel.....	422
Alloy, New, Unaffected by Boiling Acids.....	425	Electric Plant, Remarkable Showing by.....	410
Alpine Mountaineers, How Risk Their Lives....	399	Electric Radiator Now Adapted to the Home..	408
Anchor, Ship's, Reward for Recovery of.....	391	Electricity will Detect Fraud in Maple Sugar...	320
Animal Trap, Prehistoric, Yields Fossil Remains.	418	Exploration, Modern Equipment Used in.....	360
Aqueduct, Great New York, Nearly Completed	336	"Fake" Picture Made a Reality.....	423
Atomizer for Combining Several Perfumes.....	397	Fans, Small Electric, for Limousines.....	368
Automobile and Boat, Combined.....	369	Fencing, Bayonet, a Soldier's Sport.....	309
Automobile Fender of New Design.....	394	Fire Alarm, Hoots from Horns Give.....	364
Automobile Heater Uses Engine Exhaust.....	378	Fire Engine, Old, Heats Railway Station.....	346
Automobile Lamp with Double Bulb, New-Type	361	Fireplaces of All the World.....	362
Automobile Somersaults Down Embankment....	342	Fountain Drawing Pen for Draftsmen.....	393
Automobile That Carries Sterilizing Device....	408	Fuel, New Automobile, Cheaper than Gasoline..	376
Automobiles, Handy Shopping Bag for.....	407	Garbage Can Which is Always Closed.....	387
Automobiles, Rear Bumpers for.....	383	Garbage Collection, Sanitary.....	374
Babies, Dutch, Need No Cradles.....	334	Golf Balls, Explosive, Menace to Sight.....	421
Babylonian Bricks, Electric Oven Restores.....	395	Golf Club, Novel Rubber Grip for.....	346
Balloon, Fire Department Repairs.....	416	Grade-Crossing Problem, What It Means.....	393
Balloon, German, Breaks World's Record.....	364	Gradient Meter, New, for Motor Cars.....	375
Banks Protect Bullion by Steel Cars.....	402	Grave of a Coupling Pin in Railroad Switch Yard.	425
Battleship "Delaware" Cleared for Action.....	352	Grindstone, Vibrating, New Invention.....	398
Battleship "Vermont" in Storm.....	372	Hand Drier, Electric, Supplants Towels.....	333
Belt Handler, Safety, Prevents Accidents.....	383	Hatpin Guide, Injury to Hat Prevented by.....	381
Bicycle, Torpedolike Windshield for.....	335	Head Carved by Eskimo from Spruce Knot....	365
Bird Residences, An Architect of.....	371	Heaters, Street-Car, Cause Peak Load.....	318
Boat Making by Djockas Interesting Process....	401	Hose Reel and Standpipe Combined.....	392
Bombs, Explosive, for Use with Aeroplanes....	364	Hot Springs of Iceland Make Natural Laundry..	315
Box Kites, Collapsible, Used by Government...	314	Hotel Cabinet Vends Toilet Articles.....	420
Brakes for Street Cars, Noiseless.....	395	House Plans—A Picturesque Concrete Cottage..	462
Burning House Advertises Real-Estate Sale....	416	Hudson Bay Route, Dredging Harbors on.....	378
Canal Locks, Balanced, Lift Boats High.....	390	Hunting the Biggest of All Big Game.....	322
Cannon Ball, Breaking Stone with.....	316	By Roy C. Andrews	
Cars That Run Straight without Steering.....	385	Iron Pipe, Burlap Covering for.....	410
Carver's Handle for Leg of Mutton.....	396	Irrigation Dam, Bassano, Canada.....	351
Checking Cabinet Requires No Attendant.....	387	Ladders, Fire, Detachable Hook for.....	355
Chin Lifter Makes Child Sit Up While Writing..	361	Landmark Where Tropics Begin, Mexican.....	421
China, Great Wall of, in Perfect Condition....	321	Leather-Softening Device.....	376
Clock with Electrical Winding Device.....	396	Life-Saving Equipment, Sensible.....	373
Colors for Interior Decoration, Selection of....	394	Lighting Dynamo, Simple, for Automobiles...	380
Concrete Box for Trees.....	313	Lion, Stone, at Chaeronea, Greece.....	411
Concrete, Lining a Deep Mine With.....	340	Lock, Simple, for Door Key.....	390
Concrete Mixer Ties Up Street-Car Line.....	342	Locomotive, French, Uses Naphthalene as Fuel.	413
Concrete Posts, New, Staples are Driven into..	382	Locomotive, Gasoline, for Terminal Work....	366
Crane, French Building, Interesting Appliance..	313	Locomotive Made of An Old Auto Hauls Train..	418
Curious Vehicles in Use the World Over.....	404	Magazine Holder, Display.....	374
Cyclecar, American.....	365	Mahogany Logs, Loading on a Steamer.....	349
Destruction of Newark (N. J.) Opera House..	367	Mahogany Used to Imitate Walnut.....	355
Diamonds, Mining, by Modern Methods.....	310	Mail Boxes Indicate Commercial Activity.....	333
Dirigible, Italian, Shows Innovations.....	403	Mail, Carrying on Ice Yacht.....	357

[Continued on Page 6]

Popular Mechanics offers no premiums; does not join in "clubbing offers," and employs no solicitors to secure subscriptions. It is for sale by nearly every newsdealer in the United States and Canada.

## Contents—Continued

Mechanical Work Promoted by Music.....	424	Water Supply, Securing, in the Bermudas.....	424
Microscope, Insect, for Naturalists.....	385	Windmill, Towerless, Tireless Worker.....	357
Military Car, New, Built for Service in India..	401	Windshield, Curved, Found Effective.....	356
Milk-Bottle Protector Stops Petty Thieving...	392	Wireless, Movements of Boats Now Controlled by	409
Milk Cans, Vacuum, Make Shipping Safe.....	379	Wireless on Moving Train Brings Aid in Emer-	gency 414
Mine-Rescue Motor Truck Efficient First Aid..	400	Wrench, Ingenious German.....	397
Miners, Pious, Worship at Depth of 500 Feet..	349	Wreck of the "Cobequid".....	337
Mines, Salting, Ingenious Methods Used in...	347	Wright Given Prize for Aeroplane Stabilizer...	342
Missouri River, Outwitting the.....	403		
"Mona Lisa" Identified by Paint Cracks.....	350	SHOP NOTES	
Motor Cars, Device to Elevate.....	412	Aluminum Segments, To Plane.....	444
Motor Coach for the Khedive, Gasoline-Electric..	428	Automobile, Oiling System for Main Shaft Bear-	ings 441
Motor Omnibus Feeders for Electric Lines.....	426	Automobile, Plunger Repair in, Gear Box.....	445
Motor Truck, Hydraulic Apparatus for Dumping..	391	Bell and Door-Lock Circuit for Apartment House	430
Motor Truck of Unusual Size.....	380	Blueprints, Large, Handling.....	447
Motorcycle Brigade in India.....	356	Boiler Tube, How to Plug.....	444
Motorcycle Made into Ice Boat.....	344	Calipers, Enlarging Capacity of.....	436
Moving Pictures of Flying Bullet, Making.....	392	Cap Screw, To Lengthen a Short.....	435
Navy Puts Educational Plan into Effect.....	314	Chuck Jaw, Auxiliary.....	429
Newspaper Made for Use as Wrapping Paper.....	319	Chucks, Auxiliary Drill, for Jeweler's Lathe...	433
Nose Ring, Is the, Coming Back in Style?...	312	Collets, Draw, for Milling Tools.....	447
Novel and Practical Things for Daily Use.....	388	Cup and Basin Holder for Hydrant.....	434
Ocean Liner Coated with Frozen Spray.....	347	Drill, Center-Clearance, Holder for.....	445
Oilcan Cap, Spring to Hold in Place.....	391	Drill, Twist, Counterbore Attachment for.....	433
Oiler, Automatic, Increases Lubricating Capacity.	397	Facing Small Bosses, Hand Tool for.....	443
Packlock for Automobile Starting Crank.....	382	Feed, Automatic, for Oil Cup.....	435
Painting Electric Cable a Mile Long.....	413	Filler for Metal Surfaces.....	441
Panama Bridge, Passing Dredge through.....	341	Flush-Tank Float Valve, Repairing.....	447
Panama Canal, First Boat Goes through, under	Own Steam 334	Forge Fire, Starting.....	430
Panama Canal, Fortifying.....	398	Gauge, Centering, for Lathe Tools.....	442
Panama Canal, Refrigerating Steamers for.....	402	Gauge, Glass, Used as Ruler.....	445
Panama Canal, Swimming Restricted in.....	416	Glass Bottles, Making Holes in.....	434
Parasite Which Destroys San Jose Scale.....	368	Hacksaw Frame, Thumb Rest for.....	431
Pasture Fence on Wheels.....	409	Hammer, Claw, Used for Detaching Rim.....	448
Patents, Interesting New.....	460	Hinge to Make Door Self-Closing.....	446
Penstock Problem, French Engineers Solve.....	376	Indicator, Emergency.....	441
Piano Stool, Fitting, Helps Players.....	386	Ladder, Shop, Made of Pipe.....	435
Poison Bottles, Spiked Band for.....	397	Lathe, Threading Studs in, with Solid Die.....	431
Pontoons Carry Railroad across Mississippi....	417	Leak in Heating Boiler, Repairing.....	432
Postage Stamp, Turkish, Commemorates Victory..	314	Level Bubble, Blue Ground for.....	442
Postal Card, Telephone, being Considered.....	380	Light, Obtaining Relative Intensity of Two	Sources of 431
Poultry House on Top of Box Car.....	428	Lock, Double, for a Door.....	448
Power Plant, Portable, Operates Many Tools...	333	Machine-Cutter Knives, Grinding, without Special	Machinery 443
Pumping a Billion Tons of Water a Year.....	400	Marble, Removing Oil from.....	448
Push Button, Handy, for Auto Horns.....	384	Motor, Aeroplane, Measuring Thrust of.....	446
Radium Mines, America to Hold, for Public Use.	414	Oil Feed for Machine-Cutting Tools.....	445
Radium Sets New Standard of Values.....	382	Packing Screw, Substitute.....	447
Railroad, Canadian, Uses New Type Pit Car....	375	Paint, Covering Capacity of.....	442
Railway-Car Seats, New Support for.....	384	Paint, Flat Water.....	435
Railways, Chinese, Have Variety of Gauges.....	425	Patterns, Filler for.....	433
Rain Gauge That Empties Automatically.....	346	Piston Rings, Grinding.....	429
Range, Finding the Enemy's, in Battle.....	353	Prick Punch with Hammer.....	434
Residence, Paris, with Mosaic Walls.....	348	Sawhorse for Heavy Timbers.....	433
Road Making, Novel Idea in.....	396	Shafts, Machining Long, in Short Lathe.....	440
Safety Lamps Not Always Safe.....	312	Shaper Head, Lengthening Stroke Limit of.....	444
Searchlight Makes Ships in War Color Visible..	315	Sign, Spacing Letters on.....	436
Searchlight, Portable, for U. S. Marines.....	318	Telephone Shelf, Swinging, for Two Rooms.....	436
Selling a Pig in a Poke in Singapore.....	406	Telephony, Practical—Part XII, Trouble Hints.	437
Sewer Outlet, Big, Launching in Atlantic.....	407	Threads, Cutting Special, without a Lathe.....	446
Ship Construction, Arch Principle of.....	381	Valve-Gear Link, Temporary Repair on.....	448
Shovel, New, Spreads Coal over Fire.....	393	Varnish, Black, for Leather.....	443
Sign, Portola Festival.....	360	Water, Drinking, Supplying to Shop Hands....	446
Sign Warns Thoughtless Masters.....	321		
Sinking Schooner Towed into Harbor.....	402	AMATEUR MECHANICS	
Ski Jumping in America.....	338	Bell, Continuously Ringing, How to Make.....	451
Sleeping Porch, Primitive, Used by Arabs.....	337	Box Partitions.....	458
Smokestack, Big Steel, Breaks in Two.....	341	Dents in Wood, Raising.....	451
Springs, Self-Lubricating, Now Manufactured...	398	Electrical Heating Apparatus for the Home—	Part I, A Three-Heat Electric Pad..... 453
Statue of Rameses II.....	427	Embossing Stationery.....	458
Steam, Raising, by Burning Oil in Water.....	384	Ferrule, Taper, How to Make.....	450
Street-Car Transfers Counted by Weighing.....	315	Flour Bin, Safety Catch for.....	458
Submarines, Long Trip of.....	312	Gauge, Prick-Punch Center.....	457
Synchronizing Pictures and Accompaniment.....	395	Gunstocks, Polishing.....	452
Target Which Marks Hits Automatically.....	383	Hinge with Wide Swing.....	452
Telephone Service, Small Fire Cripples City's...	336	Inkstand, Mission-Style.....	451
Thawing Frozen Ground with Steam Pipes.....	354	Leather Punch, Homemade.....	452
Ticket-Printing Machine, Railway.....	370	Porch Swing, Springs on Chains of.....	449
Time, Device Beats, for Congregation.....	316	Sextant, Simple.....	450
Top, Convertible, Latest Motor Improvement....	344	Snowball Thrower.....	449
Touring Car, Convertible, Used as Ambulance...	410	Stairway Handrails, Detachable Clamp for.....	452
Toy, French, Has Vagaries of Real Mouse.....	395	Whirligig Clapper.....	457
Train Caught When Tunnel Caved In.....	340	Whistle, Homemade.....	458
Trap for Large Game Made from Log.....	361	Wood-Scraper Handle.....	452
Trees, Big, Bringing to San Francisco.....	310	Workshop Seat, Combination.....	456
Truck, Single-Wheeled, for Madagascar.....	320		
Tunnel Building, Improved Method Used in....	319		
Tunnel, New, Built to Cut Down Air Resistance..	320		
Tunnel, Railway, Novel Plan for Building.....	383		
Tunnel under Mississippi, Remarkable.....	346		
War Vessel, British Launch New Type of.....	428		

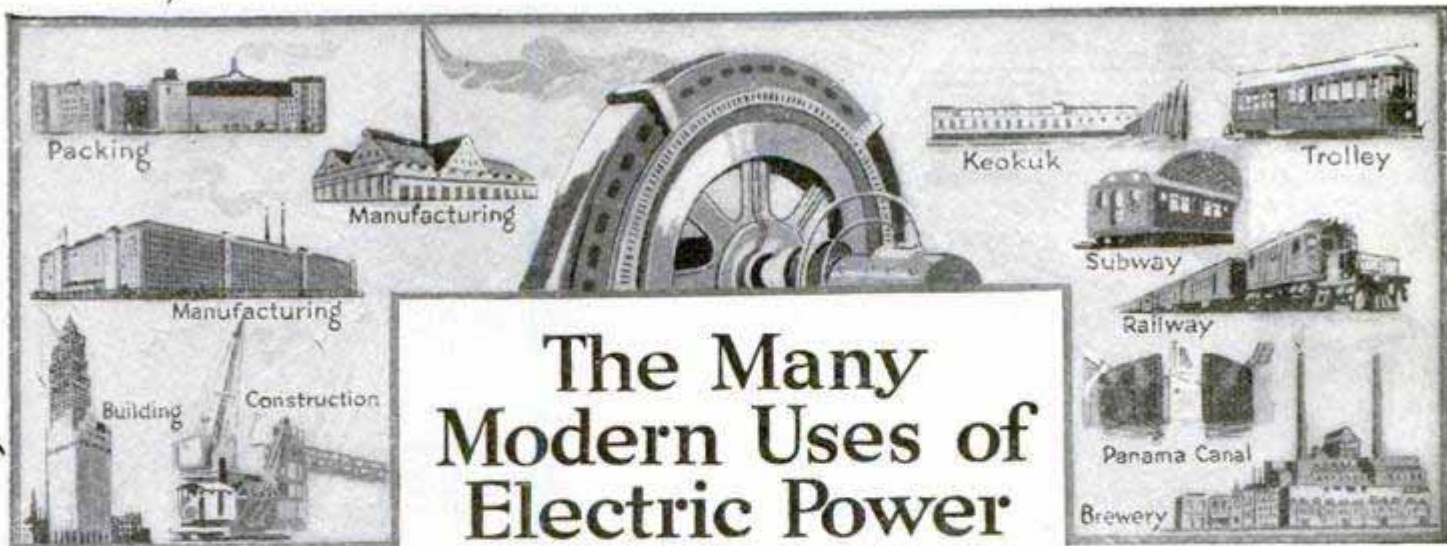

## The Many Modern Uses of Electric Power

FROM end to the other of this busy country electricity has been demonstrating its pre-eminence as the smoother and the booster of business. In large manufacturing plants and small, in production centers of an immense variety, in public works and private enterprises—in every situation where POWER is needed—electricity has been proving its twentieth century utility. It has increased light and good cheer by eliminating line shafting and substituting individual motor drive. It has reduced fire dangers and insurance rates, and

accident danger to workmen. It has promoted cleanliness. It has reduced power costs and proved its economy in related ways by simplifying operation, eliminating complexities in labor.

The Curtis Turbine has become a strong factor in power generation and the great range of G-E Motors has enabled these splendidly modern devices to meet all the intricate requirements of power transmission today. The partial list on this page will suggest the remarkable scope of usefulness in G-E apparatus.

### Amoskeag Mfg. Co.,

Manchester, N. H.—Largest cotton mill in the world—produces 60 miles of woven cloth an hour—uses G-E Motors throughout.

### Anheuser Bush Brewing Co.,

St. Louis, Mo.—G-E Motor drive is used extensively in this well known brewery.

### Buick Automobile Co.,

Flint, Mich.—When operating at full capacity this plant can produce a car a minute, G-E Motors used of course.

### Cascade Tunnel,

Great Northern R.R.—G-E Electric Locomotives haul the trains through this famous tunnel.

### Catskill Aqueduct,

New York City's water supply—practically all the electrical equipment used in constructing this famous aqueduct was furnished by the General Electric Company.

### Geat Southern Lumber Co.,

Bogahusa, La.—Largest lumber mill in the world used G-E Motors exclusively.

### Indiana Steel Company,

Gary, Ind.—Hundreds of thousands of horse power from G-E Motors in this largest steel mill in the world.

### Mississippi River Power Company,

Keokuk, Iowa—Largest power generating equipment in the world—G-E equipment throughout.

### New York City Traffic—

No steam locomotives are allowed on Manhattan Island. G-E Electrical equipment is used by the N.Y. Central, The Interboro Elevated and the Hudson & Manhattan Tubes.

### Panama Canal—

G-E Motors have helped to build and will operate the finished canal.

### Panama-Pacific Exposition,

San Francisco, Cal.—Lighted by Mazda lamps from power furnished by G-E Electrical equipment.

### "Round the World"

—Every year the General Electric Company puts out enough railway motors to operate an electric belt line around the world.

### Universal Portland Cement Co.,

Buffington, Ind.—Operated by power furnished by G-E Motors.

### Warner Sugar Refinery Company,

Edgewater, N.J.—Uses G-E Motor power extensively for all operations in connection with the refining of sugar.

### Wood Worsted Mill—

American Woolen Company, Lawrence, Mass.—G-E Motors used throughout this largest Worsted Mill in the world.

### Woolworth Building,

New York City—highest office building in the world erected by G-E Motor-driven hoists.

*The Guarantee of Excellence on Goods Electrical*



# GENERAL ELECTRIC COMPANY

Atlanta, Ga.  
Baltimore, Md.  
Birmingham, Ala.  
Boise, Idaho  
Boston, Mass.  
Buffalo, N. Y.  
Butte, Mont.  
Charleston, W. Va.  
Charlotte, N. C.  
Chattanooga, Tenn.  
Chicago, Ill.

Cincinnati, Ohio  
Cleveland, Ohio  
Columbus, Ohio  
Davenport, Iowa  
Dayton, Ohio  
Denver, Colo. (Office of Agt.)  
Detroit Mich.  
Elmira, N. Y.  
Erie, Pa.  
Ft. Wayne, Ind.  
Hartford, Conn.

## Largest Electrical Manufacturer in the World

Indianapolis, Ind.  
Jacksonville, Fla.  
Joplin, Mo.  
Kansas City, Mo.  
Keokuk, Iowa  
Knoxville, Tenn.  
Los Angeles, Cal.  
Louisville, Ky.  
Madison, Wis.  
Mattoon, Ill.  
Memphis, Tenn.  
Milwaukee, Wis.  
Minneapolis, Minn.  
Nashville, Tenn.

New Haven, Conn.  
New Orleans, La.  
New York, N. Y.  
Niagara Fall, N.Y.  
Omaha, Neb.  
Philadelphia, Pa.  
Pittsburg, Pa.  
Portland, Ore.  
Providence, R. I.  
Richmond, Va.  
Rochester, N. Y.

Salt Lake City, Utah  
San Francisco, Cal.  
St. Louis, Mo.  
Schenectady, N. Y.  
Seattle, Wash.  
Spokane, Wash.  
Springfield, Mass.  
Syracuse, N. Y.  
Toledo, Ohio  
Washington, D. C.  
Youngstown, Ohio

For Texas, Oklahoma and Arizona business refer to Southwest General Electric Co., (formerly Hobson Electric Co.)—Dallas, El Paso, Houston and Oklahoma City  
For Canadian business refer to Canadian General Electric Company, Ltd., Toronto, Ont.

EXPLANATIONS SO CLEAR A CHILD CAN UNDERSTAND

**LEARN THE AUTOMOBILE TRADE**

**Be an Auto Mechanician**

Do work at homes of auto owners, no capital required—or start a shop of your own—or if you prefer drive a car, tester or salesman. We



NOW RUNNING A GARAGE



NOW AN AUTO MECHANICIAN DOES WORK AT HOMES OF AUTO OWNERS WAS A CLEAR (BERT TIDVEL)

will teach you and show you how to start. Everyone in the business is making money and every year it grows four times.

We teach everything from A to Z—except actual driving—we have a plan whereby you can learn that. But anyone can drive; you often see children driving.

You don't have to be a mechanic; it's in knowing the principle, how to diagnose and remedy troubles and adjust—all comes from learning the principle.

**BE YOUR OWN TEACHER**

You can read, understand pictures, charts and models—then why pay \$25 to \$100 when you can learn at home during spare time for only —\$15 with

**DYKE'S WORKING MODEL HOME STUDY COURSE**

—it's quicker and easier than working in a shop—you learn through the eye, no hard study. Actual practice on real working models.



**4 CYLINDER ENGINE MODEL**  
IT WORKS, ALL MOVING PARTS REAL METAL. OTHER MODELS ARE: MAGNETO, CARBURETOR, CLUTCH, GEAR BOX, DIFFERENTIAL.

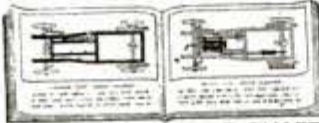

**THE PROGRESSIVE CHART MANIKIN**, SHOWING HOW THE CAR IS ASSEMBLED FROM THE GROUND UP

**LET US**  
DESCRIPTION OF  
**DYKE'S**  
NEW IDEA  
**WORKING MODEL**  
SYSTEM

**TESTIMONIALS**  
PROOFS SAMPLE  
PAGES, CHARTS  
OPPORTUNITIES  
OF THE  
MOTOR BUSINESS

**SHOW**  
**YOU**  
**EMPLOYMENT**

THESE BOOKS LETS TEACHING BY MAIL **FREE** **SEND FOR THEM**

**MANY SAY THEY LEARN A LOT FROM THESE 32-PAGE, FULLY ILLUSTRATED BOOKLETS ALONE**

**We Will Show You—** how we can teach **YOU**, how we have taught **hundreds** of others — how we can start **YOU** to making money even before you complete Course — how we have started **hundreds** of others who knew no more than you do right now—

**We Will Further Show You—** endorsements of the leading motor authorities of the world, men who could not afford to endorse this system if it was not absolutely satisfactory in every respect.

**YOU DEAL WITH A RELIABLE FIRM**

Mr. Dyke has been identified as a pioneer inventor, supply man, etc., with the auto industry since the beginning. He originated the first auto supply company and published the first book on autos in America. No other man with such experience is today teaching others. And all the experience and inside information of the auto business he has thus gained, is embodied in this Course and Employment Plan.

**On Trial** —You are allowed a trial examination of the Course—if it isn't perfectly satisfactory you can return it within two days and get your money back. The Course is all sent to you at one time.

**WRITE** **SPECIAL PRICE—Right Now—** Complete Course—only . . . **\$15.00**

**NOW**

**DYKE'S CORRESPONDENCE SCHOOL OF MOTORING,**  
Box 188, Roe Bldg., ST. LOUIS, MO.  
NOTE — Beware of Imitators — Deal with the Originator

**The Pictorial Review of Current Events**

**Cartoons**

**MAGAZINE**

By H. H. WINDSOR,  
Editor Popular Mechanics Magazine

**15 Cents a Copy \$1.50 per Year**

**Get the March Number**

And keep up with the events of this busy world without wasting hours of your time.

**In Its New Garb the Cartoons Magazine Becomes the Magazine for Everybody**

Its pages are crowded with the best work of the cartoonists of the world and these clever drawings are accompanied by comment gleaned from the columns of editorials penned by newspaper writers trained to follow the questions of the day.

**Bound Volumes One, Two and Three Now Ready**

These bound volumes contain more than 3,000 reproductions of the very best cartoons that have been printed during 1912 and 1913. A collection of more than 120,000 cartoons was made in order to secure them. Bound in the three volumes they make an "instant history" of the past months, for they are a pictorial record of the events of the world.

These three books, artistically and durably bound, are now ready for distribution and will be sent all express charges prepaid to any address in the United States or its possessions upon receipt of **One Dollar Each**.

Cartoons Magazine has become the ready reference book of the up to date man. It is not a mere collection of clever pictures but is a magazine that improves and educates.

Ask your newsdealer to show you the March number, or

**Send your order to CARTOONS**  
318 W. Washington St. Chicago, Ill.

DELCO and OTHER STARTING and LIGHTING SYSTEMS

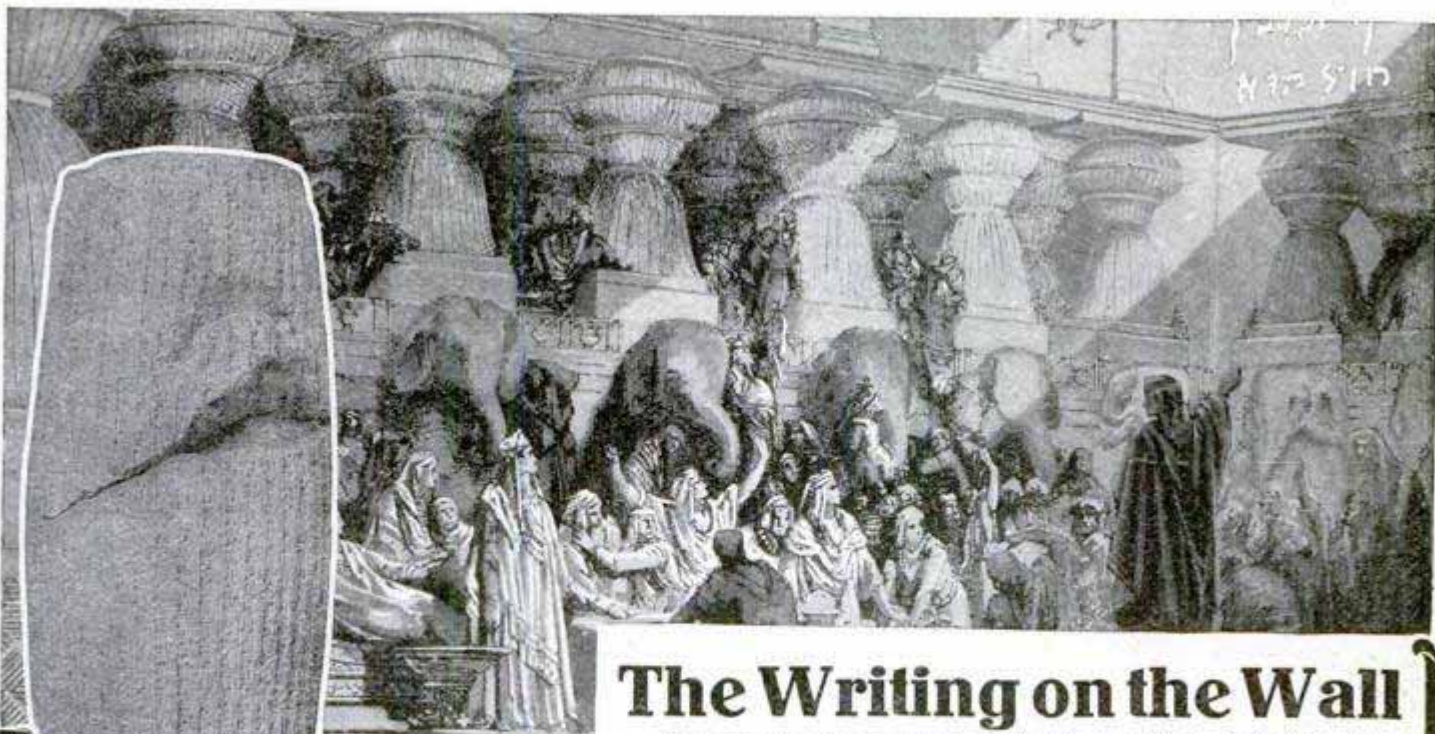

Terra-cotta cylinder containing Cyrus' own story of the "Fall of Babylon"

## The Writing on the Wall

It was at the famous feast of Belshazzar, King of Babylon, that the prophet Daniel read the awful dictum—"Mene, Mene, Tekel Upharsin." That night Cyrus and his army captured the city, but not until thousands of years later was unearthed the inscribed cylinder that told the real story of the "Fall of Babylon." This curious account, which is very different from the popular version, is but one of many thousand "original documents" contained in

# The Library of Original Sources

now for the first time available to the general public. This remarkable Library has previously been sold by subscription, but by purchasing the *entire unsold edition* from the publishers we secured it at an *absolutely unheard of reduction*. Therefore we are able to offer a few sets to POPULAR MECHANICS readers at

## AN EXTRAORDINARY BARGAIN

Send us the attached coupon AT ONCE, and we will tell you how to get the Library on EASY MONTHLY PAYMENTS, and mail you FREE a book of rare documents showing curious inscriptions of the Ancients. Remember there are only a limited number of sets, so act quickly. Mail the coupon NOW. You assume no obligation. No salesman will call. The book is FREE.

**THIS MARVELOUS WORK** is revolutionizing modern thought. It's turning upside down old notions and ideas. It gives the authoritative, rock-bottom sources of our knowledge on ALL SUBJECTS OF HUMAN INTEREST from the earliest civilization *down to today*—the inside facts which the average person has never even heard of.

**OVER 100 RESEARCH SPECIALISTS** spent 10 years gathering the contents of this great work. Ancient and remote and forgotten civilizations in all parts of the globe were uncovered, and age-buried hieroglyphics on monuments, tablets, sun-baked bricks and palimpsests yielded their secrets; untiring workers ransacked the hidden literature of every age, ancient, mediæval and modern, to find the "original documents" that shaped the civilizations and influenced the thought and life of the world. Nothing like it has ever been attempted or thought of before. You'll be amazed at the wealth of information this unique library contains.

**DO YOU KNOW** that the old Egyptians, 5000 B. C., had a Bible?

—Do you know that the Assyrian literature gives the story of the Creation?—Do you know that books and newspapers were printed in Asia thousands of years before printing was invented by Gutenberg?—Did YOU ever read Columbus' *personal log* of his great voyage?—Do you know that there occurred in Mediæval England the first great Socialistic protest?—Do you know by what unique process Harvey demonstrated the circulation of the blood?—Do you know who Machiavelli was, or what world famous treatise he wrote?

**YOU'LL FIND THEM ALL**—and thousands of others equally as curious and important—in The Library of Original Sources. Every document is in the exact words of the original, translated; every contribution is from the actual eyewitness or person who took part; every idea is in the words of the thinker, investigator, discoverer or inventor.

**JACK LONDON SAYS:**—"It is a whole library in itself. I certainly never could spare these books from my shelves."

10 sumptuous, massive volumes, bound in rich, deep red leather; full page illustrations, pure silk headbands, printed in large, clear type on handmade paper, gold tops—a triumph of the book-maker's art.

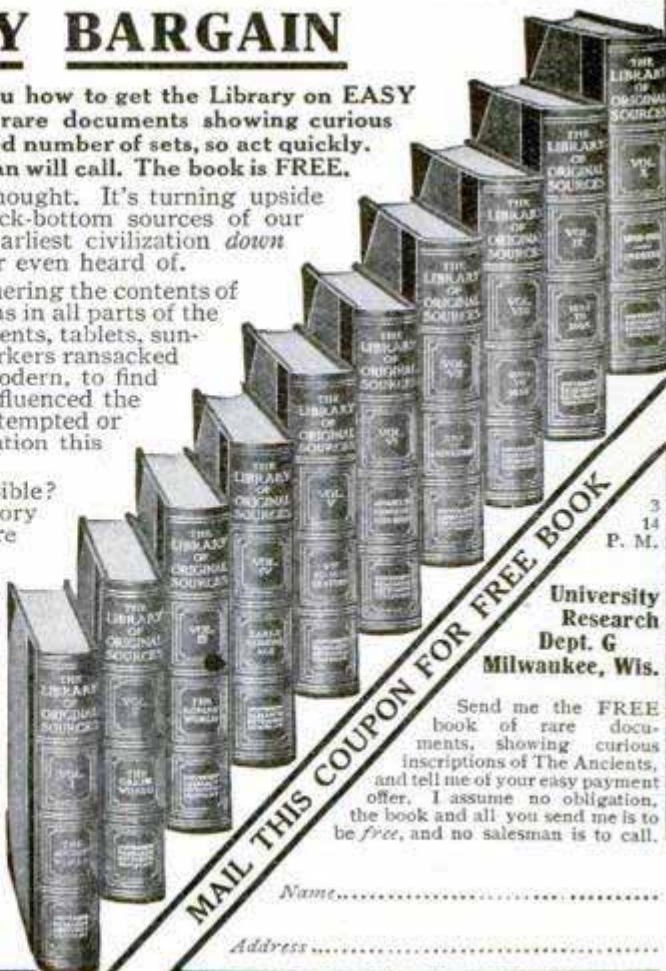

3  
14  
P. M.

University  
Research  
Dept. G  
Milwaukee, Wis.

Send me the FREE book of rare documents, showing curious inscriptions of The Ancients, and tell me of your easy payment offer. I assume no obligation, the book and all you send me is to be free, and no salesman is to call.

Name.....

Address.....

The Burlington Special  
19 Jewels Fully Adjusted

The Burlington Special  
New Style Thin Model



Here Is an Exquisite Design

Inlay Enamel Monogram

# Just Out!

*New Ideas in Watches*

Block and Ribbon Monograms, Diamond Set, Lodge, French Art and Dragon Designs. See catalog for complete set of color illustrations.

## Special Offer

You may secure one of these superb time-pieces—a watch of the very latest model, the popular new thin design, adjusted to the second—19 jewels—adjusted to positions AND temperature AND isochronism—at the same price that even wholesale jewelers must pay—and in order to encourage everybody to secure this watch at once pay this rock bottom price, either for cash or \$2.50 a month! We send the watch on approval, **prepaid**. You risk absolutely nothing—you pay nothing—not one cent, unless you want *this exceptional offer* after seeing and thoroughly inspecting the watch.

## Write for New Watch Book

Learn the inside facts about watch prices, and the many superior points of the Burlington over double-priced products. Just send the coupon or a letter or a postcard. Get this offer while it lasts.

Burlington Watch Co.  
19th Street and Marshall Blvd.  
Chicago Dept. 1193

Watch Book Coupon  
Burlington Watch Co.  
Dept. 1193  
19th Street and Marshall Blvd.  
Chicago, Ill.

Please send me (without obligation and prepaid) your free book on watches with full explanation of your rock-bottom DIRECT offer for cash or \$2.50 a month, on the Burlington Watch

Name .....

Address .....

Please Mention Popular Mechanics

# DO YOUR OWN Soldering —and Save Money



Send 55c for cloth bound Book "Simple Soldering" — and learn how to join metals, both hard and soft.

**CONTENTS** — Soldering. The Uniting of Metals. Soft Soldering. The Flux. Hard Soldering or Brazing. Soft Soldering. Heating the Work. Flux for Soldering, Etc. Methods of Holding Work. Wiring Work. Silver Solder. Soldering Copper, Etc. Cleaning Up Work. Polishing. Scraping Down. Honing, Etc. Standard Apparatus. The Blow-Pipe. Foot Bellows, Etc. Home Made Apparatus.

**SPON & CHAMBERLAIN**  
123 P. M. Liberty St. NEW YORK

# 9,059-Word Business Book Free

Simply send us a postal and ask for our free illustrated 9,059-word Business Booklet which tells how priceless Business Experience, squeezed from the lives of 112 big, broad, brained business men, may be made yours—yours to boost your salary, to increase your profits. This free book deals with

- How to manage a business
- How to sell goods
- How to get money by mail
- How to buy at rock-bottom
- How to collect money
- How to stop cost leaks
- How to train and handle men
- How to get and hold a position
- How to advertise a business
- How to devise office methods

Sending for this free book binds you to nothing, involves you in no obligation; yet it may be the means of starting you on a broader career. Surely you will not deny yourself this privilege, when it involves only the risk of 2 postal—a penny! Simply say "Send on your 9,059-word Booklet". Send to **SYSTEM, Dept. 81-3 Wabash and Madison Sts., Chicago**



## Build Bodily Strength

And Mental Vigor

Guaranteed Results in 30 Days

Write for my FREE BOOK "PHYSIOLOGICAL EXERCISES." Tells how exercising with my system ten minutes a day will improve your health and vitality, internally and externally. It tells you how to build a constitution that will defy colds and illness, that will give you muscular power, pure blood, perfect digestion, a strong heart and lungs. Send 4c. in stamps to cover postage.

**The Henry Victor System**  
14-16 Fourth Ave., Dept. 63 New York



## HERE YOU ARE, BOYS

A medallion pin of Foxy Grandpa. Everyone will notice it on the lapel of your coat and try to get a closer look at it. All you have to do is press the bulb.—Foxy Grandpa will finish the job by squirting a fine stream of water over the inquisitive one. Will squirt 20 feet. Greatest joke out. Order one today and fool your friends. Price 15c. Foxy Grandpa and Hooligan both for 25c. 5 for 50c or 1 doz. for \$1.00. A beautiful fountain pen free with every \$1.00 order.

**AMERICAN SUPPLY CO., 918 Union St., St. Paul, Minn.**

## Start a Candy Store

Clear \$1,000 to \$5,000 a year. Capital and experience unnecessary. Ideal business for both men and women. New method home instruction in making and selling all kinds of fine candies. Special low rate now open. Particulars free. Write today.

**CANDY MAKERS EXCHANGE, 918 Dwight Bldg., Kansas City, Mo.**



## 200 Kinds Iron, Wood, Wire & Steel Puzzles

Catalog and sample 10c—3 leaders for 25c  
**WESTERN PUZZLE WORKS**  
St. Paul, Minn.



## \$150,000 Was Paid by the Public to Hear Just One of These Great Lectures

Wendell Phillips, who delivered it, is dead; he can never be heard again, but his marvelous oration has been preserved for you, together with the equally great efforts of hundreds of the most wonderful speakers and lecturers the world has ever known, in these 10 beautiful volumes of

# Modern Eloquence

Every speech, lecture, and address is complete; each one is acknowledged to be the greatest ever delivered on a particular subject. You'll find that this *unequaled* work contains the most entertaining and profitable reading ever gathered in one set of books. It voices the opinions, ideas and experiences of the leading intellects of their time; it combines the brilliancy, fascination and style of the great classics, and like them the more often it is read the more interesting it becomes.

Renowned statesmen, authors, scholars, scientists, explorers and soldiers, through its pages, deliver to you, whenever and wherever you wish, the epoch-making orations that moved audiences and nations, that gained them fame and fortune. It's like *hearing* the greatest speeches and lectures ever made without stirring from your chair.

### What This Great Work Contains 300 After-Dinner Speeches by

Joseph H. Choate, Benjamin Disraeli, James G. Blaine, Wm. M. Everts, John Hay, Oliver Wendell Holmes, Sir Henry Irving, Chauncey M. Depew, Henry Ward Beecher, Mark Twain, Henry W. Grady, Joseph Jefferson, Robt. G. Ingersoll, Seth Low, Albert J. Beveridge, Woodrow Wilson, etc.

### • 150 Great Addresses by

Lyman Abbot, Charles Dudley Warner, William Cullen Bryant, Rufus Choate, Theodore Roosevelt, Arthur J. Balfour, Jonathan P. Doliver, Edward Eggleston, William E. Gladstone, Charles Francis Adams, John L. Spalding, Joseph Chamberlain, Grover Cleveland, Fisher Ames, Lawrence Barrett, Henry Drummond, Hamilton Wright Mable, William Jennings Bryan, etc.

### 60 Classic and Popular Lectures by

Charles A. Dana, Robt. J. Burdette, Russell H. Conwell, Canon Farrar, John B. Gough, Andrew Lang, Wendell Phillips, Josh Billings, John Tyndall, Geo. William Curtis, Artemus Ward, Paul DuChaille, John B. Gordon, Newell Dwight Hillis, John Morley, John Ruskin, Henry M. Stanley, Wu Ting Fang, etc.

### 200 Short Stories and Anecdotes by

Mark Twain, Chauncey M. Depew, Horace Porter, Champ Clark, Joseph H. Choate, John M. Allen, etc.

## A Wonderful Bargain

50,000 sets of Modern Eloquence were sold at a figure much higher than ours before we secured the few remaining sets of the wonderful de Luxe edition at a sale. We are now offering these while they last at an *insignificant price* that you can easily afford to pay. Send us the attached coupon by return mail and we will name this price and tell you how you can get the books on *easy monthly payments*. We will also send you

### Henry W. Grady's Great Lecture— "The Race Problem"—FREE

Reprinted from the work itself. Champ Clark says—  
"The most famous after-dinner speech within the memory of any living man." Sending the coupon places you under no obligation to buy. If you are interested, tear it off and send it NOW. Don't wait. The offer is limited.



### MODERN ELOQUENCE

consists of 10 large, handsome volumes bound in rich, red three-quarters morocco; with attractive design stamped in gold leaf on the backs. Printed in clear, legible Caxton Old Style type on beautiful white paper. Profuse illustrations in photo-gravure on Japanese vellum and each volume is gold topped. It's a set that would prove a notable addition to the finest library in the land.

Mail This Coupon For Free  
Lecture P. M. 3-14

GEO. L. SHUMAN & CO.,  
Dept. 6, Ohio Building, Chicago.

Please send me free lecture and full description of Modern Eloquence with special prices and terms.

Name .....

Address .....

# Over 1900 Successful Graduates From Sweeney Automobile School

The Sweeney School can give you the names and addresses of over 1,900 graduates who are now chauffeurs, repair men, factory experts, garage owners, salesmen, etc. These men came to us untrained. They got interested by reading our advertising, just as you are reading now. They acted on the same impulse that moves you now to investigate. And then after a few weeks' instruction they went out of this school completely equipped, got employment, and today are **Prosperous, Happy and Respected**. You can do likewise. I will teach you so that you have a chance to qualify yourself for a **Business Success** handling or repairing automobiles. It will **cost you nothing** to investigate, and let me tell you the actual experiences of my graduates.

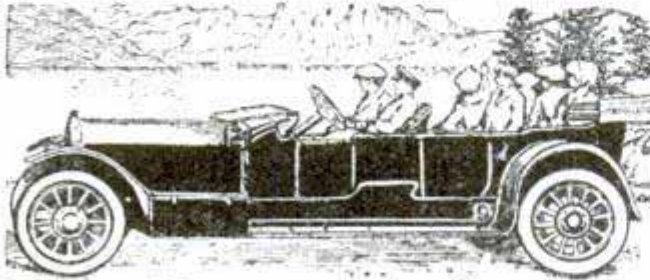

## The Sweeney System of Practical Auto Instruction

is now universally recognized a thorough, practical and interesting course of automobile instruction, leading to certain and profitable **EMPLOYMENT**. It embraces every point worth knowing, including vulcanizing, brazing, oxyacetylene welding, lathe work, machine shop practice, testing, driving, truck repairing and operating, etc. **AND YOU LEARN** by doing the work on **REAL CARS** under the watchful eyes of skilled instructors.

## All Types Self Starters Taught by Sweeney System

is free. Our course is thorough and we have a special instructor and equipment to teach this branch of the automobile business. We have the Starting Systems used on the following cars: American, Apperson, Auburn, Austin, Buick, Cadillac, Cartecar, Cole, Continental, Crow-Elkhart, Detroit, Howard, Hudson, Keeton, Krit, Lambert, Marathon, Maxwell, Meteor, Mitchell, Monarch, Moon, National Six, Oakland, Ohio, Oldsmobile, Paige, Premier, Reo, Republic, Richmond and Stutz. We guarantee this statement. **DECIDE ON A SCHOOL where you can learn all the business and not only a part of it.**

## Everybody in the Automobile Business Today is Making Money

Here is your chance. I want you to come to my school and see for yourself how quickly and easily you can learn the business and become a **HIGHLY PAID MAN**, drive any car or truck or traction engine, or open a garage or repair shop of your own. You can learn the business thoroughly in my school because I have been years working out this system and the **WONDERFUL PROMPT** success of my hundreds of **PROSPEROUS GRADUATES** proves it.

## Our Men Learn Quickly and Easily, Because Practical Experience is the Best Teacher

### FREE COUPON

E. J. SWEENEY, President

**SWEENEY AUTO SCHOOL**

1166 E. 15th St., KANSAS CITY, MO.

Send free scholarship offer and catalog. Also magazine.

Name.....

Address.....

### Pick Out a Good Job!

Chauffeur :	\$60 per month
Mechanic :	\$160 per month
Salesman :	\$1,500 per year
Demonstrator :	\$150 per month
Garage Manager :	\$35 per week
Stationary Gas Engineer :	\$100 per month
Tractor Engineer :	\$5.00 per day and up
Repairman :	\$18 per week up

Study this picture. This is the best way to learn. Do things with your own hands. Practice beats theory. We do not merely tell you how; we show you how, and you then do the work yourself. We have over 40 cars and chassis of all makes on our own floor, eight trucks, two tractors, and our **DRIVING TACHEERS** keep out on the road nearly twelve hours a day. **YOU GET PLENTY** of WORK of all sorts.

### No Books Used; Tools Furnished Free

The tuition is low and after you have paid that there are **NO MORE** expenses or extras you have to buy. If you could learn from a book there are lots published you could read at home, but **PRACTICAL WORK** is the best method, and this is what makes my School different.

**Send Today** for my big free catalogue and we will also send you our monthly magazine free, the most interesting magazine for young men who want to get on in the world ever published. The catalogue is full of fascinating **PHOTOGRAPHS** almost as good as a personal visit to the school. Send today, this very minute.

EMORY J. SWEENEY, President

**Sweeney Automobile School, 1166 E. 15th Street, KANSAS CITY, MO.**

## Learn to Run and Repair Autos and Make Big Money

Think of this. Here's a trade where you are in demand 12 months in the year. Short hours, pleasant work. Outdoor life. Travel. Enjoy the world. Meet nice people. 90 per cent of the cars in use are not in proper adjustment on account of shortage of experienced mechanics. Grasp quickly this chance to make yourself a **SKILLED MAN** who is in demand and gets big pay for his work. No matter who you are we can teach you

## \$50 Course Free to Men Who Answer This Advertisement

You know right in your neighborhood of the demand for traction engineers and mechanics. Factories want workmen and demonstrators. We teach you on two different types of tractors in actual work. Men are wanted right now for good jobs. Here is a wonderful opportunity for young men. You can learn in a few weeks. We want to start out a few graduates right away and so although the regular price of the course is \$50 you **GET THE COURSE FREE** if you enroll in Automobile School now. Sign and return the scholarship coupon today. No previous experience required.

This school, recognizing the demand for up-to-date instruction on self starters and electric lighting systems, has equipped a special department to teach all types of self starters. To any automobile mechanic who desires to take a course on self starters, the cost will be \$25.00. To the students of this school, those that have graduated and those who enroll inside of the next 90 days, this course

## Eight Trucks in Daily Use

**Teach Students** We own a truck transportation company operating eight trucks and therefore give our students practical work in handling, repairing and driving trucks as well as giving them an insight into the livery and transportation business. We offer this valuable service to students and from this alone you can get experience to open up a most profitable business of your own.







JOHN CLARK RIDPATH

# Ridpath's History of the World

*"The Work of the Century"*

JOHN CLARK RIDPATH'S History of the World is unquestionably the greatest literary work of the nineteenth century. Other men have written great histories of single countries or periods—Gibbon of Rome, Macaulay of England, Guizot of France—but it remained for Dr. Ridpath to write a complete History of the entire World, from the beginning of civilization down to the present time.

## A Quarter of a Million Sets Sold

The sale of this great work exceeds that of any other set of books published in America. Over 250,000 sets have gone into American homes, and every purchaser is more than satisfied. It is strongly endorsed by scholars and statesmen; and by the thousands of owners, as the greatest history ever written. We are closing out the remaining sets of the last edition

## At a Very Low Price and Easy Terms

We will name our special low price and easy terms of payment and mail the beautiful free sample pages to all who mail us the coupon below. Tear off the coupon, write name and address plainly, and mail now before you forget it. Dr. Ridpath is dead, his work is done, but his widow derives her support from the royalty on this History, and to print our low price broadcast for the sake of more quickly selling the sets at our disposal would cause great injury to future sales. Mail the coupon now.

### Free

We will mail free a beautiful 46-page book on history to every reader who mails us the coupon. It contains Dr. Ridpath's Race Chart, the best map of the Panama Canal ever printed, portraits of Socrates, Caesar, Napoleon.

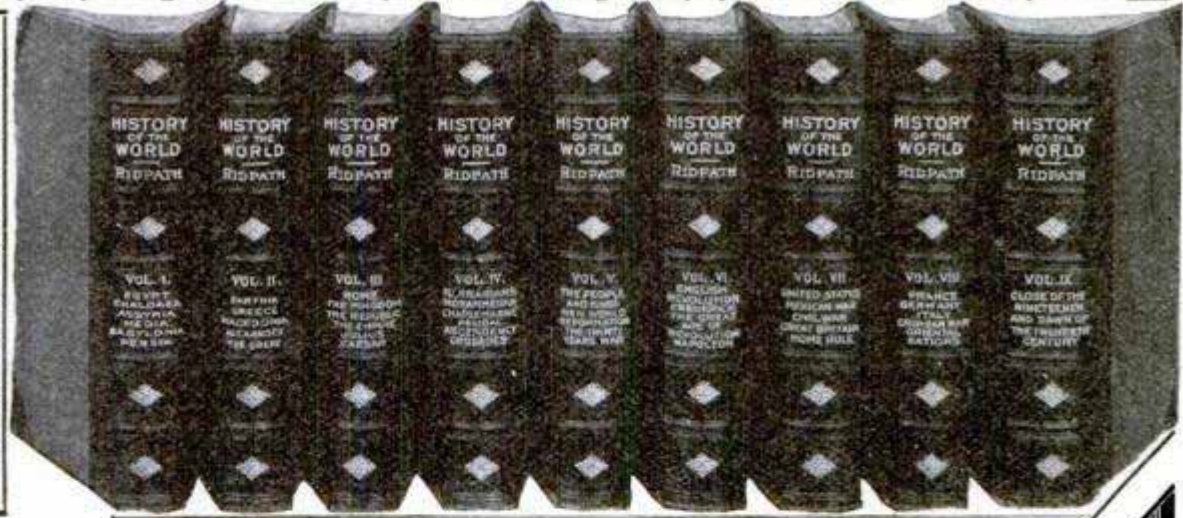

**THE REASON** for Dr. Ridpath's enviable position as an historian is his wonderfully beautiful style, a style no other historian in any generation has ever equaled. He takes the reader back to the beginning of history, 4000 years before the time of Christ when man was little more than a savage; without clothes save the skins of beasts; without shelter save in caves and overhanging-rocks, and traces his career down the long highway of time, through the rise and fall of empires until he reaches the present civilization, harnessing the powers of earth and air to be his servants, whispering messages across continents and oceans, crowning all with the glorious achievements of the nineteenth century. It is an inspiring story and Dr. Ridpath has told it better than it has ever been told before. Ridpath's history should be in your home. It is a work you will value as long as you live and read over and over again. It will increase your fund of knowledge, improve your power of conversation and help you to a larger success in life.

**WESTERN NEWSPAPER ASSOCIATION CHICAGO**

**FOLD HERE. TEAR OUT. SIGN AND MAIL.**

**3 14 FREE COUPON**

Western Newspaper Association  
**H. E. SEVER**  
 President  
 140 So. Dearborn St.  
 CHICAGO, ILL.

Please mail, free, 46 page sample booklet of Ridpath's History of the World, containing photogravures of Napoleon, Queen Elizabeth, Socrates, Caesar and Shakespeare, diagram of Panama Canal, etc., and write me full particulars of your special offer to Popular Mechanics readers.

Name .....

Address .....



# Be Boss In the New Profession

Thousands of men are needed. The new profession that is **paying big money** wants you and needs you. Here is your opportunity to get into it **now**. You don't need to leave your present employment. Just a few hours a day in your own home and soon you get your diploma and are a full-fledged Meter Engineer.

## Be a Meter Engineer

The profession of Meter Engineering is now in its infancy. It is calling for men. The Central Electric Stations **must** have Meter Engineers, because without them they cannot operate. Thousands of positions now open. Wonderful opportunities. You can get into the profession. It is calling **you**.

## A \$3000 Job for YOU

Meter Engineering is one of the best paying professions in the electrical industry. We can show you hundreds of men who are making better than \$3,000 a year. How would you like to have a \$3,000 job? Just put your name and address on the free coupon and get full particulars absolutely free. Send it now—today.

## Special

For a limited time we are making a special reduced price offer in order to induce men to start the study of Meter Engineering right away. Write for full particulars at once.

## Send the Coupon and Get 40-Page

## Book FREE

Do not delay an instant. Just put your name and address on the coupon and mail it to us at once. We will send you absolutely free and postpaid, 40-page book on Meter Engineering. It tells you all about the New Profession and about our school. It tells you how you can learn to **become a Meter Engineer** in your own home **during your spare time**. Absolutely no obligations of any kind in getting the book. Just your name and address is enough. But write today — now — immediately, while we can still make this great special offer.

**Fort Wayne  
Correspondence  
School**  
Dept. 1193  
Fort Wayne  
Indiana

## FREE Book Coupon

Ft. Wayne Correspondence  
School, Dept. 1193  
Fort Wayne, Ind.

Gentlemen: Please send absolutely free and prepaid your book on Meter Engineering. Also send me full particulars of the great special offer that is now being made to induce men to study Meter Engineering. I assume no obligations of any sort.

Name.....

Address.....

Please Mention Popular Mechanics

# Become A Government Employee—

60,000 Civil Service appointments will be made this year—1914. 60,000 men and women will secure life positions under Uncle Sam with big pay, rapid advancement, pleasant work, short hours and annual vacations with pay.

The PARCEL POST is creating thousands of openings in the RAILWAY MAIL, POST OFFICE and RURAL CARRIER SERVICES, at salaries ranging from \$600 to \$1800 a year and upward. If you're an American citizen, 18 years or over, you're eligible.

We can help you secure one of these good jobs. Civil Service examinations will be held to fill them. **DON'T WAIT—BE READY.** Write us now—**TODAY**—for our 64-page **FREE** booklet describing these and other desirable positions, and telling how you can prepare under the **personal supervision** of a former U. S. CIVIL SERVICE SECRETARY-EXAMINER—a man who knows and whose knowledge is at your disposal. Write at once.

**PATTERSON CIVIL SERVICE SCHOOL**  
303 Irving Place ROCHESTER, N. Y.



SEND  
for my  
FREE  
Books



## DO YOU WANT TO KNOW HOW TO DEVELOP VITALITY, ENERGY, ENDURANCE, NERVE STRENGTH, MUSCULAR STRENGTH PERFECT PHYSIQUE?

My **FREE** BOOKS, "The 'Whys' of Exercise" and "The First and Last Law of Physical Culture," tell you, if you are weak or underdeveloped, how to grow strong; if strong, how to grow stronger. They explain how to develop lungs and muscle, the strong heart and vigorous digestion—in short, how to improve health and strength internally as well as externally. Send **TO-DAY—NOW**—for these **FREE** BOOKS. Enclose 4c in stamps to cover postage.

**PROF. H. W. TITUS**, Department 121  
56 & 58 Cooper Square, New York City



## MAGIC TRICKS AND SUPPLIES

Just Out. New 160 Page Illustrated Catalogue of Wonders.  
**PRICE 10 CENTS**

Prompt Shipments. Satisfaction Guaranteed.  
Chicago Magic Co., 72 W. Adams St., Chicago, Ill.  
Successors to Read & Covert



## PRIZE PACKAGE FREE

We will send you **FREE** a big package of Magic Tricks, Puzzles, Cards, Jokes, Riddles, Money Making Secrets, Splendid Games, Toasts, Card Tricks, Feats in Parlor Magic, all **FREE**. Just send us 10c to pay for postage and adv. and we will send this trick package **Free**.

**NATIONAL TRICK CO. CHICAGO**

## BUTTERFLIES

and moths wanted for colleges. Highest prices. Outdoor summer work. Get complete instructions and details. Send 2c stamp.  
**JAMES SINCLAIR, Entomologist, Dept. 6, LOS ANGELES, CAL.**



## Every Boy His Own Toymaker

Greatest boys' book ever written. Tells how to make a Steam Engine, Telephone, Magic Lantern, Boats, kites, balloons, electrical and mechanical toys, traps, fishing tackle. 200 illustrations; also catalog of 150 puzzles, Keller's Magic Ace Trick Card and "DOUBLE THROAT" warbler and bird call for only 10c. **WESTERN PUZZLE CO., ST. PAUL, MINN.**

\$1

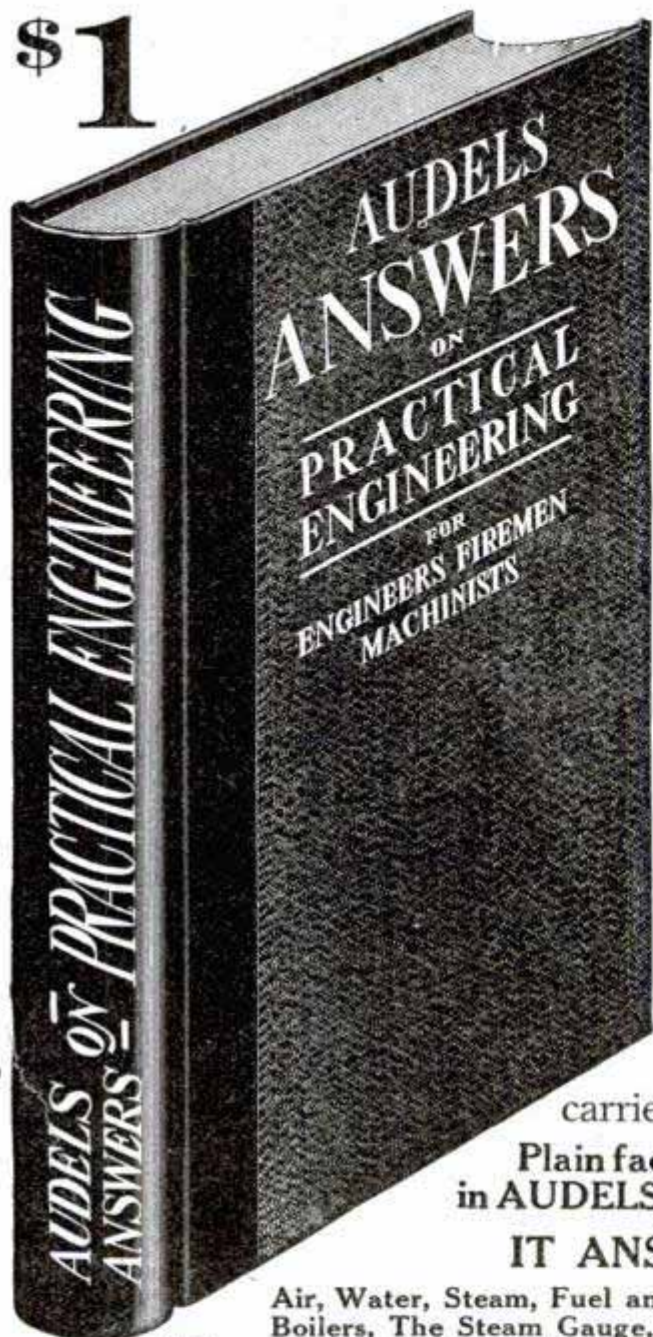

# ENGINEERS

This Book Will Help You

## Audels Answers on Practical Engineering

*When you spend your good hard earned money for books, always make sure that you are going to receive something that will assist you in bettering your position*

**T**HIS book deals largely with the foundation principles which govern the practice of steam engineering. Nothing so soon condemns the applicant as want of knowledge of the every day practice and simple laws relating to the care and management of a steam plant.

No one is expected to know everything, but all are required to be familiar with certain facts which may be called "the beginning of things."

The lack of knowledge of the small things carries conviction of the same lack in the larger.

**Plain facts, that you should know, are plainly explained in AUDELS ANSWERS on PRACTICAL ENGINEERING.**

### IT ANSWERS YOUR QUESTIONS ON

Air, Water, Steam, Fuel and Heat, Steam Boilers, Boiler Construction, Water Tube Boilers, The Steam Gauge, The Safety Valve, Properties of Steam, Installation of Boilers, Management of Boilers, Engineers' Law, Firemen's Law, Steam Engines, The Valve and Valve Gear, The Corliss Engine, Engine Arithmetic, Lubricators, Installation and Operation of Engines, Steam Pumps, Injectors, Feed Water Heaters, Steam Heating, Steam Traps, Belts, Gears and Pulleys, Steam Turbines, Refrigeration, Practical Electricity, Elevators.

Understand the framework of which your work is but a cross bar. Know something of the cause of which your work is but an effect. Know something of the effect of which your work is the cause. And, above all, know why it is done one way and not another.

**LEARN THE THEORY UNDERLYING THE WORK.** Practical Engineering contains 288 pages fully illustrated, handsomely bound and printed and is in every way a first class book.

## Examination Offer

**If You Are Interested** sign and mail the coupon, and it will bring to your plant a book of sterling merit, for free examination. You can have one week in which to dig out the mine of valuable information contained in its 200 or more pages.

### Carry It in Your Pocket for One Week

and at the end of the time, if you do not think the book is worth one dollar, mail it back to us. If it is, you can mail us \$1.00 in payment for your copy. If you fail to consider this liberal offer you are not dealing fairly with yourself. We take all risk that "Audels Answers on Practical Engineering" is a book you should own. Act now before you forget it.

Please send me for examination one copy

Audels Answers on Practical Engineering \$1

If I keep the book, I promise to send you within 7 days after receiving it ONE DOLLAR, in full payment; if I do not keep it, I will mail it back to you within 7 days.

**THEO. AUDEL & CO., 72 5th Ave., NEW YORK**

Signature.....  
 Occupation.....  
 Address.....P.M. Mar. '14

# STUDY LAW AT HOME

## Become an LL.B.

*Only Law School of its Kind in America*

### Special and Exclusive Features

**ONLY** recognized resident law school in the United States conferring Degree of Bachelor of Laws—LL.B.—by correspondence. **ONLY** law school in U. S. conducting standard resident school and giving same instruction, by mail. **ONLY** law school giving over 450 class-room lectures to its extension students. **ONLY** law school giving a full 3-year, University Law Course, by mail, having an actual faculty of over 30 prominent lawyers in active practice. **ONLY** law school in existence giving Complete Course in Oratory and Public Speaking, in conjunction with its law course.

### Written Bar Guarantee

We give an absolute written guarantee to prepare our students to pass bar examinations.

The Hamilton College of Law is a regular, thoroughly recognized, bona fide College of Law and NOT an "institute," "correspondence school," etc. It occupies the entire third floor of the New Advertising Bldg., where its large and commodious resident class-rooms and executive offices are located.



Our Degree Bachelor of Law, LL.B. NOT a Diploma or Certificate

### Direct From Class-Room to Student



**From Lecture Room to Student**  
No Other Law School Can Use This Illustration

chooses, take part of our course by mail and finish in our resident school where he will receive full credit for all work done by mail. Our resident school is recognized by all standard law schools in the United States.

The Hamilton College of Law is highly endorsed and recommended by Government Officials, Business Men, Noted Lawyers, Graduates, and Students. We have as students a number of practicing lawyers (not graduates of recognized law schools) who are now earning their degree of LL.B. Many other lawyers are using this course as a review. A probate Judge, (one of our active students) says: "I am delighted with the course prescribed and your method of teaching law. It is far in advance of what I expected to receive."

### Our Law Library

consists of 24 volumes of Student's Standard Text Books, two volumes bound together under one cover, making a total of 12 books. These books were prepared at an enormous cost especially for the students of the Hamilton College of Law, by one of the largest and best law book publishers in America. This is the only set of law text books ever prepared exclusively for student's use. We would be glad to have you submit these books to any lawyer or judge in the country and get his opinion regarding them.



These 12 Volumes are Free to Students of the largest and best law book publishers in America. This is the only set of law text books ever prepared exclusively for student's use. We would be glad to have you submit these books to any lawyer or judge in the country and get his opinion regarding them.

### Mail Coupon Today

and get our Big, Beautifully Illustrated Prospectus and complete information. Places you under no obligations whatever. This may mean the turning point in your career.

**Hamilton College of Law, 327 Advertising Bldg., Chicago, Ill.**

Gentlemen: Kindly send me your Illustrated Prospectus and full particulars regarding your method of teaching law by mail

Name.....

Address.....

Write plain and in full

Please Mention Popular Mechanics

### THIS \$2.00 BOOK OF Practical Electricity REDUCED TO \$1.00

38,000 engineers, electricians and students of electricity paid \$2.00 for this wonderful volume. You now have the opportunity of buying it at just half that price—\$1.00.

### Good As A School

This book is a school within itself. It contains twenty chapters of valuable information—and teaches the fundamental principles of electricity including designing, operation and care of dynamos and motors.

Practical Electricity was written out of the day's work—the result of our eighteen years' experience, in repairing every possible kind of electrical machinery and apparatus.

This book has helped boost hundreds of men to bigger and more responsible positions. In return for the electrical knowledge they secured from this book they boosted our repair business. We want to line up half a million more boosters—that's why we're cutting the price of the book in two.

### MONEY BACK IF NOT SATISFIED

We couldn't begin to tell all of the points and merits of Practical Electricity. We would rather send you the book and let you see for yourself. Mail us \$1.00 to-day—and if you aren't perfectly satisfied, return it and get your money back. Order it now.

**CLEVELAND ARMATURE WORKS**  
4734 St. Clair Avenue, CLEVELAND, OHIO

America's Greatest Electrical Repair Works



# SALESMEN

### Earn Larger Salaries Than Any Other Class of Men

We will teach you to be a high grade salesman, in eight weeks by mail and assure you definite propositions from a large number of reliable firms offering opportunities to earn good wages while you are learning. No former experience required. Write today for particulars, list of hundreds of good openings and testimonials from hundreds of our students now earning \$100 to \$500 a month. Address nearest office.

Dept. 29 **NATIONAL SALESMEN'S TRAINING ASS'N.**  
Chicago Kansas City New York San Francisco

### FRENCH, GERMAN, SPANISH, ITALIAN

Can be learned quickly, easily and pleasantly at spare moments, in your own home. You hear the living voice of a native professor pronounce each word and phrase. In a surprisingly short time you can speak a new language by the



### LANGUAGE-PHONE METHOD

COMBINED WITH ROSENTHAL'S PRACTICAL LINGUISTRY

Disc or Cylinder Records. Can be used on your own talking machine. Send for particulars and booklet.

THE LANGUAGE-PHONE METHOD  
961 Putnam Building, 2 West 45th Street, New York

### IF YOU STAMMER



attend no stammering school till you get my large FREE book and special rate. Largest and best school in the world curing by natural method. Write today.

Lee Wells Millard, Pres., North-Western School, Inc.  
917 First Street Milwaukee, Wis.

### JEWELRY ENGRAVING

We teach you, by our new and original method of instruction, this clean, fascinating and profitable business right at your home, and furnish you all tools needed absolutely free. Write for free book to the

**WISCONSIN SCHOOL OF ENGRAVING, Stroh Bldg., MILWAUKEE, WIS.**

### CORNET FREE!

We guarantee to teach you to play by mail and will give you a Beautiful Cornet or any Band Instrument absolutely FREE. You pay weekly as lessons are taken.

Instrument is sent with first lesson. Write today for our booklet and wonderful tuition offer.

**INTERNATIONAL CORNET SCHOOL**  
408 Music Hall, Boston, Mass.





Something worth remembering—the **Boston Garter**

is the only kind for men that has the

*Velvet Grip*

**RUBBER BUTTON CLASP**

Holds Your Sock Smooth as Your Skin

IN A VARIETY OF STYLES—PAD, CORD, DOUBLE GRIP

Lisle or Mercerized, 25 Cents Silk, 50 Cents

GEORGE FROST COMPANY, MAKERS, BOSTON

**WORN ALL OVER THE WORLD EVERY PAIR GUARANTEED**



**FREE "Linene" COLLAR**

Our free sample will prove comfort and economy. Send postal stating size and whether you want high or low collar. REVERSIBLE COLLAR CO., Dept. U, Boston, Mass.



**DEVILENE WHISTLE 10c**

Nickel plated. If you want the loudest whistle ever blown, something that can be heard against the wind; that will keep the whole neighborhood stirred up, that will rend the air with nerve racking walls, get a genuine DEVILENE and try it. Price 10c or 4 for 25c postpaid.

DEVILENE CO., 302 E. 51st St., CHICAGO



**PRIZE PACKAGE FREE**

We will send you FREE a big package of Magic Tricks, Puzzles, Cards, Jokes, Riddles, Money Making Secrets, Splendid Games, Toasts, Card Tricks, Feats in Parlor Magic, all FREE. Just send us 10c to pay for postage and adv. and we will send this trick package Free. NOVELTY CO., 305 E. 51st St., CHICAGO



**DOUBLE THROAT 10c** New Invention. Fits roof of mouth.

Greatest thing out. Astonish and mystify your friends. Make dogs or cats talk. Neigh like a horse, sing like a canary. Imitate any Bird or Beast of field or forest. Price 10c; 4 for 25c postpaid. NEW VOICE CO., 305 E. 51st St., CHICAGO

**CACHOO!** Make the whole family and all your friends "just sneeze their heads off" without knowing why, with Cachoo, the new long distance harmless snuff. Sent anywhere for 10c. 3 for 25c, 1 doz. and special premium for 90c. AMERICAN SUPPLY CO., St. Paul, Minn.



**LEARN TO WRITE ADVERTISEMENTS** **EARN \$25 to \$100 A WEEK**

We can positively show you by mail How to increase your salary. BOOK MAILED FREE. PAGE-DAVIS CO., 112 Page Building, Chicago, Ill., or 150 Nassau St., New York

# WARNING

From widely separated parts of the country come reports of the operation of subscription swindlers. These are young men who represent themselves as students working their way through college, and who are offering Popular Mechanics Magazine as a "trial offer" at 49 cents for a full year. Usually one, and sometimes two other magazines are included, all for the 49 cents.

Popular Mechanics Magazine has no subscription solicitors and prints a notice to that effect on its front cover every month, and never offers its subscription at less than the regular price of \$1.50.

**POPULAR MECHANICS COMPANY**  
H. H. WINDSOR, Pres.

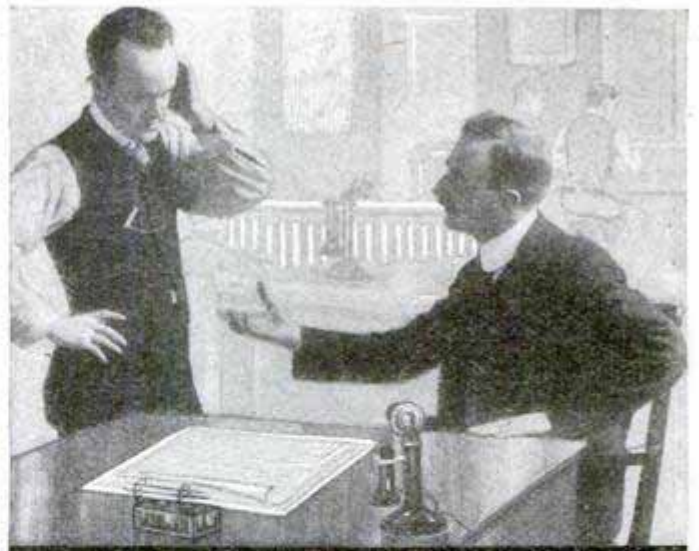

## Next to the Boss

Don't be content with the same small job with its small salary and hopeless future. Don't remain in an occupation that thousands upon thousands of others can fill and are waiting for. If you want independence, prosperity and an assured future you must enter a line that affords possibilities for expansion, prosperity, success. You cannot get success out of a profession or trade if success is not there. You want to get into an occupation that is not already overcrowded—that offers power, large salary and rapid promotion. Be in line for the higher positions—right hand to the Boss.

### \$3,000 to \$10,000 Yearly

Large firms everywhere need Expert Accountants with La Salle training. They pay \$3,000 to \$10,000 salary yearly for trained experts. This is the vocation that offers remarkable possibilities for unlimited advancement, power and income. If you are ambitious to better your condition, there is not a single reason why you cannot begin at once to become an Expert Accountant and realize a great future. No matter what your present occupation, education or wages

### We Train You By Mail

in your own home, in spare time. Makes no difference where you live. You don't give up your present position. Don't hesitate because of lack of money—we make terms to suit you.

**Present Position Makes no Difference**

It is not necessary that you already understand bookkeeping or work in an office. The LaSalle has devised a general course in bookkeeping that quickly prepares you from the ground up for more advanced work in Higher Accountancy. You can readily master and complete it in a relatively short time. Prepared by some of the world's most noted Expert Accountants—it is thorough, advanced—covering Theory of Accounts, Practical Accounting, Cost Accounting, Auditing, Business Law, etc. The course is administered under the direct personal supervision of William Arthur Chase, a nationally recognized leader, who is Ex-President of the American Association of C. P. A. Examiners, and Ex-Secretary of Illinois State Board of Examiners in Accountancy and prepares you for C. P. A. Examinations in any state.

### The La Salle Shows Results

The La Salle is a strong, reliable, conservative institution, with thousands of successful students. No other home-study course is so thorough and simple—endorsed by America's greatest Experts.

### What Every Bookkeeper Should Know

Write now for free copy of this remarkable book—learn exactly the information you require to become an Expert Accountant, studies, kind of examinations, state regulations, salaries and positions to be had.

### Special Reduced Rates LIMITED OFFER

Write quick and learn how, for a limited time, we are able to offer a special reduced rate scholarship.

### Mail Coupon NOW

Learn about the success of La Salle students and the unusual opportunities awaiting you if you let us qualify you at once. Send coupon now for free book and learn how to earn \$3,000 to \$10,000 yearly.

LA SALLE EXTENSION UNIVERSITY, Chicago, Ill.

La Salle Extension University, Dept. 640 Chicago, Ill.  
Send at once, your free book, containing What Every Bookkeeper Should Know, and full details of your Course in Higher Accountancy; also advise me about Special Time-Limited Reduced Rate

Name .....

Street No. ....

City ..... State .....



# \$3,000

## A Year to Fill This Chair

There's many a vacant chair like this waiting for you. I am training young men to fill them. Will you send your name to me? Many a man who has written to me now earns \$3,000 or more. The draftsman's training they got from me gave them the power to demand this price. There will be no obligations on you if you send me your name. Then I'll tell you just exactly how I train you personally.

## Drafting

how I do it. For 20 years I have been doing the highest paid expert drafting work as Chief Draftsman of a large and well known Company. One day the manager said to me, "Why is it that there are not more high quality men like you? *I would pay thousands of dollars a year if I could get them.*" Right there I made up my mind that I would give to ambitious men the highest quality, personal instruction in the very things which had enabled me to earn my big salary. So the kind of training I will give you is the **practical** kind. The kind you need to hold one of the big paying positions.

**I'll teach you drafting in your own home. I'll teach you personally—**

give you private instruction. This instruction is given to you by me. I make you see what I teach you. I do it all during your spare time in your own home. Remember you get my personal training. Don't hesitate about sending me your name—just cut out the coupon below—write in your name and you'll hear from me at once.

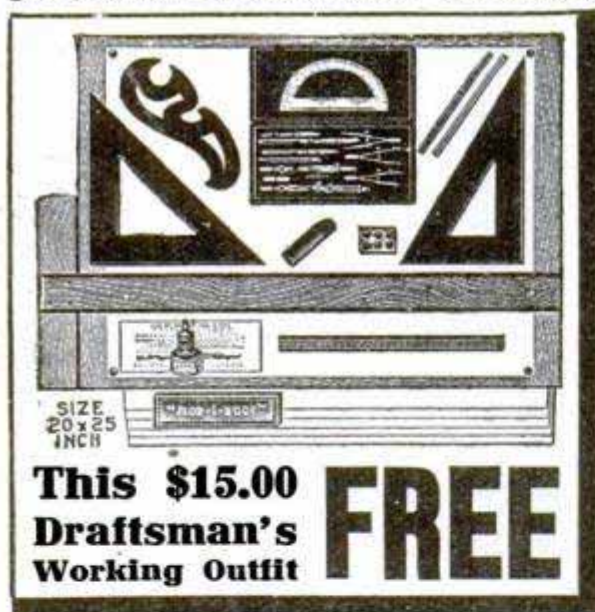

## Positions Open Right Now

Right now—this very minute—there are many positions open which pay \$3,000 and more per year to the right men who have learned drafting. There is lots of room at the top. I got there myself but have found all around incompetent men holding poor positions. They had not been trained right. The thing I want to do is to train you in the practical way you ought to be trained; to show you what to avoid and how to do things right. **YOU** can get into one of these chairs soon if you will merely send me your name on the free coupon below.

## You Can Earn While Learning

I have even perfected a plan which gives you an opportunity to begin earning money as soon as you have enrolled as one of my personal and private students. This enables a few young men or older men who could not otherwise take up this practical, personal training which I give, to pay their way as they go along. Write for this plan today. Put your name on the coupon at the bottom and get it in to me right away. If you have been one of those who have dreamed of the future of greatness and power, send the coupon.

### I Guarantee

To instruct you until competent and in a position at a regular salary, paying from \$125.00 to \$175.00 per month and furnish you free \$15 Working Outfit at once.

**\$3000 SALARY EARNING OFFER COUPON**

**CHIEF DRAFTSMAN,**  
Engineer's Equipment Co. (Inc.)  
Div. 9193 CHICAGO, ILL.

Without any obligation to me whatsoever, please mail your book, "Successful Draftsmanship" and full particulars of your liberal "Personal Instruction" offer to a few students. It is understood that I am obligated in no way whatever.

## Tear Off This Coupon and Mail Today

It will positively help you to find out all about the things which I can do for you. I will tell you what I have done for other men. Then you can make up your own mind about what I can do for you. I say I can put you into a chair paying a big salary. If you want to sit in this chair

## Put Your Name Right Here

There are no obligations in your sending your name and address to me on this free coupon. Send it today. I will mail you absolutely free and prepaid my new book, "Successful Draftsmanship." This tells you about the wonderful opportunities there are in this great profession. About the big jobs that are open. The big future ahead for the man who gets in now and knows what to do. Now, the first thing to do. Send the coupon. Do it today.

**Address CHIEF DRAFTSMAN**

Div. 9193, Engineer's Equipment Co., (Inc.) CHICAGO, ILL.

Name .....

Address .....

# CLASSIFIED ADVERTISEMENTS

We have records to prove that a classified ad in these columns will find a buyer for almost anything which can be sold. Doubtless you have some article of value to some one else which you no longer need. Why not turn it into money?

Advertisements in this section, 15 cents per word, each insertion, minimum 10 words, payable in advance. To insure ads being inserted under proper classified head in the April issue, copy must reach this office not later than March 1st.

*Popular Mechanics Magazine, Chicago, Ill.*

Gentlemen:—We have your favor of recent date and beg to advise that we are receiving such an enormous amount of mail we are hardly able to answer same and you may rest assured that we are more than pleased with our advertisement which we ran in your magazine, but as above stated the mail being so heavy, we will necessarily have to discontinue our ad for the present; however we will give you a standing advertisement in the near future.

With best wishes, we are,

BLUE GRASS FARM KENNELS.

## AUTOMOBILES

**JEWELL** Runabout, good condition, \$95. Brenan Double Opposed 18 H. P. Engine, complete with Coil, Carburetor, Sliding Gear Transmission, \$75. Complete Chassis, \$50. Would make dandy truck. Ford 4 Passenger, \$250. Oliver Typewriter, fine condition, \$25. Edison Rotary Mimeograph and equipment, \$8. All big bargains. Shaw, Warsaw, Ohio.

**AUTOMOBILE** Instruction—\$55.25. Four weeks' course. Best equipped school in the country. Men enrolled from all parts of the U. S. Booklet P. M. on request. West Side Y. M. C. A., 318 West 57th Street, New York.

**METZ 22**, 1914 model, new, with prestolite, \$425. "E. M. F.", 1913, run 4,000 miles, fine condition, \$650. Backus Utility Auto locks \$1 each. Gallup Specialty Company, Box 8, Smethport, Pa.

**HORSELESS AGE** is the leading Automobile trade weekly. Valuable to dealers and garages. Send \$1 trial subscription twenty-six consecutive weeks. Horseless Age, Motor Hall, New York.

**PARTS** for Model F. Thomas 60. Engine, Body, Frame, Wheels, Axles, Radiator, Engine and parts for 1910 Interstate 40. The Kent Auto Co., Denver, Colo.

**REDUCED** Prices on Rebuilt and Re-painted Pleasure and Commercial Automobiles. Ranging in price from \$75 to \$500. Eureka Auto Co., Beavertown, Pa.

**AUTO Accelerator** fits any automobile, adds power, saves gasoline. Great seller, \$14. Dealers, Agents, attention. C. R. Baum, Kansas City, Mo.

**HIGH** wheel automobile, solid tires, top, practically new, \$100. Pearl Wills, Canal Dover, Ohio.

**OPEN** Express auto truck. Capacity, 1800 lbs., \$275. Brush runabout like new, \$175. Edward Thompson, 1412 Federal St., N. S. Pittsburg, Pa.

1912 **FORD** Runabout \$300. No trade. C. E. Rogers, Windom, Minn.

**FORD** Instruction Book, every part fully explained. Repair your own car. Sent postpaid \$1. Particulars free. Clark, 308 N. Elizabeth St., Peoria, Ill.

**A WRITTEN** guarantee for 5,000 miles without puncture. French and German motorists are getting 10,000 miles out of their tires by increasing them about one-half inch in size. In eight months 20,000 American motorists have followed their example. It's so easy you can do it in your own garage in thirty minutes, no matter what condition your tires are in. Send for free catalogue, sample and copy of guarantee. Colorado Tire and Leather Co., 1112 Karpen Bldg., Chicago, Ill., 451 Golden Gate Ave., San Francisco, Cal., 1326 Acoma St., Denver, Colo.

**USED** Automobiles at Bargain Prices. 2913 National 7 passenger, cost \$3,400, run less than 4,000 miles, \$1,700; Hupmobile Touring car, run less than 1,000 miles, \$600; Maxwell, E. M. F., Chalmers and Ford Touring cars; Hudson, Flanders 20, Ford, Brush and Maxwell Roadster. Prices from \$100 to \$450. Write—we can please you. J. F. Burbanks, Model Garage, Union, S. C.

**AUTOMOBILE** Books. Catalogue free. Higene Co., 2441 Post, San Francisco.

\$100 UP. Hudson, Buick, Ford, others. Also tires, bodies, engines. United Motor Sales Co., Dept. 101, Detroit.

**VERY** fine Limousine Automobile. Carry 7 passengers. Beautiful design. Make good car for theatre or taxi work. Price low. Morgan's Garage, Newport, R. I.

**WANTED**—Ford, a chassis preferred. Leon Kienholz, E. 504 10th Ave., Spokane, Wash.

**CAPITAL** 45 H. P. 4 Passenger Roadster. Excellent condition. Morgan's Garage, Newport, R. I.

**FIRST** book out on Automobile Design, also treats Construction and Repair. By Victor Page, a good authority. Book has 600 (6x9) Pages, 350 Illustrations. Right up-to-date. Price \$1.50 postpaid. Popular Mechanics, 316 W. Washington St., Chicago.

**GET** in the Oxy-Acetylene welding business. Complete new outfit with instructions \$75. I do expert welding at prices that hold the trade. J. M. Shevlin, 340 Elliott Square, Buffalo, N. Y.

**REO** Runabout, good tires, \$125. 1021 Huntington, Covington, Ky.

**EXCHANGE**—25 H. P. auto for twin motorcycle, A1 condition, or what? David Breitigam, Penbrook, Pa.

**REGROUNDING** the cylinders, and fitting new pistons and rings, will make your motor as quiet and powerful as it was when new. The cost is moderate. Advise bore diameter if desire quotation. We also expertly weld broken parts. Send for booklet. Waterbury Welding Corporation, Waterbury, Conn.

**AUTOMOBILE** Instruction. A complete home study course that shows you exactly what you want to know about the automobile. 220-page book giving definite, thorough, authentic and practical detailed information about every part of the automobile as well as thorough instruction in regard to driving, repairing and general care of the complete car. 190 Illustrations. \$1.50 postpaid. Popular Mechanics Book Dept., 316 W. Washington St., Chicago.

**THE Last Word** in Automobile Literature—New Book, "The Modern Gasoline Automobile," 700 (6x9 in.) pages, 500 illustrations, is superior to any treatise heretofore published. Deals with every modern improvement. Price, \$2.50 postpaid. Popular Mechanics Book Dept., 316 W. Washington St., Chicago.

**"THE How and Why of the Automobile"**—A 200-page book of practical information for seekers after the fundamental facts regarding the gasoline engine and its application to the motor car. Interesting and instructive to both the beginner and the expert. Bound in full cloth—250 illustrations. Price, \$1 postpaid. Popular Mechanics Book Dept., 316 W. Washington St., Chicago.

**PAINT** Your Car Yourself—Save \$25 to \$75 by doing the work at home with the Arsenal system. Our big free booklet "The Car Beautiful" tells how. Send for it today. Arsenal Varnish Co., Dept. P, Rock Island, Ill.

\$3,500 **WOODS'** Electric, in good mechanical condition, for sale; price, \$300. T. P. Hodge, 1750 N. Ashland Ave., Chicago.

## AUTOMOBILE SUPPLIES

**F & O DECARBONIZER**, cleans Carbon out of Automobile Cylinders. Agents, big profits; sample can 50c. Sales Agent, C. A. Osgoodby, 340 Cypress Ave., Pasadena, Cal.

**WE** supply Limosette bodies for Ford touring cars. Classy, cheap. Clark Sales Co., 308 Elizabeth, Peoria, Ill.

**WE** teach you how to do all kinds of Vulcanizing; enclose 50c in stamps for complete course. Simplex Vulcanizer Co., Omaha, Neb.

**RECTIFIERS** for garages. All sizes; Charge 1 to 10 batteries, \$12 to \$250. American Battery Co., 1129 Fulton St., Chicago.

**FOR** Sale—Bargain. New 1914 Model Haywood Vulcanizing Plant, Complete. A. E. Grothe, 1420 Osborn St., Burlington, Ia.

**FOR** Sale—Good Vulcanizing plant. A. M. Baugh, Omaha, Neb.

35-40 H. P. **POPE** 4-Cylinder Engine, \$70; 16 H. P. 2-Cylinder opposed, \$35; 3½ Wagner Motorcycle Engine, \$20. Sisson, Martinsville, Ill.

**WATER** Solder stops leak in radiator instantly. Guaranteed. 35c parcels post. Overton, 1109 4th Avenue, Council Bluffs, Iowa.

**WE** Weld smashed-engine crank cases, cracked cylinders, transmission housings, parts of cast iron, aluminum or brass. Hobbie's Welding Plant, Hampton, Iowa.

**USE** an Air-Friction with new 1914 improvements. Increases power and economy of motor one-half. Absolutely impossible to choke or load. Uses distillate, gasoline or half kerosene with finest results. Starts easy in coldest weather. We fit all motors, guaranteeing definite results or refund money. Exclusive county rights. Liberal exchange on other carburetors. The Air-Friction Carburetor Co., Dayton, Ohio.

**ENTIRELY** new field for keen representatives putting our handsome monograms on automobiles, motorcycles, carriages, etc., by special "transfer" method. Clean, easy, congenial work, quick profits. Monograms are artistic, durable and practical. Write for plan. Motorists' Accessories Co., Ashland, O.

**TIRES**—3,500 Miles Guaranteed. Order 2 tires. We deliver, 28x3, \$8.50; 30, \$9.10; 30x3½, \$12.25; 32, \$13.15; 34x4, \$17.60; 35x4½, \$23.95. All sizes. Send 10¢ with order. Vanderpool, Springfield, O.; Jacksonville, Fla.

**BUICK** 41-Tooth Sprockets, \$5; Brush 14-Tooth, Front, \$1.90; 50-Tooth, Rear, \$3.90. National Motor Goods Co., 118 N. Third St., St. Louis, Mo.

**FOREDOORS** for open-front Cars. Prices right. Write for particulars. Economy Service Co., Indianapolis, Ind.

**INNER** Tube Vulcanizer, \$2.50. Soon pays for itself. F. P. Rees, 240 Jefferson St., Huntington, Ind.

**WHEEL** pullers for any make car. Ford, 50c. C. E. Betts, Westport, Conn.

**FOR** Sale, cheap; second-hand parts for "N" Ford Runabout. J. O. Turner, Franklin, Ky.

**PAINT** your own Car. Save the painter's profit. Write for particulars. Economy Service Co., Indianapolis, Ind.

\$500 **VULCANIZING** outfit used one season, \$250. G. H. Jones, Salisbury, Ind.





## BOOKS AND PERIODICALS

**WORLD'S** best, latest self-educational books (periodicals also). Electrical, Mechanical, Agricultural, Industrial, Science, Art, Business. Anything technical, common or unusual. Catalogues free. Explain subject thoroughly. C. Higene Co., 2441 Post St., San Francisco.

**STAGE Beauties.** Latest plays and players on Broadway. Stories of the footlights. Handsomest footlight magazine published. Ten cents copy; \$1 yearly; 25 cents for three months' trial sub. Address Stage Pictorial, 1493 Broadway, New York.

**BOOKS** About Elevators—best published. Morse, Union Place, Yonkers, N. Y.

**FREE** catalogue, educational and entertaining books. Sheridan Co., 417 E. 151st St., New York.

**DAILY** expense records, cloth bound. Regular price, 50c. Introductory price, 20c. Agents wanted. Michigan Novelty Co., Detroit.

**LATEST** book: "Boiler Construction—Laying Out." \$2. H. Jeffrey, Bourse, Phila., Pa.

**BOOKS.** Any kind published. Catalogue free. Reese Publishing House, Mount Pleasant, Pa.

**READ** "Cleopatra." 25c. Catalogue 2c. Paul J. Duff, 2713 Mozart, Chicago.

**MAGAZINES.** Lowest rates guaranteed. Catalogue free. American Magazine Agency, Box 1222, Atlanta, Ga.

**GAS** Engine Troubles and Installation. Cloth, \$1; flexible leather, \$1.50; Automobile Troubles and How to Remedy Them. Cloth, \$1; leather, \$1.50. Eight other practical and reliable mechanical books. Send for circular. Chas. C. Thompson Co., Dept. C, 1126 S. Wabash Ave., Chicago.

**BUILD** yourself a boat. A racing cat or speed launch. Send for catalogue. Yacht and Boat Building Books, Rudder Publishing Co., 2½ Hudson St., New York, New York.

**ENGINEERS'** questions and answers for license, by Hobson, for twenty-five cents, postpaid. Send stamps. Reilly's Book Store, Philadelphia, Pa.

"**METAL** Spinning" is the name of the only book published on this interesting art. A concise working manual both for those who desire to spin metal as an art recreation and to follow this work as a trade. 80 pages. 33 illustrations. Price, 50 cents postpaid. Popular Mechanics Book Dept., 316 W. Washington St., Chicago.

**HOW** to Run a Lathe. A 50-cent book for 10 cents postpaid. S. B. Lathe Works, South Bend, Ind.

**FASCINATING** books and pictures, samples and catalogue, 10c. Normal Specialty Co., L3, Englewood, Chicago.

**GAS** for power is taking the place of steam for reasons of economy. Learn all about this great change by reading our new non-technical book on this subject, written by a first-class authority for the practical man. 192 pages, profusely illustrated, cloth binding. Price, \$1 postpaid. Popular Mechanics Book Dept., 316 W. Washington St., Chicago.

## EDUCATIONAL AND INSTRUCTION

**500% PROFIT** in ornamental casting of concrete, artificial marble, plaster, papier-mache, marble dust, imitation wood, soft metals, for manufacturing interior, exterior decorations, garden furniture, statuary, artistic homes, fountains, sanitary marble flooring, tiling, tombstones, cement caskets, stuccoing buildings, life casting, ornament copying, modeling, coloring, gilding, making elastic, rigid moulds, instructions complete \$1. Material furnished free 200 illustrations beautiful casts (mail address today) Mahler, 117 Russell St., Brooklyn, N. Y.

**FOR** Sale—10 vol. Cyclopaedia Architecture, Carpentry and Building, 8 vol. Civil Engineering, 4 vol. Auto Engineering, 2 vol. Motion Picture, 4 vol. Fire Prevention and Insurance, 6 vol. Engineering, 7 vol. Applied Electricity, 8 vol. Cyclopaedia Agriculture, 6 vol. Advertising. These books are in first-class condition. Special low prices for quick sale. Engineering handbooks covering every subject. Will ship C. O. D. subject to examination. Write for my prices. Address S. C., 6th floor, 318 W. Washington St., Chicago.

**INSTANTANEOUS** Calculator—Handles multiplication, division and fractions faster than expensive machines. Introductory price, 30c. Agents wanted. Michigan Novelty Co., Detroit.

**BE** a "Shadowgraphist." Make your hands throw funny shadow subjects on the wall. Great fun. Good money giving entertainments. Book of instructions, fully illustrated, 25c. M. Germanos, 885 Broad St., Bridgeport, Conn.

**\$225 WORTH** of International Correspondence School reference books for \$90. Ira D. Russell, Dublin, Texas.

**BRIEFHAND,** the wonderful new substitute for shorthand, enables you to write 100 words a minute using longhand characters. Complete self-teaching manual containing 2,900 illustrations 50c (stamps). Premier Briefhand School, Washington, D. C.

**COMPLETE** Course in Show Card Writing and Lettering furnished absolutely free if you use our colors while practicing the lessons. Address: Alpha Color Co., 2050 Amsterdam Ave., New York City.

**COLLEGE**—Let us help you get there. Prepare quickly for entrance to Medical, Law, Engineering, Pharmacy Schools. Write for our New Method "Home Study Course." Brooks Classical School, Dept. PM, Schiller Bldg., Chicago.

**SHORTHAND** self-instructor by world's greatest court stenographer, sent postpaid \$1.50. Correspondence instruction, if desired. Osgoodby School Stenography, Rochester, N. Y.

**\$25.00 ORIGINAL** Cross Real Estate Course, \$1. Satisfaction guaranteed. Propectus, 2c. Healy, Box 348-U, Joplin, Mo.

**COMPLETE** Steam Engineering, 4 vols. I. C. S. New. Best offer over \$5.00. Chas. W. Scovell, Malta, O.

**WE** need more men in our employment department. We teach you mechanical drawing and secure you a good position. Free book. Write today. Colorado Correspondence College, Denver. Dept. B-2.

**BE** an Auctioneer. Learn by correspondence. P. O. Box 72 B, Attica, Ind.

**EARN** \$25 or more weekly by our Home Study Course and enter an uncrowded profession that offers great opportunities; we teach thoroughly. Mechanical Drafting, Engineering, Mathematics, etc. Write for convincing facts. Keystone Correspondence School, 100 Berks Trust Bldg., Reading, Pa.

**CIVIL** Service, Normal, High School, Bookkeeping, Shorthand, Typewriting, Drawing, Agricultural, English, Engineering and Law courses thoroughly taught by mail. Enrollment \$5. Tuition free. For "Free Tuition Scholarship" apply Carnegie College, Rogers, Ohio.

**WE** teach by mail. Sanitary Engineering, Sanitary Inspection, Plumbing, Hygiene, Booklet free. Anglo-American Sanitary Correspondence College, Ontario Street, Chicago.

**YOUR** handwriting improved at home in spare time, small expense. Journal Free. Francis B. Courtney, Box A492, Detroit, Mich.

**YOU** can write 100 words a minute without knowing Shorthand. My new method, Abbreviated Longhand. Simpler than the simplest shorthand; tried and approved by thousands. Your money back if not delighted. Sample lesson 20c. Full particulars free. Write today. A. B. Weaver, Court Reporter, Dept. C., Buffalo, N. Y.

**THE** Seven Wonders of the Modern World—What are they? Do you agree with the selection resulting from the international poll of greatest scientists taken by Popular Mechanics Magazine? The complete result of this vote showing the selection of the wonders together with a historical sketch of each one reprinted in pamphlet form mailed to any address for 10c in stamps. Popular Mechanics Co., 316 W. Washington St., Chicago.

**WOOD**—Working for Amateur Craftsmen—125-page book, profusely illustrated, giving every essential step in wood-working. Valuable for either self-instruction or for use in manual training courses. Cloth, 50 cents, postpaid. Popular Mechanics Book Dept., 316 W. Washington St., Chicago.

## TRADE SCHOOLS

**AUTOMOBILE** Training. New 1914 correspondence course in construction, repairing and driving, written by famous Automobile Engineers, complete for \$5. To prove it the best at any price send us \$1 and this ad and receive entire course for examination. Pay \$4 more and keep it or return and get your dollar back. Academy of Motor Engineers, 1452 Michigan Boulevard, Chicago, Ill.

**AUTOMOBILE** Training—Practical—Technical. Unlimited instruction and practice in repairing; up-to-date cars; complete machine shop course with steam, electric and gas vulcanizing, electric lighting and starting, oxyacetylene welding and cutting, day and night driving. All repaired cars tested by students on the road. Free tools. Stereopticon lectures on construction, garage management and salesmanship. Training for twenty different positions. Courses \$20 to \$50, weekly payments if desired. Academy of Motor Engineers, 1452-54 Michigan Ave., Chicago, Ill.

**MAKE** \$5 to \$8 a day as skilled Electrician. Plumber, Draftsman, Bricklayer, Moving Picture Operator. We teach you in short time at small expense, profitable trades. Free employment bureau places graduates in good jobs. Special limited offer now. Write at once for catalogue and full particulars—no obligations, Dept. 8193, Coyne National Trade School, 51 E. Illinois St., Chicago, Ill.

**PAINTING,** Decorating, Paper Hanging taught by actual practice. Free catalogue. Chicago School of Painting, 414 Dearborn Ave., Chicago.

## PERSONAL

**BROTHER**—Accidentally discovered root cures tobacco habit and indigestion. Gladly send particulars. F. Stokes, Mohawk, Florida.

## TELEGRAPHY

**TELEGRAPHY**—Morse and Wireless—Railway Accounting (Station Agency) taught quickly. Railroad and Western Union Wires and complete Wireless Stations in school. Big demand. Positions secured. Living expenses low—may be earned. Largest and oldest school—established thirty-nine years. Investment, \$25,000. Correspondence courses, also. Catalogue free. Write today. Dodge's Telegraph Railway and Wireless Institute, 15th Street, Valparaiso, Ind.

**TELEGRAPHY** taught in the shortest possible time. The Omnigraph Automatic Transmitter combined with standard key and sounder. Sends you telegraph messages at any speed just as an expert operator would. Five styles, \$2 up, circular free. Omnigraph Mfg. Co., 41 G, Cortland St., New York.

## PICTURES AND POST CARDS

**MUSICAL** Postcard—Can be played on any phonograph. Big assortment of songs and musical numbers, 10c each. Reduction in quantities. N. Nathan Company, 242 West 148th St., New York City.

**BEAUTIFUL** Blue Bird Rhyme, illustrated card, 5x7, 6 amusing cards for coloring, Easter samples, all for 10c. Holiday Message Makers, 1405 Girard St., Washington, D. C.

**BETTER** than "September Morn." Two new pictures by same painter. These and "September Morn" for silver quarter. Box 592, Minneapolis, Minn.

**POSTCARD** collecting, extremely interesting. Live club! Many members! Membership 10c. Elite Exchange, R23, 3827 Kenneth Ave., Chicago.

**DETROIT** the Beautiful—50 different colored postals, only 30c. Vernon Fratcher, Detroit, Mich.

**IMPORTANT** Notice—Send 12c and receive a real photo of the most noted old war chiefs that ever lived, and price list of my rare collection. Ransom Powell, Anadarko, Okla.

**POSTCARDS** from everywhere. Membership Aurora Postcard Exchange and copy Aurora Postcard Monthly, 10c. 6 months 50c. Ed. Gamble, East Liverpool, O.

**RECEIVE** pretty post cards from everywhere. Very best club. Membership 10c. Jolly Card Exchange, Box 127, Decatur, Ind.

**MEXICAN** Revolution photo cards, 6 for 25c. I have some remarkable pictures. Robert Runyon, Brownsville, Texas.

**CARDS** exchanged with everybody. 10c. Membership in press immediately. Pacific Card Exchange, Bryn Mawr, Wash.

**FELT** pennant, three feet long, Eagle and U. S. A. beautifully colored, 25c. Western Co., Box 472, Seattle, Wash.

**PHOTOS,** "Beautiful Women," gems of art. 24 photo miniatures, 10c. Normal Specialty Co., J-7, Englewood, Chicago.

**FIVE** colored Philadelphia postcards, 2c. Walter P. Troupe, Paschall, Philadelphia.

26 HIGH-GRADE Easter postcards, 10c. Landsman, 1380 Prospect Ave., New York.

PHOTOS—Fascinating subjects, 10 for 25c. Duff, 2713 Mozart, Chicago.

POSTCARD exchangers—You will exchange cards with our members sometime. So why not now? Trial membership 10 cents. Solare Club, Box 1342, Jacksonville, Fla.

20 ASSORTED postcards 10c. Exchange, M23, 3827 Kenneth Ave., Chicago.

ART Studies—Photographs from models; finest collection for artists and art lovers; samples 10c. Westbrook Art Printery, Holyoke, Mass.

BEAUTIFUL women postcards. Samples 10c. Exchange, D23, 3827 Kenneth Ave., Chicago.

10 DIFFERENT Exposition Buildings Postcards 10c. postpaid. Exposition Mail Order Co., Box 2446, San Francisco, Cal.

"SEPTEMBER Morning"—Pictures, Pillow-Tops, Pennants—Exactly reproduced—30c each—4 for \$1. No stamps. R. Trammell, Box 414, Rome, Ga.

JUST Girls—Postals: 10 poses, 12c. 25, 25c. Assorted postals, 100, 35c. Maple Co., 110, Napanoch, N. Y.

20 BEAUTIFUL post cards, all kinds, and big list of bargains 10c. A. C. Kennell, Dept. 28, Wellersburg, Pa.

THREE Artistic Beauty Poses 10c. Taylor Bros., 2129 Clifton, Chicago.

12 BEAUTIFUL Sunny South postcards 25c. N. R. Hathorn, Atlanta, Ga.

IF you really want to exchange post cards, try our splendid club. Lists circulate in many countries. Membership, 10c. Halcyon Club, Box 133, Erie, Pa.

MORE the merrier, everything cheerier, pastime superior. Exchange postals. "True Blue" has perfect plan. Write E. Ed. Ericson, Elroy, Wis.

3,000 SELECTED Pictures for \$3. A Panorama of World Events, Political—Industrial—Social—Humorous—Tragic—all of intense human interest. A wonderful collection of 3,000 cartoons reproduced from the newspapers of the United States, Canada, Mexico, Cuba and the cities of the Old World, has been made by Cartoons magazine from more than one hundred fifty thousand published cartoons, and bound in an artistic and durable cover, are now ready for your library table. Vol. I, Jan.-June, 1912—\$1. Vol. II, July-Dec., 1912—\$1. Vol. III, Jan.-May, 1913—\$1. Cartoons, 318 W. Washington St., Chicago.

YOU'LL get cards from everywhere. Membership 10c. Idaho Card Exchange, Dept. K, Box 906, Boise, Idaho.

### CAMERAS AND PHOTO SUPPLIES

SECOND-Hand Lenses. All makes and sizes. Work just as well as new ones. Send for our bargain-list. St. Louis-Hyatt Photo-Supply Co., St. Louis, Missouri.

TRIAL Offer—Buy Instanto, the best gas-light developing paper, direct from manufacturer; big saving; better, fresher, quality guaranteed. One full gross 4x6 or smaller and one-half gross postal cards for \$1, for three sample dozen postal cards or 4x6, 25c. The Photo Products Co. (Dept. J), 6100 La Salle Street, Chicago.

HAVE you a Camera? Write for samples of my magazines, American Photography and Popular Photography, which tell you how to make better pictures and earn money. F. R. Fraprie, 275 Pope Bldg., Boston.

THE superior work of our enlarging department has been approved by those who discriminate. Send your choice films now. 8x10, 50c; 10x12, 65c; 11x14, 80c, money order. Old photographs reproduced. Send for circulars. Fountain Studio, 1409 East 60th Street, Chicago.

KODAK Films Developed, 10c per roll, any size. Prompt attention given mail orders. Prints, 2 1/4 x 3 1/4 to 3 1/4 x 4 1/4, 3c; 4x5 to 3 1/4 x 5 1/4, 4c. J. M. Manning, Box B, 1062 Third Ave., New York City.

FILMS developed 5c per spool. 8x10 enlargements from any film, 25c each. Prompt returns. Price list and samples free. Barbeau's, 35-37 East Bridge St., Oswego, N. Y.

MONEY in Photography. Start at home with your camera. We teach you retouching; portraiture, by mail. Details, with sample pictures, sent free. Wells' Studio, East Liverpool, Ohio.

FILM developed 10c a roll. Prints 2, 3 and 4c each. Quick return. Price list free. Kodak Film Finishing Co., 112 Merchants Station, St. Louis.

QUALITY enlargements 8x10, 25c. Films developed, any size roll, 10c. Postcards \$2 per 100. Bargains new and second-hand cameras, lenses, Charles H. Loeber, 1147 Broadway, New York.

CAMERAS and Lenses. Remarkably low prices. Send for list. New Transfer Developing Paper, pictures on glass, china, watches. Liberal samples, 25c. Newark Photo Supply Co., Newark, N. J.

MAGIC Kodaks, mysterious; surprise your friends; trial roll developed and 6 pictures 45c. Birdsall, Pleasant Hill, Mo.

FORMULAS for ten of the latest fads in photography, 25c. Includes instructions for magic disappearing photos. Photo sofa pillows and neckties, beautiful, transparent, colored pictures on watch cases, chinaware, etc. Phosphorescent photos and other novelties. P. Benson, Stewartville, Minn.

FILMS developed 6c, all sizes. Prints, 2 1/4 x 3 1/4, 4c; 2 1/2 x 4 1/4, 3 1/2 x 3 1/2, 3 1/4 x 4 1/4, 4c; 40c doz. Post cards 50c doz. Work guaranteed and returned in 24 hrs. Postpaid. Send negatives for samples. Girard's Commercial Photo Shop, 104 High St., Holyoke, Mass.

LEARN Photo Coloring. Fascinating, pleasurable occupation for spare time. The artistically inclined quickly learn to do marketable work. Hand-colored gift card 25c. Send for free booklet. Kell-Burr Company, 56 P. Pine Street, New York.

SPECIAL—100 Post Cards printed from one negative \$1.50 prepaid. Films developed 10c roll. Post cards or prints 3c. Enlargements 25c up. Get next to our price and service. Hansen Photo Co., Withee, Wis.

PROBUS Preservative Paint for fixing boxes, sinks and trays. Eight-ounce trial tin 35 cents. All dealers. Descriptive circulars on request. Wolff & Dolan, San Francisco.

FILMS developed 5c, roll prints 3c. Photographs colored 10c. Photo Novelty, 1406 W. O. W. Bldg., Omaha, Neb.

LANDSCAPE Negatives bought, 4x5 and larger. Submit prints; will return. Shilling Art Company, Navarre, Ohio.

FILMS developed 5c. Prints 2 1/4 x 3 1/4, 2c; 3 1/4 x 4 1/4, 2 1/2c; 4x5, 3c. William Weiss, Shickshinny, Pa.

CYKO Postcards from your negatives, 3c; 100, \$2.75. Guaranteed Work. Quick Delivery. Fotokrafts Shop, Loveland, O.

FILMS developed ten cents. Prints three cents each. All sizes. G. W. Perkins, Tusculumbia, Ala.

KORONA and Pixie Cameras for plates, film packs and roll films. Panoramic View Cameras, Turner-Reich Anastigmat Lenses and other Lenses. Send for complete catalogue and obtain free copy of text book, "Telephotography with a Panoramic Telephoto Lens." Gundlach-Manhattan Optical Co., 839 Clinton Ave., So. Rochester, N. Y.

ANY roll film developed, 5c; when ordering prints 3 1/4 x 5 1/4, 4c; smaller sizes, 3c. Postcards, 4c; 100, \$1.50. "Kodak Hints" free. We sell Vulcan roll film, 8x10 enlargements, 25c. Caulkins Photo Works, Oneonta, N. Y.

GREATEST Photographic Bargain List ever published. Willoughby, 810 Broadway, N. Y.

WE buy, sell and exchange. Bargains in Microscopes, Telescopes, Binoculars, Cameras, etc. Bargain list sent. Kahn & Son, Opticians, No. 54 John St., New York. Established 62 years.

BIG Money Saved on Photographic Lenses and Apparatus—goods exchanged; repairing done. Ralph J. Golsen, 65 East 46th St., Chicago, Department P.

### MOTION PICTURES

TEN Lesson Course Complete \$2, teaching you how to write and where to sell Photoplays. Free Illustrated Booklet and Indorsements. Penn Ass'n, Heed Building, Philadelphia, Dept. L.

LEARN Photoplay Writing. Big money. Complete course \$1. Particulars free. Eureka Supply, B23, 3827 Kenneth Ave., Chicago.

MAKE money writing motion-picture plays. \$25 to \$100 each. Big demand. We will show you how. Send for free booklet. American Authors Ass'n, R-418 1535 Broadway, New York.

\$100 TO \$300 Weekly in Moving Picture Business. Easy payment plan, free catalog. Acorn Moving Picture Co., Dept. 13, 173 N. Green St., Chicago.

MOST money in traveling picture shows. Before investing in anything, write to me. E. Behr, 750 30th St., Milwaukee, Wis.

GO into the Moving Picture Business. We will start you with complete outfit. Best Machine, Films, and supplies, on the Payment Plan. Want to make Big money? Write for free Catalogue. Dearborn Novelty Co., Dept. P, 537 S. Dearborn St., Chicago.

FOR Sale—Moving Picture Film, \$2.50 per reel, and up. Also second-hand and new moving picture machines of all kinds. Send for list. Wichita Film & Supply Co., Wichita, Kans.

\$50 TO \$100 weekly writing moving-picture plays. Send for free booklet, valuable information and special prize offer. Chicago Photoplaywright College, Box 278 LZ, Chicago.

I ABSOLUTELY guarantee at least \$10 for first photoplay you write by my guaranteed method. Particulars free. Elbert Moore, Box 772 P. C., Chicago.

LEARN to write photoplays. Writing motion-picture plays offers a new, easy and fascinating way to earn money in your spare time. Plot all that is required. Literary training or style not necessary. Easily learned. Great demand. Producers pay \$25 to \$100 each. Our short, fascinating course will teach you how to turn your ideas into dollars. Send for free descriptive catalog. Authors' Motion Picture School, Box 130K, Chicago.

\$35 PROFIT Nightly—Moving Picture Business—small capital starts you, no experience needed. Teach you—furnish everything. Ralph J. Golsen, 65 E. 46th St., Chicago, Dept. M.

MOTION picture plays wanted. You can write them. We teach you. No experience needed. Big demand and good pay. Details free. Ass'd M. P. Schools, 601 Sheridan Rd., Chicago.

WRITE Moving Picture Plays, \$10 to \$100 each. Constant demand. Devote all or spare time. Experience, literary ability or correspondence course unnecessary. Details free. Atlas Publishing Co., 304 Atlas Bank Bldg., Cincinnati, Ohio.

MOTION Picture Work—A large 618-page book covering every phase of the moving picture, its production and its theatre. Indispensable for reference and instruction to the thousands of workers in the motion picture field. Price \$3, postpaid. Popular Mechanics Book Dept., 316 W. Washington St., Chicago.

POWERS No. 5 Moving Picture Machine. Good condition. \$85. John Heinz, Gem Theatre, Baltimore, Md.

### BUSINESS OPPORTUNITIES

WOULD you pay \$10 to achieve independence in business? Let us tell you of an opportunity that is open to you whether you have capital or not. An opportunity in the Light Manufacturing business that will be sold to only one person in each territory. Write for particulars. Taylor Service, Dept. 1-P, 220 Broadway, New York.

"THE Greatest Mail Order Proposition Ever Placed in the Hands of People Desirous of Making Money by Mail." "The Medical Field." "Building a Business With Beauty Preparations." "The Mail Order Book Business"—these and many other excellent plans fully explained in current Booster Magazine—the one bona fide publication devoted exclusively to the interests of Agents and all interested in the Mail Order business. More people read "Booster" than any other trade paper; this alone should convince you that today is the day to learn all about "Booster." Its money-making suggestions and principles. Join our ranks now. Let "Booster" put you next to the best money-making propositions—ones that really get you the money! Ten cents brings two copies worth dollars to you. If you're dissatisfied, will send your dime back. Booster Magazine, Northwestern Building, Chicago.

GET into business outdoors. Cement walks, driveways, floors, henhouses, etc. Build your own. Build for others. Large profits. "Concrete Guide" shows how. Illustrated. Every detail explained. Experience unnecessary. Price \$1. Concrete Guide, 306 Livingston Building, Rochester, N. Y.

\$75.00 CLEAR profit made weekly in Dry Cleaning business. Book gives secrets of machinery and advertising. Sent postpaid \$1. Grumbley, Dry Cleaner, 24 S. Limestone St., Springfield, O.

GET into the Penny Slot Machine Business. Make \$20 to \$50 weekly in your spare time. I made thousands. My free illustrated booklet tells how. Let me start you. Address "Money-Maker Chandler," 326 Cranston St., Providence, R. I.

**BLACK Foxes** are being bred in captivity in Prince Edward Island, Canada. Government report says, "Thousands of shareholders are receiving 25 per cent to 200 per cent yearly on investments of \$100 to \$1,000 each." A company is now being formed to purchase 3 pairs of P. E. Island registered foxes and to ranch them with the most successful fox breeder in the world, on a percentage basis. A free booklet and prospectus will be sent upon application to Dr. E. A. Randall, Truro, N. S., Canada.

**MAKE Big money** opening Safes and setting Combination. Wayne Strong, 811 Temple, Los Angeles, Cal.

**"MERCHANDISING By Mail"** now ready. Complete Compendium Mail Order Business; 24 Chapters instructions for beginners; hints, short cuts for older heads. Price \$1. Sample page free. B. Newham, Waukegan, Ill.

**BIG money** made. Baseball and football machines. Sullivan Amusement Co., St. Albans, Vt.

**CORPORATION Secretaries** wanted each locality. New, uncrowded business \$1,500-\$8,000. Congenial work. Capital unnecessary. No canvassing. Corporation Service Company, Box 1547, Boston, Mass.

**BE a chewing gum manufacturer.** No machinery necessary. 500 per cent profit. Particulars for stamp. A. J. St. Germain, 72 Canal St., Lewiston, Me.

**CALIFORNIA Tartaric Mirror Silvering Process.** Largest factories users. First time offered public. Free booklet. Barstow Company, 514 23rd St., Oakland, Calif.

**YOU will collide** with golden money-making Opportunities, Plans and Knowledge by simply sending 10c for two issues of the Agents Magazine, Chicago.

**\$345 IN one week** connecting land buyers and sellers by mail. No experience or study. Dunning System complete, postpaid \$1. Particulars free. Dunning Realty Co., Aulander, N. C.

**ADVERTISING Rate Folder Free.** Gives rates of pulling mediums. Winfield Jukes, 910 Walnut, Philadelphia.

**LET us write a business plan—One** that will make money for you and make you independent. Written especially for your own needs and circumstances. Service guaranteed. Write Taylor Service, 220 Broadway, Dept. P-P, New York.

**FREE! \$5.00 copyrighted Mail Order Course** with a year's subscription to "Good Results" at \$1. Three months' trial 10c. Money back if dissatisfied. Publishers, 2311P North Kildare, Chicago.

**FOR recreation and profit** raise Buttercups, adapted to any climate. Stamp for particulars. H. V. Meeker, Toledo, O.

**WE analyze everything.** Reliable formulas furnished. Economy Laboratories, 721 East 161st Street, New York.

**CANDY Course.** Complete instructions how to make pure candy and operate a Candy Kitchen 50c. Auburn Supply Co., Dept. CY3, 7745 Peoria St., Chicago.

**USE your spare time** to build up a mail-order business of your own. We help you start for a share in profits. 27 opportunities. Particulars free. Mutual Opportunities Exchange, Buffalo, N. Y.

**ANYONE earn \$25 weekly** silvering Mirrors; no capital. Write W. T. Abell, Lima, Ohio.

**NO man need work for wages!** Get into contracting business. It's easy when you know how; \$2,500.00 to \$10,000.00 yearly. Send \$1 for full instructions how to do it. The Hendricks Co., 46 Hendricks, Detroit, Mich.

**SPARE time** turned into Dollars, conducting profitable mail order or local business at home. Free details. Adolph P. Schmitt Co., Seattle, Wash.

**MAIL order article of food—eaten every meal—unusually suitable.** Particulars. Randel, 617 Seymour, Conn.

**"THE Art and Process of Dry Cleaning."** A fascinating and profitable occupation, 25c postpaid. Auburn Supply Co., Dept. D2, 7745 Peoria St., Chicago.

**MAIL-ORDER Agents, Salesmen—manufacture Acid or Alkali proof writing ink.** Wonder of the century. Original with us. Formula, processes, instructions complete direct to you. No 10c or \$1.00 book formula. Particulars and specimen free. Bayless Chemical Laboratory, Muncie, Ind.

**\$3,000 YEARLY** in your back yard. No Ginseng, Mushroom dope. New ideas never before published; particulars free. Metz, 306 East 88th St., New York.

**RESILVER mirrors** and make plenty of money. Full instructions, 25c. Auburn Supply Co., Dept. R3, 7745 Peoria St., Chicago.

**A "LEADER" with 100% profit—Mail Order beginners** and those already established should have our proposition. Brigden Company, Waltham, Mass.

**YOU can add (\$\$\$) to your present income** in spare time; 24 new formulas for fifty cents. Silvering mirrors, painting portrait on glass, enamel, manhol cones, artificial coal, polishing cloths, polishes, etc. John Pick, 580 Milwaukee, E. Detroit, Mich.

**MAIL Order Success** Only by selling merchandise. Get our Quality (satisfaction guaranteed) Line. No stock to carry. Literature furnished. Profits one-half. \$5 starts you. The Merford Company, Incorporated, Dept. MP, Chicago.

**NEW 25c Specialty!** Tremendous seller—prepared at home—costs less than 4c. Complete line advertising matter furnished. Also selling plan—netted \$10.34 profit in half hour. Sample, complete detail's 10c. Eisenberg-Lunkes, Advertising, Marquette Building, Chicago.

**THE best Mail Order Proposition on Earth.** Particulars free. Luther Gordon Co., Northwestern Bldg., Chicago.

**MAIL Dealers:** Add a Safety Razor department, 10c brings samples, imprint circulars. Northwestern Safety Razor Co., Northwestern Bldg., Chicago.

**\$1.75 PROFIT on \$2 Order!** Write Rodolph, 304 Northwestern Bldg., Chicago.

**START a Correspondence School!** Profits 200% to 1,100%. Everything furnished at nominal charge. Complete proposition and sample dollar course, 25c. Roberts Company, Publishers, 2311 North Kildare, Chicago.

**SPECIALTIES that sell!** Samples worth 75c. 25c. Particulars free. Rea Company, Northwestern Building, Chicago.

**MAIL order men and light manufacturers** should subscribe to better business. It broadens the mind and points the way to New Opportunities, Better Methods, and Success. Excludes all fakes and catchpenny schemes and makes for Bigger, Better Business. Subscription 50c, trial three months, 10c. Better Business, Dept. BP, Box 1764, New York.

**MAKE money** renewing old dry batteries! Send 25c for guaranteed formula and instructions; regular price \$1. If dissatisfied, we'll send you your quarter back. Northern Supply Co., 154 Randolph, Chicago.

**6,000 LIVE bona fide agents' names,** \$1. Morgan, 312 Madison, Chicago.

**MR. Mail-Order Man:** Get quick returns. Established corporation supplies fast mail-order sellers; factory prices. Classy proposition. Beginners or established firms. Copyrighted Prospectus free. Mississippi Valley Co., Inc., Box M629, Pittsburg, Kans.

**MONEY-MAKER.** Manufacture Barley Crisp. New confection. 5-cent package costs one cent. Machine, instructions complete. \$7.50 prepaid. Send ten cents for sample. Simplex Mfg. Co., Dept. A, Kewanee, Ill.

**LEARN metalizing.** Transform roses, carnations, butterflies, etc., into exquisite jewelry novelties. Big profits. Stamp brings sample and particulars. P. Benson, Stewartville, Minn.

**MAIL Order Business** at home. We start you and furnish everything. Small capital, large profits. Free booklet tells how. Write quick. W. P. Miller Co., Box 254, Muskegon, Mich.

**BE Superintendent of Agencies** for reliable Manufacturer. Sample Combination Sweeper and Vacuum Cleaner, printed matter and mail order instruction free. Dust-Vac, Adrian, Mich.

**INSTALL (Penny Box) Match Vending Machines.** Properly placed reap big money. Vernon Galster, 506 Prospect Ave., Syracuse, N. Y.

**THREE Stands and Locations—fine Creators machines;** easily capable of \$2,500 yearly profit; price \$1,500. Fisher, 107 Erie Street, Warren, Ohio.

**WILL give state rights** for instantaneous silver cleaning device. Big profit, quick sales. Philip J. Sinnott, Klamath Falls, Ore.

**\$5 DAILY earned** at home in spare time silvering mirrors; wholesale houses buy in quantities; no capital; particulars free. Paterson & Co., Dept. 3, Brooksville, Ky.

**1,000 COUNTRY Names** 25c. L. Miller, 2012 Germantown Ave., Philadelphia.

**LIFETIME opportunity—Manufacture "Substitute for Eggs."** Enormous profit. No canvassing. Particulars free. W. C. Delzell, 311A South Fickett, Los Angeles, Cal.

**FOR Sale—3½ H. P., 2 cyl. Vacuum Cleaner.** Nearly new. Guaranteed. Reason, am locating in Canada. Write 311 S. W. 4th St., Galva, Ill., for particulars.

**ADVERTISE—21 words** in 50 good weeks, \$1. Bank references. Cope Agency, St. Louis, Mo.

**ASK Bode!** Anything! Especially about Business and Advertising! Get Particulars "Now"! Bode, 2889p Main, Hartford, Conn.

**FORMULAS, knitting machines, rug machines, darners.** Prices low. John Fitch, Sac City, Iowa.

**CASH for an idea.** Patent News, Dept. 28, Washington, D. C.

**START a Silver Plating Business.** No experience necessary. Big income assured. Learn at home. Our course of simple instructions shows how. 25c Service Bureau, 3311-C, Belleplaine Ave., Chicago.

**MARINE Repair Shop.** Best unopposed location. Gulf Coast. Completely equipped. Sacrifice for \$500. Box 183, Carrabelle, Fla.

**HOME Manufacturing Processes and Formulas.** J. Severt Anderson, Minneapolis, Minn.

**100 MONEY-Making plans** 10c. 175 Trade Secrets 10c. How to start Mail-Order business, new book, 10c. Service Bureau, 3311-B, Belleplaine Ave., Chicago.

**MAKE and Sell Mission Furniture—**From our instructions one man who was an amateur made and sold \$400 worth of just one article alone. We give you 98 designs and easily followed directions for making each piece in 3 books at 50 cents each or \$1.50 per set, postpaid. Popular Mechanics Book Dept., 316 W. Washington St., Chicago.

**LEARN Electroplating—Practical results** may be obtained by following the directions in our book on electroplating. This is a working guide for the beginner written by an old hand at the business. 112 pages, 62 illustrations, cloth, 50 cents, postpaid. Popular Mechanics Book Dept., 316 W. Washington St., Chicago.

**WE start you in business,** furnishing everything; men and women, \$30 to \$200 weekly operating our "New System Specialty Candy Factories" home or small room anywhere; no canvassing. Opportunity lifetime; booklet free. W. Ragsdale Co., East Orange, N. J.

**ADD \$15 weekly** to your income working my mail order plan in spare time. No capital or experience required. Full particulars free. F. L. Miller, Dept. 30, Syracuse, N. Y.

**MAKE \$25 weekly** growing mushrooms in cellars, sheds, etc. Booklet free. North Shore Mushroom Farm, Dept. 12, Hubbard Woods, Ill.

**ANYONE, anywhere,** \$5 daily replating silverware. Samples free. E. Fisk, 101 Sheffield Ave., Buffalo, N. Y.

**I MADE \$50,000** in five years with a small mail order business; began with \$5. Send for free booklet. Tells how. Heacock, 5074 Lockport, N. Y.

**SPARE time—no canvassing.** Report news, names, etc., to us. Markets waiting. Enclose stamp. "Nisco," Dept. HDB, Cincinnati.

**AN intelligent person** may earn \$100 monthly corresponding for newspapers. No canvassing. Send for particulars. Press Syndicate, 700, Lockport, N. Y.

**YOU can make \$50 weekly,** in spare time, manufacturing Tip-Top, the new delicious, pop corn confection—the finest you ever tasted—simply melts in your mouth. No capital or experience required—great opportunity to start a big business of your own and make money easy and quick. Formula and complete directions for manufacturing ten cents silver. U. S. Specialty Co., Dept. 43, New Philadelphia, Ohio.

**EVERY Advertiser Needs** our New Advertising Rate Book. Lists 2,000 best advertising mediums in America. Gives circulation and rates. Contains special lists and advertising snaps, including "Ads That Pay" sent prepaid for 10c. Dearborn Advertising Agency, 521 Dearborn St., Chicago.

**BUILD a \$5,000 business** in two years. Let us start you in the collection business. No capital needed; big field. We teach secrets of collecting money; refer business to you. Write today for Free Pointers and new plan. American Collection Service, 101 State St., Detroit, Mich.

WOULD you like to own a good-paying mail order business? We have a line that gets repeat orders all the time. You can start in spare time; invest a dollar or two a week and soon own a nice business of your own; write for particulars. Nadico, 1664 Belmont Ave., Chicago.

I WILL start you earning \$4 daily at home in spare time, silvering mirrors; no capital; send for free instructive booklet, giving plans of operations. G. F. Redmond, Dept. 306, Boston, Mass.

PATENTABLE Ideas Wanted—Send for 3 free books. R. B. Owen, 30 Owen Bldg., Wash., D. C.

INDEPENDENCE and fortune quickly attained in the Manufacturing Mail Order business. I furnish Formulas, Manufacturing Processes and Trade Secrets in all lines. Sold under positive guarantee; 18 years' practical experience. Revision and improvement of Formulas and Processes—reduction of manufacturing cost—utilization of waste materials, etc., a specialty. Booklet, Formula List, and Valuable Information Free. W. L. Cummings, Ph. D., 127 Standard St., Syracuse, N. Y.

BE Independent—Start a mail order business in your own home; we tell you how and furnish everything needed, wholesale; an honorable and profitable business for man or woman. Many make \$3,000 a year. Particulars free. Murphy Mfg. Co., East Norwalk, Conn.

CASH for your business or property. I bring buyers and sellers together. Write me if you want to buy, sell or exchange any kind of business or property. Established 1881. Frank P. Cleveland, 1308 Adams Express Building, Chicago, Ill.

WE Sell Patents. Established 1900. If you wish to add a new product to your line, write us. Charles A. Scott Co., 596 Central Bldg., Rochester, N. Y.

INCORPORATE your business under Arizona laws. Cost small. No franchise tax. Stockholders exempt from corporate debts. Do business anywhere. Laws and forms free. Southwestern Securities & Investment Company, Box D488, Phoenix, Arizona.

LET the parcels post help you. Add (\$15 to \$25 weekly) to your present salary or income. Start during spare time and build up a permanent mail-order business of your own. We show you how and help you make good. No canvassing. Experience unnecessary. The Parcels Post makes success doubly sure. Our new ideas and up-to-date plans bring the money. No so-called "Course of Instruction" to sell. We give that free. Write today. Address Pease Mfg. Co., Inc., Dept. A, 70 Broadway, Buffalo, N. Y.

STOP Here! Let me start you in a home business that will bring you money every day. Experience unnecessary. Spare time. No canvassing. I furnish everything. Send for proofs. Voorhies, Desk C. R., Omaha, Neb.

WRITE Moving-Picture Plays, \$10 to \$100 each. Constant demand. Devote all or spare time. Experience, literary ability or correspondence course unnecessary. Details free. Atlas Publishing Co., 3046 Atlas Bank Bldg., Cincinnati, Ohio.

#### MAIL ORDER SUPPLIES

M. O. DEALERS! Sell my giant profit-clover, "The Law of Success." Everybody wants it. Big profits. Imprint circulars furnished. Sample copy 25c. Particulars free. Bernard J. Hinkle, 811 N. 21 Street, Birmingham, Ala.

MAIL Order Dealers, General Agents: We have the three best selling articles ever offered. Big profits; enclose stamp. Phelps Specialty Company, Dept. M. Caro, Mich.

THE best Mail Order Book Published, explains business fully. Gives complete instructions for starting. Price 10c (silver). Leonard O. Smith, Islip, N. Y.

INCREASE your sales. Place your proposition before the readers of "Cartoons Magazine," 23,000 copies every month. Classified rate 2c per word. Mail in a trial ad today. Cartoons Classified Dept., 316 W. Washington St., Chicago.

HEADQUARTERS for Toilet Specialties; High-grade Goods Only. Imprint Circulars Supplied. For Descriptive Matter, Address Peerless Products Company, Mail Order Dept., Newburgh, N. Y.

MAIL Dealers—My joke-novelties are paying big profits. Imprint catalogue supplied at actual printer's cost. Joseph Methieu, 203 Court St., Brockton, Mass.

#### FOR ADVERTISERS

THE Classified ad pages of the Denver Weekly Post will sell or swap anything that the human family uses. Reaches over 115,000 subscribers every week by Uncle Sam. No street or news-stand sales. A circulation not duplicated by any other medium. The largest and newest weekly newspaper between the Missouri River and the Pacific Coast. Classified ads—3c per word. Display—30c per line, \$4.20 per inch. One ad convinces. Write for sample copy. Subscription price 35c the year.

30 WORD ad in our 32-p postcard monthly 25c. Display 50c inch. Elite Exchange, 3827 Kenneth Ave., Chicago.

10c PER Line places your ads in 30 Monthlies. Stanford Agency, C184, Canonsburg, Pa.

BARGAIN—Advertising rates 1c word. Sample 10c. Barkley's Magazine, Blairsville, Penn.

ADVERTISERS—Here's your opportunity. Your proposition placed before the readers of "Cartoons Magazine" for only 2c per word. Circulation 23,000 copies. Send a trial ad for our next issue. Cartoons Classified Dept., 320 W. Washington St., Chicago.

YOUR 70-word display advertisement in 16-page, 7x10 magazine, reaching 4,000 boys, 40c. Youlhus' Magazine, Chicago.

ADVERTISERS—Special—5c per word places your ads in 133 different magazines. Send copy now for next issue. King's Magazine, Box 13-P, Little Silver, N. J.

YOUR 25 word advertisement in 100 Monthly Magazines, 3 Months, \$1. Bennett, 442 East 184th St., New York.

I WANT to send you proof of the wonderful pulling power of Popular Mechanics classified pages. What's your proposition? Write me today. F. W. Johnson, Classified Dept., Popular Mechanics Magazine, 318 W. Washington St., Chicago.

#### TO MANUFACTURERS

WANT Manufacturer for patented Aerial Toy for children; prefer royalty. E. J. Ogden, 502½ North Sixth St., Springfield, Ill.

#### AGENTS WANTED

AGENTS amazed, excited, overjoyed! Entire country clamoring. New, gigantic money success. Offers \$1,000.00 cash per man, per county. Brilliant Home Invention—just out. Millions want quick delivery. Listen! Wonderful 3-cylinder dual power home motor. No operating expense. Revolutionizes washing. Gives every home stationary wash tubs—self-filling, self-emptying—for insignificant sum—only \$3.75. No plumbing. Automatically fills tubs, boiler before washing—then automatically empties. Abolishes grueling drudgery, lifting, carrying water. Proven world's fastest seller. All records beaten. Exclusive territory. Investigate quick. Postal sufficient. Security Mfg. Co., Dept. 2, Toledo, O.

AGENTS—A free course in General Salesmanship is given to every man of our Sales Organization. This organization is a body of successful men selling the Handy Light; that unique electrical device which cuts the cost of electric lighting in half. Sells for \$3.50; is used in home, office, store, factory; weighs only one pound. Sold by demonstration. All agents furnished with well-planned methods for gaining interviews. A high-grade business for a man of ability and standing in his community. General Agents preferred. Inquire for our full proposition by addressing The Handy Light Co., 1100 Handy Light Block, Cincinnati, Ohio.

LET us start you in a permanent business of your own selling Guaranteed Planto-Silk Hosiery and Underwear direct from Factory to the homes. Capital and experience not necessary—we help you. Our representatives are making \$3,000 to \$5,000 a year. Write for spare time and full time plans. 306 Grandville Ave., Grand Rapids, Mich.

"BOOSTER" will show you how to make more money! Why not operate a good, substantial "Income Mail Business?" Every issue of "Booster" contains propositions that can easily be worked evenings. Don't invest any money until you read "Booster"—the magazine that has, for years, actually and accurately placed men like you in business for themselves by publishing money-making propositions that get the dollars. Send 10c today for two months' trial—it's worth cold cash to you. Booster Magazine, Northwestern Bldg., Chicago.

AGENTS Wanted—If you know a chance when you see it you'll see this one now. Big money—stylish, nifty clothes—little work—no experience or capital needed—can you beat that? We want agents everywhere to take care of our business in their localities and to advertise our nobby, nifty suits by wearing them. We furnish everything complete and charge nothing for agents' outfit. The swiftest dressers everywhere are our agents and all we ask is that you tell people who inquire about your fine clothes where and how they can get them. You make big money—\$10 a day—without trouble. Just a postal brings you full outfit free. Big, new sample book of up-to-the-minute suitings sent so you can pick out your first suit; also measuring blanks and everything you need. We pay express on everything—not a penny for you to pay. Send quick before some one else gets the agency there—mail postal today to American Woolen Mills Co., Dept. 314, Chicago, Ill.

AGENTS—The real live ones. The newest thing in chocolates, together with a big, free offer to your customers, makes your selling easy. Samples to your customers furnished free. Good profits. Quick sales. Same people buy every week. Forty-cent sample outfit of original packages with extra tasting samples sent to reliable agents and workers for twenty cents. For a quick return to prosperity address at once, Sales Manager M. Box 3373 Boston, Mass.

AGENTS Wanted—Agents make 500 per cent profit selling "Novelty Sign Cards." Merchants buy 10 to 100 on sight. 800 varieties. Catalogue free. Sullivan Co., 1234 Van Buren St., Chicago, Ill.

IF you live in a small town and have a little spare time, get our offer. Easy to make \$100 profit each season; still easier to get your own clothes out of the profit on a few orders. No extra charges for fancy styles, golf bottoms, pearl buttons, etc., makes sales easy. Write for free samples and our new offer. Knickerbocker Tailoring Co., Dept. 56, Chicago.

AGENTS—\$200 monthly distributing Newell's needle cases. Sell 115 needles in book for 10c and make 200% profit. Approval Plan envelopes make talking unnecessary. Crew Managers write. Send 10c for sample book and particulars. Newell Company, 509 N. Grand, St. Louis, Mo.

AGENTS Wanted—Live men who are willing to make 150% profit on \$1.50 sanitary Oil Mop, also 130% on our American Fibre Broom, retails at 75c. Easy sellers. For particulars address Columbia, 1434 W. 15th St., Chicago.

WE make Kantburn Kooker and other fast selling, money making household specialties. Savage Manufacturing Co., 303 N. 5th Ave., Chicago.

AGENTS, Managers, Deliverymen. Double your profits. New scheme up to minute catalog. Convex samples free. Credit. Family Portrait Co., Chicago.

AGENTS wanted to sell Ruton's Mechanic Soap Paste in every shop. 150% profit. Can bear Union label. 10 years on market. Sample, full size can, 14 ounces, 10c postpaid. None free. Ruton Mfg. Co., Dalton, Mass.

LEARN to play piano in one hour. Wonderful new system. Anybody can do it. Sells for \$5. Agent's sample and particulars how you can make big money for \$1. Chicago Book & Music Co., 535 So. Wabash Ave., Chicago.

PARCEL post means many Railway Mail Clerk appointments coming. Commence \$75.00 month. Examinations everywhere soon. Common education sufficient. Sample questions and schedule of places—free. Franklin Institute, Dept. D22, Rochester, N. Y.

RAY'S total commissions for 1913 over \$12,000. New Feeny Vacuum Cleaning machine has got all others skinned forty ways. Good men wanted for general agents. Exclusive territory. You risk nothing. If wise, you will write before tomorrow. Feeny Manufacturing Co., Dept. A65, Muncie, Ind.

\$61.50 WEEKLY. Introducing and Selling a New Gas Light Burner for Kerosene Lamps. Beautiful light. No chimney. No mantle. Perfectly safe. Simple in construction. Nothing to get broken or out of order. Will not burn out. Durable. Will last for years. Low price. Easy to sell. 200 per cent profit. Experience not necessary. Samples free. Why not try one on your lamp? Beware of imitations. No branch offices. Luther Manufacturing Co., Dept. 299, Cincinnati, Ohio.

GET in the big income class. Learn how to enjoy Independence and Prosperity. Read the Agents Magazine. 2 issues 10c. Agents Magazine, Chicago.

**AGENTS—New Low-Price Portable Oil-Gas Stove for Cooking, Heating and Baking.** Light in weight—compact. A possible customer in every home. Sells every season of the year. Get particulars of our wonderful offer. The World Mfg. Co., 4026 World Bldg., Cincinnati, O.

**NEW wonderful Fireless Solder** mends all metals and cutglass, crockery. No heat required. Sample 10c. Agents Wanted. Old Roman Solder Co., 202 East 46th St., New York, Dept. 2.

**POSTAL** brings sample set Art Hangers, six colors, bronze ornamentation. Positively nothing better for house to house agents on 1914 market. Showy, useful, repeater, express paid, 150% profit. Value talks, arguing unnecessary. Spring agents wanted; free samples and terms by return mail. Write Dept. M, Fibro-Bronze Works, Nevada, Iowa.

**AGENTS,** make quick sales, big profit. Write for particulars and catalogue. Hunt, 308 Westfield Ave., Elizabeth, N. J.

**SAN-CLO,** a prepared wash cloth. Eliminates soap. Sample 15c. Household Specialties Co., Mfgs., Wilmette, Ill.

**SOAP Agents:** Our Vegetable Soap, Toilet Articles, Flavoring Remedies, excel and outsell. Sample free. Buchanan & Co., 54 N. Main St., St. Louis, Mo.

**AGENTS:** Transfer pictures on paper, linen, leather, wood, etc. Sample bottle 14c prepaid. R. Yost, Watkins, N. Y.

**WRITE** today for a sample of the latest and best novelty in the market. Enclose 27c to Muller, the Penkala Man, 419 Pine St., San Francisco.

**AGENTS,** do you want to build up a real business? We make a line of men's made-to-order clothes at wholesale prices. No urging you to buy a suit for yourself. We want you to sell them. No foolish boasts or promises; a strictly business proposition. No experience necessary. Highland Tailoring Co., 3rd near Vine, Cincinnati, Ohio.

**YOUR** address on postal brings you the biggest money-making proposition you ever received. Try it. X. L. Products Co., 117 Worth St., New York.

**AGENTS,** sure repeating automobile specialty. Income earner. Every demonstration a sale. Quick sales, big profits. International Hagen Trading Co., 25 Broadstreet-737, N. Y.

**DID** you ever cut your initials on a tree or in new cement? And wouldn't you have given anything for a device that would have enabled you to make uniform, artistic, permanent letters? We have it. Send 25c for set samples. Agents wanted. Scout's Supply Co., Box 314, East McKeesport, Pa.

**AGENTS** in every town; article sells 75 cents; good profit, new patented success from Europe; pocket size, dignified proposition; cheap hot air not needed to sell. Want chiefly the make-good conservative agent who faces customers again. American Antapal Corp., Flatiron Building, New York.

**IT** gets more and more difficult to pick good salesmen. Still we have just what they need. Where are all the money-makers? We're waiting. Specialties Supply Co., 106 Fulton St., New York.

**U. S. GOVERNMENT** uses Richmond Chemical Fire Extinguishers that kill gasoline fires. Factory and auto sizes. District managers make 500% profit. Auto Prize. Richmond Chemical Co., Dept. J, Wheeling, W. Va.

**THREE** hundred thousand One-Dollar Carving Sets given away. Ten dollars a day easy for you. Pierce Factory, Station C-5, Chicago.

**DO** you want to make big money? Our new proposition gets the business for agents and general agents. We specialize on high-grade Vacuum Cleaners, all styles, and other good selling articles. Lanning Stone Sales Co., 1044 Gas Bldg., Chicago.

**AGENTS** 100% profit. Sells at sight. Auto, home and business fire protection. Particulars free. Allen Specialty Co., Stevens Point, Wis.

**"SHAVEZY** Razor Guard." Adjustable to any razor; circular free. Agents wanted. F. R. Smith Company, Dover, N. J.

**FOUR** Absolutely new Household Necessities, needed and sell in every home. Investigate today. The Logan Manufacturing Co., 2312 Lyndale, Chicago.

**BIG** Hit. Manufacture Barley-Koko-Korn Crisp. New confection. Beats popcorn. 5c package costs 1c. Machine \$7.50 prepaid. Samples 10c. Angelus Co., 1108 E. 44th, Chicago.

**HAMMER** attachment, single hand plants nails; delightful. Sample free; territory. Guillemet Co., 3529 Mission, San Francisco.

**AGENTS—Both Sexes—We** manufacture and control fastest selling household article ever invented. Connolly, 123 Liberty St., New York.

**AGENTS** make \$5 profit daily; Name Plates, House Numbers, Signs. Particulars free. Roscoe Lynch, Bausman, Pa., Dept. B.

**SOAP** Agents—Our sanitary skin soap has everything beat for profits; we protect you in territory; sample and premium list free. Daley Mfg. Co., Dept. 20, St. Louis, Mo.

**AGENTS** jump at this—dollars by thousands—Automatic Hame Fastener—a sale for every horse—lifetime opportunity—write now. Automatic Co., 1100, Cincinnati, O.

**AGENTS—Make** money quick—sure—easy. Brand new, low priced Self-Heating Iron. 100% profit. Every home a possible customer. Sell only two a day—your profit \$27 a week. Send Postal today for money-making plans and full particulars. Address C. Brown Mfg. Co., 2016 Brown Bldg. Cincinnati, O.

**AGENTS, Salesmen, Canvassers:** Sell goods put up under your own name; permanent business; 300% profit. Investigate. W. B. Williams, Montclair, N. J.

**AGENTS—Invisible Lid Hinges** sell on sight while open the lid and close it. Invisible hinged case free with order. E. R. Hanson, Austin, Minn.

**AGENTS—Make** \$4 to \$6 daily selling our famous "Straight Line to Success." 150% profit, permanent business. Barker Chemical Co., 20 Center, Auburn, Maine.

**OUR \$1 Adding Machine** Adds Quicker and better than yourself. Many already in use. Prepaid. Money returned if not pleased. Agents Wanted. Haynes Mfg. Co., Desk 5, Henrietta, N. C.

**GENERAL** Agents—Capable of calling on the big trade themselves and handling canvassers for the house to house and office to office business, to sell the newest electric specialty on the market; sold everywhere there is electricity, in the home, office, factory, store, hotel, liberal profits; sales-driving sample, weighs a pound; no experience or knowledge of electricity required; shows how to use one light instead of two and get the same results; sells for \$2.50, \$3.50, \$5.00 and saves the purchaser an investment of \$25. Write for particulars. The Handy Light Co., 152 Handy Light Block, Cincinnati, Ohio.

**AGENTS—242% profit.** Pocket sample. Side line. Sight seller. \$8.50 easy daily. Your own printed matter. Particulars free. Rollins & Co., Dept. 14, Box 5272, Boston.

**GET** Money—I did; got \$301.27 in two weeks doing plating, writes M. L. Smith of Pennsylvania (used small outfit); start as Smith did; that's easy; hundreds already started, money coming in, goods going out; people everywhere have tableware, watches, jewelry, etc., for the "Gray Plating Man." Practical outfits, all sizes, heavy plate, guaranteed. Pure Gold, Silver, Nickel, Metal Plating, latest process, taught free, quickly; experience unnecessary; secrets exposed; own and boss a business that pays \$15 to \$50 weekly—you can; write today. Gray & Co. Plating Works, 18 Gray Bldg., Cincinnati, O.

**COLLECT** names and double your income, at home. Business concerns buy millions of names yearly. Parcel post increased demand. Instructive booklet for stamp. Information System, 210, Marietta, Ohio.

**AGENTS—Money** unnecessary for my proposition. Pleasant work. Splendid money-maker. Rapid seller. Sample free. DeLacy Novelty Company, 2661 Jackson Blvd., Chicago.

**AGENTS—Make** big money selling our Aluminum ware, Silverware and Steel specialties. Write for Catalogue and Territory. Sterling Aluminum Company, Canal Station 77, Chicago, Ill.

**AGENTS—Small** investment brings 1,000% returns. Box 375, Thibodaux, La.

**400% PROFIT** selling our High Grade work. Samples free. Gordon Co., Northwestern Bldg., Chicago.

**HUSTLING** man or woman representative wanted in each locality. Part or full time. \$50 to \$500 a month. Every customer secured gives you a steady monthly income. Experience is not required. Only one appointment in each locality—hurry and be the first to apply. Write the I-L-U 1218, Covington, Ky.

**USE** your spare time to build up a mail order business of your own. We help you start for a share in profits. 27 opportunities. Particulars free. Mutual Opportunities Exchange, Buffalo, N. Y.

**AGENTS** in all trades to sell Hygienic hose supporter. Recommended by physicians. Pair 25c. Hygienic Hose Supporter Co., Toledo, Ohio.

**AGENTS—We** want live men as district managers; make big money in town or on the road, selling Hi-Dri, the latest household necessity; liberal proposition to real salesmen. Tift, 3 Stone St., New York.

**AGENTS—Make** what you sell! Save 200%. Instructions for manufacturing 24 Great Sellers, also hundreds of real opportunities, sent for 10c. Agents Information Co., 2854 Madison, Chicago.

**AGENTS—100% profit—sell** to saloons—machine whirlwind seller. Free sample and salesmanship course. Two sales a day \$15 profit. Write. Simplex Mfg. Co., Kewanee, Ill.

**YOUNG** Man, would you accept and wear a fine tailor made suit just for showing it to your friends? Or a Slip-on Raincoat free? Could you use \$5 a day for a little spare time? Perhaps we can offer you a steady job. Write at once and get beautiful samples, styles and this wonderful offer. Banner Tailoring Co., Dept. 703, Chicago.

**MR. Mail-Order** Man: Get quick returns. Established corporation supplies fast Mail-Order sellers; factory prices. Classy proposition. Beginners or established firms. Copyrighted Prospectus free. Mississippi Valley Co., Inc., Box N629, Pittsburg, Kans.

**THE** Jersey Bed Cover Clip sells at sight. Agents' profits large. Write for particulars. The Powell Specialty Co., 31 Clinton St., Newark, N. J.

**START** business for yourself. Our new agents' catalogue and 6 money-making formulas 10c. The Woodlawn Co., Rockford, Ill.

**AGENTS—Send** stamp for our proposition. Hunt's Store, Pleasanton, Cal.

**AGENTS—To** sell the newest electric appliance on the market; sold everywhere there is electricity, in the home and office; liberal profits; sales-driving sample, weighs a pound, no experience or knowledge of electricity required; it shows how to use one light instead of two and get the same results; sells for \$3.50 and saves the purchaser an investment of \$25. Write for particulars. The Handy Light Co., 14 Handy Light Block, Cincinnati, Ohio.

**AGENTS—Manufacture** your own articles and build up substantial local and out of town business from a small start. Write for particulars. Taylor Service, Dept. 1-P, Box 1764, New York.

**AGENTS** Wanted—Right here is the one big chance of your life. If you want to make good money—\$10 a day or more, as easy as rolling off a log, and get your swell clothes free besides, you can do it by acting as our agent. We are the biggest people in the business and want our agents to make big money and be nifty, stylish dressers. Send a postal today for free \$10 outfit, including a big book of nobby suiting samples to select your swell agent's suit from. Then take orders from people who admire your nifty clothes. They come to you—not you to them. This is the way to get rich—the sure, easy way. Remember, you need no money—everything is furnished by us free. We pay express on everything. Just send a postal, but do it today. You can't get started too quick, making this big money and wearing these stylish clothes. Address card to Paragon Tailoring Co., Dept. 314, Chicago, Ill.

**MAKE** \$30 to \$60 weekly selling our new 300-candle power gasoline table and hanging lamp for homes, stores, halls, churches, no wick, no chimney, no mantle trouble; costs 1c per night; exclusive territory; we loan you sample. Sunshine Safety Lamp Co., 1547 Factory Bldg., Kansas City, Mo.

**RURAL** Agents write for our "10-day free trial offer to prospective agents" on our New Improved 1914 Model Vacuum Cleaner. We pay all express charges. Best and strongest suction cleaner made. Gets both germs and dirt. Guaranteed 5 years. Postal will bring offer. Warner Vacuum Cleaner Company, Dept. "Z," Muncie, Ind.

**AGENTS,** sell newly discovered California Crystals. 100% profit. Mounted in rings and scarfpins and have appearance of genuine diamonds. Has everybody guessing. Sample pin and prices my best arguments, sent for 15c. Sunset Agents' Supply Co., 1310 Maple, Pasadena, Cal.

**AGENTS** in every city to handle our Triplex Folding Handbag; big profits; exclusive territory. Write for terms and free catalog. Other big sellers, S. V. Diamond & Bro., 35 West 21st St., New York City.

IF you can invest \$5 as an evidence of good faith, for an outfit that sells for \$8.75, we have an agent's proposition which should yield you at least \$40 per week—only requisite needed being reasonably good address and a little intelligent work—no book, insurance nor real estate scheme. Address for details, Puncture Cure Sales Co., 14 Bridge St., Newark, N. J.

AGENTS, would you take a steady job where you can clear \$20 to \$30 weekly to start and work up to yearly profits of \$3,000 or more? No experience required. Great crew managers' proposition. We manufacture. Middlemen profits saved. Get posted on our 1914 exclusive territory—business-building selling plans. Act quick. E. M. Davis, Pres., R64, Davis Bldg., Chicago.

\$5 DAILY earned at home in spare time silvering mirrors; wholesale houses buy in quantities; no capital; particulars free. Patterson & Co., Dept. 3, Brooksville, Ky.

200% PROFIT. You can't beat it. Free pocket sample. Sells everywhere. Everyone buys. Our reputation and big capital back you. Wm. J. Dick, Mgr., Dept. G4, 20 W. Lake St., Chicago.

FULLER Dustless Floor and Wall Mop, with adjustable handle, and hand duster are indispensable to housekeepers—sell at sight—100% profit to agents. Write today. Fuller Brush Co., 55 Hoadley Pl., Hartford, Conn.

LIVE Agents, here is your chance; something that will sell to automobile owners at sight; good profits; write P. Z. Clapp, Randleman, N. C.

VACUUM Cleaner Agents—Do not take an agency until you see the "U. S." Just out! Wheel-operated. Extended visible nozzle. Popular price. Good profit. The U. S. Manufacturing Company, Warren, O.

OPPORTUNITY to make \$5 to \$10 daily, selling, dressy, serviceable raincoats at less than inferior ready-made kind. Empire Tailored Raincoat Co., 2827 Third Ave., New York City.

MEDICAL Specialties—Healing salve, guaranteed. Great sellers, profitable. Sample 8c. Schauermaun Drug Co., 3601 Kensington, Phila.

AGENTS—Sample and terms for exclusive agency for the greatest seller and most needed article ever invented; patents just issued; \$1.10 postpaid. Money order. Simplicity Shade Adjuster Company, 62 W. Court, Memphis, Tenn.

AGENTS—"Our New Directory" tells where you can buy over 2,600 agents' articles at wholesale, 25c prepaid. Wesley C. Krug, Ashton, Ill.

AGENTS, make more money. Handle the Imperial Self-Heating Iron. Oldest and best. Every housewife wants one. Exclusive territory. Write today for interesting proposition. Imperial Brass Mfg. Co., Dept 733, Chicago.

AGENTS—\$5 daily selling our Handy Tool, 12 articles in one. Lightning seller. Sample free. Thomas Mfg. Company, 462 Third St., Dayton, Ohio.

PHOTO Pillow Tops, Portraits, Frames, Sheet Pictures, Photo China Plates. Rejects credited. Prompt shipments; samples and Cat. free to agents. 30 days' credit. Jas. C. Bailey Co., Desk W1, Chicago, Ill.

SELL guaranteed rain coats direct to consumer. Get our big offer and sample coat, for free inspection. Capital or experience not required. Sibley earned \$24 first P. M. Write today. Queen Fabric Mfg. Co., Dept. 108, Syracuse, N. Y.

WIDE-AWAKE, active agents or crew managers can secure special concession and reap the benefit from the best money-making agency proposition on the market by writing immediately for full particulars. Hugro Manufacturing Co., Chicago, Ill.

AGENTS, earn \$10 per day, sell three 50c ties \$1. Free Monogram gold cuff links and stick pin. Bowden cleared \$71—5 days. Cooper \$40—4 days. Free samples. Comer Neckwear Co., 1 Eighth St., Dayton, Ohio.

AGENTS—Snappiest household line on earth. Red hot sellers, steady repeaters. Over 150 different articles. Goods guaranteed. 100% profit. Write quick—Hurry. E. M. Feltman, sales mgr., 6718 Sycamore St., Cincinnati, O.

BLUE Chip Lathe Tool and Holder. Agents wanted. Send \$1 for sample. Send for circular on our hand-forged lathe tools. Noble & Westbrook Mfg. Co., Hartford, Conn.

500% PROFIT selling our wonderful sign letters for office windows, store fronts and glass signs; resembles finest gold leaf; easily applied; samples free. Metallic Letter Co., 406 N. Clark St., Chicago.

WONDERFUL opportunity, steady income, selling the Fesler Fountain Shaving Brush, \$5 to \$10 per day easy; then a continuous return on repeat soap business. 85 more live men wanted. Unique sales plan free. Address B. Fesler Sales Company, 256 West 23rd St., New York.

AGENTS—Secure exclusive territory for Kleanol specialties. Quick repeaters; over 100% profit. Monthly bonus payments extra. Get full information from The Kleanol Co., 65 Taylor St., Springfield, Mass.

AGENTS—Both sexes. We manufacture and control fastest selling household article ever invented. Exclusive territory. Connolly, 37 South 9th St., Brooklyn.

IF we had your address we'd send free sample and show you how to make \$25, not one week, but weekly. G. Mfg. Co., 20H Warren St., N. Y.

AGENTS are coining money with our Improved Keyless Padlock. 150% profit. Sample, postpaid, 75c. It's a winner. Wm. J. Dick, Mgr., Dept. G-21, No. 20 W. Lake St., Chicago.

DID you ever hear of anyone selling popular 25c sheet music at 5c? You can do it and make 300%; four sample copies and proposition, 10c. Chicago Book & Music Co., 535 S. Wabash Ave., Chicago.

AGENTS—Attention! New invention, a quick selling little article that gets the money. Why? Because it's an absolute necessity with every man—enuf sed. 10c brings sample, etc. H. A. Kane, 4317 W. Henderson St., Detroit, Mich.

WE are the largest manufacturers of twisted wire brushes in America. Highest grade goods, best service, highest profit. Write for our new catalog. You are sure to win. Fuller Brush Co., 33 Hoadley Place, Hartford, Conn.

IDEAL Trunk Strap. Binds trunk both ways with one turn. Big seller. Write for terms. Union Mail Order Co., Middleboro, Mass.

MY Octagon bottle of rare perfume is the most wonderful seller. For 10c to cover expenses, will send you one; also full particulars regarding this unusual opportunity. Address Raymond Tanner, 181 Lexington Ave., New York.

NEW proposition just out; does away with extra tire on automobiles. Write quick for details. Golden Rule Mail Order House, Wisconsin Veterans' Home, Wis.

ANY one can sell new office necessity. Secure your territory. Stamp for reply. Box 113, Framingham, Mass.

AGENTS—Write for prices on Solar, Bromides, Convexed Prints and Pillow Tops. We ship orders back in 24 hours' time. Try us. Horne Copying Co., 113 S. Jefferson St., Chicago.

AGENTS—Wanted to sell a guaranteed proposition that is a winner; exclusive territory; particulars free. C. A. Coley, Pittsfield, Ill.

150% PROFIT, representing exclusive manufacturer. Ideal Sanitary Twisted-wire brushes. Highest quality, 28 winners, \$5. Tappan Brush Co., 550 Temple Court, Minneapolis, Minn.

AGENTS—Catchy song, "Would You Like a Little Girl Like Me?" Copy 10c. Music Publisher, Box 291, Syracuse, N. Y.

LIFETIME opportunity — Manufacture "Substitute for Eggs." Enormous profit. No canvassing. Particulars free. W. C. Delzell, 311A South Fickett, Los Angeles, Cal.

DON'T waste your evenings. Sell our attractive brass easel poster frames to picture theaters. Big demand. Easy sales. Liberal commissions. Newman Manufacturing Company, Cincinnati, Ohio.

MEN or Women—The Big 3 sells on sight. Everybody, everywhere. Enormous demand. Orders repeat. Large profits. Exclusive territory. Marvel Products Co., 10 Liberty Ave., Pittsburgh, Pa.

NEW patent burglar alarm. Agents make \$5 to \$10 per day. Sample 45c. C. F. Lee Mfg. Co., 1417 Belleplaine Ave., Chicago.

AGENTS—Burglar-proof window-lock, self-acting. Any position. Sample 15c. Zenith Supply House, Morgan Park, Ill.

STAPLE article. Sells like wildfire. Sample 10c, circulars free. Central Maine Supply Co., 470 Washington St., Bath, Me.

AGENTS—250% profit. Wonderful little article. Sells like wildfire. Can be carried in pocket. Write at once for free sample. H. Mathews, 1962 Third St., Dayton, Ohio.

AGENTS—Live wire proposition offered hustlers. Exclusive territory on a profitable new article. Best seller. Write quick. Schiller Mfg. Company, 407, 175 N. State St., Chicago, Ill.

HOUSEHOLD necessity recently invented sells at 75c. Costs distributors 25c. Nothing like it on the market. Tested and approved by Good Housekeeping Institute. Get your territory now. Hugro Mfg. Co., Chicago, Ill.

MAKE and sell your own goods. Formulas by expert chemists. We obtain your government serial number. Catalogue for stamp. B. Mystic Company, Washington, D. C.

I WANT More Men—Clean, get-ahead men with energy and enthusiasm. I'll make you independent; you'll win confidence and respect; \$2,500 to \$5,000 a year; exclusive control in uncrowded field; self-advertising article, needed in every home; interests instantly; remarkable chance to own growing business; small capital required. Write me—don't delay a minute. Territory going fast. A. C. Day, Sales Mgr., Farador Company, Dept. B, Buffalo, N. Y.

AGENTS—150% Profit on Each Sale. Show housewives how to do an hour's hard work in a jiffy. Unique household preparation and our original "Entering Wedge" plan makes easy sales and big profits. Excellent opportunity to control this in your territory. Jiffy-Brite Laboratories, Dept. M, Boston, Mass.

BOTH Sexes. Ladies' 50 cent article. Sells like wildfire. Hilton Sales Co., Muncie, Ind.

AGENTS; Household necessity, sells on sight, 100% profit. Particulars free. Dept. N, Drawer K, Orville Supply Company, Fostoria, O.

ENDLESS Neckties (Patented): Just show them—men buy on sight—look like any stylish necktie—tie in a different place each time—wear 20 times longer. Hustlers can make steady \$40 to \$60 week. Sample outfit free if you mean business. Write Endless Necktie Co., Kansas City, Mo.

CALIFORNIA honey brings agents big profits and steady business. Prices 10, 11, 12c per lb. prepaid anywhere. Inspection allowed before payment. Agents sample 10c. Price list free. Spencer Apiaries Co., Box 26, Nordhoff, Calif.

LARGE income selling Specialty Rugs. Colored illustrations and important information free. Sample rug forwarded prepaid, \$1.00. Reference, Boylston Nat'l Bank, Boston. Dundee Mfg. Co., 46 Chauncy St., Boston, Mass.

AGENTS sell guaranteed Hosiery, Underwear, and Sweaters for largest manufacturer in America. Easy work. Big pay. Complete outfit free. Write Madison Mills, Dept. 7A, 590 Broadway, New York City.

AGENTS make big money selling our new gold letters for office windows, store fronts and glass signs. Any one can put them on. Write today for free sample and full particulars. Metallic Sign Letter Co., 406 N. Clark St., Chicago.

VACUUM Cleaner Agents: Absolutely new design in wheel-operated, powerful bellows vacuum cleaner; new visible nozzle and Lint Gathering Attachment; exclusive appearance; sells quick at \$7.50. Write for particulars about money-back guarantee now. Doty Company, Box 200, Dayton, Ohio.

\$1,000.00 OR \$400.00 a month—which? Agents make \$20.00 a day. Start in small way, grow to big money class. Koehler made \$12.00 first day, \$16.00 second day. "Positive Proof Sales Plan," combined with "Shakit," makes big money certain. Make your friends wonder at your success. Act Quick; particulars for postal. Nat. Dist. Co., 1674 Belmont Ave., Chicago, Ill.

GOLD Sign Letters, Instructions for making. Johnston Co., Quincy, Ill.

WE furnish you capital to run profitable business of your own. Become one of our local representatives and sell high grade custom made shirts, also guaranteed sweaters, underwear, hosiery, and neckties direct to homes. Write Steadfast Mills, Dept. 10, Cohoes, N. Y.

STAMP Names and Addresses on Key, Checks, Umbrella Plates, Watch Fobs, etc. We supply blank stock and stamping outfits, sample with name and address, 10c. Hart Mfg. Co., Desk 2; 303 Degraw St., Brooklyn, N. Y.

**AGENTS:** We want, at once, a man or woman, one capable of earning good salary, in every community where we are not represented. Write us, Sun Mfg. Co., 309 Dean Bldg., South Bend, Ind.

**\$50.00 A WEEK** guaranteed selling Pure Spun Aluminum Cooking Utensils. We are manufacturers of the largest line in the world. First Aluminum Cooking Utensils made bears our trade-mark. Wanted live men at once for protected territory. Answer quick. Divn. PM, American Aluminum Mfg. Co., Lemont, Ill.

**LISTEN!** You can make \$15 weekly easy selling high-grade jewelry, 50c weekly. Washburne, No. 325 West 47th St., N. Y.

**I NEED** one energetic, dependable representative in every county to take orders for our new Popular Mechanics book for boys called "The Boy Mechanic." This is not a story book, but a wonderful and interesting collection of 700 things boys love to make and experiment with. A very large attractive book for the price, \$1.50. Every boy's father or mother will want to buy it for their son. It sells itself. Good liberal commission and exclusive territory. You don't have to be a professional agent to be successful with this highly meritorious proposition. Work in and around your home town during spare time only if you cannot devote all your time to it. Write today for full particulars to Manager Book Dept., Popular Mechanics Co., 318 W. Washington St., Chicago.

**REMNANT** Store, 1331-E. Linn, Cincinnati. Greatest Dry Goods Bargains on Earth. For agents and store-keepers.

**SELL** advertising novelties, 25 per cent commission. Nail files and tooth picks in leather cases. Big sellers. Samples 10c. Joel Kenyon, Owego, N. Y.

**MANUFACTURE** gold window letters. Sample, particulars, 10c. Box 31, Detroit.

**WE** have agents making \$200 weekly, selling our new specialty to merchants. Retail \$7.50, your profit \$5.00. No competition; exclusive territory. Samples and descriptive matter free. Sayers Co., 408 Olive St., St. Louis, Mo.

**MAIL-ORDER** Opportunities: 25 new propositions. No competition! Make 95c profit on dollar order; complete outfit 10c. Mail Dealers Wholesale House, 521 Franklin Bldg., Chicago.

**AGENTS—Salary** or commission. Greatest seller yet. Every user pen and ink buys on sight. 200 to 500 per cent profit. One agent's sales \$620 in six days; another \$32 in two hours. Monroe Mfg. Co. X 6, La Crosse, Wis.

**STOP** Here! Let me start you in a home business that will bring you money every day. Experience unnecessary. Spare time. No canvassing. I furnish everything. Send for proofs. Voorhies, Desk C. R., Omaha, Neb.

**\$5.00 RAINCOATS—Agents** wanted everywhere. You and many others in your section need Raincoats and would gladly pay Agent \$5.00 for one. Why not be that Agent? Boston Raincoat Company, Sales Dept., Boston, Mass.

**WANTED—Hustlers** to take orders for made-to-measure, high grade men's tailored suits from \$9.00 to \$22.00. Make \$25.00 to \$50.00 weekly. Elegant large book outfit free. Experience unnecessary. No pocket folder affair. Splendid opportunity to make money. Handy Dandy Line, Dept. S, Sangamon St., Chicago.

**AGENTS** make \$100.00 monthly selling our 500 Handy Household Articles; catalogue free. Scheff Company, Desplaines, Ill.

**\$35 TO \$100** weekly made easily. Needed in every home and store; enables purchaser to save money and enjoy life. Rapid seller, profit from \$10 to \$50 each sale. Experience unnecessary; exclusive territory to hustlers. Write for full particulars. C. Hemple, Sales Mgr., 174-C, No. Sangamon, Chicago.

**YOU** can be your own boss with our Key Check Outfit. Good for \$5 a day stamping names on pocket key checks, fobs, etc. Sample check with your name and address, 15 cents. Pease Die Works, Dept. M, Winchester, N. H.

**PERFECTION** Pocket Adding Machine. Lightning seller. Agents wanted. Cincinnati Specialty Mfg. Co., Dept. R, Cincinnati, Ohio.

**AGENTS** make big money and become sales managers for our goods. Fast office sellers. Fine profits. Particulars and samples free. One Dip Pen Company, Dept. 2, Baltimore, Md.

**AGENTS** to take orders for Visiting and Business Cards; large profits; outfit free. Furman Printery, Waterbury, Conn.

**AGENTS** sell rich-looking imported 36x68 rugs \$1 each. Carter, Tenn., sold 115 in four days, his profit \$57. You can do as well. Write for sample offer and selling plan. Sample rug by Parcel Post, prepaid, 98c. A. Condon, Importer, Stonington, Maine.

**SOAP and Perfume** Agents, write us. Big Profits. Goods Guaranteed. Hopfinger and Roth, 212 N. Second St., St. Louis, Mo.

**GENERAL** Agents experienced in calling on big trade who can organize canvassing crews that will sell our products from house to house and office to office. Demand growing every day, sells the year round. Territory contracts to reliable men or women. Send \$1 for five sizes, retail value \$3.00. If you're a dreamer, keep your money. Delight-Ol Products Co., Milwaukee, Wis.

**AGENTS—\$50** weekly. We manufacture the best needle case made; a wonderful seller; 200% to 500% profit; talking unnecessary; our "Trust Scheme" Envelopes do the work; general agents can make \$100 weekly; particulars free; 25c sample outfit for 10c; buy direct from the factory. Paty Needle Co., 102 Davis Sq., W. Somerville, Mass.

**BIG Profits** for You! Manufacture Barley Crisp. New confection. 5c package costs you 1c. Machine, instructions complete \$7.50 prepaid. Send 10c for samples. Barley Crisp Co., 1605 Hyde St., San Francisco.

**I WILL** start you earning \$4 daily at home in spare time, silvering mirrors; no capital; send for free instructive booklet, giving plans of operation. G. F. Redmond, Dept. 306, Boston, Mass.

**300 TO 400%** Profit to Agents selling our guaranteed U. S. Fire Extinguishers. Tremendous demand. Orders repeat. Exclusive territory to county and district managers. United Mfg. Co., 1025 Jefferson, Toledo, Ohio.

**AGENTS** make \$5.00 to \$10.00 a day on the start. Atkinson writes: "The best proposition I have found in my forty years canvassing." Permanent work. Household necessity. Saving 80%. Write today for General or Local Agents terms. Free sample. C. H. Stuart & Co., 16 Union St., Newark, New York.

**AGENTS—Handkerchiefs.** Dress Goods. Carleton made \$8 one afternoon; Mrs. Bosworth \$25 in two days. Free Samples. Credit. Stamp brings particulars. Freeport Mfg. Company, 59 Main St., Brooklyn, N. Y.

**YOU** can make \$\$\$\$ as our general or local agent. Household necessity; saves 80 per cent; permanent business; exclusive territory; salary or commission; free sample; credit. J. Pitkin, 113 Redd St., Newark, N. Y.

**AGENTS** Wanted—Mechanics and shopmen make over \$100 a month in spare time selling transparent handled novelty knives and razors. Big profits. Sales easily made. Write for terms today. Novelty Cutlery Co., 67 Bar St., Canton, O.

**MEDALLIONS—300%** profit. Make up your own goods and be independent. Catalogue free. Resag Co., 1205 Randolph St., Chicago.

**READ** the Agents' Magazine. Make more money, 2 months, 10c. Agents' Magazine, Chicago.

**AGENTS—Sell** the Primus, genuine Swedish wickless, coal-oil stoves. Smokeless, odorless. Twice the heat of gasoline at one-eighth the cost. No danger of explosion. Big profits. James Anderson & Sons, Sidney, Ohio, American Distributors.

**WE** pay \$80 a month salary and furnish rig and all expenses to introduce our guaranteed poultry and stock powders. Address, Bigler Company, X368, Springfield, Illinois.

#### HELP WANTED

**WANTED—Salesman** to call on wholesale and retail hardware, druggists, harness and saddlery and mill supply houses, etc., to sell neatfoot and lard oils as a side line on commission basis. Pocket samples. We help you sell our products. Anglo-American Pork Products Co., 63-64 Wade Building, Cleveland, Ohio.

**WANTED—Circular** Distributors. Stamp for contract. American Distributor, Blairsville, Pa.

**ARE** you ambitious? Earn \$15 to \$25 weekly, during spare time at home writing for newspapers. Literary ability unnecessary. Instructive booklet free. Washington Press Bureau, Dept. 114, Washington, D. C.

**GOVERNMENT** Examinations. Most thorough preparation; \$5; returned if not appointed; particulars free. American Civil Service School, Washington, D. C.

**ENGINEER** wanted in every city and town, as my agent for article used the world over; excellent proposition. W. R. Du Mond, 39 South St., New York.

**YOUNG** Man, would you accept and wear a fine tailor made suit just for showing it to your friends? Or a Slip-on Raincoat free? Could you use \$5 a day for a little spare time? Perhaps we can offer you a steady job? Write us at once and get beautiful samples, styles and this wonderful offer. Banner Tailoring Co., Dept. 704, Chicago.

**\$65 TO \$150** paid men and women in government positions. Common education sufficient. Over 12,000 appointments to be made. We will instruct you by mail for your examination for only \$5. Also Short-hand, Bookkeeping, Typewriting, High School, Engineering and Law Courses taught by mail. For "Free Tuition Scholarship" apply Carnegie College, Rogers, Ohio.

**THOUSAND** of government positions open to men and women over 18. \$65 to \$150 month. Vacations. Steady work. Parcel Post means many appointments. Common education sufficient. "Pull" unnecessary. Write immediately for free list of positions now available. Franklin Institute, Dept. D 21, Rochester, N. Y.

**If** you want to rise and handle big money write us. \$5 day working your locality. New proposition; eclipses everything. Nothing to buy or sell. Dept. M, International Correspondence System, Philadelphia.

**STRUCTURAL** drafting pays. Short course and sheets corrected, \$2.00. W. D. Browning, Collinwood, O.

**GOVERNMENT** Jobs, \$90.00 month. List free. Franklin Institute, Dept. D 21, Rochester, N. Y.

**MAILING** circulars is light, pleasant work for spare time; no experience or canvassing. Send name; begin making money at once. Raymond, 100 Roxbury Crossing, Mass.

**WANTED—Salesmen** to demonstrate new patent article. Good salary. Simplex Vulcanizer Co., Omaha, Neb.

**BE** a Detective. Earn big money. Write John J. Gillies, Licensed and Bonded N. Y. State Detective. Retired Member N. Y. Police Dept. 22 yrs. Experience. 254 Huguenot St., New Rochelle, N. Y. Investigation solicited.

**WANTED** ambitious young people to sell popular specialty and receive 100% commission or salary. Address Harvey Hadlock, San Francisco.

**PLEASANT** Home Work—Ambitious persons wanted for copying, addressing. No mail-order course or trash to sell. Send today addressed, stamped envelope for particulars. Box 17, Station H. G., New York.

**BRAKEMEN,** Firemen, on all Railroads. Wages \$190. Experience unnecessary. Send age, postage. Railway Association, Dept. 298, Brooklyn, N. Y.

**LEARN** Realty Business. Big income. We'll teach you. Free booklet. Address American Realty League, San Francisco.

**MEN, Women,** Get Government Jobs; \$65 to \$150 month. Spring examinations everywhere. Full description free. Franklin Institute, Dept. D 21, Rochester, N. Y.

**PLEASANT** spare time work; mailing circulars. Good pay. No scheme. Details free. Home Pub. Society, 46 N. 12th, Philadelphia, Pa.

**WRITE** moving picture plots. Good pay. We will show you how. Ripless Co., Brockton, Mass.

**RAILWAY** Mail Clerk Examinations everywhere soon. \$75.00 month. Schedule and sample questions free. Franklin Institute, Dept. D 21, Rochester, N. Y.

**GET** into Vaudeville. Easy life, good salary. Experience unnecessary. I will show you how. Herb Monahan, Vaudeville Author, Brockton, Mass.

**WE** will pay you \$120.00 to distribute religious literature in your community. Sixty days' work. Experience not required. Man or woman. Opportunity for promotion. Spare time may be used. International Bible Press, 599 Winston Bldg., Philadelphia.

**WANTED—Men** 18 to 35 as Government Railway Mail Clerks. \$75.00 month. Examinations everywhere soon. Schedule and sample questions free. Franklin Institute, Dept. D 21, Rochester, N. Y.

**MEN** handy with tools for manufacturing business. Work at home, all or spare time. Thomas & Page, 421 E. 41st St., Chicago.

**USE** your spare time to build up a mail-order business of your own. We help you start for a share in profits. 27 opportunities. Particulars free. Mutual Opportunities Exchange, Buffalo, N. Y.

**SPRING** Railway Mail Clerk Examinations, \$75.00 Month. Sample questions free. Franklin Institute, Dep't D 21, Rochester, N. Y.

**WANTED**—District Manager in every city and town handle best paying business known. No peddling or canvassing. Outfit 10c. William Bowman, 614 Smith St., Norfolk, Va.

**A MONEY** Proposition—Co-operate with me in a profit-sharing mail-order business. Will place trial advertisement, furnish printed matter, goods to fill orders and divide the profits. Particulars, Desk 153, Hazen A. Horton, Tekonsha, Mich.

**GET** a Government Job! See ad on page 14. Write now—today. Patterson Civil Service School, Rochester, N. Y.

**ANY** intelligent person can earn steady income corresponding for newspapers. Experience unnecessary. Address Press Corresponding Bureau, Washington, D. C.

**GOOD** Positions Open everywhere. Let us place you. State qualifications, salary, etc., first letter. "Nisco," Dept. MDB, Cincinnati.

**WRITE** Moving Picture Plays, \$10 to \$100 each. Constant demand. Devote all or spare time. Experience, literary ability or correspondence course unnecessary. Details free. Atlas Publishing Co., 3045 Atlas Bank Bldg., Cincinnati, Ohio.

**BE** a Detective—Earn \$25 to \$75 weekly; chance to see the world with all expenses paid. Loraine System, Dept. 304, Boston, Mass.

**GO** on the Stage. Vaudeville career offered you. Experience unnecessary. Managers endorse my method. Instructive vaudeville book free. Write today. Frederic LaDelle, Sta. 10, Jackson, Mich.

**WANTED**—Distributors, Men and Women—to give away free pkgs. Perfumed Borax Soap Powders; no money or experience needed; good pay. S. Ward & Company, 218 Institute, Chicago.

**STOP** Here! Let me start you in a home business that will bring you money every day. Experience unnecessary. Spare time. No canvassing. I furnish everything. Send for proofs. Voorhies, Desk C. R., Omaha, Neb.

**BETTER** Light for 1/5 Cost of Electricity. Suitable for home or store. Easily installed; no experience necessary, big demand. Write for Free catalogue. Doud Lighting Co., 174-D, N. Sangamon, Chicago.

**I WILL** start you earning \$4 daily at home in spare time, silvering mirrors; no capital; send for free instructive booklet, giving plans of operations. G. F. Redmond, Dept. 306, Boston, Mass.

**LEARN** automobile repairing, driving on up-to-date cars; electrical, civil engineering, surveying; methods most practical; room and board while learning; positions secured; satisfaction guaranteed; catalog free. National School of Engineering, 2110 West Seventh, Los Angeles.

**BE** a Detective. Earn \$200 monthly, positions open. A practical course in Detective Work taught by mail. American School of Criminology, Detroit, Michigan, Dept. F.

**WANTED**—Several Honest, Industrious people to distribute Patriotic Literature. Salary, \$60 per month. Prof. Nichols, Box C, Naperville, Ill.

#### FOR SALE

**FOR** Sale—Reynolds 1912 Four-Circuit Electric Sign Flasher. Type A. C. Size, W. 30; Cycle, 60; speed, 1,700; 110 volts. Used less than one year. Address Box 401, Meriden, Conn.

**FOR** Sale—1x8 feet Slate bed Billiard Table, 12 cues with rack, bridge, chalk, and tips. Condition guaranteed good. \$70. Will ship on deposit of \$25. Marhlon Stevens, Kendall, N. Y.

**CHEAP**—Coin-operated Electric Piano; Large Upright Music Box; Large Floor Weighing Scale. Also Electric Shock Machine. Wm. Fratcher, Detroit.

**PLUMBING** and Gasfitting business. Established 20 years. Paying proposition. Good reasons for selling. Bargain, W. G. Costley, Kent, Ohio.

**2 VIEW** Cameras, Violin, Cigar Vendor, Typewriter, Anderson, Omecce, N. D.

**BARGAIN**—1 billiard, 6 pool tables, good condition; sell one or more. Box 4, Clifton, Texas.

**BUCKEY** Traction Ditcher with Apron wheels and Gumbo buckets, for sale cheap. Herman Kroska, Pomeroy, Iowa.

**AERO** Vacuum Cleaning Wagon complete. Good condition. Bargain. Roy Creamer, Jeffersonville, Ohio.

**FOR** Sale—Electro-plating machine, also safety-razor sharpener. Keen Edge Sharpening Co., Box 621, Wichita, Kan.

**FOR** Sale—Mounted specimens. Reuben Saylor, Taxidermist, 497 S. Broadway, Dayton, Ohio.

**1913 TWIN** Indian, \$165; 1912, \$125; 1912, 5 passenger Ford, \$300; Oliver or Remington Typewriter, \$20; 22 or 32 Winchester repeating rifle, \$5. Ernest Atwell, Independence, Mo.

#### WANTED

**BROKER** or manufacturer to finance, form company, lease or sell patent automatic cash register. Something new. Cuts furnished. Geo. Wolf, Bakewell Bldg., Pittsburgh, Pa.

**WANTED**—Second-hand telescope, magnify about 100 sky and 50 on land. State make, dimensions, age and lowest price. R. G., 6th floor, 318 W. Washington St., Chicago.

**OLD** Pistols and Guns Wanted. Will buy or give in exchange almost any sort of modern revolver, rifle or shotgun. Stephen Van Rensselaer, West Orange, N. J.

**WANTED**—Patented household specialty made of wood, costing 30c to 50c to manufacture. Folding Furniture Co., La Porte, Ind.

#### WANTED PARTNER

**AN** owner of basic patents on railroad equipment, covering necessary and wanted improvement. Able partner wanted. Box 436, Harrisburg, Pa.

#### MACHINERY, TOOLS AND SUPPLIES

**LATHES**—10"x5' Barnes, \$105; 12"x5' Patterson, \$135; 15"x8' Fairbanks, \$165. Hol. Spin., Comp. Rests, Pwr. Cross Feed, Chuck, 14" Prentiss light pattern geared Shaper, countershaft, chuck, \$100; New High Grade 14"x6" Quick Change Lathe, complete, \$260. Write for particulars. Western Machinery Co., Cincinnati, Ohio.

**LATHE**—9" swing, 54" bed, belt or foot power, \$55 complete. Also sensitive drill press. Metal specialties made to order. Scranton Acetylene Lamp Co., Scranton, Pa.

**NO. 1 STEPTOE** Plain Milling Machine, with Swivel Vise, Arbor, and Universal Dividing Head, new, \$265. 10½-inch Universal Dividing Head, new, \$75. Box 216, Soldier, Kans.

**DYNAMO**—15 light, \$25; 30 light, \$40; 75 light, \$50. In payments of \$5 per month. Box 161, Troy, Ohio.

**YOUR** name on steel stamp to mark your tools, for \$1—Three initials for 50c. Gideon Pike, Attleboro, Mass.

**FOR** Sale—Two 250 K.W. Rotary Converters, type E. C., form E, class 6-250-500, 500 r.p.m., 600 volts, d.c.; d.c. amperes 416; a. c. end, 25 cycles, 3 phase, 360 volts. These machines are in A-1 condition and can be delivered at once. Price \$1,400 each f.o.b. cars (Penna. delivery). F. H. Herring, Inc., 30 Church St., New York.

**FOR** Sale—30 H. P. Otto Gas Engine. A1 shape, also dynamo and switchboard. 121 W. Grand Ave., Chicago. Wm. Erby & Son.

**OPPOSED** W. C. 4x4 motor, A1 condition, cheap. Also planetary transmission, dash coil, carburetor. Box 46, Hadley, Mich.

**1,000 "GRANTS"** Gears—Catalogue No. 115—Reduced hundred prices. Samples free. Lawyer Tuttle, Fremont, Ohio.

**FOR** Sale—Simmons Kerosene Burner, 20" (new), \$16. Wanted: Model steam boilers and fittings. Jacob L. Strawn, Route 8, Jacksonville, Ill.

**PULLEYS, Gears, Sprockets, Shafting, Hangers;** see page 128. W. A. Jones Foundry & Machine Co., Chicago.

**VACUUM**—pumps, hose tanks and tools for stationary and wagon cleaners. Assemble your own plant at one-third cost. Vacuum Supply Co., Ann Arbor, Mich.

**TOOL** makers' lathe complete, \$35. 2 cylinder Waterman motor, \$40. 1½ K. W. generator, \$25. 3 small D. C. motors, \$5. 30 Evans Ave., Ingram, Pa.

**10,000 FT.** of belt at 5 cts. per ft. Send for list No. 27. Lucas & Son, Bridgeport, Conn.

**HAVE** for sale several sizes of lathes, milling machines, drill presses, punch presses, shapers, planers, boilers, steam engines, oil, gas and gasoline engines and wood-working machinery. Pinner, 122 Water St., New York, N. Y.

**ENGINE** Lathe, swings 9½", takes 25" between centers. Complete set gears cutting all size threads 3" to 40", \$43.50. Grammes & Sons, Allentown, Pa.

**HOW** to Run a Lathe. A 50-cent book for 10 cents postpaid. S. B. Lathe Works, South Bend, Ind.

#### ENGINES AND MOTORS

**SMALL** Power Turbines. Photo free. W. Holden, 104 Pomeroy St., Rochester, N. Y.

**FOR** Sale at a Bargain. New 5x6 four-cylinder, governor-controlled engine, fully equipped with carburetor magneto. Will sell for much less than cost. Fred Hanson, 579 Prior Ave., St. Paul, Minn.

**FOR** Sale—1 hp. gasoline engine, cheap. Charles Shepherd, Fairmount, Ill.

**ECONOMIZER** Engines Saw 20 cords wood with one gallon gasoline. 1914 Catalogue, also second-hand list, free. Box 595, Marcellus, Mich.

**12 STEAM** engines each \$12. Send for list 27. Lucas & Son, Bridgeport, Conn.

**COMPRESSION** restored without rebor-ing. Motor boats, automobiles, pumping and agricultural engines. Wille Adjustable Piston Company, 1534 Fulton St., Brooklyn, N. Y.

**REBUILT** Engines—We have on hand a number of rebuilt "Buffalo" engines, guaranteed, at greatly reduced prices. Write for bargain list. Buffalo Gasoline Motor Co., 1293-1305 Niagara Street, Buffalo, N. Y.

#### FLOUR & FEED MILLING MACHINERY

**SPECIAL** bargains in second-hand Attrition mills, burr mills, crushers, corn shellers, bran dusters, dust collectors, purifiers, reels, double, single, 2 and 3-pair high roller mills, sieve bolters, receiving separators, scourers, etc. Write for description and prices. Sprout, Waldron & Co., P. O. Box 429, Muncy, Pa.

#### ENGINE CASTINGS AND BLUE PRINTS

**FOUR** sizes gasoline engines—electric vacuum cleaner. Castings and completely dimensioned drawings. J. D. Wallace, 525 W. Van Buren St., Chicago.

**GASOLINE** Motors—Complete sets of blue prints for 2 to 40 horsepower, 1 to 4 cylinder engines, reversible propellers, etc. Miller Motor Company, 1006 Eye St., S. E., Washington, D. C.

**DRAWINGS** of modern 4 cycle gasoline motor, automobile-marine type; names all parts, an education, 50c set postpaid. P. M. Smith, 517 Elm St., Youngstown, O.

**GASOLINE** Engine Castings, with drawings. Cheap. Catalog for stamp. Novelty Manufacturing Co., 853 West 6th St., Cincinnati, Ohio.

#### MANUFACTURING

**WANTED**, to manufacture, small metal articles, novelties, etc., in any quantity; also nickel plating of small articles, etc. A full line of ticket punches made and repaired. L. Busby, 18 Harvard Place, Boston, Mass.

**WE** are equipped to build anything out of Iron and Brass. Builders' supplies, Structural Steel, Stirrups, Anchors, Iron, Brass, and Aluminum Castings, Practical Gas Engine & Machine Works, North Chicago, Ill.

**WANTED**—Some wooden specialty to manufacture. What have you? Write us fully. Address Manufacturer, P. O. Box 327, Chattanooga, Tenn.

**SEND** us your patterns for brass and aluminum castings. Lowest prices. Hedburg Bros., Kewanee, Ill.

**SHEET** Metal Work of every description, Buckets, Boxes, Tanks, Models, Specialties, etc. Write your wants. Lex Balfour, Anderson, Ind.

**CLEVELAND** Specialty and Manufacturing Company, Cleveland, Ohio, design or make special articles to order. Inventions developed.

**WIRE** Goods, all kinds, made to order. Cooley Mfg. Co., 553 W. Monroe St., Chicago.



**BOATS AND LAUNCHES**

\$250 TAKES thirteen-foot hydroplane; 20 h. p. Emerson, fully equipped. Bartlett, 4837 Forestville Ave., Chicago.

NEW, "Motorport Portable," only positive mechanical, reversible, detachable rowboat motor made. Cost \$70, want \$60. Dan, Box 60, Des Moines, Iowa.

MOTORCRAFT Encyclopedia—A 150-page book that tells 1001 things every motor boatman should know. How to overcome engine troubles. Price \$1, postpaid. Popular Mechanics Book Dept., 316 W. Washington St., Chicago.

CHART of a modern submarine boat showing and naming over 200 parts. Size, 14x28 inches. Printed on plate paper. Shows clearly and distinctly all the interior. Mailed in a tube for 25c. Popular Mechanics Book Dept., 316 W. Washington St., Chicago.

**BLACKSMITHS**

GOOD blacksmiths are scarce and few learning the trade and the blacksmiths must make the tools for all—from surgeon to the safe blower. Buy Toy's Modern Methods Forging and Welding different kinds of steel solid, and doing all hard jobs easy, also hardening and tempering to a standard by colored charts. Any smith can be an expert that means good jobs and big money. All for one dollar. Send for valuable samples free. W. M. Toy, Sidney, Ohio.

**CEMENT**

CONCRETE Molds. Catalogue free. 5 Market St., St. Louis, Mo.

If you want the best information on cement and concrete construction, subscribe for Concrete-Cement Age, leading cement and concrete monthly. Sample copy, 10 cents. Yearly subscription, \$1.50. Concrete-Cement Age, 135 Newberry Bldg., Detroit, Mich.

**MECHANICAL ENGINEERS**

WORKING Drawings; Machine and Tool Designing; Inventions Developed. A. E. Davis, 61 Candace St., Providence, R. I.

MACHINERY designed by experts to meet your requirements, also patent drawings. American Drafting Bureau, Webster Bldg., Chicago.

**ELECTRICAL**

"BOY Electrician." Shows how to make Batteries, Dynamos, Motors, Telegraph Apparatus, Telephone, Electric Engine, etc. 75 illustrations 20c. How to renew dry batteries, 3 guaranteed processes, 20c. Service Bureau, 3311-C Belleplaine Ave., Chicago.

TATTOOING Outfits \$1 up—Electric supplies. Roberts Co., Buffalo, N. Y.

STUDY Electricity at Home. Complete course; 30-pg. detail-book, 220-pg. text-book, 200 experiments, 105 pieces of apparatus. Complete, only \$5.60. Free bulletin "MS" explains. Thomas M. St. John, 848 Ninth Ave., New York.

VOLTMETERS and Ammeters, \$1.25. Improved, accurate and quick-reading. Ideal for experimental purposes. Built to remain in circuit without injury. Not affected by direction of current. Progressive Mfg. Co., Box 295A, Reading, Pa.

ELECTRICIANS—Blueprint showing 4 styles of group connections for 3-phase motors 25c. R. H., 134 N. Lockwood Ave., Chicago.

**WIRELESS**

WIRELESS Set. How to Make—96-page book telling how to construct at small cost an outfit suitable for transmitting four or five miles. Price, 50 cents, postpaid. Popular Mechanics Book Dept., 316 W. Washington St., Chicago.

**RARE COINS**

OVER \$100,000 amounted our coin business for 1913. We pay highest cash premiums for all rare money. Send 4c for our Illustrated Coin Circular. We pay \$6 to \$75 for certain \$5 without motto; \$50 for 1853 \$½, no arrows; 10c to \$25 for certain cents, etc. Many valuable coins circulating. It will pay you to get posted. Send now 4c for our circular. The Numismatic Bank, Dept. 8, Fort Worth, Texas.

OLD coins bought and sold. New Fall Coin Selling Catalog just out, free to collectors only. Buying Coin Catalog quoting prices I pay 10c. Wm. Hesslein, Paddock Bldg., 101 B Tremont St., Boston, Mass.

WE buy old coins. Highest prices. Our booklet, "What Your Coins Are Really Worth," 10c. Page & Burgess, Rockford, Ohio.

I HAVE the small cents, in uncirculated or proof condition, from 1857 to 1913. Prices on application. Henry Mitchell, 2857 N. Lawrence St., Phila., Pa.

JUST published—Large Illustrated Buying Catalog, 10c. Highest prices paid. Michigan Coin Co., Detroit.

10 FOREIGN Coins 15c, 5 Old Bills 15c, 200 Stamps 15c. No duplicates. F. Burgess, 522 Beacon, Toledo, Ohio.

50 DIFFERENT foreign coins, including Ceylon, Persia, Egypt, Nigeria, India, Venezuela, Panama, Travancore, Salvador, Africa, etc., \$1. Ancient Roman coin, 1,600 years old, 25c; 3 for 50c. 1,500 mixed stamps—over 500 different, \$1. 200 different stamps, 15c. F. L. Toupal Co., Dept. B9, Chicago Heights, Ill.

TRADE dollar 1885 sold for \$1.140; 20 cent 1876c \$250; \$1 gold 1861d \$230; \$3-1870s \$1,450. Equally high premiums on thousands of coins, stamps, books, paper money. Illustrated circular free. Vonbergen, Dept. O, Boston, Mass.

\$4.25 EACH Paid for U. S. Flying Eagle Cents dated 1856. We pay cash premiums on hundreds of Old Coins. Send ten cents at once for New Illustrated Coin Value Book 4x7. It may mean your fortune. Clarke & Co., Coin Dealers, Box 15, Le Roy, N. Y.

**STAMP COLLECTING**

STAMPS on approval to those sending reference. Good U. S. and foreign. Premium, 4 Dom. Rep. Mrs. Louise Kellogg, West Hartford, Conn.

HIGHEST prices paid for Stamp or Collections. Latest Buying Catalog 10c. Michigan Stamp Co., Detroit.

FOREIGN Stamps Free; 52 different foreign, including China and Venezuela, to all who apply for our high grade approval selections. Send two cent stamp for return postage. Edgewood Stamp Co., Dept. H, Milford, Conn.

STAMPS Free! 100 different or a Grand Set 6 Travancore. Send 4c postage; mention Gift E. 52. "A. B. C." illus. priced Catalogue of the World's Stamps for 1914, 930 pgs, 7,000 illus; 70c post free. Bright & Son, 164 Strand, London, England.

STAMP Album with 538 Genuine Stamps, including Rhodesia, Congo (tiger), China (dragon) Tasmania (landscape), Jamaica (waterfalls), etc., 10c. 100 diff. Jap., N. Zld., etc., 5c. Big list; coupons, etc. Free! We buy stamps. Hussman Stamp Co., St. Louis, Mo.

100 STAMPS free, or if preferred a fine Set of 10 Chinese. Send 4c postage; mention Gift 387. Approvals 50% discet. off Gibbon's prices. J. Wheeler & Co., 124 Lennard Road, Beckenham, England.

TRY approvals, postage and revenues, references. Canadian Revenues, cat. value 75c, free. Mrs. Oughtred, 28 Lincoln Ave., Montreal, Que.

STAMP catalogued \$1, free with your first 25c purchase from approvals Wendell Phillips, Lewiston, Cal.

STAMPS—108 Japan, etc., for 2c postage. Newport Co., 307 Linden Ave., Brooklyn, N. Y.

205 DIFFERENT foreign stamps or 101 United States free. Remit 25c six months subscription. McKele's Stamp Weekly, Boston, Mass.

FREE—Gold Fountain Pen—To buyers from my net approval sheets. Particulars on request. Hinman, Hillsdale, N. J.

BARGAIN Sets 5c each, with net approvals. Ten Greece, Seven Newfoundland. Palm Stamp Co., Los Angeles, Calif.

STAMPS Free—100 different for the names of two collectors and two cents postage. 10 different foreign coins; 20 Russian stamps, 10c. Lists free. Toledo Stamp Co., Toledo, Ohio.

PACKET of 23 stamps; no two countries alike, 500 hinges. Set of \$1 and \$2 U. S. Rev., all for 5c. Miami Stamp Co., Toledo, Ohio.

FREE—Fine zoological packet, 2c (stamp) postage. Lightbown's Stamp Co., Palmerston Road, Southsea, England.

FREE—108 foreign stamps, album and catalogs for 2c postage. Payu Stamp Co., 138 No. Wellington St., Los Angeles, Cal.

25 DIFFERENT British Colonials to applicants for stamps on approval who send 2c postage. Nickles, Box 2466, Washington, D. C.

STAMPS on approval at 50% discount. Kankakee Stamp Co., Kankakee, Ill.

STAMPS—105 China, etc., stamp dictionary and list, 2c. Bullard, Sta. A, Boston.

STAMPS, 100, all different, free. Postage 2c. Mention paper. Quaker Stamp Co., Toledo, Ohio.

24 VARIETIES Cuban stamps 10 cents. List of 6,000 low-priced stamps free. Chambers Stamp Co., 111 P. Nassau St., New York City.

**FORMULAS AND TRADE SECRETS**

3,000 FORMULAS, recipes, 50c. 1,000 trade secrets, plans, etc., 25c. 500 special formulas, 20c. Resilver mirrors, guaranteed process, 20c. Make Sneezing Powder and Itch Powder, 10c each. All above postpaid, \$1. Formula Bureau, 3311-C, Belleplaine Ave., Chicago.

WE analyze everything. Reliable formulas furnished. Laboratories, 721 E. 161 Street, New York City.

CLEAN Your Own Clock. Send 25c coin for best formula. Kiamath Jewelry Co., Weed, Cal.

TRIED and guaranteed formulas for anything, 25c. Waitz & Du Montier, 1733 Mack Ave., Detroit, Mich.

90 BEST Formulas. Greatest sellers out. Price 50c stamps or coin. T. Cole, 1309 Madison St., Chicago.

FORMULA—New Discovery, removes tartar from the teeth. Cost very small, easy to prepare. Contains no acid, no pumice. Guaranteed. Dentists pay me \$5 for Formula; to you 50c. M. E. Gaskill, San Mateo, Calif.

25 GUARANTEED formulas, 25c. Zeyen, 2221 Dean, Spokane, Wash.

CHEMICAL Analyses, Formulas, Duplications. Laboratory of Dr. A. R. Sasse, 710 Wyandotte, Kansas City, Mo.

20,000 FORMULAS, price \$1 prepaid. Complete list, 4c stamps. Edm. Bromley, Watervliet, N. Y.

BEST candy and ice cream formulas and recipes obtainable. Guaranteed Correct. 280 candy and 50 ice cream recipes. Increase your trade by improving your goods. Complete illustrated book prepared by practical expert. Price \$4 postpaid. Popular Mechanics Book Dept., 316 W. Washington St., Chicago.

10,000 SELECTED scientific, chemical technological, and practical recipes and processes, including hundreds of so-called trade secrets for every business, alphabetically arranged in one large volume of 800 pages. Price \$3 prepaid. Popular Mechanics Book Dept., 316 W. Washington St., Chicago.

1,000,000 FORMULAS, trade secrets, \$1.50. Ragtime piano self-instructor, \$1. Ellemm, 667 Ocean, Jersey City.

TEN Valuable Formulas Free! Enclose 2c postage. Chapman Supply Co., Minneapolis, Minn.

SILVERING mirrors formula; complete working instructions, 20c. Scientific Bureau, W. Lynn, Mass.

500 BIG Formulas and Book of Opportunities sent complete for 25c. Standard Co., 5735 Normal Ave., Chicago.

FORMULAS. Processes for anything. Chemical Analyses, tests; duplication. Satisfaction or refund guaranteed. Taylor Service, Dept. F. P., Box 1764, New York.

GOOD formulas for the manufacture of anything worked out chemically. Not copied from books. Chemical analysis. Manufacturing Chemists, 819 E. 43d St., Chicago, Ill.

**SAFETY BLADES SHARPENED**

SAFETY razors sharpened; two cents each. Guaranteed. Blade box free. Electro Stropping Co., 134 Shelby St., Detroit, Mich.

SAFETY Razors Resharpened right, 2c each. Pay after you try blades. American Tool Co., Columbus, Ohio.

SAFETY Blades sharpened, 2c each. Excel Razor House, Box 212, Poughkeepsie, N. Y.

**FOR WOMEN**

SILK remnants for fancy work. Big package 10c. 3 for 25c. Post Supply Company, Waltham, Mass.

## FOR MEN

"MECHANICS" Safety Razor with six blades, 50c. Not satisfactory, money returned. Neponset Supply Co., 20 Port Norfolk St., Neponset, Mass.

HAVANA Balsamic Tubes—Not a drug, but a new pure Havana short smoke. Sample packages of ten tubes sent on receipt of ten cents, coin or stamps, to cover expenses. Send for one. Also for free booklet about our line of clear Havana cigars. A. Ramirez & Co., Factory 1616 17th St., or Dept. M, Box 998, Tampa, Fla.

TRY the new Pipe like a cigar; neat and practical, 15c. Neponset Supply Co., 20 Port Norfolk, Neponset, Mass.

QUICK honing razor strop with genuine shell cordovan finishing strop. Guaranteed. The two, \$1.50 prepaid. The A. W. Ellis Co., 319 Meridian St., Boston, Mass.

SAVE money on shoes! Factory to feet. You save retailer's profit and get better shoes. Fit and entire satisfaction guaranteed or money back. Style book free. Pathfinder Shoe Co., Dept. P, Dudley, Mass.

COLLAR Scratch? Don't be miserable and tortured by scratchy collars and neckbands. Simple, guaranteed method completely prevents the trouble. 10c. D. Shutt, 822 Cherry St., Chattanooga, Tenn.

WITH "Handy" press your own trousers in 3 minutes. 4 oz. Aquidneck Co., Portsmouth, R. I.

EVERLASTING pocket cigar lighter, 35c postpaid. Durso, 25 Mulberry St., N. Y.

SEPTEMBER Morn Scarf Pin. Pink Cameo surrounded with Pearls, 25c. Waldemar Watch Chain with Cameo slide, 50c. Cameo Tie Clips, 35c; 3 for 1. Star Novelty Co., Attleboro, Mass.

## FOR THE HOME

WHY pay sixty to eighty cents per pound for candy? You can make it for fifteen cents. A full assortment of our delicious chocolates and bonbons with complete, simple instructions for making in your own kitchen. \$1 postpaid. Samples 12 cents. Homestead Candies, 864 Wellington Ave., Chicago, Ill.

WANTED hundred thousand Coffee users try South America's best drink, twenty million prefer to coffee. Woodley Company, Importers, Shamrock, Texas.

EASY to Make Furniture—100 Modern Designs. Make your own. Save two-thirds cost. Price \$2. Crater & Holt, Grand Rapids, Mich.

MAKE your own mission furniture at the minimum of expense. Our 3 books "Mission Furniture. How to Make It." Parts 1, 2 and 3, tell in plain, simple language just how to make 98 different pieces. Full dimensions, working drawings and half tones of finished articles. Price, 50 cents each or \$1.50 for the three volumes, postpaid. Popular Mechanics Book Dept., 316 W. Washington St., Chicago.

LAMP Shade Frames, all descriptions, made to order. Cooley Mfg. Co., 553 W. Monroe St., Chicago.

## GAMES AND ENTERTAINMENTS

TOM Barker Baseball Card Game. The card game New York has gone crazy over. More action than whist, pitch or poker. The only baseball card game ever endorsed by big league players. 52 beautiful picture cards of star players in action. The card game the whole family can play. By mail 50c. National Baseball Playing Card Co., Inc., 18 B. Tremont Street, Boston, Mass. Agents wanted in every City and Town in U. S.

TRICKS, puzzles, jokers' goods. Snake flashlight, cameras all sizes, cat in bag, latest trick pencils, steeze powder, itching powder, stink bombs, shooting cigarettes and cigars, trick matches, serpent eggs, 100 others. Send for illustrated catalogue today. Get acquainted with our goods and prices. Wholesale and retail. J. Grandfeld Mfg., 1238 Theriot Ave., Bronx, New York.

MAGICIANS—We are headquarters for handcuffs, mail bags, strait jackets, milk cans, and everything in the escape line. Large new catalogue, which also contains a complete line of novelties, tricks, puzzles. Free. Oaks Magical Co., Dept. 40, Oshkosh, Wis.

VENTRILOQUIST throat, imitate birds, dogs, cats, 10c. 250 Tricks with coins, cards, etc., 10c. Greenbacks, big bunch 10c. All 25c. Magic Bureau, 3311-C, Belleplaine Av., Chicago.

GREENBACKS: big bunch 10c. 3-25c. Exchange, R23, 3827 Kenneth Ave., Chicago.

DANCING skeleton—Magic marvel. Sample, 10c; 3, 20c. Satisfaction guaranteed. G. Olive, 702 Jessie, Willmar, Minn.

THREE-IN-ONE—The Newest, Funniest and Best Game Out. Everybody Laughs! And You Will Too. Price 15c. H. C. Ringert, 115 Broad St., Albany, N. Y.

VENTRILOQUISM easily learned, 10c. 450 tricks and puzzles, 20c. All 25c. Eureka Supply, R23, 3827 Kenneth Ave., Chicago.

15c CARD Trick, 10c Novelty, Catalog, all for 10c! "Douglas," Kiowa, Okla.

DOUBLE Throat, 10c. Fits roof of mouth; invisible. Throw your voice, make dogs, cats, horses, etc., talk. Sent postpaid with catalog, 10c. National Co., Chicago.

10 CARD tricks and cards, 10c. McGuinness, 109 Weirfield St., Brooklyn, N. Y.

"SEPTEMBER Morn." "October Eve." Classy joke, 50c. Stovers', Millersburg, Pa.

GAMES, Tricks, Puzzles, Books, etc. Illustrated catalogue and sample trick, 6c. Auburn Trick Co., Dept. T3, 7745 Peoria St., Chicago.

MAGIC Tricks, Books and Supplies. Largest line in the world. Large, 160 page, illustrated, professional catalogue, ten cents. See our advertisement on page 14. Chicago Magic Company, successors to Read & Covert, Dept. B, 72 West Adams St., Chicago, Ill.

BE a Handcuff King—I teach you how. Escape from police handcuffs, boxes, ropes, etc. Secrets of 20 sensational mysteries for \$1. Particulars for stamp. Magicraft Co., Box 251, Detroit, Mich.

KELLAR'S Improved Floating Ball for \$1. Beats the Floating Lady trick. Parlor or stage. Easily performed, mysterious and undetectable. Free illustrated catalog. Modern Magic Company, 950 Cromwell Avenue, St. Paul, Minn.

THE Wonderful Trunk Escape Trick. Thrilling, Surprising, Mystifying. Full instructions 25c. Particulars free. J. L. Hardway, Normal, Ill.

YOU sure want this! It's brand new! Mexican Bracelet. Fun galore for only a dime! Don't miss it! G. Anderson, West Chazy, N. Y.

TRICKS, jokes and puzzles, catalogs and 25-cent samples, five cents. Gilbert Novelty Co., 11128 Crescent, Morgan Park Station, Chicago.

YOU can be a magician, travel, give shows, earn money. I tell how. Send stamp. Prof. Rapp, Box 1115-F, Madison, Wis.

BIG Catalogue Magic and Entertainment goods Free. Bates Play Company, Melrose, Mass.

MAGIC pocket trick free. Worth 25c. With illustrated catalog of 250 tricks, puzzles, illusions for 6c. Stamps. Magic Co., Sta. 10, 249 West 38th St., New York.

CHICKEN Inspector Badges (latest joke), 10c pp. Percy Ewing, Decatur, Ill.

PLAYS, Vaudeville Sketches, Monologues, Dialogues, Speakers, Minstrel Material, Jokes, Recitations, Tableaux, Drills, Musical Pieces, Entertainments for all occasions. Make-Up Goods. Large Catalog free. T. S. Denison & Co., Dept. 11, Chicago.

250 MAGIC Tricks, and 13 Love Letters (reads two ways), 12c. Bailey, 131 Maple, Napanoch, N. Y.

## MUSIC

HAVE a big laugh. Send us 12c in stamps for song just out: "Don't Tell Me in the Morning What I Did the Night Before." Catalogue of new songs free. The Sharp Music Co., 855 15th St., Denver, Colo.

BEGINNERS play piano or organ selections without teacher, immediately—same hour—not next month, by note, not figures, or \$1,000 forfeit. Write, Musician Self-Maker, 2861-B Lake, Chicago.

SHEET Music: 15 latest hits, prepaid, \$1. E. R. Bittner, State College, Pa.

LEARN to play—the cords on the piano in few seconds. Chart 15c. O. Ewing, Sisson, Cal.

ALL the favorite old songs. Words and music complete in book form with attractive cover. Size 7½x9½ inches; good value. Price 50 cents, postpaid. Popular Mechanics Book Dept., 316 W. Washington St., Chicago.

GOOD music written to song poems; Chief & Neil, Song Writers, 2204 Mul-lanphy St., St. Louis, Mo.

## PIANOS AND MUSICAL INSTRUMENTS

ELECTRIC Pianos, \$100, terms, catalog. Continental Novelty Co., Omaha, Neb.

## DIAMONDS, WATCHES AND JEWELRY

PEARLS and Baroques Bought and Sold. Laverne Mapes, Indiana Harbor, Ind.

TIME and Its Measurement—An unusual book, being a readable and instructive history of time measurement from the sun dial of remote ages down to the clock period and the present day. Of interest to everyone connected with horology and contains much information not available elsewhere. Written by a great authority who has made this study a hobby. Price in cloth binding \$1.50 postpaid. Popular Mechanics Book Dept., 316 W. Washington St., Chicago.

WHOLESALE prices on watches, jewelry. Confidential list, 72-page catalogue for stamp. Kelleher Bros. & Sullivan, 76 Front St., Worcester, Mass.

## DUPLICATORS AND DEVICES

ONE hundred copies, letter size, in twenty minutes, with our duplicator. Particulars free. Garbutt Bros., Lufkin, Texas.

THE Modern Duplicator, made without glue or gelatine, is the World's Standard. Fifty to seventy-five exact duplicate copies can be made from each one you write or draw with pen, pencil or typewriter. \$2.40 to \$6.00 according to size. Booklet Free. Turkin, Reeves & Co., Mfrs., 339 Fifth Ave., Pittsburgh, Pa.

HOW to get a Hektograph that will make 150 copies in 10 minutes; letter size, \$2. Write for circular. Heyer Duplicator Co., 118 No. La Salle St., Chicago.

## MAILING LISTS

SPECIAL Offer. New Lists, 15,000 Farmers and Voters of Georgia, \$2; 18,000 from Alabama, \$2.50; 36,000 from Florida, \$3; Entire Set, \$6. National Name Supply Co., Detroit, Mich.

29,000 LADIES' names. Each sent \$1 to \$15 Mail Orders. New—Very Select—Type-written to Order; 100, 60c; 500, \$2.75; 1,000, \$5. The Avon Company, Box 4, Merrick, Mass.

TYPEWRITTEN list of 1,000 5c and 10c stores for 50c. Charles Krepps, Eccles St., Pittsburgh, Pa.

5,000 NAMES Southern housekeepers who buy by mail, freshly compiled. Entire list \$5. Thousand \$1.50. J. E. Hardwicke, Box 121, Winston-Salem, N. C.

NAMES and Addresses. Any classification, anywhere. Prices on request. "Nisco," Dept. SDB, Cincinnati.

FREE to business men, copy of our comprehensive "Silent Salesman." Contains over 2,000 different classifications of mailing lists with number and price of each list, and information every business man needs. Accept this free offer. Trade Circular Addressing Co., G 164½ W. Adams, Chicago.

## COLLECTIONS

CLAIMS; all kinds, collected anywhere. Fidelity Credit Co., Richmond, Va.

## TYPEWRITERS AND SUPPLIES

TYPEWRITERS at wholesale. All \$100 Visible \$25 to \$35. Free Catalogs, Trial, Factory Guarantee. Agents Wanted. U. S. Typewriter Syndicate, 14 Fisher Bldg., Detroit, Mich.

BIG Profits selling typewriters. Let me show you how to make fifty per cent either buying for yourself or selling to others. William Whitehead, 188 North LaSalle St., Chicago.

DON'T fail to get our bargain sheet before you buy that typewriter. The M. & M. Typewriter Co., 118-A, No. LaSalle Street, Chicago.

PRICES and Quality unequalled; we save you \$25; genuine Rebuilt Underwoods, Smiths, Remingtons, Oliviers, Royals, Foxes \$15 to \$33; binding guarantee; shipped on approval; write for "Special List." Consolidated Typewriter Exchange, 243 Broadway, N. Y.

SPEED up the Stenographer's Work. The Readasy Copyholder makes the work 20% quicker and easier. Write A. B. Reid & Co., Chicago.

ALL standard makes of typewriters. Big saving. Liberal guarantee. Catalogue, bargain list and valuable typewriter information free. The leading mail order typewriter house. A. E. Atchison, 110-112 No. LaSalle St., Chicago.

WRITE for our special circular "C" for the best offer ever made on typewriters. Young Typewriter Company, 62 West Madison St., Chicago.

ONE guaranteed typewriter ribbon 35c or four for \$1 postpaid. Any machine, any color. Mayhain Chemical Company, Cleveland, Ohio.

\$100 REMINGTON, new condition, \$15; delivered for examination. Wagner, 350 Elm, Arlington, N. J.

BENNETT Typewriters, \$18 mailed. Perfect. 6804 Minnesota, St. Louis. Instructions free.

TYPEWRITER Bargains, all makes; slightly used and rebuilt; lowest prices, bar none; satisfaction assured. Rotary mimeograph cheap. Typewriter Sales Co., Ferguson Bldg., Pittsburg, Pa.

PICK out your typewriter and pocket your saving. Typewriters rebuilt in our own factories and guaranteed for one year. Remingtons \$25 to \$65, Smith-Premiers \$23 to \$60, Underwoods \$35 to \$60, L. C. Smiths \$30 to \$50, Royals \$30 to \$40, Oliviers \$30 to \$40. We have all makes. Send for catalog, address of nearest branch office. American Writing Machine Co., Inc., 345 Broadway, New York.

### PRINTING AND ENGRAVING

PRINTING—If you want printing that will bring you in something beside a postage bill—consult us. The White Printing Company, Coudersport, Pa.

100 EACH, letterheads, envelopes, business cards, \$1.25. Elite Exchange, R23, 3827 Kenneth Ave., Chicago.

125 BOND Letterheads and 125 Envelopes, white, pink, blue or green, printed, \$1 prepaid. Samples. W. Kinnler, Box 206 Brooklyn, N. Y.

EMBOSSD Letterheads and Envelopes price of Common or Flat Printing. Send for samples. Turner & Dunlap, Wilkesbarre, Pa.

BOND letterheads, billheads, cards, envelopes, \$1.50 the 1,000. Sample 100 printed 38c prepaid. List free. Andrew Brems, Corona, N. Y.

100 NOTE Heads, 100 Cards with Envelopes; also lot Samples, all for \$1. Our printing is Better, Cheaper than ever. Service Press, 690 Chene, Detroit, Mich.

MULTIGRAPHED Letters. Cheapest. Best. Letterheads. Schwartz Bros., Congress St., Detroit, Mich.

1,000 CARDS \$1; Envelopes \$1.25; Letter Heads \$2. Samples 2c. Artist Press, 144 W. Superior, Chicago.

500 BUSINESS cards printed to your order 75c. Geo. Birt, Russell Ave., Indianapolis, Ind.

GUMMED Labels: 3,000, \$1.38p. catalogue, 2c. MacTaggart, 1233 Arch, Philadelphia, Pa.

1,000 LETTER Circulars 3 1/2-6, Book Paper, \$1. Elchar Press, Rockford, Ohio.

50 ASSORTED Comic Cards printed with your name, 25c. Retter, Box 142-P, Tippencanoe City, Ohio.

125 WHITE Bond Letterheads and 125 Envelopes, printed, \$1, prepaid. B. Lutz Printing Co., York, Pa.

COLOR Printing—100 Envelopes and 100 Letterheads printed in two colors, \$1 postpaid. Slarb Printing Co., Hamilton, Ohio.

SINGLE column copper halftones, 75 cents. Rishell, Engraver, Havana, Ill.

OUR Specialty! 50 finest quality visiting cards, elegantly printed 25c. Satisfaction guaranteed. J. Boggians Co., 3051 Third Avenue, New York.

GUMMED Labels—3,000, \$1. 1x2 inches. Catalogue Free. Helmers Company, Hoboken, N. J.

1,000 LETTERHEADS or Envelopes, \$2.50; 5,000 or more, \$1.75. Blackledge Specialty Co., 1805 Reed Street, Philadelphia, Pa.

PRINTING—100 cards or envelopes, postpaid, 40c. Other work. Good, reasonable, prompt. Get my prices. E. D. Murdock, 183 E. Tioga St., Tunkhannock, Pa.

DIGNIFY your correspondence. 100 letterheads and envelopes printed on excellent bond, \$1, prepaid. 500 letterheads or envelopes, \$1.50, 1,000 for \$2.50. Samples free. Proper printing. Robison Printing, Curwensville, Pa.

YOUR Name on 200 gummed labels, 10c. Starr Co., Clintonville, Conn.

PRINTING Presses, type, supplies. Catalogue free. L. M. Carroll & Co., 326 Madison St., Chicago.

CATALOGUES compiled. Copy for Form Letters, Folders, Booklets. Charges reasonable. Send for estimate, layout, etc. Catalogue Compiling Bureau, Graphic Arts Building, Worcester, Mass.

PRINTING—500 either noteheds, envelopes, statements, cards, \$1; 1,000, \$1.50; 1,000 linen finish letterheads or envelopes, \$2.50; 1,000 typewriter letters, \$2. Samples. Model Company, Manchester, Iowa.

PRINTING Presses, supplies, second-hand, at bargains. List for stamp. Popular Bargains, Richland, Pa.

1,000 PURPLE Multigraphed Letters, black heads printed and stock complete, \$2.75; 500, \$1.85. Specimens free. Perfection Letter Company, Muncie, Ind.

GOOD Printing at low prices. 1,000 good letterheads, envelopes, cards, billheads, labels, circulars, \$2.50. Samples free. Catalogues, booklets, and circulars our specialty. Ernest L. Fantus Co., 523 S. Dearborn St., Chicago.

### PATENT ATTORNEYS

PATENTS procured; prompt, reliable service; terms low; large prizes offered for certain inventions; get my list of inventions wanted; send 4c for new book, "The Last Word on Patents," send sketch of your invention today. Sanders, 7 Webster Building, Chicago, Ill.

NO Attorney fees until patent allowed. Send sketch for free report. Books free. Fuller & Fuller, Washington, D. C.

\$36—INVESTIGATE special proposition which gives guaranteed patent protection at smallest cost. Inventions made marketable. Inventors' Service Co., Inc., Washington, D. C.

PATENTS secured with special regard for legal protection and strength. Booklet free. Harry Patton Company, Suite 5, McGill Building, Washington, D. C.

"PATENTS and Patent Possibilities" is a 72-page treatise which tells all about patents, what to invent and where to sell it. It gives honest advice to inventors, and is full of valuable and interesting information. Write for it today! It is free. H. S. Hill, 905 McLachlen Bldg., Washington, D. C.

PATENT what you invent. It may be valuable. Write me. No attorney's fee until patent is allowed. Estab. 1882. "Inventor's Guide" free. Franklin H. Hough, 522 Loan & Trust Bldg., Washington, D. C.

THE Patentome is interesting and instructive. A liberal education in patents and how to get them. Free on request. Established 1865. Anderson & Son, Patent Solicitors, 707 G. St., Washington, D. C.

PATENT your invention. \$20,000 offered for inventions wanted. Booklet and opinion free. Milo B. Stevens & Co. Established 1864. 685 F. St., Washington; 353 Monadnock Block, Chicago.

PATENTABLE ideas wanted—Send for 3 free books. R. B. Owen, 30 Owen Bldg., Wash., D. C.

PATENTS and Trade Marks, electrical and mechanical a specialty. Book Free. Joshua R. H. Potts, Patent Lawyer, 8 Dearborn St., Chicago; 805 G St., Washington; 929 Chestnut St., Philadelphia.

JOHN R. WOODWORTH, Registered Attorney. Wardur Building, Washington, D. C.

PATENTS build fortunes for you. Our free booklets tell how; what to invent, how to choose an attorney. Write today. D. Swift, 317 Seventh St., Washington, D. C. Established 1889.

OFFICIAL Drawings Free. Patents procured or fee refunded. Expert services. Send sketch for Free search. The Patent Exchange, Jorban Bldg., Washington, D. C.

FOR Honest advice and real patents at Low Cost, consult John O. Seifert, Patent Attorney, 50 Church St., New York.

PATENTS that protect and pay. Advice and books free. Rates reasonable—highest references; best results. Watson E. Coleman, Patent Lawyer, 622 F St., N. W., Washington, D. C.

INVENTIONS Worth Thousands—Their value is governed by the strength of the patent. Get the advantage of our 39 years' experience in procuring your patent. Clients in your state. Write and send sketch. Louis Bagger & Co., 609 Barrister Bldg., Washington, D. C.

C. L. PARKER, Ex-member Examining Corps Patent Office, Patent Attorney, 910 G St., Washington, D. C. Inventor's handbook "Protecting, Exploiting and Selling Inventions," sent free upon request.

PATENTS—Herbert Jenner, patent attorney and mechanical expert, 606 F St., Washington, D. C. I report free of charge if a patent can be had and its exact cost. Send for circular.

PATENTS explained in my free books, telling what you should know—what to invent—what not to invent—how to sell your patent, etc. Write today. H. L. Woodward, 902 G St., Washington, D. C.

PATENT secured or fee returned. Send sketch for Free Expert Search and report as to patentability. Books on inventions and patents, and reference book sent free. John S. Duffie & Co., 605 F St., Washington, D. C.

PATENTS Secured—Take advantage of my personal experience; send sketch or model. Get my free book containing 200 mechanical movements. W. N. Roach, Jr., 950 McGill Bldg., Washington, D. C.

### FOR INVENTORS

PLANS — Drawings — Specifications: for anything. The excellence and completeness of our work, as well as our terms, will surprise you. Tell us your needs. The Plan Bureau, 2114 Forest Avenue, Saint Louis, Missouri.

INVENTIONS perfected—ideas developed. Expert in the development of patents. Legal and Technical advice free. R. Shelmo-Jacobsen, Consulting Engineer, Dept. C, 452 Peoples Gas Bldg., Chicago, Ill.

WANTED—An Idea! Who can think of some simple thing to patent? Protect your ideas; they may bring you wealth. Write for "Needed Inventions" and "How to Get Your Patent and Your Money." Randolph & Co., Patent Attorneys, 620 F St., Washington, D. C.

ADVICE—Best on inventions, free. Write immediately. A. Connor, Washington, D. C., Electrical, Mechanical Engineer, Patent Attorney (ex-Chief Electrical Engineer of New York).

CASH for an idea. Patent News, Dept. 29, Washington, D. C.

PATENTS sold. We do the business—not merely collecting a vance fees. If you own a valuable patent send for a free booklet. "How I can get cash for your invention." No charges made for listing. Patent Advertising & Sales Co., Frankford, Phila.

SPECIAL and complicated machines designed. Inventions perfected and simplified. Patents procured and sold. Sales exceed one-quarter million dollars. No foolish inventions entertained. Technological Laboratory, 819 E. 43d St., Chicago, Ill.

INVENTORS. If you want help with your invention, or information on Developing, Patenting, Costs, Materials, Drafting, Manufacturing, Selling, etc., send for our "Help Card." Charles A. Scott, 586 Central Bldg., Rochester, N. Y. Established 1900.

INVENTIONS Perfected: Working Models Made; Dies, Tools, Special Machinery. Free Booklet. Black Diamond Mfg. Co., Cincinnati, O.

PATENTS without advance attorney's fees. Send sketch for free report. Books free. Fuller & Fuller, Washington, D. C.

PATENTABLE Ideas Wanted—Send for 3 free books. R. B. Owen, 30 Owen Bldg., Wash., D. C.

INVENTORS: My patent made a fortune. Particulars free. Let me sell yours, Eugene Pearl, 23 Union Square, New York.

PATENTS, Trade-Marks and Copyrights. Our handbook on patents will be sent free on request. All patents secured through us are described without cost to the patentee in the Scientific American. Munn & Co., Patent Attorneys, 359 Broadway New York. Washington, D. C. office, 383 F Street.

### PATENTS FOR SALE

UNITED States, Canadian, Great Britain, French, German Patents, automobile licentia. Absolutely new, different. Not the illuminated kind. Meets all legal requirements. Appealing, artistic selling qualities; meritorious. Sure seller to one-fourth tag buyers. (1,000,000 United States 1913.) Manufacturing cost, 50c. Outright on royalty; liberal for quick transaction. Worth investigation. Ratterree, Patentee, 149 9th Ave., N., Nashville, Tenn.

**FOR Sale**—Patent including Stock on hand on Springwinder, Stock will more than pay price asked. For particulars, Fred Schaefer, 734 North 77th St., Seattle, Wash.

**FOR Sale**—U. S. and Canadian patents on device for making coffee; can be used in any pot; saves more than any other device. Simple and handy to use; cost 8c to manufacture. Royalty on British patent offered and accepted. H. Box 477, Orting, Wash.

**FOR Sale**—Patent Spring Axle, for Automobile, Motor Trucks, Auto Buggies, and all horse-drawn vehicles. With this Axle the whole vehicle, except the wheels, rides upon a perfect spring cushion. Write for illustrated circular. Star Nottingham, Cuba, N. Y.

**IMPROVED** Folding Umbrella ribs and stick. Easily manufactured. Particulars, T. Waydo, 496 Jones Ave., Toronto, Ont.

**PATENT** for sale, 1025336, for automobiles. T. Townson, 7237 Edmund St., Tacony, Philadelphia.

**PATENT** for sale on portable refrigerator. J. H. Coughlan, 869 Wash. St., Boston, Mass.

**"DEAD"** third rail patent, electric railroads, for sale; safe, sure. L. T. Crabtree, Crandon, Wis.

**CASH**, terms, Royalty, Patent just allowed. Wire, rope, hose measuring machine. John Briare, 227 W. Poplar, Stockton, Cal.

**SEE** illustration of Sawsawto, page 116 this issue. Will sell patent.

**PATENT** on draft operating device. Can be retailed complete for six dollars with big profit. \$800 cash takes it. No triflers. Victor Cozine, Gloversville, N. Y.

**FOR Sale**—Monoplane patent 1,958,390, providing absolute automatic lateral stability. W. B. Seckins, 2475 W. Washington St., Los Angeles, Cal.

**FOR sale**, cheap, automatic fire alarm, easily adjusted and cheap to construct. John Mosmann, 86 Shipman St., Newark, N. J.

**SANITARY** bread-vending device for restaurants, saloons and for business concerns. No competition. \$1,400 buys outright. Harry Blythe, 57 Byers, Denver, Colo.

**FOR Sale**, or Royalty—Automatic fuse plugs, the latest electrical patent; allowed Jan. 6th, 1914. I would like to interest a reliable capitalist in this patent. Address W. C. Farmer, 24 West First St., Tulsa, Okla.

**WILL** sell patent No. 1022028, "Mail Delivery and Receiving Apparatus." Highest bid, time limit—May. C. A. Ifert, Monroe, Wis.

**PATENT** novelty in stationary. Will sell right for \$200. M. I. Hufty, Redwater, Mont.

**PATENT** of a pen point, now on market. Frank Bumer, Monessen, Pa.

**FOR Sale**—The best fruit picker ever invented. Geo. Mitchell, Camas, Wash.

**MY** invention—Something new, pertains to poultry. Excellent for mail order trade. Will bear inspection. Lester Ryan, Lexington, Neb.

**FOR Sale**—New patented molding machine. Can be seen in operation. K. Fritz, 330 North St., Bethlehem, Pa.

**HAVE** you a Patent to sell? You'll be interested in my proposition. Write now for free particulars. F. W. Johnson, 318 W. Washington St., Chicago.

**PATENT**: Dies; sample, etc., for Bird Imitation Whistle, New and Novel. Range of two octaves. Sell at ten cents. Toy and musical instrument combined. Best offer takes it. J. J. Rieder, 146 W. Main St., Jackson, Mich.

**FOR Sale**—Valuable British patent No. 12808/12 and French patent No. 454,039 '13 (Never Leak expanding Gaskets), also U. S. patent No. 1062837/13 (Hand power Vacuum Cleaner), on reasonable terms to quick buyer. Address the Patentee, H. B. Mertz, 1408 Rutherford Ave., Pittsburgh, Pa., U. S. A.

#### MODELS AND MODEL SUPPLIES

**WE** make working models for inventors; also dies and stamping of specialties, and carry a complete stock of brass gears and model supplies. Send for catalogue. The Pierce Model Works, 3405 Pierce Ave., Chicago, Ill.

**INVENTORS**—Our staff of skilled mechanics assist and co-operate with customers to develop and perfect inventions of every description. We build first-class demonstrative models, miniature or regular full-sized machines for inventors, promoters, patentees, salesmen, patent office and manufacturers. Electrical and mechanical experts. Scientific and experimental work a specialty. Write today for further particulars. Regal Model & Tool Works, "Chicago's foremost model works," 122-128 S. Clark St., Chicago.

**WANTED**—Wood patterns and cabinet work. Pattern Shop, 1016 Germantown Ave., Philadelphia.

**CHICAGO** Model Works. Established 1867, Chicago, Ill. Gear wheels, model supplies, working models. Write for catalogue of model supplies.

**MODELS** made for inventors; general machine work; designing and perfecting; developing automatic devices and machinery. In a position to do all kinds of light tool and machine work. Prices reasonable; estimates cheerfully given. Ideal Machine Works, 62 Ann Street, New York City.

**INVENTIONS** Perfected; Working Models Made; Dies, Tools, Special Machinery. Free Booklet, Black Diamond Mfg. Co., Cincinnati, O.

**INVENTIONS** perfected and manufactured. Reference, your own banker. Russell Machine Co., Dallas.

**FREE** catalogue of model supplies. Castings, metal specialties on contract. North Chicago Tool Works, 15 Grove Ave., North Chicago, Ill.

#### REAL ESTATE AND FARM LANDS

**FARM** lands, North Dakota, will grow while you sleep; will grow corn. Thrifty persons should own farms in North Dakota, which has shown greater growth in general than other states the past ten years. We will sell excellent land near Pingree-Wilton branch, Northern Pacific railway; price \$20 to \$25 per acre; reasonable terms; worth the money. Bismarck Realty Company, Bismarck, N. D.

**VIRGINIA** orchards pay handsome profits. Good fruit lands in the famous apple belt \$15 an acre up. Easy payments. Send names of two friends interested in Virginia and receive our beautiful magazine one year free. F. H. La Baume, Agr. Agt., Norfolk & Western Ry., R259, N. & W. Bldg., Roanoke, Va.

**NATURE'S** treasure garden is calling you, come south and grow with the country. Land \$15 an acre up, cheapest in America; 2 and 3 crops grown yearly. Ample markets. Living costs low. Climate healthful and agreeable. Write for free "Southern Field" magazine and state booklets. M. V. Richards, Land & Ind. Agt., Southern Ry., R64, Washington, D. C.

**MONEY-MAKING** farms, 21 states, \$10 to \$50 an acre; live stock, tools and crops often included, to settle quickly. Big special bargain list, free. E. A. Strout Farm Agency, Station 3043, 47 West 34th St., New York.

**A** BIG milk condensing plant at Lamar, Colorado, offer to double their capacity if they can get the product from 5,000 additional cows. If you know anything about dairying, write me for particulars about what the country has to offer you. C. L. Seagraves, General Colonization Agent, AT&SF Ry., 1956 Ry. Exch., Chicago.

**TEXAS** school land for sale by the state. You can buy good land at \$2 per acre; pay 5c per acre cash and no more for 40 years, but 3 per cent interest. Send 6c postage for further information. Investor Pub. Co., Dept. 3, San Antonio, Tex.

**FORTY** acres, Oregon. Rolling, sagebrush land, \$400. Forty dollars down, ten dollars a month. Brasington, Maiden Rock, Wis.

**\$39,940, TERMS**, buys stocked 1965% operated Missouri Ranch. 66, Lakeworth, Fla.

**FARM** for Sale—190 acres under cultivation, one house, two barns, two silos, thirty-five registered Guernseys, stock, crop, machinery included. Income \$5,000 a year. I am eighty-six and wish to retire. O. T. Remington, Elk Mound, Wis.

**COME** to Georgia and buy our farm. We will pay transportation. Brewster Lumber Co., Savannah, Ga.

**160 ACRES** rich Alberta land, \$3,500. Owner, A. Simmer, Box 528, Calgary, Alberta.

**LOTS** at Artesia Wells (Southwest Texas). A place of promise that's making good. Two railroads, hotels, restaurants, stores, nice homes, etc. Desirable business lots opposite Union Depot \$50 to \$75, easy terms. Illustrated booklet free upon request. E. K. Crockett, Owner, Gibbs Building, San Antonio, Texas.

**200% PROFIT** on a small real estate investment in Bradentown, Florida, is not uncommon. Building lots in the Woodman Subdivision in that prosperous town offer an equal opportunity. Write for particulars. Ira W. Porter, Dept. P. M., Omaha, Neb.

**GET** my bargain list of Central Minnesota farms, 40, 80 to 640; very easy terms. P. L. Melberg, Randall, Minn.

**BIG** money raising hogs in Ozarks; free range. We care for them for share of profits: \$150 buys hogs and ranch, easy payments. Ozark Hog Co., 810 Olive, St. Louis, Mo.

**40 ACRES** fine fruit and truck land near Tampa, \$680 cash. Worth double. Also smaller tract. Edward Miller, Crystal Springs, Fla.

**FINE** Farm, forty acres, half mile from depot, excellent soil. Price and terms by owner, C. W. Waughel, Uptonville, Ga.

**WANTED** Information. Good farm for sale. Send full description. Western Sales Agency, Minneapolis, Minn.

**I** HAVE been holding 5,000 acres of fine agricultural lands in the Texas Gulf Coast Oil Belt as an investment. Discovery of numerous oil wells near my land led to having tests made by an expert mineralogist and his report encouraged me to drill for oil on my land. To raise funds to defray the expense of drilling operations, part of this land will be subdivided into lots and sold at \$10 each, and only enough lots will be sold to cover the cost of drilling operations. If oil is found in paying quantities, lot owners will receive 40% of the oil profits as a bonus for financing drilling operations. Having clear title to a lot, centrally located to four of the best cities in Texas, your investment is secure, free of all incumbrance, and you have a chance to share in profits derived from oil. For detailed particulars address my agents, James La Gro & Co., 1528 First National Bank Bldg., Chicago, Ill.

**LANDOLOGY**, a magazine giving the facts in regard to the land situation. Three months' trial subscription, free. If for a home, or as an investment you are thinking of buying good farm lands, simply write me a letter marking it personal and say, "Mail me Landology and all particulars free." Address Lloyd M. Skinner, Gen'l Mgr., Skidmore Land Co., 40 Skidmore Bldg., Marinette, Wis.

**CHEAP** patented state school lands, South Texas, \$1 an acre cash, balance ten years. For all particulars write F. A. Connable, Trustee, 491 Commercial Bank Bldg., Houston, Texas.

**FARMS**—Business properties, etc. Bargains everywhere. Inquiries daily. Let us sell yours. State particulars first letter. "Nisco," Dept. XDB, Cincinnati.

**FREE** booklet about farms, homes. State Board of Agriculture, Dover, Del.

**FARMS** for sale or exchange anywhere in the United States or Canada direct from the owners. Information free. American Investment Association, 37 Palace Bldg., Minneapolis, Minn.

#### DOGS, BIRDS, POULTRY, ETC.

**COLLIES**, \$10; Fox Terriers, \$5; Bull Terriers, \$5; Broken hound dogs, \$10. All breeds reasonable. Philadelphia Kennel, 170 East Allen Street, Philadelphia.

**BREED** Flying Squirrels for pets and shop windows; profits enormous; no competition; something different. Mated pair and booklet \$2.50; safe delivery guaranteed. E. F. Pope, Colmesneil, Texas.

**CHICKS** thrive, gain size and vitality when hovered under natural feathers in our Simplex-Perfection Feather Hovers and Brooders. Better than other artificial methods. Chicks raised under feathers in nature's own way. Sizes 50 to 150 chicks. A postal brings our catalog No. S17. Write today. Simplex Supply House, Pontiac Bldg., Chicago, Ill.



Eclipse \$1.50

# Ingersoll

**I**NGERSOLL WATCHES have timed the lives of thirty-four million Americans. It is only by comparison that we realize how great that number is — thirty-four millions means an Ingersoll for every third man, woman and child in the United States.

The reason for these sales is **VALUE**—the greatest time-piece ever produced for so small a price. Note particularly the small thin model Ingersolls that combine beauty, small size and low price with the guaranteed accuracy and dependability of "The Watch that Made the Dollar Famous."

**Eclipse, \$1.50**—A medium sized, thin model watch, just the right size for men.

**Junior, \$2.00**—A smaller, thinner model for boys or men.

**Midget, \$2.00**—A small, thin model watch for women and girls.

**The Wrist Watch, \$2.50**—A small, Ingersoll with a soft leather strap that goes around the wrist. Out of the way, yet ready for instant use. Worn by men and women.

Ask for an Ingersoll and be sure the name is on the dial.

**Robt. H. Ingersoll & Bro.**  
68 Ashland Building, New York City



Dollar Watch



Junior \$2.00



Midget \$2.00

Wrist

Watch

\$2.50



**POULTRY** paper, 44-124 page periodical, up to date, tells all you want to know about care and management of poultry, for pleasure or profit; four months for 10 cents. Poultry Advocate, Dept. 3, Syracuse, N. Y.

**FROGS**—Investigate bullfrog breeding. Immense financial returns. Poultry income-parable. Write for book or stock. Aquafrog, Seymour, Conn.

**MONEY** Making Poultry our specialty. Leading varieties pure bred chickens, turkeys, ducks and geese. Prize winners. Best stock and eggs. Lowest prices, oldest farm, 29th year. Fine catalog free. H. M. Jones Co., Box 156, Des Moines, Iowa.

WRITE your name on a postal for our new 112 page 1914 Book on Poultry Raising—just out. Nothing published like it—better than last year. Full of practical helps—how to breed, feed and rear. Tells how leaders succeed—which breeds lay and pay best—gives plans for poultry houses—how to build brooder out of old piano box, etc. Describes the famous Prairie State Incubators and Brooders. Worth dollars—free for writing. Prairie State Incubator Co., 309 Main St., Homer City, Pa.

**AIREDALE** Terriers and Scotch Collies. State wants? Sales list free. Phil Savage, St. Charles, Ill.

**GINSENG**

**GINSENG** seed of choice quality, 500 for \$1.50. One year old roots, 100 for \$2.50. Booklet free. C. G. McBride, Route 4, Mansfield, Ohio.

**MISCELLANEOUS**

**FORMULAS:** I furnish Practical, Workable, Reliable Processes. Moneymakers for the Manufacturing Mail Order Business. Trade Secrets for Dry Cleaning, Soap Making, Paint, Varnish, Leather, Metal, Automobile and all trades. High-Grade formulas for Toilet, Medical, and Household Specialties. Get my latest "Red Seal" Formula Lists. Valuable information to "Mixers" Free; and write me regarding any formula or preparation. Liscomb Miller Evac Chemical Works, Marietta, Georgia.

**WATERPROOF** your clothing. "Drytex" does not fill, stiffen, or injure the cloth. Regular size, sufficient for suit or overcoat, \$1. Nat'l Chemical Exchange, 306 Livingston Bldg., Rochester, N. Y.

**FREE**—Valuable gift—worth having—also our 1914 novelty catalogue. Send 10 cents. A. Shurwynn Co., 5132 Indiana Ave., Chicago.

**RENOVAR**, the new French Polish for furniture and automobiles. Send 15c for a trial bottle. Hartig & Rivoire, Rosebank, L. I., N. Y.

**SKELETON** Keys—Open all common door locks. Set 25 cents. Special set 50 cents. Catalogue free. B. & F. Novelty Co., Box 237, Rock Island, Ill.

**TANNING** skins. Formulas and directions \$1. Chemical Exchange, 306 Livingston Building, Rochester, N. Y.

**SAFETY** Razors 25c. Guaranteed. Catalog free with order. B. & F. Novelty Co., Box 237, Rock Island, Ill.

**SKELETON** keys, open most common door locks. Set 15 cents prepaid. L. D. Stottler, Stamford, Conn.

**RENEW** old dry batteries! Send 25c for guaranteed formula and instructions; regular price \$1. If dissatisfied we'll send your quarter back. Northern Supply Co., 154 Randolph, Chicago.

**HOW** to make genuine Calabash pipes for less than 20c each. Every smoker buys one. Instructions 25c. Toby Shaffer, West Boone, Iowa.

**RUBBER** stamps are indispensable. Line 15c. Catalogue free. Brabec, 3717 W. 26th Street, Chicago.

**GENUINE** Sioux Indian Beadwork and Curios, also Elk Teeth, Moccasins, Fobs, Belts, Hatbands, Pouches, Warclubs, Indian Costumes. Write us. Lyon & Strong Curio Co., Gordon, Nebr.

**BEAUTIFUL** Gems from the mines. Malachite, silica, 50c to \$1. Rough samples, list 10c. Wm. Shelman, Globe, Ariz.

**ADVERTISERS**—Here's your opportunity. 25 word classified ad inserted in "Cartoons Magazine" for 50c, one inch display ad, \$1. 23,000 copies. Send in your ad for the next issue. Cartoons Classified Dept., 320 W. Washington St., Chicago.

**BRILLIANT** Gold Ink. For writing, illuminating. Dainty decorating in gold. New process. 2 oz. postpaid 10c. Henry Chemical Co., Valle Jo, Cal.

**MAIL** Dealers' Directory tells where to buy anything cheaper than you ever will. Price 50c. Cole Co., 1309 W. Madison St., Chicago.

**ESTIMATING** and Contracting by Radford—A 900-page manual of up-to-date methods for rapid, systematic, and accurate calculation of costs of all types and details of building construction, with quotations of ordinary prices for labor and materials, standard schedules and forms, labor-saving tables and other data useful to the building trades. Flexible leather, illustrated—\$2 per copy postpaid. Popular Mechanics Book Dept., 316 W. Washington St., Chicago.

**INDIAN** Baskets and Rells. Price free. Gilham, Highland Springs, Cal.

**BE** a Handcuff King! Enormous salaries paid. Full instructions 25c. Particulars free. Forsberg, 211 N. 2nd, Portland, Ore.

"1,000 WAYS to Get Rich," 25c. "Fun, Magic and Mystery," 10c. Big Mail, 10c. All for three dimes. Chambers Mfg. Co., Bayridge, Brooklyn, N. Y.

**100** BOXES Cough and Sneeze Powder 4c per box. Sample 25c. Wooding, Manufacturer, Council Bluffs, Iowa.

**SACRIFICE** new typewriter, madstone and farm. Prof. Anderson, Summitville, Tenn.

**YOUR** Name on "Rubber Stamp" for marking linen, 70c. Steel Dies, Metal Checks, Seals, Stenells. Catalogue 10c. Buckeye Stamp Works, Market, Dayton, Ohio.

**LEARN** Brazing or hard soldering. We teach you how with each \$1 package of "3A" Cast Iron Brazing Compound. A. A. Allen & Co., 3935 Lake Park Ave., Chicago.

**CALIFORNIA** gem crystals and minerals for sale. Direct from the mines. Albert Everitt, Escondido, Cal.

**ANTIQU** curiosities copy, first newspaper ever printed in America, 1704—picture first steam railroad passenger train in America, 75c. F. A. Prince, Danielson, Conn.

**GREENBACKS!** Big bunch of stage bills, 10c. 4 bunches, 25c. Photoplay Publishing Co., 3348 Lowe Ave., Chicago.

**BLACKSMITHS**—Learn hand-wrought ornamental ironwork. Our 260-page book: "Hand Forging" points out clearly all the guiding principles and methods which underlie all forge work. Written by a practical authority. 122 illustrations, cloth, \$1 postpaid. Popular Mechanics Book Dept., 316 W. Washington St., Chicago.

**PATTERN** makers! A book devoted to the principles of pattern and core making and molding. Written by G. H. Willard, a practical pattern maker of years' experience. This book, just published, treats the subject in a much more simple, direct and effective manner than most books along this line. 224 pages, 312 illustrations. Price \$1, postpaid. Popular Mechanics Book Dept., 316 W. Washington St., Chicago.

**A COMPLETE** Drawing Outfit for \$3.75. Learn to draw without instructions; send for circular. T-Square & Triangle Co., 30 Clinton St., Newark, N. J.

**OUR** new Aluminum Solder (that holds), Soldering equipment and instructions for manufacturing jewelry for \$2. Sample beautiful cuff links for 25c. Aerodart Works, 196 Centre St., New York City.

**PATENTS** build fortunes for you. Our free booklets tell how; what to invent, how to choose an attorney. Write today. D. Swift, 317 Seventh St., Washington, D. C. Established 1889.

**DO** you want to go on the stage? Be a Handcuff King. I will teach you how; for particulars address Box 902, Springfield, Mass.

**HOW** to Solder Aluminum. How to make the solder, 25c. J. Eaton, 4512 Colorado Ave., Chicago.

**MATHEMATICS** made easy for all by Ropp's Calculator. Figures out, in the twinkling of an eye, every conceivable problem that occurs in the Office, Store, Shop, Bank, Farm or Factory. Greatest time and labor-saving work on figures in the world. Copyright 1912. Price, \$1. Vest pocket size, 50c. Popular Mechanics Book Dept., 316 W. Washington St., Chicago.

**GRANDFATHER'S** Clock Works, \$5. Slightly shop-worn, quantity limited, others with chimes, all prices; also several nice Grandfather's Clock cases, exceptional bargains. Clock Company, 1673 Ruffner St., Philadelphia, Pa.

**I WILL** start you earning \$4 daily at home in spare time, silvering mirrors; no capital; send for free instructive booklet, giving plans of operation. G. F. Redmond, Dept. 306, Boston, Mass.

**TOBACCO-CURE**—One box cures. Guaranteed or money back. Established 1894. Write for special offer. Allen Distributing Co., 3609H, Wabash Ave., Kansas City, Mo.

**YOUNG** Man! Learn Drafting—one of the most practical subjects of study to-day—indispensable in many occupations—engage in individual study successfully with the aid of our new book, "A Practical Course in Mechanical Drawing," 160 pages, 137 drawings, cloth, 50 cents, postpaid. Popular Mechanics Book Dept., 316 W. Washington St., Chicago.

**CUTS** anybody can make. Simple Etching Process, \$1. Particulars, specimens, for stamp. M. Day, Windfall, Ind.

**3000** SELECTED Pictures for \$3. A Panorama of World Events. Political—Industrial—Social—Humorous—Tragic—all of intense human interest. A wonderful collection of 3,000 cartoons reproduced from the newspapers of the United States, Canada, Mexico, Cuba and the cities of the Old World, has been made by Cartoons magazine from more than one hundred and fifty thousand published cartoons, and, bound in an artistic and durable cover, are now ready for your library table. Vol. I, Jan.-June, 1912—\$1. Vol. II, July-Dec., 1912—\$1. Vol. III, Jan.-May, 1913—\$1. Cartoons, 318 W. Washington St., Chicago.

**This Suit Yours**

To learn how you can have a swell tailored suit without cost (we pay express) make \$10.00 every day; to learn what beautiful tailoring really is; to offer styles that everybody goes wild about; to get all your own clothes easy, do this now—write us and say "Send me your New Wonderful Tailoring Offer," and you will receive a beautiful set of samples and styles to pick from, and an offer so good you can hardly believe it. No money or experience needed. Your spare time will do. Write now—sure. Don't answer unless you live in a small town under 10,000. Address

**BANNER TAILORING CO.**  
Dept. 702 CHICAGO



**Be a "Chicken" Inspector**

Latest thing out. Nickel plated, ball pointed official size star. (As illustrated.) All the rage, barrels of fun. Be my agent in your town—40 per cent profit. Sample for 25c postpaid. Address G. A. EVANS, 404 Schiller Bldg., Dept. P. M., CHICAGO, ILL.

**The Boy Mechanic**

**GREATEST BOYS' BOOK PUBLISHED**

Describes 700 Things for Boys to Make and has 1,000 Illustrations. Price \$1.50 Prepaid

**POPULAR MECHANICS BOOK DEPT.**

320 W. Washington Street, CHICAGO

# BUILD a BUSINESS OF YOUR OWN



**Make \$5,000 a Year**

Reliable, earnest men wanted to join the Merrill Co-operative System. Share in the profits of other people's work. No matter where you live or what your business or profession, I will give you instruction in the

## Real Estate and Building Business

free by mail; and if you qualify, appoint you **Special Representative**; help you to build up a lifetime business of your own that should yield you an income of \$5,000 a year; great opportunity.

**Instruction Free** I show you every step, in easy lessons, and help you to get others working for you. Write for first lesson and full details, all free. A postal will do. **J. J. BUTLER, Mgr. Special Agency Division, 1425 Monon Bldg., Chicago**

**\$25 TUITION CREDIT FREE!**

**DOUBLE YOUR SALARY**

**Learn Shorthand at Home**

Yes, absolutely free—for advertising purposes—if your name reaches me soon enough. My wonderful system—**PRATT-PITMANIC SHORTHAND**—makes you a finished, competent stenographer. Fits you to take responsible, highly paid positions with big opportunities. **Touch Typewriting Course Free.** If you want quick success don't fail to write at ONCE for free 48 page book and special terms.

**OFFER LIMITED—WRITE QUICK**

This offer is strictly limited—may be withdrawn any time—so write me at once—BEFORE TOO LATE. Court Reporters recommend my system. You can learn it now at a tremendous saving. Write me today—now—this very minute.

**PRATT SCHOOL OF COMMERCE**

**E. D. PRATT, Pres. Box 256 H, CHICAGO, ILL.**

## TANGO HESITATION & All New Dances

The New Steps Postpaid \$1.00



**QUICKLY LEARNED AT HOME**

Full, clear instruction in correct positions and steps of Tango, Castle Walk, Hesitation Waltz, Dream Waltz and others. Diagrams, Descriptions and Illustrations by experts. Only successful Home Method to quickly acquire perfection, ease and grace without an expensive teacher. Beautifully bound. Presentation Edition \$1, postpaid direct from publishers **SAUL BROS. PUB. CO., Dept. 8**

626 Federal Street CHICAGO, ILL.

**Learn to Write—Manage—Solicit**

# ADVERTISING!

Course and text by more than 60 big experts. Covers entire field. Learn by mail in home or office. Apply daily in your own work. Endorsed by large agencies. Earn \$50 to \$100 and upwards weekly. Introductory **Free Tuition Offer** open now. Act **Quick!** Text books and supplies only cost. Easy Terms. Address:

**CHICAGO UNIVERSITY OF COMMERCE, Dept. 1033, CHICAGO, U.S.A.**

## TELEGRAPHY The Only Trade that is not Crowded.

It insures steady employment and good wages. Promotion is assured for the ambitious. We are official instructors for the **Western Union Telegraph Co.**, and the only school instructing Western Union employees. Largest attendance of any Telegraph school; also authorized school for **Illinois Central Railroad Company.** Agency course free. Practical instructors; main line wires. Employment furnished to earn expenses if desired. State your age.

**Jones School of Telegraphy, Dept. M, Traders Bldg., Chicago, Ill.**

## LEARN JEWELERS' ENGRAVING

A high salaried and easily learned trade, taught thoroughly by mail. We will teach the beginner better engraving than he can gain in years of rigid apprenticeship. We will also improve the skill of any engraver. Send for our catalog. **The Engraving School 112 Page Bldg., Michigan Ave., Chicago, Ill.**



**DRAWING OUTFIT \$3.75**  
Regular \$8.75 Special

OUTFIT consists of Board, T-Square, Triangles, Fine Set of Instruments, Scale, Tacks, Pencils, Rubber, Curve, etc. Don't think these tools are plumb things just because they are low in price. The greatest draftsman on earth can use them. This same outfit is valued by others from \$5.00 to \$12.00. If you have any mechanical ability buy this outfit and begin to learn how to draw, without spending money on useless instructions. Better outfits for \$5.50, \$8.75 and \$12.50. Send for circular. **THE T-SQUARE & TRIANGLE CO., 20-22 Clinton Street, NEWARK, N. J.**

Money back if not satisfactory. THE T-SQUARE & TRIANGLE CO.

# This Complete Library of LAW IN 6 HANDY VOLUMES Only \$1 a Month

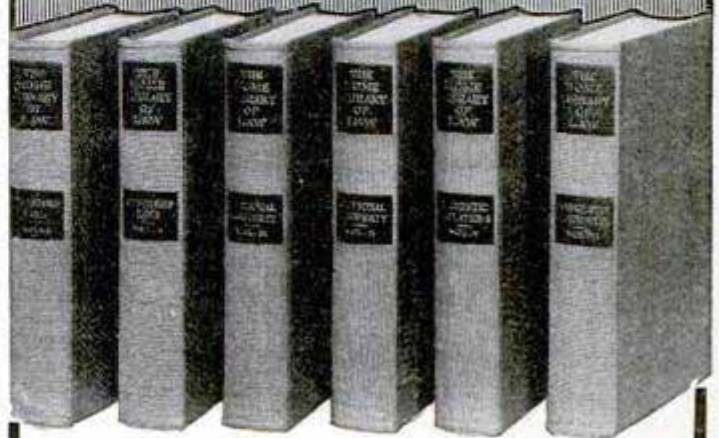

**"Ignorance of the law excuses no man"**

**THAT'S LAW.** You can't always "guess" the law. You may not have time to "study" law. Lawyers come high—especially some of them. **BUT YOU MUST KNOW LAW.**

**THIS** splendid little handy **LIBRARY OF LAW** is prepared for the average man—the business man—the doctor—the teacher—the minister—the man who works for others—the man who works for himself—the man who writes—the man who has money and the man who has not—**EVERY MAN.** This Library is a work to read at odd times and a reference work combined. The language is simple, direct, plain, and it covers every subject you need to know about. Here are just a few of them: "Wills"—"Mortgages"—"Deeds"—"Farm Laws"—"Landlord and Tenant"—"Leases"—"Copyrights"—"Trade Marks"—"Partnerships"—"Letters of Credit"—"Trustees"—"Corporations"—"Stockholders"—"Dividends"—"Marriage"—"Parental Relation"—"Employer and Employee"—"Assault"—"Defamation"—"Libel"—"Criticism"—"Self Defense"—"Automobile Laws"—"Patents"—"Contracts"—"Fraud"—"Damages"—"Negotiable Paper"—"Indorsements"—"Promissory Notes"—"Checks"—"Bills of Exchange"—"Bonds"—"Agents"—"Banks"—"Bankruptcy," etc.

## HERE IS OUR SPECIAL OFFER

**WE** can't begin to tell you all about this splendid set of books, so we are not going to try. We want to send you the books themselves—the *complete set of 6* handy volumes, measuring 6 3/4 by 4 1/2 by 3/8 inches, so that you can examine all the volumes and decide for yourself if they are just the books you want—and need. If you decide to keep them, just send us \$1 a month thereafter for 8 months. But if you do not wish to keep the books after seeing them, then you may send them back at our expense. That's fair. Isn't it?

**Mail coupon below at once.** Send me for examination, one set of your handy **LIBRARY OF LAW** in six volumes bound in Buckram. If I am satisfied with the books I will send you \$1 as first payment, and \$1 a month thereafter until the special price of \$9 is paid. If I do not wish to keep the books, I will notify you in seven days, and the books are then to be returned at your expense as offered Popular Mechanics Magazine readers.

**The Thompson Publishing Co., 1127 Pine Street, ST. LOUIS, MO.**

NAME.....  
ADDRESS.....

Please Mention Popular Mechanics

# National Students Build Racers

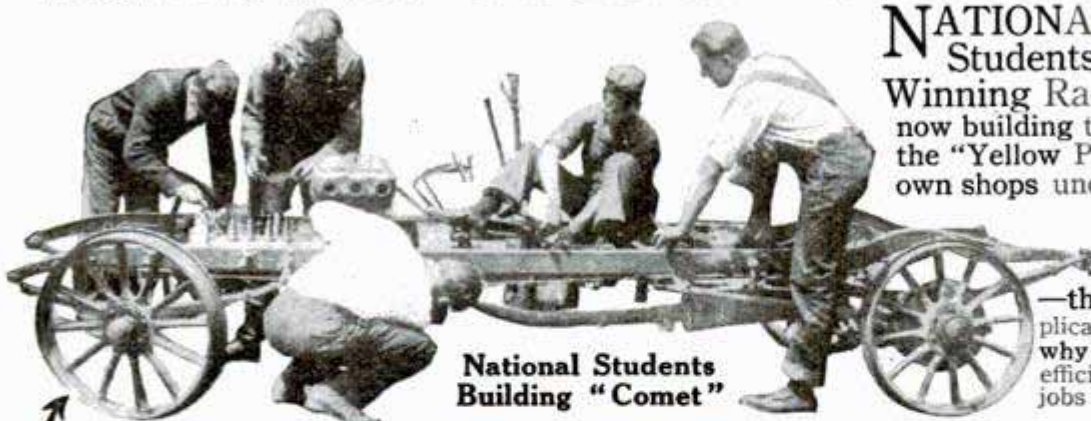

National Students Building "Comet"

**NATIONAL AUTO SCHOOL**  
Students built this Prize Cup-Winning Racer, "Comet," and are now building two more speed demons—the "Yellow Peril" and "Nasco"—in our own shops under the direction of expert

National Instructors. National students learn to build and run these cars—the most powerful and complicated of all automobiles. That's why National graduates are most efficient; that's why they get best jobs with highest pay.

## You Can Help Build These Big Speeders

—the "Nasco" and "Yellow Peril"—if you will send in the coupon now. All students who enroll in the next class will have a hand in building what we intend to be other cup winners, as these machines will be entered in big races. Our instructors hold A. A. cards as racing drivers. Send coupon for catalogue; also latest copy of our illustrated Monthly Magazine—"The National Auto School News."

## No Previous Experience Necessary

It is not necessary to have had experience in auto or similar business, in order to take our course and qualify as chauffeur, repairman, demonstrator, garage owner or manager, salesman or racing driver; in fact, men and boys with no mechanical experience whatever often make best students.

**NATIONAL AUTO SCHOOL**  
June & Reading Road, Cincinnati  
Gentlemen:—Please send catalog and latest issue of "National Auto News."

Name.....  
Address.....P. M. 3

## Big Money In All Lines Of Auto Work

National trained men find no trouble securing best pay in any branch of the business, because, when they graduate, they know automobiles "from the ground up." As drivers and chauffeurs they save their employers' money by taking proper care of cars and making repairs that would otherwise send the machine to repair shop or factory.

## Our Guarantee

We absolutely guarantee your passing State Chauffeur's Examination if you take our course. The National AUTO SCHOOL IS ENDORSED BY THE STATE LICENSING BOARD OF OHIO. When you get our diploma, you can be certain of passing chauffeur's examination in any state.

**DON'T WAIT!**  
Fill out Coupon and mail NOW.

**National Auto School**  
June & Reading Road  
Cincinnati

We absolutely guarantee your passing State Chauffeur's Examination if you take our course. The National AUTO SCHOOL IS ENDORSED BY THE STATE LICENSING BOARD OF OHIO. When you get our diploma, you can be certain of passing chauffeur's examination in any state.



"Comet" after winning race

## Young Man! Your greatest opportunity

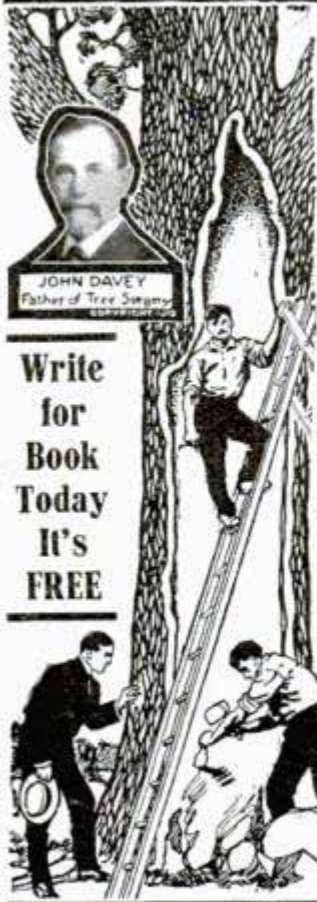

To the man who wants to improve his condition in life—to increase his earning capacity—to get away from the monotony, grind, and low wages of ordinary occupations—to elevate his social standing, the new profession of Tree Surgery, which is not overcrowded, offers the young man of today his greatest opportunity. The Extension Course given by The Davey Institute of Tree Surgery, will fit you to practice this profitable profession.

## Learn TREE SURGERY and Fruit Growing

You can become proficient in this work without interfering with your present occupation. An hour or so a day will give you a training that will make your future bright and prosperous. The work of a Tree Surgeon is healthful, fascinating and remunerative. The call for men in this profession is far greater than the supply, and the demand is growing. There are positions open at good salary and opportunities everywhere to establish a paying business of your own—Why work for others at small pay when you can be your own boss? Write today for our book "Adventures in Success."

Read what others have done, and learn how easily and quickly you can improve your condition in life.  
**THE DAVEY INSTITUTE OF TREE SURGERY**  
316 Oak Street KENT, OHIO

Write for Book Today It's FREE

## This Book FREE!



## Are You Interested In Automobiles?

This book contains vitally important information about the laws governing chauffeurs in every state—How to register—How to get a license—Fees—Driving law regulations—Rights and privileges. This book sells for 50c. But send 10c for a copy of the **American Chauffeur**—the liveliest, illustrated, technical automobile magazine, with educational qualities—the only one published exclusively for the beginner, professional chauffeur and the man who drives his own car—and with it we will send you the Chauffeur's Law Book absolutely free. Write now.  
**THE AMERICAN CHAUFFEUR PUBLISHING CO.**  
266 Butler Building, Cincinnati, Ohio



## Frank Gotch

World's Champion Wrestler, managed by the original Farmer Burns, who will now teach you **wrestling by mail**; also self defense and jiu-jitsu. Be strong and healthy. Learn all the tricks of handling big men with ease. Only opportunity ever offered men and boys to learn from **World's Champions**. Send 10c for fine book with plates by Gotch and Burns. Limited number. **WRITE TODAY.**  
**FARMER BURNS SCHOOL OF WRESTLING, 119-D Range Bldg., OMAHA, NEB.**

## PERSONAL EFFICIENCY INSTRUCTION COURSES \$4.00

PAUL MEAD CEDAR RAPIDS, IOWA

## BUSINESS LAW

Bays Miniature Law Library. Only complete work on Commercial Law. Contains Legal Forms of all kinds. Should be in every library. Fits the pocket, 9 volumes, \$12.00. Safe counsellor. Worth its weight in gold. 2000 pages. Order Now. Sent on approval.  
**CALLAGHAN & CO., Law Publishers, CHICAGO**



## AN ART SCHOLARSHIP FREE

WRITE AT ONCE for full particulars of this Special Limited Offer. No charge, no obligations. Your name and address brings you full explanation of our Free Scholarship Offer. List of Premiums free. Art Annual included for 6 cents in stamps. This offer is limited to a few in each locality who answer at once. **So WRITE TODAY.**  
**FINE ARTS INSTITUTE Studio 213 OMAHA, NEB.**



# HOW TO RUN AN AUTO IS SELF-TAUGHT IN AUDELS ANSWERS ON AUTOMOBILES

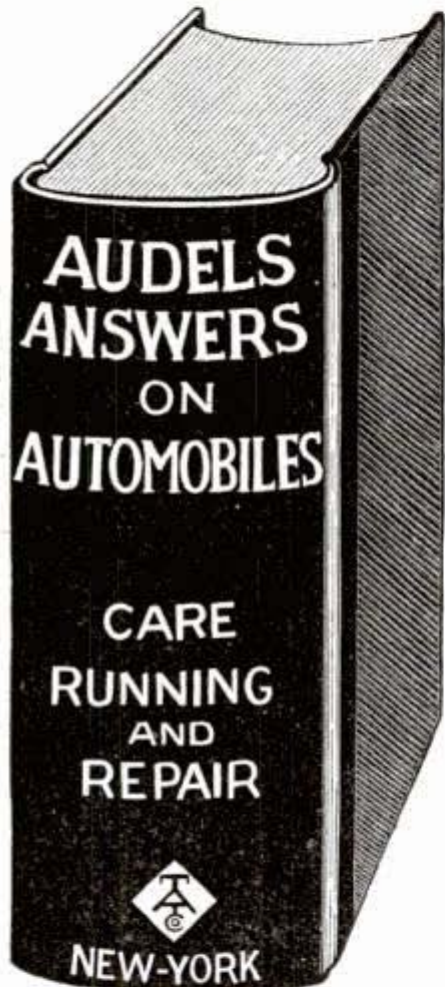

**A New Book from Cover to Cover  
LATEST — PRACTICAL — CONCISE — EXPLICIT — BEST**

**T**HE object of this book is to give, in the easiest understood form, the information necessary for the proper **operation, care and maintenance** of an automobile.

To adapt the book to many needs the subject matter is presented in the form of **questions and answers**. Technical terms are explained or made clear by the wording of the answer, which is always brief and direct.

Any one of the definite chapters on **Carburettors, Ignition, Gas Engine Operation, How to Run an Automobile, and Overhauling the Car, Battery Troubles**, are alone worth the price asked for the 28 complete chapters contained in this book of 512 pages, illustrated by **380 illustrations**.

The form and size are such that it is convenient to handle and study.

This book is a self-educator, hence: "he who runs may read" and improve his present knowledge of automobile engineering, and proficiency.

Handsomely bound in durable green cloth and full leather back.

**Audels Answers on Automobiles \$1.50**

## A BOOK WORTH HAVING

"Understand Your Car." Explained in the Following Chapters:

1. Ready Reference Index. 2. The Automobile. 3. The Gas Engine. 4. The Cycle of a Gas Engine. 5. Brief Outline of Gas Engine Principles. 6. Cooling Systems. 7. Fuels. 8. Carburettors. 9. Ignition. 10. Timing and Balancing. 11. Gas Engine Operation. 12. Clutches. 13. Transmissions. 14. The Drive. 15. The Differential. 16. The Running Gear. 17. Tires. 18. Brakes. 19. Ball and Roller Bearings. 20. Lubricants and Lubrication. 21. Motor Cycles. 22. Electrics. 23. Electricity. 24. Dynamos and Motors. 25. Storage Batteries. 26. Methods of Circuit Changing. 27. How to Run an Automobile. 28. Overhauling the Car.

## NONE OTHER JUST AS GOOD

### FREE EXAMINATION

We don't want you to take our word, or anyone else's for it. We are willing to send you the book without deposit. Use it seven days in connection with your car. Then send back the book or remit \$1.50. Could anything be fairer?

Cut out and fill in your name and address plainly at the bottom. Place it in an envelope and mail.

### **This Book Will Speak for Itself**

Theo. Audel & Co., 63 Fifth Ave., New York

Kindly mail me copy of **Audels Answers on Automobiles**, and, if found satisfactory, I will immediately remit you \$1.50, or return the book to you.

NAME .....

OCCUPATION .....

ADDRESS ..... Mar. 14, P. M.

BUY  
THESE

# Practical Handbooks

FROM YOUR  
DEALER

NEW TITLES JUST ADDED TO OUR  
PRACTICAL HANDBOOK SERIES

Air Brake . . . . .	\$1.00
Applied Electrochemistry . . . . .	1.00
Building Code . . . . .	1.00
Business English and Correspondence . . . . .	1.00
Corporation Law . . . . .	3.00
Dams and Weirs . . . . .	1.00
Fire Insurance Law . . . . .	1.50
Fireproof Construction . . . . .	3.00
Locomotive Boilers and Engines . . . . .	1.00
Machine Drawing . . . . .	1.50
Modern American Homes . . . . .	2.50
Motion Picture Work . . . . .	3.00
Real Property Law (Future Interests) . . . . .	1.50
Standard Legal Forms . . . . .	2.00
Structural Drafting . . . . .	1.00
Switchboards . . . . .	1.00
Underwriters' Requirements for Safe Electrical Installation . . . . .	1.00

If your dealer does not have the particular book of this series that you want, ask him to order it for you or order it direct from us yourself.

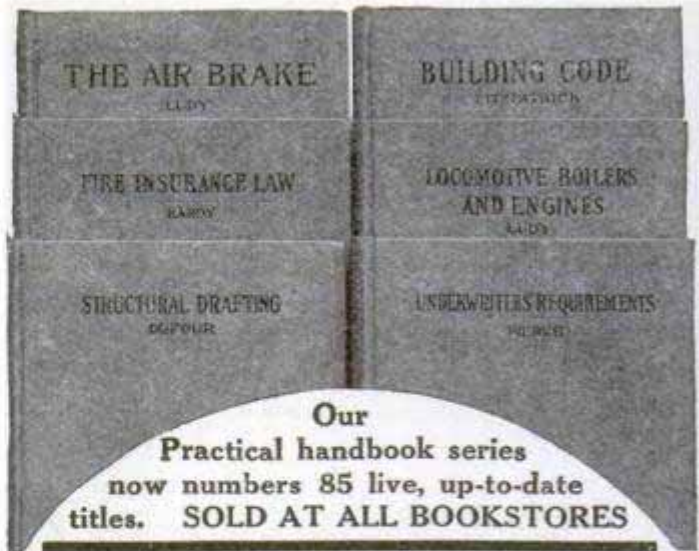

Our  
Practical handbook series  
now numbers 85 live, up-to-date  
titles. SOLD AT ALL BOOKSTORES

## PRACTICAL BOOKS FOR PRACTICAL MEN

These books were written especially for practical self-instruction, by experts whose experience and standing make them authorities.

They are so clear that the beginner can understand them; so thorough that the trained worker can learn from them; so practical that they will give any man a working knowledge of the subjects that they treat, and save him both time and money.

They not only cover the fundamental principles of mechanical science, engineering practice, and business usage, but also present the latest developments and the accepted practice of the most successful men, in those lines.

They give men a practical knowledge of practical things, which enables them to think more accurately and to work more efficiently; and they compose the most helpful, reliable, and comprehensive series of home study books ever put upon the market.

AMERICAN SCHOOL OF CORRESPONDENCE, 58th St. and Drexel Ave. CHICAGO, ILLINOIS

**"HELP WANTED"**  
-Uncle Sam.

Railway Mail Clerks  
Government Clerks at  
Washington, D. C.  
4th Class Postmasters  
Spring Examinations Everywhere

\$900<sup>00</sup> to \$1800<sup>00</sup> a Year  
for LIFE

No "layoffs" without pay, because of strikes, financial fluctuations or the whims of some petty boss. Excellent opportunities for quick advancement to Higher Government Positions. If you want immediate appointment, send **TODAY** for our schedule showing locations and dates of the Spring examinations. Any delay means the loss of just so much time in preparing yourself for examination.

We will prepare  
25 Candidates  
Free

The coupon, filled out as directed, entitles the sender to free sample questions; a free copy of our book, "Government Positions and How to Obtain Them," free list of positions now available; and to consideration for Free Coaching for the examination here checked.

SEND  
COUPON  
BELOW

FRANKLIN INSTITUTE  
Dept. E106, ROCHESTER, N. Y.

... Railway Mail Clerk (\$900 to \$1800)	... Customs Positions (\$800 to \$1500)
... Postoffice Clerk (\$800 to \$1200)	... Internal Revenue (\$700 to \$1800)
... Postoffice Carrier (\$800 to \$1200)	... Stenographer (\$800 to \$1500)
... Rural Mail Carrier (\$500 to \$1100)	... 4th Class Postmaster
... Bookkeeper (\$900 to \$1800)	... Automobile Operation

Name.....  
Address..... E 106  
Use this before you lose it. Write plainly.

### DON'T TAKE A COURSE IN Mechanical Drawing

until you have read my proposition. Practical draftsman, regularly employed by the most progressive company in the West, with long experience also as teacher of Mathematics and Drawing, will instruct a few men by mail. **Positively the best way to become a practical well-paid draftsman.** Instruments furnished. Rates reasonable. **Pay a part after in position.** For information write,

DRAFTSMAN, 252 South Corona Street, Denver, Colo.



FREDERICK W. FOOTE  
Psychologist

## YOUR MACHINE!

Needs Training if it is to give you EFFICIENCY OF SERVICE. Your brain is THE machine. Absolute Law governs it. The science of Psychology gives you possession of these laws. Thus the Master Mind makes Self Control, Concentration and Personal Power the equipment for Success. Your opportunity to gain this Training is through a correspondence course of twelve lessons in Psychological Success Training. Send for free book, "Masters of Destiny." The Chicago Institute of Menti-Culture, North American Bldg., Chicago.

## WHY NOT BE AN ARTIST?



STUDY drawing at home under Expert Faculty. We have successful students in every part of the world. **Turn your Talent into money.** Our Students are filling high salaried positions. 14 years successful teaching. Endorsed by high authorities. 18 Courses in Commercial and Illustrative Drawing. Teachers' Normal and Applied Art, Profit or Culture.

Thoroughly Equipped Residence School

Artist's Outfit FREE to Enrolled Students

SCHOOL OF APPLIED ART, 755 Applied Art Bldg., Battle Creek, Mich.



## DON'T TRY TO BE A CHAUFFEUR

or go to ANY SCHOOL to learn, or part with your hard earned dollars until you have read our valuable guide FIRST. It tells what you should PAY and what you should GET. Do not be deceived by schools which claim everything and give you nothing. **YOU CAN'T AFFORD TO SPEND ONE CENT TILL YOU GET OUR GUIDE.** It costs nothing and may save you many dollars. Write now for this FREE BOOK.

PRACTICAL AUTO SCHOOL, 68 Beaver St., New York

## This Auto FREE to New Coey Students



### COEY JUNIOR \$425

We want young men in every community to earn a Coey Junior free and then ride around and take orders for us. Write for information. This is the only Automobile School in the World that really builds automobiles and gives its students an opportunity to help build them and make big money.

### Invest Only \$15

### Make \$100 to \$400 Every Month

A small investment of only \$15.00 will prepare you to earn from \$100 to \$400 per month. Oldest Automobile School in the World, under personal supervision of Mr. C. A. Coey, America's Premier Autoist, holder of the 24 hour automobile world-record.

### Interesting Literature Free

Write today for particulars. You can earn big money the minute you enroll.

### C. A. COEY'S SCHOOL OF MOTORING

532 Coey Building, 1424-1426 Michigan Ave., CHICAGO, ILL., U. S. A.

## \$100 LAW Scholarship

### Free to You!

Yes, absolutely free for a limited time, to advertise our school. Cuts the cost of Complete Law Course to amazingly low

figures. But in order to benefit by this lifetime chance, you must write today, before it is too late. No obligation on your part.

### You Can Study Law at Home

Graduate correspondence students most successful at Bar Examinations. More than 40,000 students enrolled—largest Law School for Home Study in world. Our method of instruction same as Harvard, Michigan and other big Law Schools. We guarantee to coach graduates free until they pass bar examination. Send letter or postcard today for free \$100 law scholarship certificate and free catalog. Hurry, there is not a minute to lose.

American Correspondence School of Law, Dept. 1193 Manhattan Building, Chicago, Ill.

## Practical Electrical Education

Electrical Engineering, Installation, Wiring, Draftsmanship and all branches of Electrical Science taught by practical, scientific and thoroughly tested methods in the most completely equipped practical engineering school in America.

Students Can Enter Any Time Your education is of no consequence; we start you

at the right point and our personal instruction advances you rapidly. Positions guaranteed competent graduates; spare time work for students helps pay expenses. Write N-O-W for illustrated Booklet—Free.

SCHOOL OF ENGINEERING OF MILWAUKEE, Division 24, Milwaukee, Wis.

### COPY THIS SKETCH

and let me see what you can do with it. You can earn \$20.00 to \$125.00 or more per week, as illustrator or cartoonist. My practical system of personal individual lessons by mail will develop your talent. Fifteen years successful work for newspapers and magazines qualifies me to teach you. Send me your sketch of President Wilson with 5c in stamps and I will send you a test lesson plate, also collection of drawings showing possibilities for YOU.

The Landon School of Illustrating and Cartooning  
1438 Schottel Building, CLEVELAND, O.



## GET THIS BOOK ON ELECTRICITY

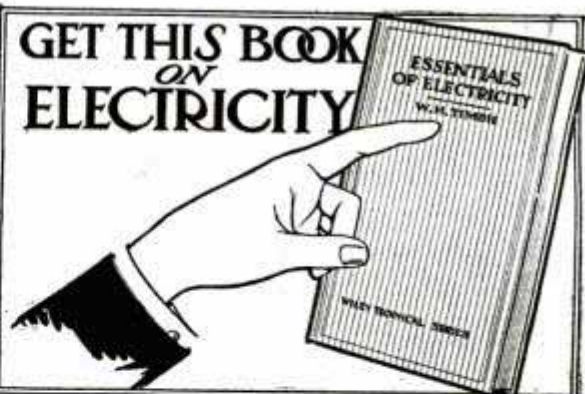

## POPULAR MECHANICS

is "Written so you can understand it"

SO IS

# TIMBIE'S "ESSENTIALS of ELECTRICITY"

If you wish to learn *quickly and surely*

- HOW *Block signals* work,
- HOW *Automatic track switches* work,
- HOW *Electric carriage calls* work,
- HOW to compute the *Amperes, Volts, Ohms and Kilowatts*,
- HOW to locate and repair "*Trouble*" in wiring,
- HOW to determine the correct *size of wire* for every job,

*This book will show you*, because you can UNDERSTAND EVERY WORD of it. It contains 270 pages, and each page is solid meat.

**NO History. NO Algebra. NO Padding.**

Ask the man who has one; take his advice, and send for a copy.

**PRICE \$1.25 POST-PAID**

## Our Hundred-Year-Old Proposition

We have been in business for over one hundred years and have always given our customers the "return privilege." We do not wish to sell anyone a book which he does not want.

..... **FILL OUT THIS COUPON AND MAIL AT ONCE** .....

**JOHN WILEY & SONS,  
432 Fourth Ave., New York, N. Y.**

DEAR SIR: Find enclosed P. O. order for \$1.25 for which please send post-paid to address below, one copy of Timbie's "Essentials of Electricity." It is understood that if I find this book is not what I desire, you will refund the purchase price, providing I return the book to you within 10 days.

Name .....

Street and No. ....

City or Town .....

State .....

# Can You Accept a \$2,500 Job

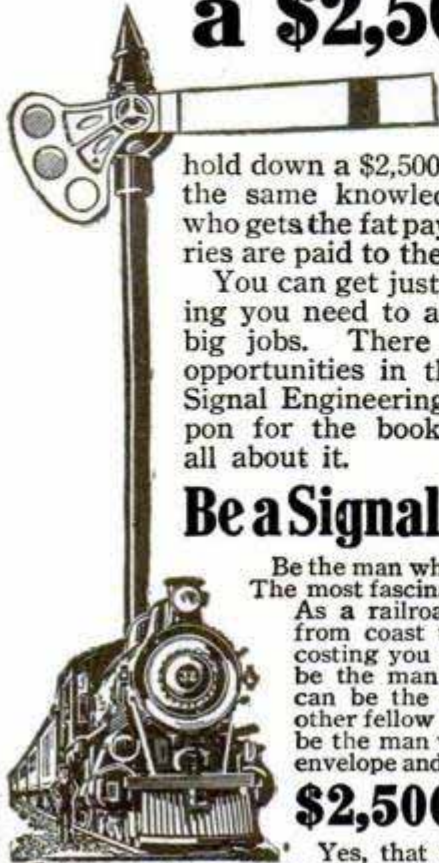

Have you the training that is necessary to hold down a \$2,500 job? Have you the same knowledge as the man who gets the fat pay envelope? Salaries are paid to the men who know. You can get just the kind of training you need to accept one of the big jobs. There are exceptional opportunities in the profession of Signal Engineering. Send the coupon for the book that tells you all about it.

## Be a Signal Engineer

Be the man who gets \$2,500 a year. The most fascinating of professions. As a railroad man you travel from coast to coast without it costing you a penny. You can be the man who knows. You can be the man who tells the other fellow what to do. You can be the man who gets the fat pay envelope and free transportation.

## \$2,500 a Year

Yes, that is what your salary will be when you are a full fledged Signal Engineer, \$2,500 a year to start. Many men making much more than that. Even while you are learning you can hold one of the positions under a Signal Engineer, paying you a handsome salary. Here is your opportunity. Send in the free coupon for full particulars.

## More Men Needed

Railroads are constantly looking for competent Signal Engineers. There are not enough men to fill the positions. Thousands and thousands of miles of track are now being equipped with automatic signals. Hundreds of new positions will be open. And there are no men to take them. Here is your chance.

## Send the FREE

### Free Outfit

If you will write at once we will tell you how you can get the big new Signal Engineer's outfit absolutely free. Our students get practical instruction. The kind the railroads demand. If you act at once the outfit is free to you. Send the free coupon for full particulars.

## Coupon for Big New Book

Just put your name and address on the free coupon and send it in to us at once. Absolutely no obligations of any kind. We will send you the big new Signal book absolutely free. Tells you all about this most fascinating profession. How you can get into the \$2,500 class. The book is free. Get your name and address in at once.

### FREE BOOK COUPON

Department of Signaling  
Desk 1193  
491 Cass St.  
Chicago, Ill.

GENTLEMEN: Please send me absolutely free and prepaid your big new Signal book. Also full particulars about your great special free outfit offer. It is distinctly understood that I assume no obligations of any kind.

Name .....

Address .....

Age..... Occupation.....

### Department of Signaling

Desk 1193  
491 Cass St.  
Chicago Ill.

# LEARN TO PAINT SIGNS and SHOW CARDS



## Earn \$18.00 to \$45.00 a Week

Many of our students make big money in business for themselves. Natural talent unnecessary. Read what students say. Crawford, B. C., Canada, says: "Earned nearly \$200.00 since taking course." Parrott, Okla., says: "Earned several times cost of course since enrolling." Fritzer, Minn., writes: "Did job recently and got \$10.00, profit \$7.05." Write for large complete catalog, testimonials, pictures, sample of work, terms.

**DETROIT SCHOOL OF LETTERING**  
Chas. J. Strong, Founder, Dept. 2030, Detroit, Mich.

### Guarantee

I guarantee to place my graduates in positions paying \$85.00 to \$125.00 when they have graduated and are competent. We have constantly more requests for men at good salaries than we can supply.

## MANY A "BORN GENIUS"



is handicapped, because lacking the mechanical skill to put his ideas into practical shape, who might otherwise become a famous inventor. Study my simplified correspondence course of mechanical drawing and engineering, at home in your spare time, and you will become an expert in a few months, certainly within a year. Drafting is an interesting and remunerative profession, and is a stepping stone to high positions. Learn it from one who has held responsible positions in all kinds of engineering work with big concerns. Elegant set of instruments FREE.

ROBT. HARDIE, 621 No. Homan Ave., Chicago, Ill.

**EARN \$20 TO \$50 A WEEK** LEARN TO SHOW-CARD WRITING.

Splendid Opportunities, Big Salaries, Constant Demand for Show Card Writers. I will make you an expert in 14 EASY LESSONS. Learn at home during spare minutes. Valuable illustrated book, "Daily's Self Instructor," describing course, sent free on request.  
Room 31 Rauh Bldg.  
BERT L. DAILY, Dayton, Ohio

## Learn Watchmaking At Home



You can learn by our modern and original system of instruction every part of the Watchmaker's Trade at home as good or better than at a shop. You can earn money while learning and secure a well paying position or start in business after completing our course of instruction. Good watchmakers are always in demand and earn from \$20 to \$35 per week. For particulars apply to the Wisconsin School of Watchmaking, Stroh Bldg., Milwaukee, Wis.

**LEARN PIANO TUNING At HOME**

Our patented TUNE-A-PHONE simplifies learning, removes guesswork, assures accuracy. Musical ear NOT required. We furnish Action Model & tools. Diploma granted. Guaranteed as represented. Write for FREE illustrated book. NILES BRYANT SCHOOL, 216 Art Inst., Battle Creek, Michigan.

**EARN \$5 to \$15 A DAY**

## LEARN JEWELRY ENGRAVING

in your own home. Earn \$20.00 to \$50.00 Weekly. Personal instructions. Write for free booklet. Chicago Engraving School, 612 Athenaeum Bldg., Chicago

## DRAWING

Caricature, Cartoon, Comic, Commercial, Fashion, Newspaper and Magazine illustrating taught by mail. Illustrated book 6c in stamps. **THE BOSTON SCHOOL OF DRAWING, 755M Boylston St. BOSTON, MASS.**



# This Man



**Has the Most Wonderful Memory Ever Known**

HE can give the population of any place in the world of over 5,000—

HE can give every important date in the world's history—HE has 300,000 Facts and Figures stored away in his brain.

Felix Berol is this man's name, and a few years ago his memory was distressingly poor. His present amazing efficiency has been developed through his own simple, practical method.

He is now teaching his system with great success to large classes at many leading educational institutions in New York City. He desires to impart his method to YOU.

## He Can Build YOUR Memory So That It Will Never Fail

You will be able to recall Names, Faces, Dates, Telephone Numbers; his simple system will cure mind-wandering and teach concentration; you can remember the facts in a book after one reading; you can recall any episode that you wish; you can become a clear thinker, and in public speaking never be at a loss for a word. Give him a few spare minutes daily, at home, and you will be astonished. He makes no promise to you that he can not substantiate in his own person.

Write to-day for full free particulars of this man's wonderful memory and his offer to YOU.

FUNK & WAGNALLS COMPANY, Dept. 962, New York

## LEARN DRAFTING

Be a mechanical, architectural or sheet metal pattern draftsman.

**EARN \$75 TO \$200 PER MONTH**

There is a constant demand for our graduates. Our employment bureau will secure you a good position. Expert instructors. Complete drawing outfit free. Write for free book today.

Colorado Correspondence College, Dept. B-1, Denver, Colo.

**LEARN TO PAINT SIGNS and SHOW CARDS**

I'll teach you personally by mail. Fourteen years' successful teaching. Big field for men and women. You can **EARN \$18.00 TO \$45.00 A WEEK**

Crawford, B. C. writes: "Earned \$200.00 while taking course." Write today for catalog, samples, etc.

**DETROIT SCHOOL OF LETTERING**  
CHAS. J. STRONG, Founder Dept. 203 Detroit Mich.



## BIG MONEY now earned by thousands of managers who studied

in spare time AT HOME. Why? Because it is the best equipment for **LARGE SUCCESS**. YOU do likewise and yourself become "THE BOSS." Regular LL.B. degree. Prepares for Bar; any State. University methods. NO BOOKS. Lessons mailed weekly. Easy terms. Write for "The Key to Success" FREE.

American Extension University  
Dept. P. M. Los Angeles, Cal.

# LAW

**ADVERTISEMENT WRITERS WANTED**  
by department stores, merchants, manufacturers. Big demand, small supply. Our graduates earn \$1,500 to \$10,000 yearly. Write TODAY for Free prospectus of our Correspondence System of instruction. **POWELL SCHOOL OF ADVERTISING, Inc.** (Est. 1901) 1680 Meyrowitz Building, Fifth Avenue, NEW YORK



## DO NOT STAMMER

My book, "How To Stop Stammering"—a treatise of merit on "scientific talking." Price \$1. School literature FREE.

M. L. HATFIELD, Prin. of The Pacific School for Stammerers  
1918 Grove St., Oakland, Cal.

# Over 1/3 Off

This \$40.00 Set—Now \$24.80

Are you interested in Civil Engineering? Then take advantage of this great opportunity. Save over fifteen dollars on this complete and extensive work—the only books ever published covering the entire "Civil" field. These eight volumes cover the four great branches of municipal, structural, railroad and reclamation engineering, and constitute in themselves an engineering reference library which has found favor with colleges, technical schools, libraries, engineers and students throughout the country. From these books the beginner can fit himself to make a successful start in this field; the experienced engineer and the consulting expert will find them invaluable for ready reference.

## Cyclopedia of Civil Engineering

Contains 3,900 pages, 7 x 10 inches, 3,000 illustrations, full page photographs, plates, folding maps, diagrams, etc.; hundreds of valuable tables and formulas, carefully cross-indexed for quick, easy reference. Printed in large, clear type on special quality paper and bound in half red morocco, gold stamped.

### What These Books Cover

- Plane Surveying — Mechanical Drawing — Plotting and Topography — Railroad Engineering — Statics — Strength of Materials — Roof Trusses — Mill Building Construction — Cost Analysis in Relation to Engineering — Masonry and Reinforced Concrete — Steel Construction — Practical Problems in Construction — Bridge Engineering — Highway Construction — Hydraulics — Water Supply — Irrigation Engineering — Water Power Development — Sewers and Drains — House Drainage and Sanitation — River and Harbor Improvements, etc., etc.

**Shipped Free** Examine this great work before you send a penny. We want the books themselves, not what we say, to help you decide whether you need them. Merely on receipt of the attached coupon we send you the complete set, express prepaid. Take a whole week to look them over. Test them on some problems that have been bothering you. Then if you decide you want the set, send us \$2 within seven days after receipt and then \$2 a month until you have paid the introductory price of \$24.80. Otherwise tell us and the books come back without a penny of expense to you. But remember—it may be your last opportunity to get these famous books at this specially reduced price.

### Free Consulting Service

Besides the practical value of the library itself, you get a year's Consulting Membership free as a holder of these books. Our staff of civil engineers takes up and solves your problems and special difficulties, absolutely without cost to you. This privilege, which regularly sells for \$12, is yours for a full year free, if you take the cyclopedia. To find out how useful these books will be to you, you must use them. It costs nothing to look the set over. It does not obligate you in any way. We stand ready to take the books back without expense to you, if you are not pleased with them. Get the books. Examine them. Then make your decision.

### FREE COUPON Worth \$15.20 to You

American Technical Society,  
Chicago, U. S. A.

Please send me Cyclopedia of Civil Engineering for 7 days' free examination. If I decide to buy, will send \$2 in 7 days and balance \$2 a month until \$24.80 has been paid, when \$40 books and \$12 Consulting Membership will be mine. Otherwise will notify you and hold books subject to your order. Title not to pass until fully paid.  
Pop. Mech. 3-14

NAME .....

ADDRESS .....

As I have had no previous dealings with you, I refer you to



# Come to Detroit

## THE AUTOMOBILE CENTER to learn the automobile business

Sixty-seven out of every one hundred autos in the country are made in Detroit's forty-four automobile factories. There are greater and better opportunities in Detroit than in any other city in the United States. Why go to some place where they practically don't make autos, when you can go right to the "Automobile Center" and learn the business right?



**THE OLD RELIABLE SCHOOL**  
*We have successful graduates in nearly every State in the Union.*

Detroit's prestige is universal. Detroit's products are known the world over. The very fact that an automobile is made in Detroit makes it the best seller.

Automobile men from Detroit are in great demand everywhere. To anyone looking for a position or to anyone starting a garage and repair shop, the very fact that he has learned the business in Detroit, the "Automobile Center," is worth money to him. A Diploma from an auto school in Detroit gives you prestige in the automobile field.

And Detroit being the auto center, naturally must have a GOOD automobile school.

The Michigan State Auto School (incorporated under the laws of the State of Michigan) is equipped to give you unlimited, practical instruction in construction, repairing and driving of standard makes of cars. Our course also includes thorough instruction on

## All Leading Types of Electric Self-Starters

such as the Gray & Davis, Delco, Westinghouse, Ward Leonard, Deaco, Jesco, U. S. L., Adams-Westlake, Entz, Aplco, etc.

We actually have a DELCO ignition, lighting and starting system and a Gray & Davis system IN OPERATION ON A MOTOR for the students to work on. We also have the Ward Leonard in ACTUAL OPERATION and expect others any day. We give our students ACTUAL, PRACTICAL experience in installing, repairing and maintaining these systems.

In addition to getting actual garage and repairshop experience in overhauling and repairing all kinds of cars, our students ACTUALLY BUILD NEW CARS, right from start to finish, getting regular factory experience in assembling, block-testing, road-testing, etc.

We have just purchased Seven New Motors or rather the parts for seven motors. Our students get actual, practical experience in assembling these motors from start to finish after which they are put on the block test.

## Our Block Test Dept.

Davis Lighting and Starting System. We now have twelve motors in this department. Here we give our students actual, practical experience in timing motors, adjusting carburetors and magnetos, in adjusting tapets, grinding valves, scraping bearings, etc.

Our course covers the automobile thoroughly. Our students must put on the overalls and "get into things." We teach you the business RIGHT. That's why we have successful graduates in nearly every state in the Union. Our students go out and MAKE GOOD, that's why we are known throughout the country as THE OLD RELIABLE SCHOOL.

While writing to us, we would ask that you kindly write to several other schools and compare them with ours. Write for our monthly paper, the "Auto School News." It is free. It contains interesting information in regard to the automobile industry and tells you why you should come to Detroit, the automobile center to learn the automobile business.

## Our Guarantee

We guarantee to qualify you for a position as chauffeur, repairman, tester, salesman or demonstrator in a short time, or we will refund your money.

**And don't forget, we furnish positions, too**

On account of being in the auto center, we can furnish positions that cannot be obtained elsewhere.

ADDRESS DEPT. P

## Michigan State Automobile School

THE OLD RELIABLE SCHOOL

11-13-15-17 Selden Ave., Cor. Woodward, DETROIT, MICH.

*Learn to Write*



**BEGIN TODAY**  
WRITE FOR MY FREE BOOK

I can make a good penman of you at home during spare time. Write for my free book, "How to Become a Good Penman." It contains specimens and tells how others mastered penmanship by the Tamblin System. Your name will be elegantly written on a card if you enclose stamp to pay postage.

**FREE BOOK** Write for it Today

F. W. Tamblin, 418 Meyer Bldg. Kansas City, Mo.

**LEARN RAG TIME**



Let me teach YOU Ragtime Piano Playing by mail. You learn quickly—easily in 20 lessons. Even if you can't play a note I'll teach you to play any piece in Real Ragtime "Money-back" Guarantee

Write me now for special low terms and testimonials from hundreds of happy students.

**Axel Christensen (Czar of Rag-Time) Director**  
Christensen School of Popular Music  
854 Christensen Bldg., CHICAGO, ILL.

**MEN WANTED**



Prepare as Firemen, Brakemen, Electric Motormen, and colored Train Porters. First Class Standard Roads. Hundreds put to work—\$65 to \$150 a month without any experience. 500 more wanted. Uniforms and passes arranged for when necessary. Enclose stamp for Application Blank. Name position you want.

**I. RAILWAY C. I., Dept. 35, Indianapolis, Ind.**

**LANGUAGES**

German—French—English  
Italian—Spanish

or any other language learned quickly and easily by either the Cylinder or Disc Cortinaphone Method at home. Write for Free booklet today: Easy Payment Plan.

**Cortina Academy of Languages.**  
1056 Mecca Building, 1600 B'way, Cor. 48th St., N. Y.

THE ORIGINAL PHONOGRAPHIC METHOD  
DISK LANGUAGE RECORD

**A GOOD POSITION**

with **UNCLE SAM** is most desirable. Life positions, pleasant surroundings, good pay, steady work, short hours, promotions on merit. Both sexes. No political pull. Thousands of appointments yearly. Most thorough preparation \$5. Returned if not appointed. Full information and questions used by the Civil Service Commission free.

**AMERICAN CIVIL SERVICE SCHOOL** WASHINGTON, D. C.

**LEARN WATCHMAKING AND ENGRAVING**

Earn while learning. Most practical watch school. Individual instructions. Graduates in great demand. Book free.

Chicago School of Watchmaking, 63 E. Van Buren St., Chicago

**BE A DETECTIVE**

Earn from \$150.00 to \$300.00 per month; travel over the world. Write

**T. T. LUDWIG, 133 Westover Bldg., Kansas City, Mo.**

**LEARNED BY ALMOST ANYONE AT HOME SMALL COST**

**VENTRILOQUISM**

Send today 2c stamp for particulars and proof.

**D. A. SMITH, Room D 99, 823 Bigelow St., PEORIA, ILL.**

**Unlimited Possibilities**

**FOR YOU**

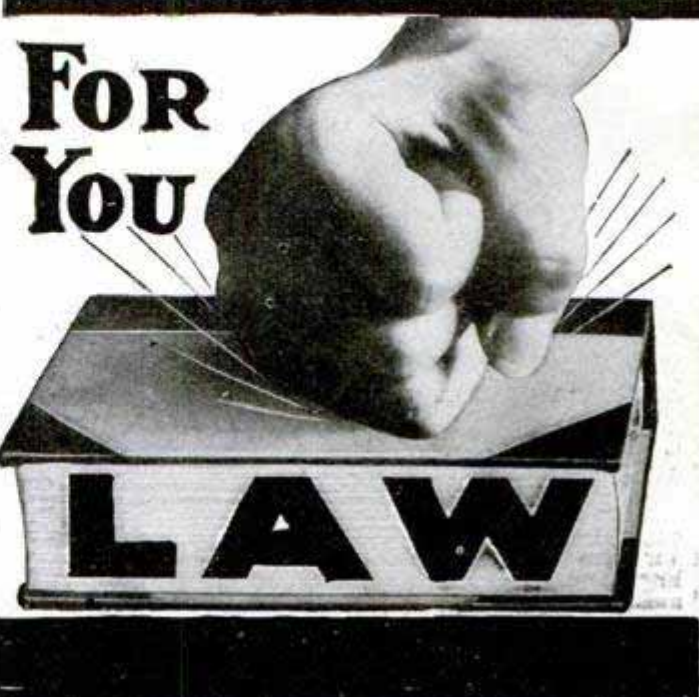

If you expect great success—a prosperous future—choose a calling offering great possibilities. There is a limit to nearly everything. A mechanic, for example, can earn only very small wages, no matter how expert he is. His greatest success must be far below that which his ability and efforts deserve. Look around you—see who are the most successful, the most prosperous, the most powerful men. They are Lawyers! Many of our greatest statesmen, capitalists and business men are Lawyers. Law is the one profession that fits a man for success in almost any line—there is no limit to the possibilities Law offers today. A Lawyer can earn \$5,000 to \$100,000 and more yearly. Let us show you how to

**Become A Lawyer**

The demand for Lawyers is increasing—Law is now a vital factor in every business—big firms need competent Lawyers for their regular staffs at large salaries. Don't decide to follow a particular line just because you think you like it best. Look before you leap—determine the possibilities—find out the incomes earned by the majority already in that line. That's the real test. If you have already chosen your life-work—no matter what it is, no matter how far you have entered into it, no matter what your age—it is not too late to start over. The La Salle is founded exactly for that purpose—to help men and women out of wrong occupations and prepare them for success, power and independence. Lack of capital makes no difference—we make terms to suit you.

**Anyone Can Learn** Law is no longer complex—you need not give up your present position and go away to college now. The La Salle Home Study Law Course has revolutionized the study of Law. Present education makes no difference—if you can read and write intelligently, the La Salle can train you to become a successful Lawyer in your own home, in spare time, by mail, as we have done for so many others situated as you are now. The La Salle law text is written in plain language by legal authorities and professors in big resident universities. Recognized as foremost home study Law Course—follows method used in resident universities.

**Guarantee** Our graduates pass bar examinations in any State and attain highest records. We guarantee to coach free and until successful any La Salle student failing to pass bar examination. We are the largest and enroll more students than any other University home study Law School in America.

**Become An LL. B.** The State of Illinois authorizes us to confer on our graduates the Degree of Bachelor of Laws, (LL. B.)

**Law Library Furnished**

Enroll now and receive complete, standard Law Library—14 volumes, richly bound, without additional cost.

**This Book Free** Write now for free copy of "Evidence," a remarkable book that shows you how to start right—that puts you on the paths of America's successful lawyers and makes possible the greatest success.

**\$100 Tuition Credit FREE**

Write now and learn how, for a short time, to secure \$100 Tuition Credit FREE. Prepare now for this dignified, lucrative profession.

**LA SALLE EXTENSION UNIVERSITY, Dept. 639 Chicago**

# Learn Electricity!



Earn \$150<sup>00</sup>  
TO  
\$300<sup>00</sup>  
a Month

Electricity is today the great motive power of the world. Its use has extended to every phase of life and industry.

Thos. A. Edison says that the field of electricity is in its infancy—that electrical workers of the future will discover uses for this great force now undreamed of.

Right now there are not enough electrical engineers to fill the big paying positions open. Every day our Free Employment Bureau has a call for Electrical Engineers greater than we can fill. Therefore, we are making a very special offer to students at this time.

Write today! Send the free coupon for our catalog and free information.

## We Teach You in a Short Time —at Small Expense

In order to supply more electrical engineers we are charging a small tuition fee. Your tools and equipment of all kinds are furnished FREE by the School. You may have easy payments if desired. Our course of instruction is clear, simple and thorough. Our Graduates demand handsome salaries. Don't pass up this opportunity.

### FREE TOOLS

We will furnish all the material and tools you use in taking our course — ABSOLUTELY FREE. All we charge is a very small amount for tuition. Many of our students earn their expenses while taking the course.

## Men Wanted for these Trades

Electricity Plumbing  
Bricklaying  
Moving Picture Operating  
Mechanical Drawing

We also teach the trades mentioned above. There are unlimited possibilities in any one of these trades. When you have completed our course you will be in a position to demand from \$5.00 to \$8.00 a day right at the start. Or go in business for yourself and make from \$3,000 to \$5,000 a year.

## Send the FREE COUPON for Catalog and Particulars

### FREE COUPON

L. L. COOKE,  
Director

Coyne National  
Trade Schools  
39-51 E. Illinois St.  
Dept. 1193, CHICAGO, ILL.

GENTLEMEN: Without any obligations on me whatsoever, please send me your school catalog and full particulars of this offer to men—ALL FREE.

NAME.....

ADDRESS.....

L. L. COOKE, Director

Coyne National  
Trade Schools  
39-51 E. Illinois St.  
Dept. 1193  
Chicago, Ill.



## Learn a Paying Profession

that assures you a good income and position for life. For twenty years we have successfully taught

## PHOTOGRAPHY

Photo-Engraving and Three-Color Work

Our graduates earn \$20 to \$50 a week. We assist them to secure these positions. Learn how you can become successful. Terms easy—living inexpensive. Write for catalogue—NOW!  
ILLINOIS COLLEGE OF PHOTOGRAPHY, 999 Wabash Avenue, Effingham, Ill.

## ELECTRICAL ENGINEERING

men with training are always in demand. Having trained over 2000 young men in the past 21 years in the fundamentals of Applied Electricity, The Bliss Electrical School, with its well-equipped shops and laboratories, is peculiarly well qualified to give a condensed course in Electrical



Including Mathematics, Steam and Gas Engines, Mechanical Drawing, Shop Work, and Theoretical and Practical Electricity, in all branches. Students construct dynamos, install wiring and test efficiency of electrical machinery. Course, with diploma, complete

## IN ONE YEAR

For practical young men with limited time. 22nd year opens Sept. 23rd. Catalogue on request. 105 Takoma Ave., Washington, D. C.

## LEARN TELEGRAPH

Morse or Wireless. Also superior station agency course. Splendid opportunities. Demand greater than supply. Graduates assisted. We own and exclusively occupy two large modern buildings equipped with K. R. and Western Union Wires and Complete \$3000 Marconi Wireless Station. Oldest and largest school—est. 39 years. Investment \$25,000. Endorsed by Railroad, Wireless and Western Union Officials. Expert practical teachers. Living expenses may be earned. Tuition low. Easy payments. Catalogs Free.

Dodge's Telegraph, Railway and Wireless Institute  
8th Street VALPARAISO, IND.

## LEARN WATCH REPAIRING

Be a watchmaker—you can learn this profitable trade by correspondence in a few weeks in your own home by the DeSelms Chart System. After you complete the course you will know a watch from A to Z. You will know just what the matter is and how to repair one. When you graduate you will be a practical watchmaker and repairer and competent to fill any position. Positions for our graduates.

Ask for our Free Book. It explains our system and terms.

THE DESELMS WATCH SCHOOL  
23 Perry Street ATTICA, INDIANA

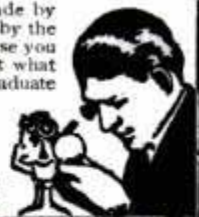

## CIVIL SERVICE

positions are in all parts of the country. Good pay, steady work, life positions, congenial surroundings, promotions on merit, short hours, annual vacation and sick leave with pay. Many thousands appointed yearly. Both sexes. No political pull. Nearly 300,000 classified positions. Common school education sufficient. Full information and questions used by the Civil Service Commission free.

COLUMBIAN CORRESP. COLLEGE, Washington, D. C.

### BE AN ILLUSTRATOR.

Learn to draw, by mail how to draw for magazines and newspapers. Send for Catalog

We will teach you School of Illustration 112 Fudge Bldg. Chicago, Ill.



## ARITHMETIC SELF-TAUGHT

A plain, easily understood volume for all who have not had the opportunity of learning this subject thoroughly, or who have forgotten what they once learned. 257 Pages. Requires no teacher. This great little book sent postpaid for 60 CENTS. Stamps accepted, leather binding \$1.

GEO. A. ZELLER BOOK CO.  
Est. 1870, 4473 W. Belle Place ST. LOUIS, MO.

SPANGENBERG'S  
PRACTICAL  
ARITHMETIC  
Self-Taught



# SHORTHAND IN 30 DAYS

We absolutely guarantee to teach shorthand complete in only thirty days. You can learn in spare time in your own home, no matter where you live. No need to spend months as with old systems. Boyd's Syllabic System is easy to learn—easy to write—easy to read. Simple. Practical. Speedy. Sure. No ruled lines—no positions—no shading as in other systems. No long lists of word signs to confuse. Only nine characters to learn and you have the entire English language at your absolute command. The best system for stenographers, private secretaries, newspaper reporters and railroad men. Lawyers, ministers, teachers, physicians, literary folk and business men and women may now learn shorthand for their own use. Does not take continual daily practice as with other systems. Our graduates hold high grade positions everywhere. Send today for booklets, testimonials, etc.

**Chicago Correspondence Schools**  
969 Chicago Opera House Block, CHICAGO, ILL.



## HOW TO TRIM SHOW WINDOWS

Shown in this new book. 150 complete windows for every season of the year illustrated by means of over 200 detail drawings and explained in 256 pages of text matter. Shipped prepaid for \$1.50. This is the 10th year for our

## SCHOOL OF WINDOW TRIMMING

**CARD WRITING AND ADVERTISING**  
Best paid and most fascinating professions in the world. A 120 page catalog FREE tells you all about it.



**KOESTER SCHOOL, 306 Jackson Boulevard, CHICAGO**

## STUDY LAW AT HOME

### The Original School and the Greatest

24 years of vital legal training—training that has made masters and won highest endorsement. Graduates are practicing in every state. Complete College Courses covering every legal matter prepared and taught by experts. Especially for ambitious young men with limited time and money. Write for catalog and "evidence."

**SPRAGUE CORRESPONDENCE SCHOOL OF LAW**  
359 American Building, Detroit, Mich.

## DO YOU LIKE TO DRAW?

That's all we want to know. Now we will not give you any grand prize—or a lot of free stuff if you answer this ad. Nor do we claim to make you rich in a week. But if you are anxious to develop your talent with a successful cartoonist, so you can make money, send a copy of this picture with 6c. in stamps for portfolio of cartoons and sample lesson plate, and let us explain.

The W. L. Evans School of Cartooning  
821 Leader Bldg., Cleveland, O.



## Mount Birds

We teach you by mail to stuff and mount all kinds of Birds, Animals, Game Heads. Also to tan skins and make rugs. Be your own taxidermist. Decorate your home with your beautiful trophies or increase your income selling specimens and mounting for others. Easily, quickly learned in spare time by men and women. Highest endorsements by thousands of students. Write today for our great free book "How to Mount Birds and Animals" Free—write today.

**N. W. School of Taxidermy, 1193 Elwood Bldg., OMAHA, NEB.**

## LEARN WATCHMAKING

and become independent. Good-paying positions secured. Easy to learn. Send for FREE CATALOG.

**ST. LOUIS WATCHMAKING SCHOOL, Dept. 5, ST. LOUIS, MO.**

## MUSIC TAUGHT FREE AT YOUR HOME

Write Today for our booklet. It tells how to learn to play Piano, Organ, Violin, Mandolin, etc. Beginners or advanced pupils.

**AMERICAN SCHOOL OF MUSIC, 50 Lakeside Bldg., Chicago, Ill.**



## BE A BANKER

Splendid opportunities. Pleasant work, short hours, all holidays off, yearly vacation with pay, good salary. Learn at home. Diploma in six months. Catalog free. **EDGAR G. ALCOORN, Pres.**  
**AMERICAN SCHOOL OF BANKING, 119 McLane Bldg., COLUMBUS, OHIO**

# Become a TRAFFIC EXPERT

## Learn at Home



## NEW UNCROWDED OCCUPATION, BIG PAY

Thousands of large shippers and all Railroads need trained Traffic experts and Managers—newly created positions are open with salaries of \$35 to \$200 weekly. The demand for competent trained men is greater than the supply. Recently enacted railroad rate laws and interstate commerce regulations have produced new conditions that necessitate trained specialists—men who know how to route shipments, to obtain shortest mileage, quickest deliveries—lowest rates. With such knowledge you can qualify for an important, big-salaried position with a future—quick.

## WE TRAIN YOU BY MAIL

at home, in spare time, without giving up your position or income. The cost is small—we make the payments to suit you. All you need, to get into this powerful, big paying occupation is our training. No matter where you live, what you work at now, how small your pay, how long your hours—no matter what your age or education—if you can read and write intelligently—our Interstate Commerce Course will train you expertly to handle proficiently a big Traffic job—to merit and retain influence, respect, power and \$35 to \$200 weekly.

## MOST THOROUGH METHOD KNOWN

The LaSalle method is simple, practical, logical—anybody can readily master it. It is the work of some of the greatest Traffic Experts in America. It covers thoroughly every feature of the profession you will ever need to know—it is different and more complete than any other method of home-training in Interstate Commerce ever known. This is the largest home-study Extension University in the world—our graduates are recognized as real experts—they are trained to do the kind of work that commands big positions.

## NEW UNCROWDED OCCUPATION

This is a new uncrowded occupation—there's room for you if you prepare at once. Let us train you now for a big future, with power, dignity, respect and a big income, with almost unlimited opportunities. All you need is a desire and proper training to become a big man with independence and a big income. Don't remain in a small job that thousands of men are constantly after—let us make you the master—the big man—a successful leader among men.

## FREE—Wonderful Book

Send the coupon below now and receive free copy of our much-talked-of book "10 Years Promotion in One"—learn more about the opportunities afforded Traffic Experts with our training—learn about the big positions now open—learn how easy it is for us to make you a traffic specialist. Remember only trained men can secure the big positions now open—remember that big employers are seeking properly trained and efficient Traffic men. Send the coupon—no money.

**La Salle Extension University, Chicago**

**La Salle Extension University, Dept. 641 Chicago, Ill.**  
Send at once, without expense to me, FREE copy of your famous book "10 Years Promotion in One"; also book telling how I may, without interfering with my present position, prepare myself as Traffic Expert.

Name .....

Address .....

Occupation .....

Please Mention Popular Mechanics

# Your Memory Can Make or Break You

**Prof. Henry Dickson**  
America's foremost authority on Memory Training, Public Speaking, Self-Expression, and Principal of the Dickson Memory School, Auditorium Building, Chicago, Ill.

## I Will Train You To Remember

Thousands of big successful men all over the country are constantly demonstrating my system of memory training is absolutely scientific, correct, and easily mastered.

As I have trained thousands of others in the past 26 years, I will train you to remember practically everything that comes within range of your consciousness, if you will give me ten minutes a day of your spare time. Train you to remember facts, faces, arguments, figures, appointments—to make your brain a classified, systematically filed treasure house of information available for instant use whenever you want it. I will train you to concentrate, to think on your feet, to make impromptu speeches with that natural ease and confidence that overcomes opposition and wins friends.

### Nothing Mysterious About My Method

Your mind can be trained and developed exactly like your muscles. My memory training system is simply a series of brain exercises so graded and arranged that they bring your memory to a state of perfection in the shortest possible time and with the least effort. These exercises can be studied at home in your spare time without interfering with your occupation.

## If You Want to Succeed Don't Overlook This Opportunity

Now is the time to take stock of yourself—be square with yourself. *Are you able to remember—to think on your feet?* If not, and you have any desire to win in the intense competition of today—you must train NOW! The sooner you realize this the sooner you will start on the road to real success. When you start with my system of memory training you will be astonished at your progress—at your ability to think and remember. *You can have a perfect memory*—you can become a dominant personality, a man to reckon with.

## FREE My Valuable Book "How to Remember"

Simply send your name and address on a postal today—you will receive this booklet by return mail—it may be the first step to greater success than you had ever dreamed of.

### How to Get Free "How To Speak In Public" Copy of Book

If you wish to be able to *think on your feet*—to meet emergencies—to express yourself clearly, logically and convincingly whether talking to one person or to a thousand, my book, "How to Speak In Public" will explain how. De Luxe edition handsomely illustrated, richly bound. Price is \$2.00, but I will present a copy absolutely FREE to every student who enrolls for course of memory training within ten days after reading this advertisement.



**Prof. Henry Dickson, Prin.**  
**Dickson School of Memory**

705 Auditorium Building, Chicago, Illinois

What possible hope can you have of success if you can't remember facts, faces or names—if you can't remember to do the things you had planned to do—if you are compelled to use that most inexcusable of all excuses, "I forgot"—all the more pitiful because absolutely unnecessary.

Many men of very ordinary ability have risen far above their fellows because consciously or unconsciously they have trained their memories so that they never fail them.

You may dig and grind 'till the crack of doom, but the only learning that will do you any good is that which you *remember*.

There are thousands of readers of this magazine who are now taking various Correspondence School courses in law, electricity, advertising, bookkeeping, accountancy, etc. Every one of these students would get far more benefit from these courses if each had been trained to remember in the Dickson school of Memory. The college graduate who fails to remember all that he has been taught is worse off than the poor fellow who never had any chance to learn. The costliest mistake in the social, political or business world—golden opportunities lost—are due directly to forgetfulness.

Are you equipped to make the most of every opportunity—if not it's time to



# J-M ASBESTOS ROOFING



Maine Manufacturing Company's Plant, Nashua, N. H.  
One of the Largest Refrigerator Factories in the World. Covered with J-M Asbestos Roofing.

## Not a Cent For Paint or Repairs In Twenty Years

The great plant illustrated above was covered with J-M Asbestos Roofing twenty years ago and in all that time it *has not cost a cent for maintenance.*

A remarkable record. But not exceptional for J-M Asbestos Roofing. This roofing has given similar service for fifteen to thirty years on hundreds of buildings of all types.

J-M Asbestos Roofing never requires coating, gravel, or any other form of protection—because it contains nothing to deteriorate.

Made of Asbestos (rock) fibres and Trinidad Lake Asphalt—both minerals.

Literally a roofing of pliable *stone*, with all the qualities of stone. Gives perfect fire protection. And is not affected by heat, cold, salt air or chemical fumes.

Lower in first cost than tin, slate or shingles. *The cheapest of all roofings on the cost-per-year basis.* J-M Roofing Cleats, packed in each roll, make joints absolutely water-tight. And as they eliminate the smearing of seams with black cement, they give the roof an unbroken, handsome white surface.

Furnished in ready-to-lay and built-up form. Sold direct if your dealer can't supply you. Write our nearest Branch for specimen of Asbestos rock and Booklet No. 3371.

## H. W. JOHNS-MANVILLE CO.

Manufacturers of Asbestos Shingles; Roofings; Stucco; Pipe Coverings; Cold Storage Insulation; Waterproofing; Sanitary Specialties; Acoustical Correction; Cork Tiling; Fireproof Doors; etc.

Akron	Charlotte	Denver	TRADE ASBESTOS MARK	Memphis	Philadelphia	San Francisco
Albany	Chicago	Detroit		Milwaukee	Pittsburgh	Seattle
Atlanta	Cincinnati	Duluth	Minneapolis	Portland, Ore.	Syracuse	
Baltimore	Cleveland	Galveston	Newark	Rochester	Toledo	
Birmingham	Columbus	Houghton	New Orleans	St. Louis	Washington	
Boston	Dallas	Houston	New York	St. Paul	Wilkes-Barre	
Buffalo	Dayton	Indianapolis	Omaha	Salt Lake City	Youngstown	
		Kansas City				
		Los Angeles				
		Louisville				

THE CANADIAN H. W. JOHNS-MANVILLE CO., LIMITED—Toronto, Montreal, Winnipeg, Vancouver

2286



## “Here’s what you need—Training”

“Jim, if you want to get ahead in this shop you’ve got to know more. You’re just an ordinary workman now, but you have ability and I’m going to give you some good advice. See this coupon? Well, it wasn’t so many years ago that I signed one just like it. At that time I was in the same position you are—holding down a little job at low wages. I was losing ambition every day—had almost concluded that I’d never be anything but an underpaid shop hand, when I happened to notice one of these ad’s. I signed the coupon, and the job I hold today I owe to this school.”

Yes, it *is* good advice. You, no matter if you haven’t much of a job and are poorly paid, have ambition and brains and the ability to rise. Other men have become successful, have risen to big jobs and big pay through training. Why not *you?*

### How you can become a trained man

The *American School of Correspondence*, one of the largest educational institutions in the world, was established over sixteen years ago for just such men as you. It is chartered under the same laws as your state university. Through the *American School* you can obtain the training and education you need without leaving home—without giving up your work. No matter where you live, the *American School* will train you for any position you desire or prepare you for entrance into any resident college.

Then follow this advice and prepare yourself in your spare time for any one of the countless big, well-paying positions always open. Sign the coupon and let us tell you how easy it is. We will not send an agent to bother you in your home or at your work. All business will be carried on privately, by correspondence.

Take the first step—sign the coupon—*now*.

# American School

of Correspondence, Chicago, U.S.A.

### Your Opportunity Coupon

Mark the position you want  
and mail the coupon now

- |                               |                          |
|-------------------------------|--------------------------|
| ....Electrical Engineer       | ....Lawyer               |
| ....Elec. Light & Power Supt. | ....Bookkeeper           |
| ....Electrical Wireman        | ....Stenographer         |
| ....Telephone Expert          | ....Private Secretary    |
| ....Architect                 | ....Accountant           |
| ....Building Contractor       | ....Cost Accountant      |
| ....Architectural Draftsman   | ....Cert'Fd Public Acc't |
| ....Structural Draftsman      | ....Auditor              |
| ....Structural Engineer       | ....Business Manager     |
| ....Concrete Engineer         | ....Fire Ins. Inspector  |
| ....Civil Engineer            | ....Fire Ins. Adjuster   |
| ....Surveyor                  | ....Fire Ins. Expert     |
| ....Mechanical Engineer       | ....Moving Picture Op'r  |
| ....Mechanical Draftsman      | ....Sanitary Engineer    |
| ....Steam Engineer            | ....Irrigation Engineer  |
| ....Municipal Engineer        | ....Textile Boss         |
| ....Gas Engine Engineer       | ....College Preparatory  |
| ....Gas Tractor Engineer      | ....Auto. Mechanician    |

NAME .....

ADDRESS .....

Pop. Mech. 3-14

This school has no connection with any other school using the name “American”

Please Mention Popular Mechanics

# Popular Mechanics Magazine

WRITTEN SO YOU CAN UNDERSTAND IT

Vol. 21

MARCH, 1914

No. 3

## Bayonet Fencing a Soldier's Sport

**F**ENCING with bayonets is the most popular as well as the most dangerous game among soldiers in the regular army. Those who participate must be strong and skillful, the game is not one for weaklings. The regulation outfit is a mask, heavily padded coat and padded gloves. The bayonets used are tipped with rubber, but despite all these precautions, men are often hurt in the set-to. Each regiment has its champions, selected by a process of elimination from the various companies.

When these champions meet on one of the field days often held at brigade posts, the rivalry is intense.

Fencing Duel between Regimental Champions at an Army Post

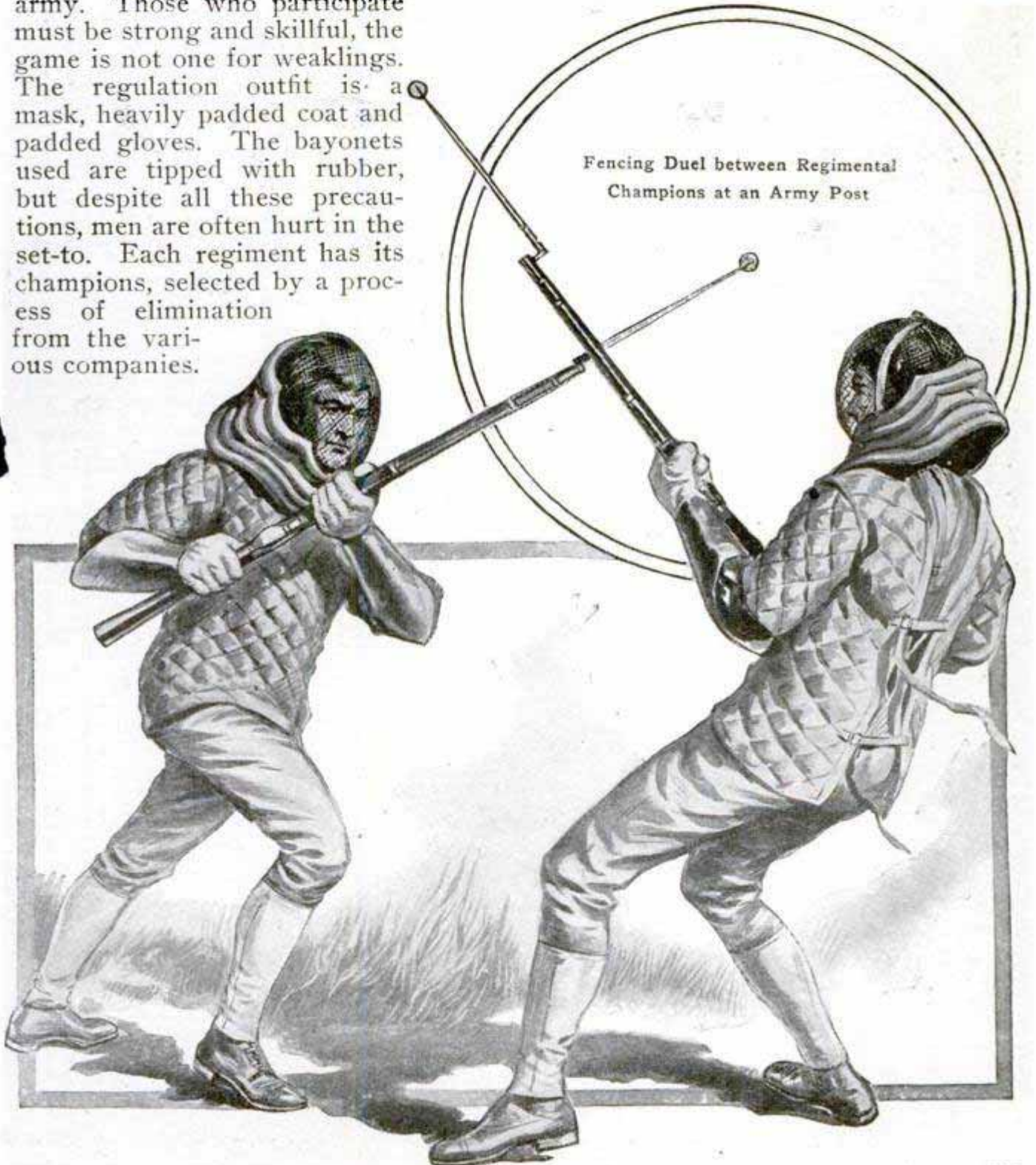

## MINING DIAMONDS BY MODERN METHODS

Machinery and barbed wire have supplanted the crude methods of break-

protected by high fences of barbed wire, with intricate arrangements at the corners and at the gates. About 4,000 miles of wire are used in the defenses about the Kimberley mines.

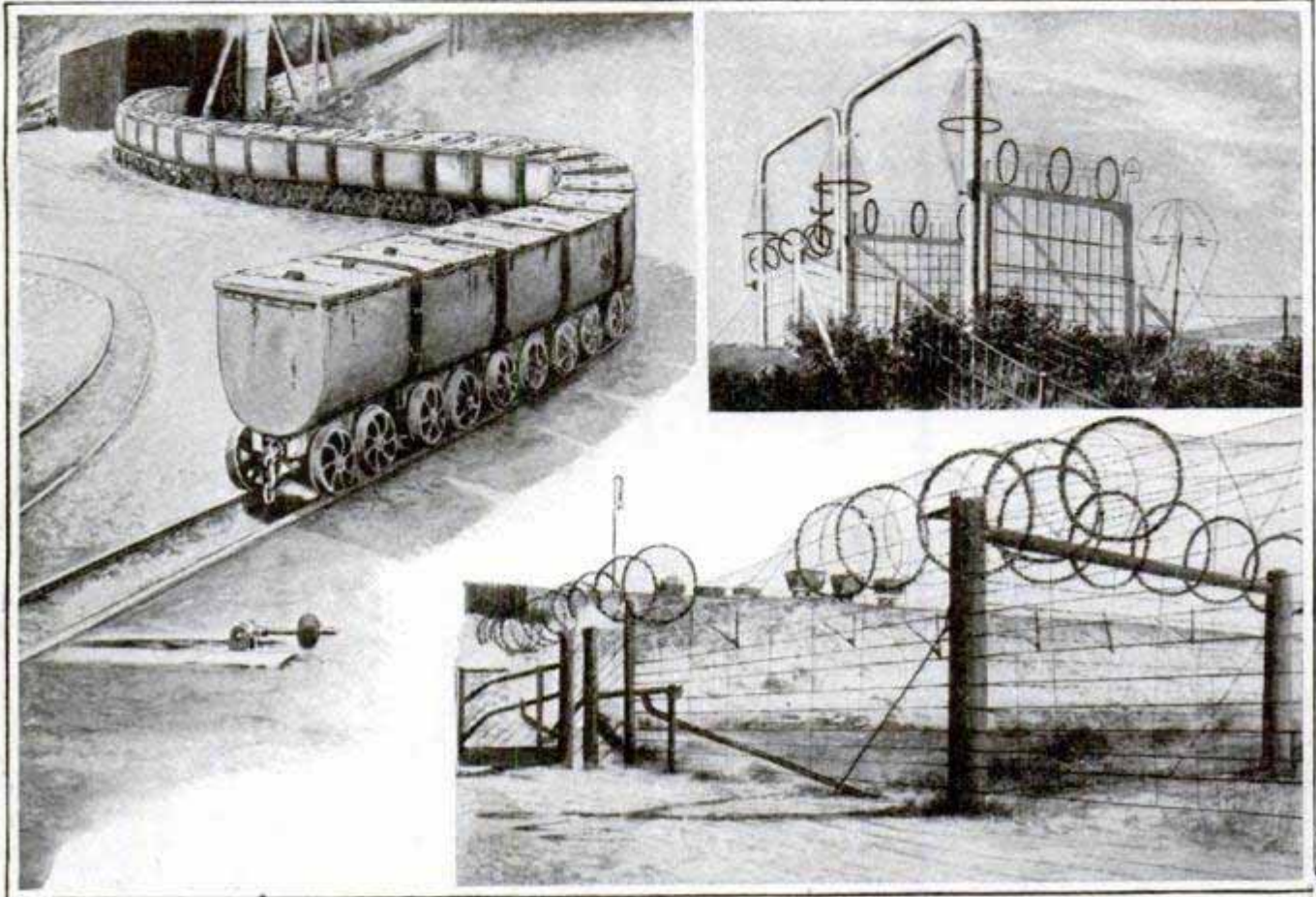

Covered Steel Trucks Carry Diamond-Bearing Earth from Mines to Pulsators. The Grounds are Protected by Barbed-Wire Fences with Unclimbable Gates and Corners

ing up diamond-bearing blue earth and protecting the valuable finds employed 20 years ago in the South African diamond mines. The depths of the strange crater-shaped hole in which the peculiar diamond-bearing earth is confined, is now penetrated by shafts, reaching hundreds of feet down into the earth, with 40-ft. levels. The broken earth is removed in closed trucks to the surface, where, after a season of exposure to sun and atmosphere strewn on the ground, it is hauled to the mills. Here pulsators finally locate the diamonds on grease-covered inclined tables, to which the diamonds adhere, while loose sand, earth and gravel are washed away by water. Acres of ground, covered by broken earth brought up from the mines, contain possibly millions of dollars worth of gems, and these treasure-troves are

## BRINGING BIG TREES TO SAN FRANCISCO

Old trees from India, Africa and the Philippine Islands have been uprooted and transported by elephants, ox team, horse and mule-power, electricity, steam and sail to the grounds of the Panama-Pacific Exposition in San Francisco. The method employed is interesting, as it was at first thought impossible to accomplish this without a very large percentage of these centuries-old trees dying.

A rectangular cut is made around the base of the tree at some little distance from the edge of the trunk, severing the side roots, leaving the bottom roots only to nourish the tree. Boards are forced down into these cuts to prevent the side roots from growing together again, and the tree is then left

undisturbed for six months. By that time the tree has become accustomed to living through its bottom roots, and these are now severed, and boards forced beneath the tree, which is then pulled over on its side. The boards are then secured into a rough box, wrapped heavily with wire rope, and the tree lifted by derrick to car or wagon, or is hauled to the shipping point by such power as is available.

Hoisted on shipboard, the tree is kept from the light, and when, weeks or months later, it arrives at the exposition grounds it is living, but in a sorry condition. A place having been prepared for it in rich soil brought from forest lands on the Sacramento River, it is replanted under conditions most favorable for its continued growth. The box is removed and the tree carefully nursed for 30 days, by which time it has again fastened its roots into the earth and will, in all probability, live.

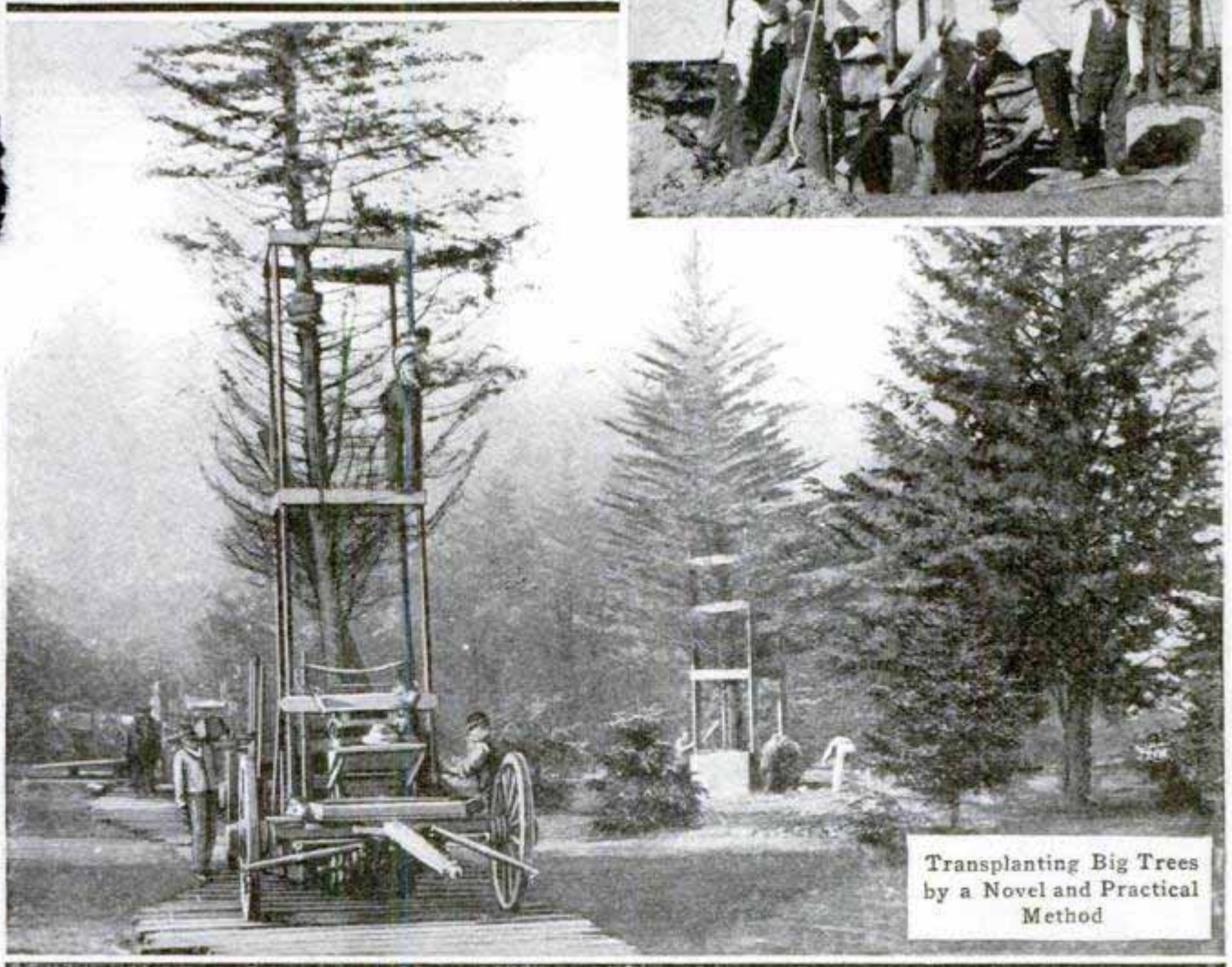
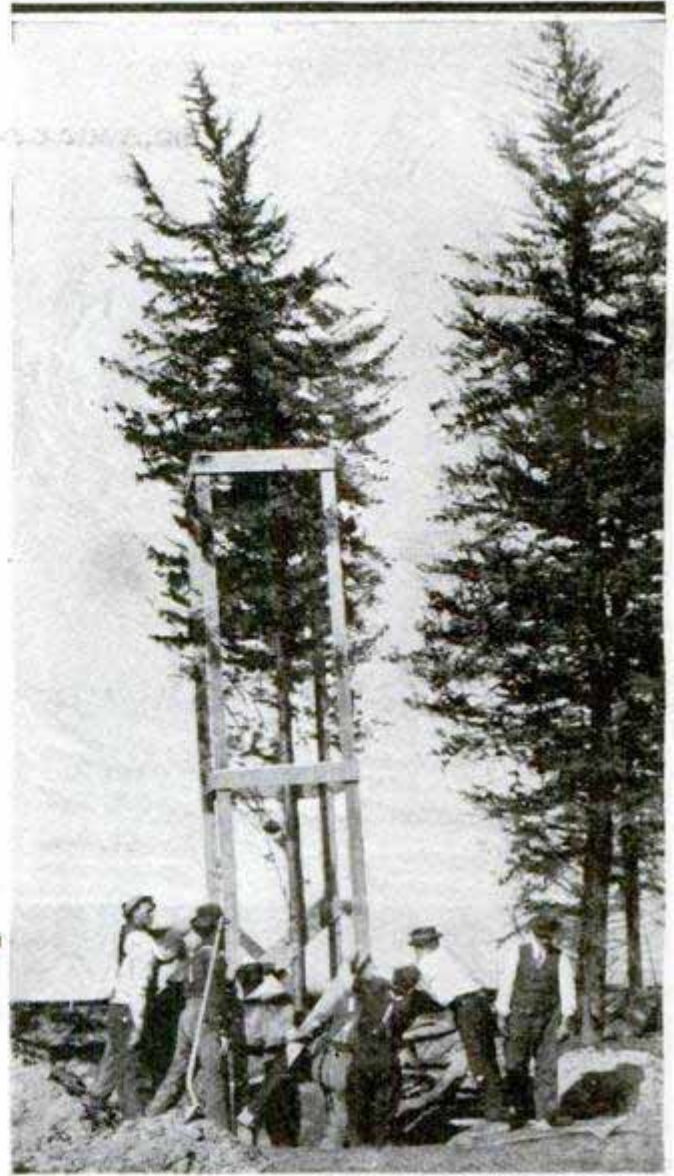

Transplanting Big Trees  
by a Novel and Practical  
Method

## SUBMARINES NOW AT COLON MADE LONG TRIP

Lying at the wharf at Colon, four of the five submarines which are to form a part of the Pacific coast defenses on

Accompanied by the monitor "Montauk" and a collier, these tiny warships crossed the Caribbean Sea and established a new claim to seaworthiness by their excellent behavior. The Caribbean is notoriously a bad patch

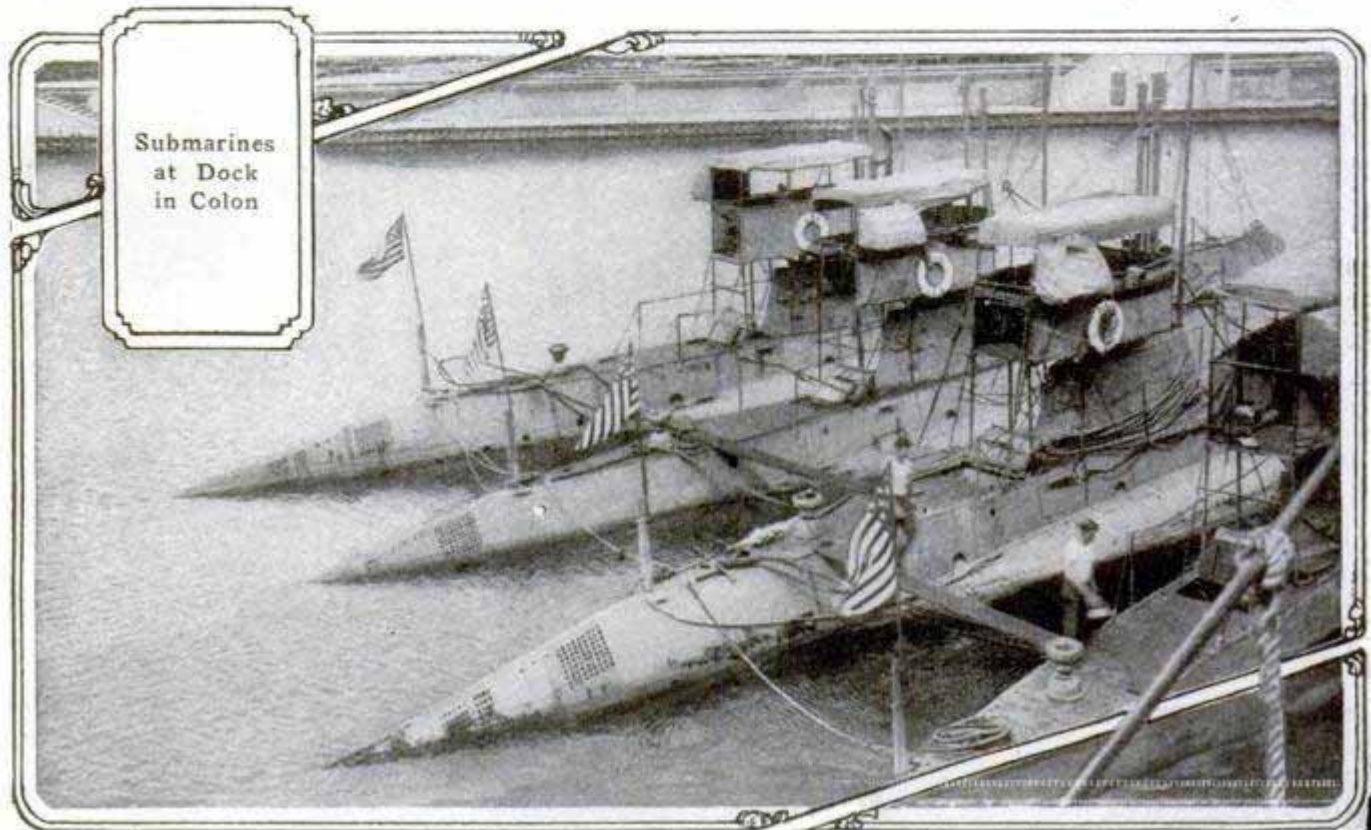

Submarines  
at Dock  
in Colon

Copyrighted by Underwood & Underwood

the Panama Canal, preparatory to their trip through the locks, were photographed after their record-breaking sea voyage from Guantanamo, Cuba.

of water, and that this flotilla was able to negotiate the distance, some thousand miles, in good order and at normal speed is considered an excellent feat.

## IS THE NOSE RING COMING BACK IN STYLE?

A famous French actress contends that wearing a nose ring gives a particularly coquettish expression to the countenance. She has suffered herself to be photographed in support of her views. It is a relief to learn, however, that the ring is simply "stuck on," although, to all appearances, the nose is pierced.

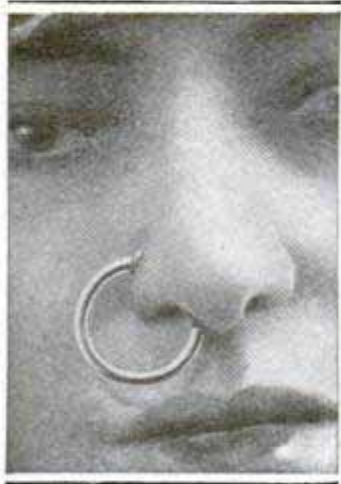

## SAFETY LAMPS NOT ALWAYS SAFE

The advent of the electric lamp for use in mines was hailed as the end of explosions, which had been frequent with old-style oil lamps, even when equipped with approved safety devices. But experiments have shown that a small piece of picture wire across the terminals of one of the small two-volt batteries, immediately becomes red hot, and easily lights a cigarette. Even if the battery box is locked and the safety terminals applied, it has been shown that two pins stuck through the cable which connects the accumulator to the lamp will afford such contacts for the current that a piece of iron wire stretched between the pins



will glow, giving enough heat to flash gas. Homemade cigar lighters operated by careless miners from these so-called safety lamps might readily cause disastrous explosions.

### FRENCH BUILDING CRANE INTERESTING APPLIANCE

French contractors make use of an ingenious derrick, crane and hoisting apparatus in erecting modern structural-steel office buildings. A trussed arm is supported from a central tower, and pivoted to move in any direction. A movable crane runs upon this arm, carrying suitable hoisting apparatus. The central tower is connected by trussed supports to other and smaller towers, the whole being capable of handling efficiently very considerable loads of structural steel.

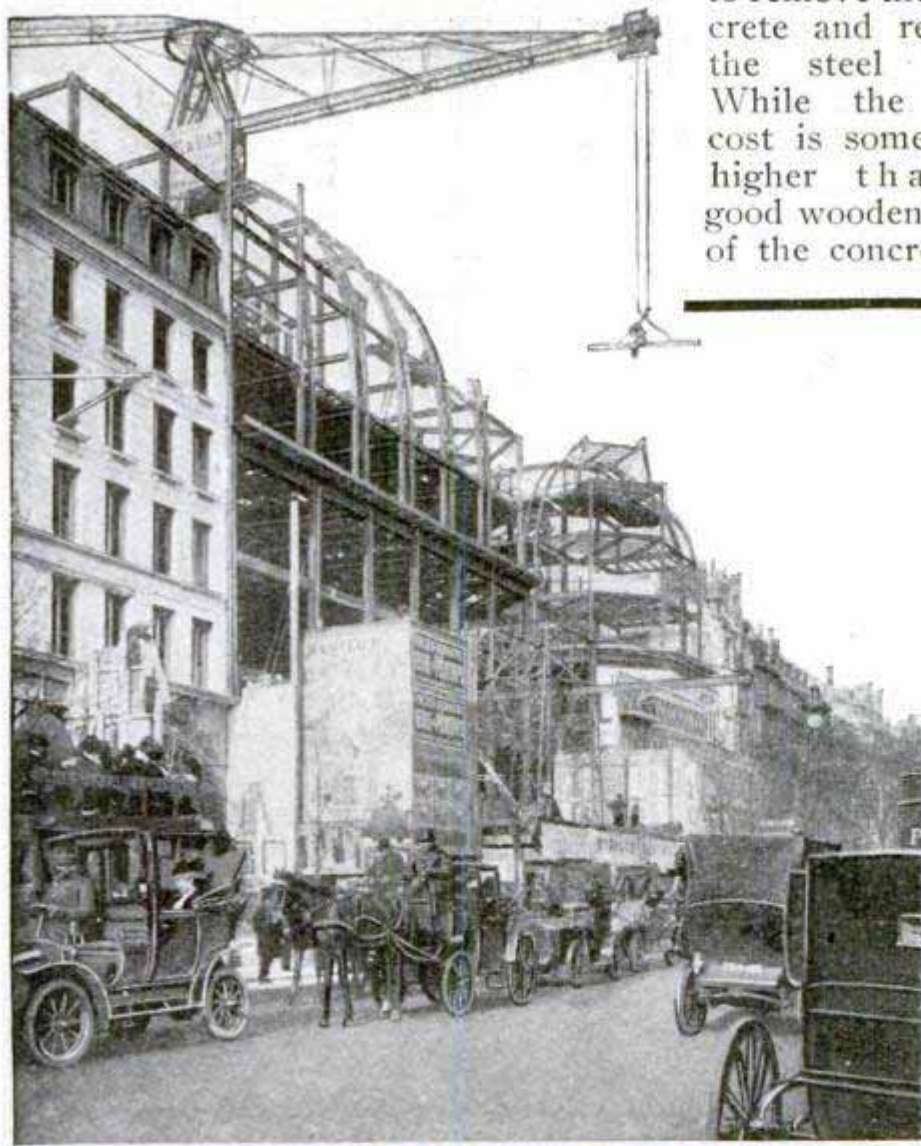

### A CONCRETE CASE OF TREE PROTECTION

To protect growing trees with some degree of permanency, the use of concrete has been adopted, reinforced by steel bars and rings, a singularly pleasing design resulting. The concrete tree box lends itself readily to decorative features, and color may be introduced to harmonize with foliage or house coloring. When the tree outgrows its narrow box, it is no great matter to remove the concrete and release the steel bars. While the first cost is somewhat higher than a good wooden box, the lasting qualities of the concrete make it worth while.

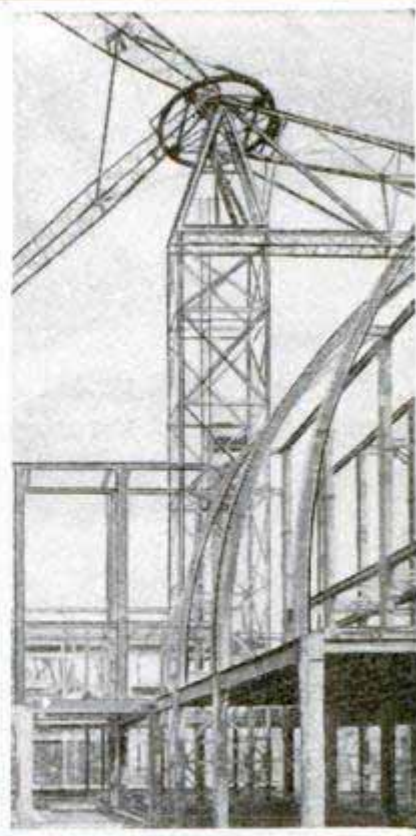
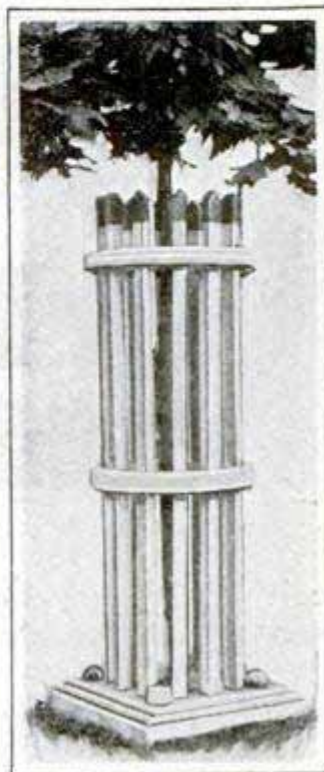

Ingenious Derrick with Movable Crane and Hoist. Right, Trussed Beams Supporting Central Tower

### COLLAPSIBLE BOX KITES USED BY GOVERNMENT

The United States experts use box kites in many meteorological experiments, but have hitherto found diffi-

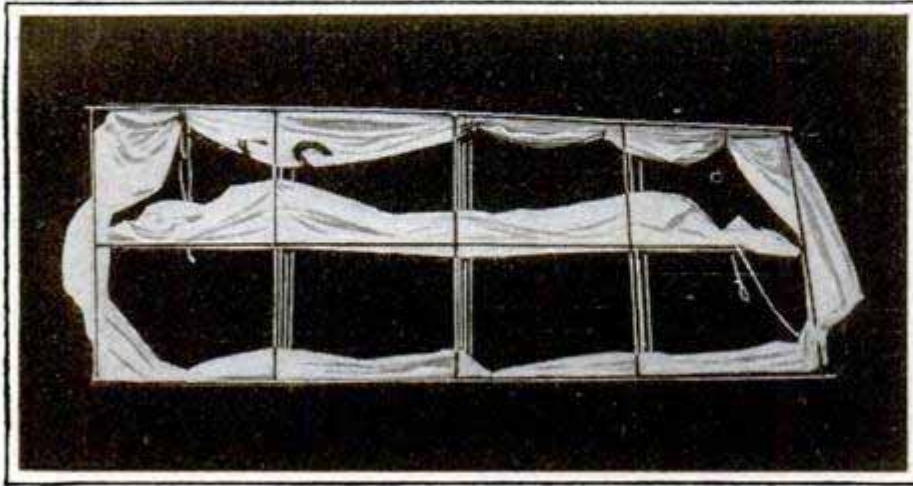

New Box Kite Designed by Government Experts for Easy Shipment

culty in transporting them across the country from one station to another by reason of their shape and size. A novel type has been devised which, by cutting a few strings and loosening four bolts, permits the kite to be knocked down into flat, compact form, very much like a collapsible box or carton. Hinged joints are arranged at suitable points and the kite may be erected quickly, without requiring expert knowledge. When ready for shipment the kite takes up but little room and can be easily handled by one man.

### WIRELESS MESSAGE SENT TO ARCTIC EXPLORER

Through Canadian government channels a wireless message was sent to Donald B. MacMillan and his fellow explorers at Etah, Greenland, from the American Museum of Natural History. It was a "cheer-up" message of Christmas greeting, and while no response was received or expected, it is believed the message reached its destination. Doctor MacMillan's party is equipped with wireless apparatus, although it is not able to send messages over the 1,600 miles, which separate it from New York.

### NAVY PUTS EDUCATIONAL PLAN INTO EFFECT

By a general order promulgated by the Secretary of the Navy the plan for the education of enlisted men, outlined by Secretary Daniels in the September, 1913, number of this magazine, was put into effect at the beginning of the year. The instruction under both academic and technical heads is under the general direction of the commanding officer on each ship, and commissioned, warrant and petty officers will assist the men to improve themselves, not

only in learning trades, but in such other instruction as may be needed by enlisted men who have not had the benefits of a good school education. From 1:15 to 2:30 every afternoon, save Saturdays, Sundays and holidays, will be devoted to the self-improvement of every man on the ship. Special attention will be given warrant officers seeking commissions, petty officers striving for warrant rank, and enlisted men who are now taking correspondence courses in outside institutions.

### TURKISH POSTAGE STAMP COMMEMORATES VICTORY

A new series of postage stamps was issued by Turkey in commemoration of the recapture of Adrianople, which bears an artistic representation of the mosque of Selim II, the finest structure in the city. Turkey has not issued many artistic stamps, and the new series is out of circulation, being used for only one month.



## BLIND TO HEAR PRINTED CHARACTERS

The fact that metallic selenium is a better conductor of electricity when light shines upon it than when in the dark, is the basis of numerous experiments looking toward ameliorating the condition of the blind. A recent invention called an optophone consists of a box containing a check-board group of selenium cells, each connected with a modified telephone receiver which is applied to the ear. When a printed page in large type, as a poster, is passed in front of this instrument in a strong light, each cell in the group will sound a musical note in the receiver, and the blind man may detect the letter from its note or chord. The letter A, for example, when passed in front of this instrument gives a rising and falling scale, while the middle bar maintains the note for a perceptible instant. The blind man quickly learns to distinguish this combination of sounds as A, and in time to memorize the alphabet. Refinement of the process may, possibly, revolutionize the whole field of teaching the blind.

## STREET-RAILWAY TRANSFERS COUNTED BY WEIGHING

In many street-railway offices transfers are now counted by the simple and rapid method of weighing. All the transfers to be counted are dumped on the main pan of the scales. In place of the usual weight, a pan containing a given number of transfers, usually 25, is slid along the bar for securing a balance, the relative weight of the transfers in the two batches is thus determined, and from this the number of transfers in the batch being weighed is secured.

## HOT SPRINGS OF ICELAND MAKE NATURAL LAUNDRY

In Iceland hot springs boil up out of the earth and are utilized by housewives for washing their clothes. At



Reykjavik the springs are railed off as a measure of precaution, for in the past women have slipped into the boiling water and lost their lives. Iceland is of volcanic origin, earthquakes are not infrequent, and the hot springs are constant reminders of the thinness of the shell which separates the frozen land from internal fires.

## SEARCHLIGHT MAKES SHIPS IN WAR COLOR VISIBLE

That the war color of naval vessels was selected because of its invisibility by day rather than by night, is the statement recently made by a naval officer, and tests seem to show that a vessel painted in this color, while difficult to see in daylight, is easily picked up and made visible by a searchlight at night. In one case a vessel painted in the war color was detected at a distance of 17,000 yd. under the searchlight. There seems to be an insuperable difficulty in connection with this. For night work alone black is believed to be the best color, but this is a color too easily distinguished in daylight to be considered.

### DEVICE BEATS TIME FOR CONGREGATION

An unique contrivance designed to beat time for congregational singing has been installed in a Vineland, N. J.,

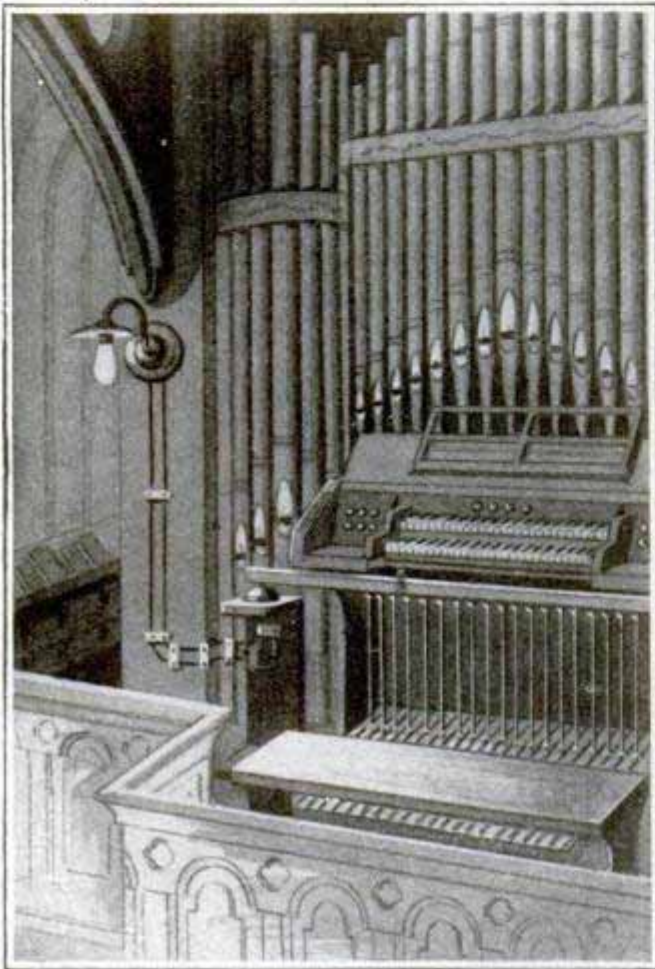

Light Aids Congregation to Keep Time

church. It consists of a circuit attached to the lighting system, the switch being operated from the footboard of the pipe organ. When the organist's foot presses the bass pedals the crossbar is pulled by rawhide thongs, and opens and closes the circuit in perfect time with the music. A light is placed in front of the choir loft connected with this switch, and flashes rhythmically in plain sight of the congregation.

For the purpose of communicating with the fire commissioner's office the fireboat "James Duane," of the New York fire department, has been equipped with wireless and it is planned to install similar equipment on the entire fleet of 11 vessels.

### FAIL TO WIN PRIZE FOR NEW MOTOR FUEL

An English society offered a prize of \$10,500 some time since, for a fuel which would replace motor spirit by a less costly fluid. Thirty-eight papers from competitors living in eight countries were received and referred to an eminent scientist, upon whose recommendation, however, all were refused, none of the applicants having succeeded in complying with the conditions.

### BREAKING STONE WITH CANNON BALL

A cast-iron cannon ball, weighing 3,000 lb., was used by a contractor to break up masses of rock at a quarry near Pittsfield, Mass. It was hoisted by a derrick boom, and a jerk of the cord released it. The workmen became quite expert in this and the rapidity

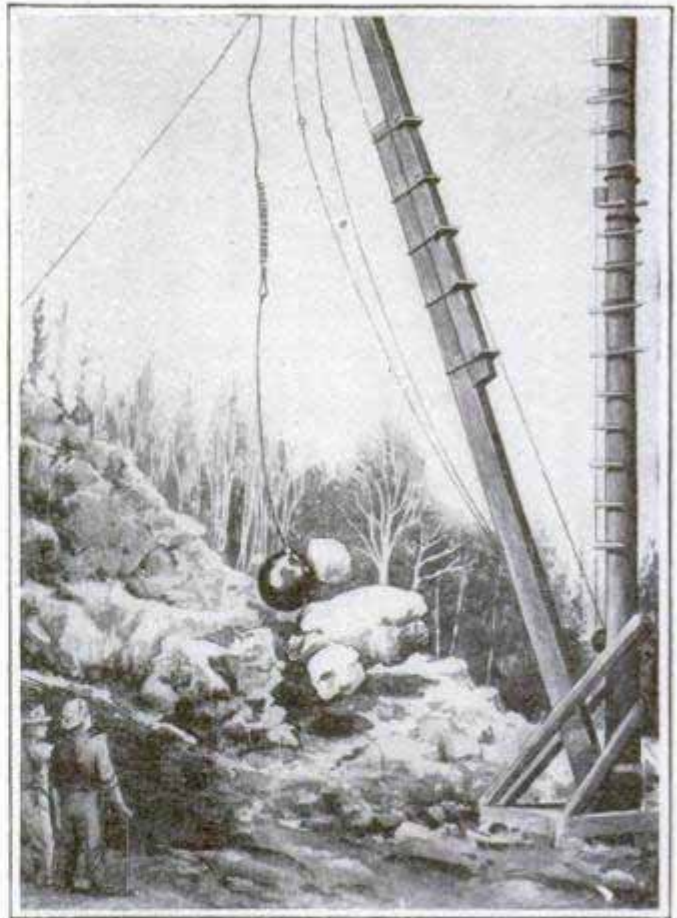

A Cannon Ball Used for Peaceful Task

and efficiency of its operation made it available wherever the contractor had blasted rock to break up.

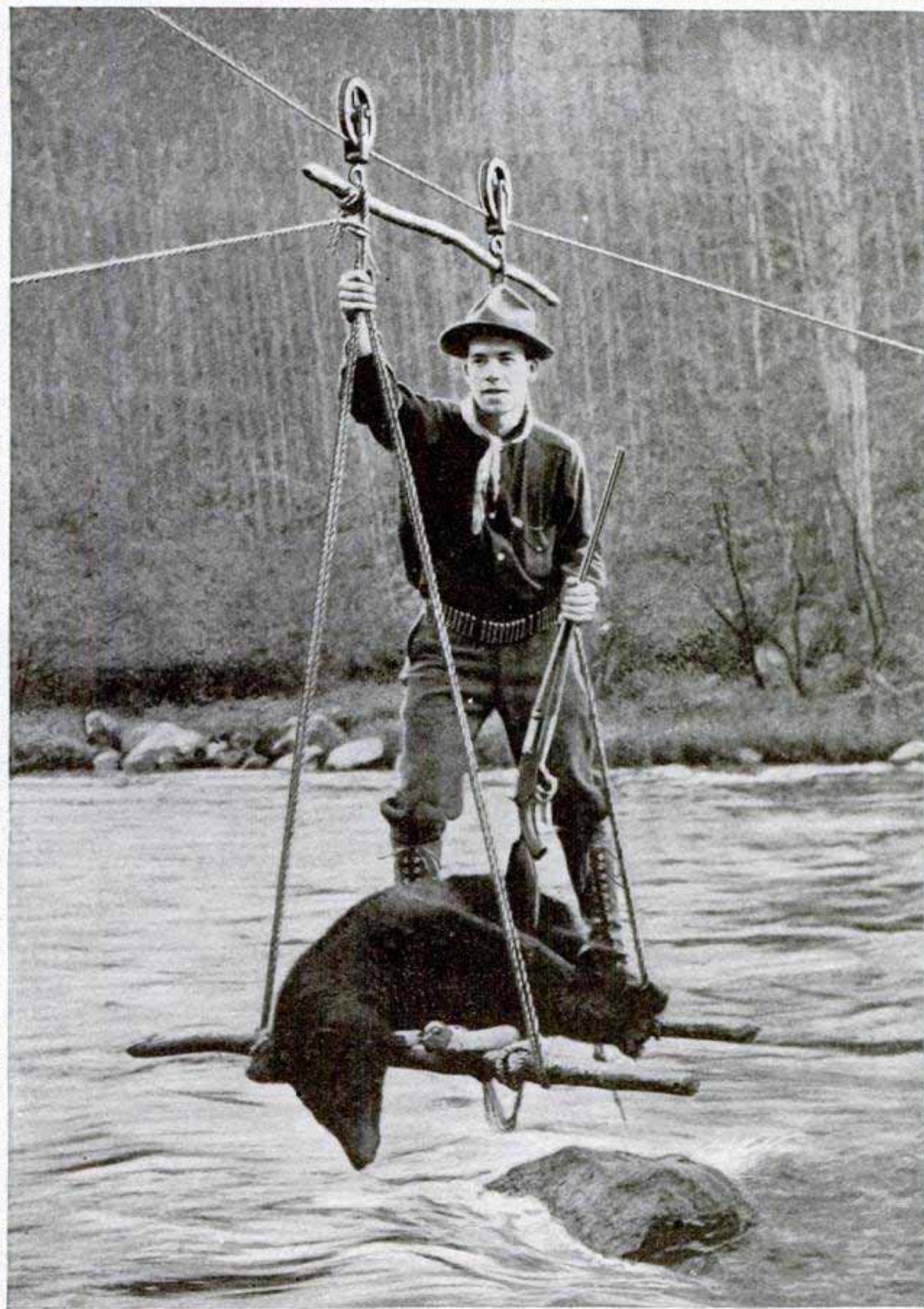

Every Year During the Hunting Season Sportsmen Flock to the Slopes of the Adirondacks for the Big Game That Abounds in That Region. Formerly it was Often Necessary to Abandon the Result of the Day's Sport on Account of the Difficulty of Transporting It across the Turbulent Streams, on Which it is Difficult to Handle a Boat of Any Kind. This has been Overcome at One Point on the Sacandaga River by the Erection of an Improvised Aerial Railway across the North Branch of This Stream

## PORTABLE SEARCHLIGHT FOR U. S. MARINES

A 40-in. searchlight, mounted on a light truck, and a gasoline engine and



dynamo on another, form a compact lighting plant for exploration and signal purposes, now a part of the equipment of the United States Marine Corps. The searchlight itself and a reel of heavily insulated wire, 1,000 ft. long, may be drawn by hand, or by a pair of horses or mules. The power plant is a 2-cyl. gasoline engine, which drives the generator by a detachable belt. The engine is water-cooled, and simple in construction. The searchlight has a shutter for use in signaling, by means of which messages by the Morse or navy code can be sent for long distances.



New Lighting Equipment for Marines

## STREET-CAR HEATERS CAUSE PEAK LOAD

That the current used by the electric heaters of street cars is one of the most important factors in the total amount of current consumed in a big city during the winter is indicated by charts showing the relative consumption in Chicago on cold days and on the "dark days" by which that city is occasionally visited. Comparison of the chart for a clear day and for a day when it was almost as dark as night, the temperature being about the same on both days, shows that the average consumption for the dark day was about 10,000 amperes greater than for the clear day during business hours.

All this excess is attributed to the operation of lights, as the power and heating requirements would be about the same in both cases. The record load for the month, however, occurred on a clear day when the temperature was low, and it was apparent that this excess load was caused almost entirely by the consumption of current by the electric heaters which are now exclusively used in the street cars.

ⒸThe use of chemical extinguishers for fighting forest fires has not proved very successful. Forest officers, in explaining this fact, say that the unlimited supply of oxygen in the open tends to neutralize the effect of the chemicals.

## IMPROVED METHOD USED IN TUNNEL BUILDING

In the two-mile Mount Royal tunnel, completed last December, gangs working from either end joined headings after 17 months, by the use of a new method of handling drills. Usually drills are applied to the face of the rock and borings made sufficiently deep to plant the dynamite cartridge, when the drills, which weigh 80 lb. apiece and more, are dragged back by main force out of the danger zone and the charge exploded. The drills are then dragged forward, and again applied to the rock. This entails an immense amount of extremely hard labor. The Montreal engineers, however, mounted the drills on a horizontal bar, connected with a steel beam on a

carriage running on steel rails, which could easily be run back 20 ft. After the shot was fired, the beam was run forward, and an endless chain carried out the "muck," or broken rock.

## NEWSPAPER MADE FOR USE AS WRAPPING PAPER

Two days each week a daily paper published at Eberswalde, a Prussian town near Berlin, is printed on only one side of the sheet, and on these days the paper is made twice as large as usual so that the public loses nothing in the way of reading matter. The object of this curious arrangement is to make the paper useful as well as instructive, as it can then be used for wrapping up provisions without any touch of printers' ink.

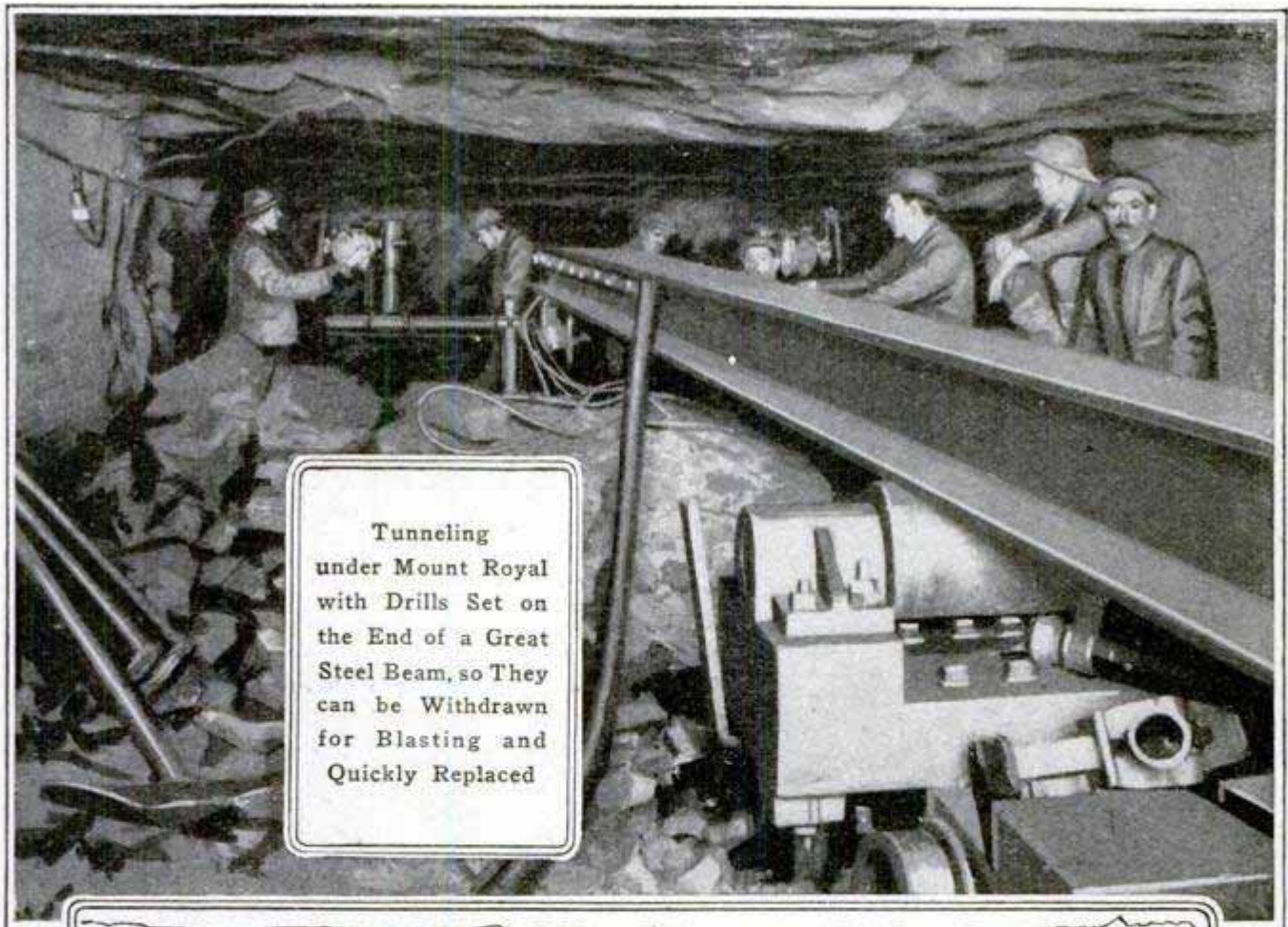

Tunneling under Mount Royal with Drills set on the End of a Great Steel Beam, so They can be Withdrawn for Blasting and Quickly Replaced

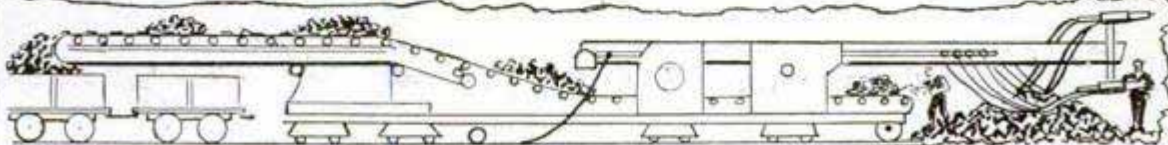

Horizontal Bar with Drills, and Endless Chain Loading Rock on Cars

## SINGLE-WHEELED TRUCK FOR MADAGASCAR

A truck of novel design has been constructed by a French official in Madagascar, consisting of a metal



Courtesy L'Illustration  
Practical One-Wheel Truck for Use in African Brush

body with but one wheel. In spaces on either side of the wheel a load of approximately one ton may be carried. The flat, stiff shafts serve to keep the truck balanced and the harness is so arranged that any kind of a draft animal may be used; ox, mule, or horse. With two men in charge, this truck is capable of supplanting 40 native bearers. The body is water-tight and can cross shallow watercourses without damaging the load.

## BUILD NEW TUNNEL TO CUT DOWN AIR RESISTANCE

When a train moves through a tunnel the resistance of the air is an important factor, experiments having demonstrated that it measures 13.86 lb. per ton of train weight in the Simplon tunnel, as against only 8.8 lb. in the open air, a difference of over 50 per cent. This is when the train is running at 37 miles an hour in the direction of the ventilating air current; when running in the opposite direction the resistance increases to 20.46 lb. These facts point out the significance of the new tunnel, costing some \$9,000,000, which is now being built and will parallel the old, with numerous cross tunnels connecting them, to promote an equilibrium between the air masses in the tunnels, and thus reduce the resistance.

## ELECTRICITY WILL DETECT FRAUD IN MAPLE SUGAR

Granulated sugar at less than 5 cents a pound is similar to maple sugar retailing at four times that price, but the flavoring and the color is so small an amount that the identification of granulated sugar in maple sugar is not easy. However, a Canadian scientist has employed electricity to detect adulteration, and as pure granulated sugar offers a certain definite resistance to the passage of electric current, and maple sugar offers a different resistance, he finds it a mere matter of reading the ohmmeter to determine the purity of any sample.

## CANARY BIRD DETECTS BAD AIR

The canary has been found to be extremely susceptible to the presence of carbon monoxide, the dreaded "white damp" of the coal mine, and rescue parties from the Bureau of Mines now take with them cages containing these birds, when penetrating entries and chambers in search of injured or dead miners. A small proportion of the white damp in the air causes the canaries great uneasiness, and close observa-



tion of the actions of the birds enables the rescuers to retreat before being themselves overcome by the gas.



## SIGN WARNS THOUGHTLESS MASTERS

Bicyclists, motorcyclists, and automobilists who own dogs, sometimes fail to remember that dogs cannot keep up



Photo by Paul Thompson  
Sign Speaks for Doggie

with men who ride the flying wheel. An English society is distributing signs bearing the appeal: "Remember, You Ride, I Run!"

## CO-OPERATION IN STUDY OF WIRELESS

Wireless telegraphy has enabled the French and American authorities to determine within the one-hundredth part of a second the difference in time between Paris and Washington. The interchange of signals between the Eiffel tower and the radio station at Arlington will be continued, and experiments and studies will be made in such subjects as the photographic registration of wireless signals and the velocity of wireless waves. In carrying on this work the two governments exchange officers, so that there are always some French naval officers at Arlington and some American naval officers at Paris.

## THE MIGHT OF THE MOONLIGHT

Sleeping in the moonlight in the tropics is attended, so it is said, with danger. There is an affliction called "moon blinks," which has been traced to the reflected light of the moon, caused by polarization of reflected light. This has no connection with the one-time popular superstition that sleeping in the moonlight caused insanity, whence came the name "lunacy." One scientific publication concludes that the bad effect observed in fish exposed to the rays of the moon may produce sickness in humans.

## GREAT WALL OF CHINA IN PERFECT CONDITION

Few people realize what an almost perfect condition prevails along a large part of the great wall of China. The bricks of the parapet are as firm as ever, and their edges have stood the severe climatic conditions of North China with scarcely a break. The paving along the top of the wall is so smooth that one may ride over it with a bicycle, and the great granite blocks with which it is faced are smooth and as closely fitted as when put in place over two thousand years ago. The



The Great Wall of China Still Well Preserved

entire length of this wall is 1,400 miles, it is 22 ft. high, and 20 ft. in thickness. At intervals of 100 yd. or so, there are towers some 40 ft. in height.

# HUNTING THE BIGGEST OF ALL BIG GAME

By ROY C. ANDREWS

*Assistant Curator of Mammals, American Museum of Natural History*

*Illustrated with Photographs by the Author*

WITH the perfection of the harpoon gun, invented by Svend Foyn, a Norwegian, began a new era in the history of whaling. This invention has made possible the capture, in tremendous numbers, of the fin whales, animals which had been little troubled by the men who hunted in a small boat with a hand harpoon and lance, because their great speed and tendency to sink when dead, as well as their thin blubber and short, coarse "whalebone," or baleen, made them difficult and unprofitable to kill.

Svend Foyn discovered that by mounting a small cannon, which shot a heavy harpoon, upon the bow of a small iron steamer the fin whales could be killed in sufficient numbers to warrant the erection of stations at certain places upon the shore near the feeding grounds of the animals, where the huge carcasses could be hauled out of the water by means of a steam winch and

converted into commercial products. These shore stations proved so immensely profitable that within a few years they had been erected in almost every part of the world where conditions were favorable—in Newfoundland and Labrador, Alaska, British Columbia, Washington, Oregon, Mexico, South America, and the islands of the Antarctic; on the coasts of Japan, Korea, Africa, and Russia. Australia has recently been invaded; in New Zealand humpback whales are being taken in wire nets, and so in nearly every part of the globe the world hunt goes on. But it is from the stations on the South Atlantic islands that the greatest fortunes are being made today.

It was only after years of experimenting that the harpoon gun of the present time was evolved. This is a short, heavy cannon, 51½ in. long, with a 3-in. bore, and is mounted upon a swivel which works easily up and



A Modern Steam Whaling Ship, with Harpoon Gun Mounted in the Bow

The Modern Harpoon Has Four Barbs  
and an Explosive Head

The Harpoon Line Passes through  
the Platform to a Winch

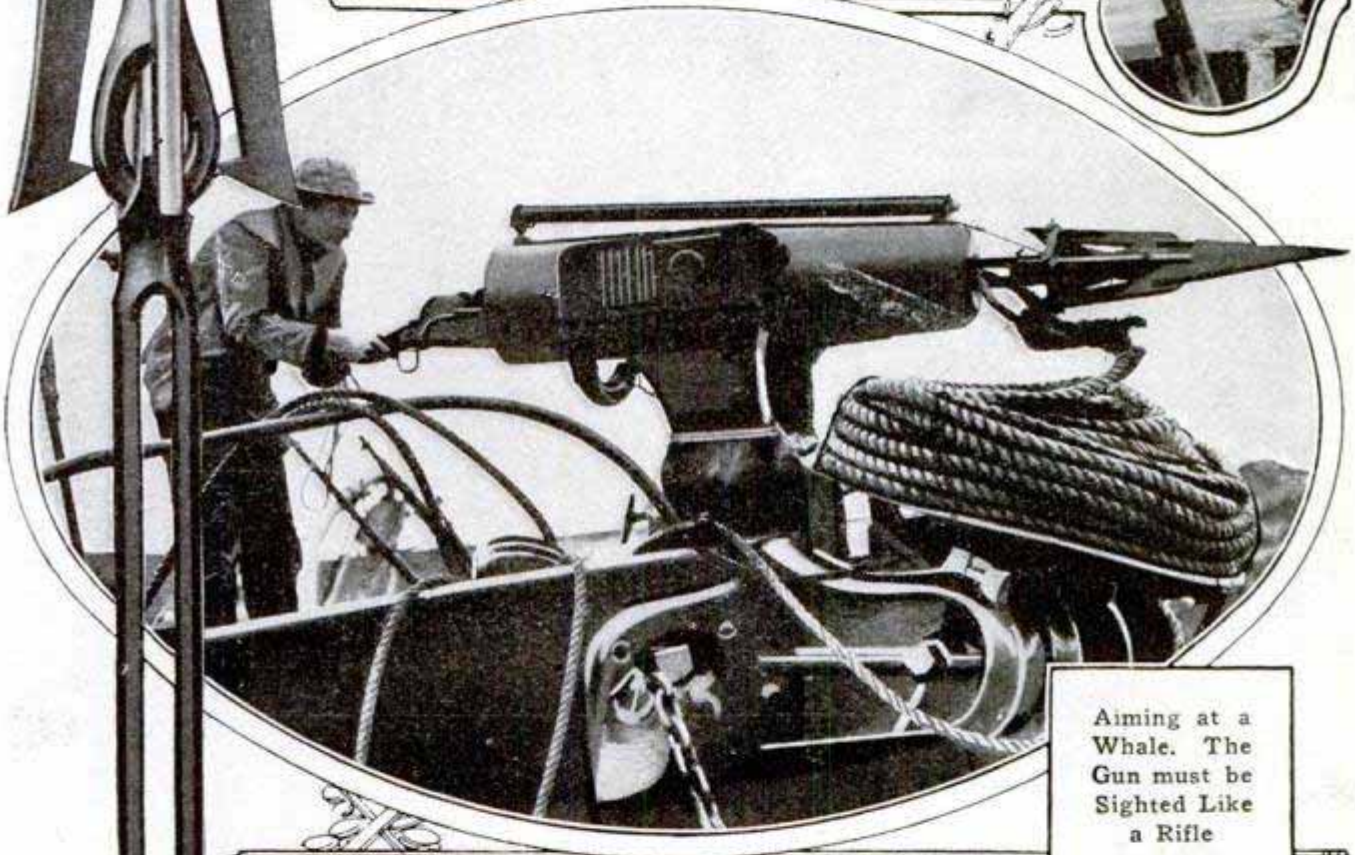
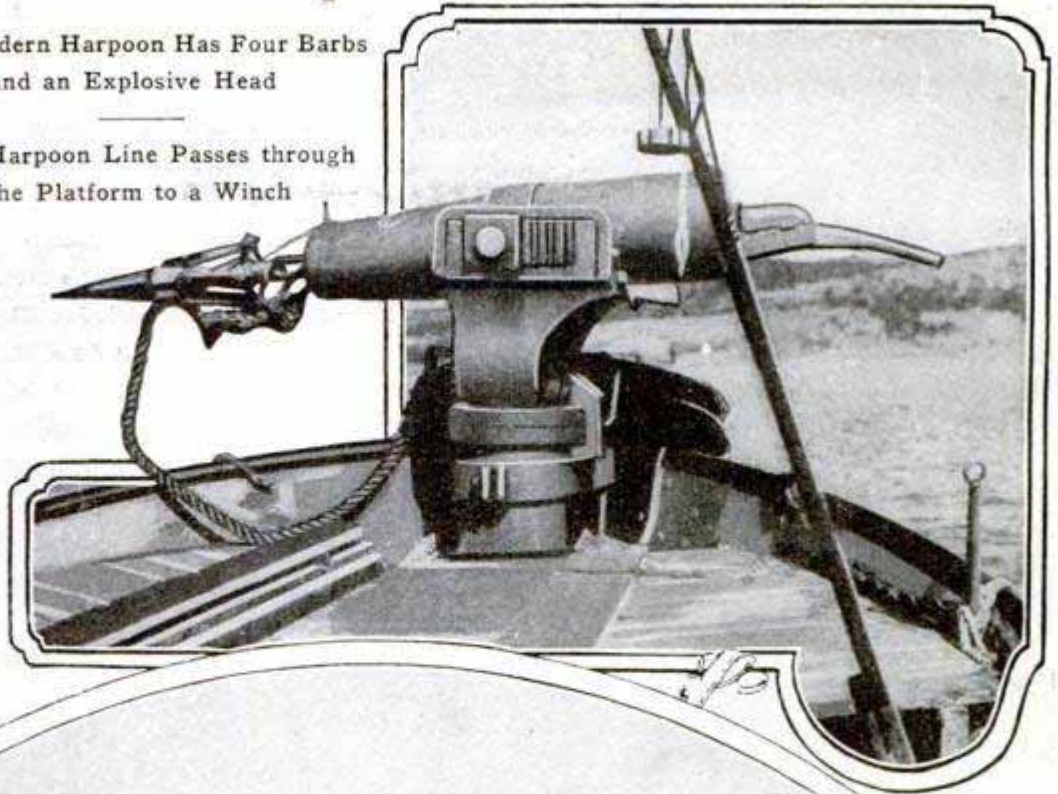

Aiming at a  
Whale. The  
Gun must be  
Sighted Like  
a Rifle

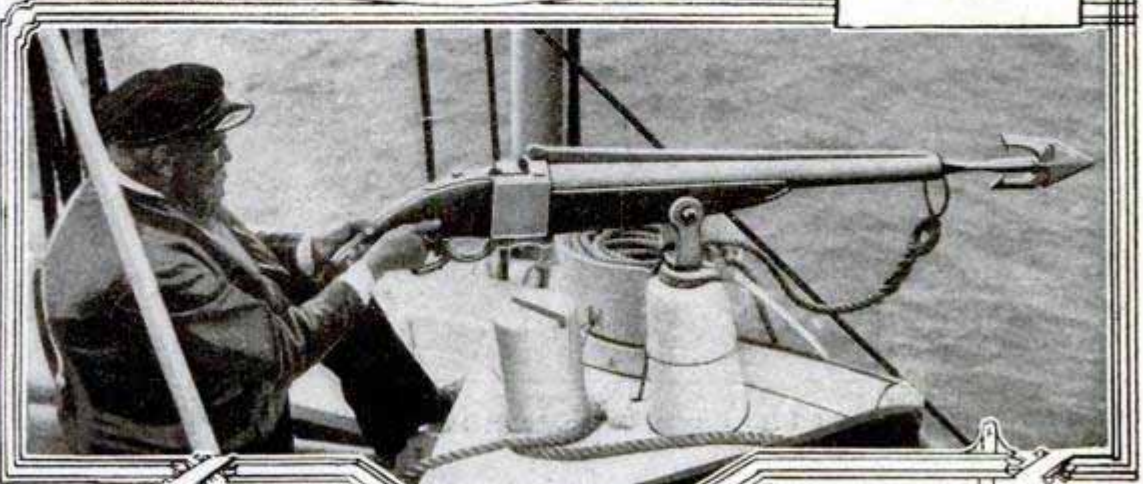

A Lighter Form  
of Harpoon and Gun,  
Used for Smaller Sea Animals

THIS PHOTO COPYRIGHT  
BY UNDERWOOD AND  
UNDERWOOD

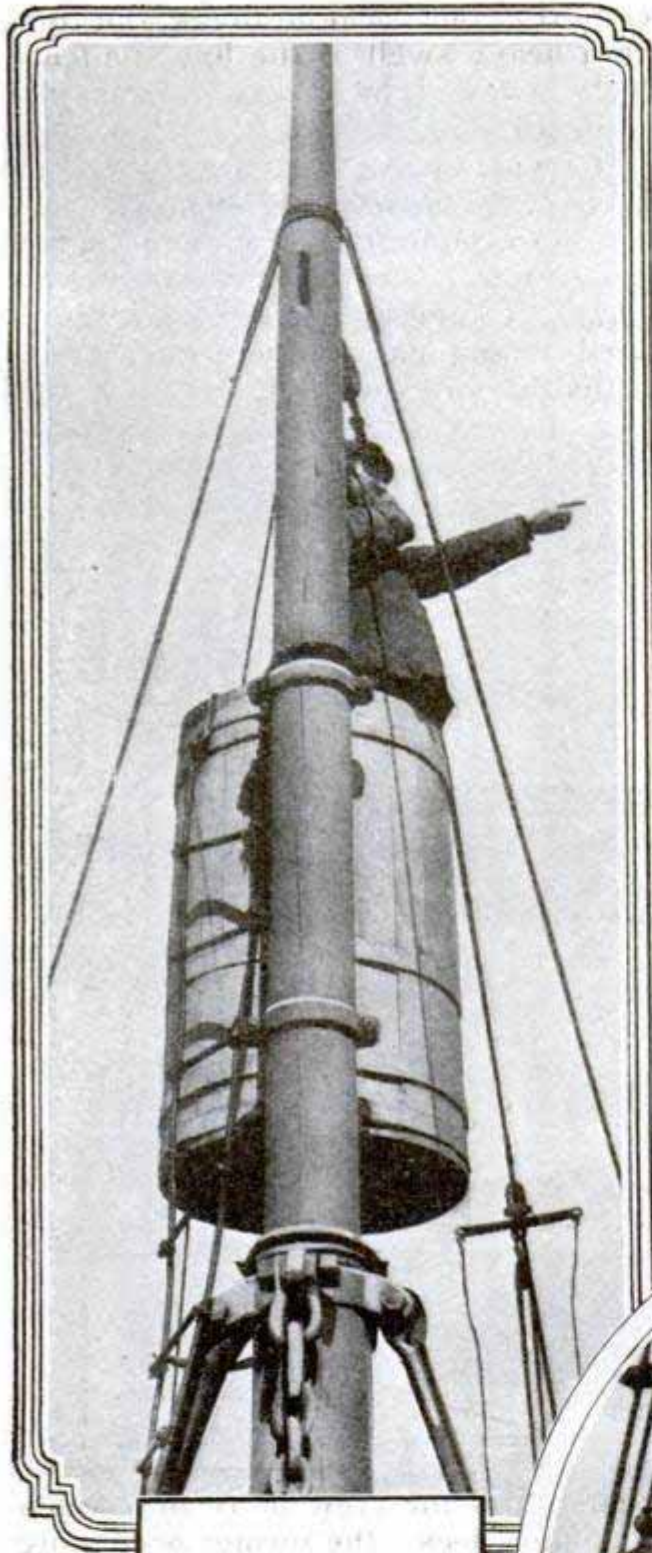

Lookout in the "Barrel"  
Sighting a Whale

Loading the Harpoon Gun  
While Awaiting a Signal from  
the Lookout That a Whale is in Sight

down and from side to side. At the butt end a short wooden handle projects, under which is an iron lever, the trigger. The charge is 300 to 375 drams of very coarse black powder, which is sewed up in a cheesecloth sack and rammed in from the muzzle; then come wads of oakum, hard rubber or cork, and wool, after which the harpoon, well greased, is pushed in and hammered solidly into place with a wooden mallet. Some guns require more powder than do others, but if too much is used the harpoon will be bent when leaving the muzzle.

The gun is effective to a distance of 150 ft., but few whales are killed that far. Generally the animals are shot when not more than 60 to 90 ft. away, and at this range the gun is as accurate as a rifle and must be sighted almost as carefully.

The harpoon is 76 in. in length and has a double shaft, at the end of which are four 12-in. flukes, or barbs; these spread and prevent the iron from drawing out of the whale's body. The tip of the harpoon is a hollow point, called the "bomb," which is filled with powder and ignited by a time fuse; three of four seconds after the discharge of

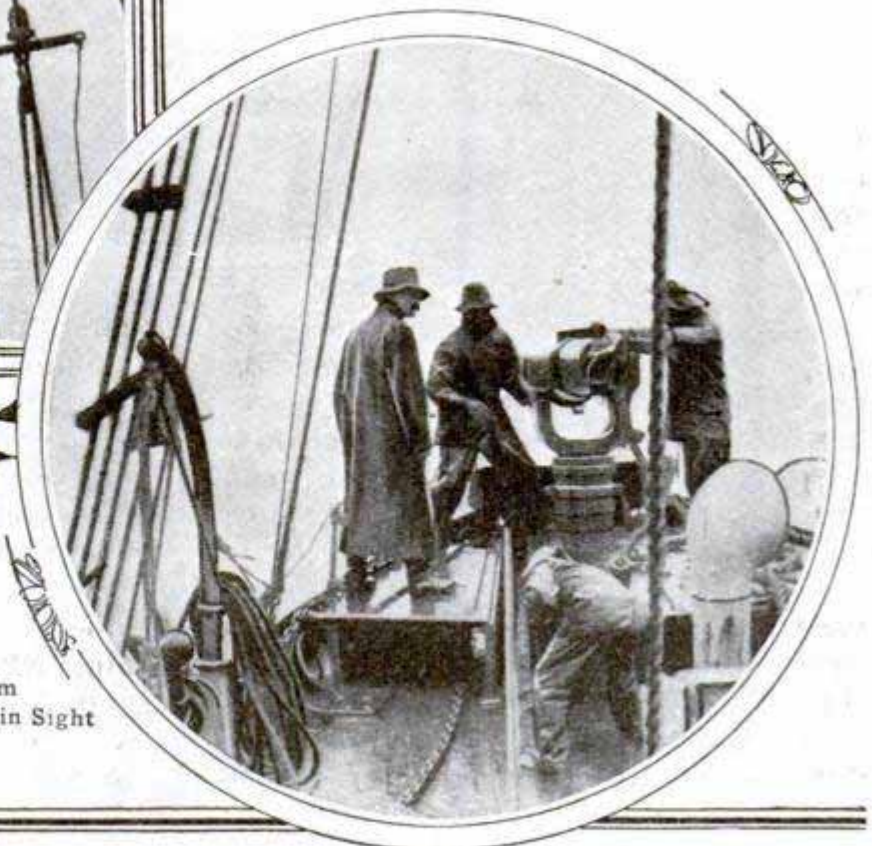

the gun the bomb bursts, often killing the whale almost instantly. The best Swedish iron is used in the construction of the harpoon and it weighs about 110 lb. After it has been fired into the body of a whale it is usually badly bent and twisted, but the tough, elastic iron can be straightened by the station blacksmith and made as good as new.

A large wire ring slides freely along the double shaft of the harpoon, and to this one end of a rope is fastened.

jerks, the ropes seldom break, but during a heavy swell, if the line suddenly slacks away, I have seen it part like whipcord.

The whaling steamers are trim, high-bowed vessels of about 100 tons burden, 90 to 100 ft. long, and have a speed of from 9 to 12 knots (10 to 14 miles an hour). Round-bottomed to facilitate speedy manipulation, they ride the water like a cork, but roll and pitch tremendously in the slightest seaway.

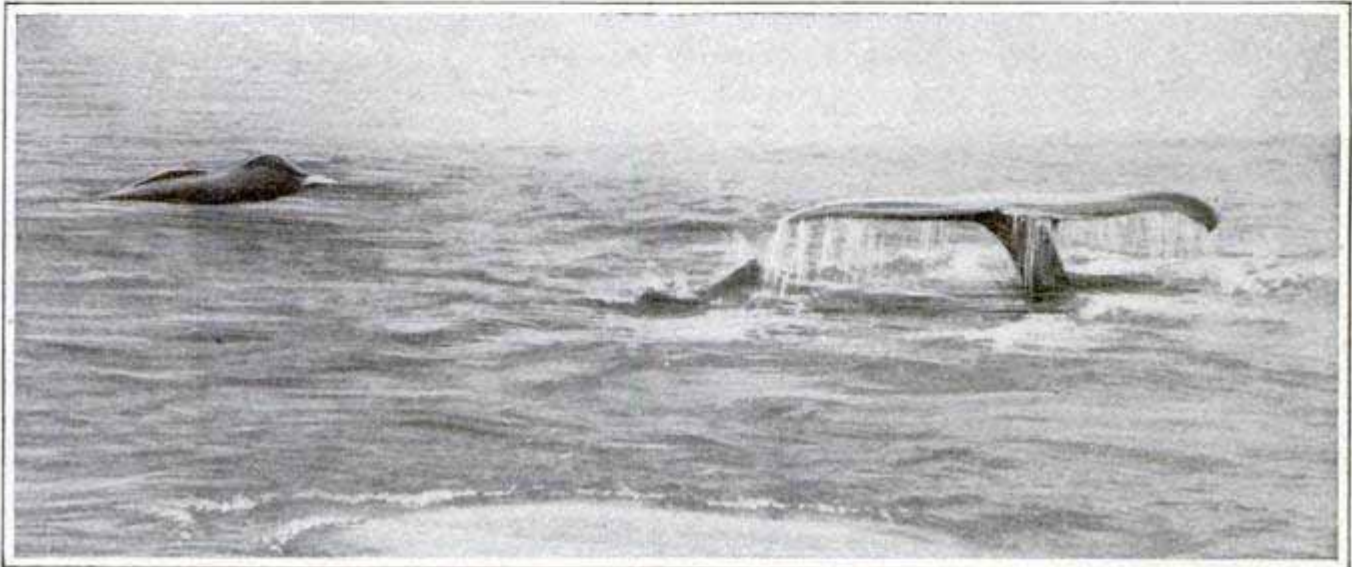

"There She Blows!" A Humpback Whale Diving and Another Whale Close By

The main line measures 5 in., but 250 to 300 ft. of a somewhat smaller rope, called the "forerunner," are coiled upon a heavy iron pan just beneath the gun, thus giving slack to be carried with the harpoon as it flies through the air. From the pan the rope passes backward over a roller in the bow of the ship to a double winch, just forward of the bridge, and down into the hold where 3,000 ft. or more are carried. By means of the winch the whales are "played" as one would use a reel on a fishing rod, and after they have been finally killed are hauled to the surface and fastened to the side of the ship.

The harpoon lines are made of the finest Italian hemp and tested for a breaking strain of 18 tons, but the forerunner for 15 or 16 tons. Some lines, made especially for hunting the great blue whales, are tested as high as 28 tons. If a tight line is kept when fast to a whale, and there are no sudden

Not far forward of the winch the single mast is stepped, bearing near its head a small barrel. The man in this "crow's nest" can see far over the water and, if it is smooth, down into it, often sighting a whale, which is rising to blow, several seconds before it reaches the surface.

Both the captain, who is usually the gunner, and the crew of 10 or 12 men live below decks, the former occupying a small but comfortable cabin aft and the latter the forecabin forward.

As soon as a whale is sighted at sea the vessel is headed at full speed straight for it. When close by, some captains will "lie to" with engines stopped, waiting for the animal to rise again, while others prefer to steam slowly in a wide circle about the spot where the whale went down. If the animal rises near enough for a shot, the gunner waits until the maximum amount of its body is shown above the

water and usually fires just as the dorsal fin is appearing above the surface.

Often the harpoon will be driven into the flesh for its entire length and, in fact, in one instance when I saw a small finback whale killed, it went com-

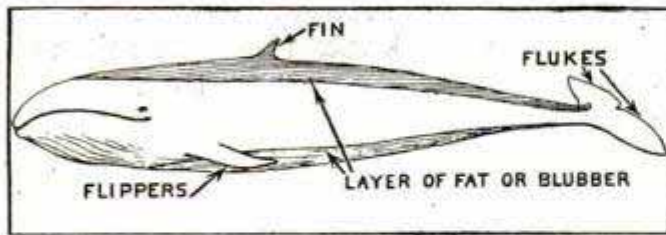

Outline of a Whale Indicating the Various Parts

pletely through the body. If the iron penetrates the thoracic cavity and the bomb explodes near the heart or lungs, the animal is killed instantly. Often, however, two harpoons are required to finish the work, and in rare instances even three or four.

As soon as the whale is dead, the body sinks and must be raised by means of the steam winch. When it is at the surface, a leaded rope is thrown under the "flukes," or tail, a chain

drawn about them by means of it, and the carcass made fast, flukes foremost, to the bow of the vessel. Immediately a coil of small rubber hose is prepared, one end of which is attached to the air pumps and the other to a hollow, spear-pointed tube of steel with perforations along its entire length. This is jabbed well down into the stomach, the pumps started and the body slowly filled with air. When it has been inflated sufficiently to keep it afloat, the tube is withdrawn and the incision plugged with oakum.

If the whale has been killed early in the day, or there are others near by, the carcass will usually be marked by a flag and set adrift to be picked up at the end of the day's hunting. Several times I have been on board ship when as many as six whales were killed in a single day, and it meant a long, slow tow back to the station even for the powerful little steamer.

I will never forget my intense surprise at the extraordinary ease and

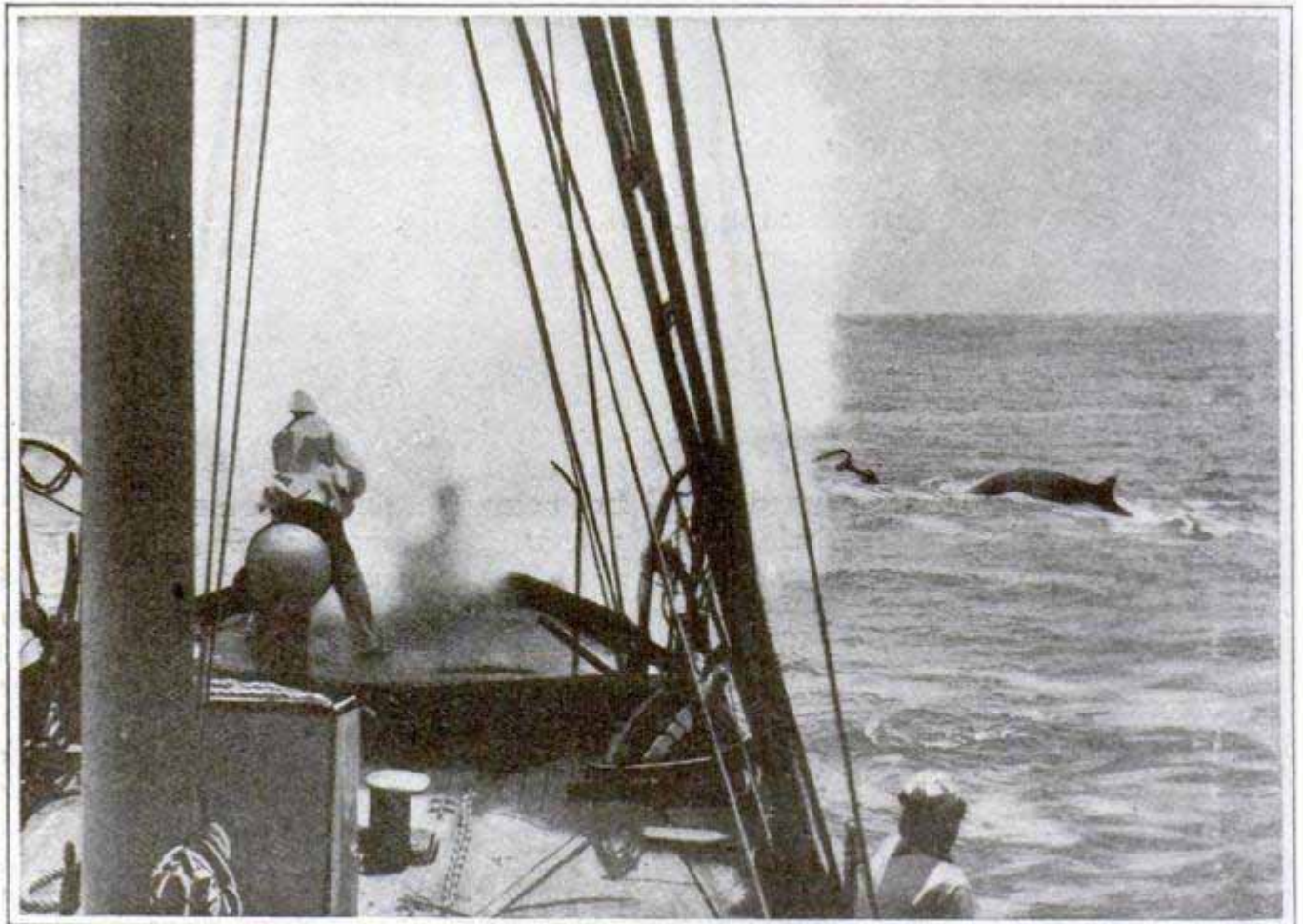

Shooting a Finback Whale; the Harpoon in the Air

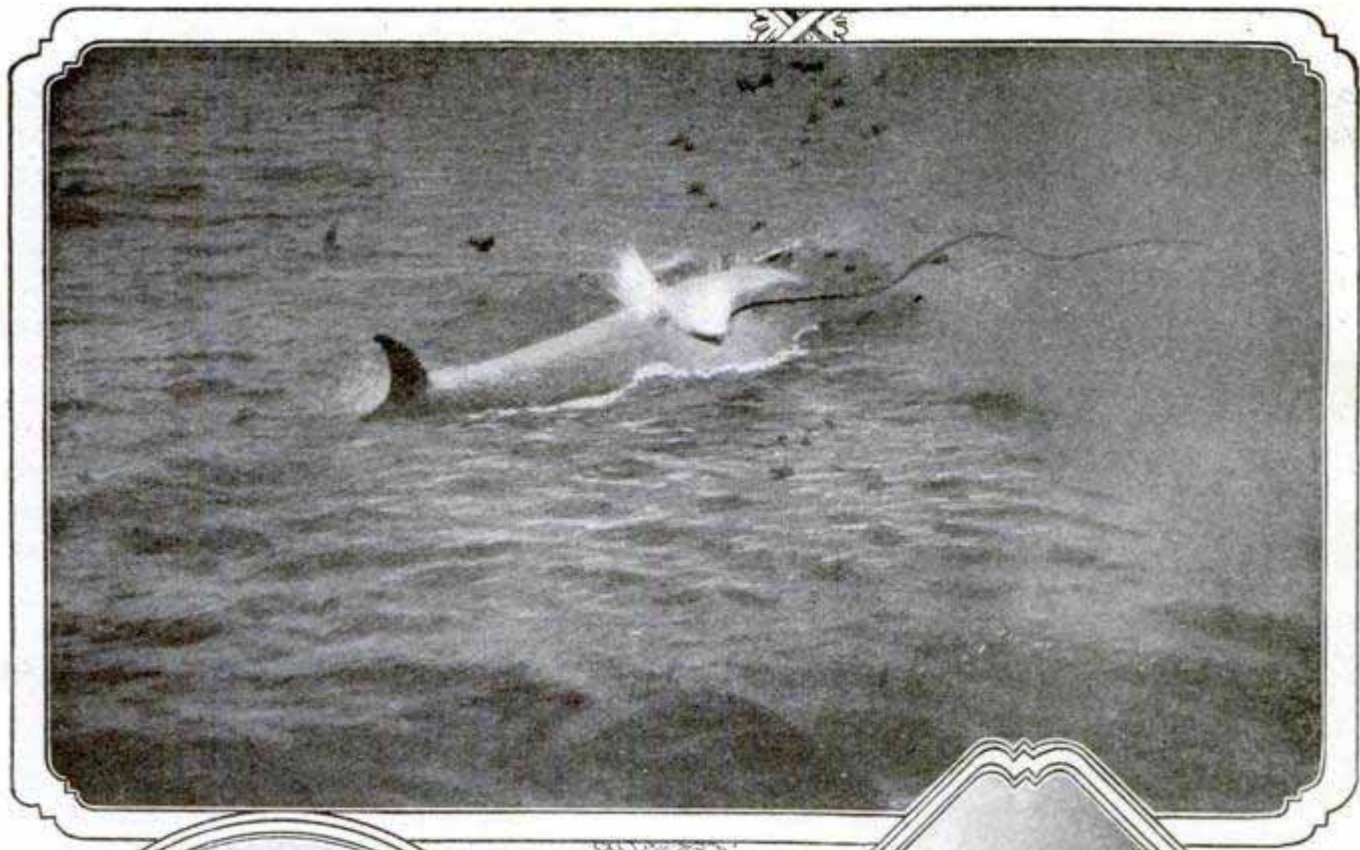

As the Bomb Explodes  
in the Whale

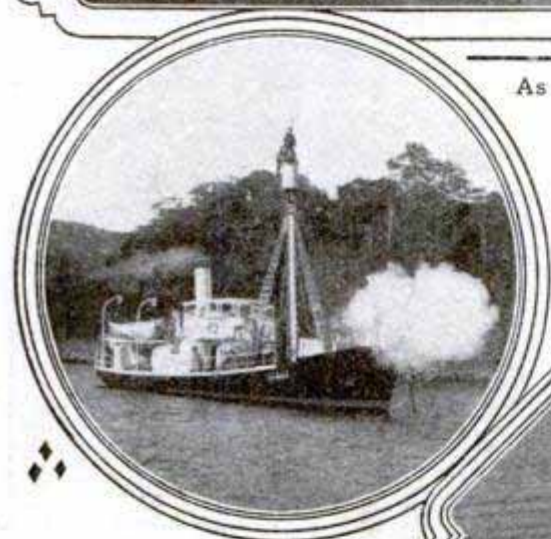

Another Remarkable  
Picture of the Firing  
of the Harpoon Gun

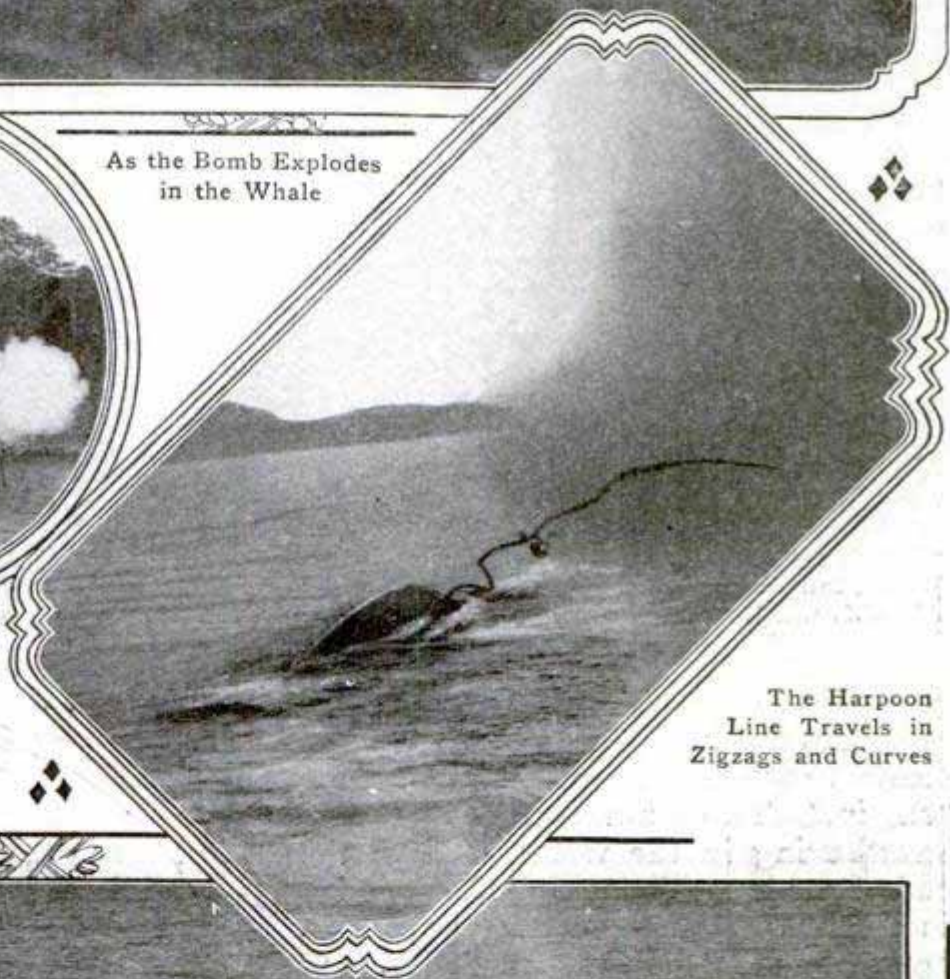

The Harpoon  
Line Travels in  
Zigzags and Curves



"Playing" a Harpooned  
Whale with the Steam  
Winch and Rope, Used  
Like a Fishline and Reel

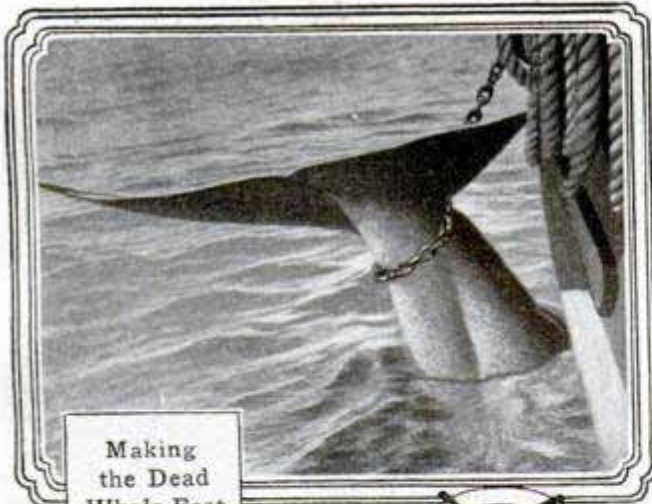

Making  
the Dead  
Whale Fast  
to the Side  
of the Ship

the water, other cutters, or "flensers" as they are called, had begun to make longitudinal incisions through the blubber along the breast, side and back, and from the flukes the entire length of the body to the head. The wire cable was then made fast to the blubber at the chin, the winch started, and the great layer of fat stripped off exactly as one would peel an orange. When the upper side had been denuded of its blubber covering, the whale was turned over by means of the "canting

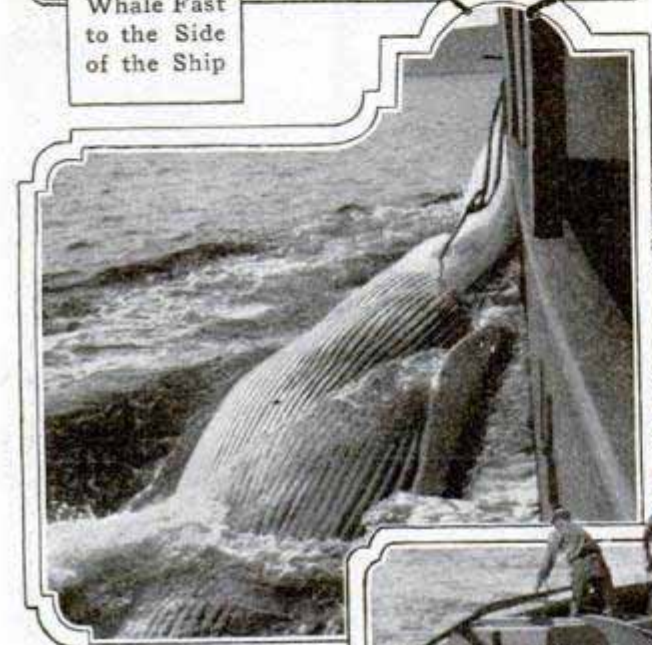

"Blowing Up" a Fin  
Whale; Inflating It with  
Air so It will Not Sink

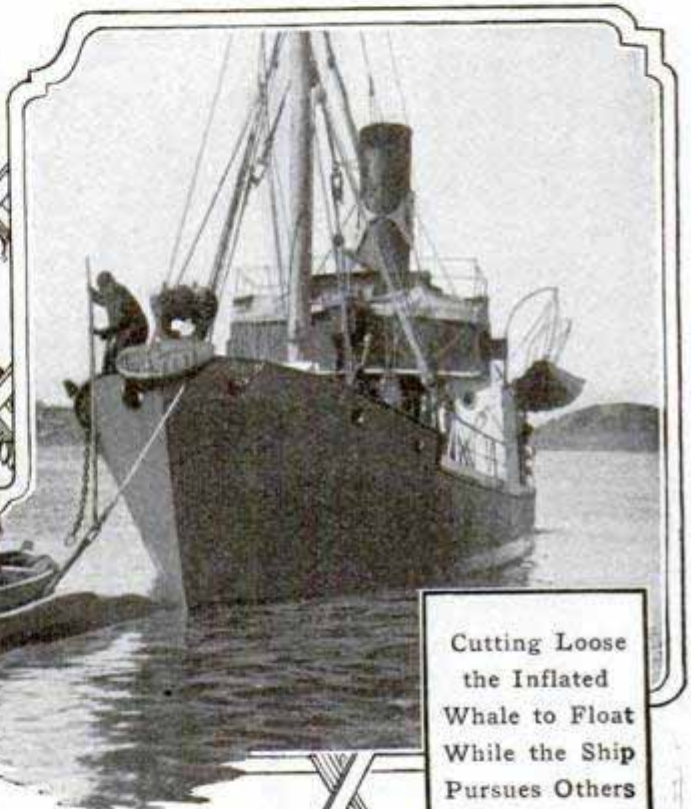

Cutting Loose  
the Inflated  
Whale to Float  
While the Ship  
Pursues Others

quickness with which the enormous carcasses are handled by means of the steam winch when I first saw a whale "cut in." Three humpbacks had been left floating in the water, tied to the end of the long inclined platform called the "slip." When work began, a heavy wire cable was made fast to one of the whales just in front of the flukes, the winch started, and the carcass, weighing perhaps 45 tons, drawn slowly out of the water upon the slip. One of the cutters scrambled up the whale's side, and balancing himself upon the smooth surface by the aid of his long knife, made his way forward to sever at the "elbow" the great side fin, or flipper, 16 ft. in length.

Before the carcass was half out of

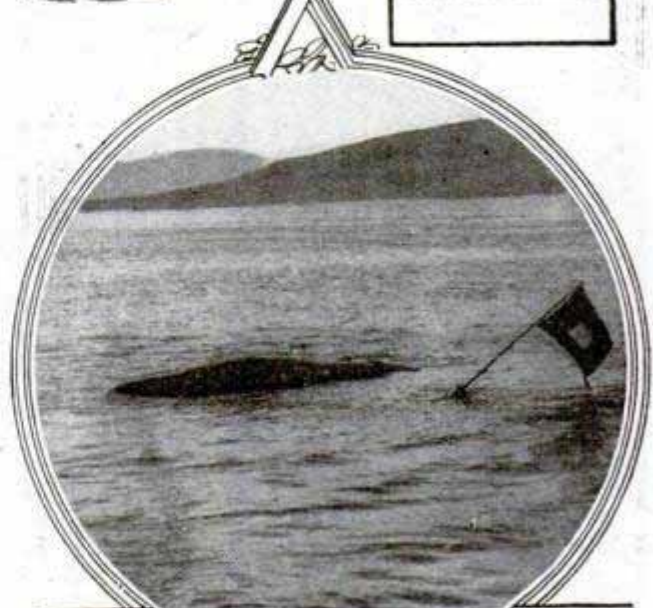

"Flagged." The Floating Whales are Marked  
so They can be Picked Up Easily



winch" and the other surface flensed in the same manner.

The "blanket pieces," as the blubber strips are called, were cut into large oblong blocks and fed into a slicing machine, chipped into small bits, carried upward and dumped into enormous vats to be boiled or "tried out" for oil.

The carcass had meanwhile been opened by chopping through the ribs of the upper side, a heavy iron hook was attached to the tongue bones at

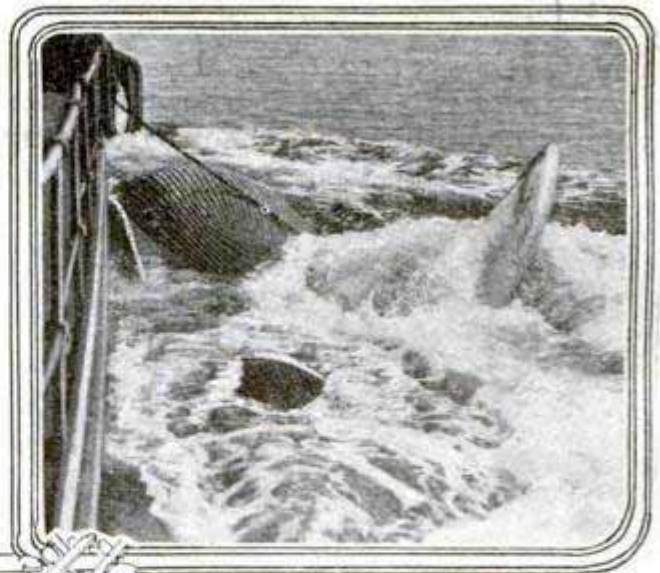

A Big Blue Whale in Tow

Towing the Day's Catch to the Shore Station

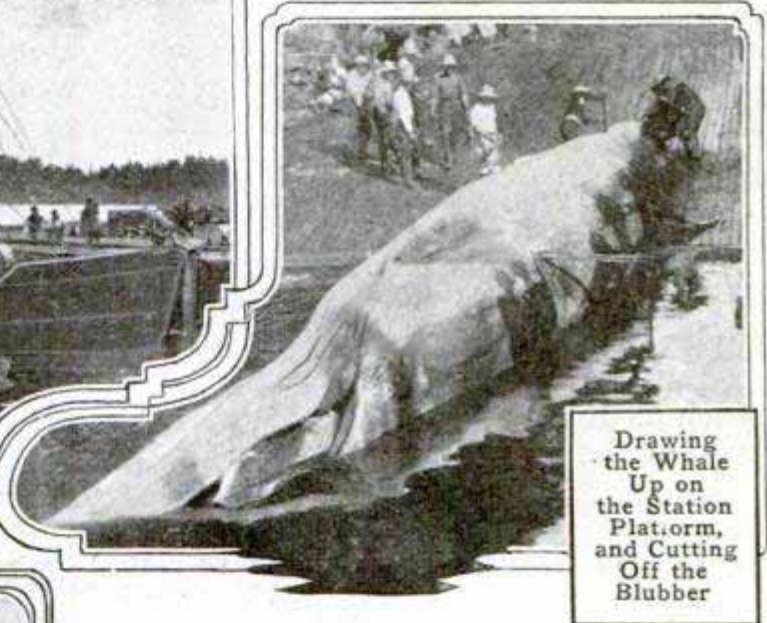
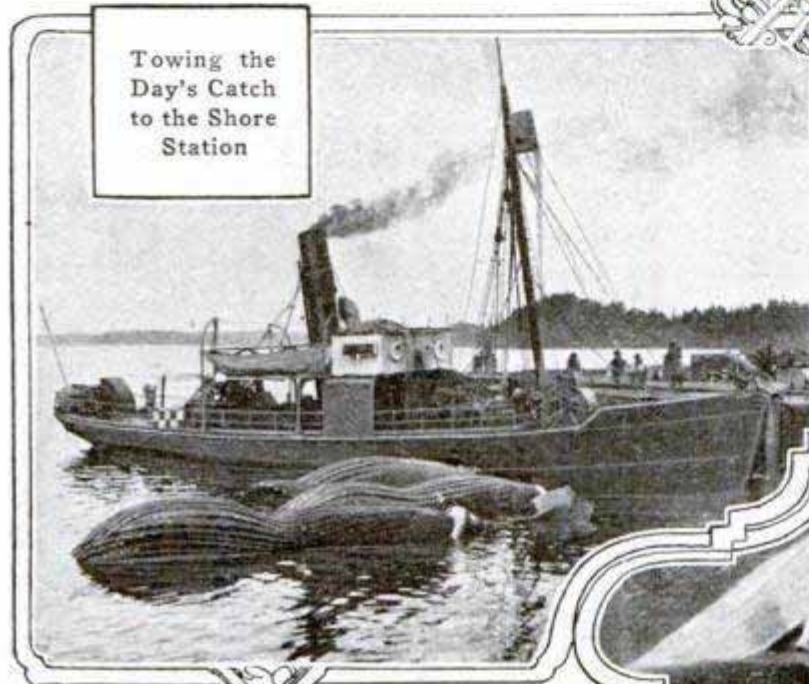

Drawing the Whale Up on the Station Platform, and Cutting Off the Blubber



A Sperm Whale Being "Cut In" by the Norwegian Method

the throat, and the entire mass of heart, lungs, liver and intestines drawn out at once. The body was then hauled to the "carcass platform," at right angles to the "flensing slip," the flesh torn from the bones in two great masses by the aid of the steam winch, and the skeleton disarticulated.

Both flesh and bones were piled separately into great open vats, which bordered the carcass platform, and boiled to extract the oil. The flesh was then artificially dried and sifted, thus being converted into a very fine guano, and the bones pulverized to form "bone meal," also a fertilizer. Even the blood, of which there are several tons in a large whale, was care-

fully drained from the slip into troughs, boiled, dried, and converted into fertilizer. Finally the water in which the blubber had been tried out, was used in the manufacture of glue.

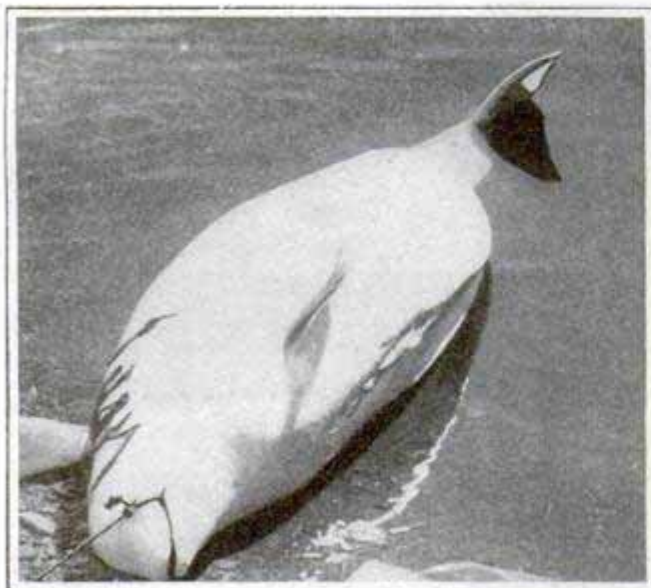

A White Whale: This Beautiful and Rare Species is of Little Commercial Value

This, with the exception of minor details, is the method of handling whales which the Norwegians developed after years of experimenting, and which is followed in almost all other parts of the world except Japan.

In the Island Empire shore whaling as a great industry has developed during the last 20 years, but nowhere else in the world are the by-products so perfectly utilized. At the Japanese stations the Norwegian method of handling whales is sometimes used, but the more favored way of "cutting in" is one of their own adoption.

At the end of a wharf extending into deep water, two long, heavy spars are erected, and joined at their extremities by a massive crosspiece, from which the great blocks carrying the wire cables from the winch are suspended.

A heavy chain is made fast about the whale just forward of the flukes, the winch started, and the body drawn slowly upward over the end of the wharf. As it appears, the cutters slice off great blocks of flesh and blubber, which are immediately seized by "hook men" and drawn to the back of the platform. Two other cutters, working

from a boat at the end of the wharf, divide the carcass just forward of the dorsal fin. The entire posterior part of the whale is then drawn upward and lowered upon the wharf to be stripped of blubber and flesh.

Transverse incisions are made in the portion of the body remaining in the water, a hook is fastened to the blubber, and as a blanket piece is torn off by the winch the carcass rolls over and over. The disjointed head is hoisted onto the pier and, section by section, the carcass is cut apart and drawn upward to fall into the hands of the men on the wharf, where it is sliced into blocks 2 or 3 ft. square.

If a ship arrives at night with a whale, fires of coal and fat in iron racks along the wharf are lighted, and the work of cutting in goes on as merrily as in the daytime, for the meat and blubber must be hurried on board fast transports and sent to the nearest city to be sold in the markets and peddled from house to house.

Few people realize that whale flesh supplies the greatest part of the meat diet of the ordinary Japanese. It is prepared in a variety of ways, but perhaps is most frequently chopped finely, mixed with vegetables, and eaten raw,

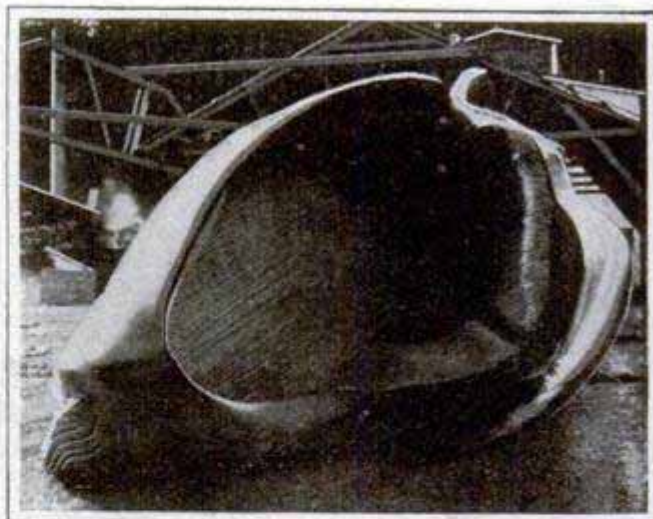

The Open Mouth of an 80-Ft. Blue Whale, the Largest Species: The Mouth would Hold 10 or 12 Men But the Throat is Only 9 In. in Diameter

dressed with a brown sauce. Almost every part of the great carcass is utilized for human consumption, even the tendons, heart, liver and intestines being prized by the cooks.

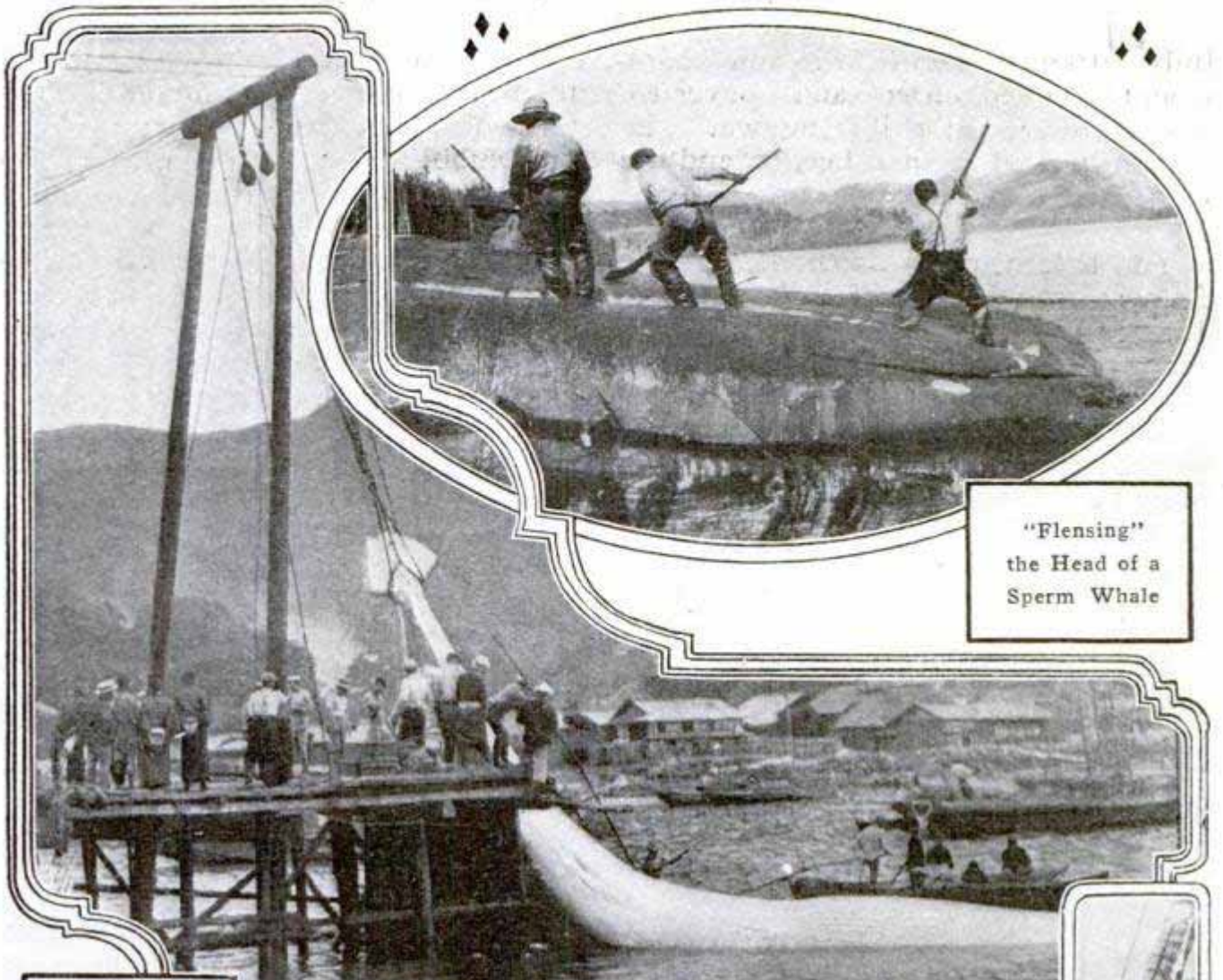

"Flensing"  
the Head of a  
Sperm Whale

A Finback  
Whale being  
Hauled Up to a  
Japanese Station  
Platform



The Japanese  
Strip Blubber  
from Whale  
as Carcass  
Rolls Over



Drawing Up a Gray Whale by the Japanese Method

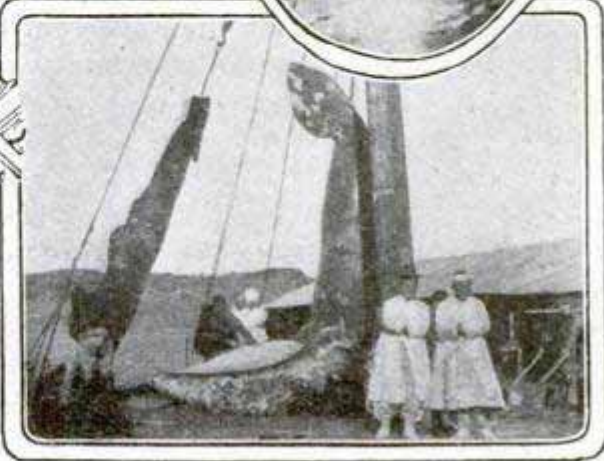

Head and Flipper of a Gray Whale

In summer when it is impossible to ship the meat to any distance because of the heat, much of it is canned. The flesh is cooked in great kettles, and the cans made, packed and labeled at the stations.

The baleen, or "whalebone," of the fin whales, which is of little value in Europe and America, has been put to many uses by the clever Japanese. Cigar and cigarette cases, charcoal baskets, sandals and other beautiful things made of this material are in daily use by the natives and are being sent abroad.

The commercial value of whales in Japan depends to a large extent upon the time of the year when they are taken. If it is cold enough to allow the meat to reach the nearest large city without decomposition, and the supply of fish in the markets is limited, a blue whale may bring 8,000 yen (\$4,000); under conditions less favorable, perhaps only 6,000 or 7,000 yen. By actual

weight it was ascertained that a blue whale (the largest species), 76 ft. long, yielded over 40 tons of red meat alone; the blubber, viscera, bones, and other parts, making up the total weight of 63 tons.

The humpback whale, which reaches a maximum length of 55 ft., although considerably smaller than the finback or blue whales, in Japan is the most highly prized because of its delicate flavor, the flesh sometimes bringing as much as 30 sen (15 cents) per pound; but such a price is unusual and ordinarily it can be purchased for 16 sen or less.

In America and other countries the commercial value of whales depends entirely upon how thoroughly the by-products are utilized. If only the oil is taken, a blue whale may be worth little over \$200, but if the entire carcass is worked up, it may bring \$1,000 or \$1,500, according to the price of oil and guano.



"Cutting In" a Finback Whale: Stripping the Last of the Flesh from the Gigantic Bones

## PORTABLE POWER PLANT OPERATES MANY TOOLS

A general-utility machine for office buildings, apartment houses and small shops is now on the market, which is

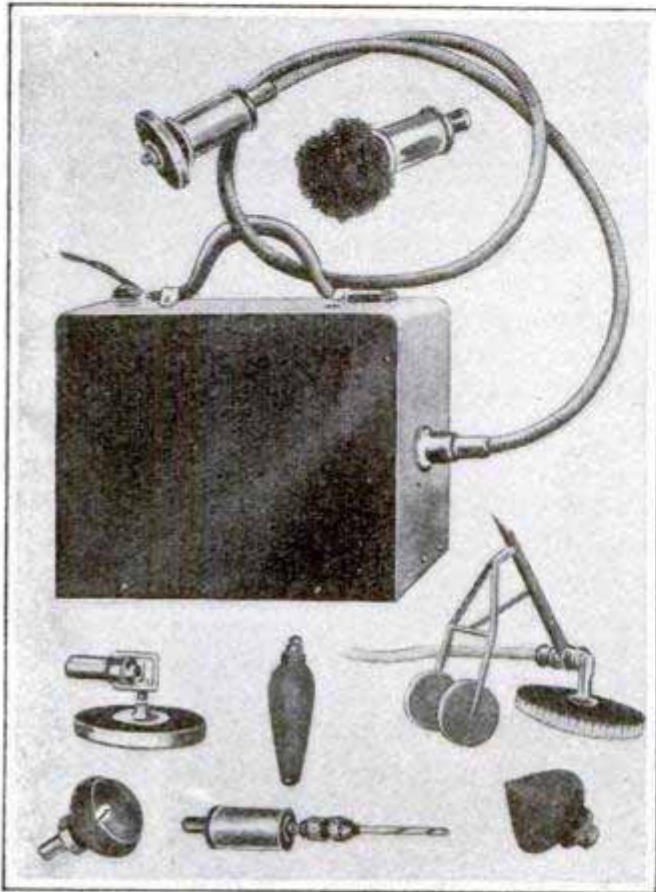

Attached to Any Light Socket, This Machine will Operate 77 Tools, One at a Time

so adaptable that its uses are manifold. Seventy-seven tools, so the manufacturers say, may be operated by this one handy contrivance. A friction-drive handle with flexible shaft attached to a  $\frac{1}{4}$  or  $\frac{1}{2}$ -hp. motor, gives a speed of from 1,650 to 2,700 revolutions per minute. Among the many uses may be mentioned riveter, casting chipper, chisel hammer, brick drill; one can remove varnish, polish floors, grind down marble and tile floors, make keys, repair safe locks, polish brass, and drill holes in brass, iron, cement, marble, and brick. Garage and automobile owners find this small machine available for polishing automobile bodies and brass fixtures without removing them from the machine. It will scrub floors, clean walls, or hammer 1,700 blows a minute, as may be desired.

## MAIL BOXES INDICATE OUR COMMERCIAL ACTIVITY

A German statistician has figured out that the number of collection boxes used by the postal authorities of each nation may serve as an indication of commercial activity. According to his information the nations rank commercially as follows: Germany, with 155,766 boxes for collection of mail; the United States, with 144,640; France, 79,724; British India, 75,083; United Kingdom, 71,986; Japan, 67,694; Austria-Hungary, 59,503; Italy, 39,767; Russia, 31,714. Other countries range from Switzerland with 13,472, to Persia with 17, and Abyssinia with only 6.

## ELECTRIC HAND DRIER SUPPLANTS TOWELS

Drying the hands by means of a current of warm air is a modern sanitary device recently installed in a Washington office building. The electric hand drier is an upright cabinet about 3 ft. high. An opening at the top, over which the hands may be held, gives egress to a current of air blown from within, and controlled by a lever operated by the foot. When the lever is depressed, the



electric current is switched on the blower, and the air is forced through a heating coil, which brings it to a proper temperature. Thirty seconds is all the time required for the drying process, and the cost per hundred pairs of hands is just one cent. This contrivance meets sanitary requirements and threatens to supplant, if it does not abolish, both the roller towel and its paper substitute.

## AERIAL PROPELLER FOR AUTOMOBILE

A speed of 50 miles an hour has been attained by two Vancouver youths in a novel craft equipped with

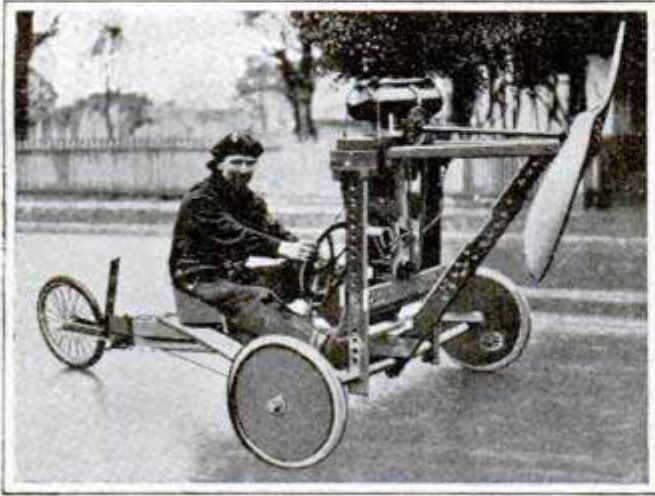

Curious Auto Driven by Aerial Propeller

an aerial propeller. The machine has three wheels. Upon the front axle, carrying two wheels, the engine is supported and drives a 6-ft. blade at the rate of 700 revolutions per minute. The rear wheel is set 7 ft. behind the front axle and is used to direct the course, being operated by a steering wheel in the hands of the driver. Only  $4\frac{1}{2}$  hp. is developed by the engine, but as the propeller blade has a pitch of 5 ft., sufficient pulling power is produced to give high speed. It is stated that the aerial propeller is much cheaper to operate for the power developed than ordinary automobile gearing. It is proposed to build larger and more powerful tractors using this form of propulsion for commercial purposes.

## FIRST BOAT GOES THROUGH CANAL UNDER OWN STEAM

The first vessel to go through the Panama Canal from one end to the other under its own steam was the crane boat "Alexander Lavalley," regularly employed in construction work on the isthmus. Eighty months from the day work was begun under Maj. G. W. Goethals as chief engineer, navigation through the completed canal was an accomplished fact.

## DUTCH BABIES NEED NO CRADLES

The "baby tender" invented and used to this day in the Island of Marken in the Zuyder Zee is the substitute for the cradle which resists the advance of baby carriages and modern high chairs. In Marken, babies of both sexes are dressed exactly alike, the accepted fashion having been unchanged for three centuries. At so early an age is the infant incased in the stays of this costume that there is no use for a cradle for babies in Marken. The child is supported and kept out from under foot in a wooden contrivance serving both as a chair and cradle, which is mounted on small wheels so that it may be readily moved about. A shelf in front serves as a rest, or receptacle for food or playthings.



Copyrighted by Waldon Fawcett  
Famous "Baby Tender" of Holland is  
Substitute for Cradle

Two furnaces at Alburty, Pa., are said to be the only remaining blast furnaces in the country operating exclusively on anthracite coal.

## TORPEDOLIKE WINDSHIELD FOR BICYCLE

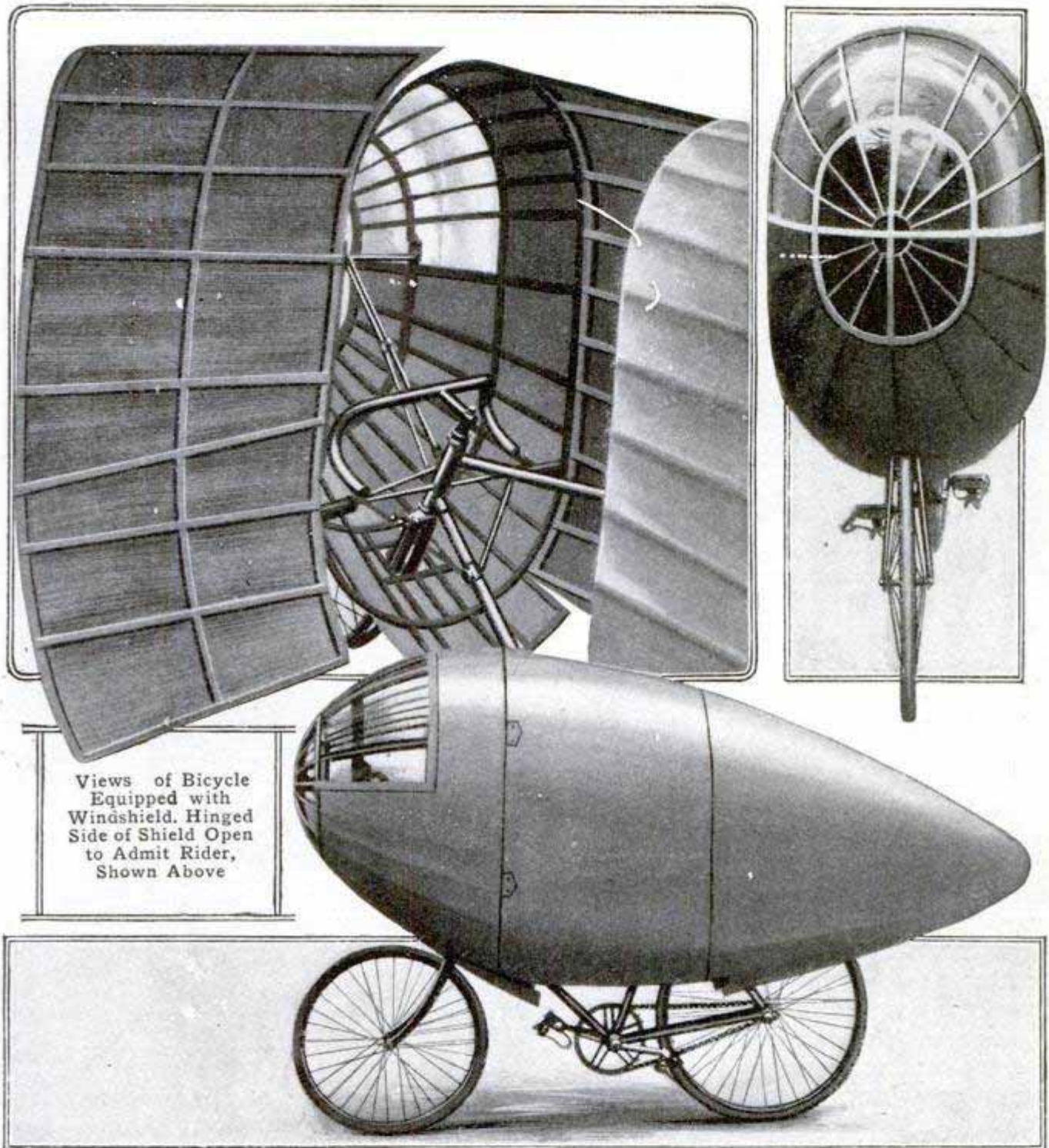

Views of Bicycle Equipped with Windshield. Hinged Side of Shield Open to Admit Rider, Shown Above

Photos by Underwood & Underwood

Equipped with This Shield, the Bicycle Covered a Three-Mile Course at the Highest Speed Known to have been Attained by a Foot-Propelled Vehicle

Using a windshield shaped much like a torpedo, a French cyclist covered a course of 5 kilometers, or a trifle over 3 miles, at the Velodrome d'Hiver in Paris, in 5 min. 46 $\frac{1}{2}$  sec. This is said to be the highest rate of speed known to have been attained on a course of this length by a foot-propelled bicycle. The shield consists of

a light frame over which canvas is stretched. At the front a portion of the canvas is cut away and mica substituted in order to provide the rider with the necessary view ahead. The front of the shield splits the wind with a minimum of resistance, while the rear tapers off to prevent the formation of eddies or a partial vacuum.

## GREAT NEW YORK AQUEDUCT NEARLY COMPLETED

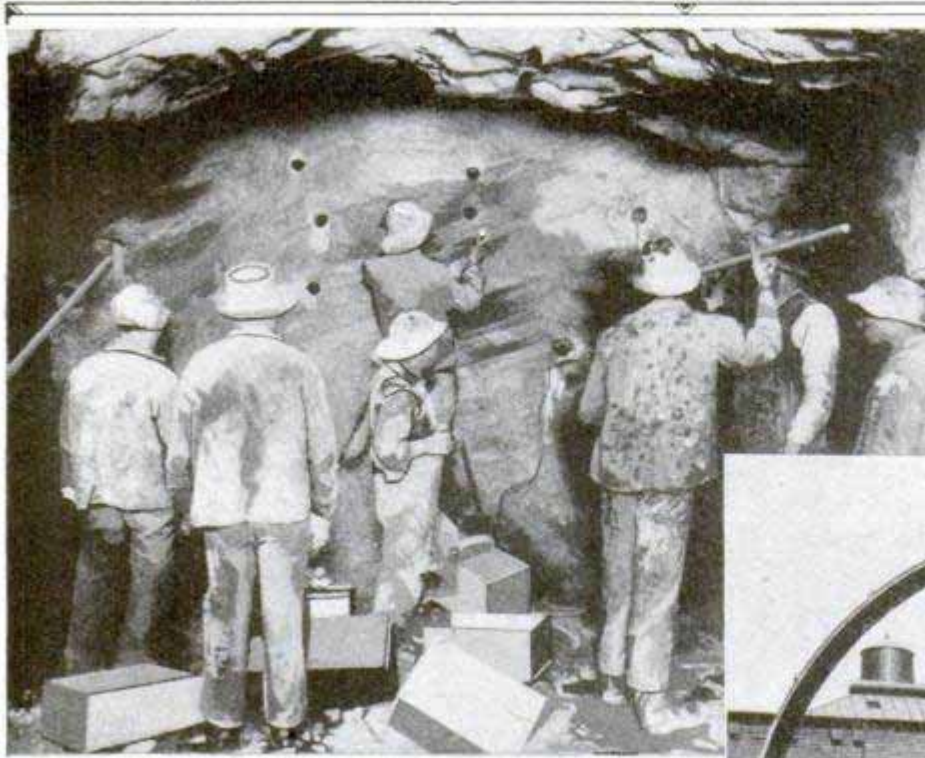

Placing Dynamite for the Last Blast in the New York Aqueduct Tunnel



Building One of the Great Venturi Meters Which will Record the Flow of Water

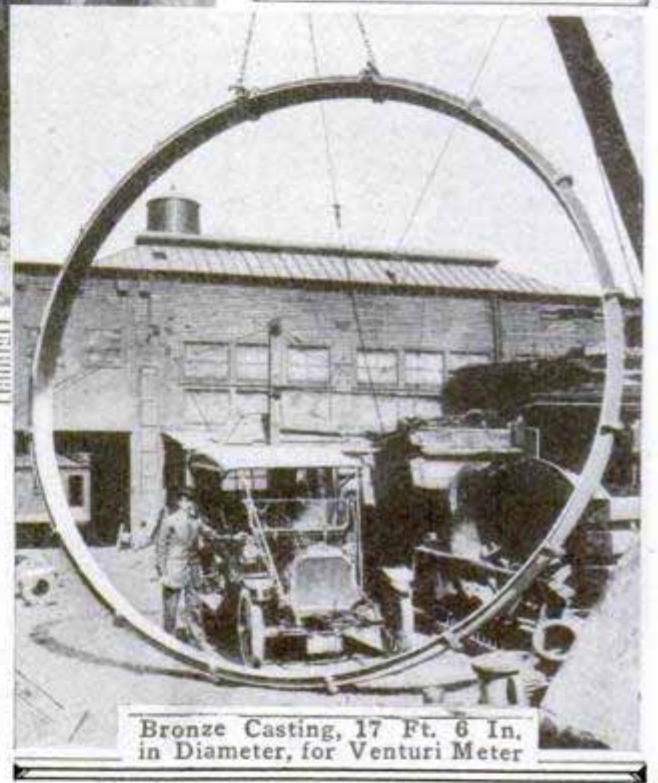

Bronze Casting, 17 Ft. 6 In. in Diameter, for Venturi Meter

Photos by Underwood & Underwood

The hundred-mile tunnel through the rocks, which is to bring pure water from the Ashokan reservoir to New York City, has been so far completed that the building of the great Venturi meters has begun. Late in the eighteenth century an Italian philosopher, J. B. Venturi, observed that fluids discharging through an expanding nozzle exert a sucking action at the smaller diameter, which diminishes as the diameter enlarges toward the outlet. A hundred years later this principle was applied in the construction of meters for measuring the flow of great volumes of water through tunnels and aqueducts. Three such meters are being installed in the New York project, which will measure the flow of water through the tunnel without in the least interrupting or restricting the amount delivered. Tubes extending from both the normal and the expanded diameters of the aqueduct indicate different pressures, affording a basis for calculating the flow. No flow of water takes place through these tubes, as they simply transmit the two pressures, the difference in which controls the reading of the instrument.

### SMALL FIRE CRIPPLES CITY'S TELEPHONE SERVICE

When some of the telephone wires of the Montreal public-telephone service came in contact with a power or high-voltage circuit a slight blaze broke out in the "main" exchange, which was extinguished in five minutes, but the damage done was so great that telephone service was interrupted for more than a week, although 40 expert repairmen were employed in relays in the reconstruction work. The wires forming the switchboard connections for 12,000 lines were destroyed, the paraffin covering over the insulation being very inflammable, so that



the flames spread quickly until extinguished. The tie-up affected the entire down-town district, and patrons were obliged to resort to messenger and special-delivery service for communication.

### THE WRECK OF THE "COBEQUID"

The royal-mail packet "Cobequid" was wrecked on Trinity Rock in the Bay of Fundy last January, and 108 persons rescued after suffering intensely from cold and exposure. A wireless call for help was sent out as soon as the ship struck, but the operator could not give the ship's location, for no one on board knew it exactly, and a heavy fog rendered it impossible either for the wrecked to make out their position or the rescuing vessels to find the wreck. The ship broke in two, the water poured into the engine room, extinguishing the fires and interrupted wireless apparatus. Thirty-six hours later, however, through the lifting of the fog, a fisherman made out the wreck on Trinity Ledge, and gave information which brought the coastal steamers "Westport" and "John L. Cann," which rescued the passengers and crew. The vessel was covered with ice and almost submerged when the rescuers arrived.

### PRIMITIVE SLEEPING PORCH USED BY ARABS

This curious structure made of mud and open to the sky is used as a sleeping chamber at night in Arab villages, during the great heat of the summer. Detached from the house, it affords

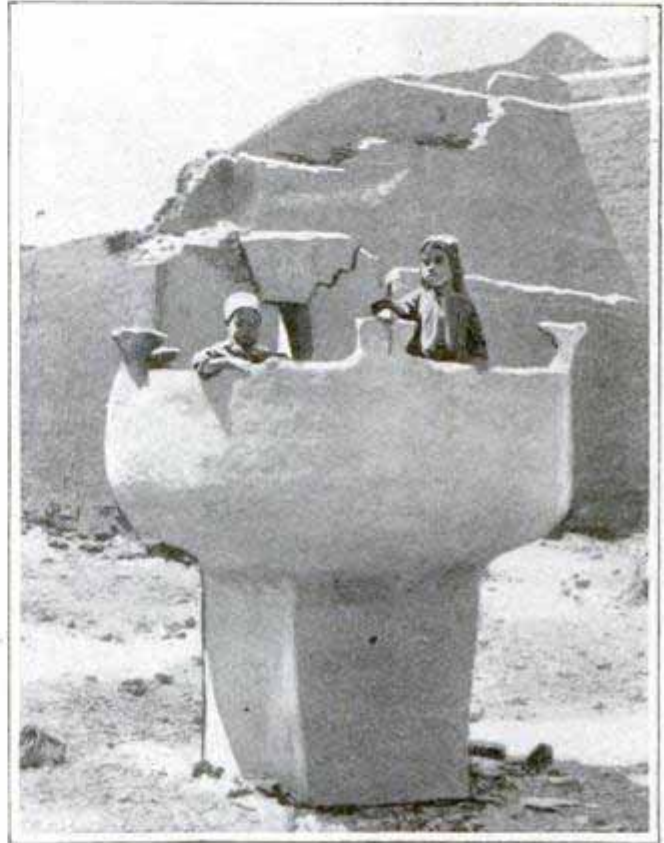

Arab Outdoor-Sleeping Device Which Gives Protection from Nocturnal Pests

protection against the snakes, scorpions and lizards abounding in the summer.

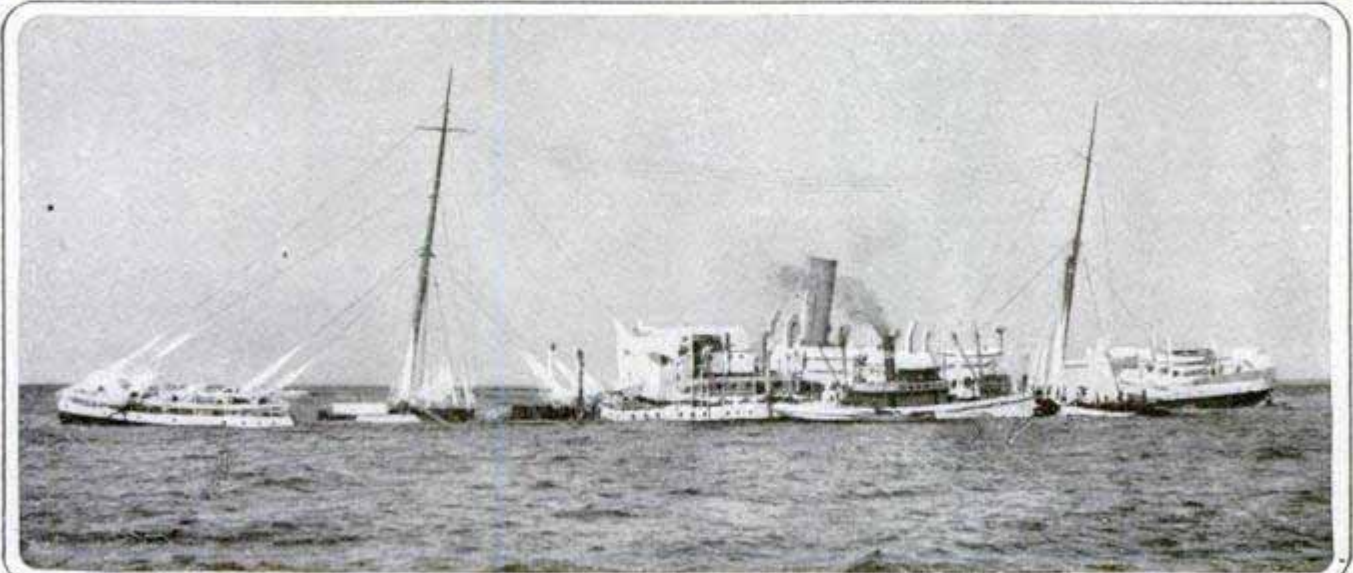

Coasting Steamers Taking Off Passengers and Mail from the Wrecked "Cobequid"

# SCANDINAVIAN PASTIME ENJOYED IN AMERICA



Photo Int'l News  
 Jumping with Skis  
 at St. Moritz,  
 Switzerland



Watching  
 the Jump-Off  
 at Prospect  
 Park,  
 Brooklyn



Measuring the  
 Length of a Ski  
 Jump at Duluth

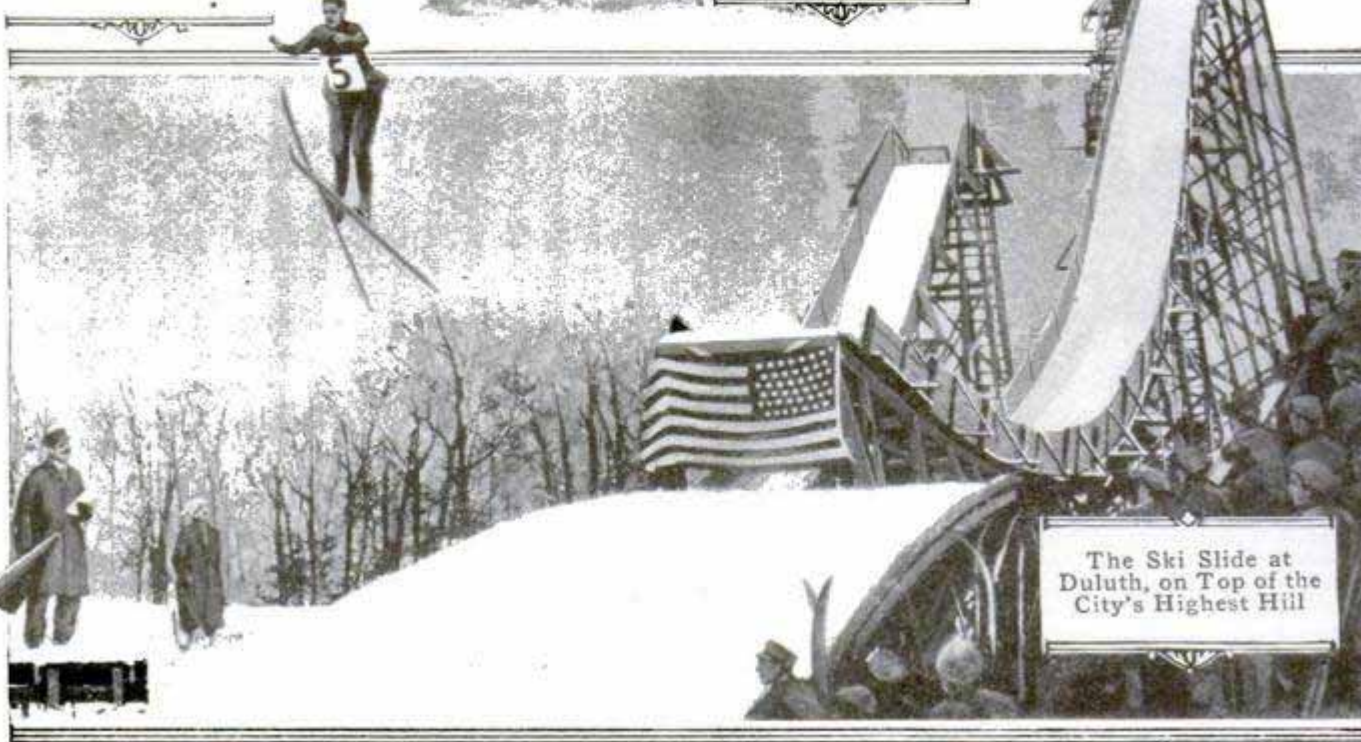

The Ski Slide at  
 Duluth, on Top of the  
 City's Highest Hill

# SKI JUMPING IS INCREASING IN POPULARITY



Photo Int'l News Service  
 Exhilarating Sport on a  
 Swiss Lake; Here the Skis are Used  
 as Sleigh Runners, and Galloping Horses  
 Furnish the Motive Power



Photo Underwood & Underwood  
 In Montreal Ski Jumping  
 is an Institution



This Popular Sport  
 Always Draws a Big Crowd  
 to Prospect Park, Brooklyn



Canadian Girls  
 Find Skiing  
 Fascinating Exercise

## TRAIN CAUGHT WHEN TUNNEL CAVED IN

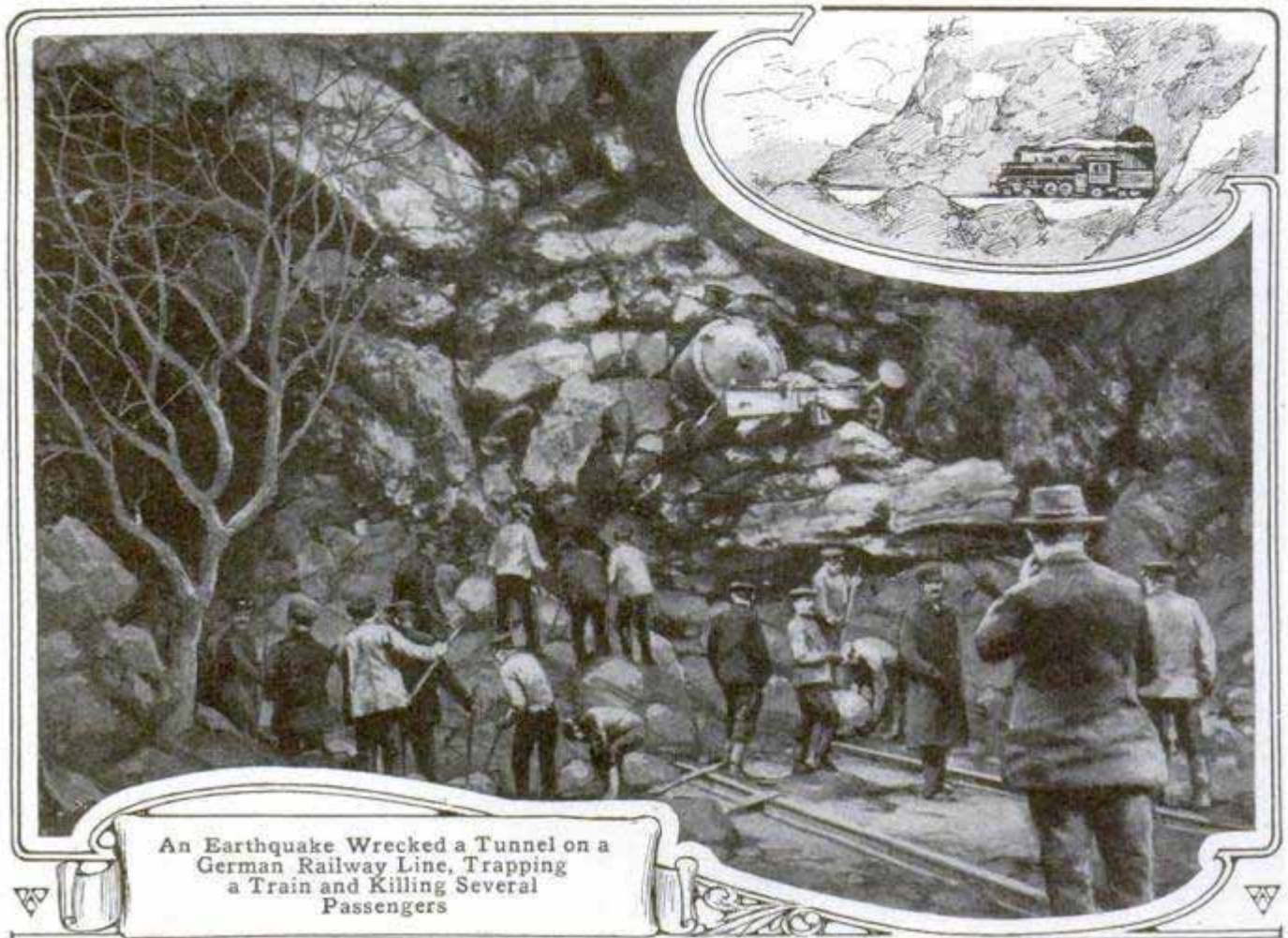

An Earthquake Wrecked a Tunnel on a German Railway Line, Trapping a Train and Killing Several Passengers

Photo by Underwood & Underwood

A slight earthquake in Saxony was responsible for a cave-in as a passenger train was passing through the railroad tunnel through the Harras cliffs, near Chemnitz. The locomotive had just emerged when the falling rocks

caught it, crushing several coaches and causing several fatalities. A high wind and a blinding snowstorm hampered the rescue work, so that it took several days of hard work to clear away the debris.

### REINFORCED TUBING WHICH HAS WALL IN CENTER

A seamless steel tubing, having a central pillar or support, has been invented to withstand the extreme



stresses developed in automobile operation. This tubing may be bent to any desired shape, and stands up under bending and flattening strains. It is being used in the manufacture of cyclecars, automobiles, motorcycles and aeroplanes, as well as in

such vehicles as gocarts, bicycles and small wagons.

### LINING A DEEP MINE WITH CONCRETE

More than a third of a mile beneath the surface of the earth, the junction shaft of an Arizona mine became a manhole for the water from all the other mines of the district. Immense steam pumps were required to lift this drainage water to the surface, where it was utilized for irrigation. Engineers suggested that lining the mine with concrete would stop the influx of water and avoid the heavy expense

of pumping. A strong concrete mixture was made at the surface, piped down to lower levels into molds and allowed to harden in place, where it does away with the necessity for wooden supports, lessening fire risk, reducing cost as well as shutting out water flow entirely. Very little reinforcement was used, and notwithstanding frequent predictions of failure, the concrete, which is completed for 1,500 ft. from the bottom, is proving a successful solution of many problems.

### PASSING DREDGE THROUGH PANAMA BRIDGE

To permit the passage of a dredge up the Chagres River arm of Gatun Lake, a girder span of the Panama Railroad was moved out of the way on barges and then replaced after the dredge had passed, the work being done so quickly that train service was not interfered with in any way. The two barges were securely fastened together, and a strong timber scaffold for supporting the span was built across them. When all was ready, the span was lifted by two powerful locomotive cranes, one at each end, the barges were floated under, the span was lowered upon the scaffold and the barges were towed out of the way. The dredge is to be used in excavating gravel from extensive gravel beds in the old Chagres River.

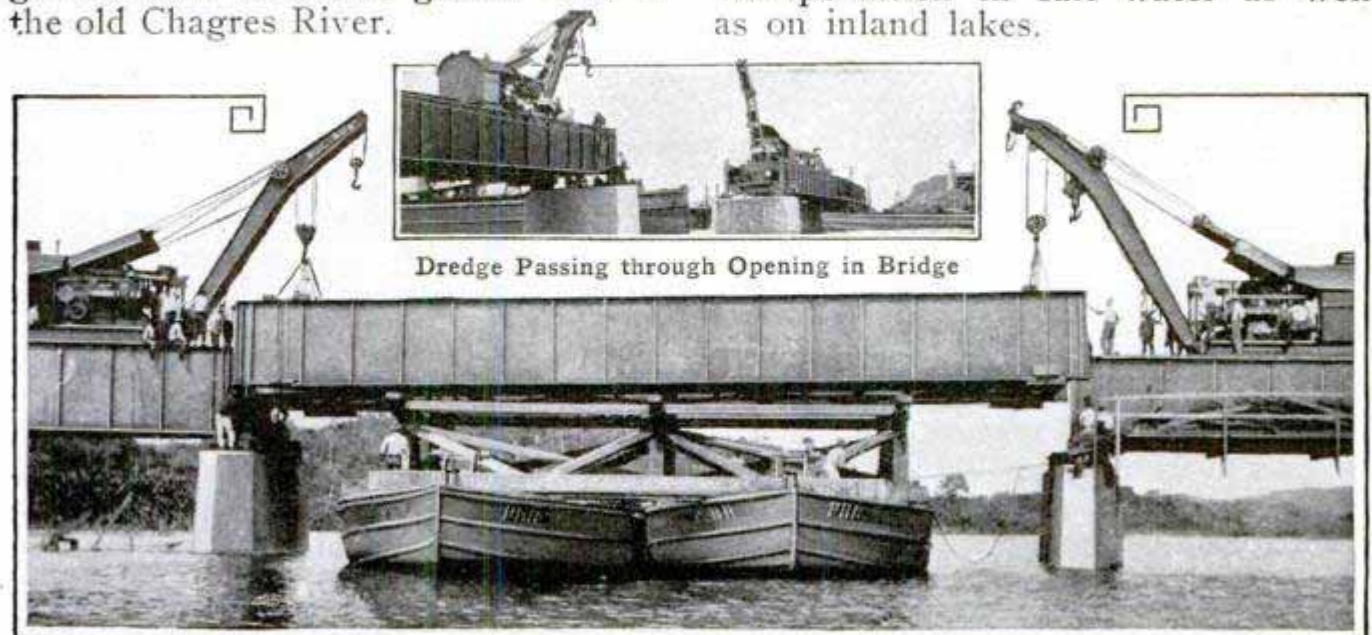

Dredge Passing through Opening in Bridge

Copyrighted by Underwood & Underwood

Moving a Steel Span of a Panama Railroad Bridge to Permit the Passage of a Dredge into the Chagres River

### BIG STEEL SMOKESTACK BREAKS IN TWO

During a cold spell last winter a new steel smokestack in North Adams, Mass., gave way under the stress of high winds, and broke just above the ring to which the guy wires were attached. Toppling over to one side, four sections hung until a scaffolding was built up to enable the workmen to remove the wreckage.

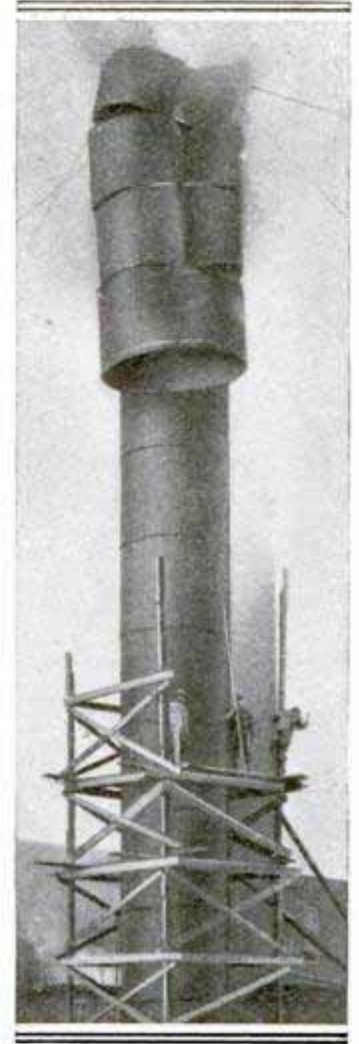

☐ In the Philippines a launch is used by the forestry bureau for service between the islands, while in Alaska and Florida the forest service employs a number of launches for transportation in salt water as well as on inland lakes.

## CAR SOMERSAULTS DOWN EMBANKMENT

An automobile went down a steep embankment, 16 ft. high, into a creek

Fortunately the driver was walking beside his horses when the accident happened and escaped electrocution, as did the horses, which were quickly unhitched. Street-car traffic was de-

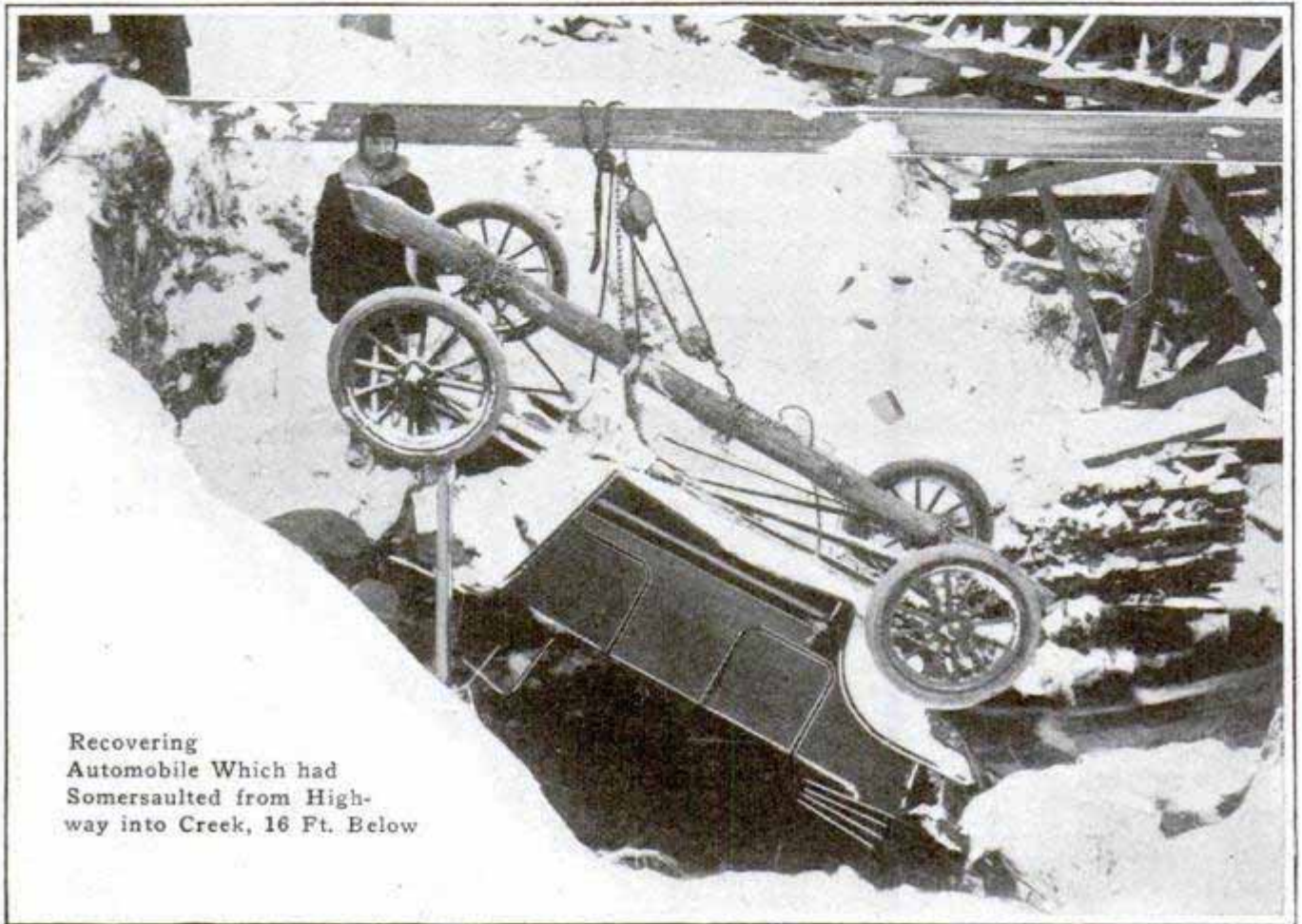

Recovering  
Automobile Which had  
Somersaulted from High-  
way into Creek, 16 Ft. Below

at Marion Hills, Minn., on New Year's day, turning two somersaults before it came to a stop, bottom side up. While the car body was considerably damaged, the engine was in such good condition after the accident that the car was able to proceed under its own power after being replaced on the highway.

## CONCRETE MIXER TIES UP STREET-CAR LINE

When a concrete mixer was driven beneath a low railway viaduct, the top of the vehicle came in contact with the lowered trolley wire of the car line which passed under the bridge, thus forming an electrical connection between the wire and the rails below. Portions of the mixer were melted by the high-voltage current, the iron wheels being welded to the tracks.

layed for several hours until the mixer was chiseled loose.

## WRIGHT GIVEN PRIZE FOR AEROPLANE STABILIZER

The Collier Prize of the Aero Club of America for the most valuable advance in the science of aviation in 1913 has been awarded to Orville Wright for his automatic stabilizing device. This apparatus is described by Mr. Wright as follows:

"The stabilizer consists of two parts—one controlled by a pendulum for maintaining the lateral balance; the other controlled by a vane for fore-and-aft balance. The power for warping the wings and turning the elevator is furnished by a small windmill attached to the aeroplane, so that the stopping of the motor does not affect the operation of the device."

With the experimental applications of this principle that have been tested in practice, several remarkable flights have been made by Mr. Wright and others, with and without passengers, with the hands of the pilot off the control and steering mechanism for minutes at a time.

Power for the wing warping and elevator control is transmitted by means of compressed air from a compressor which is operated by the windmill, the deflection of the pendulum or the vane opening air valves, which are closed as the machine resumes a normal position. No definite design of this apparatus has been finally decided upon and the experiments will be continued until a satisfactory form has been found.

### MECHANICAL DRIER WHICH OPERATES RAPIDLY

An ingenious mechanical drier for use in garbage crematories or wherever masses of wet or damp grain, coal, or other material, must be freed from moisture quickly has been invented. The first requisite is of necessity an abundance of dry air, and this is secured by means of a furnace and exhaust fan. The material to be dried enters a long tubular container at a point over the furnace, where both the heat and the air pressure is greatest.

As the container revolves, the material drops from sheet-metal blades by gravity, while warm, dry air continually flows through it. As the container is inclined, the gradually drying mass is thrown farther and farther back, until, when entirely dry, it is discharged at the lower end. Along the sides of the cylinder are numerous openings through which the heated air from the furnace, but not the products of combustion, are admitted. It will be seen from the illustrations that no matter how finely the material may be pulverized, none of it can drop through the air openings, owing to the peculiar form of the registers, which are cylindrical with the inner openings protected by smaller pipes. This mechanical drier can also be used without furnace heat and will even then evaporate a great deal of water, through the continual cascading of material and the influx of air.

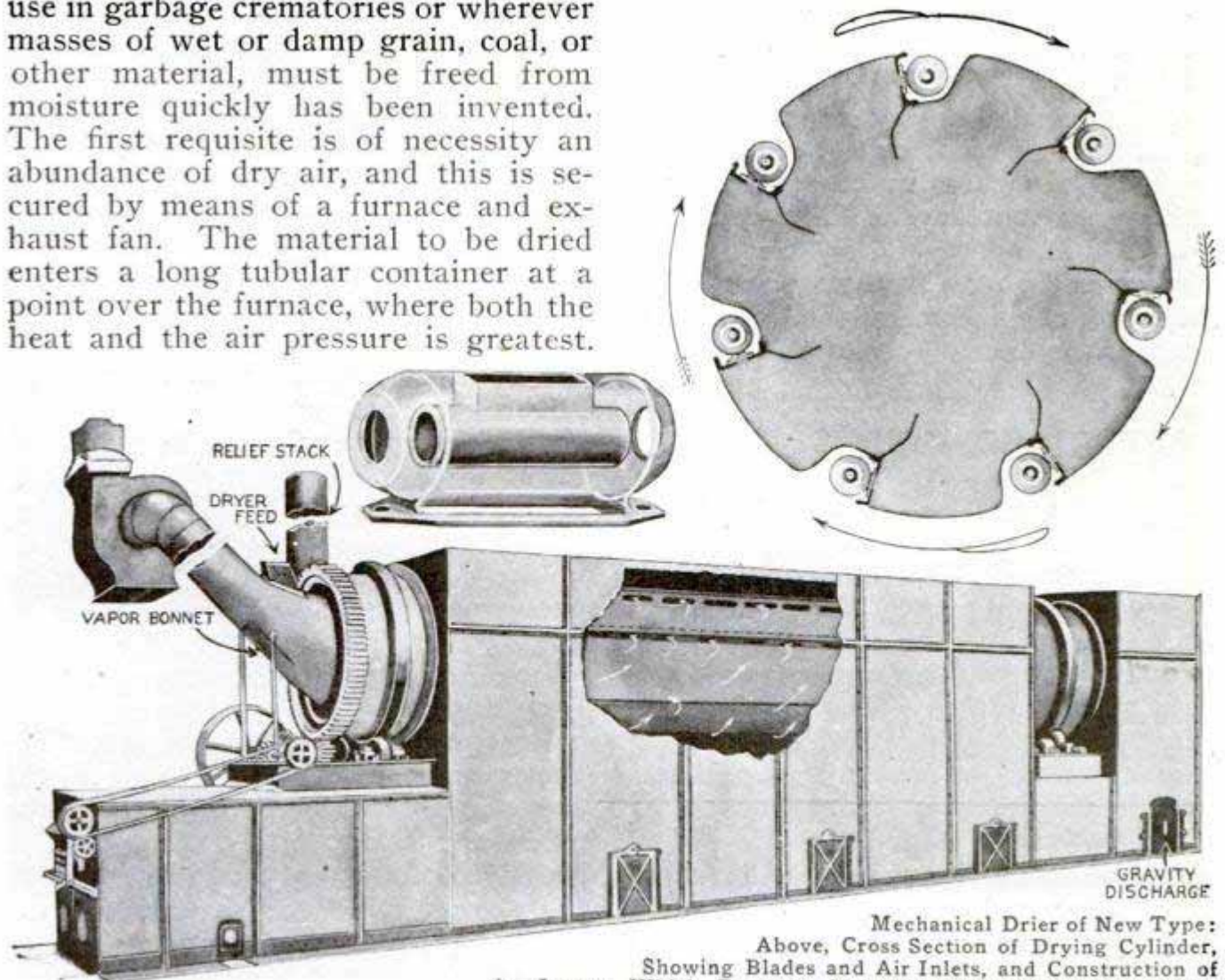

Mechanical Drier of New Type: Above, Cross Section of Drying Cylinder, Showing Blades and Air Inlets, and Construction of the Latter, Which Prevents Material from Dropping Through

## MOTORCYCLE MADE INTO ICE BOAT

By removing the rubber tires and placing iron bands studded with sharp

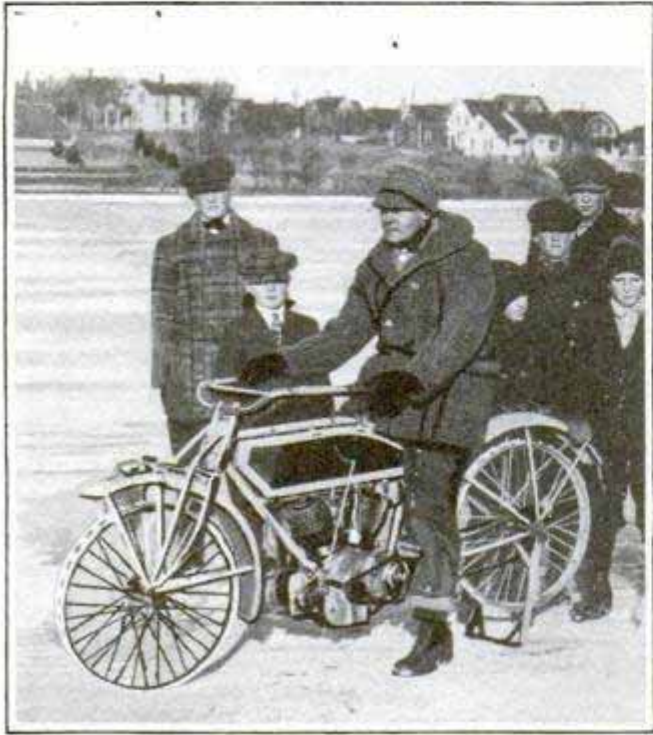

Motorcycle Capable of Making 75 Miles an Hour over Smooth Ice

horseshoe calks around the wheel rims a Minnesota motorcyclist has converted his machine into a practical and speedy ice motorcycle. The calks are placed 3 in. apart, and so effective are they in securing a firm grip on the ice, that the machine is capable of making a speed of about 75 miles an hour.

## MOVING-PICTURE OPERATOR BLINDED

Intense actinic rays are given out by the electric arc, which have injurious effect upon the eye if permitted to strike the retina for any length of time. Moving-picture operators who have to deal with this form of illumination usually protect their eyes by wearing glasses of heavy orange-brown shade, which absorb these dangerous rays. One instance is related, however, of an operator in Spokane who endeavored to repair some mechanism connected with his machine without turning off the light and without wearing his pro-

tecting glasses. Although he was engaged in this occupation but a few minutes, and felt no immediate pain, three hours later he was entirely blind, and but for prompt treatment would doubtless have been permanently injured. Fortunately the affection was only temporary.

## CONVERTIBLE TOP LATEST MOTOR IMPROVEMENT

Among the improvements shown at the recent automobile shows the convertible top will probably strike the man who can keep but one car as being among the most important. At least three roadsters having tops by which the car can be quickly made into an open or closed car are now being manufactured in this country, but it remained for the French to develop a top of this kind that is applicable to the largest touring cars. Just what this will mean in the way of comfort and economy is apparent in view of the almost universal practice of winter driving, and the extreme changes in weather that are characteristic of winters in this country. Owing to a cold snap at the beginning of the past winter many touring cars were changed from open to closed tops. During a succeeding spell of warm weather the closed tops were a positive discomfort, but in most cases another change could not well be made owing to the expense, such a change requiring either the substitution of one body for the other or elaborate changes in the top that amounted to about the same thing.

The new French tops for touring cars work much after the manner of the convertible roadster tops with which American motorists are becoming familiar. The roof is made to telescope, and folds down with the back upon the rear of the body in the same way as a buggy top, while the sides are made to drop into recesses in the sides of the body. With either of these tops, which differ in minor details, a change to an open or closed car can be made in a few minutes.



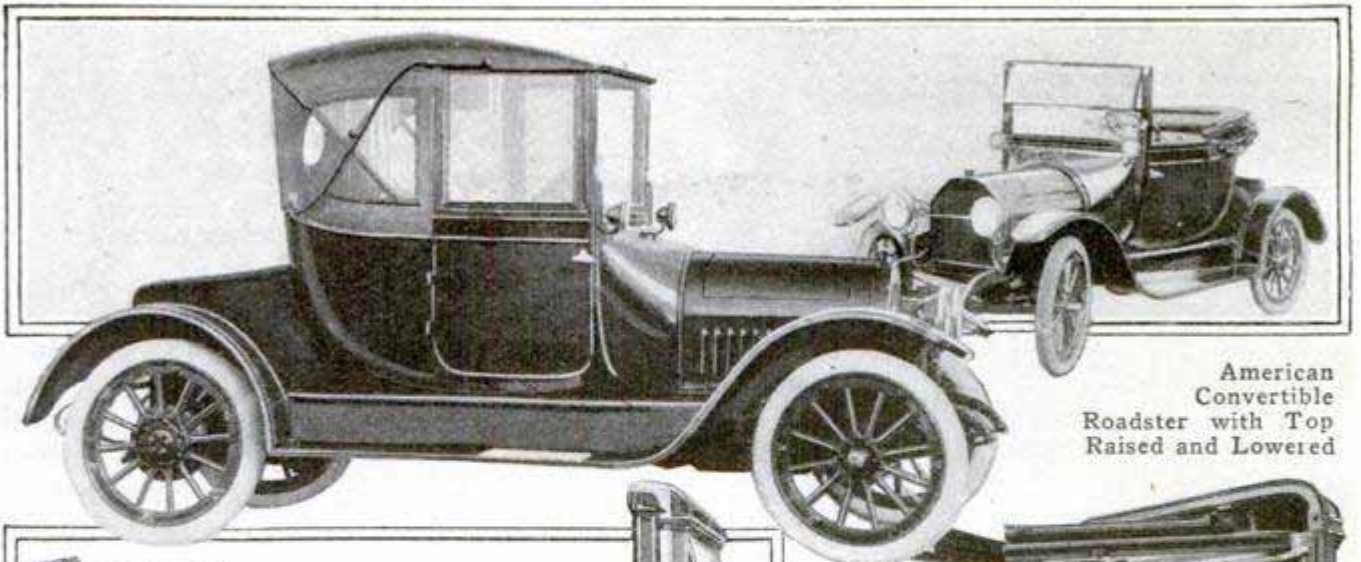

American Convertible Roadster with Top Raised and Lowered

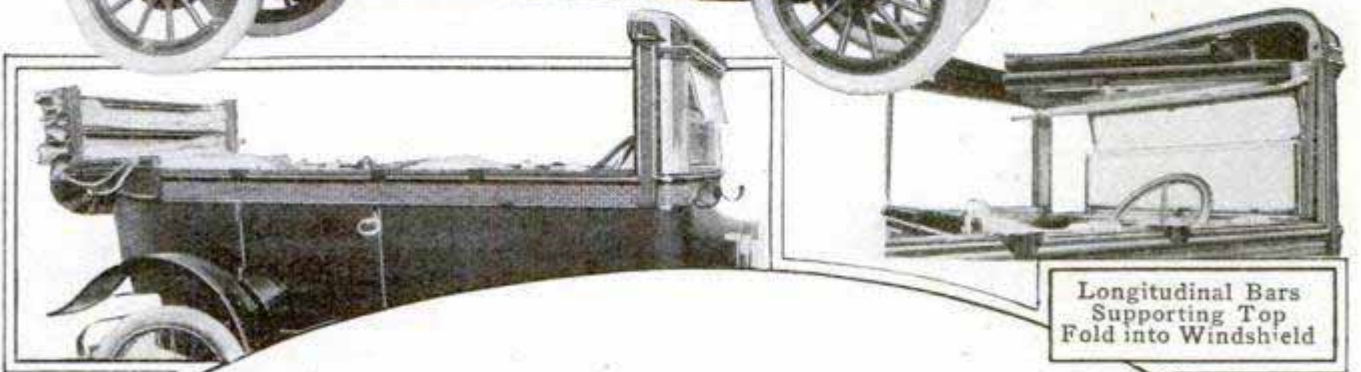

Longitudinal Bars Supporting Top Fold into Windshield

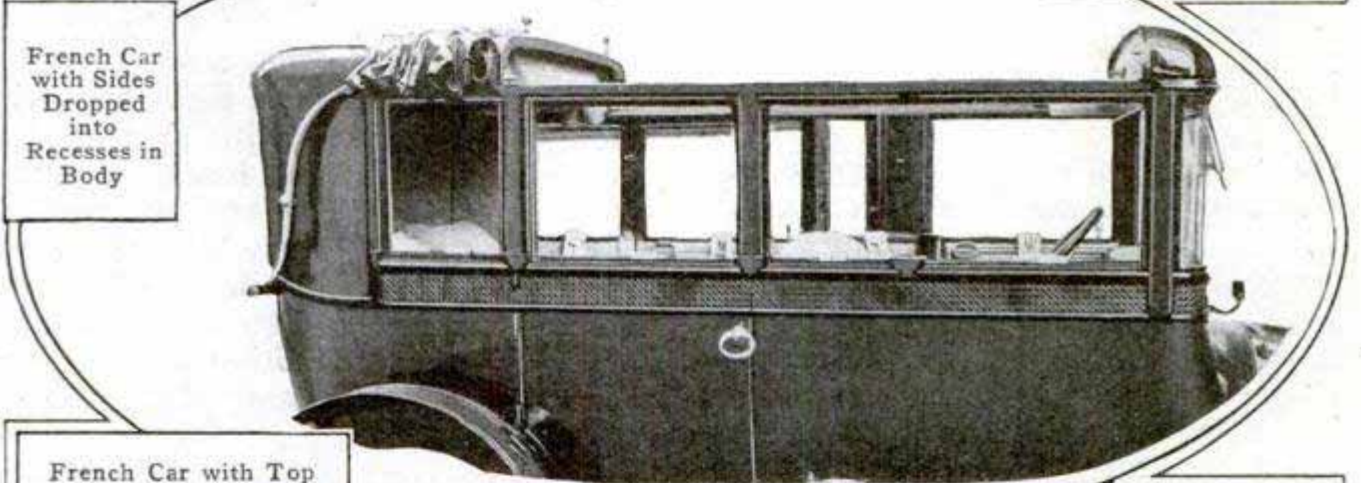

French Car with Sides Dropped into Recesses in Body

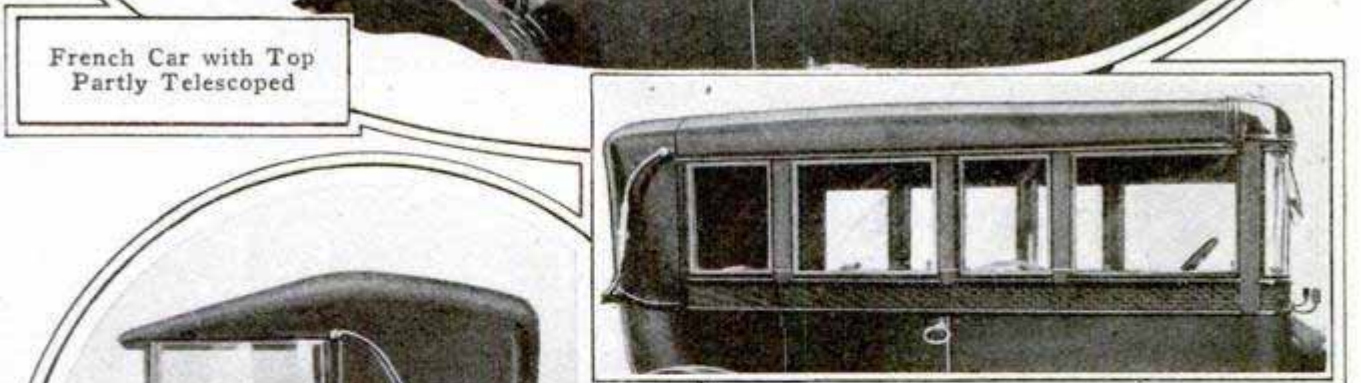

French Car with Top Partly Telescoped

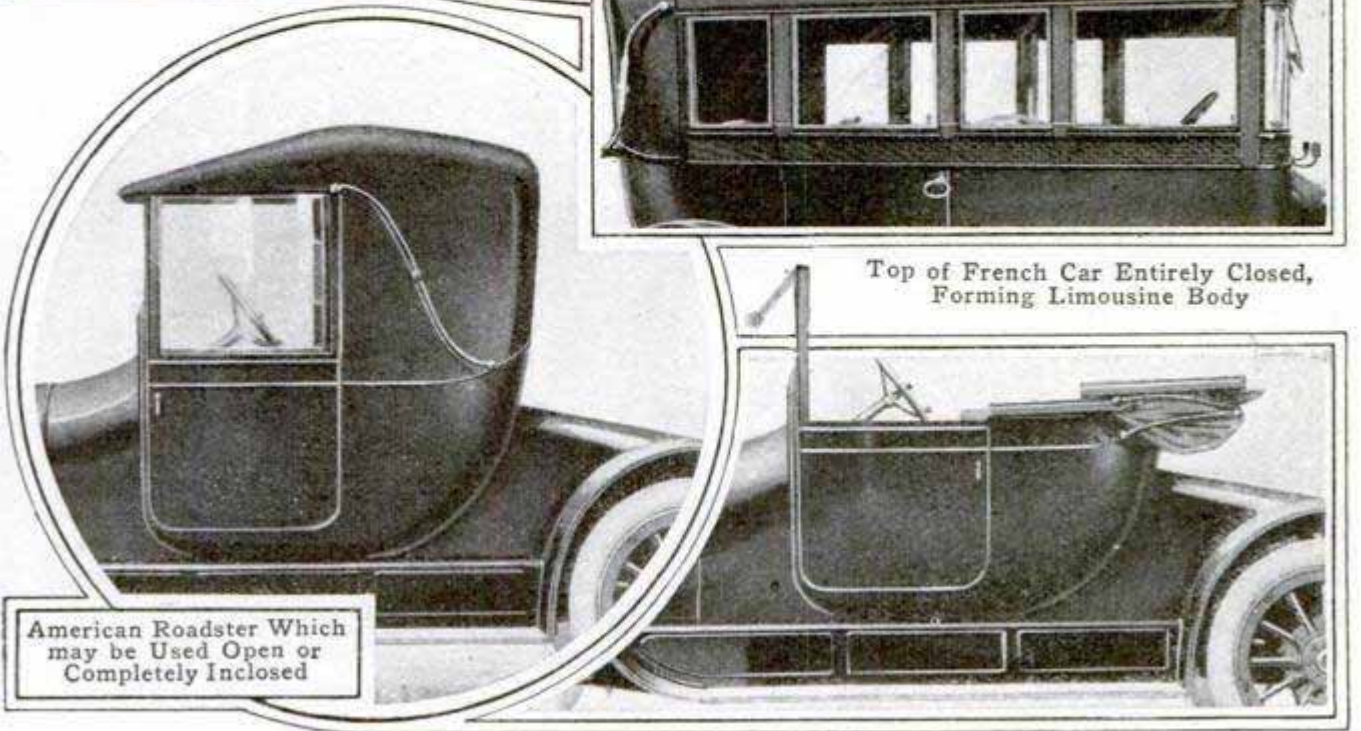

Top of French Car Entirely Closed, Forming Limousine Body

American Roadster Which may be Used Open or Completely Inclosed

## OLD FIRE ENGINE HEATS RAILWAY STATION

When the regular heating plant of a Mississippi railway station was put out of commission by reason of dam-

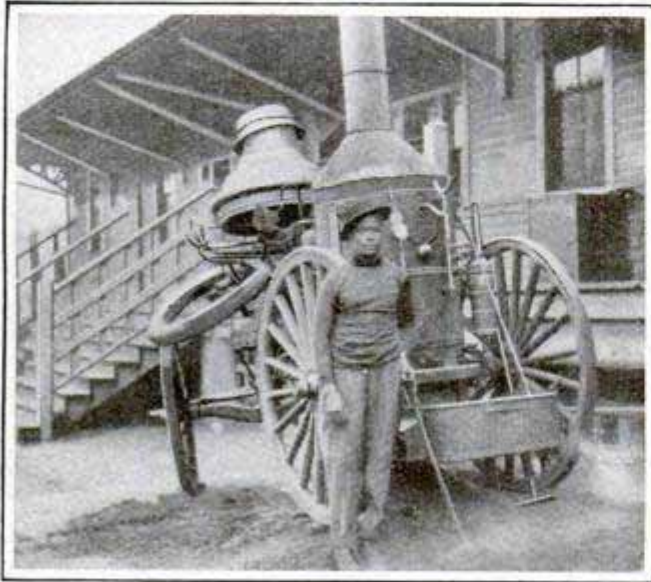

Fire Engine Used as Temporary Heating Plant

age to the boiler, an old fire engine was coupled to the heating coils of the station, and a comfortable temperature maintained without difficulty. Pipes were run from the boiler of the fire engine to the mains in the basement of the station and steam was sent to all radiators until the regular boiler was in commission again.

## REMARKABLE TUNNEL UNDER THE MISSISSIPPI

The city of St. Louis is safeguarding its water supply by a tunnel blasted out of solid limestone, 64 ft. beneath the Mississippi River. When this new intake tunnel is completed it will be 2,766 ft. long, 516 ft. extending beneath the land and 2,250 ft. under the river. The tunnel is tubular, 8 ft. in diameter, and will be lined with concrete when finished. Three shifts work consecutively, and dynamite is exploded three times a day. A new intake tower with a modern arrangement for the inflow of water, is provided, and the menace from slush ice will be reduced to a minimum.

## DIRIGIBLE OPERATED BY WIRELESS

A new type of dirigible controlled and propelled by wireless waves has been tested out at Genoa, Italy. By transforming the intermittent impulses of the wireless into a continuous current, the inventor has been able to operate the various propellers at will. The transforming device is contained within the basket, or car, of the dirigible, and also operates the bomb-dropping device by which the dirigible is designed to aid the army and navy in case of war.

## NOVEL RUBBER GRIP FOR GOLF CLUBS

Greater control of the grip on the golf club is secured by a device recently seen in England, which consists of a rubber attachment that slips over the handle, molded with grooves for the fingers of the left hand. For the little finger a slightly overhanging support is provided on which the club may be suspended while in use. The grooves being separated, the fingers assume a correct position on the club, permitting an easy and efficient grip.

## RAIN GAUGE THAT EMPTIES ITSELF AUTOMATICALLY

At Wagon Wheel Gap, in the heart of the Rocky Mountains, the United States Weather Bureau and Forestry Service maintains a meteorological station where rainfall is automatically recorded by a tipping bucket gauge. When the small cup or bucket in the inclosure is filled with water it automatically tips and makes an electrical record at headquarters, half a mile away.



## OCEAN LINER COATED WITH FROZEN SPRAY

When the "Oceanic" arrived in New York recently after a cold snap, her

as "salting." Such crude methods were easily discovered, however, and shrewd schemers have found less obvious means of defrauding prospective purchasers.

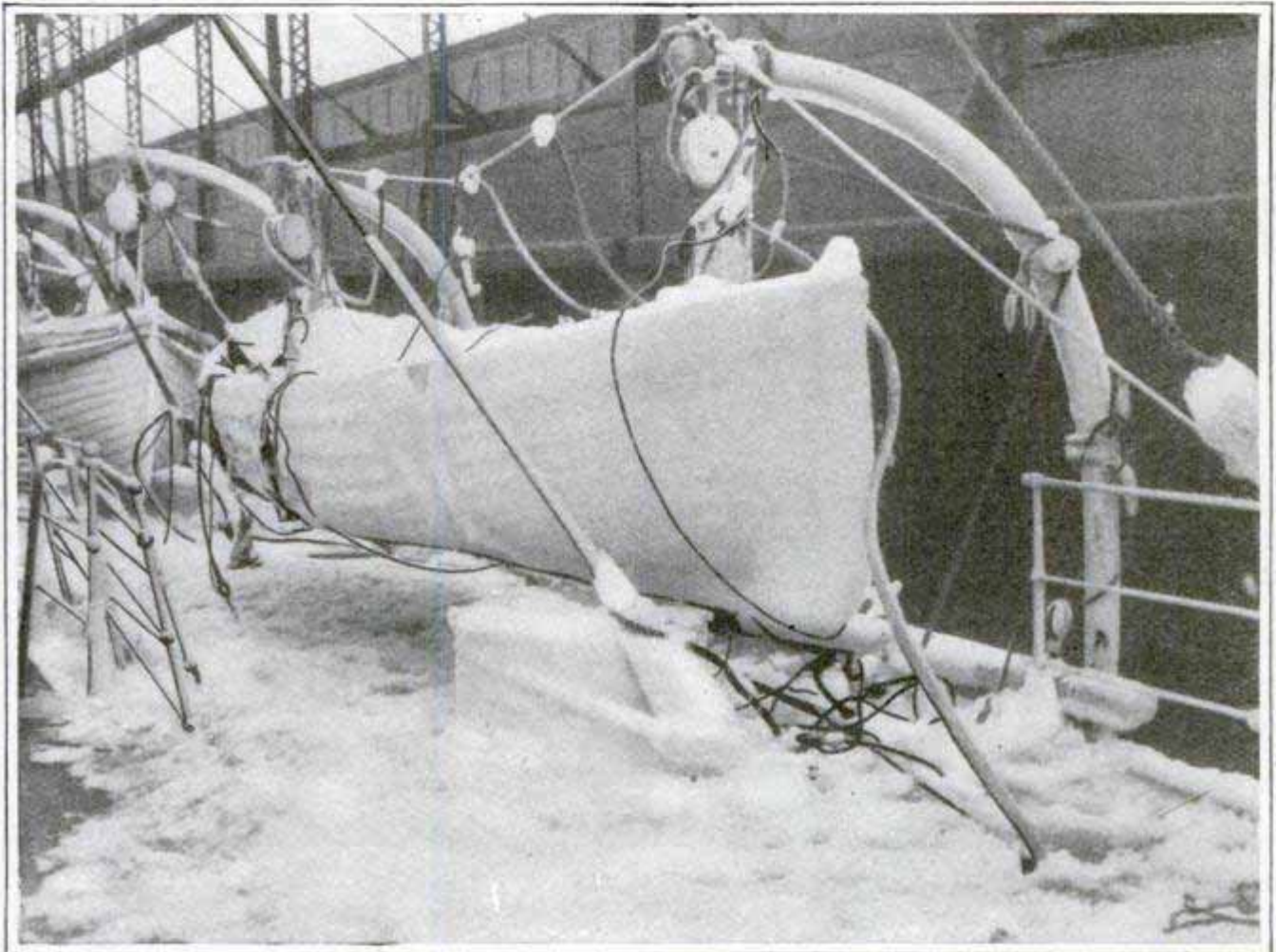

Copyrighted by International News Service

The Upper Works of the "Oceanic" Completely Coated with Frozen Spray

upper works were completely incased in ice. The spray from heavy seas which constantly broke over her froze before there was time for it to evaporate, so that on the ship's arrival at New York, she suggested a polar-exploration vessel.

## INGENIOUS METHODS USED IN SALTING MINES

Years ago it was no uncommon practice for unscrupulous speculators to offer for sale gold or silver mines of little or no value, but showing upon tests an ore assaying high, and often remarkable, values. This was accomplished by distributing ore taken from high-grade mines in the workings of the poor mine, the process being known

In one instance a low-grade mine in Alaska was sold to eastern buyers through an ingenious "salting" which defied precautions. The prospective buyers sent two different corps of engineers to Alaska to investigate the mine, but the miners were able to "salt" the samples so that the values appeared large. A third engineer was at length sent, who insisted that he be permitted to visit the mine alone and obtain samples in his own way. He took several tons of ore with him in large sacks, which remained on the wharf for several days awaiting the arrival of the ship which was to take it to San Francisco, in charge of watchmen night and day. Two men dressed as tourists strolled about the wharf, also evidently awaiting the arrival of

the vessel, and engaged the watchmen in conversation, asking all manner of foolish questions, and all the while punching the bags with their canes. This was repeated day after day, sometimes in one disguise and sometimes in another.

The ore finally reached San Francisco, and assayed so well that the deal was completed and the first payment on the mine, amounting to over \$100,000 was made, before the fraud was discovered. The canes which the tour-

ists carried were filled with chloride of gold, and at each punch several ounces were injected into the ore. This gold was revealed in the assay, and the value of the ore was apparently great. Other methods, no less cunning, have been exposed, such as shooting chloride of gold from a shot gun into the breast of the drifts and the bottom of the shaft. Fortunately the practice of salting is now uncommon, although instances are occasionally brought to light.

### PARIS RESIDENCE WITH MOSAIC WALLS

One of the most curious residences in the world is that built by an architect of Paris for his own use, in which the exterior walls are composed of mosaic. The mosaic is worked out in rather elaborate patterns, and stones of large size are used to correspond to

the scale of the patterns. This treatment is used consistently throughout the exterior, borders of mosaic being placed as vertical and horizontal panels around the windows and doorways, while over the main entrance is a picture composed of fragments of stone representing the profession of architecture.

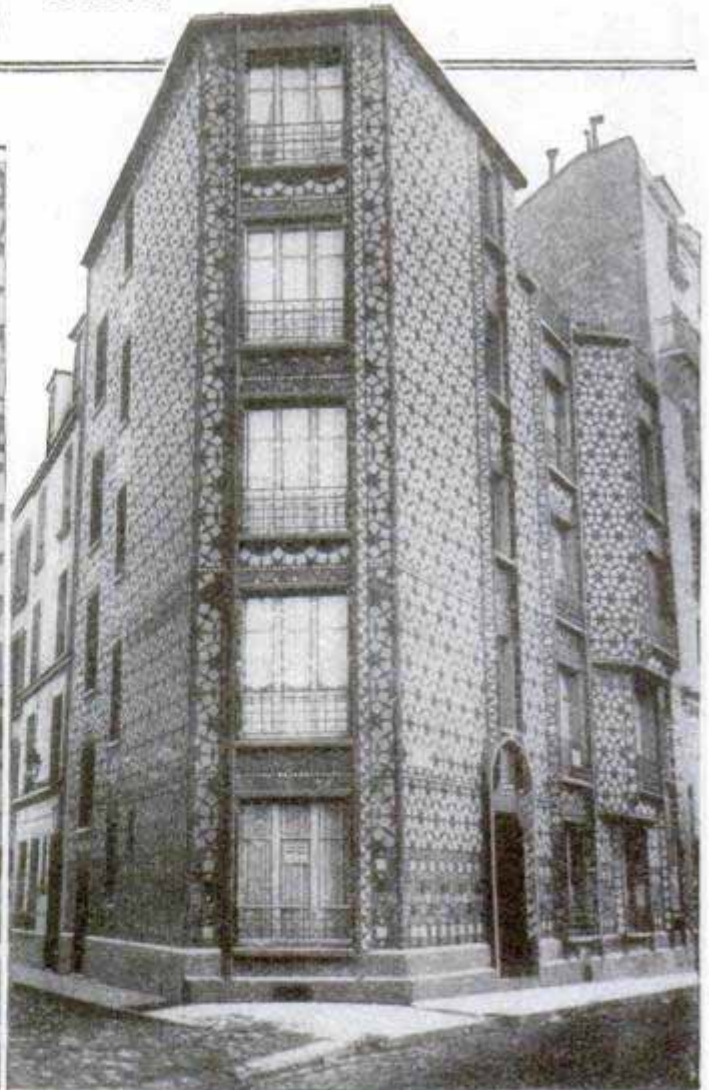
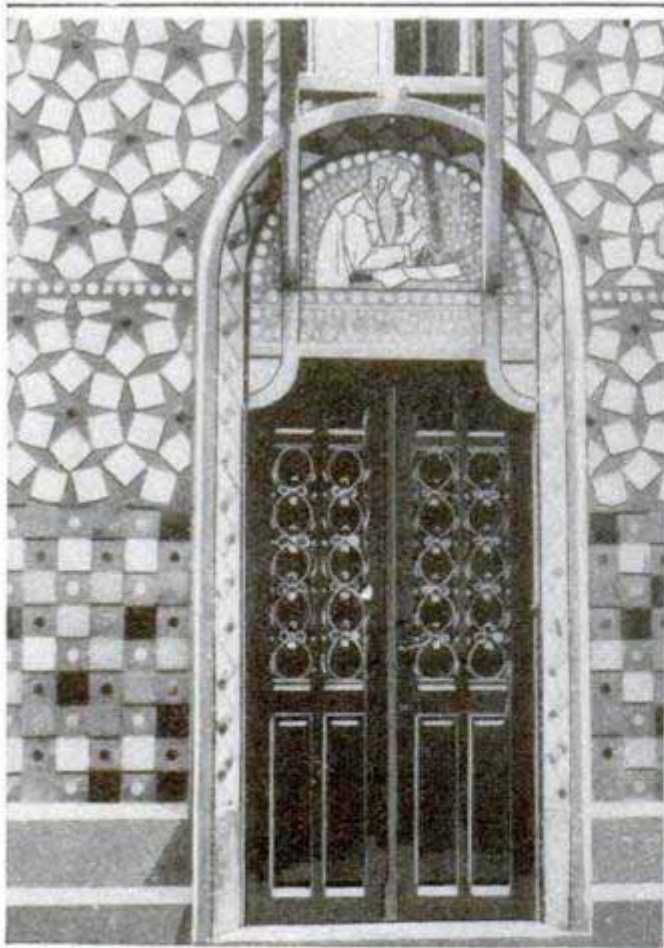

Residence in Paris, France, Composed Entirely of Mosaic, and, at Left, Main Entrance, with Mosaic Figure Representing Profession of Architecture

Photos by Underwood & Underwood

### PIOUS MINERS WORSHIP AT DEPTH OF 500 FEET

Five hundred feet below the surface of a silver mine in Mexico one may

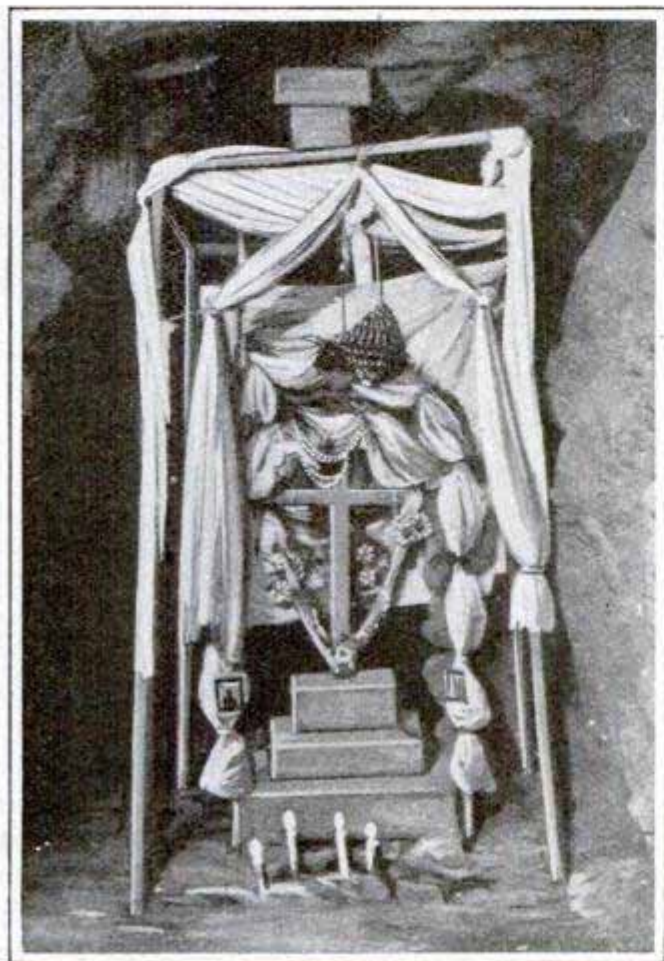

Candles Burning before a Shrine, 500 Ft. Underground

see a cross, surrounded with offerings, before which burn constantly many candles. The more ignorant of the native miners believe that if they place candles before the shrine no evil can befall them, and that accidents likely to happen in mines are warded off.

### AIRMAN SEEKS TO FLY AROUND THE WORLD

The French airman, Vedrines, who has made a successful flight from Paris to Cairo, now plans to continue on around the globe. He will fly from Cairo to India, Indo-China, and the East Indies to Australia, if possible, but beyond Australia he does not profess at this time to determine his further path. A glance at a map will indicate his difficulty in arranging a practicable route from Australia.

### LOADING MAHOGANY LOGS ON A STEAMER

The interior of Nicaragua contains forests of mahogany, some of the finest grades of that splendid wood being shipped from that country. Felled in the dense tropical forests, roughly hewn and hauled to the seaboard, these huge logs are thrown in the water, chained in large booms to await the passage of an up-bound steamer. To see them hauled up, glistening in the sunlight, their grain showing up in a brilliant red, is one of the interesting sights for the tourist. Some of the logs weigh as much as two tons, and are valued at a hundred dollars each.

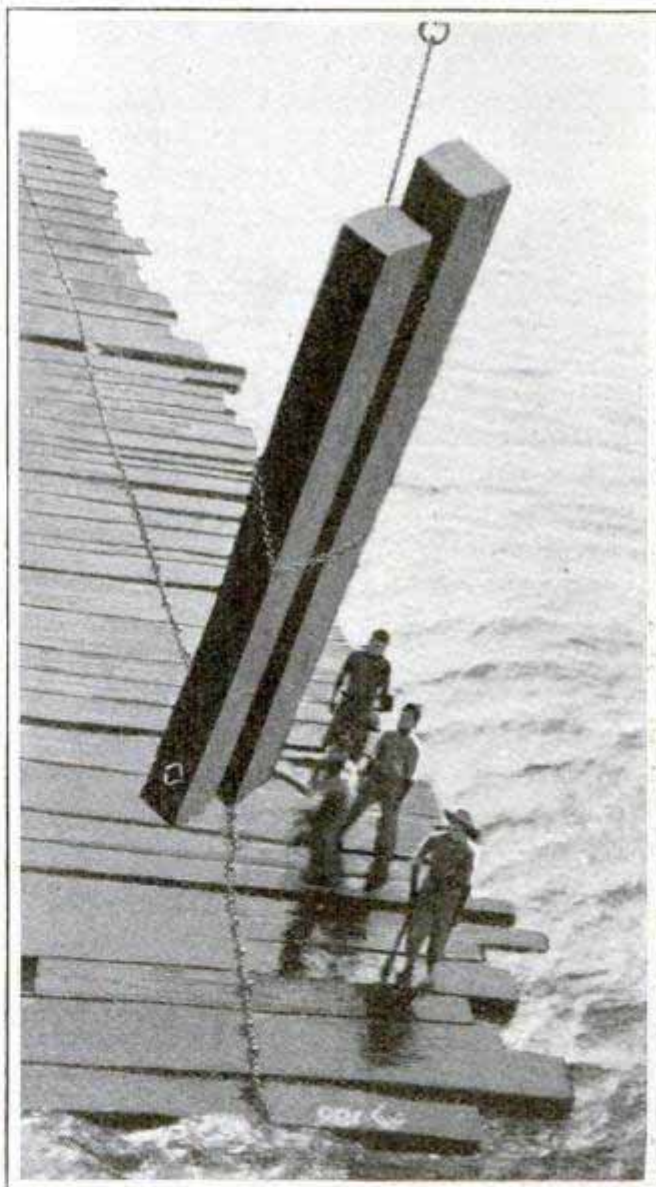

Logs of Mahogany being Hoisted on Shipboard at a Nicaragua Port

White mahogany is also shipped from Nicaragua, and is increasing in popular favor.

## "MONA LISA" IDENTIFIED BY PAINT CRACKS

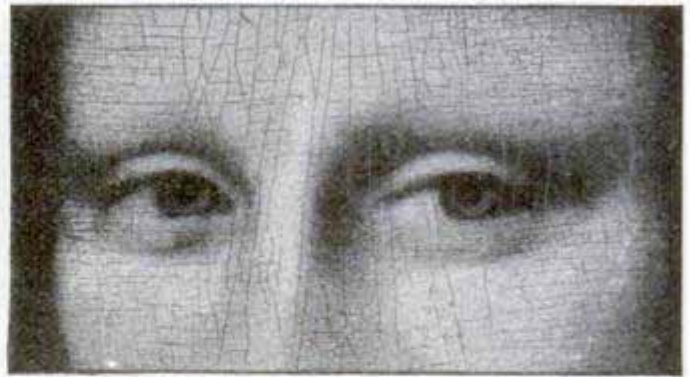
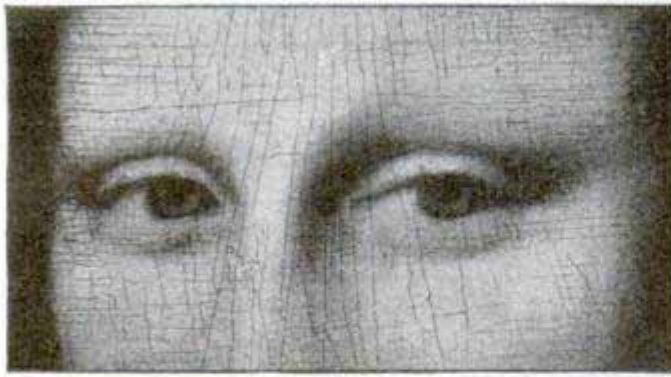

How Lost "Mona Lisa" was Identified by Paint Cracks. Photograph, Made before Painting was Stolen, at Left. Photograph, Made after Painting was Found, at Right

The first question asked by the average person after the announcement of the finding of the lost "Mona Lisa" was "How do the experts know with any certainty that this is the same painting that was stolen from the Louvre?" A big business is carried on in faked works of art, and there are many accomplished artists in the world who can imitate an "old master" so skillfully as to deceive even an expert. But the cleverest imitation falls short in just one particular. A network of fine paint cracks is sure to exist in any painting of considerable age, and no way has ever been found for copying these with minute exactness. Through the paint cracks in the "Mona Lisa" it was easy to identify the famous painting positively. This was done by comparing, inch by inch, a photograph taken after the painting was found in Italy with a photograph made before the painting was stolen.

A curious feature in connection with the theft is the fact that the identity of the man who carried off the painting might have been established immediately if the Bertillon records of the Paris police had been classified differently. On the frame, which was left under a stairway of the Louvre, were found five finger prints. Only one of these, a print of the left thumb, was sufficiently distinct to serve for identification. While an impression of both thumbs is always taken, criminal rec-



Courtesy Illustrated London News

Thumb Print Found in Police Records and Thumb Print Found on Frame of Painting

ords are classified by the Paris police by means of the right thumb. With 750,000 such records on file it was impossible to find the criminal with only a left-thumb impression. Since his arrest it is found that he is a well-known criminal and that his record is on file with the Paris police.

### FOIL BURGLARS BY SAFETY CHAINS FOR DOORS

A door fastened with the ordinary door chain, which is often relied on as an additional protection against thieves, is easily picked by the skillful use of a big gimlet and a piece of stout wire. A hole is bored through the door immediately above the chain, the wire, properly bent, is inserted and the button at the end of the chain is moved in the slot by twisting the wire like a key. If the slotted casting is put on obliquely, at an angle of about 45°, so that the chain must be not only slid back but raised in order to get it out of the slot, it cannot so readily be tampered with.

## CANADA TO IRRIGATE VAST STERILE TRACT

Two thousand square miles of scaly earth, of shifting sand and parched prairie grass will be made fertile through irrigation, now that the huge Bassano dam across the Bow River, in Alberta, Canada, is completed. Here the drainage from thousands of miles to the north comes down toward Calgary, 80 miles to the west, but heretofore the district has been little bet-

ter than a desert. Three years have been spent in construction of an irrigation system by which it is proposed to reclaim this great territory, and at a cost of nearly \$4,000,000 a dam which ranks as one of the engineering feats of the century has been completed. A large irrigation reservoir has been constructed within the irrigable tract and near the farms. A concrete spillway, 720 ft. in length, has a heavy concrete floor protected by cut-off walls. Upon this, buttresses are erected, with a sloping deck, designed to pass 100,000 cu. ft. of water per second, with extreme height of 13 ft. above the crest. An earthen dike at the western end protects the concrete portion of the dam. This dike is a mile and a half long, and 45 ft. high, and contains more than a million cubic yards of material. The main canal extends in an easterly direction from the dam for five miles, when it divides, the smaller portion turning to the north, while the larger continues to the east. One million acres of parched desert will be made to bear abundant crops, repaying a thousandfold the immense sums expended upon the project. There still remain to be placed gates and locks for the irrigating ditches before the district is ready for settlers.

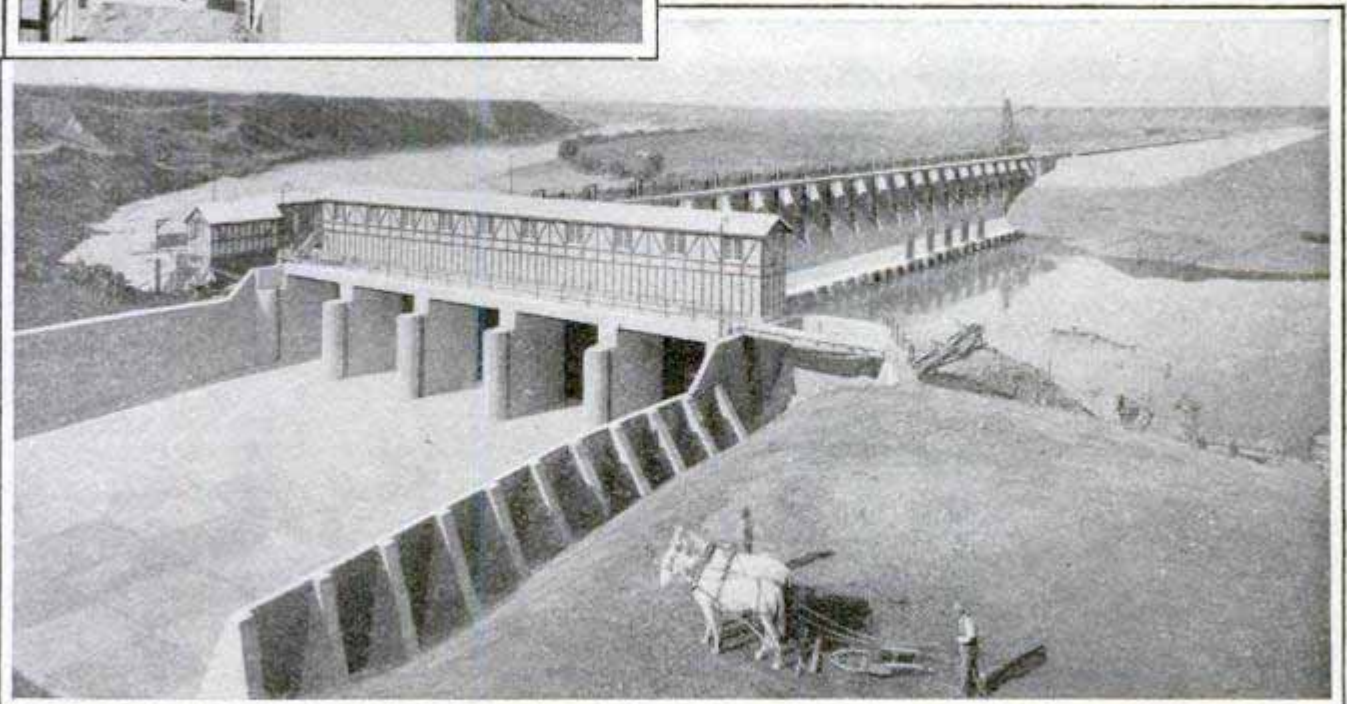
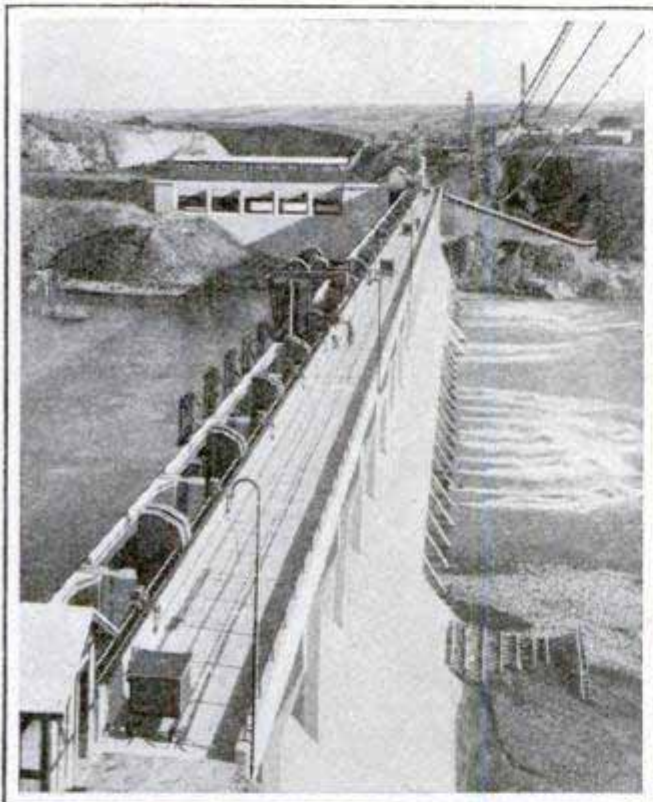

Bassano Dam and Beginning of Main Canal, Upper View Showing Spillway and Protecting Dike

# BATTLESHIP "DELAWARE" CLEARED FOR ACTION

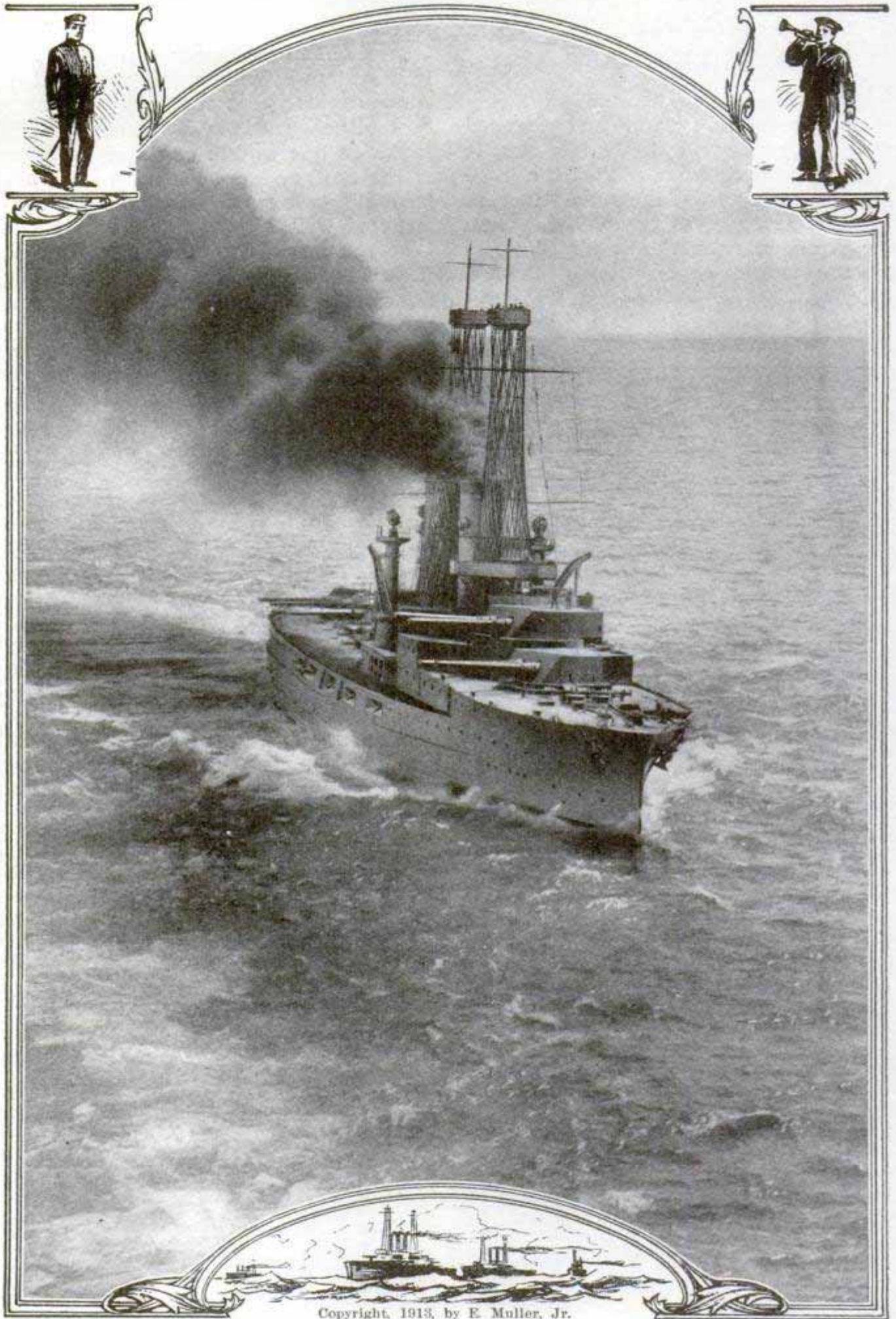

Copyright, 1913, by E. Muller, Jr.

Few Landsmen Ever See a Warship Stripped Down to Fighting Trim. At the Signal "Clear Ship for Action," Every Movable Object on the Decks is Removed and Stowed Below



# FINDING THE ENEMY'S RANGE IN BATTLE

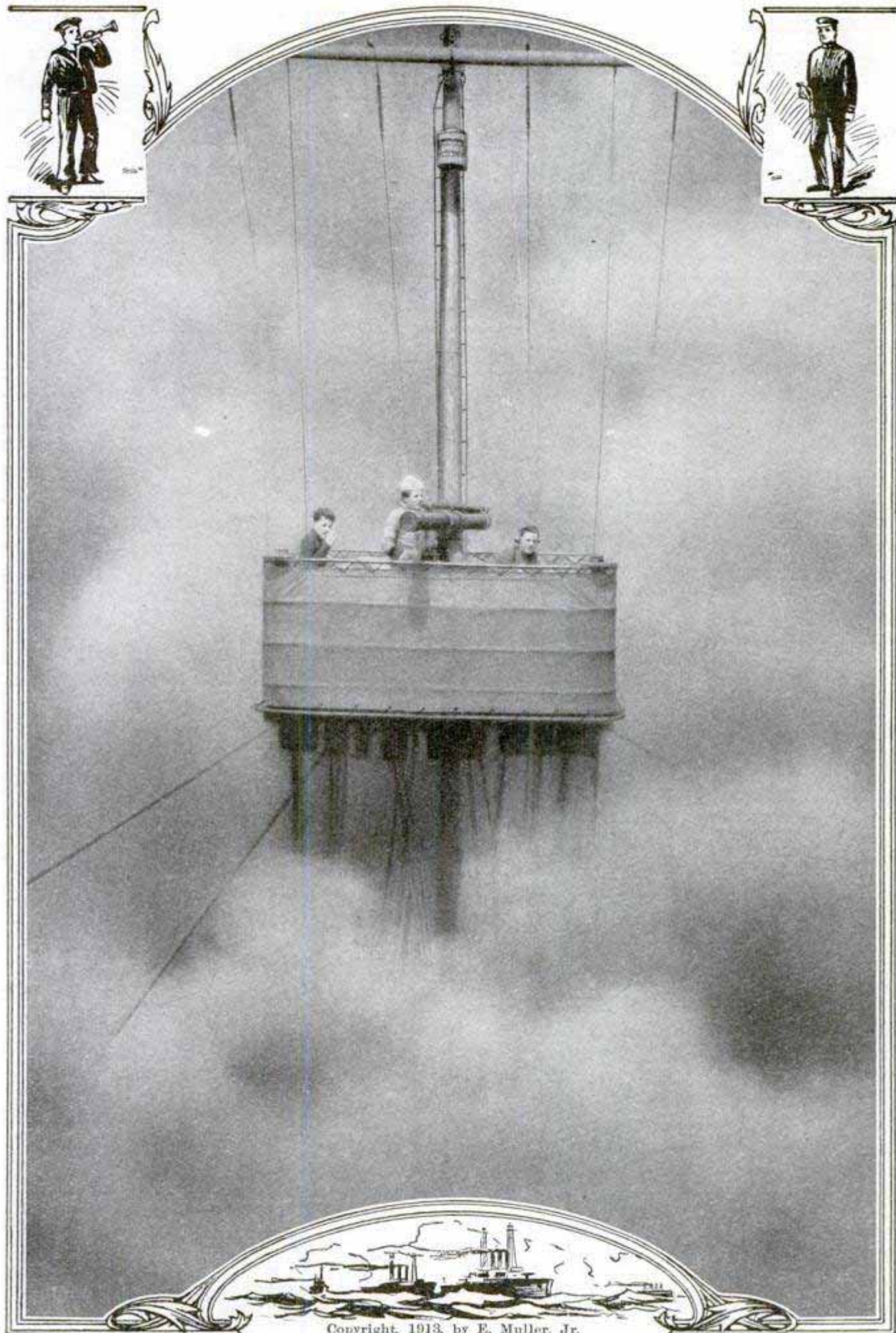

Copyright, 1913, by E. Muller, Jr.

On the Fire-Control Platform of the Dreadnought "North Dakota" during Target Practice. The Gases from the Guns Envelop the Men Who are Trying to Determine the Distance of the Target

## AEROPLANE MAY ATTEMPT ATLANTIC FLIGHT

One of the biggest and most powerful aeroplanes in the world, which, it is believed, may attempt the flight across the Atlantic is now being built at Kingston, England. This enormous craft is provided with seaworthy floats and is a biplane with wings of 81-ft. span, or more than double that of the ordinary aeroplane. It is driven by two 6-cyl. engines, each of 120 hp., giving a power plant with a total capacity of 240 hp. These engines are chain-connected to a single propeller shaft which carries a four-bladed propeller having a diameter of 12 ft. 6 in. and a pitch of 14 ft. In front of the engine and placed side by side are two seats, one for the pilot and one for the wireless operator. Power for the wireless plant is supplied independently of the main engines by a motorcycle engine fixed to the aeroplane within convenient reach of the operator. In addition

to the seats for the pilot and wireless operator, there is a larger seat for a gunner with space for the mounting of a gun.

ⒸAbout 1,000 electric motors, ranging from 7 to 50 hp., will be used in operating the locks, pumps, bridges, emergency dams and gates of the Panama Canal.

## STEAM PIPES THAW FROZEN GROUND

Mining in Alaska is restricted because of the long and severe winters, and the ground remains frozen to considerable depth. An ingenious method of combating this condition is illustrated in the photograph, where miners are seen driving  $\frac{3}{8}$ -in. pipe into the ground. Steam is forced into the pipes under strong pressure, and in this manner the ground is thawed so that it can be worked.

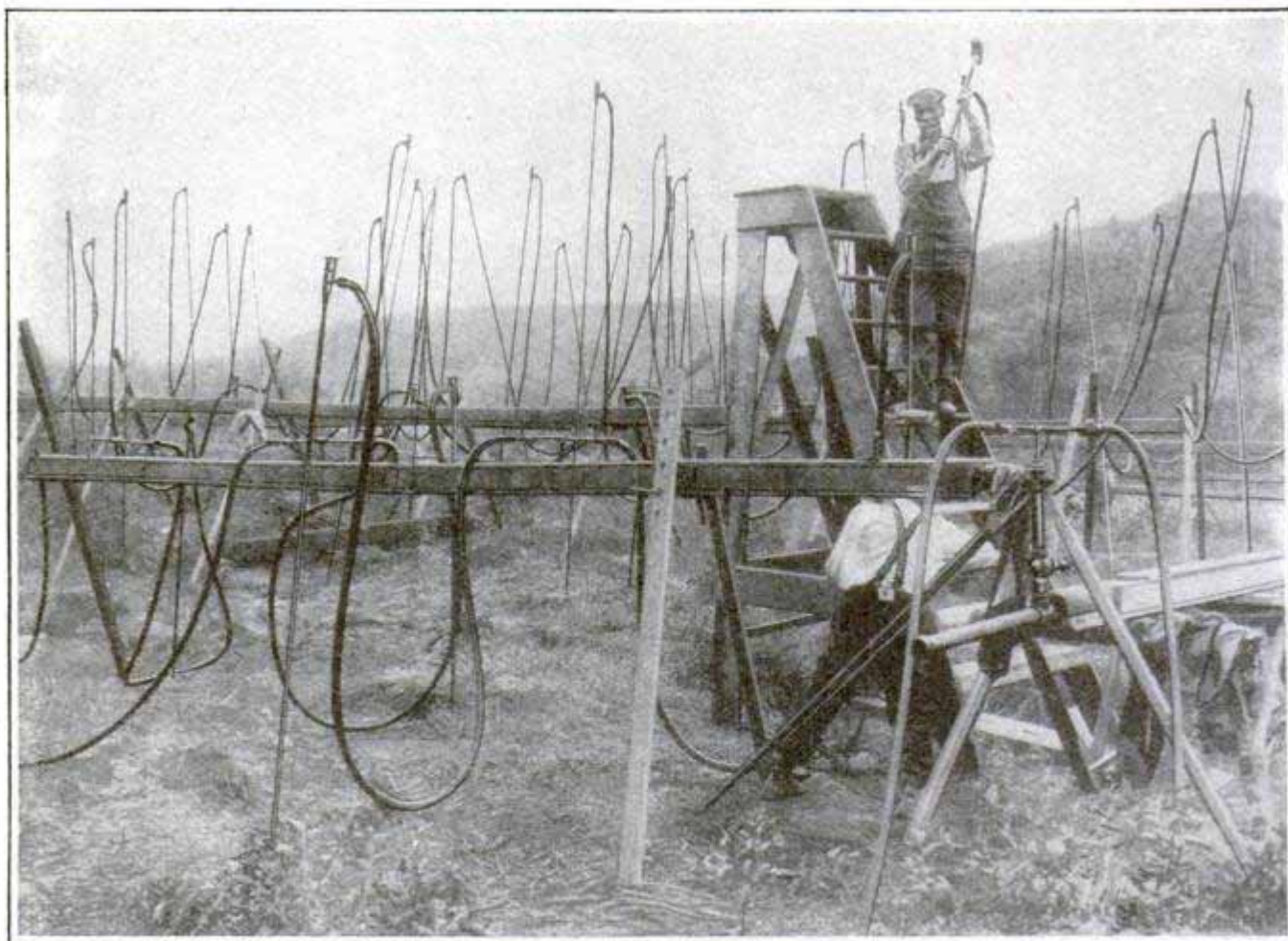

Courtesy The Valve World  
The Long Alaskan Winter Freezes the Soil to Great Depth, Rendering Mining Difficult. Patches of Ground are Thawed Out with Live Steam

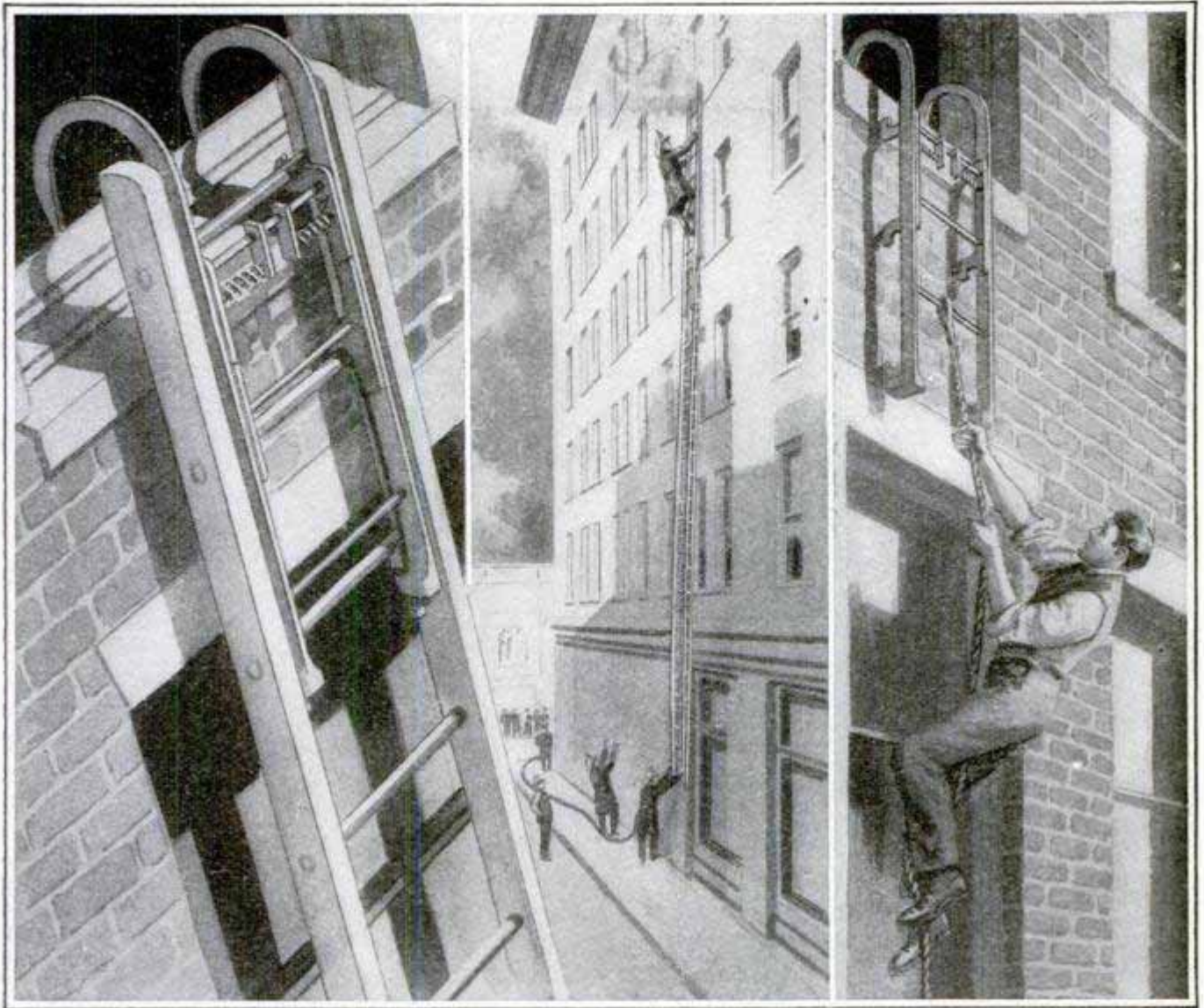

New Detachable Hook, in Combination with Either Scaling Ladders or Life Rope, Aids Firemen in Rescue Work or Fire Fighting

## DETACHABLE HOOK FOR USE WITH FIRE LADDERS

While designed primarily for use with fire ladders, a detachable hook recently invented has a wide adaptability in connection with construction work of all kinds in which ladders may be employed. The hook provides a simple, convenient and inexpensive attachment for ladders, whereby any ordinary ladder may be converted into a scaling ladder, and the hook may be applied to the ladder, removed from it or transferred from one ladder to another quickly and easily. Fire departments find this useful in connection with the life-line section, and a total weight of 1,150 lb. has been demonstrated safely and successfully on this hook. Heretofore such hooks as

have been used in scaling ladders have been permanently attached to the ladder. Thus when an old hook or ladder became broken or impaired a new ladder had to be provided.

## MAHOGANY USED TO IMITATE WALNUT

A case of wood staining that has attracted considerable attention was that of staining mahogany to represent walnut. This seemingly purposeless use of one valuable wood to imitate another came about from the fact that a walnut finish was wanted for a room at a time when walnut of the exact size and kind was not available. Owing to the similarity in grain and texture in the two woods the imitation might deceive even an expert.

## CURVED WINDSHIELD FOUND EFFECTIVE

A French scientist has constructed a windshield with a curved surface

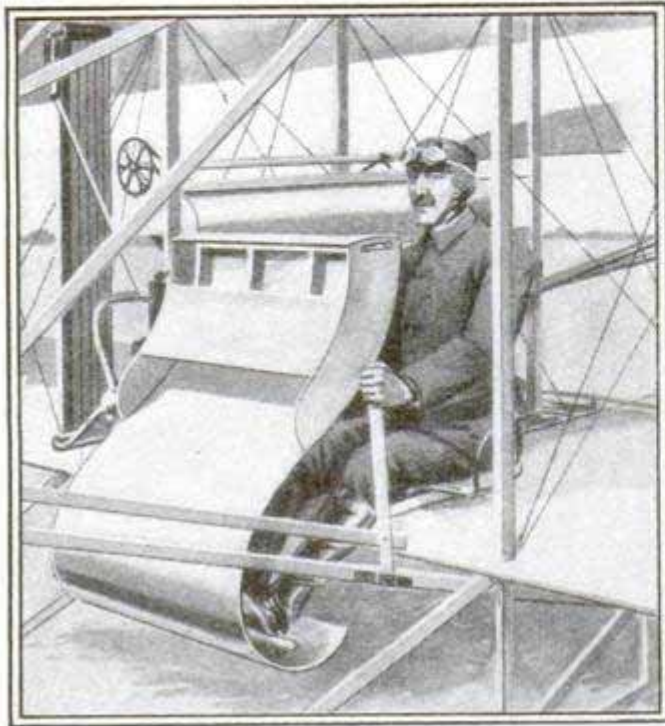

Curved Windshield Attached to Aeroplane

which has been found equally effective when used on an automobile, an aeroplane, a dirigible or on shipboard.

## A MILITARY INNOVATION IN INDIA

A detachment of 35 men on motorcycles and four motor cars equipped with machine guns has recently been added to the cycle force of the Calcutta Rifle Battalion. Possessing the only machine guns so far mounted on cycle-

When the wind strikes an obstacle like a wall, it is observed to "jump over," leaving a region of calm which extends above the top of the wall, so that an observer looking over is shielded from the effects of the wind. The new curved windshield is a deflector of sheet metal bent into a curved body, with a smaller and similarly curved top, hinged to permit adjustment to varying winds. Placed on an automobile, this curved deflector protects the driver and passengers not only from the wind but also from dust and insects so effectively that they can ride comfortably without goggles and smoke as if sitting in a closed room. On an aeroplane it works as well. Drops of oil projected from the engine are thrown aside instead of spattering into the eyes of the pilot or smearing his goggles. On board ship it is equally effective when applied to deck chairs, and French military authorities have installed this form of windshield on several dirigibles.

Over 28,000,000 corncob pipes, valued at \$500,000, were turned out last year by six factories in Missouri.

cars, this detachment is extremely mobile, capable of proceeding at the rate of 40 miles an hour, thus making it invaluable in case of riots, or to hold threatened bridges, and the like. The machine gun weighs 60 lb., and the tripod 48 lb., while the ammunition box with one filled belt weighs 21 lb. The detachment also carries rifles.

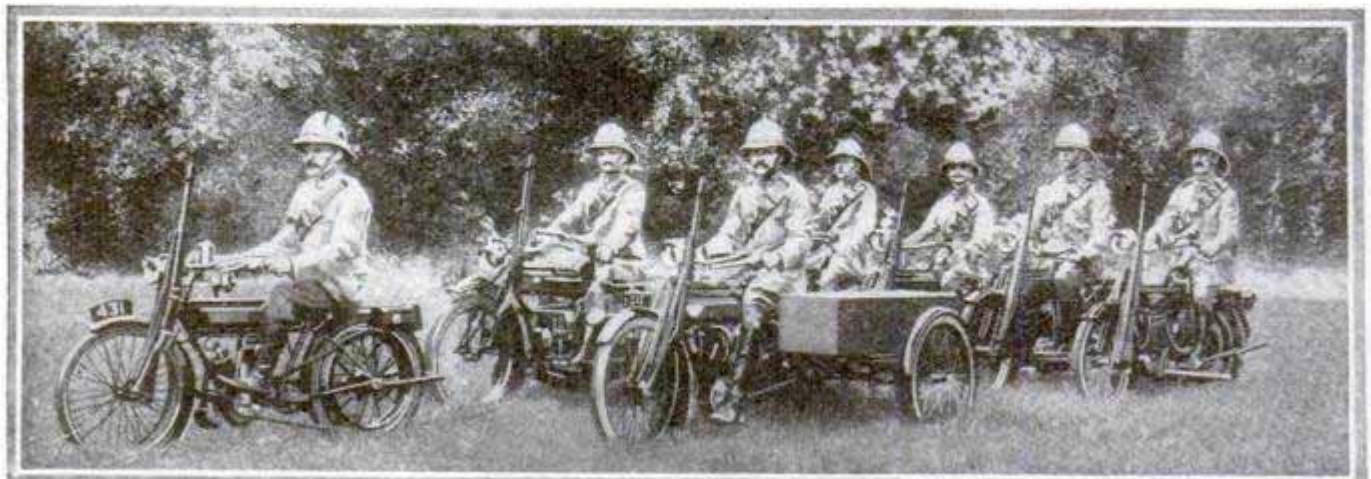

A Motorcycle Machine-Gun Detachment

Courtesy The Spence

## TOWERLESS WINDMILL IS TIRELESS WORKER

A novel windmill manufactured in Portland, Ore., is supported by a tubular column, instead of the usual tower. The fans are arranged in two sections, four in each, and are of galvanized iron, concave, and so adjusted that they quickly receive the full propelling force of the wind, while on the return they are shielded behind a movable screen of canvas. The shield is kept in the correct position by the tail vane, moving about as the wind shifts. Ball

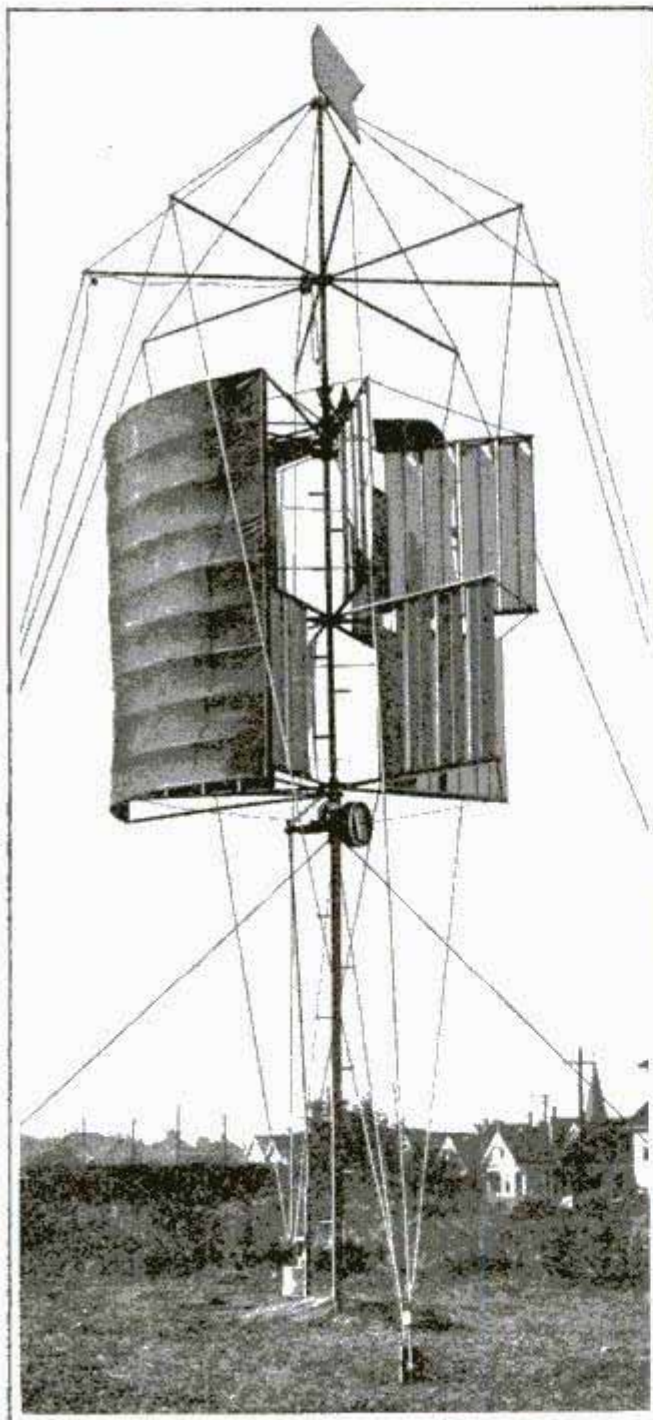

New Idea in Windmill Construction

bearings are used on all wheels. The steel tubular column is kept in rigidly upright position by guy cables attached to the top of the column, trussed and anchored, and by a secondary set of cables guyed beneath the revolving wheel. Steel spikes set into the column form steps by which the machinery is reached for lubrication and repair.

## CARRYING THE MAIL ON ICE YACHT

If there is a point south of the Alaskan boundary where the United States mail carriers have to contend with adverse weather conditions paralleling those of the Arctic regions, it is at Put-in-Bay, that famous island in Lake Erie where Perry won his victory a century ago. Separated from the Ohio mainland by 12 miles of open water, the coming of winter brings hardships to the men whose daily task it is to traverse the distance laden with the mails. Few have been the days in the past 14 years, however, when the weather was so inclement that the trip could not be made. A stout sailboat is the usual means of communication, but when the ice closes, and boating is impossible, the ice boat is called into play, and the distance is traversed in record time. An automobile has been driven over the ice in 17 minutes, from Port Clinton on the mainland to Put-in-Bay, but the flying ice boat made the trip in 14 minutes.

Here, too, is one of the most favorable places for the winter sport of fishing through the ice. A canvas-covered fishing shanty, containing a sheet-iron stove, and equipped with cushioned seat, makes this endurable even in howling winds and bitter cold.

Carrying the mails in an ice yacht has distinct advantages—a thrilling ride, a hearty welcome and an opportunity to coax from beneath the ice a dozen or more pickerel, perch and saugers. Little wonder that in 14 years few days have been found too inclement to bring the mails from the mainland to Put-in-Bay.

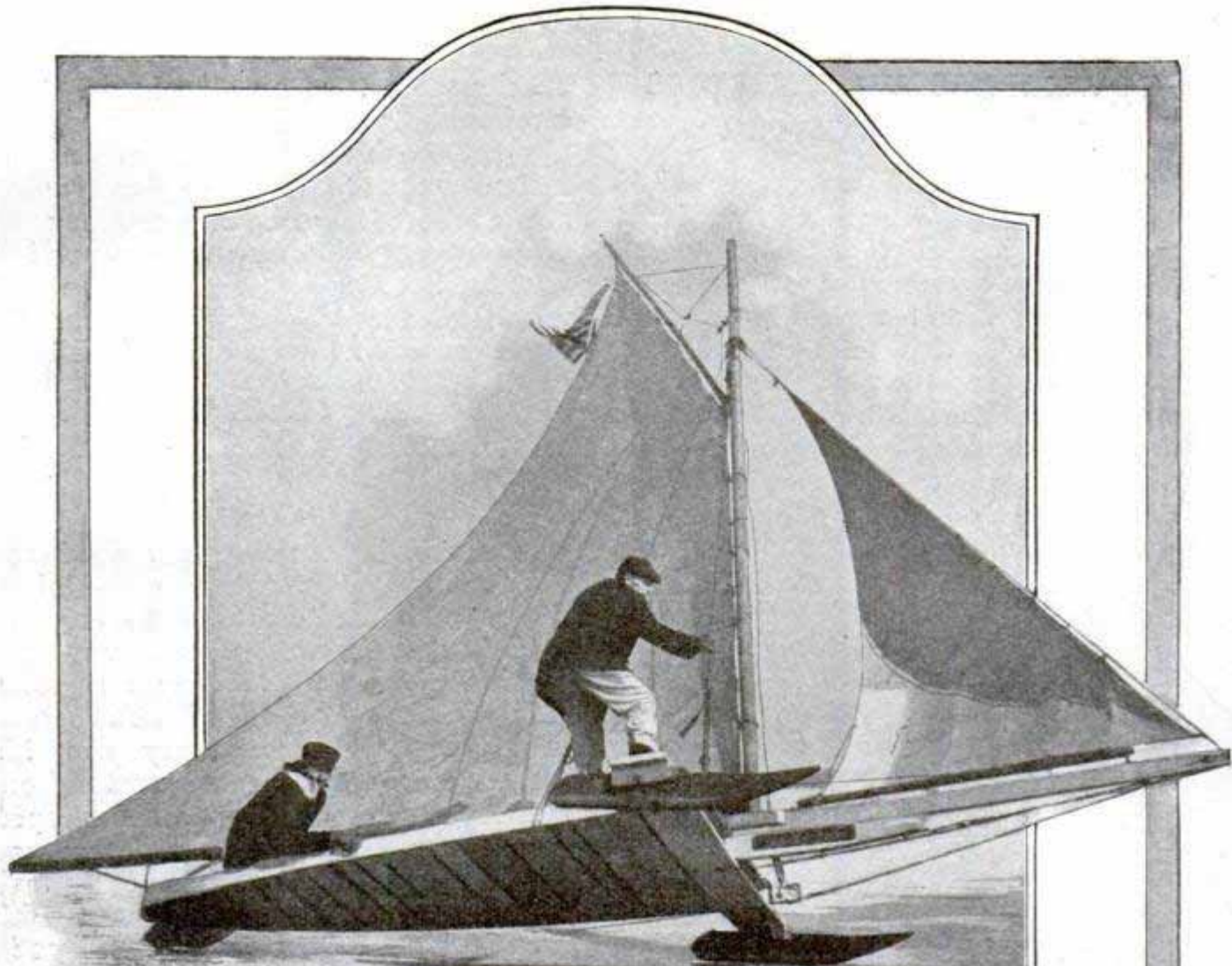

Carrying  
the Mails on  
Ice Yacht  
from  
Put-in-Bay  
to Mainland

Right,  
Fishing  
through  
the Ice in  
Comfort

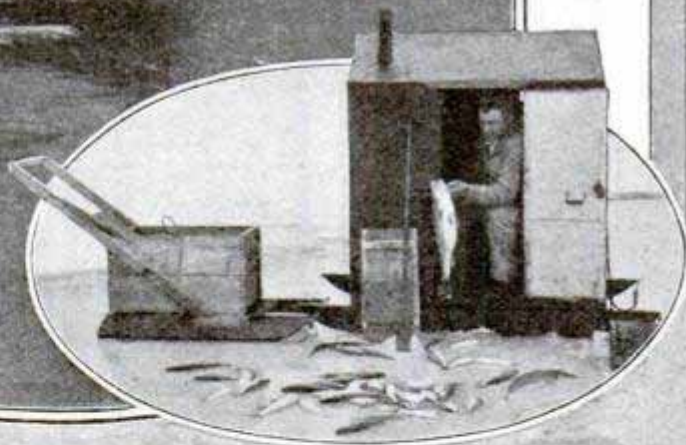

Ice Breaker Making a Way through  
the Ice Field

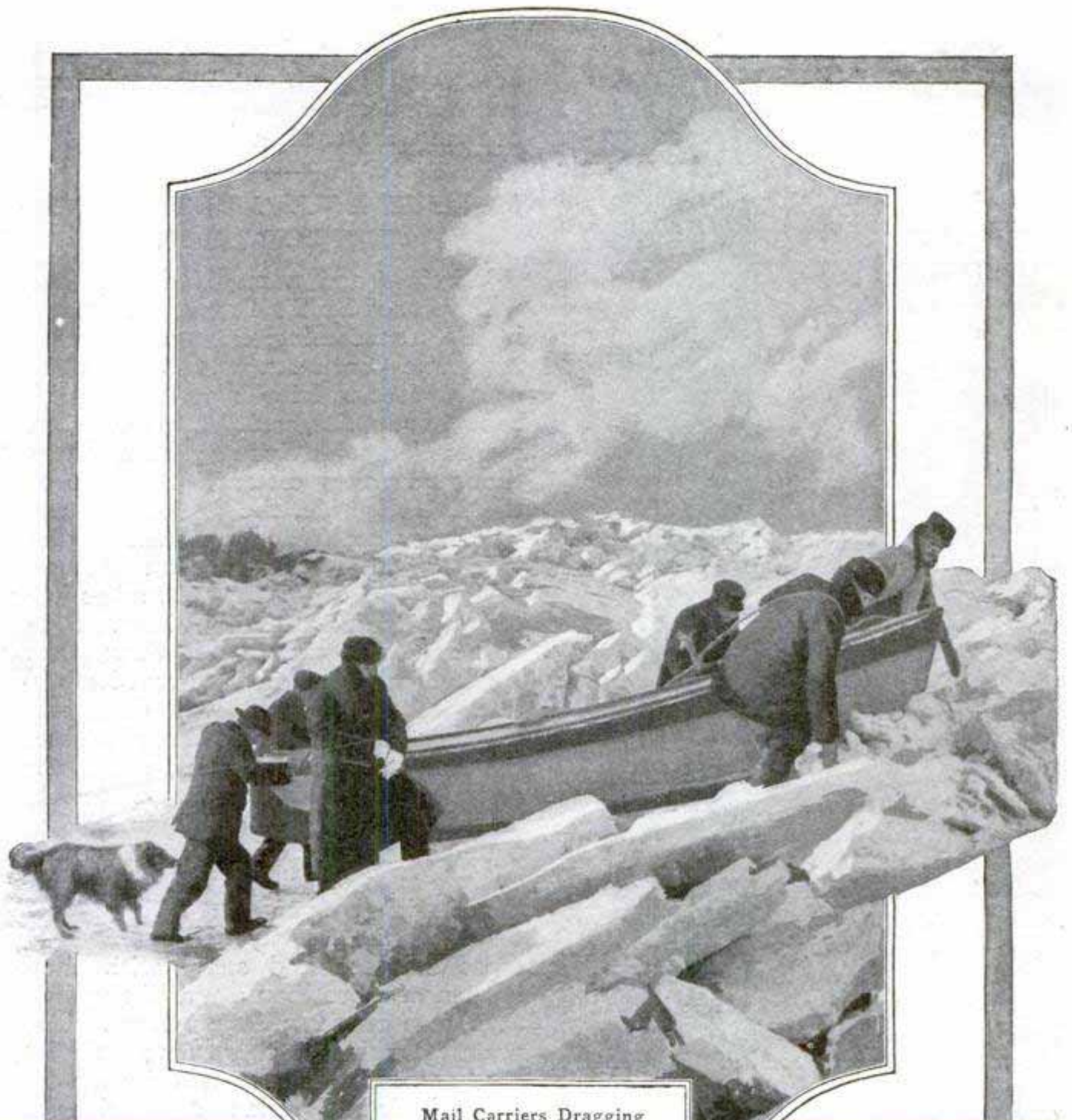

Mail Carriers Dragging  
Launch across Ice Pack  
on Lake Erie



Ice Boats and Fishing Shanties  
at Put-in-Bay

## HE WHO RUNS MAY READ THIS SIGN

Outdoor publicity on a large scale was undertaken by authorities in charge of the Portola festival in San



Sign as Long as Five City Blocks on Hillside

Francisco, when upon a hillside they dug huge trenches shaped in letter forms and filled them with lime, spelling the words, "Portola Festival, Oct. 22-25." In selecting the location for this great sign, Yerba Buena Island, opposite San Francisco, was chosen, and the side facing the city being the first object seen by travelers entering San Francisco from the east, was found the most conspicuous site. The entire sign is 1,400 ft. long and is 136 ft. from top to bottom. Each letter is 48 ft. long and each line in the letters is 8 ft. wide. In preparing the site, it was

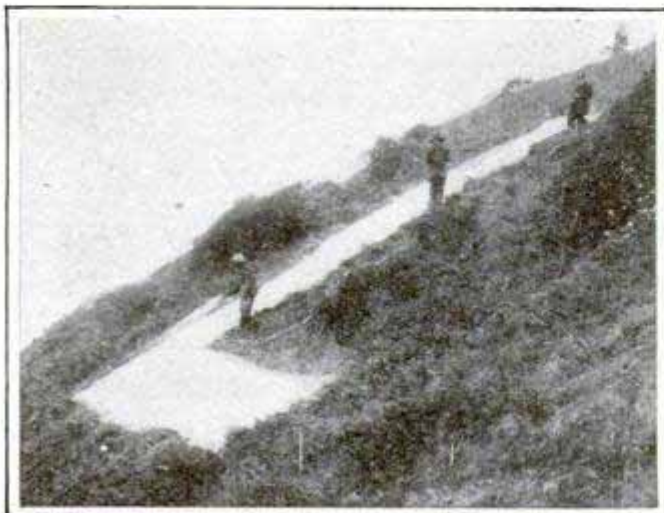

Putting the L in Festival

necessary to grub out 500 small trees and innumerable bushes. Thirty tons of lime were used in the trenches.

## MODERN EQUIPMENT USED IN EXPLORATION

Wireless and a modified aeroplane will be used by Sir Ernest Shackleton in his forthcoming expedition to the Antarctic continent. By such means he proposes to keep in touch with his bases of supplies, and also to have communication with Sydney, more than a thousand miles distant. Starting on the Atlantic side, the exploring party will cross the frozen continent, which is considerably larger than Europe, emerging on Ross Sea, 1,700 miles in a straight line from the first base. Here a second ship will await them, near Amundsen's base on the great ice barrier. The explorer will determine whether the Victorian range crosses the Antarctic continent and lies in the direction of the Andean range. Shackleton has adopted a motor sledge, equipped with aerial propeller and short planes or wings, which it is believed will give sufficient lifting power to enable the heavily laden sledges to cross soft ice and snow with their burden of more than a ton of supplies, at a rate of six miles an hour. The practical value of these aero-ice gliders has been demonstrated during the past winter in Siberia and Canada, and they are expected to render efficient aid in establishing and maintaining advanced supply stations along the route. Both ships attached to the expedition will burn oil and are provisioned for two years. They carry complete wireless apparatus and will keep constantly in touch with the exploration party throughout the trip. This constant communication with the party and with the station on the opposite side of the Antarctic continent, will make it possible to render aid in case of storms or accident, while communication with the world, through the wireless station at Sydney, will apprise civilization of the progress made and give the news of the world to the mem-



bers of the expedition. It will be remembered that Doctor Mawson was able, by means of wireless, to advise the authorities at Sydney of Amundsen's success over thousands of miles of frozen sea, and while Shackleton's base on the Atlantic side is a long way from Sydney, there appears no valid reason why the experiment should not be a success.

### NEW-TYPE AUTOMOBILE LAMP WITH DOUBLE BULB

A headlight for automobile use which permits brilliant light in the country and a less intense light on city streets has been devised. A

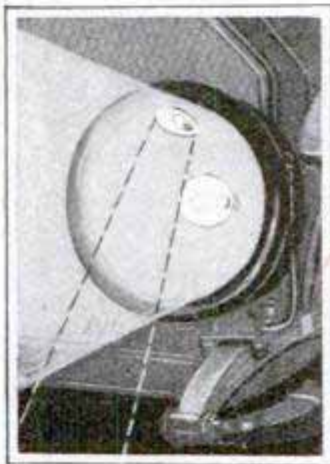

12-in. reflector is fitted with a 16-cp. main bulb, and a 2-cp. city light bulb with a little semireflector is let into the top of the main reflector. The wiring is double so that the lights may

be independently controlled.

### TOW GREAT FLOATING DOCK FROM HOLLAND TO JAVA

A bigger towing job than that when the dry dock "Dewey" was towed from the Chesapeake to the Philippines was successfully completed when the 14,000-ton floating dry dock which left Nieuwediep, Holland, June 23, 1913, arrived safely at Surabaya, Java, recently. The tow was handled by two ocean-going tugs of Amsterdam and required the exercise of the greatest skill and patience. The towing fleet was equipped with complete wireless apparatus as a safeguard against untoward events. The United States dry dock "Dewey," at that time considered gigantic, only weighed about 11,000 tons.

### CHIN LIFTER MAKES CHILD SIT UP WHILE WRITING

A common fault in beginners is the tendency to stoop over the desk when practicing penmanship. In order that



Girl Writing with Chin Lifter in Use

Copyrighted by International News Service

children shall sit erect when they write, a device called a "chin lifter" is now being used in some schools, which keeps the child at the correct distance from the work. The device is adjustable and may be arranged for children of any size.

### TRAP FOR LARGE GAME MADE FROM LOG

A figure-4 trap made from a section of a hollow sugar-pine log caught a small black bear, several timber wolves and a number of raccoons during the past summer in the Tahoe National Forest, California. The trap was constructed by a government forest ranger, who uses a sheep's head for bait.



Rustic Trap That Catches Bears Alive

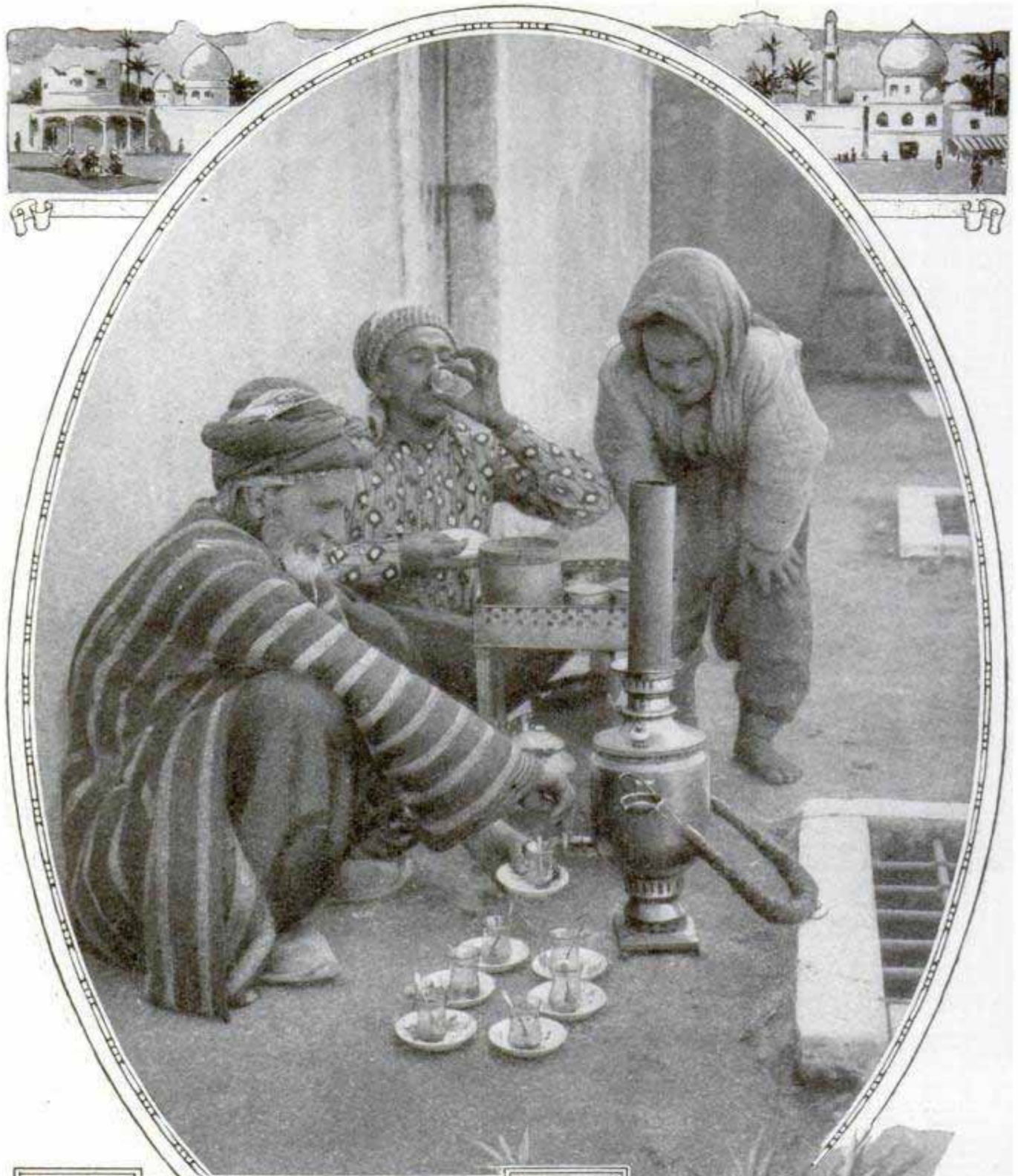

Bagdad, Famed as the Scene of Many of the Stories in the "Arabian Nights," is Now But the Decayed Capital of a Turkish Province. The Tea Merchant, Squatting beside His Samovar in the Crooked Street, is a Familiar Sight. The Copper Urn is Filled with Water, Heated by Charcoal within the Central Pipe

# THE FIREPLACES OF ALL THE WORLD—IV

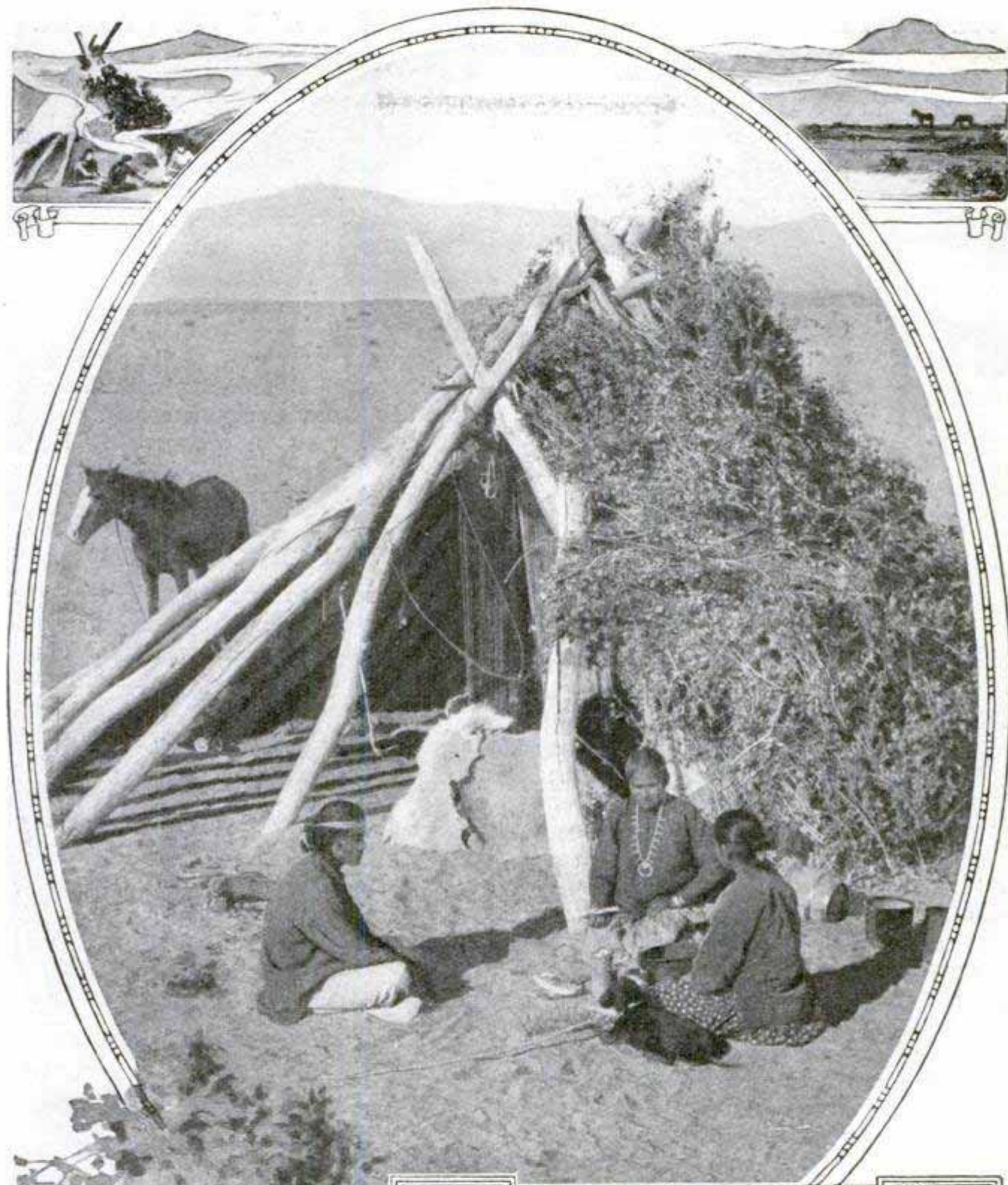

Indian Cooking is Primitive beyond Description. The Navajos Use an Open Fire, Sometimes in a Little Shallow Depression in the Ground, More Often Just a Bit of Brush or Broken Branches, Which Admits of Few Culinary Graces. With the Sand for a Hearth, with Sagebrush for Fuel, with No Chimney But the Unbroken Blue of the Arizona Sky, the Navajo Lives the Simple Life

## HOOTS FROM HORNS GIVE FIRE ALARM

Hooter fire alarms for rousing a whole community or only the members of the fire department, as desired, are now being installed in a number of the smaller cities. Each

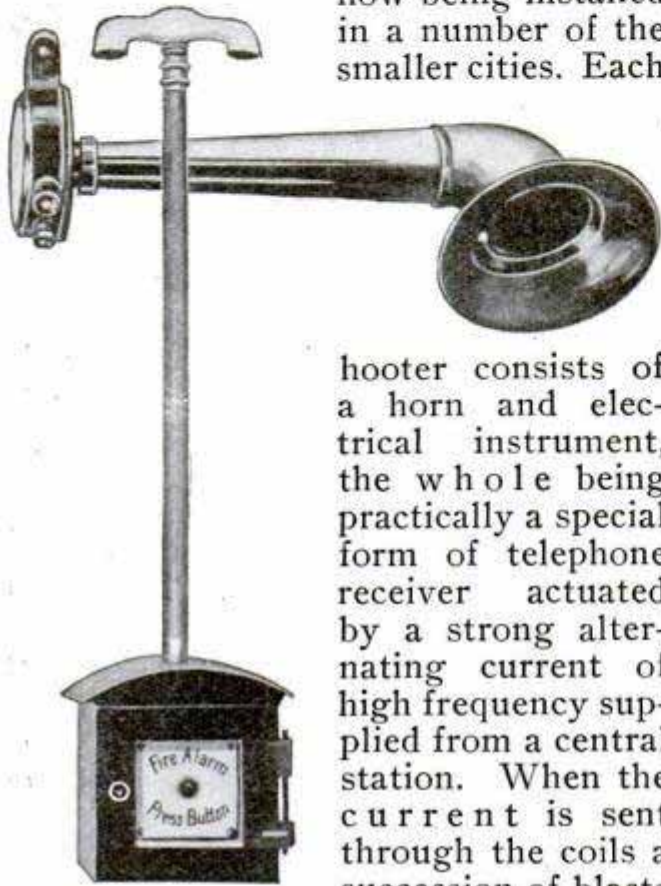

hooter consists of a horn and electrical instrument, the whole being practically a special form of telephone receiver actuated by a strong alternating current of high frequency supplied from a central station. When the current is sent through the coils a succession of blasts

or "hoots" is produced which is sufficient for rousing an entire community from slumber. If not available, the alternating current can be produced by converting the continuous current of a lighting or power circuit or of a battery of dry or wet cells by means of a vibratory generator. Where the system is to give a general alarm the city is divided into districts and each district is provided with a vibratory generator, and, as ordinarily arranged, the alarm is given only in one district. In some cases, especially in small communities, hooters are placed only in the homes of members of the fire department. The alarm is started by pushing the button in an annunciator or "push," of which a number are located at convenient points, and the remainder of the process is automatic. A switchboard in the central fire station indicates the point from which the alarm was turned in.

## GERMAN BALLOON BREAKS WORLD'S RECORD

The world's record for long-distance flights by spherical balloons was broken recently when the German balloon "Duisburg" rose from a village in Saxony and descended 87 hours later at a point in European Russia near the Siberian frontier. The total distance covered in this flight was a fraction of a mile more than 1,738 miles. The longest previous flight was that of a French balloon which, in March, 1913, flew from Paris to a point near Kharkov, Russia, a distance of 1,492 miles.

## EXPLOSIVE BOMBS FOR USE WITH AEROPLANES

Bombs for use in aerial warfare are now being considered by several governments, one type of which is illustrated here-

with. Previous to dropping the bomb, the safety pin is withdrawn, leaving the winged tail-

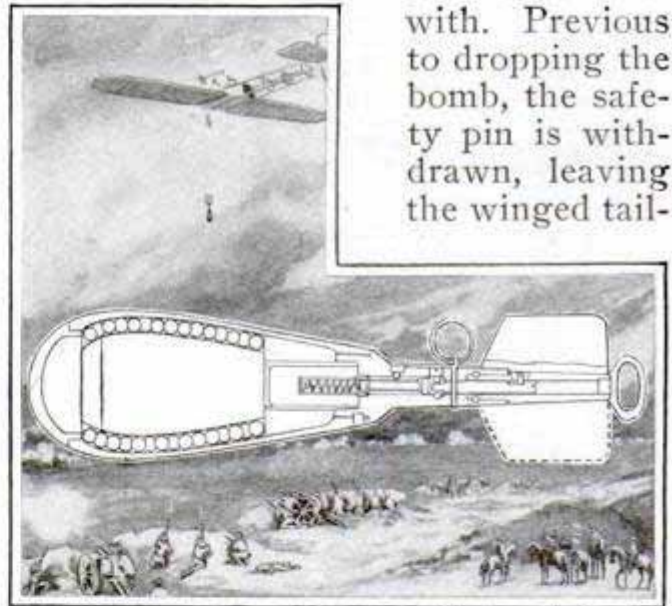

Courtesy Engineering

### New Weapon for Use in Aerial Warfare

piece free to rotate under the action of the air in flight. Steadiness is insured by this means, and whether the bomb is simply dropped or is fired from a spring gun, the firing mechanism is so sensitive that explosion ensues on very slight retardation of flight, due to impact on water, soft earth or snow, at any angle of incidence, even so low as  $5^{\circ}$ . The charge is 4 lb. of explosive and 340 steel balls, weighing 6 pounds.

## AN AMERICAN CYCLECAR

An interesting development in the cyclecar is shown by an American manufacturer in a narrow-gauge, low-hung, two-passenger tandem car, with

from the rear seat, which is set 3 in. higher than the front seat, and the steering column is 2 in. off center, giving a clear view of the road to the driver. The motor is four-cylindrical, water-cooled, with 5-in. stroke and is

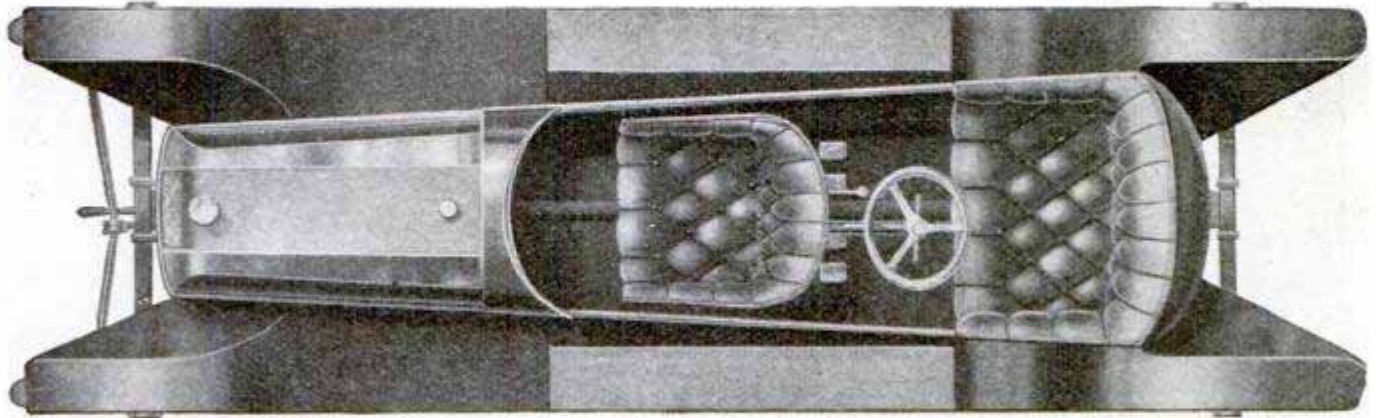

New American Tandem Cyclecar in Which the Driver Sits behind the Passenger

several novel features. The frame and body are combined, and the propeller shaft is inclosed in a tube, 5 in. above the floor. This gives a road clearance of but 9½ in. with the passenger's feet 14 in. from the road. In this way the center of gravity is brought low, tending to stability. The steering is

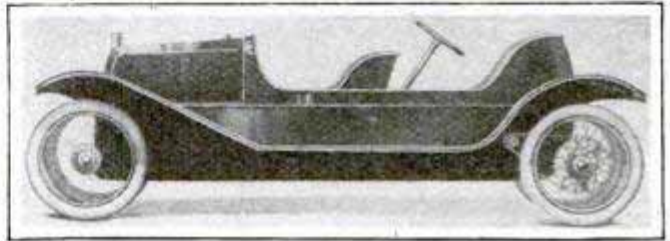

rated at 12-15 hp. A friction drive is provided and the wheel base is 120 in. A parcel box is provided in one model taking the place of the front seat.

## HEAD CARVED BY ESKIMO FROM SPRUCE KNOT

Inside the arctic circle overlooking a steep bank of the Yukon River a spruce knurl, or knot, several feet high stood for years. An Eskimo trapper



An Eskimo Artist Carved This Statue in Wood

found a big campaign poster that bore the picture of William H. Taft. During the long winter, when he was not occupied with his work, this rude sculptor put in his spare time carving the knot into a likeness of the former president. When it was completed to his satisfaction, he secured several pieces of moose hide and fashioned a scalp and moustache. Travelers in the interior of Alaska viewed the carved knot with interest, and one of them painted a sign "Vote for Taft," and placed it near the likeness, but contrary-minded visitors have riddled the sign with bullets from their rifles. None, however, has been disrespectful enough to shoot at the image.

ⒸThe first cargo of lumber from the Tongass National Forest in Alaska, recently received in San Francisco, consisted of 1,500,000 ft. of Sitka spruce.

## GASOLINE LOCOMOTIVE FOR TERMINAL WORK

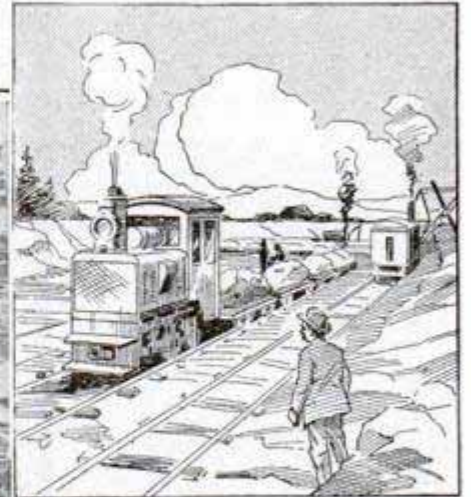
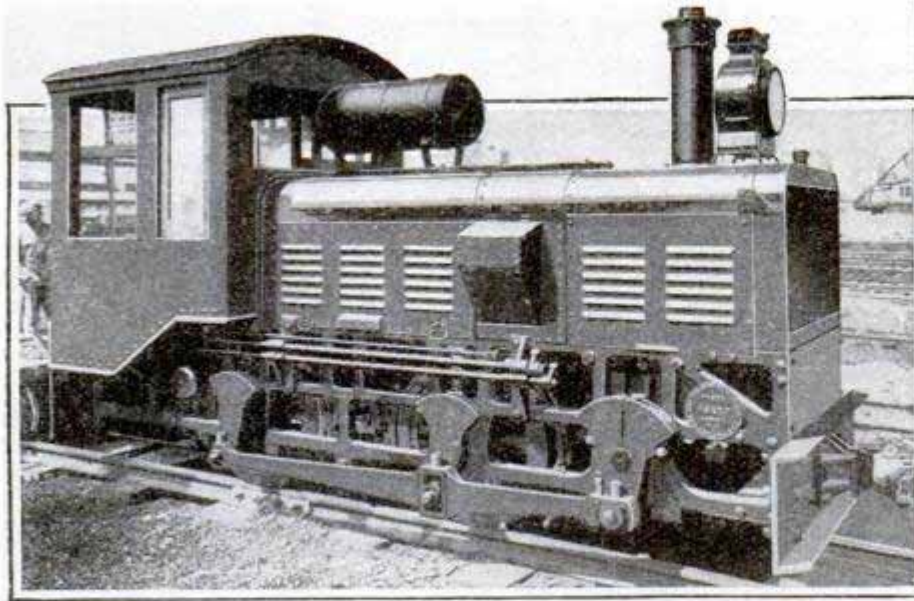

Curious Narrow-Gauge Gasoline Locomotive Which Gives Efficient Service

A powerful industrial locomotive, using gasoline for motive power, is in use on the lake front in Chicago, hauling cars of dirt for filling in where improvements are contemplated. A steel frame is built inclosing the wheels, which are 30 in. in diameter. The engine, which is narrow-gauge, has a width of 4 ft. 8 in. and is 12 ft.

4 in. long. Its height is but 7 ft. 6 in., as it is used in an industrial tunnel, and it weighs seven tons. The short wheel base, 4 ft., enables it to make sharp turns, and it has been found to be a sturdy little worker, adapted both to the outside tracks with heavy grades and to the tunnel where electric propulsion is used for ordinary work.

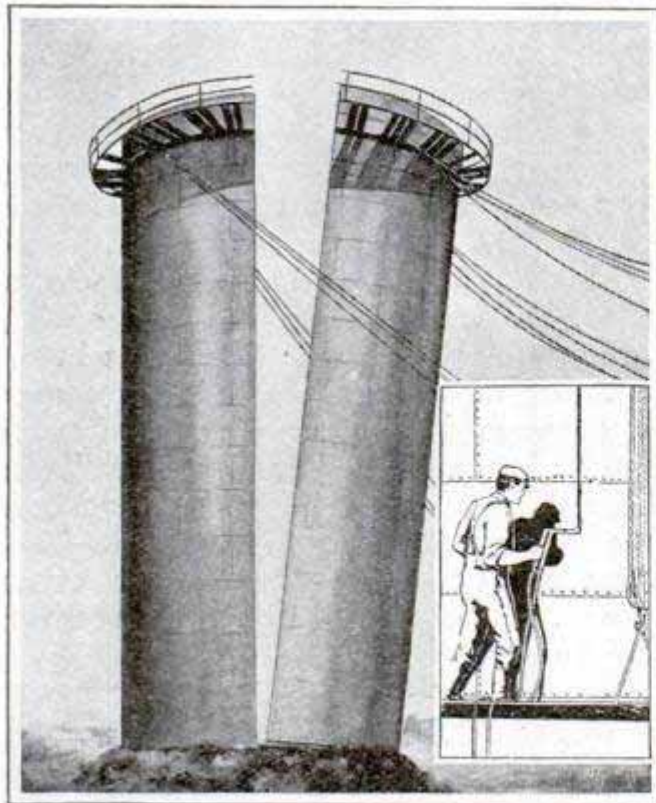

Pulling Down Standpipe Which had been Cut in Two by Oxyacetylene Torch  
Insert—Cutting Standpipe with Torch

## STANDPIPE REMOVED BY ACETYLENE TORCH

A disused standpipe which had been sold for junk was cut in two and quickly disposed of by the use of an acetylene torch. A staging with operator was raised to the top of the tank and as fast as he cut, which was about a foot a minute, with the oxyacetylene cutting torch, he was lowered until the ground was reached. The process was repeated on the opposite side, and then the tank was cut entirely around the bottom. A set of tackle was made fast to each corner, at the top, and each severed half was pulled over. The tank was 60 ft. high and 40 ft. in diameter and the operation took only a few hours, while, if a staging had been built inside, it would have taken several weeks for the men to have cut it by the usual method of sledge hammers and cold chisels.

# FIGHTING FIRE WHEN THE MERCURY IS BELOW ZERO



There are Few More Impressive Sights Than a Great Building Burning in the Night. The Photograph Shows the Destruction of the Newark (N. J.) Opera House

## SMALL ELECTRIC FANS FOR LIMOUSINES

Limousines and other inclosed automobiles are so hot and stuffy in summer weather that small electric fans,

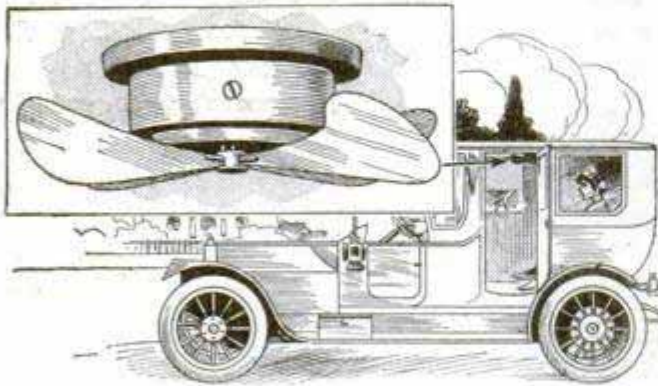

Small Electric Fan for the Interior of a Limousine Automobile

especially designed for them, have come into use in England. The fan and motor are flat and compact, arranged to fasten to the inside of the roof of the limousine. In motor de-

sign they are exactly like the larger fans—which means that they need no more attention than a little oil once a year.

## PARASITE WHICH DESTROYS SAN JOSE SCALE

A parasite which destroys the dreaded San Jose scale has been found by scientists, and in Pennsylvania, where the new insect has been given an opportunity to demonstrate its effectiveness against the pest, it has been completely successful. The new enemy of the scale is the Chalcid fly, related to the wasps, and is one-fiftieth of an inch in length. It is yellowish in color and has hair on its wings. It destroys the scale by boring a hole through the scale and laying an egg within it. This egg develops into a worm which thrives on the scale, eating its way out of the shell and finally



The Scale Parasite, Greatly Magnified



Microphotograph of San Jose Scale with Holes Made by Chalcid Fly

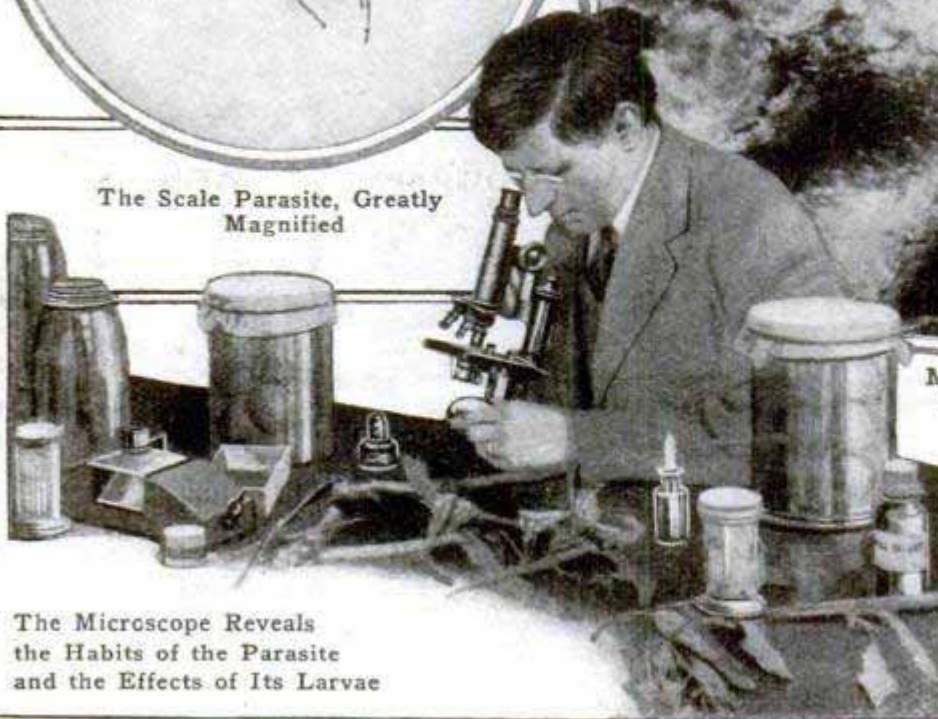

The Microscope Reveals the Habits of the Parasite and the Effects of Its Larvae

developing into a wasplike fly. The San Jose scale, it is stated, came originally from China, where the Chalcid fly has multiplied sufficiently to check the pest.



## COMBINED AUTOMOBILE AND BOAT

Two or three years ago the automobile journals were full of illustrations of an automobile that could run on both land and water. Patents have recently been granted on such a vehicle, which, when it meets with a stream of water, is expected to dive boldly in and

swim across. Fenders, somewhat similar to mudguards in shape, are arranged on each side of the hood. The water, striking against these fenders, has a tendency to keep the "bow" of the machine above the surface. The body of the car is built water-tight.

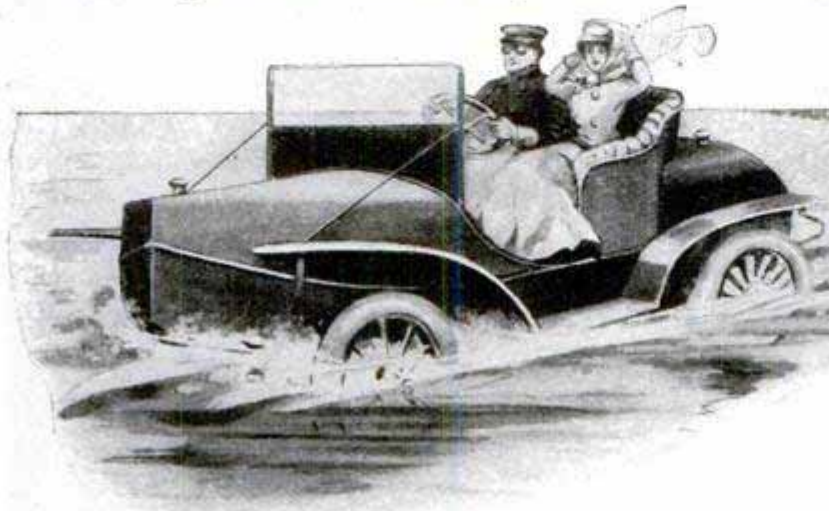

An Automobile Built to Run on the Water  
as Well as on Land

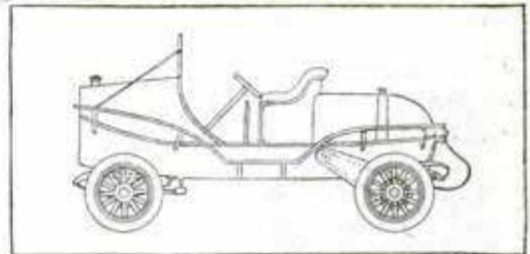

## DIRIGIBLES CARRY MANY PASSENGERS

Despite the fatalities attending the Zeppelin airships attached to the German navy, passenger-carrying dirigibles last year made many trips and covered long distances without accident. The airships "Hansa," "Sachsen" and "Viktoria Luise" during the year 1913 carried 12,382 passengers. The "Hansa" in 210 trips covered more than 15,000 miles, carrying 4,086 passengers. The "Sachsen" made 206 trips and the "Viktoria Luise" 400.

## SANITARY POCKET DRINKING TUBE

Since the banishing of the common drinking cup, many kinds of collapsible pocket cups have been invented to take its place. But they are always bulky to carry and are seldom at hand when wanted. A handy substitute that has recently appeared is a patented drinking tube that does not bulge a vest

pocket. It is a piece of nickelplated brass tubing,  $\frac{3}{16}$  in. in diameter and about 5 in. long, shaped like a letter "S" with one curve straightened out. It can be used for drinking out of a



Using a Sanitary Pocket Drinking Tube  
Instead of a Cup

doubtful cup, a faucet, a sanitary fountain, or even a soda-water glass.

Extinguishing fires by smothering with the exhaust gases from the engines is the latest method of fighting fires aboard ship. These gases contain only 9 per cent of oxygen, while 15 per cent is required for combustion.

## RAILWAY-TICKET PRINTING MACHINE

A ticket-printing machine that greatly simplifies the work of the railroad ticket agent is being installed in a number of offices in Germany. This machine, which is not complicated and which can be worked as fast as the ordinary date-stamping machine, prints the ticket in complete form, and keeps a record of the number of tickets sold and the amount of cash taken in, all in one operation. A cast-iron table which forms part of the machine carries a series of blocks, arranged in station order for printing the tickets, and the printing press is mounted on a slide so that it can be moved to any part of

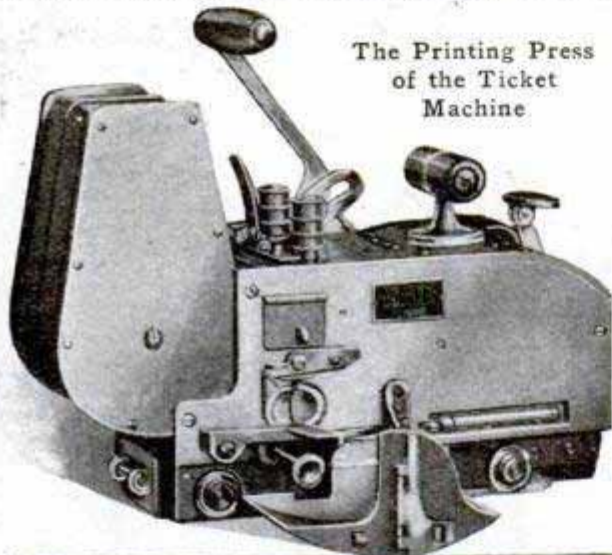

The Printing Press  
of the Ticket  
Machine

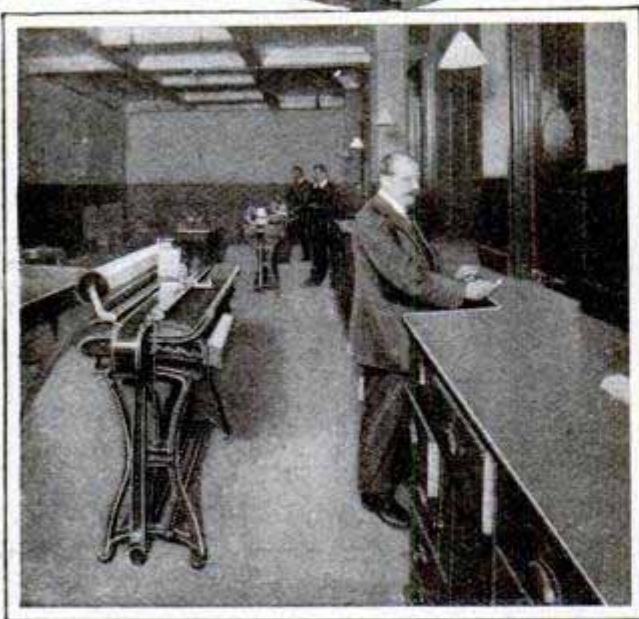

Ticket Office Equipped with Two Machines

the table and set over any desired block. The tickets are numbered automatically in consecutive order.

## ANTISLIP MUD HOOKS FOR AUTOMOBILES

To prevent automobile wheels from slipping and spinning in mud or loose sand a mud hook has been invented

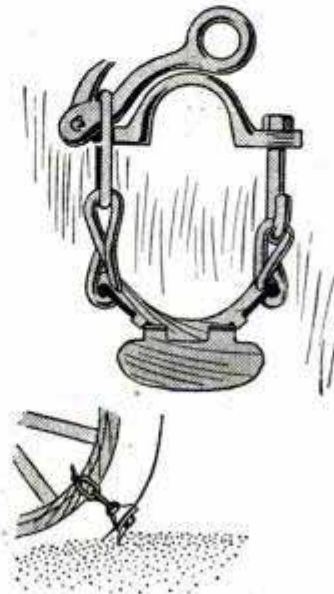

which increases the tractive power of the driving tires when it is most needed. It consists of a hook or spoon hinged to a saddle which is held on the tread of the tire by a chain and clasp over the rim. When the wheel rolls over a smooth road, the spoon lies flat against the tire;

but as soon as the wheel slips or spins, the spoon is raised by friction and projects about  $2\frac{1}{2}$  in. from the tire. As it is held at an angle of 60 deg. with the tread, it gives the wheel a good grip in sand or mud.

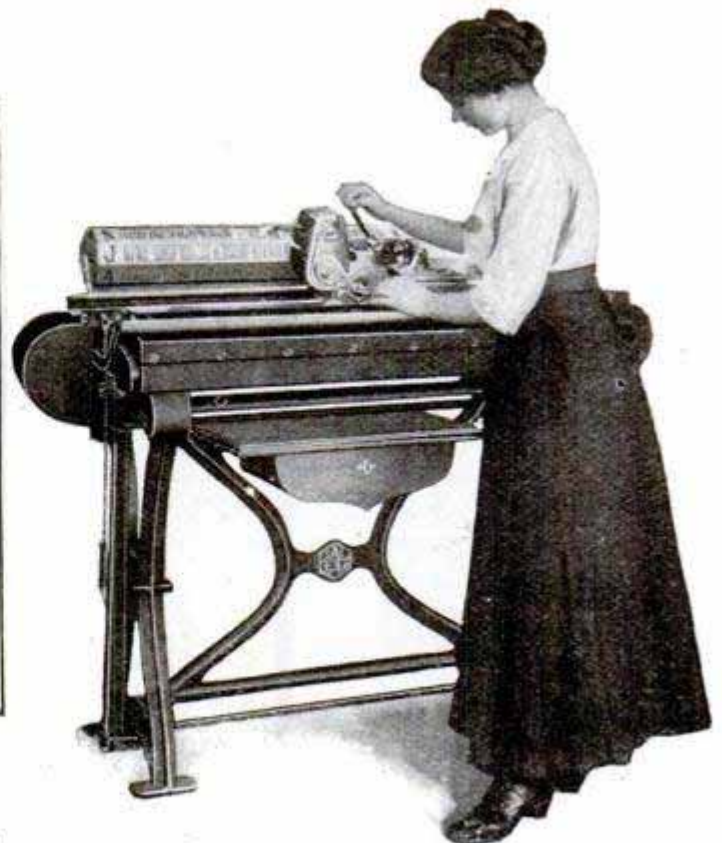

Operating the Ticket-Printing Machine

## AN ARCHITECT OF BIRD RESIDENCES

Cosy little cottages and large roomy apartment houses designed to suit the various tastes of fastidious bird ten-

ants are being built by an Ohio man. The material used in the construction is cement stucco, modeled with a trowel. Some birds, like martins, prefer to live in families under one roof; for them he builds 20-room colonial homes of several stories. For birds who like seclusion, he constructs tiny one-room cottages arranged to suit the tenant's taste. Hutlets for wrens, cotes of a different shape for bluebirds, thrushes, etc., and tiny cottages for woodpeckers, flickers, and birds of their class. The bird houses are practically indestructible and very artistic in design.

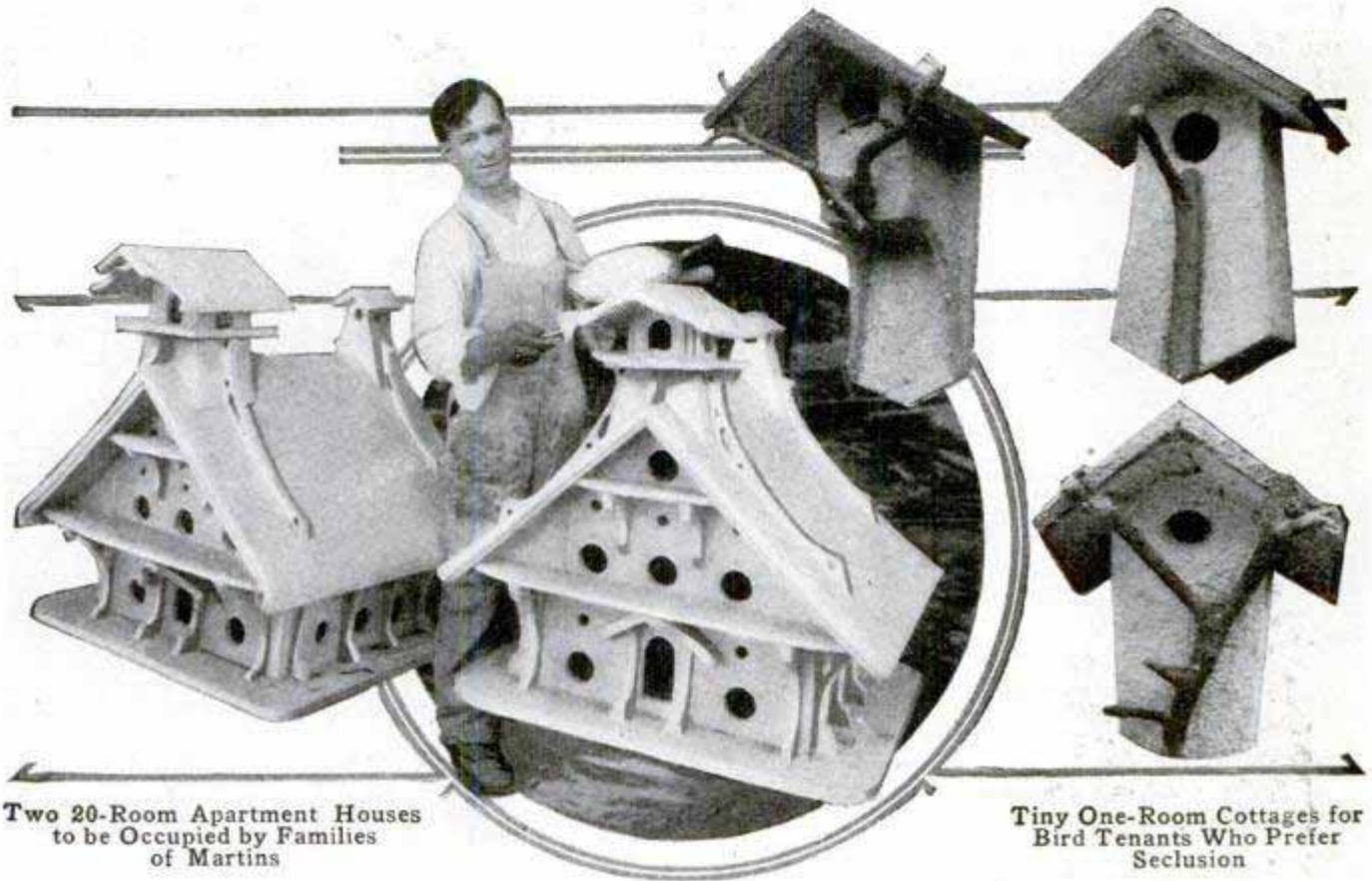

Two 20-Room Apartment Houses to be Occupied by Families of Martins

Tiny One-Room Cottages for Bird Tenants Who Prefer Seclusion

### Artistic Birdhouses Made of Cement Stucco

ants are being built by an Ohio man. The material used in the construction is cement stucco, modeled with a trowel. Some birds, like martins, prefer to live in families under one roof; for them he builds 20-room colonial homes of several stories. For birds who like seclusion, he constructs tiny one-room cottages arranged to suit the tenant's taste. Hutlets for wrens, cotes of a different shape for bluebirds, thrushes, etc., and tiny cottages for woodpeckers, flickers, and birds of their class. The bird houses are practically indestructible and very artistic in design.

## AUTOMOBILE TOP MANAGED WITH ONE HAND

An adjustable top for the automobile, which may be extended over the whole car or folded back snugly behind the rear seat and covered, has

to the main frame. The forward part is hinged in the middle of the frame, which extends around its edge. A

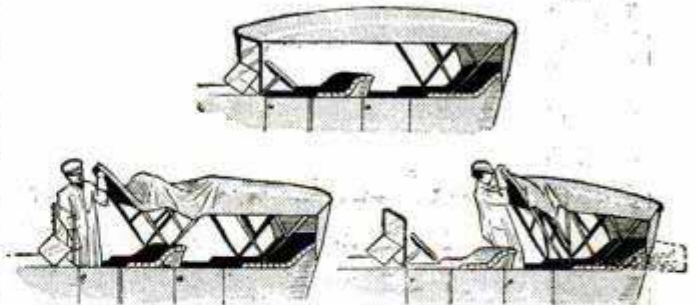

Flexible Cable Prevents Sagging in New Adjustable Automobile Top

flexible cable, invisible, is attached to the intermediate bow of the rear half of the top, running over two pulleys in the forward main bow, giving the top support and taking the strain off the fabric, which is of cravenette or mohair. The forward end of the top is attached to the windshield by straps, which, when loosed, permit the top to be easily pushed back and folded.

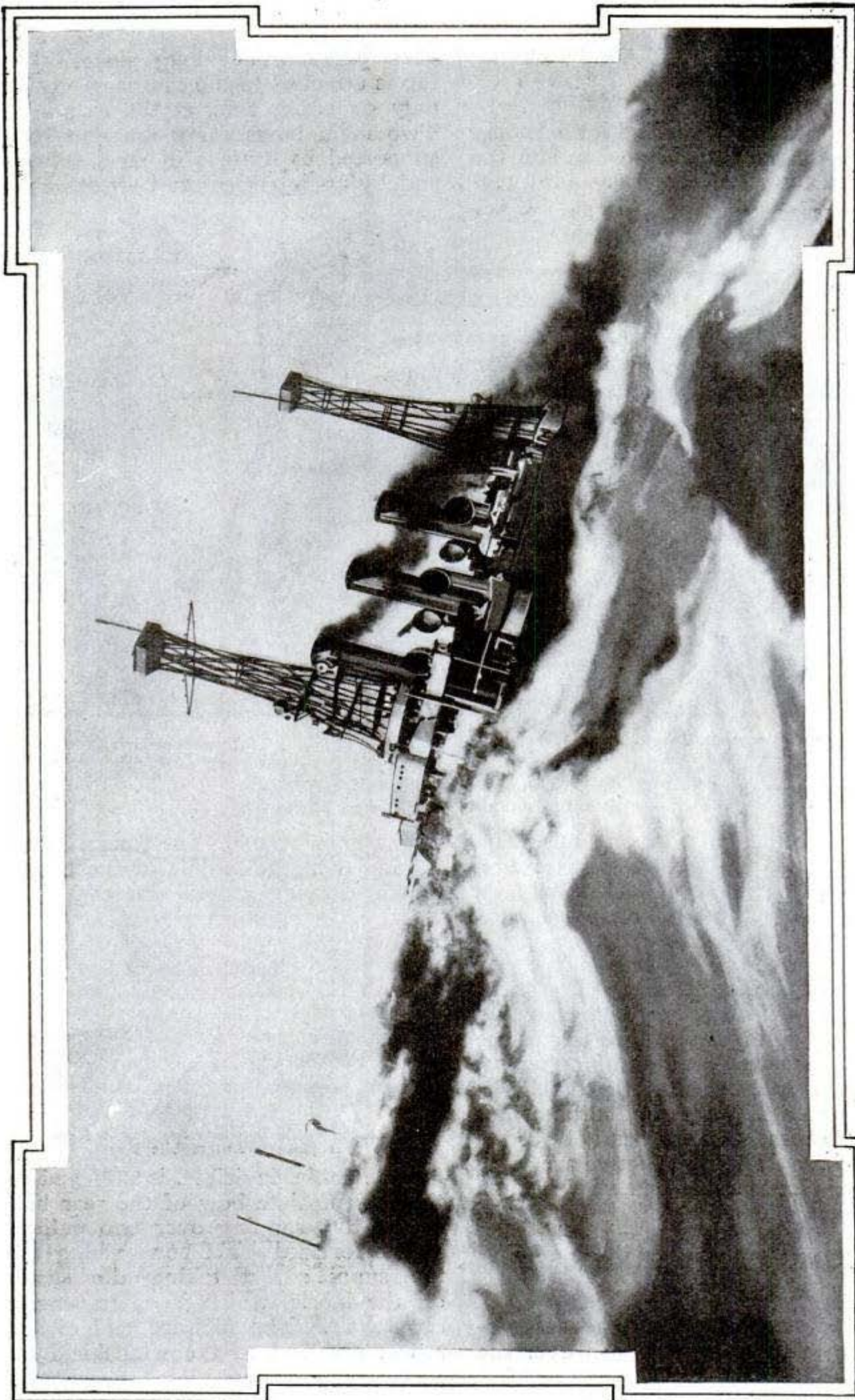
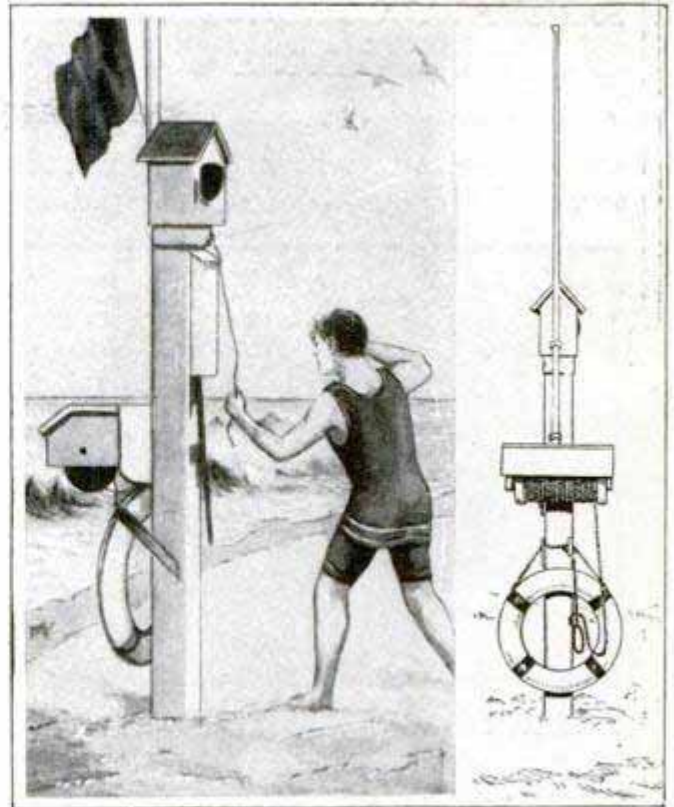

Photo by Underwood & Underwood  
Gripped by a Five-Day Gale, the Atlantic Fleet, Homeward Bound from the Mediterranean Cruise, Rode Out the Storm, But the Battleship "Vermont" was Partly Disabled. Huge Waves Lifted Her Stern Out of Water, Causing Her Propellers to Race. The Unequal Strain Snapped Her Starboard Shaft, Forcing Her to Proceed to Port under One Engine Only

## SENSIBLE LIFE-SAVING EQUIPMENT

On the beach at Ocean Park, about 15 miles from Los Angeles, a new life-saving station has been installed which is notable because of its adaptability to immediate use. Upon a support close to the water's edge, a post is driven, equipped with a life preserver, a gong and a signal flag, and an electric signal connected with the main life-saving station. In case of danger, any bystander pushes a button on the post which rings a bell in the main station, and the life-saving crew is on the spot in a few minutes. Meanwhile the life preserver is carried to the surf and flung to the one in peril. The gong is rung and the flag hoisted to direct the crew to the spot. Several lives have been saved in this way since the new stations have been installed.



A First-Aid and Danger Signal for the Beach

## NEW TRACTOR DESIGNED TO MEET FARM NEEDS

A number of special features which serve to make it particularly adapted to farm work are embodied in a tractor that has just been brought out. This tractor has only three wheels and the chassis consists of a strong triangular frame of structural-steel members firmly riveted together. The motor operates on kerosene or distillate as well as gasoline. An extra-strong differential is provided and there is a differential lock by which the full

tractive effort may be thrown on both rear wheels whenever necessary. The rear wheels are provided with tapered holes for the insertion of spuds or toe holds, which may be easily attached or removed and which are furnished in different designs and lengths to suit the soil conditions. The final drive is by means of a belt, and with the belt off the pulley the motor may be used for threshing, pumping, bailing hay, and other farm operations. This machine has one speed forward and reverse and is capable of pulling four or five plows two miles an hour.

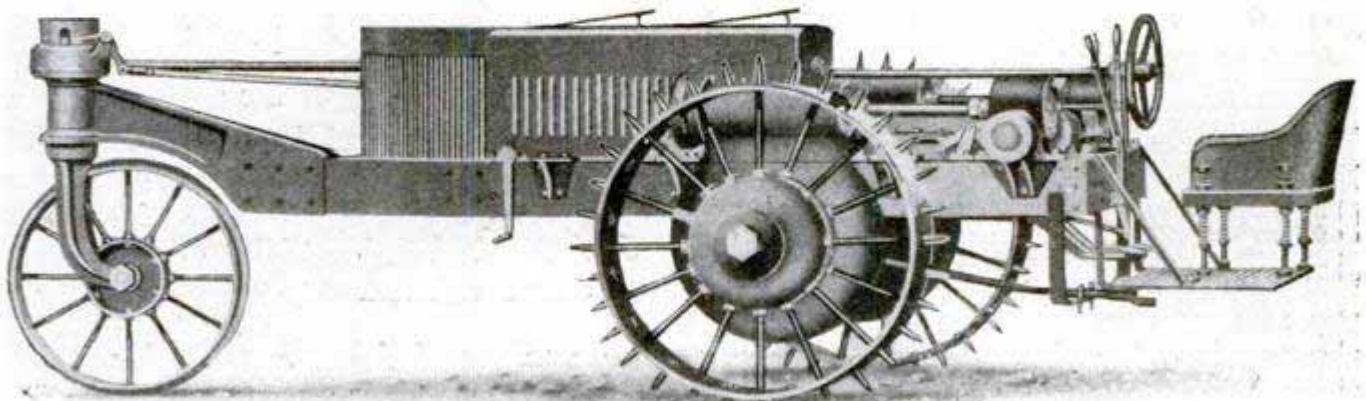

Farm Tractor That is Readily Converted into Power Plant for Threshing and Other Farm Operations

## SANITARY COLLECTION OF GARBAGE

A system of odorless, flyless garbage collection, which is in use in many European cities, has been

wagon or can open to the air. Special bottom-dump wagons with sliding bodies, that make an extra-long wheel base unnecessary, are used in the regular equipment, but the patent wagon cover can be used on any dump wagon

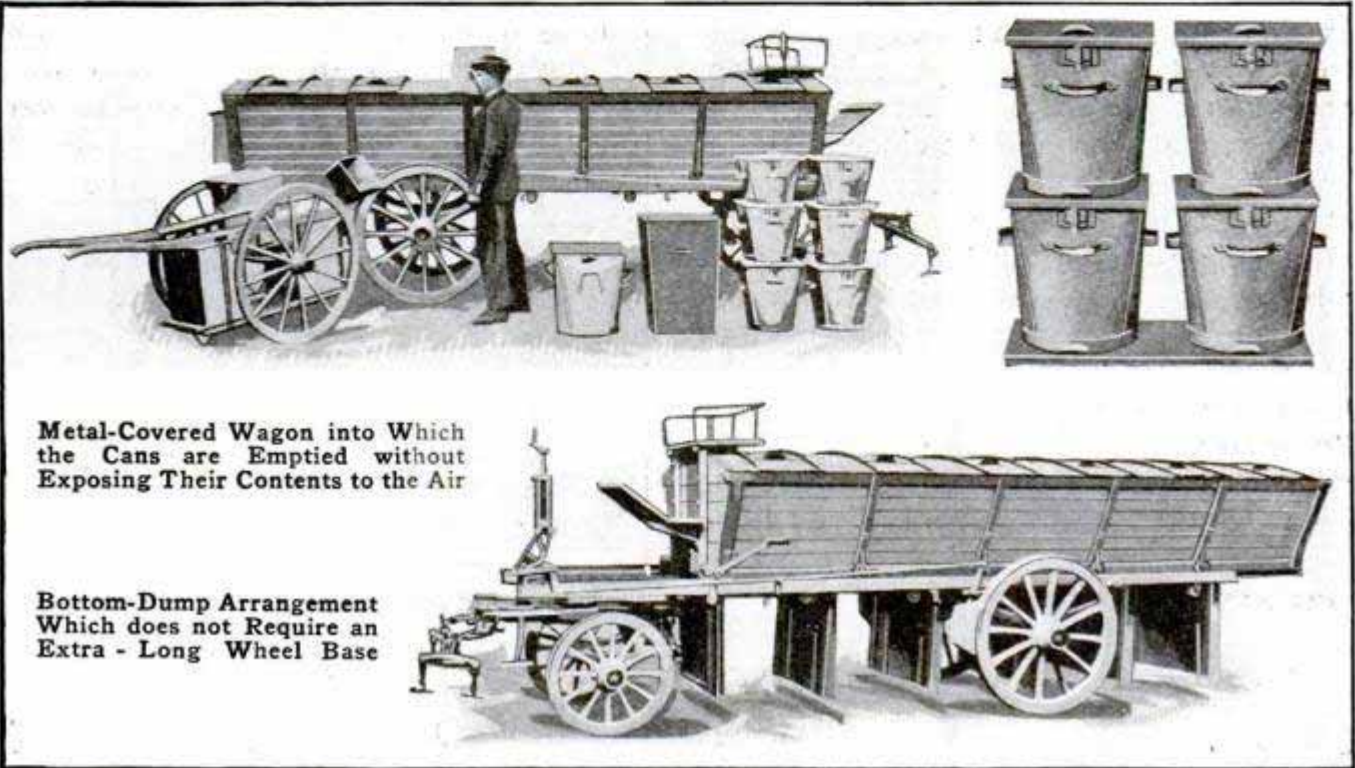

Metal-Covered Wagon into Which the Cans are Emptied without Exposing Their Contents to the Air

Bottom-Dump Arrangement Which does not Require an Extra - Long Wheel Base

Special Equipment Used in New System of Sanitary Garbage Collection: The Cans Have Square Tops and Tightly Fitting Sliding Covers

brought to this country and is being tested in New York City. Sanitation is secured in this system by the use of wagons and cans that are always tightly closed, even while the cans are being emptied into the wagons, so that there is no chance for odors to escape or flies to gather. The special cans are like ordinary garbage cans except that the top of each is square and has a tightly fitting sliding cover. Each wagon has an air-tight metal cover on which there are several square holes with flat covers, sliding in tracks just wide enough to fit the tops of the cans. When a can is to be emptied into a wagon, it is turned upside down and pushed into one of the tracks on the wagon's cover; as the can moves along the track, its cover slides open and the can pushes back the slide in the wagon top and empties its contents. Then as the can is drawn back along the track, the wagon cover closes and the can's cover returns to its place. At no time during the entire operation is the

the top of which does not reach above 5 ft. from the ground.

## DISPLAY MAGAZINE HOLDER OF WIRE

A very simple holder by which maga-

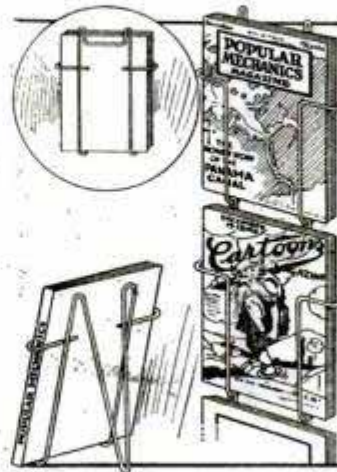

zines, books and other merchandise may be advantageously displayed for sale or advertisement has been placed on the market. It is constructed of heavy wire, as shown in the illustration. The holder is made

in a variety of sizes, suitable for magazines of any size and may be used to advantage in windows or other display places.

## NEW GRADIENT METER FOR MOTOR CARS

A meter which indicates the gradient on which a motor car is running at any time has recently been placed on the market and is shown in the accompanying illustration. It is designed to be attached to the dashboard so as to be constantly in view of the driver. A screw is provided for setting the mechanism to level when the car is in that position, and when the car is traveling on a slope



figures appear opposite the pointers, ascending slopes being indicated by black figures and descending slopes by red figures. If, for example, the figure 5 appears in black, it indicates that the car is climbing on a slope of 1 in 5. For use at night an internal electric lamp is fitted to cast its light through the scale. By means of a simple formula the approximate horsepower developed on different slopes can be easily determined.

ⒸOwing to discrepancies in old surveys, the acreage of mountain lands in the Appalachians as recently surveyed by the government, is, on an average, about 1 per cent in excess of the acreage claimed by the owners, while one tract in Tennessee, supposed to be 850 acres, actually contains 1,840 acres.

## CANADIAN RAILROAD USES NEW TYPE PIT CAR

Cars of special design, having a portion of the floor removable for the purpose of carrying machinery, which if placed on the floor of an ordinary flat car would be too high for railroad clearance, have been built for use on a

Canadian railroad. The opening in the floor also allows the load to be placed nearer the track, lowering the center of gravity, thus insuring greater stability on curves. The pit opening has a clear width of 6 ft. and a clear length of 18 ft., and the trucks are of extra-heavy design. The opening may be closed by means of removable sections of floors, making the cars suitable for use as standard flat cars.



Pit Car with Opening Closed, Ready for Use as Ordinary Flat Car

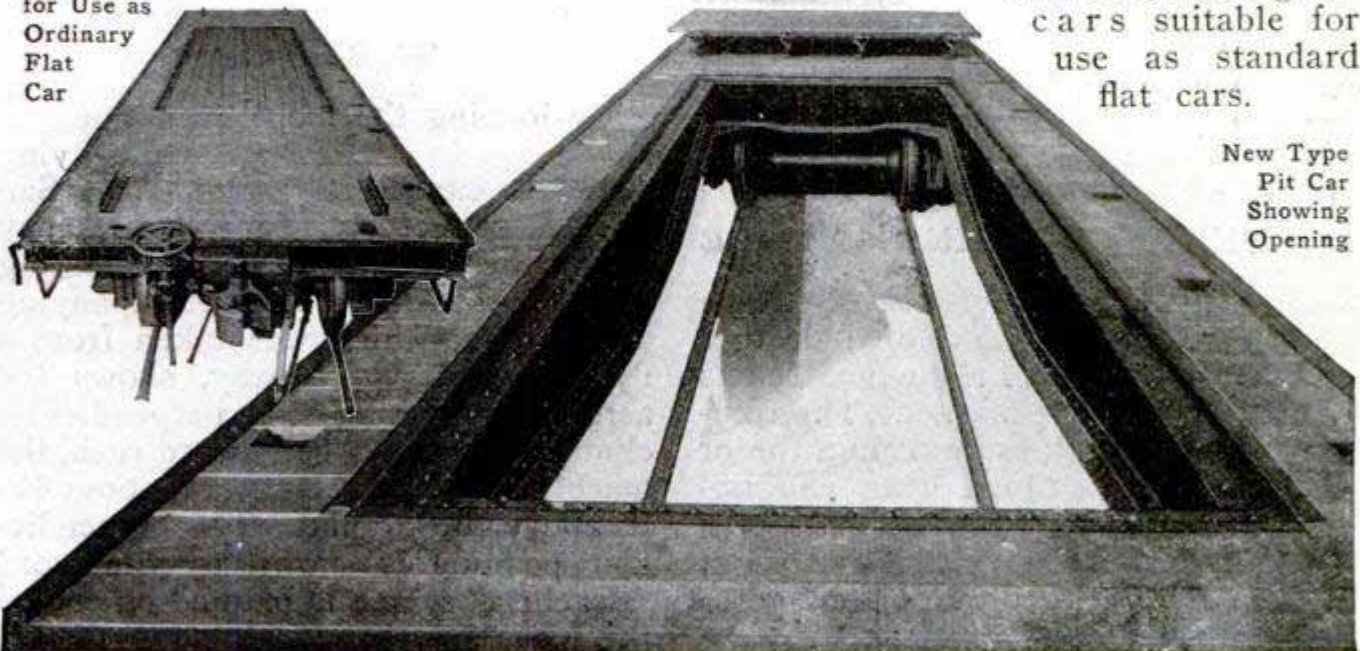

New Type Pit Car Showing Opening

## FRENCH ENGINEERS SOLVE PENSTOCK PROBLEM

A penstock, having unusual features, conveys water collected in the French

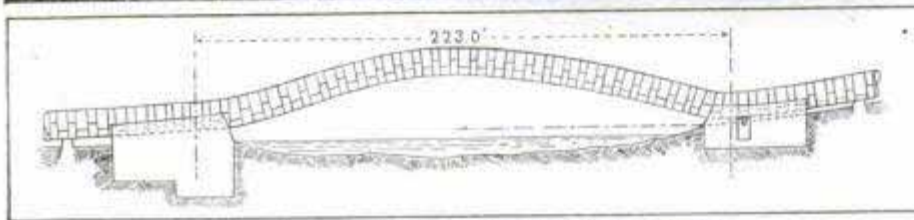
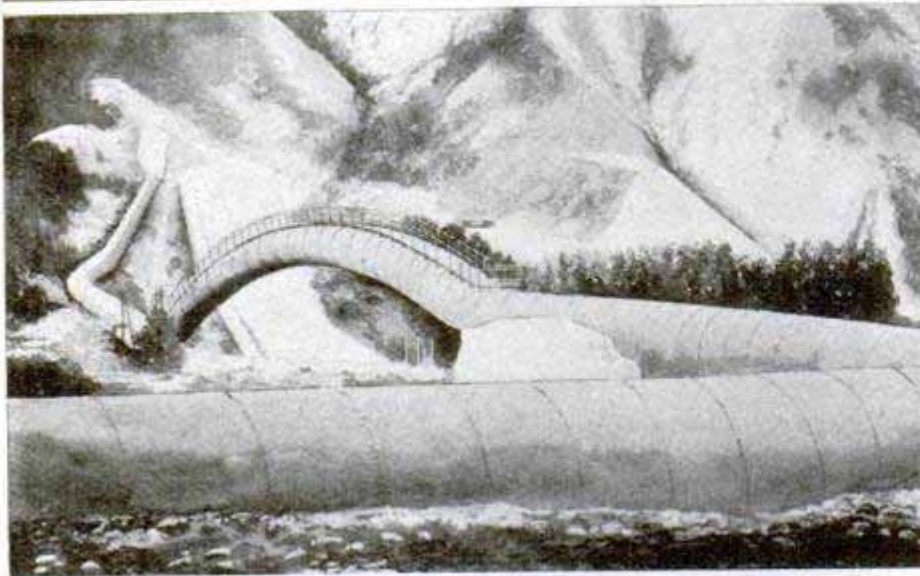

Penstock Arching over the River L'Arc

Alps into the river L'Arc. A 13,000-ft. tunnel brings the water to the forebay, whence the penstock, which is 11 ft. in diameter, conducts it to the power house. Steel plates,  $\frac{5}{16}$  in. thick at the upper end and  $\frac{3}{4}$  in. at the lower end, constitute the penstock. Where it bridges the river the plates are  $\frac{11}{16}$  in. in thickness and are held with 1-in. rivets. The span is 223 ft., and the rise in the center of the arc, 19.7 ft. A footwalk is placed on top of the pipe.

## LEATHER-SOFTENING DEVICE

A compound by means of which hard, brittle and discolored leather stock is softened and made flexible has been placed on the market. The compound is used by placing it in a tub or vat, warmed to blood heat, and immersing the leather in the liquid for 6 or 8 hours, whereupon it is taken out and dried in racks, when it is found to be plumped, bleached and pliable.

## A NEW AUTOMOBILE FUEL CHEAPER THAN GASOLINE

Treated with superheated steam in the presence of pure nickel, creosote becomes transformed into a substance resembling benzol, according to an English process recently invented. Creosote is a by-product of the illuminating-gas industry and is produced in large quantities in England at a price ranging from 4 to 5 cents a gallon. When superheated and mixed with steam it is blown upon a rod of pure nickel which acts as a catalyzer. A chemical reaction takes place, incorporating into the oil hydrogen taken from the steam, changing the surplus of carbon in the creosote to a surplus of hydrogen and thus making an ideal fuel. About 75 per cent of the creosote is so transformed, and the cost is inconsiderable, giving a fuel admirably adapted for use in internal-combustion engines and much cheaper than gasoline.

## AMERICAN AIRMAN LOOPING THE LOOP

By looping the loop seven times in succession in his biplane while flying over the exposition buildings at San Francisco recently, Lincoln Beachey broke the world's record for daring feats of this kind. The accompanying photograph, which was taken from a flying boat 150 ft. away, shows the aeroplane making its perpendicular climb after a swift downward rush, the machine being at this instant about 600 ft. above the ground. The perpendicular position is shown by the word "Beachey," which is painted on top of the top plane.





American Airman Emulates  
Pegoud's Famous Feat by  
Looping the Loop Seven  
Successive Times over  
Exposition Buildings at  
San Francisco

## DREDGING HARBORS ON THE HUDSON BAY ROUTE



Seagoing Suction Dredge That will be Used for Excavating Harbors in Hudson Bay, in Connection with Short Route from Canadian Northwest to Europe

As a part of the plan for establishing a short route through Hudson Bay from the Canadian Northwest to Europe, harbors for seagoing vessels are to be built at Port Nelson, the Hudson Bay terminus of the Port Nelson Railway, and at a point on the south shore of James Bay. For digging these harbors one of the largest suction dredges ever built in Canada has been completed at Toronto, and it is planned to tow this vessel down the St. Lawrence River, along the coast of Labrador, and into Hudson Bay during the coming season. Hudson Strait and the northern waters of Hudson Bay are icebound during the greater part of the year, but so positive are the Canadian authorities that this route can be kept open during the season when the heavy grain shipments take place, that construction work is to be carried forward vigorously. Enormous ice-breaking vessels will be used for maintaining a channel through the ice, and it is believed that there will be no serious danger from icebergs during the season when the route is in operation.

The dredge, to be used in building

the harbors, is 180 ft. long, has a beam of 43 ft., and weighs 1,200 tons.

On account of the isolated location of the work, the dredge is provided with a complete machine shop, which is equipped with lathes, planers, drills, and all other tools needed in making repairs. Both sides of the main deck, at the front of the engine room, are divided into cabins for the officers and crew. The vessel has a coal-storage capacity of 250 tons, and will carry a fresh-water tank of 80 tons capacity. It is expected that a crew of about 35 men will be carried.

#### AUTOMOBILE HEATER USES ENGINE EXHAUST

A new type of automobile heater, which uses the exhaust gases from the engine, consists of a strong, light aluminum casing, 26 in. long, 10 in. wide and 1½ in. thick, through which the burned gases pass. This heater is laid flush with the floor, the edge of the floor being lined with an asbestos-fiber cement as a protection from the heat. The quantity of heat entering the heater is regulated by a valve.

## A MOUNTAIN OF PRECIOUS MINERALS

A mountain, 1,000 ft. high and two square miles in area, devoid of all vegetation except cactus and agave and believed to be one of the most highly mineralized masses of rock in existence, stands near the headwaters of the Gila River in New Mexico. It is called Alum Mountain and is owned by one man. One of the minerals which forms a large proportion of its billions of tons of rock is so rich in aluminum that it is expected to afford an inexhaustible supply after the bauxite deposits of the East are used up. The peak is of volcanic origin and it is thought that almost pure aluminum, as well as large deposits of gold, will ultimately be found in it. Beautiful imitation rubies, emeralds, topazes and diamonds have been made from its minerals. It is also expected to prove a valuable source of sulphuric acid, which is in great demand as a reducer of phosphate rock for fertilizers.

## VACUUM MILK CANS MAKE SHIPPING SAFE

That heat and cold cannot penetrate a vacuum is the principle upon which a patented shipping can for dairy farmers is constructed.



ers is constructed. Heavy metal containers, built double — simply a can within a can — are connected at the neck, the air being exhausted from between them. Milk

placed in the can at 38 deg. F., so the manufacturers claim, will at the end of 24 hours be not above 50 deg. F., no matter how high the thermometer goes. Likewise, if milk is placed in the can at 60 deg. F., it will not freeze for 24 hours, thus giving the milk producer protection both from winter's cold and summer's heat, which is, obviously, a great advantage.



Alum Mountain, New Mexico; Rich in Aluminum and Thought to be Almost a Solid Mass of Valuable Minerals

### SIMPLE LIGHTING DYNAMO FOR AUTOMOBILES

A simple lighting set for illuminating the headlight of an auto is provided for in the system illustrated, consisting of armature, magnets and a friction disk,

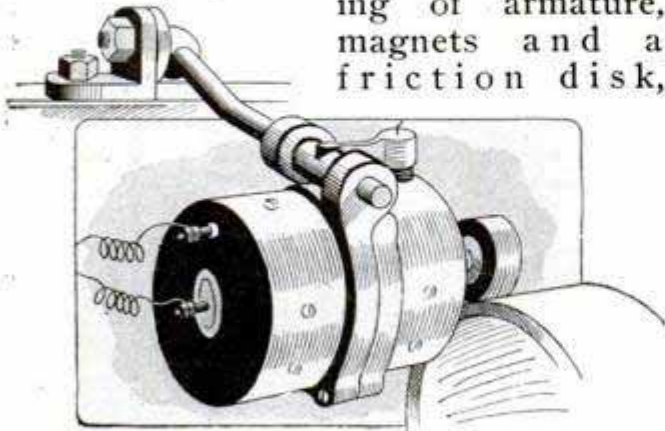

Copyrighted by The Car  
Small Dynamo for Headlights Which Takes  
Its Power from the Flywheel

which a spring forces against the periphery of the flywheel. The headlights can only be used when the engine is in action, and oil or other illuminants must be used to comply with the law when the car is not running. No battery is carried in which current can be stored for employment when the motor happens to be stationary.

When the headlights are no longer required, the friction disk is withdrawn from the edge of the flywheel, an operation under the control of the driver.

### TELEPHONE POSTAL CARD BEING CONSIDERED

The postmaster-general is considering the adoption of a new form of post card, which will show not only the ordinary street address of the recipient but his telephone number also. Upon its arrival at destination, a clerk would immediately call up the telephone number and ask for the person to whom the card is addressed and read the message, after which the card would be delivered in the usual way. The card would bear a special stamp, costing five cents, and would have preference over other first-class mail matter in the same manner the special-delivery letters do now. A reply postal card would be 10 cents. The number of words might be limited, and no liability assumed by the postal authorities other than that now borne in the special-delivery letter.

### MOTOR TRUCK OF UNUSUAL SIZE

A motor truck that is almost as large as a railroad box car, and which is said to be the largest in the world, has recently been put into delivery service

in Chicago. This truck is 29 ft. 5 in. long over all and has a wheel base of 17 ft. 4 in., but in spite of its size it is so controlled as to be readily handled on crowded city streets. An automatic controlling mechanism limits the speed to 12 miles an hour.

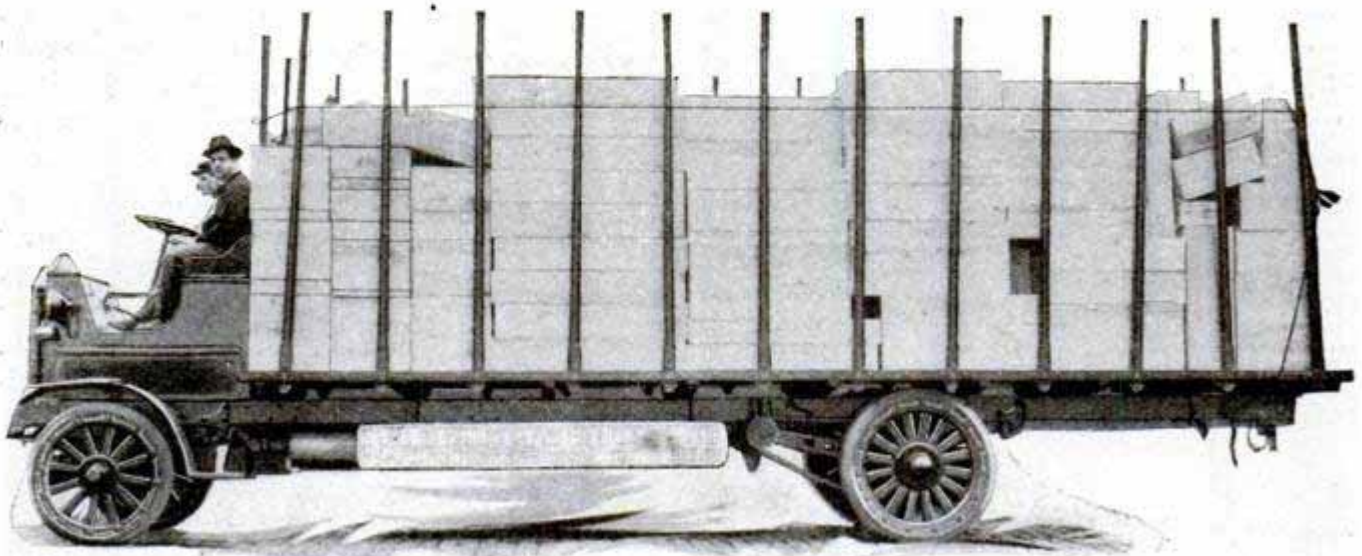

Motor Truck That is Said to be Largest in the World

## ARCH PRINCIPLE OF SHIP CONSTRUCTION

Ships are being built under an English patent in which the principle of arch construction is employed. The arch system is an innovation in the form of the upper structure and consists of strengthened girder frames at regular intervals reinforcing the intermediate usual framing. Below the normal molded depth there is no alteration in structure from the ordinary ships. The ordinary upper or weather deck is raised to the usual height of

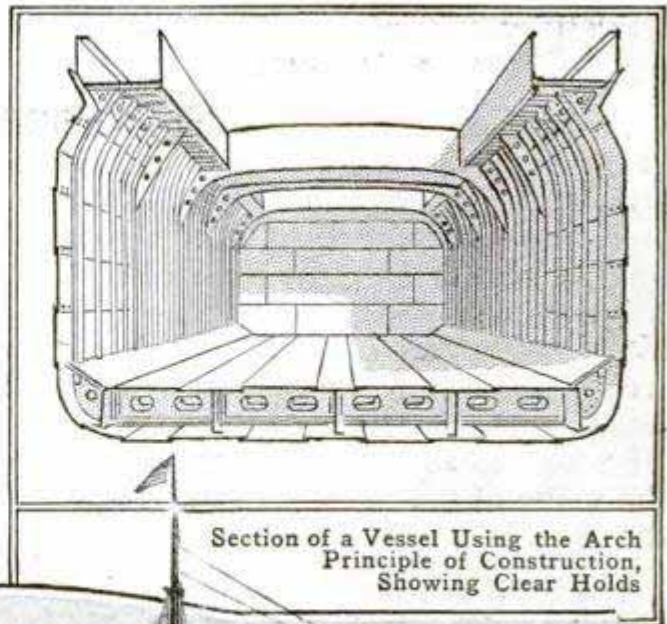

Section of a Vessel Using the Arch Principle of Construction, Showing Clear Holds

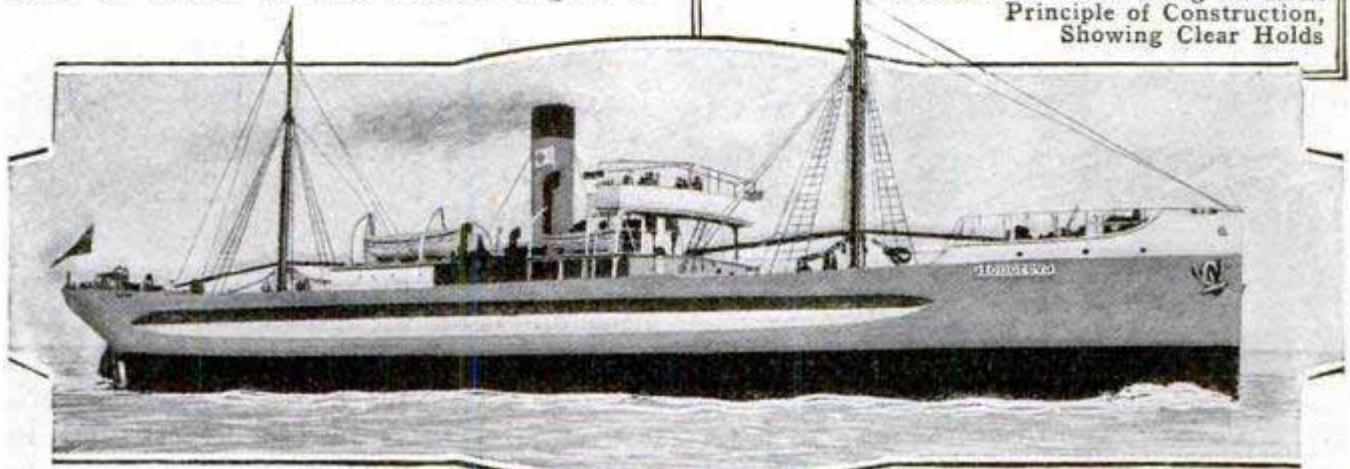

One of the Arch-System Vessels Afloat

a deck bridge by means of the transverse-arch construction, making a continuous deck fore and aft. This transverse arch does away with the necessity of pillars, yet supports both the deck and the vertical side of the vessel. The adoption of this system is claimed to give a saving in cost of construction, and an increase in carrying capacity over a ship of similar dimensions built along ordinary lines. The holds are deeper and clear of supports and the cargo is more easily loaded and unloaded. A number of vessels built under this system are now engaged in ocean trade, carrying coal, timber, grain, and the like, showing great adaptability in handling economically various cargoes.

☐ Last year the government gave away more than 120,000,000 ft. of timber to settlers and miners living in or near the national forests.

## INJURY TO HAT PREVENTED BY HATPIN GUIDE

A French novelty designed to prevent the disfiguring of hats with numerous pin holes consists of a button-like guide to be attached to the hat, and through which the hatpin is inserted. It is made of crystal or colored stone and may be secured in colors to harmonize with the hat trimmings. By



means of a spiral wire, the guide is quickly attached to the hat, or removed, after the manner of a screw button. A fine wire leaving only an inconspicuous mark is used, so that the guide causes little damage to the hat.

## RADIUM SETS NEW STANDARD OF VALUES

A speck of radium weighing 35 milligrams, and incased in a lead container 1 in. long and less than  $\frac{1}{8}$  in. in diameter, was lost recently in a Chicago hospital, where it was being used in treating a cancer case. The value of this bit of rare metal was \$4,500. The same weight in blue-white perfect diamonds would only be \$30 at current prices. This serves to give a concrete idea of the value of the most precious metal in the world.

## STAPLES ARE DRIVEN INTO NEW CONCRETE POSTS

Concrete fence posts into which wire staples can be driven are now being manufactured in large quantities. In

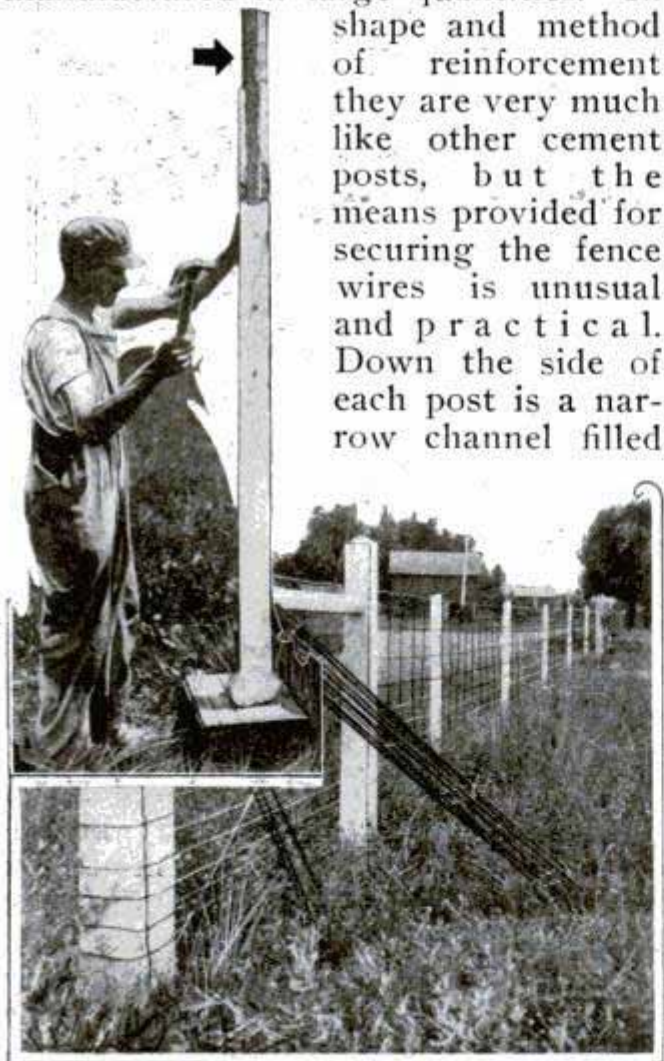

Fence Made of Concrete Posts into Which Iron Staples can be Driven

shape and method of reinforcement they are very much like other cement posts, but the means provided for securing the fence wires is unusual and practical. Down the side of each post is a narrow channel filled

with a composition into which nails and staples can be driven as easily as into wood. And when the staples have

## PADLOCK FOR AUTOMOBILE STARTING CRANK

Small automobiles which do not have self-starters can be protected against thieves by a lock for the starting crank which has recently appeared. It is a heavy padlock with a long shank which fits around the stem of the crank and makes it impossible to press the crank into engagement with the engine shaft in order to start the motor. The key fits in the lock either side up and can be turned in either direction to open the lock, so that fumbling in the dark is avoided.



## NEW GAS ENGINE HAS TWO PISTON HEADS

An internal-combustion engine has been brought out in which the essential feature is two piston heads that are forced apart by the explosion of the charge in the space between them, both piston heads being directly connected with the same shaft. Engines operating on this principle are not new, but heretofore have been built with a complicated and indirect connection between the upper piston head and the shaft. This difficulty is overcome in the new engine by passing the rod from the upper piston head through an opening in the lower piston head to a direct connection with the shaft, the rod being carefully packed to prevent leakage. The two crank arms are placed as close together as possible and the upper part of the cylinder has an offset so that the upper rod will clear the lower.

## NOVEL PLAN FOR BUILDING RAILWAY TUNNEL

Driving one tunnel to furnish access to the workings in another is the novel means adopted by the contractors in building a five-mile railway tunnel under the Selkirk range in western Canada. The main tunnel is designed for double tracks and is to be 22 by 30 ft., while the smaller or "pioneer" tunnel, as it is called, will consist of a 7 by 8-ft. heading driven parallel with the main tunnel. From this heading numerous crosscuts will be made into the line of the main tunnel, which in this way can be excavated simultaneously at many points. The main purpose of the "pioneer" tunnel is to provide an unobstructed route for the removal of the material excavated at the different workings in the main tunnel, but it will also be of great value in supplying ventilation. Although the contractors are driving the "pioneer" tunnel at their own expense, they estimate that they will save time and money by being able to attack the main tunnel at many points.

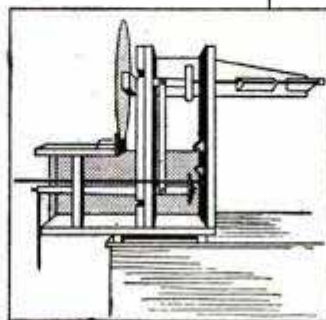
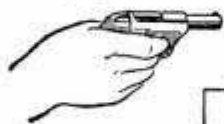

## TARGET WHICH MARKS HITS AUTOMATICALLY

French army officers are using a new target in practice shooting at short range, which automatically marks

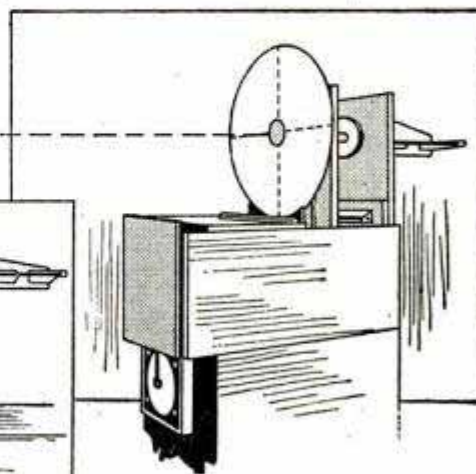

A French Invention Which Registers Hits in Target Practice

hits by means of a balanced pointer. An arrangement of levers, capable of being adjusted for various weights of projectiles, carries an index hung in front of a false target to the exact relative position of the shot striking the true target. The index remains in position indicating the last shot until released by a pull on a string from the firing line.

## REAR BUMPERS FOR AUTOMOBILES

Many automobiles carry bumpers to protect their headlights and radiators, but the prevalence of dented tanks,

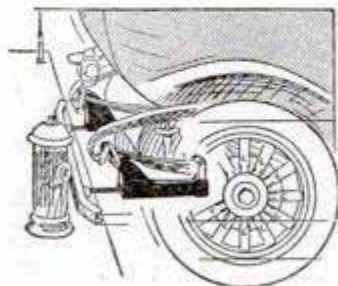

marred tonneaus, and buckled springs indicates that rear-end protection has been neglected. To fill this need a bumper has been patented which can be

clamped to the rear springs without disturbing the shackle bolts or drilling holes in the frame of the car. In design the bumper is similar to front-end bumpers and has coil springs to take up shocks.

## SAFETY BELT HANDLER PREVENTS ACCIDENTS

A safety belt handler designed to make impossible distressing accidents

from placing belts on rapidly moving pulleys has recently been patented, in which a sliding roller, operated by a rope or lever, enables the operator to shift the pulley without moving from his machine. The device makes large reduction not only of danger in the shop but also of cost.

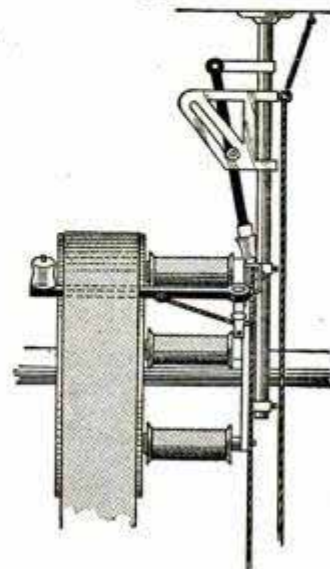

## NEW SUPPORT FOR RAILWAY-CAR SEATS

A new form of support for railway-car seats, which has been invented and patented, is designed to do away

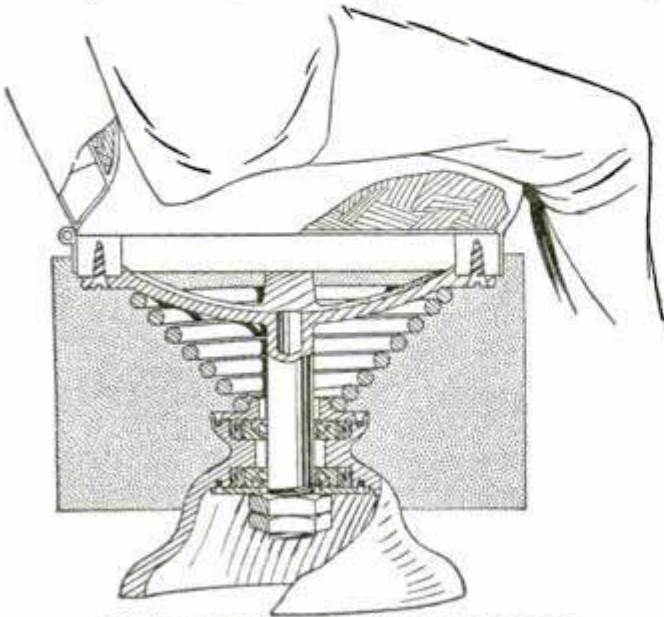

Car-Seat Support Designed to Absorb Vibration of Train.

with the disagreeable vibration to which the passenger is subjected when a train is in rapid motion. This device consists simply of a volute spring, with the wide end up, on which the seat frame is supported and which rests on the pedestal, and a central tubular shaft so mounted on the pedestal as to prevent any movement sidewise. The shaft moves freely up and down in the pedestal under varying loads, and is secured in place by means of nuts on the lower end. A special arrangement of springs and ball bearings prevents the shaft from binding in the pedestal when the load is off the center of the seat.

## HANDY PUSH BUTTON FOR AUTO HORNS

An electric push button in which the whole top is the movable part is being manufactured for use on electric automobile horns. Pressure from any direction on the top or sides operates the button so that the chauffeur can

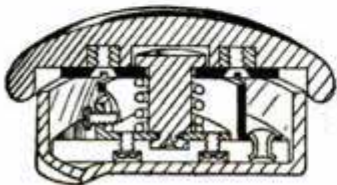

use his elbow, as well as his fingers, to sound the horn. The push button is not quite 2 in. in diameter and can be clamped to one of the spokes of the steering wheel.

## RAISE STEAM BY BURNING OIL IN WATER

A demonstration of the possibility of steam raising by the combustion of liquid fuel directly in contact with water has been made in Bremen, Germany. An apparatus consisting of a cylindrical boiler, provided with a number of pockets isolated and drained by suitable valves and drain-cocks, was used. Each

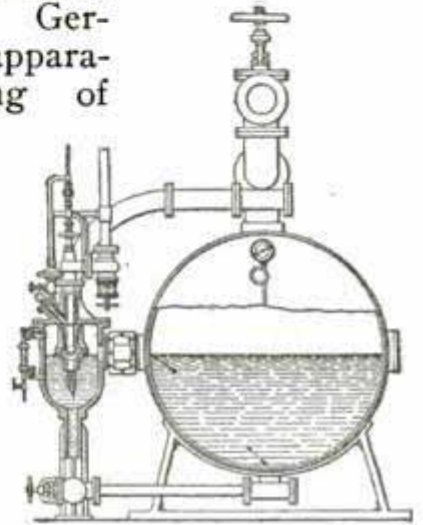

of these pockets contains an oil burner, with a pilot burner, by means of which the main burner can at starting be sufficiently heated to effect complete combustion of the oil. When the main burners are well alight, water from the boiler is permitted to flow into the previously drained pockets, and the circulation of heated water commences, the products of combustion as well as the steam generated being used as a source of power in a steam engine.

## LIGHT SHOES FOR TANGO DANCERS

Tango dancing has created a demand for special shoes, and ballet slippers, hand-sewed and hand-turned of light leather, are now on the market. The shoes have soft soles of oak-tanned leather, without heels and with soft toes. They are light as a feather, and were formerly sold to the theatrical trade exclusively. Now, however, their vogue extends to high-class retailers.



## INSECT MICROSCOPE FOR NATURALISTS

The insectoscope is the name applied to a binocular microscope recently brought out in France to aid in the study of insects. Its purpose is to combine the high magnifying power of a microscope with a mechanism that will enable the naturalist to study the insect from all sides. The lenses magnify 80 diameters and the double vision made possible by the binocular arrangement puts surface objects into relief. The interesting part of the insectoscope is its apparatus for holding the insect. An ingenious arrangement of pivoted arms makes it possible to rotate the holder in three directions so that it can describe a complete sphere with the insect always at the center under the lenses. The insect can thus be studied systematically from every possible point of view.

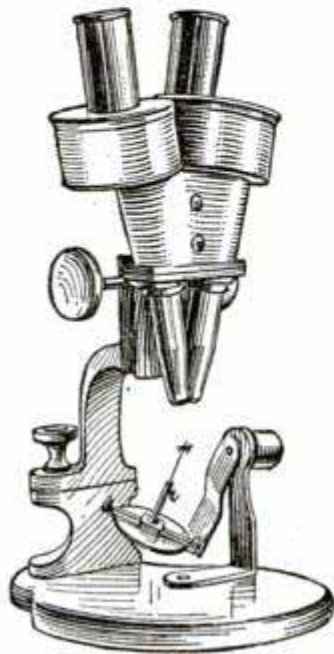

The insectoscope is the name applied to a binocular microscope recently brought out in France to aid in the study of insects. Its purpose is to combine the high magnifying power of a microscope with a mechanism that will enable the naturalist to study the insect from all sides. The lenses magnify 80 diameters and the double vision made possible by the binocular arrangement puts surface objects into relief. The interesting part of the insectoscope is its apparatus for holding the insect. An ingenious arrangement of pivoted arms makes it possible to rotate the holder in three directions so that it can describe a complete sphere with the insect always at the center under the lenses. The insect can thus be studied systematically from every possible point of view.

## CARS THAT RUN IN STRAIGHT LINE WITHOUT STEERING

A new feature in automobile construction, that is expected to add greatly to comfort and convenience in driving, is an arrangement of the front axle that causes the front wheels to straighten out automatically with reference to the car body after the car has turned a corner. At least one of the 1914 models has this feature, while patents are being taken out for a different mechanism designed to accomplish the same result.

In the ordinary type of car the axis of the knuckle joint on which the front wheel is turned in steering is vertical,

while in the new car the axis of this joint is inclined so that the lower end of the joint is ahead of the upper end.

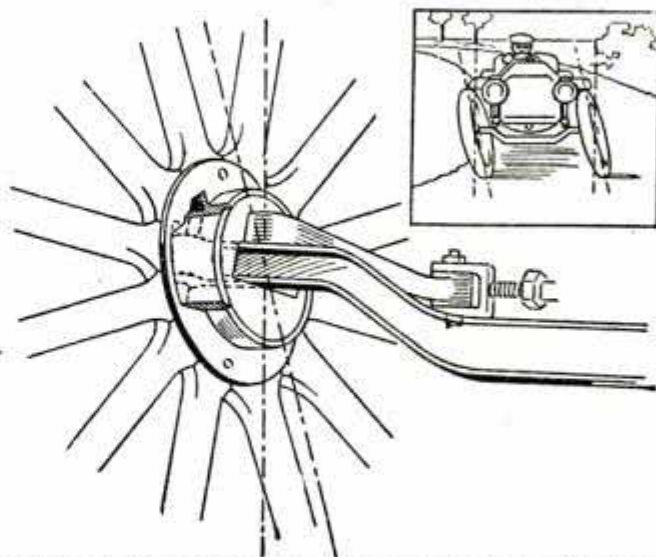

Caster Effect Secured by Connecting Axle with Hub at Point Ahead of Wheel Center. Position of Wheels as Car Makes Turn Shown at Top

The entire axle is built on this angle and, owing to the drop in the middle of the fixed axle, the supports of the front end of the car body are an inch, or more, ahead of the wheel centers. The spring supporting the body is also inclined at this angle, the front end being several inches higher than the rear end, and as a result of this, the weight of the car acts as a thrust forward on the axle. This thrust combined with the fact that the supports of the car are ahead of the wheel centers causes the wheels, when freed from the con-

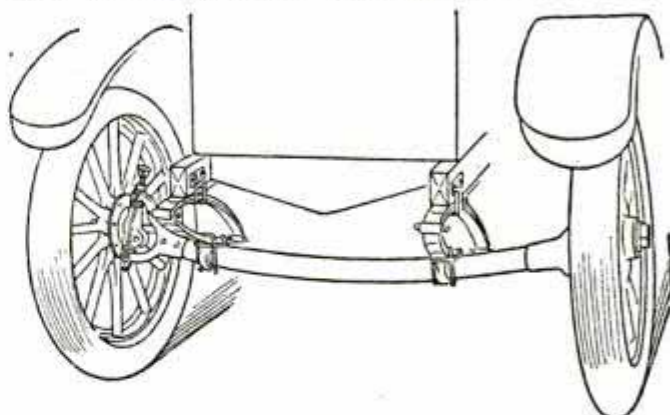

Inclined Front Axle with Support of Car Body Placed Ahead of Wheel Centers

trol of the steering column, to trail into position at right angle to the fixed axle, for exactly the same reason that a caster trails into line when an article of furniture is being moved. With the knuckle joint inclined in the way described, the wheels lean inward

toward the center of the curve when the car is rounding a corner.

In the other mechanism, which is not yet on the market, but has been subjected to the test of practical operation on the inventor's car, an inclined joint and axle are used, with an additional feature designed to make the caster action more positive. The wheel hub is sleeved over an inner stationary hub on which it revolves, ball or roller bearings being used between the two hubs. The axle is attached to this inner hub by means of a knuckle joint that is inclosed in the inner hub and has its axis in the plane of the wheel spokes, an arrangement designed to do away with practically all the bending strain on the joint. This joint is placed at a point slightly ahead of the wheel center, and it is claimed that this, combined with the inclined joint and mounting, produce so strong a caster action that the car will run in a straight line over the roughest roads without any control from the steering column. As in the other car, the wheels lean toward the center of the curve when the car is making a turn.

### TILTING PIANO STOOL NOW HELPS PLAYERS

An adjustable piano stool, the head of which may be tilted to any desired angle, is announced by a manufacturer

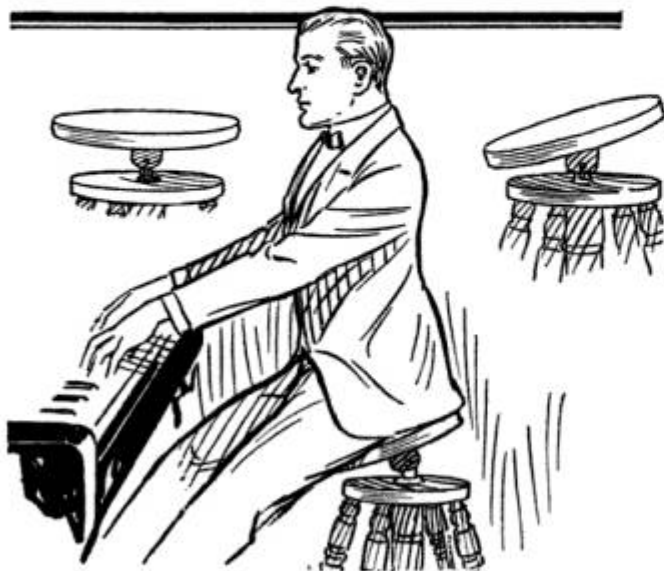

Piano Stool on a Tilting Head Makes Pedaling Easier

who believes he has solved the problem presented by customers who demand both piano bench and stool, as this new arrangement permits the freedom of the piano bench with the added feature of adjustable height, an advantage heretofore enjoyed only in the revolving stool. The new stool is furnished with rubber tips on the brass crow feet instead of glass balls, insuring that the stool will not slip even on the smoothest floors, no matter how vigorously the performer uses the pedals.

### PORTABLE TELEPHONE SET FOR SECTION GANGS

A portable telephone outfit has been designed especially for the timekeepers of section gangs at work on railroads which use telephones for train dispatching. By the use of the portable outfit the timekeeper can keep posted on all train movements either by asking the dispatcher where a given train is, or simply by listening to the orders that are going over the wire.



When trains are running late, or extras are frequent, it is common for a rail or ballast gang to hold up trains until the track can be closed or a run-off finished. By means of the telephone set, such delays can be avoided.

The type of portable outfit used on the Chicago and Northwestern system is here shown. The box contains the complete mechanism, and the jointed pole for making the line connection is the only other equipment required. A line wire, about 150 ft. long, is supplied, so that the timekeeper or foreman can arrange the connection at the most convenient point.

## "BRUSHING" COLD CREAM INTO THE SKIN

Modern methods in beauty culture demand new utensils for the war



against age. A sanitary improvement for applying cold cream to the face and neck is shown, whereby the cream is held in a tube in the handle of the brush. By pressing the collapsible tube the cream is forced out as needed and applied to the skin by the brush. When the cream is almost used up, a key may be placed upon the bottom of the

tube and the tube rolled up until the cream is all forced out.

## PARCEL-CHECKING CABINET REQUIRES NO ATTENDANT

An automatic, coin-controlled locker, recently patented, is being placed in railway stations and similar places for the convenience of travelers and shoppers. Each locker is large enough to hold two large suitcases, and the doors are normally not locked. To check baggage or bundles, the door is opened, and articles placed within the locker, and the door swung shut. By placing a coin in the slot the key may be turned, locking the door, and the key is then withdrawn and carried as a check, giving access to the locker when articles are again required. Unlocking and opening the door, automatically locks the key in the lock once more, from which it cannot be withdrawn without depositing another coin. Umbrella lockers are attached,

providing suitable receptacles also for golf clubs, fish poles and guns.



Pressed-Steel Cabinet for Checking Baggage, with Umbrella Lockers Attached

## GARBAGE CAN WHICH IS ALWAYS CLOSED

A garbage can with a cover that can be opened by a simple pressure of the foot has recently been patented. When the can is standing upon the ground its handle falls over the front and forms a lever that automatically raises the



This Garbage Can is Opened with the Foot

lid when the toe is pressed upon it. Its advantage is in the fact that the lid is always closed. The device is being marketed in several forms for garbage, waste, or oily refuse.

## NOVEL AND PRACTICAL THINGS FOR DAILY USE

Individual windshields for motorists



Individual Windshields for Protection of Passengers

are among the latest novelties in the way of automobile accessories. The shield is held in position a few inches in front of the wearer by a simple attachment which hooks over the shoulders and rests on the chest, so that

the whole device, unlike a fixed windshield, moves with the wearer.

A new type of shoe, recently brought out, is designed to be worn in skating or while engaged in other sports in which a firm support of the ankle is essential. The ankle rests in an inner canvas leg and is held firmly against the back of the shoe by means of the strap passing through to the buckle outside of the outer shoe.



Shoe Designed for Skating or Other Sports for Firm Support of Ankle

An electric signal for answering the night bell has been installed in clubs and small hotels in England. The signal consists of the word "Coming" painted in white letters on a red glass disk, behind which is an electric-light bulb controlled by a switch in the night porter's bedroom.



Electric Signal for Use in Answering Night Bell

When the bell rings the porter switches on the light.

A new route and speed indicator for automobiles

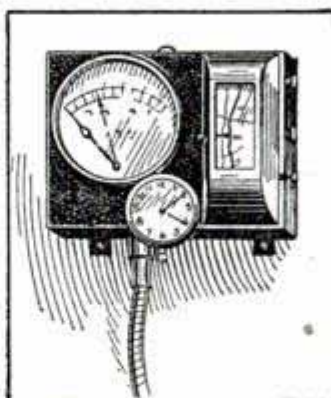

Automobile Indicator That Shows Time, Speed and Position on Road

combines in one case a speed indicator, road map and watch. The road map, which works in conjunction with the speed indicator, automatically indicates the exact position of the car on the road at any

time. This device is apparently of particular value for driving at night or in time of fog.

A new device for lifting the cream from a bottle of milk consists simply of a flexible rubber disk to which three aluminum-wire handles are attached. These are so arranged that the disk can be dropped down edge wise through the cream and then be brought up flat in such a way as to lift the cream from the top of the milk.

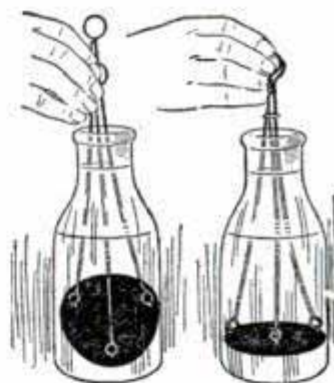

Flexible Rubber Disk Provides an Easy Means of Lifting Cream from Milk

A handy novelty recently brought



Pencil Sharpener That Works Like a Safety Razor

out is a pencil sharpener, adjustable to light or heavy cuts and worked after the manner of a safety razor. The blade is of razor steel and may be removed and sharpened in the same way as a razor blade. The case that carries the blade has a

receptacle in which all chips and shavings are deposited automatically.

A recently invented kitchen utensil is a wrench designed to be used in tightening and loosening the screw lids of fruit jars. This wrench is provided with clamps which fit closely over the rim and these take a firm grip on the lid when the handles of the wrench are drawn together, and the top is easily removed.



Wrench for Tightening and Loosening the Screw Lids of Fruit Jars

Rubber overshoes having a decidedly novel purpose, since they are designed to protect the ground instead of the shoes of the wearer, have been introduced in England. This type of overshoe consists of a rubber covering which fits over the heel and comes forward



Rubber Overshoe That Protects Ground from Shoe of Wearer

to the ball of the foot, the idea being to protect croquet grounds or tennis courts from damage by high and narrow heels.

Wherever washing or dyeing is done some sort of a stick is commonly used for lifting the clothes from the boiler or kettle. A laundry utensil, recently placed on the market, is a clothes stick provided with two prongs, a feature that apparently adds greatly to the effectiveness of this simple tool. The prongs are of metal coated with rust-proof enamel.



New Form of Clothes Stick Having Pronged End

A new form of hoe, which is practically a hoe and hand plow combined, is intended as a universal instrument for gardening, for trimming sidewalks and fences, and for cleaning out around shrubbery. This implement is so shaped that it can be used for almost all the operations in connection with gardening, such as hoeing and bedding, furrowing, covering seed, and weeding.



Hoe Adapted to Variety of Uses in Gardening and Caring for Lawn

Much of the labor of freezing ice cream is eliminated by a new freezer that requires no turning. It is claimed that this freezer will freeze ice cream in 15 minutes and with no attention other than that of placing the cream and brine in the proper receptacles. The outer wall consists of a vacuum chamber, so that practically all the heat absorbed by the brine is taken from the cream in the central chamber.



Ice-Cream Freezer with Which No Turning is Required

A recently invented implement, shaped like a pair of tongs, is designed for protecting the hands and for overcoming much of the drudgery of kitchen work. It can be used efficiently for scraping and cleaning, lifting and holding meats and vegetables, and as a holder for the dish towel in washing dishes.



A Handy Tool Designed for Kitchen Use

## AUTOMOBILE LOCK GIVES COMPLETE SECURITY

The theft of an automobile, which according to the daily papers is no uncommon crime, may be prevented in many cases by the adoption of a device recently patented, which cuts off the gasoline between the tank and the carburetor. This novel lock has no key, being operated by an easily set and readily changed combination, and not only cuts off the fuel, but at the same time breaks the ignition. When leaving the car the driver simply turns a spiked wheel on the dashboard. It will be impossible to start the car until the handle is adjusted to the prearranged numbers. The lock is capable of hundreds of combinations, and is as readily locked and unlocked in the dark by one who knows the combination as if operated with a key.

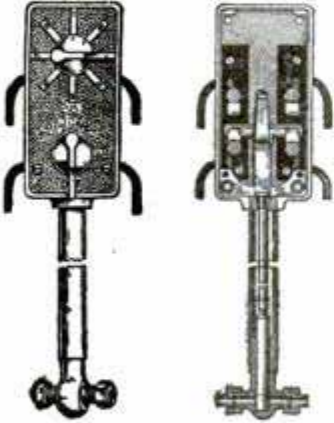

not only cuts off the fuel, but at the same time breaks the ignition. When leaving the car the driver simply turns a spiked wheel on the dashboard. It will be impossible to start the car until the handle is adjusted to the prearranged numbers. The lock is capable of hundreds of combinations, and is as readily locked and unlocked in the dark by one who knows the combination as if operated with a key.

## BALANCED CANAL LOCKS LIFT BOATS HIGH

A mechanical lift has been planned for the Berlin-Stettin Canal at Niederfinow, which will take canal boats directly from high to low level, or vice versa, a distance of 118 ft., making it, when completed, the highest vertical ship lift in the world. The structure, as planned, consists of two beams of bridge construction joined together and

pivoted along a transverse line on a central pier. At either end is swung a trough, 223 ft. in length, into which the vessel to be lifted enters. The lifting is accomplished by four steel-skeleton towers pivotally attached to the beams at their upper ends and built upon platforms which move in water-filled wells. The motive power is furnished by two 100-hp. electric motors, each capable of moving the loaded lift alone. Guide arms hold the troughs steady while being lifted and the platforms on which the lifting towers stand are so fitted to the wells, that little side play is allowed. The boats plying this canal are of about 660 tons burden, and the troughs are ample to accommodate them. When fully loaded, the troughs weigh approximately 2,300 tons, including the necessary water. The lift will handle one trough only or both with equal ease.

## A SIMPLE LOCK FOR DOOR KEY

A recently invented device for locking a door key in the lock so that it will be proof against the burglar's nippers used to turn a key from the outside consists simply of a heavy metal ribbon shaped like a hairpin and having two bends or curves near the end of each prong. This device is set astride the stem of the door knob and the prongs are inserted in the loop of the key.

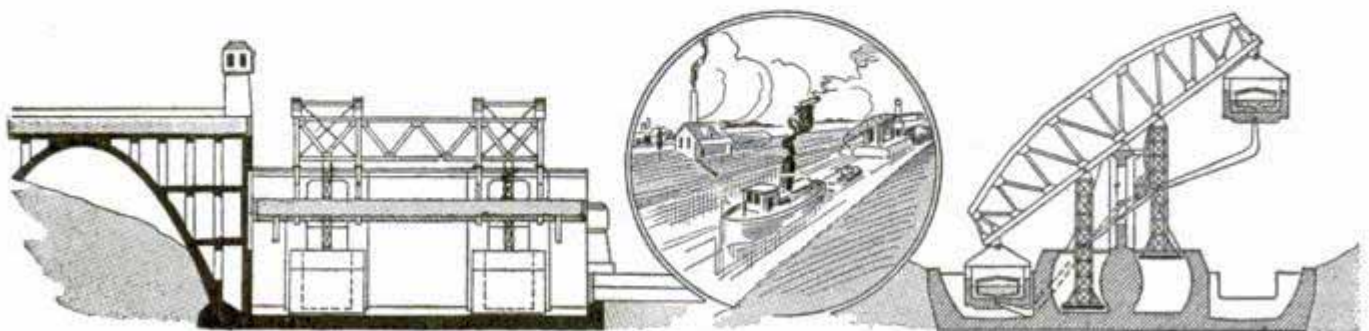
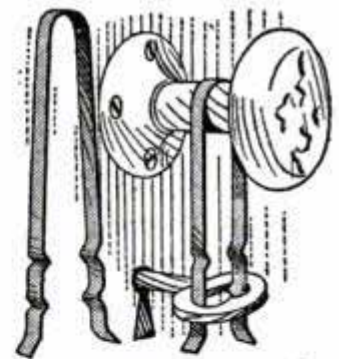

New Canal Lock of Great Lifting Power, Showing Towers and Wells, and How Trough is Raised to High Level

## HYDRAULIC APPARATUS FOR DUMPING MOTOR TRUCK

One of the new features in motor trucks is a dumping body operated by

valued at about \$1,000, were lost off Block Island in about 108 ft. of water. Bearings of the ship's position were taken at the time, but in spite of this it will be necessary to search the sea

Motor Truck with Body in Normal Position and Raised for Dumping the Load

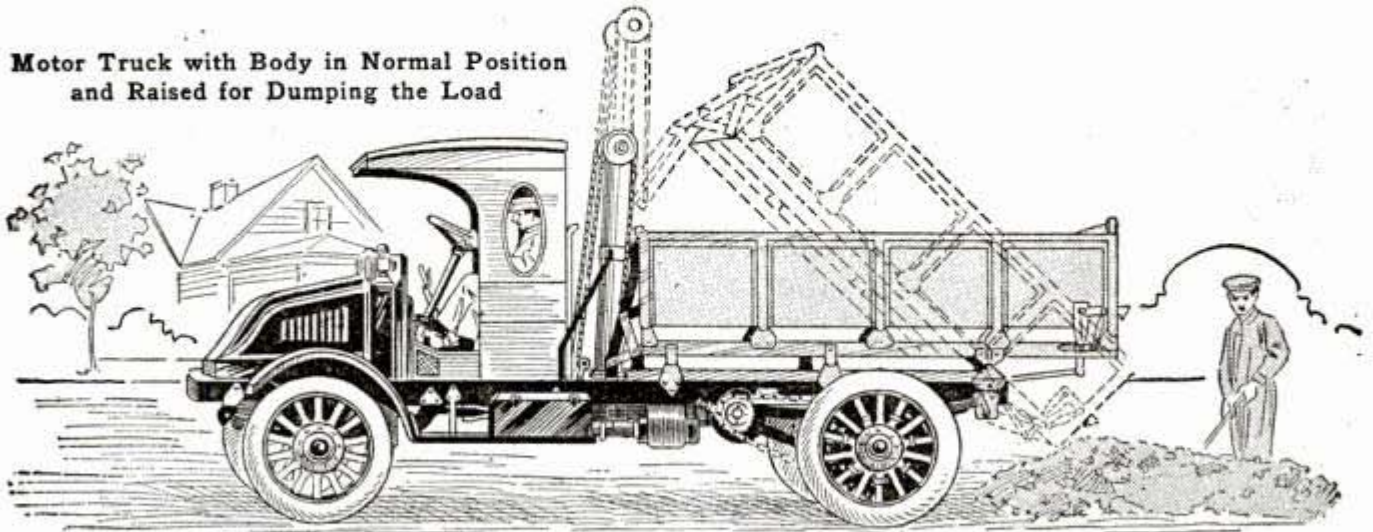

an oil-driven hydraulic apparatus. The apparatus consists of a steel cylinder, 6 in. in diameter, standing upright on the frame of the car, as shown, and containing an ordinary piston with piston rod passing out through the top casing. At the upper end of the piston rod are two pulleys over which run the wire ropes used in hoisting the end of the body. The back end of each of the wire ropes is fastened to the lifting nose of the steel body, and the other end is fastened to a stationary equalizer, which insures equal tension in the two ropes. Oil is forced into the cylinder, driving the piston up or down as required, by means of a gear pump fastened to the cylinder base. The steel body is pivoted near the rear end and the front end is raised and lowered by means of this apparatus. A 3-ton load can be lifted and the body brought back to its seat in about one minute.

## REWARD FOR RECOVERY OF SHIP'S ANCHOR

A reward of \$250 has been offered by the United States Navy Department for the recovery of an anchor and chain lost from the battleship "Rhode Island" last August. The anchor and chain, which together are

bottom over a radius of about half a mile. One man has offered to hunt for the equipment for \$200 a day and to keep up the search until it is found.

## SPRING TO HOLD OILCAN CAP IN PLACE

An oilcan cap that never gets lost is shown in this drawing. It is fastened permanently to the tube of the can by a small coil spring. When the can is not in use the spring holds the cap on tightly, to keep out dust and water, and when the can is being used the spring draws the cap back out of the way. The wire rings which hold the spring in place are soldered to the tube and the cap. Such an arrangement is especially useful on a can of gasoline used for priming.

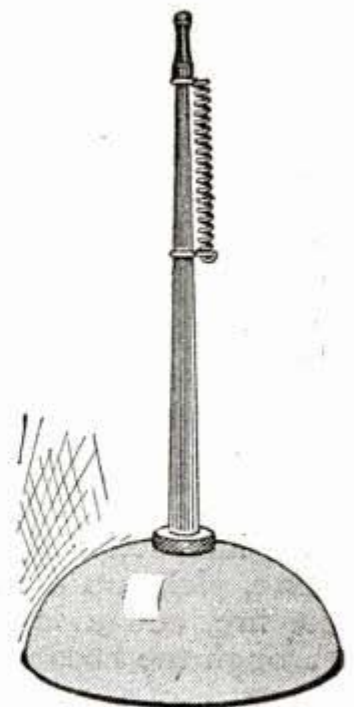

## DOOR KEY TURNS LIGHTS ON AND OFF

A recently invented lighting device is so designed that when the key is inserted and the door is locked from the outside the electric lights in the room or suite of rooms are automatically turned off, while the reverse operation of unlocking the door automatically turns them on. Locking or unlocking the door from the inside does not

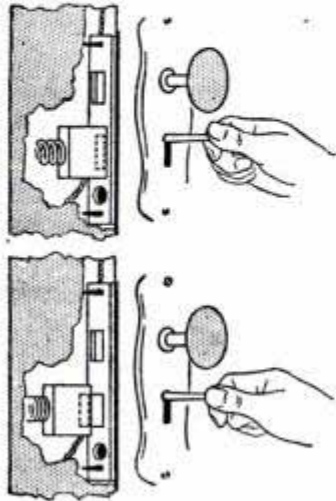

affect the lights in any way, while the device may be entirely disconnected from the lighting system by means of an ordinary switch. This system is intended principally for hotel rooms, but is suited for installation in other buildings as well.

## HOSE REEL AND STANDPIPE COMBINED

Quick action at fires is secured by a new hose reel mounted on a standpipe to which the hose is always attached ready for instant use. Its central pivot, as it is patented, is a water pipe with an air chamber at the top and fittings to be attached permanently to one end of the hose. One



man can get the hose into action. He opens the water valve, picks up the nozzle and runs to the fire, and a full stream is running through the hose while it unwinds, the pressure of the water assisting in the unwinding. The hose drains itself as it is coiled back on the reel and is always dry and free from kinks.

## MILK-BOTTLE PROTECTOR STOPS PETTY THIEVING

It is more than a suspicion that some people endeavor to reduce the high cost of living by taking bottles of milk from door steps of late risers. To

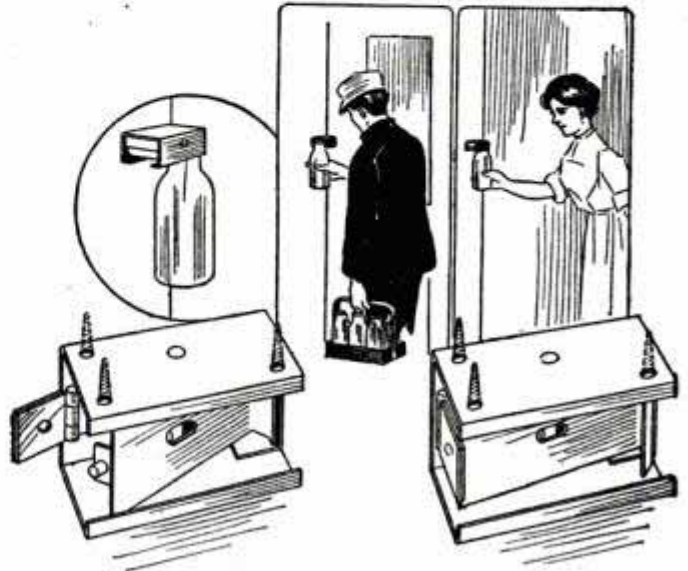

Prevents Loss of Milk after Delivery

discourage this form of thrift a device has been invented which automatically locks the bottle in such a manner that it can only be removed by the occupants of the house upon opening the door. The contrivance is fastened to the door jamb with screws. When the milkman makes his delivery in the morning, he slips the bottle under two projecting flanges. As the bottle is pushed further in, it comes in contact with a pivoted plate, the outer end of which is bent downward and, when released by the bottle striking the other end, drops, effectively locking the bottle in place. The locking device can only be released by opening the house door.

## MAKING FILM PICTURES OF FLYING BULLET

An apparatus capable of making film pictures at the rate of 100,000 a second has been invented, and with it some remarkable pictures have been made. In one case 72 consecutive views of a bullet fired from a revolver were taken while the bullet was passing through a space of 10 in. This bullet was fired



through a thin piece of wood, and the film showed a curious situation. The wood did not show any effect from the impact of the bullet until the bullet had passed completely through it. Then splinters began to form, the stick split, and finally fell to pieces. No camera shutters can be used with this apparatus. A series of electric sparks are flashed at the rate of 100,000 a second and a picture is made with each flash. The film is carried on a wheel 3 ft. in diameter that makes 9,000 revolutions a minute.

### WHAT THE GRADE-CROSSING PROBLEM MEANS

The accompanying bulletin relating to the question of safety at railroad grade crossings has been posted in all stations of the Pennsylvania Railroad.

## Safety At Railroad Grade Crossings

"The railroads are only too happy to remove all grade crossings, to equip every mile of track with automatic block signals, to make every car of all steel construction, but to do these things is utterly impossible without the money with which to pay for them."

—from Letter by Mr. Samuel Ray, President of the Pennsylvania Railroad Company, to Philadelphia Public Ledger.

### What the Pennsylvania Railroad System Has Done

There remain on the 11,000 miles of line comprising the Pennsylvania System 13,027 crossings at grade. It costs an average of at least \$50,000 to remove a grade crossing. Thus, to eliminate every such crossing on the lines of this System would cost upwards of \$600,000,000. The various Companies of this System have since 1902 expended \$66,641,294 in improvements resulting in the elimination of 1052 grade crossings.

### An Appeal to the Public

Grade Crossings are unavoidable. Without them, few railroads could have been built in this country. They are one of the inconveniences of progress, to be eliminated just as fast as possible. Railroad officers are doing their best, but it all takes time and money.

Meanwhile, the public demands that trains be run on time. To do so involves speed over crossings. The Railroad appeals to the driver of every vehicle and every pedestrian before crossing a railroad track to "STOP, LOOK, LISTEN." A little care and a momentary stop may mean the saving of a human life.

Human lives are the most precious things in the world.

Bulletin No. 2

Conditions on other lines are probably not much different from those given, although the average cost for eliminat-

ing a grade crossing is doubtless somewhat lower on the less important single-track railroads. This bulletin indicates what an enormous undertaking the railroads will have to face in complying with the public demand for the removal of all grade crossings.

### NEW SHOVEL SPREADS COAL OVER FIRE

A shovel provided with ribs placed as shown in the illustration and designed for separating small coal or cloggy coal dust and spreading it in a thin sheet over the fire, is a recent invention intended particularly for use in firing boilers where a cheap grade of coal is used. It is claimed that this type of shovel will overcome one of the greatest difficulties in furnace firing, that of cooling the fire and obstructing the draft by too thick a layer of coal.

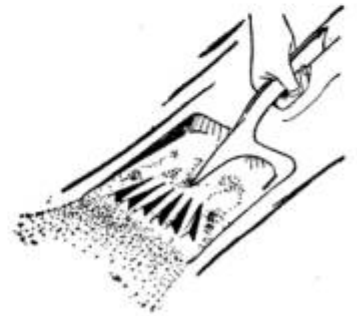

### FOUNTAIN DRAWING PEN FOR DRAFTSMEN

A fountain drawing pen, which has recently been patented and placed on the market, seems to have overcome the difficulty of using heavy drawing ink in a fountain pen. The ink reservoir is a rubber tube in the handle of the pen, and ink is fed to the pen in any quantity by a slight pressure of the finger on a lever on the side of the pen. The lever compresses the soft rubber reservoir so as to force the ink into the pen point.

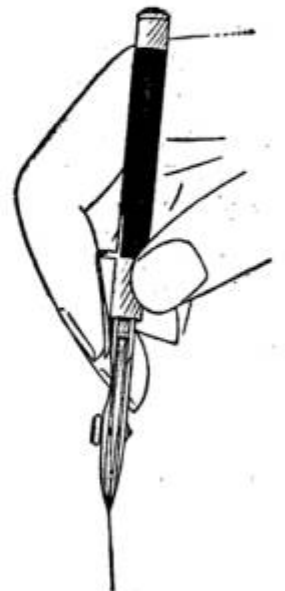

## SELECTION OF COLORS FOR INTERIOR DECORATION

The use of colors in interior decoration ceases to be a matter of taste and can almost be reduced to rules when the relations which various colors bear

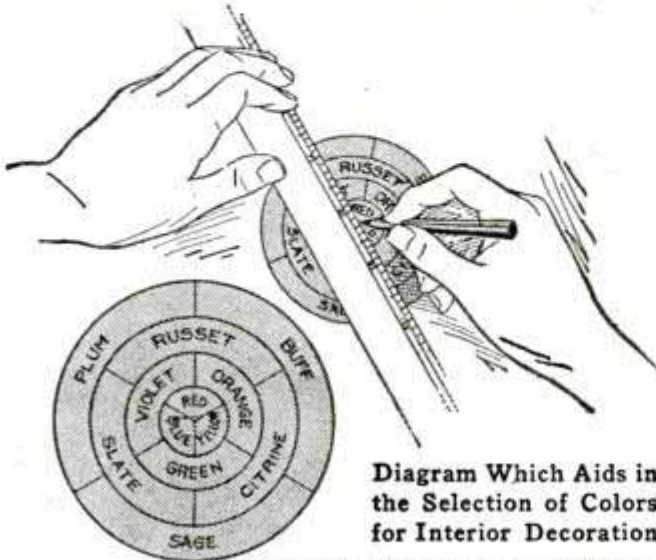

Diagram Which Aids in the Selection of Colors for Interior Decoration

Copyrighted by Howard Vincent O'Brien

to each other are considered. There are certain fundamental colors which are too strikingly different to go well with one another, and by a mixing of these primary colors are made combination colors that are related to each other just as are the fundamental colors of which they are made. This relationship is illustrated by the accompanying diagram. The smallest circle contains the three primary colors; the next circle gives the three possible combinations of the primary colors, and so on, to the fifth circle. From the diagram it is possible to see what combination of colors is contained in each color outside the primary circle, and it is also possible to determine from this relationship what combination of colors will go well together. If a straight line is drawn in any direction from the center of the diagram to the circumference, the four colors that it intersects can safely be used together in interior decoration. For example, if a prevalent sage color is desired, a line from one end of the sage section to the center shows that slate, green, and blue can be used with it; or a line from another point indicates that citrine, green, and yellow will make a safe combination. Complementary col-

ors can be determined in the same way. As blue and yellow are complementary of red, their combination, green, can be used with red; and sage can be used as a complement of russet. When the prevalent color for a room has been selected, the rule of color combinations will supply the other possibilities.

## AUTOMOBILE FENDER OF NEW DESIGN

One of the many automobile fenders designed to throw a pedestrian out of the way and keep the wheels from passing over his body consists of guards over the front wheels, as shown in the accompanying picture. This device, which is patented, is not cumbersome or unsightly when out of use, but is arranged to drop into position automatically when a pedestrian is struck. A sheet-steel guard, a little wider than a tire and ending at the lower end in thick leather, backed by a flat spring, hangs over each front wheel, pivoted on the steering knuckle. Ordinarily the guards are elevated almost to the mudguards but when a pedestrian comes in contact with a brass bar that stretches across the front of the car, the guards drop down to within  $\frac{1}{2}$  in. of the pavement ready to push his body

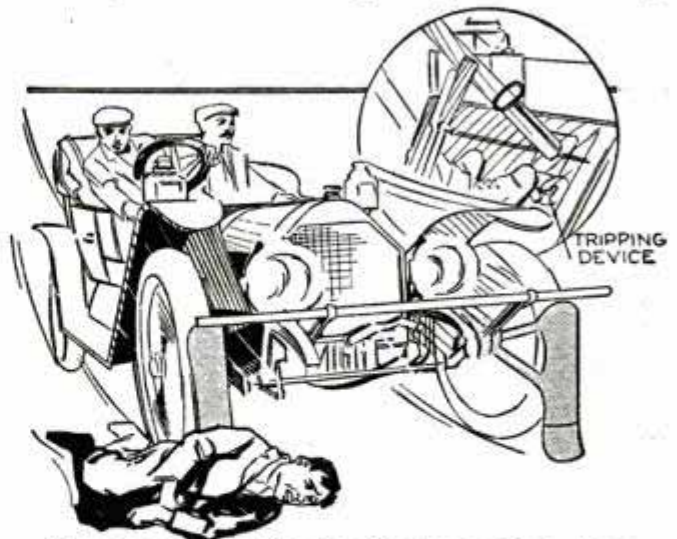

New Automobile Fender Pushing a Body Out of the Way of the Wheels

out of the way of the wheels. A button at the driver's feet enables him to drop the fenders before the pedestrian is struck and a handle on the steering column draws them back to their upper position.

## ELECTRIC OVEN RESTORES BABYLONIAN BRICKS

A collection of bricks from ancient Babylon in the library of the University of Strassburg, Germany, was threatened with loss from disintegration, as some of the bricks had been only sun-baked and were badly deteriorating, so that little hope remained of preserving or translating the cuneiform inscriptions with which they were covered. It was suggested that the unfinished baking be completed in the electric oven of the chemistry department, and this experiment succeeded so well that the ancient bricks, rejuvenated by a modern process, will have as lasting qualities as the rest of the collection. Not only were the tablets protected from disintegration, but foreign matter which had made translation difficult, was burned away and the characters are now easily read.

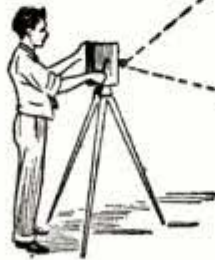

## SYNCHRONIZING PICTURES AND ACCOMPANIMENT

Where moving pictures are designed to be accompanied by piano, band, or orchestra, it has been extremely hard

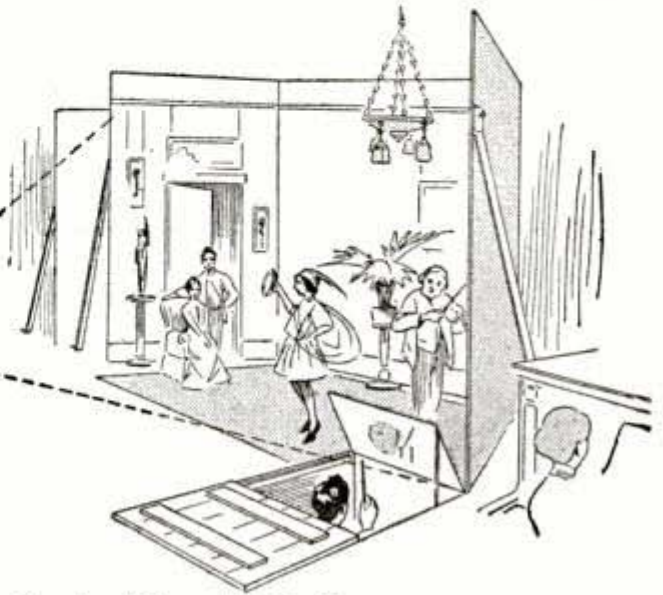

Keeping Time with Movies

to secure perfect synchronization. A German inventor has recently secured a United States patent for a device which is intended to obviate this difficulty. When a moving-picture play is being photographed, the bandmaster of the orchestra is photographed simultaneously with the play, at the side or lower edge of the film. Either the whole or a partial photograph of the leader is provided for, by means of a mirror which reflects his image as he stands in his place, and the motions of his baton or arms may be plainly seen by the performers who later play the music at the reproduction of the pictures. The movements of the bandmaster may be screened from the audience by means of walls, curtains, wings, or the like, while the actors, singers and musicians can see them.

## FRENCH TOY HAS VAGARIES OF REAL MOUSE

A toy mouse that acts like a real mouse is a French novelty. If placed on a sharply inclined and polished surface, it will move down in an irregular path, changing its direction frequently as if impelled by a wayward

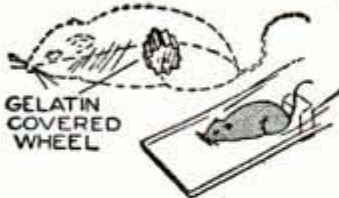

fancy. This action is brought about by the peculiar construction of a small wheel, which revolves on a pin within the body of the toy and which just touches the surface on which the mouse moves. The surface of the wheel consists of teeth, like those of a gear, and these teeth are covered with gelatin. The irregular motion is due to the varying adhesion of the gelatin to the polished surface.

## NOISELESS BRAKES FOR STREET CARS

A brake shoe having a strip of asphaltum let into the surface has been adopted for use on street cars in New York recently. The new brake is said to be practically noiseless, while having good wear-resisting qualities.

## BAFFLE-PLATE SILENCER FOR GASOLINE ENGINES

A new silencer for automobile engines, made in England, consists of a series of baffle plates strung upon a rod surrounded by a cylinder to the head of which the rod is attached. The baffle plates are held in place by small bolts. In passing through this silencer, nearly all of the gas oscillates right and left between the plates



and collides with a straight core of gas which passes through the round holes in the plates. The velocity of the gas is thus rapidly diminished by interference of one portion with another. The result is claimed to be absolute noiselessness without back pressure. The construction also permits easy removal for cleaning.

## CLOCK WITH ELECTRICAL WINDING DEVICE

An English patent has been issued for an improvement in electric clock movements which may be attached to any household timepiece. A small induction motor, supplied from dry cells, actuates the drum containing the spring by a worm and wheel, but instead of attaching the outer

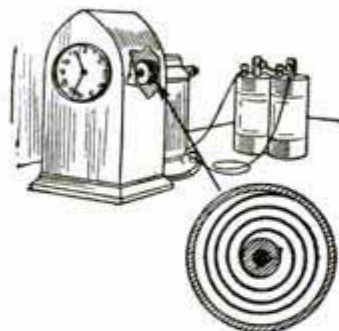

end of the spring to the drum, it is left free. The spring pressing against the drum drives the clock train, and if the speed of the motor exceeds that necessary to keep the spring wound, the spring, being free, slips inside the drum on the principle of a friction clutch.

## CARVER'S HANDLE FOR LEG OF MUTTON

An implement which the carver will appreciate has recently been placed on the market.

It is designed to hold a leg of mutton from slipping or splashing sauce while being cut or served. The implement has a short wooden handle and two flaring tongs of metal to grasp the bone. A screw ring secures the holder firmly against the bone while in use.



## NOVEL IDEA IN ROAD MAKING

Ruts are the bane of country roads and one farmer has experimented until he has found a way to eliminate them. The idea is simply to fill the ruts of a prairie wagon road with concrete. The filling should be 4 or 5 in. thick and about 8 in. wide on top, the surface being hollowed out about 1½ in. deep for vehicle wheels, as shown in the illustration. It is easy to drive over, as the wheels follow the tracks "with first intent," and four years' wear on the experimental roads built by the originator show no wear nor corrosion. The cost is given as 10 cents per lineal foot—\$528 per mile—and the roads are not only free-driving

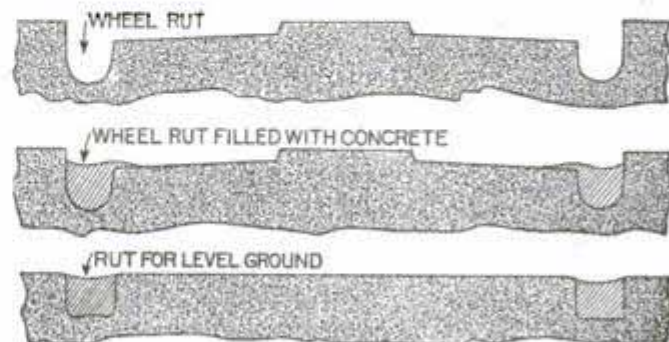

Using Ruts in Road Building

in wet weather but are almost dustless in dry condition.

**AUTOMATIC OILER INCREASES LUBRICATING CAPACITY**

A new automatic oiler, adapted for use where there is a demand for greater lubricating capacity, has recently been placed on the market. The bottom plate is removed from the crank case

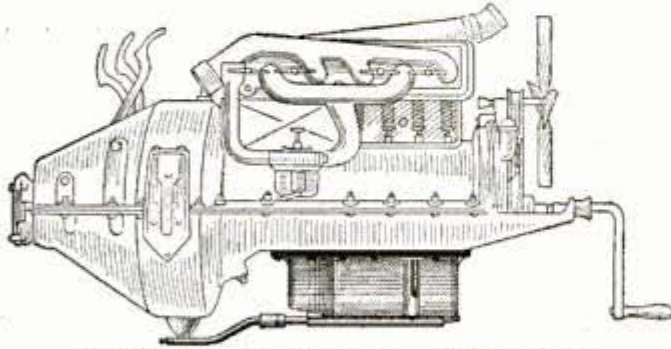

Auxiliary Oiling System for Which Many Advantages are Claimed

of the motor and the oiler is bolted into place beneath the engine as shown. That the appliance doubles the oil capacity, allows four or five times the mileage on one filling of oil, and helps to cool the motor by rapid circulation of oil from reservoir to crank case, are some of the advantages claimed by the inventor.

**ATOMIZER FOR COMBINING SEVERAL PERFUMES**

A compartment perfume bottle for persons who like various scents mixed together has been brought out in Paris.



The device forms a multiple atomizer which throws out one perfume or several in combination. The bottle is divided into four compartments and each section has a separate valve and discharge pipe within the cover. The removable top of the bottle contains a small pump for compressing the air within. A different perfume is kept separately in each compartment and any combination can be secured by a plunge of the pump after the desired valves have been opened.

**INGENIOUS GERMAN WRENCH**

An expanding and contracting wrench of ingenious design has made its appearance on the German market. It is made of forged steel folded over several times at either end to receive the nuts. It is obvious that the more force is applied the tighter the nut will be gripped, without any danger of the wrench slipping off or wearing the edges of the nut. By exerting pressure in the opposite direction the wrench head expands, and thus the tool can be easily removed.

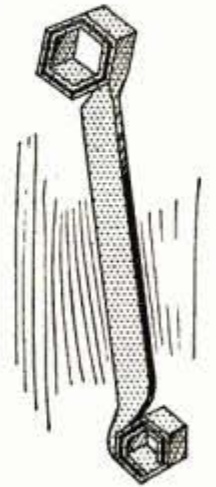

**A SPIKED BAND FOR POISON BOTTLES**

The safety-first campaign which is being urged on every hand finds a quick response in devices to make accidental mistakes in handling poisonous substances less frequent, if not impossible. One poison signal is shown herewith, in which a rubber band, armed with small rubber spikes projecting from it, is placed about a bottle, round or square boxes or packages in which poisonous substances are offered for sale or distribution, giving an unmistakable warning to any person picking up or handling it. The band is very flexible and there is sufficient elasticity in the rubber of which it is made to allow it to be placed about bottles of various sizes and shapes.

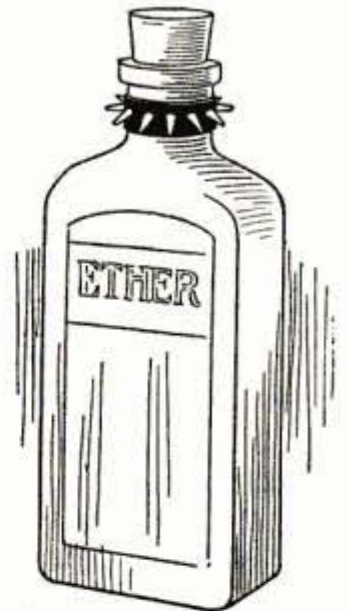

## VIBRATING GRINDSTONE NEW INVENTION

Instead of revolving, a novel grinding tool has been placed on the market which vibrates to and fro rapidly in

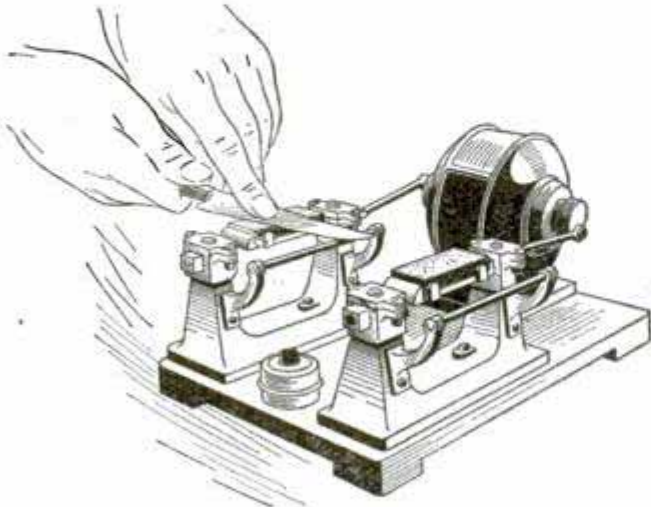

Electrical Vibrating Grinder

a horizontal plane. The stones, one for roughing and the other for finishing, are given a short-stroke vibration by a small driving motor, running at 1,400 revolutions per minute. Small wedges hold the stones in place, and the stones may be easily removed and replaced by any desired kind of polishing or grinding surface. The tool is so constructed that it operates noiselessly, and a cushioning arrangement is employed to avoid shocks at the ends of the stroke. The power taken is about one-tenth horsepower.

## FORTIFYING THE PANAMA CANAL

Having invested nearly \$375,000,000 in the canal, the United States is intent upon safeguarding that tremendous outlay against the possibility of damage through foreign war. Fortification of the canal has been undertaken purely as an insurance matter. It is sought to make it impossible in time of war, for any enemy to take possession of the waterway, or to damage it to such an extent that the ships of the United States could not use it at will.

Guns of 14 and 16-in. caliber will be placed at forts guarding both the Pa-

cific and Atlantic entrances, commanding a radius of 15 miles. The forts at the Pacific entrance are constructed on three islands in Panama Bay, at the very beginning of the canal, Flamenco, Perico, and Naos. These are huge masses of volcanic rock, behind which, safe from the fire of any ship, no matter how powerful, the forts stand. The great Miraflores Locks are seven miles inland from the forts, and no gun at the present time is powerful enough to send a shell the 22 miles intervening between the outside of the zone of fire from the forts and those locks which control the canal. Even with the marvels of modern gunnery it would be as difficult to place a shell, even if it could be thrown that far, as for a rifleman to hit a lead pencil at a distance of 2,000 yards.

The Canal Zone will be a military reservation, with ample guard always on duty, with field artillery, and wireless equipment which will be in touch with naval stations at all times, and instant alarm will be given of threatened attack from any source. Three regiments will be stationed at Culebra, a regiment of marines at Balboa, and a full force of artillerymen at the forts.

## SELF-LUBRICATING SPRINGS NOW MANUFACTURED

Automatic lubrication of leaf springs is accomplished, according to a recent design for which patent is sought, through small cups or depressions, formed near the ends of the leaves and filled with heavy grease. This lubricant is evenly distributed by the motion of the different members of the

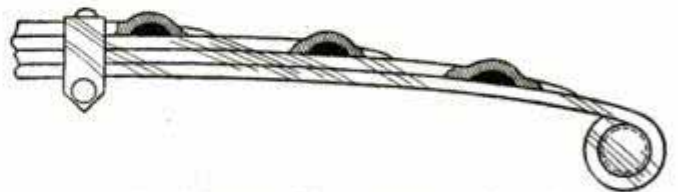

Leaf Spring Which Greases Itself

spring upon each other, the largest amount of the lubricant being spread at the point where the greatest relative movement occurs.

# HOW ALPINE MOUNTAINEERS RISK THEIR LIVES

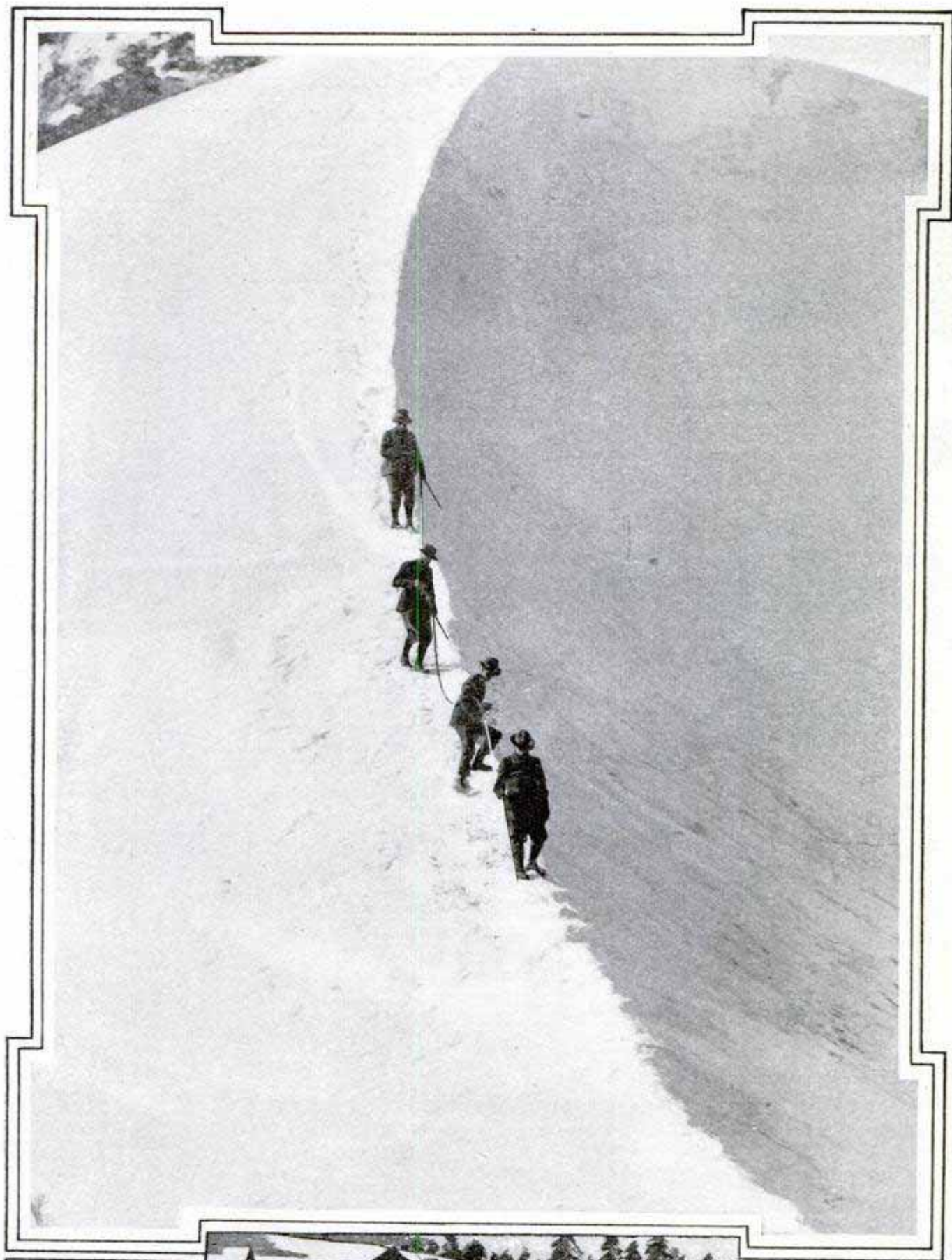

Alpine Climbers Face Innumerable Dangers, Not the Least of Which are Those Encountered upon the Snow Slopes. Without Warning the Whole Body of Snow may Start As an Avalanche, Carrying an Entire Party Down to Certain Death

## MINE-RESCUE MOTOR TRUCK EFFICIENT FIRST AID

To rescue, revive, and treat entombed and injured miners and thus reduce the loss of life and lessen the

oxygen pump, operated by the power of the motor. Crowbars, tent poles, picks, shovels, sledges and axes, saws, hose couplings, reducers, spanners, and a reel of  $\frac{1}{2}$ -in. rope are conveniently ranged on either side, while a complete telephone system is carried, part of which is to be taken into the mine. Suspended on the outside of the body on specially arranged hooks and clamps are stretchers, fire extinguish-

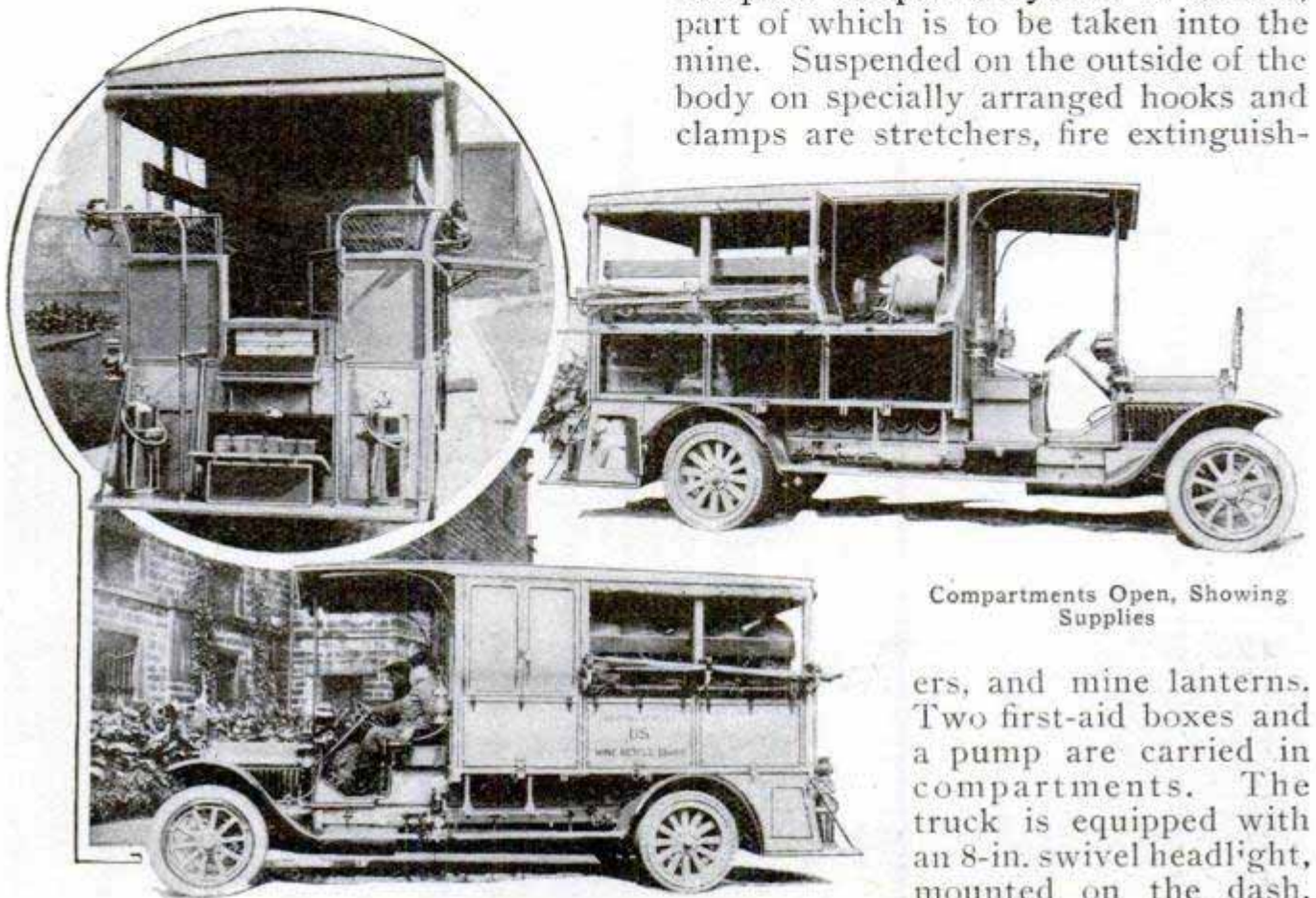

New Type Rescue Truck, Ready for Work. Above, Rear View of Truck, Showing Seating Capacity and Fire Extinguishers

Compartments Open, Showing Supplies

ers, and mine lanterns. Two first-aid boxes and a pump are carried in compartments. The truck is equipped with an 8-in. swivel headlight, mounted on the dash.

Seats for 10 operators are found in the body of the truck, protected by curtains when necessary, and the driver's seat accommodates two persons.

injuries received in disasters in the coal mines of the United States, the Bureau of Mines has evolved a new plan of relief work involving the extensive use of motor rescue trucks of special design, equipped with all the paraphernalia known to science in relief work. The new vehicle is a veritable hospital, carrying every piece of portable equipment that is useful in rescuing miners, quenching flames, resuscitating the unconscious and administering first aid. Instant accessibility is given by having a place for everything and keeping everything in its place. Under the driver's seat are 10 reviving outfits. Six oxygen tanks lie on crossframes beneath the body of the car, so they can be pulled out quickly. On the left side of the chassis is an

## PUMPING A BILLION TONS OF WATER A YEAR

Fifteen tons of water must be pumped out of the mines for every ton of anthracite coal produced in Pennsylvania. As the more accessible coal seams have been exhausted, shafts have been sunk deeper, and the volume of water to be pumped out has increased rapidly. Statistics give the production of anthracite coal from the Pennsylvania fields as a little less than 70,000,000 tons of hard coal per year, which, on a fifteen-to-one basis, makes the water pumped amount to over a billion tons in a twelvemonth.



## BOAT MAKING BY DJOCKAS INTERESTING PROCESS

The black natives of Dutch Guiana, called Djockas, are adepts in boat making, their craft being light and extremely graceful. The only tools used are an ax, a cutlass and a knife. A tree is selected in the standing forest, often miles from a watercourse, and is felled and roughly hewn into shape where it falls. With fire and the ax, the interior is partly hollowed and the log then dragged through the thick underbrush to the waterside. Carefully removing most of the interior, the boat is filled with wet sand, or is submerged in the water until the sides become somewhat softened, permitting them to be bent outward, when they are stayed with stout sticks and the seats are fixed in their places. The ends are shaped and triangular pieces

a plank, or extra streak, and the junction of this streak with the canoe is carefully calked with shreds from the inner bark of certain trees and then pitched with resinous gum, mixed with beeswax. If the canoe is to be used for long journeys a tent is added for the protection of the goods, usually in the form of a mat of sticks, woven and filled with palm leaves. This covering is perfectly waterproof and may be placed or removed in a few minutes. In these canoes the natives spend much of their lives and traverse great distances to trade.

## NEW MILITARY CAR BUILT FOR SERVICE IN INDIA

Folding berths to accommodate 66 soldiers are provided in a new military railway carriage lately built in the shops of the principal railway at Matunga, India. The body of the car is 68 ft. long and 10 ft. wide. The berths are arranged in three tiers on tubular-steel framing, similar to those in use on troop ships. There is a corridor, 2 ft. wide, into which the berths open. Rifle racks beneath the seats, and large parcel holders above, for the soldiers' kits, are provided. Specially designed tanks beneath the floor of the car hold 500 gal. of water;

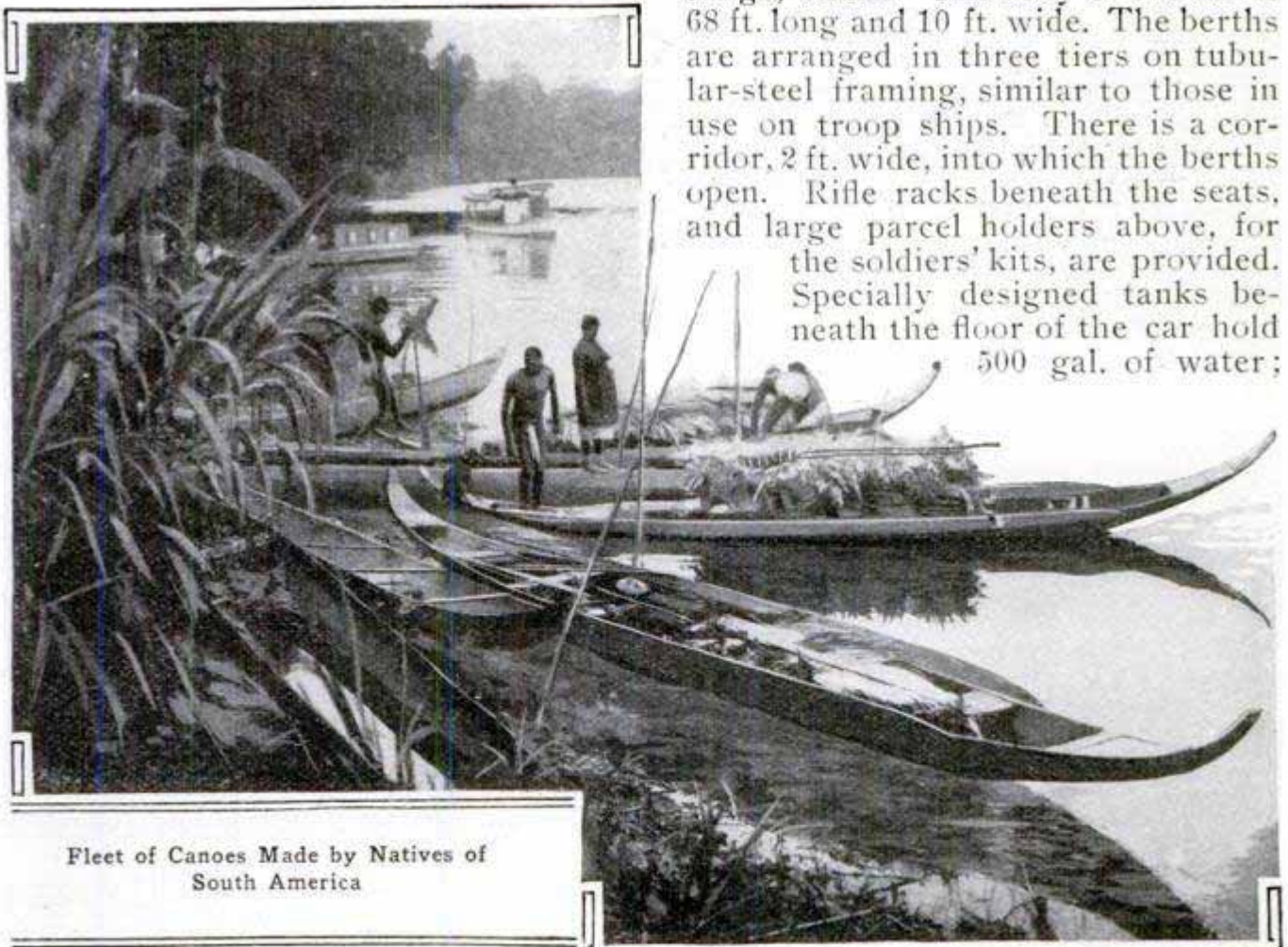

Fleet of Canoes Made by Natives of  
South America

of wood are fitted into the stem and stern, the sides and squared ends of the canoe are raised by the addition of

the ends of the car are fitted with vestibules and a thorough system of ventilation is installed.

## BANKS PROTECT BULLION BY STEEL MOTORS

French bankers, aroused by many



**Motor Dreadnought That Foils Robbers**

recent robberies, have adopted steel-clad motors for conveying bullion, cur-

rency and other valuables through the streets of Paris, as well as distributing money to outlying banks. The automobiles are constructed with an all-steel body, entirely inclosed, except in front. Admittance to the interior is from the front of the vehicle, where an armed guard sits beside the driver.

## REFRIGERATOR STEAMERS FOR PANAMA CANAL

Several concerns engaged in the shipping of citrus fruit from California are making preparations for transporting large quantities of this product from the Pacific coast to Europe through the Panama Canal. One shipper is building six fast steamships equipped with every fruit-saving device. Holds properly refrigerated will hold 20,000 boxes of fruit, and passage to Europe is promised in 21 days.

## SINKING SCHOONER TOWED INTO HARBOR

Almost cut in two in a collision with a steamer, the three-masted schooner "John D. Spreckels" of San Francisco, laden with a cargo of salt cod-

sank, but the cargo slid forward, partly stopping the leak, leaving the stern high and dry out of water, in which position she floated for several days, and was finally towed into the harbor of San Francisco by a revenue cutter. Most of the crew escaped by jumping



**Unusual Plight of a Damaged Schooner**

fish from Alaska, did not sink immediately. The forward part of the wrecked boat filled with water and

on board the steamer when the collision occurred, but two were drowned in the forecabin.

## ITALIAN DIRIGIBLE SHOWS INNOVATIONS

Combining the advantages of the rigid and the nonrigid type, the new Italian dirigible "Citta di Milano" has

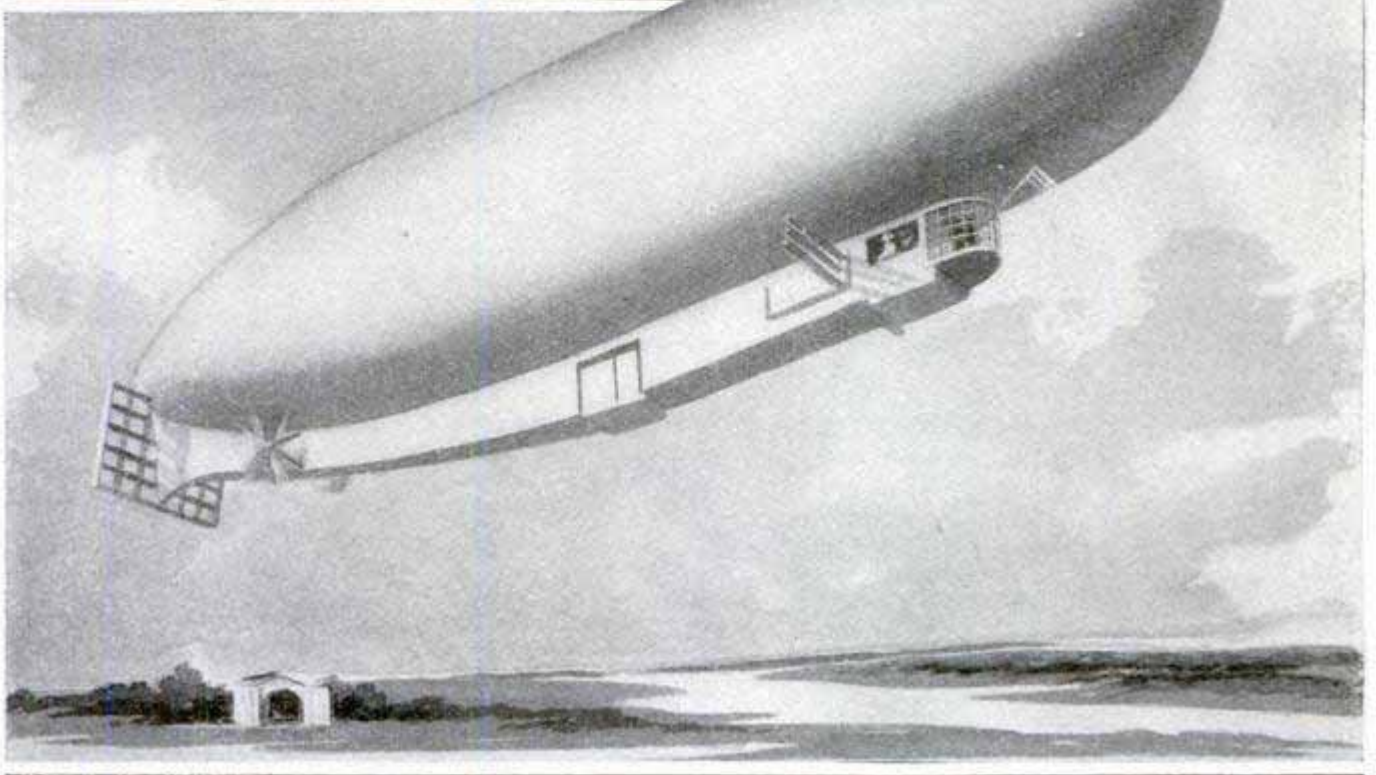

Courtesy The Engineer

New Type of Dirigible Accepted for the Aerial Navy of Italy

been accepted by government experts and is now in use. With a length of 236 ft. and a breadth of 59 ft., it is remarkable for the closeness with which the lower structure hugs the under side of the gas bag. Two motors of 100 hp. each drive the dirigible, which is of the Forlanini type, at a speed of 45 miles an hour. The propellers are 13.7 ft. in diameter and make 260 revolutions per minute. The gridlike stabilizer at the rear of the car is another innovation.

## OUTWITTING THE MISSOURI RIVER

The changing channel of the "Big Muddy" is proverbial, and when the engineers in charge of the government reclamation project at Williston, N. D., came to establish the pumping station, which is to send water through the ditches on more than 25,000 acres of bench land near that place, they con-

ceived the idea of putting the pumps on a barge, which could change its position with the changes of the river. As no one can say that the shore line of today will be the same a year hence, the engineers solved the problem in a

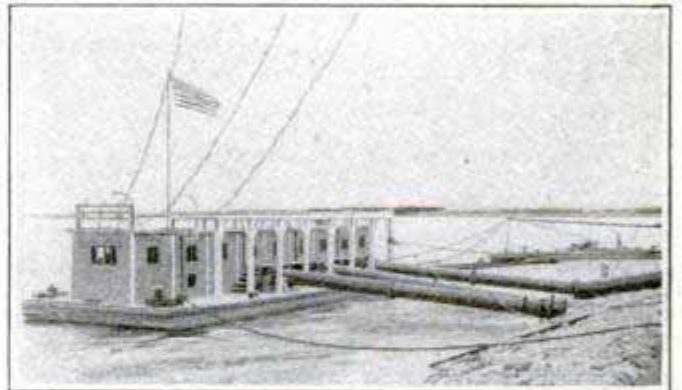

Novel Pumping Station of Irrigation Project

novel manner. The pipes were made with flexible joints, a huge diverting boom built to keep floating trees and drift away from the pumps, and the barge anchored by guy lines to the shore. The power is electric and is derived from a plant 20 miles away.

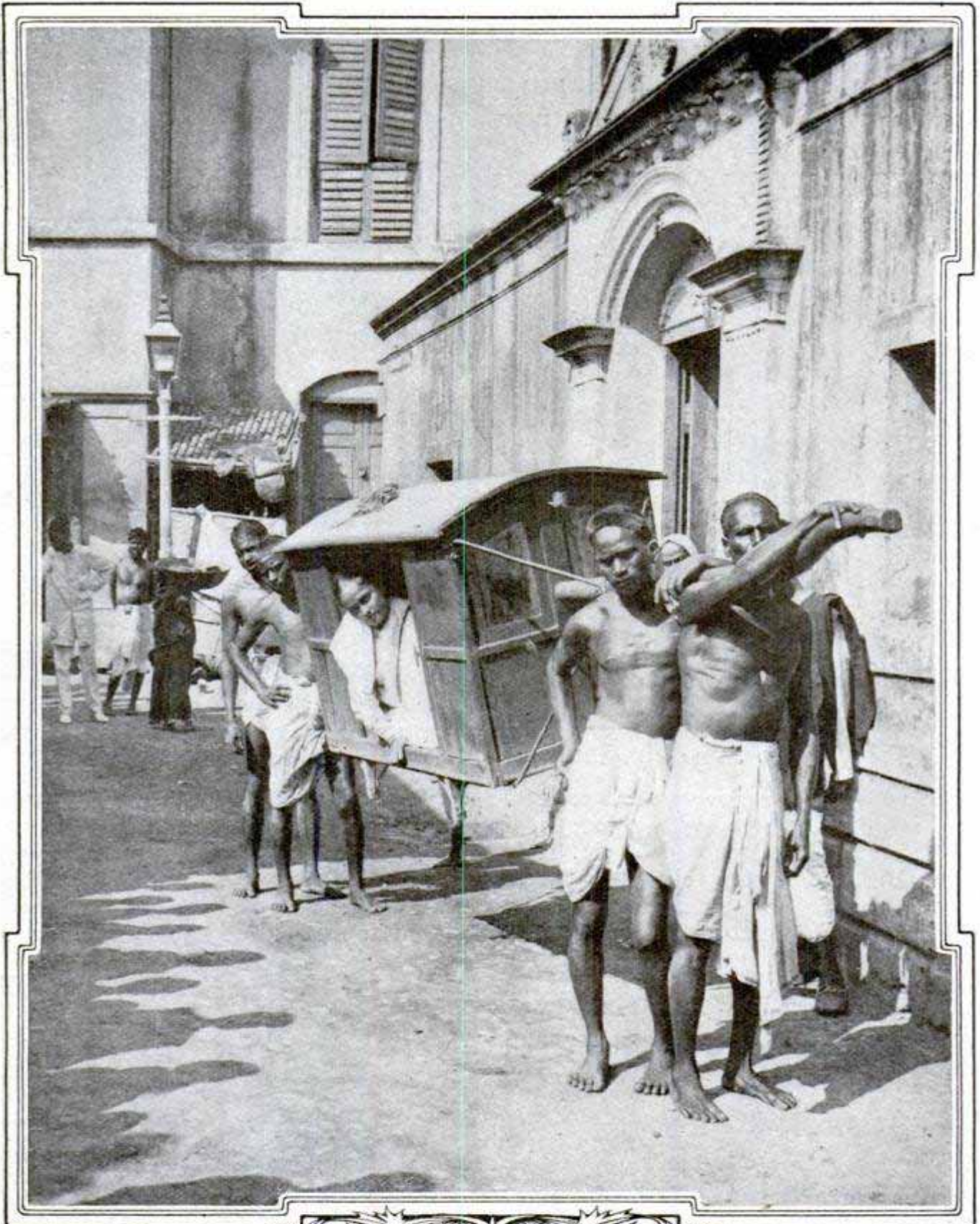

Such a Scene as This is Not Uncommon in the Cities of India. The Photograph Shows a High-Caste Hindu Girl being Carried in a Palanquin through the Streets of Calcutta. In Asia, Where Human Beings are Even Cheaper than Horses, This Means of Transportation is Not as Expensive as It would Be in America



In the "Low Countries" of Northern Europe the Humane Societies have Not Yet Aroused Public Sentiment against the Commercial Use of Dogs, and These Animals are Employed for Almost Every Purpose for Which Horses are Used in America. Often They Haul Even Heavier Loads Than This Dutch Matron, Photographed near Enkhuisen, Holland

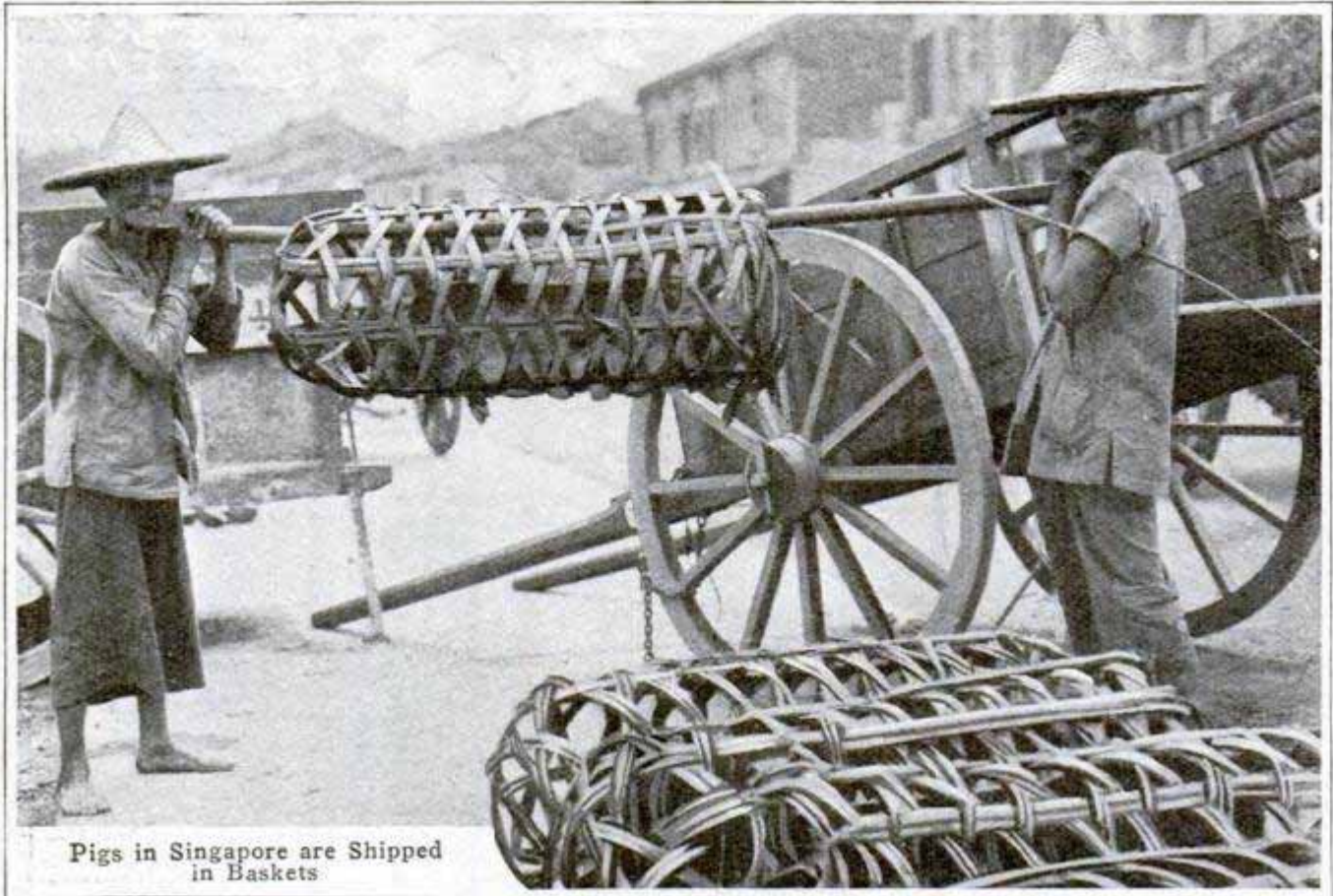

Pigs in Singapore are Shipped  
in Baskets

### SELLING A PIG IN A POKE IN SINGAPORE

Although the parcel post may not welcome the shipment of the great American hog in the United States, natives of Singapore have adopted a basket compartment for the conveyance of pigs, big and little, which might lend itself easily to the requirements of parcel-post usage. Stout framework baskets or cartridge-shaped receptacles of native wood, containing one porker, are easily handled by thrusting a long pole through the mesh.

### STABILIZER FOR AEROPLANE CALLED "PANCAKE"

A disk of canvas, 7 ft. in diameter, slightly dished and mounted above the plane of an air craft is the latest device evolved in the effort to enable airmen to fly successfully without using ailerons. The principle involved is that the curve of the stabilizer is such that when the aeroplane starts to tilt sideways, the air banking against the lower side of the disk will bring

it back to level. Although the stabilizer undoubtedly tends to increase the head resistance of the machine, in actual flight there seems to be no

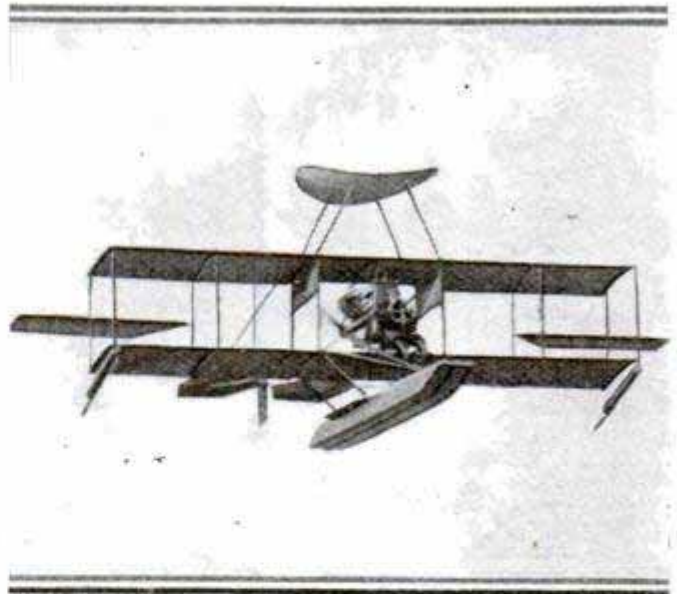

"Pancake" Stabilizer on Biplane

diminution of speed, as it is not necessary to use the ailerons, which of course act as a brake. When making a turn, the machine banks automatically, and there is little or no tendency to pitch. The sides of the disk rise but 10 in. above the horizontal at the extremities.

## LAUNCHING A BIG SEWER OUTLET IN ATLANTIC

Half a mile of 12-in. wrought-iron pipe, jointed together, presents some slight difficulties when it is proposed to place it, as the authorities of Ocean Grove, N. J., purposed, straight out in the Atlantic as an outlet for their sewer system. The great weight, the necessity of avoiding choking by sand, or damage by the swell, presented problems calling for original treatment. Joined together, the pipe was placed on small wooden trucks, the outer end being attached to a cast-iron plate with two cradles and bent upward at an angle of 45 deg. To prevent the water from entering, while the pipe was being run out to sea, its end was capped with a wooden plug, like a cork in a bottle, closely but not tightly fitted, and heavily lubricated with white lead at the joint. Somewhat over half a mile from shore were placed five ship anchors, firmly imbedded, with a sheave attached to them through which was passed a  $\frac{5}{8}$ -in. steel cable. One end of this cable was attached to the iron bedplate of the outlet pipe, while the other was wound around the drum of a hoisting engine. As the engine was started, the pipe, partly submerged, swung easily through the water, free from all obstructions, and in two hours and a quarter the outlet was in place. The outer end is 35 ft. below sea level.

## HANDY SHOPPING BAG FOR AUTOMOBILES

The automobile offers to shoppers great saving in time and exertion, but there is often very little space in which



to place the various packages acquired in a round of the shops. A recent convenience offered to automobile owners is the tonneau luggage bag which is strapped to the robe rail, taking up but little room when not in use, and offering a safe and convenient storage for parcels. There are two small pockets and one large one. The bag is made of stout cloth or imitation leather and may be matched exactly with the upholstery.

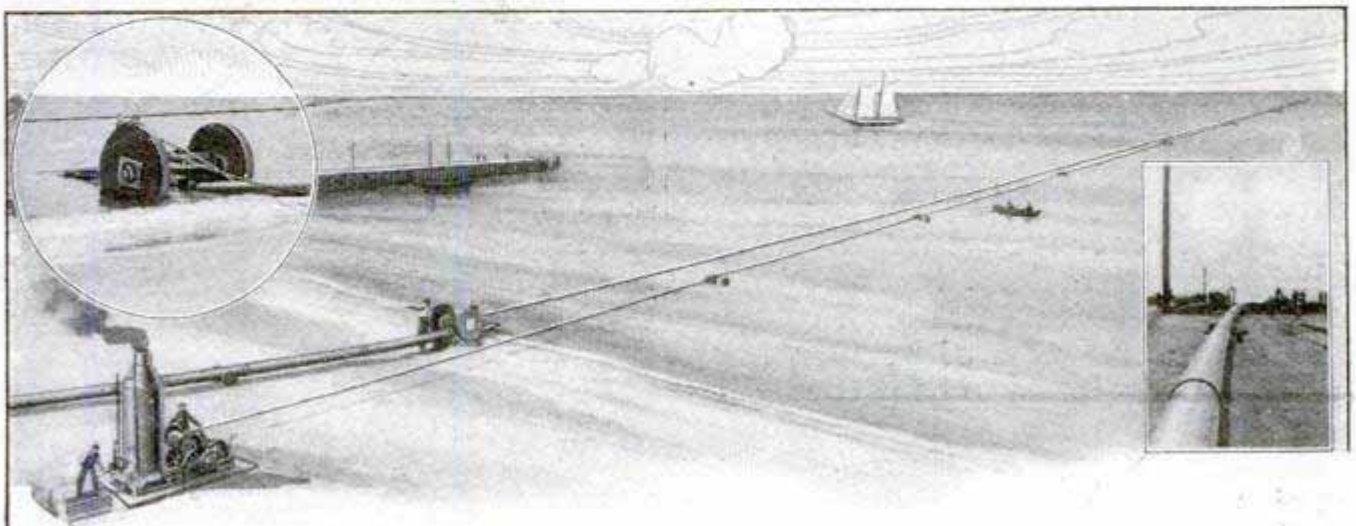

Sending a Sewer Out to Sea. Ingenious Method Used to Float Big Pipe As Outlet for Sewer System

## AUTOMOBILE THAT CARRIES STERILIZING DEVICE

For field maneuvers the French army has adopted a simple method of sterilizing the water supply of the troops by

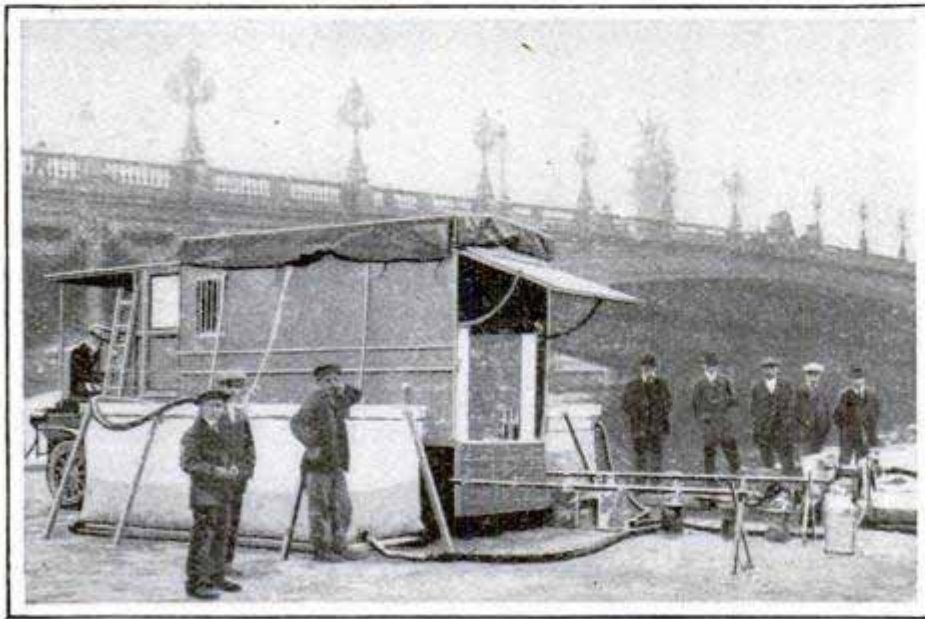

Installation of Water Purifier During French Army Maneuvers

means of the automobile trucks used in transporting stores. The sterilizing process, which is electric, is not new, but utilizing the motor, which is switched to drive the machinery of the electric sterilizing plant, is a novel application. Collapsible canvas tanks at either side of the motor truck contain the water to be sterilized.

## CONCRETE TILE BLOCKS FOR CANAL-ZONE BUILDINGS

Hollow concrete tile blocks are to be used in the construction of many of the permanent government buildings in the Panama Canal Zone and a factory for making these blocks is now in operation under the supervision of the Canal Commission. The process used is a new one and employs steam instead of dry heat for drying the blocks. The process of molding is carried out by automatic machines much like the ones ordinarily used, and the blocks are then sent to curing rooms, where they are treated

with a combined steam and water dripping process calculated to set up and harden the blocks so that within a period of 48 hours they are ready for removal to the storage yard. The plant is to be operated in two shifts of 7½ hours each, and it is estimated that the daily output under this arrangement will be about 5,000 blocks.

## ELECTRIC RADIATOR NOW ADAPTED TO THE HOME

In Switzerland, Sweden, and Norway, where electrical energy can be obtained for approximately 1 cent per kilowatt-hour, heating systems using electric current are now installed in homes, affording a convenient and economical method of securing an even temperature in living rooms. Recently a new type of radiator has been constructed, in which the heating elements are incased in slabs of "steatite," a variety of talc, found to be particularly adapted to this use, as it is not only highly insulating, but has great heat-storing capacity. The radiators are, in fact, a sort of heat accumulators or storage batteries. They are quickly

heated, but give off heat slowly, making the automatic regulation of the room temperature an easy matter.

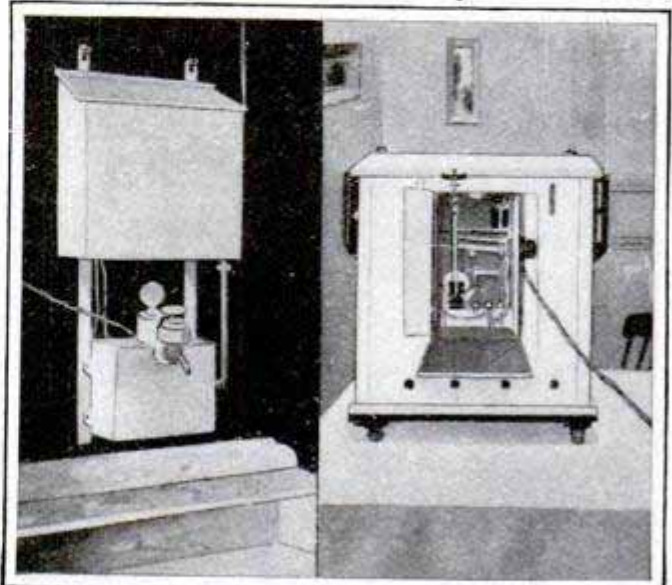

New Electric Heater in Bathroom and Rear View of Living-Room Heater, Open



## MOVEMENTS OF BOATS CONTROLLED BY WIRELESS

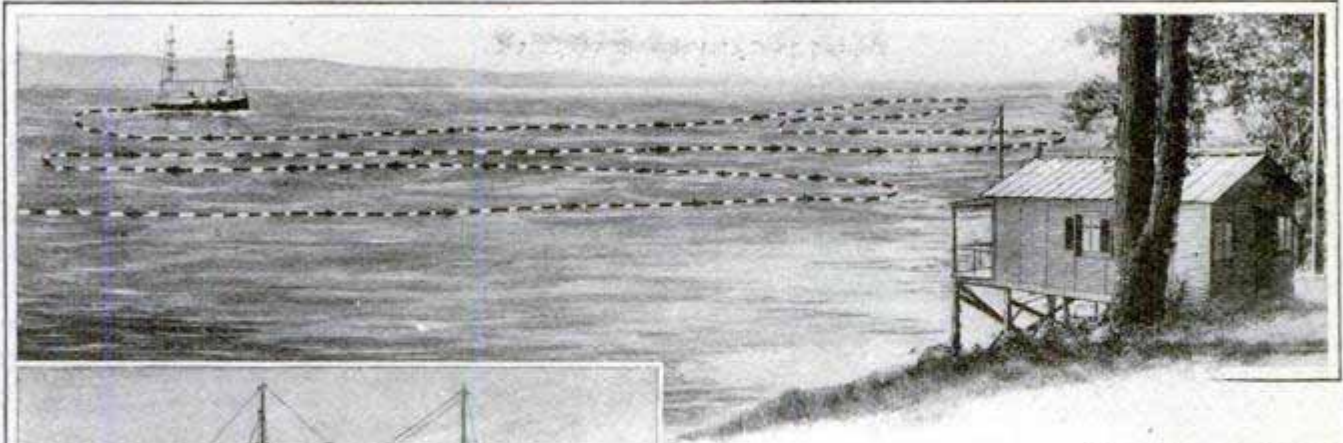

Boat Moved at Will  
by Wireless Impulses from Shore Station

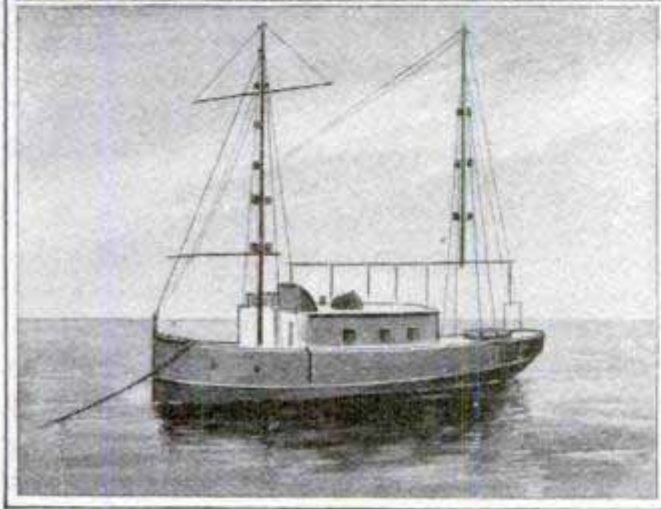

Vessel Equipped for Wireless Control  
of Machinery and Steering Gear

An improvement in the method by which the movements of distant boats, aeroplanes or torpedoes may be controlled by wireless impulses sent from

land stations is now under the observation of government officials. Heretofore, while it has been possible to operate a torpedo from the shore at an eight-mile speed, such control could always be interfered with by an enemy. The wireless apparatus operating the motor and rudders would respond to impulses sent from hostile stations as readily as from its own base. Now, however, a mechanism has been constructed which is delicately sensitive to control from the land station with which it is attuned, but free from outside interference.

### FISH IS FROZEN BY NEW METHOD

A novel way to freeze fish for shipment has been invented in Denmark, which consists of dipping the fish in fresh water and then thrusting it into a vessel containing refrigerated brine. The fresh-water film around the fish congeals instantly, preventing the access of the salt from the brine. So quickly does this method work that a live codfish 18 in. long was frozen hard enough to be sawn in 15 minutes.

### PASTURE FENCE ON WHEELS

A portable pasture fence, made out of the framework of set pieces of fireworks, is the interesting solution offered by an Illinois farmer to the problem of caring for a spirited horse which

runs itself out in a large meadow. The little pasture is 16 by 20 ft. and the fence is mounted on wheels. One

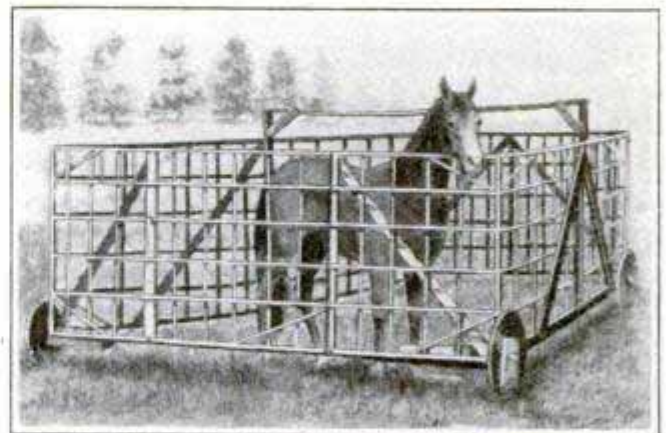

A Movable Pasture for a Nervous Horse

man can move it easily. The horse seems quite contented, and when one piece is grazed sufficiently, the fence is moved to a fresh piece.

## ALASKA MINER USES BICYCLE BOAT

When a report of a new gold field reaches one of the Alaskan mining camps there is a rapid exodus, for the



Swift Little Bicycle Boat Used in Rush for New Gold Fields

rule of the gold diggings is "first come, first served." All kinds of craft are used to navigate the streams of the north, among the most curious of which is the bicycle boat, built by a miner with a mechanical turn of mind. Two narrow skiffs, rigged close together, uphold a bicycle frame in such a manner that the pedals operate a paddle wheel, and the rudder is actuated by the handlebars. The rider is able to make good progress even against a stiff current.

## BURLAP COVERING FOR IRON PIPE

A new protective process for iron piping to be used underground consists in winding impregnated burlap in spiral strips over the coating of mineral rubber ordinarily used for this purpose, and it is claimed that this process not only protects the pipe from corrosion, but supplies a covering that is strong mechanically. The pipe is first dipped in the liquid mineral rubber, and the burlap is thoroughly soaked in the same material. The pipe is then placed in a wrapping machine, and as it is rotated the burlap is wound around it tightly, the whole process being mechanical. The result is a spiral-wound burlap covering, which, as soon as the mineral rubber has cooled, sticks firmly to the pipe.

## REMARKABLE SHOWING BY ELECTRIC PLANT

A substantial profit is being made at Pasadena, Cal., on current delivered to the consumer at the rate of 5 cents per kilowatt-hour, according to the annual report for the fiscal year ended June 30, 1913, covering the operation of the electric light and power plant built in that city in 1907. The total cost of manufacturing and distributing current, including depreciation of plant, was a trifle less

than  $2\frac{87}{100}$  cents per kilowatt-hour for the period covered by the report, while the total cost on the basis of current sold was less than  $3\frac{2}{3}$  cents. The rate in most of the neighboring cities is 8 cents per kilowatt-hour, or 60 per cent higher than that at Pasadena.

## CONVERTIBLE TOURING CAR USED AS AMBULANCE

A German firm is making a touring car which may be converted into an ambulance in an emergency. None of

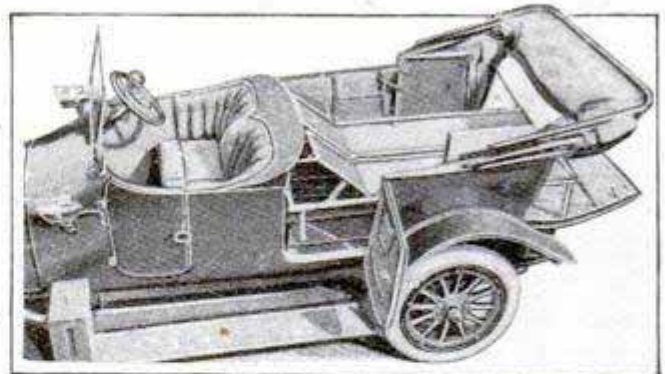

When the Car is Used for Touring the Stretchers are Kept under the Seats

the usual outside features of the ambulance design is present and the car, converted, would not attract attention. Stretchers which come into play when the rear seats are raised, are fixed at the head and project slightly in the rear. Covered by a canvas curtain, the patients are protected from the weather as well as from sight.

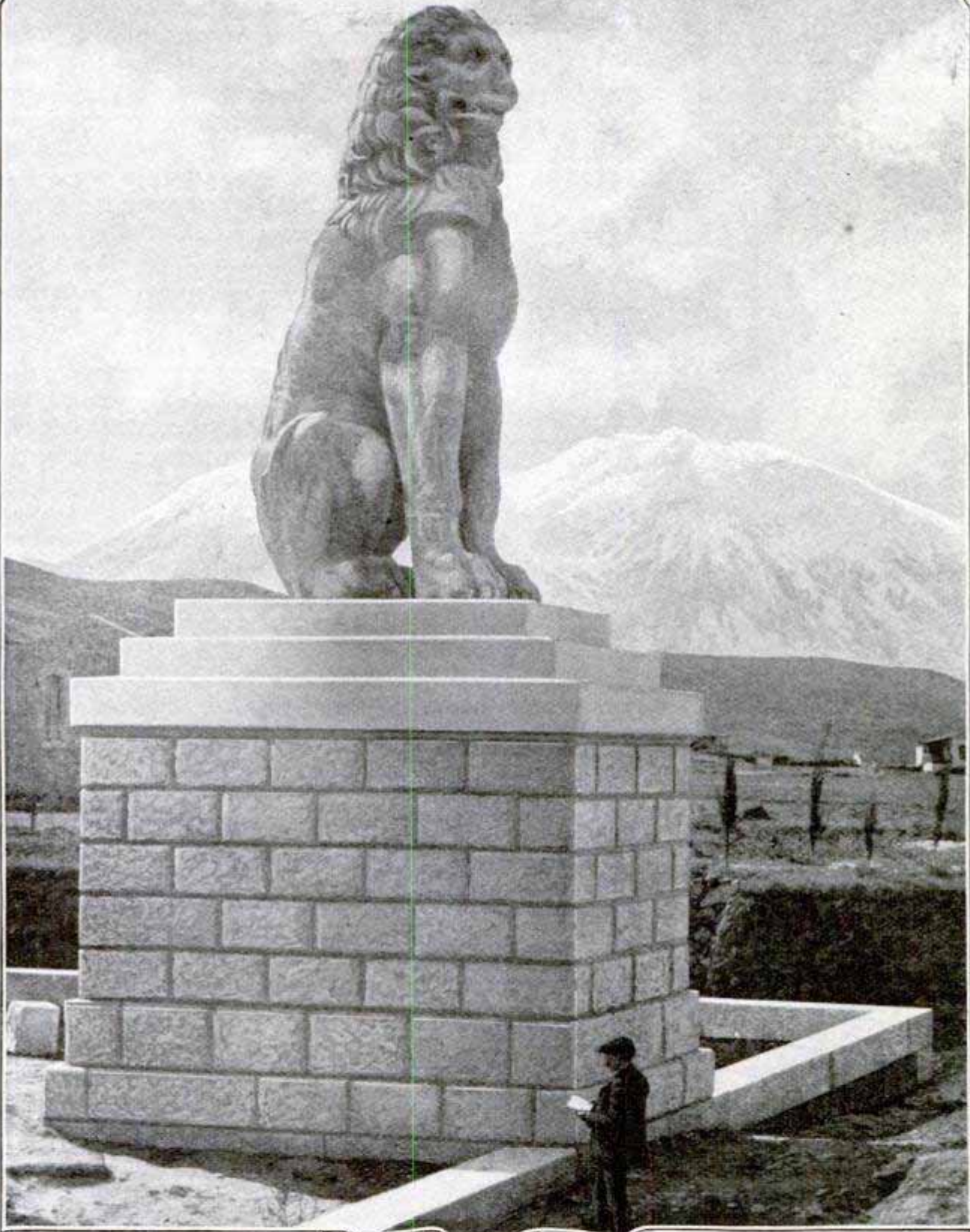

A Stone Lion, Erected Centuries Ago at Chaeronea, Greece, to Commemorate the Victory of Philip of Macedon over the Theban and Athenian Forces, for Many Years Lay Broken, Half-Buried on the Spot, and Only Recently did Public Spirit in Greece Demand That the Memorial be Restored. Today It Stands Again a Funeral Monument, Not Alone to Theban and Athenian Dead, But to an Early Republic Which could Not Survive the Jealousies of Its Confederated States. Chaeronea Lies at the Head of the Defile Presenting the Last Serious Obstacle to an Invasion in Central Greece. It was at This Spot, About Two Centuries Later, That the Roman Legions under Sulla Crushed the Myriad of Mithridates

## TACKLESS DRAWING BOARD FOR DRAFTSMEN

A drawing board for making rapid sketches is shown in the illustration, and possesses several conveniences

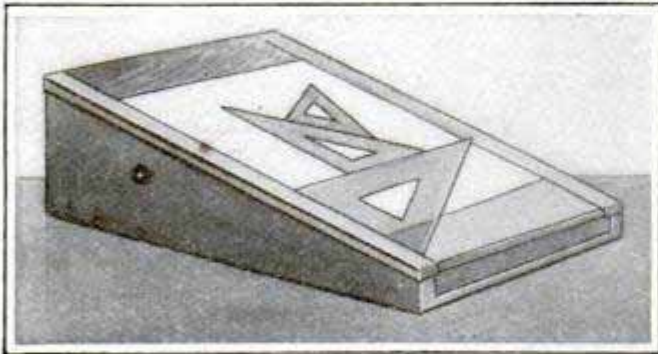

Sketching Board Does Away with Thumbtacks

not found in the ordinary kind. The paper is used in a roll, placed within the boxlike base of the drawing board, and is pulled through the spring-actuated wing at the top of the board and fastened at the bottom by a similar wing. Rubber disks inserted in these wings permit tight stretching of the paper and obviate the use of thumbtacks, often an obstruction to the use of a T-square. A mahogany straight-edge along the left side of the board permits the use of large triangles in place of the T-square.

## DEVICE TO ELEVATE MOTOR CARS

For the automobile owner who makes his own repairs a winch elevator has been designed which obviates the

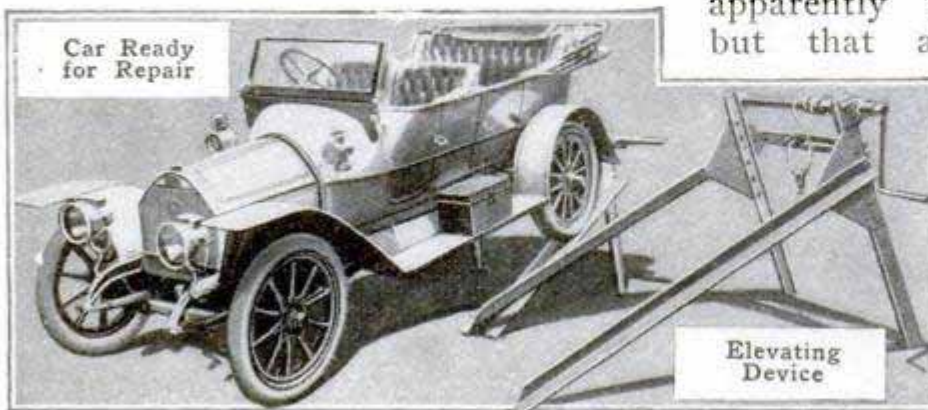

necessity of a pit for inspection. Two lengths of flanged steel plate are supported at some height from the ground at the opposite ends by steel struts

suitably braced. Across the top a small steel drum is attached, fitted with ratchets and a handle, the drum having a wire cable wound about it. At one end the cable is attached to a cross-beam connecting the struts, and a pulley with hook attachment permits attaching the axle of a car. When attached, the car is drawn up the incline by means of the winch, and repair or inspection is easily made.

## CACTUS PLANT NEW SOURCE OF RESIN

A fruit-bearing cactus, known as the pitahaya, growing in Lower California, has been found to contain valuable resin in its bark. The plant grows wild, is from 6 to 12 ft. in height and bears a fruit that is very sweet and palatable. The resin is found only in mature plants which have died naturally and remained some time in the sun. The resin is dark in color, with a smooth surface and hard texture. When heated it is very adhesive and could be used to advantage in the manufacture of varnishes, electric insulators, and the like.

## EFFECT OF WIRELESS WAVES ON BIRDS

Observations made in sections of the world where there are many wireless stations indicate that birds are disturbed in a singular way by the wireless waves. It is stated that gulls are apparently the principal sufferers, but that also large numbers of doves are in some way prevented from finding their way home when there are wireless stations in the line of flight. This strange phenomenon is attributed to some effect of the ether waves not yet understood.

Fire-killed Alpine fir and Engelmann spruce of Colorado are now being used in making a good grade of excelsior.

## FRENCH LOCOMOTIVE USES NAPHTHALENE AS FUEL

An internal-combustion locomotive of a novel type, which is designed to use naphthalene as a fuel, has been brought out in France. Since naphthalene is a solid which must be both melted and vaporized, provision is made for starting the locomotive with gasoline, benzol, or some other volatile liquid, separate carburetors being installed for the different fuels. The tank in which the naphthalene is carried is inclosed in a water jacket, and the arrangement is such that the water is heated to the boiling point by the exhaust from the engine. In this way a constant temperature is provided which is more than sufficient for melting the naphthalene, which, as fast as it is melted,

is lifted to the fuel tank by a pump operated by the engine. The shift from gasoline or benzol to naphthalene is readily made by means of a three-way valve. The motor is a 4-cyl., 70-hp. engine of the ordinary automobile



Internal-Combustion Locomotive That Uses Naphthalene as a Fuel

type, which can be run at varying speeds of from 250 to 1,000 revolutions per minute. A speed of about 12½ miles an hour with a drawbar pull of 7,700 lb. has been obtained with this locomotive, the fuel consumption being ½ lb. per horsepower-hour.

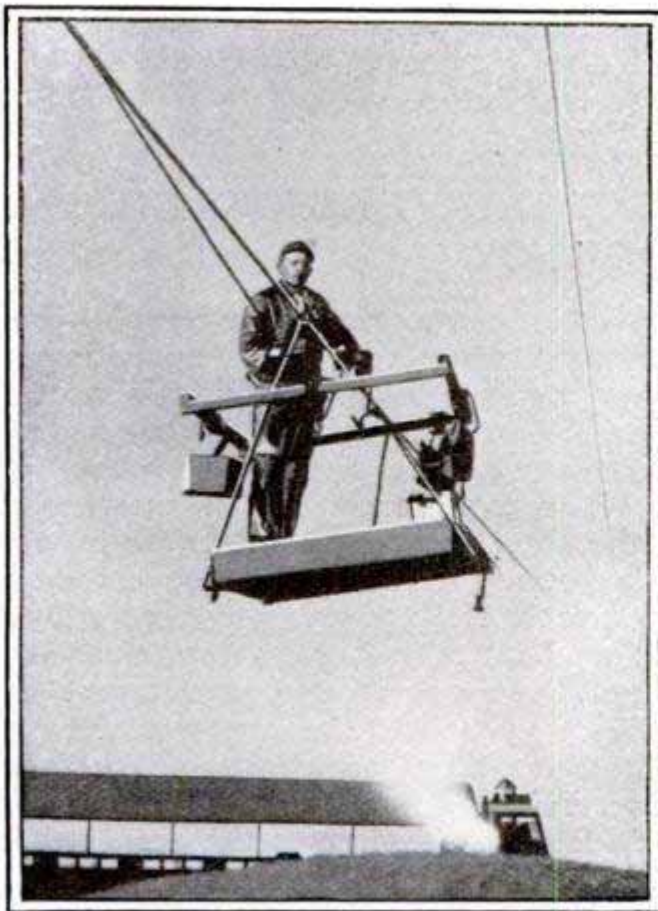

Suspended on a One-Inch Cable over Carquinez Straits

## PAINTING ELECTRIC CABLE A MILE LONG

Four plow-steel cables an inch in diameter stretch across Carquinez Straits, a narrow part of San Francisco Bay, a mile in width, and carry high-voltage electric current, brought from the power plant at De Sabla, to San Francisco over 246 miles of wire. These steel cables must be painted at intervals, no small job at the best, but when the nature of the work is considered, it would seem that the men performing the task take their lives in their hands. The minimum height of the cables above the water is 206 feet.

ⒸAn old city garbage dump of 10 acres' extent located near Savannah, Ga., took fire recently and burned for weeks a few feet under the surface. This curious underground fire was allowed to burn itself out, as the nearest fire hydrant was a mile away.

## BED WITH NONSINKABLE MATTRESS

A demonstration was recently given on the River Seine of a nonsinkable mattress to be used as a life preserver



Photo by Underwood & Underwood  
Interesting Experiment Made in Paris  
with Life-Saving Mattress

on passenger-carrying vessels. Mattress and bed are of one piece, which has so high a flotation point that even with a heavy person on it, the top of the mattress is above the water. Marine officials in the French cabinet were interested spectators. It is claimed that had the "Titanic" been equipped with such life preservers all passengers and crew might have easily been saved.

## AMERICA TO HOLD RADIUM MINES FOR PUBLIC USE

Secretary of the Interior Lane has approved the proposal to withdraw radium deposits in the United States from public entry. According to the secretary there are less than two grams of radium in the United States today, although in 1912 more than three-quarters of all the radium produced in the world was obtained from American ores. Radium-bearing ores are now sent to Europe, where laboratories in France, Austria, Germany and England treat the mineral by secret processes, and little radium is sent to the western hemisphere, nor can any be procured on short notice. It is proposed to erect a laboratory in Denver where radium ores will be treated by a process invented by chemists in the Bureau of Mines, and the radium obtained will be put in the hands of the United States Public Health Service for public use.

## WIRELESS ON MOVING TRAIN BRINGS AID IN EMERGENCY

When the conductor on the Lackawanna Limited was suddenly taken ill a few weeks ago, a wireless message was flashed from the moving train to the office of the superintendent in Scranton, Pa., 30 miles away. Half an hour later, when the train rolled into the station, a relief conductor stepped on board assuming charge, while a physician waited to hurry the sick man to the hospital.

This is the only train in the world today that is equipped with a full set of wireless apparatus, but the officials of the railroad predict that the time is not far distant when wireless equipment will be required on every train, even as it is now required on vessels.

Not only emergency aid but the ordinary routine of train dispatching is contemplated, with such train control as will serve to make collisions and accidents remote, if not impossible.

The equipment used is interesting, the antenna being a rectangle of wire projecting a few inches above the top of each of four cars, supported by a stanchion 2 ft. high, at each car corner. An operating compartment has been built in the rear end of the second car from the front, so that the receiving and sending instruments are beneath the center of the aerial. The power is obtained by cutting in on the electric-lighting system of the train, and the "ground" is provided by at-

At the railroad stations in Binghamton and at Scranton, the aerials are attached to towers on the top of the buildings and have considerable range. Messages have been received at these stations from Washington and New York, but the problem of sensitive sending antennae without high aerials has not yet been solved.

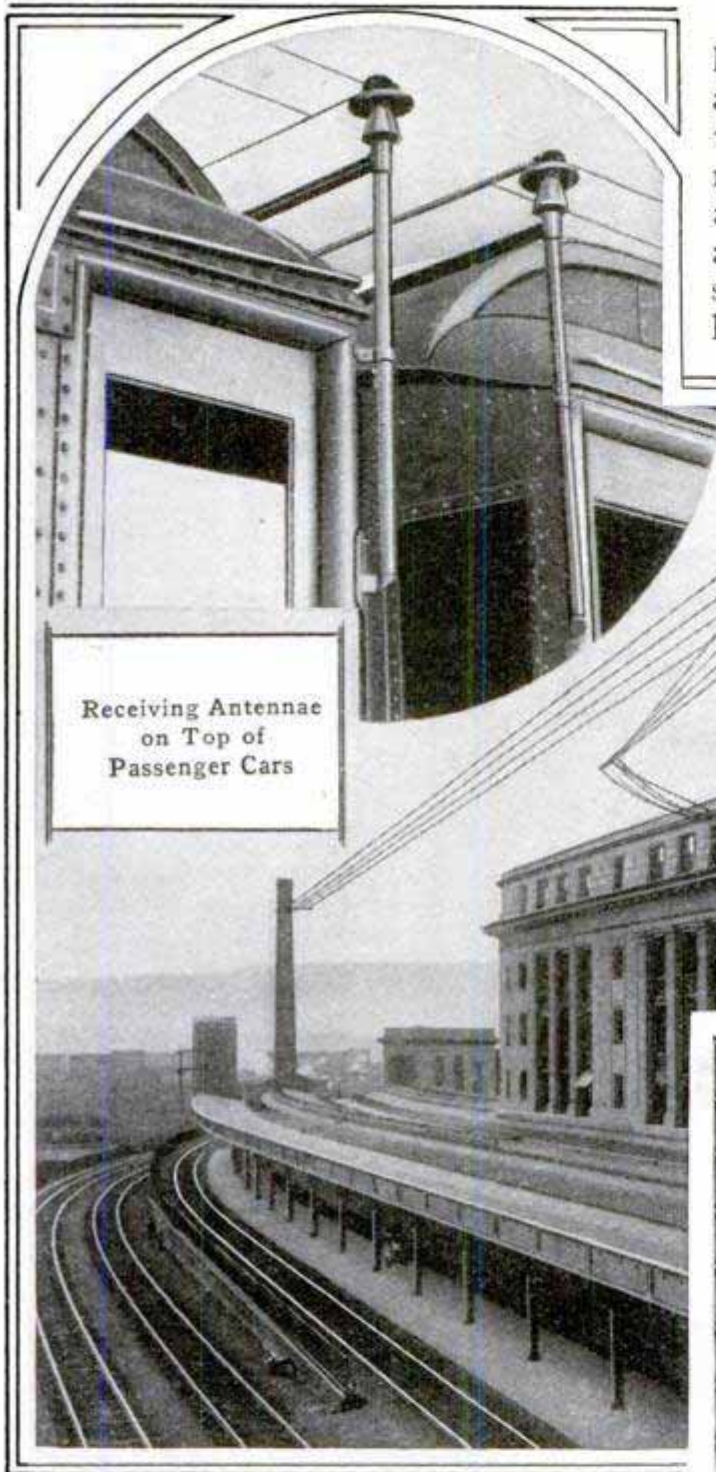

Receiving Antennae  
on Top of  
Passenger Cars

Sending Antennae on Top of Station at Scranton

taching a wire to the metal framework connected with the wheels, the current seeking the earth through the rails. From the antenna the wires enter the car through a conical extension over the rear window above the operator's compartment and into the receiving coil. From the fact that the aerials extend so short a distance above the tops of the cars, it is as yet impossible to send messages to a greater distance than 50 or 60 miles, although messages may be caught from stations hundreds of miles away.

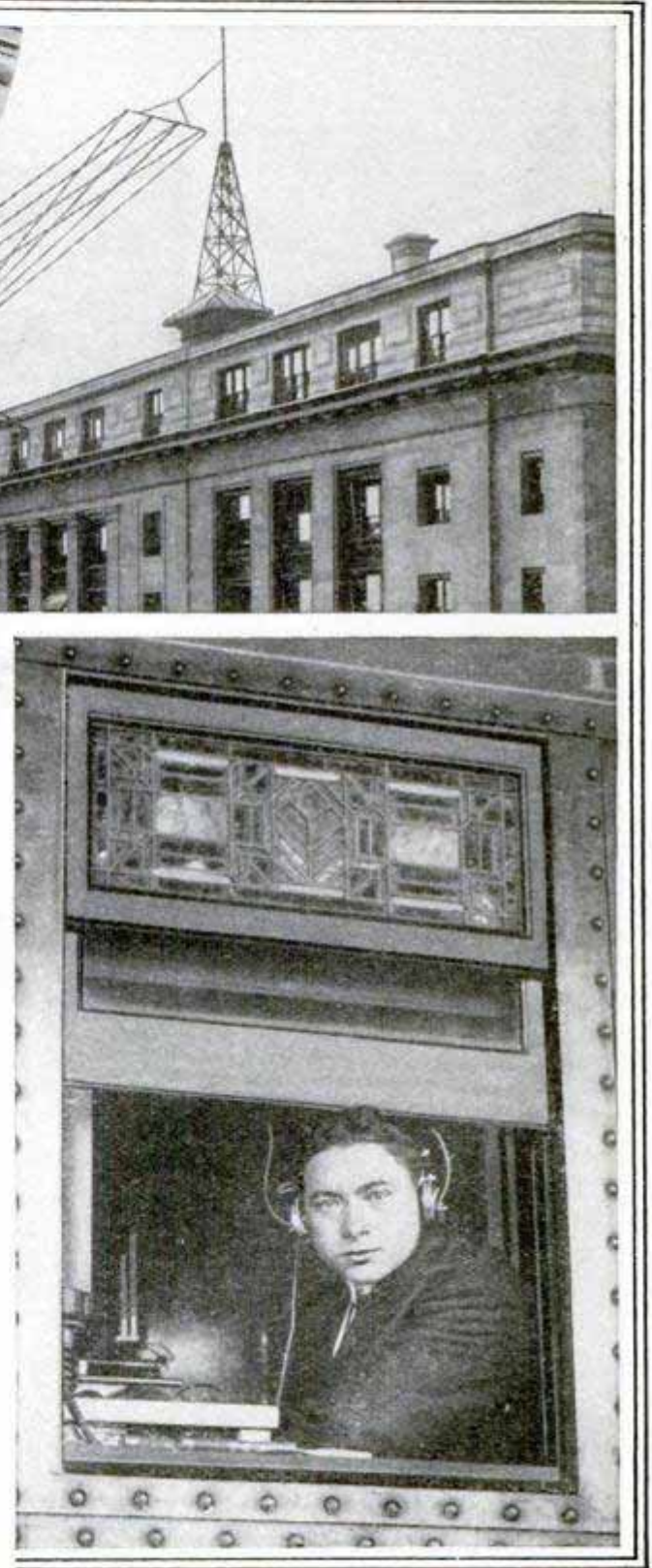

Wireless Operator in Compartment on Moving Train

## BURNING HOUSE ADVERTISES REAL-ESTATE SALE

A unique advertisement attracted a crowd of buyers in Los Angeles when a real-estate dealer burned a substan-



Selling Lots While House Burns

tial house recently, just to bring spectators to the tract he was placing on the market. Thousands of visitors flocked to the scene, and, it is said, over \$12,000 worth of lots was disposed of while the house was going up in smoke.

## SWIMMING RESTRICTED IN PANAMA CANAL

To avoid serious accidents to persons swimming and bathing in the Panama Canal, Colonel Goethals has authorized certain points at Cristobal, Gatun, Gamboa, Empire, Culebra, Paraiso, Pedro Miguel, Miraflores, Corozal

and Balboa to be designated for the purpose, forbidding it in other places. Additional points to be used by the soldiers at Camp Otis and Camp Elliott are to be provided, but civilians are prohibited from using them. Suitable signs, floats and necessary life-saving appliance will be provided at the points mentioned.

## FIRE DEPARTMENT REPAIRS BALLOON

At a balloon race in Germany last fall, the basket of one of the balloons, in rising, collided with the envelope of one of the others, tearing some of the meshes of the net surrounding the gas bag. No way of repairing the damage, save emptying the bag, seemed possible, and this was rejected on account of the loss of time involved, as well as the expense. It was suggested that the fire department be called, and repairs made from a tall ladder. The firemen, however, volunteered the use of the water tower, from the top of which, when extended, the broken lines were soon mended, and the balloon proceeded in due course in the race.

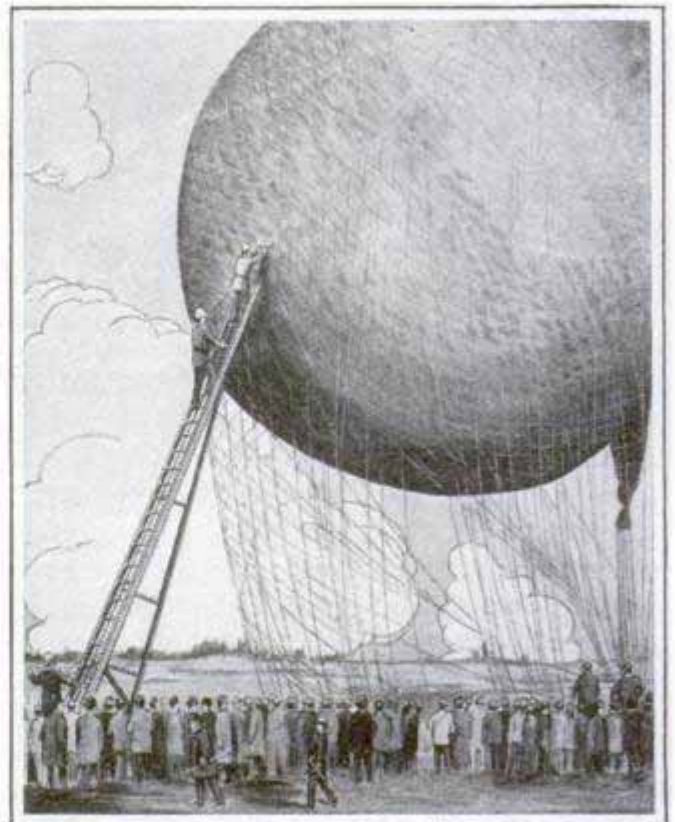

Firemen Mending a Torn Balloon from Water Tower



## PONTOONS CARRY RAILROAD ACROSS MISSISSIPPI

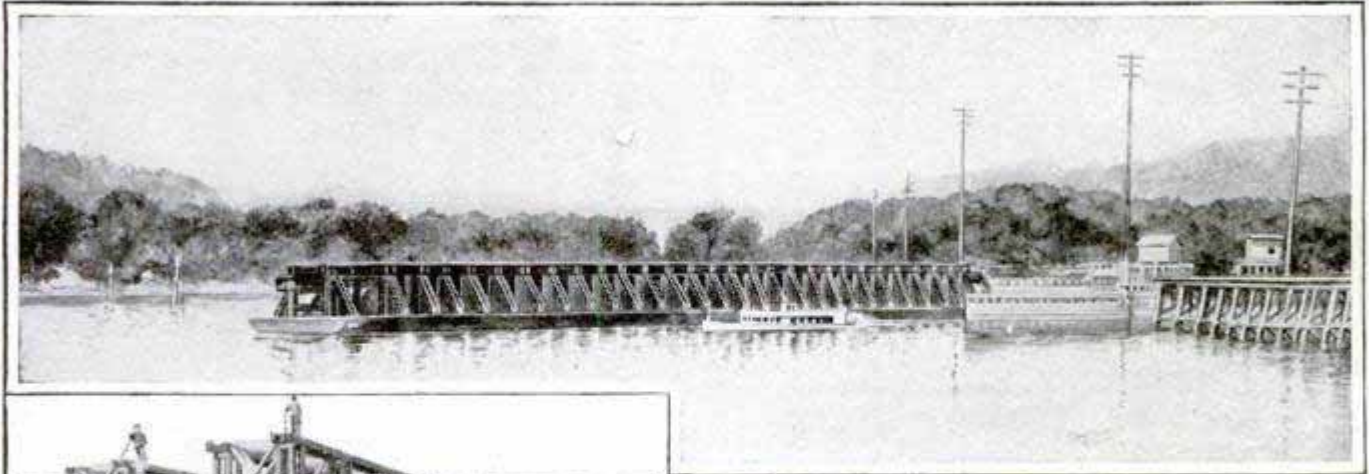

Pontoon being Swung into Place by Steamer

necessary, through the differing levels occasioned by the various stages of the river. The pontoon complete cost \$70,000.

## TEN-CYLINDER ENGINE FOR AEROPLANE

Navigation of the air was made possible through securing an engine which was both light and powerful. Mar-

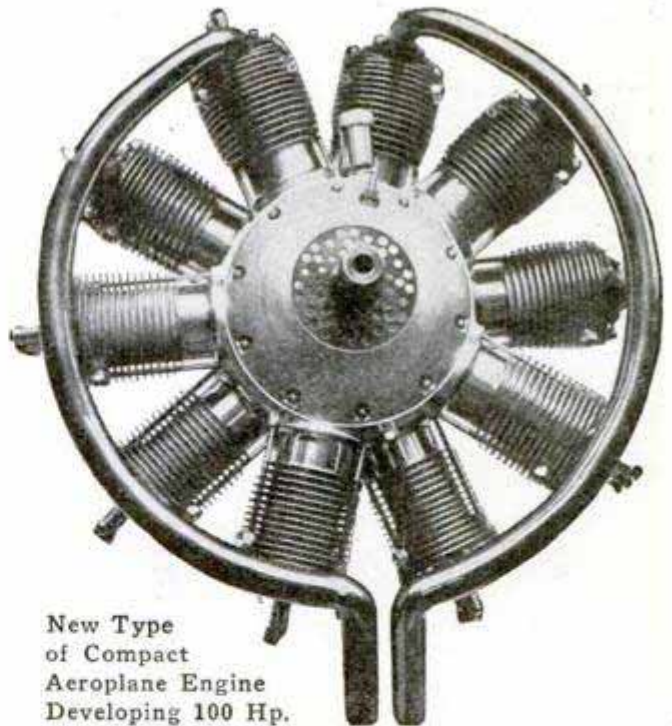

New Type  
of Compact  
Aeroplane Engine  
Developing 100 Hp.

velous as the first engine seemed, each year brings new models, more compact, more powerful and more trustworthy than before. At the Aero Salon in Paris a ten-cylindered engine was shown, developing 100 hp., which attracted much attention.

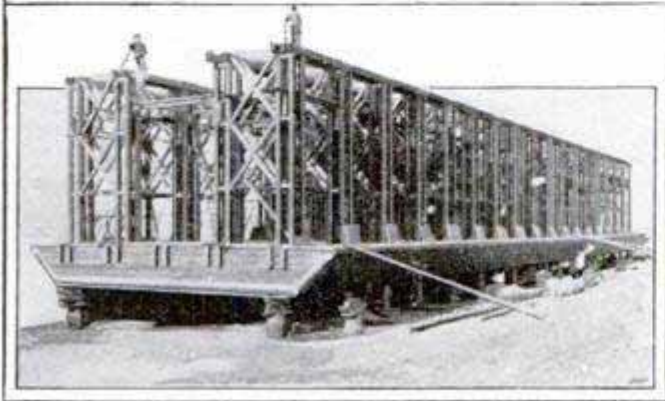

Building the Big Pontoon for the  
Prairie du Chien Bridge

The Mississippi River is crossed at Prairie du Chien, Wis., by a pontoon bridge which in these days of concrete arches and cantilever construction presents some interesting features. The boat is 210 ft. long, 58 ft. wide and contains over 278,000 ft. of lumber, weighing 3,508 tons, besides many tons of iron and other construction material. It took a ton of oakum to calk the structure, and the lumber was thoroughly soaked in a creosote preparation to protect it against the ravages of decay. Upon the deck of the pontoon are erected four rows of upright posts which will guide the automatic hoist for raising and lowering the tracks across the center of the pontoon, and act as braces for the entire structure. The motive power for opening and closing the bridge, as well as for working the hoist, is contained in a small steamer hitched to the pontoon. This power boat is 60 ft. long and is a stern-wheeler, with an 80-hp. boiler, and operates a big sprocket-wheel winch and chain in swinging the bridge. An adjustment permits shunting the power over to the hoists when

## LOCOMOTIVE MADE OF OLD AUTO HAULS TRAIN

The whole power equipment of a railroad in Kansas consists of a rebuilt six-cylinder touring car, which main-

went into the hands of a receiver. Only eight miles of the road had been built, but there was considerable traffic, and the road was operated until the equipment wore out. Then the receiver sold the two old locomotives

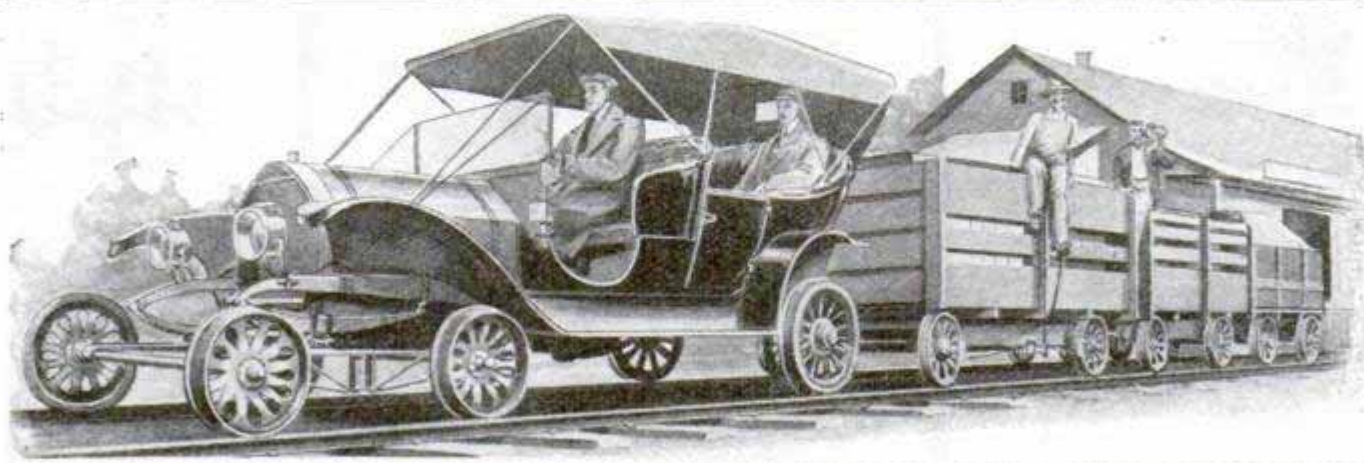

Touring Car Transformed into Locomotive

tains the scheduled run on the Kansas, Southern and Gulf Railroad, between Blaine and Westmoreland, a distance of eight miles. Years ago the road, which was projected to connect the wheat fields of the Dakotas with the gateway of the Gulf, at Galveston,

for scrap, and realized enough to purchase and rebuild the touring car, equipping it with a front truck with wheels from an old box car, and drivers from a passenger coach. In 15 months over 100,000 tons of freight were hauled by the "gasoline locomotive."

## PREHISTORIC ANIMAL TRAP YIELDS FOSSIL REMAINS

Caught by the yielding asphalt, animals now long extinct were drawn to their death as they sought water or preyed upon other unfortunate creatures at the springs now known as Rancho-la-Brea, near Los Angeles, California. The petroleum of southern California has an asphalt base. Unlike the fields of Pennsylvania and Ohio, the heavy oils, when evaporated, do not yield paraffin, but asphalt. The oil which wells up about the springs evaporates slowly, catching the dust, hardening into a film which will bear small animals, but clutching with firm grasp any foot that stands too long upon its yielding surface.

Commercial exploitation of the asphalt about these springs disclosed many bones, whole skeletons of creatures pronounced by scientists as belonging to another age than ours. Excavations carried on by the Uni-

versity of California have brought to light many hundreds of skulls and bones impregnated with asphalt, but otherwise little altered. Flesh and hide, horns and hoofs have been dissolved ages since, but the bones are easily cleaned and when mounted give a comprehensive knowledge of the fauna of that district when the glaciers covered a large part of this continent.

Most of the animals uncovered were carnivorous birds and beasts of prey, wolves, lions, saber-toothed tigers, eagles and vultures predominating. Then came bisons, horses, ground sloths, and others. More than 50 varieties of birds have been found, and fully as many different kinds of animals. No remains of man, no tools, nor weapons, nor other indications of his presence, no sign that prehistoric man ever saw this grim death trap in operation has been discovered.

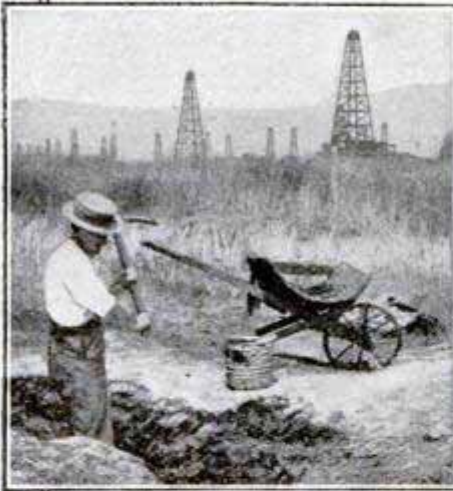

Digging for Fossils



Present View of Prehistoric Animal Trap

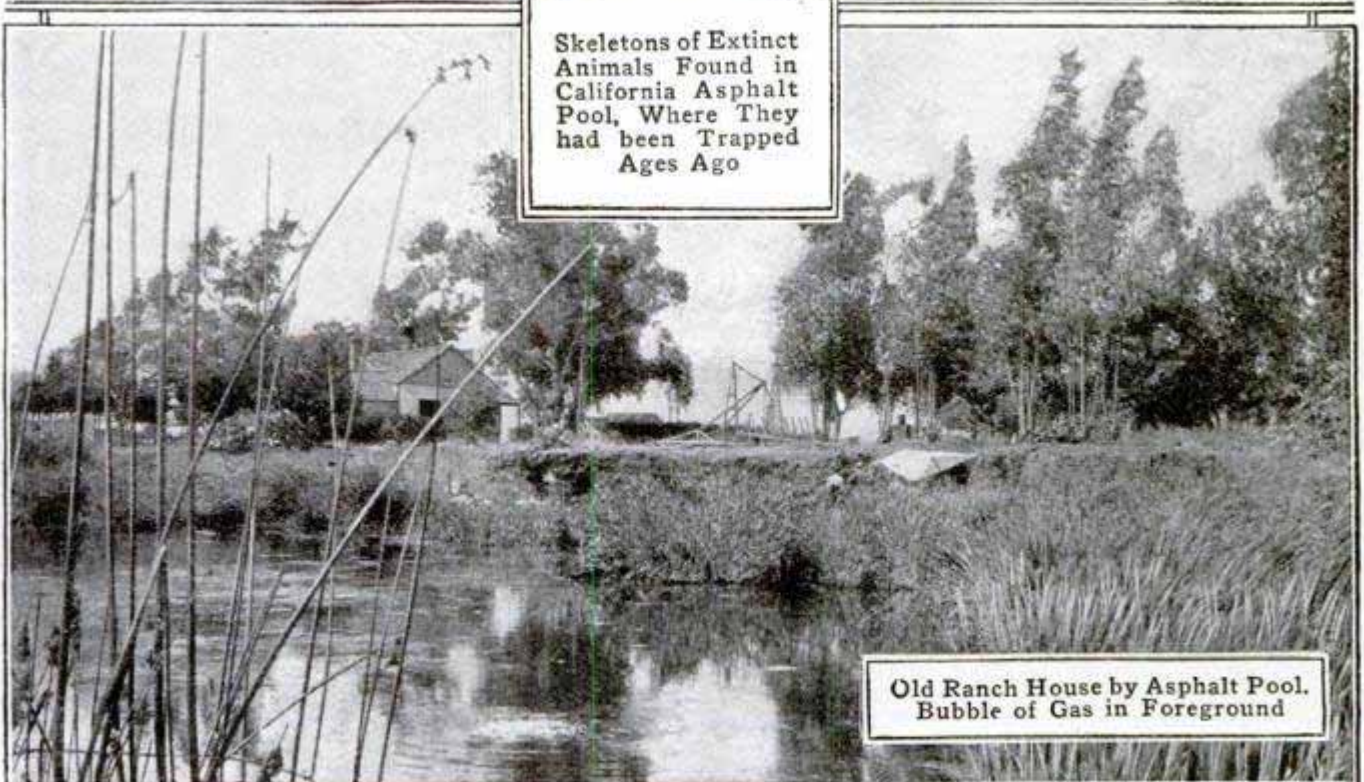
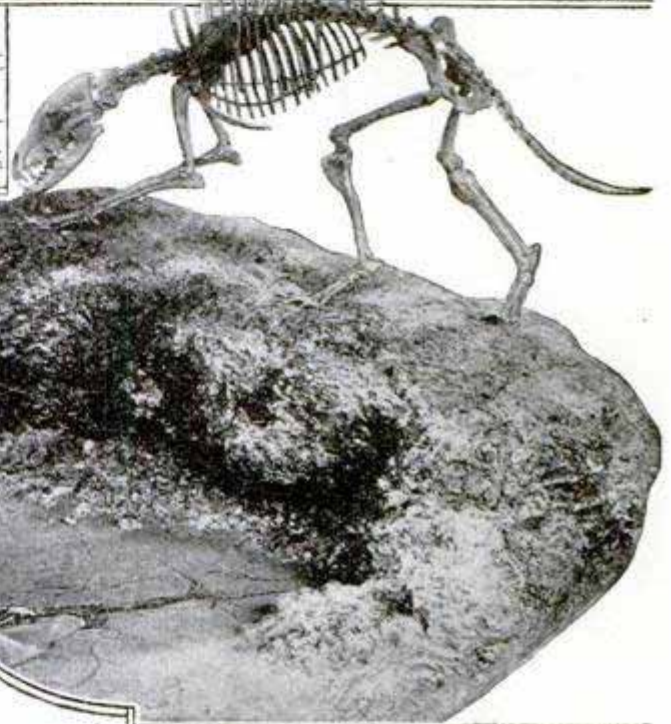

Skeletons of Extinct Animals Found in California Asphalt Pool, Where They had been Trapped Ages Ago

Old Ranch House by Asphalt Pool. Bubble of Gas in Foreground

## HOTEL CABINET VENDS TOILET ARTICLES

A cabinet, finished in nickel or white enamel, is being placed in hotel bathrooms and toilet rooms, offering to

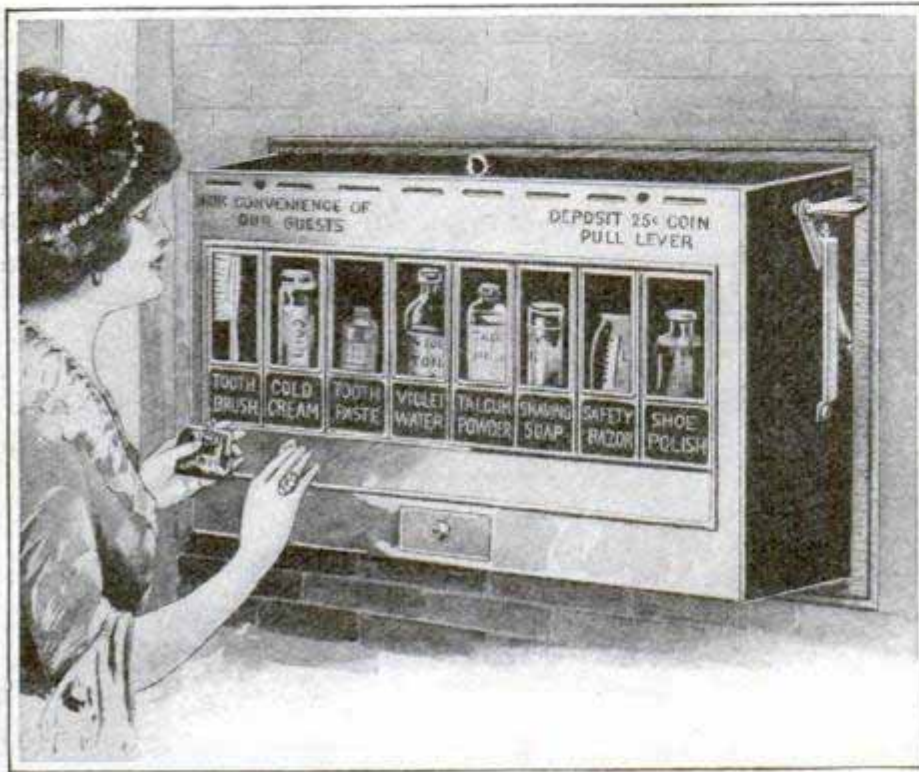

Individual Shops for the Convenience of Travelers Give Quick Service in Hotel or Stateroom

the guests standard toilet articles, including toothbrush, dental cream, toilet water, talcum powder, and the like, at standard advertised prices. By placing a coin in the slot and turning the lever the selected article is delivered, avoiding the necessity of sending the bell boy out for a hurry-up purchase, with its attendant waiting and tipping. The cabinet may also be installed in staterooms on board trains or ships.

## TECHNICAL SCHOOL TEACHES AERONAUTICS

A course in aerodynamics has been established by the Massachusetts Institute of Technology, making it the first educational institution in the country to begin the work of developing the study of the science of aeronautics. It is recognized that the real advances in the knowledge that must underlie flight have come from skilled engineers. Pilots must have skill, ability, courage and the faculty of coördination, but construction of the machines utilized by them in flight must depend upon the technically trained men. Technical schools in England, France and Germany have such courses which are well attended. The

University of Paris, the University of Göttingen and the National Physical Laboratory in England provide instruction under eminent specialists. Technical high schools in Berlin and Aachen also have courses in aeronautics and well equipped laboratories. Building air craft now ranks as an industry in France and Germany, the former having a thousand aeroplanes in service, and fifteen hundred airmen.

## STRANGE ACCIDENT TO A STREET CAR

A street car played tag with an automobile in Chicago recently, with disastrous results for all concerned. Jamming on the emergency brake to avoid striking an automobile crossing his path, the motorman of a car passed from one shock to another till he found himself in the emergency ward of a hospital a few minutes later. The car

first jumped the track, striking the automobile and demolishing it. Plunging on, the car, well filled with passengers, crossed the street, climbed the curb, and bored into the basement of a large apartment building, striking halfway through the wall. A big gas main supplying the building was broken by the impact of the runaway car, and the gas, flooding the basement, came in contact with the furnace fire, exploding in a series of detonations,

setting fire to the car and to the building. One occupant of the automobile was killed, and a dozen passengers in the street car injured, while tenants of the building were rescued by firemen with some difficulty. The fire was extinguished with little trouble, although one fireman was rendered unconscious by escaping gas.

### MEXICAN LANDMARK WHERE TROPICS BEGIN

The tropic of Cancer, that imaginary line  $23\frac{1}{2}^{\circ}$  north of the equator which marks the northward path of the sun at the summer solstice, passes through Mexico. A curious monument has been erected by the Mexican government at one point on the line, a photograph of which is shown. The picture shows the southerly side, within the torrid zone. Upon the opposite side the words "Zona Templada" denote the temperate zone, while the fingers point east and west along the line of the tropic of Cancer. Two towns in Mexico lie almost directly upon the tropic, Miquihuana, on the east, in Nueva Leone, and Todos Santos on the west, in Lower California.

At This Sign the Sun Turns  
Back in Its Course

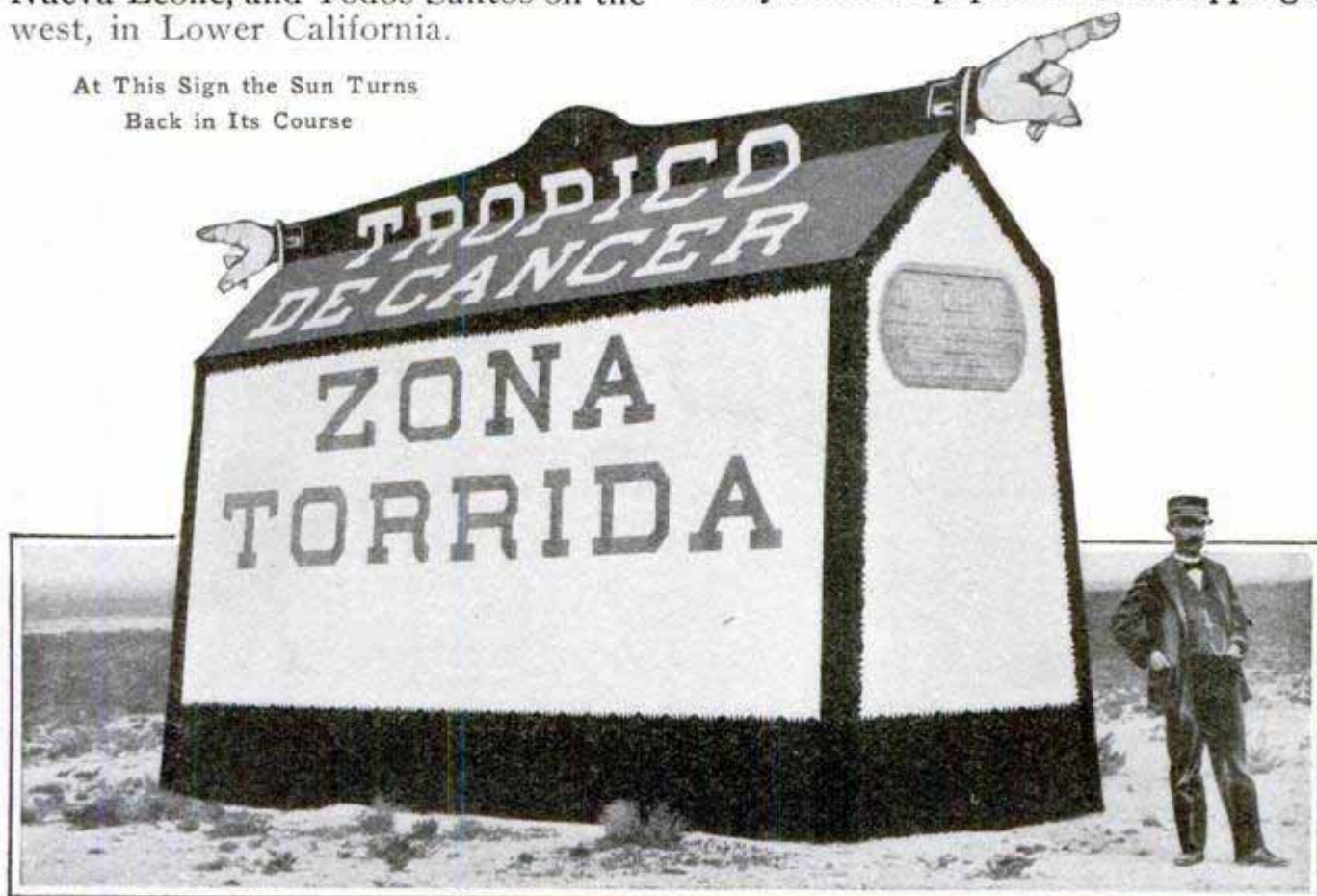

Copyrighted by Underwood & Underwood

### EXPLOSIVE GOLF BALLS MENACE TO SIGHT

The United States Golf Association has found it necessary to issue a formal warning against cutting open golf

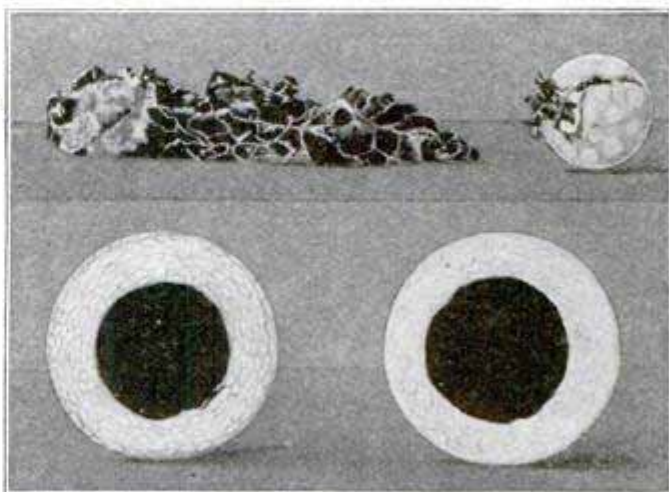

Courtesy Travelers Insurance Co.

X-Ray Photographs of Two Golf Balls with Liquid Cores. Above, One of These Balls Cut Open, with Contents Removed

balls, owing to the fact that certain manufacturers have used acids, caustic alkalis and other sight-destroying compounds in the center of their product. Many accidents have resulted from this cause. Golf balls were originally made of paper or cloth clippings,

tightly pressed and sewn into a canvas cover. The solid ball made of gutta-percha was the first step toward a "live" ball, and this was quickly followed by the ball with hollow core. Then came windings of rubber thread and rubber tape over a solid rubber core, and finally the liquid core appeared. Water under high pressure was injected into a rubber bag, and this was then wound with rubber thread and tape, with a final solid coat of gutta-percha cast over it. To increase the weight of the ball, other liquids of greater specific gravity than water were sought, such as sulphuric and hydrochloric acids, or strong alkalis, and these were sometimes mixed with other substances with the purpose of forming gases which should increase the tension of the bag in which they were confined, adding to the resiliency of the ball. When curious persons cut into the golf ball, these substances or gases, impelled by the powerful pressure, squirted suddenly out and into the faces and eyes, in several instances causing total blindness.

### NOVEL ELECTRIC-FIXTURE EXTENSION

A device, recently placed on the market, which permits an electric light or chandelier to be lowered over a

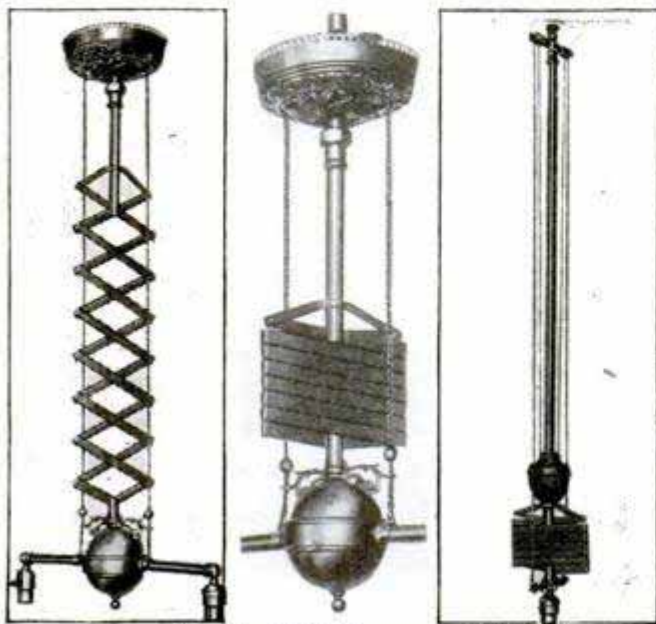

Extension Electric Fixture in Different Positions

library or writing table, is constructed on the principle of lazy tongs. With this contrivance it is not necessary to discard old fixtures, as the extension can be attached to the old chandelier. It sustains itself at any desired height and may be easily raised or lowered.

### QUAINT SIGN MADE FAMOUS BY CHARLES DICKENS

Over the entrance of an ironmonger's

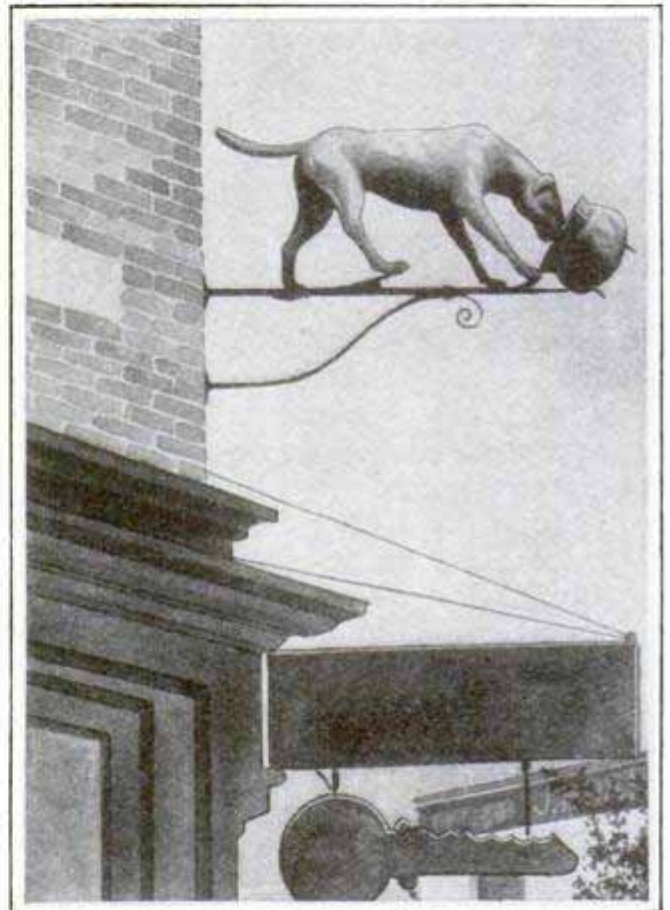

The Quaint Sign of an Ironmonger's Shop in London

er's shop, as the English call a hardware store, in Blackfriars Road, London, is a quaint sign representing a dog eating out of a tilted cauldron. It is referred to by Charles Dickens in his autobiographical record. In the days when he worked in a blacking factory his usual route to and from home was marked by several things, one of which was "the image of a golden dog licking a golden pot."

A total of nearly 800,000 acres of land in the eastern states has been purchased by the government for Federal forests.

## HOW A "FAKE" PICTURE WAS MADE A REALITY

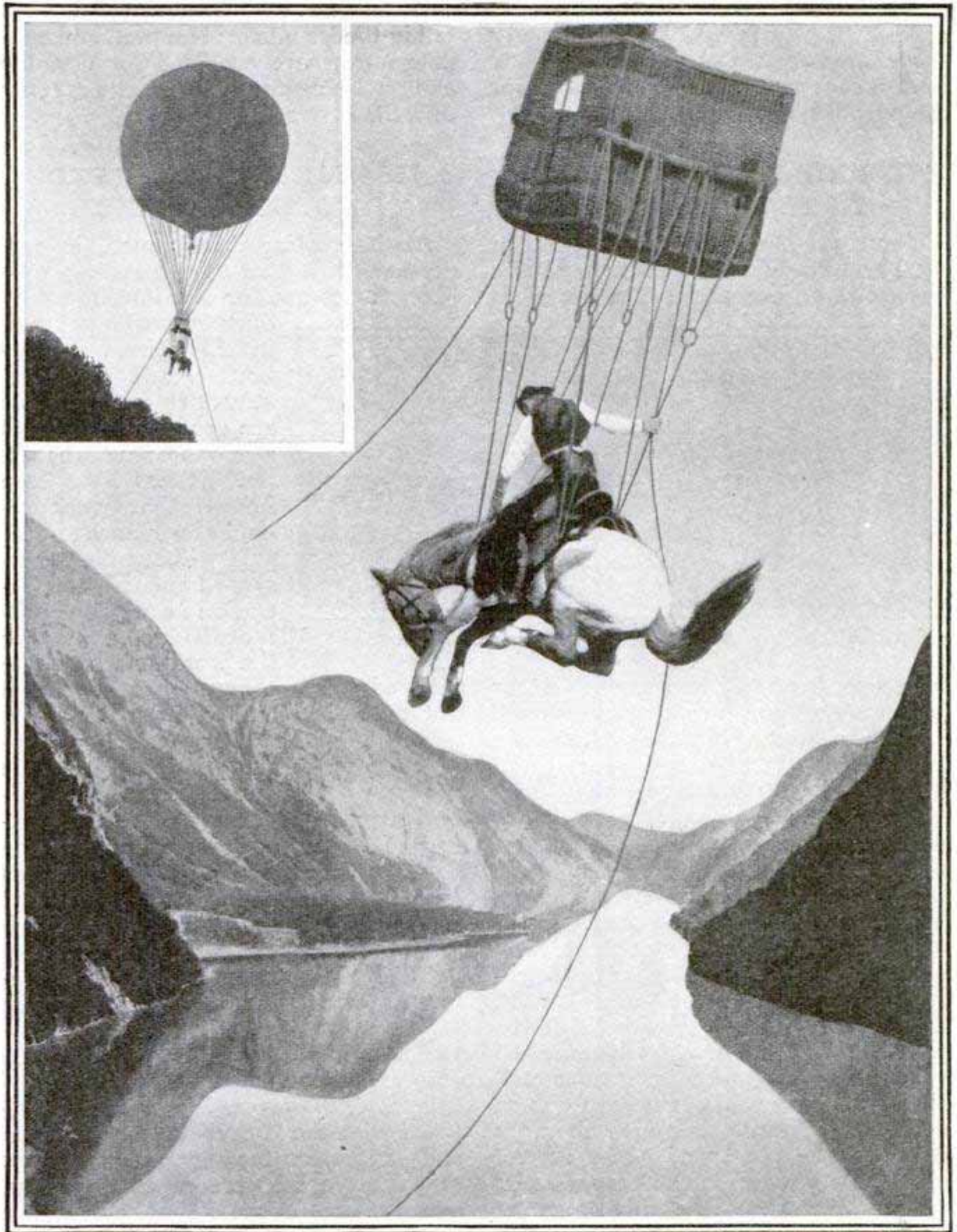

Courtesy The Sketch

A Made-Up Picture of a Cowboy Riding a Horse Slung Beneath a Balloon,  
and an Actual Photograph of the Real Thing

A German paper some time ago published a "made-up" picture of a mounted cowboy hanging from a bal-

loon under the title "Col. Cody Flies Over the Lake of the Four Cantons." It was a good-natured joke on the cred-

ulous, and as such was well received by its readers. Recently, however, a motion-picture concern turned the make-believe into reality, by actually suspending a cowboy on horseback from a captive balloon over Berlin, for the purpose of a film drama.

### SECURING WATER SUPPLY IN THE BERMUDAS

There are no springs or brooks in the Bermuda Islands, neither are there reservoirs or waterworks, in the mod-

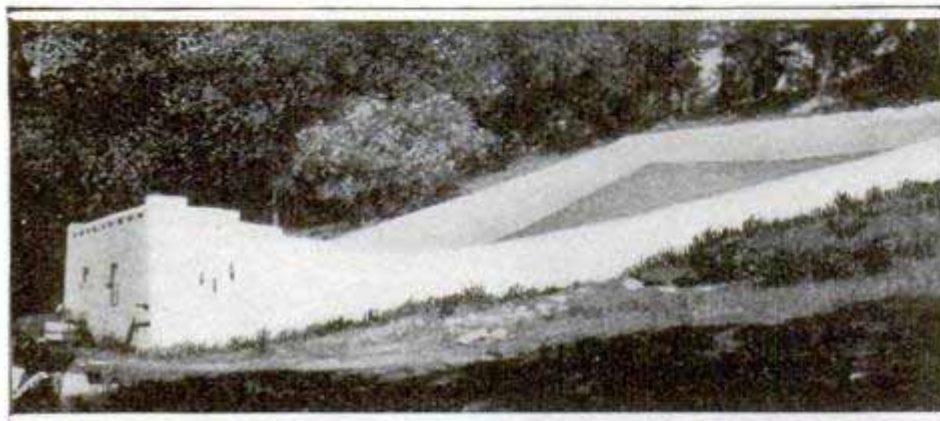

A Bermudian Rain Catch Shines White Against the Green Slope of the Hill

ern sense, to supply houses with water for washing or drinking purposes. Wells are driven, but they yield only brackish waters, the seepage from the hills mixed with salt water that flows through the porous coral rock, rising and falling with the tide. Thus, instead of deriving their water in the usual way, each house must have its private arrangements for collecting a supply of water and of storing it away for use. This is accomplished by catching and storing the rain water. Houses are roofed over with thin slabs of native limestone and whitewashed frequently. The more pretentious residences install a rain catch with cistern attached, by means of which they are able to have plenty of water for all purposes. These rain catches are made by scraping away the thin layer of top soil on a convenient hillside and laying bare the coral rock of which the island is composed. This coral floor is cemented and whitewashed, and a low wall raised on three sides. At the foot of the sloping basin thus

formed, a covered cistern is built and forms no inconspicuous part of the rural Bermuda landscape. As the rainfall in the islands is abundant, and suitable means are provided for cleaning and purifying the cisterns, the absence of wells is not noticed.

### MECHANICAL WORK PROMOTED BY MUSIC

An interesting development in connection with the loud-speaking telephone is its use for distributing music during working hours in factories, warehouses, and other institutions where men are engaged in work of a monotonous character. It has long been known that work requiring mechanical skill without the necessity of mental concentration can be promoted by supplying the workers with some

kind of pleasant amusement that will not take the attention from the work, and the loud-speaking telephone appears to make this possible on a scale not thought of heretofore. In the cigar factories of Tampa, Fla., the reading of books and periodicals to the workers during working hours has long been an established custom, and in many of the factories expert readers are employed for this purpose. The value of diversion of this kind in promoting work is also recognized in the United States navy, where the practice is to have the band play while the ship is being coaled. Amusement of this kind, however, is not to be confused with the "heave-ho" of workmen and sailors, or the monotonous chant of Japanese laborers in coaling ship, as these are designed simply to secure unison of action among the workers.

¶The metric system has been adopted in all the leading countries of the world except the United States, Great Britain, and Russia.



## CHEAPER ACETONE BOON TO MOTORISTS

Acetone, a volatile spirit derived from wood distillation, is used as the vehicle in which acetylene gas is carried in order to obviate danger of explosion. Its high cost has heretofore prevented the extensive use of acetylene as a motor fuel, although calcium carbide, from which the gas is derived, may be produced cheaply wherever coal wastes and limestone are available in the same neighborhood. German inventors have succeeded in devising a process for producing acetone which should reduce the price of this commodity to one-half or even one-fourth its present quotations. It has been found that if lubricating oils used for motoring are treated with acetone certain portions of the oil are removed and the oil so treated does not give off pungent, ill-smelling gases in the exhaust of the motor. The present price of acetone, however, renders it impossible to use it for this purpose commercially.

## NEW MATERIAL UNAFFECTED BY BOILING ACIDS

In the manufacture of highly concentrated nitric acid directly from the air the need of a malleable material of sufficient mechanical resistance to withstand high pressures, and immune to the action of fuming acid, has developed a new alloy called elianite. This is a product of the electric furnace and is of such extreme hardness that it cannot be worked by steel tools, corundum being used to fashion it. According to the inventor, an Italian scientist, it enters into chemical combination with but one out of every 10,000 known substances. No acid, even if boiled in a vessel of the new alloy, corrodes it.

## GRAVE OF A COUPLING PIN IN RAILROAD SWITCH YARD

Marking the disappearance of the coupling pin and link from use in railroading, a sentimental flagman, who



Grave of the Coupling Pin

has spent 37 years in active service, heaped a mound of cinders beside the tracks in the freight yards of the Pennsylvania Railroad in Chicago, and placed thereon two coupling pins with a link as mementos of a strenuous past. The "grave" is outlined with white stones and upon its surface, traced in pebbles, are the words, "Old Timers—Days Gone By—Parted Forever."

## CHINESE RAILWAYS HAVE VARIETY OF GAUGES

The building of the railways of China without any regard to a national system has resulted in the use of a variety of gauges. Practically every road has been built as a local proposition, and where interests other than Chinese have been in control, these interests have insisted on following their own ideas and plans without regard to those of other roads. The Chinese as a rule have adopted the standard gauge of 4 ft. 8½ in., but several important lines are built to other gauges, the use of the meter gauge and even narrower gauges being common. In connection with the present movement to standardize the railways of China this one feature will call for enormous expenditures.

## MOTOR OMNIBUS FEEDERS FOR ELECTRIC LINES

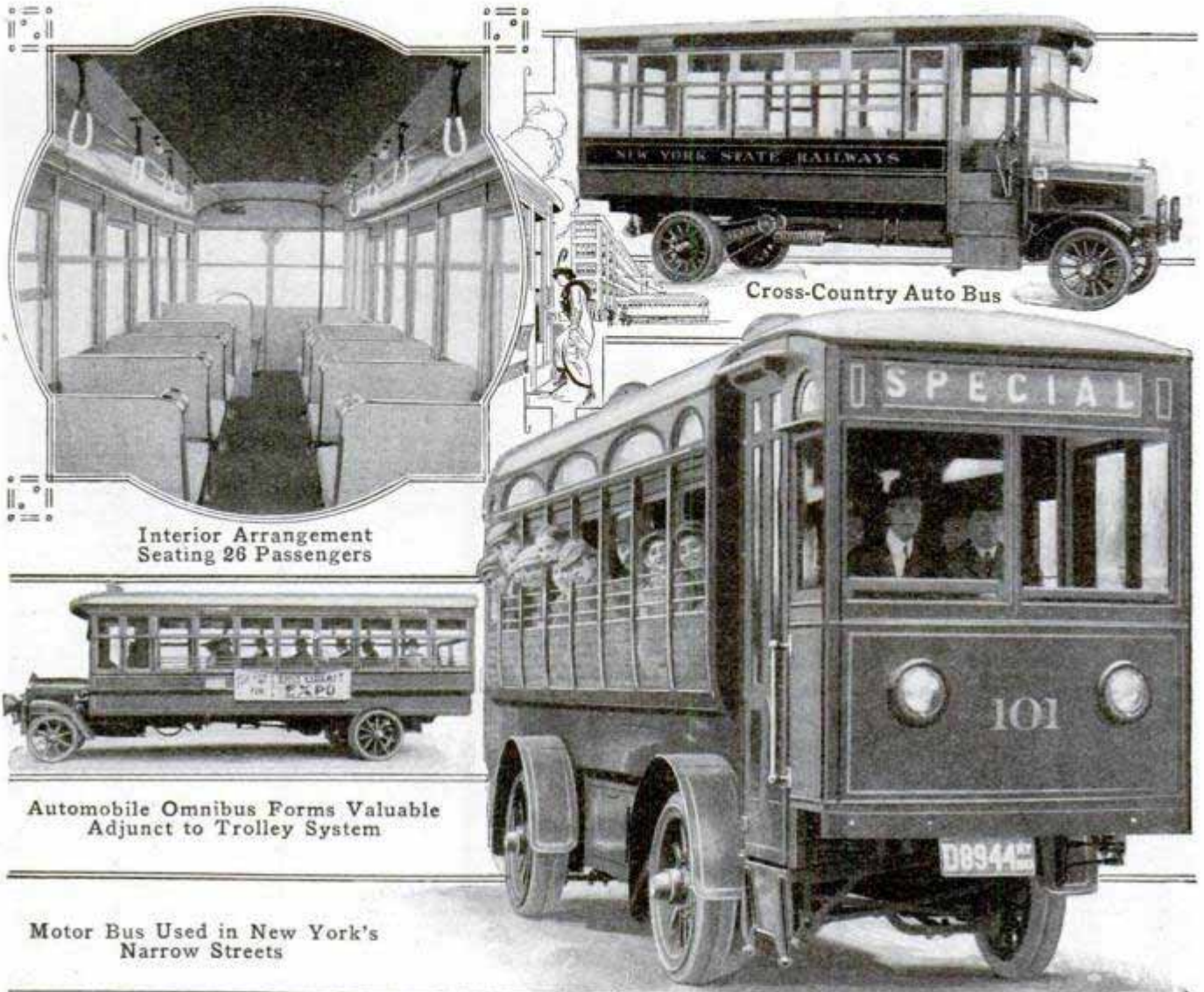

Interior Arrangement  
Seating 26 Passengers

Cross-Country Auto Bus

Automobile Omnibus Forms Valuable  
Adjunct to Trolley System

Motor Bus Used in New York's  
Narrow Streets

Copyrighted by International News Service

A valuable feeder for street-car lines and for interurban traffic is found in the automobile omnibus, seating from 26 to 35 passengers and furnishing accommodations for 20 more by means of sanitary hand straps. The automobile bus is in use in Pittsburgh, covering a route through the residence districts where well-paved streets are untouched by the street-car system. A longer and wider body than heretofore used gives this type a greater carrying capacity and the front opening makes for economy in operation, as it provides for "pay-as-you-enter" service with but one employe. A 26-passenger omnibus is in use by the New York State Railways, as a feeder for the trolley lines of that interurban system, running between Utica and Saquoit, a village about 10 miles distant. Here conditions are almost ideal for

the use of the motor bus, as there are a number of important manufacturing establishments in the district which are not supplied with trolley service. Good roads are found on the state highways and good running time is made. A three-ton chassis for the 26-passenger bus and a five-ton chassis for the 35-passenger bus are used. The motive power is gasoline and the lighting is electric. In New York City the street-railway company is operating a motor bus on some of the narrow east-and-west streets where it is impracticable to lay tracks and the traffic is light, transferring passengers to the regular lines.

☐ For use in reforestation work, the forest service collected 40,000 lb. of tree seed last year. The total area reforested was about 30,000 acres.

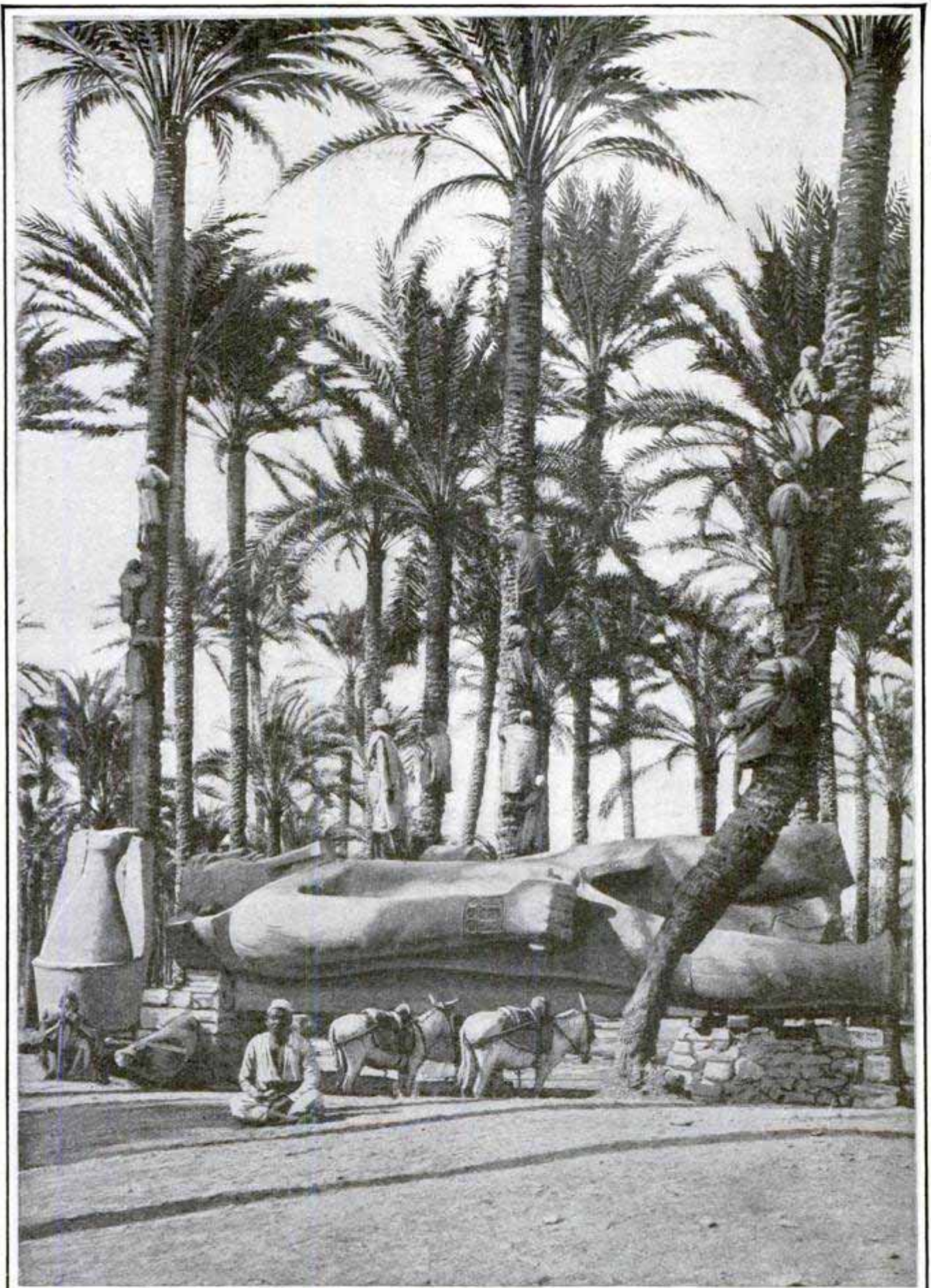

The Immense Statue of Rameses II, One of the Greatest of the Egyptian Kings, is to be Brought to Cairo and Erected in the New Square by the Railway Station. This Statue Weighs over 100 Tons; Even in Its Broken Condition Far Too Great a Weight for the Older Bridges on the Egyptian Railways to Bear. It Lies in a Palm Grove near Bedrashin, Some Miles South of Cairo, and will be Brought to the City and across the Nile on Special Rails

## BRITISH LAUNCH NEW TYPE OF WAR VESSEL

The "Aurora," a light armored cruiser recently launched from a British shipyard, has been described as the smallest and fastest vessel protected by vertical armor ever built for the British navy. This vessel has a displacement of about 3,700 tons, and is about 410 ft. long. Power will be supplied by a battery of oil-burning engines of 30,000 hp., and the maximum speed is estimated at 29 knots. The armament will be light, consisting probably of six or eight 6-in. guns. It is announced that this vessel, which is the first of its class, is designed for attendance on the battle fleet, and that in addition to being adapted to scout duty it will be able to overhaul and cut down any destroyer afloat.

## GASOLINE-ELECTRIC MOTOR COACH FOR KHEDIVE

A composite car for the private use of the Khedive of Egypt has been built by an English concern, which uses as power unit a 350-volt direct-current dynamo and a 100-volt exciter, coupled direct to a 100-hp. gasoline engine. The engine is supported upon an independent truck, pivoted so as to permit vertical motion, but is contained within the steel framework of the car. Compressed air is used to start the engine, a storage reservoir being used. The outside of the coach is faced with steel plates, painted ivory-white and lined with gold.

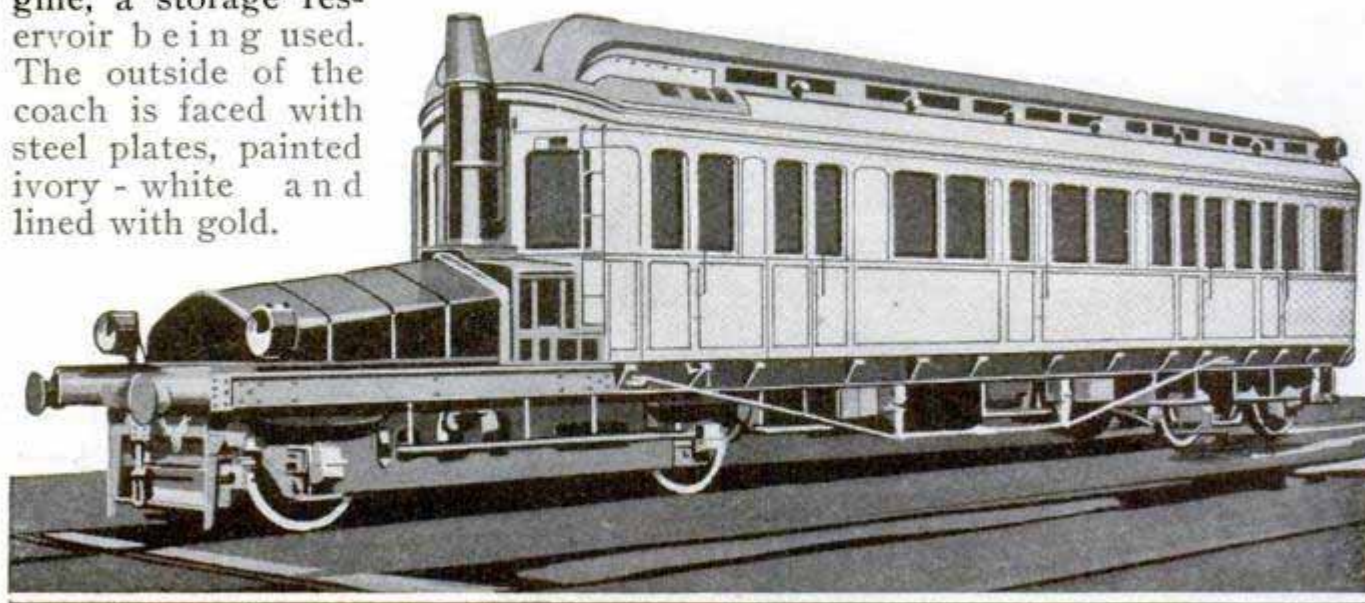

One of the New Self-Propelled Cars Made for the Khedive

## POULTRY HOUSE ON TOP OF BOX CAR

Coops containing dozens of fine chickens arranged on the top of a box car is a bridge foreman's idea of stick-

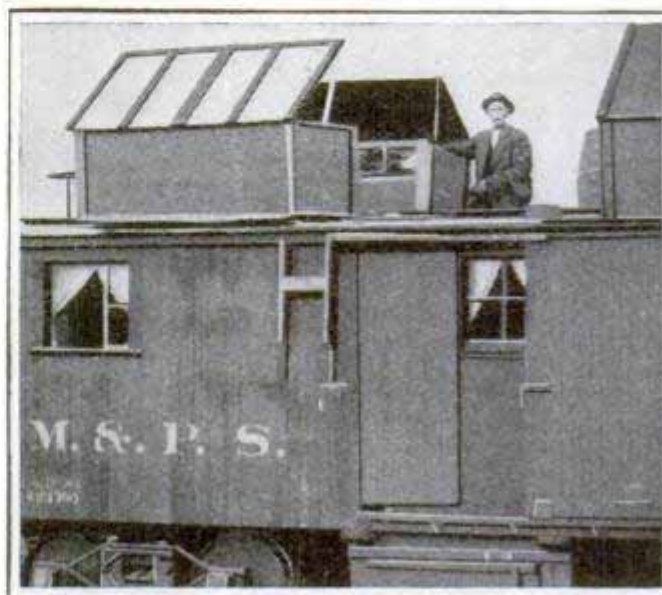

Chicken Fancier Takes Prize Fowls with Him While Repairing Bridges

ing close to one's hobby. The birds are prize winners, and their constant trips about the road interfere neither with their health nor happiness, so far as their owner can discover. The owner is an employe of one of the great western railroads and his position as bridge foreman keeps him constantly engaged in constructing or repairing the bridges on his division. Caring for the fowls is his recreation and pastime.

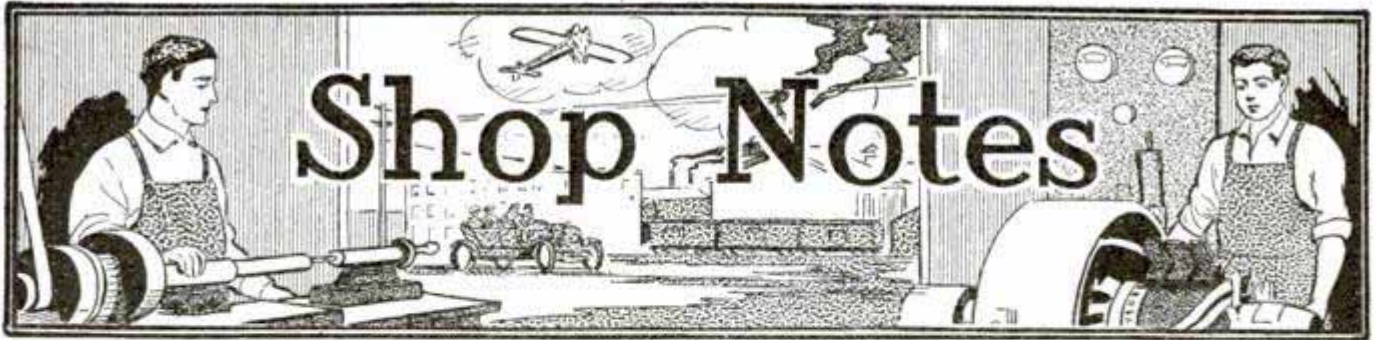

### Grinding Piston Rings

The base of the casting from which the piston rings are cut is left on the faceplate of the lathe and bored out to snugly receive the piston. On new work the piston should be turned to  $\frac{1}{8}$  in. oversize. The bored-out base is used as a gauge in cutting the rings, after the edges have been ground to fit the ring grooves in the piston. After cutting them, they are placed in the piston in the usual manner.

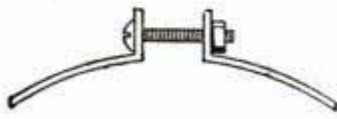

Provide as many sheet-metal strips as there are rings, each about  $\frac{1}{4}$  in. wider than the ring and not over  $\frac{1}{8}$  in. in thickness. Bend these around the piston and turn the ends out at right angles so that there will be a gap of about  $\frac{1}{2}$  in. Drill or punch holes in the projecting ends for a small stove, or other, bolt. The clamp end with bolt is shown in the sketch.

Procure some engraver's wax, which is made of resin, beeswax and a little shellac. Heat the pistons in an oven until hot enough to melt the wax. Melt the wax in a ladle and pour it in the cut in the ring until the space is well filled, then slip on a clamp with the bolt over the cut in the ring and well centered. Draw up the clamp, squeezing out the surplus wax until the ends of the ring are close together. The clamps, being of thin metal, allow the rings to take their own shape and also center them in the piston groove. All rings are treated in the same manner, then the piston is set aside to cool.

When the wax is set, remove the clamps, then wipe off the surplus wax with a rag soaked in gasoline. Center

the piston in a lathe and grind both piston and rings to snugly fit the bore of the cylinder, which should also be ground to size. Place the piston in a pan, return it to the oven and heat sufficiently to remove the wax, then set it in gasoline for 48 hours to clean it thoroughly of the wax. If it is desired to remove all clinging wax quickly, boil it in soda water. In this manner the rings can be fitted accurately, so that their entire surface will be in contact with the cylinder walls.—Contributed by S. A. Asquith, Waterloo, Ia.

### An Auxiliary Chuck Jaw

The illustration shows an auxiliary jaw which sometimes is very handy for use in a lathe chuck. The jaws should be made of soft brass or copper so that they will not mar the piece gripped in them. Make them about three-quarters the length of the regular chuck jaws. If the regular chuck jaw is 1 in. wide, make the auxiliary jaws .005 in. smaller. Fasten a small spring, or clip, on each side of the jaws. These serve to hold the auxiliary on the chuck jaw while placing the work in the chuck. As will be seen, the back of the jaws are convex or rounding. This allows the auxiliary jaws to conform to odd-shaped pieces or tapers. The illustration shows the jaws gripping a taper shank.—Contributed by Chas. Home-

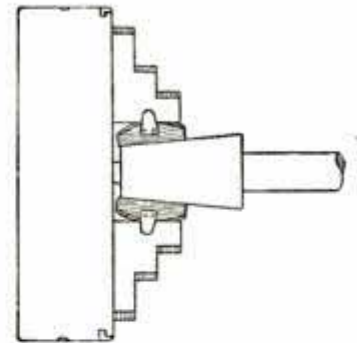

wood, Waterloo, Iowa.

### Bell and Door-Lock Circuit for an Apartment House

The accompanying diagram shows the method of wiring the front and back-door bells and the electric lock

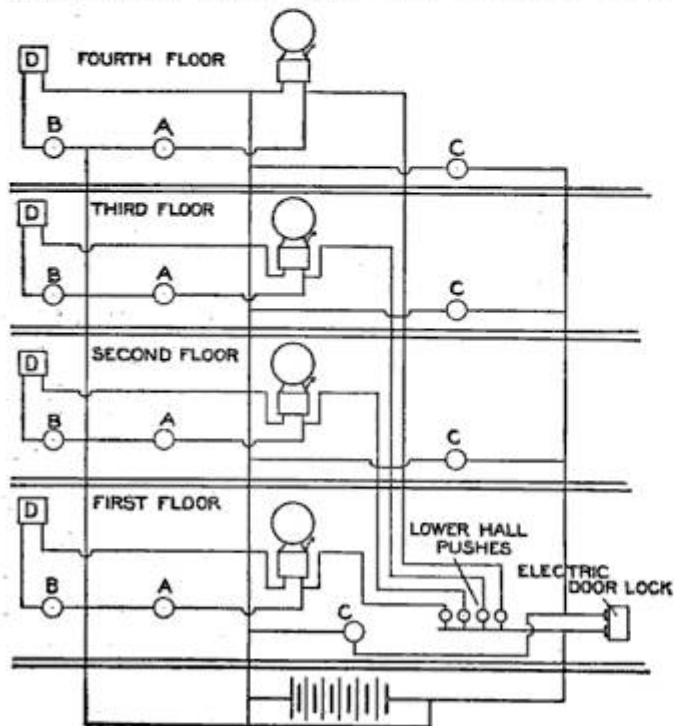

Complete Electrical Circuit for the Front and Back-Door Bells and the Electric Lock

on the front door. Four separate push buttons are located in the lower hallway and connected so as to ring the bells in the different apartments. These buttons are usually mounted on the mail boxes and near the mouthpieces of the speaking tubes, which are also, as a rule, mounted on the mail boxes. Another button is often added to operate a bell in the janitor's quarters. The push buttons marked A are mounted on the side of the doors entering the flats from the front hallway. These push buttons, of course, operate the same bells as the push buttons in the lower hallway. Buzzers or bells, D, of different tones than those in the front of the apartments are wired to be operated by push buttons, B, located at the back doors. Push buttons, C, are located near the mouthpiece of the speaking tubes leading to the vestibule or entrance which control the electric door lock. These circuits can be elaborated to meet almost any requirements. The wires used should be well insulated and in-

stalled in such a manner that there is little likelihood of shorts or grounds occurring on any of the circuits. A small bell-ringing transformer may be used in place of the battery, thus doing away with the trouble due to exhausted batteries and the cost of renewing same. It is always best, if possible, to make all splices and branch connections at a push button or bell, as this often reduces complications in testing out the circuits and locating causes of trouble.

### Starting a Forge Fire

If a forge fire is used only occasionally, the starting of a fire requires considerable time, but where gas is available the fire may be hastened by equipping the blower with a gas-supply pipe, as shown.

The pipe leading from the blower to the tuyère is drilled and tapped for a  $\frac{3}{8}$ -in. pipe at any convenient location, as at A, and connected to a gas line. A valve, B, is located in the gas line where it will be handy for the operator.

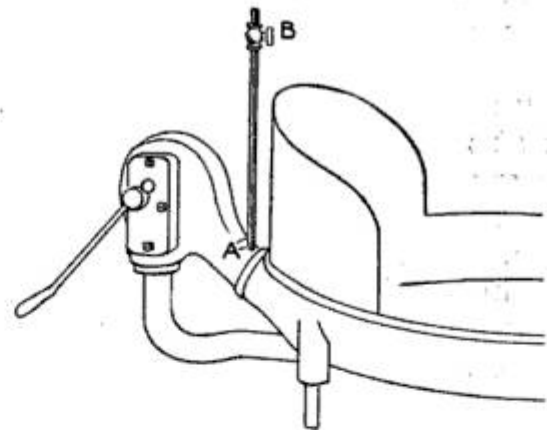

The Burning Gas Starts the Coal Fire and Leaves No Harmful Residue in the Forge

All that is required to start the fire is to lay a lighted match on top of the coal in the forge, turn on the gas lightly and turn the blower, slowly at first, and then gauge the gas and air to the proper mixture. The coal will be ignited and burning at a welding heat in a short time.—Contributed by Earl Pagett, Coffeyville, Kans.

ⒸA piece of paper placed between finished metal surfaces keeps them from sliding.

### Thumb Rest for a Hacksaw Frame

In using a hacksaw for a considerable length of time, I found that the pressure applied with the thumb of the left hand resulted in a blister or the breaking of the skin. To overcome this difficulty I made and attached the thumb rest

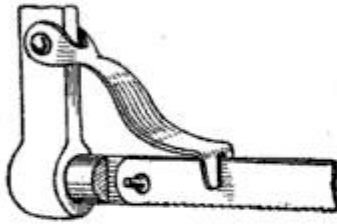

shown in the sketch. The rest consists of sheet metal thick enough not to bend under the pressure, and is cut and hinged to the front end of the hacksaw frame so that, in use, it lies on the back of the blade. This makes a thumb rest and also stiffens the saw blade.—Contributed by Chas. Walte.

### Threading Studs in a Lathe with a Solid Die

Having occasion to hurriedly thread quite a number of small studs when no bolt cutter was at hand, and the usual stock and die being an unwieldy affair for this kind of work, I accomplished the threading quickly in the following manner. There was a small lathe in the shop and the die was centered in

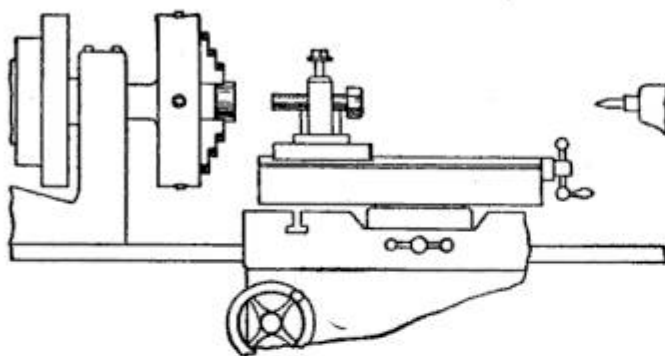

The Studs were Clamped in the Tool Post and Threaded in a Die Held in the Chuck

the jaws of the chuck. The studs were of a size that easily passed through the tool slot in the post, and were tightened down by the holding screw. A few shims were laid in the slot to line the studs with the center of the die, and it was a quick piece of work to thread them by simply starting the lathe to cut the threads.—Contributed by F. W. Bently, Jr.

### Obtaining the Relative Intensity of Two Sources of Light

The following simple device may be used in determining the relative intensity of two sources of light, or measuring what is called the candlepower of one lamp in terms of the candlepower of another lamp which is known. The operation of the device depends entirely upon what is known as the law of inverse squares, which may be illustrated as follows:

Take a point source of light, such as A, Fig. 1, and consider the illumination on surfaces located different distances from this source. It is quite obvious that the illumination on a given area decreases as the distance between the area and source of light increases, and

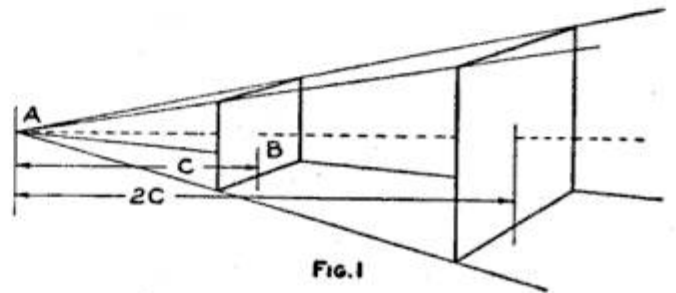

FIG. 1

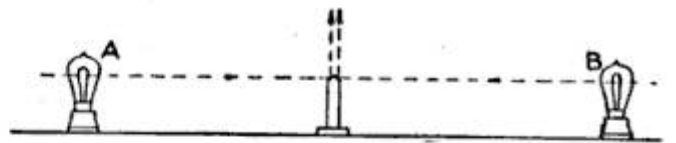

FIG. 2

Illustrating the Law of Inverse Squares, and a Simple Photometer

it can be shown that there is a definite relation between the illumination on a given area and the distance between the area and the source of light. If an area, B, be located a distance, C, from the source of light A, and lines be drawn from the source of light through the four corners of the area B, a pyramid will be formed. A certain quantity of light will be contained in this pyramid and it will be distributed over the area B. If a second area be taken at twice the distance— $2C$ —from the source of light, it will be four times that of B, but the same quantity of light will be distributed over this new area that was distributed over the area B. A third area may be considered at a distance of  $3C$  from the source of

light, and it will have an area nine times that of B, and the same quantity of light will be distributed over it as was distributed over the first and second areas. Other areas may be taken at less, intermediate, or greater distances than those just given, but they will be related to each other as the square of their respective distances from the source of light. Now, since the same quantity of light falls on each of these areas, the quantity per unit area must decrease as the areas increase, or the light per unit area varies inversely as the square of the distance the area is from the source of light. If, then, two sources of light be placed a given distance apart, as shown in Fig. 2, there will be some point between them where the illumination from each source is the same. This point may be located with a fair degree of accuracy as follows:

A block of wood, about 1 in. square and several inches long, is cut V-shaped at one end so that the surfaces thus formed will be at right angles to each other. Cover these two surfaces with pieces of pure-white drawing paper. The edges of the pieces of paper should be beveled where they join. Now, by moving this block so that the

surfaces move on a line joining the two sources of light, and at the same time observing the relative illumination on the two surfaces, a point may be located where the two surfaces will be equally illuminated. If the total distance between the two light sources A and B is 100 in. and the source of light A is 40 in. from the wedge and the source of light B, 60 in. from it, when a balance is obtained, the light obtained from A on one of the white surfaces will be equal to  $\frac{A}{40^2}$ , and that from B, on the other, equal to  $\frac{B}{60^2}$ . These two values being equal, it is easily found that, in this case, the intensity of the light source A is four-ninths that of B, so that when the candlepower of one of these sources is known, the candlepower of the other source is easily computed.

Better results can be obtained by using a screen of some kind to cut out all the light from the observer's vision except that coming from the two paper surfaces. The surfaces of the wood block as well as the base on which it slides, should be given a coat of dull black paint. A number of balances should be obtained by moving the wedge in the opposite directions, and the average taken as a final value.

### Repairing a Leak in a Heating Boiler

A heating boiler sprung a leak at a time when it was most needed. The boiler was of the sectional type,

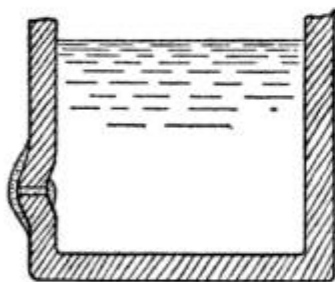

the sections arching over the fire box and carrying the water. To remove one section would have made it necessary to take the whole boiler apart to repair it. This would have required a week or more, during which business would have been suspended unless the weather moderated. The leak was seemingly caused by corrosion in the pocket where the core had been supported by a wire

when cast. The corrosion made the casting at what is usually a weak spot very thin, and finally a small pinhole was blown through. When over 2 or 3 lb. of steam was carried the increased heat caused greater expansion, and the hole was so enlarged as to let a good stream of water through on the fire. The location was too confined to permit drilling or plugging by any ordinary methods. It was then suggested to try a plug of softer material. The hole was enlarged, by pricking it, and filled with asbestos, but this would not hold when under pressure. Fire-clay was then mixed and enough forced in to fill two holes of like diameter, and the outside well smeared over. This repair was entirely successful.—Contributed by Donald A. Hampson, Middletown, N. Y.



### Filler for Patterns

Cracks, holes, corners and irregularities in wood patterns must be filled up before the patterns are in shape for the foundry. Beeswax, plaster of Paris, paraffin, etc., are used for this purpose, but a better substance is metal filler that is sold in paste form for smoothing castings. The color of the paste is the same as that given to most patterns. The paste is applied after putting on a coat of shellac. It is rubbed in with the fingers after dipping them into water. When all the holes have been filled and the filler has partly dried apply another coat of shellac, and a good surface will be the result. This is not a substitute for a filler in corners of patterns requiring a definite radius; it is only a filler for holes and depressions.

### Auxiliary Drill Chucks for a Jeweler's Lathe

The chuck on my dentist's lathe would not hold smaller drills than the size of the hole in the chuck satisfactorily, and I proceeded to make auxiliary jaws for the drill sizes, each having an outside diameter of  $\frac{5}{32}$  in., the size of the hole in the lathe chuck. These were made of wire nails,  $\frac{5}{32}$  in. in diameter. The heads and points were cut off and the squared ends, thus made, were centered accurately. A hole, A, was drilled through the center, to admit the drill used in drill-



Each Small Drill was Supplied with a Chuck to Fit the Lathe Chuck

ing the hole. One end of the piece was then cross-slotted, as shown at B, with a small saw, thus making a small holder to fit the lathe chuck.

After using the auxiliary chuck a few times it would cling tightly to the drill and, in a manner, make a drill shank of the size for the lathe chuck. It would also prevent very small drills from being lost. Each of the small drills was supplied with a chuck of its own.—Contributed by L. L. Llewellyn.

### Sawhorse for Heavy Timbers

When it is necessary to saw a heavy board lengthwise and no bench is at hand, the job can be easily done by the

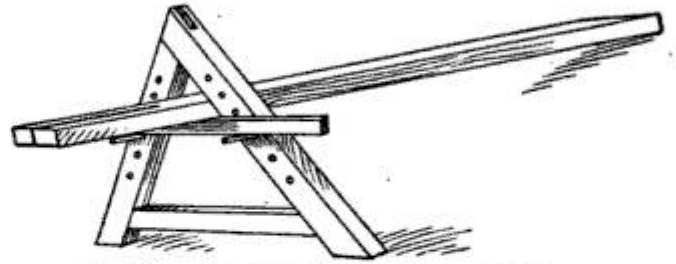

A Horse for Holding a Heavy Timber While Ripping It with a Handsaw

aid of the simple device shown herewith, the construction of which is self-evident. The board is clamped in the upper angle of the A-shaped horse by means of the movable crossbar which is held in position by pins, as shown. By allowing the larger end of the board to drop to the ground, it is held very rigidly for sawing. When sawed through about halfway, the split end is pushed out and the other end sawed.

### Counterbore Attachment for a Twist Drill

The attachment can be used on a twist drill for countersinking the hole when it is drilled through the metal, or be set to make the countersink when the drill reaches a certain depth. The attachment is made of a piece of cold-rolled

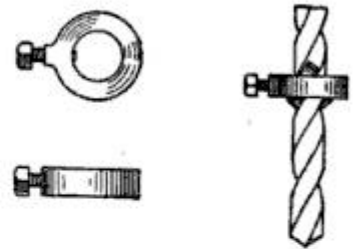

steel, drilled through its center larger than the drill upon which it is to be applied. Two pieces of tool steel are ground to fit the flutes on the drill and of sufficient thickness to form cutters for the size of the countersink. The cold-rolled steel can be shaped as desired, but it is always best to have a piece large enough so that a flush screw can be used for safety. The attachment can be set on the drill at any point desired and used as a stop.—Contributed by Chas. G. England, Washington, Pa.

### Making Holes in Glass Bottles

A firm of chemists preparing a certain lotion for bruises and sprains decided that its sale and field of usefulness

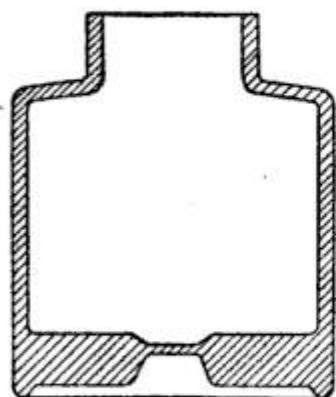

would be increased if the preparation were put up in a bottle having a hole through the bottom. The purpose of the hole is not important, but the manner of making it may aid some

other workman, having similar work to do. The hole, of course, was to be corked after filling the bottle. The size of the hole was not essential, but it was found impossible for the bottle makers to blow the hole in the bottom.

The bottom of the bottle was  $\frac{3}{8}$  in. thick and, in submitting an estimate on drilling the holes, I placed the cost at 5 cents for each bottle. As the bottle only cost 2 cents, this method was too expensive, and I suggested a plan which the chemists adopted.

The molds for the bottles were altered slightly by the addition of parts that would form a recess in the bottom, as shown in the sketch. This left a thin web of glass at the bottom of the recess, or depression, and added nothing to the cost of the bottle. A boy was put to work with a punch and hammer to knock the web out of the bottom. Only a few bottles were broken, so that the added cost was very small. The break was irregular, but this was of no consequence. The surrounding wall was so heavy in comparison with the web that the glass gave away without any trouble.—Contributed by Donald A. Hampson, Middletown, N. Y.

¶The most convenient way of hanging plans, bills of material, or other papers, in the shop is to make a small hole in one of the upper ends of an ordinary spring clothespin and hang it on a brad.

### A Hydrant Cup and Basin Holder

The yards about a shop, factory, or boarding house usually have an ordinary hydrant where water is obtained

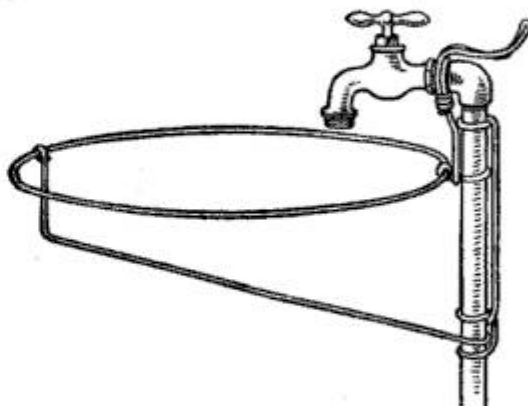

A Basin and Cup Holder Made of Wire and Attached to a Yard Hydrant Pipe

for drinking and washing purposes. As a rule, the basin is filled and carried to a resting place on some box or barrel. The attachment shown holds both basin and cup. The basin can be filled and then turned to the rear or side, as desired, while others obtain water. Two pieces of heavy wire, preferably copper, is all the material necessary, and the sketch clearly shows how it is applied.

### Prick Punch with Hammer

The prick punch made as shown does not require the use of a hammer. The punch is turned from tool steel and a steel ball is drilled centrally to fit on the handle part. The upper end of the handle is threaded to receive a cap to hold the ball in place. The point of the punch is properly hardened. To

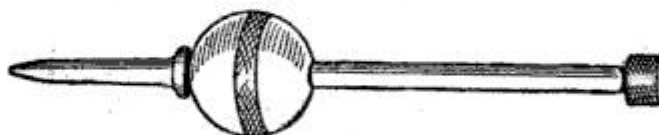

The Ball on the Handle is Used for Driving the Point of the Punch into the Metal

use, place the point on the spot and raise the ball to the upper end of the handle; then it is brought down quickly to strike the flange at the lower part, which forces the point into the metal.—Contributed by Abner B. Shaw, No. Dartmouth, Mass.

### To Lengthen a Short Cap Screw

Finding the cap screw in a socket just a little too short to clamp the spindle and not having a longer one of the same size, I filed away a portion of the bottom of the head, removing a part of the body below the threads as

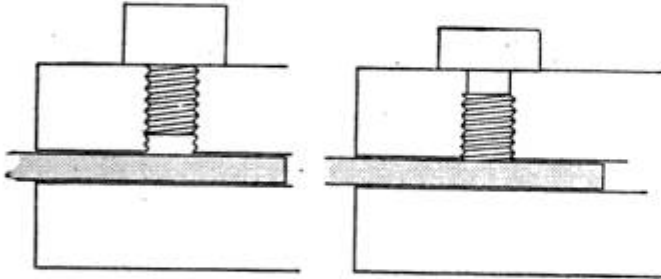

The Extra Length for the Screw was Made by Cutting Away Part of the Head

shown. This made enough extra length to clamp the spindle tightly.—Contributed by James M. Kane, Doylestown, Pa.

### Shop Ladder Made of Pipe

A small ladder is a handy article about a shop, but the uses to which shop ladders are sometimes subjected are too severe on most wood ladders.

The sketch shows a light, durable and strong ladder made of pipe. At each point where a rung is to be located, the pipe is flattened to allow a long  $\frac{5}{8}$ -in., or  $\frac{3}{4}$ -in., stud to pass through and be secured at each end by two nuts. The lower ends of the ladder are drawn to a point to prevent its slipping. The upper ends are improved in appearance by the application of two pipe caps.

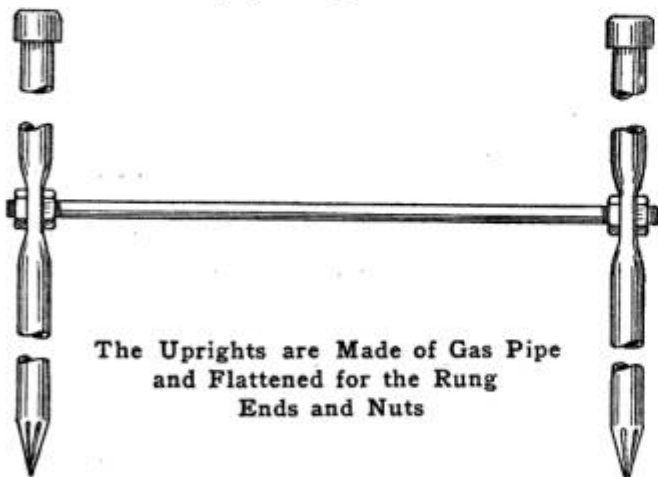

The Uprights are Made of Gas Pipe and Flattened for the Rung Ends and Nuts

A ladder of this type is both valuable and durable and its uses are almost innumerable.

### Automatic Feed for an Oil Cup

Hand-adjusted oil cups very often become clogged with particles of dirt, which results in a hot bearing or a damaged shaft, if not watched closely. The cup illustrated is hand-adjusted when starting the machine, but later the feed is operated automatically by a thermostat spring, if the bearing begins to heat up a trifle.

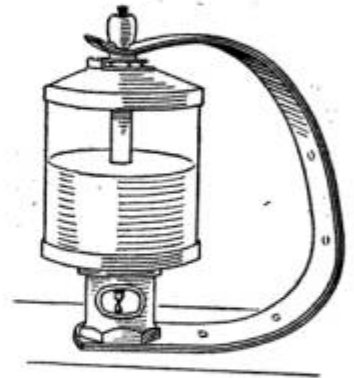

The cup is similar to the ordinary sight-feed kind with the needle valve operated by a thermostat spring. The spring consists of two pieces, one brass, 16 gauge, and one steel, 20 gauge, bent as shown, then drilled for rivets and the holes countersunk. The brass piece is placed on the inside of the bend and both pieces are riveted together solidly. If any substance clogs the opening at the point of the needle, the bearing will begin to warm up, which will cause the spring to raise the valve and let the oil rush through. It works automatically without attention when set.—Contributed by Louis Stankewitz, New York City.

### A Flat Water Paint

To make a good flat water paint, take 50 lb. of gilders' bolted whiting, place it in a tub and pour water over it until the mass is covered. Allow this to stand several hours, say, over night, then pour off the excess water and add 2 gal. of hard oil finish—gloss or resin oil will do—and any desired color, then beat up the mass until it is perfectly smooth. Use water color or dry color, not oil color. Thin the mass down to a brushing consistency with turpentine, benzol or benzine, and it is ready for use. This will make a very nice, flat, lusterless finish as good as the much advertised water paints of the same character.

### Swinging Telephone Shelf for Two Rooms

Quite often two persons occupying adjoining offices wish to make use of the same telephone. If the partition dividing the two offices be a thin wooden one this can be accomplished very easily by making use of a swinging shelf similar

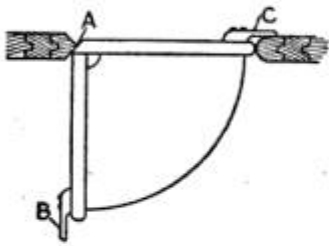

to that shown in the accompanying illustration.

A small opening, of sufficient size to accommodate the telephone, is cut in the partition so as to place the telephone as near the desks on opposite sides of the partition as possible. The edges of this opening should be shaped as shown in the sketch. The shelf proper is in the form of a quadrant of a circle whose radius is a little less than the breadth of the opening in the partition. Two sides are attached to the shelf as shown, and are of such size and shape that they will just fit into the opening when their common edge is beveled off at a 45-deg. angle. The shelf may be supported by double hinges, A, attached to the beveled edge. Two stops, B and C, should be provided to prevent the shelf from swinging too far through the opening or past its proper position. These stops may be so shaped that they will serve as handles in moving the shelf. The edges of the opening may be covered with heavy felt, which will serve to close any crack that might otherwise exist. A small piece of quarter-round is shown fastened in the corner between the two sides to give a good anchorage for the screws holding the hinges. The cord leading to the telephone should pass through a hole in the back corner of the shelf.

CA painter's brush having reasonably stiff bristles is much better for dusting heavily carved furniture than the ordinary feather duster.

### Spacing Letters on a Sign

Frequently it is a more difficult task to space letters properly than to write them on a sign. I often find it con-

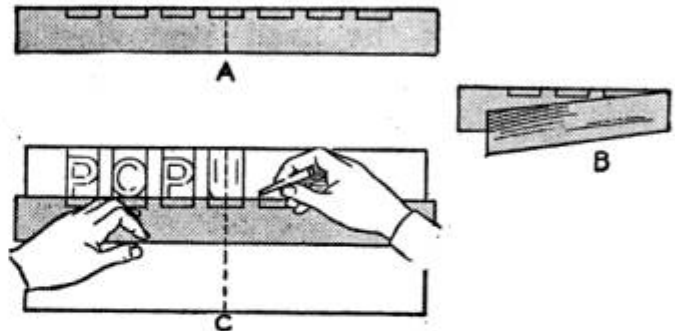

The Letters are First Spaced on Paper Which is Creased to Show the Center Line

venient to first lay out the letter spaces on a strip of paper, A, double it as shown at B, and then lay the crease on the center line of the design. The spaces are then easily and correctly laid out on the sign C, without spotting the surface with trial marks.—Contributed by James M. Kane, Doylestown, Pa.

### Enlarging the Capacity of Calipers

It is not an uncommon occurrence in the routine of general lathe work, to come across some work with a diameter too great to be measured with the largest pair of calipers in the tool kit. The sketch shows how to fasten two pairs of calipers together with a hand vise to increase their reach for measuring large diameters. The hinges on both pairs of calipers can be brought into use while on the work, and when

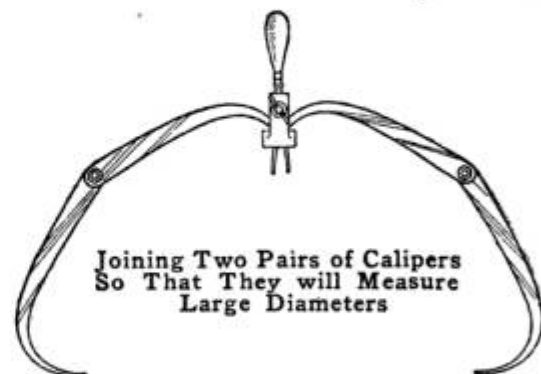

rigidly clamped together by means of a small hand vise, the arrangement is as practical as a large, heavy pair of calipers. The adjustment is made with the two extending arms.

## Practical Telephony

By HAROLD HINTON

### Part XII—Trouble Hints

A few general directions for locating trouble in telephone work will be given in this concluding part, but they will be only such as to give the workman an idea of what to do, as hints of this kind, to cover all troubles, would require considerable space and many of them would be put in practice only occasionally.

A solid-back transmitter has practically no adjustment. If the carbon should become packed together, the trouble can be remedied by tapping gently upon the top or side of the case. This will jar the caking loose and separate the particles. All connections in the primary circuit as well as in the battery should be kept in perfect condition.

A receiver whose magnets are too weak to support an 8-oz. weight should be condemned, and the diaphragm adjusted to within .015 in. of the magnet. All bent or corroded diaphragms should be replaced.

All bell screws must be kept tight and firm, and all dust or corrosion removed from the hook connection. The wire connections of bells should be securely fastened and contact points well soldered.

Examine cords frequently to discover breaks.

Exhausted dry batteries should be replaced, but they may be restored in emergency cases, for temporary use, by perforating the bottom and standing them in a sal-ammoniac solution.

Ground-wire connections should never be permitted to corrode. When testing to establish the condition of the ground wire no result should be taken for granted until the full talking efficiency of the instrument has been obtained.

All unworkmanlike inside wiring should be brought to standard when repairing, such as two wires under one staple, sagging wires, soldered connections to line wires, wires which

run in places where they may be exposed to damage.

#### Magneto Troubles

If two magneto bells or drops ring together, look for a cross of office or line wires. If a common return wire is used, the return wire may be broken or the drop ground is broken. By opening one line at the central office and ringing out on the other line the trouble can be located. If both bells ring, the lines are crossed, but if neither bell rings, the common return will be found broken. If the trouble is with the drops, the line at one subscriber's station should be opened and the other one rung. If both drops fall, the line is crossed; if neither falls, the drop ground will be found broken.

If a magneto bell rings frequently from no apparent cause, it indicates a swinging cross with telegraph or other lines.

If a bell can receive a ring, but cannot ring out, it shows that a wire is broken either in the line or office; that a protector is open; line is grounded, if bridged to ground, or short-circuited, if bridged to metallic line. By tapping on the transmitter and listening on the line little or no sound will be heard, if the line or protector are open. If the line is short-circuited or grounded, the transmitter will give a loud sound.

If the bell rings, but no response can be obtained, the trouble is usually a grounded or open line, or burned-out protector, if bridged.

If a magneto bell receives a ring, but cannot ring its own bell, it indicates a broken wire or connection in the generator or a conducting wire from it; the armature does not make contact with the spring if bridging; the coils are short-circuited, or the current cannot get to the line because the shunt will not open.

If a magneto bell receives and transmits a ring, but no talking can be heard, it indicates a broken receiver cord, weak battery, bad connections, or the hook does not go up to place. A weak spring or a hook which does not move easily will cause the latter trouble and the talking instruments will not be connected to the line.

If a magneto bell receives a strong ring itself, but rings other bells feebly, it indicates generator trouble, usually due to bad connections, but sometimes caused by weakness of the permanent magnets of the generator.

If the magneto bell rings other bells vigorously and its own bells weakly or not at all, the trouble will usually be found to be poor adjustment of the armature or weakness of the ringing magnet.

If the magneto bell will not ring at all, look for a burned-out protector; a broken wire in box, or broken line, or ground wire.

If the magneto bell rings feebly, but talking can be heard plainly over the wire, look for a poor connection inside the box.

If a call is made on a toll or party line and no response is obtained, test out the trouble as for a bell that receives a ring but cannot ring out.

If toll or party-line bell rings, but no talking can be heard, treat trouble as where a bell receives and transmits a ring, but talking cannot be heard.

If a ring is received on a four-party selective system, but talking cannot be heard, test for an open line.

#### Battery Trouble

If transmission of speech is feeble, but is received normally, the trouble is usually due to a weak battery. The test for a weak battery is to listen in the receiver, tapping at the same time on the transmitter or mouthpiece with the finger. Do not tap on the diaphragm. The sound will be loud and clear if battery is in good order, but little or no sound will be heard if battery is weak.

If a singing or sputtering sound is heard in a telephone, a few taps on

the transmitter or mouthpiece will sometimes remedy it, but a scratching sound is usually due to a broken wire in the flexible cord making an imperfect and irregular contact.

Examine the battery connections often so that perfect contact may be maintained at all times, and oxidation, or other foreign matter, which may accumulate at these points, can be removed.

#### Common Battery

If speech is not distinct and is accompanied by a grating or scratching sound, look over the transmitter circuit in the transmitter terminals and at the induction coil.

If a call is made and no answer can be obtained, the trouble may be laid to any of the following causes:

1. The subscriber's relay in the central office may not work on account of the line circuit of the relay being open or short-circuited on terminals or in coils, or from poor contacts existing in the local circuit because of improper adjustment of relay-line circuit.

2. A burned-out lamp may be the cause.

3. The coil of an electromagnetic circuit may be open or short-circuited in terminals or coil; armature may be stuck or imperfectly adjusted.

4. The trouble may also be caused by an open circuit, a ground or short circuit in protectors, on the line or in the subscriber's condensers.

5. A permanent signal showing at the central office indicates a ground or short circuit.

If the bell receives a ring, but speech is impossible, the trouble is usually due to the repeating coil in the central office being open; the springs of the ringing keys not making connection with the back contact; a broken wire, blown-out fuse or burned-out coil. The subscriber's receiver, transmitter or winding of the induction coil may be open.

If a ring cannot be received, it indicates an open, short circuit, or ground in instrument, line, or office wire. The trouble may also be caused

by an armature being out of adjustment or a ringer magnet being weak. Burned-out ringer coils, or a broken line wire, or condenser circuit may cause the open, while a short circuit or ground will cause a permanent signal to show in the central office.

If a receiver is weak, reverse the receiver cord.

If speech can be heard, but conversation cannot be effected, the trouble may be due to a broken wire between the transmitter and induction coil; transmitter may be short-circuited; transmitter cord may be broken; or a secondary induction-coil winding may be short-circuited.

If the central office signal is weak, the cause may be assigned to a bad contact in relay causing high resistance in local circuit, or insufficiency of main batteries, or too small power leads.

If the central office signal will not act, it is due to an open line, broken local circuit, improper relay adjustment or insufficiency of battery.

If speech is indistinct and accompanied by a grating or sputtering noise, the line is crossed, or there is a loose connection in the line circuit. A signal showing in the central office indicates a cross in line. Loose connections in this case may be due to poor contact in protectors; in hook switch; in spring jacks; defective switchboard cord or defects in office or line-wire connections.

#### Pole Lines

The easiest way, and incidentally the proper way, to keep clear of trouble on pole lines is systematic inspection of every pole, cross arm and fixture, as well as all wires and cables attached to them.

It may be interesting to note that the life of a pole in the average toll line is from 8 to 10 years while the life of a subscriber's line pole is from 15 to 20 years. This difference is due to the fact that toll-line poles are usually set where there is more or less vegetation, whereas the subscriber's poles are usually located in places

which are comparatively free from vegetation.

The butt of the pole, from the ground line down, should be carefully watched, as when it once starts to decay, it is a comparatively short time before the pole is rotted off. A screwdriver, or other semipointed tool, is good for testing pole butts, cross arms, etc. Simply drive it into the wood by a sharp blow, also being sure to test the ends of the cross arms.

Pole-line inspection and maintenance, under ordinary conditions, require the services of a lineman, a ground man, and a horse and wagon. This crew can cover considerable territory and keep the average rural line in good condition by testing and replacing defective poles, cross arms, etc.; keeping all guys, etc., up taut; stringing new wire in place of wire that is in a defective condition.

This pole-inspection crew also shoots trouble on their line and must understand inside wiring as well in order to successfully cope with trouble arising from defective interior work, and for that reason a few pointers will be found valuable.

The line, or outside wire, should be run as near as possible to the location of the instrument in order to keep the inside wiring as short as possible.

The hole in the window or door frame, through which the wires are run into the house, should have a slight pitch downward on the outside end. This is to prevent the entrance of water and snow.

Lead wires should always be soldered to the ends of the line wires.

All wires entering the building should pass through separate holes,  $2\frac{1}{2}$  in. apart, and should be run through tubing or taped at these points.

Use No. 19 twisted-pair, rubber-covered wire from the instrument to the arrester, and fasten it securely in place with insulated staples.

The outside wires cause the most trouble from crosses and shorts, while the inside wiring is responsible for a great many cases of grounds.

Crosses are usually found outdoors, where the wires are unprotected by insulation, and may be caused by a piece of baling wire, or other metal, being thrown across the line wires, and by wires being too slack and swinging against each other in the wind.

Ground wires are a continual source of trouble on rural lines. This is the wire which runs to earth at each end of the line, so that the ground can complete the rest of the circuit, removing the necessity of running two wires for each circuit. Dry earth, sand, gravel, etc., are not good conductors, so that, to obtain the best results, the ground wires must lead to damp earth, and the wires should extend down below the point where the earth becomes dry in summer or freezes in winter. Dry ice itself is a material of high insulating qualities so that a ground wire is totally useless in frozen earth.

There are two ways of making perfect ground connections; the first is to use a ground rod and drive it well down into the soil. The top is then scraped bright and a piece of clean tinfoil wrapped around the rod. The cleaned ground wire is wrapped over the foil, another layer of foil is wrapped over the wire, and a couple of layers of friction tape are put on over the whole.

The best, most satisfactory and most economical ground connection is made by attaching the ground wires to a gas pipe or, better still, to a water pipe by the aid of a clamp. Care should be taken to connect the ground wire outside of the meter so that, if the meter is removed for any reason, the phone will not be put out of commission.

A common return wire is often resorted to, to avoid the noisy effects of induction caused by electric-railway and electric-light currents. This common return wire consists of the grounded lines on certain routes being carried back and grounded at the central office by a common return wire to which they are all connected. A separate copper return wire must be provided for each route, and the insulation and connection of the return

wire should be perfect. The gauge of the wire should also be heavy enough to dispose of the business of the subscribers' lines and avoid cross talk.

After a thunderstorm an "open" line may be due to a burned-out arrester fuse, or a wire burned off in the annunciator, or in the ringing coils of the magneto bell. If small particles of carbon should lodge between the carbons in the arrester, it will cause the line to ground. The principal cases of trouble have been outlined in this part and anyone with a mechanical turn of mind should have no difficulty in tracing out, by a little persistent effort and experiment, nearly any case of trouble which may arise.

### Machining Long Shafts in a Short Lathe

Every mechanic is familiar with the problem of handling some jobs too large for the machine, but many times work is sent out for the reason that no one knows just how to do it quickly with tools seemingly inadequate for the occasion. For example, in one small shop a piece of 3-in. cold-rolled steel, 30 ft. long, had to be machined for a line shaft, the ends requiring a

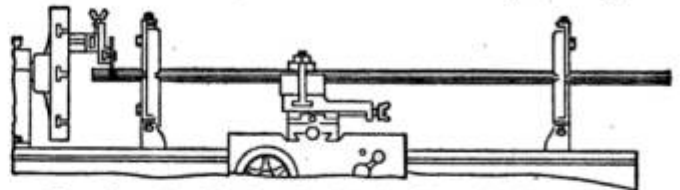

Turning the Ends of a Shaft That is Too Long for the Bed of a Lathe

smaller diameter to fit into the coupling. This was accomplished as follows: One end of the shaft was gripped in a chuck, one steady rest placed near the chuck and another at the end of the lathe bed. The steady rests were set to center the shaft perfectly true and in line. The shaft was then loosened from the chuck and fastened to the crosshead.

Remove the lathe chuck, substitute a large faceplate and attach a small compound rest, as shown. In this manner the cutting tool travels around the shaft while the latter is fed by the lathe carriage.



### An Emergency Indicator

The regrinding of an air-cooled cylinder made it necessary to chuck it accurately, and as I had no indicator, a temporary tool was made of wood.

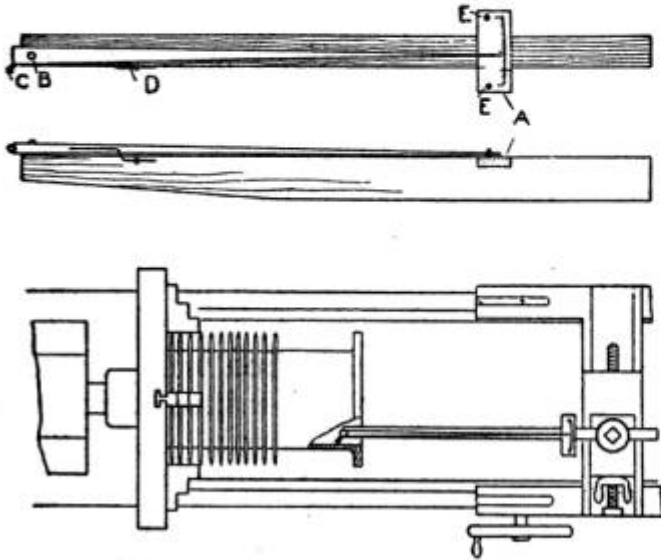

This Homemade Tool will Indicate Any Slight Setting Out of True

The main beam, or pointer support, was made of white pine,  $\frac{5}{8}$  in. thick,  $1\frac{1}{2}$  in. wide, and 1 ft. long. One end was tapered, as shown, for the sake of appearance. The pointer was made of another piece of white pine,  $\frac{3}{16}$  in. thick,  $\frac{5}{16}$  in. wide at one end, and tapered to a point at the other, the length being 9 in. A groove was cut in the upper edge, at A, and a piece of wood inserted for a graduated scale. The pointer was pivoted  $\frac{1}{4}$  in. from the end, at B, to the beam, and a small pin inserted, at C, on an angle, as shown. The pointer should swing freely. A small spring was made of spring wire and fastened with staples, at D, to apply pressure on the pointer. Two small pins, EE, were placed in the scale, to keep the pointer from swinging too far either way.

The indicator in use is shown in the sketch. The shank of the beam is placed in the tool post of the lathe, and the pin at the end of the pointer is run against the bore of the cylinder. Any small deviation out of center will show by a slight movement of the pointer on the scale.—Contributed by Joe V. Romig, Allentown, Pa.

### Oiling System for Main-Shaft Bearings of an Automobile

The main-shaft bearings on my automobile were not oiled sufficiently by the wick oilers, and I supplied an oiling system as shown in the sketch. An ordinary sight-feed oiler was attached to the dash with a bracket, made of No. 16 gauge sheet brass. The oiler was clamped in place on the bracket by turning a pipe coupling on the threads after they were run through the hole in the bracket. The valve controlling the flow of oil was screwed into the coupling and the pipe lines were made of  $\frac{1}{8}$ -in. brass tubing.

As I did not have a three-way cock at hand, I made one out of an ordinary shut-off cock. A  $\frac{1}{16}$ -in. hole was drilled through the body of the cock, at A, and into the cross hole of the valve, as shown at B. The position of the valve for running oil to the front bearing is

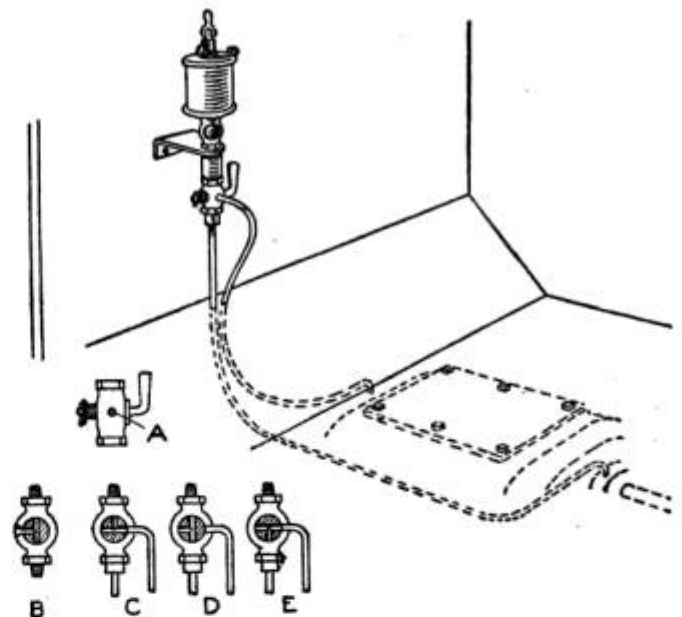

An Oiling System to Take the Place of Wick-Oiling the Bearings on an Automobile

shown at C, and to the rear bearing, at D, while E represents its position when the oil is entirely shut off from both bearings.—Contributed by L. L. Llewellyn, Hayward, Cal.

### Filler for Metal Surfaces

In finishing a piece of machinery, use a filler as follows: Dry filler, 6 parts; whiting, 3 parts; lead in oil, 3 parts, and pulverized silica, 6 parts.

Make this into a paste with a liquid composed of 3 parts of rubbing varnish, 2 parts of coach japan, and 1 part of turpentine, all by weight. Mix to a stiff paste and run through a paint mill, or work up on a slab. Fill the surface of the metal with the paste, and when it has become dry and hard, rub smooth with fine sandpaper. If it is desired to have a darker color add some lampblack. Thinned, the filler can be used as a paint for iron.

### Centering Gauge for Lathe Tools

The gauge shown is a recent addition, and one of the handiest in my kit. The usual way for turning tapers, no

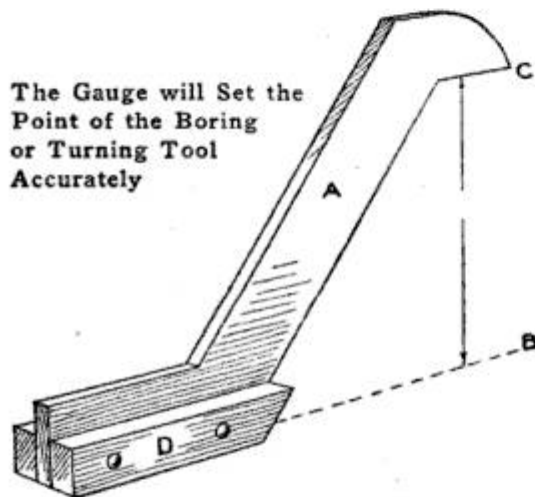

matter whether the lathe has a taper attachment or not, is to cut in with a parting tool to the size at both ends of the taper, then setting the lathe until a small scale has the correct "feel" between the parting tool and the taper sizes. When a heavy piece of work is between centers it is difficult to set the tool exactly at the center of the stock, which is absolutely necessary for accurate work either in setting or turning, without removing the work and setting the tool to the lathe center. This gauge will overcome these difficulties and can be used also for boring, which is the hardest job of the two for tool setting.

The body, A, of the gauge consists of a piece of  $\frac{1}{8}$ -in. soft steel and the distance from the base line B to the point C is the same as from the top of the tool rest to the lathe center. The base may be reinforced with  $\frac{1}{8}$  by  $\frac{3}{8}$ -

in. strips, as shown at D, to rest firmly on top of the tool rest. In setting a tool for cutting or turning tapers, the top or cutting edge is placed under the point C. For boring, the gauge is set on the tool rest and up against the work and marked with a scribe, then the boring tool is set to the line before starting the lathe head.—Contributed by G. O. Reed, Stratford, Can.

### Covering Capacity of Paint

To ascertain the amount of white-lead paint required to cover a given surface of wood, divide the number of square feet by 200, which will give the number of gallons of mixed paint required for a two-coat job. It is usually estimated that a gallon will cover 500 sq. ft. of average wood or smooth metal surface one coat.

The number of pounds of keg white lead required to cover a certain area is found by dividing the area in square feet by 18, which will give the number of pounds of lead required for a three-coat job.

Exclusive of glass, the paint materials required to do an average dwelling will be from 20 to 30 per cent of the total cost of the painting. The labor will be the largest portion.

### Blue Ground for a Level Bubble

The bubbles in level glasses, set directly into the plaster-of-Paris bed, are difficult to see in some of the many positions the level

is necessarily held while in use. The sketch shows an excellent way to set



a glass so that the bubble will show up clear and plain in any position the body of the level may be held. Just before the glass is pressed into the plaster a thin strip of dark blue paper is wrapped halfway around the glass on the under side and pressed into place with the glass.—Contributed by F. W. Bently, Jr., Milwaukee, Wis.

### Hand Tool for Facing Small Bosses

For machining small bosses where power is not available, or cannot be used owing to the location of the boss

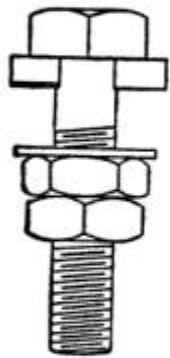

on the machine, a tool similar to that shown in the sketch will be found to accomplish the work in a very satisfactory manner.

Where there are a number of bosses with holes of varying sizes it is best to have

bolts turned to fit the holes, but the same facing cutter may be used for bolts of different sizes, and by the use of bushings, one bolt may be used on several different-sized holes.

The tool shown was made to face a boss,  $1\frac{5}{16}$  in. in diameter, with a  $\frac{5}{8}$ -in. hole through it. It consists of a  $\frac{5}{8}$ -in. hexagon-head turned bolt with a slot under the head to take a  $\frac{3}{16}$  by  $\frac{3}{8}$ -in. tool-steel cutter, backed off on opposite sides, at the ends, for clearance. A washer and two hexagon nuts with rounded corners complete the arrangement. The nut directly beneath the washer is the feed, while the function of the locknut is to prevent the bolt from turning in the feed nut, and from jamming when the wrench is applied to the bolt head.—Contributed by J. A. Shelley, Brooklyn, N. Y.

### Black Varnish for Leather

A varnish for use in making a mixture to coat leather black, so that it will not break by rough handling, is as follows: Equal quantities of turpentine, turpentine oil, and resin are mixed together, 30 parts each. Then 6 parts of sandarac gum and 120 parts of shellac are added, whereupon the whole mixture is dissolved in 900 parts of 90-per-cent alcohol. The liquid thus prepared is filtered and then 15 parts of fine lampblack, previously dissolved in a little alcohol, is thoroughly mixed in it. Apply with a soft rag.

### Grinding Machine-Cutter Knives without Special Machinery

The knives used on paper cutters, wood planes, in leather work, etc., require a special machine for grinding. They must have a keen, straight edge, preferably a little hollow ground. The grinding machines are expensive, and as their field of usefulness is limited, they are seldom found except where much of this work is being done. However, with the rig described, such knives can be well ground on any emery wheel, or grindstone, having its bearings well fitted and being of a grade adapted to some form of tool grinding. Theoretically, the only proper wheel is the one of the grit and grade for knives, but, with care in not overheating, any wheel can be made to do the work.

Take two pieces of flat iron, A, say  $\frac{1}{2}$  by 1 in., bend a hook on one end of each and clamp them with C-clamps, B, one on each side of the wheel, to the frame of the machine. Procure a piece of angle iron, C, of any size, and lay across the two bent ends. Place the knife as shown, and grasping its back with a hand at each end, feed it back and forth across the wheel's face. If the pieces A are set about right, the weight of the blade will furnish sufficient pressure to grind without bearing

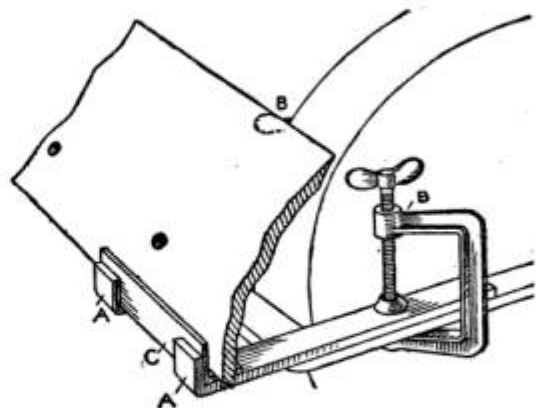

Holder for Grinding Machine-Cutter Knives on an Ordinary Stone or Emery Wheel

down on it and the hands simply move the knife across the stone. If a straight edge is required check it with a straightedge, unless this can be determined with the eye.

### To Plane Aluminum Segments

In a certain machine an aluminum band was required. This band being  $3\frac{1}{8}$  in. wide,  $34\frac{1}{2}$  in. inside diameter and 36 in. outside diameter, was cast in four segments. The only finishing required was to cut the width from  $3\frac{1}{8}$  in. down to 3 in., to smooth the edges and make each segment the same width.



To hold them so that they would not be bent out of shape was not an easy thing, as the light metal was readily sprung. All four pieces were put together on edge on the planer and placed against two angle plates to which they were lightly held with two clamps. Blocks of wood were wedged down in the spaces between the segments in their centers and then the clamps could be tightened sufficiently to hold the cut taken without bending the segments out of shape. After taking a cut on one side a clamp was put on the center to keep the pieces in position while turning them over and until the end clamps were again applied.

For roughing off aluminum use a keen, round-pointed and slightly V-shaped tool. For finishing, say, removing  $\frac{1}{100}$  in., use a broad, flat tool, and a highly polished surface will be the result.—Contributed by Donald A. Hampson, Middletown, N. Y.

### How to Plug a Boiler Tube

A leaky tube in a fire-tube boiler may be fixed at reasonable cost by means of plugs and a rod, as illus-

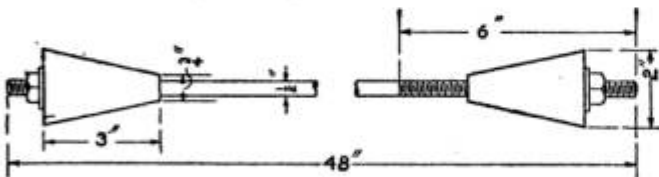

Tapered Cast-Iron Plugs and a Rod Used to Stop Up a Leaky Boiler Tube

trated. The dimensions given are suitable for a tube length of 40 to 44 in. and a diameter of about  $2\frac{1}{2}$  in. Two

pieces of cast iron are drilled with a  $\frac{1}{2}$ -in. drill and then turned tapering on the outside. A  $\frac{1}{2}$ -in. rod, with a short thread on one end and a longer thread on the other, is provided. One plug is driven into each end of the leaky tube, the rod is put in and the nuts are tightened. A little asbestos packing is of advantage. Other sizes may be made in proportion. A tube plugged in this manner will last for years, but it should, nevertheless, be taken out and replaced at the first opportunity, for the plugs are only intended as a temporary repair.

### Lengthening the Stroke Limit of a Shaper Head

A small shop with limited equipment but doing a great variety of general work is the birthplace of a great many ingenious methods for getting the work out in spite of innumerable obstacles. One small shop possessing a shaper with a limited stroke had a job of machining the bottom faces of a large crossyoke. The side toward the head of the shaper could be reached readily, but the head could not be thrown for-

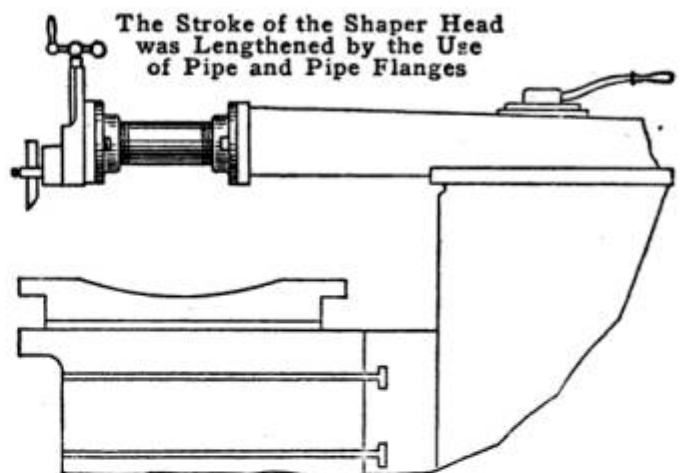

ward far enough to finish a cut on the opposite side of the yoke. It was impractical to shift the work in the chuck, as it was necessary to have the faces of the cuts true. The method used to overcome the difficulty was a last resort to prevent the job from going to another shop, and was very practical.

After the inner side of the yoke had been machined, the head of the shaper was removed and again applied after

two pipe flanges and a short nipple had been inserted, thus throwing the head of the shaper ahead of the limit allowed by its construction. The cuts taken were necessarily a trifle lighter to prevent chattering of the improvised head extension, but aside from that the results were very satisfactory. The sketch will readily show how the head was extended by means of the large pipe fittings.

### Oil Feed for Machine-Cutting Tools

A simple but good oil feed can be made of an old oilcan, as shown. The

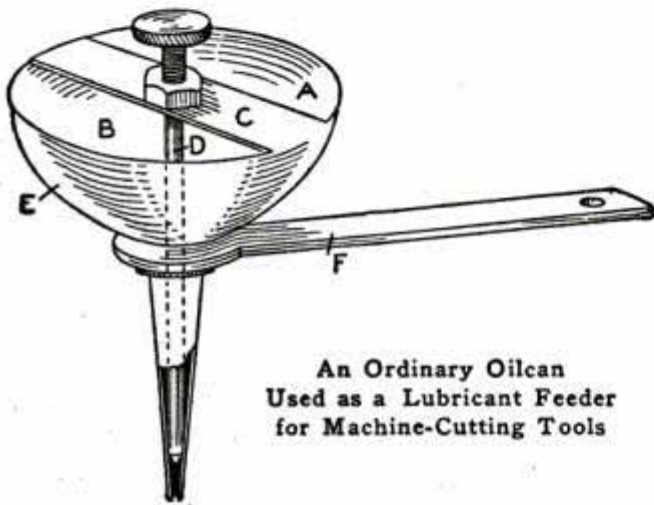

An Ordinary Oilcan  
Used as a Lubricant Feeder  
for Machine-Cutting Tools

sections A and B are cut from the bottom of the can, leaving the strip C, which is the width of a small-sized nut. The nut is soldered to the center of the strip, and a pin, D, threaded part way, is screwed through the nut, the unthreaded part being filed to a size a trifle smaller in diameter than the threaded part. A piece of sheet iron is shaped as shown at F, and slipped over the neck of the can, where it is held by the spout when the latter is in place. The can may then be attached to any part of the machine for use. Oil or lubricant is poured into the can and the flow regulated by the pin D.—Contributed by Jos. J. Kolar, Maywood, Ill.

### Glass Gauge Used as a Ruler

A heavy glass gauge makes an excellent ruler for ink work. In addition to its being transparent, it safeguards against accidental blotting, as any ink adhering to its surface is clearly seen.

### Holder for a Center-Clearance Drill

A very simple and handy tool for machinists, especially for those not supplied with combination centering



Holder for a Center-Clearance Drill  
to be Used in a Lathe

drills, is shown in the sketch. The tool consists of a piece of hexagon brass with a notch cut out, as shown at A, a V-shaped opening cut in the center with a hacksaw, and a hole drilled to receive the shank of a drill and a center hole drilled in the opposite end. The hexagon shape affords a ready grip for the hand. The dotted lines show the work when the holder is in position for use after being centered. The straight shank of the drill is ground tapering, like a chisel edge, to fit into the V-shaped notch cut in the holder.—Contributed by John Harger, Honolulu, H. I.

### Plunger Repair in an Automobile Gear Box

The plunger which prevents the gears in the gear box of an automobile from any movement broke, as indicated in the sketch, at A.

As a new one would cost more than I cared to pay I decided to repair it at home. The repair was made as shown. A piece of hardened drill rod was inserted to replace the broken upper portion and a steel ball was placed between the two pieces. By forcing the two together a firm and secure joint was made, the metal of the upper portion B being forced between the ball and the lower piece. This joint is much better than a threaded joint.

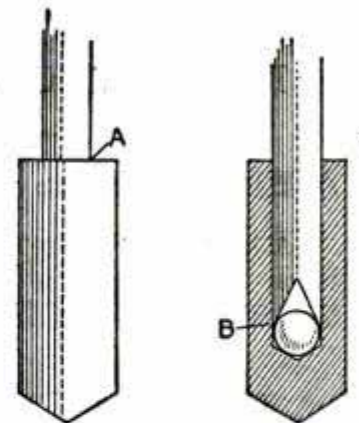

—Contributed by Adolph Klein, New York City.

## Cutting Special Threads without a Lathe

To make a screw on a rod or shaft of any diameter using only a standard thread cutter, proceed as shown in the

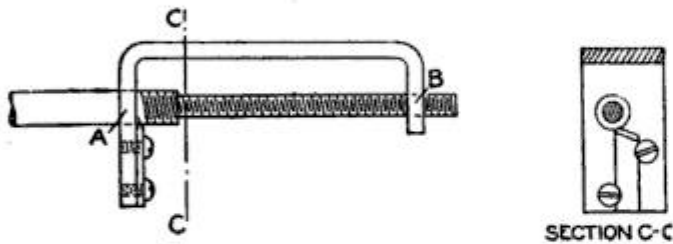

The Standard-Size Threads Make a Feed for the Tool Which Cuts the Threads on the Large Part

sketch. A piece of flat iron is bent and drilled, at A, to receive the shaft, and tapped, at B, with a standard thread of the required pitch. A thread-cutting tool is made of flat tool steel, ground to a 60-deg. cutting point and clamped to the flat iron with two screws, as shown.

The shaft on which the screw is to be made is turned down at the end and a standard thread cut on the end. The shaft is then inserted in the large hole in the flat iron and turned into the threaded hole, which causes a thread to be cut on the large part. A better thread can be made by taking several light cuts. The end with the standard threads is cut off, leaving only the special thread on the shaft.—Contributed by Phillip K. McGall, W. Orange, N. J.

## A Hinge to Make a Door Self-Closing

When fastening strap hinges on a barn door it is a good plan to bend the wings of the lower hinge at right angles as shown.

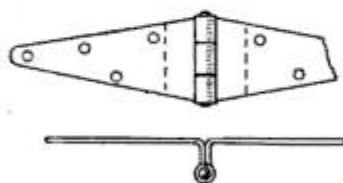

This is easily done by gripping the hinge in a vise  $\frac{3}{8}$  in. or more below the joint, the amount depending on the size of the hinge. A door arranged with a lower hinge of this kind will have a tendency to swing shut at all times.—Contributed by J. V. Loeffler, Evansville, Ind.

## Supplying Drinking Water to Shop Hands

A manufacturing concern found that their men lost about 15 minutes by stopping their machines, laying down their tools and walking to the cooler, located in the center of the shop, for a drink. Sometimes they had to wait their turn, or they would swap a story, walk back and start their work. The cooler was taken out and at regular intervals during the day a boy passed water to the workmen in individual glasses carried in wire trays. They also offered it to everyone in the offices, and it was rarely refused. This practice saved a large amount of time in a year and in addition improved the drinking habits and consequently the general habits of the men.—Contributed by T. F. Webster, Pittsburgh, Pa.

## Measuring the Thrust of an Aeroplane Motor

Sometime ago I had occasion to measure the thrust of my aeroplane motor, and as I had no scale large enough, I rigged up the arrangement

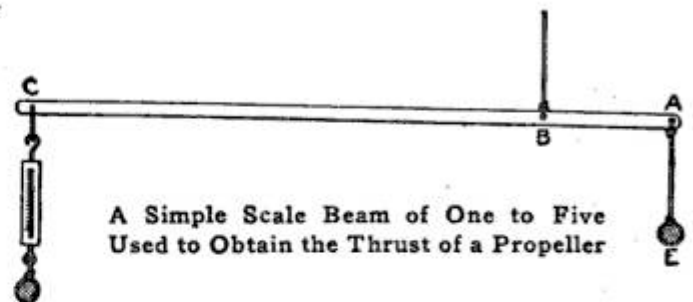

A Simple Scale Beam of One to Five Used to Obtain the Thrust of a Propeller

shown in the drawing, making the distance AB 1 ft., and AC, 5 ft. At A, the lever was fastened to the stake E by means of a wire; at B, the wire from the machine was fastened, and a 50-lb. spring balance was attached at C. The reading of the spring balance should be multiplied by 5.

If a larger balance were used it could be moved nearer B with more accurate results, the reading always being multiplied by the number of times AB is contained in AC.—Contributed by Geo. F. Hess, Corvallis, Ore.

### Draw Collets for Milling Tools

The milling machine I was using had a draw collet for  $\frac{1}{2}$ -in. cutter shanks, and as some work required the use of a  $\frac{3}{16}$ -in. end mill, I had no way of holding them. I therefore made a collet for these mills as follows:

A piece of cold-rolled steel, 2 in. long, was drilled centrally with a  $\frac{3}{16}$ -in. hole



A Draw Collet Having a Different Diameter in Each End for Small Mills

through its entire length, and then a  $\frac{1}{4}$ -in. hole halfway. A slot was cut through the diameter, beginning at one end and extending to within  $\frac{1}{8}$  in. of the other; then another slot was cut at right angles to the first slot and finishing  $\frac{1}{8}$  in. from the end in the same manner, only beginning and finishing at opposite ends from the first slot. This formed a double-end socket for  $\frac{3}{16}$  and  $\frac{1}{4}$ -in. end mills.

A draw collet can be made in this manner very cheaply, and it has two sizes. The smaller mills have the shank the same size as the cutter, which must have a holder, or else the tool will not run true.—Contributed by Walter Butz, Pearl River, N. Y.

### A Substitute Packing Screw

After breaking the last packing screw I had, in an effort to remove some old packing from the gland of a main feed pump, I used the next best thing that happened to be at hand, which was a  $\frac{3}{8}$ -in. lag screw, 6 in. long. This proved to be a better device to remove the packing, as the large thread took a good hold in the soft packing and did not pull out.—Contributed by Edwin M. Davis, Philadelphia, Pa.

### To Repair a Flush-Tank Float Valve

The outlet valve in my closet flush tank leaked badly and when I examined it, the rubber on the under side of the ball was found to be roughened by contact with the outlet seat and let the water through. The repair was made, after turning the water off, by removing the valve and cleaning the roughened surface well with gasoline, then applying rubber cement and a rubber patch larger than the valve seat. This fitted the valve seat smoothly enough to hold the water.—Contributed by W. E. Crane, Cleveland, Ohio.

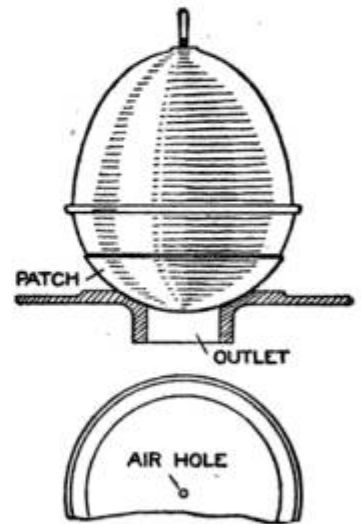

### To Handle Large Blueprints

Experience in handling large blueprints on the drawing board has proved the simplicity of the following method in saving much wear and tear on the prints and greatly facilitating the reference to any part. Fold the print into at least six parts, the folds running from the top to the bottom of the print. The folds can be turned over like the pages of a book, and the whole print occupies so much less space and is so much more easily handled that it can be kept on the drawing board without

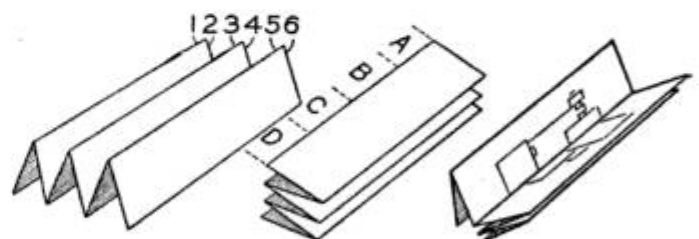

Folding and Indexing Blueprints for Ready Reference in Using on a Drawing Board

in the least interfering with the work. To still further facilitate reference where there is much confusing detail,

divide each print vertically into 6-in. spaces, giving each space a letter, beginning at the top with A. Number the folds 1, 2, 3, etc., as if they were pages in a book. By means of simple notes, as A-3, B-6, etc., like the marginal key to a map, this system provides a ready means of finding any desired part easily.—Contributed by J. Harmer Knight, Philadelphia, Pa.

### Claw Hammer Used for Detaching a Rim

An automobilist recently asked me to help him remove what he termed a quick-detachable rim from one of the wheels on his car. After watching him try to pry it loose with a screwdriver, I procured an ordinary claw hammer

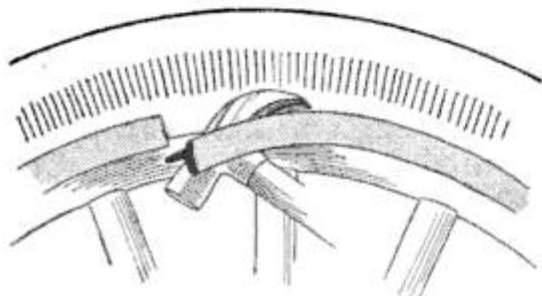

The Claw on a Carpenter's Hammer Inserted under a Rim will Quickly Remove It

and, inserting the claw in the space he had opened with the screwdriver, easily removed the rim. No doubt it would be a good plan to include a claw hammer in the auto tool box.—Contributed by James M. Kane, Doylestown, Pa.

### Removing Oil from Marble

In shops it is sometimes desirable to remove grease and oil from marble floors, or marble used in machine construction. An easy and effective way is to apply strong lye and quicklime. Any-strength solution can be made as needed and no matter how strong it may be, it will not injure the marble.

The best method of application is to simply throw on the lye, powder with the quicklime and use some water with a scrub brush. The solution can be kept ready for use and marble slabs can be cleaned daily.—Contributed by Loren Ward, Des Moines, Ia.

### Temporary Repair on a Valve-Gear Link

One of my men informed me that one of the larger boiler-feed pumps was disabled, says a correspondent of

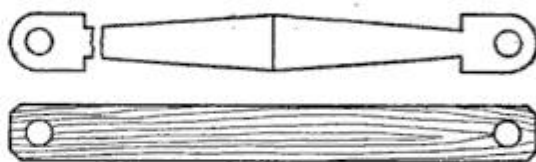

The Broken Link was Removed and One Cut from a Piece of Wood Substituted

Southern Engineer, and it was found that one of the links in the valve gear had been broken. As we had no spare pump at that time, something had to be done, and done in a hurry. Seeing a piece of 2 by 4-in. scantling in the boiler room, I grabbed a saw and soon had a wood link made, as shown in the sketch. In 35 minutes I had the pump running, and this served the purpose until there was time to have a new link made.

### A Double Lock for a Door

When a lock is of simple construction and a more secure one is desired an additional safety device can be

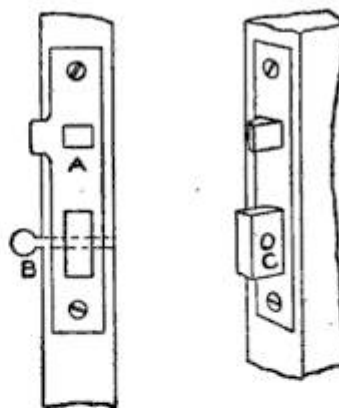

easily attached to it. The door is closed and the lock bolt turned, then a hole, about  $\frac{1}{8}$  in., is drilled through the frame of the door, just back of the plate A, passing through the bolt, as shown at C. By this arrangement the door can be secured from the inside with a pin, B, pushed into the hole and through the bolt C. A skeleton key, or other lock-picking devices, cannot withdraw the bolt. The hole in the bolt should be a trifle larger than the pin and countersunk slightly on both sides to allow for any slight movement out of line.—Contributed by Joseph J. Kolar, Maywood, Ill.



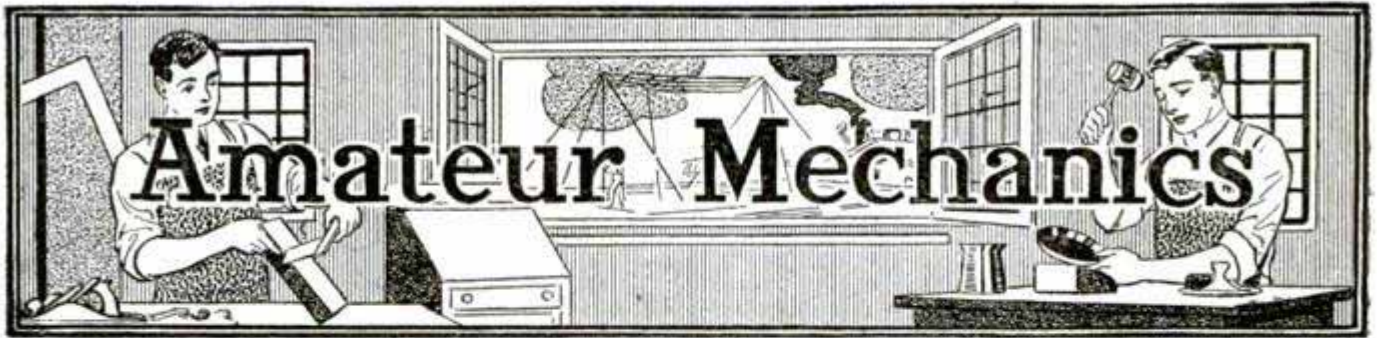

## A Snowball Thrower

By ALBERT BATES, JR.

The snow fort with its infantry is not complete without the artillery. A set of mortars, or cannon, placed in the fort to hurl snowballs at the entrenched enemy makes the battle more real. A device to substitute the cannon or a mortar can be easily constructed by any boy, and a few of them set in a snow fort will add greatly to the interest of the conflict.

The substitute, which is called a snowball thrower, consists of a base, A, with a standard, B, which stops the arm C, controlled by the bar D, when the trigger E is released. The tripping of the trigger is accomplished by the sloping end of D on the slanting end of the upright F. Sides, G, are fastened on the piece F, with their upper ends extending above the bar D, to

which all the working parts are mounted. The upper end of the arm C has a piece, K, to which is attached a

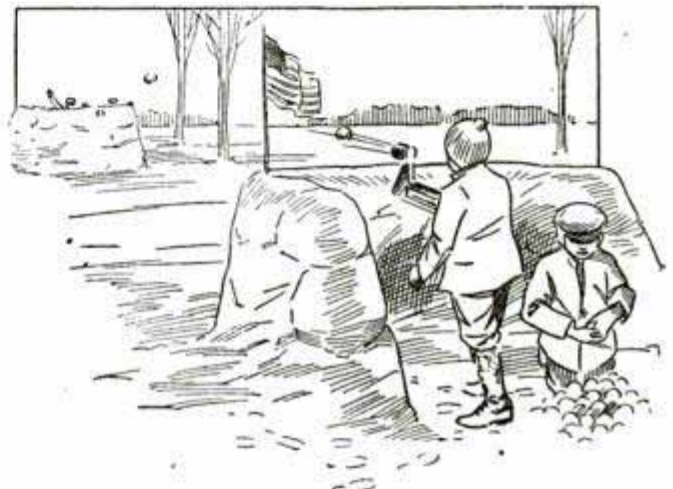

Cannonading a Snow Fort with the Use of a Snowball Thrower

tin can, L, for holding the snowball to be thrown. A set of door springs, M, furnishes the force to throw the snowball.

All the parts are given dimensions, and if cut properly, they will fit together to make the thrower as illustrated.

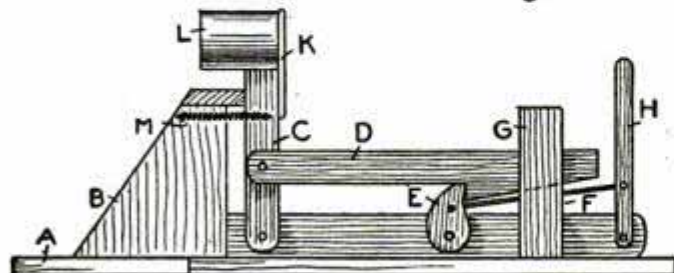
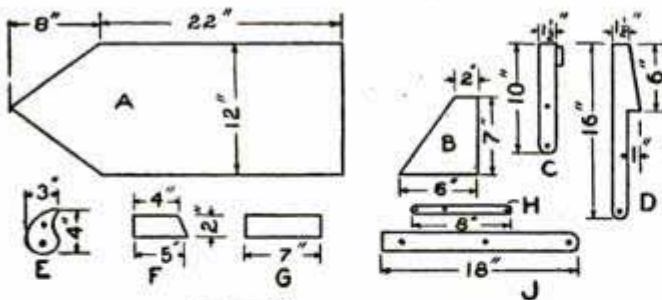

The Dimensioned Parts and the Detail of the Completed Snowball Thrower

prevent the latter from jumping out when it is released by the trigger.

The trigger E is tripped with the handle H, connected to the piece J, on

## Springs on the Chains of a Porch Swing

Two coil springs of medium strength placed in the chains of a porch swing will make it ride easier and also take up any unpleasant jars and rattles occasioned when a person sits heavily in the swing. If the swing is provided with a four-chain suspension, the springs should be used on the two rear chains to get the best results.—Contributed by E. K. Marshall, Oak Park, Illinois.

### A Simple Sextant

A sextant for measuring the latitude of any place can be easily constructed as follows: While a board, 1 in. thick, 6 in. wide, and 12 in. long is about right for the instrument, any dimensions can be used, providing the line AB is at perfect right angles to the level of the sights C and D. The sights are better to use, although the upper edge of the board, if it is perfectly straight, will do as well. If it is desired to use sights, a slight groove is cut in the upper edge; a V-shaped piece, cut from tin, is fastened at one end, and a small pointed nail is driven in at the other. In doing this, be sure to level the bottom of the V-notch and nail point so that in drawing the line AB it will be at perfect right angles to a line between the sights. A tack is driven into the side of the board at the upper edge, a line fastened to it and a weight tied to the lower end which should swing below the lower edge of the board.

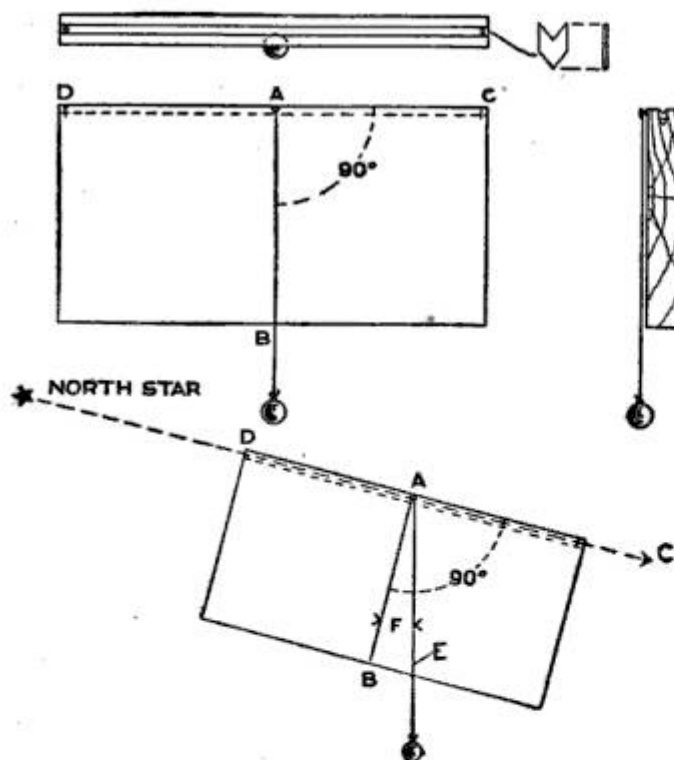

The Main Part of the Instrument Consists of a Board with a Plumb Attached

The instrument is placed in such a manner that the North Star is sighted, as shown, and the point on the lower edge of the board is marked where the line E comes to rest. A line is then drawn from A to the point marked and

the angle F is measured with a protractor. The number of degrees in this angle will be approximately equal to



The Two Stars at the End of the Great Dipper are Pointers to the North Star

the number of degrees in the latitude of that place.

The North Star is easily located by reason of its position relative to the Great Dipper, as shown by the diagram.—Contributed by Carlos Harrison, Anderson, Ind.

### How to Make a Taper Ferrule

Having occasion to make a taper ferrule of irregular form, a pattern from which to cut the material was made as follows: A mandrel of the desired shape was made, a piece of writing paper, soaked in water, wrapped around the mandrel, and a piece of twine wound over it, coil after coil like the thread on a spool. This was allowed to dry thoroughly, using a little heat. The string was then removed and a longitudinal cut made in the paper while on the mandrel. When opened this paper formed the pattern.

A piece of metal was cut from the pattern and the edges were brought together and brazed with spelter. The point of the mandrel was driven through a piece of block tin, about  $\frac{1}{2}$  in. thick. The mandrel was then removed, the ferrule was placed on it, and both then started in the hole made in the tin and driven through it. As the mandrel with the ferrule passed through the tin, the metal was shaped exactly to the mandrel. It is best to oil the hole in the tin slightly. Tin is preferable as it is harder.—Contributed by James H. Beebe, Rochester, N. Y.

## How to Make a Continuously Ringing Bell

The bell shown in the accompanying diagram is known as the continuously ringing type, and has quite a field of usefulness in connection with burglar alarms, door-bell signals, telephone signals, etc. The operation of the bell proper is identical with that of the ordinary vibrating bell and, in addition, there is a circuit controlled by the armature of the bell, which is normally open, but becomes closed as soon as the armature is drawn over. The closing of this circuit by the operation of the armature amounts to keeping the push button in the bell circuit depressed, and the bell will continue to ring until the latch A is restored by pulling the cord B.

Any ordinary vibrating bell may be converted into a continuously ringing bell as follows: In the armature, C, mount a short metal pin, D, and round off its under side slightly. A latch, A, should now be constructed similar to the one shown in the sketch and mounted in such a position that its left end will rest on the outer end of the pin D when the armature, C, of the bell is in its extreme outer position. The length of the latch should be such that its left end will drop off the end of the pin D, due to the action of the spring E, when the armature C is drawn over

the terminal of the bell marked H. The latch A is connected to one side of the line, as shown in the sketch, so as to include the bell winding and battery in a local circuit that is formed by the latch coming in contact with the spring G. The end of the latch should not interfere with the free operation of the armature when it is resting on the spring G. A cord, B, attached to the outer end of the latch, is used in restoring it, and at the same time stopping the bell from ringing. The tension in the spring E should be so adjusted that the operation of the latch is sure and firm, yet not too stiff.

## A Mission-Style Inkstand

Having a couple of good-sized ink bottles of the ordinary type lying

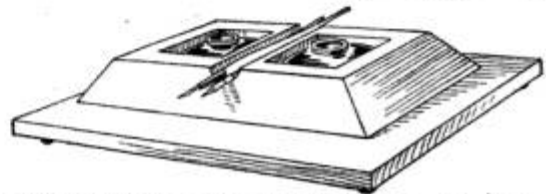

Two Pieces of Pine Shaped to Receive the Inkwells and Finished in Mission Style

around, I fashioned a mission-style stand for them out of a piece of yellow pine, 2 in. wide and 3 in. long, set on another piece of pine large enough to project all around on all four sides of the block, for a base. The wells were cut out with a wood chisel, and the parts fastened together with screws. The supports were four brass-head or upholsterer's tacks. The finish was flat black.—Contributed by James M. Kane, Doylestown, Pa.

## Raising Dents in Wood

The imprint of a hammer on finely finished wood caused by a glancing blow, or otherwise, may be removed in the following manner: Pour enough wood alcohol on the dented spot to cover it, then light the alcohol and allow it to burn out. The heat will expand the wood and raise it enough so that the spot can be planed and smoothed in the usual manner.—Contributed by W. F. Elwell, Waltham, Massachusetts.

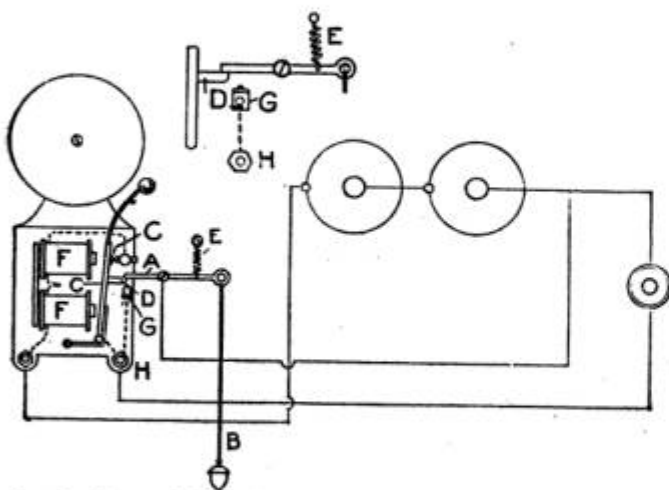

An Ordinary Vibrating Bell Used as a Continuously Ringing Bell, and the Wiring Diagram

by the electromagnets F, thus allowing it to come into contact with a spring G, which is electrically connected to

### Hinge with a Wide Swing

In constructing a box I needed a hinge that would carry the cover farther away from the top than the or-

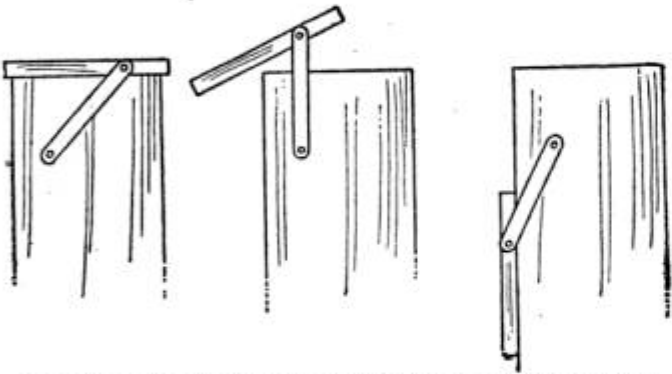

The Two Bars Provide a Way to Carry the Cover Away from the Box

dinary double-leaf hinge. I found that two pieces of  $\frac{1}{4}$  by  $\frac{5}{8}$ -in. wrought iron, attached in the manner shown, answered the purpose. By using round-head screws it was unnecessary to countersink the metal.—Contributed by James M. Kane, Doylestown, Pa.

### A Detachable Clamp for Stairway Handrails

The sketch shows a handrail clamp, or holding device, which is detachable, for use on stone stairways in the winter when there is ice or snow on the steps. The clamps are made of  $\frac{3}{16}$ -in. strap iron, of any desired width, conforming to the shape of the balustrade and provided with a hook at either end. To the inside end of the band an upright is riveted and to this upright is riveted an ordinary handrail holder to take the handrail. A heavy thumb screw allows the clamp to be fastened firmly to the balustrade at the outside.

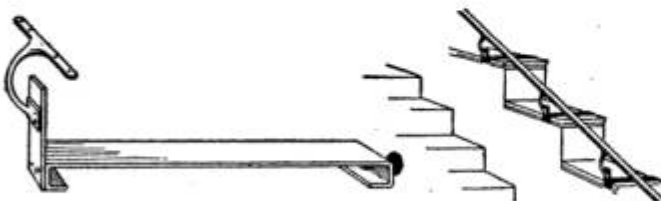

A Detachable Handrail for Use on Stone or Concrete Stairways during Winter

This is a simple and inexpensive device which affords protection against falls.—Contributed by John De La Mater, Chicago, Ill.

### A Homemade Leather Punch

An empty bottle-neck rifle cartridge can be easily made into a leather punch by grinding the edge of the opening sharp and cutting a hole near the top in one side. The hole is for removing the leather slugs and should be just a little larger in diameter than the inside diameter of the shell. The cartridges can be had in various sizes and almost any size of punch can be made.—Contributed by Merhyle F. Spotts, Shelby, Ohio.

### A Wood-Scraper Handle

In using a plain scraper on the surface of wood the task grew exceedingly tiresome and I lightened the tedious work to some extent by making a handle for the scraper. The handle consisted of a piece of wood, 1 in. thick, 3 in. wide, and 6 in. long. A cut was made in the edge of the wood the width of the scraper blade and about 3 in. deep, and a bolt run through a hole bored centrally in the side, about

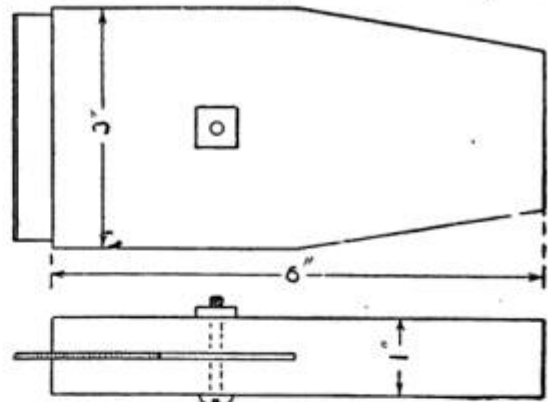

A Handle Attached to a Plain Scraper Blade Makes the Work Much Easier

$2\frac{1}{2}$  in. from the lower edge. The blade was clamped in place with the bolt.—Contributed by J. D. Keiley, Yonkers, New York.

### Polishing Gunstocks

The fine polish applied to gunstocks and wood parts of tools will not wear well, and if one cares for a fine finish, a much better and more durable polish can be applied as follows: Soak the wood in linseed oil for a week and then rub the surface with an oil-soaked cloth for a short time every day, for a couple of weeks.

## Electrical Heating Apparatus for the Home

By ARTHUR MOORE

## Part I—A Three-Heat Electric Pad

There is, perhaps, no electric-heating device on the market at the present time that will give the user better satisfaction or more solid comfort than the electric heating pad. This device, as all others heated by electricity, depends upon the heat generated in a wire when there is a current of electricity in it; and the amount of heat, thus generated, depends upon the value of the current and the resistance of the portion of the wire considered. In this particular device the heat generated in any portion of the circuit should not be such that there is any likelihood that cloth or other combustible material in contact with the wire be set on fire.

In brief, the heating pad described consists of a piece of specially insulated resistance wire, sewed between two pieces of muslin and provided with the necessary protection devices to prevent any serious damage that might result from short circuits or the restraining of the heat in the pad to such an extent that its temperature may become dangerously high.

The first, and as a rule the most difficult, thing to be procured in order to construct a heating pad is the wire that is to form the heating element. There are, at present, numerous kinds of wire on the market that might be used, if it were not for the fact that the wire must have an insulation of asbestos, or other suitable material, which will not easily catch fire. The heating element, in a pad constructed by the writer, was made of what is known as heating-pad wire, it being manufactured by several companies especially for this purpose. In this heating-pad wire, the bare resistance wire is wound around a core of asbestos, about  $\frac{3}{32}$  in. in diameter, the turns being approximately  $\frac{1}{16}$  in. apart, and outside of this an asbestos insulation is either woven or twisted on. Almost

all heating pads now on the market are constructed of wire made up in a similar manner. The wire used by the writer had a resistance of 23 ohms per foot and was about  $\frac{5}{32}$  in. in diameter, outside the insulation.

The amount of wire necessary depends upon the resistance of the circuits, and the size of the wire upon the current it is to carry.

In order that the degree of heat

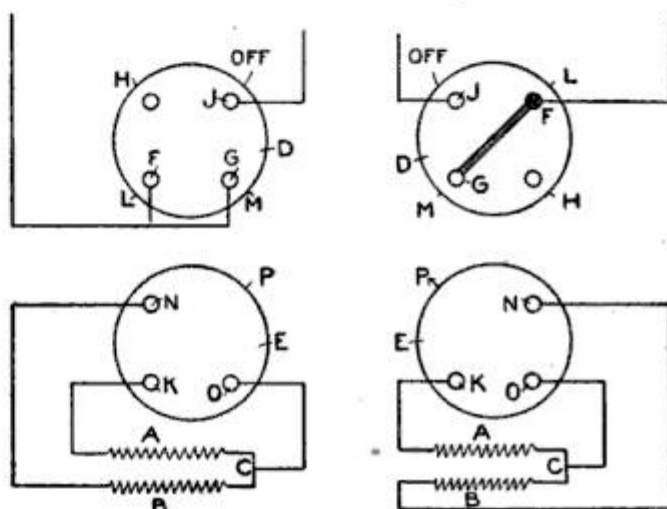

FIG. 1  
FIG. 2  
Connections of the Heating Elements to Produce Three Changes of Heat in the Pad

generated in the pad may be varied, some simple arrangement must be provided to change the watt-input to the pad by altering the connections of the wires forming the heating elements. Such an arrangement, by means of which three heats may be obtained, is shown diagrammatically in Fig. 1. The heating element is divided into two equal parts, A and B. These two parts are joined at the point C, and three leads extend, from the point C and from the extremities of A and B, to a special switch, as shown in the upper part of the diagram. This switch consists of two cylindrical pieces, D and E. Four holes, three of which have metal clips in them, are provided in D, and three projecting lugs are provided on the piece E. The metal clips are indicated by the letters F, G, and J, and

the three lugs by K, N, and O. These clips and lugs should be mounted in the exact corners of two squares of exactly the same size, so that the lugs on the piece E will enter the clips mounted in the holes in the piece D. The three leads from the resistance element are connected to the lugs in the piece D, and the two leads from the source of energy are connected to the clips in the holes in the piece E, as shown.

By an inspection of Fig. 1 it will be seen that, if the piece D be placed directly over the piece E, the circuit will not be completed through any portion of the heating element, because the terminal of the circuit, from which energy is to be derived, that is connected to the clip J is not connected to any part of the heating element. If, however, the piece D be turned through 90 deg. in a clockwise direction, and then placed over the piece E a circuit will be established through both the resistances A and B. Turning the piece D through another 90 deg. in the same direction connects the two resistances in series, and when the piece D is turned through the next 90 deg. the resistance B is in circuit alone. If the resistance of the elements A and B are the same, the total resistance in circuit, for the positions of D with respect to E mentioned, will be as follows: When the two resistances are in parallel, their combined resistance is equal to one-half the resistance of either of them, and when the two are in series, their combined resistance is equal to twice that of either of them. The resistance of the circuit is a maximum when the two elements are in series; it is one-half this amount when a single resistance is in circuit, and one-fourth of the series resistance when the two elements are in parallel. If the voltage impressed upon the circuit in the three cases is the same, the current for the parallel connection will be four times that for the series connection, and the current with the single resistance will be twice that for the series connection. The watt-input to the circuit for the

parallel connection will be four times that for the series connection, and with the single resistance the watt-input will be twice that for the series connection.

The maximum input to the ordinary heating pad is usually in the neighborhood of 66 watts, the size of the pad being approximately 12 in. by 15 in. This input of course corresponds to the parallel connection. For the single resistance, it would be 33 watts, and for the series connection, 16.5 watts.

A connection that will give a better gradation of heat for the three positions of the switch is shown in Fig. 2. In this method of connecting the resistances, they are used singly and in parallel. The resistances A and B should be in the ratio of one to two. Some difficulties will be experienced in constructing the pad if the same size of wire is to be used for both A and B, as they will be of unequal length and cannot be placed side by side. This difficulty can, however, be overcome by using two wires in parallel, permanently connected together, for the lower of the two resistances.

Assuming that the watt-input to the heating pad to be constructed, for the three different heats, are to be 22, 44 and 66 watts, respectively, proceed to determine the values of the resistances A and B. The current in the three cases will be .2, .4 and .6 ampere, respectively, if the voltage is 110, and the resistances will be 550, 275 and 183 ohms, respectively. The 183 ohms is the combined resistance of the 550-ohm element and the 275-ohm element in parallel. For the connections shown in Fig. 2 the resistance A should be the larger. The wire used by the writer was a No. 32 gauge, and had a resistance of 23 ohms per foot, so that  $\frac{550}{23}$ , or 24 ft. were required for the high-resistance element, and a like amount for the low-resistance element, since it was composed of two wires in parallel which gave a circuit of the same length in both cases. It is not necessary to use more than 12 ft. in the low-resistance circuit, but in this case extra

loops should be made in the longer circuit when they are being fastened in the pad.

If the wire obtained has a different resistance per foot than that given above, the proper change should be made in the lengths ordered.

The construction of the pad proper is as follows: Having procured the wire, next obtain four pieces of rather heavy unbleached muslin, two pieces of bleached muslin, and two pieces of "iderdown;" all approximately 13 in. by 16 in. Start with the two pieces of resistance wire near the center and

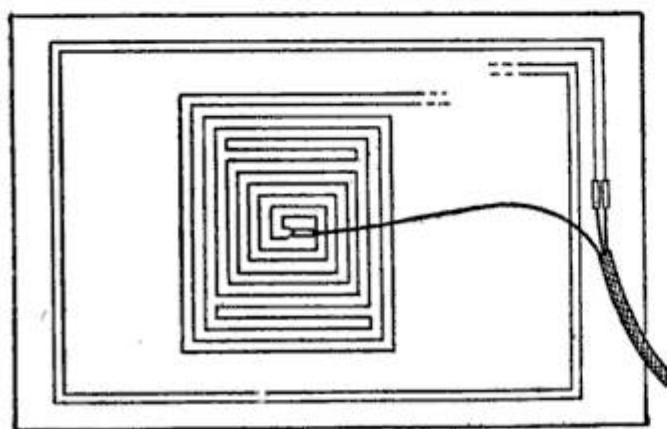

FIG. 3

The Arrangement of the Heating Element in the Pad So That No Part Touches Another

baste them on one of the pieces of unbleached muslin, about as shown in Fig. 3. Several extra loops should be made in the longer piece so that both pieces will terminate at the same point. It may be necessary to repeat the above operation several times before the proper distribution of the two circuits can be made. Both pieces of wire should be thoroughly inspected along their entire length before they are fastened to the muslin, to make sure that there are no blemishes in the insulation. When satisfied with the arrangement of the two circuits, a second piece of unbleached muslin should be placed on top of the wire and stitched to the under piece of muslin, all the way along between the wires. The ends of the resistance wires should be brought out through holes made in the upper piece of muslin, and allowed to protrude about 1 in., and the two pieces of muslin securely bound together around the edges.

Obtain a piece of three-conductor lamp cord, about 3 ft. long, and remove the outside insulation for a distance of approximately 8 or 9 in. Join the inside ends of the resistance wires to one conductor of the cord, at the end where the insulation has been removed. Cut off about 5 in. of the other two ends and join them to the outside terminals of the resistances. Some difficulty will be experienced in trying to solder the resistance wire, and it will be best, perhaps, to just twist the ends of the resistance wires and copper conductors securely together and then tape the joint. It would be best also to have the outside terminals terminate, if possible, at the center of one of the short sides of the pad, and to run the cord along the edge to the corner, sewing it fast to the muslin, all the way along, with heavy thread. The outside dimensions of this portion of the pad should be about 11 in. by 14 in.

A muslin bag should then be made from the two remaining pieces of unbleached muslin and fastened over the pad permanently. A second bag should be made from the two pieces of bleached muslin, but an opening should be left in one corner so that it can be easily removed. An outside covering should be made from the pieces of "iderdown," which is also arranged so it can be easily removed.

This completes the heating pad. The special switch shown in Fig. 2 may be made as follows: Obtain two cylindrical pieces of rubber, or other similar insulating material, about 1 in. in diameter and  $1\frac{1}{4}$  in. long. Draw a circle,  $\frac{5}{8}$  in. in diameter, on one end of each of these pieces, and lay off four points equidistant around these circles. In one piece drill three  $\frac{1}{8}$ -in. holes to correspond to those shown in E. Procure three pieces of brass rod,  $\frac{3}{32}$  in. diameter and 1 in. long. Round off one end of each piece, giving it a slight taper back about  $\frac{1}{2}$  in., and drill a  $\frac{1}{16}$ -in. hole in the other end to a depth of  $\frac{1}{4}$  in. Open up the end of the three-conductor cord leading from the heating pad and solder the three ter-

minals in the ends of the three pieces of brass. The insulation around each cord should be bound with a piece of linen thread, close up to the piece of brass. Now shove these pieces of brass up through the holes in the piece of insulation E until they protrude about  $\frac{1}{2}$  in. When they are all in place, drill a small hole through the insulation and each rod, in turn, and drive a small metal pin into each of the holes, so that the ends of the pieces are below the surface of the insulation.

Obtain three  $\frac{3}{4}$ -in. pieces of thin brass tubing, of such inside diameter that it will not quite slip onto the pieces of brass, before they are tapered. Split each of these tubes a distance back of about  $\frac{1}{2}$  in. by means of a fine saw, and solder a piece of lamp cord into the back end of two of them. Next drill four holes, in the remaining piece of insulation D, of such a size that these pieces of brass tubing will fit snugly in them. Shove the pieces of tubing down into these holes so that the end opposite the cord will be about  $\frac{1}{8}$  in. from the surface of the end of the piece of insulation. Two of these tubes should be connected together by means of a metal pin, driven into a hole drilled through the two tubes and the insulation. The third tube should be fastened in place by a separate pin.

A small metal screw eye should be fastened in the back end of each piece of insulation to be used in anchoring the cords so as to take the strain off the soldered connections. Heavy linen thread may be used for this purpose.

The switch may be made self-indicating by placing an arrow P on the part E, and four arrows on the part D, in such positions that they in turn are opposite the arrow P, as the piece D is placed in its four possible positions. The four arrows on the piece D may be marked "off," L, M, and H, as shown in Figs. 1 and 2, meaning open circuit, low heat, medium heat and high heat, respectively.

An ordinary plug should be connected to the remaining end of the

three-conductor cord and the heater is ready to be tried.

Practically all heaters are equipped with thermostats, mounted in the pads themselves. These thermostats open the circuits, if the heat should exceed a predetermined value, depending upon the adjustment of the thermostats. Space will not permit the description of a thermostat suitable for this particular purpose, but it differs little from any ordinary thermostat, except in point of size. One should be extremely careful in the use of this pad until perfectly familiar with its behavior under all ordinary conditions.

(To be continued)

### Combination Workshop Seat

A most practical and satisfactory way of using a stool in a small workshop is shown in the illustration. In much of my small work at the bench I find it an advantage to sit, and for that purpose I purchased a small stool. My lathe is operated by a geared foot motor, provided with two foot levers which may be operated singly in a standing position or both at a time when sitting.

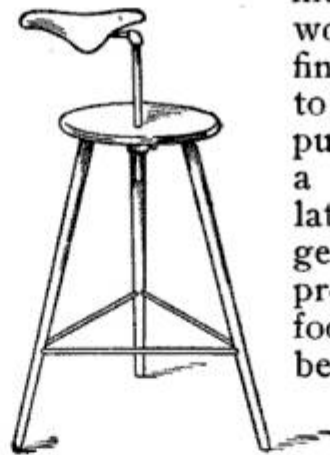

The attachment shown converts the stool, the seat of which is too low except for bench work, into a comfortable and neat seat for working at a lathe. The sketch is self-explanatory.

A plate with a setscrew is mounted under the center of the stool seat, through which a hole is bored for the seat post. Two pieces of iron pipe, an elbow and an old bicycle saddle constitute the remaining parts of the device. Provision is made for adjustment as to height, and the position of the saddle may be changed in the ordinary way by using a wrench on the part which grips the horizontal length of pipe, just the same as the seat on a bicycle-seat post is adjusted.



### A Prick-Punch Center Gauge

A simple instrument for finding and marking the center of shafting, etc., can be easily made of three pieces of sheet brass and a small prick punch.

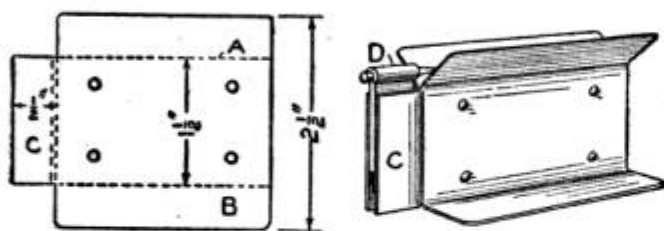

The Point of the Punch is Quickly Adjusted to the Center of the Work

Take two pieces of stiff sheet brass,  $2\frac{1}{2}$  by 3 in. in size, and cut two corners,  $\frac{1}{2}$  in. square, out at one end of each piece as shown in the sketch. Bend the metal on the dotted line A, until it stands at an angle of 45 deg. The part B should be bent up in the same direction, but at right angles to the plate, while the part C should be bent out only slightly. A hole should be drilled near each corner for rivets. Be sure that the two plates are bent in opposite directions, then rivet them firmly together.

Roll one end of a strip of sheet brass,  $\frac{7}{8}$  in. wide and  $2\frac{3}{4}$  in. long, into a tube large enough to firmly hold a small steel prick punch. Place the opposite end of the brass strip in between the two ends C. These ends should spring together slightly in order to hold the punch D at any height it may be placed. If accurately made, the point of the punch will be exactly in the center of the V-shaped trough.

In use, to find and mark the center of a round bar, it is placed in the trough with the end just touching the point of the punch. The brass holding the punch is raised between the parts C until the point of the punch is brought as near to the center of the shaft as can be judged. Press the point of the punch against the end of the shaft and turn the latter in the trough. If the punch marks a circle the center has not been found. This is corrected by slowly moving the punch up or down until the point ceases to make a circle, then the punch is tapped with a hammer to mark the exact center.

### A Whirligig Clapper

A good noise maker for Halloween or any other occasion, can be made by carefully following the directions here given. The box is the first thing to make. It is constructed of wood pieces,  $\frac{1}{2}$  in. thick, and consists of two ends and two sides. The ends are each  $1\frac{1}{2}$  in. square and the sides  $1\frac{1}{2}$  in. wide and 6 in. long. These parts are nailed together with the ends lapping the sides.

The ratchet wheel A is a disk of hard wood,  $1\frac{1}{2}$  in. in diameter. Its rim is divided into eight equal parts, and notched with a knife as shown. It is placed in the forward end of the box on a wood axle of  $\frac{3}{8}$ -in. diameter to which it is glued. One end of this axle is squared and projects 1 in. beyond the side of the box. The squared end passes through a square hole in the end of the crank C, which is a piece of wood  $\frac{3}{4}$  in. thick, 1 in. wide and 4 in. long, and is fastened with brads and glue. At the other end of the crank, a similar hole connects with a handle whittled to the shape shown at B.

A flat piece of steel spring,  $\frac{1}{2}$  in. wide and long enough to reach from the rear end of the box to the teeth of the ratchet wheel, is shaped as shown at D. The spring may be made from a stiff piece of corset steel or bicycle

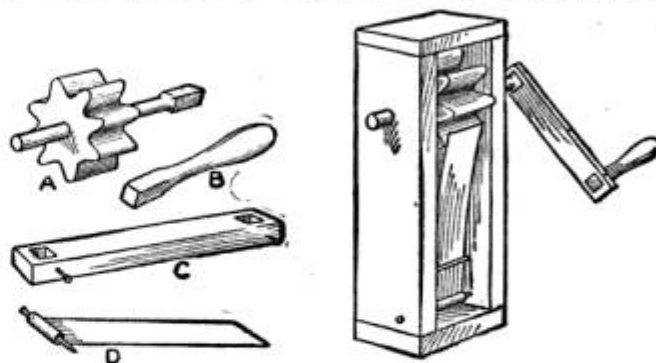

Detail of the Parts and How They are Assembled to Make the Clapper

trousers guard. The spring is fastened with a nail through the end and box sides and a second nail passes through the sides over the spring, about 2 in. forward from the first nail. This is to give the spring tension on the teeth.

To operate the clapper, it is allowed

to hang straight down, while the right hand grasps the handle and whirls the box in a circle around to the left.—Contributed by C. C. Fraser.

### Box Partitions

As I needed a box with a number of narrow partitions and it was impossi-

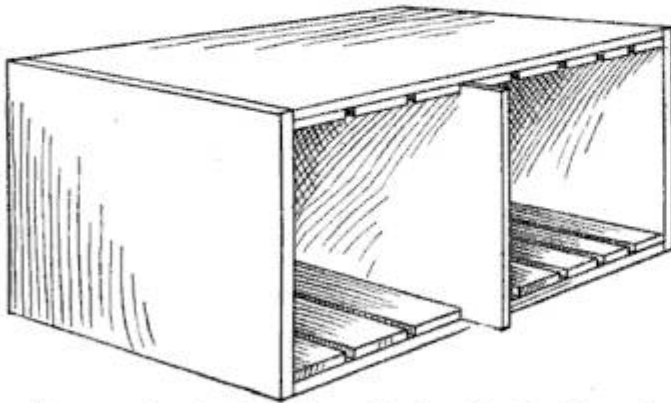

Grooves for the Partitions Made with the Use of Small, Thin Strips of Wood

ble to cut grooves for the sections without removing the bottom, I spaced off the places for the partitions with pieces of thin wood and fastened these in place with small nails clinched on the outside of the box. This method was much more rapid and satisfactory than sawing the grooves and cutting them out with a wood chisel.—Contributed by James M. Kane.

### Safety Catch for a Flour Bin

A flour bin, counterbalanced to swing closed at all times, is liable to

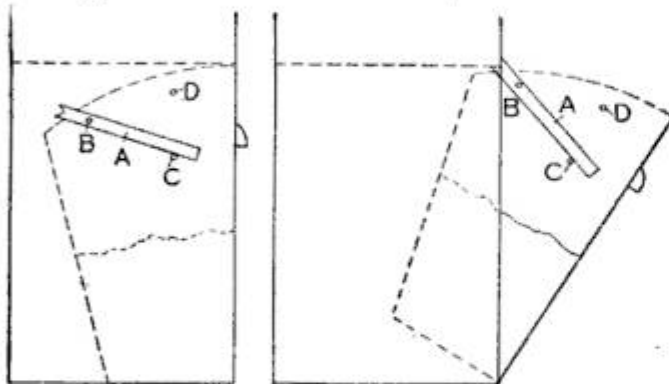

FIG. 1

FIG. 2

Automatically Operated Catch to Hold a Flour Bin Out While Taking Flour from It

catch the arm of the one taking out flour. To make it safe, I applied the device shown in the sketch. The bin, at rest, is shown in Fig. 1. The safety catch consists of a stick of wood, A,

notched at one end, and is pivoted at B on a small bolt. Two stops, C and D, are located on the side of the box to prevent the catch from being thrown out of position when the bin is quickly pulled out. These stops are nails driven into the box side. When the bin is pulled out the catch takes the position shown in Fig. 2. The catch stick should be a little shorter than the distance the bin is pulled out, so that it may be raised to release the bin for its return.—Contributed by O. F. Fouche, Erie, Pa.

### A Homemade Whistle

Procure two empty No. 30 gauge brass cartridge shells. Cut one shell  $\frac{3}{8}$  in. shorter than the other, then flatten and bend them as shown in the sketch. The mouthpiece should be at an angle of 60 deg. File a slot,  $\frac{3}{16}$  in. in width, about  $\frac{1}{2}$  in. from the end. File off the flange on the shorter shell so that it will fit snugly against the



The Tapering End of a Cartridge Shell is Flattened and Bent to Make a Whistle

side of the other and solder them together. A ring may be soldered on the end of the long shell to fasten it on a chain or string. To give the whistle a shrill sound place a large shot in each shell before flattening them.—Contributed by Peter Veneman, Paterson, New Jersey.

### How to Emboss Stationery

A person's monogram or any special lettering embossed on stationery is quite expensive. The engraving of the dies by experts commanding high salaries, and the subsequent presswork necessary to give relief to the design upon the paper cause an expense which the economical person hesitates to accept, much as the refinement and individuality of the embossed work

may be admired. But there is a way by which almost anyone may emboss stationery at home with one's own design at no expense whatever. The work is easy and the results pleasing, and monograms or lettering thus done will compare very favorably with the printer's work, especially if there is a good design to follow and the work is done with care. A little artistic ability will, of course, aid one in preparing a design, but is not essential, for the letters required may be cut from printed matter and used as a guide for tracing. There is no limit to the varieties of work possible by this process. Single letters, monograms, words or designs are suitable for reproduction in raised characters.

All the materials required for embossing the stationery are the envelope or paper on which the design is to appear, a stylus and a blotter. The paper should be of fair quality. If it is too thin the stylus point is likely to push through it. The linen-finished papers of medium weight and tough texture give excellent results, although almost any grade of good writing paper can be used successfully. As embossing by this process can be done well only through one thickness of paper, in working on envelopes it is best to put the design on the central portion of the flap, or turn it up and make the design in the left-hand corner of the envelope.

The stylus may be any kind of a pencil-like instrument, easy to grip between the fingers, with a hard, smooth point, rounded slightly so that it will not cut the paper. The ordinary bone stiletto, used in embroidering, makes an ideal tool for this purpose. If this is not to be had, a substitute is easily whittled from a piece of hard wood. Even a wire nail, with its point smoothed with a file, may be used, the upper portion being wound with string to afford a better grip.

The blotter should be white, perfectly clean, and of good weight. A thin, hard blotter will not produce a good raised letter as a softer one will. When the surface of a blotter has be-

come covered with creases from repeated use, it should be discarded and a new one substituted.

As it is best to adopt a distinctive form of monogram or design for stationery and to use it without deviation, it should be selected or worked up with care until something is outlined that will suit. With the design settled upon and drawn on a piece of paper, go over

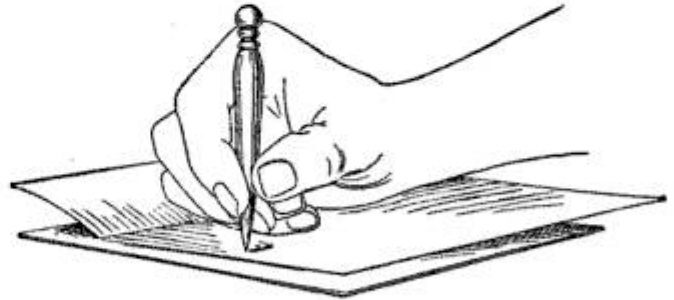

Manner of Holding the Stylus When Tracing the Design on the Back Side of the Paper

it with a soft pencil to deposit sufficient graphite for an impression. Lay the pattern, face down, upon the back of the paper to be embossed, and directly opposite the spot on the other side where the raised characters are to appear. With the handle of a knife or scissors rub over the back of the pattern till the graphite has left the tracing of the design reversed on the writing paper.

The pattern is now laid aside until required for transferring the design to another sheet of writing paper. Lay the blotter on some smooth, hard surface, such as a desk leaf or table top and lay the writing paper on the blotter, reversed design uppermost. Hold the stylus firmly at an angle as shown in the illustration and keep the blotter and paper from moving with the other hand. Carefully trace the design, using considerable pressure to insure a good relief upon the opposite side of the paper. A soft eraser should be used to remove the guide marks on the back of the sheet when the relief is finished.

After a little practice with a certain design, if it is not too intricate, the operator will find that it can be reproduced quite faithfully freehand, without the use of the pattern, but, of course, the use of the pattern will be the only guarantee of exact duplicates.

## INTERESTING NEW PATENTS

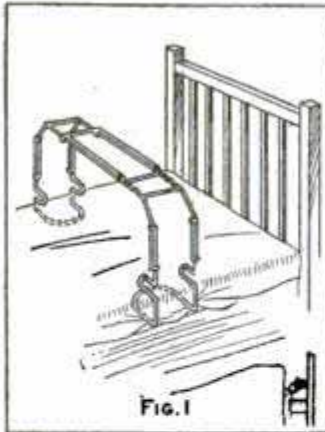

Fig. 1

**SUPPORT FOR BED CLOTHING** (Fig. 1)—This adjustable frame is intended to support the bed clothing in such a manner that it will not come in contact with the occupant of the bed, and is designed particularly for use in the sick room. It is adjustable for height and can be fitted to any size of bed by means of the sliding connections, as shown. The lower ends of the frame consist of loops which are slipped in between the springs and mattress.

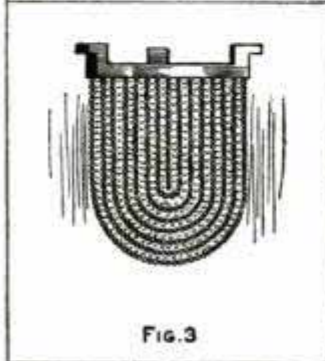

Fig. 3

**EGG LIFTER** (Fig. 2)—This kitchen utensil is a handy substitute for the spoon or ladle ordinarily used in removing boiled eggs from the boiling water. The metal strips across the lower loops are bent to such a shape as to hold an egg securely.

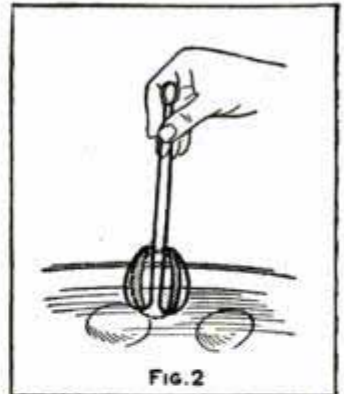

Fig. 2

**INCANDESCENT GAS MANTLE** (Fig. 3; British patent)—This mantle is to be used in inverted position, as shown, and consists of a series of wire loops on which are threaded beads capable of being made incandescent by the heat of the flame. The wires are suspended from the ring at the top of the lamp and may be braced together by cross wires if desired.

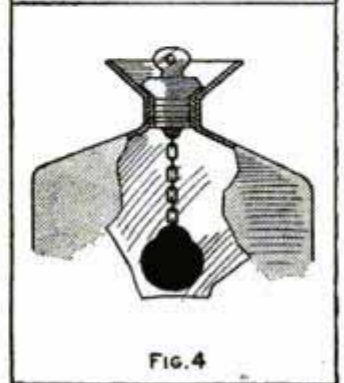

Fig. 4

**STOPPER FOR HOT-WATER BOTTLE** (Fig. 4)—The interesting feature of this device is the attachment by which the stopper is secured to the bottle and is thus prevented from becoming misplaced or lost. The metal strip suspended from the chain is too large to pass through the neck of the bottle, while the chain is long enough to permit convenient emptying or filling of the bottle.



Fig. 5

**PISTOL MADE TO LOOK LIKE WATCH** (Fig. 5)—The object of this invention is to provide a pistol that can be carried in the vest pocket and that can be presented and fired at a highwayman while apparently obeying his command to "hand over your watch and be quick about it." The muzzle of the pistol is the milled head of what is apparently the winding stem. The trigger is a round bar which slides in a groove and runs back to a point where it engages the hammer. The pistol is fired by pressing the projecting end of the trigger back until it loses engagement with the hammer, as in the usual automatic pistol. In loading, the inner tube of the barrel is removed by turning the milled head, a fresh cartridge is inserted, and the tube is screwed back into place.

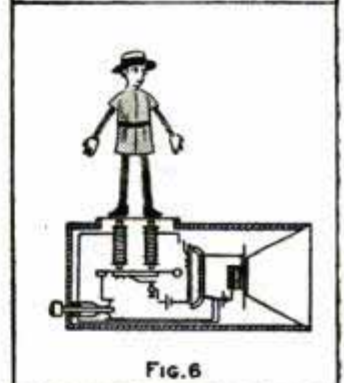

Fig. 6

**TOY OPERATED BY SOUND** (Fig. 6; British patent to Hungarians)—This is an electrical device operated by the vibration of a microphone placed in the end of the case. Through a system of magnets and circuit breakers a succession of sounds received by the microphone causes the figure to dance.

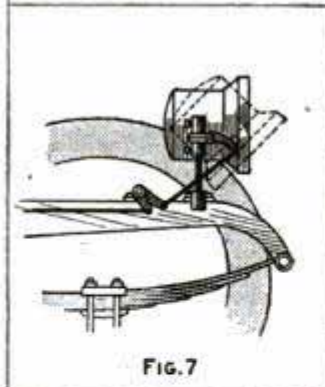

Fig. 7

**MOVABLE HEADLIGHT FOR AUTOMOBILE** (Fig. 7)—This headlight is so mounted and controlled that the driver can throw the light up or down as desired. Its principal value is in throwing the light down to avoid producing glare in city streets or when meeting another car. The headlight is controlled from the driver's seat.



Fig. 8

**SHOE FASTENER** (Fig. 8)—This novel form of shoe fastener consists of an arched spring-metal plate provided at each end with a hinged arm which is passed through the opening in the shoe. The arm is curved to fold closely against the under side of the plate.

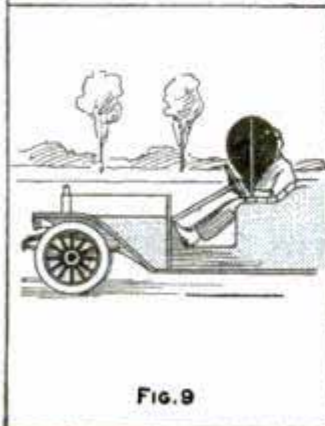

Fig. 9

**WIND VANE FOR AUTOMOBILE** (Fig. 9; British patent to an American)—One or more of these vanes are placed on a car to counteract the centrifugal force of the car when it is taking a curve. These vanes may be turned to any position by means of a pedal to which they are chain connected.



Fig. 10

**ROCKERS FOR BABY CARRIAGE** (Fig. 10)—This device for converting a baby carriage into a cradle consists of two grooved rockers with sliding hooks for clamping the rockers to the wheels. The rockers are spaced the right distance apart by cross-bars.



Fig. 11

**HOLDER FOR COW'S TAIL** (Fig. 11)—This holder is designed to prevent a cow from switching her tail while being milked, a deplorable habit to which many milch cows are addicted. It consists of two toothed plates which are clamped to the long-haired part of the tail by means of a setscrew, and an attached strap which is buckled around the cow's hind leg.

**DEVICE TO PREVENT SNORING** (Fig. 12; British patent to a German)—As a rule snoring occurs only when the mouth is open, and this device is intended to prevent snoring by keeping the mouth closed in a manner that will be comfortable to the sleeper. It consists of a collar having a support for the chin and provided with fastenings for attaching to the front and back of the night garment.



Fig. 12

**ROUND-TOP TABLE EXTENSION** (Fig. 13)—This table is designed to do away with the necessity for inserting detached leaves when the table is to be extended. The extension leaves are hinged to the inner edges of the top sections and are concealed under the top when not in use. When the top is pulled apart the leaves are guided into position by a mechanism consisting of springs and extension arms.

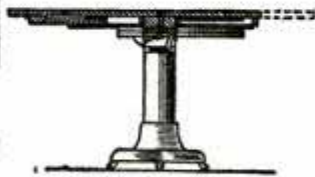

Fig. 13

**APPARATUS FOR FILLING TOBACCO PIPE** (Fig. 14; British patent to an American)—This filler is cylindrical in form, to fit the bowl of the pipe, and has an opening on one side to which a tobacco pouch is fitted. The cylinder is filled from the pouch and the charge of tobacco is then forced into the pipe bowl by means of a plunger. The plunger is provided with a spring which returns it to its original position as soon as released.

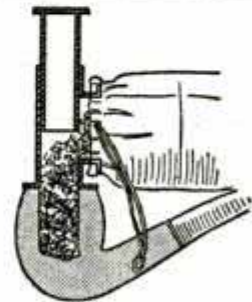

Fig. 14

**MIRROR ATTACHMENT FOR AUTOMOBILE GOGGLES** (Fig. 15)—The mirror is carried on an arm that holds it at a suitable distance in front of the glass; is adjustable to any position and may be swung up and out of the way if desired. It is intended to take the place of the fixed mirror commonly used to enable the driver to see objects at the rear of his car.



Fig. 15

**FRAME FOR AIRING BEDCLOTHES** (Fig. 16; British patent)—The arms for carrying the bedclothes are attached to the foot frame of the bedstead by means of straps, and are supported on the movable upright by a ring, an arrangement that permits the whole device to be folded compactly when not in use.



Fig. 16

**INFLATABLE HORSE COLLAR** (Fig. 17)—The main part of the collar is made of strong and rigid material capable of taking the strain of the pulling, and in a hollow space in the rear is inserted an inflatable bladder so placed as to provide a soft and flexible bearing against the horse's shoulder.

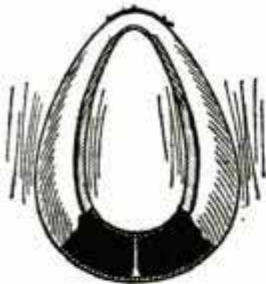

Fig. 17

**NEW TYPE OF LIFEBOAT** (Fig. 18; British patent)—The object of this invention is to provide lifeboats which, when nested, fit together in such a way that a clear space is left in each boat for the storage of food and water. Each boat has removable seats. The storage space is provided by means of deep keels which hold the boats the required distance apart.

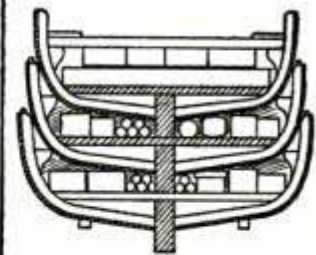

Fig. 18

**APPARATUS FOR RAISING SUBMERGED BODIES** (Fig. 19; American patent by a Frenchman)—This novel apparatus, evidently intended for raising light bodies, consists of a number of balloons, which after being submerged and attached to the body to be raised, are inflated and made buoyant by air pumped in through rubber tubing. To prevent complete collapse when not inflated each balloon contains a balloonet filled with water.

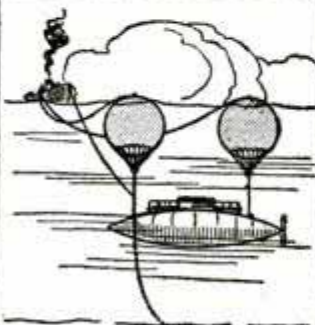

Fig. 19

**WINCH FOR CHECKING RUNAWAY HORSES** (Fig. 20; British patent by an Austrian)—A trace runs from the winch to an attachment about the middle of the ordinary reins. In case of runaway the driver simply winds up this trace on the winch. A pawl and ratchet wheel prevents back revolution of the winch, but the whole apparatus may be thrown out of action by a hand lever.

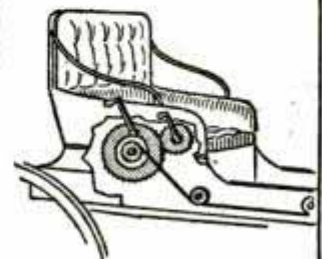
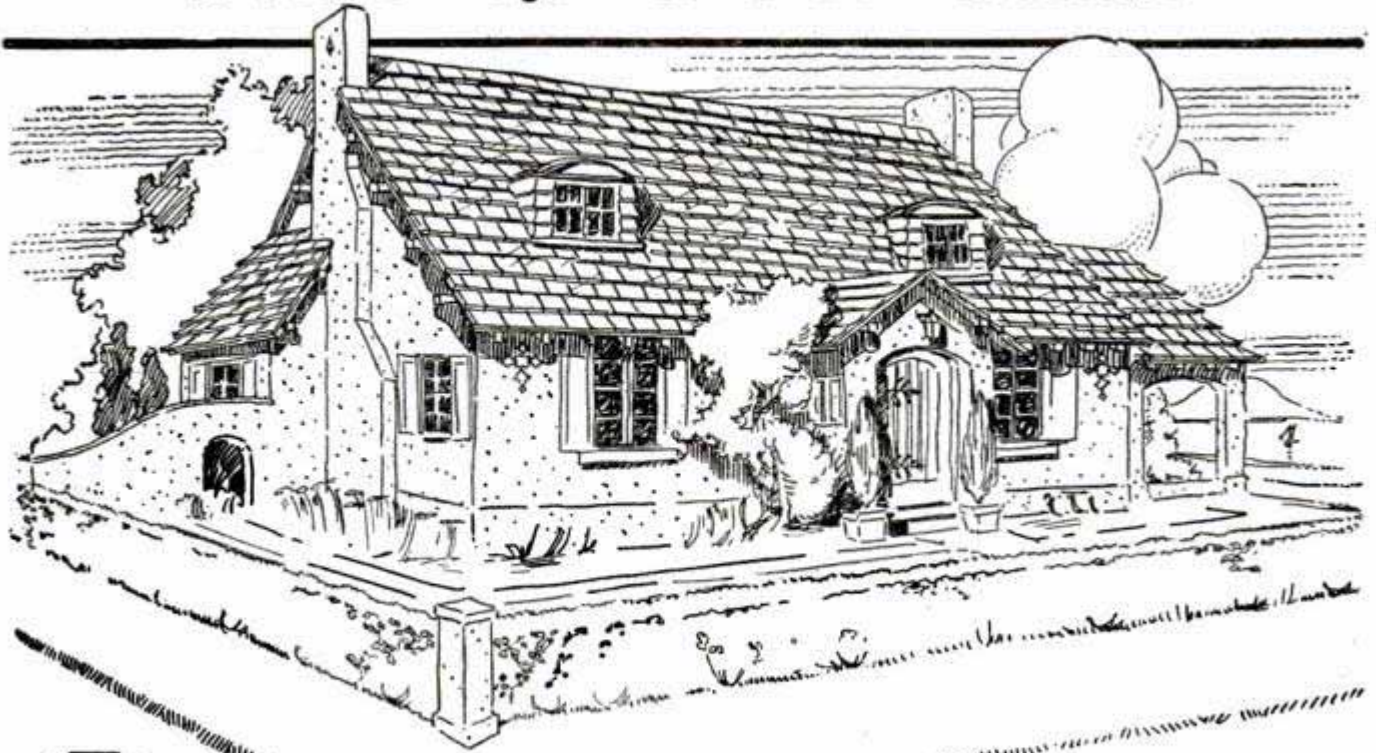
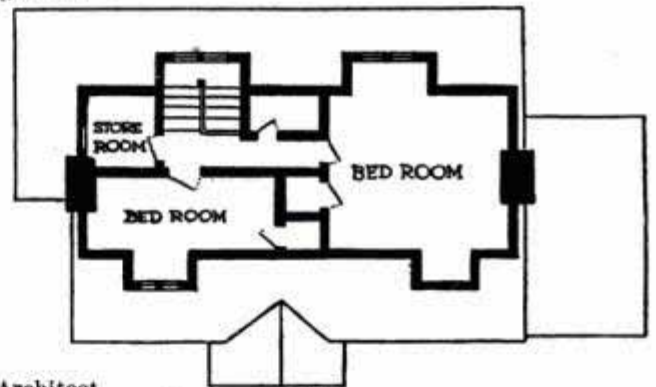

Fig. 20

## A PICTURESQUE CONCRETE COTTAGE



FIRST FLOOR

Ernest C. Redstone, Architect,  
Boston, Mass.

SECOND FLOOR

A type of dwelling that is evidently gaining in popularity is the small concrete cottage with exterior finish of cement stucco. This type of dwelling lends itself readily to picturesque treatment, a feature that is strongly emphasized in the six-room cottage illustrated above, and is a kind of building that fits particularly well in a suburban setting. In this dwelling, the steep gable roof with dormer windows, the entry and porch in which the gable effect is repeated, the irregular outline of the chimneys, and the extension of the windows up to the eaves, are all features that add much to the general effect.

The first floor contains the living room, dining room, kitchen, bathroom and one chamber, the latter being placed in such a location as to be secluded from the remainder of the floor. No hallway is provided and an economical use of space is made throughout. The compact way in which the stairway is arranged, with approaches from both the kitchen and the living room, is particularly worthy of note. The main entrance leads directly into the dining room, which is a room of unusual size for a building of this type, and to which distinction is given by a heavily beamed ceiling. This room and the living room virtually form one big room extending across the front of the building, being connected by a wide archway. Each is provided with a fireplace, and the arrangement throughout is such as to conform to the picturesque effect of the exterior. The kitchen, while directly connected with the dining room, is entirely separated from the remainder of the floor. Two stairways lead from the kitchen, one to the upper floor and the other to the basement, and between these is placed the pantry. The upper floor contains two chambers and a storeroom. Owing to the arrangement of the stairway, room is available on the second floor for a stair hall that gives ready access to each of the rooms.

The building is of concrete construction with exterior walls of pebble-dashed cement stucco. The color scheme of the exterior is an important feature of the design. The walls are cream colored, the blinds are of yellow green, while the shingles of the roof and the exterior trim are brown. The building is equipped with modern systems of heating and plumbing and is wired for electric lighting. The total cost, fully equipped, was approximately \$3,000.

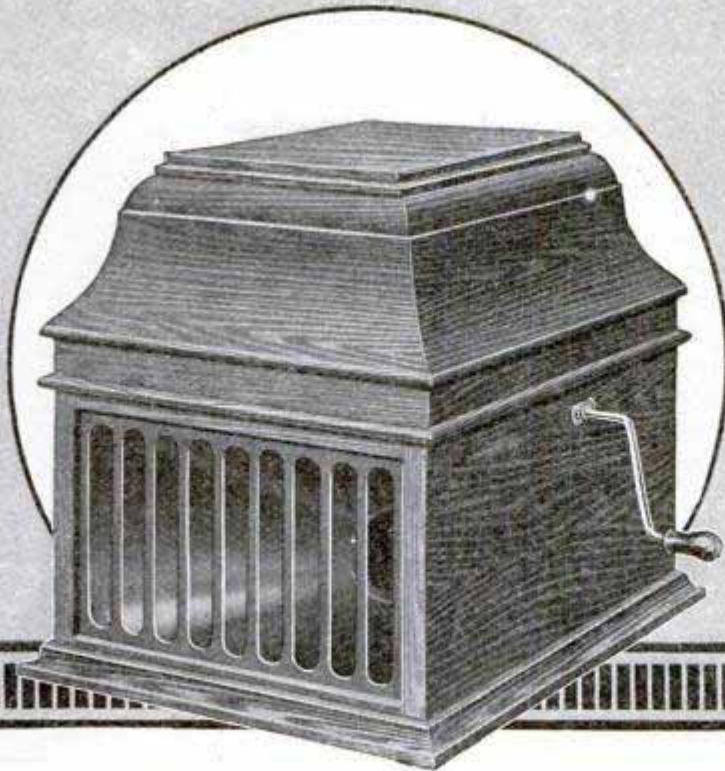

# NEW Edison Phonograph (Mr. Edison's Latest Invention) FREE

## Now Shipped

An offer introducing *The New Edisons*. Write quick—*while this offer lasts*. Edison's new phonograph—*just out!*—the perfected musical wonder of the age!

**W**RITE *today* for our *new* Edison Catalog—the catalog that tells you all about the wonderful *new* model Edison with Mr. Edison's *new* diamond point reproducer. It will also tell you about **our NEW Edison offer**. Now read:

**The Offer:** We will send you the *new* model Edison and your choice of all the brand new records on an **absolutely free loan**. Hear all the waltzes, two-steps, vaudevilles, minstrels, grand operas, old sacred hymns, every kind of comic and popular music, also your choice of the highest grade concerts and operas, as rendered by the world's greatest artists. Entertain your family and your friends. *Then, when you are through with the outfit you may send it back at our expense.*

**REMEMBER**, not a penny down—no deposit—no guarantee—no C. O. D. to us—no obligation to buy—a full free trial in your own home—**direct** from us—**direct** to you. Returnable at our expense or payable (if you want to keep it) at the actual rock-bottom price direct from us.

**The Reason:** Why should we make such an ultra-liberal offer? Well, we'll tell you:—we are tremendously proud of this magnificent new instrument. When **you** get it in your town we **know** everybody will say that nothing like it has ever been heard—so wonderful, so grand, so beautiful, such a king of entertainers—so we are sure that at least some one, if not you, then somebody else, will want to buy one of these **new style** Edison's **especially as they are being offered now at the most astounding rock-bottom price and on easy terms as low as \$2.00 a month.**

## Our New Edison Catalog Sent FREE!

Your name and address on a postal or in a letter, (or just the coupon) is enough. No obligations in asking for the catalog. Get this offer—*while this offer lasts*. Fill out the coupon today.

**F. K. Babson, Edison Phonograph Distributors**  
9193 Edison Block, Chicago, Ill.

Canadian Office: 355 Portage Avenue, Winnipeg, Man.

To  
**F. K. BABSON,**  
Edison Phonograph Distributors,  
Dept. 9193, Edison Block, Chicago, Ill.

*Gentlemen:*—Please send me your New Edison Catalog and full particulars of your free trial offer on the new model Edison Phonograph.

Name .....

Address .....

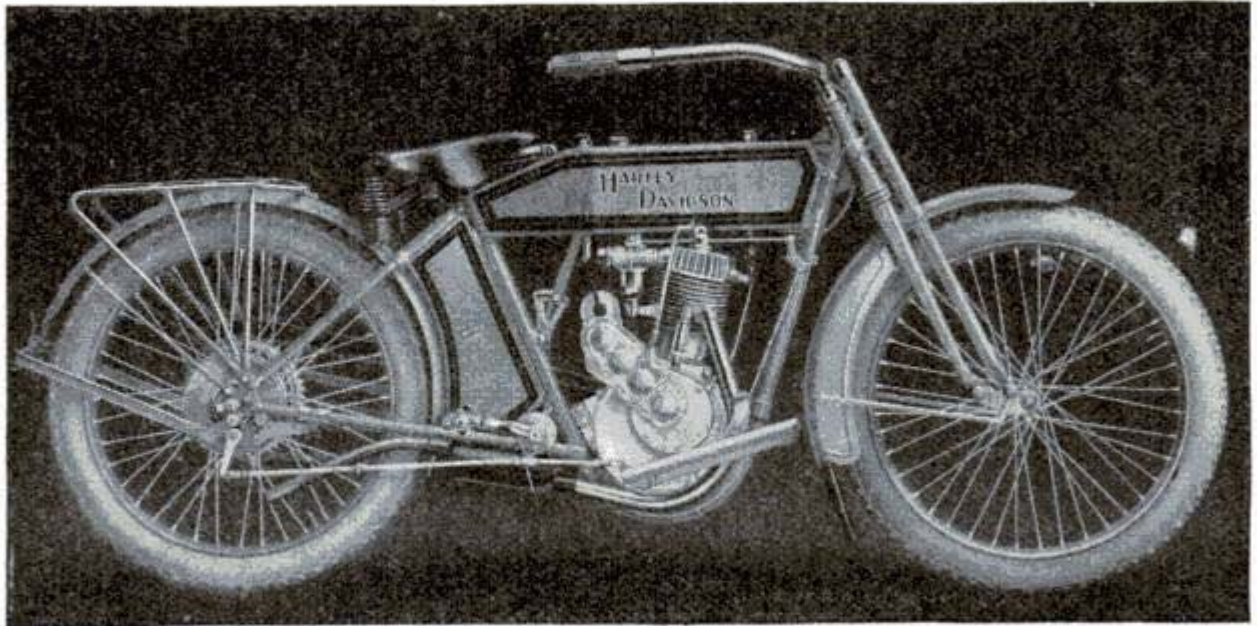

# The Harley-Davidson

## With Starter \$210.00

**No Need to Dismount or Place Machine on the Stand  
to Start the Motor**

The Step-Starter (a patented exclusive Harley-Davidson feature) makes it no longer necessary, in case of an accidental stalling of the motor to hold up traffic or dismount in the mud or both, while the driver finds a level place to lurch, drag or lift the machine onto the stand for starting. Instead, the rider may keep his seat and with a downward pressure on either pedal engage the Step-Starter, thus starting the motor.

The Harley-Davidson Step-Starter is not a heavy complicated attachment liable to derangement but a simple, effective, efficient starter, built right into the machine.

### **No Need to Maintain One Tiresome or Cramped Position When Touring**

The Folding Foot Boards on the Harley-Davidson are long and sturdy yet light. Their length permits any rider, regardless of height to assume a number of comfortable riding positions. If he desires he may also use the pedals as foot rests.

### **No Need to Stand on the Pedals or Foot Boards When Going Over Bumps or Rough Roads**

Every Harley-Davidson today is built with a Ful-Floteing Seat. The Ful-Floteing Seat has two heavy compressed springs inside the frame. The weight of the rider is carried between these two springs. These absorb all jolts and jars as well as the recoil due to traveling over rough or rutty roads.

The Ful-Floteing Seat now incorporated in use in over thirty thousand Harley-Davidsons has proven itself to be the greatest comfort device ever offered to the motorcycle public.

*Copy of our advance announcement describing this and other models will be sent, together with the name of our nearest dealer, on request.*

**HARLEY-DAVIDSON MOTOR CO., 377 B St. Milwaukee, Wis.**  
Producers of High-Grade Motorcycles for More Than Twelve Years

### **No Need to Take Either Hand Off the Handle Bars to Operate the Clutch**

All models this year are equipped with Double Control of the Clutch. The clutch can be engaged or disengaged by a slight pressure of the heel or toe on the clutch pedal which is conveniently located on the left foot board or if desired, the clutch can be operated by the regular clutch lever in use on all motorcycles.

### **No Need to Take the Feet off the Foot Boards to Operate the Brake**

A brake pedal located beside the foot board convenient to the rider's foot does away with the necessity of taking the feet off the foot boards to operate the brake. The brake may also be operated by back pedaling if desired.

### **No Need For Noise**

A new muffler tail pipe extending beyond the frame, enclosed valves and a padded chain guard makes this year's model even more quiet than heretofore.





## Johnson's Wood Dye

In 17 shades—for the  
artistic coloring of wood  
—*soft and hard.*

## Johnson's Prepared Wax

A complete finish and polish for  
all wood—*floors, woodwork and  
furniture.*

### Use This Coupon

for Free trial packages and Instruction  
Book, "*The Proper Treatment for  
Floors, Woodwork and Furniture.*"

**S. C. Johnson & Son**

*"The Wood Finishing  
Authorities"*

Racine,  
Wis.



PRESENT THIS COUPON TO YOUR DEALER IN PAINTS

**45c—Value FREE—45c**

To Paint, Hardware or Drug Dealer: Furnish the  
bearer, free of all expense, with

- 1—25c Instruction Book
- 1—10c Bottle Johnson's Wood Dye
- 1—10c Can Johnson's Prepared Wax

S. C. Johnson & Son, Racine, Wis.

(Must be presented by an adult.)

PA3

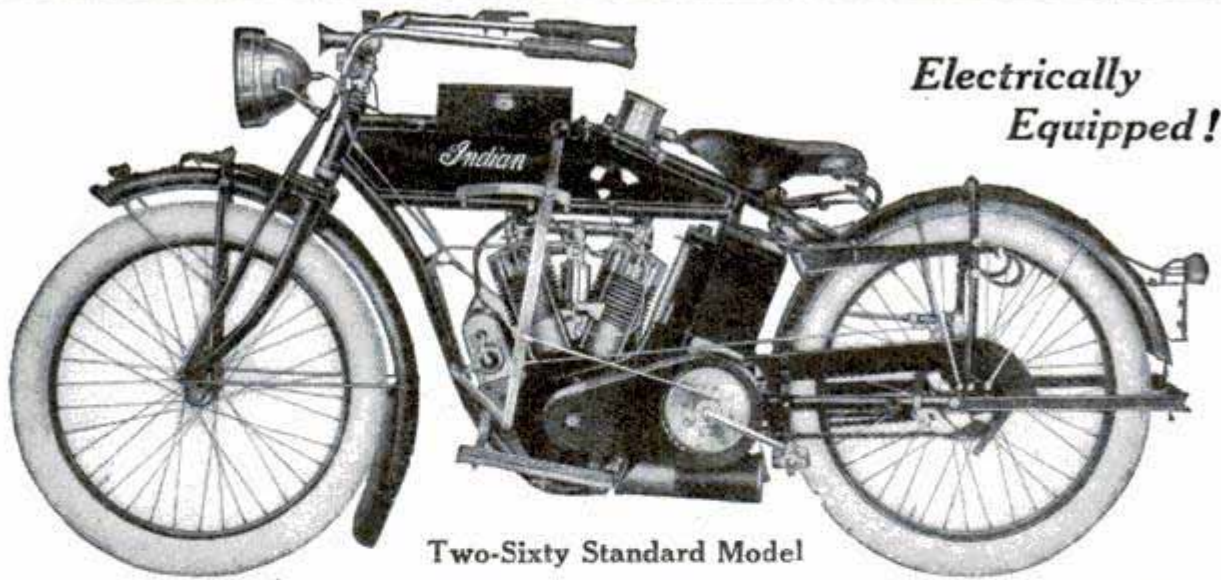

Two-Sixty Standard Model

Give this machine the acid test of comparison at these three vital points:

*Price — Equipment — Reputation*

THE Two-Sixty Standard Indian (illustrated) represents a motorcycle value decidedly in advance of the field today. A close examination will conclusively prove the 1914 Indian with 38 Betterments to be—price for price—quality for quality—an achievement in worth which successfully carries it beyond competition.

1914

# Indian Motorcycle

equipment has been a true sensation. The Indian has nailed its flag of leadership higher up on the pole than ever by evolving Motorcycle Electricity and putting it into efficient operation. All standard models are equipped with electric head light, electric tail light, two sets high amperage storage batteries, electric signal and Corbin-Brown rear-drive speedometer.

The Indian reputation behind every Indian machine is the greatest guarantee of reliability and sound construction that any motorcycle purchaser could have. The Indian has developed more genuine mechanical devices for the advancement of the motorcycle—including the famous, incomparable comfort feature, the Cradle Spring Frame—than all other makes combined.

Ask for a demonstration from any of the 2500 Indian dealers. 1914 Catalog now ready

The 1914 line of Indian Motorcycles consists of:

4 H.P. Single Service Model . . . . .	\$200.00
7 H.P. Twin Two-Twenty-Five Regular Model . . . . .	225.00
7 H.P. Twin Two-Sixty Standard Model . . . . .	260.00
7 H.P. Twin Two-Speed Regular Model . . . . .	275.00
7 H.P. Twin Two-Speed Tourist Standard Model . . . . .	300.00
7 H.P. Twin Light Roadster Model . . . . .	260.00
7 H.P. Twin Hendee Special Model (with Electric Starter) . . . . .	325.00

Prices F.O.B. Factory

**HENDEE MANUFACTURING COMPANY, 816 State St., Springfield, Mass.**

*Largest Motorcycle Manufacturers in the World*

Chicago      Dallas      Kansas City      Minneapolis      Toronto      San Francisco  
                  Atlanta      Denver      Melbourne      London

← **THE SILENT INDIAN** →

Please Mention Popular Mechanics

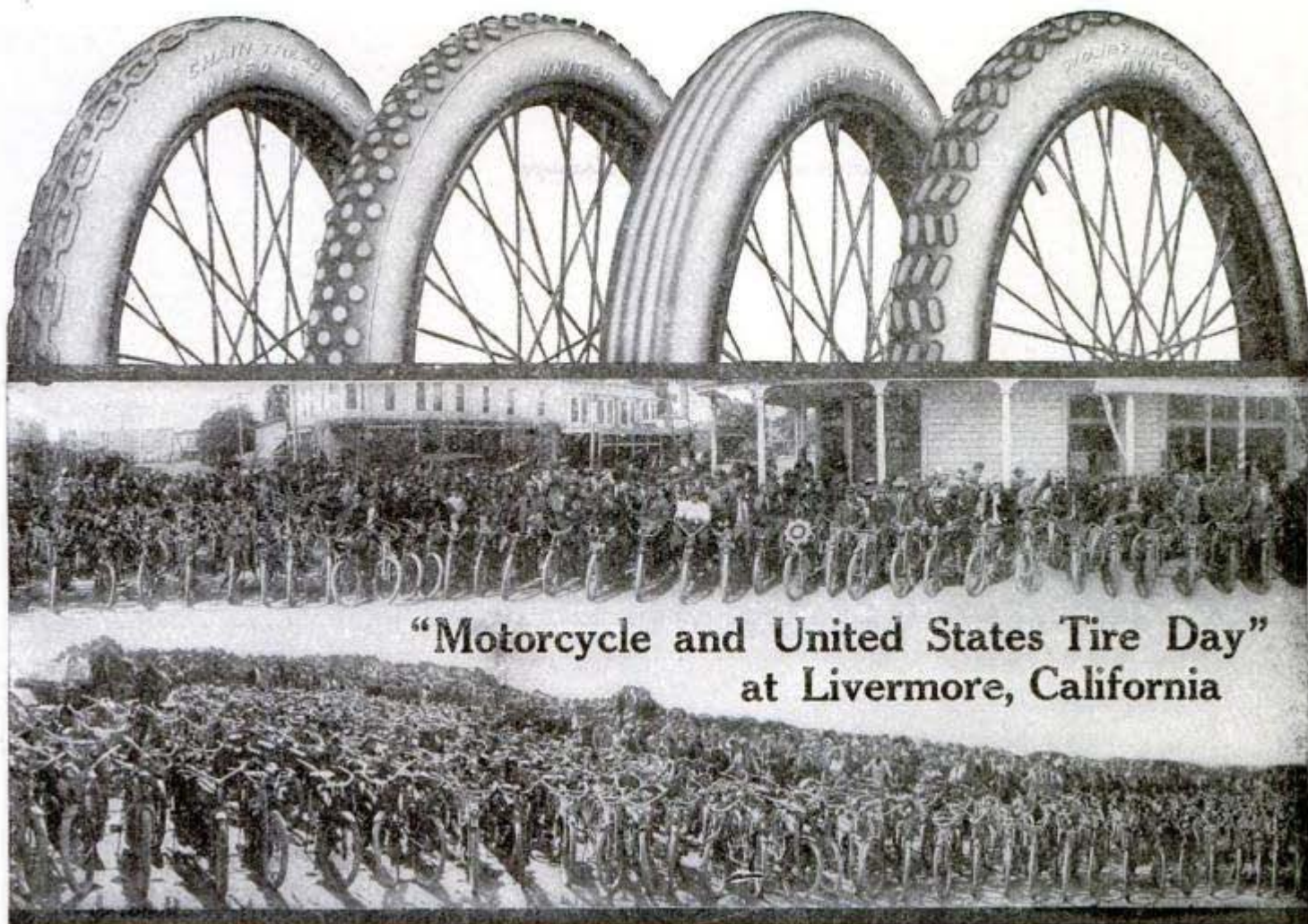

**"Motorcycle and United States Tire Day"  
at Livermore, California**

**In the pleasures, the usefulness, and the economy of the motorcycle today—United States Motorcycle Tires are acknowledged to be one of the greatest factors**

We, the builders of UNITED STATES TIRES, have kept step with the growth and the perfection of the motorcycle.

We have studied the motorcycle's progress.

We have watched the motorcycle's needs.

We build tires for the actual requirements of the motorcycle.

We have solved the motorcycle tire problem.

Our motorcycle tires have proved to be one of the greatest factors in the life and progress of the motorcycle.

UNITED STATES MOTORCYCLE TIRES are today the accepted standard of the motorcycle world.

UNITED STATES MOTORCYCLE TIRES are today the most popular motorcycle tires in the world.

And they deserve to be.

**In one year, 1913, the sales of UNITED STATES MOTORCYCLE TIRES increased 139 per cent.—an increase that is without a parallel in motorcycle history**

**NOTE THIS:—Dealers who sell UNITED STATES MOTORCYCLE TIRES sell the best of everything**

# United States Motorcycle Tires

Made by the

**Largest Rubber Company in the World**

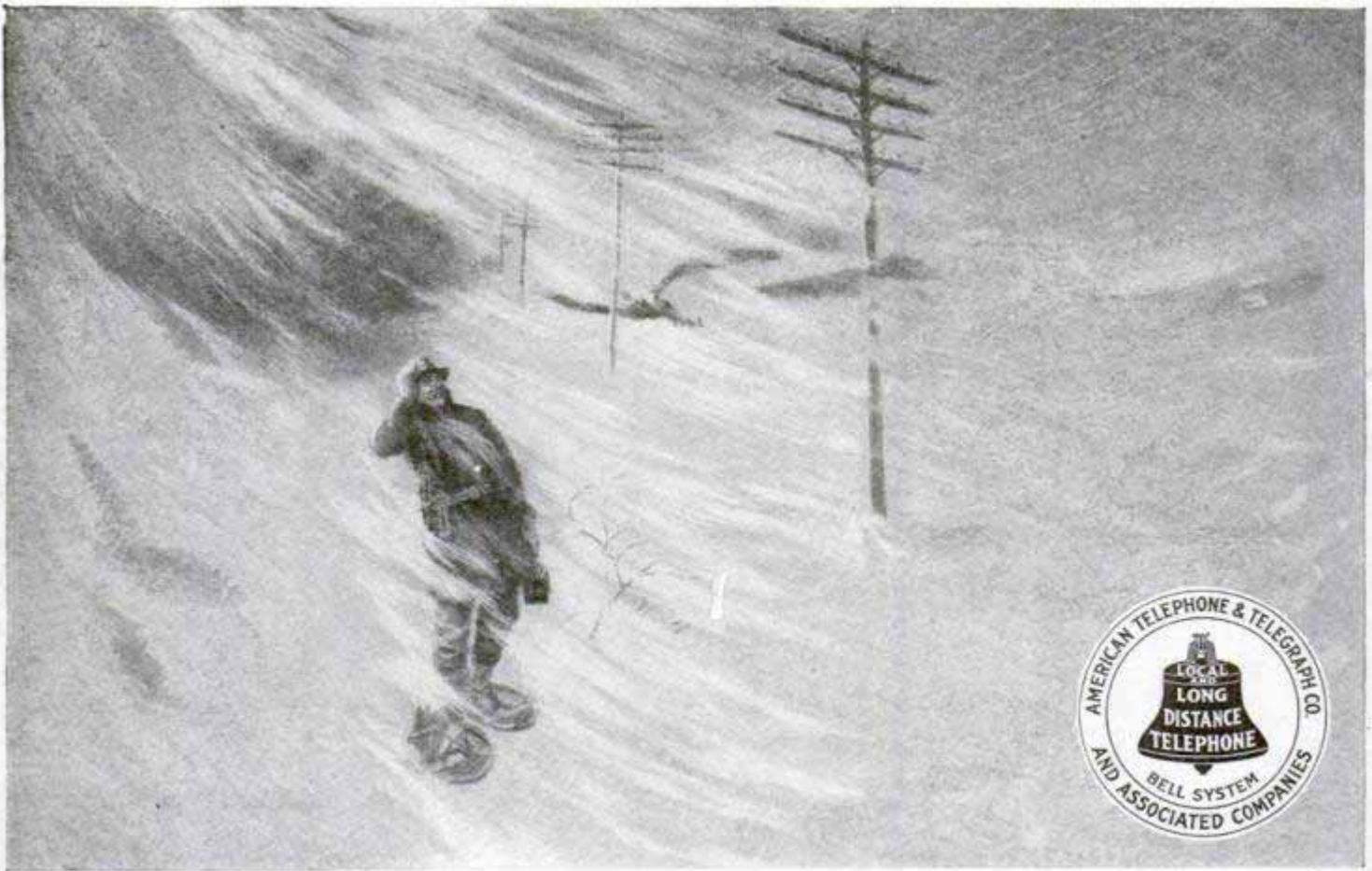

## The Spirit of Service

**W**HEN the land is storm-swept, when trains are stalled and roads are blocked, the telephone trouble-hunter with snow shoes and climbers makes his lonely fight to keep the wire highways open.

These men can be trusted to face hardship and danger, because they realize that snow-bound farms, homes and cities must be kept in touch with the world.

This same spirit of service animates the whole Bell telephone system. The linemen show it when they carry the wires across mountains and wilderness. It is found in the girl at the switchboard who sticks to her post despite fire or flood. It inspires the leaders of the

telephone forces, who are finally responsible to the public for good service.

This spirit of service is found in the recent rearrangement of the telephone business to conform with present public policy, without recourse to courts.

The Bell System has grown to be one of the largest corporations in the country, in response to the telephone needs of the public, and must keep up with increasing demands.

However large it may become, this corporation will always be responsive to the needs of the people, because it is animated by the spirit of service. It has shown that men and women, co-operating for a great purpose, may be as good citizens collectively as individually.

**AMERICAN TELEPHONE AND TELEGRAPH COMPANY  
AND ASSOCIATED COMPANIES**

*One Policy*

*One System*

*Universal Service*

# Did the U. S. Government Make a Mistake?

When the U. S. Government *specified* Williamson Underfeed furnaces for Dam Keepers' houses along the Ohio River, did it err? The Government put the Underfeed through the hardest possible tests and *proved* that such statements as, "Coal bill \$10.22 for 7 rooms;" "\$5.40 to heat 4 rooms;" "Reduced coal bills from \$109 to \$53;" "Underfeed reduces coal bill 60%;" "A great fuel saver;" "Have cut coal bill \$70 each winter for 9 years;" "Saved \$122 a season;" "I have divided my coal bill by five;" "Even temperature with no smoke or dirt;" *were absolutely true.* What's best for Uncle Sam is best for you.

## 25,000 Underfeed Users

For over twelve years Underfeed furnaces and boilers have been cutting coal bills  $\frac{1}{2}$  to  $\frac{2}{3}$ , thereby saving millions of dollars for coal buyers. Why not save *your* share? The economy and efficiency of Underfeed heating has startled the world.

Cheap slack soft coal or pea and buckwheat hard coal yield in the Underfeed *more* heat, *cleaner* heat and *evener* heat than the most expensive coal burned in other heaters. And 25,000 Underfeed users have *proved* it!

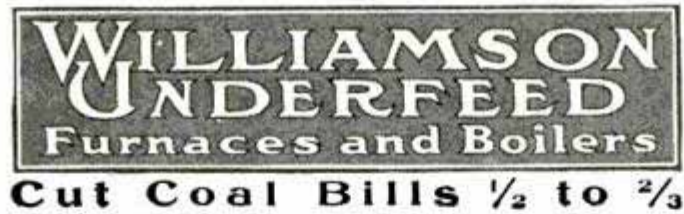

With the Underfeed coal is fed from below. All the fire is on top. Smoke and gases are burned up, making more heat with *no* smoke, soot, clinkers, smell and dirt and but few ashes. No other furnace or boiler does this. The Underfeed principle is the greatest improvement ever made on *any* heating system. Soon pays for itself in any home, store, church, hall and other buildings. Adds to renting and selling value of any building. Adapted to warm air, steam and hot water.

## 50% Saving in Coal Bills Guaranteed

With every Underfeed furnace or boiler, when properly installed and operated, we guarantee a saving of at least 50% in your coal bills. This guarantee is backed by a \$750,000 corporation. You take no chances. The burden of proof is on the Underfeed. It has made good for thousands—it will make good for you. Let us send you the names and addresses of over 2,000 Underfeed users—some right in your neighborhood—who *know* that an Underfeed in the basement means

### Clean, Even, Economical Heat

in the home. If you are going to build; if your furnace or boiler is unsatisfactory; if you use stoves or grates; if you want to reduce your high heating costs, then send in the coupon. We'll send you a big budget of money-saving heating facts that will surprise you. Stop making rich coal barons richer by sending the coupon today—NOW.

**The Peck-WILLIAMSON CO.**  
51 Fifth Street Cincinnati, Ohio

### Mail This Coupon and Learn How to Cut YOUR Coal Bills $\frac{1}{2}$ to $\frac{2}{3}$ !

**The Peck-WILLIAMSON COMPANY** (5)  
51 Fifth Street, Cincinnati, Ohio

I would like to know *how* to cut my coal bills from  $\frac{1}{2}$  to  $\frac{2}{3}$  with an Underfeed.

Warm Air \_\_\_\_\_ Steam or Hot Water \_\_\_\_\_  
(Mark an X after System interested in)

NAME \_\_\_\_\_

ADDRESS \_\_\_\_\_

My Dealer's Name is \_\_\_\_\_

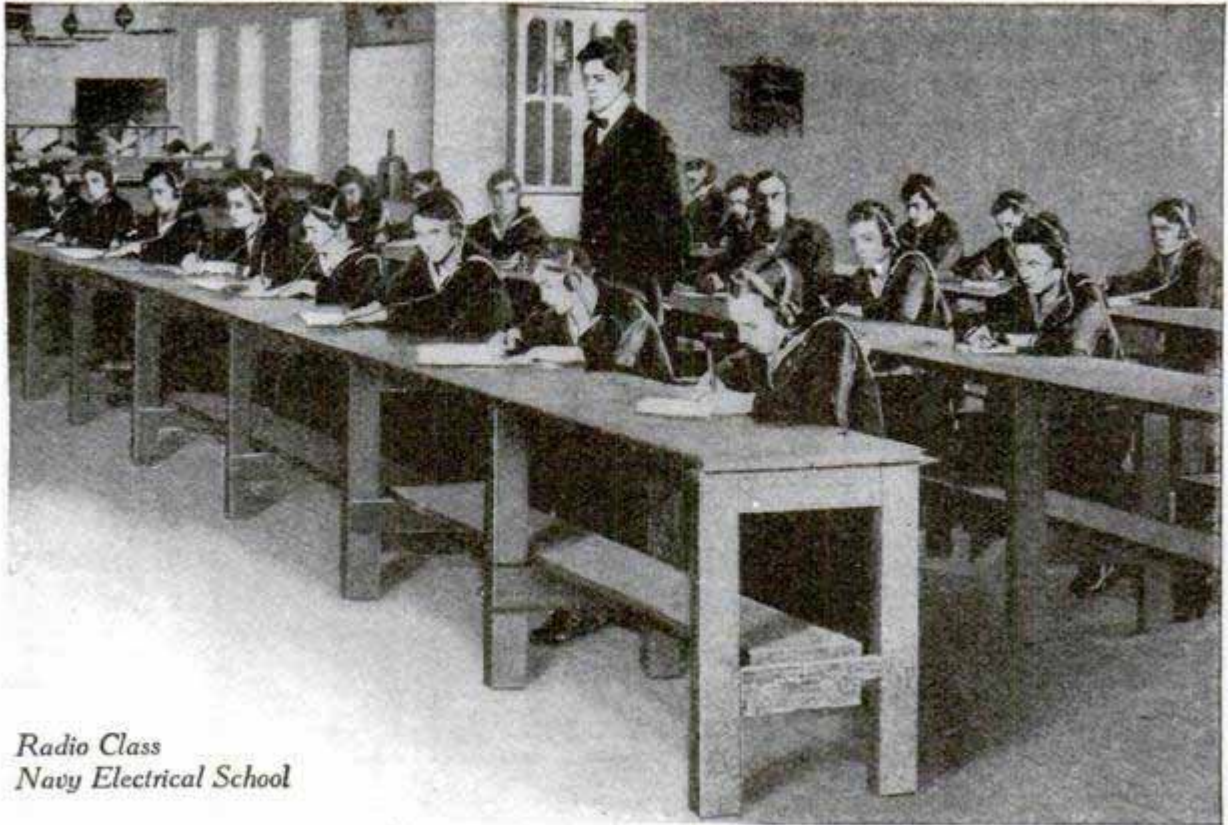

*Radio Class  
Navy Electrical School*

## What are You doing Now?

**I**F you are between 18 and 25, the things you are doing and thinking and learning *now* are the things that will stick to you *all through life*.

Are you busy learning or practicing some useful, interesting trade, which you *like*, and which will earn you *good wages* throughout your life? Or are you doing the first thing that came handy—satisfied just to have “a job”?

If you are *ambitious* and are *looking ahead*, investigate the trades and special kinds of work taught and practiced in the U. S. Navy. 50 different trades and special pursuits. Electricians, Wireless and Telegraph Operators, Machinists, Carpenters, Firemen, Boiler-makers, Drug Clerks, Nurses, Stenographers, Musicians, etc.

Besides these good-pay trades, the Navy offers the healthiest kind of life, the companionship of ambitious, clean-minded men, and the chance to learn by study and travel.

Isn't it worth a few minutes' call at the Navy Recruiting Station for full information?

Look for nearest Navy Recruiting Station address in the “want” columns of your Sunday paper. Or, if living at a distance, write for an interesting free booklet, “The Making of a Man-o'-Warsman.” Clear pictures and description of Navy life, training, recreation, work, etc. Write today to

Bureau of Navigation, Box 69, Navy Department, Washington, D. C.

# UNITED STATES NAVY



## When You Are Motoring You Must Have "PIPER"!

Eating up the road — nerves a-tingle — wish you had some tobacco. You can't smoke *then*. Your two hands are busy; you can't have ashes flying in your face; you can't light up without stopping. A hundred reasons.

What's your old pal yelling in your ear?

"Take a chew of 'PIPER'. Beats smoking anyway!"

# PIPER Heidsieck

CHEWING TOBACCO — Champagne Flavor

In this way thousands of men have made the discovery that there is *more solid, satisfying enjoyment* in chewing PIPER Heidsieck than in any other form in which tobacco is used.

The *rich, wine-like flavor* that

distinguishes PIPER Heidsieck from all other tobaccos, comes from the ripest, mildest, mellowest tobacco leaf, carefully selected from the world's choicest crops. This delightful, lasting flavor completely *satisfies the taste* as nothing else can.

**FREE** Send 10 cents and we will send a full-size 10 cent cut of "PIPER" and a handsome leather pouch FREE. The tobacco, the pouch and mailing expenses will cost us 20c and we are glad to spend the money to get you to try "PIPER" just once. We know that once you have started, you will become a permanent friend of this wonderfully wholesome, healthful and satisfying tobacco.

*This offer applies to U. S. only.*

*In writing us please tell us the name of the dealer of whom you buy your tobacco.*

THE AMERICAN TOBACCO COMPANY, New York

# Hartman Will Trust You Requires No References Asks No Advance Payment

## Remarkable Bargain Sale

No. 0E712—Warswick  
Brussels Rug Bargain



Exceedingly effective semi-oriental medallion design, red center, seamless, closely woven worsted yarn, fast colors; standard 8x12 size, combination colorings, green, red and tan, fully guaranteed to wear. **\$9.75 75c Per Month**

No. 7D286—Hartman's  
Refrigerator Bargain

A Model, Sanitary Refrigerator, Gray Enamel Exterior, White Enamel Interior, Easily kept clean. Rounded corners, lift out ice chamber, splendid drain, best cooling radiation. Best hard wood veneers, trimmed with real nickel. Guaranteed. Size 43 in. high 24 in. wide 16 ins. deep. Holds 65 lbs. ice. **\$12.75 Monthly**



No. 3F714—Complete  
Bed Outfit Bargain

Consisting of massive iron bed, 4 ft. 6 in. wide; 40 lb. elastic top fibre filled mattress, durable ticking, and all angle iron springs, spiral spring supports. Bed has 1-8 in. continuous posts and heavy fillers. White or pea green enamel or Vernis Martin. Price, **\$8.75 75c Per Month**

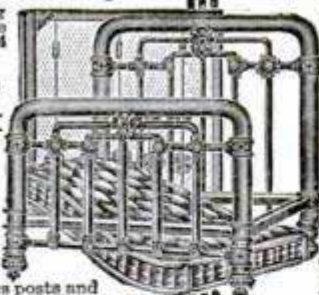

**50c Per Month**

Now is the time to furnish—to get the rug, rocker, refrigerator or any of those other home-furnishings you've been needing so long. Never has this great House of Hartman, or anyone else, been able to equal these truly remarkable values. The importance of this great Price-Smashing Sale of Guaranteed Dependable Quality Home Furnishings, cannot be over estimated.

### No Need of Meagerly Furnished Homes

Not only the necessities of home-furnishing, but the comforts and even the luxuries, found here-to-fore only in the homes of the rich and prosperous have been brought within the reach of even those of very limited means by the remarkably low prices and most liberal Easy Payment Plan offered by the famous House of Hartman. You should send today for the Big, Special, FREE Hartman Credit Bargain Book and find out for yourself. It shows everything in home-furnishings, including a marvelous assortment of carpets, rugs and draperies in color, patterns and designs photographed from the originals. It's like bringing into your own home an enormous stock of home-furnishings, many times the size of largest city store, including

**Furniture Stoves, Ranges Dishes Jewelry  
Carpets Refrigerators Clocks Curtains  
Rugs Silverware Go-Carts Springs  
Bedding Mattresses Sewing Machines**

### Your Credit Good at Hartman's

To the millions of honest home-lovers, everywhere, Hartman says: "I will trust you—just as I am trusting over a million of other home-lovers who are now buying their household needs from Hartman." Hartman's transactions with you are strictly confidential, no references are asked—no embarrassment. Your neighbors need not know your business—you'll like the Hartman plan when you know all about it.

### Hartman Makes Easiest Terms

No matter who you are or where you live, your credit is good at Hartman's. No matter how small your income Hartman meets your requirements. We trust home-lovers everywhere on an open charge account without any red tape whatever. There are no extra charges, no mortgages to sign, no interest to pay—nor do we ask for any security. The Hartman modern credit system is free from ALL objectionable features. With long-time credit as easy to get as it is from Hartman there is no reason for anyone, even of limited income, to live in a meagerly furnished home. **During this big sale you can order any of these special advertised bargains without sending us any advance payment.**

### 30 Days' Free Examination

Every Hartman Bargain must actually sell itself on its own merit, after you see it in your own home. At the end of a month return anything you do not find to be perfectly satisfactory. Hartman refunds your money—including freight.

Send Address On Postal NOW For Hartman's Big **FREE Bargain Catalog**

You must see this Mammoth Hartman Credit Special Bargain Book—so send name and address on postal today to

**HARTMAN**  
Furniture & Carpet Co.  
3945 Wentworth Ave.  
Chicago, Ill.

No. 1D332—Hartman's  
Big Rocker Bargain

Large, comfortable rocker, selected hardwood finished American quarter-sawn oak, upholstered Imperial leather. Strongly built, stout runners. The carvings on posts and runners are unusually deep and beautiful—unique designs. Back tufted, handsomely ruffled all around edge. Seat set over full strong construction, handsome ruffled front. Our bargain price for this remarkable rocker only **\$3.65**

No. 0E444—Go-Cart



New one-motion collapsible go-cart. In a twinkling of an eye motion easily folds cart as shown. All steel construction covered with Imperial leather. Has 3 bow hood, half

inch rubber tires. Most remarkable bargain at **\$4.95 50c Per Month**

No. 5F466—Stunning  
Colonial Library Table



This beautiful library table of selected hardwood finished, American quarter-sawn oak. Thoroughly substantial in construction. Expertly finished. High gloss, hand rubbed polish. Large 28x42 top. Big roomy drawer. Base has artistically shaped feet. Striking Colonial pattern. Is right in style. Value cannot be duplicated under \$13 to \$15. Our price only **\$7.65 75c Per Month**

No. 7F460—Hartman's  
Ball Bearing Washer



Tub of eight shirt capacity. Bottom and sides corrugated, made of selected cyprus, known to withstand effect of lye, soap and acids. Heavily varnished. Lid has detachable hinges, easily removed. Tub supported on heavy legs, strongly braced. Improved wringer attachment securely fastened. Ball bearing connections makes the work so easy that it is a pleasure to wash with this machine. Four-pronged dasher, large and strong, cannot split or crack. Remarkable value at **\$5.75 50c Per Month**

**HARTMAN'S Legal Guarantee**  
We Unreservedly Guarantee every article sold by us to be exactly as represented and described in our catalog.

We Guarantee our prices to be lower than those of any other concern for goods of equal quality. We Guarantee to ship each and every article on approval, and if within 30 days from receipt of the goods, anything is not perfectly satisfactory, FOR ANY REASON WHATSOEVER, we will accept their return and when the goods are returned to us, we will refund all moneys paid on them including payment of freight charges both ways.

**The Big Credit SPECIAL BARGAIN Book FREE**



# NOTHING DOWN

**\$4** After Free Trial  
AND  
**\$4 Per Month**  
Only \$56 in All

# GUARANTEED

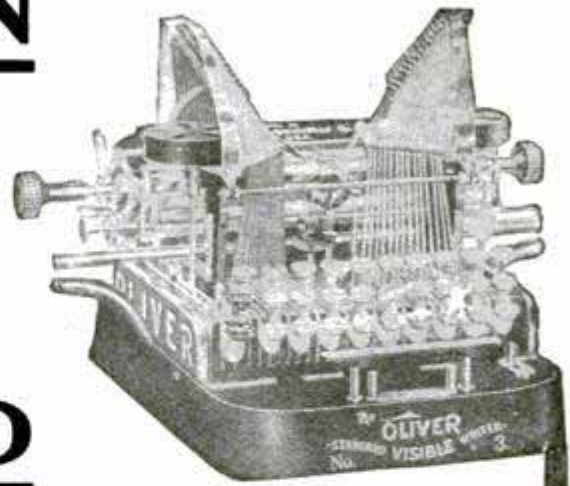

**I**F you are content to pay the full price for a standard typewriter we have **nothing** to say, but if you are one of the many thousands who believe that \$100.00 is too much to pay for a typewriter and that it is only necessary because of the expensive method of selling then this offer is your opportunity.

## The Famous Genuine No. 3 Oliver

Complete with every perfection, every device that ever went out with this model. Our method makes the offer possible; if we had to sell this same typewriter through salesmen, we would have to charge practically twice as much.

We have undertaken to buy in order to get the minimum price 1,000 Oliver typewriters (Model No. 3) per month.

These No. 3 Olivers are guaranteed to be the equal in quality of any typewriter, regardless of price. Each is protected by the standard guarantee against defect of material or workmanship.

## FEATURES

**Visible Writing** Every letter in plain sight as soon as printed, a necessity to those who compose as they typewrite.

**Universal Keyboard** All \$100 standard typewriters have adopted the universal keyboard, you would waste your time learning any other.

**Capacity** You will never be held back in your work if you own an Oliver. Unlimited speed. The ingenious arrangement of its working parts cannot be described on paper. You will appreciate when you use. The beautiful work of this splendid typewriter will give your letters distinction. It's a point well worth careful consideration. The success or failure of a letter is affected by the impression conveyed by its appearance. Great manifolder—20 carbon copies can be made at one writing.

**Will write on ruled lines** GREAT FOR INDEX CARDS, notes and small memorandums. Rules lines single or double without pen or pencil. Will do any practical thing any typewriter will do and has many features not found on other makes. Cuts a perfect stencil for mimeograph work.

**Will last a lifetime** Because the Oliver has only one-third as many working parts as the other \$100 machines—because it is built on the correct mechanical principle—because it is made of better than necessary material, it outlasts all others—does not get out of order—so simple anyone can easily master its construction and operation with a few minutes' attention. There is no task too great for this sturdy machine and above all it is dependable.

**Easy to run** The downward stroke of the type bar and the perfect lever adjustment and smooth, wide bearing gives the Oliver the lightest action. It is a pleasure to strike the keys. Compact—Portable—Efficient—a typewriter any one may be proud to own.

**The proven typewriter** You cannot make a mistake in getting a typewriter of the make that the two largest mail order houses have selected and use exclusively—183 railroads have purchased them—thousands of merchants and professional men all over the world endorse the Oliver.

**Easy to own** On our plan you pay just the regular rental rate—\$4 per month—which is only 13c a day. You practically rent the machine for 13 months and then it is yours. You save practically one-half and you use the machine while paying for it. It will earn its own way.

## Give this typewriter a chance to sell itself

You can have it on trial without obligation—no salesman or agent will call on you—you will be the sole judge. It has got to sell itself or there is no sale and no obligation. Do not hesitate to accept this offer—it is our method of doing business and we urge you to let us send the machine for trial and examination.

If you do not find it to be a satisfactory typewriter—if you do not find that it meets your every requirement, that it is perfect in every detail and the best typewriter you ever saw, you are not obliged to keep it and we pay the transportation charges back.

With each machine is a complete outfit, metal cover, ribbon, tools and a big instruction book, practice paper, carbon paper—everything you need.

You need not send any money, just send the coupon.

**TYPEWRITERS DISTRIBUTING SYNDICATE**  
166 N-66 North Michigan Boulevard, CHICAGO

## TRIAL ORDER COUPON

TYPEWRITERS DISTRIBUTING SYNDICATE,  
166 N-66 North Michigan Blvd., Chicago.

GENTLEMEN:

You may send me a No. 3 Oliver Typewriter for five days' trial.

If I find the typewriter satisfactory and decide to keep it, I agree to pay you \$56, as follows: \$4 within five days from the date of delivery and \$4 per month thereafter until your special price of \$56 has been paid, title to remain in you until then. Otherwise, I agree to return it to you at your expense.

Name.....

Address.....

References.....

# TYPEWRITER SENSATION!

## 2 DOLLARS A MONTH

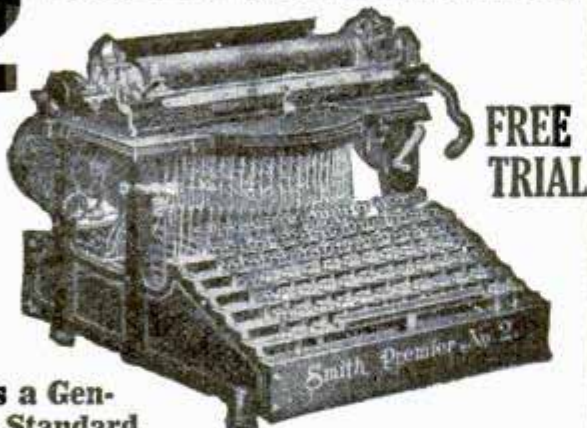

**Buys a Genuine Standard**

**No. 2 SMITH-PREMIER Typewriter and at \$71.20 less than the original price.**

Never before has anything like this been attempted. Dealers get \$3.00 a month rent for this make of machine, not nearly as perfect as the one we will send you, and you pay only TWO DOLLARS A MONTH AND OWN IT.

**A Guaranteed Typewriter \$28.80**

Perfect machines only, complete outfit, nothing extra to buy, no strings of any kind to this offer. Just think of buying such a typewriter for \$8.80 down and \$2.00 a month. Cash price \$27.40. Thousands of people have paid \$100.00 cash for Smith-Premiers. It's standard, by many considered the best typewriter ever built. A key for each character, so each character is always the same, a type brush for cleaning the type built into the machine; the tilting carriage throws all previous writing in plain sight of the operator. Comes to you with two color ribbon, complete operating instructions, tools, waterproof cover, practice paper, everything, ready. It runs beautifully. Writes as perfect and clean cut a letter as quickly and easily as any machine bought for \$100.00. It's wonderfully simple, a child can operate it with half an hours practice and rapidly attain speed. It's strongly built and will give you years and years of honest service and complete satisfaction.

**Send the Coupon and We Will Ship You this Smith-Premier Typewriter**

When the typewriter arrives, deposit with the express agent \$8.80 and take the typewriter three days and try it. If you find it to be the best typewriter you ever saw, satisfactory in every respect, keep it and send us \$2.00 each month, until our special price of \$2.80 is paid. If you don't want to keep it, return it to the express agent, and he will give you back your \$8.80, and return the typewriter to us. We will pay the return express charges.

You won't want to send this machine back after you have seen it and tried it. You can't imagine the perfection of these machines till you see one, and the price is \$71.20 less than the catalogue price, and it is guaranteed just as if you paid \$100.

**Only 200 orders will be filled on this offer. Act today to be sure**

This coupon states the terms. Fill it out, send it now, today. You can't lose, and it's the greatest economical typewriter opportunity you will ever have.

### COUPON

**HARRY A. SMITH, No. 180 N. Dearborn St., Chicago.**

Ship me a No. 2 Smith-Premier, f.o.b. Chicago, as described in this advertisement. I will pay you the \$20.00 balance of the special \$28.80 purchase price, at the rate of \$2.00 per month. The title to remain in you until fully paid for. It is understood that I have three days in which to examine and try the typewriter. If I choose not to keep it I will carefully repack it and return it to the express agent. It is understood that you give the standard guarantee for one year.

Name.....

Address.....

Pop. Mech. Mar.

Please Mention Popular Mechanics

## DO YOU NEED MONEY?

?

To educate your children, support a family, pay off a mortgage, buy a home or dress better. Then do as thousands of others are doing. Make money selling **World's Star Hosiery and Klean Knit Underwear** in your home town.

No previous experience is necessary. We show you how to make money in an easy, congenial and profitable way. Two lady agents began in their home town in California and each made over

**\$3000 First Year**

We sell direct from the mill to the home, eliminating the middleman's profit, thereby giving better value for the money. Our lines for men, women and children are famous the world over. We have in 12 years grown to be the largest concern in the world manufacturing and selling knit goods direct to the consumer.

Agents wanted in every town. It is a permanent, pleasant and profitable business. Write today for our free catalog. We protect agents in territory and make prompt delivery.

**WORLD'S STAR KNITTING CO.**  
Dept. 141 BAY CITY, MICH.



## MAKE BIG INCOME

Men and Women can do this all the year at home growing mushrooms in cellars, stables, sheds, boxes, etc. Crop sells for \$50 to \$1.00 a lb. \$20.00 a week easily made. Great demand, markets waiting. Start Now. Write for big 32 page Free Illustrated Booklet and learn how to do it.

NAT'L SPAWN CO., Dept. 12, BOSTON, MASS.

## MONEY IN POULTRY and SQUABS

Start small. Grow BIG. Get winter eggs. Keep healthy fowls. Save your chicks. Foy's big book tells how. Describes largest poultry and pigeon farm Mailed Free. **F. FOY, Box 39, DES MOINES, IA.**



A total of 6,489 medals and 3,857 service bars had been earned by employes on the Panama Canal work up to November, 1913.



## Greider's Fine Catalogue

and calendar of pure-bred poultry for 1914, large, many pages of poultry facts, different breeds in natural colors, 70 varieties illustrated and described. Incubators and brooders, low price of stock and eggs for hatching. A perfect guide to all poultry raisers. Send 10c for this noted book.

B. H. GREIDER Box 19, RHEEMS, PA.



## SHOEMAKER'S BOOK ON POULTRY

and Almanac for 1914 has 224 pages with many colored plates of fowls true to life. It tells all about chickens, their prices, their care, diseases and remedies. All about incubators, their prices and their operation. All about poultry houses and how to build them. It's an encyclopedia of chickenhood. You need it. Only 15c.

C. C. SHOEMAKER, Box 1107, FREEPORT, ILL.

## "Jimmy, Always Give 100 Cents' Worth for Every Dollar You Get"



Jim Rohan, Pres.

That's what my father said to me when I was a boy—and that's what I'm doing when I send you my Belle City hatching outfit. 276,000 users will tell you so. I am giving you more when you compare my 8-Times

## World's Champion

140-Egg Belle City

**\$7.55**

with any other incubator made. Double cases all over, best copper tank; nursery, self-regulating. Best 140-chick hot-water brooder, \$4.85. Both, \$11.50.

Frt. prepaid E. of Rockies. Satisfaction guaranteed.

Write for free book today or send price now and save time. Belle City Incubator Co., Box 164, Racine, Wis.



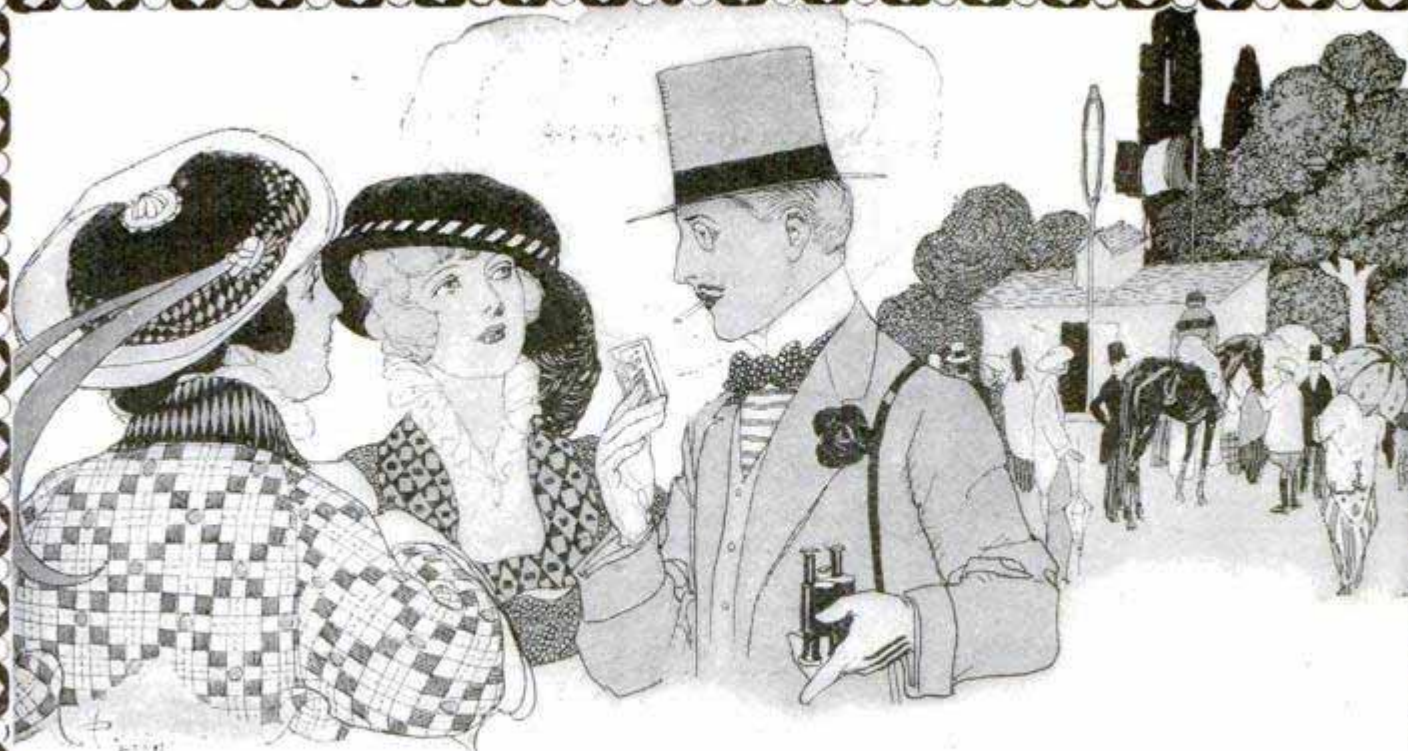

## THE FINESSE OF LIFE

Nowhere is it more glorified than at the Spring Races in Paris. At the Course de Longchamps the fashionable world finds all that is of the most *chic*:—horses of the noblest blood, women gowned in *le dernier cri* of the *couturiers*, men-of-the-world from all over the world. A great, glittering array of those in the very gusto of living! And right in the centre of the Longchamps *mode*, you find

# RIZ LA ☩.

(Pronounced: REE-LAH-KROY)

## FAMOUS CIGARETTE PAPERS

Favorite little aides to the man of elegance and refinement, the man who *makes up his own* cigarette from his favorite tobacco. To cherish your cigarette *for what you yourself put into it* and make out of it: this is the new decree among fastidious smokers. *And the only papers used are Riz La Croix!*

They are strong. Riz La Croix do not burst while rolling.

They are adhesive. Riz La Croix, made from natural flax-linen, adhere immediately.

They are light and thin. You smoke Riz La Croix papers, yet you never taste them.

They are pure. Purely vegetable, hence entirely healthful.

15,000,000 books of Riz La Croix papers are sold annually in Paris. 90,000,000 on the continent. 60,000,000 in this country!



FREE

An interesting illustrated booklet about RIZ LA CROIX Cigarette Papers, together with a booklet showing the best way to roll a cigarette, will be sent anywhere in U.S. on request. Address AMERICAN TOBACCO CO., 111 Fifth Ave., N.Y.

# 2c a Week Pays Wash Bill!

Write for  
FREE Book

## Electricity or Water-Power Does the Work

### Just a "Twist of the Wrist" Starts or Stops the Machine!

The 1900 Motor Washers are now at work in thousands of homes. They are doing the work formerly done by women, at a cost of 2c a week for power! Saving thousands upon thousands of dollars in wash bills. Saving worlds of wash-day troubles. Leaving the women free to do other work while the machines are doing the washing.

## The 1900 Motor Washer

1900 Water Motor Washer  
Can be connected with  
any water tap instantly



### Washes a Tubful in Six Minutes!

Handles Heavy Blankets or Dainty Laces

The outfit consists of the famous 1900 Washer with either Electric Motor or Water Motor. You turn on the power as easily as you turn on the light, and back and forth goes the tub, washing the clothes for dear life. Then, turn a lever, and the washer does the wringing. All so simple and easy that it is mere child's play.

### A Self-Working Wringer Sent With Every Washer!

The motor runs Washer and Wringer. We guarantee the perfect working of both. No extra charge for Wringer, which is one of the finest made. Write for FREE BOOK and 30 Days' FREE TRIAL OFFER! Don't doubt! Don't say it can't be done. The free book proves that it can. But we do not ask you to take our word for it. We offer to send a 1900 Motor Washer on absolute Free Trial for an entire month to any responsible person. Not a cent of security—nor a promise to buy. Just your word that you will give it a test. We even agree to pay the freight, and will take it back if it fails to do all we claim for it. A postal card with your name and address sent to us today will bring you the book free by return mail. All correspondence should be addressed to

Doing the wringing with  
1900 Electric Motor Washer



1900 WASHER CO., 6134 Court St., BINGHAMTON, N. Y.

OR, IF YOU LIVE IN CANADA, WRITE TO THE CANADIAN WASHER CO., 355 YONGE ST., TORONTO, CANADA.

(23)

## FREE to Hunters and Trappers

Fine Taxidermy Book Now Free! 48p.  
with hundreds of photos of mounted  
birds and animals. Learn this profession. Save your trophies.  
Decorate your home and den. Great value to sportsmen.

Learn to Stuff Birds animals, game heads,  
and robes. Quickly learned by men and boys. Big Profits from  
spare time. Intensely interesting. INVESTIGATE! Write Today  
for Free Book. Only a few free—so rush.

Northwestern School of Taxidermy, 9193 Elwood Bldg., Omaha, Neb.



## Sunshine Lamp 300 Candle Power FREE!

### To Try in Your Own Home

Turns night into day. Gives better light than gas, electricity or 18 ordinary lamps at one tenth the cost. For Homes, Stores, Halls, Churches. A child can carry it. Makes its own light from common gasoline. Absolutely SAFE.

### COSTS 1 CENT A NIGHT

We want one person in each locality to whom we can refer new customers. Take advantage of our SPECIAL FREE TRIAL OFFER. Agents Wanted.

SUNSHINE SAFETY LAMP CO.  
911 Factory Bldg. Kansas City, Mo.



## FACTORY TO YOU CLASS PINS

For College, School or Society

Catalog with attractive prices mailed free upon request. Special offer, either style of pins here illustrated with any three letters and figures, one or two colors of enamel. STERLING SILVER, 30c each, \$3.00 dozen; SILVER PLATE, 15c each, \$1.50 dozen.

BASTIAN BROS. CO., 278 Bastian Bldg., ROCHESTER, N. Y.



## BIGGEST DIAMOND BARGAIN Ever Offered "Mechanics" Readers

Our enormous importations as one of America's greatest diamond houses, enables us to sell diamonds at less than the average retail dealer pays for them. Our world-beater bargain is this magnificent \$70 Gentleman's Ring for only \$50—on easy credit terms. The stone is genuine blue-white, perfect in cut and proportions, firmly set in new tiger claw 14K solid gold mounting. Satisfaction guaranteed or money refunded. Write for big illustrated catalog of diamonds and watches. Free. Address

RYER JEWELRY CO. 648 Ryer Building KANSAS CITY, MO.

\$5 Down Balance \$5 Month!



## WORK FOR US

ALL—OR—SPARE TIME



## 150% PROFIT—Start—Now

Two turns of crank wrings out every drop of water. Simple, practical, reliable, durable, never wears out. Every home buys. No talking necessary. Show it, take the order. Get started now, don't wait. We will help you.

We want Agents, Salesmen, Managers in every county to fill orders, appoint, supply, control sub-agents. 150 per cent profit. No investment required. Sample free with first order. New catalog, instructions, sworn-to evidence, all free.

U. S. MOP CO., 162 MAIN STREET, TOLEDO, OHIO

## GET YOUR SHARE OF THIS EASY MONEY

Selling Easy Wringer Mops



This cut shows mop on floor. It spreads out and is held down to floor at all points.

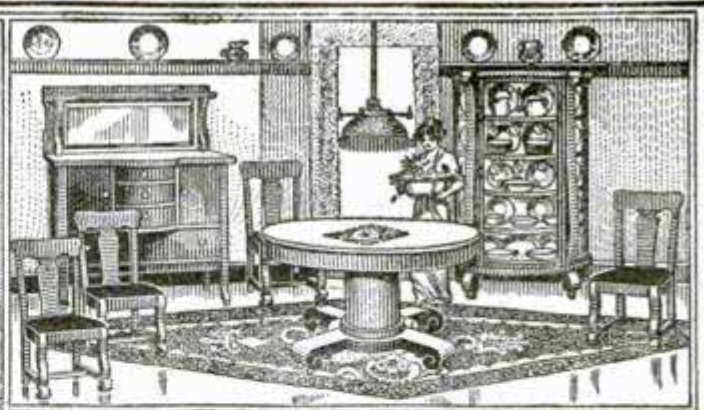
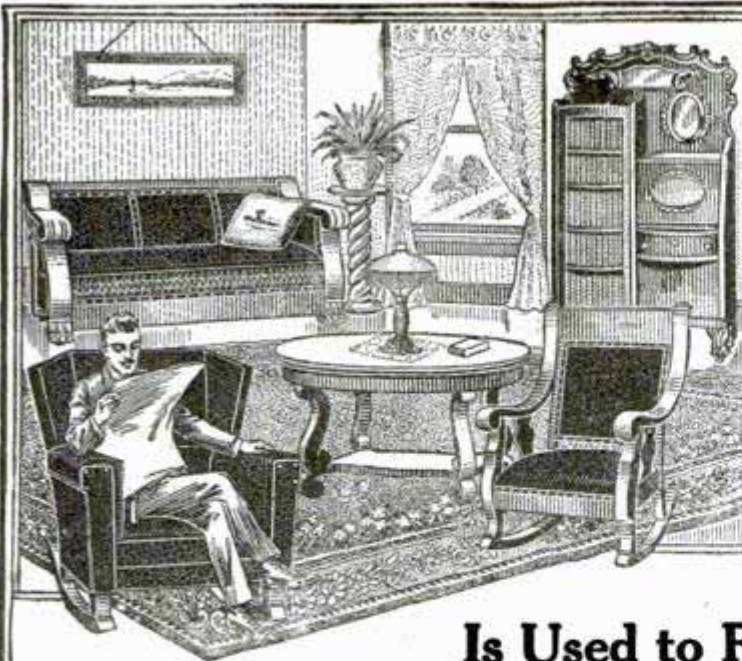

## This New-Style Credit

Is Used to Furnish 1,666 Homes a Day

**Your Credit Card Will Come With Your Catalog**  
No References Required

We now give credit to home lovers without any red tape. No references, no contract, no security. Ask for our catalog and your credit card will go with it. You will then have an open charge account and can order what you wish.

We furnish an average of 1,666 homes per day for people on these easy terms.

**Pay 3 Cents a Day**

Goods are all sent on 30 days' approval. You have a month to return anything not wanted, and we'll pay freight both ways.

Take a year to pay for the goods you keep. Pay as

**50c Brings This Solid Oak Rocker**

Price **\$3.65**  
Pay Only  
50c Monthly

Be Sure to try this remarkable bargain; order right from this paper. The entire frame is built of solid oak nicely finished in a rich shade of golden with high gloss. Notice the carved front posts, the claw feet and the broad arms.

Fabric and Leather of guaranteed quality is used in seat and back. Seat is 19 by 20 inches, fitted with full setting of springs. Shipping weight about 50 lbs.

No. 50D4B152. Price....



**\$3.65**

# Spiegel, May, Stern Co

1404 W. 35th Street, Chicago

convenient—a little each month. If sickness comes or loss of work we will gladly extend the time.

You can furnish a home in beautiful shape by saving 2 or 3 cents a day.

**What You Save**

We sell at cash prices on credit, and no interest is charged. We guarantee to save you from 15 to 50 per cent under any cash prices in catalogs or stores. If we don't do that, return the goods.

We do this by enormous buying, and by selling direct to an average of 1,666 homes a day. We take whole factory outputs, buy up surplus stocks. We sell hundreds of things at just one-half store prices.

**Five Costly Books Free**

Our Spring Furniture Book pictures 5,112 things for the home. Many are pictured in actual colors. This mammoth book costs us \$1 per copy, but we send it free.

We issue four other big catalogs, named in the coupon. Ask for any you want. See our styles, our variety, our prices. You will be amazed.

Mail this coupon for the books you want and your credit card will go with them. Do this today. Cut out the coupon now.

**5,112 Things TO CHOOSE FROM**

Furniture	Silverware
Carpets—Rugs	Chinaware
Oilcloths, etc.	Sewing Machines
Draperies	Bicycles—Toys
Blankets—Linens	Cameras—Guns
Baby Cabs	Pictures—Clocks

**A YEAR TO PAY**

**Get Martha Lane Adams' Book of Spring Styles for Women**

SPIEGEL, MAY, STERN CO.  
1404 W. 35th Street, Chicago

(631)

Mail me free your Spring Furniture Book.  
Also send me books marked below.

Stove Book.  Dress Goods.  
 Watches and Jewelry.  
 Spring Styles for Women.

Name.....

Address.....

Write plainly. Give full address.  
Check which catalogs you want.

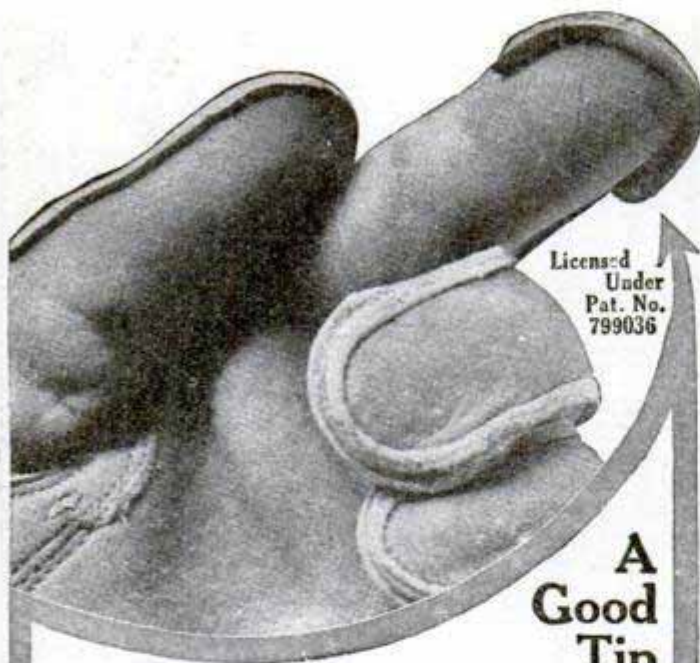

Licensed Under Pat. No. 799036

### A Good Tip

HERE'S fine news for your hands! A glove with all the comforts of the outside seam, yet strongly reinforced where the direct wear comes. This patent tip is another proof of the extreme detailed care in the making of

# Hansen's Gloves

This protected tip resists, with double force, the wear which comes directly on the weakest point of an out-seam glove. The adoption of this patent tip for our out-seam gloves is a fine example of the Hansen Progress. Hansen leathers are not only perfect, but the method of manufacture leaves no weak spot or flaw. Heat and steam proof. Will not stiffen after wetting. Easily cleaned in gasoline. All built to fit the hand.

Gloves for driving, motoring, railroading, farming, sport, etc. Men in every branch of the world's work find a Hansen Glove which exactly suits their needs. Write for booklet. If your dealer is not supplied we will tell you where to buy.

O. C. HANSEN MFG. CO.

291 Milwaukee St.,

Milwaukee, Wis.

# 1/2 PINT 1/2 DOLLAR



Buy the big Household or Factory Size 3-in-One and get 8 times as much oil for your money.

3-in-One keeps almost everything in home, office or store perfectly oiled—also as clean and bright as a new silver dollar.

Always use 3-in-One on sewing machines, typewriters, razors, cameras, talking machines, furniture, bath room fixtures, guns, reels, and hundreds of other things.

The 3-in-One Dictionary, with every bottle, shows you scores of ways this good oil makes hard work easy.

**FREE** Generous sample bottle sent on request. Try before you buy.

SOLD AT ALL GOOD STORES



## 3-IN-ONE OIL COMPANY

42CNH. Broadway, New York

Housewives—Try 3-in-One for Dusting.

**NATIONAL DEBTS OF PRINCIPAL COUNTRIES**—The national debts of the world now aggregate \$42,000,000,000, having increased 20 per cent in the last decade and doubled in the last 40 years. The largest national debt is that of France, \$6,284,000,000; the next largest being Russia, \$4,553,000,000; the United Kingdom, \$3,486,000,000; Italy, \$2,707,000,000; Spain, \$1,815,000,000; British India, \$1,475,000,000; Japan, \$1,242,000,000; and the United States, \$1,028,000,000. The combined debt of the German Empire and of the German States totals \$4,914,000,000, that of Austria-Hungary, \$3,753,000,000.

## SEESAWTO

Patent For Sale

This cut shows but one use of this patent

**C. A. NEEDHAM, 145 E. 23d St., N. Y. CITY**

6034-\$50.

Only 20% down and 10% a month

6038-\$75.

6258 \$25.

6226 \$35.

6211 \$100.

6188 \$175.

6261 \$35.

16026 \$175.

## DIAMONDS ON CREDIT

Buying a high grade Diamond is saving money, not spending it. The "Lyon Method" makes it easy for you to save. Lyon Diamonds are Blue-white and perfect. A written Guarantee Certificate with each Diamond. All goods sent prepaid for inspection. No security required. Write now for Catalog No. 3. 10% discount for cash.

### J. M. Lyon & Co.,

71-73 Nassau Street  
NEW YORK

# Get My Latest and Best Engine Offer



## Let Me Send You An Engine To-Earn-Its-Own-Cost, While-You-Pay-For-It

### A Personal Word I Am An Engine Specialist

"All my life it has been my business to provide means for taking hard work out of the day's duties."

My factory is the only one, that started in the gasoline engine business 27 years ago, which has come through successfully under the same management with which it started.

I have manufacturing advantages, (among them, Natural Gas from my own well, that gives me free power, heat and light) that make my cost of production less than in any plant I know of. I share my advantages with every customer, in lower prices for strictly highest standard engines.

I know the WITTE is at once, the most simple, and consequently the most durable; it is more easily understood, and so more easily managed; and last but not least, it takes less fuel per horse-power hour.

I have reduced the number of wearing parts to the very fewest, and then reduced the amount of wear on the few parts, to the very lowest point. You can have 60 days' free use of any WITTE, to prove that to yourself, and then have five years' insurance against defects and any subsequent faulty operation. You can't buy a WITTE and NOT get a square deal.

Any honest man, no matter where he lives in the U. S., can have a WITTE engine suitable to his needs, on any easy, reasonable terms.

No man can say he can't afford an engine, until he has read my new book and considered my selling plan.

Ed. H. Witte

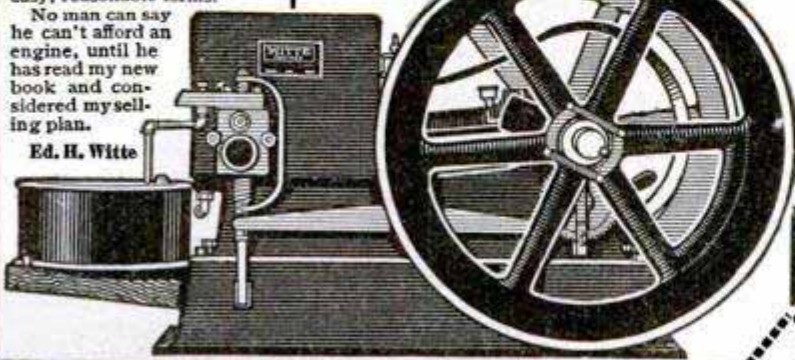

Why buy an engine blindly, or partly by guess and partly by faith, when you can be absolutely sure of getting just what you want, in any size or style, from 1½ to 40 H. P. in the unmatched, high standard WITTE line? For 7 years I have set the standard in engine quality and I take special pride in the fact that most of my orders come from and through my old customers. (I have no agents.) I have had no trouble to keep in the lead in engine quality. I had only to be honest to hold the respect and good-will of my customers. That's why I claim you can't buy any better engines at any price and none so good for my price.

With my own hands, 27 years ago, I made my first engine, and gave it my own name. Ever since, I have personally supervised the building of every WITTE engine. I know every engine, inside and out, that leaves my factory.

I am the only man in the U. S. who makes his own engines, in his own debt-free factory, from his own designs, using his own special machinery, and selling his whole output under his own name—direct from factory to user only.

# WITTE ENGINES

	Kerosene	Gas	Gasoline	Naphtha	Distillate
<b>ROCK BOTTOM</b>	2 H. P. \$ 39.45	4 H. P. \$ 75.50	6 H. P. \$ 99.35		
<b>FACTORY PRICES</b>	8 H. P. 139.65	11 H. P. 208.90	20 H. P. 389.50		
	Other sizes from 1½ to 40 H. P. proportionately low.				

While nobody can sell you any better engine than I make, nobody can make you as low a price as I now offer, Direct from my Factory. (No red tape; no useless expense and no needless waste of time. No middlemen in it anywhere.) Nature, by giving me, from my big natural gas well, absolutely free power, heat and light, for my immense factory, enables me to manufacture the highest engine quality and to undersell the field by a big margin.

## 60-Day Free Trial Offer

I want you to know of the new and fairer way I have established for selling engines. Get full particulars from me before arranging to try any engine. Write me immediately. Don't delay.

Send Coupon at Once

**ED. H. WITTE**  
**WITTE IRON**  
**WORKS CO.**  
 1749 Oakland Ave.,  
 KANSAS CITY, MO.

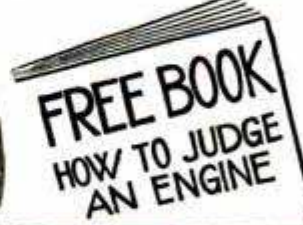

## Mail This COUPON Now

Ed. H. Witte, WITTE IRON WORKS CO.,  
 1749 Oakland Ave., KANSAS CITY, MO.

Without any obligation or cost to me, send me your FREE Book, and your new Selling Plan.

NAME.....

ADDRESS.....

# Cheaper to Own One Than to Do Without

# Play Billiards and Pool at Home



## BURROWES Billiard and Pool Table

### Used by Experts

Burrowes Tables are beautifully constructed, scientifically correct to the smallest detail. The most delicate shots, calling for skill of the highest type, can be executed with the utmost accuracy. No special room is needed. The Burrowes Table can be set up in a minute on dining-room or library table or on its own legs or stand, and instantly put aside when not in use.

### \$100 DOWN

You will be astonished to find how little it will cost to have your own Burrowes Table, and how easy the purchase is made by our monthly payment plan. The prices are from \$15 up, on easy terms of \$1 or more down (depending on size and style selected), and a small amount each month. Sizes range up to 4½ x 9 ft., (standard). Balls, cues and other necessary playing equipment free.

**FREE TRIAL—NO RED TAPE**—Catalog contains order blank and full instructions for ordering. On receipt of first installment we ship table. Play on it one week. If unsatisfactory return it, and on its receipt we will refund your deposit. This insures you a free trial. Write for the catalog to-day.

**THE E. T. BURROWES CO.**

**165 Spring Street, Portland, Maine**

Manufacturers of Burrowes Rustless Insect Screens and Folding Card Tables

**ENDLESS NECKTIE** All the rage. Newest style. Ties in different place each time. A wonder. Girl makes \$87 one week; man \$20 one day. **FREE SAMPLE** and amazing offer. Write quick.  
**ENDLESS NECKTIE COMPANY, Dept. 10, Kansas City, Mo.**

**U. S. EXPORTS TO LATIN AMERICA**—Exports from the United States to Latin America in the fiscal year 1913 amounted to a million dollars for every business day in the year and show an increase of nearly 200 per cent since 1900. In the term "Latin America" are included South America, except the Guianas; Central American Republics; Mexico, Cuba, Haiti, and Santo Domingo.



The most satisfactory, moderate price  
**Self-Filler on the market**

(See Illustration)

Merely place ball of clip in hole and press once. Pen fills instantly. 5000 words with one filling.

**The "E-Z Self-Filler Pen"**

Handsome Chased Barrel and Cap. 14 Kt. Gold Pen and Patent Clip. Price complete.....

**\$150**

AGENTS WANTED

**J. C. ULLRICH & CO., 27 Thames St., New York**



### TYPEWRITERS ALL MAKES

All the Standard Machines **SOLD** or **RENTED** ANYWHERE at ¼ to ⅓ M.F.'S PRICES, allowing **RENTAL TO APPLY ON PRICE**. Shipped with privilege of examination. Write for Illustrated Catalog L.

TYPEWRITER EMPORIUM, 34-36 W. Lake St., CHICAGO

### Greatest Bargains in History of Typewriters



Underwoods, \$30.00; Olivetti, \$25.00; L. C. Smiths, \$27.00; Remingtons, \$15.50; Smith Premier, \$16.50, and other makes \$10 and up. Expert repairing and rebuilding. Every machine in perfect condition and guaranteed two years. Write for our liberal free trial offer and cut rate prices.

All-Makes Typewriter Exchange Co., 157 N. Clark St., Chicago, Ill.

### CLEANLINESS OF OPERATION



is one of the strong features that has helped to earn the present world-wide reputation and endorsement of the

**DAUS IMPROVED TIP TOP DUPLICATOR**

No printer's ink used, thus avoiding soiled hands and clothing. No expensive supplies. 100 copies from pen-written and 50 copies from type-written original. **SENT ON TEN DAYS TRIAL WITHOUT DEPOSIT.**

Complete Duplicator, cap size (prints 8 3/4 x 13 inches), contains roll of "Dausco" Oiled Parchment Back Duplicating surface (which can be used over and over again). Price **\$5**

FELIX A. L. DAUS DUPLICATOR CO., Daus Building, 111 John St., New York

### Over 80,000 in Use

Mostly sold by recommendation. For Personal Desk or General Office.

It checks mental calculations. Handsome Morocco case free. Buy Thru Your Stationer.

Write for 30 day trial offer. E. Ganeber, A. A. M. Co., 119 W. Broadway, New York City.

Agents Wanted

### Golden Gem \$10

Adding Machine



Multiplies - Subtracts



### 3 CUSTOM SHIRTS FOR \$5.00

I make shirts that fit you, because I make your shirts from your measurements and guarantee to take them back if they do not satisfy you.

I send you 100 samples to select from

I send you measurement blank with rules. I send you the finished shirts express prepaid. No ready-made shirts in my shop, but facilities for quick delivery of the highest grade of custom work. Write for my samples. (Higher priced fabrics, too.) Spring samples now ready. No agents.

CLARENCE E. HEAD (Master of Shirtercraft), 110 Cayuga St., Ithaca, N.Y.







## “EVINRUDE”

ENJOY MOTOR-BOATING WITH ANY ROWBOAT OR CANOE

ALL the pleasures of motor-boating are yours. The fishing parties, the camping trips with the work left out, the moonlight rides on the water—are yours if you own an



### Built-In Reversible Magneto

is on the 1914 models. No batteries to wear out. The motor weighs about fifty pounds and carries like a satchel; is so simple that women and children operate it. Every motor guaranteed by largest manufacturer of rowboat motors in the world. Yearly capacity 60,000 “Evinrudes.”

It attaches to any rowboat in less than one minute and also attaches to canoes, duck boats, house boats, rafts or odd shaped craft of all kinds. Speed with rowboat eight miles an hour; with canoe nearly twelve; may be slowed down so that trolling becomes a pleasure instead of hard work. The “Evinrude” possesses exclusive features not found in any other marine motors in the world.

See the “Evinrude” at your Hardware dealer or Sporting Goods dealer, or write for illustrated catalogue—sent free

EVINRUDE MOTOR COMPANY, 234 M St., Milwaukee, Wis.

BRANCH OFFICES—New York, 69 Cortland St.; San Francisco, 423 Market St.; Boston, 218 State St.; Portland, Ore., 106 Fourth St.; Jacksonville, Fla., Foot of Main St.

# PRINCE ALBERT

the  
national  
joy  
smoke

**THIS BUNGALOW \$900  
CAN BE BUILT FOR**

This and many others in my new book, Building Plans for Modern Homes, will save you hundreds of dollars. One of the most complete and comprehensive books of plans ever published by any architect. Fifth edition just off the press. One hundred and fifty floor plans and photographs of bungalows, etc., costing from \$250 up; gives sizes and cost to build. Sent postpaid for \$1.00



**FREDERICK H. GOWING  
ARCHITECT**  
18 Tremont St., BOSTON, MASS.

**A BOOK THAT EVERY SHOOTER SHOULD OWN**

**50c**

“A New Chapter in an Old Story”—an intensely dramatic recital of man’s development of his means of defense and offense from the stone age to the present day. A temptingly readable volume. Price 50c prepaid. Address

**50c**

Remington Arms-Union Metallic Cartridge Co., 299 Broadway, NEW YORK

## Shirley President Suspenders

Shoulder-freedom  
for work or play

**50¢**

“Satisfaction or money back”

Be sure “SHIRLEY PRESIDENT” is on buckles  
The C. A. Edgarton Mfg. Co., Shirley, Mass.

# “I’ll Pay \$1.00 For Every Knot”

That’s my 1914 challenge to every man who buys or sells lumber. I’ll pay \$1.00 per knot for every knot any customer can find in our Red Cedar Siding shipped from Bay City. I stand ready to prove to you in this way that the lumber in Aladdin houses is higher in grade throughout than is regularly carried by any seller of lumber in America. O. E. Sovereign, Gen. Mgr.

## Dwellings, Bungalows, Summer Cottages, Garages

Besides having the best of lumber, Aladdin houses have character, distinction and beauty. You can save \$200 to \$300 on the cost. Aladdin lumber comes direct from the forest, no middlemen’s profits, material cut to fit, saving one-half the expense for labor. They are warmer and stronger. Price includes Clear Siding, Clear Flooring, Clear Interior Finish and Clear Shingles, framing lumber and sheathing, all cut to fit: outside and inside finish, windows, frames, stairways, hardware, nails, paints and varnishes, shingles, lath and plaster or plaster board, in short everything to complete the house. Send today for catalog 180. North American Can. Branch: C.P. Construction Co. R. Bldg., Toronto, 183 Aladdin Ave.

**5-Room House \$298**

This Warm, Snug Winter Home with five cozy rooms only \$298. Price includes all material cut-to-fit, all hardware, nails, paints—in short everything to complete the house. Can be shipped same day order is received.



## Holstein Cows' Milk Will Make Your Baby Happy and Sturdy

A healthy baby is a good baby every time. Your baby will never be fretful if you keep it free from digestive troubles by using Holstein Cows' Milk.

Babies flourish and grow strong on Holstein milk because it is so much like breast milk — the food to which nature has adapted the little stomachs of infants.

In Holstein milk as in human milk, the cream or fat is divided into minute uniform globules less than half the size of those in common milk. So when Holstein milk reaches the stomach it acts just as human milk does. It forms small soft curds, flaky and easy to digest.

Holstein cows are large, healthy, full of vitality, exactly the kind of cows you would expect to give the most wholesome milk.

Holstein milk costs no more than ordinary milk. If your dealer cannot supply you, send us his name and we will help you secure a supply. At all events send for our free literature, it's full of good points about Infant Feeding.

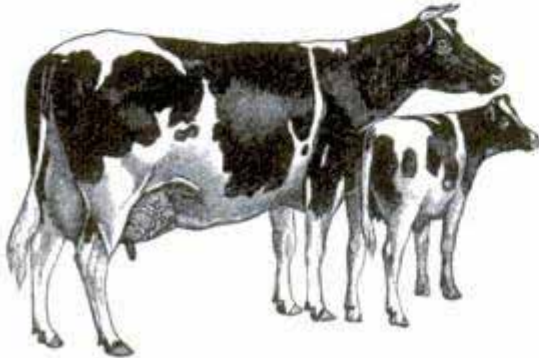

**HOLSTEIN - FRIESIAN ASSOCIATION**  
3-F American Building Brattleboro, Vermont

## Learn the new profession Tree Surgery



Not overcrowded and offers splendid and unusual opportunities to honorable young men. Ages 20 to 28. Students must have attended high school, be physically sound, and of good character. After completing two years' course, good men make large annual incomes. Positions guaranteed to good men after graduation. Every city, park, orchard and private estate needs an Expert Tree Surgeon. Positions open also with established companies or State and National Governments. Special attention to Fruit Growing. Tuition moderate, including first year's board. We pay salary second year. Write promptly for full particulars. Address the Secretary

**DAVEY INSTITUTE OF TREE SURGERY**  
Box 301, KENT, OHIO

## "Book of Complete Information About Pianos"

The most valuable piano book ever published — 156 pages of inside information — it's **free**.

The most intimate facts of piano construction and manufacture laid bare. Practical, reliable and thorough tests explained by which **you** can test the value of **any** piano. With this book of reference, no piano salesman can deceive you. You are made thoroughly acquainted with every detail of action, case, sound board, in fact everything connected with the production of a high grade piano. The New York World says: "A book of educational interest everyone should own." Worth a good price. Also tells how you can get a Wing Piano on **free trial**. The great Wing Piano that is shipped direct from the factory, saving all middlemen's profits. This splendid book now sent **free**, upon receipt of your name.

**Send Postal Now** Send it to us immediately.

If you ever intend to own a piano, take advantage of this opportunity. Valuable piano information **free**, that may mean more than \$200 saving to you. To those who write at once, we will also send our beautiful catalog showing latest art styles of the famous Wing Pianos and full particulars of our great rock bottom and free trial shipment offer. Write now. **We Have Been Manufacturing Pianos for 45 Years**

**WING & SON (Est. 1868), Wing Building, 9th Avenue and 13th Street, Dept. 1193, New York, N. Y.**

# FREE



One of Our 38 Styles

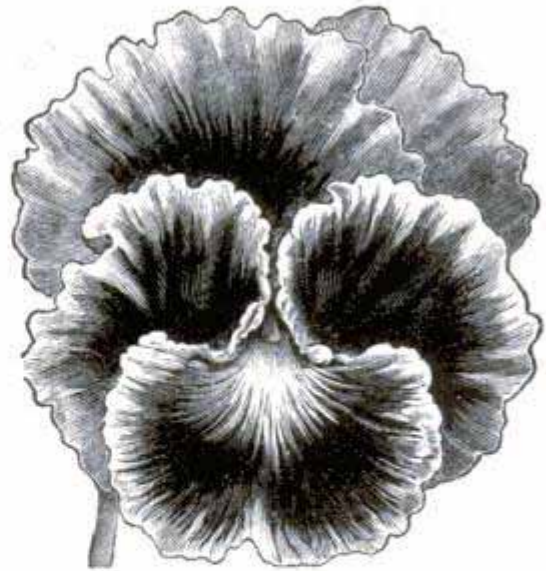

Once Grown Always Grown

## Maule's Seeds

Endorsed by more than 450,000 progressive gardeners as the best ever

My new Seed Catalogue contains everything good in seeds, bulbs, small fruits and plants. 750 illustrations; 178 pages. Free to any one sending me a request for it. *Send for it today.*

**WM. HENRY MAULE**

21st and Arch Sts., Philadelphia, Pa.



*Send 10 cents, mention this paper, I will enclose in the catalogue a packet of the above GIANT pansy.*

**TREASURES OF THE RIVER TIBER**—The waters of the river Tiber are said to cover many costly treasures of antiquity. From Lake Nemi, near Rome, many bronze armaments and statuary from the floating palaces of the emperors Tiberius and Caligula have already been recovered. It has long been the belief of antiquaries that the Tiber's bed conceals a vast amount of artistic treasures which have been flung into it either from wanton recklessness or for the purpose of preservation from sacrilege. There has of late been

## DISHWASHING DRUDGERY GONE FOREVER



The **Kitchenette Family Dishwasher** takes the place of the old dishcloth, dishpan way. Washes and sterilizes in a few minutes. Will not break the most delicate china. Hands do not touch the water. No red, rough, chapped, dishwasher hands. Approved by Good Housekeeping Institute of N. Y. and guaranteed by us. Send no money. **30 days free trial** and easy payment plan. All freight prepaid. Address **CARY-DAVIS CO., INC., Dept. P-A., 42 Pearl St., Buffalo, N. Y.**

## Why Pay \$17.50?

The material and workmanship of this chair—Genuine, Select, Quarter Sawn White Oak of rare quality—costs less than half of \$17.50 at the factory. Yet that is the price you would pay for it at a store.

**We Ship It Direct From Our Factory In Sections—**

**You Set It Up and Save \$8.55**

You pay only for materials, workmanship, and the usual small profit to manufacturer. We save you all other unnecessary expenses—dealer's profit, jobber's profit, traveling men's salaries, high packing expenses—and freight rates, etc.—almost 50%.

And back of each piece is our guarantee—if you are not satisfied at any time within a full year you may ship it back and we immediately refund your money, including freight.

**"COME-PACKT"  
FURNITURE**

**Only  
\$8.95**

**In Four Sections**

Select Quartered WHITE Oak. Built with the care and skill of the old master cabinet makers—possessing an individuality and artistic charm befitting the home of quality. Eight different shades of finish. Imperial leather cushions. Packed in compact crate—shipped at knock-down rates.

**New 1914 Catalog FREE**

Shows over 400 other beautiful examples of Come-Packt craftsmanship in living, dining and bedroom furniture—in sections—at 30% to 60% price savings. Sent free—postpaid. Mail postal today.

**Come-Packt Furniture Co., 301 Dorr St., Toledo, O.**



**Mail  
Postal  
For This  
Catalog**

talk of dredging the bed to increase its utility and lessening the dangers of its overflows. This course may bring to light some of the fabled treasures.

## MAKE \$10 A DAY WITH THE MONITOR

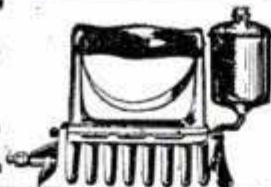

### MONITOR AGENTS MAKE MONEY

EVERY home a prospect. Over 575,000 Monitor Irons sold. Makes and contains its own heat. Easy to operate, highest in quality, lowest in price. Satisfaction guaranteed. Big profits. Martin (Tennessee), made \$5000 in one year. **Exclusive Territory Free.** Write to-day.

The Monitor Sad Iron Co. 400 Wayne St., Big Prairie, O.

## This Watertight Raincoat \$4.68

Drape over a pail or barrel and let water stay over night in the bag the garment forms. We guarantee that no water will leak through this coat.

We make honest raincoats and sell direct from factory to wearer. Raincoat shown here is 1914 style and supreme value. Has snug-fitting military collar, belted back, wrist straps, slashed pockets with openings through to trousers or skirt pockets, full sleeves and skirts, thorough ventilation, is warm and roomy. Double texture, tan cloth outside, plaid inside, rubber-coated between and vulcanized. All seams stitched, cemented and strapped.

This handsome, guaranteed garment at \$4.68, postpaid is one of many big values. No extra charge up to 46 inch bust measure. Boys' and Misses' sizes, age 8 to 16, \$4.28 postpaid. Send height, bust, and sleeve measurement over your coat or dress, and we will fit you perfectly, and delight you or refund your money instantly. Order direct, or write for catalogue for men, women and children. Cut out the jobber and the retailer, save \$2 to \$6 and deal with a concern whose guarantee is as good as gold.

TORPEDO BRAND MFG. CO., Dept. D, Brookline, Mass.



## Yours for \$2 a month. This \$35.00 set now only \$19.80!

Here's a real opportunity! You can buy at almost half price, the most complete and comprehensive work on electricity ever published—the world's greatest electrical library is now offered to you on the easiest of monthly payments. This plan brings these great books within the reach of all. Take advantage of this opportunity. Be an Electrician—start now. These books and our wonderful consulting privilege will give you a complete electrical education. Whether worker, engineer or expert, these books will add to your knowledge, add to your job and add to your salary.

### Cyclopedia of Applied Electricity

Contains 3,200 pages, 7x10 inches; 2,600 illustrations, full page plates, diagrams, etc.; hundreds of valuable tables and formulas; carefully cross-indexed for quick, easy reference. Printed in large, clear type on special quality paper and bound in half red morocco, gold stamped.

#### Read These Subjects Carefully

Theory, Calculation, Design and Construction of Generators and Motors—Electrical Measurements—Electric Wiring—Electric Welding—Types of Generators and Motors—Management of Generators and Motors—Storage Batteries—Electric Lighting—Alternating Current Machinery—Station Appliances—Power Stations—Power Transmission—Central Station Engineering—Electric Railways, including Single-Phase—The Electric Telegraph—Telephone Equipment, Systems and Operation—Wireless Telegraph and Telephone—Telautograph, Telegraphone, etc., etc.

**Shipped Free** The complete seven volumes, not a sample volume, will be sent, express prepaid, for seven days' free examination; returnable at our expense if they fail to meet with your expectations. If you keep them, pay \$2.00 seven days after receipt and then \$2.00 a month until you have paid the introductory price of \$19.80. Fill in and mail the coupon—today. It won't cost you a cent to examine the books, so get them into your home and look them over at your leisure. Remember, if you don't like them they may be returned at our expense.

### Consulting Service Free

With every set is included a year's Consulting Membership, regular value \$12.00, entitling you to the free advice of a staff of electrical experts. This will give you practical help in handling your difficult working problems. There will be no limit to this service—ask as many questions as you wish for an entire year. This service alone may be worth more than the first cost of the books. Don't wait. This means \$15.20 saved if you act now. You take no chances whatever. It costs nothing to inspect and you are nothing out if you do not care to buy. Mail the coupon today.

### FREE COUPON Worth \$15.20 to You

**American Technical Society,  
Chicago, U. S. A.**

Please send me Cyclopedia of Applied Electricity for 7 days' free examination. If I decide to buy, will send \$2 in 7 days and balance \$2 a month until \$19.80 has been paid, when \$35 books and \$12 Consulting Membership will be mine. Otherwise will notify you and hold books subject to your order. Title not to pass until fully paid. Pop. Mech. 3-14

NAME .....

ADDRESS .....

As I have had no previous dealings with you, I refer you to

Please Mention Popular Mechanics



# PATENT YOUR IDEAS

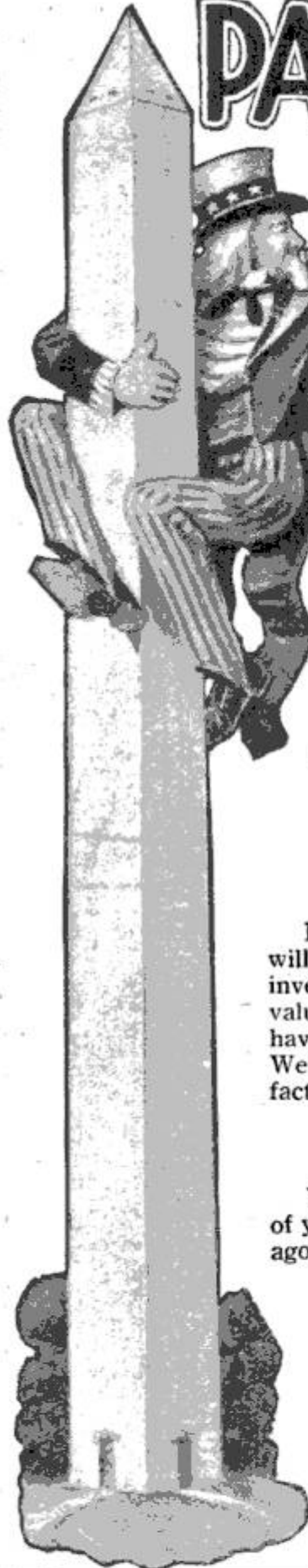

*—There is a Constant Demand for Good Inventions*

Thousands of the biggest money-making inventions have been the "little" things that have made people wonder why they were never thought of before.

## "WHAT TO INVENT" *and* "HOW TO OBTAIN A PATENT" *These Books Sent Free*

If you have an invention send us a sketch, photograph or model of it. We will give you a report as to its patentability absolutely free. If you have no invention send for our book, "What to Invent." It contains hundreds of valuable suggestions. We are recognized authorities on patent matters and have helped hundreds to find a ready and profitable market for their ideas. We can prove it. If you wish to sell your patent we will advertise it in manufacturers' journals at our expense.

***Don't Wait—Find Out NOW!***

Your idea will never do you any good if some one else patents it ahead of you. Act quick! Let the other fellow say "he thought of it a long time ago." You reap the profit. Let the others wish they had.

***Advice Free—All Matters Confidential***

We have secured patents for thousands of inventors and have many letters proving the value of our services. Write us. Send rough drawing or model of your invention for our opinion. We will guard it carefully and report quickly. You are under no obligations to proceed further. Our plan is simply a square deal to all. Our books, "What to Invent" and "How to Obtain a Patent" are the best publications written for the man who has an idea to patent, or who is of an inventive turn of mind. They show just how to proceed with your idea and tell of hundreds of things to invent. We gladly send these books free. The sooner you write for them the sooner you will know all about patents and the many different lines in which new inventions or improvements may be made.

*If you have an invention send us a sketch of it for report and ask for the books at the same time.*

**CHANDLEE & CHANDLEE, 945 F Street, Washington, D. C.**  
REGISTERED ATTORNEYS (Combined with H. Ellis Chandlee & Co.)

# Patents

Trade Marks and  
Copyrights Secured  
or Fee Returned

## Special Offer—Free Search of Patent Office Records

Send us a model or sketch and description of your invention, and we will make a *Free Search* of the *Patent Office Records* to ascertain if it is patentable. If we report the invention patentable, we will guarantee to obtain a patent or return our fee, and furnish a certificate of patentability backed by a bonded contract to that effect. **This Certificate of Patentability will protect the inventor and serve as proof of the invention until the case can be filed in the U. S. Patent Office.**

### Obtaining Assistance for Inventors

Our certificate is of great assistance to inventors who require financial aid to obtain patents.

### Our Five Books Mailed Free

(SEE COUPON BELOW)

to any address. Send for these books—the finest publications ever issued for free distribution.

#### How to Obtain a Patent

Our illustrated eighty-page Guide Book is a book of reference for inventors, and contains 100 mechanical movements illustrated and described.

#### Money in Patents

Tells how to invent for profit, and gives history of successful inventions.

#### What to Invent

Contains a valuable **LIST OF INVENTIONS WANTED** and suggestions concerning profitable fields of invention; also information regarding prizes offered for inventions, among which is

#### Prize of One Million Dollars

offered for one invention, and \$10,000 for others.

#### Patents That Pay

Contains letters from our clients who have built up profitable enterprises founded upon patents procured by us; also endorsements from prominent inventors, manufacturers, Senators, Congressmen, Governors, etc.

#### We Advertise Our Clients'

#### Inventions Free

In a list of Sunday newspapers with two million circulation, in manufacturers' journals and in the *World's Progress*. Sample Copy Free. We save you time and money in securing patents. After the patent is granted we assist you **TO SELL YOUR PATENT.**

#### Foreign Patents

WE HAVE DIRECT AGENCIES IN ALL THE PRINCIPAL FOREIGN COUNTRIES and secure FOREIGN PATENTS in the shortest possible TIME and at the LOWEST COST. Write for our Illustrated Guide Book on Foreign Patents, sent free to any address.

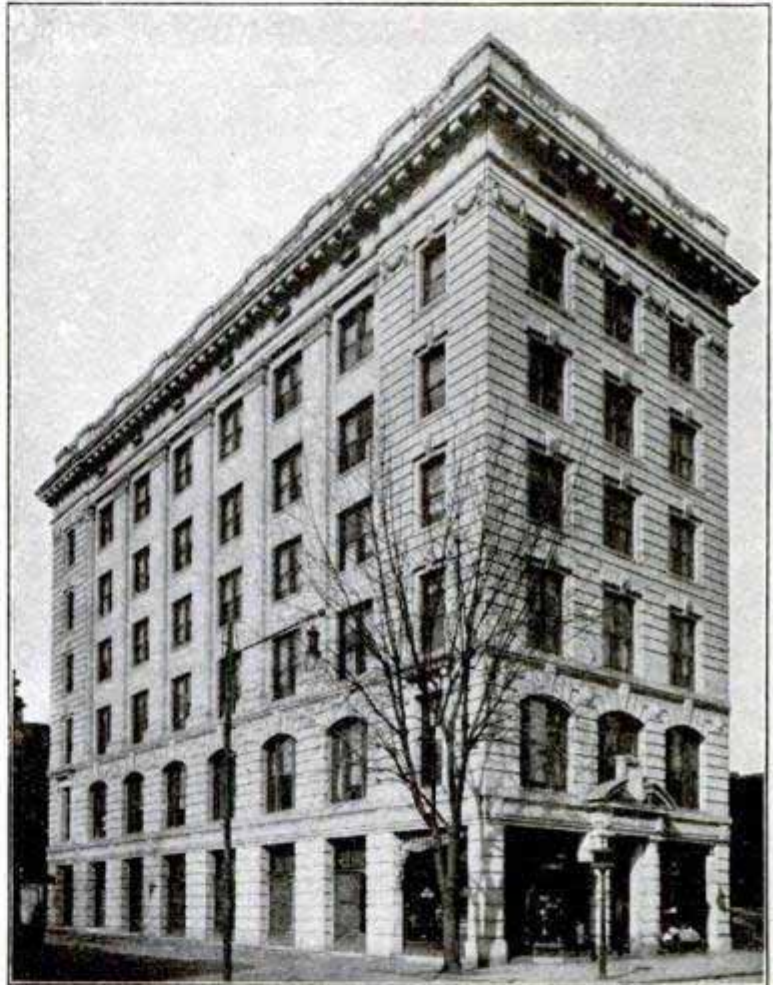

**VICTOR BUILDING**

Our new \$200,000 building opposite U. S. Patent Office  
SPECIALLY ERECTED by us for OUR own use

## WANTED NEW IDEAS

Send for **LIST OF PATENT BUYERS** who consult us when purchasing patents. Contains requests from **MANUFACTURERS, MAIL ORDER HOUSES** and **PROMOTERS** for patents secured by us, and suggestions as to New Ideas they wish to purchase. We invite manufacturers and promoters to address our Sales Department regarding the purchase or leasing of a number of meritorious patents secured by us.

### REFERENCES

Second National Bank, Washington, D. C.; Union Savings Bank, Washington, D. C.; Chamber of Commerce, Washington, D. C.; Pitner Gasoline Lighting Co., Chicago, Ill.; R. G. Dun & Co., Washington, D. C.; Smethport Glass Co., Smethport, Pa.; The Melvin Gauge and Signal Co., Scranton, Pa.; M. Winter Lumber Co., Sheboygan, Wis.; National Savings and Trust Co., Washington, D. C.

### FREE COUPON!

**VICTOR J. EVANS & CO., Patent Attorneys**

NEW YORK OFFICES: 132 Nassau St.

PHILADELPHIA OFFICES: 1429 Chestnut St.

Main Offices: 724-726 9th St., N. W., WASHINGTON, D. C.

GENTLEMEN: Please send me FREE OF CHARGE your FIVE Books as described above.

NAME..... ADDRESS.....

# WANTED-IDEAS

Manufacturers are constantly writing me for patents procured through me. The demand for good ideas

## Protected by Owen Patents

is greater than ever before. Send for my free books and read the letters from the greatest manufacturers in this country. Read their requests for Owen Patents and see for yourself what ideas they want. You can help supply the unceasing demand for good inventions.

My clients are provided with manufacturing facilities, and I aid them in many ways, without charge, to sell their patents. Applications filed through me advertised free.

You will get a strong patent or I will get no compensation. Your interests are my interests.

# FREE!

A simple request will bring you the following three finest patent books published absolutely free—you will incur no obligation by writing me.

**"SUCCESSFUL PATENTS"**--a new 72 page guide book; tells how to proceed to be successful; describes my advantageous business methods.

**"STEPPING STONES"**--gives lists of over 200 inventions wanted; gives forecasts from interviews of Edison and many other authorities; tells the plain truth about prizes of millions of dollars for inventions.

**"PATENT PROMOTION"**--tells you how to promote your invention; why some inventors fail; the value of your rights, etc.



Write for these books today—NOW! Advice costs nothing

### VERY HIGHEST REFERENCES

Columbia National Bank,  
Washington, D. C.  
National Locktile Co.,  
Washington, D. C.  
The Carnahan Press,  
Washington, D. C.  
Lightning Gun & Cycle Works  
Oklahoma City, Okla.  
Antholene Mfg. Co.,  
Hutchinson, Kans.

National Rack Co.,  
61 Hannover St.,  
Boston, Mass.  
The C. J. Loftus Co.,  
19 Spring Common,  
Youngstown, Ohio  
Whitehead Hosiery Mills,  
Burlington, N. C.  
Dickinson Mfg. Co.,  
Des Moines, Iowa.

And an immense number of others whose letters are printed in my booklets.

### SPECIAL!

Send me a sketch or model of your invention and I will make a search of the U. S. Patent Office Records **FREE OF CHARGE** and report to you concerning patentability, practicability, etc.

Your work will receive my **PERSONAL** supervision—but my fees are no higher than others.

**RICHARD B. OWEN** 9-303 OWEN BLDG.  
WASHINGTON, D. C.

Inventors submitting their inventions to me are protected in a tangible manner until their applications are filed.

# Inventors! Send for these Remarkable FREE BOOKS, Today

Complete and full information about patents, everything the inventor or manufacturer should know, has been included in these books. Never before has such an inexhaustible fund of valuable information been at the inventor's disposal. Regardless of the fact that the compilation of this information cost us thousands of dollars, we will send to all interested persons, any or all of these books, entirely without charge or obligation.

## "Money In Patents"

This volume, 100 pages, tells the story of the romance of invention. The brain of the inventor is the magician that has made the ancient fairy tales come true. Millions have been paid for a hook, fortunes have come from a toy. Read "Millions In Patents," and you will realize that this country and all the nations of the world are ready to enrich you beyond your wildest dreams if you can contribute one useful or amusing thing.

## "What Is a Trademark?"

It is not an exaggeration to say that billions of dollars have been made out of trademarks, labels and copyrights. He who can fashion a trademark or design a label which will make a product stand out above all similar products, is indisputably a genius for whose brains the world offers almost unlimited money.

## "Foreign Patents"

A good invention is bought not by one country but by the world. "Foreign Patents" shows you how the inventor may be paid by other countries and other peoples, as well as by this nation, for his ideas and his inventions. It explains how we, through our representatives in the capitals of the world, maintain for your benefit an endless chain of opportunities which, if you take advantage of them, will girdle the earth and make of your product an agent that may bring back to you rich rewards.

## "Inventions Needed"

This book, 196 pages, lays before you a description of the active and profitable field of invention. It tells you the inventions the world needs today, the devices manufacturers are seeking for their business, the ideas for which the public will pay big money. It gives great men's ideas of the most important things needed in inventions now. Science is the key to wealth, and this key can be turned best by the inventor. This book tells you why.

## "How to Get Your Patent and Your Money"

The man who invents needs the co-operation of the man who invests. This book, 132 pages, is a guide to the inventor. It describes, according to the teachings of our experience and the lessons of men made rich by patents, how the inventor may secure money, the right amount of money, for the device which his brain has constructed. If you have invented something and desire to learn what it will cost you to get your patent and what you must do to find your market, read this book.

## "Special Bulletin of Patent Buyers"

This bulletin, 52 pages, contains copies of hundreds of letters from wealthy men who are seeking to purchase patents. Next to the idea of the invention itself, the most valuable thing to the inventor is a hint of where there is a man ready to buy the invention or to finance the inventor so that his device can be readily marketed. We act as intermediary, without one cent of charge, between the man who invents and the man who invests.

**We Secure Reliable Patents, Trade Marks, Copyrights, On Most Liberal Terms Ever Offered**

**Send Model or Sketch and description of your invention for Free Search of the United States Patents**

**Rejected and Difficult Cases are Our Specialty**

**Here is one of our Many References**

**Randolph & Co.**  
600 F St., N. W.  
**Washington, D. C.**

**RANDOLPH & CO., WASHINGTON, D. C.**

Gentlemen: Please send me, without obligation on my part, the books indicated on margin of this coupon. (Write on margin of coupon, names of books desired.)

NAME .....

STREET .....

CITY .....

STATE .....



THE SPEAKER'S ROOM  
HOUSE OF REPRESENTATIVES  
WASHINGTON, D. C.

August 20, 1912.

To Whom It May Concern:

It gives me pleasure to state that I am acquainted with the firm of Randolph & Company, patent attorneys, of this city, and believe them to be thoroughly reliable, capable and exceedingly well equipped to look after the interests of their clients.

They are entirely up to date in their methods and able to render efficient service to their clients.

Sincerely,  
*Chauncy Clark*

AN ENDORSEMENT FROM MR. CHAUNCEY CLARK, SPEAKER OF THE NATIONAL HOUSE OF REPRESENTATIVES.

# PATENTS THAT PROTECT and PAY

Advice free. Terms reasonable. Highest references. Best results.

Send sketch or model for FREE examination and opinion.

Recommended Patent Lawyer in the Bankers' Register and special list of selected lawyers. Also in Martindale's Law Directory, Sharp and Alleman's Directory of Lawyers, The Gast-Paul Directory of Lawyers, and Kime's International Law Directory.

**ALL BUSINESS GIVEN PROMPT AND PROPER ATTENTION**

A large list of strong recommendations furnished free

**WATSON E. COLEMAN, Patent Lawyer, 622 F St., N.W., Washington, D.C.**

## PATENTS

**C. L. PARKER**  
Formerly Member Examining  
Corps, U. S. Patent Office  
**PATENT LAWYER**  
210 MCGILL BLDG.  
WASHINGTON, D. C.

Patents, Trade Marks, Copyrights, Patent Litigation

Handbook for Inventors, "Protecting, Exploiting and Selling Inventions" sent free upon request.

For Interesting and Valuable Information about  
**PATENTS WANTED**  
and bought by Manufacturers, send 6 cents postage for large Illustrated paper *Visible Results and Terms Book*.  
R. S. & A. B. Lacey, Dept. Y, Washington, D. C. Estab. 1869.



## BRASS GEARS

Cut by an entirely new process. The most accurate made and at prices that cannot be equalled by others. Every gear has a hub, center painted ebony black, edges turned true, highest grade red brass, and much heavier than others. We carry the largest stock in the world and every gear listed is always shipped on date of order.

SEND FOR CIRCULARS

**CHICAGO STOCK GEAR WORKS**  
16 S. Fifth Av. Chicago



**INVENTORS** Our Brain Belongs  
Are Free of Charge.

All we want in return is to build your model, special machinery, dies, tools and jigs to manufacture sheet metal goods, etc. We are expert mechanics, over thirty years experience and have one of the best equipped shops in the country. Ask for Booklet No. 17. Consultation free. Experimental work strictly confidential.

**A. NACKE & SON**  
236-242 S. 9th St., Philadelphia, Pa.

Active Powers of Inventive Genius

## PATENTS THAT PAY—

\$561,530 Made

by my clients. List Free of PRIZES OFFERED. 127 Page Patent Book—"What and How to Invent—Proof of Fortunes in Patents"—FREE.

E. E. VROOMAN, Pat. Atty., 871 F St., WASHINGTON, D. C.

## PATENTS TO BUILD ON —

H. L. WOODWARD, ATT'Y. WRITE FOR  
300 G. WASHINGTON. MY BOOKS

WHAT TO INVENT—WHAT NOT TO INVENT—HOW TO PROFIT

The consumption of toys in the United States has grown with remarkable rapidity. Importations in the fiscal year 1893 were less than \$3,000,000; in 1903 \$4,225,000; in the fiscal year 1913, practically \$8,000,000, and for the calendar year about \$9,000,000.



**MECHANICAL SUPPLIES AND MATERIAL** of all kinds. EXPERIMENTAL AND LIGHT MACHINE WORK to order. 132 MILK STREET. BOSTON



The rapid development of Wyoming makes it safe for us to pay 6 per cent—because Wyoming legal 'nt. rate is 8 to 12 per cent. Our stringent banking laws give you the same protection you get at home. Why be content with 3 to 4 per cent when we will pay you 6 per cent. Resources over \$100,000. Write today for booklet.

**PIONEER SAVINGS BANK** 12 Pioneer Street Barin, Wyo.

## Get a Broader View of Life in Bitter Root Valley

Arrange with us to join one of our coming low rate, first-class excursions and see with your own eyes the money making, health making and home making opportunities in this famous scenic environment, with good roads, hunting, fishing, and mountain climbing. Learn on the ground how you can obtain a return of \$200 an acre or more annually from a Bitter Root Valley fruit orchard. For excursion dates and particulars, address

**BITTER ROOT VALLEY IRRIGATION COMPANY**  
849-855 First National Bank Building, CHICAGO, ILL.

## PATENT POINTERS

Things to know before applying for a patent:

1. Is my invention perfected or complete?
2. Is it new and patentable? If so, what will a patent cost?
3. Does it infringe any patent?
4. Is there a demand for such an invention?
5. Can a demand be created at reasonable expense?
6. What will it cost to demonstrate the utility of and demand for my invention?
7. Who are likely to be interested in the manufacture and sale of such inventions?
8. Where can I get reliable information and advice on the above points?

We will be glad to demonstrate to your satisfaction that we can render the service required to fully post you upon the above points.

**BENJAMIN AND BASSETT**  
Patent Attorneys and Mechanical Experts  
Provident Savings Bank Bldg., WASHINGTON, D. C.



## Get Your Canadian Home From the Canadian Pacific



The Home Maker

**W**E will make you a long time loan—you can move on the land at once—your Canadian farm will make you independent and

### We Give You 20 Years to Pay

Rich Canadian land, \$11 to \$30 per acre—*one-twentieth down*. Long before final payment comes due your farm will have paid for itself.

### We Lend You \$2000 For Farm Improvements Only

No other security than the land. You are given twenty years to pay with interest at 6%. In case of approved land purchaser, we advance live stock to the value of \$1,000 on a loan basis.

Or if you want a place already established, you will find one on our Ready-Made-Farm. All planned by our experts, and our service and advice is yours free.

### This Great Offer Is Based on Good Land

Finest on earth for general mixed farming—irrigated and non-irrigated lands. Located on or near railway. The famous Canadian West has magnificent soil, good climate, churches, public schools, good markets, good hotels, unexcelled transportation—and 20 years to pay. Time is precious.

WRITE TODAY

G. E. THORNTON, Colonization Agent

### Canadian Pacific Railway

Colonization Department 112 West Adams Street, Chicago, Illinois

FOR SALE—Town lots in all growing towns. Ask for information on industrial and business openings.

## Do Your Printing!

Cards, circulars, books, newspaper. Press \$5, Larger, \$18, Rotary \$60. Save money. Big profit printing for others. All easy, rules sent. Write factory for press catalog. TYPE, cards, paper, outfits, samples. **THE PRESS CO., Meriden, Conn.**

### BUYS THIS PRINTING PRESS

The "Ideal" is an absolutely practical printing press, suitable for store, office or home. It's a wonder—always ready for work. Save dealers' profits. Write for a copy of our free catalog of printing presses and supplies. **IDEAL PRESS CO., 2011 N. Lawndale Ave., Chicago, Ill.**

### 1/2 H.P. YOURS \$19.50

1 and 1 1/2 HP sizes at equally low prices. You can never hope to obtain a fully guaranteed Gas Engine complete, ready to run, on 10 DAY TRIAL, at lower prices than ours. Neat, simple, reliable and easy to start. For experimental or practical work. Will run the laundry, dairy, light plant, etc. Send stamp for catalogue.

**SIEVERKROPP ENGINE CO. 1224-18th St. RACINE, WIS.**

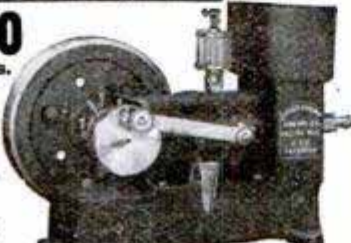

## FREE Plan Book and Consulting Service

**Carpenters!** Make big money in the construction field. This business getting combination yours without cost. A year's Consulting Membership, entitling you to the unlimited advice of a staff of experts, and our big Plan Book absolutely free. Contains 224 pages, 9 1/2 by 12 3/4 inches, and 426 illustrations. Covers completely 168 structures, from city and country homes to apartment houses and public buildings, including plans and specifications, exterior and interior views, and detailed estimates.

The advice of our experts, which alone may be worth more than the entire cost of the books, together with the **Plan Book** and our **Cyclopedia of Architecture, Carpentry and Building**, will enable you to figure on any job, no matter how large. Your ability to save the usual architect's fee will get you the business.

### The Cyclopedia of ARCHITECTURE, CARPENTRY AND BUILDING

consists of ten massive volumes; 4,760 pages, 7x10 inches; 4,000 illustrations, full page plates, building plans, diagrams, etc.; hundreds of valuable tables and formulas; carefully cross-indexed for quick, easy reference.

This great work covers everything in the building professions, from the first rough sketch of the architect to the acceptance of the finished structure. It includes wood, stone, steel, and reinforced concrete construction; estimating and contracting; a study of the Greek and Roman Orders; interior finishing and decorating, and modern house lighting and sanitation.

**Now offered at half price and on the easiest of easy payment plans.**

#### Partial Table of Contents

Mechanical, Freehand, Perspective and Architectural Drawing, Lettering, Pen and Ink Rendering, The Orders, Superintendence, Strength of Materials, Masonry, Reinforced Concrete, Carpentry, Steel Square, Stair-Building, Hardware, Steel Construction, Roof Trusses, Practical Problems, Estimating, Contracts, Specifications, Building Law, Sanitation, Sheet Metal Work, Electric Wiring and Lighting.

With every order for a Cyclopedia we will include the Plan Book and a year's Consulting Membership absolutely free of charge, and send you the Cyclopedia and the Plan Book, express prepaid, for seven days' free examination. You keep the books a full week—examine them thoroughly at your leisure—and if they don't meet with your expectations they may be returned at our expense. Remember—the complete set, Cyclopedia and Plan Book, are sent free upon receipt of the coupon below and we pay express charges both ways if they are not satisfactory.

Don't wait. This means money saved if you act now. You take no chances whatever—it costs nothing to inspect and you are nothing out if you do not care to buy. Isn't this offer worth investigating? It may mean your success, so mail the coupon today—now—before you turn the page.

#### COMBINATION OFFER COUPON

American Technical Society, Chicago, U. S. A.

Please send Free Plan Book, also Cyclopedia of Architecture, Carpentry and Building for seven days' examination. I will send \$2.00 within seven days and \$2.00 a month until I have paid \$24.80 for Cyclopedia (Plan Book and Consulting Membership included free), or notify you and hold books subject to your order. Title not to pass until fully paid. POP. MECH. 3-14

NAME.....

ADDRESS.....  
As I have had no previous dealings with you, I refer you to

Free Plan Book

Please Mention Popular Mechanics

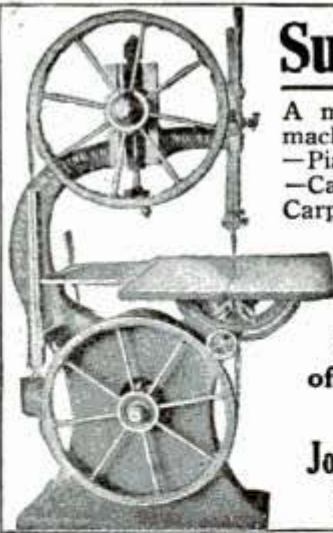

## Superior Woodworking Machinery

A modern line of woodworking machinery for Furniture Factories—Piano Factories—Box Factories—Cabinet Shops—Pattern Shops—Carpenter Shops—Wagon Shops—Repair Shops—Contractors—Manual Training Schools, etc. If interested write for our catalogue and *net prices*.

**Largest manufacturers of woodworking machinery in Chicago.**

**Jones Superior Machine Co.**  
1266 W. North Ave., CHICAGO



Jones Machine Moulded  
**PULLEYS and GEARS**  
Clutches, Sprockets  
Shafting and Hangers

THE LARGEST LINE OF  
**Power Transmitting Appliances**  
IN THE COUNTRY

SEND FOR GENERAL CATALOGUE A18  
**W. A. JONES FOUNDRY & MACHINE CO.**  
1400 North Ave. CHICAGO

**\$300<sup>00</sup> IN ONE SEASON**

Make it sharpening Lawn-mowers on the "Ideal" Lawn-mower Grinder.

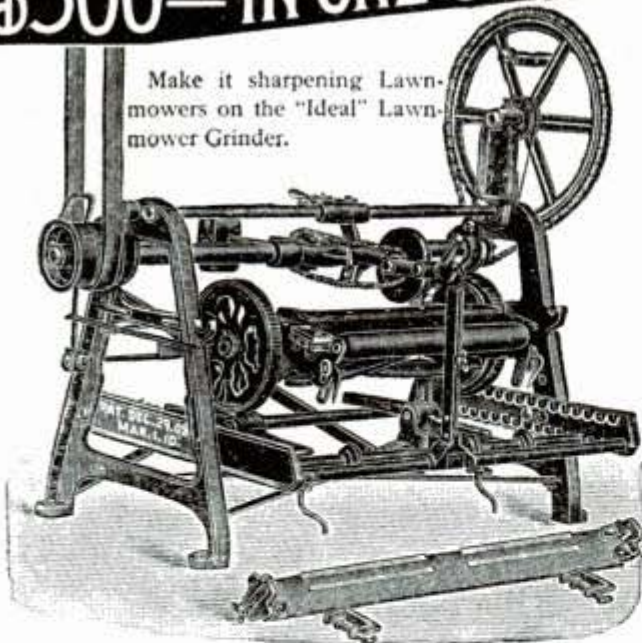

"You Grind It As You Find It"

Many have done better. Mr. Zabst, Mich., writes: "I sharpened 2178 mowers in 3 seasons at 75c to \$1.50 each." Mr. Stoy Ia., writes: "I ground over 500 mowers this season and expect to do better next year." Sharpens skates in winter, too. The best money maker you can have in your shop. Nothing like it on the market. Sharpens all makes of mowers perfectly in fifteen minutes. Over 6000 in use. Fully warranted. Write today for catalog and full information.

**The ROOT-HEATH MFG. CO., Plymouth, O.**

## "SEBASTIAN" LATHES

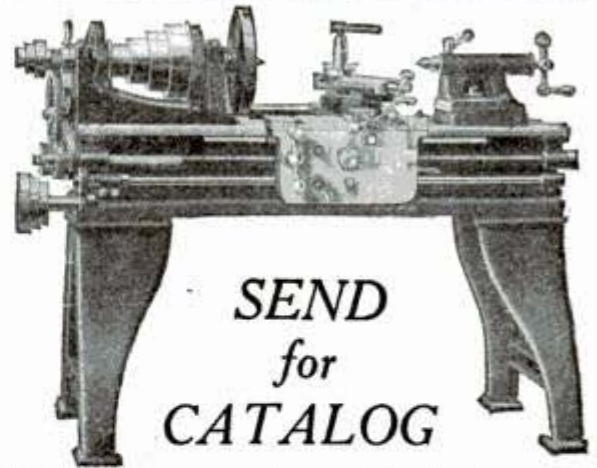

SEND  
for  
CATALOG

We want you to have this informative, finely illustrated booklet of Lathes —

*For Garage, Automobile and General Repair Work*

The "Sebastian" is of simple construction, easy to operate and is sold at the right price.

**The Sebastian Lathe Co.**  
107 Culvert Street CINCINNATI, OHIO

**PRESSED-STEEL PANS FOR LATHES**—An interesting, new application of pressed-steel work is the production of sheets large enough to make tanks or pans for lathes, screw machines and other metal-working machinery which are now made of cast iron and, therefore, heavier and not so strong as the steel pans. Recently one of these steel pans was turned out 10 ft. long and 34 in. wide with sides 5½ in. deep, and it is believed that the new product will be widely used.

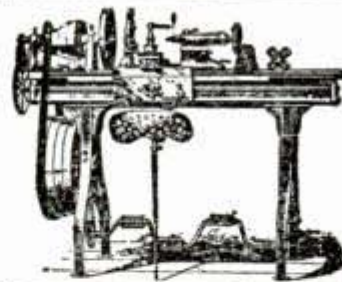

## LATHES

**9 to 13-inch Swing**

List price \$75 and up according to size. When ready to buy send for Lathe Catalog and prices.

**W. F. & John Barnes Co.**  
100 Ruby Street, ROCKFORD, ILL.



## South Bend Lathes

**9 to 18" Swing**  
Foot Power, Steam Power  
Electric Motor Drive  
Straight or Gap Bed

**\$7500**

and up

*Write for Catalog and Price*  
**SOUTH BEND MACHINE TOOL CO.**  
423 Madison St., South Bend, Ind.



## CRESCENT WOOD WORKING MACHINES

are right both in quality and the price

Our line consists of band saws, jointers, saw tables, swing saws, planers, planers and matchers, shapers, disc grinders. Universal wood workers, variety wood workers. Catalog is free for the asking. Send for it today.

**THE CRESCENT MACHINE CO.**  
93 Columbia St. LEETONIA, OHIO

# A PRIVATE WATER SYSTEM

at low first cost and no operating expense is supplied by a

# RIFE RAM

This ram will pump and deliver where you want it, either into a pneumatic or open tank, any quantity of water.

It operates automatically with the overflow from a stream, artesian well or spring amounting to 3 or more gallons per minute and a head or slanting fall of 3 or more feet.

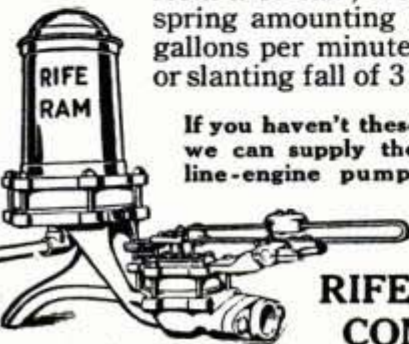

If you haven't these conditions, we can supply the best gasoline-engine pumping system

Free Booklet on request

**RIFE ENGINE COMPANY**

2131 Trinity Bldg., NEW YORK CITY

# Coin Money MAKING CEMENT PIPE



Increase Your Income and be Independent

Making cement pipe offers big opportunities. We started over 3000 men and firms in business last year making cement Sewer Pipe and Drain Tile. Every community uses pipe for sewers, land drainage, irrigation, road culverts, well casing or other purposes. 24 inch Bell mouth pipe can be made for 35 cents a foot with sand and cement at ordinary prices. Vitri-fied clay pipe, the closest competitor, sells up to \$1.25 per foot depending on distance from factory. Attractive profits in every size. This proposition is well suited to the smaller cities and country towns, and every village can support a cement pipe plant. Cement is getting cheaper every year; sand and gravel are found everywhere.

**How to Start at the Business**

Our catalog tells all about the manufacture of cement sewer pipe and drain tile and gives data on cost of manufacture. Sent free on request.

Send now and get started early for the big summer trade. We also make a complete line of mixers and concrete machinery for building blocks, brick, burial vaults, sidewalk, tile, fence posts, etc. Write today.



**LANSING CO., 724 Cedar St., LANSING, MICH.**  
Agents everywhere

An increase in the exportation of manufactures will be the leading feature in the export record of the United States for the year 1913. Each of the great groups of manufactures shows an increase so far, and a total gain of \$100,000,000 is confidently expected.



**LEIMAN BROS. ROTARY VACUUM-PUMPS AND BLOWERS**  
for Vacuum Cleaning, Melting, Forging, Soldering, Sand Blasting. Take up their own wear.  
**LEIMAN BROS., 62P John St., New York**

## VACUUM PUMPS Tools, Hose and Parts

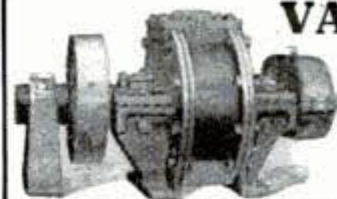

for cleaners at wholesale. Electric or gasoline power. For stationary, house or flat machine or wagon outfit. Our pumps rugged, will stand any wear. Assemble your own machine. Saves half. Dept. E.

**VACUUM SUPPLY CO., Ann Arbor, Mich.**

**DO YOU HAVE KNIVES TO GRIND, SILVER TO POLISH, SMALL TOOLS TO OPERATE, WASHING MACHINES OR WRINGERS TO RUN? LET THE RED DEVIL**

**DO YOUR WORK**

Attached to any water faucet will develop up to 3 Horse Power according to size of pipe and water pressure. Only perfect small motor made. Improved bucket wheel construction.

**6 in. Motor for Mechanics and Tradesmen. Washing Machine, 1/2 H. P. on 1/2 in. pipe, 80 lbs. water pressure; 1 H. P. on 60 lbs. pressure, 2 in. pipe. Net price \$5, cash with order.**

**No. 1492—4 in. Motor for grinding, polishing, fans, sewing machines; for Doctors, Dentists, Druggists, etc., with emery, buffing wheel, silver polish and pulley, \$3.**

**No. 1493—4 in. Motor and pulley only \$2.50, cash with order. Money back for any reason. Order your motor from dealer or from us. Send your water pressure and size of supply pipe. Active Agents wanted. Catalog free.**



6 in. Motor

**DIVINE WATER MOTOR CO. DEPT P. UTICA, N. Y.**

# This Machine Will Earn \$20 to \$50

**Daily Profit For YOU Making Cement Brick and Blocks**

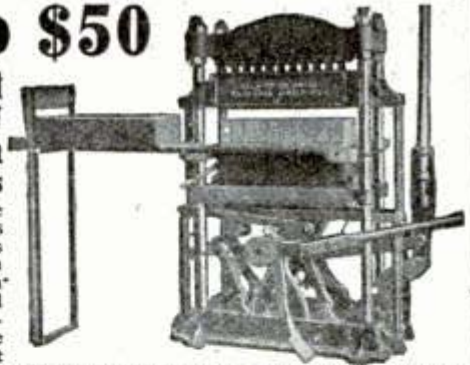

Factory owners are the biggest money makers in America and this machine will place you in their ranks. You can start with little capital and even without experience. This machine makes pressed cement brick and blocks under 80,000 POUNDS PRESSURE. No tamping, and easy work. It makes 1,000 blocks or 10,000 brick daily. No burning required. Ready for the market in a few days' time. They are necessary for the

## Helm DRY WALL Building System

This is the system which appeals to builders, contractors and architects. It overcomes the opposition to concrete because it offers absolutely DRY WALL construction. It saves money for builders, as no furring and lathing are required, and it makes rigid walls and fireproof walls. This is the system which is bound to get you business and give you the advantage over all other products.



**Send for This FREE CONCRETE BOOK**

Tear off the corner coupon right now before you turn the page. Let this free book tell you all about

this great opportunity which is open to you today. It will tell you all the details of this system, about the Helm Press and the DRY WALL building system. It will show you how easy it is to start a profitable business. It tells how each product is made, how it is cured and sold. Write today. Do it now.

**Queen City Brick Machine Co. 123 Bank Bldg. Traverse City, Mich.**

**Queen City Brick Machine Co., 123 Bank Bldg., Traverse City, Mich.**

Please send FREE the book on concrete and Helm Presses.

Name.....

Address.....

Please Mention Popular Mechanics

## A dependable drop-forged Clamp for every purpose

You can't have had a cast Clamp without paying for its failures. "What's the use!" A Williams' "Light Service" Clamp may be had at a price which you must pay for most any kind of a cast Clamp. Go to your dealer for Williams' help.



"Light Service"  
7 sizes, Capacities 0 to 12"  
Quick acting, square thread Screw



Heavy Service  
"VULCAN"  
11 sizes,  
Capacities  $\frac{1}{4}$  to  
12 $\frac{1}{2}$ ". U. S. Std.  
thread Screw  
Unyielding grip



Medium Service  
"AGRIPPA"  
7 sizes,  
Capacities  $\frac{3}{8}$  to 18"  
U. S. Std. thread  
Screw



"VULCAN"  
Tool Makers'  
Clamp  
4 sizes,  
Capacities 0 to 4"  
Removable  
Swivel Screw

Get Catalogue of dependable tools—see pages 119 to 134 and learn some of the story.

**J. H. Williams & Co.**

47 Richards St.  
BROOKLYN, N. Y. CITY

32e So. Clinton St.  
CHICAGO, ILL.

## WHEN TOOLS GET TIRED

There are times when edge tools need refreshing.—Bring them back to a keen-cutting edge on a

## CARBORUNDUM NIAGARA GRINDER

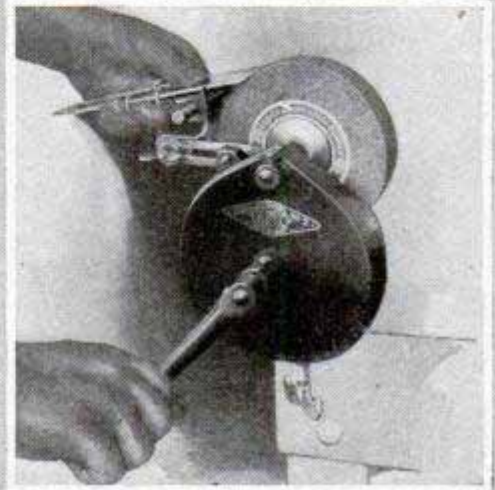

These little machines are fitted with Carborundum wheels and practical tool rests.—It takes but a jiffy to grind the tool true and keen—then a couple of rubs on a Carborundum Sharpening Stone and the tool is ready for service.

Carborundum Niagara Grinders are sturdy, durable, mechanically simple, machines—smooth running—high speeded—nicely finished—genuinely serviceable.

Made in several sizes, for tool-kit or work-bench. Ask your hardware man.

**THE CARBORUNDUM  
COMPANY**

NIAGARA FALLS, N. Y.

# Starrett Tools for Electricians and Mechanics

There's always a Starrett to help you out when you are doing a particularly difficult piece of work or when you must work to extremely accurate measurements. It makes no difference whether it's laying out your work or measuring it or actually constructing it, there's a Starrett that is a little better than anything you have ever used. Starrett micrometers, or squares, or combination sets, or protractors, or levels, or any of the other Starrett Tools are all just what you need for your best work. If you aren't familiar with Starrett Tools, send for Catalog 20AP. It shows the full line.

You can buy Starrett Tools at any good Hardware Store

## L. S. STARRETT CO.

The World's Greatest Toolmakers

Athol, Mass.

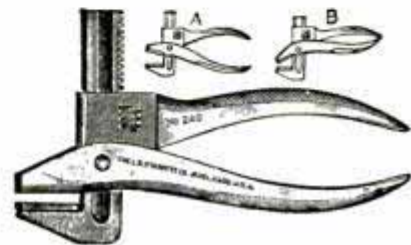

42-142

**\$1.00**

**Postpaid**  
**Myers' Wonderful Sewing Awl**  
sews leather, canvas, shoes—anything, heavy or light. Complete repair shop in itself. Saves many trips to town. Mends harness, saddles, wagon covers, blankets, buggy tops, belts, etc. Can't get out of order. Original and only awl with diamond point full grooved needle to protect the thread. **BIG MONEY FOR AGENTS.**  
**C. A. MYERS CO., 6339 Lexington Ave., Chicago, Ill.**

**Portable Cases**  
**FOR TOOL MAKERS AND MACHINISTS**  
Twelve styles, felt lined drawers, solid brass trimmings, best of material, beautiful finish, low prices, satisfaction guaranteed. Ask for booklet of cases built for service.  
**The Pilliod Lumber Co.**  
**SWANTON, OHIO**

**To Meet Your Need**  
for a really first class dependable drill, at a moderate price, we offer our  
**Hand Drill No. 3**

This is a rarely good tool for the money; has cut gears and chuck for round shanks 0 to 3/16"; light, yet strong and thoroughly well made in every detail.

**Look it up, and send for catalog**

**MILLERS FALLS COMPANY**  
28 Warren St., New York

### NEW SLIDE RULE—ADDS—SUBTRACTS—MULTIPLIES—DIVIDES

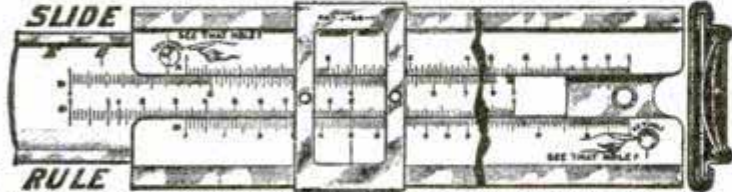

For years the Slide Rule was considered so complicated an instrument that it was used only by Technical men, and there are people today who still have this opinion. The **Richardson Direct Reading Slide Rule** has put an end to the mystery surrounding this machine, and my 52 p. book, **The Slide Rule Simplified**, shows the actual setting of the rule by 90 full size engravings, for problems which confront men in any vocation. It is written so that you can understand it, and makes the use of the Slide Rule possible for everyone. The examples selected are those which frequently come up for solution by the **Banker, Broker, Auditor, Inventory and Insurance**

Man, Cost Estimator, Manufacturer, Contractor, Salesman, Manual Training Teacher, Time-Keeper, Book-keeper, Lumber, Land, Marine, and other merchants too numerous to mention.

This Simple Instrument multiplies, divides, adds, subtracts, solves proportion, extracts the square and cube roots, changes fractions to decimals and vice versa, calculates interest, discount, percentage, mensuration of superficies, the rule of three, etc., and performs almost any other kind of calculation almost instantly. For Engineers, Draftsmen, Master Mechanics—all technical men—it is indispensable. For Electricians it is a complete wire table. The operation with the use of the key and keyhole is very simple, and the answer is given direct for such problems as Horse Power of Engines, Pumps, Belts, etc., size of duct for ventilating, radiation and size grate and steam main, change gear and pulley problems, area, circumference and diameter of circles, etc. My new 1914 rule is made in two sizes, coat and vest pocket, 10x1 1/4x1/4" and 5 1/2x1 1/4x1/4". 10" has Sine, Log and Tangent scales on the face of rule always in plain sight. No wood in their construction, scales white celluloid, printed from engine divided plates in two colors, washable, and secured by an improved locking device in non-corrodible Monel Metal framing.

Price 10" Rule, Add, Subtract, Multiply and Divide, \$3.00; 10" Rule (non-Add and Subt.) \$2.50; leather case, 50c extra; 5" Rule (non-Add and Subt.), leather case, \$2.50. 10" Dummy Rule bristol board scales, \$1.00. Postage prepaid. If ordered now the book, **The Slide Rule Simplified**, goes Free with each rule. If interested in forming clubs, write for large list of tools GIVEN FREE.

**GEO. W. RICHARDSON, 4218 24th Place, CHICAGO, U. S. A.**

## Speed Changed— Quick as a Flash



Just a push on the shifter pin, changes the speed to fast or slow without removing drill from the work; scarcely stopping.

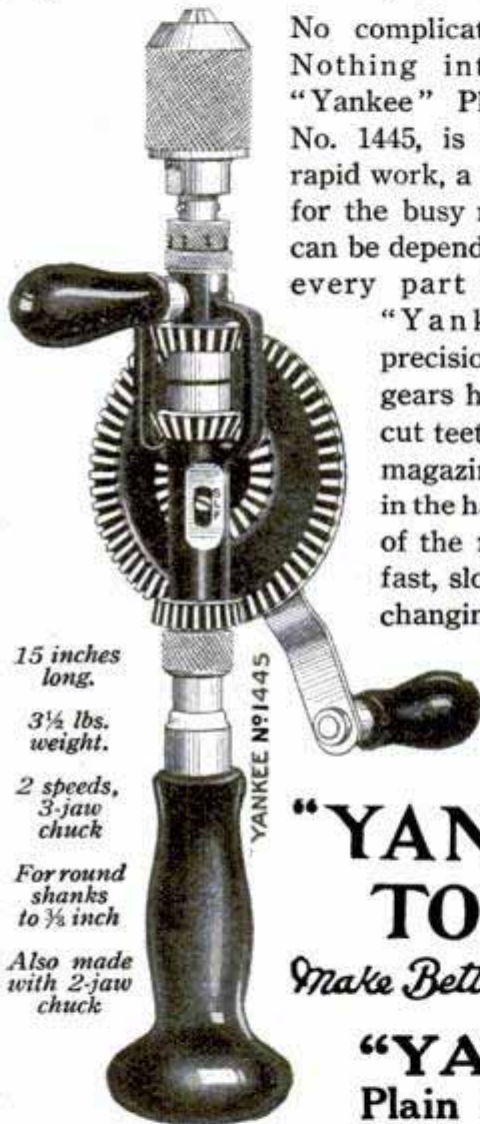

No complicated adjustment! Nothing intricate! This "Yankee" Plain Hand Drill, No. 1445, is built for quick, rapid work, a labor saving tool for the busy man, a drill that can be depended upon because every part is made with "Yankee" care and precision. The spindle gears have extra strong cut teeth. A convenient magazine for drill points in the handle. 3 positions of the ratchet shifter—fast, slow, or locked for changing drills.

Appreciated by the man who is on the job—are

## "YANKEE" TOOLS

*Make Better Mechanics*

### "YANKEE" Plain Hand Drill

3 jaw chuck, No. 1445; or 2 jaw chuck, No. 445—Price \$3.00

The smallest of the "Yankee" hand drills is the No. 1430. A little hustler; small, compact, light; and strong and durable—Price \$1.75.

### YOUR DEALER CAN SUPPLY YOU

Write for "'Yankee' Tool Book" Free. For mechanics and householders. "'Yankee' Tools in the Garage." Free for motorists.

**NORTH BROS. MFG. CO.**  
Philadelphia, Pa.

## As Strong As a Breast Drill

*Goodell-Pratt's*

Two Speeds  
Cut Gears  
Ball Bearings

### No. 5½ B

For round shanks  
0—¾ inch

Ask Your  
Dealer

As Light as  
a Hand Drill

Tool  
Catalog  
Free

**GOODELL-PRATT COMPANY**

*Toolsmiths*

Greenfield,  
Mass.,  
U. S. A.

There are 55 varieties of oak in the United States, about evenly divided between the East and the West. The eastern species and particularly white oaks are the most valuable.

## GASOLINE SOLDERING IRON BLOW TORCH

IT'S SIMPLICITY  
COMPOUNDED

Address Dept. 1. EMMELMANN BROS. MFG. CO., INDIANAPOLIS, IND., U.S.A.



## YOU

can dig 40-foot wells quickly and in any ground with our outfit costing but \$12.00 delivered, east of the Mississippi.

Write today for our large descriptive circular, enclosing 2c stamp  
**STANDARD AUGER CO.**  
1128-A Newport Ave., CHICAGO, U.S.A.



REGISTERED

## "Ohio" Edge Tools

are made from specially selected tool steel, by careful and skillful workmen. They are tempered by the most improved process and are sold with a money back guarantee.

Insist on "Ohio" Tools when buying Planes, Chisels, Drawing Knives, Auger Bits, Screw Drivers, etc.

CATALOGUE FREE

**OHIO TOOL CO.** (Dept. 3)  
Charleston, W. Va.

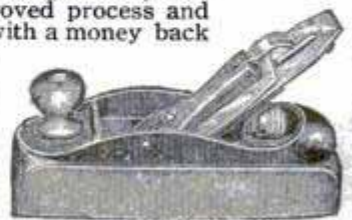

# The Latest Tool of Its Kind

## Direct Reading Micrometer Caliper

Thousandths of an inch read  
in exact figures.

HAVE YOU SEEN ONE?



Patented  
Aug. 22, 1911

If the hard-  
ware dealer  
cannot show  
you one, send  
for special  
folder.

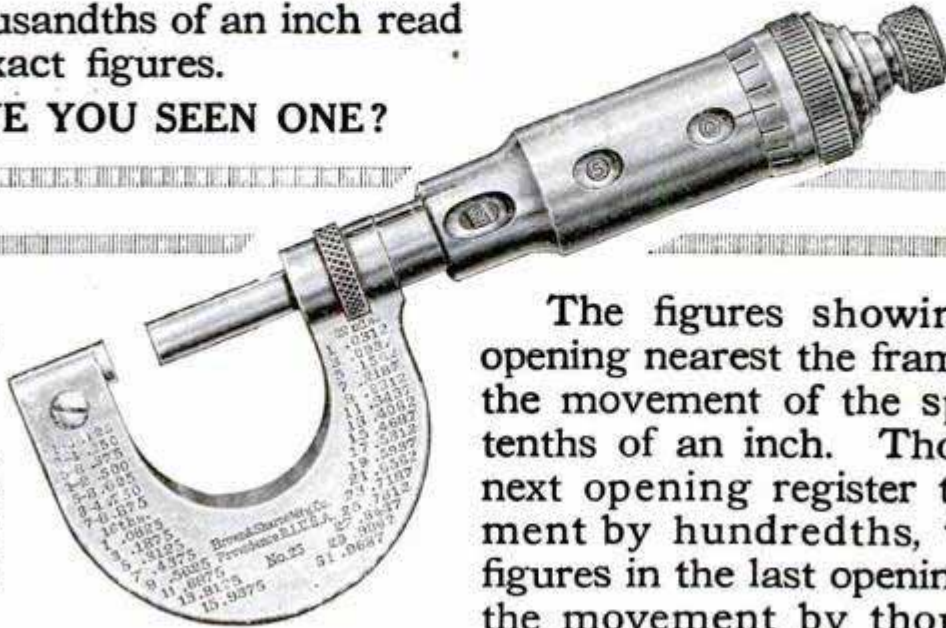

The figures showing in the opening nearest the frame indicate the movement of the spindle by tenths of an inch. Those in the next opening register the movement by hundredths, while the figures in the last opening indicate the movement by thousandths.

**BROWN & SHARPE MFG. CO., Providence, R.I., U.S.A.**

Don't Throw It Away

### MENDETS

Mend leaks instantly in all utensils, graniteware, aluminum, tin, brass, hot water bags, etc. No solder, cement or rivet. Any one can use them. Send for sample box, **10c**; large box, all sizes, **25c**, postpaid. Agents Wanted. Collette Mfg. Co., Box 404, Amsterdam, N. Y.

## GROBET SWISS FILES

Are the standard of excellence in files, and have been for over 100 years. We send post paid as an introducer 48 files especially adapted for tool makers and machinists on receipt of **\$5.00**. This is a chance to get a set of files you'll appreciate and we'll get future orders.

**MONTGOMERY & CO.**

111 Fulton Street NEW YORK CITY

Ask about our  
3,000 R. D. Tools

### "Red Devil" Glass Cutters

*"It's all in the wheel"*

For 3 2c. stamps we will send any glazier 1 No. 024 Glass Cutter.

**SMITH & HEMENWAY CO.**  
150 - 152 Chambers Street, New York, N. Y., U. S. A.

## Quick Drilling Where You Want It

—by Electricity



Saves time  
and labor.  
It doubles  
efficiency.

Attaches to any  
Electric Light Socket.

### A Portable Machine Shop

Handiest device ever known for drilling, tapping, grinding valves, sharpening tools, etc.—quickly and easily. Does away with tiring hand work.

## TEMCO Electric Portable Drill

Weights only 11 pounds. Perfect balance between handles makes it seem doubly light and free to place and hold. Has famous Temco motor. Connect with any lamp socket (A. C. or D. C.) Costs only 1 cent per hour to run. Reverses instantly on full speed. Changes tap to drill in one minute. Has multitude of uses. Saves cost quickly in time and hard work. Guaranteed not to burn out.

**Ten Days' FREE Trial**

Mail postal or letter quick—get descriptive CATALOG FREE. Address

**The Temco Electric Motor Co.**  
377 Sugar St., Leipsic, Ohio

Special Designers and Mfrs. of 1-50 to 1-6 H.P. Motors.

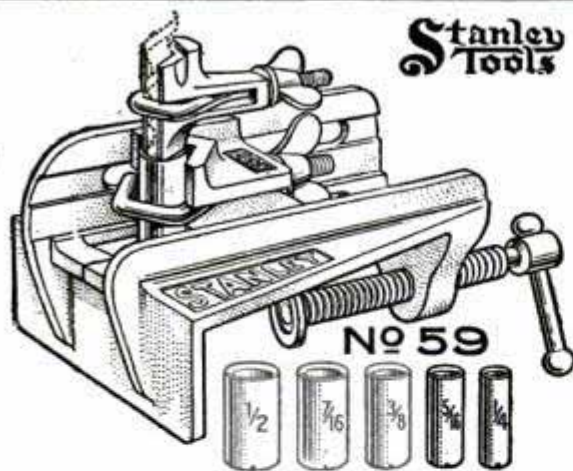

## Stanley Doweling Jig

A new and most unique tool that will enable the user to bore dowel holes in the edge, end or surface of work with the greatest ease and with absolute accuracy.

A tool that will immediately commend itself to Carpenters, Cabinet Makers, Pattern Makers,—in fact to every artisan or amateur who has occasion to do any kind of doweling.

A postal brings you a special circular containing complete description and showing various forms of work in which the Jig will be found of great assistance.

Address

**STANLEY RULE & LEVEL CO.**  
NEW BRITAIN, CONN. U.S.A.



## The New Britain Drill Chuck

Ball Bearing

Hand Operated Wrenchless

This chuck gives the tightest gripping power of any Drill Chuck now on the market. The greater the pressure on the drill, the tighter it grips.

**SAVES DRILLS—SAVES TIME**

**UNION MANUFACTURING CO.**

Makers of a Complete Line of Chucks

26 Cortlandt St., New York New Britain, Conn.

## You ought to have one of our Insured - "VANDOR" - Hammers



—"VANDOR"—Hammers are drop forged from Vanadium Steel, tempered in oil and are Warranted Against All Defects for a Lifetime

Attached to every "VANDOR" hammer is a numbered guarantee certificate, insuring lifetime service.

A—"VANDOR"—will bite and draw a headless nail that defies the claw of an ordinary hammer.

Sent by Parcel Post Anywhere —"VANDOR"—

Send us \$1 and your dealer's name. We'll ship the postpaid by return mail. Please state whether wanted for light, medium or heavy work.

**VAN DOREN MFG. CO., Dept. 103, CHICAGO HEIGHTS, ILL.**  
Reference 1st Nat. Bank, CHICAGO

## Give these Bolts the hardest test you know—

See how they hold. Electricians and Mechanics like to handle and work with



## SEBCO Expansion Bolts Screw Anchors

They grip like a vise, cannot pull out and are the only really dependable bolts for fastening electrical fixtures and apparatus to brick, stone or other hard surfaced walls.



Write for Samples and Catalog—make your own test and be convinced of the inestimable value of these bolts in your work. They mean quicker, neater and better work for you.

## STAR EXPANSION BOLT CO.

147-149 Cedar Street, NEW YORK

## SPLENDID BENCH GRINDER

for 2 wheels any size up to 8 in. diameter 1 1/2 in. face. Split babbit bearings. Tight and loose pulley. Requires little power. Rests easily adjusted or removed. Excellent finish. Price with one 7 in. x 3-4 in. general use emery wheel, \$4.50. Iron column for mounting same 32 in. high, \$3.00. PLYMOUTH MACHINE SHOPS, Plymouth, Ind.



**INTERESTING BRIDGE CONSTRUCTION IN CANADA**—A new bridge across the Bow River, at Calgary, Canada, offered some engineering problems which were overcome in a novel and interesting manner. The town lies on both sides of the river, the north bank of which is a high bluff. To build the bridge inclining from the south side to the top of the north bank, would not do, as an important section of the town is situated at the foot of the bluff, and a deep cutting would have ruined much of the property on the high ground. It was therefore decided to construct a level bridge across the river, while, to gain the heights an inclined tunnel was bored through the cliffs.

## SOLDERING IRON ALWAYS READY

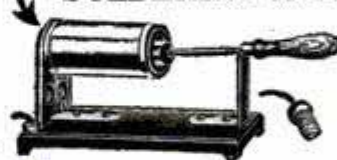

With the use of the Current Electric Furnace, any voltage, comes in three sizes complete. Cost of operation very low, cheapest and by far superior than any other known method. No more expensive delays and dangers caused by the use of gas, oil, gasoline, etc. Furnace absolutely guaranteed, money refunded if not

satisfactory. Price very low. WRITE FOR PRICES AND CIRCULAR. CURRENT ELECTRIC COMPANY, 18 E. Kinzie St., Dept. E19, Chicago, Ill.



## Tool Cases for Toolmakers and Machinists.

Keep your tools orderly arranged in a Gerstner Portable Tool Case. There's a place for every tool in one of the felt lined drawers. Every up-to-date mechanic needs one and you'll find our Cases the best built, neatest and most practical on the market. We guarantee to please or refund all money.

**Gerstner & Sons**

Mrs. of Mechanics' High Grade Tool Cases  
818 Columbia St. DAYTON, OHIO

Write for our free booklet



# The Luther "BEST MAIDE" Grinder

## Sharpens Tools Quick

It's the handiest, easiest-running, most efficient hand-power tool sharpener you ever saw—absolutely accurate, wonderfully speedy and quickly convertible by special attachments to dozens of uses. No matter what tools you use, you will find the "Best Maide" far and away the best sharpener.

Luther "Best Maide" Grinders can be equipped with special attachments for hand or bench drilling and for sharpening twist drills.

## Double-Faced Sharpening Wheels of DIMO-GRIT

With "Best Maide" Grinders the tool is brought to an edge on medium grit body and finished on fine grit side face—grinding and polishing are both done on a single wheel. Both faces are of "Dimo-Grit," the wonder-working, new, artificial diamond abrasive that cuts the hardest steel as easily as emery does copper. No water needed—no danger of drawing temper. Wheels guaranteed for five years.

## Perfect Worm Gear

Worm gear and shafts are cut from solid steel and are of sufficient size to provide great wearing surface and make the wheel run true without vibration. Ball bearings insure easy, even motion and long life.

## Improved Swiveling Device

This new patented feature permits quick and accurate adjustment of frame to any desired angle, horizontal or vertical, holds machine rigidly in position and makes the most awkward job of tool grinding easy.

## Mail Back the Coupon If Your Dealer Does Not Sell Luther Grinders

Nearly all leading hardware dealers handle Luther Grinders. If on inquiry you find yours does not, send in his name on attached coupon, telling us what tool grinder he does handle, and we will mail you a Dimo-Grit Pocket Hone free, with folder describing "Best Maide" Grinders.

## Send Us This Coupon

Luther Grinder Mfg. Co.,  
839 Point St., Milwaukee

My dealer's name is .....

He handles ..... Grinders.  
Please send Free Sample Pocket Hone and descriptive folder.

Name .....

Address .....

Luther Grinder Mfg. Co., 839 Point St., Milwaukee, Wis.

## L. E. B. Caliper Square

A practical combination of the following tools. Outside caliper, inside caliper, straight edge, T square, universal bevel, rule gauge, protractor, tri square, bevel edge, hook rule, scribe gauge, scratch gauge, depth gauge, scratch awl and scale. In nicked case. Price 25c postpaid (no stamps).

Guaranteed satisfactory or your money refunded

CLYDE FAHRNEY, Box 157, Waynesboro, Pa.

## FREE TRIAL

### Automatic Electric Floor Surfer

Money saver for Contractors. Big opportunities for carpenter or a hustler. You can earn from \$10.00 to \$20.00 per day by purchasing one of these Wonderful Self-Propelling Machines, made in three sizes, 12", 15" and 18" Cylinder Roller. We also manufacture the well known Stone Floor Surfers in three sizes. Write us for circulars and complete information.

M. L. SCHLUETER, 103-105 No. Canal St., CHICAGO, ILL.

## THE MASTER SLIDE RULE,



the only RULE IN THE WORLD whereby inside measurements of doors and windows, etc., can be taken rapidly and accurately. Also superior to any other rule for outside measurements of walls and ceilings, etc., as it can be extended and closed instantly. MECHANICS, BUILDERS, AND ARCHITECTS, TRY ONE TODAY! DON'T WAIT. Ask hardware dealer for it.

On receipt of 15 cents per lineal foot, a 4, 5, 6 or 8 foot rule will be sent to you prepaid. Large profits to agents. Write for circulars and particulars. DAHL MFG. CO. 51-A East 42nd St. NEW YORK CITY

## Classy Den Pictures

EXQUISITE STUDIES IN BEWITCHING POSES Every one a genuine photo from living models on double-weight stock. 3 swell cabinets, 25c; 6 for 50c, with fine 6½x8½ photo FREE with order for 6. Our Dollar Special: 6 cabinets, two 6½x8½, and over 50 small photos, all for \$1.00. 10c extra for sealed postage. Money back if not as represented. KING CO., 2806 P. M., ANDOVER, OHIO

## The newest big-seller is the littlest Oster

No. 81



This little all-in-one die-stock is the season's sensation. It wasn't thought possible that one small pipe-threading tool could contain all its good features. We've had to get out a special folder to describe No. 81 and No. 3B, a large all-in-one die-stock. If you would like a copy of this, together with our booklet "The Bulldog Tale" (both free), just fill out the coupon and mail it to us. You will get a new idea of what a pipe-threading tool can be.

THE OSTER MFG. CO.  
2100 E. 61st St. CLEVELAND, O., U. S. A.

Kindly send me by return mail the No. 81 folder and "The Bulldog Tale."

Name .....

Business .....

Address .....

City.....State.....(2100)

Please Mention Popular Mechanics

MAKE MONEY HERE

**AGENTS! DROP DEAD ONES. AWAKE! GRAB THIS NEW INVENTION! THE 20th CENTURY WONDER AGENTS!**

LEARN the NEW WAY

Get started in an honest, clean, reliable, money-making business. Sold on a money-back guarantee

World's magical gift realized by this new invention. The **BLACKSTONE WATER POWER VACUUM MASSAGE MACHINE** for the home. No cost to operate. Lasts life-time. Price within reach of all. No competition. New field. New business. That's why it's easy. Removes blackheads, wrinkles, rounds out any part of the face or body and brings back Nature's beauty. Endorsed by leading doctors and masseurs. Listen: Parker, Okla., says, "8 orders first day." Margwarth, Pa., writes, "I am making \$19.00 per day." Shea, "First order 12, second 35, third 72." Schermerhorn, Ia., orders eight dozen machines first month. Shaffer, Va., "selling 4 out of 5 demonstrations." Vaughn, Wash., orders one dozen. Four days later wires "Ship 6 dozen by first express." Spain, Tenn., started with sample. Orders one dozen, then 2 dozen, next 3 dozen. Lewis, Ind., sells 3 machines first hour. Says "Best article he ever saw for merit and money-making." No experience necessary. Territory with protection given free to active workers. Nothing in the world like it. Best agent's article ever invented.

We own all U. S. and foreign patents. Big book entitled, "The Power and the Love of Beauty and Health" Free. Investigate now, today. A Postal will do. A big surprise awaits you. Address **BLACKSTONE MFG. CO.** 871 Meredith Bldg. TOLEDO, O.

**25c. Book on Deep Breathing and Chest Expansion Now for 10c.**

**D**EEP breathing will increase vitality and energy to an immense extent in a very short time, besides improving bodily appearance; it will give you a much better carriage to the body, even sleep will be more natural and a person who breathes deeply sleeps deeply and wakes up bright and fresh for a full day's work, and work will be a pleasure in place of drudgery. Appetite will be great, so will the digestion. Send at once at the reduced price of ten cents for the illustrated book on deep breathing and chest expansion to

**PROF. ANTHONY BARKER**

3640 Barker Bldg., 110 West 42nd Street, New York

**Health? Take Turkish Bath at Home — Only 2c**

Exhaustion and many other ills means that waste matter has over-accumulated in your body. Drugs do not drive them out. Exhausted men and women have been remarkably strengthened, right at home, in a few moments' time, by the use of

**Robinson's Turkish Bath Cabinet**

Prominent physicians in many cases are abandoning drugs for this new treatment. If your mind or body is tired, open your pores, and feel the rapid change in your condition, right at home, at cost of 2c a bath. The Robinson Bath Cabinet is the only scientifically constructed bath cabinet ever made, a model of ingenuity. **Great \$2 Book Sent FREE**—"The Philosophy of Health and Beauty" represents lifetimes of thought of well-known scientists and is written plainly so that anyone can understand every word. Write in time—today. Agents wanted in unoccupied territory.

**ROBINSON MFG. CO., 681 Robinson Bldg., TOLEDO, OHIO****Deafness**

Perfect hearing is now being restored in every condition of deafness or defective hearing from causes such as

Relaxed or Sunken Drums, Roaring or Hissing Sounds, Perforated, Partially Destroyed Drums, etc.

**Wilson Common-Sense Ear Drums**

"Little Wireless Phones for the Ears"—

require no medicine but effectively replace what is lacking or defective in the natural drums. They are simple devices, which the wearer easily fits into the ears where they are invisible. Soft, safe and comfortable to wear at all times.

Write today for our 168 page FREE book on DEAFNESS, giving you full particulars and plenty of testimonials.

**WILSON EAR DRUM CO., Incorporated**

642 Inter Southern Bldg., Louisville, KY.

**Boy Electrician** with 75 illustrations for making Batteries, Dynamos, Motors,

Telegraph apparatus, Telephone, Lights, Bells, Alarms, Coils, "Wireless" Current Reverser, Electric Engine, Etc. By Electrical Experts so that anyone can understand it. With Cat. All 10c Ppd.

**J. C. DORN, 705 So. Dearborn St., Dept. 21, Chicago, Ill.****Big Entertainer** 320 Jokes and Riddles,

153 Parlor Games and Magic, 15 Tricks with Cards, 73 Toasts, 7 Comic Recitations, 3 Monologues, 22 Funny Readings. Also Checkers, Chess, Dominoes, Fox and Geese, 9 Men Morris. All 10c. postpaid.

**J. C. DORN, 709 So. Dearborn Street, Dept. 17, Chicago, Ill.****Boys' Own Toy Maker**

Tells how to make a Talking Machine, Camera, Electrical Motor, Bicycle Boat, Canoe, Boomerang, Bobsled, Wind Mill, Microscope, Water Wheel and Motor, Stilts, Toboggan, Snow Coaster and Sail Boat, Telephone, Electric Bell, Railroad Wind Mobile, Paddle Raft, Traps, Kites, etc. All 10c, postpaid.

**J. C. DORN, 707 So. Dearborn St., Dept. 38, Chicago, Ill.****ERICKSON LEG**

Does not chafe, overheat or draw end of stump.

SEND FOR CATALOG

Arms, Braces, Wheel Chairs, Stockings.

**SOLD ON EASY TERMS****E. H. ERICKSON ARTIFICIAL LIMB CO.,** 17 Wash. Av. N., MINNEAPOLIS, MINN.

Largest Limb Factory in World.

**ACCIDENT CAUSED BY SELF-STARTING OF AUTO ENGINE**—A recent accident, which occurred to an autobus running from Chemnitz to Buchholz, near Berlin, was due to the self-starting of the engine. The motor had stopped suddenly, and while the driver had left his seat to remedy the trouble, it started up again, the bus ran over a bank and fell 6 ft., and 27 persons were injured.

**TOBACCO HABIT BANISHED**

**In 48 to 72 Hours** Yes, positively permanently banished almost before you know it. Pleasant, easy to take. Results quick, sure, lasting. No craving for tobacco in any form after first dose. Not a substitute. Harmless, no poisonous habit forming drugs. Satisfactory results guaranteed in every case or money refunded. *Tobacco Redeemer* is the only absolutely scientific and thoroughly dependable tobacco remedy ever discovered. Write for free booklet and positive proof.

**NEWELL PHARMACAL CO., Dept. 25, ST. LOUIS, MO.****NO MORE BALD HEADS**

When our **VACUUM CAP** is used a few minutes daily. We accept no pay until you have tried the Cap 60 days and are satisfied. The Vacuum Cap is an appliance that draws the blood to the Hair Roots and starts a new healthy crop of hair. It stops Dandruff, stops the hair from falling out. Bought by Doctors and men who

know that it is the only reasonable **HAIR GROWER** known to science. No Drugs Used. Write for application blank, testimonials, and booklet on "HAIR," sent sealed in plain envelope, FREE.

**THE MODERN VACUUM CAP CO.****D. 559 BARCLAY, DENVER, COLO.**

## THE CORONA

A Typewriter for Personal Use



**T**HIS sturdy machine marks the greatest advance in typewriter building since the introduction of visible writing. For, not only is it a complete modern typewriter in every detail—from back spacer to stenciling device—but it is the lightest and most compact standard typewriter ever made.

It is universally accepted as the logical machine for personal use, *in the home or on the road*. Because of the simplicity of its construction, it weighs but 6 lbs. or with case, 8 $\frac{3}{4}$  lbs. When folded it fits into the drawer of a desk or a corner of your suitcase.

Booklet D will bring full information.

STANDARD TYPEWRITER COMPANY  
GROTON, N. Y.

New York Office, 1493 Broadway

Agencies in principal cities of the world

## I WILL START YOU

earning \$4 daily at home in spare time, silvering mirrors; no capital; send for free instructive booklet, giving plans of operation.  
G. F. REDMOND, Dept. 306-A, BOSTON, MASS.



### We Ship on Approval

without a cent deposit, prepay the freight and allow 10 DAYS FREE TRIAL on every bicycle. **IT ONLY COSTS** one cent to learn our unheard of prices and marvelous offers on highest grade 1914 models.

**FACTORY PRICES** Do not buy a bicycle or a pair of tires from anyone at any price until you write for our new large Art Catalog and learn our wonderful proposition on the first sample bicycle going to your town.

**RIDER AGENTS** everywhere are making big money exhibiting and selling our bicycles. We sell cheaper than any other factory.

**TIRES, Coaster-Brake rear wheels, lamps, repairs and sundries at half usual prices. Do Not Wait; write today for our latest special offer on "Ranger" bicycle.**

**MEAD CYCLE CO. Dept. T 108 CHICAGO**

## Perfect Hearing

Write for our big Introductory Offer on the latest scientific hearing instrument, the perfected 1914 Diploma Model

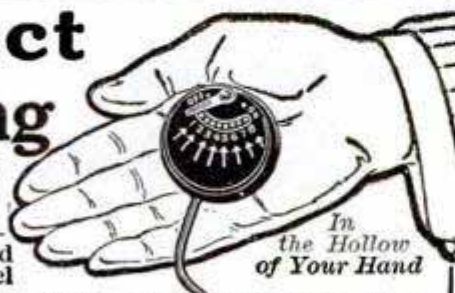

In the Hollow of Your Hand

### New 8-Tone Mears Ear Phone

EIGHT times as efficient, EIGHT times as powerful, EIGHT times as convenient, EIGHT times as helpful as our former One-Tone model, and with double the efficiency of our well-known 4-Tone. Eight different adjustments instantly changed by a touch of the finger.

**Free Trial** Sold only direct from our New York office on trial at our expense. Test it for 15 days. Your money returned if you do not want to keep it. Easy monthly payments if you wish, at the lowest net laboratory price direct to you. Send for this offer and the Mears Booklet—FREE.

Mears Ear Phone Co., Dept. 1193 45 West 34th Street, New York.

# SENT FREE Big 80 Page Book on LAW

New Course—New Text—New Method

60 handy pocket size law volumes yours with this great new law course. The **ONLY** complete series of law text books **EVER PREPARED ESPECIALLY FOR CORRESPONDENCE INSTRUCTION**. Written for the American School of Correspondence by 56 of America's greatest legal authorities, including deans and professors in leading resident university law schools, judges of federal and state courts, and prominent practicing attorneys. HARVARD, YALE, PENNSYLVANIA, CHICAGO, WISCONSIN, ILLINOIS, MICHIGAN, and other great universities have contributed to this wonderful aggregation of legal talent. No other correspondence school uses these remarkable law texts. No other school can supply them. Far superior to studying from a "Law Library" or "Cyclopedia of Law" intended for reference purposes only.

## America's Newest and Best Correspondence Law Course

The last word in American Law and Practice. Everything right down to date. Every branch of the law thoroughly covered. Stripped of all non-essentials and useless technicalities. Written in plain, simple, easily understood language. All legal terms thoroughly explained and made perfectly clear. 100 per cent efficiency in law instruction. Simple method makes it easy for you to get **ALL** the knowledge contained in the complete course. Not half nor three-quarters, but **ALL**. Handy pocket size text books enable you to study under any and all conditions. You can have your lesson always in your pocket—with you at all times—and take advantage of every spare moment. Saves time and means quicker admission to the bar. Handsome 13 volume "Library of American Law and Practice" and 36 Case Books furnished every student. The most complete and practical correspondence law course ever devised.

## The World's Greatest Correspondence School

For sixteen years the American School of Correspondence has stood at the head of all non-resident educational institutions. The only correspondence school in the United States chartered solely as an educational institution for the benefit of its students, not as a commercial enterprise for the benefit of stockholders. Enjoys the proud distinction of having graduated a higher percentage of its students than any other correspondence school in the world. Positively the best school for **YOU**.

Mail the Coupon Today!

For Special Law Book, "How To Acquire a Legal Training." Explains all about this wonderful new system of law instruction. Send for it today. Get full particulars regarding this great course at once. Eliminate all possibility of failure. Be Sure of Success. Fill in the coupon and mail it today. Better do it **RIGHT NOW!!**

American School of Correspondence  
58th St. and Drexel Ave.  
Chicago, U. S. A.

**FREE BOOK COUPON**

American School of Correspondence, Chicago, U.S.A.  
58th St. and Drexel Ave.

Gentlemen: Please send me your **FREE** Law Book, "How To Acquire a Legal Training," and full particulars regarding your wonderful new system of correspondence law instruction.

NAME.....

ADDRESS.....

Pop. Mech. 3-1

Please Mention Popular Mechanics



Fastest, cleanest, most saving Fireless Cooker possible to buy—at a big price saving. My new Book shows big, full page photographs of cooking in a RAPID. Send your address today and

**Get This FREE BOOK**

# My New Cut Price

**Makes Every Woman Happy**

Cut down your meat and grocery bills; have better tasting food with half the work. One trial convinces every housewife. Extra size 3-compartment Cooker Outfit of "Weavever" Aluminum Cooking Utensils. Compartments and covers lined with pure aluminum.

**Rapid Fireless Cooker**  
30 Days' Free Trial

I guarantee to suit you or take the cooker back. Roasts meats a perfect brown. Bakes cakes, pies, vegetables, desserts—everything in every way. Cuts gas bills from hours to minutes. Write today for my new Book and direct factory price.

**WILLIAM CAMPBELL COMPANY**  
Dept. 164 DETROIT, MICH.

Sent Only Direct From Factory



**KEROSENE AND GASOLINE LIGHTING SYSTEMS**

**WIZARD LIGHT** Burns Kerosene and Gasoline

Lamps constructed to burn kerosene are an achievement surpassing all other known methods of artificial lighting, while the cost of operating is very small and about 1-9c per hour.

Our gasoline lamps are the most perfect and up-to-date, while certain styles can be lit with an ordinary match, like city gas. For complete illustrated catalog and agency, address

**THE NAGEL-CHASE MFG. CO., 148 E. Erie St., Chicago**

**The "BEST" LIGHT**

**300 CANDLE POWER**

A handsome portable lamp that gives a brilliant, economical light. Makes and burns its own gas. Makes you independent of gas or electric lighting companies. Over 200 styles of lamps, ranging from 100 to 2,000 candlepower.

**AGENTS MAKE BIG MONEY.**  
Write quick for catalog.

**The Best Light Co.**  
324 E. 5th St., Canton, O.

**Beacon Burner FREE!**

**Fits Your Old Lamp** 100 Candle Power Incandescent pure white light from (kerosene) coal oil. Beats either gas or electricity.

**COSTS ONLY 1 CENT FOR 6 HOURS** We want one person in each locality to whom we can refer new customers. Take advantage of our Special Offer to secure a Beacon Burner FREE. Write today. **AGENTS WANTED.**

**HOME SUPPLY CO., 11 Home Bldg., Kansas City, Mo.**

**WEAR**

Trade Mark Registered **B.V.D.** U. S. Patent Office and Foreign Countries

**UNDERWEAR**

**WHITE FLAME**

**BURNERS** make your old kerosene lamps and lanterns give a brilliant white light better than electricity or gas. Doubles your light. Saves oil. **NO MANTLE TO BREAK.** Guaranteed Safe and Reliable. Delights every user. Send now for complete sample postpaid 35 cts., stamps or coin. 3 for \$1. **MONEY BACK IF NOT SATISFACTORY.**

**Live Representatives Wanted. Exclusive Territory.**

**WHITE FLAME LIGHT CO., 68 Clark Bldg., Grand Rapids, Mich.**

## New KEROSENE LIGHT BEATS ELECTRIC OR GASOLINE

**10 Days FREE—Send No Money**

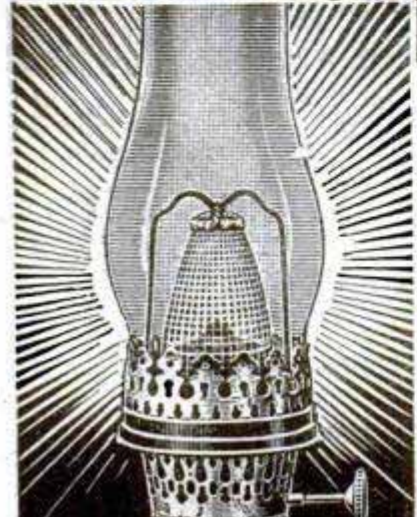

We don't ask you to pay us a cent until you have used this wonderful modern light in your own home for ten days, then you may return it at our expense if not perfectly satisfied. We want you to prove for yourself that it gives five to fifteen times as much light as the ordinary oil lamp; beats electric, gasoline or acetylene. Lights and is put out just like the old oil lamp; costs

**ONLY 1 CENT FOR 6 HOURS**

Gives a powerful white light, burns common coal oil (kerosene), no odor, smoke or noise, simple, clean, won't explode. Guaranteed.

**\$1000.00 REWARD**

will be given to the person who shows us an oil lamp equal to this Aladdin in every way (details of offer given in our circular). Would we dare make such a challenge to the world if there was the slightest doubt as to the merits of the Aladdin? We want one person in each locality to whom we can refer customers. Write quick for our 10 Day Absolutely Free Trial Proposition, Agents' Wholesale Prices, and learn how to get **ONE FREE.**

**MANTLE LAMP CO., 448 Aladdin Bldg., Chicago, Ill.**

**AGENTS WANTED**

to demonstrate in territory where oil lamps are in use. Experience unnecessary. Many agents average five sales a day and make \$300.00 per month. One farmer cleared over \$800.00 in 6 weeks. You can make money evenings and spare time. Write quick for territory and sample.

A Bulletin of the U. S. Forest Service says: "The largest tree in the United States is said to be the 'Mother of the Forest,' a giant redwood in the Calaveras big-tree grove in California. It is supposed to contain 140,619 board ft. of lumber. There are, however, many claimants for the honor of being the 'largest tree' and the 'oldest tree,' and these claims, according to foresters, cannot always be verified."



**FREE TRIAL**  
**No DEPOSIT**  
**No OBLIGATION**

**VICTOR** **VICTROLA**

Choose any Victor or Victrola and **six double face records** (12 pieces to play), from my complete illustrated catalog and I'll send just what you have selected to your home for a **FREE** trial.

Send no money—make no deposit—there are no strings to this offer. I want you to learn that you **need** Victor or Victrola music in your home. I can convince you of this by sending you the machine and the records of your selection, on free trial. And further—when you decide to keep it, pay for it on

**My Easy Payment Plan**

As little as \$2.00 a month will buy a Victor or Victrola my way, and you pay me no more for it than if you paid spot cash anywhere else, for I charge you no interest and no premium.

Please understand—if you don't want the machine after the free trial, all you have to do is to ship it back **at my expense**—you are under no obligations to buy.

**My Complete Free Catalog**

sent on request. Handsomely and fully illustrated—detailed descriptions of all machines and full list of records. A card will bring it—it is free. Write **now**.

**PETER GOODWIN, Pres.,**  
**PETER GOODWIN MERCANTILE CO.**  
 Victor and Victrola Distributors.  
**322 Century Bldg., St. Louis, Mo.**

Nothing like a good lather to make the path of the razor smooth.

**Colgate's Shaving Lather**  
**STICK—POWDER—CREAM**

Wonderfully softening and soothing in whichever form you use it. Send 4 cts. for a trial size of stick, powder or cream.

**Colgate & Co., Dept. 81, 199 Fulton St., N. Y.**

**HILDEBRANDT BAITS HOOK AND LAND 'EM**

The choice of experienced anglers. A small outfit, interchangeable, catches any fresh water game fish. "Standard," "Slim Eli," "Idaho" shapes—nickel, copper, brass, aluminum, black and gold finishes suitable for bright or dull days. Ball bearing "spin so easy" blades—reversible.

**FREE NEW 1914 CATALOG**

Actual sized illustrations, new flies, spinners, rods, lines, etc.  
*—2c stamp brings it—*

**THE JOHN J. HILDEBRANDT CO., 1313 High St., Logansport, Ind., U.S.A.**

**MAGIC FISH LURE!**



Best bait for attracting all kinds of fish ever discovered. It sure does get 'em! Seems as though they just can't keep away from it. Will keep you busy hauling in the finny beauties. Makes fishing a REAL pleasure. Use Magic Fish Lure and you'll catch a big string every time while the other fellows go home empty-handed marveling at your "luck." Good any season. Won't spoil. Not unlawful to use. Send 25c for box containing enough for 500 baits. Money back if not satisfied. Valuable catalog sent FREE. Write for it today.

**Lotz Bros. 155 N. Main St., St. Louis, Mo.**

**Guaranteed Used Pianos**

A large number of fine instruments at exceptional bargain prices, many like new, exchanged for **Kimball Player Pianos**, thoroughly overhauled and guaranteed to be in splendid condition in every way.

Examples:	Schaefer Upright \$140	Hallet & Davis . \$190
Briggs Upright . \$ 70	Hinze Upright . . 145	Kimball Upright . 220
Colby Upright . . 90	Fisher Upright . . 165	Steinway Upright 275
Emerson Upright 110	Whitney Upright 185	Kimball Upright . 275
Decker Bros. Upr't 135	Chickering Upright 175	Knabe Upright . 175

We ship anywhere to reliable people on easy payment terms. Write Today For Complete List, Prices, and Terms and Beautiful Illustrated Musical Herald **FREE**, and catalogue New Kimball Pianos.

**W. W. KIMBALL COMPANY, 1293 Kimball Hall, Chicago, Ill.**

**The Burlington Special**

19 Jewels Fully Adjusted



**The Burlington Special**

New Style (Thin Model)

Here is an Exquisite Design

Napoleonic Inlay Enamel Monogram

**No Money Down!**

The superb Burlington, encased in your choice of the exquisite new design cases, will be sent to you **prepaid**, without a penny down. See and examine the watch for yourself. Compare it with **any** watch you ever saw at **any price**. Then—if you are not absolutely satisfied send the watch back to us *at our expense*.

You risk absolutely nothing—you pay nothing—not *one cent*, unless you want *this exceptional* offer after seeing and thoroughly inspecting the watch.

If you decide to keep the watch, send us only a small deposit. The balance can be paid as you choose, in cash or at the rate of only \$2.50 a month. You get the superb Burlington at the **DIRECT** rock-bottom price—the same price that **even the wholesale jeweler** must pay.

**New Ideas in Watches**

On this great special offer you have some wonderful designs to select from—the latest triumphs of the master goldsmiths. Open face or hunting case, ladies' or gentlemen's sizes. **Block and Ribbon Monograms, Diamond Set, Lodge, French Art and Dragon Designs, Etc.** Our catalog shows complete illustrations.

**New Book on Watches**

Learn the inside facts about watch prices, and the many superior points of the Burlington over double-priced products. Just send the coupon or a letter or a postal. Get this offer while it lasts.

<b>Burlington Watch Co.</b> 19th Street and Marshall Blvd. Chicago, Ill. Dept. 9193	<b>Burlington Watch Co.</b> Dept. 9193 19th St. & Marshall Blvd. Chicago
--	--

Please send (without obligations and prepaid), your free book on watches, with full explanation of your cash or \$2.50 a month offer on the Burlington Watch.

Name.....  
 Address.....

# "Made \$28 in 1 Day

**I Don't Know of Anything to Compete with the Minute Picture Business"**

Price  
\$7.50  
Up



So says J. A. McMillian, of Nettie, W. Va., who has one of our Champion Cameras. If you want to make more money than you've ever made before—quicker and easier—this is the business for you. No matter where you live or what your occupation, you can coin money right from the start.

## Experience Not Necessary

J. H. Arnold, Rock Lake, N. D., writes: "Received outfit O. K. Took it to a little town, set it up for 2 hours and took in \$12.35."

"Made \$25 yesterday," writes Arthur Neely, Alvarado, Tex. "First day did \$30 in business," says B. Busha, Bell Island, Newfoundland. "Made \$50 Christmas."—C. V. Lovett, Fort Meade, Fla. "Had an excellent business of \$29.90."—Vernard Baker, Holbrook, Neb.

**Photo Post Cards All the Rage** at Fairs, Picnics, Carnivals, Resorts, Schools, Factories, Depots, on Streets—anywhere, everywhere. Camera takes pictures size 2½ x 3½, 1½ x 2½ and one-inch buttons. Photograph persons singly or in groups, houses, animals, autos, beautiful scenes, etc. Make them on the spot, in broad daylight. *No gallery, no rent, no profits to divide with others.* The

## Champion Minute Picture Machine

takes, develops and finishes perfect pictures in 30 seconds: 200 an hour. **No Dark Room.** Nearly 85¢ profit on each \$1.00 you take in. Get into this lucrative business at once. Travel if you like—see the world and enjoy life. *Quit working for others; be your own boss.* An opportunity like this does not occur every day. Take advantage of it and write for Free Book, Testimonials, Liberal Offer, etc.

**AMERICAN MINUTE PHOTO COMPANY**  
2214 Ogden Ave. Dept. A 95 CHICAGO, ILL.

# \$50.00 A WEEK

## CLEAR PROFIT FOR YOU

In the minute picture business. Everybody buys. Fairs, picnics, parades, and all busy places offer you an unlimited money-making field. **No experience needed.**

## \$12.00 Starts You

in your own business that will easily bring you \$50 weekly profit. W. C. Cox, Ind., made \$48 in 2 days. Nichols, Pa., made \$21.26 in 5 hours. This chance is yours with a

## One Minute Camera

Makes finished photos on post cards and buttons in one minute. Detailed information free. Write at once.

**THE ONE MINUTE CAMERA CO.**  
Dept. 394 538 So. Clark Street, CHICAGO



## WE START YOU IN MOTION PICTURE BUSINESS



**A Postal Card or Letter** is all that it costs to learn how we do it. Many of our clients whom we started **WITH SMALL CAPITAL**

are among the most successful exhibitors in the country. The business is just at the height of its prosperity—its profits are now the greatest—you can't fail to get your share if you start at once. **\$35 to \$50 and More Daily Profit.** Write today for our Plan & full Details.

**ATLAS MOVING PICTURE CO.**  
Room 280, 508 South Dearborn Street, Chicago, Illinois

# One Day's Pay One Man's Work

## \$28.50 With This

made by Jos. Hancock, Lamoni, Iowa. Schearer, Montana, made \$22.35 in 5 hours. Miller, Iowa, made \$13.65 in one afternoon. *We have proof of this and hundreds of similar reports.* No matter who you are or where you live, here's your chance to double your present salary or income, working during spare time or permanently as a **one minute photographer.** *No experience needed.* A new, live business of big cash profits. You can work at home or travel, enjoy the healthful, outdoor work and become independent in your own business. **Invest one cent for a postal—ask us for proof of what others are doing—of what you can earn with a**

## Mandel Post Card Machine

A portable post card gallery. Takes, finishes and delivers photo post cards and buttons in a minute's time—makes five different styles of pictures in 3 sizes. *No plates, films or dark-room.* One minute pictures sell like wildfire. Everybody buys. Picnics, fairs, carnivals, busy corners, small towns and large cities—**Big Money Everywhere.**

## This Picture-Taking Outfit

gives you a complete, ready-made business that produces profits for you at once. You can make 100 to 200 sales a day, easy. Each sale brings 8c to 16c clear profit. Small capital. Sale of first supplies brings back practically your entire investment. Write at once for full particulars **FREE.**

## The Chicago Ferrottype Co.

52 Ferrottype Bldg., Chicago or  
Dept. 52 Public Bk. Bldg., New York



**RAILWAY-TRACK MILEAGE OF U. S.**—According to the report of the Interstate Commerce Commission for the fiscal year ended June 30, 1912, the aggregate mileage of railway tracks of all kinds was 360,714.24. This mileage was classified as follows: Single track, 240,238.81; second track, 24,920.51; third track, 2,511.76; fourth, fifth, and sixth tracks, 1,783.97; odd tracks and sidings, 91,250.19 miles. The number of locomotives in service was 61,250, of which 14,206 were classified as passenger, 36,600 as freight, 9,475 as switching, and 969 were unclassified.

## Go Into THE MOVING PICTURE BUSINESS.

Write for  
**FREE**  
Catalog



**Earn \$30-\$50 Per Night**  
**No Experience Necessary**

A small investment will start you in this great money making business. We furnish Machine, Film, Lighting Equipment and complete traveling and stationary outfits.

**ACORN MOVING PICTURE CO.**  
173 N. Green St. Dept. C, Chicago

## \$15.00 to \$35.00 Per Day Easily Made

Taking photographs with our **ONE MINUTE TINTYPE and POSTCARD CAMERAS.** Pictures made direct without use of negatives. Toned, fixed and developed in one solution. No experience or dark room necessary. Cameras from **\$10.00 up to \$35.00 each.** Complete photos cost 1c to 2c each, sell for 10c, 15c and 25c each.

Send for Free Catalogue and Price List today.  
**THE NEW YORK FERROTTYPE CO., Dept. 111**  
168 Delancey St. 1113 S. Halsted St.  
New York City, N. Y., U. S. A. Chicago, Ill., U. S. A.



# Only \$36.00 The Wonderful ILLUSTRATOR LANTERN

With our improved famous **ALCO RADIANT LIGHT.**

This new 1912 Model has many improvements and double brilliancy. Write for illustrated circular of this and Lanterns of all styles and lights at bottom prices. **IF YOU OWN A LANTERN** we should have your name to mail to you our regular announcements of new slides and lecture sets. 75,000 Lantern Slides to rent. **POST CARD MAGIC LANTERN** reflects image of postcard or any other picture or object. Prices, \$2.75, \$12.50, \$25.00, \$60.00, express paid.

**WILLIAMS, BROWN & EARLE, Inc., 918 Chestnut St., Philadelphia, Pa., Lantern Dept. 20**  
Engineering, Microscope, Optical, Scientific, Photo Lantern Slide Supplies



## WE TRUST YOU

### \$2.95 Brings You This Suit

### BE WELL DRESSED

Thousands of men have charge accounts with us and take six months to pay. You, too, can have a credit account with us and we want you for a new customer—your credit is good—we'll trust you.

### We Give You 6 Months to Pay

#### Guarantee Satisfaction

Remember, we save you big money on made-to-order clothes that are better in quality than can be bought elsewhere. No matter who you are or where you live, we'll sell you order made clothes on credit.

### Stanley-Rogers Show You How to Take Your Own Measurements—Don't Hesitate—It's Easy—Order Blank Shows All.

We have the easiest special system of taking measurements ever used. You'll like it when you see the simple instructions.

## \$2.95 Brings You This Suit

This elegant all-wool suit, made in latest style as shown, of fine brown fabric. Sent to you—made to your order—upon receipt of \$2.95 and measurements. Order by No. 799 S.

Price \$12.95. Balance \$2.00 Monthly

No References Asked—No Red Tape

### Free STYLE BOOK and SAMPLES

Write for book showing latest styles and fabrics being worn by swell dressers all over the country. Get your copy now. It's Free. Send a postal for it today. Write to

**STANLEY-ROGERS COMPANY**

526 536 South Clark Street

CHICAGO, ILL.

Get  
1914  
Style  
Book  
Now

## BUY PLUMBING and HEATING SUPPLIES



at WHOLESALE

Will Save  
You 30%

Don't pay retail prices. Full stock on hand for prompt shipment. Send for free catalog.

B. P. KAROL, 768 to 772 W. Harrison St., CHICAGO



Be Your **OWN BOSS**

**AGENTS EARN  
BIG MONEY**

selling Golden Rule

genuine hand forged English Razor Steel Knives. We will put any photo or lodge emblem on one side of the transparent handle, and name and address on the other. We have a complete, fully guaranteed line of knives, razors, strops and cutlery specialties. Quick sales. Big profits. Experience unnecessary. Write today for catalog and terms.



Golden Rule Cutlery Co., 552 W. Lake St., Dept. 112, Chicago

## AGENTS \$6 a Day

Should be easily made selling our Concentrated Non-Alcoholic Food Flavors, Soaps, Perfumes and Toilet Preparations. Over 100 kinds, put up in collapsible tubes. Ten times the strength of bottle extracts. Every home in city or country is a possible customer. Entirely new. Quick sellers. Good repeaters. Not sold in stores. No competition. 100 per cent. profit to agents. Little or no capital required. Elegant sample case for workers. Start now while it's new. Write today—a post card will do—for full particulars **FREE**



AMERICAN PRODUCTS CO., 5470 Sycamore St., Cincinnati, O.



# \$7.50

## and You Keep This Superb New Edison

An astounding offer—the great New Edison with the new Diamond Stylus reproducer and your choice of all the brand new Diamond Style Records will be sent to you on free trial without a penny down. The finest, the best that money can buy at one-fourth, yes, one-fifth the price of highest grade instruments—a rock-bottom offer direct from us.

## Entertain Your Friends

Hear all the latest up-to-date song hits of the big cities. Laugh until the tears stream down your face from laughing at the funniest minstrel shows. Entertain your family and your friends with everything from Grand Opera to Comic Vaudeville—then if you choose, send the outfit back to us at our expense.

## Rock-Bottom Direct Offer

If you wish to keep Mr. Edison's superb new instrument, send us only \$7.50 after the free trial. Pay the balance on the easiest kind of monthly payments.

Think of it—a \$7.50 payment, and a few dollars a month to get this brand new style outfit—the Diamond Stylus reproducer, the stand for records, the musical quality—the same Diamond Style Records—all the musical results of the highest price outfits—yes, the greatest value for \$7.50 down, balance on **easiest monthly terms**—convince yourself—a free trial first! No money down, no C. O. D., not one cent to pay us unless you **choose** to keep the instrument.

## Our New Edison Catalog Sent Free!

Your name and address on a postal or in a letter, (or just the coupon) is enough. No obligations in asking for the catalog. Get this offer—while this offer lasts. Fill out the coupon today.

**F. K. BABSON**  
Edison Phonograph Distributors  
1193 Edison Block  
Chicago, Ill.

Canadian Office:  
355 Portage Ave.,  
Winnipeg, Man.

TO  
**F. K. BABSON**  
Edison  
Phonograph Distributors  
Dept. 1193, Edison Block  
Chicago, Ill.

Gentlemen.—Please send me your new Edison Catalog and full particulars of your free trial offer on the new model Edison Phonograph.

Name.....

Address.....

# CONGRESS

GOLD EDGES  
PLAYING CARDS



## For Social Play

Decorative designs. Exquisite coloring. Flexible, easy to shuffle. They bespeak good taste and add tone to the occasion.

Air-Cushion Finish

50¢ PER PACK

THE  
OFFICIAL RULES  
OF  
CARD GAMES  
Hoyle up-to-date  
SEND 15¢ IN STAMPS

ISSUED  
YEARLY

# BICYCLE

CLUB INDEXES  
PLAYING CARDS



## For General Play

The old saying "merit will tell" was never more true than when applied to Bicycle Cards. Used everywhere.

Ivory or Air-Cushion Finish

25¢ PER PACK

THE U. S. PLAYING CARD CO., CINCINNATI, U. S. A.

## Get Edwards Latest Special STEEL Shingle Offer



Don't buy wood shingles, which burn and rot, but use Edwards "Interlocking" Steel Shingles, which are rust-proof (made rust-proof by famous "Tightcote" Process), fire-proof, lightning-proof and cheaper than wood. Sold direct from factory at wholesale prices. No painting, no extras, no tools needed—just a hammer and nails. 125,000 delighted owners. We pay the freight.

Write at once for Special Price Roof Book No. 350 and give size of roof if possible.

## This Brings Big Offer!

THE EDWARDS MFG. CO.  
300-350 Lock St., Cincinnati, Ohio

Please send book on your Steel Shingles, together with latest Freight-Paid Prices.

Name .....

Address .....

## Makes Talking Machines Sound Life Like

## This is the Original and Genuine Morse Clarifier

A remarkable little device made to fit in tube adjoining reproducer of any make of machine. It renders the sound loud, clear, life-like and eliminates that unpleasant metallic effect. Easily inserted without marring or adjusting machine. Is everlasting.

Send dollar bill, 2c stamps or check at our risk. **\$1.00 MAILED PREPAID**

**GUARANTEED** Absolutely satisfactory or money refunded.

Reference, any bank in Minneapolis. In ordering state whether for Victor, Victor-Victrola, Edison Cylinder with metal or rubber connection, Edison Disc, Columbia Disc, with new bayonet or former tone arm or Columbia Cylinder. Information matter free. Buy our extra fine imported needles, medium and loud. 5 cents per hundred postpaid.

**MORSE BROTHERS, Mfrs. and Distributors**  
550 Lincoln Building, MINNEAPOLIS, MINN.



**ELECTRIC-POWER OUTPUT OF THE UNITED STATES**—The combined electrical-power output of the 7,500 central generating stations of the United States aggregates 12,000,000,000 hp., according to one of the electric-light and power associations which has been gathering statistics on the subject. It would take 5,000,000 of the most powerful locomotives to exert this amount of power, which is sufficient to propel some 350,000 of the largest ocean steamships.

## AGENTS—A WINNER



**Labyrinth Keyless Padlock.** Works like a safe, operated in the dark as easily as in daytime. Every combination different. Used on henhouse, cellar door, barn door, corn crib, refrigerator, automobile, gym locker, mail box—a hundred places. Sells everywhere—city or country. Enormous demand. Splendid profits. Patented. No competition. Write quick for territory, terms and canvassing sample if you mean business.  
**THOMAS KEYLESS LOCK CO.**  
9648 West Street DAYTON, OHIO

## There's Money in Agricultural Blasting

WE TEACH YOU FREE

Our extensive national advertising yields thousands of inquiries from farmers, orchardists, etc., who need blasters to clear land, blast ditches, holes for tree planting, tight subsoils, etc. More than twenty million pounds of agricultural dynamite used in 1913. We refer all inquirers to nearest blaster, supply free advertising matter and help you get the business. We want to start in this independent business, reliable men who have \$200 capital for tools, magazine, and running expenses.

Write for free booklet No. 248-B.

Agricultural Division, Du Pont Powder Company, Wilmington, Del.





# Diamonds on Credit Watches

**2000 ILLUSTRATIONS**

**SEND FOR Free Jewelry CATALOG**

This handsome 100-page illustrated Catalog may truly be called the "Book of Bargains." All the new, popular styles in Jewelry are shown—gorgeously beautiful Diamonds, artistic solid gold and platinum mountings—exquisite things—that sell in some cash stores at almost double our prices. Select anything desired and let us

**Send It to You on Approval**  
If satisfactory, send us one-fifth of purchase price as first payment, balance divided into eight equal amounts, payable monthly. We pay all delivery charges. Send for Catalog.

**THIS IS THE RING SHE WANTS**

**\$50**

**Credit Terms: \$5 a Month**  
The Loftis Credit System is a great convenience at all times. Big bargains in ladies' and men's watches. We give better values and easier terms than any house in America. Write today.

**BARGAIN SPECIAL**

**DIAMONDS WITH HEARST**

**THE BEST GIFT OF ALL**

**LOFTIS BROS. & CO., Diamonds, Watches, etc.**  
Dept. L 894, 100 to 108 N. State St., CHICAGO, ILL.  
(Established 1858) STORES IN: PITTSBURGH, ST. LOUIS, OMAHA. (55 Years of Success)

## Chauffeur's Law Book FREE!

The first and only book of its kind ever compiled. Contains vitally important information about the laws governing chauffeurs in every state—When and how to register—How to get a license in each state—What the fees are for the first year and renewals—Driving laws and regulations—Rights and privileges of the chauffeur—And scores of valuable facts every chauffeur should know. This book, at any book store, would sell for 50c. But send us 10c for a copy of the **American Chauffeur** and with it we will send you this book free.

This offer is made for a limited time to get you acquainted with the **American Chauffeur**—the liveliest magazine in the automobile field and the only one published exclusively in the interest of the beginner, the professional chauffeur, and the man who drives his own car. Every issue crammed with valuable articles that will make you a better chauffeur and help you make more money. Write your name on the margin of this page and send it with 10c in stamps or coin, and we will forward the **Chauffeur's Law Book** and a current copy of the **American Chauffeur** by return mail.

**THE AMERICAN CHAUFFEUR PUBLISHING CO.**  
251 Butler Building CINCINNATI, OHIO

### ELECTRIC LIGHT PLANTS

Complete gasoline engine, dynamo, switchboard and storage battery \$240.  
Agents wanted. American Battery Co., 1139 Fulton St. Chicago (Estab. 1889.)

### ELECTRIC HOME, FARM, THEATER or STORE LIGHTING PLANTS.

Wonderful Economy. Flash, Xmas Tree, Bicycle & Carriage Lights, Railways, Engines, Dynamos

### MOTION PICTURE THEATER COMPLETE EQUIPMENTS

Start YOU in the Most Profitable Business in America with **BIG ADVANTAGES**. Small Audiences Pay. Catalog 3c.  
**OHIO ELECTRIC WORKS, DS, CLEVELAND, O.**

## UNCLE SAM WANTS YOU

Parcel Post

Positions Available

### Spring Examinations Everywhere for Many Positions

Thousands of Appointments Coming

Good wages to commence. Better wages later. No "Layoffs" because of STRIKES, FINANCIAL FLURRIES or THE WHIMS OF SOME PETTY BOSS. **THE POSITION IS YOURS FOR LIFE.** Country residents and city residents stand the same chance for immediate appointment. Common sense education sufficient. Political influence NOT REQUIRED.

**WE GIVE FREE SCHOLARSHIPS**

Write immediately for schedule showing the places and dates of the Spring examinations. Don't delay. Every day you lose means the loss of just so much coaching before the rapidly approaching examinations.

**FREE COACHING COUPON**

**FRANKLIN INSTITUTE, Dept. E 174, Rochester, N. Y.**

The coupon, properly filled out, entitles the sender to free sample questions; a free copy of our valuable copyrighted book, "GOVERNMENT POSITIONS AND HOW TO OBTAIN THEM," and to consideration for FREE COACHING for the Civil Service Examination here checked:

... Railway Mail Clerk (\$900 to \$1800)	... Customs Positions (\$600 to \$1500)
... Postoffice Clerk (\$800 to \$1200)	... Internal Revenue (\$700 to \$1500)
... Postoffice Carrier (\$800 to \$1200)	... Stenographer (\$800 to \$1500)
... Rural Mail Carrier (\$600 to \$1100)	... Clerk in the Departments at Washington (\$800 to \$1500)
... Automobile Operation	

Name.....  
Address.....  
*Use this before you lose it. Write plainly.*

### COAL EXPORT OF THE UNITED STATES—The United States now occupies third place in the list of coal-exporting countries of the world, the coal exports

## 9,059-Word Business Book Free

Simply send us a postal and ask for our free illustrated 9,059-word Business Booklet which tells how priceless Business Experience, squeezed from the lives of 112 big, broad, brainy business men, may be made yours—yours to boost your salary, to increase your profits. This free book deals with

- How to manage a business
- How to sell goods
- How to get money by mail
- How to buy at rock-bottom
- How to collect money
- How to stop cost leaks
- How to train and handle men
- How to get and hold a position
- How to advertise a business
- How to devise office methods

Sending for this free book binds you to nothing, involves you in no obligation; yet it may be the means of starting you on a broader career. Surely you will not deny yourself this privilege, when it involves only the risk of a postal—a penny! Simply say "Send on your 9,059-word Booklet". Send to **SYSTEM, Dept. 24-A Wabash and Madison Sts., Chicago**

**No. 57 83c**

## A Genuine \$2 Knife for 83c

**THIS KNIFE HAS BRAINS IN IT.** Equally good in the Shop, the Farm, or Forest; light but extra strong; resharpened easily. Stag handle, German silver finish; blades file tested, hand forged razor steel and warranted. Sample 83c, 3 for \$2, postpaid. Choicest Pearl, \$2 each.

Send for 80-page Free List and "How to Use a Razor"

**MAHER & GROSH CO., 106 A St., Toledo, Ohio**

**El Diablo**

**RAZOR STEEL**

# DUCK'S CATALOG

Big 325 Page Electrical and Wireless

Supplies mailed for 8c, stamps or coin, which you may deduct from your first order of \$1  
 Great cost of catalog and low prices prohibit distribution except to those interested  
**20% to 33% is Saved in Purchasing from Us**

Whether you are interested in an experimental or commercial wireless outfit, a flashlight or a lighting plant, we can save you money and at the same time guarantee you the highest quality.

## WHAT OUR CATALOG CONTAINS:

125 pages wireless insts. for commercial and amateur use, with over 30 diagrams; 10 pp. raw material for wireless insts.; 15 pp. telegraph insts.; 35 pp. toy and commercial motors and generators; 15 pp. flash-lights and miniature lamps and 125 pages ammeters, voltmeters, storage batteries, transformers, vibrators, switchboards, lighting plants, tools, air rifles, pocket knives, radiotronics, miniature railways, mechanical and electrical books, and general electrical supplies.

**THE J. J. DUCK COMPANY, Arcade Building, TOLEDO, OHIO**

### "THE ELECTRO RADIOSON"

"The Ultra Sensitive Electrolytic"



The Radioson today represents the most sensitive detector made, without any exception whatsoever. Far more sensitive than the Audion as well as the ordinary Electrolytic. Will bring in messages which cannot be heard at all by other detectors. The Radioson cannot be knocked out by nearby sending stations. Messages come in clear and distinct even while the detector is shaken violently. The Radioson never requires attention. Always ready for you. You never lose part of important messages on account of bothersome adjustments, common to every other detector. Quite useful for Radio telegraphy as well as Radio Telephony. No potentiometer required. Works on two flashlight cells. This detector must be used in connection with a 2,000 Ohm head set for best results. Instrument is mounted on heavy opal glass base, solid

hard rubber standard. Detector proper can be snapped in and out readily. Size over all 4x2 1/2 in. x 3 1/2 in. Shipping weight 2 lbs. This detector is absolutely guaranteed to be the most sensitive manufactured today. We guarantee satisfaction. Price complete \$4.50  
 Send today 3c postage for our great 212 page electrical cyclopedia No. 12 with 450 illustrations and 1600 electrical articles, loads of experiments on electricity and electrical apparatus. No postal-cards answered. Ask for our free 160 page Wireless Course in 20 lessons.

**The Electro Importing Co., 233 A Fulton Street, New York**  
 "Everything for the Experimenter"

### A Complete Wireless Station \$985

Receives 1200 Miles  
 Send 12 to 15 Miles

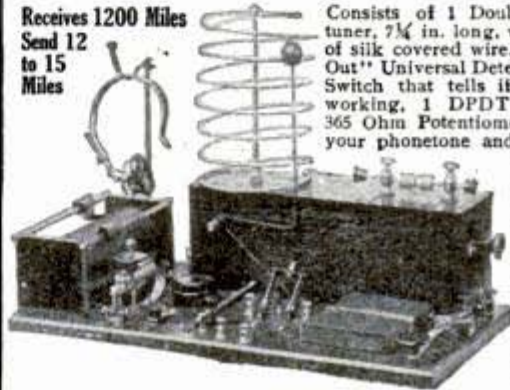

Consists of 1 Double slide tuner, 7 1/4 in. long, wound with 160 ft. of silk covered wire. Our "Don't Jar Out" Universal Detector, 1 Buzzer and Switch that tells if your Detector is working, 1 DPDT Aerial Switch, 1 365 Ohm Potentiometer - It increases your phonetone and distance 30%, 1 fixed Condenser, 1 standard Wireless Key, 1 Spark Coil guaranteed to give 1 1/2 inch spark, 1 Helix & Cord, 1 machine turned Spark Gap, 1 flat 8 plate Condenser, 1 1000-ohm double pole Receiver and Cord, 1 nickle Headband, 6 Insulators & Diagram.

Send stamp for Bulletin "P" for other remarkable values.

**NICHOLS ELECTRIC CO., 35 Frankfort St., New York**

of the United Kingdom for the year 1912 having been 85,000,000 tons; those of Germany, 39,000,000; and of the United States 26,500,000 tons.

## EXPERIMENTERS



This is the **Experimenter's Reference Book**

It's the latest edition of the famous **Amco Catalogue**, 128 pages, fully illustrated, complete description and prices of the latest electrical and experimental apparatus - Storage

Batteries, Rectifiers, Transformers, Induction Coils, Wireless Apparatus, Lamps, Flashlights, Meters, X-Rays, Books, Tools, Electric Railways, Steam Engines, Water Motors, Dynamos, Motors, Telegraphs, Telephones, Electrical Supplies, Model Aeroplanes, and Parts for building your own apparatus. 4c in stamps will bring you this wonderful book. The best catalogue of *Wireless Apparatus, etc., published.*



**ADAMS-MORGAN CO.** "The Experimenter's Supply House"  
 Box 72 M, Upper Montclair, N.J.

## BING'S CONSTRUCTOR

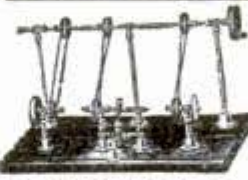

Most fascinating building toy. No screws or rivets. Build *anything* you want - *Machinery*, bridges, towers, wagons, machine shops, etc. Outfits \$2, \$4, \$6, up to \$60. Ask your dealer about them, or write to us for full particulars.

Made with Bing's Constructor **BING BROTHERS, Manufacturers**  
**JOHN BING, Sole Representative, 382 Fourth Ave., N. Y.**

## Send for Copy of Our New Wireless Manual P1

It contains 96 pages and tells how to erect and maintain wireless telegraph stations. Shows a number of diagrams. Has the Morse and Continental Telegraph Codes. Illustrates the best instruments to use; tells what they are for and how to use them. Do not wait until some other time, but sit down now and send your name and address, and get one. It costs you nothing.



## Send for Our Pocket Catalog P26

It contains 212 pages, with over 1,000 illustrations and describes in plain, clear language all about Bells, Push Buttons, Batteries, Telephone and Telegraph Material, Electric Toys, Burglar and Fire Alarm Contrivances, Electric Call Bells, Electric Alarm Clocks, Medical Batteries, Motor Boat Horns, Electrically Heated Apparatus, Battery Connectors, Switches, Battery Gauges, Wireless Telegraph Instruments, Ignition Supplies, etc.

It Means Money Saved to You to have our Manual and our Catalog when you want to buy

**MANHATTAN ELECTRICAL SUPPLY CO.**



# Would You Accept This 30-Day Offer?

Standard of the World. Endorsed by Government and Railway Officials. Harris-Goar's enlarged Easy Credit Plan now enables you to own one of these superb Elgin Watches without missing the money. Write for Free Catalog.

## 17-Jewel Elgin

Now, during this Special Sale, is the time to buy this elegant 17-JEWEL Elgin. Thoroughly factory tested, fitted in a beautiful Gold Strata Case, Factory stamped and

Guaranteed 25 years, hand engraved, plain polished or with your own monogram, and our startling offer is to send you this celebrated 1914 Model free of charge for your approval

## No Money Down

Because we want to prove to you that the great volume of our business actually enables us to do better by you than any other Watch or Diamond House in the World, and that on this particular watch, we save you nearly half for it sells regularly at \$20 to \$22, while our

**Special Price is only \$12<sup>75</sup>**

### 3 Fine BOOKS FREE

MR. HARRIS wants to send you his three latest Books FREE—one the story of "The Diamond," its discovery, where and how mined, cut and marketed, the other, "Facts vs Bunc," or all about the Watch Business, both at home and abroad, also our Big Free Watch and Diamond Book.

We don't want you to send us one cent—not a penny. Merely give us your full name and address that we may send you this superb 17-Jewel Elgin on approval, and if after you receive it and want to keep it, then pay us the sum of

### Only \$2.00 a Month

But if after you have worn it 30 days FREE and don't want to keep it, send it back at our expense. You assume no risk whatever. You do not buy or pay a cent until we have placed the watch right in your own hands for your decision. We want no security, no interest, no red tape—just common honesty among men. Write for our BIG FREE WATCH AND DIAMOND BOOK today. Do it now!

**HARRIS-GOAR CO., Dept. 1193, KANSAS CITY, MO.**

The House That Sells More Elgin Watches Than Any Other Firm in the World.

25-Year Gold Case

17 Ruby Jewels

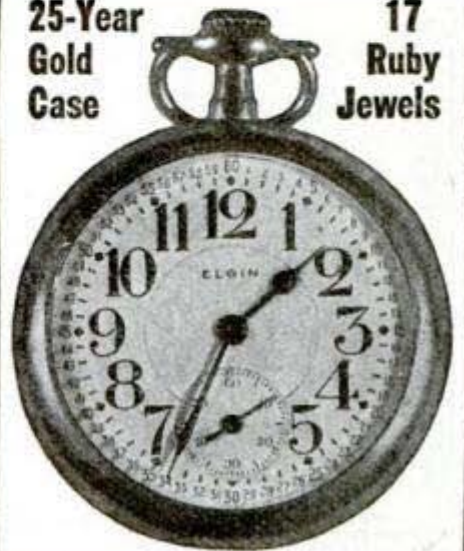

Some of the eucalyptus trees of Australia are taller, it is claimed, than the California redwoods, hitherto considered the highest trees in the world.

## SUPPLIES FOR THE WIRELESS EXPERIMENTER

This little ad is just to catch your Eye. Our Catalogue "B" is sure to catch your Fancy. A 2 cent stamp brings it by return mail. Send for it NOW. WINGER ELECTRIC & MANFG. CO., 711 So. Dearborn St., CHICAGO, ILL. Successors to Dawson & Winger Electric Co.

## Electric Flashlight Pistol

Complete with two batteries and tungsten light. Gun metal finish, handy to carry, never in the way. Size 3x3 1/4. It's no toy, but a neat, handy flashlight. Protect yourself in the dark.

Price, prepaid, \$1.60  
SEND FOR CIRCULAR  
MOHR BROS., 2809  
N. Halsted St., CHICAGO



## ELECTRICITY

This is your "elbow book." It's the latest edition of the VOLTAMP ELECTRIC Catalog—128 pages full of cuts, complete description and prices of latest experimental apparatus—Dynamos, Motors, Rheostats, Transformers, Wireless Coils—Electrical Repair Material; Raw Materials; Telephone, Telegraph and Wireless Outfits; Handbooks; Miniature Electric Railways and parts, Toys, etc. 6c in stamps or coin will bring you this book (with valuable coupon)—you'll find it worth dollars. (No postals answered.)

VOLTAMP ELECTRIC MFG. CO. Voltamp Block, BALTIMORE, MD.

## BRASS AND STRINGED INSTRUMENTS

Biggest line of band and orchestra instruments for band and home use. Cornets, trombones, clarinets, drums, violins, guitars and all wind and stringed instruments. Send for a free catalog of any instrument you may want—we can save you money. We give you a fifty lesson certificate FREE with each instrument. Write today mentioning instrument in which you are interested.

JENKINS MUSIC HOUSE, 40 Jenkins Bldg., Kansas City, Mo.

## Can You Stand Prosperity?

Post-card photography with a Daydark is an easy road to a good income.

Engesser writes: "I have just returned from a mill town 'Glenn' and in eight hours made \$42.50." With a

### PLATELESS DAYDARK PHOTO POST-CARD MACHINE

Earn big money at home, traveling, at fairs, on streets, taking, finishing and delivering 3 photo post-cards a minute—all done with the Daydark. NO EXPERIENCE NECESSARY.

**FREE TRIAL**—10 DAYS CHARGES PREPAID

Be independent—be prosperous. Write postal to-day for Free Catalogue and sample post-card showing fine work this machine does.

DAYDARK SPECIALTY CO.  
302 Daydark Building  
St. Louis, Mo.

MADE \$42.50 IN 8 HOURS

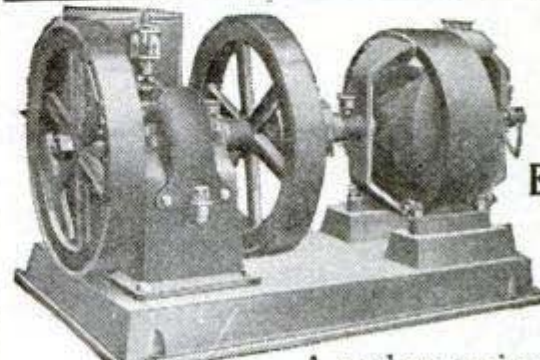
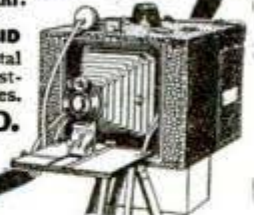

## LIGHT YOUR HOUSE WITH ELECTRICITY

Put in a Direct Connected Gasoline Engine and Dynamo.

A modern equipment at small cost for farm and house lighting and small isolated plants. Dynamo has an output of 42 volts, charges the battery during the day, and 32 volt lamps are used to light the house. Operation steady and quiet. Write for circular. THE CARLISLE & FINCH CO., 244 East Clifton Ave., CINCINNATI, OHIO



Frank Gotch uses the Swedish Rhythmic Vibrator and says:

"For limbering up, keeping in condition and strengthening the muscles, there is nothing that equals or exceeds the use of the Swedish Electric Vibrator. I always use one in my training and I certainly find it a wonderful help. It reaches the seat of all stimulation and gives me a perfect circulation. Its use gives all the muscles elasticity, makes one powerful, quick and active."



**One Sale a Day Means \$90 Profit a Week for You**

No experience necessary. No delay. No charge for Territory. No competition. **Exclusive field.** Success assured. **Remarkable offer.** Read every word carefully. Get an appointment and get started without delay. We are appointing men every day to manage our business in local territories. We **honest men who are willing to work.**

It is the chance of a lifetime. You will be in business for yourself. You will be your own boss — **independent, abundant money, pleasant position** — and your time will be your own. **At home or traveling — all or spare time** — get an appointment immediately and commence earning money next week. We will give you today this opportunity to **Make a Big Income this year.**

**Make \$5,000.00 This Year**

We will commission you our representative to introduce THE SWEDISH VIBRATOR, a most amazing seller. An instrument for home vibratory massage treatments. **Needed by every man, woman and family. Endorsed by the highest medical authorities in the world.** Sells to the home, to physicians, masseurs, osteopaths, chiropractors, barbers, beauty parlors — **unlimited market.**

**Don't Delay** Throw away the little novelties upon which you have to make ten or twenty sales a day to pay expenses. Become a real salesman and make real and quick and big money. Many averaging four, five and even ten sales a day. **This is actually the**

**SWEDISH RHYTHMIC VIBRATOR CO., 116 Vibrator Bldg., CHICAGO, ILL.**  
211-215 Schiller St.,

# Wanted

## AGENTS & SALESMEN

most brilliant, easy and high class proposition that has ever been offered to wide-awake agents, general agents, and managers.

**Investigate** Get free literature and complete information at once. Send just your name and address on a postal card and all will be mailed FREE immediately. **Agent's sample furnished at wholesale price.** Investigate. It costs you nothing to find out. Territory being rapidly assigned. **But one man allowed in a field.** Give the name of your county. Send your name and address today. This is a brilliant opportunity. Do not neglect. Do not put it off. **Act immediately.** Address

**START A MAIL ORDER BUSINESS**

30 new propositions. No competition. Make 95c profit on dollar orders. Complete plans, 10 cts. **MAIL DEALERS WHOLESALE HOUSE**  
541 Franklin Bldg. CHICAGO

**Natural Hen Incubator \$3.** No freight. Actual hen controls everything. No lamps, no costly mistakes. Over 600,000 sold. Agents wanted. Free catalog. **Special Introductory Offer.** **Natural Hen Inc. Co., Sta. H, Dept. 27, Los Angeles, Cal.**

Detailed figures given out by the Department of Commerce show that, despite a falling off in imports into the United States in the month of August and in the eight months ended with August, 1913, exports so increased that a comparison with the corresponding period of 1912 shows a substantial increase in our aggregate foreign trade, the exact figures for the two eight-month periods being \$2,671,741,352 and \$2,604,427,663, respectively.

## \$60 A WEEK and Expenses

That's the money you should get this year. I mean it. I want County Sales Managers quick, men or women who believe in the square deal, who will go into partnership with me. No experience needed. My folding Bath Tub has taken the country by storm. Solves the bathing problem. No plumbing, no water works required. Full length bath in any room. Folds in small roll, handy as an umbrella. I tell you it's great! GREAT! Rivals \$100 bath room. Now listen! I want YOU to handle your county. I'll furnish demonstrating tub on liberal plan. I'm positive—absolutely certain—you can get bigger money in a week with me than you ever made in a month before—I KNOW IT!

### Two Sales a Day—\$300 a Month

That's what you should get—every month. Needed in every home, badly wanted, eagerly bought. Modern bathing facilities for all the people. Take the orders right and left. Quick sales, immense profits. Look at these men. Smith, Ohio, got 18 orders first week; Meyers, Wis., \$250 profit first month; Newton, California, \$60 in 3 days. You should do as well. **2 SALES A DAY MEANS \$300 A MONTH.**

The work is very easy, pleasant, permanent, fascinating. It means a business of your own.

### Demonstrating Tub Furnished

Little capital needed. I grant credit — Help you out — Back you up — Don't doubt —

Don't hesitate—Don't hold back—You cannot lose. My other men are building houses, bank accounts, so can you. Act then quick. **Send No Money.** Just name on penny post card for free tub offer. **Hustle!**

249 Vance St., Toledo, O. Walkersville, Ont., Canada



**YOU! YES, YOU CAN GET IT**



**H. S. ROBINSON**  
President



With a White Cross Electric Vibrator you can make a vibrating chair from an ordinary rocker.

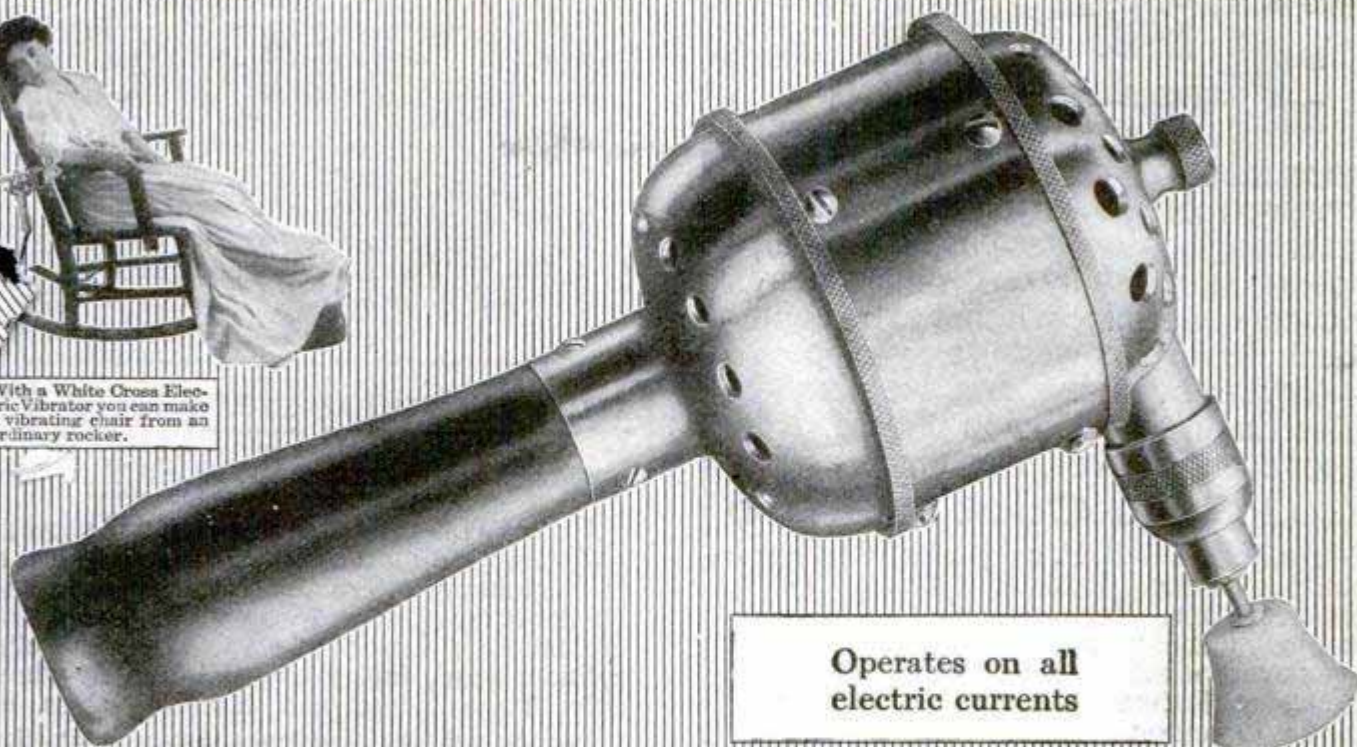

Operates on all electric currents

# \$7.50 For Our New Model No. 10. White Cross Electric Vibrator

The marvelous instrument that has been such a boon to the medical and scientific world. Endorsed by prominent physicians everywhere. Used by physicians in their practice and can be used by an individual himself. The greatest aid to health and beauty known to man. Nature's own remedy, perfected by man's ingenuity. On a great special offer you may now get this superb new model No. 10 for only \$7.50. Send the coupon now for the free book that tells you all about it. We have over a dozen different types of vibrators for you to choose from and our prices are from 25 to 50 per cent lower than our competitors'. Write today—send coupon.

*The only vibrator that can make a vibrating chair from any chair*

## Power and Health For All—For You

Power from within. Strength that is more than mere muscular strength—the strength of the perfect man now within your reach through vibration. Do you feel "tuned up" all the time? Aren't there times when something is wrong—just a little something that takes the edge off things—takes away the keenness of appetite and enjoyment. Usually there is just one thing wrong—circulation. If you only knew how much vibration would do, you would not allow yourself to go another day without trying it. Send the coupon for the free book that tells you all about it.

## White Cross Combination Vibrator

This superb instrument operates on direct or alternating current, or on its own powerful batteries. It gives mechanical vibration, galvanic and faradic electricity. Combined vibratory and electrical treatments can be taken at the same time or separately. It has an electric lamp for examining all cavities of the body. It furnishes current for operating the electric needle for removing superfluous hair and all kinds of facial blemishes. Attachments are furnished for treating the eye, ear, face, scalp and all parts of the body. It is complete with electric brush, sponges, foot plates, etc., etc., so that every member of the family can take any kind of treatments they wish.



Model No. 18

## Send the Coupon for New Book "Health and Beauty"

Get the book (also our Special Reduced Price offer). We are mailing out this great book absolutely free and postpaid. It tells you how the earliest man turned to vibration (common rubbing) as a relief, through instinct. Send the free coupon today and find out about vibration and what it will do for you. It is so easy to use—so simple for you to find out how good it is. The book, "Health and Beauty," tells about our great offer. Send free coupon now or a letter or postal card. We'll send you the book free and prepaid. Do it NOW.

FREE COUPON

Lindstrom-Smith Co.  
1100 So. Wabash Avenue  
Dept. 1193 Chicago, Illinois

Without any obligation to me, please send me free and prepaid, your new book "Health and Beauty." Also send me full particulars of your Special Offer on the White Cross Electric Vibrator.

**Lindstrom-Smith Company**

1100 So. Wabash Ave. • Dept. 1193 Chicago, Ill.

We manufacture White Cross electric irons, hair driers, stoves. Dealers write.

Name.....

Address.....

My Electrical Dealer's Name is

# ELLIS ENGINES

develop more power on kerosene than other engines on gasoline. Will also operate successfully on distillate, petrol, alcohol or gasoline without extra equipment. Strong, powerful, easy to operate—only three working parts. No vibration. Ellis Engines are low in price and the most economical engines made, as they

## Cut Fuel Cost in Two

34c will run a 6-H. P. engine for 10 hours on cheap kerosene. Patent throttle makes three engines in one. Force-feed oiler, automobile muffler, speed-changing governor and many other exclusive features. We'll send it to you on

### 30 Days' Free Trial

Test its strength, simplicity and economy. You'll be surprised at their low cost—we sell direct—you save the agent's profits. Guaranteed 10 years. Send today for new 1914 catalog describing latest models and quoting lowest prices. **ELLIS ENGINE CO.**  
66 Mullett St., Detroit, Mich.

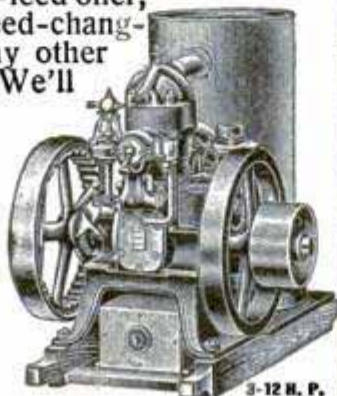

3-12 H. P.

**\$50  
to  
\$300  
SAVED**  
**Just Write!**

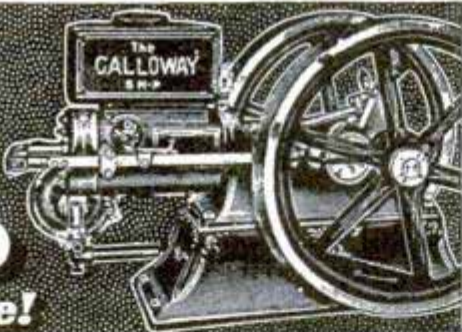

Get my prices—my new offers—get them right

away. If you're going to buy an engine I'll put \$50 to \$300 in your pocket sure. All the dealers' profits cut off—you get them. You buy direct from my big factory.

**30 Days' Free Trial** Satisfaction guaranteed or your money back without a word. Any size from 1-4 to 15 H.P. Galloway Engines will run on gasoline, kerosene, naphtha, distillate, natural gas or motor spirits. Write for my Big Engine Book and Special Offers today.

**William Galloway, Pres., WILLIAM GALLOWAY CO.**  
965 Galloway Station, Waterloo, Iowa 565

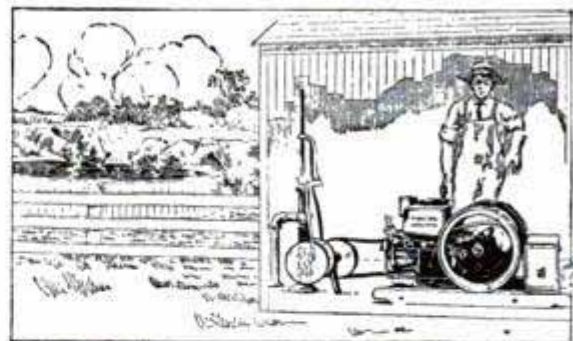

## International Harvester Oil and Gas Engines

**A** LITTLE careful observation will show you that the most satisfactory, economical engines are International Harvester engines. No doubt is left when features like the following are studied: Detachable valve guides, offset cylinder head, fuel pump, split-hub fly-wheels, extra large intake and exhaust valves, etc.

Ask the men who have used and know International engines. That is the best test. They will explain the excellence of International Harvester construction, simplicity, strength and durability.

International Harvester engines are of all styles, and range in size from 1 to 60-H.P. They operate on both low and high grade fuels.

Write for our catalogues and learn more about these engines

**International Harvester Company of America**  
(Incorporated)

**16 Harvester Building CHICAGO U S A**

"FARTHEST NORTH" IN AUTOMOBILE—An American, who last year completed a 50,000-mile automobile trip around the world, claims a new record. From Karesuando, Lapland, he reports that he had reached 68 deg. 27 min. north latitude, or 197 miles north of the Arctic circle.

## Don't Buy an Engine

until you investigate the famous **TEMPLE Gasoline-Kerosene**, slow speed, heavy duty, all-purpose engines. Bulk and weight less than horizontal engines; **cylinders built low**, close to base, eliminating shock and vibration, increasing strength and durability, and giving scientifically correct distribution of strain. **Pay for themselves in fuel saving alone.** Have won five 1st premiums for low operating cost, stability and steady power. Old reliable pioneer concern (manufacturers for 61 years) guarantees these engines. Write today for catalog and particulars of 30-day trial offer.

**THE TEMPLE ENGINE & PUMP CO., 435 Meagher St., Chicago, Ill.**

TERMS TO SUIT

Write for  
Catalog  
A3

**FREE TRIAL FOR 30 DAYS NON-CRANKING KEROSENE ENGINE**

"The Masterpiece of the Largest Manufacturers of Two-Cycle Engines in the World"

It is unusual to find in any one piece of machinery so many exclusive features as in

## The Wonderful Bessemer Kerosene Engine

The Bessemer Universal Fuel Feeder automatically regulates the fuel feed for heavy or light load—the sensitive Bessemer governor absolutely prevents "racing"—the perfectly balanced Bessemer sub-base prevents vibration, the thing that wrecks many an engine. Thus Bessemer's go to their work day in and day out, year in and year out, noiselessly, surely, economically. If you would like to know more about the "best little workers in the world," write us. 2 to 350 H. P.; two-cycle. 30 days free trial. Immediate shipment.

FUEL AND CRUDE OIL ENGINES UP TO 165 H. P.

**THE BESSEMER GAS ENGINE CO., 121 Lincoln Ave., Grove City, Pa.**



Pays for  
itself in fuel saved



BEST FOR  
WATER SYSTEMS

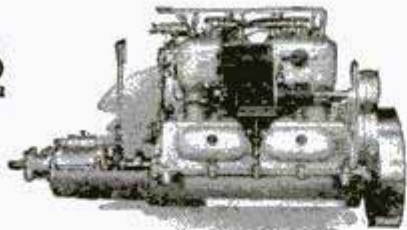

## The Scripps "Midget"

A HIGH grade, four cylinder, four cycle, 7-horse power miniature power plant, designed and built wholly for use in the yacht tenders, dingies, and small boats.

Equipped with modern accessories, such as starter, magneto, control mechanism. Weight—only 200 lbs. Beautifully finished; completely enclosed. Price, complete with all accessories, \$500, f. o. b. Detroit.

Send for catalog, containing full information

**SCRIPPS MOTOR COMPANY**  
637 Lincoln Ave. DETROIT, MICH.

SCRIPPS MOTORS ARE CARRIED IN STOCK BY

- New York.....Bowler, Holmes & Hecker Co., 141 Liberty Street
- Chicago, Ill.....O. L. Cosgrove & Co., 215-219 Englewood Ave.
- Philadelphia.....W. E. Gochenaur, 631 Arch Street
- St. Louis, Mo.....Chas. J. Pettit, 1860 N. Market Street
- Jacksonville, Fla....Gibbs Gas Engine Co., Foot of Main Street
- Seattle, Wash.....S. B. V. Miller, 72 Marion Street
- San Francisco, Cal...Ellery Arms Co., 583-5 Market Street
- Los Angeles, Cal...Marine Engine & Supply Co., 109 East 7th Street
- Duluth, Minn.....Kelley Hardware Co., 118-120 W. Superior Street
- Toronto, Ont.....Schofield-Holden Machine Co., 2 Carlow Avenue
- Winnipeg, Man....D. A. Ross
- New Orleans, La...Arthur Duvic, 130 Chartres Street

EXPORT OFFICE — 17 Battery Place, New York City

## Small Gas and Gasoline Engines

Air and Water Cooled. 1/4, 1/2 and 1 H. P.

Electric light plants from 6 to 50 lights. All prices. All kinds of electrical apparatus. Motors, Dynamos and Batteries. Gas, Gasoline and Steam engines from 1/4 h. p. up. Get our No. 12 Toy and Engine or No. 20 Engines and General Catalogs. Ten cents each. (Coin preferred.) Refunded on first order.

**AMATEUR MECHANICS SUPPLY CO.**  
860 G, Monadnock Block, CHICAGO

## Simple, Safe, Sure and Serviceable

—the four principal features of the speedy little REDEMOTOR Engine. No experience in operating gas engines necessary. Runs on almost any adjustment of the carburetor. Easy for a woman or child to start, the

### REDEMOTOR ENGINE

is absolutely safe and sure. Uses gas, gasoline, kerosene or alcohol. Runs fine on city gas. Made in 3 sizes, 1/4, 1/2 and 1 horse power. Silent running—as noiseless as an electric motor—and much cheaper to operate. Positive satisfaction guaranteed or your money back. Write today for FREE booklet 143.

**ELGIN WHEEL & ENGINE CO.**  
ELGIN, ILLINOIS



## GRAY MOTORS

Send today for our Big Engine Book "M"—the most complete book on marine engines ever published. Shows our complete line of engines for pleasure boats, hunting and fishing boats, row boats and canoes, hydroplanes, work boats and cruisers. Engines of both 2-cycle and 4-cycle type. Material and workmanship absolutely guaranteed. We are largest world and have over 1000

**3 HORSE POWER \$55 COMPLETE**

OTHER SIZES FROM 4 1/2 TO 30-45 H.P.—1 TO 6 CYLINDERS

builders of 2-cycle engines in the dealers who sell Gray Engines and give Gray service.

**GRAY MOTOR CO.**  
398 Gray Motor Bldg. Detroit, Mich.



## WATERLOO BOY TRACTORS GASOLINE ENGINES CREAM SEPARATORS



Waterloo Boy Farm Tractors, Engines and Separators are the best for the money the world has ever produced. Any one of these machines will increase the production of your farm at a big saving in labor.

Our light Farm Tractor is a wonder. It turns short and will go anywhere you can work with a team. Our tractors sell at such reasonable prices that you cannot afford to be without one.

All Our Machines are Sold Under Our Strong Five-Year Guarantee

Write today for our catalog and let us tell you about our tractors, engines and separators.

Waterloo Gasoline Engine Company

Waterloo, Iowa

This Marvelous Tractor and Plows only \$1,050.00

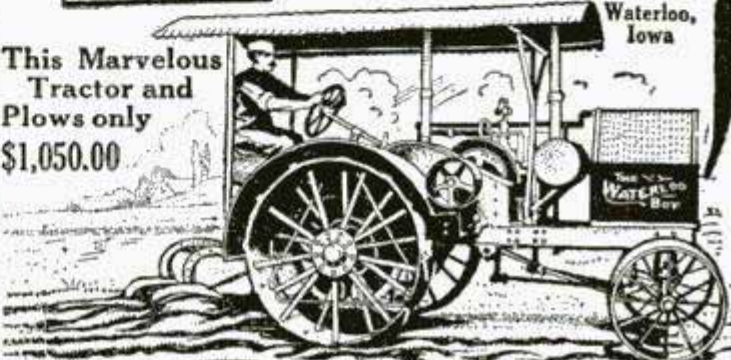

## AMERICA'S STANDARD 12-H.P. MARINE MOTOR

# KERMATH

4 Cycle 4 Cylinder

\$180 to \$260, depending on equipment

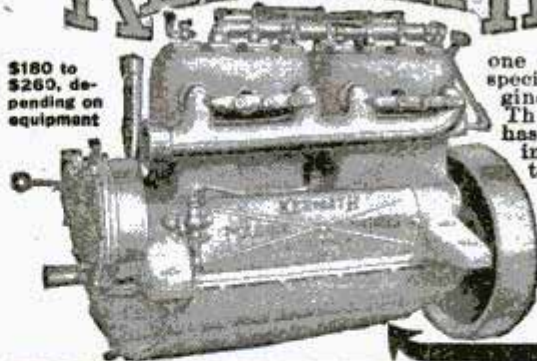

Made in one size only by specialists in engine building. The Kermath hasn't an equal in this size and type, absolutely regardless of price. Catalog on request.

**KERMATH MFG. CO.**  
Dept. P DETROIT, MICH.

## Americanize Your Boat

Why not be patriotic in practice as well as in principle—even tho you don't carry a "big" gun you can drive your boat with an AMERICAN Motor and fly the American flag. If you install an AMERICAN, you are sure to be a true AMERICAN booster. Starts without cranking, uses Kerosene (coal oil), also gasoline, benzine, petrol, alcohol, distillate or naphtha without change of equipment. Our new Kerosene Carburetor cuts fuel cost in half. Every AMERICAN motor is fully guaranteed.

Send for our handsome new catalog, showing our complete line of AMERICAN motors—all sizes from 2 to 30 H. P.—at lowest prices. Catalog is free to any address. Live Agents and Dealers wanted. Some good territory still open. Write for our liberal proposition.

2 H.P. \$38

**American Engine Co.,**  
422 Boston St., Detroit, Mich.



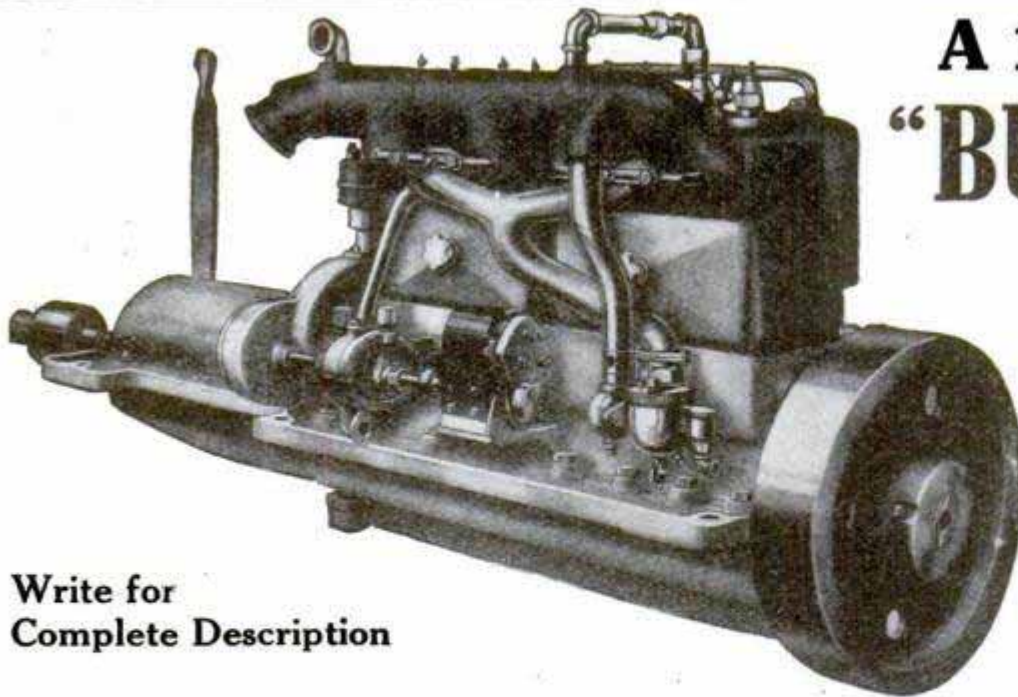

Write for  
Complete Description

## A 16-20 h. p. "BUFFALO"

Four Cycle  
Four Cylinders  
Bore 3 $\frac{3}{4}$  inches  
Stroke 5 inches  
Speed 800 r. p. m.  
Weight 525 pounds  
All working parts  
enclosed  
Splash Lubrication  
Double Ignition

### The Best Engine Value Ever Offered

By building the new 16-20 h. p. "Buffalo" High Speed model in lots of 100 at a time we are able to effect a great saving which is deducted from the selling price. Remember it is the highest "Buffalo" quality — an engine built like a watch—but the price is reduced by quantity production.

**BUFFALO GASOLENE MOTOR CO.,** 1293 - 1305 NIAGARA STREET  
BUFFALO, N. Y.

### For Real Sport



This is the motor you should own if you are going to own any. It is built by men who have had 12 years experience building large marine motors. This is the **third successful season** of the

## WISCONSIN DETACH-Row Boat Motor

Our 1914 model leads in improvements but is in no way freakish or experimental. It is the first detachable motor equipped with **reversible high tension magneto**. Steers by a rudder; made almost entirely on automatic machinery assuring accuracy and interchangeability of parts. 4 models—2 to 3 $\frac{1}{2}$  H. P.

WRITE TODAY FOR CATALOG P  
WISCONSIN MACHINERY & MFG. CO.  
Dept M MILWAUKEE, WIS.

Catalog  
Free



### Jewel Detachable Electric Rowboat Motor

Attaches to any rowboat or canoe, runs on 2 six-volt batteries. No odor, noise, or dangerous gasoline. Complete, without batteries, \$75.

### JEWEL OPEN WINDOW STORAGE BATTERY

Look inside your battery through the patented open window. See condition of plates and height of acid. Jewel Special 6-60, \$9. 6-80, \$12. 6-100, \$15. 6-100 Starting Battery, \$18.

Write for Catalog. Business Est. 1880

JEWEL ELECTRIC CO., Dept. P, 1469 S. Michigan Ave., CHICAGO, ILL.

INTERNATIONAL LONG-DISTANCE TELEPHONE IN EUROPE—It is announced that a convention between Belgium, France, and Switzerland is about to be signed for the establishment of telephonic communication between Belgium and Switzerland. The principal telephone line will pass from Brussels, by way of Nancy, France, to Zurich, a distance of about 350 miles.

### Send for This Valuable Boat Buyers Guide



Illustrates and describes complete motor boats of all types and sizes—fishing and hunting boats, launches, hydroplanes, work boats and cruisers. Shows stock model of practically all the country's foremost Boat Builders and gives prices of boats complete with Gray Motors installed. Also knock-down frames and plans. Write today for this Boat Buyer's Guide and our Big Engine Book "M"  
GRAY MOTOR CO., 38 Gray Motor Bldg., DETROIT, MICH.

### Light Weight Cushman All-Purpose Engine



4 cycle, 4 H. P. Weight 190 lbs. A wonder helper, famous for its great power in light weight. Convenient to handle—fits in anywhere—adapted to all duties. **The Original Binder Engine**. Also double cylinder specialty engines for all power work, 6 H. P. to 20 H. P. Throttle governor, Schebler carburetor. Catalog free.

Cushman Motor Works, 900 N. 21st St., Lincoln, Neb.

### MULLINS CANOES CAN'T SINK

Enjoy the delights of canoeing without fear. **MULLINS Canoes**, when equipped with patented buoyancy pads, and steadied by special keel construction, are the most stable, safest canoes afloat—Graceful in design—Elegant in appearance—Made from carefully selected cedar—Open gunwale construction—Oil finished—One piece duck canvas coverings that cannot crack or wrinkle—Polished brass and copper fastenings—Brass bang plates



Special broad flat bottoms. Two thousand canoes of assorted lengths, grades and colors in stock for immediate shipment. Write for beautiful canoe catalog illustrated in color.

THE W. H. MULLINS CO.  
362 Franklin St., Salem, O., U. S. A.  
The World's Largest Boat Builders

STEEL MOTOR, DUCK & ROW BOATS



# Buy a Waterman PORTO—the Original

Makes any boat a Motor Boat.  
1914 model, 2½ to 3 H. P.  
Weight 59 lbs.  
Fits any shape of stern.

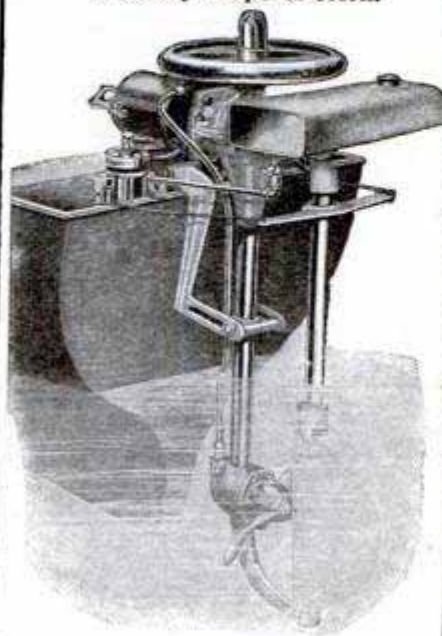

## Outboard Motor—Direct from Factory— Freight Prepaid—and Keep Agent's Profit

Make your rowboat into a 7-mile-an-hour motorboat. The Waterman Porto does it. It's the best made. Nine years successful use. Gives more power for the price, more power for the weight. Fits any shaped stern; simple, compact, economical in upkeep, **Guaranteed for Life.**

In common with all other motors, the Waterman Porto has a cylinder, piston, crank shaft, etc.;

**BUT**—in addition it has this superior equipment: a reliable Carburetor instead of "mixing valve"; 3 Piston Rings instead of 1; Removable Phosphor Bronze Bearings instead of "fixed bearings"; Solid Bronze Skeg, protecting the 10½" x 16" propeller and supporting an Independent Rudder; Water Cooled Exhaust Manifold; Noiseless under-water Exhaust; Bronze Gear Pump for water circulation; Spun Copper Water Jacket, highly polished; any Ignition Equipment desired;

**YET**—costs no more than other portable motors without these essentials. Demand these features in any outboard motor you buy—or you are not getting the worth of your money.

*Write for FREE BOOK and learn about the engine  
that has displaced 50,000 oars during the past 9 years.*

**WATERMAN MARINE MOTOR CO.**  
230 Mt. Elliott Ave. DETROIT, MICH.

BOATS OF QUALITY  
Latest Designs



## Build Your Own Boat

Save the boat builders' profit and excessive freight rates on finished boats. With ordinary care you can build as perfect a craft as you can buy. Every Dunphy frame is set up in shop, each rib is properly bent in place, beveled, marked and securely stayed, keel is finished complete, full instructions with each frame. We also have a complete line of finished boats in stock. Write for catalog.

**DUNPHY BOAT MFG. CO.** Department D  
EAU CLAIRE, WIS.



## WATKINS' SPECIAL MOTORS

3 H. P. Single Cylinder . . . 30 lbs.  
6 H. P. Double Cylinder . . . 60 lbs.  
12 H. P. Four Cylinder . . . 100 lbs.

A strictly HIGH GRADE Motor that will give CONSTANT and EFFICIENT service. Especially adapted for CANOES and LIGHT BOATS. Aluminum base, copper water jacket, steel shaft, bronze bearings.

THE WATKINS MOTOR CO.  
837-839 West Sixth Street CINCINNATI, OHIO

## Figure Now on That New Canoe

Fishing, paddling and vacation time will soon be here. An "Old Town Canoe" will double your pleasure for years to come. It will get you out into the open air, away from the common haunts of man—give you rest and exercise in one. Send for the

## "Old Town Canoe" CATALOG

and get acquainted with canoe construction. It gives intelligent and valuable advice about selecting canoes for all waters. 4000 canoes in stock. Agents everywhere.

OLD TOWN CANOE CO., 1363 Middle St., Old Town, Me., U.S.A.



MARINE

AERIAL

# ROBERTS

AUTOMOBILE

STATIONARY

The Motors That Never Backfire

In Which Motor Are You Interested?

The Roberts Motor Co., 419 Columbus Ave.  
SANDUSKY, OHIO

**LA**  
**Marine Motors**  
**Direct from Factory**  
**to You**



## Save the Dealer's Profit

It won't cost you as much as you thought to enjoy the pleasure of motor boating this summer. The old, reliable, "keep-going" Lockwood-Ash motors are sold direct from factory to you at a big saving. No dealer's profits to pay.

**Immediate Delivery**—Six models, all guaranteed for one year, and sold on 30 days' trial. No strings to this offer, no freight to pay. Just send for one of our complete outfits, and if it doesn't delight you send it back at our expense. The 6 H.P. Motor with Outfit complete, shown in illustration, freight paid, only.....  
 — a clear saving of at least \$29.00. Post yourself on motor boating and the safest, cheapest way to buy by writing today for our 1914 catalog. It's soon time to start — get busy.

**\$96.00**

**LOCKWOOD-ASH MOTOR CO., 336 Horton Ave., Jackson, Mich.**

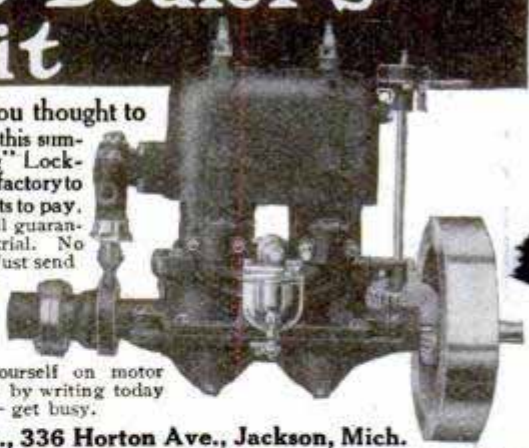

*"Speedaway swiftly, silently  
 Like a magic craft,  
 Without oars, without labor."*

## Speedaway

*Detachable*  
**Rowboat Motor**

hooked onto the stern of your rowboat converts it into a Motorboat that spins along at the rate of

**8 to 10 Miles an Hour**

Multiplies the pleasures of the Summer vacation; a boon to the hunter or fisherman; a pleasure-giver for the whole family every comfortable day in the year.

The Speedaway is a complete two-horse-power gasoline motor and propeller, built from superior materials in a workmanlike manner and beautifully finished.

Underwater exhaust (part of the equipment, and not an "extra") makes it noiseless.

Its self-locking tiller leaves both your hands free.

Carries like a satchel, slips onto stern of boat in two minutes without tools.

Any boy or girl old enough to be trusted on the water can operate it.

Send for Catalog

**SPEEDAWAY BOAT MOTOR CO.**

(Owned and controlled by the Hoefler Mfg. Co.)

165 Chicago Street

Freeport, Ill.



## HUNTERS—TRAPPERS

If you want an ideal lamp for night fishing, trapping, hunting or for work about farm or machinery, send to-day for a



At all dealers or by mail prepaid, \$1.00

## BALDWIN LAMP

Projects a 14 candle power light 150 feet. Burns Acetylene Gas. Weight 6 oz. Height 3½ in. Can be carried in hand or worn on cap or belt, leaving both hands free. No oil, soot or glass. Absolutely safe and simple. Fifty hours' bright light costs 25c. Useful as well during Automobile repairing. Catalogue free and instructive booklet, "Knots and How to Tie Them" mailed on request.

**JOHN SIMMONS CO., 162 Leonard St., NEW YORK CITY**

## VIM MOTORS

5 to 55 h.p. 3 kinds.  
 Speed—Regular—  
 Heavy Duty

Strong, neat, simple—absolutely dependable. Wins your enthusiastic confidence. Accessible. Built to last a life time. Heavy brass fittings. Non-back-firing. Double ignition.

**VIM MOTOR CO.**



1, 2, 3 and 4 Cylinder  
 Use Gasoline or  
 Kerosene

Your boat will provide exhilarating and healthful recreation — equipped with a VIM. It's the old boatman's choice. Read 27 reasons why in "Boating Facts" — our new free book.

**103 Water Street  
 SANDUSKY, OHIO**

## THE SPEEDY STITCHER

SEWS LEATHER LIKE A MACHINE

Price \$1.00



Send for terms to Agents

**Automatic Awl Co., 26 Hermon St., Worcester, Mass.**

IF IT ISN'T  
**AN EASTMAN**  
 IT ISN'T A KODAK

**\$54.75** Freight  
 Paid

## L. A. Rowboat Motor

— a brand new member of the famous L. A. family. The fruit of 8 years' marine motor experience and sold direct from factory on

**30 DAYS' FREE TRIAL**

The popular outboard style of motor is now, for the first time, offered for sale at a popular price. You can enjoy all the pleasures of motor-boating this summer — such a summer as you never had before. The L. A. is light as the lightest, strong as the strongest, with many exclusive refinements. It drives a rowboat 8 miles an hour, or slow enough to troll. Instantly attachable — instantly removable.

**Order Today**, sending \$54.75, and motor will be sent back at our expense if unsatisfactory. Fully guaranteed.

Send for L. A. catalog and post yourself on this popular motor at a popular price.

**LOCKWOOD-ASH MOTOR CO.**  
 336 Horton St., Jackson, Mich.

**Save The  
 Dealer's  
 Profit**



# A Family Launch At Trifling Cost

If you have a row boat—or can rent one—you can have a reliable little family launch at a trifling cost. You can glide over lake and stream at will—just like the bigger launches and all you have to do is sit and steer your

## Caille Portable Boat Motor

It attaches to any square or pointed stern row boat by simply turning two thumb screws. Develops 2 h. p. and weighs but 55 lbs. Steers with a rudder, like any launch—not by the propeller. The rudder is of our folding, stone-dodging type (Pat. applied for). Weedless propeller is protected by a substantial fin. Motor can be easily adjusted to any angle or depth of stern. Starts with half a turn of the fly wheel. Drives row boats 7 to 9 miles an hour. Can be used in salt or fresh water. Fully guaranteed. Send today for beautiful catalog.

### We Also Build

marine engines from 2 to 30 h.p., in 1 to 4 cylinder designs for both pleasure and work boats. If interested ask for our Marine Motor Blue Book.

Caille Perfection Motor Co.,  
1418 Caille St. Detroit, Michigan

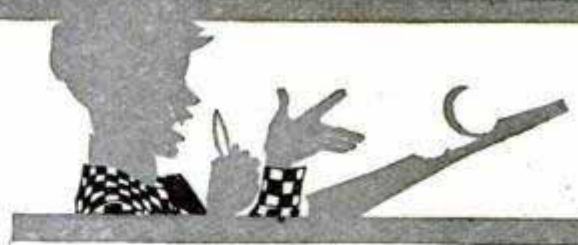

## Ouch! It slipped!

Teach your boy the danger of cuts becoming infected. Germs are everywhere. They may enter through the tiniest break in the skin. The safe way is to paint the hurt with

# New-Skin

It kills germs and protects the skin. Always have it handy.

10c and 25c, at druggists. The genuine has our name on the box. Home Size by Parcel Post for 25c in stamps. Address Dept. L, Newskin Co., N.Y.



When you need it, you need it badly

### GET THIS CATALOG

FULL OF VALUABLE INFORMATION TO EVERY BOAT OWNER ON

RACING PROPELLER WHEELS,  
REVERSE GEARS AND  
MARINE ACCESSORIES

LARGE CATALOG FREE. SEND TODAY

MICHIGAN WHEEL CO.

1139 MONROE AVE. GRAND RAPIDS, MICH.



## Toledo MARINE MOTORS

"Nothing Cheap but the Price"

3 H. P. 1 cyl. complete	\$ 65.00
6 H. P. 1 " "	84.00
6 H. P. 2 " "	125.00
12 H. P. 2 " "	160.00
18 H. P. 3 " "	250.00

Fully guaranteed by a responsible concern. 2 cycle, 2 port, 2 1/2 x 3 1/4 and 4 1/2 x 4 1/4. Send for free catalog "C."

THE UNIVERSAL MACHINE CO., Pike Ave., Bowling Green, O.



NONE BETTER

## \$130 The Greatest Motor Boat For The Money Ever Built

MULLINS 16 foot special steel launch affords the pleasures of motor boating, and provides a safe, seaworthy, dependable motor boat, with graceful lines and beautiful finish—**Absolutely Guaranteed Against Puncture**—Safe as a life boat, with air chambers concealed beneath decks in bow and stern—Can't warp, split, dry out or rot—No seams to calk—No cracks to leak.

MULLINS \$130 Special Launch is equipped with 2-Cycle, 3-H. P. Ferro engines, that can't stall—Speed 8 1-2 to 9 miles an hour—One man control—Fitted with MULLINS silent under-water exhaust.

This 16 footer seats 8 people comfortably—has 4 foot beam and 11 foot 4 inch cockpit—Positively the greatest launch value ever offered. Write today for beautifully illustrated motor boat catalog, containing full particulars.

THE W. H. MULLINS COMPANY  
151 Franklin St. Salem, Ohio, U. S. A.  
THE WORLD'S LARGEST BOAT BUILDERS



MULLINS STEEL BOATS CAN'T SINK

# FREE



Yes, we will send you a genuine Lachnite Gem for you to wear for 10 full days absolutely free. This is the most astounding jewelry offer ever made. See a genuine Lachnite for yourself. Wear it for 10 days. Then if you can tell it from a genuine diamond send it back at our expense. They are cut by the world renowned diamond cutters of Europe and their dazzling fire last forever. A superb gem set in solid gold. Write today for our big new catalog.

## Open An Account

Don't save up your money for months and months before you wear beautiful jewelry. Open an account with us. Have all the genuine Lachnites and other handsome jewelry you want. Write today for the big new catalog. We trust you. No red tape. Your credit is good.

## Pay As You Wish

Just a small amount down. Take your time about paying for the rest. Your choice of any of the superb Lachnites and all sorts of other superb, elegant jewelry. All at the rock bottom price. Astounding prices never equalled before. Pay as you are able. The most liberal of terms. Get the free book that tells you all about it. Write today—now.

## Free Book—Write Today

Do not delay an instant. Put your name and address on a postal or a letter and send it in to us at once. We'll send you our big new catalogue of air tant jewelry absolutely free. Find out about genuine Lachnites. Find out how you can wear one of these superb gems for 10 days absolutely free. Do not delay an instant. Send in your name and get the big new jewelry book absolutely free.

HAROLD LACHMAN CO.  
Dept. 1193, 12 N. Michigan Ave., Chicago, Ill.



# Ask For "Champion" Priming Plugs



Open needle valve slightly (you needn't remove glove) and inject gasoline. Passing through its own channel to plug base, it vaporizes directly at spark point.

New steel needle valve hardened and ground to a perfect compression tight seat.

They start any motor—in any weather—on first quarter turn. Don't accept a substitute.

The "Champion" is not a pet cock priming plug. It has a steel needle valve which opens easily for priming, and is compression-tight when closed.

It is the only priming plug in which the gasoline flows down a separate channel, in the plug's shell.

That's why there is no danger of breaking the porcelain if you get the genuine "Champion."

The gasoline used for priming is liberated where it makes perfect ignition without "sooting up" the porcelain or the firing points.

Make no mistake. See that the name "Champion" is on the porcelain.

**Champion Priming Plugs** for Motor Car, Motorcycle, Motor Boat or other motors, \$1.25 each.

If your dealer is not ready to supply you with **Champion Priming Plugs**, don't delay. Remit to us in any safe, convenient form for the number of priming plugs you need and we will send them to you—guaranteed and prepaid—the day your order is received.

(Licensed under the Canfield Patent No. 612,701, October 18, 1898)

**Champion Spark Plug Co., 405 Avondale Ave., Toledo, Ohio**  
 F. D. STRANAHAN, Treasurer R. A. STRANAHAN, President



## Morgan Gas Lighter

Agents wanted everywhere to handle this Specialty. **LARGE PROFITS** Increasing Demand. Send for Territory and Sample.

B. MORGAN, Bellevue St., Newport, R. I.

**OIL-BURNING CREMATORY FOR CANAL ZONE**  
 —Such a crematory will soon be built by the United States government, at Ancon, according to Engineering News. It is stated that the contract includes the construction of two retorts, each equipped with burners, placed side by side. They are required to be free from smoke, noise, or odor, and complete incineration must take place in two hours.



Rider, be our representative in your town. **EARN \$40.00 PER WEEK.** Get our **FREE CATALOG** and compare prices with your local dealer. Introduce our electric bicycles and our wonderfully improved everlasting puncture proof tires \$10.00; Sample pair \$5.00. Guaranteed one year. **Park Row Motorcycle Co.,** Dept. A31, No. 36 Vesey St., New York  
 Largest Eastern Supply House



## \$40 Motorcycle

We have the largest line of new and used Motorcycles in the country at the lowest prices. We also have a thoroughly equipped repair department and are in position to furnish repairs for any machine. Send us your machine to be overhauled. We pay cash for second hand motorcycles. *Send for Catalog.*

**HARRY R. GEER CO., 888 McLaran Ave., ST. LOUIS, MO.**



## AUTO HEEL REST

USED ON ALL CARS FOR BRAKE, CLUTCH AND GAS PEDALS.

Four Heights, 1/2, 1, 1 1/2, 2 in. **75 CTS. POSTPAID**  
**LUCAS & SON, Bridgeport, Conn.**

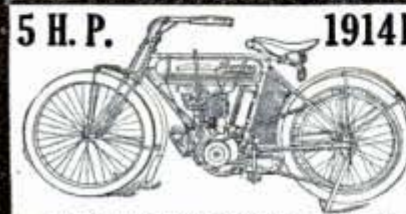

## 5 H. P. 1914 Peerless Motorcycle

With Free Engine Idler and Bosch Magneto, together with the best there is in motorcycle construction—Power, Silence, Endurance, and those Wearing Qualities so essential for low cost of maintenance. **5 MILES FOR ONE CENT**  
 Agents Wanted—Liberal Discounts

**PEERLESS MOTORCYCLE CO., 179 Huntington Ave., BOSTON, MASS.**

**YOU CAN NOW GET**  
**Diamond Automobile Squeegee Tread Tires**  
**ON YOUR MOTORCYCLE OR BICYCLE**  
 You have exactly the same tire problems as the automobilist. Realizing this, we have built for you a tire made of the same Vitalized Rubber, the same fabric, the same principle of construction, and built in exactly the same manner as the automobile tire. Diamond Vitalized Rubber Motorcycle Tires are made with the Squeegee or Studded Tread and Perfect 3-Point Rim Contact; also the "More Mileage" Strip on the tread, an exclusive Diamond feature. They "won't slip—won't slide—won't skid—but grip and hold."  
**YOUR DEALER CAN SUPPLY YOU**



## RANGER BICYCLES

Have imported roller chains, sprockets and pedals; New Departure Coaster-Brakes and Hubs; Puncture Proof Tires; highest grade equipment and many advanced features possessed by no other wheels. **Guaranteed 5 yrs.** direct to you are less than others ask for cheap wheels. Other reliable models from \$12 up. A few good second-hand machines \$3 to \$8.

**10 DAYS' FREE TRIAL** We ship on approval, freight prepaid, anywhere in U.S., without a cent in advance. **DO NOT BUY** a bicycle or a pair of tires from anyone at any price until you get our big new catalog and special prices and a marvelous new offer. A postal brings everything. Write it now. **TIRES, Coaster-Brake Rear Wheels, lamps, parts, sundries, half usual prices.** Rider Agents everywhere are coining money selling our bicycles, tires and sundries. Write today.  
**MEAD CYCLE CO., Dept. T108, CHICAGO**

# \$250.00 A MONTH REPAIRING TIRES

Be first to enter this new big paying business in your town. Open your pockets. Let the dollars pour in. Act quick. Automobile business growing fast. Each Auto Sold Means More Tires to Mend. Enormous field for tire repairing. Punctures and blowouts are common. Tires need retreading and vulcanizing. Something going wrong all the time. Thousands forced to buy new tires because they can't get old ones fixed. Think of the old bicycle days—repair shops on every corner—all making money—busy day and night. Autos make same proposition over again—only ten times bigger and better. Users of Haywood Tire Repair Plants are making big money. Johnson, Tex., writes, "I made as high as \$18 profit in a day." Another man who bought a plant September, 1911, writes he has cleared over \$3,000.00. Be the first to start. Experience unnecessary. You learn quick. Simply follow directions. Business comes fast and easy.

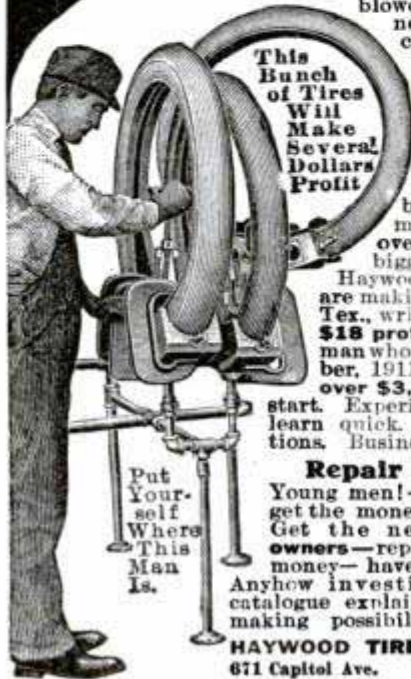

This Bunch of Tires Will Make Several Dollars Profit

Put Yourself Where This Man Is.

**Repair Tires at Home**  
Young men!—repair father's tires—get the money he pays garage man. Get the neighbors' work. **Auto owners**—repair your own tires—save money—have outfits for home use. Anyhow investigate. Send today for catalogue explaining wonderful money making possibilities in this field.

**HAYWOOD TIRE & EQUIPMENT CO.**  
671 Capitol Ave. INDIANAPOLIS, IND.

# Factory Price Saves You \$25 or More



Every style of vehicle and harness for every purpose of pleasure and business. Many new styles and big improvements in 1914 line. 40 years of success selling direct proves quality and big savings.

## Large New Book FREE

Handsomely illustrated. Let us send you a copy and quote prices that will surprise and please.

**ELKHART CARRIAGE & HARNESS MFG. CO. Elkhart, Ind.**

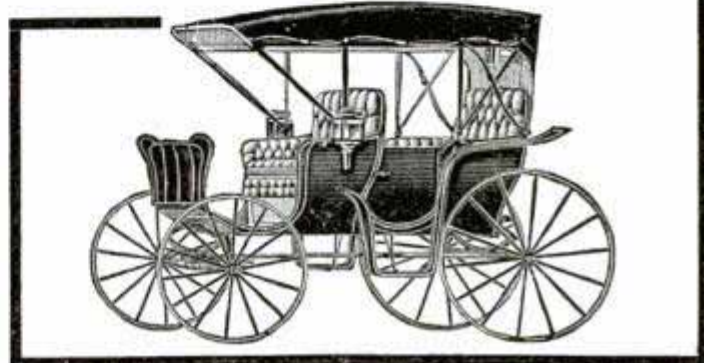

# Garage \$49.50

Genuine "Edwards." Ready-made, fire-proof garages. Quickly set up any place. Direct-from-factory prices—\$49.50 and up. Postal brings illustrated 64-page catalog.



**THE EDWARDS MFG. CO., 320-370 Eggleston Ave., Cincinnati, Ohio**

## DON'T DRINK GERMS

Avoid Typhoid, dysentery and kindred ills by using the

### Crystal Water Filter

Anyone can instantly attach it to the ordinary kitchen faucet without expense. Price only \$3.50. The most expensive is not better. Will last a life time. Agents Wanted, Men or Women, wherever city water systems are established. No experience or talking needed, will sell as fast as demonstrated. **Crystal Filter Co., 1009 S. S. Wabash Ave., Chicago, Ill.**



## Solar Motorcycle Lamps

are the neatest looking, strongest and most efficient lamps made. The product of light specialists, makers of 90% of the automobile lamps used on the high grade cars of America. Catalog shows many styles—gas, oil and electric. Write for it today.

**BADGER BRASS MFG. CO.**

Kenosha, Wis. New York City, N. Y.



# Motorcycles EXCELSIORS

State Distributors for  
Everything for the Motorcycle

**Harry Svensgaard Sales Corporation**  
471-473 Woodward Ave. Detroit, Mich. Telephone Grand 671

# MAKE YOUR BIKE A MOTORCYCLE

at a small cost, by using our attachable outfit. Fits any Bicycle. Easily attached. No special tools required.

Mr. Collins of Kentucky writes:

"Motor Attachment received O. K. and I cannot say too much for it's SHAW 2 1/2 h.p. motor. If I could not get another, \$100.00 would not take it off of my frame. It is the attraction of the road. Last Sunday I rode it about 20 miles with no trouble at all. Also, pulled a hill 1 mile long on trip with all ease."



**FREE BOOK** Write today for bargain list and free booklet, fully describing the SHAW Bicycle Motor Attachment. Motorcycles all makes, new and second-hand, \$35.00 up.

**SHAW MANUFACTURING CO.**  
Dept. 6 GALESBURG, KANSAS

Please Mention Popular Mechanics

# \$5.00 and You Keep This SUPERB BAADER Violin

An exquisite instrument—made by the Master Violin Maker Adolph Baader IV. Yours for only \$5.00 down. Pay the balance at the rate of only 10c a day. These superb instruments are made in the renowned Mittenwald shops. Each bears the name of the maker.

Generous allowance for old instruments

**WURLITZER**  
250 page catalog on request

Write today for our big new 250 page Band catalog. Your choice of 2,561 instruments shipped on free trial. All at the rock-bottom direct-from-manufacturers' price. Pay for them at a rate of only a few cents a day. We supply the U. S. gov't. The catalog is free. **RUDOLPH WURLITZER CO.**  
E. 4th St., Cincinnati, O. Dept 1193 S. Wabash Ave., Chicago



The



## Duplex Coaster Brake

doubles the pleasure of bicycling.

Going down hill your feet are at rest on the pedals—not forced to follow them around and around in a tiring grind.

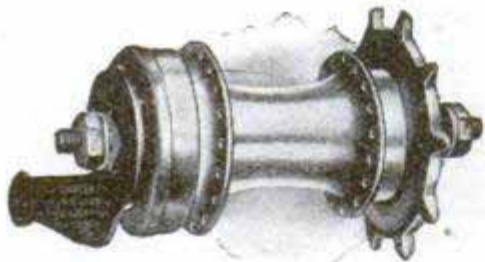

And the wheel is under your complete control at all times—in crowded streets—when coasting down the steepest hills.

You stop it gradually or instantly as you choose.

*"Corbin Control Means Safety Assured"*

Sold and equipped by bicycle and hardware dealers everywhere

Write for new 1914 Catalog

**THE CORBIN SCREW CORPORATION**

The American Hardware Corporation, Successors

201 HIGH STREET

New Britain Conn.



Please Mention Popular Mechanics

# Prest-O-Lite



## The Only Practical Light for Motorcycles

Prest-O-Lite is the only lighting system that makes night riding possible, pleasant and SAFE.

This ready-to-use gas costs no more—usually costs less—than the carbide a generator consumes.

The first cost is low [\$10]. Prest-O-Lite never gets to be second-hand, and is always a READY CASH ASSET.

You can easily afford it. You cannot afford to be without it if you ride at night. One accident might cost you more than years of Prest-O-Lite service.

Easily attached to any motorcycle. We will arrange for immediate exchange service for anyone, anywhere.

**DON'T ACCEPT AN IMITATION!**

The genuine Prest-O-Lite, when empty, can be immediately exchanged for a full one, ANYWHERE AND ALWAYS. Imitations cannot.

Ask for our free book on ALL lighting systems.

THE PREST-O-LITE CO., Inc., 265 Speedway, Indianapolis, Ind.

Contributor to Lincoln Highway

Branch offices and Service Stations in all principal cities. Charging plants in all parts of the country.

Exchange Agencies Everywhere

## DIRECT FACTORY SALE

### THE WARREN MOTOR CAR COMPANY

are closing out all surplus stock of new auto parts at prices that demand quick sale:—

\$ 1.00 Spark Plugs.....	\$ .19	Anything else? We have it.
150.00 Full Floating Rear Axles.....	50.00	
30.00 Front Axles.....	12.50	
50.00 Pressed Steel Frames—all sizes...	10.00	
100.00 Auto Bodies.....	30.00	
60.00 Radiator—many sizes and styles	15.00	
100.00 Magnetos.....	35.00	
8.00 Iron Vises.....	3.19	
15.00 Electric Horns.....	3.98	
5.00 Complete Tool Kits.....	1.09	
50.00 Steering Gears.....	12.19	
10.00 Gasoline Tanks—square.....	1.00	
18.00 Oval and Round Tanks.....	3.00	

Send for a Big Bargain list of new goods being sold at this sale. Get on our mailing list. Hundreds of other automobile parts and accessories are shown on our Big Bargain Sheet of goods sold at this sale. Write for this quick.

WARREN MOTOR CAR CO., 64 TENTH STREET DETROIT, MICH.

## WATER SAVING DEVICE



Eureka Self Closing Nozzle for washing Automobiles, Carriages, etc. A button operated self closing nozzle, designed for use in Garages, Stables, etc. Water is shut off when hose is dropped. Rubber cover to prevent scratching of any part of vehicle body with which it may come in contact. Has a flexible rubber tip for spraying purposes. Write for descriptive pamphlet.

GEO. GROSSELFINGER, 83 Water St., New York

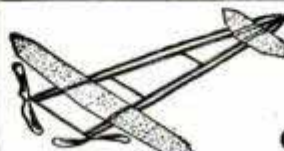

1914 Champion Racer

Designed by Harry Schultz  
Model Editor of Aeronautics  
You build it . . . \$2.50  
We build it . . . \$7.50

## MODEL AEROPLANES

Complete handbook of Models and Supplies Free on Request.

WADING RIVER MFG. CO.

WADING RIVER, N. Y.

# PATENTS

If you have an invention which you wish to patent you can write fully and freely to Munn & Co. for advice in regard to the best way of obtaining protection. Please send sketches or a model of your invention and a description of the device, explaining its operation.

All communications are strictly confidential. Our vast practice, extending over a period of nearly seventy years, enables us in many cases to advise in regard to patentability without any expense to the client. Our Hand-Book on Patents is sent free on request. This explains our methods, terms, etc., in regard to **Patents, Trade Marks, Foreign Patents, etc.**

All patents secured through us are described without cost to the patentee in the **SCIENTIFIC AMERICAN**.

**MUNN & COMPANY**  
SOLICITORS OF PATENTS

359 BROADWAY, NEW YORK  
and 625 F STREET, WASHINGTON, D. C.



## HOW TO IRON

Marvelous invention in flat irons. The Sette Self-Heating Sad Iron does work of two irons at less cost—less

labor—less time than one. Send for useful book, "How to Iron."

Agents  
Write Quick

**Book Free** Book "How to Iron" post paid free. Every woman should have it. Book for agents FREE. Get this book and all particulars and our special low price. **WRITE TODAY.**

**SETTE MFG. CO., Dept. 5247, Kenosha, Wis.**

## RIDER AGENTS WANTED

in each town to ride and exhibit sample 1914 model. Write for Special Offer. Finest Guaranteed 1914 Models **\$10 to \$27** with Coaster-Brakes and Puncture-Proof Tires. 1912 and 1913 MODELS **\$7 to \$12** ALL OF BEST MAKES.....

**100 Second-Hand Wheels** All makes and models, good as new Great Factory Clearing Sale. **\$3 to \$8**

We Ship on Approval without a cent deposit, pay the **10 Days' Free Trial** freight & allow

**TIRES** coaster-brake wheels, lamps, and sundries, half usual prices. **DO NOT**

BUY till you get our catalogue and offer. Write now. **MEAD CYCLE CO. Dept. 7108 CHICAGO**



## BASEBALL OUTFIT FREE



**BOYS!** Here is your chance to get a fine baseball outfit, consisting of complete suit, including shirt, pants, cap and belt, good quality, extra well sewed, or combination of big catcher's mitt, fielder's glove, catcher's mask (extra strong and durable) and rubber center ball, big league style, or fine chest protector. **Will Not Cost One Cent.** Send your name and we will send you 8 set of our fine pictures to dispose of at 25 cents each. Send us the \$2 you collect and for your trouble will send you outfit as described. **WRITE TODAY** for pictures. No harm done. I take back what you can't sell.

**M. O. SEITZ 3M159 Chicago**

# Now \$15.20 Less

This \$35.00 Set—Now \$19.80

This is one of the greatest book offers ever made. Read it carefully—then investigate. Here's your chance to obtain the famous **Steam Engineering Library**, the work of 27 of the biggest and best known engineering experts in America, at a simply phenomenal price. The regular \$35.00 edition for a short time at \$19.80 complete—\$2.00 a month. Not only do you save almost half by getting these books now, but you can buy them on the most liberal of easy payment plans.

Every beginner, as well as the experienced stationary, locomotive or marine engineer, should own these books. Every section, every page, every line, is full of practical, up-to-date information just suited to your needs. This wonderful work will give you a knowledge of steam engineering and gas engine operation that cannot be obtained from any other set of books, and will pave the way to a better job and bigger pay.

## Cyclopedia of Steam Engineering

Contains 3,300 pages, 7x10 inches, 2,500 illustrations, full page photographs, plates, folding maps, diagrams, etc.; hundreds of valuable tables and formulas, carefully cross-indexed for quick, easy reference. Printed in large, clear type on special quality paper and bound in half red morocco, gold stamped.

### What These Books Cover

Construction of Boilers—Boiler Accessories—Fuel Economizers—Mechanical Stokers—Steam Pumps—Steam Engines—Indicators—Valve Gears—Steam Turbines—Gas and Oil Engines—Fuels—Automobiles—Carburetors—Locomotive Boilers and Engines—The Air-Brake—Single-Phase Electric Railway—Elevators—Marine Boilers—Marine Engines—Heating and Ventilating—Compressed Air—Transmission—Absorption and Compression—Refrigeration—Ammonia Machines—Direct Current Dynamos and Motors—Management of Dynamos and Motors—Electric Wiring—Electric Lighting, etc.

## Shipped Free

Examine this great work before you send a penny. Merely on receipt of the attached coupon we send you the complete seven volumes, express prepaid. Look them over for a whole week. Test them on some problems that have been bothering you. Then if you decide you want the set, send us \$2 within seven days after receipt and then \$2 a month until you have paid the introductory price of \$24.80. Otherwise tell us and the books come back without a penny of expense to you. But remember—it may be your last opportunity to get these famous books at this specially reduced price.

## Free Consulting Service

Besides the practical value of the library itself, you get a year's Consulting Membership free as a holder of these books. Our staff of expert engineers takes up and solves your problems and special difficulties, absolutely without cost to you. This privilege, which regularly sells for \$12, is yours for a full year free, if you take the Cyclopedia. To find out how useful these books will be to you, you must see them. It costs nothing to look the set over. It does not obligate you in any way. We stand ready to take the books back without expense to you, if you are not pleased with them. Get the books. Examine them. Then make your decision.

## FREE COUPON Worth \$15.20 to you

**American Technical Society, Chicago, U. S. A.**

Please send me Cyclopedia of Steam Engineering for 7 days' free examination. If I decide to buy, will send \$2 in 7 days and balance \$2 a month until \$19.80 has been paid, when \$35 books and \$12 Consulting Membership will be mine. Otherwise will no if you and hold books subject to your order. Title not to pass until fully paid. Pop. Mech. 3-14

NAME.....

ADDRESS.....  
As I have had no previous dealings with you, I refer you to



# \$1200.00 IN COLD CASH

Made, Paid and Banked in 30 Days, by  
Stoneman—\$15000.00 To Date

Reader, this offer is open to you—this money—the cold cash—can be yours. You and you alone by waiting too long can lose it. Investigate today—get the proof. Send your name and address—but **NO MONEY**—this very minute.

## \$1000.00 PER MAN PER COUNTY

Don't worry—don't find excuses—no experience is necessary—business supplies the capital. You don't have to wait a month not even a week—payments can start the first day—and continue daily up to \$1,000.00 per month, per county. For years we have been quietly picking men from all walks of life: ministers, clerks, farmers, preachers, doctors, lawyers, teachers and so on—enabling them with our co-operation and \$50,000.00 appropriation to get what we here offer and can do for you—\$1,000.00 per man, per county. Some of these men you may know—possibly have envied without understanding the reason of their prosperity.



**INVESTIGATE AND BE AMAZED** Demand absolute proof—accept no other kind. Either we have the best thing that ever happened or we're colossal liars. Ask Schleicher, minister, whether it's true that he received

## \$195 TWELVE HOURS AFTER APPOINTMENT

Langley, liveryman, \$115 first day; Rasp, agent, \$1,685 in 73 days; Beem, solicitor, \$164.25 weekly for 12 weeks; Korstad, farmer, \$2,212 in a few weeks; Zimmerman, farmer, \$3,856 in 30 days; Juell, clerk, \$6,800; Hart, farmer, \$5,000; Wilson, cashier, \$3,000 in 30 days. Let us refer you to these men, to the U. S. government, to banks, business houses, noted people at home and abroad. Heed this caution from Chas. Starr, of Mich., who writes: "Sorry this field is closed. Should have acted sooner but was skeptical. Your local man's great success has set everybody talking and proves I was a chump. Wonderful what a man can do with a real opportunity." Then read this from Lodewick who acted quickly: "Lucky I answered ad. It's great. Money coming fast." Which will you be, Starr, a victim of "neglected opportunities," or Lodewick, the "early bird." To escape Starr's fate, send your postal this very minute—

## SPEND ONE CENT TO MAKE THOUSANDS

Strange invention startles world. Gives every home that long-desired blessing, a modern bathroom with hot and cold running water facilities for only \$6.50. No plumbing—no water works—self-heating. Only ten minutes to install. Gives cleansing plus friction, massage and shower baths in any room. Equivalent to any \$200 bathroom. Over 200,000 delighted users. Used by U. S. government. More remarkable than this invention is our startling plan of universal distribution through special representatives who become virtually profit sharing partners in a business that's immense—exciting—fascinating—dignified—and above all, has enabled them, will enable you, to get \$1,000.00 per month, per county. Asking to be shown doesn't obligate you one bit. Investigate today by all means.

ALLEN MFG. CO., 3863 Allen Bldg., TOLEDO, O.



**EVERYTHING** in Guaranteed Plumbing and Heating Supplies at wholesale. Our \$200,000 establishment behind our Guarantee. Send 20c for complete CATALOG 61, to be refunded on 1st order. J. HARDIN CO., 30 years at 4533-35-37-39-41-43 Cottage Grove Ave., CHICAGO

## POWERFUL AIR RIFLE

Length '32 inches. Working parts of the best grades of steel. The stock is finely polished walnut. Shoots small game. Powerful, accurate, durable. You can have this air rifle for distributing only 8 of our fast selling art pictures at 25 cents on our special offer. Everybody will take one. **IT COSTS YOU NOTHING** to try, as we take back those you can't dispose of. Send no money, just your name and address. **M. O. SEITZ, 3D159, CHICAGO**

## No Local Dealer Can Sell You This Chair For Less Than \$18.00

## Our Price Is Only \$9.75

Height 36 ins.—Width 30 ins.—Depth 24 ins.

We are able to save you this money because our sectional method, of which we are the originators, enables us to reduce costs. All our furniture is **SHIPPED IN EASILY ASSEMBLED SECTIONS—PUT TOGETHER IN A JIFFY BY ANYONE!** We are the manufacturers! Own the largest plant of its kind in the world. Not a mail order house or jobber or wholesaler. Our sectional method saves  $\frac{1}{4}$  the packing cost,  $\frac{1}{4}$  the freight and  $\frac{1}{2}$  the factory floor space usually required! There you have the reason why you should secure

## Master-Built Furniture Direct from the Factory —No Middlemen



It means not only the best of furniture in your house but also money in your pocket.

## Our Free Book Is Awaiting You!

It shows scores of styles of superbly designed furniture—all obtainable at our factory prices. Write for it.

**Brooks Mfg. Co.**  
2703 Rust Ave.  
Saginaw, Mich.



## LEARN SHOW CARD WRITING

**A FREE OFFER** We have contracted for a limited number of a complete course in Show Card Writing and lettering which we will give absolutely free to purchasers of an assortment of our colors; to introduce. Address: Alpha Color Co., 2050 Amsterdam Ave., N. Y. City



## Ten Days' Free Trial

allowed on every bicycle we sell. We Ship on Approval and trial to anyone in the U. S. and prepay the freight. If you are not satisfied with the bicycle after using it ten days, ship it back and don't pay a cent.

**FACTORY PRICES** Do not buy a bicycle or a pair of tires from anyone at any price until you receive our latest Art Catalog of high grade bicycles and sundries and learn our unheard-of prices and marvelous new special offers.

**IT ONLY COSTS** a cent to write a postal and everything will be sent you FREE by return mail. You will get much valuable information. Do Not Wait; write it NOW!

**TIRES, Coaster-Brake, rear wheels, lamps, parts, repairs and sundries of all kinds at half usual prices.**  
**MEAD CYCLE CO. Dept. T108 CHICAGO**



## Flash Like Genuine DIAMONDS

at 1/50 the cost—IN SOLID GOLD RINGS  
**WHEN YOU BUY A BARODA**

do not think of it as an imitation diamond; think of it as it is—A Genuine Mined Gem with a hardness, lustre and environment that classes it with a genuine diamond. It answers every quality you require—brilliantcy, lasting qualities, hardness and perfect cut—so let us send you one of these bargains O. O. D. returnable in 3 days, if unsatisfactory. Ladies' Tiffany style 14 K Solid Gold ring, 1 carat stone, \$5.98, Men's ring, \$6.98, stud or pin, \$4.98. Our catalogue shows full line. Enclose 10c for ring measure.

**BARODA CO., Dept. J5, 4711 N. Clark St., CHICAGO**

## FREE







New York's Latest  
**MEN'S  
STYLE BOOK**  
Send for it  
It's FREE

Men everywhere like to know exactly what the best dressed business men of New York are wearing. The Glen Rock Style Book tells you—tells you as well as a visit to New

York. Page after page of men's fashion ideas. But this will interest you most—this booklet contains handsome Fashion Plates and 40 sample pieces of the very woollens which New York men consider "the thing" this very minute.

So much for style. Have you ever worn a Glen Rock suit or overcoat? If you have you know that the fit is perfect. You know that every detail of tailoring is most expertly done. You must know that every Glen Rock garment is made from good material for garments which give such long wear as "Glen Rocks" do are made only of good materials. Prices all the way from \$10 to \$22.

Here's the "Glen Rock" plan. Every garment guaranteed a perfect fit and stylishly made. Because we sell to you direct (from the mill) we save you at least \$8.00 on every suit or overcoat. You see you save the retailer's profit. Get in on this plan. We save you money! We want to make you a friend of ours.

Send for FREE Book of Styles  
and 40 Patterns Today!

**Glen Rock Woolen Co.**  
219 Main Street, Somerville, N. J.

Imports of platinum into the United States in 1912 aggregated \$4,503,682 in value.



**Heralding a New Fashion—and Rainproofed!**

High-crown telescopes are decreed for Easter and Spring. "THE PLATEAU" is our exclusive model. Of spring-weight, RAINPROOFED cloth; silk-lined; leather sweatband. Four-inch crown, 2 3/8 inch flexible brim. Ventilating eyelets. Four colors: Dark Gray Check; Dark Brown Check; Dark Blue Check; Light Gray Check. Easily worth \$3. We charge \$2 PREPAID. Money back if you don't like it. Order now—simply state size and color and enclose \$2. Write for "1914 Spring and Summer Style Book"—FREE.

**FRENCH CO., PHILADELPHIA, PA.**

**BUY YOUR FURNACE  
\$10 DOWN \$10 A MONTH**



Our monthly payment plan of selling direct saves you the dealer's profits and charges for installation. The

**Jahant Furnace**

with the patented "Down Draft System" is best for residences, schools, hotels, churches, etc., because it delivers plenty of heat wherever and whenever desired at a saving of 1-3 to 1-2 in fuel bills. Install the Jahant yourself. We send complete outfit, freight prepaid with special plans, detailed instructions and all necessary tools for installation. Satisfaction guaranteed or money refunded.

Write for free illustrated book.

**THE JAHANT HEATING CO.**

168 Mill Street

Akron, Ohio

**Save 1/3 to 1/2 on Fuel Bills**

**Hot-Water  
Heating by the  
Andrews System**

Seven Rooms  
and Bath

**\$198**



**"Cut To Fit, Ready To Screw**

**Together"** During 13 years we have sold these systems in 2274 cities and towns of this country. Practically all of them were sold on our "cut-to-fit" method—plants built complete in our shop and shipped ready to screw together by any man handy with tools. As an assurance of satisfaction we give

**360 Days Free Trial**

**Guaranteed by Bond**

**ANDREWS  
Steel Boilers**

like power boilers. Burn less fuel of any grade.

The most economical and easily operated boilers made. Have double the heating surface of other boilers. Built of steel plate

**72-Page Heating Book FREE**

Write for this big book if you contemplate installing new heating plant in either new or old house. It explains our systems in detail and tells how we "cut-to-fit" so successfully. Contains valuable information about all kinds of heating.

WRITE TODAY

**ANDREWS HEATING CO.**  
1407 Heating Bldg., Minneapolis, Minn.

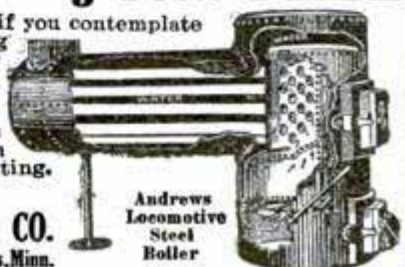

Andrews  
Locomotive  
Steel  
Boiler

**Like a clean china dish**

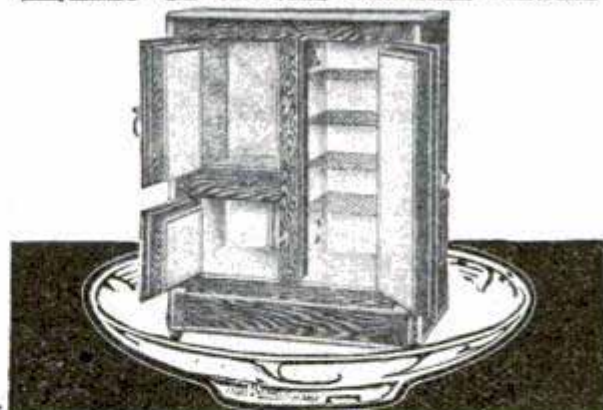

Superb Porcelain Lined—the delight of every woman's heart—the pride of every housekeeper. Here's that famous Refrigerator with the seamless, scratchless, dish-like lining, the genuine

**Leonard Cleanable**

Don't confuse this wonderful sanitary lining with paint or enamel. I will mail you—free—a sample of Leonard Porcelain that will quickly show you the difference. You can't scratch it even with a knife. It's everlasting—easily kept beautifully sweet and clean. You'll never be satisfied with anything else.

Style shown is No. 4, in polished oak case. Size 35x21x45 . . . **\$35.00**

**50 Styles, \$15.00 up; Freight Paid**

to Ohio and Mississippi Rivers. I take the risk; send for catalog today. Money returned if you are not perfectly satisfied. Ask for sample of porcelain and I'll mail my booklet, "Care of Refrigerators." Every woman should have a copy of this valuable book.

C. H. LEONARD, President

**GRAND RAPIDS REFRIGERATOR COMPANY**  
157 Clyde Park Ave., Grand Rapids, Mich. (1)

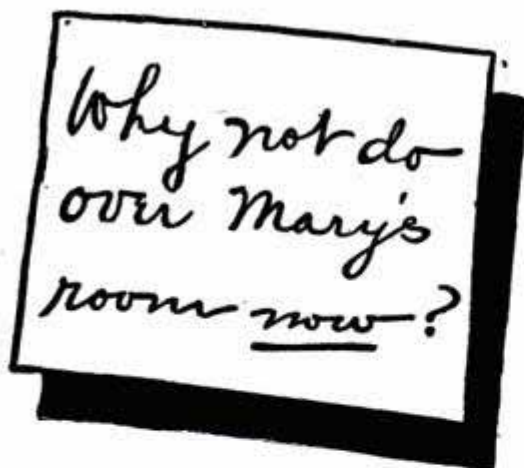

**F**OR a long time you've meant Mary to have a really, truly pretty room—a room she'd love and be proud of. You can make Mary's room—or any room in your home—a thing of beauty—economically, quickly with

## UTILITY Wall Board

Don't put up with the muss and dirt of lath and plaster. Cover your walls with Utility—long, clean strips of non-porous, moisture-proof fibre. Easily applied—never chips, checks or cracks; takes alabastine or flat tone paints and tints beautifully.

### Write for This Free Book

By all means, get this handsomely illustrated, free book "Artistic Interiors"; also free samples of Utility Wall Board. Write today.

## THE HEPPEES CO.

Mfrs. also of Flex-a-Tile Asphalt Shingles, Asphalt Paint and Asphalt Roofing in any Finish.

4516 Fillmore Street, Chicago, Ill.



start. Profits bigger and quicker. Anyone can do it. Women and children too. Now is best time. Send for free book. Bureau of Mushroom Industry, Dept. 119, 1342 N. Clark St., Chicago

## ABOUT MUSHROOMS

How to really make big money in mushrooms, is fully explained in the wonderful book, "The Truth About Mushrooms," a great revolutionary improvement, things many growers never knew before. Everything explained from A to Z, at first hand, from the greatest practical authority in America. Add \$10 to \$70 a week to your income. Demand exceeds supply. Grow in cellars, sheds, boxes, etc. Small capital to start. Profits bigger and quicker. Anyone can do it. Women and children too. Now is best time. Send for free book.

Now is best time. Send for free book.

Bureau of Mushroom Industry, Dept. 119, 1342 N. Clark St., Chicago

## MAKE \$25 A DAY BE YOUR OWN BOSS

\$750 and up



You can easily do it with our wonderful new invention. Every dime you take in, you make 80 net profit. The **DIAMOND POST CARD GUN** is a unique metal camera—takes official size post cards and button photos, 4 sizes, without the use of films, dry plates or dark room. JUST CLICK THE BULB AND DELIVER THE PICTURE—takes one minute—it's easy. BIG MONEY awaits you at Beaches, Parks, Fairs, etc. No experience needed. SEND FOR FREE ILLUSTRATED BOOKLET AT ONCE. International Metal and Ferrotyping Company 2230-B West 12th Street Chicago, Ill.

Please Mention Popular Mechanics

# Let Us Figure On Your Furnace

**Our Free Plans and Direct Factory Prices Will Help You Greatly No Matter Where You Decide To Buy.**

Expert heating engineers will draw detail plans to your special needs and quote exact cost on furnace with fittings—no obligation.

## Customers Everywhere To Refer You To

No Delay—No Freight to Pay—Satisfaction Guaranteed. And \$25 to \$75 saved. Cash or easy terms.

**WRITE for Catalog**  
Ask for No. 936

See the simple, practical, economical plan that is winning favor everywhere.

**KALAMAZOO STOVE CO.**  
Mfrs., Kalamazoo, Mich.

We make a full line of Ranges, Stoves, Furnaces, Metal Kitchen Cabinets and Gas Stoves. Mention catalog wanted.



This Book Saves You From \$25 to \$75

**A Kalamazoo Direct to You** And Gas Stoves Too  
Trade Mark Registered

## AGENTS WANTED

Fifty cents (in quantities) buys a full size compressed air clothes washer. Weighs only two pounds. Women grab it at \$1.50; 200% profit. Thoroughly cleans tub of clothes in three minutes. Washday no longer dreaded. Mrs. Marrick earned \$90 first three weeks. A 14-year-old Kansas boy made \$55.40 outside school hours during September. Send for catalog today and get your county right, which is free. Wendell Washer Co., 147 Oak St., Leipsic, O.

## \$100<sup>00</sup> to \$500<sup>00</sup> a month

Thousands making more. Exceptional opportunities. Get into the profession of Life Insurance Underwriting. We'll teach you at home during your spare time.

### POSITION ABSOLUTELY GUARANTEED

You start up the ladder to fortune the minute you graduate. Positions for all—paying big money. WRITE TODAY—for full particulars. No obligations. Don't delay an instant—Write now. National Insurance Bureau, Dept. 1193, Ft. Wayne, Ind.



## Convert Your Wheel Into a Motor-Cycle

Motor fits any wheel. BEST. MOST RELIABLE. Best Hill Climber. More STEFFEYS in use than any others. Send stamp for circulars. STEFFEY MFG. CO., Girard Ave. and 30th St., Phila., Pa.

## VELVATONE WOOD NEEDLES

### FOR DISK TALKING MACHINES

New Idea in Talking Machine Needles. Made of hard wood chemically treated. No fiber. Preserve and improve records with continued use. Give softer, smoother and much sweeter tone to the music. Self-sharpening. A single needle has played 30 records. Send name of your Talking Machine dealer for Free Sample, or 50c for full size package, enough to play over 1000 records. VELVATONE WOOD NEEDLE CO. DEPT. 1 KANSAS CITY, MO.

# Own a Factory like this You Can

We Built This Factory Paid For It In 3 Years

We will furnish Equipment Free

Here's a chance for any ambitious man or woman to get into a business that requires no experience and but very little capital (from \$50.00 to \$200.00.) We start you in your own town—furnish the tools free—teach you how to make canvas gloves—show you how to market them.

We do all this for you. Start your factory simply with the understanding that you buy your supplies from us so long as our prices are as low or lower than you can get elsewhere.

The demand for canvas gloves is enormous, everybody everywhere wears them—the farmer—mechanic—doctor—lawyer—laborer. Millions of canvas gloves are required yearly to supply the demand.

## Right in Your Own Locality is Your Market

Your surplus can be sold to jobbers and dealers whose names we furnish—you make money from the beginning—profits are immense—we borrowed the money a few years ago to start—beginning with two sewing machines. Today we own the factory pictured above.

You become in reality, a branch of the McCreery Mfg. Co. working independently—we furnish the raw material—you turn out the finished product—reap the big profits. You are not bound by any contract to buy from us—only a man to man agreement. That's all.

We tell you all about the business in our interesting booklet. Costs you nothing to learn about it. Your copy is now ready to mail to you. Write for it. It's FREE.

Write today for this book. Don't delay it. Only a limited number of equipments will be offered free.

McCREERY MFG. CO. 711 Dorr St. TOLEDO, O.



## Try This Genuine Optimo Shutter and Nacomat Anastigmat Lens

TEN DAYS FREE

Can be adjusted to any post-card size, plate or film kodak or camera. Don't send us a

penny. Merely your name and address, and we will send you this Genuine Optimo Shutter, operating from one second to 1/300th of a second. Also time and bulb stop. If it suits you, pay for it in eight monthly installments of \$5.00 each—\$40.00 in all. This is the cash price anywhere else. If you do not like it, simply return it at our expense. You take no risk.

NATIONAL CAMERA COMPANY  
1410 Chestnut St. ST. LOUIS, MO.



## WE TRUST YOU! Pay Us From Your Profits!

We start you in a business all your own—where you are sole Boss! We furnish everything necessary—you pay us later. The Filmless Post Card Camera takes 5 sizes of post cards; also photo buttons. A complete photographic studio in itself. Takes, develops, tones, and finishes right on the spot! No Films, Plates or Dark-room.

You Make \$50 to \$100 a Week Easy At Bathing Beaches, Parks, Fairs, Carnivals, etc. No experience needed. Nets you 8c profit on every dime. Send today for FREE particulars and get started at once.

FILMLESS POST CARD CAMERA WORKS  
2203B, W. 12th St., CHICAGO, ILL.



# FREE!

This Handsome Ford Automobile

—or a Thor Motorcycle! And a steady income of \$10 a day and up in just your spare time taking orders for Reliable Tailored-to-Order Clothes.

**Read Carefully!** If you will agree to act as the local representative for the famous **Reliable Made-to-Order Clothes**, we have a plan to equip you with a new, 1914 Model Ford Touring Car or Thor Motorcycle **absolutely free** and start you in a business which will **pay you \$10 and up a day** for just your spare time.

Here's how we can make this offer: The automobile or motorcycle multiplies your acquaintances—thus gets business. Distance doesn't tie you down—you make trips of 50 to 200 miles a day, see the country, enjoy the wonderful, joyous thrill of automobiling anywhere you want to go. We make our representatives the big people of their communities so they can do a big business and earn big profits both for themselves and us. No experience necessary—any live man can make good. **And you are your own boss all the time.**

## Send for Free \$10-a-Day Book

**Get Started Now!** Don't let anybody beat you to it. It's the most **Don't Waste a Minute!** amazing opportunity you ever had. A postal brings you our splendid big Book, **complete outfit**—samples, tape measure, blanks, full instructions—**everything free—at once.** **You can't lose**—but you must act quick—**Today!** Write

RELIABLE TAILORING CO., 958C, W. Jackson Boul., CHICAGO

## A POWERFUL ELECTRIC SEARCHLIGHT



## Do You Go Out Much Nights?

For safety always carry a powerful Niagara Searchlight in your pocket.

**5000 Only \$1** Positively a genuine Niagara Electric Searchlight, Mazda Lamp, Mazda battery, all metal case 7" long, throws strong, penetrating light over 200 ft., cannot be short circuited—the most recent development of modern science—For the garage, farm, barn—reporters, policemen, electricians, watchmen—in fact, if you're out at night at all, have one.

Sent Prepaid for \$1.00—most remarkable offer ever published—Act Quick—5000 only, then regular price of \$2.40—so don't delay. If not the most wonderful lamp you ever purchased—money back—our reputation is back of this, and that counts.

DEPARTMENT C

NIAGARA SEARCHLIGHT CO. NIAGARA FALLS N.Y.

MANUFACTURERS OF HIGHEST QUALITY HAND AND CAP SEARCHLIGHTS IN THE WORLD

## Big \$1 Offer—KEITH'S



80 page monthly magazine for 6 months with Keith's BOOK

### 100 PLANS

#### Bungalows—Cottages

Keith's Magazine is the recognized authority on building and decorating artistic homes. Each issue contains 6 to 10 Plans by leading architects. Subscription \$2. News-stands. Any one of Keith's Arch. Studies, giving authorized authority on building and decorating artistic homes, \$2

No. 1065—\$2200. One of the 100

Views, Costs, etc., FREE with a year's subscription to Keith's Magazine, \$2

Keith's Famous Plan 136 Plans of Bungalows 175 Plans estgr. below \$6000

Books, direct or thru 104 " Cottages 125 " over \$6000

Newsdealers, \$1 each 125 " estgr. below \$4000 100 " Cement and Brick

175 " 50 Garages, 40 Duplex & Flats \$5000

M. L. KEITH, 506 McKnight Bldg., Minneapolis, Minn.

\$2.95



## American Thin Model 20 YEAR Watch \$2.95

Special Closing-out Sale of American made watches. Send your name and address and we will send you by parcel post or express C.O.D. \$2.95 this elegant thin model 18 size for geants, 16 size for boys, open face, solid nickel silver screw back and bezel case, dust proof, with lever mechanism, jeweled expansion balance, hard enamel dial, stem wind and pendant set, will keep time equal to a \$15.00 watch, case and works guaranteed 20 years. **ORDER AT ONCE.** This sale for a short time only. Satisfaction guaranteed. Pay your postman or expressman. Address

# THIS MAN MADE \$1500<sup>00</sup> IN ONE MONTH WITH THIS MACHINE



This is a recent picture of the man who made \$1500 in one month with a Long Crispette machine, in a store window. After he got his machine he only had \$10 left, but he sailed in and made good.

## Make Your Fortune in 5 Cent Pieces

Think of the fortunes made in 5 cent pieces—street cars, moving picture shows, 5 & 10c stores, etc. It's the way to make money. Everybody will spend a nickel. Everybody likes crispettes—children—parents—old folks. One sale always means two—two means four. So it goes. It's a great business. I found it so—so should you.

Send for my Free Book "How to Make Money in the Crispette Business."

36 pages illustrated—complete information and story of how I built my business. Read it and then come to Springfield.

W. Z. LONG, 853 High St., Springfield, Ohio

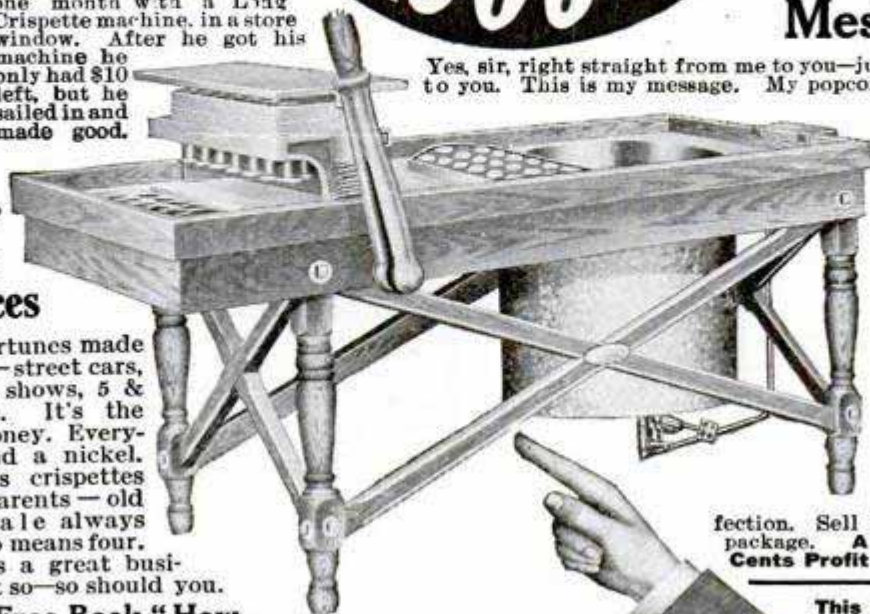

Yes, sir, right straight from me to you—just as if I were talking personally to you. This is my message. My popcorn crispette machine built a big store for me—a big confectionery business, right here in Springfield, on High Street. I have started a lot of other men in business. I want to start YOU. Just let a small store or a cozy nook where the rent isn't high, where people pass by and you're ready for business. The nickels will drop in almost like rain. Then later this summer you can make a lot of money at Fairs, Parks, Resorts, Carnivals, Circuses, Picnics, Conventions, on street corners, in small stands, moving picture lobbies, etc. Five machines at Coney Island, three at Atlantic City. Thousands of resorts haven't any. Crispettes are a new, delightful, crisp, popcorn confection. Sell for a nickel a package. **Almost Four Cents Profit in Each Sale.**

This Machine has made me and others wealthy. It will do the same for you.

This Machine has made me and others wealthy. It will do the same for you.



## Sell Automatic Gas Lighters

Lights any gas or gasoline. Guaranteed two years. Price 50c. Sells itself everywhere.



Handier, cleaner and cheaper than matches. Agents making BIG MONEY. Send 25 cents for agent's sample and start now to MAKE MONEY FAST.

STEEL STAMPING CO., 141 W. Austin Ave., CHICAGO



## AGENTS—KEYLESS PADLOCK 100% Profit

No keys to lose, no knobs to turn, no clicks to count. Press the buttons and it flies open. 40,000 combinations. Solid brass. No competition. L. Morton, Cal. "Sold first doz. in 3 hours. Have orders for over 100." C. R. Potts, Pa. "Send 2 doz. quick. Sold 4 doz. this week." Amazing profits. SAMPLE FREE to Workers. ROBINSON BUTLER CO., 112 Vance St., TOLEDO, O.



Only \$3.95

Our new Hand Craft design at a sensational special price for a limited time. A big, roomy, magnificent rocker. Quarter Sawed Oak. Rich new Fumed Oak finish. Height 38 inches. Seat 19x20 inches. Our new Automobile Everlasting Spring seat, 16 springs. Fabrikoid leather upholstered. Shipped in assembled sections, simple, extremely strong, new method of bolt and dowel pin invisible construction.

On Approval

To introduce this splendid rocker we will fill orders for a limited time at only \$3.95. Your money returned if you are not delighted with this really handsome rocker. Send us \$3.95 today on this unusual offer and see this chair on approval.

**Book Free** Our new book of furniture at factory prices sent free. Write for it. Our book on Piedmont Red Cedar Chests is the biggest and finest ever issued. The famous Piedmont Chests—genuine moth-proof, at factory prices. Write for it. Either book or both books sent postpaid free. Write today.

Piedmont Red Cedar Chest Co., Dept. 55, Statesville, N. C.

## 205 ALL DIFFERENT FOREIGN STAMPS FREE

if you remit 25 cents for 6 months' subscription to McKELE'S WEEKLY STAMP NEWS, Boston, Mass. If preferred, 101 different U. S., fine book on U. S. stamps, 2000 stamp hinges or album for 600 stamps.



Agents Wanted

## WRITE 600 WORDS WITH ONE DIP

Why use ordinary pens with the never ending dip—when One Dip Pens make every penholder virtually a fountain pen?

Send 10c for Sample Package

One Dip Pen Co., 34 Daily Record Bldg., Baltimore, Md.



## Amazing Profits In Mushrooms

Anybody can add \$8 to \$40 per week to their income, in spare time, entire year growing mushrooms in cellars, sheds, barns, boxes, etc. I tell you where to sell, at highest prices.

Free Illustrated Instruction Booklet

HIRAM BARTON

Desk 2, 329 W. 48th St., New York



## OWN A BUSINESS WHERE THE CROWDS ARE ALWAYS WAITING TO HAND YOU MONEY

The Motion Picture Business is the Business. It's the greatest Money making business of the times, and our free book "How to Make Money in the Moving Picture Business" tells you how you can start with a very small capital, and begin making money from the very start.

ABSOLUTELY NO EXPERIENCE NEEDED

This book is a guide for the inexperienced; it tells everything pertaining to the business and how to conduct it profitably. Don't wait, send for your copy today. It's free.

P. & W. SALES COMPANY, 741 Como Bldg., Chicago, Ill.

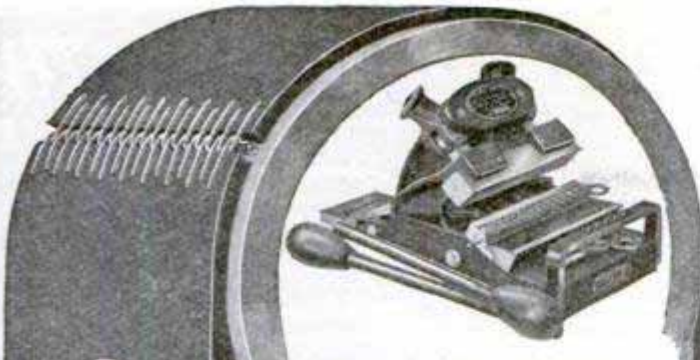

**A Lacing more pliant than the belt**

**Lace Machine Belts in 3 Minutes**

It will pay you to investigate the **Clipper Belt Lacer**

if you are interested in saving the machine-time, man-time and resulting output lost in lacing by hand. The Clipper joint is stronger, more flexible, lasts longer, costs less, and will not stretch or tear loose. Any boy can lace a belt as well as a high priced mill-wright, if he uses the Clipper.

SEND FOR OUR FREE BOOKLET AND TRIAL OFFER  
**Clipper Belt Lacer Co.**  
1032 Front Ave. GRAND RAPIDS, MICH.

**BUILD A** We have accurate scale drawings and knock-down parts of all man-carrying aeroplanes for class-room demonstrations, exhibition purposes, etc. Students of aeronautics, everyone with an inquiring turn of mind, should construct one of these fascinating models.

**PRICES OF 3-Ft. MODEL SCALE DRAWINGS—** Curtiss Flying Boat, 25c; Nieuport Monoplane, 25c; Bleriot Monoplane, 15c; Wright Biplane, 25c; Curtiss Convertible Hydroaeroplane, 35c; Cecil Peel's Champion Racer, 25c

Complete Set of Six \$1.25 Postpaid  
50 pp. Ideal Model Aeroplane Supply Catalog 5c.  
**IDEAL AEROPLANE & SUPPLY CO., 82-88 West 87th St., N.Y.**

**The "WASHBURNE" Paper Fastener** of "O.K." fame. Brass, 3 sizes, in brass boxes of 50 & 100 each. Your Stationer, 10 & 20¢. Send 10¢ for sample box of 50. Yearly Sale Over 100 Million. Booklet of our 3 "O.K." office necessities Free. Liberal Discounts to the Trade.

**THE O. K. MFG. CO., Syracuse, N.Y., U.S.A.**

**8 1/2 Pound Electric Vacuum Cleaner**

At last a vacuum cleaner a woman can handle as easily as a carpet sweeper. Weighs no more. Takes up only two-thirds as much room. Is absolutely guaranteed. Rolls on rubber-tired wheels without effort. As powerful as many big unwieldy machines.

**The MORROW**  
10 Days Free Trial We take all the risk, write today for our Free Book.  
**The MORROW CO., Dept. 1193, Waukegan, Ill.**  
Good Territory Still Open—Agents and Dealers Write

**Ruby for Your Name**

To quickly introduce our dazzling blue white Maztec gems (United States Letters Patent) and to distribute our beautiful art catalog, "The Story of the Maztec Gem." We will, for only 2 two cent stamps to cover cost of mailing, send you free a genuine uncut Navajo Ruby bought from the Navajo Indians together with our low cost-price offer for cutting and mounting. Write today—now. (Sellers of Genuine Gems since 1902.)

**FRANCIS E. LESTER CO., Dept. E.T.3R, Mesilla Park, New Mexico**

**Almost 1/2 Price**

**This \$35.00 Set—Now \$19.80**

If you have anything to do with metals, tools or machines—get these books. Get them today, now, at a saving of over fifteen dollars and on the easiest of easy payment plans. This great work was planned especially for the use of the mechanic. It covers the design, construction and operation of steam and gasoline engines, and of machines in general; and the manufacture and working of all metals used in the mechanical trades. Contains hundreds of practical ideas on the management and operation of the Modern Shop. Get these books now—have them ready when you need them. They'll solve every shop problem quickly and correctly—no waiting—no asking—just a little time and study will make you the expert man on the job.

**Cyclopedia of Mechanical Engineering Gas Engine Operation and Modern Shop Practice**

Contains 3,092 pages, 7x10 inches; 2,327 illustrations, full page plates, diagrams, etc.; hundreds of valuable tables and formulas; carefully cross-indexed for quick, easy reference. Printed in large, clear type on special quality paper and bound in half red morocco.

**Subjects Thoroughly Covered**

- Machine Shop Work—Vertical Milling Machine—Motor-Driven Shops—Shop Lighting—Forging—Electric Welding—Tool Making—Metallurgy—Manufacture of Iron and Steel—High-Speed Steel—Flaws in Castings—Electric Lifting Magnets—Magnetic Clutches—Making a Machinist—The Ideal Foreman—Pattern Making—Foundry Work—Automatic Coal and Ore Handling Appliances—Machine Parts—Construction of Boilers—Types of Boilers—Boiler Accessories—Steam Pumps—Air Compressors—The Steam Engine—The Steam Turbine—Indicators—Valve Gears—Refrigeration—Gas Producers—Gas Engines—Automobiles—Elevators—Sheet Metal Work—Practical Problems in Mensuration—Mechanical Drawing—Drafting Room Organization—Machine Design, Etc.

**Shipped Free** Seven volumes, not a sample volume, will be sent, express prepaid, for seven days' free examination. If you keep them pay \$2.00 seven days after receipt and then \$2.00 a month until you have paid the special introductory price of \$19.80. Remember, you save almost half by buying the set now. Examine these great books at your leisure and in your own home. It won't cost you a cent and the books may be returned if they do not meet with your expectations.

**Free Consulting Service**

Every man who takes advantage of this offer now gets absolutely free a complete Consulting Membership, under which our entire staff of experts answers all questions and solves all engineering and shop problems a whole year absolutely free. One question answered may be worth more than the entire cost of the books. Usual price—\$12.00—now free with this set. Fill out and mail us the coupon. Books go to you at once, express paid. Our liberal offer protects you. You take no chances. You are not bothered. If the books cannot sell themselves to you strictly on merit, don't keep them. But first inspect them. Mail the coupon today.

**FREE COUPON Worth \$15.20 to You**

**American Technical Society, Chicago, U. S. A.**

Please send me Cyclopedia of Mechanical Engineering for seven days' free examination. If I decide to buy, will send \$2.00 in seven days and balance \$2.00 a month until \$19.80 has been paid, when \$35.00 books and \$12.00 Consulting Membership will be mine. Otherwise will notify you and hold books subject to your order. Title not to pass until fully paid.

Pop. Mech. 3-14

NAME .....

ADDRESS .....

As I have had no previous dealings with you, I refer you to .....



# I SMASH The Terms

Watches  
on  
**CREDIT**

16 Size Thin Model



ELGIN  
HAMILTON  
HOWARD  
ILLINOIS  
**Any Watch  
You Want**

on

**30 Days' Free Trial**

**No Money Down**

**Express Prepaid in Advance by Me**

That's the way I smash terms. That's the reason why I am doing the greatest credit watch and jewelry business. I am "Square Deal" Miller and I trust the people.

I do business on your terms, send you what you want. Suppose it is a watch. I have it for you, **no money down**, express prepaid by me, and a full month to carry it in your pocket. **That's the test that tells.** All these watches

**Guaranteed 25 Years**

**Now for Business:** Send me your name and address and I will send you my

**Costly Catalog FREE**

I want you to have our catalog. It is a gem, it illustrates all kinds of valuable watches, diamonds and jewelry on the easiest and most liberal terms ever offered.

**You Take no Chance** My terms are made to suit your convenience. I assume all the risk, you are the sole judge of value and quality. I prepay the charges, trust you, give you the easiest, best and squarest terms and live up to my title as "Square Deal" Miller. Write for this catalog today and get a letter from me that will make you a friend of mine from the start.

**"Square Deal" MILLER, Pres.**

MILLER-HOEFER CO., 248 Miller Building., Detroit, Michigan



**Made-to-Measure**

Express Prepaid **\$275**

Pants cut in the latest style. Made to your individual measure. Fit, workmanship and wear guaranteed.

**No Extra Charge**

for peg tops, no matter how extreme you order them.

**Agents Wanted**

A good live hustler in every town to take orders for our celebrated made-to-measure clothes. Samples of all the latest materials **FREE**.

**We Pay Big Money**

to our agents everywhere. Turn your spare time into cash by taking orders for our stylish clothes. Write today for beautiful **FREE** outfit.

The Progress Tailoring Co., Dept. 603, Chicago

## Electric Light and Power Anywhere

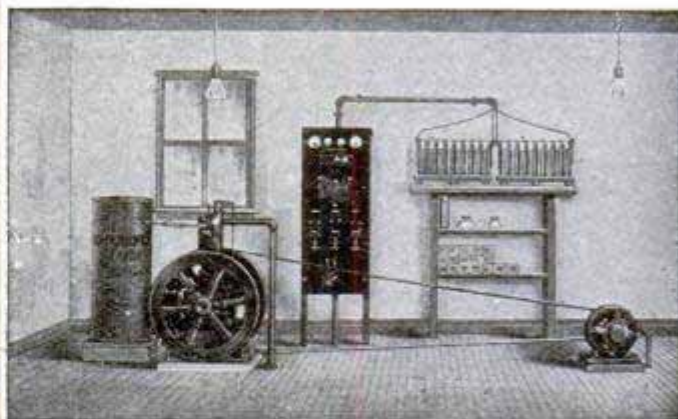

### Fairbanks-Morse Electric Plants

Make it possible for every one, everywhere, to enjoy the benefits of electric lighting and power. Fairbanks-Morse plants are complete, independent units of ample capacity to light fully any ordinary home and will also furnish power for doing other work, such as running the cream separator, churn, washing machine, etc. Current may be used for operating the many electrical devices for the home.

Complete outfit with 2 H. P. engine, dynamo, storage battery, switchboard and 50 Mazda lamps furnished. Safest, best and most reliable lighting and power system. Write for Catalog No. 449 TQ.

**Fairbanks, Morse & Co.**

New York

Chicago

San Francisco

## STAMPINGS

Metal spinnings and stampings a specialty. All sorts of die work

and metal patterns. Manufacturers of patent specialties and novelties. Can get out samples at moderate cost. Experts in black enameling. Prices reasonable. Prompt delivery.

THE STANDARD SPINNING & STAMPING CO., Toledo, O.

## Let Us Give You This Hat



This rich imported Austrian Velour Hat—very finest hare fur; Softer and Glossier than plush—Extra heavy, pure grosgrain silk band—has fashionable bow. Russia Leather sweat band—Silk Lined, absolutely newest and swellest style, \$7.00 value.

**We GIVE IT To Our Agents**

All that we require is that you show our samples and take a few orders for our special made-to-measure clothes. We pay highest cash profits—give presents besides, choice of 628 valuable premiums such as Suit Cases, Pipes, Watches, Guns, etc. Write for elegant **FREE** outfit and full particulars.

SPENCER MEAD CO.

Dept. 812

CHICAGO

## Rent This Level 9 Months— Then It's Yours

**BUILDERS—CONTRACTORS—ARCHITECTS**

High price and cash payments are eliminated. For the first time it is possible to obtain a high grade Level on terms so easy that you can not afford to be without one.

### Convertible Level

Besides its use as a Level it can also be used for running straight lines, getting angles, taking vertical sights, etc. for which ordinarily a Transit is required.

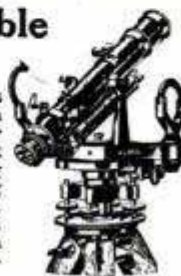

For more than fifty years Aloe's surveying instruments have been recognized as standard instruments. This Level is offered to you with an absolute guarantee that is backed by a **ten day free trial offer**.

**FULL PARTICULARS**

and details of our extraordinary selling plan will be sent on request.

**A. S. Aloe Co., 515 Olive St., St. Louis, Mo.**



## Hear the Faultless Tones of Artists' Living Voices

With the Arteste Tone Magnifier as part of your talking machine or graphophone you hear the actual living voice of the singer without a trace of mechanical noise. It is the final step in the reproduction not only of vocal but of orchestral and instrumental music.

**\$2** until May 1st only  
Regular Price **\$3.50**

No matter how fine or how expensive a disc record machine you own, you cannot realize its fullest possibilities without the Arteste Tone Magnifier. Simple instructions so you can attach it yourself. Try it. Hear it yourself and ask your friends' opinions. If it is not all we claim you get your money back at once. State name of machine and name or number of reproducer when ordering. *Send today.*

**The Stetson Manufacturing Co.**  
810 Hippodrome Bldg. Cleveland, Ohio

Never  
Requires  
Readjustment

Dealers—  
Send for our  
proposition

## You Mr. Man of the House

### Do Your Own Tinkering—Enjoy It

Five minutes spent on the chair with the loose joint saves you 25c or 50c cash—fixing the shelf in the pantry—mending screens in Spring or Fall—tinkering with the lock that will not catch. Fussing with odds and ends about the house that need repairs is going to interest—give you pleasure—relaxation from the cares of business—freshen you up for tomorrow's problems when you have

### A GRAND RAPIDS HOME BENCH

in your basement or store room. It gives you the facilities—the proper working surface of Hard Maple, provided with rapid acting wood screw vises—pays for itself in a short time in the saving on odd jobs that now require the expense of a mechanic. Has a tool cabinet—place for the nails, tacks, screws—odds and ends that are always needed and never to be found. A necessary convenience in every home.



Write for free catalog giving complete information of this and other HOME BENCHES.  
**GRAND RAPIDS HAND SCREW CO.**  
Box 1620  
Grand Rapids, Mich.

## The Farm YOU Want

is compact, easy to pay for, and enormously productive—and it *must* be near a big live city



Here it is—yours for

3 1/2 cents per day per acre

**IN OUR NEW LITHIA TRACT SUBURBAN TO TAMPA, the metropolis of South Florida. It is one of the few choice small farm tracts left in Hillsboro County, the recognized center of Florida's grape fruit and orange belt.**

This is the third great Hillsboro County tract to be subdivided by our old established, responsible, thoroughly experienced organization. Over 2,500 families are now rejoicing because they bought at opening prices in our two former tracts. Every family can tell you they got a square and generous deal.

Our New Lithia Tract now offers you the same wonderful opportunity—and more, because of the rapid growth and development on all sides within the past four years. Our surveyors have completed their work of subdividing the New Lithia tract into 10, 20 and 40-acre Citrus Fruit and Truck Farms, and it is now being thrown open to home-seekers and investors.

Hillsboro County is building ONE MILLION DOLLARS' WORTH OF NEW BRICK COUNTRY ROADS. Improvements of all kinds are going rapidly forward. Already buyers are building homes on our new Lithia Tract, and values are due to rise here just as they have in our two former suburban farm tracts in this same county.

The visible supply of select Hillsboro County grape fruit land is melting away very fast. Prosperous homes are scattered around the Lithia Tract—grape fruit and orange groves are flourishing on all sides.

One judicious investment, remember, means more to your bank account than years and years of labor. Honestly, now, what have you to show for that little 3 1/2 cents per acre per day that might just as well be buying you a beautiful 10-acre Hillsboro County farm?

No use imagining savings bank interest will ever make you independent. Your money isn't working when you tie it up in such ways—it's LOAFING. MAKE it work for you, right here where a few dollars put to work NOW will reap all the benefit of development work and growth in population.

If you do not wish to improve your farm, you can cash in on it from the investment standpoint in a few years without a stroke of work on your part.

Get our big new Florida book and look at the map—four big railroads intersect these suburban tracts—all the comforts of modern life right at hand! The completion of the Panama Canal throws the spotlight on Tampa, the nearest deep water port, and the traffic of the whole maritime world will pause at Tampa's door.

Think of it—a 10-acre farm near a great city like this—a farm big enough to keep you in comfort all your lives, yet yours for just 3 1/2 cents per acre per day!

Get the facts now. The coupon brings them to you without cost or obligation—now, while prices on this newly opened tract are still low and terms easy. Today \$1.00 per acre per month buys you independence and a future. Tomorrow—who knows?

We have prepared a special bulletin and a large illustrated book which we will gladly send you free on receipt of the coupon. Tear it off and mail it NOW and we will lay before you, by return mail, full and complete information showing how you can easily become the owner of one of these beautiful suburban farms, and why it is sure to prove the shrewdest, most profitable investment you can ever make.

## North Tampa Land Co.

C. E. THOMAS, President  
1128 Commercial National Bank Bldg.,  
CHICAGO

**CHICAGO**  
NORTH TAMPA LAND CO., 1128 Commercial National Bank Bldg., CHICAGO  
Please send me FREE your latest and best illustrated book on choice Citrus Fruit and Truck Farms suburban to Tampa, Florida.  
Name \_\_\_\_\_  
Street No. \_\_\_\_\_  
City \_\_\_\_\_  
State \_\_\_\_\_

# 3 Years to Pay — for the — Sweet-Toned Meister Piano



## 30 Days' Free Trial We Pay the FREIGHT

You are not asked to deposit, or pay or advance a cent in any way until you write us and say that the MEISTER is entirely satisfactory and you wish to keep it. Then these are the terms of sale:

### \$1 a Week or \$5 a Month

No Interest On Payments

No cash payment down. No extras of any kind. Piano stool and scarf free.

Sold direct from the maker to you and we guarantee you a saving of \$100.

Send now for our beautiful Free Catalog which shows eight styles of Meister Pianos. Our resources exceed \$4,000,000.

## \$175

## Rothschild & Company, Dept. N16 Chicago, Illinois

## Bausch and Lomb BALOPTICON

THE PERFECT STEREOPTICON

Bausch & Lomb Optical Co., 576 St. Paul St., Rochester, N. Y.



The Most Independent Man in the World Today is the Farmer—the Producer. We are All Talking about The High Cost of Living and our Ablest Counselors are Advocating *Forward To the Farm*, which is the real solution of the problem. The city toiler, the workingman, the clerk, the office man—All must look to the soil for the opportunity to break clear from the Eight o'clock Bell, the tyranny of the boss, and the diminishing chance.

YOU CAN MOVE ON A TEN ACRE FARM in our PORT AUSTIN COLONY and Begin Farming *Right Away*, by paying the first monthly payment, \$7.50. This simply means the saving of 25 cents each day and you will become the owner of a Fertile Farm that will make YOU ABSOLUTELY INDEPENDENT. Your

## 10 ACRES

Money in a Savings Bank will Earn you only 3%; Invested in Our Land It will in All Likelihood Double and Quadruple in the next Five Years. Texas Gulf Coast Growers of Oranges, Strawberries, Early Vegetables, and Figs. Clear all the way from \$300 to \$1000 an Acre—That's The REASON. Our contract provides Free INSURANCE, no Interest or Taxes, and Money Refunded, if you are dissatisfied, as per contract conditions.

Send for Our BIG FREE BOOK. It will tell you all About the Soil, Climate, etc., and three crops a year from the same land. You can have your land set out to Figs and Oranges, which bear in two to four years. Write The OWNERS—TEXAS COAST DEVELOPMENT CO. R. 1231—115 Broadway, New York City.

## 25 cts A DAY

### Get a Handsome Self-Acting Blow Torch and a Tube of Solderall (a Complete Soldering Outfit) for One Dollar Delivered to You



Solderall so simple even a child can solder

anything in metal. In use by all first-class electricians and mechanics. Solderall is a pure metal solder in paste form ready for instant use (no acid or flux required.)



Pocket Size

Size of Torch, 6"x2"x1 1/4"

Price of Torch, 75c  
Solderall . . . 25c  
Sent postpaid

Dealers write us for prices

Solderall Co., 143 Liberty St., New York

## New Typewriter

### \$18

In U.S.A.

Built by a mechanical wizard. Has only 250 parts. Other machines have 1700 to 3700 parts. This sensational simplicity is the secret of the unheard-of selling price of \$18. It's built in famous Elliott-Fisher Billing Machine factory and sold on a money-back-unless-satisfied-guaranty. 33,000 in use.

### The Bennett \$18 Portable Typewriter

does work of high-priced machines. Every big improvement: visible writing,

standard keyboard, reversible ribbon. Wt. 4 1/2 lbs. Easily carried. Write for catalog

Chas. M. Bennett Company  
1303 Cedar Street,  
Harrisburg, Pa.

Foreign Add.: 75 Cannon St. London, E.C.



We can use a few more live agents

### HOFFMAN'S PAT'D DRAWING BOARD BRACKET FOR Artists, Illustrators, Designers & Draftsmen

Attach to table or desk. Adjust any height, to draw standing or sitting. Adjust any angle. The board revolves. A strictly first-class article. Neat, Strong, Firm, Durable. Made of steel and iron, handsomely finished. Weighs 6 1/2 lbs.; will support a board 30" square. 30 days free trial. Write for booklet H 25. A. HOFFMAN & CO. 51 Kenwood Ave. Rochester, N. Y.



## MONEY IN MUSHROOMS

### Add \$10 to \$50 a Week to Your Income Grow Mushrooms

at home in your basements, barns, sheds, etc., without interfering with your regular occupation. Small beds, 5 x 10 ft., costing practically nothing to start, often produce 60 to 100 lbs., selling at 50c to \$2.00 a lb. Your whole family can help in raising them. Others are making money growing mushrooms. Why don't you? My illustrated booklet telling how to start, how to sell, etc., sent free. Write today.

A. V. JACKSON, Falmouth Mushroom Cellars, Inc., 196 Gifford Street.



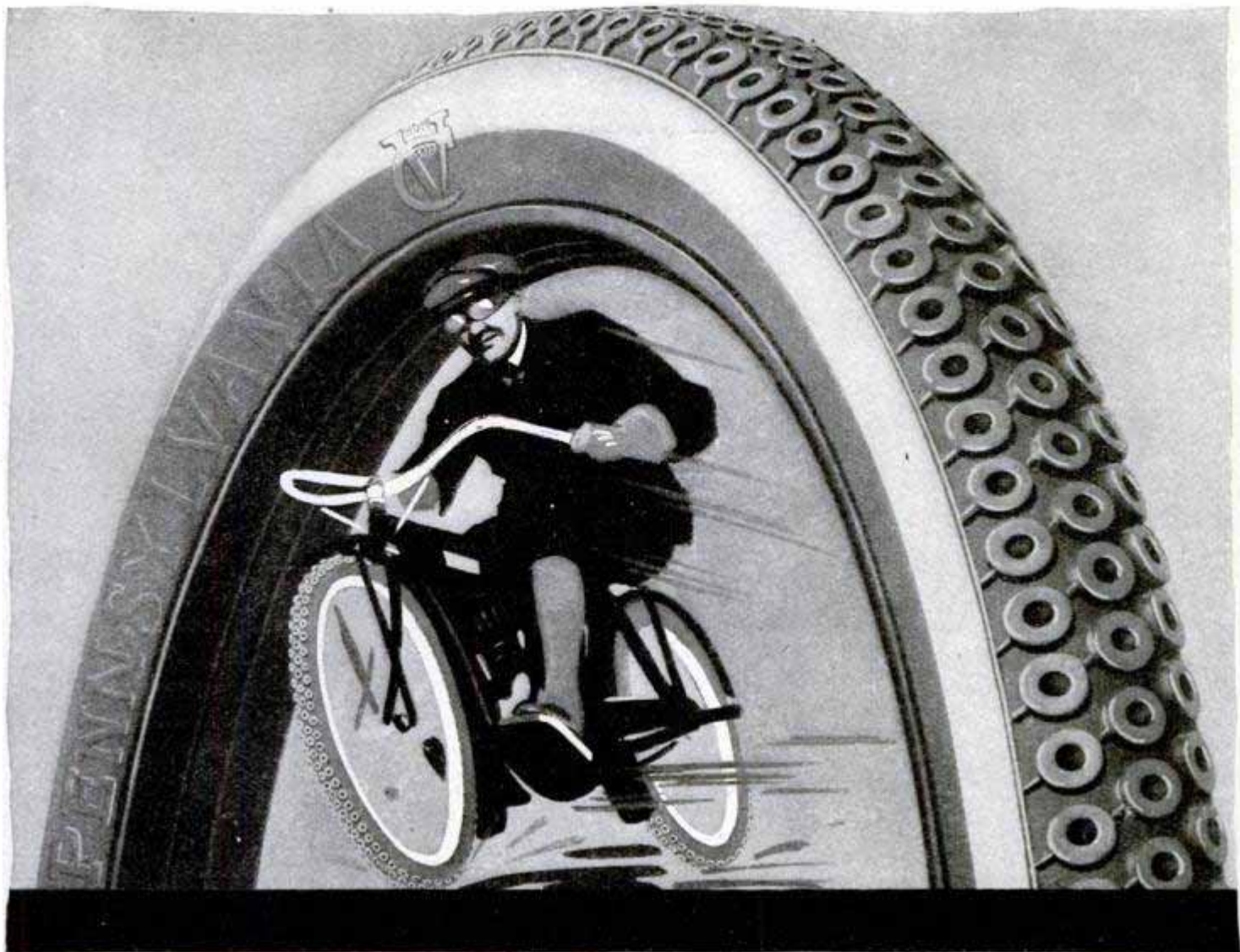

**Y**OUR motorcycle is converted into a different machine—far more efficient, dependable and safe—when you equip with

## PENNSYLVANIA Oilproof VACUUM CUP TIRES

Every stroke of your engine is effective; every varying brake pressure tells—with V. C. Tires. On the slipperiest asphalt pavement, the powerful, elastic grip of the suction cups conserves motor energy, provides perfect traction, and nips skidding in the bud.

Vacuum Cup Tires are absolutely oilproof through and through the rubber.

Extra thick treads—plus the tough suction cups—mean longest mileage. The cups alone outwear the ordinary motorcycle tire, and then the tread beneath comes into service.

*Guaranteed for 5,000 Miles of Service, Vacuum Cup Tires average far in excess of this figure, under all normal conditions.*

**Pennsylvania Rubber Co., Jeannette, Pa.**

Pittsburgh	Cleveland	Detroit	Chicago	Minneapolis
Kansas City, Mo.	Omaha	Seattle	St. Paul	
New York City	Boston	Dallas	Atlanta	
San Francisco		Los Angeles		

*An Independent Company with an Independent selling policy*

*Please Mention Popular Mechanics*



## You'll like this coat-shirt

Every railroad man who has worn a Signal Shirt will have no other. You'll make it a point to try the Signal, too, when you have seen how stylish and well-made it is, and the many exclusive features it has.

# SIGNAL Coat-Shirts

## \$1.00

(\$1.25 West of Mo. River)

UNION MADE

Has all these improvements; Easy-on, easy-off coat style. Extra big armholes that give plenty of arm movement. Specially cut skirts overlapping 3 inches in front and with extra button at bottom to prevent gapping. Two detached or attached collars; cuffs made with both button and extra buttonhole so they can be buttoned or used with detachable cuffs. Double needle machine stitching (prevents rips), buttons sewed on extra strong; 2 pockets, one a triple combination pencil, watch and handkerchief pocket. Signal Shirts are made from fast color percales that won't shrink or fade. Big variety of neat patterns. Only expert union labor employed.

**Sent at our risk** Ask your dealer. If he hasn't them, tell us his name and your size, and we will express you a couple C. O. D. If not delighted with them on examination, return at our expense, without paying us a cent. Be sure and write for folder showing a big variety of other styles and sample swatches.

**HILKER-WIECHERS MFG. CO., 1254 Mound Ave., Racine, Wis.**  
Also manufacturers of the famous Signal Overalls and Coats

## Hello Boys!

Do You Know thousands of boys like you are having barrels of fun with this toy? Parents give some, many boys "save up" and buy themselves. Can't you get in on this good time? Get now

### The Mysto ERECTOR

**FREE BOOK** My free, 24 page book, in two colors, describes this wonderful toy, its NEW MOTOR, girders, wheels, etc. **HURRY!** Send postal now. Ask about prize contest. Give dealer's name. Address A. C. Gilbert, Pres.,

MYSTO MFG. CO.  
53. Foote Street, New Haven, Conn.



Make lots of Toys

## Caementum (Pronounced Sementum) The Cement which Repairs Everything



Caementum is a liquid porcelain cement which sets rapidly and becomes absolutely insoluble. It is impervious to steam, water, heat or acids. It repairs everything from the finest china and glass to steam pipes and automobile radiators. With it you can build missing parts of china articles, stop leaks in pots and pans, repair woodenware or metals. Its uses are almost unlimited. It is made in France and is the only preparation of its kind on sale in America.

At dealers or by mail postpaid **25c**  
**STANDARD GLUE CO.**  
Dept. A BALTIMORE, MD.  
Sole Agents for U. S. and Canada

Regular Price **\$1.25** **THE RAPID VACUUM WASHER**



Sold on 30 days' trial.

The only Washer with Automatic Suction

Washes everything from blankets to fine laces. Tub of clothes washed in 5 to 10 minutes. A child can operate it.

**AGENTS WANTED. Special price on sample postpaid.** Write for terms and trial offer.  
**STEWART-SKINNER CO., 26 Cherry St., Worcester, Mass.**

**\$25 TO \$40 Week**



Sells on sight. Instant hit in every home. Smith, Ohio, sold **38 one day. Profit \$19.00.** All metal bread and pastry board and rolling pin.

Can't rust, absorb dirt or disease germs. Lasts lifetime. Endorsed by Good Housekeeping Institute. Agents get good appointments. Make Big Money.

**UNION MFG. CO.**  
129 Main St. Cambridge, O.



"AMERICAN" Key Cutter

**ADD TO YOUR INCOME** With little effort you can make **\$5 to \$10 a day**

The "AMERICAN" is the only machine on the market (barring none) that sharpens, hones, and strops razors, sharpens all kinds safety razor blades, scissors, clippers, pocket knives, surgical instruments, etc. No previous experience required. **REMEMBER THE "AMERICAN" Key-Cutter is a little wonder. Cuts Square, Angular or Round slots.**

**AMERICAN SHARPENING MACHINE CO. (Inc.)**  
Dept. 3 184 W. Washington St. CHICAGO



"AMERICAN" Sharpener

# Western Electric Inter-phones

## The Telephone Within the Home

Every modern home should be provided with Inter-phones for communication between floors or between rooms on the same floor. Not only comfort, but efficiency in home management must be considered. Wasted effort and tiresome stair climbing should be saved both to mistress and maid.

Western Electric Inter-phones are easily installed in any house and should certainly be provided for in the specifications of every *new* home when the wiring can be done at slight expense.

The special two-station set, shown in the illustration, can be put up between any two rooms, and the work can be done by anyone as easily as putting in a door bell.

Your local electric goods store should be able to supply you. If they haven't this Inter-phone outfit, we will mail it direct to you by parcel post. It includes two Inter-phones and the necessary wire, etc., with simple directions for setting up. Price, \$15.

Write for "The Way of Convenience." It is booklet No. 31-AW.

*There is an opportunity for agents to represent us in some unoccupied territories.*

### WESTERN ELECTRIC COMPANY

Manufacturers of the 7,500,000 "Bell" Telephones  
463 West St., New York. Houses in all Principal Cities  
of the United States and Canada.

Agents Everywhere

**EQUIPMENT FOR EVERY  
ELECTRICAL NEED**

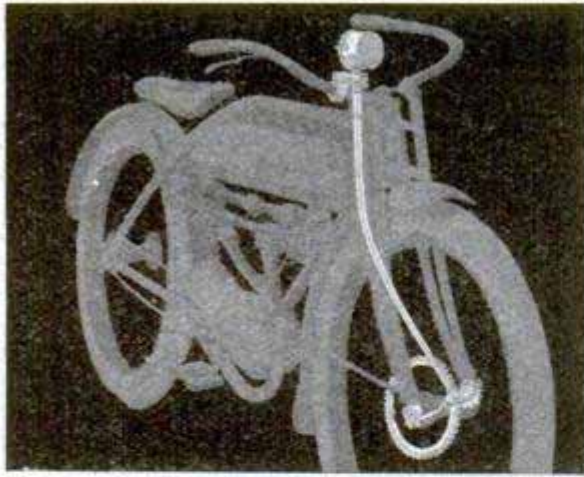

# Accurate for Life

This new Magnetic Type Stewart Front Wheel Drive instrument is the only motorcycle speedometer made that tells the *absolute truth* about speed and mileage for life. We also make a rear wheel drive Stewart for those who prefer it, and there is none better of this type. But all rear wheel driven speedometers show false mileage, because the rear wheel constantly slips under power, and registers mileage while simply being tuned up. To get absolute accuracy, be sure you buy a *Stewart Front Wheel Drive Model*.

## Stewart Motorcycle Speedometer

MAGNETIC PRINCIPLE

The only front wheel drive motorcycle speedometer that can last long under the spring action and jar of the front fork. All that have flexible shafts will soon whip to pieces.

In this new Stewart Front Wheel Drive, model 101-A, the drive shaft operates through a *rigid steel tube*. This tube supports the bracket that holds the angle joint and fibre pinion. This bracket moves free on the axle of the front wheel and

# \$12

Complete

Fully Guaranteed

absorbs all the deadly spring fork action without injuring these shafts in the slightest degree.

The instrument itself is the famous Stewart Magnetic Type. Over 1,000,000 automobiles and motorcycles are now equipped with our magnetic instrument. It is standard. And the price is only \$12 complete—the lowest at which a magnetic type speedometer has ever been sold.

For sale by dealers everywhere. Insist on getting the new Front Wheel Drive Stewart.

Stewart-Warner Speedometer Corporation,

Factories: Chicago, Ill., and Beloit, Wis.

Branches and Service Stations in all principal cities.



Stillwell-California

### BUNGALOW HOMES

ONE AND TWO STORIES  
Built from Coast to Coast

You can build genuine (Stillwell-California) Bungalows anywhere at a surprising economy of space and cost. Comfortable in any climate; artistic, sensible. Stillwell built-in conveniences save furnishings and woman's work. Our books show

Photos - Plans - Costs of 129 Model Homes

"REPRESENTATIVE CALIFORNIA HOMES" ALL 3

50 ideal homes, \$1600 to \$6000—Price 50c BOOKS

"WEST COAST BUNGALOWS" FOR \$1

51 inexpensive homes, \$600 to \$2000—Price 50c

"LITTLE BUNGALOWS" 28 perfect little homes, \$300 to \$1400—Price 25c (POSTPAID)

We Sell Books and Blue Prints on a Money-Back Guarantee

E. W. STILLWELL & CO., ARCHITECTS

4166 HENNE BLDG., LOS ANGELES



**"A Kalamazoo** And Gas Stoves Too  
Trade Mark Registered **Direct to You"**

Means true economy in stove buying—deal direct—save middlemen's profits.

**YOU SAVE \$5 to \$40**

according to style. Write for FREE

Book—shows 500 styles at factory prices. We pay freight and

allow a year's test. Ask for catalog No. 473.

Write For Big FREE Catalog

Kalamazoo Stove Co., Mfrs., Kalamazoo, Mich.

We make a full line of Ranges, Stoves, Furnaces, Metal Kitchen Cabinets and Gas Stoves. Mention catalog wanted.

## See Yourself in Motion Pictures

A new invention enables you to make and show Motion Pictures of yourself, family, friends, sports, travels, or anything that interests you. FOR PLEASURE OR PROFIT.

**AS EASY TO WORK AS A KODAK**

Send for descriptive catalogue No. 5

A 400-page book, 80 illustrations, free with each camera

**MOTION PICTURE CAMERA CO., Inc.**

5 WEST 14th STREET, NEW YORK

Importers and Mfrs. of Motion Picture Apparatus

## Your Old Camera Taken in Trade

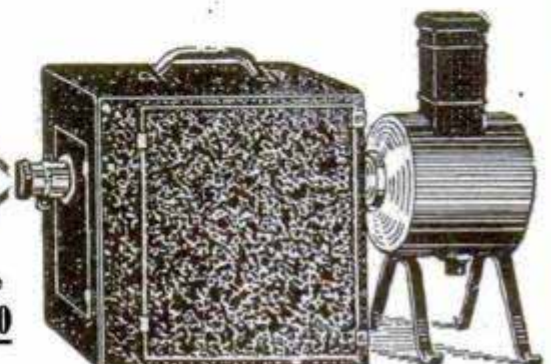

Price **\$39.00**

Cash or Easy Payments

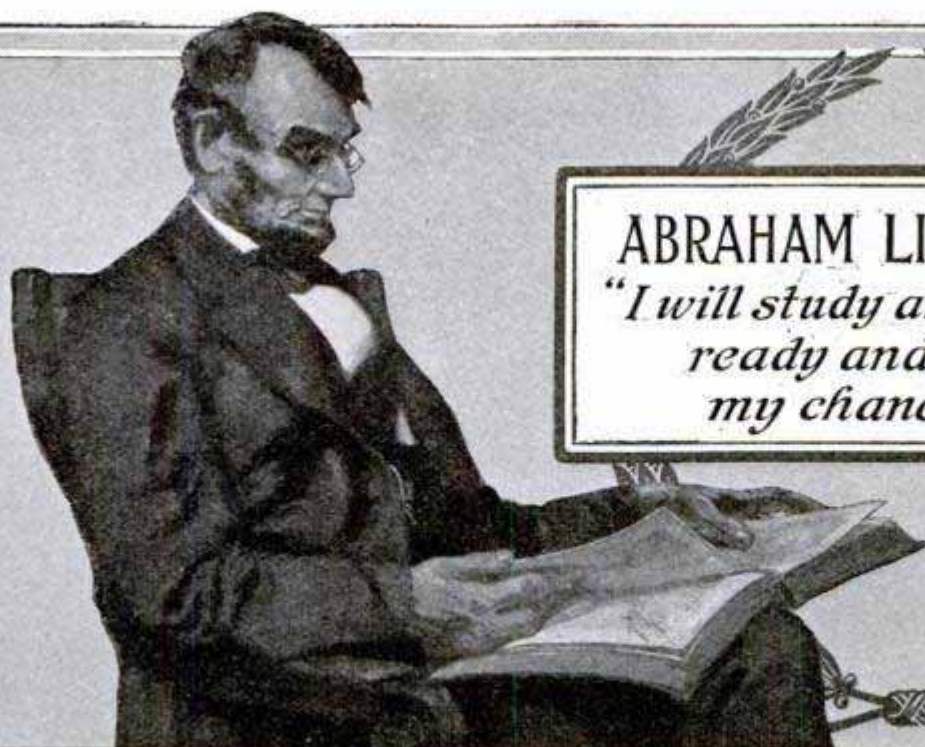

ABRAHAM LINCOLN *said:*  
*"I will study and get  
 ready and maybe  
 my chance will come."*

## *YOUR Chance Will Come*

Born in a one-room log cabin on the Kentucky frontier, Abraham Lincoln had very little chance to acquire an education. But he was determined to succeed. "Some day," he said, "my chance *will* come." So he studied and got ready. And his chance *DID* come.

*YOUR chance will come.* Some day you'll be considered for promotion or for a good job in some other line of work. If you are ready, you'll go *UP*—there will be no limit to your chances to advance—if you are ready to meet them.

And you *CAN* get ready. No matter if your schooling *was* limited—if you *do* have to work long hours. If you really *want* a better job, the International Correspondence Schools can train you for it right in your *own home* during your *spare time*.

Every month more than 400 I.C.S. Students voluntarily report promotions or salary increases that have come as a *direct* result of the help of the I.C.S. What the I.C.S. have done for these men they can do for *YOU* right in your *own home* during your *spare time*.

Just mark on the attached coupon the position or occupation you most like and mail the coupon to the I.C.S. This won't obligate you in the least—but it will bring you the facts about this exceptional opportunity that may change the course of your entire life.

**Mark the coupon NOW**

### INTERNATIONAL CORRESPONDENCE SCHOOLS

Box 872-T, Scranton, Pa.

Please explain, without obligating me, how I can qualify for the position, before which I have marked X.

Electrical Engineering  
 Electric Lighting  
 Electric Railways  
 Electrician  
 Electric Car Running  
 Dynamo Foreman  
 Wireman  
 Mining Engineer  
 Telephone Expert  
 Surveyor  
 Civil Engineer  
 Automobile Running  
 Agriculture

Mechanical Engineer  
 Mechanical Draftsman  
 R. R. Construction  
 Concrete Construction  
 Architect  
 Contracting and Build'g  
 Architectural Draftsman  
 General Illustrating  
 Chemist  
 Bookkeeper  
 Advertising Man  
 Civil Service Exams.  
 Salesmanship

Name \_\_\_\_\_

St. and No. \_\_\_\_\_

City \_\_\_\_\_ State \_\_\_\_\_

Present Occupation \_\_\_\_\_



# EXCELSIOR

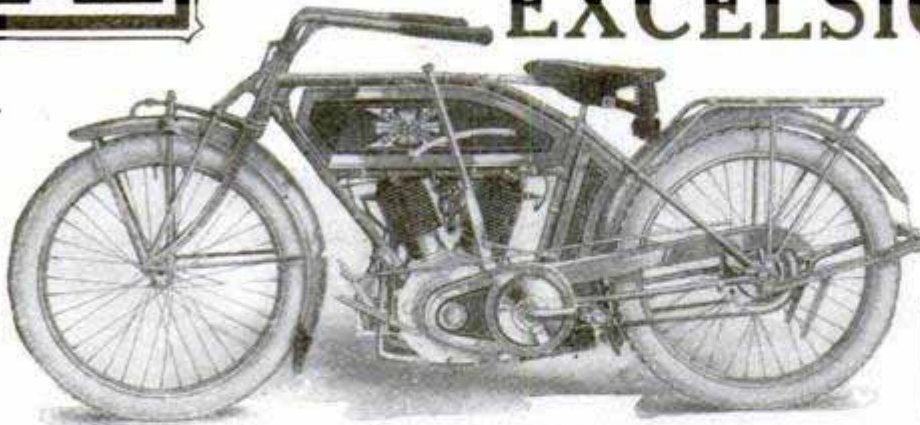

== The ==  
**Motorcycle  
 That Always  
 Makes Good**

**SEVEN MODELS  
 FOR 1914**

**T**HE leading features of the Excelsior Autocycle include Grip Control—that enables you to control its speed, clutch, spark and compression release without removing the hands from the handle bar grips or in any way interfering with the steering or other details of operation.

**The Greatest Factor of Safety Ever Put in a Motorcycle**

The Excelsior Two Speed is Simple, Efficient and Durable with no sliding gears and no possibility of stripped gears or other breakage. One movement of one lever engages either speed or shifts from one to the other. *Another feature of great value.*

Our catalog tells the story of seven models at prices from \$190 to \$260.  
 A postal card will get it. Write for it today.

**Excelsior Motor Manufacturing & Supply Co.**  
 2202-2250 South Union St., CHICAGO

a GOERZ gets it *Always*

You get successful pictures without fail where photographic results are possible, with

**GOERZ LENSES  
 CAMERAS**

Equal to any demand for speed. Produce sharp brilliant pictures where others wait for "better light." They are professional standard for amateur use—cost more because better—and they get results!

Did you know there is a difference both in Trust and in Tariff conditions NOW? Ask your dealer

Send for "The Optics of Lenses" in our Illustrated Price Catalogue

**C. P. GOERZ AMERICAN OPTICAL COMPANY**  
 No. 3230 East 34th Street New York City



**POPE BICYCLES** The Most Economical Means for Rapid Transit

Send for Catalogs



Thirty-six years' experience in building high quality goods. Over fifty distinct models to select from. Reliable machines for business, pleasure and racing. Frames specially

constructed and fully reinforced. Large graceful bars, wide comfortable saddle. All our product backed by a broad guarantee. Special "Pope" Bicycle with coaster brake and mud guards . . . . . **\$35.00**

Write us which bicycle you like best

THE POPE MANUFACTURING COMPANY, 16 Cycle St., Westfield, Mass., U.S.A.

# CRISPETTE

**Dellenbarger Will Start You!**

in this big money making business that is making hundreds of men independently wealthy. It's the business of quick cash sales and big profits. No other business will pay you as well in as short a time. You'll cash in **big** from the very beginning.

**Dellenbarger's Patented Kettle Process**

of popping popcorn, means 25% more bulk corn per pound than from other methods. The popcorn is seasoned while popping.

**Great Big—Light—Fluffy Kernels** That melt in your mouth. Makes

and delicious—the kind that makes every customer come back for more. Crispettes wonderfully rich

**Start at Once—NOW!** Dellenbarger makes it easy for you. Send for our big offer—

tells how to get started—the best locations, how to get the big profits—and explains fully how we will start you on easy payments.

**Write Dellenbarger Today for Full Particulars.**

Get our Catalogues, our prices, our assistance. It's up to you NOW to act. We'll show you the way and help you to make big money right from the jump. Address

**C. F. DELLENBARGER & CO., 631 W. Jackson Boul., Chicago, Ill.**

Barrels of Money Are Being Made in the Pop Corn, Crispette and Candy Business

We teach you the business FREE

# Become An Expert Draftsman

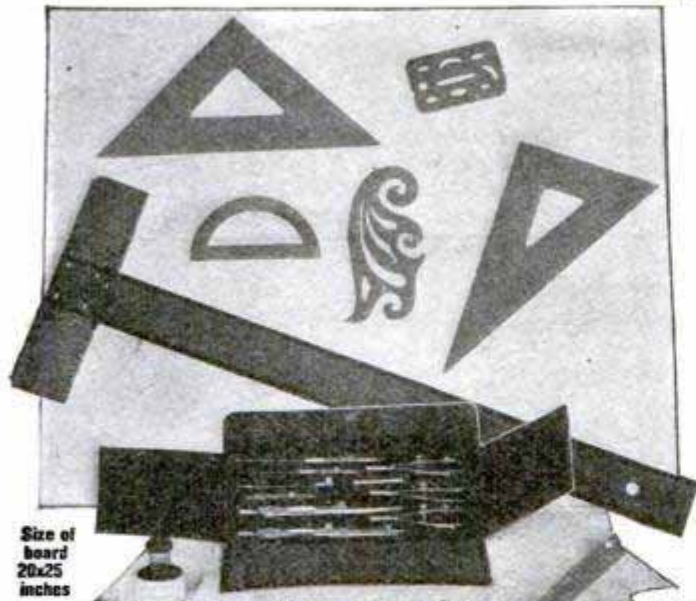

## Learn Mechanical, Structural or Architectural Drafting by Mail

Absolutely the greatest drafting offer ever made. Read it carefully. Then investigate. Sign and mail the coupon at once. Here is your opportunity to get the training you need to hold down a good job and earn big money—\$100.00 to \$250.00 per month paid to expert draftsmen. Our easy, practical method will teach you ARCHITECTURAL DRAFTING, STRUCTURAL DRAFTING or MECHANICAL DRAFTING in a few months. You will receive expert individual instruction in the course you select. All drafting instruments and materials supplied absolutely free of charge. Also big four volume Cyclopedia of Drawing sent free if you enroll now. Drafting is the foundation of all engineering professions—Learn drafting if you are ambitious to be an engineer. Prepare yourself for a real man's work. And remember—this great special offer is made by the greatest non-resident educational institution in the world—a school whose guarantee is backed by sixteen years of successful teaching by correspondence.

# FREE

This \$20.00 Cyclopedia of Drawing also included absolutely free in this special limited offer. Four big volumes as illustrated below. The only work which thoroughly covers MECHANICAL, STRUCTURAL and ARCHITECTURAL DRAFTING. Worth many times \$20.00 to any drafting student. Not only will you receive the best expert instruction, but you will have these books handy for reference at all times—they will answer all your questions authoritatively and promptly. Just think of it—four big volumes bound in half red morocco, gold stamped, 1,720 pages, 7x10 inches, 1,037 illustrations, page plates, diagrams, designs, etc., and the handsome \$20.00 Draftsman's Outfit. All free if you enroll now under this special limited offer.

Size of board 20x25 inches

**FREE \$20 Outfit**  
**FREE \$20 Library**

This \$20 Draftsman's Outfit as illustrated. Imported German silver drawing instruments in morocco case; 20 x 25 inch drawing board; ebony lined mahogany T-square; transparent triangles; German silver protractor; French curve; triangular boxwood scale; waterproof ink; pencil; erasers; shield; pencil pointer; handmade drawing paper and thumbtacks. Instruments guaranteed accurate—made by largest and most reliable manufacturer. This handsome, expensive outfit free to you if you enroll now!

### SALARY GUARANTEE

THE AMERICAN SCHOOL OF CORRESPONDENCE GUARANTEES that you will receive an increase of fifty per cent over your present salary within three years from the date of your enrollment; or, failing in this, the School guarantees to refund to you the full amount paid for your course. Back of this guarantee stands the American School—for more than fifteen years the foremost educational institution of its kind in the world. A school that has succeeded because it has been true to its principles of giving its students the instruction for which they enrolled.

## Just Mail the Coupon

Accept this great offer now—today! It never has and never will be equalled. You get the \$20 Drafting Outfit and the \$20 Cyclopedia of Drawing absolutely free of charge. Don't miss this opportunity. Your future success may depend upon whether you fill in and mail the coupon. It will only cost you a stamp to investigate. It means success and a big future for you.

**American School**  
of Correspondence, Chicago, U.S.A.



### FREE OFFER COUPON

**American School of Correspondence, Chicago, U. S. A.**

Please send me full information about the course checked below, also further particulars regarding the drafting outfit and library sent FREE with this course. Pop.Mech.3-14

- ....Mechanical Drafting
- ....Structural Drafting
- ....Architectural Drafting

NAME

ADDRESS

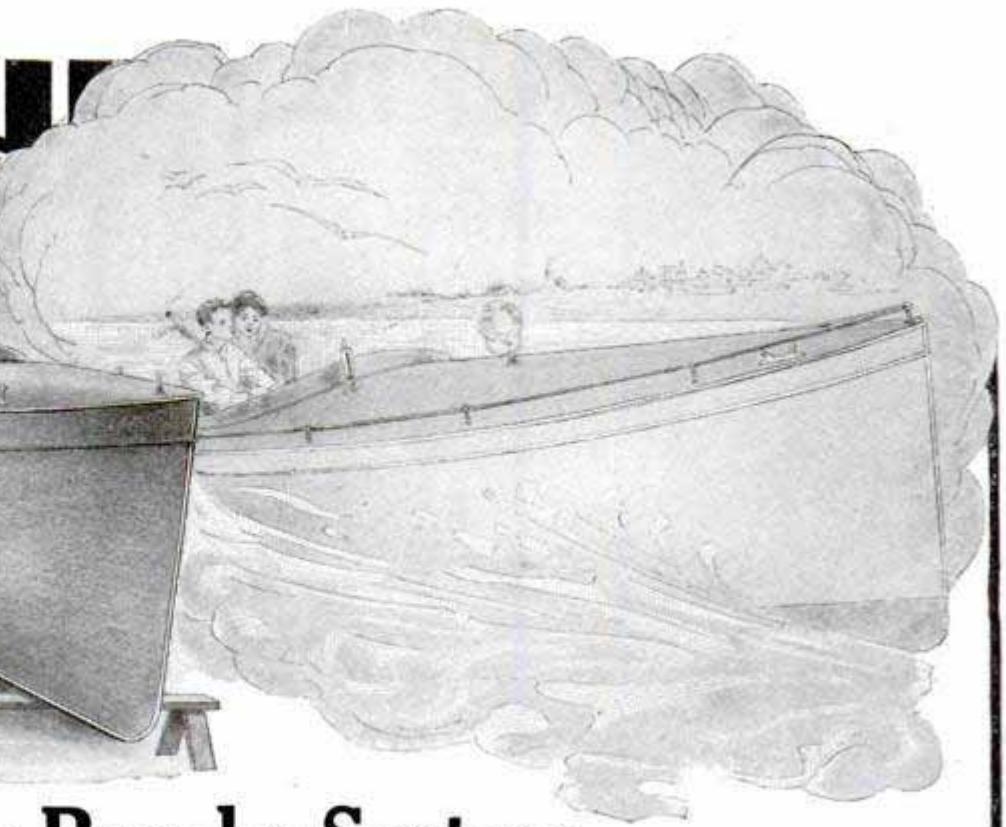

## Let the Brooks System Make Your Boat Dream Come True



### Read This Letter From Two Boys Who Did:

**Niman Bros., Louisville, Ky., Write:**  
"About May 1st, 1908 we purchased from you a knocked down 234 model that reached us in good time, and was finished about a month later, with very little, if any trouble. It made a beautiful boat \* \* \*. We later put in a 12 H. P. good engine and won several races. Later we put in an 18 H. P. light weight engine and can run around everything in its class and some speed boats out of our class. Won a silver cup last season over some speed boats. It is still in fine form, almost as good as new. I am enclosing, under separate cover, a picture of same after it had returned from a Floral Parade, and won a beautiful silver loving cup. The boat has always been admired, and many people have asked what model it was."

### Only \$33

buys the complete knocked down frame with full set of patterns and directions for the 23 foot boat illustrated below (the same model mentioned in the Niman Bros. letter above). Write for the Brooks Boat Book and see this and many more like it.



You have fancied yourself owning a beautiful, speedy boat. You have longed to be able to look at a beautifully designed cruiser, a speedy motor boat, a handsome launch, and feel that it was your own. And that you could go wherever and whenever you pleased on lake or stream.

Make that dream come true with the aid of the Brooks System. It's easy, and the cost is low. Thousands of men and boys are today able to enjoy the charms of boating only because the Brooks System enabled them to build their own boats easily, economically and in a surprisingly short time.

This system gives you the latest and most seaworthy designs. You can take your boat anywhere and have just pride in its ownership. Brooks Boats have won many silver cups in fast races and parades—they have been pointed out as models of beauty everywhere.

Many men build a new Brooks Boat every year, and sell their old boat at a profit. D. H. Durgin, of Blue Creek, Wash., writes that he made his Brooks Boat pay him **\$516.00 in 63 days** and then he sold it at a profit of \$153.75. So why not see what the Brooks System offers for you? Write for the Brooks Boat Book and learn why

### It's Easy to Build Your Own Boat— And the Saving Is Big

All the parts come to you cut, shaped and fitted. You simply follow illustrated directions with full sized patterns. Just a few hours' pleasant work with a saw, hammer and a screw driver and your boat is ready to launch. You pay for only the actual material needed. You save just about two-thirds what the boat builder would ask. You have complete confidence in your boat—you know that it is designed to be thoroughly seaworthy, and that it is built with the very highest grade materials. The directions are so clear—and the full size patterns are so easy to work with that any one can build a beautiful boat. You do not need experience. J. P. Brittan, of Grenfell, Sask., writes that before he started he could not saw a straight line, yet he built the fastest boat on the lake.

### Boat Patterns \$2 and Up

Take your choice of three propositions. No. 1. We send all parts with full size patterns and directions—you simply put the parts together. No. 2. We send patterns and directions with complete frame only. No. 3. We send patterns and directions only. All patterns are taken from actual models that we have built complete and tested ourselves. Here's your chance to make your boat dream come true. Build your new boat now. We will show you the way. Mail a postal or a letter today for the Brooks Boat Book and get the full story. Address

**Brooks Mfg. Co. 8203 Rust Ave.  
Saginaw, Mich.**

The Largest Plant of Its Kind in the World  
Originators of the Pattern System of Boat Building



### Write— Get This Great Boat Book Free

See illustrations of beautiful cruisers, "V" Bottom Models, motor boats, launches, sail boats, row boats, canoes—boats of all kinds that you can build easily and in spare time.





W. T. Wells, who lives two miles west of Wauchula, Florida, made \$787.50 from one crop of beans, cucumbers and melons, between the rows of young grapefruit and orange trees. Only 5 $\frac{1}{4}$  acres. Wauchula Combination Soil means a **good living** from the start in vegetables, and fortune when the grapefruit and orange trees begin to bear.

## Roses Are Blooming in Florida Now

Down in Wauchula, Florida, today, people are enjoying outdoor life. Warm air, perfumed flowers, real spring sunshine. Men, women and children are healthy and prosperous.

Haven't you looked forward to the time when you could escape from hurly-burly BUSINESS and live a free out-of-door life? Haven't you often wished you could avoid snow, ice, rain, sleet, blizzards, that make up the Northern winter?

You CAN get back to the land and at the same time double or triple your income.

THE REASON—Wauchula Combination Soil—equally well adapted to vegetables and citrus fruits.

Vegetables are planted between the rows of young grapefruit and orange trees. Three and four crops a year is common. And see what a crop makes. Mr. Wells' record above is only average.

Don't think vegetables make the BIG money. They're just the start. Vegetables keep you comfortable and pay

for your land. But you can cash in when your grapefruit and orange trees begin to bear. Then you'll be in the class of men who make \$3,000, \$5,000, \$8,000—even \$10,000—a year.

Get this straight. Everything we tell you you can do at Wauchula other men have done time after time. And more big successes in the Wauchula District today than ever before.

Come to Wauchula. And don't imagine you're coming to a wilderness. Beautiful orange groves dotted all over this region. Many of them ten to twenty years old. Four banks in Wauchula and two neighboring towns have deposits of nearly \$500,000. Vandolah is a new, rapidly growing town. Wauchula now 2,000 inhabitants—1,500 last year. Churches, modern schools, lodges, well-equipped and stocked stores. First class transportation. Live cash markets right at Wauchula. Immediate sales of crops on good basis. Fine water, good drainage, healthful climate the year round. Hunting and fishing right at hand. More money, more health, more happiness.

## Land GUARANTEED By Bankers —Wauchula District, Florida

Wauchula soil is so rich, so fertile, so productive—the climate and yield are so remarkable—that the home company of bankers behind it guarantee your satisfaction.

These bankers guarantee your land. You have a year to inspect your plot. Plenty of time to arrange a trip down here. Make a vacation of it. You'll be taken all over this region in an automobile. You can talk to grove owners,

investigate our statements of \$3,000 to \$8,000 a year incomes. And then if you're not satisfied, every cent of your money will be returned with 6 per cent interest.

The first payment clinches your option on a choice plot of rich vegetable and citrus fruit land. And your money will have been earning 6 per cent all the time we've had it if you decide not to keep your land.

## Do You Want a \$3,000 to \$8,000 Yearly Income? Then Write for the Facts

You may have read land ADVERTISING before—but you never had another land OFFER like this. The reason is that there's only ONE Wauchula District. If there's land anywhere else in the United States about which our statements can be truthfully made we've yet to hear of it.

WRITE FOR OUR LITERATURE—LEARN WHY YOU CAN MAKE \$3,000 to \$8,000 a year. Study our entire offer, our low prices, easy terms, bankers' guarantee. Get this information NOW—today. Send a letter, postal or the coupon.

WAUCHULA  
DEVELOPMENT  
COMPANY,  
Box 72  
Wauchula, Fla.

Please send me actual facts regarding your combination vegetable and citrus fruit land. Also prices, terms, guarantee, settlers' letters, etc.

Name .....

St. No. or R. F. D. ....

Town .....

State .....

**Wauchula Development Co.**  
Box 72 Wauchula, Florida

# DON'T SELL YOUR AUTOMOBILE

Bring it up to the Minute with a NEW STODDARD-DAYTON BODY 3 sizes 2 and 4 passenger roadsters. 6 sizes 4-5-6 and 7 passenger Touring Bodies. Fore door deep crawl light delivery body. These bodies FIT ANY CHASSIS. Sold at  $\frac{1}{4}$  cost of Manufacture WHILE THEY LAST. Send for our Illustrated Circular with DIMENSIONS.

**STODDARD-DAYTON SALES CO. (BODY DEPT.)**

WEST OF MISSISSIPPI

3701 Main St., Kansas City, Mo.

EAST OF MISSISSIPPI

E. State and Fremont Sts., Dayton, O.



## No Tiresome Stooping

nor back-breaking effort when you use a Bissell. It readily gathers up the threads, clippings and other miscellaneous litter that utterly defy other methods of cleaning.

# BISSELL'S

"Cyco" BALL BEARING

## Carpet Sweeper

cleans deeply, thoroughly, silently, and confines the sweepings within the sweeper case. It's an added comfort to have two sweepers—one for upstairs and one for down. Sold by dealers everywhere at \$2.75 to \$5.75. Let us send you the booklet, "Easy, Economical, Sanitary Sweeping."

**BISSELL CARPET SWEEPER CO.**  
Grand Rapids, Michigan

"We Sweep

the World"



Please Mention Popular Mechanics

**FINDS THEM:**

**LEAVES THEM:**

**SKAT SOAP** Quickly removes grime, grease, dust, etc., from hands, leaving white and soft. Needed in every household, garage, office and factory. A great cleanser—injures nothing, 10c cans everywhere—but if your dealer hasn't it, send his name for free sample.

**SKAT** **THE SKAT COMPANY**  
Dept. P HARTFORD, CONN.  
AGENTS AND DEALERS  
Write for liberal terms.

**MAKE  
\$200 A  
MONTH**

**BE YOUR  
OWN  
BOSS**

If you are making less than \$50 a week write us today. We can help you to wealth and independence by our plan, you can work when you please, where you please, always have money and the means of making far more of it.

**JUST LISTEN TO THIS**

Mr. Lloyd started from San Francisco and traveled to New York. He stayed at the best hotels, lived like a Lord wherever he went and cleaned up more than \$10.00 every day he was out. Another man worked the fairs and summer resorts, and when there was nothing special to do, just started out on any street he happened to select, got busy and pulled in \$8.00 a day for month after month. This interests you, don't it?

**MY PROPOSITION** is a Wonderful New Camera with which you can take and instantaneously develop pictures on paper, Post Cards and Tintypes. Every picture is developed without films or negatives and is ready to deliver to your customer in a minute after making the exposure. **This remarkable invention** takes 100 pictures an hour and pays you a profit of from 500 to 1,500 per cent. Everybody wants pictures and each sale you make advertises your business and makes more sales for you. Simple instructions accompany each outfit and you can begin to make money in a short time after the outfit reaches you.

**WE TRUST YOU** So much confidence have we in our proposition that we trust you for part of the cost of the outfit. The regular selling price of the Camera and complete working outfit is reasonable. The profits are so big, so quick, so sure that you could afford to pay the full price if we asked you to do so. But we are so absolutely certain that you can make big money from the start that we trust you for a substantial sum which you need not pay unless you clean up \$200 the first month. **Fair enough, isn't it!**

Do not delay a minute, but write us today for our free catalog and full particulars.

**L. LASCELLE, 627 W. 43d St., Dept. New York**

# Yes, Billiards!

## It's the Finest Home Pastime for Leisure Hours

The game of Billiards is today recognized everywhere as the ideal pastime and relaxation for leisure hours at home. It is wholesome, healthful and beneficial.

The time has come when a Billiard Table fills just as important a place in the home as the piano. Billiards is a stimulating, interesting game of skill in which young and old may indulge to their hearts' content, with the greatest pleasure and profit.



The Brunswick-Balke-Collender Company, oldest and largest of all Billiard Table concerns, now offers a complete line of Home Billiard and Pocket-Billiard Tables, in a variety of styles. The tables possess the same superlative excellence in playing qualities as the world-famous Regulation Tables bearing the BRUNSWICK name.

## "Baby Grand" The Beautiful Table With the Fast Cushions

The "Baby Grand" is by far the finest home-size Billiard Table made. It is a superb creation in genuine Mahogany. Fitted with the celebrated Monarch Cushions which have the highest possible speed obtainable with absolute accuracy of angle. Slate Bed is covered with the finest imported Billiard Cloth. The angles and cushion action are absolutely unexcelled. The "Baby Grand" furnished as a Carom, Pocket-Billiard, or Combination Carom and Pocket-Billiard Table. Sizes 3x6, 3½x7, 4x8. Other Brunswick styles include the popular "Convertible" Billiard and Pocket-Billiard Tables, which serve also as Dining Tables, Library Tables or Davenport. These tables can be used in any room and serve their double purpose in a most admirable manner.

### A Word to Parents

The widespread adoption of billiards by Young Men's Christian Associations, Institutional Churches and Welfare Associations is the highest possible tribute to its value as an innocent diversion for young folks.

Your boys and girls will get a world of enjoyment and benefit from a Brunswick Home Billiard Table. Billiard playing affords a combination of mental training and mild physical exercise. It cultivates concentration and self control. Hundreds of parents gladly testify to the good results secured.

Ask for a little book entitled, "Our Boys Now Live at Home," in which fathers and mothers tell how the "Baby Grand" has made home more attractive to boys.

### Free Outfit Included

The price of each table includes a complete, high grade Playing Outfit—Cues, Balls, Bridge, Rack, Chalk, Assorted Cue Tips, Cue Tip Cement, Markers, Billiard Brush, Lightning Cue Clamps, Wrench, Spirit Level, Cover, book on "How to Play," etc., etc., etc.

**The Brunswick-Balke-Collender Company**  
Dept. SA—623-633 So. Wabash Ave., CHICAGO

### Easy to Buy —Here's Why

We are pleased to extend the most liberal terms of payment on any size or style of Brunswick Home Billiard Table you may select. Let the small payments cover an entire year if you desire. You will find it true economy to buy a *real* billiard table, rather than a mere makeshift. Brunswick home-style tables are as well built as our larger sizes and will give lifetime service.

**Send Coupon** for richly illustrated book, "Billiards—The Home Magnet." Free postpaid

The Brunswick-Balke-Collender Co., (207)  
Dept. SA, 623-633 S. Wabash Ave., Chicago

Please send me the free color-illustrated book —  
"Billiards—The Home Magnet"

Name .....

Address .....

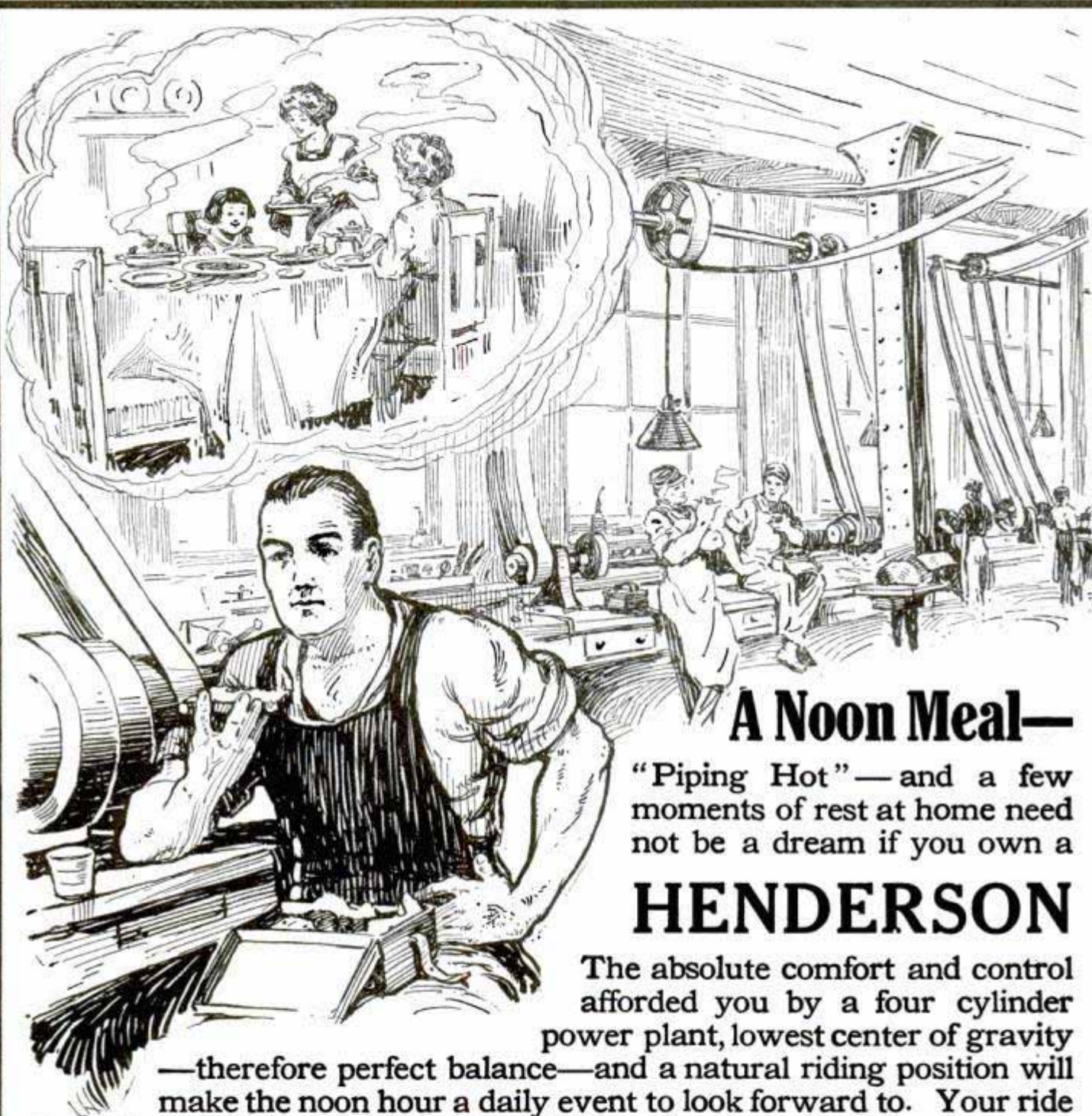

## A Noon Meal—

“Piping Hot”—and a few moments of rest at home need not be a dream if you own a

## HENDERSON

The absolute comfort and control afforded you by a four cylinder power plant, lowest center of gravity —therefore perfect balance—and a natural riding position will make the noon hour a daily event to look forward to. Your ride through the bracing outdoor air will *fit* you for the toils of the afternoon.

**AND IT COSTS BUT  $\frac{3}{4}$  OF A CENT A MILE**

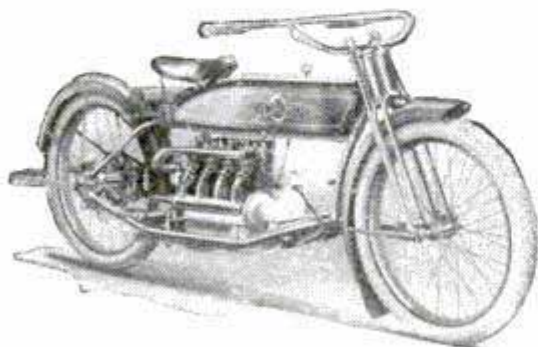

4 Cylinders, 8 H. P.

Two Speed Model

**\$325<sup>00</sup>**

**\$365<sup>00</sup>**

Our nearest dealer will demonstrate to you, or write for the Henderson letter

**HENDERSON MOTORCYCLE COMPANY**

**DETROIT, MICHIGAN**

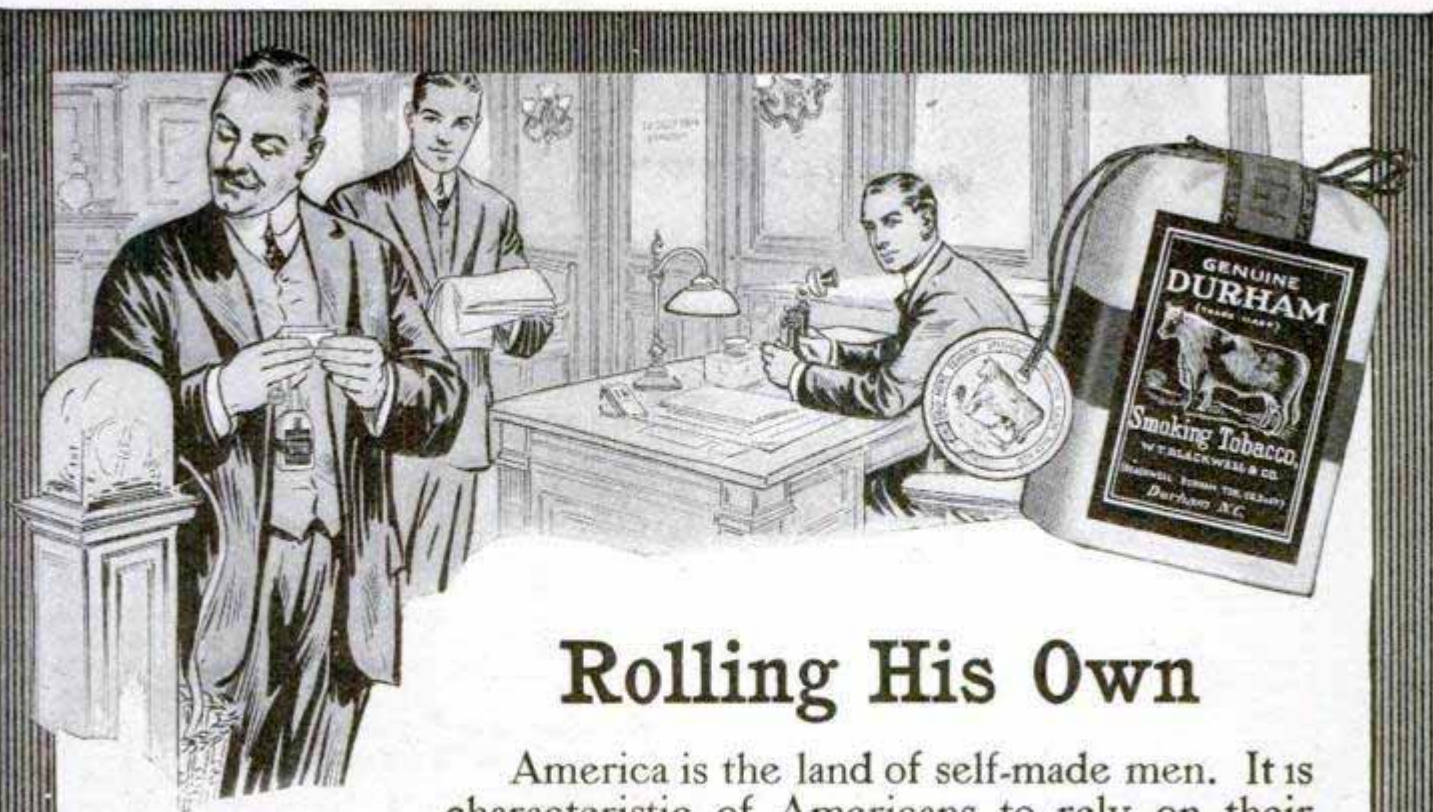

## Rolling His Own

America is the land of self-made men. It is characteristic of Americans to rely on their own efforts—to do things for *themselves*. The millions of "Bull" Durham smokers are of this energetic, self-reliant, American type in all walks of life. These men like to *make their own cigarettes*, to their liking, from ripe, mellow "Bull" Durham tobacco—*prefer* these cigarettes, made by their own hands, to any ready-made kind they can buy.

Particularly notice the unique and pleasant aroma of "Bull" Durham. It is as distinctive to "Bull" Durham as the cocked hat is to Napoleon.

GENUINE

# "BULL" DURHAM

## SMOKING TOBACCO

(Enough for forty hand-made cigarettes in each 5-cent sack)

Ask for **FREE**  
book of "papers"  
with each 5c sack

The "Bull" Durham aroma is produced by a secret process known only to the makers of this tobacco. You get this delightful fragrance only in "Bull" Durham.

**FREE** An Illustrated Booklet, showing how to "Roll Your Own," and a Book of cigarette papers, will both be mailed, *free*, to any address in U. S. on postal request. Address "Bull" Durham, Durham, N. C.

THE AMERICAN TOBACCO COMPANY



# Drawing \$150 a Month



**T**HAT'S the ordinary salary for a Draftsman. Hundreds making much more. I have trained hundreds of men—given them the practical instruction that put them in the big money class. The opportunities are almost unlimited. Jobs paying from \$75 to \$100 a week are open right now. Send me the coupon now. I'll send you free and prepaid a new book on drafting and tell you how you can qualify for one of the big jobs.

## You Can Do It

Yes, sir—**YOU** can become a draftsman and get into the big money class. No experience necessary. I will give you practical instruction—the kind that the big firms are demanding—right in your own home. And furthermore, I will give you this instruction just so long as you need it. **I guarantee to train you in practical drafting and designing until you are in a position paying at least \$125.00 a month.**

### Chief Draftsman Will Instruct You

I am Chief Draftsman of a large and well known company. For over 20 years I have been doing the highest paid drafting work and I know just the kind of training that the big firms are demanding. Practical instruction is absolutely necessary and it is by practical instruction that I fit you to accept a high salaried position. My offer to give personal instruction to a few ambitious men is limited. Send the coupon.

## FREE

### \$15 Draftsman's Working Outfit

I'll give you this complete \$15.00 outfit free as soon as you enroll. Practical regular working instruments—just the kind I use myself. Sent to you absolutely free. Send the coupon.



## Earn While Learning

I have even perfected a plan which gives you an opportunity to begin earning money as soon as you have enrolled as one of my personal students. This enables a few young men or older men who could not otherwise take up this practical, personal training which I give, to pay their way as they go along. Write for this plan today.

## Positions Open Now

Right now—this very minute—there are many positions open that pay \$3,000 and more per year to the right men who have learned drafting. There is lots of room at the top. I got there myself but have found all around incompetent men holding poor positions. They had not been trained right. The thing I want to do is to train you in the practical way you ought to be trained; to show you what to avoid and how to do things right. **YOU** can get one of the big jobs soon if you will merely send me your name on the free coupon below. No obligations of any kind.

### I Guarantee

To instruct you until competent and in a permanent paying position at a regular Draftsman's salary of at least \$125 to \$175 per month and guarantee to furnish you free complete Draftsman's working outfit at once from the start.

## Send The Coupon For Big New Book

Put your name and address on the coupon or a letter or a post card and send to me today. I'll send you absolutely free and prepaid the new book on drafting "Successful Draftsmanship" and tell you all about my great offer to train you to become an expert draftsman. No obligations in sending the coupon. Don't delay an instant—your opportunity to get into the big money class is here. The coupon starts you up the ladder to success. Send it—now.

## CHIEF DRAFTSMAN

Engineers Equipment Co. (Inc.) Div. 1193 Chicago



### Free Course Offer Coupon Chief Draftsman

Engineer's Equipment Co.  
Div. 1193. Chicago, Ill.

Without any obligation to me whatsoever, please mail your book "Successful Draftsmanship," and full particulars of your liberal "Personal Instruction" offer to a few students. It is understood that I am obligated in no way whatever.

Name .....

Address .....

# Genuine Perfect Cut DIAMONDS \$97.50 PER CARAT

## How We Can Sell Diamonds at This World's Lowest Price

By importing *direct to you from the diamond cutters* of Europe we save you *more than \$50 per carat*; for by our plan we eliminate the expenses and profits of three middlemen! Our cash methods avoid all expenses and losses; and because ours is the largest cash diamond mail business in the world, we can figure on the smallest, closest profit over the original importing cost! We ship any diamond to your city at our expense; *ALLOW FREE EXAMINATION*; permit any comparison; and unless you plainly see a saving of at least 33%, you may order it returned at our expense!

### A Few of Our Wonderful Values



No. 24701  
14K. Solid Gold  
Engagement Solitaire  
Complete with

1/8 carat dia. . . .	\$ 12.00
1/4 carat dia. . . .	\$ 21.25
1/2 carat dia. . . .	\$ 48.75
3/4 carat dia. . . .	\$ 71.25
1 carat dia. . . .	\$101.25

**Importers' Prices for**



No. 24702  
Solid Gold  
Tie Clasp

Guaranteed,  
patent spring

1 diamond

**\$1.00**

No. 24703  
14K. Solid Gold  
Tooth Solitaire Ring  
Complete with

1/8 carat dia. . . .	\$ 13.75
1/4 carat dia. . . .	\$ 23.00
1/2 carat dia. . . .	\$ 50.50
3/4 carat dia. . . .	\$ 73.00
1 carat dia. . . .	\$103.00

**Genuine Perfect Cut Diamonds!**

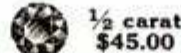
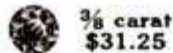
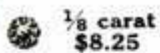

—and in addition, we protect you with our

## MONEY BACK GUARANTEE

—nothing like it in the whole diamond business: an **unanswerable argument** that has given us the world's business after we have shown that our values are the world's best! Written legal guarantee to refund the full price in cash, less 10%, any time within 2 years and to allow the full purchase price in exchange any time! Carat weight, quality and value legally certified in writing.

If you are at all interested in Diamonds—if you own a Diamond or expect to buy one now or in the future, you will appreciate the helpful, expert information in the

### 128-page DE LUXE BASCH DIAMOND BOOK—FREE!

Explains how direct importing, cash methods and low expenses enable us to save you more than 1/3 on any diamond. 10,000 illustrations of the latest fashions in Diamond, Platinum, Gold and Silver Jewelry, Watches, etc., at factory prices. An authoritative book that is well worth owning.

DE LUXE BASCH DIAMOND BOOK **FREE!**

Please mail me copy of 1914 De Luxe Basch Diamond Book, without cost to me or obligation to purchase.

Name .....

Address .....

Address  
**L. BASCH & CO.**  
Dept. M247  
State and Quincy Sts., CHICAGO



**L. BASCH & CO.**

Dept. M247, State and Quincy Sts., CHICAGO

This machine  
has settled  
the Oilstone  
question



Longest Lasting



These three stones have undergone an equal test on the rubbing bed. See how the Pike India Oilstone (in the center) has held its thickness and shape.

Fastest Cutting



Magnified edges of two chisels after each had been given an equal test by the machine. No. 2 shows the fine, smooth edge produced by Pike India.



## PIKE INDIA OILSTONES

SCIENTIFIC tests made lately on this ingenious machine, especially designed for the purpose of testing abrasives, have proved beyond a doubt that Pike India Oilstones are the **FASTEST CUTTING** and the **LONGEST LASTING** oilstones made.

In competition with other stones of corresponding grits, these tests proved that—

- 1—Coarse Pike India cuts 4 times as fast and lasts 3 times as long.
- 2—Medium Pike India cuts just as fast and lasts 7 times as long.
- 3—Fine Pike India cuts twice as fast and lasts 3 times as long.

The many tests, covering several weeks' time, were made in duplicate to check up the results more accurately. Both the stones and the chisels were carefully weighed and measured, before and after each test—and the average of all the tests gave the conclusive results here stated.

PIKE MANUFACTURING CO.

"Fastest cutting" means a saving of *time*.  
"Longest lasting" means a saving of *money*.  
So why buy any but Pike India Oilstones?

Pike India Oilstones are made in 66 shapes and in three grits—coarse, medium, and fine. There's a right style for every use in homes as well as in shops. Ask your dealer to show them to you. Also ask to see Pike Peerless Grinders, the Pike Strop-Hone and the Pike India Kantbreak Knife Sharpener.

"PICK A PIKE"

**FREE** A Pike India Stone

Send us your dealer's name and 4c for packing and mailing and we'll send our Pike India Vest Pocket Stone for pen knives, ink erasers, office use, etc., also our famous book "How to Sharpen"—tells how to get a good edge on knives, tools, etc., and how to select and care for oilstones. You'll be pleased. Write today.

193 Main Street. Pike, N. H.



**"CUT OUT REPAIR BILLS—Build of CYPRESS Lumber at FIRST!"**

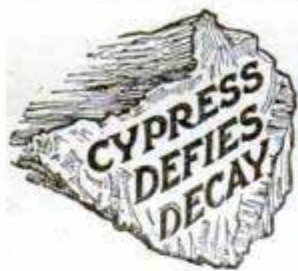

# CYPRESS

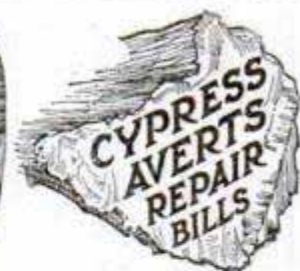

In response to a very wide demand we respectfully offer  
**Another Cypress House Plan Free**

The artistic, cozy and strictly modern CYPRESS SHINGLE HOUSE shown below meets completely and delightfully the desires of people who need more room than most bungalows contain, yet who wish to "keep the cost down." This CYPRESS house has 9 rooms besides the basement, and should be built complete for close to \$3,800. Complete WORKING PLANS and SPECIFICATIONS (sufficient for any competent carpenter to build from) are YOURS WITH OUR COMPLIMENTS IN VOL. 29 OF THE CYPRESS POCKET LIBRARY, SENT ON REQUEST. WRITE TODAY.

"Stop Depreciation BEFORE IT BEGINS—  
 BUILD WITH CYPRESS AT FIRST!"

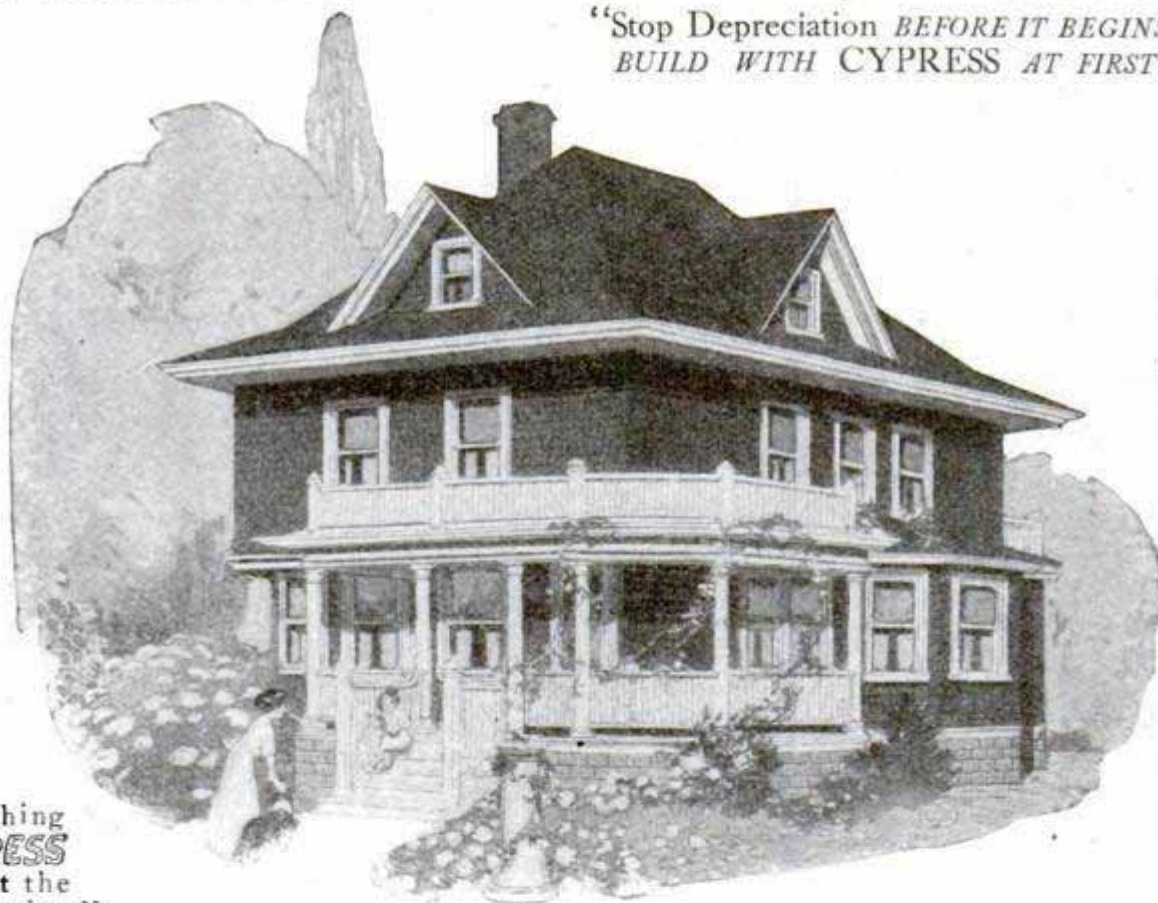

"Everything  
**CYPRESS**  
 except the  
 window glass."

Mr. GUSTAV STICKLEY, the well-known Craftsman, writes: "In my experience, CYPRESS is the best American wood for all exterior use, such as shingles, timbers, pergolas, and all woodwork subject to weather. Its slight natural oil makes it practically impervious to moisture, so that it does not shrink or swell like other woods, and is very durable when protected merely by a coat of oil. In this it is similar to teakwood, in my opinion is quite as durable, and of course much more practicable."

ASK our "ALL-ROUND HELPS DEPT." any question about Wood. Our reply will be frank. We recommend CYPRESS only where CYPRESS can prove itself "the one best wood" for your use.

## SOUTHERN CYPRESS MANUFACTURERS' ASSOCIATION

1219 HIBERNIA BANK BUILDING, NEW ORLEANS, LA.

We produce CYPRESS—and talk it—but do not retail it. INSIST ON IT NEAR HOME. Probably your Local Dealer sells CYPRESS; if not, WRITE US, and we will tell you where you CAN get it.