

# POPULAR MECHANICS MAGAZINE

WRITTEN SO YOU CAN UNDERSTAND IT



Motorcycle Fire Equipment  
For Rural Service  
Page 181

# \$10,000 PLAN BOOK FREE

Photographic Reproductions, Floor Plans, Complete Prices, Etc., Etc.,  
The most comprehensive volume of its kind published. Really too valuable to give away  
indiscriminately. If you intend building and desire some practical suggestions, write  
today, and get a copy FREE from

## The World's Greatest Bargain Center We Save Home Builders 30% to 50%

No one else in all the world can make such low prices on NEW, HIGH GRADE building material and merchandise. Our reputation as "CASH BUYERS" places at our command first every bargain worth having. We are satisfied with one small profit. All the in-between profits of the wholesaler, jobber and retailer remain in your pockets. Think what a saving this means for you! Read below what our customers say. Do you want any better proof?

**YOUR PROTECTION: UNCONDITIONAL GUARANTEE; CAPITAL STOCK \$10,000,000.00.**  
NO MONEY IN ADVANCE; WE SHIP SUBJECT TO APPROVAL.

We would not dare ship you a carload of building material, valued anywhere from \$300.00 to \$2,000.00 without ONE CENT DOWN, if we misrepresented one single item. You are perfectly safe and can arrange to pay for the material after it is received.

### FREE PLAN OFFER

Complete Blue Print Plans, Specifications and Material List free if you purchase. If sent for examination. \$2.00 deposit required; money refunded if unsatisfactory.

### Architectural Service

We develop building ideas. If you are not suited with any of the designs in our book, our building experts can help you. A special department of personal service for the individual home builder.

### \$86.95 Modern Plumbing Complete for this Design

Those who know quality are always astonished at our low prices on high grade plumbing material; no seconds—everything strictly first-class. System complete from ground line up, including Bathroom Outfit, Kitchen Sink and Range Boiler; all roughing-in material.

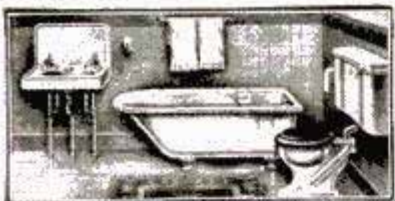

# \$759

BUYS THE MATERIAL  
FOR THIS HOUSE  
HOUSE No. 6-A

An example of our truly wonderful bargains: A modern home of 7 rooms and bath. Our Plan Book contains more than 100 carefully selected designs.



### Description of No. 6-A

House No. 6-A is a full two-story residence, size 23 ft. by 33 ft. 3 in., up-to-date; well planned for comfort and convenience, standard construction. Large porch; abundance of light; good ventilation; economically heated.

### Material Specification

No. 1 Framing Lumber; Clear Siding; Red Cedar Shingles; Clear Geo. Pine Interior finish; 5 Cross Panel Doors; Clear Y. P. Flooring; windows glazed; door and window frames fitted; hardware to match; sheathing, sub-floor, nails, sheet metal, etc. Quantities guaranteed.

### Complete Hot Air \$87.22 Plant for this Design



At this price we will furnish you with the complete hot air plant, efficient in every way. Can be easily installed by anyone handy with the use of tools. We furnish comprehensive instructions and necessary blue prints and drawings. Let us make you an estimate on a hot air, steam or hot water heating plant. We can quote prices that will save you 30 to 50 per cent; easy to install; all necessary instructions furnished, so any man of ordinary intelligence can easily install his own plant.



Complete Steam Heating Plant. \$188.63  
Complete Hot Water Plant. \$199.24

## PROOF!

Thousands of satisfied customers have written us letters similar to these. We do not wish to have these good folks annoyed by unnecessary correspondence but will supply Post Office addresses to any showing sufficient interest.

### \$1,000.00 Saved

Everything arrived in good condition. I saved on the building, including steam heat and bathroom outfit, about \$1,000 as this kind of lumber would be very dear here. My house is open for inspection at all times.

(Signed) LEWIS YOUNG  
Pennsylvania

### \$700.00 Saved

I am perfectly satisfied. Don't be a bit backward in referring to me for you have done all and if anything more than you agreed to do by me. I saved on house, \$700.00 and also got better material and a better house.

(Signed) JOHN J. DUNN  
Ohio

### \$300.00 Saved

We received the lumber in good shape. Everything came that the plan called for. I have saved \$300.00 on the house by buying lumber of you. You can refer anybody to me that you want to, and they can inspect our house.

(Signed) THOS. JENSEN  
Illinois

### \$200.00 Saved

I write to express my entire satisfaction with the lumber which you sent me last fall. I have saved about \$200.00 in spite of the heavy freight rates for a haul of about 1100 miles.

(Signed) FRANK W. SMITH  
Massachusetts

## Send Us Your Lumber Bill For Low Estimate

Enormous stock always on hand, ready for quick shipment. Our marvelous facilities in buying, handling and distributing enable us to undersell any market. Great bargains in building materials of every kind: Mill work (Doors, Windows, Frames); Mantels and Grates; Cabinets, Colonnades and Grilles; Hardware; Paint; Structural Iron; Sheet Metal, Roofing, etc., etc. Also Furniture, Carpets, Rugs, Groceries, Clothing, Shoes and other general merchandise. We handle nearly everything and we can save you money on everything we handle. If you can spare the time come to Chicago and get acquainted with us. A trip through our plant will be an education in economy.

## CHICAGO HOUSEWRECKING CO.

Prominently known to the public for 20 years as the great "Price Wreckers" and now owned by the Harris Brothers Company, have decided that their best interests require that the name of the principal owners of the company be more prominently brought to the public's notice. There is no change in our business, except that the four Harris Brothers will, in the future advertise and sell their goods, heretofore advertised and sold under the name of the CHICAGO HOUSEWRECKING COMPANY, under the name of the Harris Brothers Company.

FREE CATALOGS—Building Material; Plumbing; Heating; Paint; Electric Lighting; Furniture and Stoves; Roofing; Clothing; Shoes and a Mammoth General Catalogue which embraces everything.

# Harris Bros. Co. 35<sup>th</sup> & IRON Sts. Chicago

Be sure to mention  
DEPT. GG-7

**"Why do you buy it by the box?"**

**"Why not? It's  
only 85 cents  
for twenty  
5 cent  
packages.**

**Clean,  
pure,  
healthful**

**WRIGLEY'S  
SPEARMINT** 

**is the only gum  
I buy any way!"**

**"It brightens my  
teeth, stimulates  
saliva and aids  
digestion."**

**Be SURE it's  
WRIGLEY'S.**

**It's the hospitality  
confection. It stays  
fresh until used.**

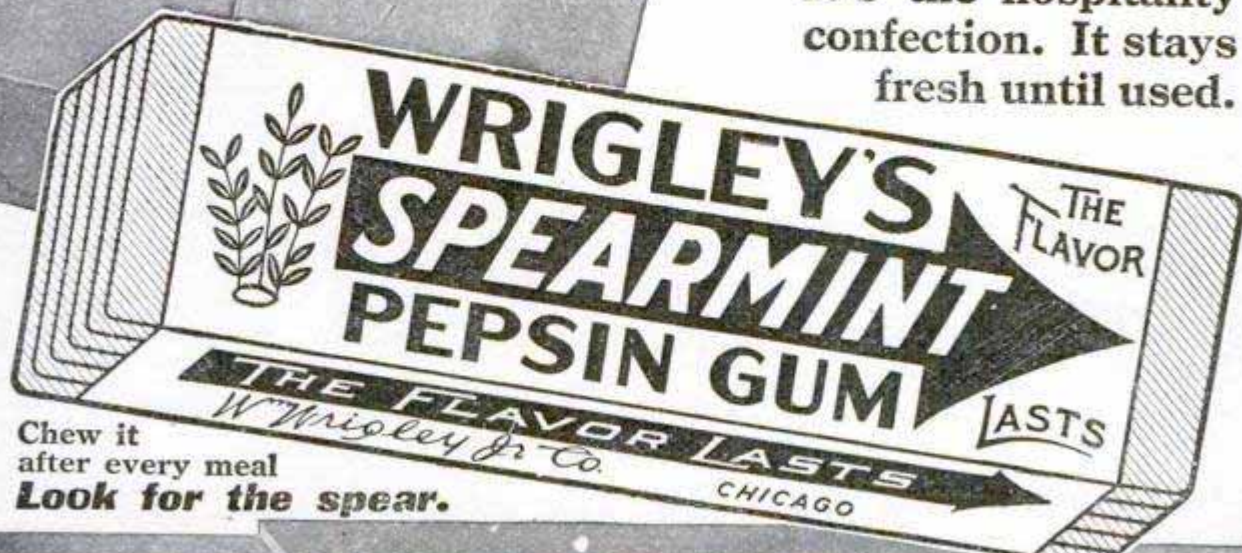

Chew it  
after every meal  
**Look for the spear.**

This One



0967 477 5014

Please Mention Popular Mechanics

# NEXT COMES the CYPRESS "SUGI" BOOK:

"The most usable free book ever printed for folks like you and us."

## HERE'S A CYPRESS "SUGI" TRAY

THAT YOU CAN DUPLICATE FOR WEDDING GIFTS

by your own labor (and very little of it) and at the smallest cost.

ornate effect is  
CYPRESS GRAIN.

This wonderfully  
THE NATURAL



Its tone is a Rich  
Lasts forever. Done

Warm Brown.  
with Torch and Brush!

"The most distinguished novelty in Wood Finish presented to the artistic public in a century." (*And you can do it.*)

It reproduces perfectly the famous Antique Japanese Driftwood Effects

### Get your order in for New VOL. 26 Cypress Pocket Library

at once so as to give you time to decide *what* articles made of *SUGI* you want to give, and whether to make it yourself or hire it done. The book tells all about it, gives many delightful ideas *what to make* of light-weight Cypress boards after applying the wonderful Japanese "Sugi" finish, and tells exactly *How To Do The Work At Home.*

(Note: The same process has been attempted on other woods but without success. This is our good fortune as well as yours. LEARN WHY in *new Vol. 26.*)

When planning a Mansion, a Bungalow, a Farm, a Sleeping-Porch or just a Fence, remember—"With CYPRESS you BUILD BUT ONCE."

Let our "ALL-ROUND HELPS DEPARTMENT" help YOU. Our entire resources are at your service with Reliable Counsel.

**SOUTHERN CYPRESS MANUFACTURERS' ASSOCIATION**  
1219 HIBERNIA BANK BUILDING, NEW ORLEANS, LA.

INSIST ON CYPRESS AT YOUR LOCAL DEALER'S. IF HE HASN'T IT, LET US KNOW IMMEDIATELY

CROSBY-CHICAGO

# Popular Mechanics Magazine

318 W. Washington Street, Chicago, U. S. A.

EDITED BY H. H. WINDSOR

ISSUED MONTHLY

SUBSCRIPTION:

SINGLE COPY, 15 CENTS

In United States, and its possessions, Cuba and Mexico, per year, postpaid - - - - \$1.50  
To Canada - - - - - 1.75  
To all other countries in the Postal Union - - - - - 2.50

All subscriptions are discontinued at expiration. Please examine the date printed on your wrapper.

Entered as Second Class Matter Sept. 15, 1903, at the Post Office at Chicago, Illinois, under Act of March 3rd, 1879.  
Entered as Second Class Matter at the Post Office Department, Canada.

Published monthly by POPULAR MECHANICS CO.

Copyrighted 1914, by H. H. WINDSOR.

The attention of prospective advertisers is called to the policy of this magazine in accordance with which the publisher waives all claim for payment of any advertisement appearing in any issue where the number of copies actually printed and circulated is less than the number printed on the front cover page.

## Contents for February, 1914

Accident Preventers and Safety Tools.....	239	Electricity, Effect of, on Human Body.....	230
Accident to French Interurban.....	210	Electricity for Cooking Fostered by Cities.....	175
Aeronautics, Bird Muscles and.....	205	Elephant That Uses a Typewriter.....	159
Aeroplane in Postal Service, French Use.....	226	Engine, Runaway, Goes to Market.....	188
Airmen, New Belt Designed for.....	166	Engines, Gas, Cooling with Injected Water.....	206
Aluminum Utensils Safe for Cooking.....	222	Fan, Multiblade, Gives Large Air Current.....	175
Aluminum-Wire Coils for Electrical Apparatus..	229	Fireplaces of All the World.....	268
Ameer of Afghanistan Has 58 Motors.....	177	Flagpole, Big, Erecting at Vancouver.....	156
Angle Indicator, New, an Aid to Airmen.....	267	Flood, Disastrous, in Texas.....	192
Arch, Curious Flat Brick, in Panama.....	216	Flying Boat, New, Adapted to Inland Rivers...	246
Automobile Designs, Styles in Women's Dress		Friction Drive Uses Cone for Speed Variation...	166
Control.....	245	Frying a Steak with a Newspaper.....	242
Automobile Scissors Grinder.....	164	Gas, High-Pressure, for City Lighting.....	239
Automobiles, Luxuriously Furnished.....	258	Gas Well, New Method of Closing "Wild".....	250
Automobiles, Sand-Box Equipment for.....	216	Glass That Cracks but Will Not Splinter.....	271
Automobiles, Spring-Leaf Spreader for.....	235	Gun, New Invention Makes Carrying Easy.....	242
Automobiles, "Trouble" Lamp for.....	237	Guns, Big, Result of Testing Steel in.....	254
Automobiles with Plenty of Storage Space.....	250	Hacksaw Test, Remarkable.....	209
Aviation—How Airman Steers Biplane.....	179	Horns Clear Streets for Fire Engines.....	159
Aviation—Long-Distance Flight by French Air-		House-Boat Replica of Columbus Caravel, Unique	210
man.....	156	House, "Futurist," Odds and Ends Used to Make	168
Aviation—Navy Man Flies 40 Miles without Using		House Moved on Floating Dry Dock.....	249
Hands.....	271	House Plans—Conveniently Arranged Six-Room	
Aviation's Death Toll in 1913 the Heaviest Yet..	184	Cottage.....	308
Bamboo Grove Preserved in Erecting Building..	161	Hub Registers the Miles in New Device.....	214
Bananas, Handling by Machinery.....	258	Ice Boat, Air-Propelled, Newest Motor Vehicle..	217
Band Stand, Concrete, Built in a Day.....	222	Igorrotes Make Steep Mountains into Rice Fields.	218
Battleships, Reading Rooms on.....	159	Irrigation Dam, Another Great Completed.....	208
Block of Stores Only Six Feet Deep.....	263	Irrigation of Bombay an Enormous Project.....	248
Boiler, Floating 60-Ton from Ship to Shore.....	242	Lamp, Glareless, for Automobiles.....	188
Bridge, Concrete, with Suspended Floors.....	264	Light, New Emergency, for Electric-Lighted Cars	273
Building, Collapse of Reinforced-Concrete.....	246	Lions, Man-Eating, Menace Railroad Builders....	197
Canal Zone, Strong Defenses of.....	240	Locomotive, New Type of Railway.....	200
Carboy, Danger-Lessening Device for.....	229	Locomotive, Wrecks, to Save Train.....	262
Card Index, Visible, Newest Office Help.....	252	Lunch-Counter Cars, Railroad to Run.....	172
Carriage over 200 Years Old Still in Use.....	233	Mail Box, New Type Recently Adopted.....	202
Cave Dwellers, Home of African.....	254	Memorial Bell, Spoil, to Save Human Life.....	264
Cement, Substitute for, Used in Turkey.....	225	Mine-Rescue Car, New.....	158
Chimney, Brick-Lined Steel, 400 Ft. High.....	170	Mine-Shaft Accidents, Simple Device Prevents..	215
Clock Dial, Vertical, with One Hand.....	238	"Mona Lisa," Famous Painting, Found.....	167
Clock with Single Hand Tells Time Accurately..	244	Motor Bus, Glass Roof Novel Feature of.....	203
Clothes Wringer, New, Has Pneumatic Rollers...	240	Motor Car, Pontoon, to Cross Africa.....	190
Coal-Handling Plant, Lake Superior.....	270	Motor Fire Engine, Homemade Trailer for.....	177
Collapse of Busy Chicago Street.....	226	Motor Sleigh Breaks Snow Roads.....	203
Colliers, New Navy, are Highly Efficient.....	162	Motor Truck Crosses Alaska.....	267
Color-Blind, New Type of Danger Signal Benefits	246	Motor Truck, New Low-Platform.....	273
Concrete Pillars, Artistic, for Bungalows.....	170	Motorcycles, Simple Exhaust Silencer for.....	236
By Albert Marple		Motorcycles, Rural Fire Departments Use.....	181
Concrete, Wires Used for Cutting Masonry and..	244	Museums, Group of, for New York City.....	169
Counterfeits, How are Detected.....	172	Nome Wrecked by Storm.....	190
Dam, Great Assuan, Proves Effective.....	292	Novel and Practical Things for Daily Use.....	232
Denver Saves Snow for Summer Fete.....	182	Oil is Future Fuel, Secretary of Navy Says....	164
Dirigible, Big American, in Passenger Service..	257	Oil on Sea, How Keeps Waves from Breaking..	256
Dirigibles, German Navy Building Two More..	243	Pacific, Japanese Cross in Small Boat.....	197
Electric Cooker, New Automatic.....	221	Panama Canal, First Vessel through.....	251

[Continued on Page 6]

Popular Mechanics offers no premiums; does not join in "clubbing offers," and employs no solicitors to secure subscriptions. It is for sale by nearly every newsdealer in the United States and Canada.

## Contents—Continued

Panama Canal, Natural Beauty of, to be Enhanced	265	Automobile Spring, Temporary Repair on	286
Panama Canal, Swims through	165	Automobiles, Ventilating Front Apartment of	279
Panama, Permanent Buildings at	173	Belts, Shifter for Overhead	294
Parcel Post will Handle Larger Packages	203	Bench Drawers, Handy Arrangement of	287
Patents, Interesting New	306	Blower for Removing Dust in a Watch	284
Peat, Brick Made of, Used as Wood Substitute	178	Boat, Keeping on an Even Keel Out of Water	279
Penguin Oil, Making, Southernmost Industry	161	Bolt Threads, Protecting, While Passing through Cored Holes	278
Pharmacy, Great, in Moscow Established 200 Years	259	Buffing Wheel, How to Make a Felt	289
Photographing Contents of Sealed Envelope	263	Burglar Circuit, Emergency	288
Plating with Spray of Molten Metal	201	Cables, Aerial, Bonding and Grounding	291
Plow, Folding, for Fighting Forest Fires	248	Carpenter's Clamps, Substitute for	289
Poison Bottles, Safeguard for	230	Cellar Door, Counterbalance for	285
Poisonous Gases Used to Dislodge Desperado	182	Chucks, Handling Large, on Lathes	280
Post-Office Clerks Use Roller Skates	194	Cleaning Iron of Burned and Caked Grease	276
Power Plant, Important, on Southern River	251	Coloring Copper	294
President Plants Elm in White House Grounds	183	Connections, Solder, for Copper or Iron Wire	278
Pulley, New, Has Novel Features	217	Cooking, Dispelling the Odors from	289
Pump, Vacuum, Valveless	237	Cutting Thick Metal with Hand Shears	289
Pumpkin, Monster, Feature of Corn Show	169	Envelope, Long, Made of Two Small Ones	277
Radium, New Method to Cheapen Cost of	217	Feed Box for Horses, Wagon	290
Radium Preparation, New, Makes Metals Lumi- nous	166	Galvanometer, Torsional Wire	285
Railroad Auto Carries Newspapers	248	Gauge, Gasoline-Tank	278
Railroad, German, Built on Sand Dunes	203	Gauge, Taper, for Boring Mills	292
Railroad Inspection Car Uses Gasoline Power	226	Gauges, End	290
Railroad in the Himalayas, Short Curve in	228	Glass, Polishing	284
Railroad Operation, Thermometer in	225	Gold Varnish	277
Railway, Cable, Revolving Platform for	236	Grindstone Frame, Truck Wheel on a	280
Refrigerator Car, New Type of Railroad	231	Keyways, Parallel, Laying Off	278
Residence Wrecked by Falling Tree	224	Kitchen Sink, Setting with Concrete	275
Ropeway, Aerial, across the Andes	156	Ladder, Adjustable Folding	275
Rubber Clings to Steel in New Process	223	Ladder, Guard Attachment for a Long	280
Safety Sought through Collision Carriages	225	Lathe Center, Revolving	284
Satchel, Thief-Proof for Paymasters	231	Lathe-Tool Guard	293
Schoolhouse, High-School Boys Build	271	Lathes, Emery-Wheel Arbor for	279
Self-Starter, Electric, for Flying Boat	212	Lathes, Taper Attachment for	288
Shaft Coupling, Flexible Insulated	243	Nails, Starting, in Inaccessible Places	283
Shaving Mirror with Electric Light	180	Nut, Emergency	290
Sidocar, Flexible, for Motorcycles	196	Overalls, Trousers Guard an Aid in Drawing On	284
Sidewalk Light, Detachable	167	Painting Figures on the Dial of a Gauge	276
Sign in New York, Idealists Erect	165	Pencils, Striping, Care of	280
Soot in the Air, Measuring the	166	Pulleys, Two, Driven by One Belt without Idler	276
Speech, Coherent, Sent across Atlantic	209	Rod Ends, Pointing	277
Sponge Fisheries, American, Worked by Greeks	260	Scarf Pin, Repairing a	284
By Leonora Beck Ellis		Screwdriver, Made of Bicycle Pedal	280
Stay Bolt, Ball-and-Socket Joint in	224	Sewer Opening, Wagon Wheel Used as Grate for	277
Staircase, Famous Geometrical	160	Shovel, Snow, Substitute for	284
Staircase, Steel, for Testing Motor Cars	228	Spline Grooves, Cutting by Hand	287
Steamship Lines, More for Atlantic	200	Telephony, Practical—Part XI, A Rural Tele- phone Line	281
Steel Tubes, Automatic Machine for Making	206	Template, Adjustable, for Making Taper Keys	276
Stone Figures, Quaint, of Old-World Gardens	266	Toggle Bolts, Homemade	284
Stone Quarry Made into Landscape Feature	174	Tongs for Holding Flat and Round Stock	293
Suction between Ships, Strength of	213	T-Square, Removable Head on	290
Taxicabs, Public Call Stations for	224	Tubing, Holding Thin Brass, for Turning	294
Telephone, Loud-Speaking, for Airmen	180	Tubing, Measuring with Ordinary Micrometer	293
Telephone Makes Cost Keeping Easier	236	Twist-Drill Driver	286
Theater, Modern, to be Built in Manila	205	Valve Tool, Homemade	286
Tire, Housing the Spare	212	Well, Watering a Dry	283
Tires, Automobile, Patch for	231		
Toothbrushes, Changeable Bristles for	242		
Tractor, Rolling-Hoop, for the Farm	155		
Train, Special, Used by German Emperor	157		
Trains, Grades Flattened to Help Downhill	231		
Trains, Marines to Handle in Enemy's Country	201		
Trap, Unique, for Burglars	230		
Trap, Humane, Invented by Health Officer	192		
Tree Surgery, Novel Case of	264		
Trees, Individual Furnaces for	266		
Trucks, Delivery, Three-Wheeled	207		
Tunnel, Highway, under Hudson River	202		
Turbines of "Aquitania"	195		
Umbrella, Wireless, Built for Strength	241		
Vehicles, Curious, in Use the World Over	198		
Ventilating Device, Automatic	170		
Water Pipe, Fence Railing Serves as	253		
Waves, Machine on Nova Scotian Coast Counts	220		
Wells, Artesian, Furnish Hydroelectric Power	268		
Window Panes, Securing with Lead	244		
Wireless Foils Vanity of African Natives	172		
Wireless Messages to Go around the World	234		
Wireless Messages, New Classification of	190		
Wounds, New Clip Forceps for Closing	235		
Wreck of Freight Steamer "Charles S. Price"	204		
Wreck Which Menaced Commerce, Destroying	176		

## SHOP NOTES

Automobile Engine, Temporary Leather Bearing Replaces Babbitt in	297
---	-----

## AMATEUR MECHANICS

Aeroplane Frames, Braces for	301
Belts, Splice for Round	302
Boring a Clean-Edged Hole	305
Brush Handles, Utilizing Old	299
Camera Shutter, Electrically Operated	300
Chisel Handle, Protector Cap for	304
Clothes Peg, Wood	305
Development Methods, Tank, Used in Tray De- velopment	296
Drawing Pen, Starting the Ink Flowing from	302
Drill Press on an Ordinary Brace	295
Drilling Thin Metal	305
Electroplating without a Tank	300
Ellipsograph, Homemade	303
Flatiron, Electric, Flexible-Cord Adjuster for	305
Galvanometer, D'Arsonval	297
Ice Racer, Pushmobile	296
Lantern Slides, How to Make Advertising	299
Milk-Bottle Tray	301
Miter Box, Homemade Picture-Frame	296
Pencil-Sharpener Stick	302
Planing Rough-Grain Boards	301
Puzzle, Spool-and-Ball	302
Scratch Pads, Making, of Old Labels	305
Springboard	301
Sweeping Compound	304
Water Faucet, Rubber Bumper on a	305
Wing Nuts, Homemade	302

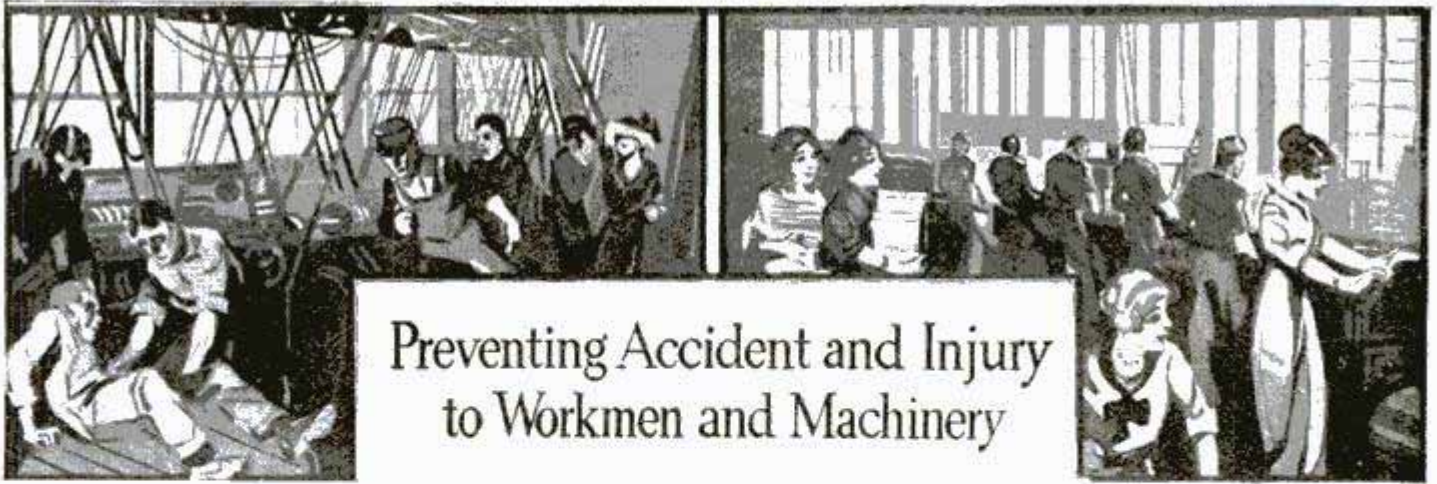

## Preventing Accident and Injury to Workmen and Machinery

"An accident!" The news flashes through the plant. There is a scurrying of many feet, then a lull.

"Anybody hurt?" is likely to be the first inquiry. Maybe the answer is, "Bretley broke his arm." Or maybe the answer is, "Just a scratch, but the big cutting machine is a wreck."

It is a familiar story repeated with thousands upon thousands of variations month after month. The Manufacturers' Association says that 500,000 *avoidable* accidents occur within a year.

"Avoidable." Men are turning to that word—they have begun to consider safety with more care than ever before. New York established a Museum of Safety. A Congress of Safety has gone deep into this vital problem of applied conservation.

Safety is being made a science—"Safety First," a watchword.

And the science of safety finds its chief safeguard in *mechanical security*. To attain mechanical security in all the many avenues of its application no step is more direct than that made possible by Electricity.

For example, electric motors placed within the base or frame of a machine so as to drive the machine with gears or belts that are totally enclosed, make it practically impossible for man or woman to have clothing caught and life endangered.

Power application in this form cuts out all the many dangers of overhead shafting—the danger of falling sections, belt wheels, broken belts, which have filled the history of American manufactures with so many tragic chapters.

The cheering up of a shop by the removal of overhead shafting and the multiplicity of belts, not only puts the entire working force in a more efficient frame of mind—not only lifts output all along the line—but decreases danger from darkness and entanglements.

It decreases danger in case of fire by leaving free space not only for the movement of individuals, but for the movement of hose, fire buckets or other extinguishing apparatus.

Beyond this, it directly decreases fire danger by eliminating transmission bearings that may be overheated to the point where they cause fire, as well as other frictions that are a constant fire danger.

To decrease fire danger is to reduce insurance rates. In a still larger sense the increased safety of electrical power and motor drive are themselves an insurance that means unquestionable economy. It was declared at a session of the Manufacturers' Association that "a conservative estimate of the economic loss in this country, through industrial accidents, places it at a quarter of a billion dollars each year." The actual experience of manufacturers who have installed the modern system of using power made possible by electricity, proves that an immense reduction in the number and seriousness of accidents and injuries, and a vast saving of money penalties, may be confidently counted on to follow the extension of this system.

Add to this insurance the productive advantages of the motor drive method, in small plants as well as in large plants, the low cost of installation and of maintenance, the labor economies, the advertising effect of a clean, lighter, more attractive-looking plant, and the business wisdom of this method needs no further argument.

Take up the matter today with your electric power and light company or any General Electric Company Dealer or agent in your vicinity. You will find them more than glad to cooperate with you, and no matter how complex your problem may be they have at their command the service of any part of our organization that may be most helpful to them and to you.

*The Guarantee  
of Excellence on  
Goods Electrical*



# GENERAL ELECTRIC COMPANY

Atlanta, Ga.  
Baltimore, Md.  
Birmingham, Ala.  
Boise, Idaho  
Boston, Mass.  
Buffalo, N. Y.  
Butte, Mont.  
Charleston, W. Va.  
Charlotte, N. C.  
Chattanooga, Tenn.  
Chicago, Ill.

Cincinnati, Ohio  
Cleveland, Ohio  
Columbus, Ohio  
Davenport, Iowa  
Dayton, Ohio  
Denver, Colo.  
Detroit Mich. (Office of Agt.)  
Elmira, N. Y.  
Erie, Pa.  
Ft. Wayne, Ind.  
Hartford, Conn.

**Largest Electrical Manufacturer  
in the World**

Indianapolis, Ind.  
Jacksonville, Fla.  
Joplin, Mo.  
Kansas City, Mo.  
Keokuk, Iowa  
Knoxville, Tenn.  
Los Angeles, Cal.

Louisville, Ky.  
Madison, Wis.  
Mattoon, Ill.  
Memphis, Tenn.  
Milwaukee, Wis.  
Minneapolis, Minn.  
Nashville, Tenn.

New Haven, Conn.  
New Orleans, La.  
New York, N. Y.  
Niagara Fall, N. Y.  
Omaha, Neb.  
Philadelphia, Pa.  
Pittsburg, Pa.  
Portland, Ore.  
Providence, R. I.  
Richmond, Va.  
Rochester, N. Y.

Salt Lake City, Utah  
San Francisco, Cal.  
St. Louis, Mo.  
Schenectady, N. Y.  
Seattle, Wash.  
Spokane, Wash.  
Springfield, Mass.  
Syracuse, N. Y.  
Toledo, Ohio  
Washington, D. C.  
Youngstown, Ohio

For Texas, Oklahoma and Arizona business refer to Southwest General Electric Co., (formerly Hobson Electric Co.)—Dallas, El Paso, Houston and Oklahoma City  
For Canadian business refer to Canadian General Electric Company, Ltd., Toronto, Ont.

Please Mention Popular Mechanics

EXPLANATIONS SO CLEAR A CHILD CAN UNDERSTAND

# LEARN THE **AUTOMOBILE** TRADE

## Be an Auto Mechanician

Do work at homes of auto owners, no capital required—or start a shop of your own—or if you prefer drive a car, tester or salesman. We



NOW RUNNING A GARAGE

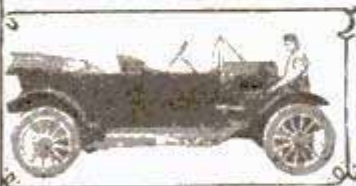

NOW AN AUTO MECHANICIAN GOING WORK AT HOMES OF AUTO OWNERS WAS A CLERK (LEFT THREE)

will teach you and show you how to start. Everyone in the business is making money and every year it grows four times.

We teach everything from A to Z—except actual driving—we have a plan whereby you can learn that. But anyone can drive; you often see children driving.

You don't have to be a mechanic; it's in knowing the principle, how to diagnose and remedy troubles and adjust—all comes from learning the principle.

### BE YOUR OWN TEACHER

You can read, understand pictures, charts and models—then why pay \$25 to \$100 when you can learn at home during spare time for only—\$15 with

### DYKE'S WORKING MODEL HOME STUDY COURSE

—it's quicker and easier than working in a shop—you learn through the eye, no hard study. Actual practice on real working models.

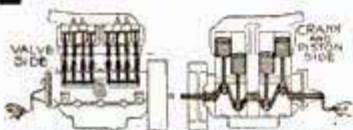

4 CYLINDER ENGINE MODEL IT WORKS. ALL MOVING PARTS REAL METAL. OTHER MODELS ARE: MAGNETO, CARBURETOR, CLUTCH, GEAR BOX, DIFFERENTIAL.

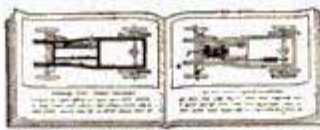

THE PROGRESSIVE CHART MANIKIN, SHOWING HOW THE CAR IS ASSEMBLED FROM THE GROUND UP

**LET US** DESCRIPTION OF **DYKE'S** NEW IDEA **WORKING MODEL SYSTEM** **ONE OF THE** BEST **WORK** **TEACHING BY MAIL**

**TESTIMONIALS** SAMPLE PAGES, CHARTS **OPPORTUNITIES** OF THE MOTOR BUSINESS

**SHOW YOU** **EMPLOYMENT** **HOW WE START YOU** **SEND FOR THEM**

**FREE**

MANY SAY THEY LEARN A LOT FROM THESE 32-PAGE, FULLY ILLUSTRATED BOOKLETS ALONE

We Will Show You—how we can teach you, how we have taught hundreds of others—how we can start you to making money even before you complete Course—how we have started hundreds of others who knew no more than you do right now—

We Will Further Show You—endorsements of the leading motor authorities of the world, men who could not afford to endorse this system if it was not absolutely satisfactory in every respect.

### YOU DEAL WITH A RELIABLE FIRM

Mr. Dyke has been identified as a pioneer inventor, supply man, etc., with the auto industry since the beginning. He originated the first auto supply company and published the first book on autos in America. No other man with such experience is today teaching others. And all the experience and inside information of the auto business he has thus gained, is embodied in this Course and Employment Plan.

On Trial—You are allowed a trial examination of the Course—if it isn't perfectly satisfactory you can return it within two days and get your money back. The Course is all sent to you at one time.

WRITE

**SPECIAL PRICE—Right Now—** Complete Course—only . . . \$15.00



**DYKE'S CORRESPONDENCE SCHOOL OF MOTORING.** Box 188, Roe Bldg., ST. LOUIS, MO. NOTE—Beware of Imitators—Deal with the Originator

# Prizes Awarded

By Popular Mechanics Magazine in the contest for our Young Readers which closed December 10th, 1913

### FIRST PRIZE \$35

EDWARD SIEJA . . . . . Chicago  
"How to Make a Flymobile"

### SECOND PRIZE \$25

ALBERT BATES, JR. . . . . Chicago  
"A Snowball Thrower"

### THIRD PRIZE \$20

HARRY MARCELLE . . . . . Honolulu, H. I.  
"Musical Door Bell"

### FOURTH PRIZE \$15

WALDO SAUL . . . . . Lexington, Mass.  
"Foot Boats"

### FIFTH TO NINTH PRIZES, INCLUSIVE, \$10 EACH

L. J. L. POULIOT . . . . . Ottawa, Can.  
"Separating Wedged Drinking Glasses"

L. G. BURNAUD . . . . . Lyons, Iowa  
"Camera Shutter"

JOHN N. MAHLMEISTER . . . . . Brooklyn, N. Y.  
"An Engraving Machine"

J. H. FINDLEY . . . . . Lincoln, Cal.  
"Prospector's Tools"

P. ROGERS . . . . . Cleveland, O.  
"Model Aeroplane Engine"

### TENTH TO TWENTIETH PRIZES, INCLUSIVE, \$5 EACH

WM. JENKINS . . . . . New York City  
"Finger-Ring Trick"

GEO. W. CATLIN . . . . . Winnipeg, Can.  
"Trick Bottles and Glasses"

MISS E. SMITH . . . . . New York City  
"Homemade Rotary Grater"

WALTER VEENE . . . . . San Diego, Cal.  
"Homemade Roller Skates"

NEVILLE G. BROWN . . . . . Bridgeport, Conn.  
"Aeroplane Propellers"

W. P. SHAW . . . . . Toronto, Can.  
"How to Make a Snare Drum"

R. F. POHLE . . . . . E. Lynn, Mass.  
"A Waterscope"

CHAS. MOTTON . . . . . Toronto, Can.  
"A Puzzle Purse"

MRS. WM. DONOVAN . . . . . Seattle, Wash.  
"Decorative Wood Panels"

WM. WEITZACKER . . . . . Buffalo, N. Y.  
"Enlarging Pictures"

THEODORE KRUGER . . . . . Peoria, Ill.  
"Model Electric Engines"





## King Sennacherib

OF ASSYRIA, 2,600 years ago, inscribed, on sun-baked bricks, his own story of his great siege of Jerusalem, mentioned in the Bible. This curious and ancient record tells also how Sennacherib "made Nineveh splendid," how he constructed irrigation systems and city water-works. But Sennacherib is only one of the thousands of world leaders, thinkers, inventors, and discoverers who tell *in their own words* of their marvelous achievements and experiences in the great work—

# The Library of Original Sources

In this wonderful library Tacitus, for example, tells how he *saw* the Christians burned before Nero, Plato tells how he *watched* Socrates drink the death-cup of hemlock, Galileo describes his emotions when looking at the stars through the first crude telescope, and in the same way *thousands of others* give the *inside facts* about themselves and the great events they witnessed and took part in—facts which the ordinary history never even mentions. Every account is in the exact language (translated) of the original manuscript, papyrus, clay tablet or inscribed cylinder; every contribution is from an actual eye-witness or participant.

## An Extraordinary Bargain!

By buying the entire unsold edition from the original publishers we secured it at an unheard of reduction. We offer the remaining sets to Popular Mechanics readers AT LESS THAN HALF of the original price because we sell through the mails only. Note that the attached coupon specifies NO SALESMAN WILL CALL—no agent's commission to pay. Send the coupon AT ONCE and we will mail FREE a book of rare documents and curious inscriptions and tell of our low price offer ON EASY MONTHLY PAYMENTS. Mail the coupon NOW. You assume no obligation. The book is Free.

**THIS MARVELOUS WORK** is revolutionizing modern thought. It's turning upside down old notions and ideas. It gives the authoritative, rock-bottom sources of our knowledge on all subjects of human interest from the earliest civilization down to to-day.

**OVER 100 RESEARCH SPECIALISTS** spent 10 years gathering the contents of this great work. Ancient and remote and forgotten civilizations in all parts of the globe were uncovered, and age-buried hieroglyphics on monuments, tablets, sun-baked bricks and palimpsests yielded their secrets; untiring workers ransacked the hidden literature of every age, ancient, mediæval and modern, to find the "original documents" that shaped the civilizations and influenced the thought and life of the world. Nothing like it has ever been attempted or thought of before. You'll be amazed at the wealth of information this unique library contains.

**YOU'LL FIND EVERYTHING YOU WANT to know** in the Library of Original Sources. 10 sumptuous, massive volumes, bound in rich, deep red morocco; full-page illustrations, pure silk head-bands, printed in large, clear type on hand-made paper, gold tops—a triumph of the bookmaker's art.

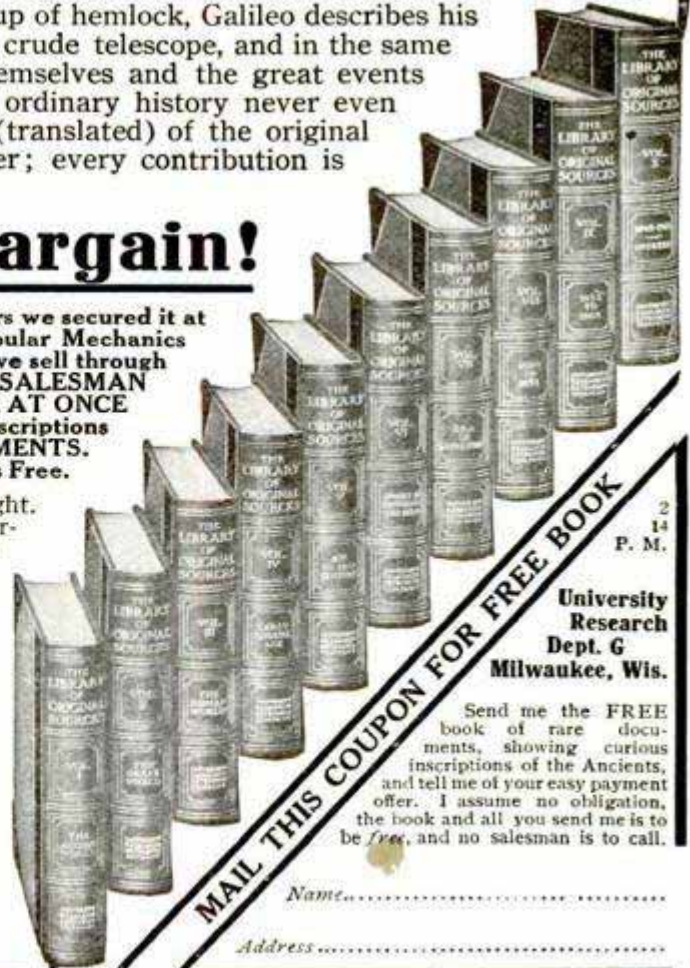

**MAIL THIS COUPON FOR FREE BOOK**

Name.....  
Address.....

2  
14  
P. M.

University  
Research  
Dept. G  
Milwaukee, Wis.

Send me the FREE book of rare documents, showing curious inscriptions of the Ancients, and tell me of your easy payment offer. I assume no obligation, the book and all you send me is to be free, and no salesman is to call.

The  
Burlington  
Special

19 Jewels  
Fully Adjusted



The  
Burlington  
Special

New Style  
Thin Model

Here  
Is an  
Exquisite  
Design

Inlay  
Enamel  
Monogram

# Just Out!

*New Ideas in Watches*

Block and Ribbon Monograms, Diamond Set, Lodge, French Art and Dragon Designs. See catalog for complete set of color illustrations.

## Special Offer

You may secure one of these superb timepieces—a watch of the very latest model, the popular new thin design, adjusted to the second—19 jewels—adjusted to positions AND temperature AND isochronism—at the same price that even wholesale jewelers must pay—and in order to encourage everybody to secure this watch at once pay this rock bottom price, either for cash or \$2.50 a month! We send the watch on approval, prepaid. You risk absolutely nothing—you pay nothing—not one cent, unless you want this exceptional offer after seeing and thoroughly inspecting the watch.

### Write for New Watch Book

Learn the inside facts about watch prices, and the many superior points of the Burlington over double-priced products. Just send the coupon or a letter or a postcard. Get this offer while it lasts.

Burlington Watch Co.  
19th Street and  
Marshall Blvd.  
Chicago  
Dept.  
9192

Watch  
Book Coupon  
Burlington Watch Co.  
Dept. 9192  
19th Street and Marshall Blvd.  
Chicago, Ill.

Please send me (without obligation and prepaid) your free book on watches with full explanation of your rock-bottom DIRECT offer for cash or \$2.50 a month, on the Burlington Watch

Name .....

Address .....

Please Mention Popular Mechanics

## 9,059-Word Business Book Free

Simply send us a postal and ask for our free illustrated 9,059-word Business Booklet which tells how priceless Business Experience, squeezed from the lives of 112 big, broad, brainy business men, may be made yours—yours to boost your salary, to increase your profits. This free book deals with

- How to manage a business
- How to sell goods
- How to get money by mail
- How to buy at rock-bottom
- How to collect money
- How to stop cost leaks
- How to train and handle men
- How to get and hold a position
- How to advertise a business
- How to devise office methods

Sending for this free book binds you to nothing, involves you in no obligation; yet it may be the means of starting you on a broader career. Surely you will not deny yourself this privilege, when it involves only the risk of a postal—a penny! Simply say "Send on your 9,059-word Booklet". Send to SYSTEM, Dept. 81-2 Wabash and Madison Sts., Chicago



### ENCYCLOPEDIA 25c of Physical Culture

*"Be Strong and Stay Strong"*  
By MICHAEL MACFADDEN

The most complete work, in concise form, ever published on physical culture. It explains all the phases of physical training. Here are some of its topics:

Diet—Constipation—Drinks—Out Door—Life—Bathing—Clothing—Air Baths—Sleep—Breathing—In Case of Sickness—Normal Weight—Truth About Fat—How Not To Be Thin—Exercise.

The regular price of my book is \$1.00 but for a limited time I offer it for 25c. Send stamps or coin.

MICHAEL MACFADDEN  
156 East 23rd St. Dept. 60 New York



### MAGIC Tricks, Books and Supplies

Amateurs supplied as well as the great Professionals. Easy, interesting and entertaining. Mystify and astonish your friends.

Large, illustrated professional catalogue of wonders. Price 10c

CHICAGO MAGIC CO., Successors to  
READ & COVERT  
Dept. B., 72 W. Adams St., Chicago, Ill.

### Start a Candy Store

Clear \$1,000 to \$5,000 a year. Capital and experience unnecessary. Ideal business for both men and women. New method home instruction in making and selling all kinds of fine candies. Special low rate now open. Particulars free. Write today.

CANDY MAKERS EXCHANGE, 918 Dwight Bldg., Kansas City, Mo.



### PRIZE PACKAGE FREE

We will send you FREE a big package of Magic Tricks, Puzzles, Cards, Jokes, Riddles, Money Making Secrets, Splendid Games, Toasts, Card Tricks, Feats in Parlor Magic, all FREE. Just send us 10c for 6 months' subscriptions to The Boys' Companion, the finest boys' paper published. Dept. devoted to Me-

chanics, Carpentry, Stamps and Coins and full of snappy stories. Send 10c for Boys' Companion and ask for premium No. 15. COMPANION CO., Dept. 45, 305 E. 51st St., CHICAGO

Greatest Book Bargain Ever Offered 10 Books for 10c. Book of 14 Short stories; How to Get Rich; Detective Story Book; Joke Book; Parlor Tricks; Song Book; Toymaker Book; Secrets of New York; Book of Startling Information; Book of Special Secrets. ALL 10 Books 10c Postpaid, or 30 Books, all different, for 25c, with large Bargain Catalog. NATIONAL BOOK CO., 304 E. 51st St., CHICAGO

**CACHOO!** Make the whole family and all your friends "just sneeze their heads off" without knowing why, with Cachoo, the new long distance harmless snuff. Sent anywhere for 10c. 3 for 25c, 1 doz. and special premium for 90c. AMERICAN SUPPLY CO., St. Paul, Minn.



**BUTTERFLIES WANTED** every summer for colleges. Profitable outdoor work. All salable if properly prepared. Complete instructions, market prices, and details. Send 2c stamp.  
**AND MOTHS** JAMES SINCLAIR, ENTOMOLOGIST  
Dept. 6, LOS ANGELES, CAL.



### Every Boy His Own Toymaker

Greatest boys' book ever written. Tells how to make a Steam Engine, Telephone, Magic Lantern, Boats, kites, balloons, electrical and mechanical toys, traps, fishing tackle. 200 illustrations; also catalog of 150 puzzles, Keller's Magic Ace Trick Card and "DOUBLE THROAT" warbler and bird call all for only 10c. WESTERN PUZZLE CO., ST. PAUL, MINN.



## \$150,000 Was Paid by the Public to Hear Just One of These Great Lectures

Wendell Phillips, who delivered it is dead; he can never be heard again, but his marvelous oration has been preserved for you, together with the equally great efforts of hundreds of the most wonderful speakers and lecturers the world has ever known, in these 10 beautiful volumes of

## Modern Eloquence

Every speech, lecture, and address is complete; each one is acknowledged to be the greatest ever delivered on a particular subject. You'll find that this *unequaled* work contains the most entertaining and profitable reading ever gathered in one set of books. It voices the opinions, ideas and experiences of the leading intellects of their time; it combines the brilliancy, fascination and style of the great classics, and like them the more often it is read the more interesting it becomes.

Renowned statesmen, authors, scholars, scientists, explorers and soldiers, through its pages, deliver to you, whenever and wherever you wish, the epoch-making orations that moved audiences and nations, that gained them fame and fortune. It's like *hearing* the greatest speeches and lectures ever made without stirring from your chair.

### What This Great Work Contains

#### 300 After-Dinner Speeches by

Joseph H. Choate, Benjamin Disraeli, James G. Elaine, Wm. M. Everts, John Hay, Oliver Wendell Holmes, Sir Henry Irving, Chauncey M. Depew, Henry Ward Beecher, Mark Twain, Henry W. Grady, Joseph Jefferson, Robt. G. Ingersoll, Seth Low, Albert J. Beveridge, Woodrow Wilson, etc.

#### 150 Great Addresses by

Lyman Abbot, Charles Dudley Warner, William Cullen Bryant, Rufus Choate, Theodore Roosevelt, Arthur J. Balfour, Jonathan P. Doliver, Edward Eggleston, William E. Gladstone, Charles Francis Adams, John L. Spalding, Joseph Chamberlain, Grover Cleveland, Fisher Ames, Lawrence Barrett, Henry Drummond, James A. Garfield, Hamilton Wright Mable, William Jennings Bryan, etc.

#### 60 Classic and Popular Lectures by

Charles A. Dana, Robt. J. Burdette, Russell H. Conwell, Canon Farrar, John B. Gough, Andrew Lang, Wendell Phillips, Josh Billings, John Tyndall, Geo. William Curtis, Artemus Ward, Paul DeChaille, John B. Gordon, Newell Dwight Hillis, John Morley, John Ruskin, Henry M. Stanley, Wu Ting Fang, etc.

#### 200 Short Stories and Anecdotes by

Mark Twain, Chauncey M. Depew, Horace Porter, Champ Clark, Joseph H. Choate, John M. Allen, etc.

## A Wonderful Bargain

60,000 sets of Modern Eloquence were sold at a figure much higher than ours before we secured the few remaining sets of the wonderful de Luxe edition at a sale. We are now offering these while they last at an *insignificant price* that you can easily afford to pay. Send us the attached coupon by return mail and we will name this price and tell you how you can get the books on *easy monthly payments*. We will also send you

### Henry W. Grady's Great Lecture— "The Race Problem"—FREE

Reprinted from the work itself. Champ Clark says—"The most famous after-dinner speech within the memory of any living man." Sending the coupon places you under no obligation to buy. If you are interested, tear it off and send it NOW. Don't wait. The offer is limited.

### MODERN ELOQUENCE

consists of 10 large, handsome volumes bound in rich, red three-quarters morocco; with attractive design stamped in gold leaf on the backs. Printed in clear, legible Caxton Old Style type on beautiful white paper. Profuse illustrations on photo-gravure on Japanese vellum and each volume is gold topped. It's a set that would prove a notable addition to the finest library in the land.

### Mail This Coupon For Free Lecture P. M. 2-14

GEO. L. SHUMAN & CO.,  
Dept. 5, Ohio Building, Chicago.

Please send me free lecture and full description of Modern Eloquence with special prices and terms.

Name .....

Address .....





Radio Class  
Navy Electrical School

## What are You doing Now?

**I**F you are between 18 and 25, the things you are doing and thinking and learning *now* are the things that will stick to you *all through life*.

Are you busy learning or practicing some useful, interesting trade, which you *like*, and which will earn you *good wages* throughout your life? Or are you doing the first thing that came handy—satisfied just to have “a job”?

If you are *ambitious* and are *looking ahead*, investigate the trades and special kinds of work taught and practiced in the U. S. Navy. 50 different trades and special pursuits. Electricians, Wireless and Telegraph Operators, Machinists, Carpenters, Firemen, Boiler-makers, Drug Clerks, Nurses, Stenographers, Musicians, etc.

Besides these good-pay trades, the Navy offers the healthiest kind of life, the companionship of ambitious, clean-minded men, and the chance to learn by study and travel.

Isn't it worth a few minutes' call at the Navy Recruiting Station for full information?

Look for nearest Navy Recruiting Station address in the “want” columns of your Sunday paper. Or, if living at a distance, write for an interesting free booklet, “The Making of a Man-o'-Warsman.” Clear pictures and description of Navy life, training, recreation, work, etc. Write today to

Bureau of Navigation, Box 69, Navy Department, Washington, D. C.

# UNITED STATES NAVY



**The Partition of Poland** was one of the greatest tragedies in History. It was accomplished by the three monarchies, Russia, Austria and Prussia, represented in this illustration by the three crowned eagles. Poland is shown by the fallen soldier, the flag of his country trailing in the dust. The Goddess of Liberty is defending the soldier, trying to beat back the crowned powers. The burning fire brands, the battered walls, the broken cannon, the burning cities in the distance, all serve to illustrate this event. This illustration from Ridpath's History is only **one** of **2,000** in the complete work and illustrates but **one event** of all the thousands in the world-famed publication,

## Ridpath's History <sup>OF</sup> THE World

WE will name our special low price and easy terms of payment only in direct letters. A coupon for your convenience is printed on the lower corner of this advertisement. Tear off the coupon, write your name and address plainly and mail. We do not publish our special low price for the reason Dr. Ridpath's widow derives her support from the royalty on this History, and to print our low price broadcast would cause injury to the sale of future editions.

### Six Thousand Years of History

RIDPATH takes you back to the dawn of history long before the Pyramids of Egypt were built; down through the romantic troubled times of Chaldea's grandeur and Assyria's magnificence; of Babylonia's wealth and luxury; of Greek and Roman splendor; of Mohammedan culture and refinement; of French elegance and British power, to the dawn of yesterday. He covers every race, every nation, every time and holds you spellbound by its wonderful eloquence.

### 46 Page Booklet FREE

WE will mail our beautiful forty-six page free booklet without any obligation on your part to buy. It will show Ridpath's wonderfully beautiful style. He pictures the great historical events as though they were happening before your eyes; he carries you with him to see the battles of old; to meet kings and queens and warriors; to sit in the Roman Senate; to march against Saladin and his dark-skinned followers; to sail the southern seas with Drake; to circumnavigate the globe with Magellan. He combines absorbing interest with supreme reliability, and makes the heroes of history real living men and women, and about them he weaves the rise and fall of empires in such a fascinating style that history becomes as absorbingly interesting as the greatest of fiction.

USE THIS COUPON →

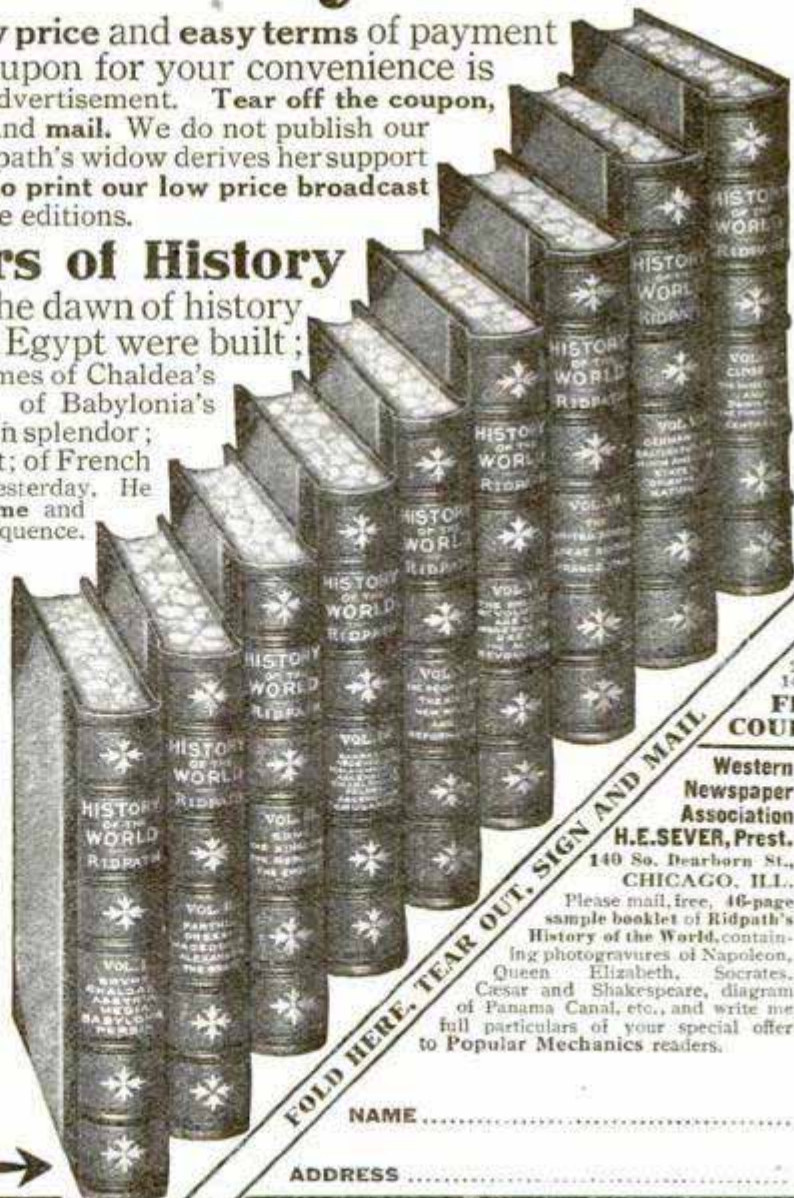

2  
14  
**FREE  
COUPON**

**FOLD HERE. TEAR OUT. SIGN AND MAIL.**

NAME .....

ADDRESS .....

**POPULAR MECHANICS**

Western  
Newspaper  
Association  
H.E. SEVER, Pres't.  
140 So. Dearborn St.,  
CHICAGO, ILL.  
Please mail, free, 46-page  
sample booklet of Ridpath's  
History of the World, contain-  
ing photogravures of Napoleon,  
Queen Elizabeth, Socrates,  
Cesar and Shakespeare, diagram  
of Panama Canal, etc., and write me  
full particulars of your special offer  
to Popular Mechanics readers.

# An Expert ACCOUNTANT

Holds a Job Like This

He is the Man Who Knows—  
In Touch with Every Detail.



Could You  
Fill This  
Place?

He knows the Theory of Accounts, Practical Accounting, Cost Accounting, Auditing, Business Law, Organization, Management, etc.

## Higher Accounting LEARN At Home By Mail

No need to leave your present occupation. You can thoroughly prepare yourself by the use of your spare time. The demand for qualified accountants is vastly in excess of the supply—not enough in the entire country to meet the needs of a single city like New York or Chicago. The opportunities are simply unlimited for well-trained men. Become an expert in the higher branches of this work. Get away from drudgery and poor pay. A little time and application will prepare you for the place higher up. The home of economic business efficiency is in the accounting department. The successful conduct of a business and the highest order of efficiency in all departments depend upon the constant supervision of the expert accountant. His services have become an absolute necessity. Many positions of this kind are paying over \$10,000 per annum. No line of work carries greater dignity or importance. Thousands of expert accountants have developed into executives of rare ability, all because of their training and intimate knowledge of economic principles and scientific methods. Decide today, now, that you will write and learn of the splendid course of training we offer; how you can become an expert accountant or a C. P. A. by the use of your spare time at home. Our facilities to teach you by correspondence are unexcelled. The course we offer has been prepared under the general supervision of

**WILLIAM ARTHUR CHASE, LL. B., C. P. A.**

Ex-President of the American Association of Certified  
Public Accountant Examiners

Former Member of the Illinois State Board of Examiners in Accountancy; Author of "C. P. A. Examinations and How to Pass Them," which treatise forms part of the text material furnished in this course.

Your instruction will be under the direction of experts who rank among the very highest. You can cover the complete course in *One Year*. No expense has been spared to make this the finest course of its kind in America. Let us tell you all about it. Write immediately for catalog and particulars describing our unique plan of instruction. All information is Free. Send in the Coupon now. You will be surprised when you learn how easily you can prepare yourself for this profitable line of work.

### Our Big Scholarship Offer

We are offering a limited number of reduced scholarships to those, who, by occupation, make desirable students. Ambitious men will find our course a positive means to qualify for large incomes. Write today and learn of this limited scholarship offer. Tell us your occupation and we will advise you promptly if eligible for one of these reduced-rate scholarships. Don't wait until the offer is withdrawn and it is too late. You may never have another opportunity like this. It will cost you nothing to inquire about this offer. Our handsome catalog and all particulars are free for the asking. Send for them now. Easy monthly payments within the reach of all.

**LA SALLE  
EXTENSION  
UNIVERSITY,  
Dept. 539,  
Chicago,  
Illinois.**

**Tear Off and Mail the Free Coupon this minute**

**FREE COUPON.** La Salle Ex. Univ. Dept. 539, Chicago

Please send, without cost or obligation to me, catalog and full particulars regarding your course in Higher Accountancy and advise at once if I am eligible for one of your Special Scholarships. My occupation is given below.

Name.....  
Occupation.....  
City.....  
State.....

# SHORTHAND IN 30 DAYS

We absolutely guarantee to teach shorthand complete in only thirty days. You can learn in spare time in your own home, no matter where you live. No need to spend months as with old systems. Boyd's Syllabic System is easy to learn—easy to write—easy to read. Simple. Practical. Speedy. Sure. No ruled lines—no positions—no shading as in other systems. No long lists of word signs to confuse. Only nine characters to learn and you have the entire English language at your absolute command. The best system for stenographers, private secretaries, newspaper reporters and railroad men. Lawyers, ministers, teachers, physicians, literary folk and business men and women may now learn shorthand for their own use. Does not take continual daily practice as with other systems. Our graduates hold high grade positions everywhere. Send today for booklets, testimonials, etc.

**Chicago Correspondence Schools**  
969 Chicago Opera House Block, CHICAGO, ILL.

## BE A SALESMAN

**EARN \$1,000 TO \$5,000 A YEAR**

We will teach you to be a high grade Salesman in eight weeks by mail and assure you definite propositions from a large number of reliable firms offering opportunities to earn good wages while you are learning. No former experience required. Write today for particulars, large list of good openings and testimonials from hundreds of our students who are now earning \$100 to \$500 a month.

Address nearest office. Dept. 29

National Salesmen's Training Association  
Chicago New York Kansas City San Francisco



## Learn the Auto Business Earn a Splendid Salary



By practical experience we train you for a good position as automobile mechanic, salesman or chauffeur. 3,000 graduates are earning big salaries. Complete training in 4 weeks, including extensive practice in repairing and driving high powered cars. Tuition and board reasonable.

Send today for catalog P and list of graduates

**Cleveland Automobile School**  
2340 Euclid Ave., CLEVELAND, OHIO

## ART Scholarships To Interested Readers of This Magazine

# FREE



Given to demonstrate our exclusive methods in Drawing, Painting, Illustrating and Cartooning. Aid students in qualifying for Home Employment or Salaried Position. We guarantee results. List of Premium Outfits and full particulars FREE. Scholarship Awards limited, so write today

Art Annual included for 6 cts. in stamps

**FINE ARTS INSTITUTE, Studio 212, Omaha, Neb.**

## Learn Automobile Driving and Repairing

We give you driving lessons and teach you all the technical parts to prepare you for a good paying position. Write for Booklet P. Day and Evening Class.

**NORTHWESTERN MOTOR INSTITUTE, 228-230-232 Wisconsin St., MILWAUKEE, WIS.**

## TELEGRAPHY FREE

Easily learned at home by mail. Wire-less, Commercial or Railroad taught FREE by mail. Write today for free Telegraph Code and particulars.



**BROOKLYN TELEGRAPH SCHOOL, 313 Fulton St., BROOKLYN, N. Y.**



LEARNED BY  
ANY MAN  
OR BOY  
AT HOME  
SMALL COST

**VENTRILOQUISM**  
Send today 2c stamp for particulars and proof.  
**O. A. SMITH, Room D 98, 823 Bigelow St., PEORIA, ILL.**

\$1

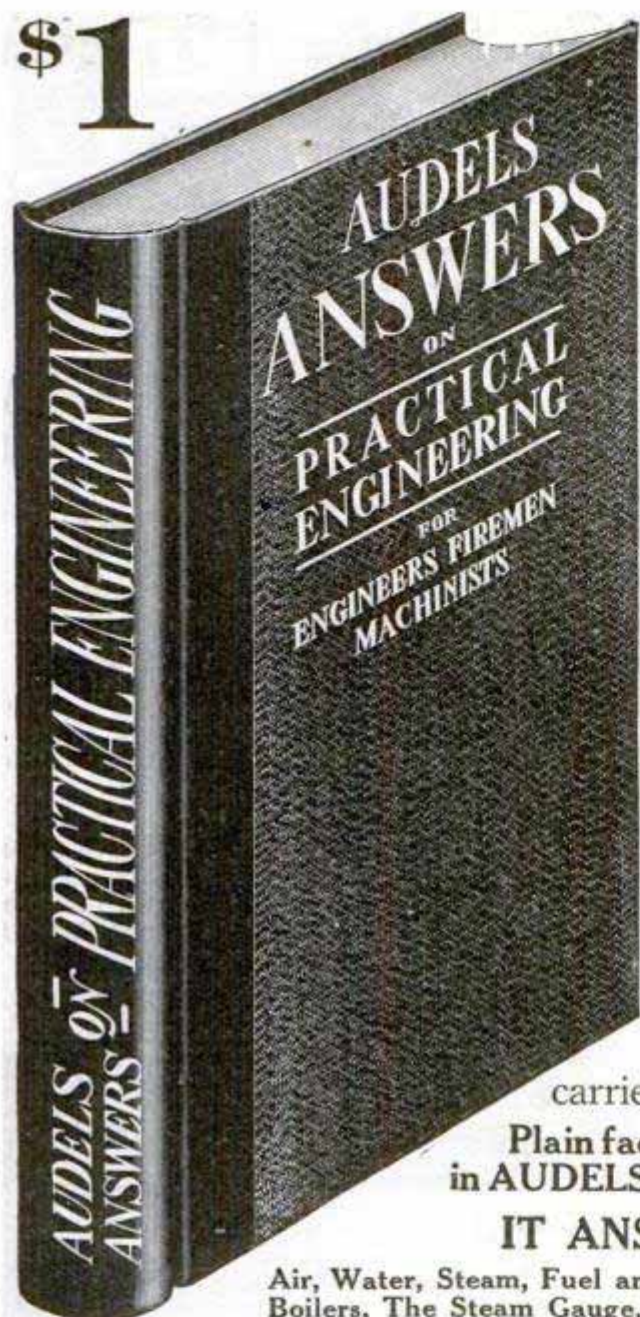

# ENGINEERS

This Book Will Help You

## Audels Answers on Practical Engineering

*When you spend your good hard earned money for books, always make sure that you are going to receive something that will assist you in bettering your position*

**T**HIS book deals largely with the foundation principles which govern the practice of steam engineering. Nothing so soon condemns the applicant as want of knowledge of the every day practice and simple laws relating to the care and management of a steam plant.

No one is expected to know everything, but all are required to be familiar with certain facts which may be called "the beginning of things."

The lack of knowledge of the small things carries conviction of the same lack in the larger.

**Plain facts, that you should know, are plainly explained in AUDELS ANSWERS ON PRACTICAL ENGINEERING.**

### IT ANSWERS YOUR QUESTIONS ON

Air, Water, Steam, Fuel and Heat, Steam Boilers, Boiler Construction, Water Tube Boilers, The Steam Gauge, The Safety Valve, Properties of Steam, Installation of Boilers, Management of Boilers, Engineers' Law, Firemen's Law, Steam Engines, The Valve and Valve Gear, The Corliss Engine, Engine Arithmetic, Lubricators, Installation and Operation of Engines, Steam Pumps, Injectors, Feed Water Heaters, Steam Heating, Steam Traps, Belts, Gears and Pulleys, Steam Turbines, Refrigeration, Practical Electricity, Elevators.

Understand the framework of which your work is but a cross bar. Know something of the cause of which your work is but an effect. Know something of the effect of which your work is the cause. And, above all, know why it is done one way and not another.

**LEARN THE THEORY UNDERLYING THE WORK.** Practical Engineering contains 288 pages fully illustrated, handsomely bound and printed and is in every way a first class book.

## Examination Offer

**If You Are Interested** sign and mail the coupon, and it will bring to your plant a book of sterling merit, for free examination. You can have one week in which to dig out the mine of valuable information contained in its 200 or more pages.

### Carry It in Your Pocket for One Week

and at the end of the time, if you do not think the book is worth one dollar, mail it back to us. If it is, you can mail us \$1.00 in payment for your copy. If you fail to consider this liberal offer you are not dealing fairly with yourself. We take all risk that "Audels Answers on Practical Engineering" is a book you should own. Act now before you forget it.

Please send me for examination one copy

**Audels Answers on Practical Engineering** \$1

If I keep the book, I promise to send you within 7 days after receiving it ONE DOLLAR, in full payment; if I do not keep it, I will mail it back to you within 7 days.

**THEO. AUDEL & CO., 72 5th Ave., NEW YORK**

Signature.....

Occupation.....

Address..... P.M. Feb. '14



## Be Boss In the New Profession

Thousands of men are needed. The new profession that is **paying big money** wants you and needs you. Here is your opportunity to get into it **now**. You don't need to leave your present employment. Just a few hours a day in your own home and soon you get your diploma and are a full-fledged Meter Engineer.

### Be a Meter Engineer

The profession of Meter Engineering is now in its infancy. It is calling for men. The Central Electric Stations **must** have Meter Engineers, because without them they cannot operate. Thousands of positions now open. Wonderful opportunities. You can get into the profession. It is calling **you**.

### A \$3000 Job for YOU

Meter Engineering is one of the best paying professions in the electrical industry. We can show you hundreds of men who are making better than \$3,000 a year. How would you like to have a \$3,000 job? Just put your name and address on the free coupon and get full particulars absolutely free. Send it now—today.

### Special

For a limited time we are making a special reduced price offer in order to induce men to start the study of Meter Engineering right away. Write for full particulars at once.

### Send the Coupon and Get 40-Page

### Book FREE

Do not delay an instant. Just put your name and address on the coupon and mail it to us at once. We will send you absolutely free and postpaid, 40-page book on Meter Engineering. It tells you all about the New Profession and about our school. It tells you how you can learn to become a Meter Engineer in your own home during your spare time. Absolutely no obligations of any kind in getting the book. Just your name and address is enough. But write today—now—immediately, while we can still make this great special offer.

### FREE Book Coupon

Ft. Wayne Correspondence  
School, Dept. 1192  
Fort Wayne, Ind.

Gentlemen: Please send absolutely free and prepaid your book on Meter Engineering. Also send me full particulars of the great special offer that is now being made to induce men to study Meter Engineering. I assume no obligations of any sort.

Name.....

Address.....

Fort Wayne  
Correspondence  
School  
Dept. 1192  
Fort Wayne  
Indiana

Please Mention Popular Mechanics

## A Government Special To You

60,000 Civil Service appointments will be made this year—1914. 60,000 men and women will secure positions for life, with big pay, rapid advancement, pleasant working conditions, short hours and annual vacations with pay. **Will you be one of them?**

The PARCEL POST is creating thousands of openings in the RAILWAY MAIL, POST OFFICE and RURAL CARRIER SERVICES, at salaries ranging from \$600 to \$1800 a year and upward. If you're an American citizen, 18 years or over, you're eligible.

**Don't wait.** Civil Service examinations will be held to fill the new positions. **BE READY.** Write us TODAY—NOW—for our big FREE 64-page illustrated catalog describing these and other desirable positions and showing how you can prepare under the personal supervision of a former UNITED STATES CIVIL SERVICE SECRETARY-EXAMINER.

**PATTERSON CIVIL SERVICE SCHOOL**  
302 Irving Place Rochester, N. Y.



*Learn to Write*

**BEGIN TODAY**  
WRITE FOR MY FREE BOOK

I can make a good penman of you at home during spare time. Write for my free book, "How to Become a Good Penman." **FREE** Write for it Today

It contains specimens and tells how others mastered penmanship by the Tamblin System. Your name will be elegantly written on a card if you enclose stamp to pay postage.

**BOOK**

F. W. Tamblin, 418 Meyer Bldg. Kansas City, Mo.

### LEARN WATCH REPAIRING

Be a watchmaker—you can learn this profitable trade by correspondence in a few weeks in your own home by the DeSelms Chart System. After you complete the course you will know a watch from A to Z. You will know just what the matter is and how to repair one. When you graduate you will be a practical watchmaker and repairer and competent to fill any position. Positions for our graduates.

Ask for our Free Book. It explains our system and terms.  
**THE DeSELMS WATCH SCHOOL**  
23 Perry Street ATTICA, INDIANA



### IF YOU STAMMER

attend no stammering school till you get my large FREE book and special rate. Largest and best school in the world curing by natural method. Write today.  
**Lee Wells Millard, Pres., North-Western School, Inc.**  
917 First Street Milwaukee, Wis.



### How To Do It Safely?

Give up struggle for mere existence in city? Plan now safe way out. No cost to investigate. Free Book explains plan for man or woman. (No land to sell. No agents.) We teach Farming by Mail. All subjects. Which interests you?

**American Farmers School** 449 Laird Bldg. Minneapolis, Minn.



# An All-Mineral Shingle Roof Permanently Durable and Ornamental

J-M Transite Asbestos Shingles are made of Asbestos (rock) fibres and Portland Cement, both minerals. They are immune to the destructive action of fire, water, acids, gases, chemical fumes and climatic conditions. The longer they are exposed to the weather the harder and tougher they become.



*Residence of D. J. Dickson, Wayne, Pa. Covered with J-M Transite Asbestos Shingles. Francis Gogert, Architect, Wayne, Pa.*

## J-M Transite Asbestos Shingles

are moulded under tremendous hydraulic pressure into a homogeneous mass. J-M Transite Asbestos Shingles cannot rot, crack, warp or decay.

Furnished  $\frac{1}{8}$ -inch thick with smooth edges, in colors of gray, Indian red, and slate; and  $\frac{1}{4}$ -inch thick with rough edges, in gray and Indian red.

**Write our nearest Branch for booklet**

### H. W. JOHNS-MANVILLE CO.

MANUFACTURERS OF READY ROOFINGS; SHINGLES; STUCCO; PIPE COVERINGS; SPARK PLUGS; DRY BATTERIES; FIRE EXTINGUISHERS; BRAKE LINING; FIREPROOF PAINT; COLD WATER PAINT AND SPRAYERS, ETC.

Albany  
Baltimore  
Boston  
Buffalo

Chicago  
Cincinnati  
Cleveland  
Dallas

Detroit  
Indianapolis  
Kansas City  
Los Angeles

ASBESTOS

Louisville  
Milwaukee  
Minneapolis  
New Orleans

New York  
Omaha  
Philadelphia  
Pittsburgh

San Francisco  
Seattle  
St. Louis  
Syracuse

THE CANADIAN H. W. JOHNS-MANVILLE CO., LIMITED, Toronto, Montreal, Winnipeg, Vancouver 1482

## DO YOUR OWN Soldering —and Save Money



Send 55c for cloth bound Book "Simple Soldering" — and learn how to join metals, both hard and soft.

**CONTENTS** — Soldering. The Uniting of Metals. Soft Soldering. The Flux. Hard Soldering or Brazing. Soft Soldering. Heating the Work. Flux for Soldering, Etc. Methods of Holding Work. Wiring Work. Silver Solder. Soldering Copper, Etc. Cleaning Up Work. Polishing. Scraping Down. Honing, Etc. Standard Apparatus. The Blow-Pipe. Foot Bellows, Etc. Home Made Apparatus.

**SPON & CHAMBERLAIN**  
123 P. M. Liberty St. NEW YORK

## WARNING

From widely separated parts of the country come reports of the operation of subscription swindlers. These are young men who represent themselves as students working their way through college, and who are offering Popular Mechanics Magazine as a "trial offer" at 49 cents for a full year. Usually one, and sometimes two other magazines are included, all for the 49 cents.

Popular Mechanics Magazine has no subscription solicitors and prints a notice to that effect on its front cover every month, and never offers its subscription at less than the regular price of \$1.50.

**POPULAR MECHANICS COMPANY**  
H. H. WINDSOR, Pres.

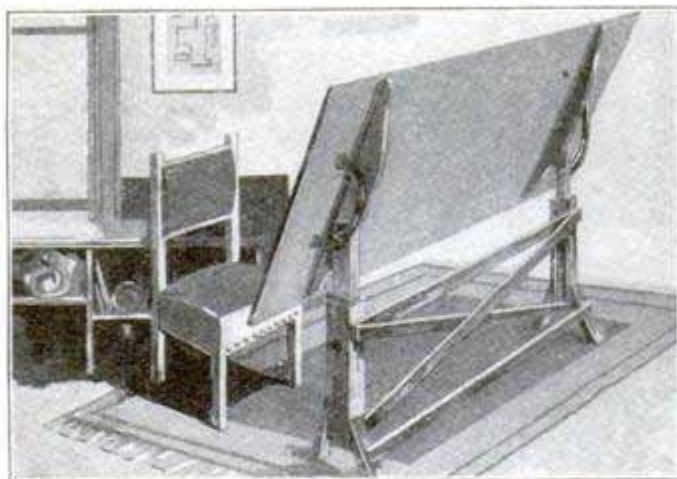

# \$3000

## Per Year to Fill This Chair

There's many a vacant chair like this waiting for you. I am training young men to fill them. Will you send your name to me? Many a man who has written to me now earns \$3,000 or more. The draftsman's training they got from me gave them the power to demand this price. There will be no obligations on you if you send me your name. Then

I'll tell you just exactly how I train you personally. If you could know of all the chairs like this to be filled you wouldn't hesitate. You can have a money making future if you will let me show you how to do it.

# Drafting

how I do it. For 20 years I have been doing the highest paid expert drafting work as Chief Draftsman of a large and well known Company. One day the manager said to me, "Why is it that there are not more high quality men like you? I would pay thousands of dollars a year if I could get them." Right there I made up my mind that I would give to ambitious men the highest quality, personal instruction in the very things which had enabled me to earn my big salary. So the kind of training I will give you is the **practical** kind. The kind you need to hold one of the big paying positions.

## I'll teach you drafting in your own home. I'll teach you personally—

give you private instruction. This instruction is given to you by me. I make you see

what I teach you. I do it all during your spare time in your own home. Remember you get my personal training. Don't hesitate about sending me your name—just cut out the coupon below—write in your name and you'll hear from me at once.



This \$15.00  
Draftsman's  
Working Outfit

**FREE**

## Positions Open Right Now

Right now—this very minute—there are many positions open which pay \$3,000 and more per year to the right men who have learned drafting. There is lots of room at the top. I got there myself but have found all around incompetent men holding poor positions. They had not been trained right. The thing I want to do is to train you in the practical way you ought to be trained; to show you what to avoid and how to do things right. **YOU** can get into one of these chairs soon if you will merely send me your name on the free coupon below.

## You Can Earn While Learning

I have even perfected a plan which gives you an opportunity to begin earning money as soon as you have enrolled as one of my personal and private students. This enables a few young men or older men who

### I Guarantee

To instruct you until competent and in a position at a regular salary, paying from \$125.00 to \$175.00 per month and furnish you free \$15 Working Outfit at once.

tical, personal training which I give, to pay their way as they go along. Write for this plan today. Put your name on the coupon at the bottom and get it in to me right away. If you have been one of those who have dreamed of the future of greatness and power, send the coupon.

**\$3000 SALARY  
EARNING OFFER COUPON**

**CHIEF DRAFTSMAN,  
Engineer's Equipment Co. (Inc.)  
Div. 1192 CHICAGO, ILL.**

Without any obligation to me whatsoever, please mail your book, "Successful Draftsmanship" and full particulars of your liberal "Personal Instruction" offer to a few students. It is understood that I am obligated in no way whatever.

## Tear Off This Coupon and Mail Today

It will positively help you to find out all about the things which I can do for you. I will tell you what I have done for other men. Then you can make up your own mind about what I can do for you. I say I can put you into a chair paying a big salary. If you want to sit in this chair

## Put Your Name Right Here

There are no obligations in your sending your name and address to me on this free coupon. Send it today. I will mail you absolutely free and prepaid my new book, "Successful Draftsmanship." This tells you about the wonderful opportunities there are in this great profession. About the big jobs that are open. The big future ahead for the man who gets in now and knows what to do. Now, the first thing to do. Send the coupon. Do it today.

Name .....

Address **CHIEF DRAFTSMAN**

Div. 1192, Engineer's Equipment Co., (Inc.) CHICAGO, ILL.

Address .....

# CLASSIFIED ADVERTISEMENTS

We have records to prove that a classified ad in these columns will find a buyer for almost anything which can be sold. Doubtless you have some article of value to some one else which you no longer need. Why not turn it into money?

Advertisements in this section, 15 cents per word, each insertion, minimum 10 words, payable in advance. To insure ads being inserted under proper classified head in the March issue, copy must reach this office not later than February 1st.

Popular Mechanics Magazine, Chicago, Ill.

Gentlemen:—The best way we can express our opinion of the Classified Section of Popular Mechanics, is to advise you that through some error our classified ad was omitted from the September and October issues, due to our change of agency, and when same was discovered the writer jumped on the Agency good and hard for the omission, as we figured that it meant that we were losing at least \$100.00 per month business by leaving out the ad. We consider Popular Mechanics one of our best classified mediums.

Very truly yours,

E. M. DAVIS SOAP COMPANY.

## AUTOMOBILES

A WRITTEN guarantee for 5,000 miles without puncture. French and German motorists are getting 10,000 miles out of their tires by increasing them about one-half inch in size. In eight months 20,000 American motorists have followed their example. It's so easy you can do it in your own garage in thirty minutes, no matter what condition your tires are in. Send for free catalogue, sample and copy of guarantee. Colorado Tire and Leather Co., 1112 Karpen Bldg., Chicago, Ill., 451 Golden Gate Ave., San Francisco, Cal., 1326 Acoma St., Denver, Colo.

AUTOMOBILE Instruction—\$55.25. Four weeks' course. Best equipped school in the country. Men enrolled from all parts of the U. S. Booklet P. M. on request. West Side Y. M. C. A., 318 West 57th Street, New York.

AUTOMOBILE Instruction. To learn the business and qualify for a job quick, write L. I. Lutes, Ex-State Examiner of Chauffeurs, Utica, N. Y.

TRUCK,  $\frac{3}{4}$  Ton, Tires Good, \$275. 20-H.P. 4-Cylinder Flanders, Engine Complete, \$75. No. 0 Deane Steam Water Pump, \$20. All above in good running condition. Warren F. Blaisdell, York Village, Me.

ONE Ford, Model Y, in good condition, \$175. Also one 10 H.P. "Frick" Stationary Boiler with stack, etc., \$60. F. O. B. J. Holmes Wilson, Carlisle, Pa.

2 CYL. five passenger Jackson, fully equipped, \$185. Badger Motor Co., Milwaukee, Wis.

\$150 TAKES 1911, 2-cylinder Metz Roadster, equipped. Running order; good tires. Koren, 1621 Jackson Blvd., Chicago.

REGROUNDING the cylinders, and fitting new pistons and rings, will make your motor as quiet and powerful as it was when new. The cost is moderate. Advise bore diameter if desire quotation. We also expertly weld broken parts. Send for booklet. Waterbury Welding Corporation, Waterbury, Conn.

FIRST Aid to the Motorist, teaches what no other books do, makes you more expert than repair man. 25c copy. Box 422, Bridgeton, N. J.

AUTOMOBILE Instruction. A complete home study course that shows you exactly what you want to know about the automobile. 220-page book giving definite, thorough, authentic and practical detailed information about every part of the automobile as well as thorough instruction in regard to driving, repairing and general care of the complete car. 190 illustrations, \$1.50 postpaid. Popular Mechanics Book Dept., 316 W. Washington St., Chicago.

GET in the Oxy-Acetylene welding business. Complete new outfit with instructions \$75. I do expert welding at prices that hold the trade. J. M. Shevlin, 340 Elliott Square, Buffalo, N. Y.

THE Last Word in Automobile Literature—New Book, "The Modern Gasoline Automobile," 700 (6x9 in.) pages, 500 illustrations, is superior to any treatise heretofore published. Deals with every modern improvement. Price, \$2.50 postpaid. Popular Mechanics Book Dept., 316 W. Washington St., Chicago.

"THE How and Why of the Automobile"—A 200-page book of practical information for seekers after the fundamental facts regarding the gasoline engine and its application to the motor car. Interesting and instructive to both the beginner and the expert. Bound in full cloth—250 illustrations. Price, \$1 postpaid. Popular Mechanics Book Dept., 316 W. Washington St., Chicago.

FORD Instruction Book, every part fully explained. Repair your own car. Sent postpaid \$1. Particulars free. Clark, 308 N. Elizabeth St., Peoria, Ill.

PAINT Your Car Yourself—Save \$25 to \$75 by doing the work at home with the Arsenal system. Our big free booklet "The Car Beautiful" tells how. Send for it today. Arsenal Varnish Co., Dept. P, Rock Island, Ill.

## AUTOMOBILE SUPPLIES

TIRES Delivered, 3,500 miles guarantee. 28x3, \$8.70; 30, \$9.55; 30x3 $\frac{1}{2}$ , \$12.75; 32, \$13.65; 34x4, \$17.60; 35x4 $\frac{1}{2}$ , \$23.95; 36, \$24.95; 37, \$25; order 2 tires, we deliver. Send 10 per cent with order. Vanderpool's, Springfield, Ohio; Jacksonville, Fla.

CYLINDERS rebored or reground, \$7.00 to \$11.00, including piston and ring. Cylinders and automobile parts welded. Address Sterling Engine Co., 331 So. Clinton St., Chicago.

CONE clutches, \$7 and \$10. Planetary transmission, \$15. 140-inch Auto Frame, \$7. Four Shock Absorbers, \$8. New Radiators with hood, \$14.50. Badger Motor Co., Milwaukee, Wis.

FOR Sale—20 H.P. White Steam Engine, Generator, Burner, \$60. 4 $\frac{1}{2}$  H.P. Locomobile steam engine, \$10. Two cylinder opposed gasoline engine, \$35. 1423 North Ave., Bridgeport, Conn.

ON account of changing office and sales-room will quote special prices on magnetos and coils this month. Pellet's Magneto Exchange, 1606 Michigan Avenue, Chicago, Ill.

GUARANTEED electric horn. Only \$4. Best Goggles, 65c. O. C. Brickell, Fairbury, Neb.

NICKEL plate your automobile trimmings. "Quick-Knick" deposits a beautiful stay-there plate. Does away with polishing brass forever. Nothing like it on earth. Complete outfit, enough to plate any car, \$2. Forest City Sales Co., Fremont, Nebr.

RADIATOR, prestolite tank, speedometer, top, windshield, horns, full set lamps, chassis, cyclopedia automobile engineering, 8 type SS Edison primary cells, power bench drill, planer chuck. C. E. Betts, Westport, Conn.

USE an Air-Friction with new 1914 improvements. Increases power and economy of motor one-half. Absolutely impossible to choke or load like other carburetors. Uses distillate, gasoline or half kerosene with finest results. Starts easy in coldest weather. We fit all motors guaranteeing definite results or refund money. Exclusive county rights. Special price first order. Liberal exchange on other carburetors. The Air-Friction Carburetor Co., Dayton, Ohio.

STORAGE Batteries Repaired and Exchanged. Meder-Staudt Company, Distributors of Witherbee Batteries, 1876 Broadway, N. Y. City.

TIRES. New, Standard Makes. 28x3—\$7.20—Tube, \$2.30; 30x3—\$7.65—\$2.40; 30 x 3 $\frac{1}{2}$ —\$11—\$3.50; 32 x 3 $\frac{1}{2}$ —\$12—\$3.60; 34 x 4—\$17.25—\$4.75. Other sizes, prices accordingly. Write for complete catalog; 10% with order. Balance C. O. D. Examination allowed. Para Auto Tire Co., 1417 Michigan Ave., Chicago, Ill.

GASOLINE Engine Trouble Chart—a sectional view showing clearly all parts of a typical four-cylinder gasoline engine of the four-cycle type and outlining distinctly all parts liable to give trouble. Also details the derangements apt to interfere with smooth engine operation. Invaluable to motorists. Size, 25x38 inches. Mailed on receipt of 25 cents by Popular Mechanics Book Dept., 316 W. Washington St., Chicago.

BIG money vulcanizing at home. Easy learned. Book 50c. Vanderpool's, Springfield, O.

AUTOMOBILE model. Every part shown and named. You can to all intents and purposes take off the wheels, raise the hood and remove the body, exposing to view the vital parts. The only practical method of studying the automobile. Price, 50 cents postpaid. Popular Mechanics Book Dept., 316 W. Washington St., Chicago.

## MOTORCYCLES, BICYCLES & SUPPLIES

CLOSING Out Sale of high-grade, slightly used motorcycles, all standard makes, twins and singles, belt and chain drives. Prices, \$25 up. Write for complete list. Gotham Sporting Goods Company, 57 Warren Street, New York.

BARGAINS—Heitger Carburetors, \$3.50; Fauber Crank Hangers (Motorcycle), complete, \$2.75; Yale Motorcycle New Tires, snap, \$45; Smith Premier Typewriter, like new, \$18. Wandersee Company, 129 Gratiot, Detroit, Mich.

1913 TWIN X.; Fully Equipped Electric light; good as new, \$165; 1 new Harley, two speed, fully equipped, \$260; Thor 7s, fully equipped, \$150 and \$175; other bargains. E. Harlow, 5403 N. Clark, Chicago.

MY 1912 red 4-h. p. motorcycle in good running order. Has magneto and good tires; \$90 for quick sale. Terms, \$30 first payment, then \$3 a week. Arthur Johnson, 9 Norway St., Suite 21, Boston, Mass.

INDIAN Twin, \$65; Harley, \$40; Thor Twin, \$75; Flanders, \$60; Yale, Iver Johnson, Pope, Merkel, Monarch, others, cash only. Hail & Gravatt, Atlantic City, N. J.

MY fully equipped A. M. C. single cylinder 1913 Motorcycle, run 850 miles, will sell for \$150, cost \$245. First deposit of \$25 takes it, balance C. O. D. W. L. Dolph, 115 Lexington Av., Rochester, N. Y.

MOTORCYCLES cheap: Emblem, \$75; Thors, \$75; New 1913 Twin Thor, equipped, \$220. Anderson's Motorcycle Store, Bantavia, Ill.

FOR Sale—Good motorcycle, nearly new. Nell Struble, Bryan, O.

FOR Sale—De Luxe Twin, Special, Rogers Side Car, full equipment, almost new. M. A. Welch, Owego, Tioga Co., N. Y.

3 REAL Fine Motorcycles. 1913 De Luxe 9 Twin, \$190; 1913 Pope Twin, \$200; Thor 6 Twin, fine, \$75. Write, F. C. Dolder, St. Charles, Minn.

BARGAINS in used guaranteed motorcycles. Save \$25. Write for list. Mueller Cycle Co., Milwaukee, Wis.

MERKEL Twin, \$75; Yale, \$75; Light, \$40; Dayton, Wagner and other bargains. Feiler, 2121 N. Broad, Philadelphia, Pa.

FOR Sale—1911 Harley-Davidson, Magneto, fully equipped, in excellent condition. Will sell for \$150. P. Stuart Riggs, 416 Penna. Bldg., Phila., Pa.

1913 HARLEY-Davidson, 5 h. p. Guaranteed good condition, \$165. Joe H. Ries, Carroll, Ia.

LARGE stock 1911-13 Thor parts. Prompt shipments. Anderson's Motorcycle Store, Batavia, Ill.

TWO Speed Twin Thor, \$175. Four cyl. Pierce (new), \$175. Thor V, almost new, \$135. Thor Four free engine, \$100. Excelsior 4, fine condition, \$60. Many others, down to \$35. Will ship on \$10 deposit, balance on delivery. Whipple, The Motorcycle Man, 1227 W. Jackson Blvd., Chicago.

\$50 TO \$150 buys the best Motorcycles, every make and model in our large stock—must be cleared. Half price. Send for list today. Brown Music Co., 9119 Commercial Ave., Chicago, Ill.

MOTORCYCLES Cheap. Big clearance sale of new and second hand machines; ask for list "M" just out. American Motor Co., 2724 Michigan Ave., Chicago, Ill.

SUPPLIES—Catalog Fourteen is largest ever printed. Prices the lowest. Write today. Meco, Hammondspoint, N. Y., or Thirty-six Hundred Main, Los Angeles, Cal.

N. S. U. TWIN, first-class condition, magneto, bargain, \$85. C. H. Torrence, 54 West Park St., Butte, Mont.

2 SPEED Motorcycle for Sale. Good. David Zarger, Chambersburg, Pa.

NEW 8-horsepower Twin Harley-Davidson for \$212.55. Information on request. M. E. Melton, McKinney, Tex.

BEST offer buys 1913 two speed twin Thor. Cost \$340 in July. First class condition. D. R. Guild, Twin Falls, Idaho.

\$340 YALE twin, 1913, Prestolight, "Dream" tandem, \$165. Need money. Morris, 1350 Larimer, Denver, Colo.

A 1913 INDIAN twin, Electric equipped, Exhaust whistle. Write Anton Lander-gott, Crandon, Wis.

1911 EXCELSIOR single, magneto, new tires, \$90. Write immediately. Max, 1926 Spear Blvd., Denver, Colo.

FREE—Largest illustrated bicycle and motorcycle catalogue. Geo. W. Beardsley, Houston, Tex.

BIG bargains in second-hand motorcycles. \$25 up. Indians, Harleys, Thors, Excelsiors and Merckels. Write for descriptions. Howard A. French & Co., Baltimore, Md.

BIG bargains in good motorcycles we have taken in exchange on new ones. Send for special bargain list. Shaw Mfg. Co., Galesburg, Kansas.

DON'T buy a Bicycle Motor Attachment until you get our catalog and prices. Shaw Mfg. Co., Dept. 27, Galesburg, Kansas.

MOTORCYCLES at cut prices. We guarantee to save you \$25 to \$50 on your motorcycle. Second-hand and rebuilt motorcycles \$25 to \$100. Indians, Harleys, Kulturs, Thors, Excelsiors, Merckels, Readings, Hendersons. Tires \$4. Buy direct. Save dealers' profits. Send for catalogue. Denninger Cycle Co., Rochester, N. Y.

\$25 TAKES M. M. Single, 1909 Model, Magneto. Max Throop, Kewanee, Ill.

FOR Sale. Fully equipped 1911, 7 h.p. Indian motorcycle; good condition, rode 2,600 miles. W. E. Kelly, Three Oaks, Mich.

### CYCLECARS

LIVE agents wanted for the "Sterling Cyclecar." High class machine for small money. Send stamp for proposition M. Sterling Cyclecar Co., Chicago, Ill.

### CYCLECAR MATERIAL

BUILD your own Cyclecar, from parts we furnish, such as axles, wheels, motors, etc. Send stamp for list M. Chicago Cyclecar Co., 2722 Michigan Ave., Chicago.

NEW Cyclecar running gear, wire wheels, tires; act, \$35. W. J. Adams, Cochranton, Pa.

BUILD your own Cyclecar. Every part needed at wholesale prices. Consult our engineering department free. Correspondence invited. Allied Motors Corporation, 1427 Carroll Ave., Chicago.

CYCLECAR, Friction Drives, hubs, rims, brakes, steering gear, air and water cooled motors, Palmer Bros., Coscob, Conn.

### AERONAUTICS

ROBERTS Aviation Motors. One 50-h. p. 4-cylinder, \$450; catalogue price, \$1,500. One 75-h. p. 6-cylinder, \$950; catalogue price, \$2,250. Motors in first-class condition. Price includes complete radiator and propeller equipment. National Aeroplane Company, Harvester Building, Chicago.

THE Aero Mart, 406 Ellsworth Building, Chicago, buys and sells. Bargain list free.

COMPLETE Plan, drawn to scale, with precise instructions for building a Curtiss 3-foot Model Flying Boat, 25c. Other Plans: Bleriot, 15c; Wright, 25c; Nieuport, 25c; Curtiss Hydro, 35c; "Peoli" Racer, 25c. Set of six, \$1.25. 48-pp. Model Supply catalog, 5c. Ideal Aeroplane Co., 82½ West Broadway, N. Y.

EXPERT Aviators and Constructors command big salaries! We teach everything. Liberal terms. Practical instruction by mail. Advanced training on standard aeroplanes and in factory. Flying, handling, and construction. Make application early. Aviation Directory, Lawrence, Kans.

PROPELLERS for air, water, land and stream. Heath propellers represent the survival of the fittest. Heath Aerial Vehicle Co., Chicago.

KEMP Aero Motors: Efficient, Reliable, Reasonably Priced. 16 to 75 h.p. Kemp Machine Works, Muncie, Ind.

GAS turbines. Guaranteed, 80 h.p., 90 pounds. E. R. Holmes, 350 Acoma, Denver.

BUILDING and Flying an Aeroplane—160-page handbook covering the building of small models and full sized gliders and machines. In both biplane and monoplane models the well-known Curtiss and Bleriot types are followed. Fully illustrated with detail drawings. Price, \$1 postpaid. Popular Mechanics Book Dept., 316 W. Washington St., Chicago.

HOW To Make a Biplane Glider—Our book "Amateur Mechanics No. 2" contains a complete detailed description of how to make one. Price of book, 25c postpaid. Popular Mechanics Book Dept., 316 W. Washington St., Chicago.

BLUEPRINTS for all standard make aeroplanes. \$1.75 per set. Modern Electric Shop, 3315 Belleplaine Av., Chicago.

AVIATION Motors, all makes and H.P. from \$250 up. Complete aeroplanes, all types from \$500 up. Aero Exchange, 38 Park Row, N. Y. C.

### BOOKS AND PERIODICALS

BOOKS. Any kind published. Catalogue free. Reese Publishing House, Mount Pleasant, Pa.

ENTERTAINING and educational books. Catalogue free. Sheridan Company, 417 East 151st St., New York.

WORLD'S best self-educational books. Agricultural, Electrical, Mechanical, Automobiles, Science, Business, Art; anything technical, common or unusual. Catalogues 4c. Mention subject (full details). C. H. Gene Co., 2441 Post St., San Francisco.

INTERNATIONAL Correspondence Schools, Reference Libraries, Architectural, Structural, Engineering, Bridge Engineering. Box 38, Osgood, O.

READ "Cleopatra," 25c. Catalogue 2c. Paul J. Duff, 2713 Mozart, Chicago.

MAGAZINES. Lowest rates guaranteed. Catalog free. American Magazine Agency, Box 1222, Atlanta, Ga.

GAS Engine Troubles and Installation. Cloth, \$1; flexible leather, \$1.50; Automobile Troubles and How to Remedy Them. Cloth, \$1; leather, \$1.50. Eight other practical and reliable mechanical books. Send for circular. Chas. C. Thompson Co., Dept. C, 1126 S. Wabash Ave., Chicago.

BUILD yourself a boat. A racing cat or speed launch. Send for catalogue. Yacht and Boat Building Books, Rudder Publishing Co., 2½ Hudson St., New York, New York.

ENGINEERS' questions and answers for license, by Hobson, for twenty-five cents, postpaid. Send stamps. Reilly's Book Store, Philadelphia, Pa.

"METAL Spinning" is the name of the only book published on this interesting art. A concise working manual both for those who desire to spin metal as an art recreation and to follow this work as a trade. 80 pages. 33 illustrations. Price, 50 cents postpaid. Popular Mechanics Book Dept., 316 W. Washington St., Chicago.

HOW to Run a Lathe. A 50-cent book for 10 cents postpaid. S. B. Lathe Works, South Bend, Ind.

WE sell Civil Service Books. Lamont's Agency, Matteawan, N. Y.

FASCINATING books and pictures, samples and catalogue, 10c. Normal Specialty Co., L3, Englewood, Chicago.

GAS for power is taking the place of steam for reasons of economy. Learn all about this great change by reading our new non-technical book on this subject, written by a first-class authority for the practical man. 192 pages, profusely illustrated, cloth binding. Price, \$1 postpaid. Popular Mechanics Book Dept., 316 W. Washington St., Chicago.

SHOP Notes—Many valuable kinks for blacksmiths are contained in our series of Shop Notes books, 10 volumes, 50c each postpaid or \$5 per set prepaidd. Popular Mechanics Book Dept., 316 W. Washington St., Chicago.

MECHANICAL Books. Catalogues for stamp. Crescent Book Store, 309 South Halsted, Chicago.

### EDUCATIONAL AND INSTRUCTION

LEARN to paint signs and show cards. There's money in it. I'll teach you personally by mail. You will succeed. Fourteen years successful teaching. Big field. Show cards and signs used by the thousands by merchants. Our course teaches everything. Pay good. Work easy and fascinating. Hours short. Earn \$18 to \$45 a week. Many students make big money in business for themselves. Earn while you learn. Crawford, B. C., says, "I earned nearly \$200 since taking up your course." Complete practical outfit free. I agree to place my graduates in positions paying \$85 to \$175 monthly when they have graduated and are competent. Write for complete catalog, testimonials, pictures, samples of work, terms, etc. Do it now. Detroit School of Lettering, Chas. J. Strong, Founder, Dept. C2020, Detroit, Mich.

FOR Sale—10 vol. Cyclopaedia Architecture, Carpentry and Building, 8 vol. Civil Engineering, 4 vol. Auto Engineering, 2 vol. Motion Picture, 4 vol. Fire Prevention and Insurance, 6 vol. Engineering, 7 vol. Applied Electricity, 8 vol. Cyclopaedia Agriculture, 6 vol. Advertising. These books are in first-class condition. Special low prices for quick sale. Engineering handbooks covering every subject. Will ship C. O. D. subject to examination. Write for my prices. Address S. C., 6th floor, 318 W. Washington St., Chicago.

LEARN bookkeeping at home for \$1. Its simplicity shown by practical set of books and business forms. For every entry full and clear explanations. No long study, no high tuition. Price \$1. postpaid by G. Melville, H. Box 531, Syracuse, N. Y.

WE need more men in our employment department. We teach you mechanical drawing and secure you a good position. Free book. Write today. Colorado Correspondence College, Denver, Dept. B-2.

HOW to test ground for gold. How to prospect for precious metals, and how to take up mining claims. I teach it by mail. Louis Stroh, Warm Springs, Mont.

"LODGE Talks" will make you a good speaker. Everyone should have a copy, 10c. Johnson, 1819 E. Sergeant, Philadelphia.

BE an Auctioneer. Learn by correspondence. P. O. Box 72 B, Attica, Ind.

WANTED—Experimenters to purchase best book, "How to Make a Transformer." Illustrated directions. Postpaid, 25c. Education Extension, Lock Box 41, Hanover, N. H.

EARN \$25 or more weekly by our Home Study Course and enter an uncrowded profession that offers great opportunities; we teach thoroughly, Mechanical Drafting, Engineering, Mathematics, etc. Write for convincing facts. Keystone Correspondence School, 100 Berks Trust Bldg., Reading, Pa.

**\$1 COMPLETE** instructions, manufacturing interior, exterior decorations, garden furniture, statuary, artistic homes, ornamental casting, concrete, artificial marble, plaster, papier-mache, pulp, composition (imitation wood), soft metals, stuccoing buildings, life casting, copying ornaments, modeling, coloring, gilding, making elastic, rigid moulds, sanitary marble flooring, tiling, tomb stones, cement caskets, ornamental bridge work, fountains—material furnished (highest class workmanship) free! 200 illustrations beautiful casts (mail address today), 500% profit. Mahler, 117 Russell St., Brooklyn, N. Y.

**CIVIL Service, Normal, High School, Bookkeeping, Shorthand, Typewriting, Drawing, Agricultural, English, Engineering and Law courses** thoroughly taught by mail. Enrollment \$5. Tuition free. For "Free Tuition Scholarship" apply Carnegie College, Rogers, Ohio.

**COLLEGE—Let us help you get there.** Prepare quickly for entrance to Medical, Law, Engineering, Pharmacy Schools. Write for our New Method "Home Study Course." Brooks Classical School, Dept. PM, Schiller Bldg., Chicago.

**SHORTHAND Manual** for self-instruction. Osgoodby's Speed-Method by the world's greatest living court stenographer. Postpaid \$1.50. Osgoodby's School Stenography, Rochester, N. Y.

**WE teach by mail, Sanitary Engineering, Sanitary Inspection, Plumbing, Hygiene, Booklet free.** Anglo-American Sanitary Correspondence College, Ontario Street, Chicago.

**YOUR handwriting improved** at home in spare time, small expense. Journal Free. Francis B. Courtney, Box A492, Detroit, Mich.

**YOU can write 100 words a minute** without knowing Shorthand. My new method, Abbreviated Longhand, Simpler than the simplest shorthand; tried and approved by thousands. Your money back if not delighted. Sample lesson 20c. Full particulars free. Write today. A. B. Weaver, Court Reporter, Dept. C., Buffalo, N. Y.

**THE Seven Wonders of the Modern World—What are they? Do you agree with the selection** resulting from the international poll of greatest scientists taken by Popular Mechanics Magazine? The complete result of this vote showing the selection of the wonders together with a historical sketch of each one reprinted in pamphlet form mailed to any address for 10c in stamps. Popular Mechanics Co., 316 W. Washington St., Chicago.

**WOOD-Working for Amateur Craftsmen—125-page book, profusely illustrated, giving every essential step in wood-working.** Valuable for either self-instruction or for use in manual training courses. Cloth, 50 cents, postpaid. Popular Mechanics Book Dept., 316 W. Washington St., Chicago.

#### TRADE SCHOOLS

**MAKE \$5 to \$8 a day** as skilled Electrician, Plumber, Draftsman, Bricklayer, Moving Picture Operator. We teach you in short time at small expense, profitable trades. Free employment bureau places graduates in good jobs. Special limited offer now. Write at once for catalogue and full particulars—no obligations. Dept. 8192, Coyne National Trade School, 51 E. Illinois St., Chicago, Ill.

**AUTOMOBILE Instruction.** \$15 license guaranteed. Driving and practical repairing taught. Easy payment. Students aided to secure good positions. Open evenings. Letze, Inc., 293 Eagle St., Buffalo, N. Y.

**PAINTING, Decorating, Paper Hanging** taught by actual practice. Free catalogue. Chicago School of Painting, 414 Dearborn Ave., Chicago.

#### PERSONAL

**DENTAKLEEN—Antiseptic Deodorant.** Cleans, polishes, removes discolorations from gold fillings, crowns, bridges and false teeth. 50c. Dr. Vnette, Lehigh, Okla.

**BROTHER—Accidentally discovered** root cures tobacco habit and indigestion. Gladly send particulars. F. Stokes, Mohawk, Florida.

#### COLLECTIONS

**500 SLOW Accounts Collected, \$1; 5 samples, 10c.** These forms are simple and effective. No letter-writing required. Louis J. Herzog, Box 635, Baltimore, Md.

#### TELEGRAPHY

**TELEGRAPHY—Morse and Wireless—Railway Accounting (Station Agency)** taught quickly. Railroad and Western Union Wires and complete Wireless Stations in school. Big demand. Positions secured. Living expenses low—may be earned. Largest and oldest school—established thirty-nine years. Investment, \$25,000. Correspondence courses, also. Catalogue free. Write today. Dodge's Telegraph Railway and Wireless Institute, 15th Street, Valparaiso, Ind.

**TELEGRAPHY** taught in the shortest possible time. The Omniograph Automatic Transmitter combined with standard key and sounder. Sends you telegraph messages at any speed just as an expert operator would. Five styles, \$2 up, circular free. Omniograph Mfg. Co., 41 G, Cortland St., New York.

#### PICTURES AND POST CARDS

**POSTCARD** collecting is extremely interesting. Live club. Many members. Trial 10c. Elite Exchange, R22, 3827 Kenneth Ave., Chicago.

**If you really want to exchange** post cards, try our splendid club. Lists circulate in many countries. Membership, 10c. Halcyon Club, Box 133, Erie, Pa.

**WILD Animal Postals** in colors. Assortment for 10c. A. McKee, Allegan, Mich.

**NIFTY Postcards—Beautiful Women.** Samples 10c. Exchange, 3827 Kenneth Ave., Chicago.

**REAL Photos—French models.** Catalog and samples 10c. De Vito, Dept. 2, New Dorp, N. Y.

**GIRLS in swimming.** Photos 25c set. Ritter, Los Angeles, Cal., Sta. A.

**30 NIFTY Postcard Views** 10c. Stewart Co., Providence, R. I.

**THREE Artistic Diving Beauty Poses,** 10c. Catalogue, 2c. Taylor Brothers, 2129M Clifton, Chicago.

**10 DIFFERENT Exposition Buildings,** Postcards, 10c postpaid. Exposition Mail Order Co., Box 2446, San Francisco, Cal.

**5 SPORTING Post Cards, including "September Morn,"** 10c. Miss Blanche Girard, Box 29, Holyoke, Mass.

**MORE the merrier, everything cheerier,** pastime superior. Exchange postals. "True Blue" has perfect plan. Write E. Ed. Ericson, Elroy, Wis.

**NIFTY, Transparent Pictures.** French models. Four, 15c. S. Wra, Council Bluffs, Iowa.

**YOUR name in gold** on 12 Floral Postcards, 10c. The Excelsior Co., 1254 Franklin Ave., Bronx, New York City.

**FIVE Parisian beauty cards,** 25c. Durso, 25 Mulberry St., N. Y.

**VIEWS of Episcopal churches and chapels** throughout the United States and the foreign Mission field. Send for catalogue. A. Moore, 588 Throop Ave., Brooklyn, N. Y.

**JUST Girls—Postals; 10 nifty poses,** 12c. 25, 25c. Assorted postals, 100, 35c. Bailey, 110 Maple, Napanoch, N. Y.

**NIFTY Photos—Fascinating subjects,** 10 for 25c. Duff, 2713 Mozart, Chicago.

**18 PRETTY Post Cards, 10c; 40 for 20c.** J. R. Dickey, 1081 Jason, Denver, Colo.

**3,000 SELECTED Pictures for \$3.** A Panorama of World Events. Political—Industrial—Social—Humorous—Tragic—all of intense human interest. A wonderful collection of 3,000 cartoons reproduced from the newspapers of the United States, Canada, Mexico, Cuba and the cities of the Old World, has been made by Cartoons magazine from more than one hundred fifty thousand published cartoons, and, bound in an artistic and durable cover, are now ready for your library table. Vol. I, Jan.-June, 1912—\$1. Vol. II, July-Dec., 1912—\$1. Vol. III, Jan.-May, 1913—\$1. Cartoons, 318 W. Washington St., Chicago.

**STAGE Beauties.** Four entrancing full-length, richly-colored poses, fourteen inches high, and twenty life-like illustrations, 10c. Gordon Art Co., New York City.

**RECEIVE** pretty post cards from everywhere. Very best club. Membership 10c. Jolly Card Exchange, Box 127, Decatur, Ind.

**BETTER** than "September Morn." Two new pictures by same painter. These and "September Morn" for silver quarter. Box 592, Minneapolis, Minn.

**CARDS** exchanged for results, 10c. Membership in press immediately. Pacific Card Exchange, Bryn Mawr, Wash.

**PHOTOS, "Woman Beautiful,"** gems of art. 24 photo miniatures, 10c. Normal Specialty Co., J. T. Englewood, Chicago.

**YOU'LL get cards from everywhere.** Membership 10c. Idaho Card Exchange, Dept. K, Box 906, Boise, Idaho.

#### CAMERAS AND PHOTO SUPPLIES

**PHOTOGRAPHIC Handbooks—The most compact and practical information ever printed for photographers** is contained in our books at 10c each. "Retouching for Amateurs," "Secret of Exposure," "How to Take Portraits," "How to Make Enlargements," "Manual of Photography," "Practical Development," "Popular Printing Processes," "Hints on Composition," "How I Make Lantern Slides." The nine for 75c. American Photography, 274 Pope Building, Boston.

**KORONA and Pixie Cameras** for plates, film packs and roll films, Panoramic View Cameras, Turner-Reich Anastigmat Lenses and other Lenses. Send for complete catalogue and obtain free copy of text book, "Telephotography with a Panoramic Telephoto Lens." Gundlach-Manhattan Optical Co., 839 Clinton Ave., So. Rochester, N. Y.

**TRIAL Offer—Buy Instanto, the best** developing paper, direct from manufacturer; big saving; better, fresher, quality guaranteed. One full gross 4x6 or smaller and one-half gross postal cards for \$1, for three sample dozen postal cards or 4x6, 25c. The Photo Products Co. (Dept. J), 6100 La Salle Street, Chicago.

**HAVE you a Camera? Write for samples** of my magazines, American Photography and Popular Photography, which tell you how to make better pictures and earn money. F. R. Fraprie, 270 Pope Bldg., Boston.

**PARALLAX—A reflecting condenser,** decided advance in optics, gives powerful light with mazda bulb. Makes enlargements in one second. 11 inch size \$8. Circular free. R. D. Gray, 115 Paramus Ave., Ridgewood, N. J.

**MONEY in Photography.** You can start home studio with your camera. We tell how. Details: portraiture, retouching, and sample pictures sent free. Wells' Studio, East Liverpool, Ohio.

**FILMS Developed, 10c a Roll.** Prints, 2, 3 and 4c. Work returned next day. Write for free enlarging offer. Kodak Film Finishing Co., 112 Merchants Station, St. Louis.

**FILMS Developed, 4c roll; Prints, 1 1/2c.** Satisfaction guaranteed. Send for price list. A. Blad, Maynard, Mass.

**FORMULAS** for ten of the latest fads in photography, 25c. Includes instructions for magic disappearing photos, Photo sofa pillows and neckties, beautiful, transparent, colored pictures on watch cases, chinaware, etc. Phosphorescent photos and other novelties. P. Benson, Stewartville, Minn.

**AIR-BRUSH Effect Backgrounds** successfully taught by mail. No air-brush necessary. Satisfaction guaranteed. Price \$1. The Taylor Studio Company, Frankfort, Kan.

**ROLL film developed, ten cents per roll.** Special 5x7 enlargement in 8x10 frame, 50 cents. Write for price-lists. Address T. H. Knight, Racine, Wis.

**ANY roll film developed, 5c; when ordering** prints 3 1/4x5 1/4, 4c; smaller sizes, 3c. Postcards, 4c; 100, \$1.50. "Kodak Hints" free. We sell Vulcan roll film, 8x10 enlargements, 25c. Caulkins Photo Works, Oneonta, N. Y.

**LANDSCAPE Negatives** bought. Submit prints for inspection; state price. Shilling Art Company, Navarre, Ohio.

**PHOTOGLOW** makes red frelight photographs. Formula, 15c. Perfectly titled negatives assured. New Process, 10c. E. Greenhalgh, Brightwood, Ind.

**GREATEST Photographic Bargain List** ever published. Willoughby, 810 Broadway, N. Y.

**500 BROWNIE Roll Film Cameras** to be given away just for names. Drop us postal. Sun Photo Supply Co., Jamestown, N. Y.

**FILMS** developed ten cents, prints three cents each. All sizes. G. W. Perkins, Tusculum, Ala.

**ROLL Films** developed, 5c. Blickenstaff Studio, North Manchester, Ind.

**WE buy, sell and exchange.** Bargains in Microscopes, Telescopes, Binoculars, Cameras, etc. Bargain list sent. Kahn & Son, Opticians, No. 54 John St., New York. Established 62 years.

**COLOR Photography.** Print your landscape views in colors. Send 2 stamps for circular. Rud. Isenmann, 385 Bergen St., Newark, N. J.

**BIG Money Saved on Photographic Lenses and Apparatus—goods exchanged; repairing done.** Ralph J. Golsen, 65 East 46th St., Chicago, Department P.

**KODAK Films Developed, 10c per roll, any size.** Prompt attention given mail orders. Prints 2 1/4 x 3 1/4 to 3 1/4 x 4 1/4, 3c; 4x5 to 3 1/4 x 5 1/2, 4c. J. M. Manning, Box B, 1062 Third Ave., New York City.

**8x10 PHOTOGRAPHIC enlargements, 30c each, from any size negative or film.** We guarantee better results. The Quality Enlarging Company, P. O. Box 836, Philadelphia, Pa.

### MOTION PICTURES

**LEARN to write photoplays.** Writing motion-picture plays offers a new, easy and fascinating way to earn money in your spare time. Plot all that is required. Literary training or style not necessary. Easily learned. Great demand. Producers pay \$25 to \$100 each. Our short, fascinating course will teach you how to turn your ideas into dollars. Send for free descriptive catalog. Authors' Motion Picture School, Box 130K, Chicago.

**\$100 TO \$300 Weekly in Moving Picture Business.** Easy payment plan, free catalog. Acorn Moving Picture Co., Dept. 13, 173 N. Green St., Chicago.

**FOR Sale—Moving picture film \$2.50 per reel and up; also second hand and new moving picture machines of all kinds.** Send for list. Wichita Film Supply Co., Wichita, Kan.

**MAKE Money Writing Photoplays, \$25 to \$100 each.** Our method superior. We will show you how to write and sell. Instructive booklet free. American Authors' Assn., Room 418, 1535 Broadway, N. Y.

**\$50 TO \$100 weekly writing moving-picture plays.** Send for free booklet, valuable information and special prize offer. Chicago Photoplaywright College, Box 278 FJ, Chicago.

**PHOTOPLAYS and short stories wanted.** E. W. Meyer, Niles, Cal.

**TEN Lesson Course Complete \$2,** teaching you how to write and where to sell Photoplays. Free Illustrated Booklet and Indorsements, Penn Ass'n, Heed Building, Philadelphia, Dept. L.

**\$35 PROFIT Nightly—Moving Picture Business—small capital starts you, no experience needed.** Teach you—furnish everything. Ralph J. Golsen, 65 E. 46th St., Chicago, Dept. M.

**MOTION picture plays wanted.** You can write them. We teach you. No experience needed. Big demand and good pay. Details free. Ass'd M. P. Schools, 601 Sheridan Rd., Chicago.

**WRITE Moving Picture Plays, \$10 to \$100 each.** Constant demand. Devote all or spare time. Experience, literary ability or correspondence course unnecessary. Details free. Atlas Publishing Co., 304 Atlas Bank Bldg., Cincinnati, Ohio.

**MOTION Picture Work—A large 618-page book covering every phase of the moving picture, its production and its theatre.** Indispensable for reference and instruction to the thousands of workers in the motion picture field. Price \$3, postpaid. Popular Mechanics Book Dept., 316 W. Washington St., Chicago.

### BUSINESS OPPORTUNITIES

**WANTED—High-class Sales Managers** who wish to acquire exclusive State Rights for the sale of our automatic ticket selling and cash register, which is rapidly becoming part of the standard equipment in moving picture and vaudeville theatres throughout the United States. Very liberal contracts affording opportunity for large profits to parties having sufficient capital to make an initial investment and the ability to establish a first-class selling organization in their territory. Apply to The Automatic Ticket Selling and Cash Register Company, 605 Third National Bank Building, St. Louis, Mo.

**ESTABLISHED** wholesale bakers and confectioners' supply house, with yearly business of over \$100,000. Will sell at inventory and give lease of store. No bonus asked. Address, A. H., 6th floor, 318 W. Washington St., Chicago.

**MAIL Order Book Business, \$1 starts you.** Samples 25c. Particulars free. B. Newnam, Waukegan, Ill.

**KNITTING Machine** and enough material to make \$10 worth of knitted and crocheted neckties, which will find ready sale. While no experience is necessary, it is particularly suitable to persons of a mechanical turn of mind. Complete outfit costs you only \$25. Honest business proposition you cannot afford to miss. Send for catalogue. Edwin A. Newton, 312 North 4th St., Philadelphia, Pa.

**MANUFACTURE typewriter ribbons.** Small capital. Demand enormous, big profits. I lease wonderful little machine, teach you everything—appoint you general manager for your territory to lease machines to sub-agents and big consumers. Sample ribbon, any machine, 34c stamps. Particulars free. A. J. Mahler, General Offices, Rand-McNally Building, Chicago.

**MR. Mail-Order Man:** Get quick returns. Established corporation supplies fast mail-order sellers; factory prices. Classy proposition. Beginners or established firms. Copyrighted Prospectus free. Mississippi Valley Co., Inc., Box M629, Pittsburg, Kans.

**LET me start you in a paying business** at home; a business that is pleasant and easy to learn; requires no canvassing and is good as long as you live. Full particulars free. Cyphers, 515 A. So. Main, Fort Worth, Texas.

**100 MONEY-Making plans 10c.** 175 Trade Secrets 10c. How to start Mail-Order business, new book, 10c. Service Bureau, 3311-B, Belleplaine Ave., Chicago.

**BIG money manufacturing splendid hair tonic.** I made \$2,800 last year. Quart costs 9c. Sells for \$1. Complete formula \$2. W. F. Rockow, Winslow, Ill.

**"MAIL Order Flashes," "Selected Opportunities," "Money-Making Secrets Exposed,"** suggest greatest money-making plans ever published; each \$1. All \$2. Molock, 718 N. Caroline, Baltimore, Md.

**MINK-Breeding, \$3,750 side line.** Particulars for stamp. Freer Norton, 234 East 178th Street, N. Y.

**MAIL Order Dealers.** Get our proposition. California wonder. Stamp for catalogue. Hunt's Store, Pleasanton, Cal.

**PAYING profession; show-card lettering.** \$30 courses, price \$5. Testimonials and particulars free. Owsley, Hilliards, O.

**MAKE big money at home.** Particulars free. Strang, West Unity, Ohio.

**ADVERTISE—21 words in 50 weeklies \$1.** Cope Agency, St. Louis.

**MAKE and Sell Mission Furniture—**From our instructions one man who was an amateur made and sold \$400 worth of just one article alone. We give you 98 designs and easily followed directions for making each piece in 3 books at 50 cents each or \$1.50 per set, postpaid. Popular Mechanics Book Dept., 316 W. Washington St., Chicago.

**LEARN Electroplating—Practical results** may be obtained by following the directions in our book on electroplating. This is a working guide for the beginner written by an old hand at the business. 112 pages, 62 illustrations, cloth, 50 cents, postpaid. Popular Mechanics Book Dept., 316 W. Washington St., Chicago.

**MAIL Order Dealers.** Agents Supply Houses. Get our circular. Best nickel plated specialty in years. Tremendous demand; or, enclose 25c for two samples; refunded first order. Douglass Mfg. Co., 1230 Fulton St., Brooklyn, N. Y.

**THIS beats all.** Charters for stock companies lower than other states. Information free. Philip Lawrence, former Assistant Secretary of State, Huron, S. D., 101 Dakota Ave.

**OPERATE Hahn's Premium Machines,** the best seller for cigars and candies. J. Hahn, 1016 Germantown Ave., Philadelphia, Pa.

**LET "Schemer Magazine," Alliance, Ohio,** help you get \$\$\$; contains 48 pages new \$-getters every month; latest copy, money back scheme, and book, 21 winners, only 10c.

**A "LEADER" with 100% profit—Mail** Order beginners and those already established should have our proposition. Bridgen Company, Waltham, Mass.

**SELL herbs by mail.** New Idea instruction book worth dollars, only 10c. Indiana Herb Gardens, Box M, Hammond, Ind.

**START Detective Agency; write Chicago** Detective Agency, Morton Building, Chicago.

**LEARN metalizing.** Transform roses, carnations, butterflies, etc., into exquisite jewelry novelties. Big profits. Stamp brings sample and particulars. P. Benson, Stewartville, Minn.

**"THE Greatest Mail Order Proposition** Ever Placed in the Hands of People Desirous of Making Money by Mail"; "The Medical Field"; "Building a Business with Beauty Preparations"; "The Mail Order Book Business"—these four and many other excellent plans fully explained in current **Booster Magazine**—the one bona fide publication devoted exclusively to the interests of agents and all interested in the Mail Order Business. More people read "Booster" than any other trade paper; this alone should convince you that today is the day to learn all about "Booster," its money coining suggestions and principles. Join our ranks now. Let "Booster" put you next to the best money making propositions—ones that really get you the money! Ten cents brings two copies worth dollars to you. If you're dissatisfied we'll send your dime back. **Booster Magazine, Northwestern Bldg., Chicago.**

**\$25 TO \$50 a week.** Results proven. Send for our Free Offer. Make your own test at home. Don't take our say-so. A large line of Patented, Not Sold to the Store Trade, Quick Repeat Order Money Makers Manufactured by us. A New, Profit-Making Leader every month. You are seeking a Profit-Making Business Builder. We have a Test Offer which will interest you. New Leader ready. Positive Proof and Sworn Statement of Results. Big Profits, Quick Sales and Steady Income. Mail Order Instructions and all Printed Matter Free. Kimo Mfg. Co., 45 Kimo Bldg., Buffalo, N. Y.

**UNUSUAL Opportunity:** My tested formula and instructions for making and marketing most reliable and effective razor sharpening compound, including instructions for sharpening safety razor blades without machinery. Unlimited field with large profits. Postal brings particulars. Opportunity, Box 816, Richmond, Va.

**WE start you in business, furnishing** everything; men and women, \$30 to \$200 weekly operating our "New System Specialty Candy Factories" home or small room anywhere; no canvassing. Opportunity Lifetime; booklet free. W. Ragsdale Co., East Orange, N. J.

**RESILVER mirrors and make plenty of** money. Full instructions, 25c. Auburn Supply Co., Dept. R2, 7745 Peoria St., Chicago.

**ADD \$15 weekly to your income working** my mail order plan in spare time. No capital or experience required. Full particulars free. F. L. Miller, Dept. 30, Syracuse, N. Y.

**\$1 WILL bring you formulas and explicit** directions for silvering mirrors; also glass embossing, etching, transferring photographs, etc. George L. Patterson & Co., Dept. 3, Brooksville, Ky.

**MAIL Order Men—My joke-novelties** are paying big profits. Imprint circulars furnished at printer's cost. Joseph Methuen, 203 Court St., Brockton, Mass.

**THE best Mail Order Proposition on** Earth. Particulars free. Luther Gordon Co., Northwestern Bldg., Chicago.

**"THE Art and Process of Dry Cleaning,"** A fascinating and profitable occupation, 25c postpaid. Auburn Supply Co., Dept. D2, 7745 Peoria St., Chicago.

**600 ORDERS for 15 cent article from one** small advertisement. Our circulars (in your name) are pullers. F. A. Turner, 19 High St., Boston.

**MAKE \$25 weekly growing mushrooms** in cellars, sheds, etc. Booklet free. North Shore Mushroom Farm, Dept. 12, Hubbard Woods, Ill.

**USE your spare time to build up a mail** order business of your own. We help you start for a share in profits; 27 opportunities. Particulars free. Mutual Opportunities Exchange, Buffalo, N. Y.

**ANYONE, anywhere, \$5 daily replating** silverware. Samples free. E. Flisk, 101 Sheffield Ave., Buffalo, N. Y.

**"HOW to Make Good" in the mail order** business. Our magazine will enlighten you. Trial three months, 25c, including supplements, giving inside facts and helps. Single copy 10c. The "Lever" Mail Trader, 44, Elizabeth, N. J.

**I MADE \$50,000 in five years with a small** mail order business; began with \$5. Send for free booklet. Tells how. Heacock, 5074 Lockport, N. Y.

**CASH or Desirable Exchange—Farms,** homes, business, quickly, quietly, profitably, confidentially. Safe plan free. 22 years' experience. Allen Stephens, Muncie, Ind.

**MAKE big money opening safes and setting** combinations. Write Wayne Strong, 811 Temple St., Los Angeles, Cal.

**\$1.75 PROFIT on \$2 Order! Write Ro-**dolph, 304 Northwestern Bldg., Chicago.

GET into the Penny Slot Machine Business. Make \$20 to \$50 weekly in your spare time. I made thousands. My free illustrated booklet tells how. Let me start you. Address "Money-Maker Chandler," 326 Cranston St., Providence, R. I.

INCREASE your income by collecting names and addresses for business concerns. Demand increasing. Proof and booklet for stamp. Information System, 200, Marietta, Ohio.

6,000 AGENTS' names. \$1. Morgan, 312 Madison St., Chicago, Ill.

START a Correspondence School! Profits 200% to 1100%. Everything furnished at nominal charge. Complete proposition and sample dollar course, 25c. Roberts Company, Publishers, 2311 North Kildare, Chicago.

SILVERING mirrors, auto-trimmings; plating tableware home. No capital; plans free. Clarence Sprinkle, East Grant, Marion, Ind.

MAKE your own Spawn. Grow Mushrooms. Big profits. Our improved method of making pure culture spawn opens a new field to you. Now is the best time to start. Spawn started now will produce Mushrooms for the spring market, and meet the rush of orders from the small growers. Full instructions, \$1. The Pacific Spawn Formula, Box 246, San Francisco, Cal.

CASH for an idea. Patent News, Dept. 28, Washington, D. C.

SPARE time—no canvassing. Report news, names, etc., to us. Markets waiting. Enclose stamp. "Nisco," Dept. HDB, Cincinnati.

YOU can make from \$200 to \$400 per month, bridge contracting. I teach you how. James A. Wallace, Springfield, Ill.

100 WAYS to make money in your back yard; only few dollars necessary to start. Send for Back Yard Circular. Metz, 306 East 88th St., N. Y.

SPECIALTIES that sell! Samples worth 75c, 25c. Particulars free. Rea Company, Northwestern Building, Chicago.

AN intelligent person may earn \$100 monthly corresponding for newspapers. No canvassing. Send for particulars. Press Syndicate, 700, Lockport, N. Y.

LEARN Photo-Tinting and increase your income. Pleasing and fascinating art, quickly learned at small cost to you. Send for free booklet. Sample hand-colored print 10c. Keil-Burr Co., 58P, Pine St., New York.

YOU can make \$50 weekly, in spare time, manufacturing Tip-Top, the new delicious, pop corn confection—the finest you ever tasted—simply melts in your mouth. No capital or experience required—great opportunity to start a big business of your own and make money easy and quick. Formula and complete directions for manufacturing ten cents silver. U. S. Specialty Co., Dept. 43, New Philadelphia, Ohio.

EVERY Advertiser Needs our New Advertising Rate Book. Lists 2,000 best advertising mediums in America. Gives circulation and rates. Contains special lists and advertising snaps, including "Ads That Pay," sent prepaid for 10c. Dearborn Advertising Agency, 521 Dearborn St., Chicago.

BUILD a \$5,000 business in two years. Let us start you in the collection business. No capital needed; big field. We teach secrets of collecting money; refer business to you. Write today for Free Pointers and new plan. American Collection Service, 101 State St., Detroit, Mich.

A-B-C of the Motorcycle—250 page "Show How" book for owners and operators of motorcycles. Fully illustrated, cloth binding. Price \$1, postpaid. Popular Mechanics Book Dept., 316 W. Washington St., Chicago.

WOULD you like to own a good-paying mail order business? We have a line that gets repeat orders all the time. You can start in spare time; invest a dollar or two a week and soon own a nice business of your own; write for particulars. Nadico, 1664 Belmont Ave., Chicago.

I WILL start you earning \$4 daily at home in spare time, silvering mirrors; no capital; send for free instructive booklet, giving plans of operations. G. F. Redmond, Dept. 306, Boston, Mass.

\$1 STARTS profitable business at home, spare time. New proposition—a sure winner. Particulars free. Harshberger, 4120, Moundville, W. Va.

PATENTABLE Ideas Wanted—Send for 3 free books. R. B. Owen, 30 Owen Bldg., Wash., D. C.

INDEPENDENCE and fortune quickly attained in the Manufacturing Mail Order business. I furnish Formulas, Manufacturing Processes and Trade Secrets in all lines. Sold under positive guarantee; 18 years' practical experience. Revision and improvement of Formulas and Processes—reduction of manufacturing cost—utilization of waste materials, etc., a specialty. Booklet, Formula List, and Valuable Information Free. W. L. Cummings, Ph. D., 127 Standard St., Syracuse, N. Y.

BE Independent—Start a mail order business in your own home; we tell you how and furnish everything needed, wholesale; an honorable and profitable business for man or woman. Many make \$3,000 a year. Particulars free. Murphy Mfg. Co., East Norwalk, Conn.

CASH for your business or property. I bring buyers and sellers together. Write me if you want to buy, sell or exchange any kind of business or property. Established 1881. Frank P. Cleveland, 1308 Adams Express Building, Chicago, Ill.

OPPORTUNITY of a lifetime manufacturing "Substitute for Eggs." Enormous profit supplying groceries, etc. Eggs highest now. Secret formula and instructions \$1. Particulars free. W. C. Deizell, 311A South Fickett, Los Angeles, Cal.

WE Sell Patents. Established 1900. If you wish to add a new product to your line, write us. Charles A. Scott Co., 596 Central Bldg., Rochester, N. Y.

INCORPORATE your business under Arizona laws. Cost small. No franchise tax. Stockholders exempt from corporate debts. Do business anywhere. Laws and forms free. Southwestern Securities & Investment Company, Box D488, Phoenix, Arizona.

ASK Bode! Anything! Especially about Business and Advertising! Get acquainted "now!" Bode, 288p Main, Hartford, Conn.

LET the parcels post help you. Add (\$15 to \$25 weekly) to your present salary or income. Start during spare time and build up a permanent mail-order business of your own. We show you how and help you make good. No canvassing. Experience unnecessary. The Parcels Post makes success doubly sure. Our new ideas and up-to-date plans bring the money. No so-called "Course of Instruction" to sell. We give that free. Write today. Address Pease Mfg. Co., Inc., Dept. A, 70 Broadway, Buffalo, N. Y.

STOP Here! Let me start you in a home business that will bring you money every day. Experience unnecessary. Spare time. No canvassing. I furnish everything. Send for proofs. Voorhies, Desk C. R., Omaha, Neb.

WRITE Moving-Picture Plays. \$10 to \$100 each. Constant demand. Devote all or spare time. Experience, literary ability or correspondence course unnecessary. Details free. Atlas Publishing Co., 3046 Atlas Bank Bldg., Cincinnati, Ohio.

SILVERING mirrors home. Derr's French method. Process guaranteed. No capital. Instructive booklet tells how. Anton Eyring, Station E, Brooklyn, N. Y.

DON'T wait another minute. I will start you earning \$50 weekly. No canvassing. Send for booklet. Greame, Dept. M, Scranton, Pa.

#### GINSENG

GINSENG and Golden Seal. The two most wonderful crops in the world today; there is room in the garden to grow hundreds of dollars worth. Send 10c for our booklet, telling all about them. The Rising Sun Ginseng Nursery, Box 225, Narrows, Kentucky.

GINSENG Roots, 20,000, nice, one year old. February special price, \$12 per 1,000. C. G. McBride, Route 4, Mansfield, O.

GINSENG Seed, best quality. Stratified, 1912 crops for sale very cheap. Daniel Wyss, New Philadelphia, Ohio.

#### FOR ADVERTISERS

TRY Denver Weekly Post for results. It carries more classified ads than any weekly paper in the West. Guaranteed circulation over 115,000 delivered by Uncle Sam. No street or news-stand sales. The largest and best Weekly Newspaper published between the Missouri River and the Pacific Coast, a circulation not duplicated by any other medium—circulation furnished by states on request. Classified ads 3c a word. Display, 30c per line, \$4.20 per inch. Subscription price, 35c the year. One ad convinces. Write for sample copy.

1c PER word, your ad in our 32 page postcard monthly. Display 50c inch. Elite Exchange, 3827 Kenneth Ave., Chicago.

ADVERTISE in 133 different magazines for only 5c per word. Send copy now. List free. King's Agency, Box 13-P, Little Silver, N. J.

BARGAIN Advertising Rate—15 words, one insertion; guaranteed 18,000 copies printed, and one year's subscription, 25c. Digest, Grand Rapids, Mich.

25-WORD advertisement in 100 magazines \$1; rates on newspapers; 2c brings lists. Gem Advertising Agency, 362 Appel Bldg., Denver, Colo.

YOUR 60-70 word adv. in 16-page magazine reaching 3,500 boys, 30c. Youths' Magazine, Chicago.

#### TO MANUFACTURERS

WANTED—Agencies for Electrical and Mechanical Appliances, Machinery, new and improved tools, printing and type-writing machines, vacuum cleaners, lighting outfits, household requisites, novelties, etc., or any other proposition in mail-order business or otherwise. Have travelers all over South Africa. Write full particulars to Joe Zweiback, P. O. Box 67, Kimberley, South Africa. Postage to South Africa is 5 cents.

#### AGENTS WANTED

AGENTS—A free course in General Salesmanship is given to every man of our Sales Organization. This organization is a body of successful men selling the Handy Light; that unique electrical device which cuts the cost of electric lighting in half. Sells for \$3.50, is used in home, office, store, factory; weighs only one pound. Sold by demonstration. All agents furnished with well planned methods for gaining interviews. A high-grade business for a man of ability and standing in his community. General Agents preferred. Inquire for our full proposition by addressing The Handy Light Co., 199 Handy Light Block, Cincinnati, O.

AGENTS and mail order men. We have decided to impart to live, hustling, energetic men or women our secret formulas. The two most desired preparations ever discovered. One wanted by every man. The other by all humanity. Complete instructions and working plans for fifty cents. Worth many dollars. This small charge to keep away curiosity seekers. If making money your aim, act at once. LeMar Toilet Co., Dept. C, Alliance, Ohio.

"BOOSTER" will show you how to make more money! Why not operate a good, substantial "Income Mail Business"? Every issue of "Booster" contains propositions that can easily be worked evenings. Don't invest any money until you read "Booster"—the magazine that has, for years, actually and accurately placed men like you in business for themselves by publishing money making propositions that get the dollars. Send 10c today for two months' trial—it's worth cold cash to you. Booster Magazine, Northwestern Bldg., Chicago.

\$61.50 WEEKLY. Introducing and Selling a New Gas Light Burner for Kerosene Lamps. Beautiful light. No chimney. No mantle. Perfectly safe. Simple in construction. Nothing to get broken or out of order. Will not burn out. Durable. Will last for years. Low price. Easy to sell. 200 per cent profit. Experience not necessary. Samples free. Why not try one on your lamp? Beware of imitations. No branch offices. Luther Manufacturing Co., Dept. 277, Cincinnati, Ohio.

AGENTS. Free book, worth dollar for pink stamp. Chuck full bright ideas and selling schemes. Tells how to be your own boss and start factory in your own home on less than five dollars capital. Manufacturing rugs and floor coverings from old material. Imitating any colors or designs desired. Large pieces made in less than one hour at cost of less than \$1. Patented. Be first to learn of this wonderful Home Mfg. Business. Novelty Rug Co., Toledo, O.

WANTED—Successful merchants and tailoring sales agents. We have the right sample equipment if you have the ability and ambition to become the biggest dealer in your locality selling made-to-measure clothes at popular prices. Unlimited money making possibilities for you. We are a big House, furnish big sample equipments only—want big men to represent us and to such we will give unlimited assistance and advertising helps. Write today for exclusive selling rights. Address Desk 82, Lock Box 483, Chicago, Ill.

HOUSE to house demonstrators. Factory price. Food blender. Retail 25c. Mary E. French, Clyde, Ohio.

**AGENTS Wanted**—Right here is the one big chance of your life. If you want to make good money—\$10 a day or more, as easy as rolling off a log, and get your swell clothes free besides, you can do it by acting as our agent. We are the biggest people in the business and want our agents to make big money and be nifty, stylish dressers. Send a postal today for free \$10 outfit, including a big book of nobby suiting samples to select your swell agent's suit from. Then take orders from people who admire your nifty clothes. They come to you—not you to them. This is the way to get rich—the sure, easy way. Remember, you need no money—everything is furnished by us free. We pay express on everything. Just send a postal, but do it today. You can't get started too quick, making this big money and wearing these stylish clothes. Address card to Paragon Tailoring Co., Dept. 214, Chicago, Ill.

**CAN You Beat This?** A safety razor in a neat case, that carries the same guarantee as any \$5.00 razor, for the small sum of 35c. To those ordering from this issue, we will mail absolutely free a neatly bound book, containing 125 valuable formulas for making up your own toilet articles for the home or shop. Guaranteed the greatest value ever offered. Agents Wanted—Sells at sight; one agent cleared \$390 in November. Barbers Guide & Formula Co., Box 605, Columbus Grove, Ohio.

If you live in a small town and have a little spare time, get our offer. Easy to make \$100 profit each season; still easier to get your own clothes out of the profit on a few orders. No extra charges for fancy styles, golf bottoms, pearl buttons, etc., makes sales easy. Write for free samples and our new offer. Knickerbocker Tailoring Co., Dept. 13, Chicago.

**SIGN Agents**—Every professional man and dealer a likely prospect. Our complete line of high quality, low-priced Window Letters, Glass Signs, Name-Plates, Cloth and Wood Signs sell easily to real estate men, doctors, lawyers, dentists, grocers, druggists, hardware, meat market men, etc. Big profits and exclusive territory to responsible agents. Write today for new catalogs. Attracto Sign Co., 2656 North Clark St., Chicago.

**AGENTS**—Drop dead ones! Awake! Grab this New Invention. Low-priced, water-power home Massage Machine. Magical, marvelous, mysterious. New field; big profits; sold on money-back guarantee. "Marg-worth sold 5 in 10 minutes; 31 in 2 days." "Parker sells 8 first day." Vaughan: "Your machine has merit. Express six dozen. Certainly wonderful." Big surprise awaits you. Address Blackstone Company, 858 Meredith Building, Toledo, Ohio.

**AGENTS**—When you sell a Fesler Fountain Shaving Brush, you make 100% cash and 25% on soap renewals each year. Our men are making more money than any agents in the field. \$25 to \$50 per week is easy. Write today for our sales plan. Fesler Sales Company, 256 West 23rd St., New York City.

**MR. Mail-Order Man:** Get quick returns. Established corporation supplies fast Mail-Order sellers; factory prices. Classy proposition. Beginners or established firms. Copyrighted Prospectus free. Mississippi Valley Co., Inc., Box N629, Pittsburg, Kans.

**ENDLESS Neckties (Patented):** Just show them—men buy on sight—look alike any stylish necktie—tie in a different place each time—wear 20 times longer. Hustlers can make steady \$40 to \$60 week. Sample outfit free if you mean business. Write Endless Necktie Co., Kansas City, Mo.

**DISTRICT Agents** are making big money selling the Reliance Vacuum Cleaners, best and neatest hand power machine sold. Write quick for particulars and territory for 1914. Reliance Specialty Co., 1754 Bertrian Ave., Chicago.

**CALIFORNIA** honey brings agents big profits and steady business. Prices 10, 11, 12c per lb. prepaid anywhere. Inspection allowed before payment. Agents sample 10c. Price list free. Spencer Apiaries Co., Box 26, Nordhoff, Calif.

**AGENTS**—Just out. Unique invention. Sells at sight. New Vacuum Massaging machine that works without electricity, water, or drugs. Durable, sanitary, inexpensive. Small, but powerful. Used anywhere. Big money for those who act quick. Don't delay. Send postal. Aztec Remedy Co., Dept. E, Toledo, O.

**AGENTS!** Big money for you selling the Merchandise Register Clock. New, clever premium plan. Every merchant buys. You make \$4 every sale. Write quick. Edward Ellis, Menominee, Mich.

**ABSOLUTELY** new specialties for "live-wire" agents, street men and demonstrators. Seven sensational sellers. Enormous money makers. Territory going fast. Write quick. Dept. 2, United Sales Co., Newburgh, N. Y.

**SELL** the "Sellem" Match Machine. 30,000 sold by jobbers. Room for 30,000 more. Never sold by agents before and is your opportunity. Send for "The talk that sells it." Vern Galster, 508 Prospect Ave., Syracuse, N. Y.

**LARGE** income selling Specialty Rugs. Colored illustrations and important information free. Sample rug forwarded prepaid, \$1.00. Reference, Boylston Nat'l Bank, Boston. Dundee Mfg. Co., 46 Chauncey St., Boston, Mass.

**AGENTS Wanted**—Agents make 500 per cent profit selling "Novelty Sign Cards." Merchants buy 10 to 100 on sight, 800 varieties. Catalogue free. Sullivan Co., 1234 Van Buren St., Chicago, Ill.

**AGENTS** sell guaranteed Hosiery, Underwear, and Sweaters for largest manufacturer in America. Easy work. Big pay. Complete outfit free. Write Madison Mills, Dept. 7A, 590 Broadway, New York City.

**AGENTS** make big money selling our new gold letters for office windows, store fronts and glass signs. Any one can put them on. Write today for free sample and full particulars. Metallic Sign Letter Co., 406 N. Clark St., Chicago.

**AGENTS Wanted**—Live men who are willing to make 150% profit on \$1.50 sanitary Oil Mop, also 130% on our American Fibre Broom, retails at 75c. Easy sellers. For particulars address Columbia, 1434 W. 15th St., Chicago.

**AGENTS**—If you don't make \$4 profit the first day selling Tate's Guaranteed Dust Absorbing Cloths, Brushes, Mops, etc., return sample outfit. Consumers Direct Supply Co., Boston, Mass.

**PORTRAIT agents**—Deal direct with the artist. You get a better picture. Send for price list. T. S. Richardson, 600 Blue Island Ave., Chicago.

**AGENTS**—Something new—fastest sellers and quickest repeater on earth. Permanent, profitable business. Good for \$50 to \$75 a week. Write for particulars. American Products Co., 6718 Sycamore St., Cincinnati, O.

**AGENTS**, make more money. Handle the Imperial Self-Heating Iron. Oldest and best. Every housewife wants one. Exclusive territory. Write today for interesting proposition. Imperial Brass Mfg. Co., Dept. 732, Chicago.

**AGENTS**—\$4 to \$6 a day with our "Straight line to success." 150% profit. Permanent business. Barker Chemical Co., 20 Center, Auburn, Maine.

**PHOTO** Pillow Tops, Portraits, Frames, Sheet Pictures, Photo China Plates. Rejects credited. Prompt shipments; samples and Cat. free to agents. 30 days' credit. Jas. C. Bailey Co., Desk S2, Chicago, Ill.

**VAPOR**—Gas Burners in cook stoves or ranges stop use of coal or wood; wonderful invention. Agents coin money. Vapor Gas Co., Desk 8, Columbus, O.

**VACUUM Cleaner Agents:** Absolutely new design in wheel-operated, powerful bellows vacuum cleaner; new visible nozzle and Lint Gathering Attachment; exclusive appearance; sells quick at \$7.50. Write for particulars about money-back guarantee now. Doty Company, Box 200, Dayton, Ohio.

\$1,000.00 OR \$400.00 a month—which? Agents make \$20.00 a day. Start in small way, grow to big money class. Koehler made \$12.00 first day, \$16.00 second day. "Positive Proof Sales Plan," combined with "Shakit," makes big money certain. Make your friends wonder at your success. Act quick; particulars for postal. Nat. Dist. Co., 1674 Belmont Ave., Chicago, Ill.

**MANUFACTURER** of new exclusive linen heel and toe guaranteed hosiery wants agent in every county. Sales enormous. Re-orders insured; permanent, increasing income. Protected territory. Credit. N. Parker Mills, 720 Chestnut St., Philadelphia, Pa.

**200% PROFIT.** You can't beat it. Free pocket sample. Sells everywhere. Everyone buys. Our reputation and big capital back you. Wm. J. Dick, Mgr., Dept. F4, 20 W. Lake St., Chicago.

**AGENTS**—Our \$1.50 new fire extinguisher sells at sight. 100% profit. Biggest seller out. Particulars free. Allen Specialty Co., Dept. 2, Stevens Point, Wis.

**GOLD** Sign Letters. Instructions for making. Johnston Co., Quincy, Ill.

**YOUNG** Man, would you accept and wear a fine tailor made suit just for showing it to your friends? Or a Slip-on Raincoat free? Could you use \$5 a day for a little spare time? Perhaps we can offer you a steady job. Write at once and get beautiful samples, styles and this wonderful offer. Banner Tailoring Co., Dept. 637, Chicago.

**OUR \$1 Adding Machine Adds Quicker** and better than yourself. Many already in use. Prepaid. Money returned if not pleased. Agents Wanted. Haynes Mfg. Co., Desk 5, Henrietta, N. C.

**YOUR** address on postal brings you the biggest money-making proposition you ever received. Try it. X. L. Products Co., 117 Worth St., New York.

**AGENTS:** Big Profits, Quick sellers, write for particulars. Sample free. Hilton Sales Company, Muncie, Ind.

**AGENTS**—Men and women, newest invention. Wing Self Heating Gasoline Flat Iron; guaranteed, sells everywhere. Women delighted. Write for particulars. Wing Mfg. Co., 1608 Fulton St., Chicago.

**MEAN** and women get government jobs. \$65 to \$150 month. Examinations everywhere soon. Write immediately for free list of positions now available and Spring Examination schedule. Franklin Institute, Dept. C22, Rochester, N. Y.

**AGENTS**—Greatest value ever offered. With every Sale of Duncan's Polish Mops a \$1.00 can Cedar Polish absolutely free, 90 cents profit on each sale. 10 to 15 Sales daily easy. Duncan Bros., 2616 Grand Ave., Chicago.

We furnish you capital to run profitable business of your own. Become one of our local representatives and sell high grade custom made shirts, also guaranteed sweaters, underwear, hosiery, and neckties direct to homes. Write Steadfast Mills, Dept. 10, Cohoes, N. Y.

**AGENTS**—150% Profit on Each Sale. Show housewives how to do an hour's hard work in a jiffy. Unique household preparation and our original "Entering Wedge" plan makes easy sales and big profits. Excellent opportunity to control this in your territory. Jiffy-Brite Laboratories, Dept. M, Boston, Mass.

**SEND** for new and rapid seller, big profits, repeats. Barr Mfg. Co., 509 N. Marshall, Philadelphia, Pa.

**AGENTS**—Salesmen. Seasonable seller, latest \$3.50 electric invention, fills demand never before supplied; home, office, store, everywhere eagerly sought. Repeat orders outnumber first sales, you control territory, no competition, unlimited possibilities. Write, Frank W. Alden, Agency Manager, 139 Station F, Cincinnati, O.

We want agents in every town or city to sell our household and auto article. We don't guarantee \$100 daily, but we pay liberal commissions and give territory to right party. Our goods are guaranteed. We send you full size sample for 15c, or you can write for particulars without sample. James Kearney, proprietor, 213 Sixth St., New York.

**WRITE** quick for list of practical mail order sellers which you manufacture at home. "All Winners." P. Benson, Stewartville, Minn.

**AGENTS:** We want, at once, a man or woman, one capable of earning good salary, in every community where we are not represented. Write us. Sun Mfg. Co., 309 Dean Bldg., South Bend, Ind.

**STAMP** Names and Addresses on Key, Checks, Umbrella Plates, Watch Fobs, etc. We supply blank stock and stamping outfits, sample with name and address, 10c. Hart Mfg. Co., Desk 2, 303 Degraw St., Brooklyn, N. Y.

**DOUBLE** your income by collecting names and addresses for mail order concerns. Demand increasing. Some clear over \$100 monthly. Proof and booklet for stamp. Information System, 201, Marietta, Ohio.

**\$50.00 A WEEK** guaranteed selling Pure Spun Aluminum Cooking Utensils. We are manufacturers of the largest line in the world. First Aluminum Cooking Utensils made bears our trade-mark. Wanted live men at once for protected territory. Answer quick. Divn. PM, American Aluminum Mfg. Co., Lemont, Ill.

**HERE'S** something new! Unique article having the characteristics of a novelty—popularity will exceed your expectations! New selling plan—no talking or experience required. Write for particulars and prices. Sample 10c. If you can't make big money with this, we'll send you dime back. Garfield Supply Co., 929 Flick St., Middletown, Ohio.



**AGENTS Wanted**—If you know a chance when you see it you'll see this one now. Big money—stylish, nifty clothes—little work—no experience or capital needed—can you beat that? We want agents everywhere to take care of our business in their localities and to advertise our nobby, nifty suits by wearing them. We furnish everything complete and charge nothing for agents' outfit. The swellest dressers everywhere are our agents and all we ask is that you tell people who inquire about your fine clothes where and how they can get them. You make big money—\$10 a day—without trouble. Just a postal brings you full outfit free. Big, new sample book of up-to-the-minute suitings sent so you can pick out your first suit; also measuring blanks and everything you need. We pay express on everything—not a penny for you to pay. Send quick before some one else gets the agency there—mail postal today to American Woolen Mills Co., Dept. 214, Chicago, Ill.

**AGENTS**—Here's a whirlwind seller. Every family needs one. Big profit on every sale. Western Specialty Co., Bismarck, N. D.

**LISTEN!** You can make \$15 weekly easy selling high-grade jewelry, 50c weekly. Washburne, No. 525 West 47th St., N. Y.

**AGENTS**—To sell the newest electric appliance on the market; sold everywhere there is electricity, in the home and office; liberal profits; sales-driving sample, weighs a pound, no experience or knowledge of electricity required; it shows how to use one light instead of two and get the same results; sells for \$3.50, and saves the purchaser an investment of \$25. Write for particulars. The Handy Light Co., 13 Handy Light Block, Cincinnati, O.

**AGENTS Wanted** in every town and city to sell our high grade household specialties. Cole Specialty Co., Dep't L, 403 E. 37th St., Savannah, Ga.

**TRANSFORMERS**—All capacities, for ringing Bells, operating Heat Regulators, Door-openers, Signals, etc. Free Demonstration Set for Agents. We make Transformers for Wireless Telegraphy from 5 to 15,000 Volts, operating on Alternating Current. Electrical Massage Devices from \$5 to \$25. Electric Star Devices Co., Pittsfield, Mass.

**AGENTS Wanted**—Carpenters preferred, in all towns and cities in the United States. New Improved Mortising Auger and Machine to mortise locks in doors, and other work for carpenters and contractors, guarantee machine will do all work perfect. The Mortising Auger and Machine Co., Cheyenne, Wyoming.

**I NEED** one energetic, dependable representative in every county to take orders for our new Popular Mechanics book for boys called "The Boy Mechanic." This is not a story book, but a wonderful and interesting collection of 700 things boys love to make and experiment with. A very large attractive book for the price, \$1.50. Every boy's father or mother will want to buy it for their son. It sells itself. Good liberal commission and exclusive territory. You don't have to be a professional agent to be successful with this highly meritorious proposition. Work in and around your home town during spare time only if you cannot devote all your time to it. Write today for full particulars to Manager Book Dept., Popular Mechanics Co., 318 W. Washington St., Chicago.

**AGENTS**—Write for prices on Solar, Bromides, Convex Prints and Pillow Tops. We ship orders back in 24 hours' time. Try us. Home Copying Co., 113 S. Jefferson St., Chicago.

**AGENTS**—If you are looking for a novelty, something of worth and merit, send for particulars. Helaino Supply Co., 15 Broad St., N. Y.

**AGENTS**: Big Money Selling Automatic Telephone Disinfectors. Used and endorsed by hundreds New England's leading firms. Sample 50 cents. Particulars free. Eucalyptus Parfeno Co., New Bedford, Mass.

**WANTED**: Mail Order Dealers to enclose stamp, description and prices best 25c article ever offered. New. Phelps Specialty Company, Caro, Mich.

**YOU** can make money. Talking not necessary. Anyone can do it. Samples and directions 10c. None free. Bayles Supply Co., 275 86th St., Dept. 203, Brooklyn, N. Y.

**MAKE** and sell your own goods. Formulas by expert chemists. We obtain your Government Serial Number. Catalogue for stamp. B Mystic Company, Washington, D. C.

**NEW Patent Burglar Alarm.** Agents make \$5 to \$10 per day. Sample postpaid, 38c. Lee Mfg. Co., 1417 Belleplaine Ave., Chicago.

If we had your address we'd send free sample and show you how to make \$25, not one week, but weekly. G. Mfg. Co., 20 H Warren St., N. Y.

**AGENTS** make big profits selling standard household article. Easy seller. Sample 15c. John Sullivan, Jr., North Attleboro, Mass.

**AGENTS** for specialties that sell; write for particulars. Household Specialties Co., Wilmette, Ill.

**AGENTS**—Repeater; costs 5c, sells for \$1; sample 2c. Dr. Thornber, Ferris, Ill.

**SMALLEST** alarm clock, bible and telescope. 10c each postpaid. W. H. Garner, 1013 W. 24th St., Los Angeles, Cal.

**REMNANT** Store, 1331-E. Linn, Cincinnati. Greatest Dry Goods Bargains on Earth. For agents and store-keepers.

**AGENTS**: Be a sign letter man—nothing could pay you better, ask us why! Forest Letter Company, South Amboy, N. J.

**SELL** advertising novelties. 25 per cent commission. Nail files and tooth picks in leather cases. Big sellers. Samples 10c. Joel Kenyon, Owego, N. Y.

**HUSTLERS** get busy! California novelty. Something new. Stamp for catalogue. Hunt's Store, Pleasanton, Cal.

**AGENTS**, write us for latest invention. Large profits. Birkbeck & Son, Freeland, Pa.

**AGENTS** for splendid high-grade seller; easy to handle; large demand; big profits. Write at once. Streich & Co., Box 556, Swift Current, Sask., Canada.

**MANUFACTURE** gold window letters. Sample, particulars, 10c. Box 31, Detroit.

**GENERAL Agents**—Capable of calling on the big trade themselves and handling canvassers for the house to house and office to office business, to sell the newest electric specialty on the market; sold wherever there is electricity, in the home, office, factory, store, hotel, liberal profits; sales-driving sample, weighs a pound; no experience or knowledge of electricity required; shows how to use one light instead of two and get the same results; sells for \$2.50, \$3.50, \$5.00 and saves the purchaser an investment of \$25.00. Write for particulars. The Handy Light Co., 151 Handy Light Block, Cincinnati, O.

**AGENTS**—\$5 daily selling our Handy Tool, 12 articles in one. Lightning seller. Sample free. Thomas Mfg. Company, 462 Third St., Dayton, Ohio.

**AGENTS**—250% profit. Wonderful little article. Sells like wildfire. Can be carried in pocket. Write at once for free sample. H. Mathews, 1962 Third St., Dayton, Ohio.

**SELLS** Like Hot Cakes. Samples for 10c. Stamp brings particulars. Address Manager, 740 1/2 Kohler St., Los Angeles, Cal.

**"LIVE-Wires"**—Four absolutely new household necessities. Labor and "Money-Savers." Enormous moneymakers. Logan Mfg. Co., 2314 Lyndale St., Chicago.

**AGENTS** are coining money with our Improved Keyless Padlock. 150% profit. Sample, postpaid, 75c. It's a winner. Wm. J. Dick, Mgr., Dept. F-21, No. 20 W. Lake St., Chicago.

**SALESMEN**—Send your name and address to Raymond E. Wood, 115 Dreyer Bldg., Cincinnati, Ohio. I am the manufacturer's Sales Manager for the best household and office electric specialty ever invented. Sells for \$3.50 and \$2.50. Guarantee for credit or deposit required. Capable men only need apply. I want only a few men. The work is permanent, profitable and high-grade. You will be given territory and expected to produce business.

**WE** have agents making \$200 weekly, selling our new specialty to merchants. Retail \$7.50, your profit \$3.00. No competition; exclusive territory. Samples and descriptive matter free. Sayers Co., 408 Olive St., St. Louis, Mo.

**RURAL** Agents write for our "10-day free trial offer to prospective agents" on our New Improved 1914 Model Vacuum Cleaner. We pay all express charges. Best and strongest suction cleaner made. Gets both germs and dirt. Guaranteed 5 years. Postal will bring offer. Warner Vacuum Cleaner Company, Dept. "Z," Muncie, Ind.

**MAIL-ORDER** Opportunities: 25 new Propositions. No competition! Make 95c profit on dollar order; complete outfit 10c. Mail Dealers Wholesale House, 521 Franklin Bldg., Chicago.

**SOAP** agents make more money selling the celebrated Linro line. Coffee, flavorings, spices, soaps, perfumes, and 135 other items. Big commissions to you. Exclusive territory. Freight allowed. Handsome premiums to your customers. Free sample case. No deposit required. Free catalog. Linro Company, 13 Linro Bldg., St. Louis, Mo.

**AGENTS**—Every household on farm, in small town or suburbs where oil lamps are used needs and will buy this wonderful mantle lamp; burns kerosene, gives a light five times as bright as electric; one farmer cleared over \$500 in 6 weeks; hundreds earning \$100 to \$300 per month. Write quick for wholesale prices, territory and sample lamp for free trial. Mantle Lamp Co., 351 Aladdin Bldg., Chicago, Ill.

**AGENTS**—Salary or commission. Greatest seller yet. Every user pen and ink buys on sight. 200 to 500 per cent profit. One agent's sales \$620 in six days; another \$32 in two hours. Monroe Mfg. Co. X 6, La Crosse, Wis.

**STOP** Here! Let me start you in a home business that will bring you money every day. Experience unnecessary. Spare time. No canvassing. I furnish everything. Send for proofs. Voorhies, Desk C. R., Omaha, Neb.

**\$5.00 RAINCOATS**—Agents wanted everywhere. You and many others in your section need Raincoats and would gladly pay Agent \$5.00 for one. Why not be that Agent? Boston Raincoat Company, Sales Dept., Boston, Mass.

**WANTED**—Hustlers to take orders for made-to-measure, high grade men's tailored suits from \$9.00 to \$22.00. Make \$25.00 to \$50.00 weekly. Elegant large book outfit free. Experience unnecessary. No pocket folder affair. Splendid opportunity to make money. Handy Dandy Line, Dept. S, Sangamon St., Chicago.

**AGENTS** make \$100.00 monthly selling our 500 Handy Household Articles; catalogue free. Scheff Company, Desplaines, Ill.

**FULLER** Dustless Floor and Wall Mop, with adjustable handle, and hand duster are indispensable to housekeepers—sell at sight—100 per cent profit to agents. Write today. Fuller Brush Co., 55 Hoadley Pl., Hartford, Conn.

**\$35 TO \$100** weekly made easily. Needed in every home and store; enables purchaser to save money and enjoy life. Rapid seller, profit from \$10 to \$50 each sale. Experience unnecessary; exclusive territory to hustlers. Write for full particulars. C. Hemple, Sales Mgr., 174-C, No. Sangamon, Chicago.

**YOU** can be your own boss with our Key Check Outfit. Good for \$5 a day stamping names on pocket key checks, fobs, etc. Sample check, with your name and address, 15 cents. Pease Die Works, Dept. M, Winchester, N. H.

**PERFECTION** Pocket Adding Machine. Lightning seller. Agents wanted. Cincinnati Specialty Mfg. Co., Dept. R, Cincinnati, Ohio.

**AGENTS** make big money and become sales managers for our goods. Fast office sellers. Fine profits. Particulars and samples free. One Dip Pen Company, Dept. 2, Baltimore, Md.

**AGENTS** to take orders for Visiting and Business Cards; large profits; outfit free. Forman Printery, Waterbury, Conn.

**AGENTS** sell rich-looking imported 36x68 rugs \$1 each. Carter, Tenn., sold 115 in four days, his profit \$57. You can do as well. Write for sample offer and selling plan. Sample rug by Parcel Post, prepaid, 98c. A. Condon, Importer, Stonington, Maine.

**SOAP** and Perfume Agents, write us. Big Profits. Goods Guaranteed. Hopfinger and Roth, 212 N. Second St., St. Louis, Mo.

**GENERAL** Agents experienced in calling on big trade who can organize canvassing crews that will sell our products from house to house and office to office. Demand growing every day, sells the year round. Territory contracts to reliable men or women. Send \$1 for five sizes, retail value \$3.00. If you're a dreamer, keep your money. Delight-Ol Products Co., Milwaukee, Wis.

**400% PROFIT** selling our high grade work. Samples free. Gordon Co., Northwestern Bldg., Chicago.

**DON'T** miss this. You can easily earn a little money this winter during your spare time. No investment required to start. Write today to E. W. Vacher, New Orleans, La.

**AGENTS—\$50 weekly.** We manufacture the best needle case made; a wonderful seller; 200% to 500% profit; talking unnecessary; our "Trust Scheme" Envelopes do the work; general agents can make \$100 weekly; particulars free; 25c sample outfit for 10c; buy direct from the factory. Paty Needle Co., 102 Davis Sq., W. Somerville, Mass.

**BIG Profits for You! Manufacture Barley Crisp.** New confection. 5c package costs you 1c. Machine, instructions complete \$7.50 prepaid. Send 10c for samples. Barley Crisp Co., 1605 Hyde St., San Francisco.

**I WILL start you earning \$4 daily** at home in spare time, silvering mirrors; no capital; send for free instructive booklet, giving plans of operation. G. F. Redmond, Dept. 306, Boston, Mass.

**300 TO 400% Profit to Agents** selling our guaranteed U. S. Fire Extinguishers. Tremendous demand. Orders repeat. Exclusive territory to county and district managers. United Mfg. Co., 1925 Jefferson, Toledo, Ohio.

**\$30 WEEKLY** Selling "Easy" Suction Sweeper. Wheels operate cylinder, creating powerful suction. All metal. No pump. No bellows. Low price. Guaranteed Sample Free. Write quick. Foote Sweeper Co., Box 2060, Dayton, Ohio.

**AGENTS make \$5.00 to \$10.00 a day** on the start. Atkinson writes: "The best proposition I have found in my forty years canvassing." Permanent work. Household necessity. Saving 80%. Write today for General or Local Agents terms. Free sample. C. H. Stuart & Co., 16 Union St., Newark, New York.

**AGENTS—Handkerchiefs.** Dress Goods. Carleton made \$8 one afternoon; Mrs. Bosworth \$25 in two days. Free Samples. Credit. Stamp brings particulars. Freeport Mfg. Company, 59 Main St., Brooklyn, N. Y.

**WE are the largest manufacturers of Twisted Wire Brushes in America.** Highest grade goods, best service, highest profit. Write for our new catalog. You are sure to win. Fuller Brush Co., 33 Hoadley Place, Hartford, Conn.

**500% PROFIT** selling our wonderful sign letters for office windows, store fronts and glass signs; resembles finest gold leaf; easily applied; samples free. Metallic Letter Co., 406 N. Clark St., Chicago.

**YOU can make \$\$\$\$ as our general or local agent.** Household necessity; saves 80 per cent; permanent business; exclusive territory; salary or commission; free sample; credit. J. Pitkin, 113 Redd St., Newark, N. Y.

**AGENTS Wanted—Mechanics and shopmen** make over \$100 a month in spare time selling transparent handled novelty knives and razors. Big profits. Sales easily made. Write for terms today. Novelty Cutlery Co., 67 Bar St., Canton, O.

**MEDALLIONS—300% profit.** Make up your own goods and be independent. Catalogue free. Resag Co., 1205 Randolph St., Chicago.

**READ the Agents' Magazine.** Make more money. 2 months, 10c. Agents' Magazine, Chicago.

**AGENTS—Sell the Primus,** genuine Swedish wickless, coal-oil stoves. Smokeless, odorless. Twice the heat of gasoline at one-eighth the cost. No danger of explosion. Big profits. James Anderson & Sons, Sidney, Ohio. American distributors.

**AGENTS—Would you take a steady job** where you can clear \$20 to \$30 weekly and work up to yearly profits of \$3,000 or more? My line is snappy household goods. Quick sellers. Get busy with postal, asking particulars. E. M. Davis, R 64 Davis Block, Chicago.

**WE pay \$80 a month salary and furnish rig and all expenses to introduce our** guaranteed poultry and stock powders. Address, Bigler Company, X368, Springfield, Illinois.

#### HELP WANTED

**YOUNG Man,** would you accept and wear a fine tailor made suit just for showing it to your friends? Or a Slip-on Raincoat free? Could you use \$5 a day for a little spare time? Perhaps we can offer you a steady job? Write us at once and get beautiful samples, styles and this wonderful offer. Banner Tailoring Co., Dept. 638, Chicago.

**WANTED—Circular Distributors.** Stamp for contract. American Distributor, Blairsville, Pennsylvania.

**\$25 TO \$50 a week.** Open a branch for manufacturers. Our Co-operative Method is your opportunity to build up a Mail Order or Local Business of your own. Experience unnecessary. Don't take our say-so. Our test offer and positive proof will interest you. Kimo Mfg. Co., 146 Kimo Bldg., Buffalo, N. Y.

**EXPERIENCED** novelty salesmen—you with clean records, grit, confidence and enthusiasm—\$3,000 a year or more for attending to vacant territories on high-grade advertising novelties. Write giving details and references. L. F. Grammes & Sons, 340 Union St., Allentown, Pa.

**A MONEY Proposition—Co-operate with me** in a profit-sharing mail-order business. Will place trial advertisement, furnish printed matter, goods to fill orders and divide the profits. Particulars, Desk 153, Hazen A. Horton, Tekonsha, Mich.

**LADY** representatives wanted. We offer splendid income, valuable house furnishing premiums. Goods on credit. Spare time work. Experience unnecessary. Particulars free. Dept. B, Peerless Products Company, Newburgh, N. Y.

**ORDINARY** person may earn \$25 weekly corresponding for newspapers. Pleasant, independent work. Particulars, News Press Bureau, 177 Post Office Bldg., Medina, N. Y.

**RAILWAY** mail clerks get \$900 to \$1,800 year. Vacations with pay. Interesting work. We coach you to pass Civil Service Exams. Booklet free. Lincoln Civil Service School, Dept. 10, Rochester, N. Y.

**MEN and women** wanted for government jobs. \$65 to \$150 month. Vacations. Steady work. Parcel Post and Income Tax mean many vacancies. Common education sufficient. "Pull" unnecessary. Write immediately for free list of positions now available. Franklin Institute, Dept. C21, Rochester, N. Y.

**\$65 TO \$150** paid men and women in government positions. Common education sufficient. Over 12,000 appointments to be made. We will instruct you by mail for your examination for only \$5. Also Short-hand, Bookkeeping, Typewriting, High School, Engineering and Law Courses taught by mail. For "Free Tuition Scholarship" apply Carnegie College, Rogers, Ohio.

**ANY** intelligent person can earn steady income corresponding for newspapers. Experience unnecessary. Address Press Corresponding Bureau, Washington, D. C.

**WANTED—Railway Mail Clerks,** \$75.00 month. Parcel Post means many appointments. Examinations everywhere soon. Write for schedule and sample questions. Franklin Institute, Dept. C21, Rochester, N. Y.

**MAILING** circulars is light, pleasant work for spare time, no experience or canvassing. Send name; begin making money at once. Raymond, 100 Roxbury Crossing, Mass.

**BECOME** Railway Mail Clerks. \$75.00 month. Examinations everywhere soon. Write for dates, Franklin Institute, Dept. C21, Rochester, N. Y.

**BRAKEMEN,** Firemen, on all railroads. Wages \$100. Experience unnecessary. Send age, postage. Railway Association, Dept. 298, Brooklyn, N. Y.

**GOOD** Positions Open everywhere. Let us place you. State qualifications, salary, etc., first letter. "Nisco," Dept. MDB, Cincinnati.

**RAILWAY** Mail Clerk Examinations. Sample questions free. Franklin Institute, Dept. C21, Rochester, N. Y.

**WE** will start you in the cleaning and dyeing business, little capital needed, big profits. Write for booklet. Ben-Vonde System, Dept. C, Charlotte, N. C.

**GOVERNMENT** Jobs Open to Men—Women. Big pay. Write for list of positions now available. Franklin Institute, Dept. C21, Rochester, N. Y.

**GET a Government Job!** See ad on page 16. Write now—today. Patterson Civil Service School, Rochester, N. Y.

**\$75.00 MONTH.** Paid Railway Mail Clerks. Sample examination questions free. Franklin Institute, Dept. C21, Rochester, N. Y.

**WRITE** Moving Picture Plays, \$10 to \$100 each. Constant demand. Devote all or spare time. Experience, literary ability or correspondence course unnecessary. Details free. Atlas Publishing Co., 3045 Atlas Bank Bldg., Cincinnati, Ohio.

**BE a Detective—Earn \$25 to \$75 weekly;** chance to see the world with all expenses paid. Loraine System, Dept. 304, Boston, Mass.

**GO on the Stage, Vaudeville career** offered you. Experience unnecessary. Managers endorse my method. Instructive vaudeville book free. Write today. Frederic LaDelle, Sta. 10, Jackson, Mich.

**WANTED—Distributors, Men and Women**—to give away free pkgs. Perfumed L'orax Soap Powders; no money or experience needed; good pay. S. Ward & Company, 218 Institute, Chicago.

**BECOME** Detectives—Earn \$150-\$300 monthly. Easy work. Write Wagner, 1243 Lexington Avenue, New York, Dept. 451.

**STOP Here!** Let me start you in a home business that will bring you money every day. Experience unnecessary. Spare time. No canvassing. I furnish everything. Send for proofs, Voorhies, Desk C. R., Omaha, Neb.

**BETTER** Light for 1/5 Cost of Electricity. Suitable for home or store. Easily installed; no experience necessary, big demand. Write for Free catalogue. Doud Lighting Co., 174-D, N. Sangamon, Chicago.

**I WILL** start you earning \$4 daily at home in spare time, silvering mirrors; no capital; send for free instructive booklet, giving plans of operations. G. F. Redmond, Dept. 306, Boston, Mass.

**WANTED—Crackerjack** salesman to market high grade lubricating oils and mixed paints. Big inducements on salary and commission with expenses paid. Give experience and references first letter. Box 389, Cleveland, Ohio.

**MILLWRIGHT** wanted to take care of machinery, large plant. Must have good references. A-1 mechanic and inventive. In reply, give salary, age and references. B. S. P., 6th floor, 318 W. Washington St., Chicago, Ill.

**LEARN** automobile repairing, driving on up-to-date cars; electrical, civil engineering, surveying; methods most practical; room and board while learning; positions secured; satisfaction guaranteed; catalog free. National School of Engineering, 2110 West Seventh, Los Angeles.

**MAKE** money writing short stories. Big pay. Free booklet tells how. United Press Syndicate, San Francisco.

**BE a Detective.** Earn \$200 monthly, positions open. A practical course in Detective Work taught by mail. American School of Criminology, Detroit, Michigan. Dept. F.

**ARE you ambitious?** Earn \$15 to \$25 weekly, during spare time at home writing for newspapers. Literary ability unnecessary. Instructive booklet free. Washington Press Bureau, Dept. P, Washington, D. C.

#### WANTED

**WANTED—To get in touch with** Mechanics, Inventors and others who can furnish photos and description of novel adaptations of gasoline engines in every line of work. Accepted contributions will be paid for. Editor, Gas Power, St. Joseph, Mich.

#### FOR SALE

**FOR Sale—Harris Automatic Printing** Machine, size 15x18, envelope, card, paper bag and sheet feeding attachments, excellent condition. Price low; must sell. Becker Bros., Butler, Pa.

**\$25.00 PUBLIC** Speaking course, \$5. \$25.00 real estate course, \$5. Box 154, Aulander, N. C.

**COMPLETE** Mechanical Drawing Outfit, new. Box 131, Shelburne Falls, Mass.

**ELECTRIC** light outfits, 75c up. 4 H. P. boat motor \$30. R. H. Putnam, West Springfield, Mass.

**FOR Sale—10-20 H.P. International** Kerosene Gasoline Tractor; run one year. Write particulars. F. H. Cole, Bonne Terre, Mo. Route 1.

**AUTO** engine, motorcycle, tools, graphophone, camera. What do you need? Palek, 3816 Croton Ave., Cleveland, Ohio.

#### SALE OR EXCHANGE

**WILL** exchange talking machines for gasoline or coal oil engine, 1½ or 2 h.p. dynamo, magnet, diamond ring or what? Make offer. Ed. D. Sizer, Sizerville, Pa.

**HAVE** camera, mandolin, Edison \$60 phonograph, three hundred records. Want anastigmat lens, panoramic camera, motorcycle, typewriter or offer. Howard Rogers, Sidney, Ill.

**MOTORBOAT,** first class, trade for motorcycle, or first check for \$100 takes same. A. P. Hochman, Ft. Cobb, Okla.

## MACHINERY, TOOLS AND SUPPLIES

CELLAR drainers, operated by water from city water pipes. Water motors, water motor emery wheels, water motor forge blowers, steam ejectors, jet pumps, syphons, injectors. Catalogue. Frank C. Douds & Co., New Castle, Pa.

FOR Sale cheap, Roberts Alfaifa Machinery, complete. 100 h. p. Atlas Engine. 125 h. p. Atlas Boiler. E. H. Link, Hillrose, Colo.

WANTED—Machine, or drawings of machine, to make Jack chain or Pump chain, using one-quarter-inch wire. D. C., 6th Floor, 318 W. Washington St., Chicago.

10,000 FT. of belt at 5 cts. per ft. Send for list No. 27. Lucas & Son, Bridgeport, Conn.

(1) 7 H.P. SINGLE cylinder Marine Gasoline Engine; (2) 7 H.P. double cyl.; 16 to 24 H.P. double cyl. Bargains. Western Machinery Co., Cincinnati, O.

14" SCREW cutting lathe, countershaft, chuck, tools, \$100. Gasoline engine, 2½ h.p., \$35. Trepagnier, No. 2469 North Galvez, New Orleans, La.

2 H.P. MARINE engine and propeller, \$26. 5 H.P. gasoline stationary, \$45. 10 H.P. upright boiler, \$35. 8 H.P. vertical steam engine, \$25. Badger Motor Co., Milwaukee, Wis.

WANTED—2 H.P. "Fairbanks Morse" Special electric gasoline engine; also dynamo. Harlan Edgington, Mapleton, Iowa.

PULLEYS, Gears, Sprockets, Shafting, Hangers; see page 131. W. A. Jones Foundry & Machine Co., Chicago.

FOR Sale—Complete saw and planing mill outfit; have cut out timber holdings and will sell machinery at a bargain; list of machines, etc., furnished upon request. Address P. O. Box 792, New Bern, N. C.

HAVE for sale several sizes of lathes, milling machines, drill presses, punch presses, shapers, planers, boilers, steam engines, oil, gas and gasoline engines and wood-working machinery. Pinner, 122 Water St., New York, N. Y.

ENGINE Lathe, swings 9½", takes 25" between centers. Complete set gears cutting all size threads 3" to 40", \$43.50. Grammes & Sons, Allentown, Pa.

HOW to Run a Lathe. A 50-cent book for 10 cents postpaid. S. B. Lathe Works, South Bend, Ind.

SERIES of 8 lithographic models—Steamship, automobile, locomotive, gas engines, steam engine, steam turbine, wireless telegraph and dynamo. Size 8x14 inches. All parts of these machines are shown and numbered to correspond to printed keys of names. Price each, 50 cents, postpaid, or set of 8, \$3.50, postpaid. Popular Mechanics Book Dept., 316 W. Washington St., Chicago.

PATTERN makers! A book devoted to the principles of pattern and core making and molding. Written by G. H. Willard, a practical pattern maker of years' experience. This book, just published, treats the subject in a much more simple, direct and effective manner than most books along this line. 224 pages, 312 illustrations. Price \$1, postpaid. Popular Mechanics Book Dept., 316 W. Washington St., Chicago.

## MANUFACTURING

CLEVELAND Specialty and Manufacturing Company, Cleveland, Ohio, design or make special articles to order. Inventions developed.

ARE you getting lowest manufacturing prices on your articles? Address "Prewitt," Boone, Iowa.

TEX Balfour, expert tinner and sheet metal worker. Specialties. Write me your wants. Anderson, Ind.

ROYALTY or Contract Wanted, by well equipped machine and metal stamping establishment, first-class metal specialty or machine to manufacture. Parsons Specialty & Machine Works, 1725 N. Howard St., Philadelphia.

WIRE Goods, all kinds, made to order. Cooley Mfg. Co., 553 W. Monroe St., Chicago.

## WIRELESS

WIRELESS Set. How to Make—96-page book telling how to construct at small cost an outfit suitable for transmitting four or five miles. Price, 50 cents, postpaid. Popular Mechanics Book Dept., 316 W. Washington St., Chicago.

## ENGINES AND MOTORS

COMPRESSION restored without rebor-ing. Motor boats, automobiles, pumping and agricultural engines. Wille Adjustable Piston Company, 1534 Fulton St., Brooklyn, N. Y.

WANTED, second hand motor—single phase, alternating, 60 cycle, 220 volts. W. F. Tumber, Newtane, N. Y.

FOR Sale—10 Hp. Vertical Steam Engine, fine condition, cheap; also Boiler. The Banker Motor Co., Corning, N. Y.

REBUILT Engines—We have on hand a number of rebuilt "Buffalo" engines, guaranteed, at greatly reduced prices. Write for bargain list. Buffalo Gasoline Motor Co., 1293-1305 Niagara Street, Buffalo, N. Y.

GAS and Gasoline Engines, all sizes and many makes. Rebuilt and new. Colborne Mfg. Co., 416 W. Grand Ave., Chicago.

## FLOUR &amp; FEED MILLING MACHINERY

SPECIAL bargains in second-hand Attrition mills, burr mills, crushers, corn shellers, bran dusters, dust collectors, purifiers, reels, double, single, 2 and 3-pair high roller mills, sieve bolters, receiving separators, scourers, etc. Write for description and prices. Sprout, Waldron & Co., P. O. Box 429, Muncy, Pa.

## ENGINE CASTINGS AND BLUE PRINTS

BUILD a 3 horsepower revolving cylinder motor, light, simple. Complete drawings. One Dollar (no stamps). M. S. Lewis, Colton, Cal.

GASOLINE Engine Castings, with drawings. Cheap. Catalog for stamp. Novelty Manufacturing Co., 853 West 6th St., Cincinnati, Ohio.

## BOATS AND LAUNCHES

\$125 TAKES 16' 3 Hp. Racine Launch, used 2 seasons. Dandy engine, equipped. Koren, 1621 Jackson Bl., Chicago.

FINE Auto Motor Boat, 15 H. P. Used one season. Price only \$200. N. Long, Spirit Lake, Ida.

MOTORCRAFT Encyclopedia—A 150-page book that tells 1001 things every motor boatman should know. How to overcome engine troubles. Price \$1, postpaid. Popular Mechanics Book Dept., 316 W. Washington St., Chicago.

CHART of a modern submarine boat showing and naming over 200 parts. Size, 14x28 inches. Printed on plate paper. Shows clearly and distinctly all the interior. Mailed in a tube for 25c. Popular Mechanics Book Dept., 316 W. Washington St., Chicago.

## BLACKSMITHS

SHOP Notes—Many valuable hints for blacksmiths are contained in our series of Shop Notes books, 10 volumes, 50c each postpaid or \$5 per set prepaid. Popular Mechanics Book Dept., 316 W. Washington St., Chicago.

GOOD blacksmiths are scarce and few learning the trade and the blacksmiths must make the tools for all—from surgeon to the safe blower. Buy Toy's Modern Methods Forging and Welding different kinds of steel solid, and doing all hard jobs easy, also hardening and tempering to a standard by colored charts. Any smith can be an expert that means good jobs and big money. All for one dollar. Send for valuable samples free. W. M. Toy, Sidney, Ohio.

BLACKSMITHS—Learn hand-wrought ornamental ironwork. Our 200-page book "Hand Forging" points out clearly all the guiding principles and methods which underlie all forge work. Written by a practical authority. 122 illustrations, cloth, \$1 postpaid. Popular Mechanics Book Dept., 316 W. Washington St., Chicago.

## CEMENT

CONCRETE molds. Catalogue free. 5 Market St., St. Louis, Mo.

IF you want the best information on cement and concrete construction, subscribe for Concrete-Cement Age, leading cement and concrete monthly. Sample copy, 10 cents. Yearly subscription, \$1.50. Concrete-Cement Age, 135 Newberry Bldg., Detroit, Mich.

## MECHANICAL ENGINEERS

INVENTIONS—Examined, Patent and Working Drawings made, Models Developed and built. Free report as to patentability and cost for development of your invention. Address Inventions, Dept. M., The Toledo Engineering Agency, Toledo, O.

AUTOMATIC and special machinery and tools designed, detailed, etc.; results guaranteed; references furnished. Western Engineering Co., 350 N. Clark St., Chicago.

## ELECTRICAL

"BOY Electrician." Shows how to make Batteries, Dynamos, Motors, Telegraph Apparatus, Telephone, Lights, Bells, Alarms, Electric Engine, etc. 75 illustrations 10c. How to renew dry batteries, 3 guaranteed processes, 10c. P. S. Bureau, 3311-B, Belleplaine Ave., Chicago.

100 BLUE Print Electric wiring diagrams and descriptions covering all kinds of practical work. Send \$1.50, Engineering Service, Box 565, Rochester, N. Y.

HEAR a Whisper—With this device you can hear conversations at any distance. Plans and information, 25c. Lobe Mfg. Co., 167 W. 102d St., New York City, N. Y.

## STAMP COLLECTING

FOREIGN Stamps Free; 52 different foreign, including China and Venezuela, to all who apply for our high grade approval selections. Send two cent stamp for return postage. Edgewood Stamp Co., Dept. H, Milford, Conn.

STAMPS on approval. Fine stock of U. S. Also low and medium priced foreign, recent issues. Reference necessary. Good premiums for new customers, and for each \$2 purchase. Mrs. Louise Kellogg, West Hartford, Conn. Dept. C.

300 DIFFERENT Foreign stamps 20c. Ask for approvals. H. T. Belden, 129 Thompson St., Springfield, Mass.

101 DIFFERENT United States stamps, or 265 foreign free; remit 25c. six months' subscription McKee's Stamp Weekly, Boston, Mass.

FREE—108 foreign stamps, album and catalogs for 2c postage. Payn Stamp Co., 138 No. Wellington St., Los Angeles, Cal.

CAMPBELL Collector—1 yr. sub. and 25-word ad, 25c; ½ yr. sub., Album and Packet, 15c. Advertisers write. H. R. Campbell, Ellenville, N. Y.

25 DIFFERENT British Colonials to applicants for stamps on approval who send 2c postage. Nickles, Box 2466, Washington, D. C.

1,000 ENGLISH Hinges and 300 different Stamps, 30c. Hardy's Bookstore, Oakland, Cal.

STAMPS—108 Japan, etc., for 2c postage. Newport Co., 308½ Linden Ave., Brooklyn, N. Y.

STAMPS on approval at 50% discount. Kankakee Stamp Co., Kankakee, Ill.

STAMPS—105 China, etc., stamp dictionary and list, 2c. Bullard, Sta. A, Boston.

STAMPS, 100, all different, free. Postage 2c. Mention paper. Quaker Stamp Co., Toledo, Ohio.

PACKET of 23 stamps; no two countries alike, 500 hinges. Set of \$1 and \$2 U. S. Rev., all for 5c. Miami Stamp Co., Toledo, Ohio.

24 VARIETIES Cuban stamps 10 cents. List of 6,000 low-priced stamps free. Chambers Stamp Co., 111 P. Nassau St., New York City.

STAMPS Free. Grand set of 6 Tunis. Send 4c postage; mention gift 380. Approvals. 50% discount. J. Wheeler & Co., 124 Lennord Rd., Beckenham, Eng.

## RARE COINS

\$100 FOR \$1 gold piece, 1854, C. Mint. \$50 for \$2.50 piece, 1854, S. Mint. We pay highest cash prices for all rare money to 1909. Many of great value in circulation. Get posted. Send stamp for large illustrated Coin Circular. It may mean much to you. The Numismatic Bank of Texas, Dept. 8, Ft. Worth, Texas.

50 DIFFERENT foreign coins, including Ceylon, Persia, Egypt, Nigeria, India, Venezuela, Panama, Travancore, Salvador, Africa, etc., \$1. Ancient Roman coin, 1,600 years old, 25c; 3 for 50c. 1,500 mixed stamps—over 500 different, \$1. 269 different stamps, 15c. F. L. Toupal Co., Dept. B9, Chicago Heights, Ill.

OLD Coins bought and sold. New spring catalog just out free to collectors only. Buying coin catalogue quoting prices I pay 10c. Wm. Hesslein, Paddock Bldg., 191-B, Tremont St., Boston, Mass.

ILLUSTRATED coin value book 10c. Selling list free. L. J. Mathewson, Wauhay, S. Dak.

TRADE dollar 1885 sold for \$1.140; 20 cent 1876cc \$250; \$1 gold 1861d \$230; \$3-1870s \$1,450. Equally high premiums on thousands of coins, stamps, books, paper money. Illustrated circular free. Vonbergen, Dept. O, Boston, Mass.

COINS, Antique Relics—Five curious, rare coins with catalog, 10c. Ray Chapin, New Berlin, N. Y.

\$4.25 EACH Paid for U. S. Flying Eagle Cents dated 1856. We pay cash premiums on hundreds of Old Coins. Send ten cents at once for New Illustrated Coin Value Book 4x7. It may mean your fortune. Clarke & Co., Coin Dealers, Box 15, Le Roy, N. Y.

### FORMULAS AND TRADE SECRETS

BUILDERS, Farmers and Land Owners: Make your fence posts everlasting. My formula will preserve the wood a lifetime. Yours for \$1. J. P. Sweeney, 99 Washington St., Somerville, Mass.

3,000 FORMULAS, recipes, 50c. 1,000 trade secrets, plans, etc., 25c. 500 special formulas, 20c. Resilver mirrors, guaranteed process, 10c. Make Sneezing Powder and Itch Powder, 10c each. All above postpaid, \$1. Formula Bureau, 3311-B, Belleplaine Ave., Chicago.

500 VALUABLE formulas and complete encyclopedia of everyday wants. This splendid book prepaid for 10c. H. B. Essex, Box 476, Baltimore, Md.

CHEMICAL Analyses, Formulas, Duplications, Laboratory of Dr. A. R. Sasse, 710 Wyandotte, Kansas City, Mo.

WE Analyze and test everything. Have you anything you want tested? Formulas furnished. Laboratories, 721 East 161st Street, New York City.

20,000 FORMULAS, price \$1 prepaid. Complete list, 4c stamps. Edm. Bromley, Watervliet, N. Y.

FORMULAS—3,000 Formulas and Digest (25,000 readers), publishing monthly 150 formulas, etc. One year, 50c. Silvering mirrors formula, 20 analyses of successful advertised products selling at 50c, cost 5c, and 150 other formulas and Digest one year, 25c. Digest, Grand Rapids, Mich.

BEST candy and ice cream formulas and recipes obtainable. Guaranteed Correct. 280 candy and 50 ice cream recipes. Increase your trade by improving your goods. Complete illustrated book prepared by practical expert. Price \$4 postpaid. Popular Mechanics Book Dept., 316 W. Washington St., Chicago.

10,000 SELECTED scientific, chemical technological, and practical recipes and processes, including hundreds of so-called trade secrets for every business, alphabetically arranged in one large volume of 800 pages. Price \$3 prepaid. Popular Mechanics Book Dept., 316 W. Washington St., Chicago.

### FOR MEN

SAVE money on shoes! Factory to feet. You save retailer's profit and get better shoes. Fit and entire satisfaction guaranteed or money back. Style book free. Pathfinder Shoe Co., Dept. P, Dudley, Mass.

PATENTED stick-pin guard, prevents loss of pin. Gold plated. Postpaid for 10 cents. Special prices in quantities to agents and mail order houses. Abner B. Shaw, No. Dartmouth, Mass.

QUIT tobacco entirely, or control amount used, without hardship. Pay when satisfied. Samples of Tobaccocure free. Tobaccocure Co., Carthage, Mo.

AT last—Safety Razor, 25 cents. Guaranteed. Catalogue free. B. & F. Novelty Co., Box 237, Rock Island, Ill.

RELIABLE Clothes Hanger and Whisk Broom-holder. Space economizer. Attach anywhere. Sample 10 cts. Irvine Bros., 254 Fulton St., Brooklyn, N. Y.

SAFETY razors sharpened; two cents each. Guaranteed. Blade box free. Electro Stropping Co., 134 Shelby St., Detroit, Mich.

SAFETY blades sharpened 1½c each. Keen Cutter, Box 184, San Bernardino, Cal.

### FOR THE HOME

FORMULAS—100 valuable, reliable recipes, toilet, medical, domestic; can make for home use or sell; send 2-cent stamp for lists. Canadian Recipe Publishing Co., Windsor, Ontario.

EASY to Make Furniture—100 Modern Designs. Make your own. Save two-thirds cost. Price \$2. Crater & Holt, Grand Rapids, Mich.

TO wash clothes easy; use Snowflake Blue Laundry Tablets. A trial convinces; send 10c coin for six weeks' supply. Snowflake Blue Tablet Co., 2021 N. 21st St., Philadelphia, Pa.

LAMP Shade Frames, all descriptions, made to order. Cooley Mfg. Co., 553 W. Monroe St., Chicago.

METAL Work and Etching—A 96-page handbook for art metal workers telling how to make a great variety of useful and ornamental objects, such as desk sets, arts-crafts, jewelry, etc. Price, 50c, postpaid. Popular Mechanics Book Dept., Chicago.

### GAMES AND ENTERTAINMENTS

MAGIC Tricks, Books, and Supplies. Largest line in the world. Old reliable firm. Large, illustrated, professional catalogue, ten cents. See our advertisement on page 10. Chicago Magic Company, successors to Read & Covert, Dept. B, 72 West Adams St., Chicago, Ill.

BE a Handcuff King. We teach you. Escape from handcuffs, boxes, ropes, etc. Secrets of 20 sensational mysteries. \$1 postpaid. Circulars free. The Magicraft Co., 834 Canton Ave., Detroit, Mich.

TRICKS, jokes and puzzles, catalogs and 25-cent samples, five cents. Gilbert Novelty Co., 11128 Crescent, Morgan Park Station, Chicago.

YOU can be a magician, travel, give shows, earn money. I tell how. Send stamp. Prof. Rapp, Box 1115-F, Madison, Wis.

SOMETHING New! My Charades, Enigmas, etc., for entertainment. 50c brings 50. E. Edwards, 1614 Kay St., Sacramento, Cal.

250 MAGIC tricks with coins, cards, etc., 10c. Greenbacks, big bunch, 10c. 13 funny love letters and book of tricks, 10c. All, 25c. Magic Bureau, 3311-B Belleplaine Ave., Chicago.

GAMES, Tricks, Puzzles, Books, etc. Holiday specials. Illustrated catalogue and sample tricks, 6c. Auburn Trick Co., Dept. T2, 7745 Peoria St., Chicago.

VENTRILLOQUISM book 10c. 153 Tricks 10c. Eureka Supply, R22, 3827 Kenneth Ave., Chicago.

BIG Catalogue Magic and Entertainment goods Free. Bates Play Company, Melrose, Mass.

CARD Secrets that are new. Learn some unusual tricks the others don't know. Send postal. G. C. Haynes, Mattapan, Mass.

FREE—New Magic Book. Contains real Hindoo Magic—Handcuff Act; Pocket Tricks; Ventriloquism; Mind Reading. Two big catalogues newest tricks. Just out. Send 4c postage. J. Harto, 707 So. Capital, Indianapolis, Ind.

GREENBACKS! Stage money, 10c bunch, 4 bunches, 25c. Elite Exchange, P22, 3827 Kenneth Ave., Chicago.

MAGIC pocket trick free. Worth 25c. With illustrated catalog of 250 tricks, puzzles, illusions for 6c. Stamps. Magic Co., Sta. 10, 249 West 38th St., New York.

DOUBLE Throat, 10c. Fits roof of mouth; invisible. Throw your voice, make dogs, cats, horses, etc., talk. Sent postpaid with catalog, 10c. National Co., Chicago.

FREE Bargain Magical List and Vault Escape. Douglas, Kiowa, Okla.

CHICKEN Inspector Badges (latest joke), 10c pp. Percy Ewing, Decatur, Ill.

13 FUNNY Love Letters (read two ways), dime, silver. J. L. Hardway, Normal, Ill.

MARVELOUS Magic Cards Free. Greatest trick ever shown. Baffles even the Magicians. Sent with our big bargain catalogue of tricks and games. Send six cents stamps to cover postage. American Mercantile Company, Box 223-E, Minneapolis, Minn.

PLAYS, Vaudeville Sketches, Monologues, Dialogues, Speakers, Minstrel Material, Jokes, Recitations, Tableaux, Drills, Musical Pieces, Entertainments for all occasions. Make-Up Goods. Large Catalog free. T. S. Denison & Co., Dept. 11, Chicago.

250 MAGIC Tricks, and 13 Love Letters (reads two ways), 12c. Bailey, 131 Maple, Napanoch, N. Y.

### MUSIC

MUSIC Lovers. Latest and catchiest two-step published. Everybody wants it. 25c a copy. Get it today. Cameron Flagg, Power, Richland Co., N. Dak.

ALL the favorite old songs. Words and music complete in book form with attractive cover. Size 7½x9½ inches; good value. Price 50 cents, postpaid. Popular Mechanics Book Dept., 316 W. Washington St., Chicago.

LEARN to play the Harmonica; instruction book only 12c; 4 songs guaranteed; Peter Montforte, Maritime Bldg., N. Y.

GOOD music written to song poems; Chief & Nell, Song Writers, 2204 Mulvanphy St., St. Louis, Mo.

### PIANOS AND MUSICAL INSTRUMENTS

TALKING machines and records at cut prices. 100,000—10 inch records never sold less than 60 cents. Our cut price 20c each. Send for catalogue. Deninger, North St., Rochester, N. Y.

### DIAMONDS, WATCHES AND JEWELRY

LIFETIME service. Famous Knickerbocker watch. New \$10. Year to pay. Particulars. The Watchman, 153 East 124th St., N. Y.

SAVE half on jewelry. This month's special, solid gold scarf pins, 50c. Money refunded if not solid gold. Fay, So. Emerson St., New Bedford, Mass.

TIME and Its Measurement—An unusual book, being a readable and instructive history of time measurement from the sun dial of remote ages down to the clock period and the present day. Of interest to everyone connected with horology and contains much information not available elsewhere. Written by a great authority who has made this study a hobby. Price in cloth binding \$1.50 postpaid. Popular Mechanics Book Dept., 316 W. Washington St., Chicago.

WHOLESALE prices on watches, jewelry. Confidential list, 72-page catalogue for stamp. Kelleher Bros. & Sullivan, 76 Front St., Worcester, Mass.

### DUPLICATORS AND DEVICES

EDISON Rotary Mimeograph. Good as new. Cheap. Pike, St. Charles, Ill.

THE Modern Duplicator, made without glue or gelatine, is the World's Standard. Fifty to seventy-five exact duplicate copies can be made from each one you write or draw with pen, pencil or typewriter. \$2.40 to \$6.00 according to size. Booklet Free. Durkin, Reeves & Co., Mfrs., 339 Fifth Ave., Pittsburgh, Pa.

HOW to get a Hektograph that will make 150 copies in 10 minutes; letter size, \$2. Write for circular. Heyer Duplicator Co., 118 No. La Salle St., Chicago.

### MAILING LISTS

NAMES and Addresses. Any classification, anywhere. Prices on request. "Nisco," Dept. SDB, Cincinnati.

FREE to business men, copy of our comprehensive "Silent Salesman." Contains over 2,000 different classifications of Mailing lists with number and price of each list, and information every business man needs. Accept this free offer. Trade Circular Addressing Co., G 164½ W. Adams, Chicago.

### TYPEWRITERS AND SUPPLIES

THIS Month—100 No. 3 Oliver Visible Typewriters at a sensational price. Terms \$3 a month—5 days' Free Trial—completely equipped. Guaranteed same as if regular catalog price were paid. United States Typewriter Exchange, Dept. 97, Federal Life Bldg., Chicago.

TYPEWRITERS, all makes, all guaranteed at prices lower than the lowest, free trial allowed, typewriters from \$6 to \$60. Get our prices before purchasing a writing machine. The Coast Typewriter Exchange, Atlantic City, N. J.

ALL standard makes of typewriters. Big saving. Liberal guarantee. Catalogue, bargain list and valuable typewriter information free. The leading mail order typewriter house. A. E. Atchison, 110-112 No. LaSalle St., Chicago.

**BIG Profits selling typewriters.** Let me show you how to make fifty per cent either buying for yourself or selling to others. William Whitehead, 188 North LaSalle St., Chicago.

**TO prolong the life of your typewriters and carbon papers** use a \$2 set of high grade "Spring Cushion Feet." For sale by Nicholas Romanoff Cottman, Keyser Building, Baltimore, Md.

**TYPEWRITERS.** Carbon Paper; guaranteed ribbons, 30c in dozen lots. Typewriter Specialty Co., 15 North 7th, St. Louis, Mo.

**TYPEWRITER Bargains,** all makes; slightly used and rebuilt; lowest prices, bar none; satisfaction assured. Rotary mimeograph cheap. Typewriter Sales Co., Ferguson Bldg., Pittsburg, Pa.

**FOX Typewriter.** All improvements; cost \$102.50, will sell \$80. Foxall, Cumberland, Md.

**BLICKENSBERGER Typewriter.** Excellent condition. Must sell quick. Bargain, \$15. P. Molsen, 3315 Belleplaine Ave., Chicago.

**PICK out your typewriter and pocket your saving.** Typewriters rebuilt in our own factories and guaranteed for one year. Remingtons \$25 to \$65, Smith-Premiers \$23 to \$60, Underwoods \$35 to \$60, L. C. Smiths \$30 to \$50, Royals \$30 to \$40, Oliviers \$30 to \$40. We have all makes. Send for catalog, address of nearest branch office. American Writing Machine Co., Inc., 345 Broadway, New York.

**PRINTING AND ENGRAVING**

**GOOD Printing—Low Prices.** 1,000 good letterheads, \$2.50; 1,000 envelopes, cards, statements, billheads, \$2. Samples. We print for others, why not for you? Thos. M. Weaver, Main and Kilbourne Streets, Bellevue, Ohio.

**1,000 LETTERHEADS or Envelopes,** \$2.50; 5,000 or more, \$1.75. Blackledge Specialty Co., 1805 Reed Street, Philadelphia, Pa.

**PRINTOGRAPH Typewritten Letters,** \$1.50 per thousand. Large quantities less. Write us today. LaCrosse Letter Company, LaCrosse, Wis.

**GUMMED labels!** All kinds! Illustrated catalog free! Agents wanted. Gh. Edward Harrison, Baltimore, Md.

**3,000 3x6 CIRCULARS,** white paper, \$1 postpaid. Sheridan Co., 417 E. 151st St., New York.

**CELEBRATED Model Printing Press.** Do your own printing. Make money in spare time. How to Print, 49-page booklet, 25c. Cut Book, 10c. Catalogue free. Type at bargain prices. Rubber Stamp making outfits. New Rotary Attachment for Model Presses. Address Model Press, York, Pa.

**ATTRACTIVE Printing.** 50 8 1/2 x 11 white, blue or golden. Linen Finish Bond letterheads, and 50 envelopes, matched, 60c; 100 each, \$1. Postpaid. Prompt service. Race Bros., Hudson, N. Y.

**PRINTING—100 cards or envelopes,** postpaid, 40c. Other work. Good, reasonable, prompt. Get my prices. E. D. Murdock, 183 E. Toga St., Tunkhannock, Pa.

**DIGNIFY your correspondence.** 100 letterheads and envelopes printed on excellent bond, \$1, prepaid. 500 letterheads or envelopes, \$1.50. 1,000 for \$2.50. Samples free. Proper printing. Robison Printery, Curwensville, Pa.

**200 ENVELOPES,** 200 Letterheads, \$1. Prepaid. Asire, Forest, O.

**YOUR Name on 200 gummed labels,** 10c. Start Co., Clintonville, Conn.

**SAMPLE 100 letterheads, envelopes, billheads or cards, printed,** 38c, prepaid. Andrew Brems, Corona, N. Y.

**QUALITY Multigraphed Letters.** Letterheads. Cheap. Schwartz Brothers, Congress St., Detroit.

**GUMMED Labels,** 3,000, \$1. 38-pp. catalog, 2c. MacTaggart, 1233 Arch, Philadelphia, Pa.

**100 EACH,** linen letterheads, envelopes, cards, \$1, prepaid. Acme Press, 515 So. 9th St., Minneapolis.

**5,000 A-1 HAMMERMILL Bond Letterheads,** \$7.50; 5,000 imitation typewritten letters, heading black, body purple, \$10. Elegant samples free. Good's Printery, Harrisonburg, Va.

**125 BOND Letterheads and 125 Envelopes,** white, pink, blue or green, printed, \$1 prepaid. Samples. W. Kinnier, Box 206, Brooklyn, N. Y.

**BETTER Printing at low prices.** 1,000 letterheads, envelopes, cards, billheads, labels, circulars, \$2.50. Extra fine price list free. Catalogs and Booklets our specialty. Daily News Record, Drawer b-358, Harrisonburg, Va.

**WRITE for estimates on printing needs.** 1,000 3 1/4 x 5 1/2 Bond circulars, \$1. Prepaid. Samples. B. Newnam, Waukegan, Ill.

**PRINTING Presses, type, supplies.** Catalog free. L. M. Carroll & Co., 326 Madison St., Chicago.

**CATALOGUES compiled.** Copy for Form Letters, Folders, Booklets. Charges reasonable. Send for estimate, layout, etc. Catalogue Compiling Bureau, Graphic Arts Building, Worcester, Mass.

**PRINTING—500 either noteheds, envelopes, statements, cards, \$1; 1,000, \$1.50; 1,000 linen finish letterheads or envelopes, \$2.50; 1,000 typewriter letters, \$2. Samples.** Model Company, Manchester, Iowa.

**PRINTING Presses, supplies, second-hand, at bargains.** List for stamp. Popular Bargains, Richland, Pa.

**1,000 PURPLE Multigraphed Letters,** black heads printed and stock complete, \$2.75; 500, \$1.85. Specimens free. Perfection Letter Company, Muncie, Ind.

**GOOD Printing at low prices.** 1,000 good letterheads, envelopes, cards, billheads, labels, circulars, \$2.50. Samples free. Catalogues, booklets, and circulars our specialty. Ernest L. Fantus Co., 523 S. Dearborn St., Chicago.

**CUT Price Printing tells only half the story.** Trial order proves. 500 letterheads, \$1.25; 1,000 letterheads, \$2.00; 3,000 letterheads, \$5.00, on Hammerrill Bond, white or colors. Edw. Zindler & Co., Detroit, Mich.

**PATENT ATTORNEYS**

**PATENTS and Trade Marks, electrical and mechanical a specialty.** Book Free. Joshua R. H. Potts, Patent Lawyer, 8 Dearborn St., Chicago; 805 G St., Washington; 929 Chestnut St., Philadelphia.

**THE Patentome is free.** An education in obtaining patents. Established 1865. Anderson & Son, Attorneys, 707 7th St., Washington, D. C.

**AMERICAN and Foreign Patents.** Prompt, persevering, reliable service. Write for information. W. X. Stevens, 76 Adams St., Washington, D. C.

**SEND sketch for free search.** Write for my advice regarding patent matters. Inventor's Guide, Washington, D. C.

**JOHN R. WOODWORTH,** Registered Attorney. Wardur Building, Washington, D. C.

**PATENTS procured; prompt, reliable service; terms low; large prizes offered for certain inventions; get my list of inventions wanted; send 4c for new book, "The Last Word on Patents," send sketch of your invention today.** Sanders, 7 Webster Building, Chicago, Ill.

**PATENT your invention.** \$20,000 offered for inventions wanted. Booklet and opinion free. Milo B. Stevens & Co. Established 1864. 685 F St., Washington; 353 Monadnock Block, Chicago.

**PATENTS build fortunes for you.** Our free booklets tell how; what to invent, how to choose an attorney. Write today. D. Swift, 317 Seventh St., Washington, D. C. Established 1889.

**CASH for an idea.** Patent News, Dept. 29, Washington, D. C.

**PATENT Books Mailed Free—Showing 100 mechanical movements invaluable to inventors and mechanics—and telling what is patentable, how to obtain patent or partner, how to sell, etc.** Free on request. Chas. E. Brock, 701 Eighth Street, Washington, District of Columbia.

**"PATENTS and Patent Possibilities"** is a 72-page treatise which tells all about patents, what to invent and where to sell it. It gives honest advice to inventors, and is full of valuable and interesting information. Write for it today! It is Free. H. S. Hill, 905 McLachlen Bldg., Washington, D. C.

**REGISTERED Attorneys make our searches.** Send sketch for free report. No Attorney fees until patent allowed. Free books. Fuller & Fuller, Washington, D. C.

**PATENT What You Invent.** It may be valuable. Write me. No attorney's fee until patent is allowed. Estab. 1882. "Inventor's Guide" Free. Franklin H. Hough, 522 Loan & Trust Bldg., Washington, D. C.

**PATENTABLE Ideas Wanted—Send for 3 free books.** R. B. Owen, 30 Owen Bldg., Wash., D. C.

**OFFICIAL Drawings Free.** Patents procured or fee refunded. Expert services. Send sketch for Free search. The Patent Exchange, Jorban Bldg., Washington, D. C.

**FOR Honest advice and real patents at Low Cost,** consult John O. Seifert, Patent Attorney, 50 Church St., New York.

**PATENTS that protect and pay.** Advice and books free. Rates reasonable—highest references; best results. Watson E. Coleman. Patent Lawyer, 622 F St., N. W., Washington, D. C.

**C. L. PARKER, Ex-member Examining Corps Patent Office, Patent Attorney,** 910 G St., Washington, D. C. Inventor's handbook "Protecting, Exploiting and Selling Inventions," sent free upon request.

**PATENTS—Herbert Jenner, patent attorney and mechanical expert,** 606 P St., Washington, D. C. I report free of charge if a patent can be had and its exact cost. Send for circular.

**PATENTS explained in my free books,** telling what you should know—what to invent—what not to invent—how to sell your patent, etc. Write today, H. L. Woodward 902 G St., Washington, D. C.

**PATENT secured or fee returned.** Send sketch for Free Expert Search and report as to patentability. Books on inventions and patents, and reference book sent free. John S. Duffie & Co., 605 F St., Washington, D. C.

**PATENTS Secured—Take advantage of my personal experience; send sketch or model.** Get my free book containing 200 mechanical movements. W. N. Roach, Jr., 950 McGill Bldg., Washington, D. C.

**INVENTIONS Worth Thousands—Their value is governed by the strength of the patent.** Get the advantage of our 39 years' experience in procuring your patent. Clients in your state. Write and send sketch. Louis Bagger & Co., 609 Barrister Bldg., Washington, D. C.

**INVENTORS' Service Co., Washington, D. C., makes inventions yield profits.** Register today. Patent, Legal, Developing, Exploiting Departments. Free Booklet.

**FOR INVENTORS**

**INVENTORS.** If you want help with your invention, or information on Developing, Patenting, Costs, Materials, Drafting, Manufacturing, Selling, etc., send for our "Help Card." Charles A. Scott, 588 Central Bldg., Rochester, N. Y. Established 1900.

**We want to manufacture on royalty, a patented article that can be made of pressed metal.** R. P. K. Pressed Metal Co., 331 Madison Ave., N. Y.

**INVENTIONS Perfected; Working Models Made; Dies, Tools, Special Machinery.** Free Booklet. Black Diamond Mfg. Co., Cincinnati, O.

**PATENTS sold.** We do the business—not merely collecting advance fees. If you own a valuable patent send for a free booklet, "How I can get cash for your invention." No charges made for listing. Patent Advertising & Sales Co., Frankford, Phila.

**PATENTS without advance attorney's fees.** Send sketch for free report. Books free. Fuller & Fuller, Washington, D. C.

**PATENTABLE Ideas Wanted—Send for 3 free books.** R. B. Owen, 30 Owen Bldg., Wash., D. C.

**INVENTORS; My patent made a fortune.** Particulars free. Let me sell yours. Eugene Pearl, 23 Union Square, New York.

**PATENTS, Trade-Marks and Copyrights.** Our handbook on patents will be sent free on request. All patents secured through us are described without cost to the patentee in the Scientific American. Munn & Co., Patent Attorneys, 359 Broadway, New York. Washington, D. C. office, 383 F Street.

**PATENTS FOR SALE**

**UNITED States and four foreign patents on Combination Comb and Tooth Brush,** simple and easily manufactured. Millions of these articles could be sold. Best offer outright or royalty accepted. Lennie A. Hanson, Deering, N. Dak.

**HAVE you a Patent to sell? You'll be interested in my proposition.** Write now for free particulars. F. W. Johnson, 318 W. Washington St., Chicago.

**PATENTED** United States, Canada, August, attachment grain binder, simple and very effective. Sell half or whole interest. James Drysdale, 266 Ottawa Garden, North Vancouver, B. C.

**BIG** invention on wagons, two horses can pull more than three. U. S. and Canadian patent for sale. Particulars. Write, Alfred Dube, Fribourg, Alta.

**PATENT** for sale. Sanitary Back Washing accessory. No competition on market. Good house to house canvass. Hess & Lebert, Box 426, Kalispell, Mont.

**SELL** or exchange my patent hitching device for stock. Sell for cash. Exchange for real estate or automobiles. Send offer. Copy free. Elser Klemetson, Henning, Minn.

**BEST** offer buys patent No. 1,063,435. Big improvement on mail-bag-handling apparatus. Address, H. F. Hansmann, R-1, Thorpe, Wis.

**PATENT** for automatic train stop, operated by air pressure. Particulars. Chabot Mfg. Co., Providence, R. I.

**WILL** sell reasonable, a good patent. George O. Wood, Danlison, Conn.

**FOR** Sale—Invention on aerial toy, patent pending. Apply 326 First St., Marysville, Cal.

**GAS** Fixture Chandelier Attachment. Supports shades. Protects ceilings from heat, smoke. Also Adjustable Girder Clamps and Expansion Pipe Hanger. Patent. MacTaggart, 1235 Arch, Philadelphia, Pa.

**DISHWASHER**—To manufacture and market. Ira McClure, Inventor, 208 North Adams, Marion, Ind.

**WILL** trade patent automatic latch, for automobile. M. Ostul, Ghent, Minn.

**FOR** Best Cash Offer. Three U. S. Aeroplane Patents. 989,520; 1,001,120; 1,036,178. Jos. Blondin, 3410 S. Main St., Los Angeles, Cal.

**IMPROVED** Shoe-lace fastener. Simple in construction and operation. No tying of lace. No knots. H. De Bry, 932 21st St., Ogden, Utah.

**SALE** or Royalty, combined mop holder and wringer. Will be bargain for manufacturers. First offer takes it. J. W. Krueger, Litchfield, Minn.

**PATENTS** for Sale. French digging shovel and machines used for digging ditches in marsh meadows. J. Lapin, 214 Hamilton Ave., Brooklyn, N. Y.

**AUTOMOBILE** Shock Absorber for sale, fully covered by patent. Efficient, reliable and cheap. Roland G. Spearman & Co., Talladega, Ala.

**PATENT** automobile household, and advertising specialties. Cheap to manufacture. J. Walters, 1118 Center St., Milwaukee.

**PATENTS.** Cooking utensil. Cheap. M. E. French, Clyde, Ohio.

**PATENT** No. 1,062,650. Mail sack holder for sale, or trade for machinery. E. D. Coultas, Quaker City, Ohio.

**MUST** sell patent on curtain hanger. No. 1056384. Give me an offer. Quick action. John Umstatter, 783 Prospect Ave., New York.

**WIRE** snow guard patent. Best of all. Andersen, 77 Sabin St., Providence, R. I.

**I WANT** to send you proof of the wonderful pulling power of Popular Mechanics classified pages. What's your proposition? Write me today. F. W. Johnson, Classified Dept., Popular Mechanics Magazine, 318 W. Washington St., Chicago.

### MODELS AND MODEL SUPPLIES

**MODELS** made for inventors; general machine work; designing and perfecting; developing automatic devices and machinery. In a position to do all kinds of light tool and machine work. Prices reasonable; estimates cheerfully given. Ideal Machine Works, 62 Ann Street, New York City.

**GENERAL** Machinists and Model Makers. Machine designing and building. Scientific and experimental work a specialty. Our staff of skilled mechanics assist customers to simplify and perfect inventions. Write for information. Regal Model and Tool Works, "Chicago's Foremost Model Works," 122 S. Clark, Chicago.

**We** make working models for inventors; also dies and stamping of specialties, and carry a complete stock of brass gears and model supplies. Send for catalogue. The Pierce Model Works, 3405 Pierce Ave., Chicago, Ill.

**INVENTIONS** Perfected; Working Models Made; Dies, Tools, Special Machinery. Free Booklet. Black Diamond Mfg. Co., Cincinnati, O.

**CHICAGO** Model Works. Established 1867, Chicago, Ill. Gear wheels, model supplies, working models. Write for catalogue of model supplies.

**INVENTIONS** perfected and manufactured. Reference, your own banker. Russell Machine Co., Dallas.

**FREE** catalogue of model supplies. Castings, metal specialties on contract. North Chicago Tool Works, 15 Grove Ave., North Chicago, Ill.

### PLATING

**PLATING**—(electro process) Nickel, Oxidize, Copper, etc. "Monarch," Boone, Iowa.

### REAL ESTATE AND FARM LANDS

**SUBURBAN** home sites—\$2 cash and \$2 monthly at Dalworth Park, Texas, suburb on interurban, midway between Dallas and Fort Worth, the fastest growing cities in the great southwest; millions going into new skyscrapers, hotels, factories, in the two cities, and population has trebled in ten years; fortunes will be made here in suburban property; early buyers will make enormous profits, values already increased over 25 per cent. Dalworth Park offers best opportunity, being on interurban, which is being double tracked, and on railroad, and automobile pike; \$100,000 being spent on waterworks, natural gas, street improvements, etc.; 43 trains daily; beautiful large home sites only \$50 and up in this special sale; \$1 with inquiry as part payment reserves choice lot. Write today for free booklet showing views, map and all particulars. The Dalworth Company, Box 70, Dalworth Park, Texas.

**YOU** can make extra profits farming in the Salt River Valley. Fruits ripen early and bring highest prices. Hungry market right at home. \$100 acre up. Easy terms. Ask for Salt River Valley illustrated folder, which will be gladly sent free. C. L. Seagraves, General Colonization Agent, AT&SF Ry., 1952 Railway Exchange, Chicago.

**SHOULD** your income stop—what then? Prepare for such emergency. Look into the great farming, manufacturing, and industrial possibilities of the Southeast. Cheap land, living very moderate. Write for literature. "Southern Field" magazine free. M. V. Richards, Land and Ind. Agt., Southern Ry., Room 64, Washington, D. C.

**CHEAP** patented state school lands. South Texas, \$1 an acre cash, balance ten years. For all particulars write F. A. Connable, Trustee, 491 Commercial Bank Bldg., Houston, Texas.

**CALIFORNIA**—Desirable ten acre ranch, close to Fresno. All improved. Bungalow, barn, etc. Terms. A. J. Dunning, 918 Jay St., Fresno, Cal.

**WANTED**—Full particulars from owner of good farm for sale. Western Sales Agency, Minneapolis, Minn.

**WEST** Tennessee Farm, 667 acres. Renting for \$1,250 per year. Price \$20 an acre. J. N. Armstrong, Baileyton, Tenn.

**TWO** hundred acre Ozark farm. Webster county. Price five thousand. Cash or time. Address owner. Porter Smith Farm, Niangua, Mo.

**I CAN** show you the best farm in this locality. C. Rusfeldt, Manitou, Minn.

**We** will take your first crop of watermelons in full payment for our land. This crop is easily raised and harvested in four months. You need not pay us one cent in cash. We know what our land will produce. High, rolling, well drained land, clay subsoil, close to town and R. R. Elevation 100 ft., beautiful lakes, good roads. R. R. fare refunded to buyers. Lake County Land Owners' Assn., Dept. Z3, Fruitland Park, Fla. Owners, not agents.

**MONEY-MAKING** Farms, 13 States, \$10 to \$50 an acre; live stock, tools and crops often included to settle quickly. Big illustrated Catalogue No. 36 free. E. A. Strout Farm Agency, Station 3043, 47 West 34th St., New York.

**IRRIGATION** Farming can't be beat, where conditions are right. New Mexico Valleys, under Elephant Butte Project, have most healthful climate in America, rich soil, fine towns, etc. Land sold by association of farmers O. K.'d by U. S. Government. Men, expert in irrigation farming, help you free. Write today! Water Users' Association, Box 76, Las Cruces, N. M.

**FARMS**—Business properties, etc. Bargains everywhere. Inquiries daily. Let us sell yours. State particulars first letter. "Nisco," Dept. XDB, Cincinnati.

**BARGAIN:** Forty acre West Canada farm, dwelling and stable. Price \$1,200—\$25 down, \$10 monthly. Also 160 acres. Lock Box 82, Wellington, Ohio.

**VIRGINIA** orchard lands, \$15 an acre up. Easy payments. Send names of two friends interested in Virginia and receive our beautiful magazine one year free. F. H. La Baume, Agri. Agt., Norfolk & Western Ry., Room 250, N. & W. Bldg., Roanoke, Va.

**FREE** booklet about farms, homes. State Board of Agriculture, Dover, Del.

**FOR** Sale—480 acres farm and pasture land in Pecos River valley, Terrell County, Texas. Bargain price. Kemp Machine Works, Muncie, Ind.

**FLORIDA** Farm—\$16 per acre, with fruit and buildings. Leroy Chadwick, Jacksonville, Fla.

**FOR** Sale—160-acre farm on easy terms, situated five miles from Flasher, Morton county, North Dakota. In energetic hands this property can be greatly increased in value in short time. Present owner has no time to give proper management. For complete information address Mrs. Elizabeth Burt, Apartment E, 839 West End Avenue, New York City.

**SELL** your property quickly for cash, no matter where located. Don't pay big commissions. Particulars free. Real Estate Salesman Co., Desk B, Lincoln, Nebr.

**FARMS** for sale or exchange anywhere in the United States or Canada direct from the owners. Information free. American Investment Association, 37 Palace Bldg., Minneapolis, Minn.

**WANTED**—Information regarding good farm for sale. Send description. Northwestern Business Agency, Minneapolis, Minn.

**CO-OPERATIVE** Homestead Clubs enable people to own farms. Become independent. Club now locating. Edward Miller, Crystal Springs, Fla.

**GOVERNMENT** Farms Free. Our official 112 page book "Vacant Government Lands" describes every acre in every county in U. S. How secured free, 1913 diagrams and tables. All about Irrigated Farms. Price 25 cents postpaid. Webb Publishing Co. (Dept. 71), St. Paul, Minn.

### DOGS, BIRDS, POULTRY, ETC.

**CHICKS** thrive, gain size and vitality when hovered under natural feathers in our Simplex-Perfection Feather Hovers and Brooders. Better than other artificial methods. Chicks raised under feathers in nature's own way. Sizes 50 to 150 chicks. A postal brings our catalog No. S17. Write today. Simplex Supply House, Pontiac Bldg., Chicago, Ill.

**POULTRY** paper, 44-124 page periodical, up to date, tells all you want to know about care and management of poultry, for pleasure or profit; four months for 10 cents. Poultry Advocate, Dept. 3, Syracuse, N. Y.

**FROGS**—Investigate bullfrog breeding. Immense financial returns. Poultry incomparable. Write for book or stock. Aquafrog, Seymour, Conn.

**SACRIFICE** sale of Pedigreed Pit Bull Terrier Pups. Walter Yockey, Clay Center, Kans.

**BEECHWOOD** Collies, Farm raised. Healthy. Beechwood Farm, Hammond, N. Y.

**MONEY** Making Poultry our specialty. Leading varieties pure bred chickens, turkeys, ducks and geese. Prize winners. Best stock and eggs. Lowest prices, oldest farm, 29th year. Fine catalog free. H. M. Jones Co., Box 156, Des Moines, Iowa.

**WRITE** your name on a postal for our new 112 page 1914 Book on Poultry Raising—just out. Nothing published like it—better than last year. Full of practical helps—how to breed, feed and rear. Tells how leaders succeed—which breeds lay and pay best—gives plans for poultry houses—how to build brooder out of old piano box, etc. Describes the famous Prairie State Incubators and Brooders. Worth dollars—free for writing. Prairie State Incubator Co., 309 Main St., Homer City, Pa.

**AIREDALE** Terriers and Scotch Collies. State wants? Sales list free. Phil Savage, St. Charles, Ill.

## MISCELLANEOUS

**FORMULAS:** I furnish Practical, Workable, Reliable Processes. Money-makers for the Manufacturing Mail Order Business. Trade Secrets for Dry Cleaning, Soap Making, Paint, Varnish, Leather, Metal, Automobile and all trades. High-Grade formulas for Toilet, Medical, and Household Specialties. Get my latest "Red Seal" Formula Lists, Valuable information to "Mixers" Free; and write me regarding any formula or preparation. Liscomb Miller Evac Chemical Works, Marietta, Georgia.

**GREEN'S Trees at Half Price.** Everything for garden or orchard. Finest grade stock. We sell direct—no agents. Write today for free catalog. Green's Nursery Co., 76 Wall St., Rochester, N. Y.

**SPECIAL.** A beautiful petrified wood specimen, highly polished and set in a 20-year gold filled tie pin mounting, \$1, postpaid. The Bennett Indian Trading Co., Albuquerque, New Mex.

**COCOANUTS.** Just as picked in fiber husk. Curiosity or "den" ornament. Prepaid in U. S., \$1. Orchids; live alligators from the Florida Everglades. Frank Davis, Box 167, Ft. Lauderdale, Fla.

**THE Home & Camp Cooker,** using denatured alcohol, in solid form, non-explosive. Stove and supply for two hours, 60c, postpaid. The "Lever" Co., 44 Elizabeth, N. J.

**A COMPLETE Drawing Outfit** for \$3.75. Learn to draw without instruction; send for circular. T-Square & Triangle Co., 30 Clinton St., Newark, N. J.

**GREAT corn contest of 1914.** Large cash prize for best ear. Enclose 10 cents for year's membership and our guarantee. National Seed Corn Co., Bath, Me.

**DECORATE your suitcase;** package of 6 gummed hotel labels, from all parts of the U. S., 10c. Elbert C. Hall, Dept. M, Fitchburg, Mass.

**PATENTS** build fortunes for you. Our free booklets tell how; what to invent, how to choose an attorney. Write today. D. Swift, 317 Seventh St., Washington, D. C. Established 1889.

**DO you want to go on the stage?** Be a Handcuff King. I will teach you how; for particulars address Box 902, Springfield, Mass.

**MAKE** cuts, anybody. Complete instructions, \$1. Rex Printery, Trenton, Mo.

**RUBBER Stamps,** Line 15c. Catalogue free. Brabec, 3717 W. 26th St., Chicago.

**GENUINE Rubberset Tooth Brush Free!** How? Write Crescent Trading Co., Ampere, N. J.

**RENEW Old Dry Batteries!** Guaranteed formula, 25c. Northern Supply Co., 154 Randolph, Chicago.

**UTILIZE Natural Forces** for health and self-reliance. Send 10c for practical methods. A unique book of valuable information. New, original money-making proposition free. Andrew Mathews, D. 6, Mosier, Ore.

**MACHINISTS, Shopmen, Millwrights—**For \$1 I will send you a "kink" for babbling operations; if, after using, you don't say it's the "one best bet," the best you ever saw, I will refund your money. J. A. Campbell, Cambria, Wyo.

**SKELETON Keys—**Open all common door locks. Set 25 cents. Special set 50 cents. Catalogue free. B. & B. Novelty Co., Box 237, Rock Island, Ill.

**BETTS** bench block. A substantial casting 2 1/2 x 3 1/2. Planned on top. Very useful for straightening, riveting, etc. 50c postpaid. C. E. Betts, Westport, Conn.

**BELT Buckles** for Schools, Clubs, Lodges and Greek fraternities. Rubber Stamps, Stencils, Checks. Get Catalogue. Mulhaupt's Shop, Lafayette, Ind.

**YOUR name** nicely printed on 5 good, rubber-tipped Lead Pencils, 25c; 12 Pencils, 50c. H. O. Barnes, Dept. C, 1422 Holmes Ave., Springfield, Ill.

**HOW to Solder Aluminum.** How to make the solder, 25c. J. Eaton, 4512 Colorado Ave., Chicago.

**NOVELTY Penholder.** No metal to rust. 1pc. 3 for 25c. Supply Co., 100 W. Fourth St., Elmira, N. Y.

**MATHEMATICS** made easy for all by Ropp's Calculator. Figures out, in the twinkling of an eye, every conceivable problem that occurs in the Office, Store, Shop, Bank, Farm or Factory. Greatest time and labor-saving work on figures in the world. Copyright 1912. Price, \$1. Vest pocket size, 50c. Popular Mechanics Book Dept., 316 W. Washington St., Chicago.

**GRANDFATHER'S Clock Works,** \$5. Slightly shop-worn, quantity limited, others with chimes, all prices; also several nice Grandfather's Clock cases, exceptional bargains. Clock Company, 1673 Ruffner St., Philadelphia, Pa.

**I WILL** start you earning \$4 daily at home in spare time, silvering mirrors; no capital; send for free instructive booklet, giving plans of operation. G. F. Redmond, Dept. 306, Boston, Mass.

**YOUR Name** on Rubber Stamp for marking linen, 70c. Steel Dies, Metal Checks, Seals, Stencils, Catalogue 10c. Buckeye Stamp Works, Market, Dayton, Ohio.

**TOBACCO-CURE—**One box cures. Guaranteed or money back. Established 1894. Write for special offer. Allen Distributing Co., 3609H, Wabash Ave., Kansas City, Mo.

**YOUNG Man!** Learn Drafting—one of the most practical subjects of study to-day—indispensable in many occupations—engage in individual study successfully with the aid of our new book, "A Practical Course in Mechanical Drawing," 160 pages, 157 drawings, cloth, 50 cents, postpaid. Popular Mechanics Book Dept., 316 W. Washington St., Chicago.

**CUTS** anybody can make. Simple Etching Process, \$1. Particulars, specimens, for stamp. M. Day, Windfall, Ind.

**3000 SELECTED Pictures** for \$3. A Panorama of World Events. Political—Industrial—Social—Humorous—Tragic—all of intense human interest. A wonderful collection of 3,000 cartoons reproduced from the newspapers of the United States, Canada, Mexico, Cuba and the cities of the Old World, has been made by Cartoons magazine from more than one hundred and fifty thousand published cartoons, and, bound in an artistic and durable cover, are now ready for your library table. Vol. I, Jan.-June, 1912—\$1. Vol. II, July-Dec., 1912—\$1. Vol. III, Jan.-May, 1913—\$1. Cartoons, 318 W. Washington St., Chicago.

## TOO LATE TO CLASSIFY

**ENGINEERS'** transits and levels, slightly used, good bargains. W. F. Sprengnether Instrument Co., 205 Ozark Bldg., St. Louis, Mo.

# Build a \$5,000 Business

of your own  
and be Independent

## A Specialist is Always Well Paid

especially if there is a good demand for his services. We turn out specialists for a new, unlimited field. We prepare men to handle collections and credits—we practically set you up in business for yourself. Our methods are exclusive, our systems peculiar to our work and results are certain.

**CAN YOU DO WHAT 3500 OTHERS HAVE DONE?** Over 3500 men in every walk of life have completed our instructions at home, many of them in spare time. These have established themselves in a permanent, growing and highly profitable business—and there are more following in their footsteps. Can YOU do what the 3500 have done?

### CAN YOU SUCCEED WITH OVER 3500 HELPERS?

Not only are WE back of you but you will have also the co-operation of the entire system—over 3500 trained and practical assistants to cover the entire country—over 3500 sources from which to draw new business in your territory. THE CO-OPERATIVE BUREAU is a very fitting name for this organization. You become a member without charge when you finish the course.

**THIS COUPON** will bring you the synopsis of the entire course—will bring you a wealth of evidence, facts and figures—our **ABSOLUTE GUARANTEE** is on file with every publisher carrying our advertisements. Use the coupon, that's what it's here for, but be sure and mail it promptly—today is a good time.



W. A. SHRYER  
President

AMERICAN COLLECTION SERVICE  
603 State St. Detroit, Mich.

C. D. West, St. Louis, Mo.: "I earned net profit \$170.00 the first month. Next seven months, average net monthly profit, \$342.00."

A. P. Hyde, South Hadley Falls, Mass.: "My commissions, spare time only, for four consecutive weeks, as follows: \$31, \$54, \$78, \$100. Will devote all my time to collections."

H. A. Murphy, Youngstown, O.: Commissions for March, \$348.02; April, \$430.48; May, \$439.72; June, 484.58. Expect to double business within next three months."

### Coupon, Cut or Tear Off and Mail Today

W. A. Shryer, Pres. American Collection Service, 603 State St., Detroit, Mich.—Please mail without cost or obligation to me, the full synopsis of your course; and pointers on the Collection Business.

Name \_\_\_\_\_  
Address \_\_\_\_\_

This Complete Library of

# LAW

IN 6 HANDY VOLUMES

Only \$1 a Month

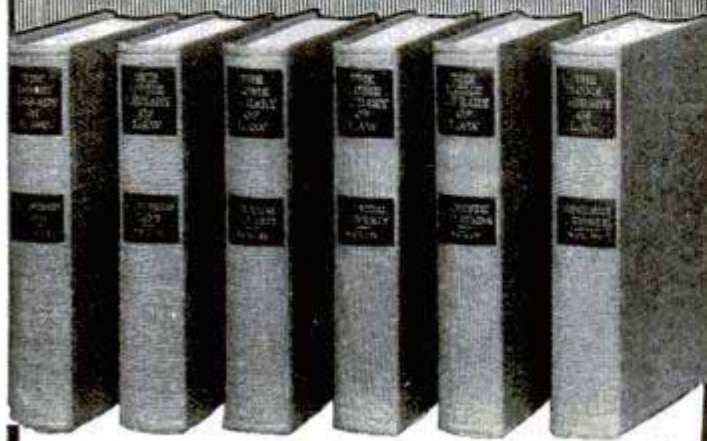

**"Ignorance of the law excuses no man"**

**THAT'S LAW.** You can't always "guess" the law. You may not have time to "study" law. Lawyers come high—especially some of them. **BUT YOU MUST KNOW LAW.**

**T**HIS splendid little handy LIBRARY OF LAW is prepared for the average man—the business man—the doctor—the teacher—the minister—the man who works for others—the man who works for himself—the man who writes—the man who has money and the man who has not—EVERY MAN. This Library is a work to read at odd times and a reference work combined. The language is simple, direct, plain, and it covers every subject you need to know about. Here are just a few of them: "Wills"—"Mortgages"—"Deeds"—"Farm Laws"—"Landlord and Tenant"—"Leases"—"Copyrights"—"Trade Marks"—"Partnerships"—"Letters of Credit"—"Trustees"—"Corporations"—"Stockholders"—"Dividends"—"Marriage"—"Parental Relation"—"Employer and Employee"—"Assault"—"Defamation"—"Libel"—"Criticism"—"Self Defense"—"Automobile Laws"—"Patents"—"Contracts"—"Fraud"—"Damages"—"Negotiable Paper"—"Indorsements"—"Promissory Notes"—"Checks"—"Bills of Exchange"—"Bonds"—"Agents"—"Banks"—"Bankruptcy," etc.

**HERE IS OUR SPECIAL OFFER**

**W**E can't begin to tell you all about this splendid set of books, so we are not going to try. We want to send you the books themselves—the complete set of 6 handy volumes, measuring 6¼ by 4½ by ¾ inches, so that you can examine all the volumes and decide for yourself if they are just the books you want—and need.

If you decide to keep them, just send us \$1 a month thereafter for 8 months. But if you do not wish to keep the books after seeing them, then you may send them back at our expense. That's fair. Isn't it?

Mail coupon below at once.

The Thompson Publishing Co.,  
1127 Pine Street,  
ST. LOUIS, MO.

Send me for examination, one set of your handy LIBRARY OF LAW in six volumes bound in Buckram. If I am satisfied with the books I will send you \$1 as first payment, and \$1 a month thereafter until the special price of \$9 is paid. If I do not wish to keep the books, I will notify you in seven days, and the books are then to be returned at your expense as offered Popular Mechanics Magazine readers.

NAME.....

ADDRESS.....

## This Suit Yours



To learn how you can have a swell tailored suit without cost (we pay express) make \$10.00 every day; to learn what beautiful tailoring really is; to offer styles that everybody goes wild about; to get all your own clothes easy, do this now—write us and say "Send me your New Wonderful Tailoring Offer," and you will receive a beautiful set of samples and styles to pick from, and an offer so good you can hardly believe it. No money or experience needed. Your spare time will do. Write now—sure. Don't answer unless you live in a small town under 10,000. Address

**BANNER TAILORING CO.**  
Dept. 636 CHICAGO

## Amateur Experimenters and Wireless Operators

will be glad to know that a man who has been in the wireless field for six years, having held some of the most important positions, has written a book intended expressly to fill the long felt want for practical information. Of necessity all books of value on this subject have been more or less theoretical, but the results given in this one have nearly all been obtained from practice.

### Wireless Telegraphy and Telephony

By C. I. HOPPOUGH

200 pages. Cloth. 150 illustrations. Price \$1.50 postpaid  
POPULAR MECHANICS BOOK DEPT., CHICAGO

## Chart of a Modern Submarine

Price 25c Postpaid

Showing and naming over 200 parts. Size 14x28 inches. Printed on Plate Paper.

POPULAR MECHANICS BOOK DEPT.  
318 W. Washington St. CHICAGO

## MONTHLY CASH PRIZES

Until further notice in this magazine the Editor of Popular Mechanics will pay two cash prizes each month for the best original contributions to its

### SHOP NOTES DEPARTMENT

\$10 for the Best Contribution  
\$5 for the Second Best

THIS IS IN ADDITION to our usual rates for such contributed articles.

Quality, not length counts.

Checks will be sent on the last day of each month for the prize articles received during that month. Publication in the magazine will follow in about two months.

### PRIZES AWARDED FOR DECEMBER, 1913

First Prize—ALBIN P. SWAIDMARK, Orlando, Fla.....\$10  
"Drill Press Used to Cut Spiral in a Shaft"

Second Prize—FREDA NEHLS, New York City..... \$5  
"Inserting Rod in a Lace Curtain."

### EXTRA AWARD

On account of there being five contributions this month each of which deserved second prize, we have made an EXTRA AWARD of four additional second prizes, as follows:

J. B. BEDORE, Crivitz, Wis..... \$5

"Inserting a Fiber Gasket"

F. H. TILLOTSON, Chicago..... \$5

"Entrance Signal for a Garage"

C. WHITE, Brooklyn, N. Y..... \$5

"Flexible Sandpaper Block"

PIERRE WAGNER, Indianapolis, Ind..... \$5

"Tool for Cutting Square Holes in Metals"

All accepted contributions to our departments, "SHOP NOTES" and "AMATEUR MECHANICS," are paid for immediately; checks for prize awards are sent at the end of each month.

Address, EDITOR POPULAR MECHANICS  
318 W. Washington St., Chicago



700  
Things  
For  
Boys  
To Do



700  
Things  
For  
Boys  
To Do

# THE BOY MECHANIC

The Ideal Book for the  
Wide-Awake American Boy

480 Pages—700 Articles—800 Illustrations—Cloth—Price \$1.50 Prepaid

All the things described in this volume have actually been built or experimented with by boys. The ideas contained in "The Boy Mechanic" would more than keep a boy occupied until he grows up and also be an incentive to original thinking and achievement.

## The Most Interesting Boys' Book

Unlike so many other books of a somewhat similar nature, it is not confined to only one or a few subjects but describes 700 different things boys can make and do in the fields of mechanics, electricity, sports, arts and crafts work, magic, etc.

An unusually generous book; size 7 by 10 in. and 1½ in. thick; printed from large, clear type on high grade book paper and durably bound in cloth. Attractive four-color cover design.

## Wholesome, Practical, Instructive

Besides telling how to make scores of things useful about the house, full and complete directions are given for constructing the following and hundreds of other things which appeal to the heart of every boy.

Many Electrical Appliances—Steam and Gas Engines—Turbines—Motors—Wireless and Morse Telegraph—Self-Propelled Vehicles—Toboggans—Ice-Boats—Canoes—Paddle Boats—Punts—Camping Outfits—Tents—Fishing Tackle—Magic Lanterns—Searchlights—Cameras—Telescopes—Gliders, Kites and Balloons—Electric Furnaces—Lathes—Pottery Kilns, etc.

Many hours of enjoyment are in store for the boy who becomes possessor of this book.

**PRICE \$1.50, PREPAID TO ANY ADDRESS**

Your book dealer will supply it or you can send direct to the publishers

**Popular Mechanics Book Department**  
318 W. Washington Street, CHICAGO

# Can You Accept a \$2,500 Job



Have you the training that is necessary to

hold down a \$2,500 job? Have you the same knowledge as the man who gets the fat pay envelope? Salaries are paid to the men who **know**.

You can get just the kind of training you need to accept one of the big jobs. There are hundreds of them open. We will help you to get one of them.

## Be a Signal Engineer

Be the man who gets \$2,500 a year. Hundreds of jobs open and nobody to take them. The most fascinating of professions.

As a railroad man you travel from coast to coast without it costing you a penny. You can be the man who knows. You can be the man who tells the other fellow what to do. You can be the man who gets the fat pay envelope and free transportation.

## \$2,500 a Year

Yes, that is what your salary will be when you are a full fledged Signal Engineer, \$2,500 a year to

start. Hundreds and hundreds of men making much more than that. Even while you are learning you can hold one of the positions under a Signal Engineer. Paying you \$75 to \$195 a month. Here is your opportunity. Send in the free coupon for full particulars.

## More Men Needed

Railroads are constantly looking for competent Signal Engineers. There are not enough men to fill the positions now open. Thousands and thousands of miles of track are now being equipped with automatic signals. Hundreds of new positions will be open. **And there are no men to take them.** Here is your chance.

## Free Outfit

If you will write at once you can get the big new Signal Engineer's outfit absolutely free. Our students get practical instruction. The kind the railroads demand. If you act at once the outfit is free to you. Send the free coupon for full particulars.

## Send the FREE Coupon for Big New Book

Just put your name and address on the free coupon and send it in to us at once. Absolutely no obligations of any kind. We will send you the big new Signal book absolutely free. Tells you all about this most fascinating profession. How you can get into the \$2,500 class. The book is free. Get your name and address in at once.

**FREE BOOK COUPON**

Department of  
Signaling  
Desk 1192  
491 Cass St.  
Chicago, Ill.

GENTLEMEN: Please send me absolutely free and prepaid your big new Signal book. Also full particulars about your great special free outfit offer. It is distinctly understood that I assume no obligations of any kind.

Department of  
Signaling

Desk 1192

491 Cass St.

Chicago  
Ill.

Name.....

Address.....

Age..... Occupation.....

# LEARN AUTO-DRIVING REPAIRING AT STATE APPROVED NATIONAL AUTO SCHOOL



Graduates of this School can be sure of securing State Chauffeurs' License.

*The National is approved by the State Automobile Department of Ohio.*

### READ THE PROOF!

After investigating our course, the authorities of the State Automobile Department, at Columbus, Ohio, wrote us as follows:

"We have carefully examined your Prospectus and from such examination are of the opinion that you are doing excellent work and we appreciate your cooperation. We are not able to offer any criticisms whatever and believe your course is first-class."

Repairing, Overhauling, Driving, and even the Building and Rebuilding of automobiles, are taught at the National Auto School, "Where You Learn How." Students work in small groups (as shown above), under the direction of Expert Instructors. Each man takes his turn in: Machine Shop and Repair Dept., Ignition Dept., Motor Dept., Carburetor Dept., Tire and Vulcanizing Dept.; also gets Driving Lessons through city streets. Students "learn to do by doing" (not just theory from books, charts, lectures, etc.), but actual shop work and road work—THE REAL THING!

## WE ABSOLUTELY GUARANTEE TO PREPARE YOU TO PASS ANY STATE EXAMINATION

CUT THIS OUT AND MAIL TODAY

NATIONAL AUTO SCHOOL,  
June & Reading Rd., Cincinnati, O.  
Gentlemen:—Please send free catalog.

Name.....

Address.....P. M.—2

We teach everything about automobiles and our graduates qualify as chauffeurs, repairmen, demonstrators, garage managers or proprietors, salesmen and racing drivers.

Don't Delay—Fill Out Coupon and Mail—NOW!

## NATIONAL AUTO SCHOOL

June & Reading Rd.

CINCINNATI, O.



FREDERICK W. FOOTE  
Psychologist

## YOUR MACHINE!

Needs Training if it is to give you EFFICIENCY OF SERVICE. Your brain is THE machine. Absolute Law governs it. The science of Psychology gives you possession of these laws. Thus the Master Mind makes Self Control, Concentration and Personal Power the equipment for Success. Your opportunity to gain this Training is through a correspondence course of twelve lessons in Psychological Success Training. Send for free book, "Masters of Destiny." The Chicago Institute of Menti-Culture, North American Bldg., Chicago.

## CARNEGIE COLLEGE HOME STUDY. FREE TUITION

Bookkeeping, Typewriting, Drawing, Agricultural, Shorthand, Civil Service, Normal, High School, English, Steam Engineering, Electrical Engineering, Real Estate and Law Courses thoroughly taught by mail. Enrollment \$5. "For Free Tuition Scholarship" apply CARNEGIE COLLEGE, Rogers, Ohio

**LEARN TO WRITE SALES LETTERS**  
THE SKILLED LETTER WRITER is in demand and earns a high salary. One field that is not overcrowded. I teach you by mail. You can increase your salary or business by taking my course. Write for booklet NOW. AD-MAN LEACH, BOX 25, CHICAGO, ILL.

## LEARN TO WRITE ADVERTISEMENTS EARN \$25 to \$100 A WEEK

We can positively show you by mail How to increase your salary. BOOK MAILED FREE. PAGE-DAVIS CO., 112 Page Building, Chicago, Ill., or 150 Nassau St., New York

## FREE "Linene" COLLAR



Our free sample will prove comfort and economy. Send postal stating size and whether you want high or low collar. REVERSIBLE COLLAR CO., Dept. U, Boston, Mass.

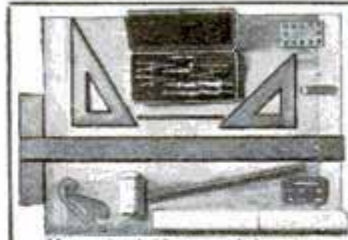

## DRAWING OUTFIT \$3.75

Regular \$8.75 Special  
OUTFIT consists of Board, T-Square, Triangles, Fine Set of Instruments, Scale, Tacks, Pencils, Rubber, Curve, etc. Don't think these tools are playthings just because they are low in price. The greatest draftsman on earth can use them. This same outfit is valued by others from \$8.00 to \$12.00. If you have any mechanical ability buy this outfit and begin to learn how to draw, without spending money on useless instructions. Better outfits for \$6.80, \$8.75 and \$12.50. Send for circular. THE T-SQUARE & TRIANGLE CO., 30-32 Clinton Street, NEWARK, N. J.

Money back if not satisfactory. THE T-SQUARE & TRIANGLE CO.

## DON'T TAKE A COURSE IN Mechanical Drawing

until you have read my proposition. Practical draftsman, regularly employed by the most progressive company in the West, with long experience also as teacher of Mathematics and Drawing, will instruct a few men by mail. **Positively the best way to become a practical well-paid draftsman.** Instruments furnished. Rates reasonable. **Pay a part after in position.** For information write, DRAFTSMAN, 252 South Corona Street, Denver, Colo.

WHEN YOU WANT ANYTHING AND DON'T KNOW WHERE TO FIND IT  
WRITE BUREAU OF INFORMATION,  
POPULAR MECHANICS CHICAGO

## LEARN TO PAINT SIGNS and SHOW CARDS

I'll teach you personally by mail. Fourteen years' successful teaching. Big field for men and women. You can **EARN \$18.00 TO \$45.00 A WEEK** Crawford, B. C. writes: "Earned \$200.00 while taking course." Write today for catalog, samples, etc. DETROIT SCHOOL OF LETTERING CHAS. J. STRONG, Founder Dept. 202 Detroit Mich.



## Mechanics for Young America

The Most Interesting Book For Boys Published Tells how to make boats, tents, fishing tackle, camps, motors, windmills, kites, balloons and many mechanical and electrical devices. 128 pages. **Every page illustrated. 25 cents postpaid** POPULAR MECHANICS BOOK DEPT., 318 W. Washington St., CHICAGO

## The Pictorial Review of Current Events

# Cartoons

MAGAZINE

By H. H. WINDSOR,  
Editor Popular Mechanics Magazine

15 Cents a Copy \$1.50 per Year

## Get the January Number

And keep up with the events  
of this busy world without  
wasting hours of your time.

### In Its New Garb the Cartoons Magazine Becomes the Magazine for Everybody

Its pages are crowded with the best work of the cartoonists of the world and these clever drawings are accompanied by comment gleaned from the columns of editorials penned by newspaper writers trained to follow the questions of the day.

### Bound Volumes One, Two and Three Now Ready

These bound volumes contain more than 3,000 reproductions of the very best cartoons that have been printed during 1912 and 1913. A collection of more than 120,000 cartoons was made in order to secure them. Bound in the three volumes they make an "instant history" of the past months, for they are a pictorial record of the events of the world.

These three books, artistically and durably bound, are now ready for distribution and will be sent all express charges prepaid to any address in the United States or its possessions upon receipt of **One Dollar Each.**

Cartoons Magazine has become the ready reference book of the up to date man. It is not a mere collection of clever pictures but is a magazine that improves and educates.

Ask your newsdealer to show  
you the January number, or

Send your order to **CARTOONS**  
318 W. Washington St. Chicago, Ill.

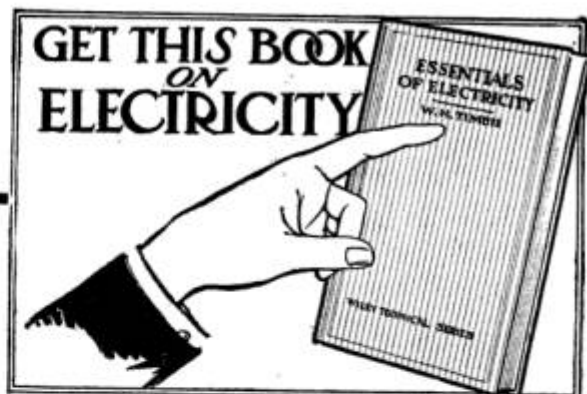

## POPULAR MECHANICS

is "Written so you can understand it"

SO IS

## TIMBIE'S "ESSENTIALS of ELECTRICITY"

If you wish to learn *quickly and surely*

- HOW *Block signals* work,
- HOW *Automatic track switches* work,
- HOW *Electric carriage calls* work,
- HOW to compute the *Amperes, Volts, Ohms and Kilowatts,*
- HOW to locate and repair "*Trouble*" in wiring,
- HOW to determine the correct *size of wire* for every job,

*This book will show you, because you can UNDERSTAND EVERY WORD of it. It contains 270 pages, and each page is solid meat.*

**NO History. NO Algebra. NO Padding.**

Ask the man who has one; take his advice, and send for a copy.

**PRICE \$1.25 POST-PAID**

### Our Hundred-Year-Old Proposition

We have been in business for over one hundred years and have always given our customers the "return privilege." We do not wish to sell anyone a book which he does not want.

..... **FILL OUT THIS COUPON AND MAIL AT ONCE** .....

**JOHN WILEY & SONS,**

**432 Fourth Ave., New York, N. Y.**

DEAR SIR: Find enclosed P. O. order for \$1.25 for which please send post-paid to address below, one copy of Timbie's "Essentials of Electricity." It is understood that if I find this book is not what I desire, you will refund the purchase price, providing I return the book to you within 10 days.

Name .....

Street and No. ....

City or Town .....

State .....

# Come to Detroit

## THE AUTOMOBILE CENTER to learn the automobile business

Sixty-seven out of every one hundred autos in the country are made in Detroit's forty-four automobile factories. There are greater and better opportunities in Detroit than in any other city in the United States. Why go to some place where they practically don't make autos, when you can go right to the "Automobile Center" and learn the business right?



**THE OLD RELIABLE SCHOOL**  
*We have successful graduates in nearly every State in the Union.*

Detroit's prestige is universal. Detroit's products are known the world over. The very fact that an automobile is made in Detroit makes it the best seller.

Automobile men from Detroit are in great demand everywhere. To anyone looking for a position or to anyone starting a garage and repair shop, the very fact that he has learned the business in Detroit, the "Automobile Center," is worth money to him. A Diploma from an auto school in Detroit gives you prestige in the automobile field.

And Detroit being the auto center, naturally must have a GOOD automobile school.

The Michigan State Auto School (incorporated under the laws of the State of Michigan) is equipped to give you unlimited, practical instruction in construction, repairing and driving of standard makes of cars. Our course also includes thorough instruction on

## All Leading Types of Electric Self-Starters

such as the Gray & Davis, Delco, Westinghouse, Ward Leonard, Deaco, Jesco, U. S. L., Adams-Westlake, Entz, Aplco, etc.

We actually have a DELCO ignition, lighting and starting system IN OPERATION ON A MOTOR for the students to work on. We also have the Gray & Davis and the Ward Leonard in ACTUAL OPERATION and expect others any day. We give our students ACTUAL, PRACTICAL experience in installing, repairing and maintaining these systems.

In addition to getting actual garage and repairshop experience in overhauling and repairing all kinds of cars, our students ACTUALLY BUILD NEW CARS, right from start to finish, getting regular factory experience in assembling, block-testing, road-testing, etc.

We do not use books. Our students must put on overalls and "get into things." We teach you the business RIGHT. That's why we have successful graduates in nearly every state in the Union. Our students make good and that's why we are known throughout the country as The Old Reliable School.

## ADVANCE IN RATES

Popular Mechanics readers a chance to get in at the old rate of \$50.00. On Jan. 1st our rates advanced from \$50.00 to \$65.00. As this raise in rates was not announced in the December or January issues of the Popular Mechanics, we will give January issues of the Popular Mechanics, we will give February, and you must use coupon attached in order to get in for \$50.00, otherwise our rate is \$65.00. If, for any reason you cannot come here by Feb. 28th, fill out coupon attached and send us \$5.00 as an evidence of good faith and we will hold our unlimited course for you any length of time at the \$50.00 rate. Should you COME here before Feb. 28th bring this coupon with you, as this "last chance" is open only to readers of Popular Mechanics.

### COUPON

GOOD ONLY UNTIL FEB. 28, 1914

The Michigan State Auto School, Inc.  
11-17 Selden Ave., Detroit, Mich.

Gentlemen:—Please enter my name for a complete, unlimited, practical course in your school, (day or night). I herewith enclose \$5.00 deposit and agree to pay the balance of \$45.00 when entering the course.

Name .....

Address .....

## Our Guarantee

We guarantee to qualify you for a position as chauffeur, repairman, tester, salesman or demonstrator in a short time, or we will refund your money.

**And don't forget, we furnish positions, too**

On account of being in the auto center, we can furnish positions that cannot be obtained elsewhere.

While writing to us, we would ask that you kindly write to several other schools and compare them with ours. Write for our monthly paper, the "Auto School News." It is free. It contains interesting information in regard to the automobile industry and tells you why you should come to Detroit, the automobile center, to learn the automobile business.

ADDRESS DEPT. P

## Michigan State Automobile School

THE OLD RELIABLE SCHOOL

11-13-15-17 Selden Ave., Cor. Woodward, Detroit, Mich.

# Free to You!



## Law Scholarship

CREDIT VALUED AT

# \$100.00

### Given Absolutely FREE to Advertise Our School

**Costs You Nothing Now, or Later, If You Act Immediately!**

**This Offer Is Limited, So Write Today—Quick! Don't Delay!**

Get this most liberal offer before it is too late. This *Free Scholarship Credit* brings you a thorough legal training for *almost nothing*—tuition surprisingly low. We are making this liberal offer for advertising purposes and may withdraw it at any time, so hurry!! If you act at once we will give you a Scholarship Credit, valued at \$100.00, absolutely FREE. Send the free coupon at bottom of this page immediately for full particulars.

### ***COSTS NOTHING TO INVESTIGATE!***

Don't be backward. To write your name and address on the coupon below will not cost you a cent. Nobody will call on you or bother you in any way. We will send you full particulars of this ultra liberal *Free Scholarship Credit* offer, also our FREE BOOK explaining how to master the law at home during your spare moments—how \$5000.00 a year is within your reach if you will study law. Don't put aside this paper until you have filled in the coupon and mailed it to us. Mail it right now—TODAY.

#### **Guarantee:**

We guarantee to coach FREE any graduate failing to pass the bar examination. Our Course covers all branches of American Law and includes same studies as leading law schools.

#### **Your Home A University!**

You can now learn the law easily and quickly at home. Learn while you earn. No preliminary education necessary.

More than forty thousand students have enrolled in our big Law School—one of the Largest Law Schools for Home Study in the World. Distinguished Faculty and Lecturers. Course combines case and text book methods of instruction—covers same ground as HARVARD, MICHIGAN, LELAND STANFORD, COLUMBIA and leading resident law schools—prepares you to pass all subjects required in bar examinations.

### **Mail Free Coupon At Once!**

Yes, send coupon without delay! Be sure to investigate immediately—before this liberal offer expires. You can cut the cost of your law training down to almost nothing if you act at once, so mail the coupon now. It will bring you full particulars by return mail; also our valuable FREE Book on Law. This does not obligate you in any way—it costs you nothing—it simply gives you a chance to go over the facts and decide. Send the coupon this minute—before you do another thing.

**AMERICAN CORRESPONDENCE SCHOOL OF LAW**

Dept. 1192 Manhattan Building, CHICAGO, ILL.

**FREE Information and FREE \$100.00 SCHOLARSHIP OFFER COUPON**

**Fold Here, Tear Off, Sign and Mail Today**

Dept. 1192 Manhattan Bldg., Chicago, Ill.

Gentlemen:—Please send me full particulars of your \$100.00 FREE Scholarship Offer; also Free Book describing your Law Course and plan of home instruction. Send everything free and post-paid. I am not obligated in any way.

Name.....

Street.....

City..... State.....

# Over 1900 Successful Graduates From Sweeney Automobile School

The Sweeney School can give you the names and addresses of over 1,900 graduates who are now chauffeurs, repair men, factory experts, garage owners, salesmen, etc. These men came to us untrained. They got interested by reading our advertising, just as you are reading now. They acted on the same impulse that moves you now to investigate. And then after a few weeks' instruction they went out of this school completely equipped, got employment, and today are **Prosperous, Happy and Respected**. You can do likewise. I don't care who you are or where you live or how ignorant you are of automobiles, I will teach you so that you have a chance to qualify yourself for a **Business Success** handling or repairing automobiles. It will **cost you nothing** to investigate, and let me tell you the actual experiences of my graduates.

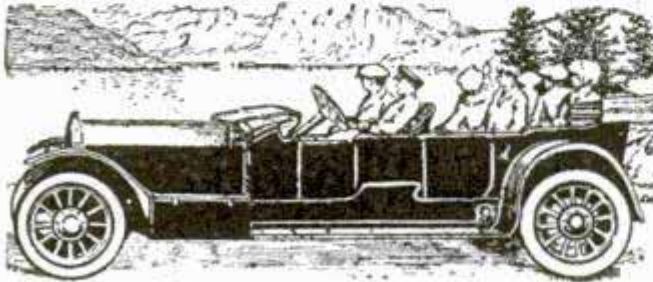

## The Sweeney System of Practical Auto Instruction

is now universally recognized as the most thorough, practical and interesting course of automobile instruction, leading to certain and profitable **EMPLOYMENT**. It embraces every point worth knowing, including vulcanizing, brazing, oxyacetylene welding, lathe work, machine shop practice, testing, driving, truck repairing and operating, etc. **AND YOU LEARN** by doing the work on **REAL CARS** under the watchful eyes of skilled instructors.

## All Types Self Starters Taught by Sweeney System

is free. Our course is thorough and we have a special instructor and equipment to teach this branch of the automobile business. We teach the following Self Starters Ignition and Lighting Systems: The Delco System, the Disco System, the Deaco System, the Jesco System, the Entz System and the Apico System. We also teach the Disco and Presto Gas Starters, and the Winton and Chalmers Air Starters. **DECIDE ON A SCHOOL** where you can learn all the business and not only a part of it.

## Everybody in the Automobile Business Today is Making Money

Here is your chance. I want you to come to my school and see for yourself how quickly and easily you can learn the business and become a **HIGHLY PAID MAN**. Six weeks after the day you enroll you will be prepared to properly repair any auto made, drive any car or truck or traction engine, or open a garage or repair shop of your own. You can learn the business thoroughly in my school because I have been years working out this system and the **WONDERFUL PROMPT** success of my hundreds of **PROSPEROUS GRADUATES** proves it.

## Our Men Learn Quickly and Easily, Because Practical Experience is the Best Teacher

### FREE COUPON

E. J. SWEENEY, President

**SWEENEY AUTO SCHOOL**

1165 E. 15th St., KANSAS CITY, MO.

Send free scholarship offer and catalog.  
Also magazine.

Name .....

Address .....

### Pick Out a Good Job!

Chauffeur :	\$60 per month
Mechanic :	\$160 per month
Salesman :	\$1,500 per year
Demonstrator :	\$150 per month
Garage Manager :	\$35 per week
Stationary Gas Engineer :	\$100 per month
Tractor Engineer :	\$5.00 per day and up
Repairman :	\$18 per week up

Study this picture. This is the best way to learn. Do things with your own hands. Practice beats theory. We do not merely tell you how; we show you how, and you then do the work yourself. We have over 40 cars of all makes on our own floor, eight trucks, two tractors, and our **DRIVING TEACHERS** keep out on the road nearly twelve hours a day. **YOU GET PLENTY OF WORK** of all sorts.

**No Books Used; Tools Furnished Free**  
The tuition is low and after you have paid that there are **NO MORE** expenses or extras you have to buy. If you could learn from a book there are lots published you could read at home, but **PRACTICAL WORK** is the best method, and this is what makes my School different.

**Send Today** for my big free catalogue and we will also send you our monthly magazine free, the most interesting magazine for young men who want to get on in the world ever published. The catalogue is full of fascinating **PHOTOGRAPHS** almost as good as a personal visit to the school. Send today, this very minute.

EMORY J. SWEENEY, President

**Sweeney Automobile School, 1165 E. 15th Street  
KANSAS CITY, MO.**

## Learn to Run and Repair Autos and Make Big Money

Think of this. Here's a trade where you are in demand 12 months in the year. Short hours, pleasant work. Outdoor life. Travel. Enjoy the world. Meet nice people. 90 per cent of the cars in use are not in proper adjustment on account of shortage of experienced mechanics. Grasp quickly this chance to make yourself a **SKILLED MAN** who is in demand and gets big pay for his work. No matter who you are we can teach you.

## \$50 Course Free to Men Who Answer This Advertisement

You know right in your neighborhood of the demand for traction engineers and mechanics. Factories want workmen and demonstrators. We are in close touch with a great traction factory here in Kansas City. We teach you on two different types of tractors in actual work and also give you **FACTORY** experience. Men are wanted right now for good jobs. Here is a wonderful opportunity for young men. You can learn in a few weeks. We want to start out a few graduates right away and so although the regular price of the course is \$50 you **GET THE COURSE FREE** if you enroll in Automobile School now. Sign and return the scholarship coupon today. No previous experience required.

This school, recognizing the demand for up-to-date instruction on self starters and electric lighting systems, has equipped a special department to teach all types of self starters. To any automobile mechanic who desires to take a course on self starters, the cost will be \$25.00. To the students of this school, those that have graduated and those who enroll inside of the next 90 days, this course

## Eight Trucks in Daily Use Teach Students

We own a truck transportation company operating eight trucks and therefore give our students practical work in handling, repairing and driving trucks as well as giving them an insight into the livery and transportation business. We offer this valuable service to students and from this alone you can get experience to open up a most profitable business of your own.



# WANTED!!



Men and Women Everywhere—  
Clerks, Bookkeepers, Teachers,  
Salesmen, Stenographers, Office  
Managers, Store-keepers, and  
Others to

## Start a Mail-Order Business of Your Own

**T**HE mail-order way has proved itself the shortest, surest and safest way to business freedom and financial independence for hundreds of ambitious men and women. I personally know many who are wealthy and independent today who were poorly-paid, hard-working clerks, bookkeepers, etc., just a few short years ago. Hundreds have built fortunes from very small beginnings in the wonderful business of selling by mail.

The great new Parcel Post opens up truly stupendous opportunities for money-making in the mail-order business, and I am going to start a few hundred more men and women in this fascinating and lucrative business before I close my school in order to give all of my time to my own advertising interests.

### Get My Free Book:

#### "How To Make Money in the Mail-Order Business"

If you want to start a mail-order business and *start right* you should send at once for a copy of my free book telling about the great money-making possibilities of the mail-order business and how ambitious men and women *anywhere*—in city, town or country—may quickly master the principles of successful selling by mail and build an independent, money-making business of their own from the use of *spare time* and *very small capital*. My *proposition*, my *plans* and my *methods* are absolutely **NEW**—just what **YOU** have been wishing for. Don't lose any time in getting **YOUR** mail-order business started. Send your name and address for the free book **TODAY**. Address

**RANDOLPH ROSE MAIL ORDER SCHOOL**  
503 Rose Bldg. CHATTANOOGA, TENNESSEE

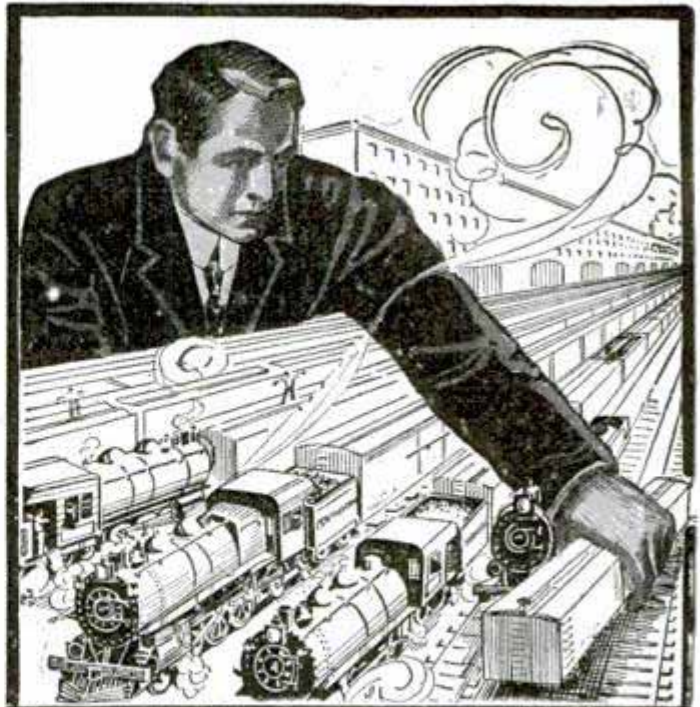

# A BIGGER JOB for YOU

Young man—there's a bigger job, a better job, more money, more responsibility waiting for you in a **NEW AND UNCROWDED PROFESSION**. New conditions have arisen, new problems; for modern transportation is a jungle of routes and rates calling for specialists, calling for men who have been *trained*, men who possess *expert knowledge of the trails of traffic*. And you can now get this training. Simply clip the coupon below and mail it. You can get the necessary knowledge; at small expense and in a short time; you can command a *high salary* as

## TRAFFIC MANAGER

For our *Interstate Commerce Course* enables you to study **AT HOME**, without leaving your occupation or sacrificing your present income. It is a simple, practical, logical course—*easy to understand*—which makes you thoroughly versed and proficient in the *strategy of shipping*, including routes and classifications, interstate commerce rules and regulations, etc., etc. The instruction is given by some of the biggest traffic managers in the country. So simple that anyone with ordinary intelligence, with reasonable application, can master this new profession and

## Earn \$35 to \$200 a Week

There are **half a million LARGE SHIPPERS** in the United States. Practically every one of them needs an expert traffic man, and this need is recognized as never before because of the recently enacted railroad rate laws and interstate commerce regulations. The demand for trained and efficient traffic men is many times greater than the supply. **THERE'S ROOM FOR YOU.**

## All you need is training

And you can now get this training easily. Simply clip the coupon below, sign and mail at once, and we will send you **FREE**, postpaid, a handsome portfolio containing complete information concerning the opportunities and requirements of this splendid profession. **Get your start now—RIGHT NOW.** Clip the coupon at once.

### LA SALLE EXTENSION UNIVERSITY

Dept. 538, Chicago

La Salle Extension University  
Dept. 538, Chicago, Ill.

I am interested in the new profession—  
Traffic Management. Please send me full  
information and Traffic Book, free of all  
cost.

# Free

Name \_\_\_\_\_

Occupation \_\_\_\_\_



## MANY A "BORN GENIUS"

is handicapped, because lacking the mechanical skill to put his ideas into practical shape, who might otherwise become a famous inventor. Study my simplified correspondence course of mechanical drawing and engineering, at home in your spare time, and you will become an expert in a few months, certainly within a year. Drafting is an interesting and remunerative profession, and is a stepping stone to high positions. Learn it from one who has held responsible positions in all kinds of engineering work with big concerns. Elegant set of instruments **FREE**.

ROBT. HARDIE, 621 No. Homan Ave., Chicago, Ill.

**CORNET FREE!** We guarantee to teach you give you a **Beautiful Cornet** or any Band Instrument absolutely **FREE**. You pay weekly as lessons are taken. Instrument is sent with first lesson. Write today for our booklet and wonderful tuition offer.



**INTERNATIONAL CORNET SCHOOL**  
408 Music Hall, Boston, Mass.

## JEWELRY ENGRAVING

We teach you, by our new and original method of instruction, this clean, fascinating and profitable business **right at your home**, and furnish you all tools needed absolutely **free**. Write for free book to the

**WISCONSIN SCHOOL OF ENGRAVING**, Stroh Bldg., MILWAUKEE, WIS.



## Build Bodily Strength

And Mental Vigor

Guaranteed Results in 30 Days

Write for my **FREE BOOK "PHYSIOLOGICAL EXERCISES."** Tells how exercising with my system ten minutes a day will improve your health and vitality, internally and externally. It tells you how to build a constitution that will defy colds and illness, that will give you muscular power, pure blood, perfect digestion, a strong heart and lungs. Send 4c. in stamps to cover postage.

**The Henry Victor System**

14-16 Fourth Ave., Dept. 62 New York

# Learn to PAINT SIGNS and SHOW CARDS



I'll teach you personally by mail. Fourteen years' successful teaching. You will succeed. Wonderful field. Thousands of merchants use window cards, price cards, sale cards, banners and signs in large quantities. They buy new ones weekly. Notice for yourself. Many excellent positions always open. Go into business for yourself. Be independent. Gold lettering on glass and wood valuable feature of the course. Our course teaches everything. This knowledge helps you wherever you are. Pay good, work easy and fascinating, hours short.



**CHAS. J. STRONG**  
Founder

## Earn \$18.00 to \$45.00 a Week

Many students make big money in business for themselves. Others make excellent salaries. Natural talent unnecessary. Davis, N. Car., writes: "Before taking course I could not make a letter. Today I am doing all the card writing for my firm."

### COMPLETE OUTFIT FREE



Root, Ill., says: "Wish I had learned of your school years ago. I am now receiving the highest wages paid in our shop." The experience of these men can be yours. Get started.

## FREE—Complete Outfit with Course

I give every student an outfit absolutely free. It is complete and practical. You can do practice work and earn more than enough to pay for course. We give you free all the tools you need, including enough ink, lettering paint, charcoal, etc. (as illustrated) to do the lessons with. With this outfit you can work any place. It is thoroughly practical. You get the outfit when you enroll. Write at once for our big complete school catalog, testimonials, pictures, sample of work and terms. Read them very carefully. The letters above are from men who acted. Don't hesitate.

## DETROIT SCHOOL OF LETTERING

Oldest and Largest School of Its Kind  
Chas. J. Strong, Founder

## Earn While You Learn

Many students begin doing work after one or two lessons and earn many times cost of course. Fritzner, Minn., says: "Did job recently, charged \$10, net profit \$7.05. Did this after taking one lesson." Parrott, Okla., writes: "I have earned several times the cost of the course since enrolling." Crawford, B. C., says: "I have earned nearly \$200.00 since taking up my course." You can do as well as these men.

## Guarantee

I GUARANTEE to place my graduates in positions paying \$85.00 to \$175.00 monthly, when they have graduated and are competent. We have constantly more requests for men at good salaries than we can supply.

## COPY THIS SKETCH

and let me see what you can do with it. You can earn \$20.00 to \$125.00 or more per week, as illustrator or cartoonist. My practical system of personal individual lessons by mail will develop your talent. Fifteen years successful work for newspapers and magazines qualifies me to teach you. Send me your sketch of President Wilson with 6c in stamps and I will send you a test lesson plate, also collection of drawings showing possibilities for you.



**The Landon School** of Illustrating and Cartooning  
1438 Schofield Building, CLEVELAND, O.

## STUDY LAW AT HOME

### Young Man! Crystallize Ambition!

Stop wishing—and act! Law is powerful, honorable and well paid. And our College Law Course is complete, easily mastered and highly endorsed. Write for catalogue and "evidence." Read the testimonies of our hundreds of graduates. Oldest and best. 24 years of biggest success. Write now!

**SPRAGUE CORRESPONDENCE SCHOOL OF LAW**  
359 American Building, Detroit, Mich.

# CIVIL SERVICE

positions are in all parts of the country. Good pay, steady work, life positions, congenial surroundings, promotions on merit, short hours, annual vacation and sick leave with pay. Many thousands appointed yearly. Both sexes. No political pull. Nearly 300,000 classified positions. Common school education sufficient. Full information and questions used by the Civil Service Commission free.

COLUMBIAN CORRESP. COLLEGE, Washington, D. C.

## FREE BOOK—"How to Write"



Send for it today. Valuable instructive book, "How to Write" Short Stories, Photoplays, Magazine and Newspaper Articles. Tells how famous authors got their start—how you can make \$3,000 or more a year. You can succeed with this great new easily-mastered method. Editor of one of America's leading magazines gives you personal instruction, criticizes your manuscripts and helps sell them. Endorsed by Jack London and other famous authors. Special introductory offer for limited time only sent with free book. Send for it today. **Authors Training School, Dept. 1192 Buffalo, N.Y.**



# Learn How to WRESTLE

In Your Own Home  
By Mail

Yes, learn to become an expert wrestler right in your own home, by mail, from the greatest wrestlers the world has ever known. Be an athlete, be strong, be healthy.

Learn how to throw and handle big men with ease. Learn to defend yourself. All taught in our course of lessons, and illustrated with hundreds of charts and actual photographs by

## Farmer Burns and Frank Gotch

Farmer Burns, "the grand old man of the mat," taught Frank Gotch, the present World's Champion, all he knows about wrestling, so Gotch says. He will now teach you Scientific Wrestling—Physical Culture—Jiu-Jitsu—Self Defense. Every man and boy in America, no difference what age, needs this wonderful course of lessons. Write today—your name and address on a postal or letter brings you the 32-page book absolutely free—no obligations of any kind. A splendid book on wrestling you should have. It's free. Write now.

Farmer Burns School of Wrestling, 1192 Rameg Bldg., Omaha



# Practical Electrical Education

Electrical Engineering, Installation, Wiring, Draftsmanship and all branches of Electrical Science taught by practical, scientific and thoroughly tested methods in the most completely equipped practical engineering school in America.

**Students Can Enter Any Time** Your education is of no consequence; we start you at the right point and our personal instruction advances you rapidly. Positions guaranteed competent graduates; spare time work for students helps pay expenses. Write N-O-W for illustrated Booklet—Free.

Spring Term Starts Feb. 4, 1914.  
**SCHOOL OF ENGINEERING OF MILWAUKEE, Division 24, Milwaukee, Wis.**

# LANGUAGES



**German—French—English Italian—Spanish**

or any other language learned quickly and easily by either the Cylinder or Disc Cortinaphone Method at home. Write for Free booklet today: Easy Payment Plan.

**Cortina Academy of Languages.**  
1055 Mecca Building, 1600 B'way, Cor. 48th St. N. Y.

THE ORIGINAL PHONOGRAPHIC METHOD

DISK LANGUAGE RECORD

CORTINA PHONE





**Sturdy and Economical**

**This Auto Free To Coey Students**

**Coey Junior \$425**

Here is your chance to learn a profession that pays \$100 to \$400 a month, and get free a Coey Junior, sold everywhere at \$425—by simply taking our Correspondence Course in automobile building, repairing, driving and selling, and qualifying for the Coey agency.

**Tuition Only \$15**

for complete course of ten lessons. Read them and you will become a master of any automobile put before you—be qualified as an expert chauffeur, repairman, salesman at high salary. If you enroll at once you get in addition a free course in building in the Coey factories.

**Free Practical Course at Factory**

Here you help build automobiles—learn practical points about them that most drivers never heard of—learn how to sell cars almost without effort—perhaps qualify for a good agency in a large metropolitan city before your course is completed.

Automobile Department,  
C. A. Coey's  
School of Motoring  
524 Coey Building  
Chicago, Ill.

Give me full particulars about your Special Free Automobile and Practical Course Offer to students who enroll at once.

**We Have 3 Splendid Offers**

A \$50 Practical Course for only \$15.00—a free Coey Junior for selling five cars—\$50.00 commission on everyone sold thereafter. These offers are open only a very limited time—so if you would like free auto and training for expert automobile man, mail the coupon at once, and get first lesson free.

**C. A. Coey's School of Motoring** 524 Coey Building CHICAGO, ILLINOIS

Cut coupon off with knife or scissors along dotted line

Name.....

Address.....

**DO YOU LIKE TO DRAW?**

That's all we want to know Now we will not give you any grand prize—or a lot of free stuff if you answer this ad. Nor do we claim to make you rich in a week. But if you are anxious to develop your talent with a successful cartoonist, so you can make money, send a copy of this picture with 6c. in stamps for portfolio of cartoons and sample lesson plate, and let us explain. The W. L. Evans School of Cartooning 821 Leader Bldg., Cleveland, O.



**LEARN DRAFTING**

Be a mechanical, architectural or sheet metal pattern draftsman. **EARN \$75 TO \$200 PER MONTH** There is a constant demand for our graduates. Our employment bureau will secure you a good position. Expert instructors. Complete drawing outfit free. Write for free book today. Colorado Correspondence College, Dept. B-1, Denver, Colo.

**A GOOD POSITION**

with **UNCLE SAM** is most desirable. Life positions, pleasant surroundings, good pay, steady work, short hours, promotions on merit. Both sexes. No political pull. Thousands of appointments yearly. Most thorough preparation \$5. Returned if not appointed. Full information and questions used by the Civil Service Commission free. **AMERICAN CIVIL SERVICE SCHOOL** WASHINGTON, D. C.

**TELEGRAPHY** The Only Trade that is not Crowded. It insures steady employment and good wages. Promotion is assured for the ambitious. We are official instructors for the Western Union Telegraph Co., and the only school instructing Western Union employes. Largest attendance of any Telegraph school; also authorized school for Illinois Central Railroad Company. Agency course free. Practical instructors; main line wires. Employment furnished to earn expenses if desired. State your age. **Jones School of Telegraphy, Dept. M. Traders Bldg., Chicago, Ill.**



**Make this car your office—**

there is \$900.00 to \$1800.00 a year in it for you



Spring Examinations will likely be held everywhere soon Rapid advancement to higher Government Positions. "No Inoffs" because of STRIKES, FINANCIAL FLURRIES or the WHIMS OF SOME PETTY BOSS. THE POSITION IS YOURS FOR LIFE. Country residents and city residents stand the same chance for immediate appointment. Common-sense education sufficient. Political influence NOT REQUIRED. We will prepare 25 candidates FREE! Write immediately for schedule showing the places and dates of the SPRING examinations. Don't delay. Every day you lose means the loss of just so much coaching before the rapidly approaching examinations. **FRANKLIN INSTITUTE, Dept. D 106, Rochester, N.Y.**

**Hundreds of Parcels Post Railway Mail Clerks Needed NOW!**

Franklin Institute (The pathway to plenty), Dept. D106, Rochester, N. Y. The coupon, filled out as directed, entitles the sender to free specimen questions; a free copy of our book, "Government Positions and How to Obtain Them," a list of positions now available, and to consideration for Free Coaching for the examination here checked. .... Railway Mail Clerk (\$900 to \$1800) .... Customs Positions (\$800 to \$1500) .... Bookkeeper ..... (\$900 to \$1800) .... Stenographer ..... (\$800 to \$1500) .... Postoffice Clerk ..... (\$800 to \$1200) .... Internal Revenue ..... (\$700 to \$1800) .... Postoffice Carrier ..... (\$800 to \$1200) .... Clerk in the Departments .... Rural Mail Carrier ..... (\$500 to \$1100) at Washington (\$800 to \$1500) .... Canadian Government Positions.....

**COUPON**

Name..... Address..... D106 Use this before you lose it. Write plainly.

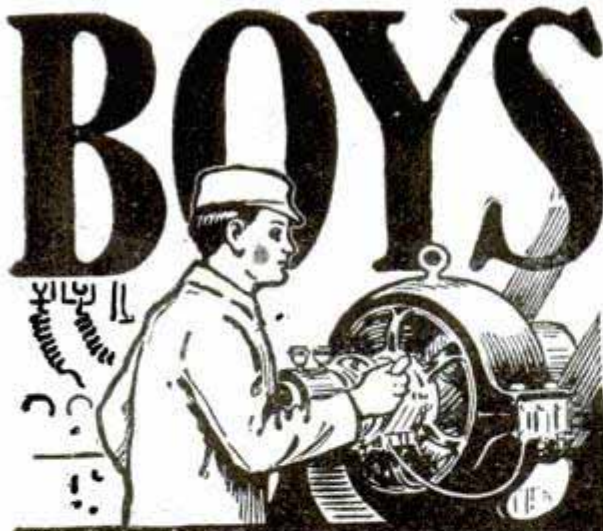

## Big Money in Electricity

The electrical field affords a wonderful opportunity to boys with a liking for electrical work. The salaries paid are large—promotion rapid, and, best of all, the profession is not overcrowded.

The International Correspondence Schools of Scranton can make you an expert in the line of electrical work you like best. Hundreds of boys have already won success through I. C. S. help. You can do the same. Everything is made so clear that you can learn in your spare time, regardless of where you live or what you do. No books to buy. See your parents about it—they want you to succeed.

There's big money in electricity. Get after it by marking and mailing the attached coupon to-day. Finding out costs you nothing.

**INTERNATIONAL CORRESPONDENCE SCHOOLS**  
Box 872E, SCRANTON, PA.

Explain, without further obligation on my part, how I can qualify for the position before which I mark X.

Automobile Running  
Mine Superintendent  
Mine Foreman  
Plumbing, Steam Fitting  
Concrete Construction  
Civil Engineer  
Textile Manufacturing  
Stationary Engineer  
Telephone Expert  
Mechan. Engineer  
Mechanical Draftsman  
Architectural Draftsman  
Electrical Engineer  
Elec. Lighting Supt.

Civil Service  
Architect  
Chemist  
Languages  
Commercial English  
Building Contractor  
Industrial Designing  
Commercial Illustrating  
Window Trimming  
Show Card Writing  
Advertising Man  
Bookkeeper  
Stenographer  
Poultry Farming

Name \_\_\_\_\_  
Present Occupation \_\_\_\_\_  
Street and No. \_\_\_\_\_  
City \_\_\_\_\_ State \_\_\_\_\_

Please Mention Popular Mechanics

## This Book Will Teach You Practical Electricity

Twenty chapters of plain, accurate, compact facts about electricity. Written in an easily understood style, it carries you from the fundamental principles to where you understand the designing, operation and care of a dynamo or motor. It is

### As Good As A School

for it contains questions and answers on each chapter that enables you to examine yourself and fix each subject in your mind as you go along. It tells all about wiring, batteries, lighting systems, and in fact every needful point in practical electricity. It contains one chapter on electric automobiles, their construction, care and operation. Thousands have found it indispensable as

### A Handbook for Practical Men

The tables, rules and formulas it contains are invaluable. It has a dictionary of 1500 electrical terms. No one can stump you if you have this book. 36,000 copies sold.

### Price \$2.00 Per Copy

and it's sold to you on a money-back guarantee. Send \$2.00 for your copy today, with privilege of examination and return if not fully satisfied.

**CLEVELAND ARMATURE WORKS**  
4734 St. Clair Ave. N. E., CLEVELAND, OHIO

Armatures and Fields wound — Commutators filed.



## ELECTRICITY

CONDENSED COURSE IN  
ELECTRICAL ENGINEERING

### Complete in One Year Bliss Electrical School

Studies restricted to theoretical and practical electricity, mechanical drawing and necessary engineering work. Teaches simplicity, concentration, hard work. For young men of energy and character. 21 years of greatest success. Graduates hold first-class positions. **Opens Sept. 23.** Write for new catalog.

104 Takoma Ave., WASHINGTON, D. C.

**EARN \$20 TO \$50 A WEEK** LEARN TO SHOW CARD WRITING.

Splendid Opportunities, Big Salaries, Constant Demand for Show Card Writers. I will make you an expert in **14 EASY LESSONS.** Learn at home during spare minutes. Valuable illustrated book, "Daily's Self Instructor," describing course, sent free on request.

This Book FREE

Send Today

Room 24 Rauh Bldg.  
**BERT L. DAILY, Dayton, Ohio**



## DO NOT STAMMER

My book, "How To Stop Stammering"—a treatise of merit on "scientific talking." Price \$1. School literature free.  
**M. L. HATFIELD, Prin. of The Pacific School for Stammerers**  
1918 Grove St., Oakland, Cal.

## ADVERTISEMENT WRITERS WANTED

by department stores, merchants, manufacturers. Big demand, small supply. Our graduates earn \$1,500 to \$10,000 yearly. Write TODAY for Free prospectus of our Correspondence System of instruction. **POWELL SCHOOL OF ADVERTISING, Inc.** (Est. 1901) 1679 Meyrowitz Building, Fifth Avenue, NEW YORK

## LEARN WATCHMAKING AND ENGRAVING

Earn while learning. Most practical watch school. Individual instructions. Graduates in great demand. Book free. **Chicago School of Watchmaking, 63 E. Van Buren St., Chicago**

## BE A DETECTIVE

Earn from **\$150.00 to \$300.00** per month; travel over the world. Write **C. T. LUDWIG, 133 Westover Bldg., Kansas City, Mo.**

**BE AN ILLUSTRATOR.** by mail how to draw for magazines and newspapers. Send for Catalog

Learn to draw. We will teach you **School of Illustration** 112 Page Bldg. Chicago, Ill.



# I Put Them There

## Give Me Ten Minutes a Day and I Will Do the Same for You

Thousands of men and women have acquired an accurate, unfailing memory through my system of Memory Training. I have letters from men in nearly all professions and trades thanking me for being of great assistance to them. **Hundreds of them attribute their success and prosperity directly to my training.** These whom I quote below are but a few of them. I want to send you others.

You, young man in college, or you, ambitious worker taking a correspondence course—what good is your study doing you? **Be square with yourself. Are you able to remember what you learn?** If not, you owe it to yourself to train your mind so you can profit by what you learn. No education in the world can help you unless you have a memory—a well ordered mind instead of one that plays you tricks.

Take inventory of yourself. You feel that others do not give you credit for your real worth. There must be a reason. Can you think and talk connectedly or are you always saying things that leap out before you give them serious reflection? **Do You Know How To Think? If not, Learn Now!**



**Prof. Henry Dickson**

America's foremost authority on Memory Training, Public Speaking, Self Expression, and Principal of the Dickson Memory School, Auditorium Building, Chicago.

## A Perfect Memory Means More Money

**Yes, it means money to you every day of your life.** My training will mean promotions, ability to see new opportunities, a real capacity to think out big problems.

There never was a big executive or great man in any line who did not have an excellent memory. If he did not have a **perfect memory** he would be taking orders—not giving them. Size up these big men. Why are they superior to you? Only in this—that they can think—they have perfect memories.

## STOP Forgetting



**A business man wrote:** "Since commencing I can endure the grind of a ten-hour business day and come home feeling tiptop—not brain dusty and all in, as heretofore."

**The curator of entomology in a Public Museum wrote:** "The exercises are most excellent and have brought instantaneous results. Within the past week I have been able to memorize a goodly number of scientific names."

## I Can Train You To Remember Don't Overlook This Opportunity

By modern scientific methods the memory, like any other function, can be trained and developed. All successful men have well developed minds and memories. **I have made thousands of them successful.**

If you want to win in the fearful competition of today **you must train.** The sooner you realize this the sooner you start to advance.

When you start with my wonderful system you will be astonished at your progress—at your ability to think and remember. **You can have a perfect memory.** It will be a revelation to you, and your friends will also notice it. It will increase your value to yourself and to your employer. The man with a **perfect memory** becomes a dominant personality—a man to reckon with.



**J. T. M., Stafford Springs, Conn., wrote:** "It has always been hard for me to get up before an audience and speak, but since practicing your exercises I feel quite at home."

**P. H. B., Alaska, wrote:** "I have been using the principles taught, during my selling and am surprised at the results, and I often smile when I have pulled off a sale I had not been sure of."

## FREE—This Valuable Book "How To Remember"

Simply clip the coupon—and mail it—or drop me a letter or postal **now.** You will receive my booklet by return mail.

## How To Get Free Copy of this Valuable Book—"How to Speak In Public"

De luxe edition, handsomely illustrated, richly bound. Is exactly suited to meet the needs of the man or woman who desires to be a successful public speaker. The price of this 1913 de luxe edition is \$2. I will, however, present a copy absolutely free to every student, who enrolls for my course of memory training within ten days after reading this offer.

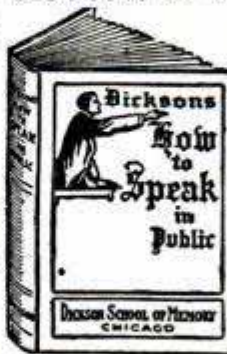

**Prof. Henry Dickson**  
Principal  
Dickson School of Memory,  
705 Auditorium Bldg., Chicago, Ill.

Send me free Booklet, "How to Remember;" also full particulars how to obtain a free copy of Dickson's "How to Speak in Public."

Mail Coupon Today

NAME.....

Street .....

City.....State.....

# STUDY LAW

## AT HOME Become an LL.B.

*Only Law School of  
its Kind in America*

### Special and Exclusive Features

**ONLY** recognized resident law school in the United States conferring Degree of Bachelor of Laws—LL.B.—by correspondence. ONLY law school in U. S. conducting standard resident school and giving same instruction, by mail. ONLY law school giving over 450 class-room lectures to its extension students. ONLY law school giving a full 3-year, University Law Course, by mail, having an actual faculty of over 30 prominent lawyers in active practice. ONLY law school in existence giving Complete Course in Oratory and Public Speaking, in conjunction with its law course.

### Written Bar Guarantee

We give an absolute written guarantee to prepare our students to pass bar examinations.

The Hamilton College of Law is a regular, thoroughly recognized, bona fide College of Law and NOT an "institute," "correspondence school," etc. It occupies the entire third floor of the New Advertising Bldg., where its large and commodious resident class-rooms and executive offices are located.



Our Degree Bachelor of Law, LL.B.  
NOT a Diploma or Certificate

### Direct From Class-Room to Student



From Lecture Room to Student  
*No Other Law School Can Use  
This Illustration*

chooses, take part of our course by mail and finish in our resident school where he will receive full credit for all work done by mail. Our resident school is recognized by all standard law schools in the United States.

The Hamilton College of Law is highly endorsed and recommended by Government Officials, Business Men, Noted Lawyers, Graduates, and Students. We have as students a number of practicing lawyers (not graduates of recognized law schools) who are now earning their degree of LL.B. Many other lawyers are using this course as a review. A Probate Judge, (one of our active students) says: "I am delighted with the course prescribed and your method of teaching law. It is far in advance of what I expected to receive."

### Our Law Library

consists of 24 volumes of Student's Standard Text Books, two volumes bound together under one cover, making a total of 12 books. These books were prepared at an enormous cost especially for the students of the Hamilton College of Law, by one of the largest and best law book publishers in America. This is the only set of law text books ever prepared exclusively for student's use. We would be glad to have you submit these books to any lawyer or judge in the country and get his opinion regarding them.



These 12 Volumes are Free to Students

### Mail Coupon Today

and get our Big, Beautifully Illustrated Prospectus and complete information. Places you under no obligations whatever. This may mean the turning point in your career.

Hamilton College of Law, 327 Advertising Bldg., Chicago, Ill.

Gentlemen: Kindly send me your Illustrated Prospectus and full particulars regarding your method of teaching law by mail

Name.....

Address.....

Write plain and in full

Please Mention Popular Mechanics

## LEARN RAG TIME

Let me teach YOU Rag-Time Piano Playing by MAIL. You learn EASILY—in just a few lessons AT HOME. My system is so simple you'll play Mendelssohn's Wedding March in the fifth lesson. You'll say



*Jee, but I'm Crazy for Rag!*



Even if you can't play a single note, I'll teach you to play ANYTHING in Happy Rag-Time.

Think of the pleasure for you—and the SURPRISE for your friends! Get Busy! Everybody's doing it! Write me for special low terms, positive guarantee, and testimonials from hundreds of happy students.

Axel Christensen (the Czar of Rag-Time) Director  
Christensen School of Popular Music  
602 Christensen Building, Chicago Ill.



## Learn a Paying Profession

that assures you a good income and position for life.  
For twenty years we have successfully taught

## PHOTOGRAPHY

Photo-Engraving and Three-Color Work

Our graduates earn \$20 to \$50 a week. We assist them to secure these positions. Learn how you can become successful. Terms easy—living inexpensive. Write for catalogue—NOW!

ILLINOIS COLLEGE OF PHOTOGRAPHY, 999 Wabash Avenue, Effingham, Ill.

## EARN TELEGRAPH

Morse or Wireless. Also superior station agency course. Splendid opportunities. Demand greater than supply. Graduates assisted. We own and exclusively occupy two large modern buildings equipped with R. R. and Western Union Wires and Complete \$3000 Marconi Wireless Station. Oldest and largest school—est. 39 years. Investment \$25,000. Endorsed by Railroad Wireless and Western Union Officials. Expert practical teachers. Living expenses may be earned. Tuition low. Easy payments. Catalogs Free.

Dodge's Telegraph, Railway and Wireless Institute  
8th Street VALPARAISO, IND.

## LEARN WATCHMAKING

and become independent. Good-paying positions secured.  
Easy to learn. Send for FREE CATALOG.

ST. LOUIS WATCHMAKING SCHOOL, Dept. 5, ST. LOUIS, MO

## LEARN JEWELRY ENGRAVING

in your own home. Earn \$20.00 to \$50.00 Weekly.  
Personal instructions. Write for free booklet.  
Chicago Engraving School, 612 Athenaeum Bldg., Chicago

## DRAWING

Caricature, Cartoon, Comic, Commercial, Fashion, Newspaper and Magazine Illustrating taught by mail. Illustrated book 6c in stamps. THE BOSTON SCHOOL OF DRAWING,  
755M Boylston St. BOSTON, MASS.



## ARITHMETIC SELF-TAUGHT

A plain, easily-understood volume for all who have not had the opportunity of learning this subject thoroughly, or who have forgotten what they once learned. 257 Pages. Requires no teacher. This great little book sent postpaid for 60 CENTS. Stamps accepted, leather binding \$1.

GEO. A. ZELLER BOOK CO.  
Est. 1876, 4473 W. Belle Place ST. LOUIS, MO.

SPANGENBERG'S  
PRACTICAL  
ARITHMETIC  
Self-Taught

# Learn Electricity

## Earn \$5.00 to \$8.00 Per Day

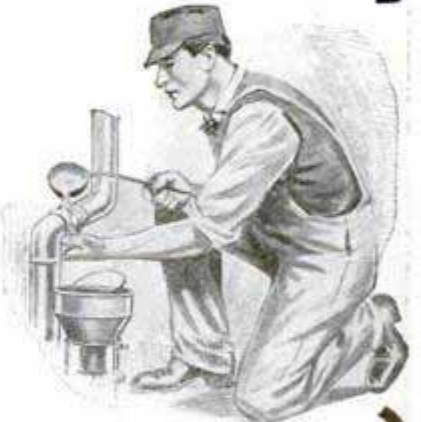

### Make Your Services More Valuable

and get a better job as Electrician, Plumber, Mechanical Draftsman, Moving Picture Operator or Bricklayer. The demand for good men in these trades is greater than the supply. We assist our graduates to good jobs or we will start you in business for yourself.

Our school is the oldest, largest and best equipped trade school in the world. We occupy the entire large building illustrated above. Our instructors are all practical men—expert in their trades. We teach you quickly, practically and thoroughly by actual work. Tools instead of books.

#### Don't be satisfied with small pay.

The money you now earn won't satisfy you forever. You must increase your earnings. It costs more to live now than it used to. Get out of the small pay class. You can do it and we can help you. *Send us the coupon below.*

#### \$5.00 to \$8.00 per day

You can earn this and more if you are skilled in the way we teach trades. Our students always successful. You are not fulfilling your whole duty to yourself if you do not send the coupon attached to this announcement at once.

#### FREE TOOLS AND MATERIAL

You have nothing extra to pay in this school. All your tools and materials are furnished free—absolutely without cost to you. Do not delay about sending the free coupon.

### Here Are the Trades We Teach

**Electricity** offers the greatest field in the world today. Thousands more skilled electrical men are needed. Wages are high and work steady, while the future offers the richest prizes in research work and new adaptation of electric power.

**Plumbing** offers easy work, short hours, big pay and steady work. It's

**Mechanical Drawing** There is always a big demand for good mechanical draftsmen. Engineering firms, contractors, railroads, etc., are always on the lookout for good mechanical drawing experts.

**Bricklaying** A highly paid, fine, healthy, out-

door occupation. Builders are almost impossible now to learn the trade as an apprentice. Even then it will take years and perhaps you will never thoroughly master it. Plumbers are always in demand.

**Moving Picture Operating** is practically a new business and good operators are so scarce that unusually high wages are enjoyed. You can soon go into business for yourself.

door occupation. Builders are always on the watch for competent Bricklayers. You can develop into contracting work where there is no limit to your profits.

## FREE COUPON to Popular Mechanics Readers

### SEND IT QUICK!

We are making a special proposition to the readers of Popular Mechanics—a special limited offer, so cut out the free coupon which we are printing here and mail it to us today. School open all the year. You can enter any time. We have students 16 years of age to 60. Day and night sessions. Free Employment Department. Tuition and expenses very low. **Easy payments if desired.** Drawing and estimating a part of each course. Delightful opportunity for general and social culture. Ten minutes' walk to the heart of Chicago's business center. Send coupon now. Get our special offer today.

Address, L. L. COOKE, Director

### Coyne National Trade Schools

Dept. 1192, 39 to 51 East Illinois Street, Chicago, Illinois

"The Oldest Practical Trade School in America"

**FREE COUPON**  
L. L. COOKE  
Director  
Coyne National  
Trade Schools,  
Dept. 1192  
39 to 51 E. Illinois St.  
Chicago, Ill.

Gentlemen: Without any obligations on me, please send me your school catalogue and full particulars of this special offer to men—all FREE.

Name.....

Address.....

CUT OFF AND MAIL TODAY

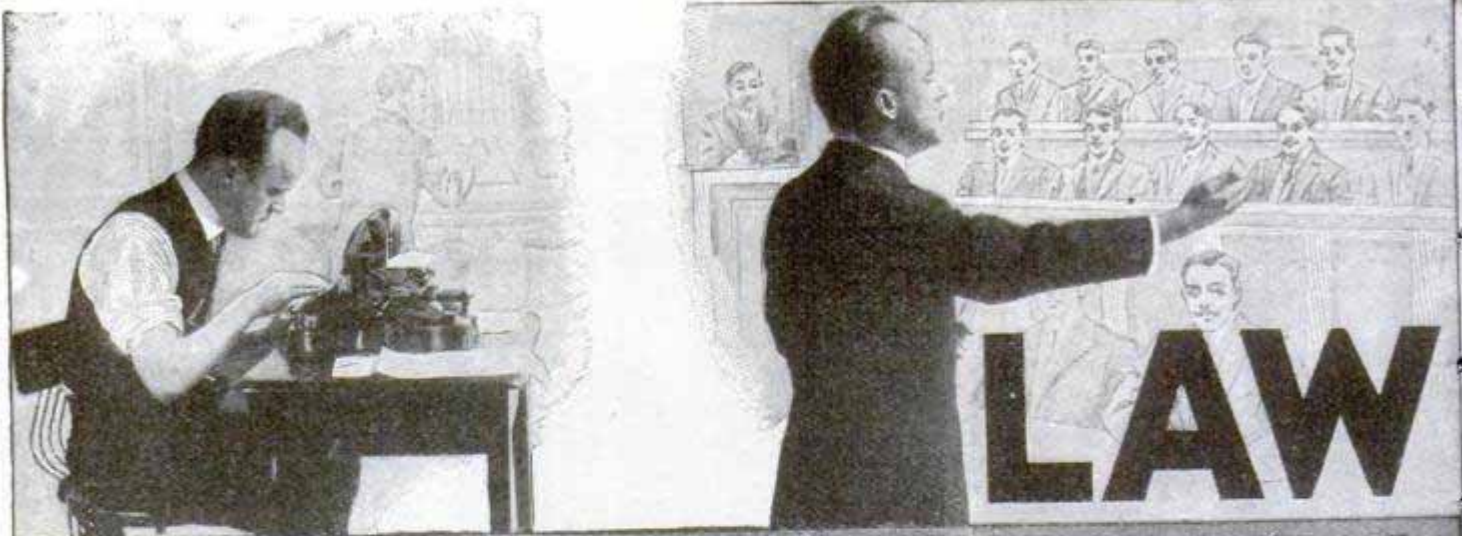

## From Stenographer at \$60 a Month to LAWYER at \$5,000 a Year

That's the remarkable success of one young man who plodded along down in W. Virginia on \$60 a month with no possibility of advancement until he trained himself for Law, at home, in his spare time. You can train yourself for this lucrative profession, in your spare time, by mail, through our simplified method. Law is the greatest profession today. Lawyers enjoy greater income than most other professional men. A Lawyer can enter any business with every chance of maximum success. Most of our greatest statesmen are

lawyers. If you become a Lawyer you can face any handicap—convert your knowledge into money over and over again. Law is the one following that requires no capital—no backing. The demand for Lawyers is rapidly increasing in every community. New corporations are growing rapidly. They require young Lawyers on their staffs and are willing to pay large salaries. Law is a great factor in the commercial world today! The failure or success of thousands of big firms and corporations now depend largely upon it. There are many high-salaried positions open today for young Lawyers.

## ANYONE CAN LEARN LAW NOW

If you can read and write we can train you to become a competent Lawyer—train you in your home, during your spare time, by mail, no matter where you live. Don't think that you need natural talent. Don't think it is a long, hard climb. It is no task to become a lawyer by our simplified, modern method. You need no longer spend years in preparation and years in college to master this dignified profession. You need not give up nor neglect your present work—you need not deny yourself pleasure. A little of your spare time at night is all that is required.

### ONLY METHOD ENDORSED BY COLLEGES

Our Law Text is written in plain language—the combined efforts of master legal minds—America's foremost legal authorities—professors of Law in such big resident colleges as Univ. of Wis., Univ. of Chicago, Harvard, Univ. of Mich., N. W. Univ. and Univ. of Nebraska. It is recognized as the foremost home-study Law course by America's greatest legal and educational authorities—the only method used in the big resident colleges. Former Pres. of the State Univ. of Iowa, George E. McLean, said: "The Professors who wrote your text books are men of highest rank in our best colleges." It is so complete that it covers every branch of America's Laws. This wonderful method is the one that gives you greatest advantages of the case and text book systems. It is the same as having the world's great legal professors in your own home to teach you privately. Don't think that the text books are dry or uninteresting. Once you start to read these eye-opening books you will never quit until you have completed them. Many of America's greatest Lawyers learned Law in their own homes.

### OUR GRADUATES ARE GREATEST SUCCESSSES

This is due to the service we render our students. We have thousands of letters from successful students everywhere to prove the absolute superiority of this institution. We enroll more students every month than any other University home-study Law School in the world. This is a powerful, reliable institution—the largest, oldest, and most complete University home-study law school on earth, whose graduates hold highest records—whose graduates are recognized as competent, trustworthy lawyers. We show actual results—we make no claim that we cannot prove absolutely!

**La Salle Extension University,  
Dept. 537 Chicago, Illinois**

Please send me FREE—copy of your two wonderful books: "EVIDENCE" and "Valuable Law Guide" at once. Also send me Free the \$100 Tuition Credit.

Name.....

Address.....

City.....State.....

Our Graduates Pass Bar Examinations in Any State and attain highest records against all competition.

**WE GUARANTEE TO COACH UNTIL SUCCESSFUL.**

**BECOME AN LL.B.** The State of Illinois authorizes the Degree of Bachelor of Laws (LL. B.) as us to confer on our graduates. This is a rare honor. YOUR DIPLOMA will make you a recognized legal authority.

### REMARKABLE FREE BOOK!

A book that shows you how to start right. A book that puts you on the path of some of America's most successful Lawyers. A book that tells you how they succeeded—how you can succeed. A book that makes possible the greatest success. If you expect to become a lawyer you should have this book, no matter what school you have in mind.

### Complete Law Library

**Great Special Offer!** Each student enrolling now will receive, at once, without additional cost, our complete Law Library—a magnificent set, richly bound—14 volumes of American Law and Procedure—completely covering every branch of law.

Every business man should have our course in law. A knowledge of law is vitally important to every business man. Many of our students are business men who recognize the necessity of legal training and the superiority of our simplified method of home training. Write us today about our Special Course in Business Law.

## \$100<sup>00</sup> TUITION CREDIT FREE

This wonderful offer is limited—it means that if you act now you can actually secure a \$100 Tuition Credit Free. Coming from US this offer means much to those wishing to better their condition and build a successful, influential future.

### BECOME A LAWYER EARN A BIG INCOME

No matter what your age, occupation, education—no matter where you live, how small your salary or how little time you have, our method of home training will prepare you to be a successful Lawyer. DON'T LET COST WORRY YOU—the cost is very small—we make the payments to suit you.

### SEND THE COUPON QUICK!

Opportunities come only to men who can handle them. Be prepared! Everything ever accomplished had its beginning. Sending the coupon is your beginning! Send no money. Act NOW!

**La SALLE EXTENSION UNIVERSITY,  
Department 537 CHICAGO, ILLINOIS**

We also have courses of Business Manager, Public Accountant (C. P. A.), Traffic Manager, Bookkeeper, Correspondent.



## FRENCH—GERMAN SPANISH—ITALIAN

Is Easily and Quickly Mastered by the

## LANGUAGE-PHONE

METHOD

Combined with the

## Rosenthal Method of Practical Linguistry

This is the natural way to learn a foreign language. You hear the living voice of a native professor pronounce each word and phrase. He speaks as you desire—slowly or quickly, night or day, for minutes or hours at a time. It is a pleasant, fascinating study; no tedious rules or memorizing. It is not expensive—all members of the family can use it. You simply practice during spare moments or at convenient times, and in a surprisingly short time you speak, read and understand a new language.

Disc or Cylinder Records—Send for Booklet and particulars.

### THE LANGUAGE PHONE METHOD

961 Putnam Building 2 West 45th Street New York



## HOW TO TRIM SHOW WINDOWS

Shown in this new book, 150 complete windows for every season of the year illustrated by means of over 200 detail drawings and explained in 256 pages of text matter. Shipped prepaid for \$1.50. This is the 10th year for our

## SCHOOL OF WINDOW TRIMMING

**CARD WRITING AND ADVERTISING**  
Best paid and most fascinating professions in the world. A 120-page catalog FREE tells you all about it.

COESTER SCHOOL, 306 Jackson Boulevard, CHICAGO

## Learn Watchmaking At Home



You can learn by our modern and original system of instruction every part of the Watchmaker's Trade at home as good or better than at a shop. You can earn money while learning and secure a well paying position or start in business after completing our course of instruction. Good watchmakers are always in demand and earn from \$20 to \$35 per week. For particulars apply to the Wisconsin School of Watchmaking, Stroh Bldg., Milwaukee, Wis.



## MEN WANTED

Prepare as Firemen, Brakemen, Electric Motormen, and colored Train Porters. First Class Standard Roads. Hundreds put to work—\$65 to \$150 a month without any experience. 500 more wanted. Uniforms and passes arranged for when necessary. Enclose stamp for Application Blank. Name position you want.

I. RAILWAY C. I., Dept. 35, Indianapolis, Ind.



## BE A BANKER

Splendid opportunities. Pleasant work, short hours, all holidays off, yearly vacation with pay, good salary. Learn at home. Diploma in six months. Catalog free. EDGAR G. ALCOORN, Pres., AMERICAN SCHOOL OF BANKING, 119 McLene Bldg., COLUMBUS, OHIO

## EARN JEWELERS' ENGRAVING

High salaries and easily learned trade, taught thoroughly by mail. We will teach the beginner better engraving than he can gain in years of rigid apprenticeship. We will also improve the skill of any engraver. Send for our catalog. Engraving School 112 Page Bldg., Michigan Ave., Chicago, Ill.



## 200 Kinds Iron, Wood, Wire & Steel Puzzles

Catalog and sample—3 leaders for 25c  
WESTERN PUZZLE WORKS  
St. Paul, Minn.



## HERE YOU ARE, BOYS

A medallion pin of Foxy Grandpa. Everyone will notice it on the lapel of your coat and try to get a closer look at it. All you have to do is press the bulb.—Foxy Grandpa will finish the job by squirting a fine stream of water over the inquisitive one. Will squirt 20 feet. Greatest joke out. Order one today and fool your friends. Price 15c. Foxy Grandpa and Hooligan both for 25c. 5 for 50c or 1 doz. for \$1.00. A beautiful fountain pen free with every \$1.00 order.

AMERICAN SUPPLY CO., 918 Union St., St. Paul, Minn.



## Tear off the Blindfold!

SUCCESS—BIGGER INCOME  
LIE WITHIN YOUR GRASP

Right now, at the beginning of this new year, tear the blindfold from your eyes and learn where success lies. Quit groping in the dark. See the big things you want—the things others have obtained. Go get them!

## Sheldon Will Help You Win Success

Sheldon will teach you that success is evolved from within yourself—that it means development—and development embodies but four things.

These four things form the basis of the Sheldon Course—the Science of Business Building. 60,000 men have profited by it. Some of the largest business institutions have applied its principles successfully to their problems. It's your turn now and the famous

## Sheldon Book Tells the Whole Story

It shows you how the latent power within you can be developed by yourself—how you can build your own business if you are an employer or command a greater salary if you are an employee.

A postal or a letter will bring you the Sheldon Book and full information—free.

The Sheldon School 401 Gunther Bldg. CHICAGO, ILL.



## Piano Tuning Pays \$5 to \$15 a Day

Our TUNE-A-PHONE eliminates all guess work and assures success with or without a knowledge of music. Diploma granted. Write today for free book. NILES BRYANT CORRESPONDENCE SCHOOL, 65 Art Inst., Battle Creek, Mich.

## WHY NOT BE AN ARTIST?

STUDY drawing at home under Expert Faculty. We have successful students in every part of the world. Turn your Talent into money. Our Students are filling high salaried positions. 14 years successful teaching. Endorsed by high authorities. 18 Courses in Commercial and Illustrative Drawing, Teachers' Normal and Applied Art, Profit or Culture. Thoroughly Equipped Residence School Artist's Outfit FREE to Enrolled Students SCHOOL OF APPLIED ART, 755 Applied Art Bldg., Battle Creek, Mich.

## MUSIC TAUGHT FREE AT YOUR HOME

Write Today for our booklet. It tells how to learn to play Piano, Organ, Violin, Mandolin, etc. Beginners or advanced pupils. AMERICAN SCHOOL OF MUSIC, 50 Lakeside Bldg., Chicago, Ill.



## DO YOU WANT TO KNOW HOW TO DEVELOP VITALITY, ENERGY, ENDURANCE, NERVE STRENGTH, MUSCULAR STRENGTH PERFECT PHYSIQUE?

My FREE BOOKS, "The 'Whys' of Exercise" and "The First and Last Law of Physical Culture," tell you, if you are weak or underdeveloped, how to grow strong; if strong, how to grow stronger. They explain how to develop lungs and muscle, the strong heart and vigorous digestion—in short, how to improve health and strength internally as well as externally. Send TO-DAY—NOW—for these FREE BOOKS. Enclose 4c in stamps to cover postage.

Department #20  
PROF. H. W. TITUS, 66 & 58 Cooper Square, New York City



# “That coupon gave me my start”

“It’s only a little while ago that I was just where you are now. My work was unpleasant; my pay was small. I had my mother to take care of, and it was tough slogging trying to make ends meet. I hadn’t had much schooling. I didn’t *know enough* to fill any better job than the one I had.

“One day I saw an advertisement of the *American School*. It told how other men got better positions and bigger salaries by taking their courses. I didn’t see how a correspondence school could benefit me, but as long as it didn’t *cost* anything to mark the coupon I thought it was worth investigating at least. I marked the coupon and sent it in on the next mail.

“That was two years ago, and *now I’m drawing more money every week than I used to get in a month.*”

If you want a *better job*, if you want more *congenial work*, if you want a salary that *will put you in the class where you belong*—

**SIGN AND MAIL THE COUPON NOW**

# American School

of Correspondence. Chicago. U.S.A.

## Your Opportunity Coupon

Mark the position you want and mail the coupon now

- |                               |                          |
|-------------------------------|--------------------------|
| ....Electrical Engineer       | ....Lawyer               |
| ....Elec. Light & Power Supt. | ....Bookkeeper           |
| ....Electrical Wireman        | ....Stenographer         |
| ....Telephone Expert          | ....Private Secretary    |
| ....Architect                 | ....Accountant           |
| ....Building Contractor       | ....Cost Accountant      |
| ....Architectural Draftsman   | ....Cert’fd Public Acc’t |
| ....Structural Draftsman      | ....Auditor              |
| ....Structural Engineer       | ....Business Manager     |
| ....Concrete Engineer         | ....Fire Ins. Inspector  |
| ....Civil Engineer            | ....Fire Ins. Adjuster   |
| ....Surveyor                  | ....Fire Ins. Expert     |
| ....Mechanical Engineer       | ....Moving Picture Op’r  |
| ....Mechanical Draftsman      | ....Sanitary Engineer    |
| ....Steam Engineer            | ....Irrigation Engineer  |
| ....Municipal Engineer        | ....Textile Boss         |
| ....Gas Engine Engineer       | ....College Preparatory  |
| ....Gas Tractor Engineer      | ....A tto. Mechanician   |

NAME .....

ADDRESS .....

Pop. Mech. 2-14

**This school has no connection with any other school using the name “American”**

Please Mention Popular Mechanics



# Popular Mechanics Magazine

WRITTEN SO YOU CAN UNDERSTAND IT

Vol. 21

FEBRUARY, 1914

No. 2

## Rolling-Hoop Tractor for the Farm

**A** GASOLINE farm tractor which works on the principle of a squirrel cage has been invented and tried out by a Connecticut farmer. It consists mainly of a wheel, 5 ft. 6 in. in diameter, with a tread of 30 in., which rolls along the ground propelled by a 12-15 hp. gasoline engine inside. The motor is mounted on four wheels fitted with gears and a clutch, like a tiny automobile, and propels the large wheel by continually trying to climb the inside surface of the wheel like a squirrel in a cage. The tractor was designed to draw cultivators, plows, and other farm implements, and can be driven between rows, up hills, and

around sharp corners; but it can also be geared higher to draw a wagon or buggy on the road. Mounted on a frame or cradle, it can be used as a handy power plant for running corn shellers, etc. Built with a 52-in. wheel, this machine weighs about 1,200 lb., and reports of tests made with it indicate a high degree of efficiency.

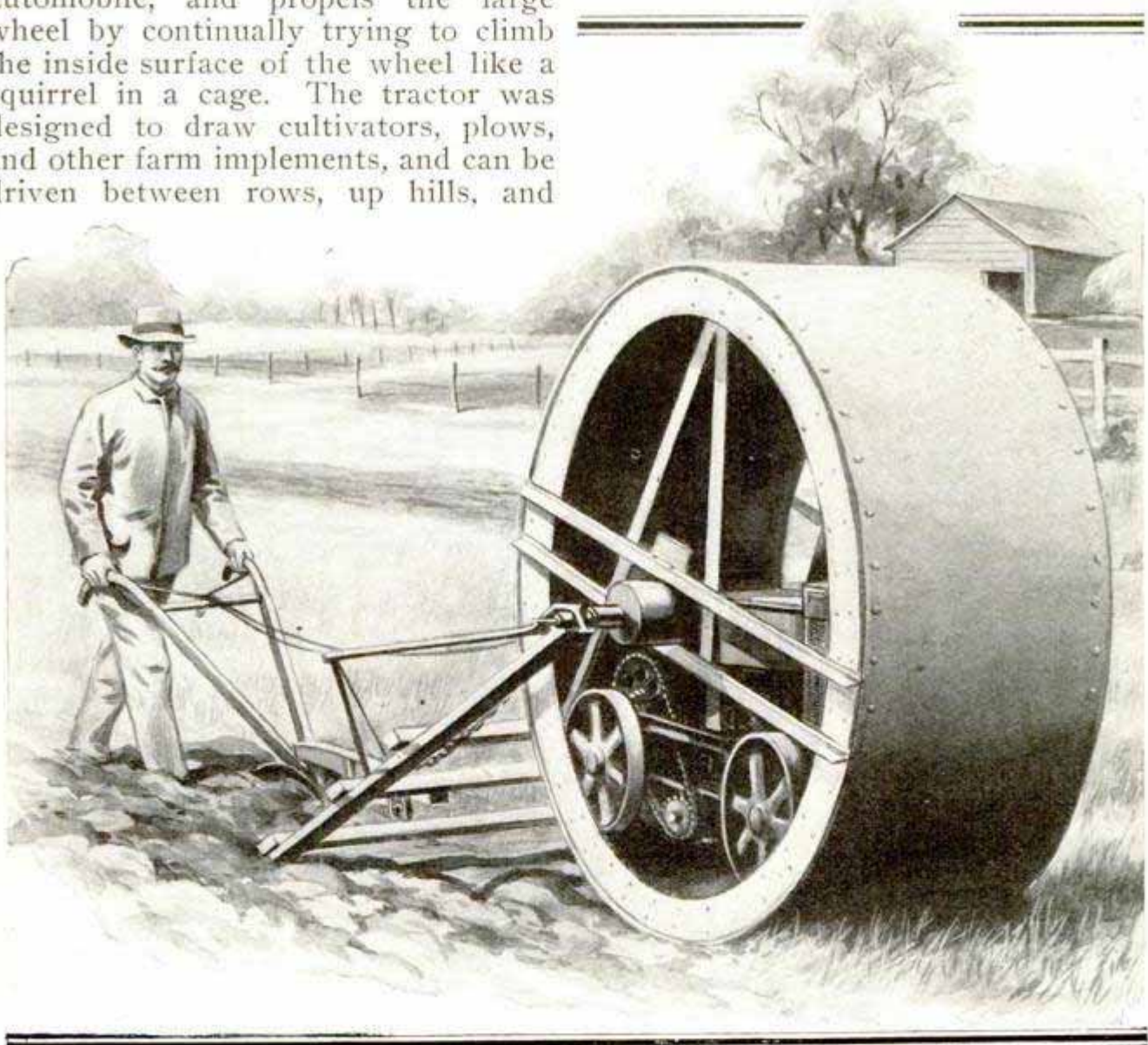

An Engine, Mounted on Wheels, Continually Climbs the Inside and Rolls This Huge Hoop along the Ground to Draw Farm Implements

## AERIAL ROPEWAY ACROSS THE ANDES

A steel ropeway,  $37\frac{1}{2}$  miles in length, will connect two Colombian cities across the summit of the Andes Mountains, being an extension of a railway already in operation. The ropeway will cross the eastern range of the Andes at a point halfway between Mariquita and Manizares, and at an altitude of 11,000 ft. Power will be supplied by water brought from a higher altitude to the power plant, 3 miles from Mariquita. The ropeway will be built in 12 sections, at each junction point of which a motor capable of handling the load of two sections is to be installed, so that if one motor is disabled, the motors on each side will be able to carry the emergency load, and traffic will not be halted.

## ERECTING BIG FLAGPOLE AT VANCOUVER

A flagpole of Douglas fir, 208 ft. high, has been erected in front of the provincial courthouse in Vancouver,

length as possible and so erect it as to protect the base from decay. A suitable timber was cut and delivered in the rough to the courthouse in the fall of 1912. Supported on blocks in a horizontal position and turned from time to time, it was left to season for a year. When finally trimmed, seasoned and painted, it was circular in the upper section and hexagonal at the base. A concrete foundation was provided below ground, 12 ft. square and 12 ft. deep, with a square hole in the center, 3 ft. on a side and 9 ft. deep, to receive the lower end of the flagpole. This hole was lined with galvanized iron, which extended above the concrete to exclude moisture. A derrick with an 87-ft. mast was used in erecting the pole, to which the hoisting cable was attached just above the center of gravity. The pole was raised without difficulty, set in the metal casing, and dry sand tightly packed around it, the metal edges being turned and driven into the wood of the pole, effectually sealing the base against dampness. The pole is guyed with eight cables, anchored into concrete

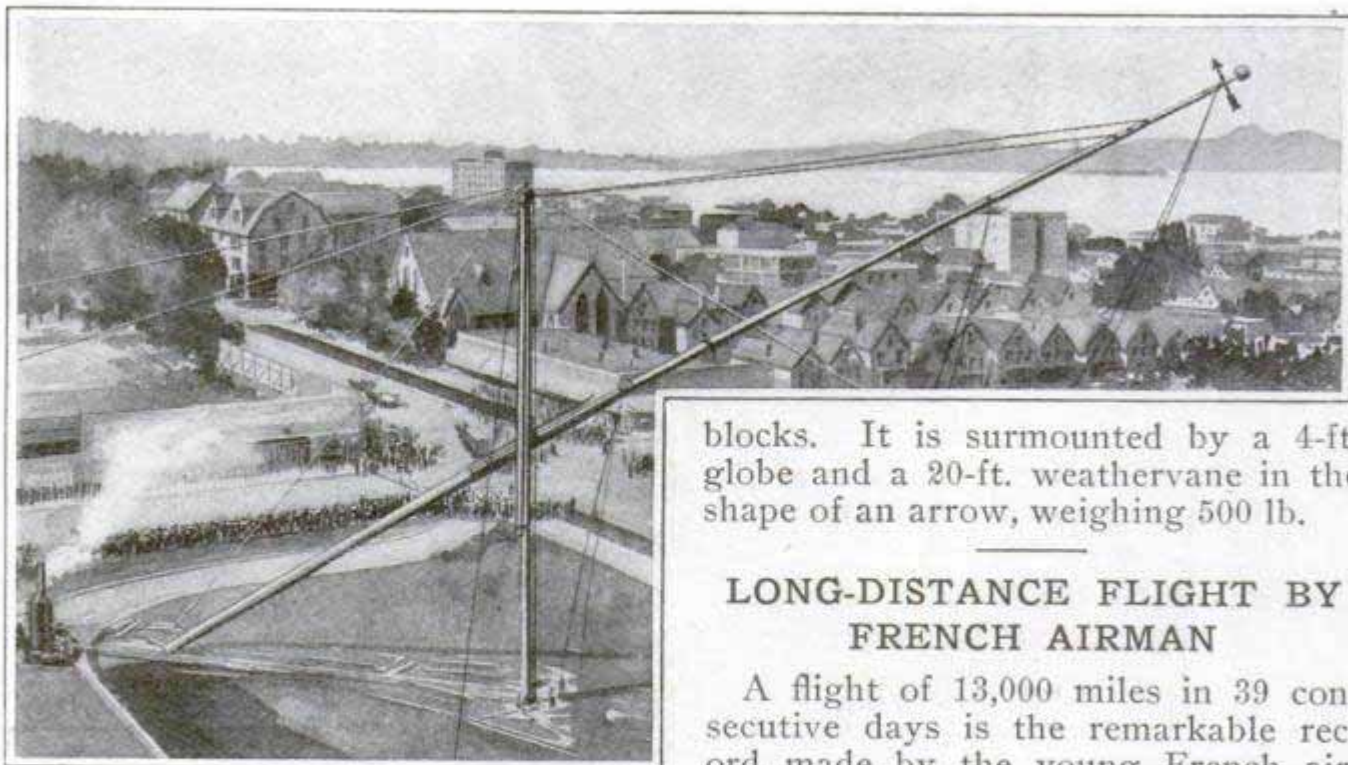

Raising One-Piece Flagpole 208 Ft. Long

B. C. To demonstrate the resources of the timber country, it was decided to secure a single stick of as great

blocks. It is surmounted by a 4-ft. globe and a 20-ft. weathervane in the shape of an arrow, weighing 500 lb.

## LONG-DISTANCE FLIGHT BY FRENCH AIRMAN

A flight of 13,000 miles in 39 consecutive days is the remarkable record made by the young French airman who won the \$8,000 Michelin prize offered in France for the longest flight of the year 1913. The flight was made over a cross-country circuit.

## FRENCH ADD SCOUT CRUISER TO AERIAL NAVY

A dirigible which may be readily taken apart, with a short gondola capable of being easily transported by rail or road, has undergone successful tests by the French government, and will be used as a scout

Dirigible Cruiser Dismantled  
for Transportation on Trucks

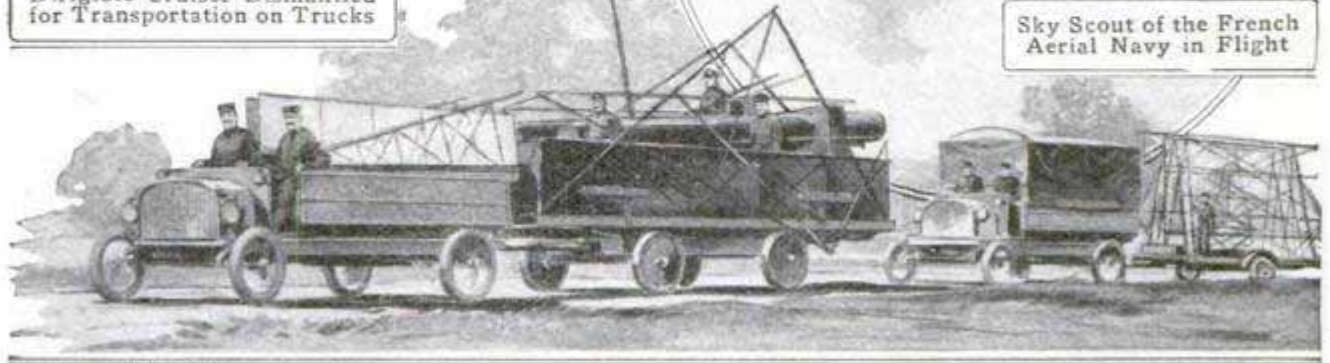

Sky Scout of the French  
Aerial Navy in Flight

Courtesy L'Aerophile

cruiser in the aerial navy of that country. It is equipped with a horizontal propeller by which it may be lowered within reach of the landing crew without the use of guide ropes. Vertical descents have been made from as great a height as 1,000 ft. by this means, and the number of men required to operate the car is thus reduced considerably. Two vertical propellers besides the horizontal one are provided, and two 90-hp. engines drive the dirigible at a speed of about 40 miles an hour. When taken apart, the dirigible is loaded upon two trucks, each hauled by a tractor. Later models will be so constructed, so it is said, that the gondola will take the place of one tractor. The gas bag has a capacity of about 230,000 cubic feet.

## SPECIAL TRAIN USED BY THE GERMAN EMPEROR

Six coaches, each weighing about 60 tons, compose the special train used by Kaiser Wilhelm, of Germany, in his travels. Of these, four are reserved for the Kaiser and his suite and the other two are used for kitchen and offices. The second coach in the train

is the one taken by the Kaiser for his personal quarters. This car contains his personal salon, bedroom, dressing room and bathroom, and sleeping rooms for his attendants. The salon is rich in historic associations. It is paneled in the wood of an ancient cedar taken from Mount Lebanon, the gift of ex-Sultan Abdul Hamid of Turkey. The floor is of black wood taken from the piles of a wooden bridge built across the Rhine by Julius Cæsar in the year 55 B. C., while the ceiling is decorated with a design representing the six great rivers of Germany. The two coaches following this car are reserved for the Kaiser's suite, while behind these is the dining car. The last coach in the train is used by the engineer who controls the operation of the train, and who has accompanied the Kaiser on all his railway journeys during the 25 years of his reign. The Kaiser's two dachshunds, Waldl and Hexl, have their regular quarters on the train and always accompany his majesty in his travels.

Cast-off clothing and second-hand uniforms of all nations find a ready market in Afghanistan.

## BALL-AND-SOCKET JOINT FOR LIGHTING FIXTURES

The difficulty often encountered in making electric-lighting fixtures hang straight is overcome by a ball-and-socket joint recently placed on the market.

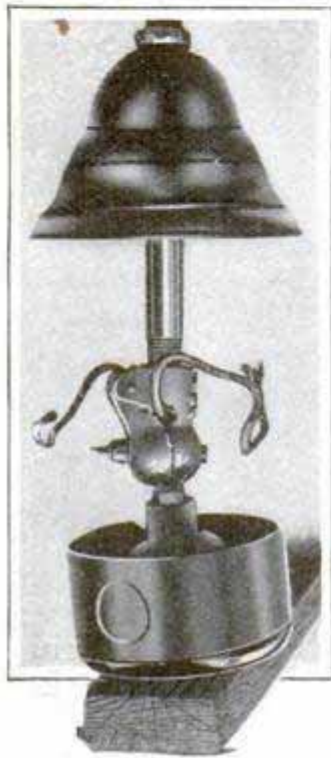

This joint is a part of the base and is tapped at the lower end to receive the threaded end of the pipe on the fixture proper. In installing the fixture, the wireman attaches the base to the ceiling and fits the socket part of the joint loosely over the ball. The fixture is then attached and its

weight causes it to swing to a vertical position. The job is completed by tightening the joint with the wing nut and placing the canopy in position.

## PRECIOUS STONES GLOW IN VACUUM

The fluorescence of gems has long been observed, but recent experiments with vacuum tubes have developed surprising qualities in the diamond, the ruby and the emerald, as well as such minerals as kunzite. Even in rarefied air some diamonds emit a blue light similar to that of sulphate of quinine under the same circumstances. In a vacuum a diamond of four or five carats emits as much light as a candle. Diamonds from different mines show marked divergence in the colors given off in vacuum. Next to the diamond the ruby glows with a beautiful phosphorescence in a vacuum. It emits a red light, as if it were incan-

descent. The emerald shines with a crimson light, while kunzite glows with a yellow radiance, sometimes tinged with rose. The same gems glow with phosphorescence under the influence of radium. Experts utilize this test to determine the value and quality of some gems, as, for instance, the rubies of Burma which are more valuable than those from the mines of Siam. Viewed in ordinary light they cannot be distinguished, but under the ultraviolet rays the Burmese stones glow like red embers, while the Siamese gems look almost black.

## NEW CAR FOR MINE-RESCUE WORK

A velocipede car is offered by a German manufacturer with which life-saving apparatus may be quickly taken into a mine where an explosion has taken place. To this end space and weight have been economized to the utmost, and when several cars are called into service each may be readily taken off the track and parked alongside at the terminal. The life-saving equipment consists, besides two pulmotors, of two oxygen containers, four potassium cartridges for absorbing the

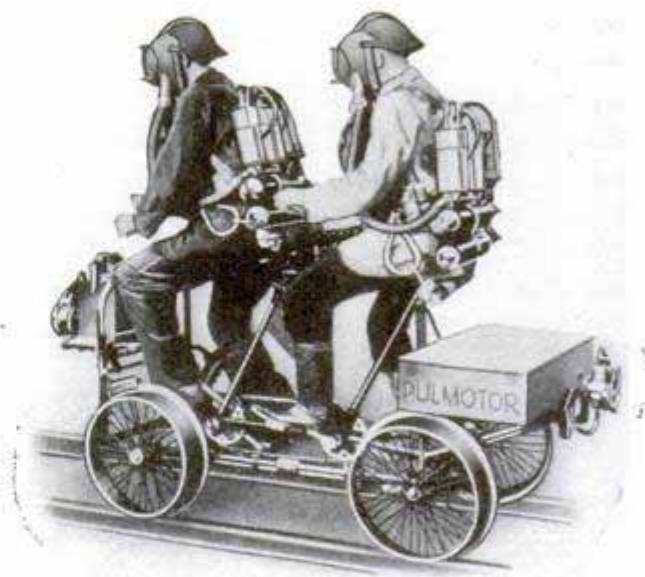

First-Aid Car for Saving Life in Mine Disaster

carbonic-acid gas of the exhaled air, and such tools as are most demanded in emergency.

## AN ELEPHANT THAT USES A TYPEWRITER

There are few offices, even during the busy season, which could use to advantage the typewriter operator shown

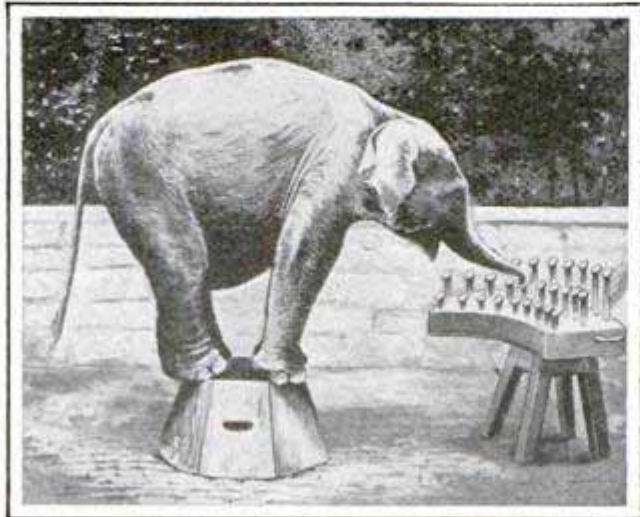

Writing a Letter to Friends in the Jungle

in the accompanying picture. Still, a German animal lover who has achieved some notable successes in training horses to "spell" words by stamping a certain number of times with their hoofs, has undertaken to educate this young elephant to take dictation from him directly on a special typewriter. In the case of the horses, there was considerable skepticism as to just how much intelligence was displayed in responding to arbitrary signals. In the writing done by the elephant, while the animal actually selects on the crude machine the proper letters to spell the simple words called to it by the trainer, it must be evident that it only obeys, as in the case of the horses, the voice and tone of command, doing exactly what it has been trained to do, but without understanding the meaning of the operation, or of the words it so promptly writes.

## READING ROOMS ON BATTLESHIPS

The new battleship "New York" will have an innovation in the shape of a room especially fitted up for the use and accommodation of the guests of the crew. Reading tables, writing desks, books, papers, and magazines

will be provided and "landlubbers," as well as friends from other vessels, may be entertained in comfort when in port. Much has been done to increase the attractiveness of the sailor's life, but the idea of providing an apartment where guests and friends of the fighting force can find enjoyable rest and recreation is a new one on a man-of-war. Similar changes for increasing the comfort of the crew and the attractiveness of the ship for enlisted men and their visitors will be installed on other ships as rapidly as possible.

## HORNS CLEAR STREETS FOR FIRE ENGINES

The instant a fire alarm is turned in in Oakland, Cal., a warning electric horn at down-town street corners is sounded, clearing the streets for an unimpeded run by the fire apparatus. The horns, driven by a small motor and controlled at the central fire-alarm station, are fastened to the electric-light poles at all corners where traffic is congested, and prove an aid when speedy motor-driven fire apparatus is used.



☪ Panama Canal tolls, as recently established by executive order, are \$1.20 per net ton on vessels available for passengers or freight, a net ton being considered as 100 cu. ft. of capacity. A reduction of 40 per cent will be made for ships without passengers or cargo.

## A FAMOUS GEOMETRICAL STAIRCASE

Visitors to St. Paul's Cathedral in London are shown the geometrical staircase in the South Tower, one of

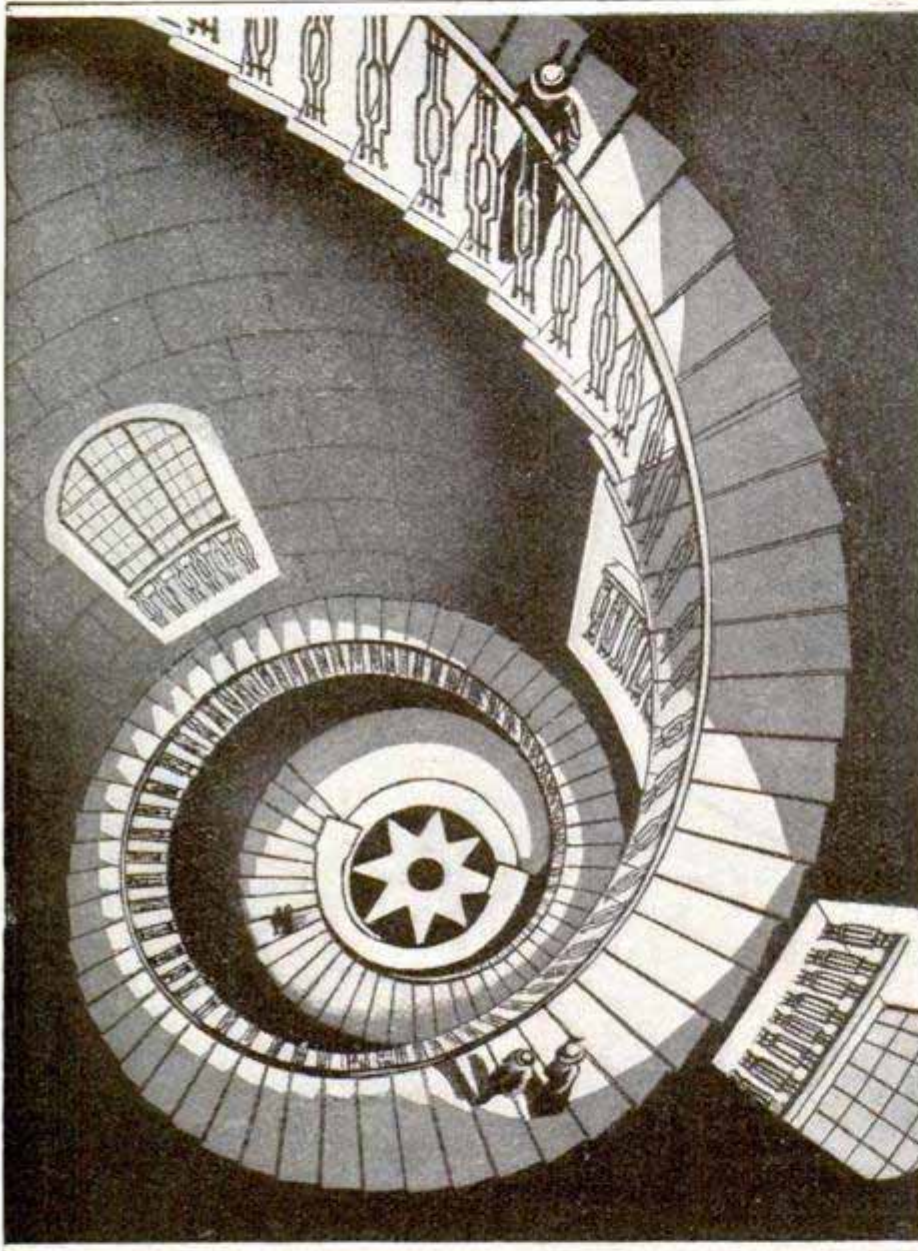

Perpendicular View of the Geometrical Staircase in St. Paul's Cathedral, London

the triumphs of Sir Christopher Wren's genius. It is a circular ascent 25 ft. in diameter, with stone steps nearly 6 ft. broad at their outer end. At one end the steps are imbedded in the wall, at the other they rest upon the edge of the next lower step, without other support from below.

Early English stairs usually consisted of flights with landings, taking up much room, restricting their use to broad halls. The women of the castle

objecting to sharing these outer stairs with the rough men-at-arms, interior stairs were constructed, connecting with the living rooms, by the simple expedient of leaving out some stones when constructing interior walls, and in the wells thus made, placing bricks, short stones or even timbers to form a rude ladder. These crude stairs necessarily took a circular flight, and as improvements were made, the steps became more regular, longer stones being used, until at last a circular stairway was formed, each step of which depended entirely upon the support afforded by the walls, and independent of the others.

The next move was the consolidation shown in the Wren creation, the so-called "geometrical" staircase, where each step rests upon the next lower, the thrust from the outer end being carried into the wall at a lower level. Another interesting specimen of the geometrical staircase is found in Lincoln's Inn Fields, London, built at a later date and probably inspired by St. Paul's.

## CUP THAT KEEPS TEA OR COFFEE HOT

A popular novelty recently introduced in France is a cup so made as to keep tea or coffee hot while the user is reading the morning paper between sips. This is accomplished by providing the cup with a double bottom into which a slip of heated metal can be placed. The liquid is kept hot for a period of about twenty minutes.

## MAKING PENGUIN OIL IS THE SOUTHERNMOST INDUSTRY

About 750 miles to the southeast of Tasmania lies a barren island having an area of perhaps 25,000 acres. It belongs to Tasmania and is known as Macquarie Island. Upon it is conducted a peculiar industry—the penguin-oil industry. About 80,000,000 penguins—“Johnnies,” the sailors call them—make their homes here, and great numbers of this fat, clumsily waddling bird are slaughtered annually for the sake of the oil obtained from it, which is used in dressing leather and in the binder-twine trade.

On Macquarie Island the carcasses are boiled in digesters having a capacity of 800 birds each; steam is applied up to about 25-lb. pressure, when it is turned off and water pumped into the bottoms of the digesters, which causes the oil to rise to the top, from which it is drawn off.

Penguins are found only in the antarctic and the south temperate regions. They can not fly, and look extremely awkward on shore, but when swimming they are quite graceful. In some localities they are so plentiful that more than 225,000 pt. of the oil have been obtained in five weeks. The penguin-oil industry is by no means confined to Macquarie Island, but is carried on also in South America, especially off the Patagonian coast.

## BAMBOO GROVE PRESERVED IN ERECTING BUILDING

In order to preserve a clump of bamboo, which is believed to be the largest ever grown in America, a nursery com-

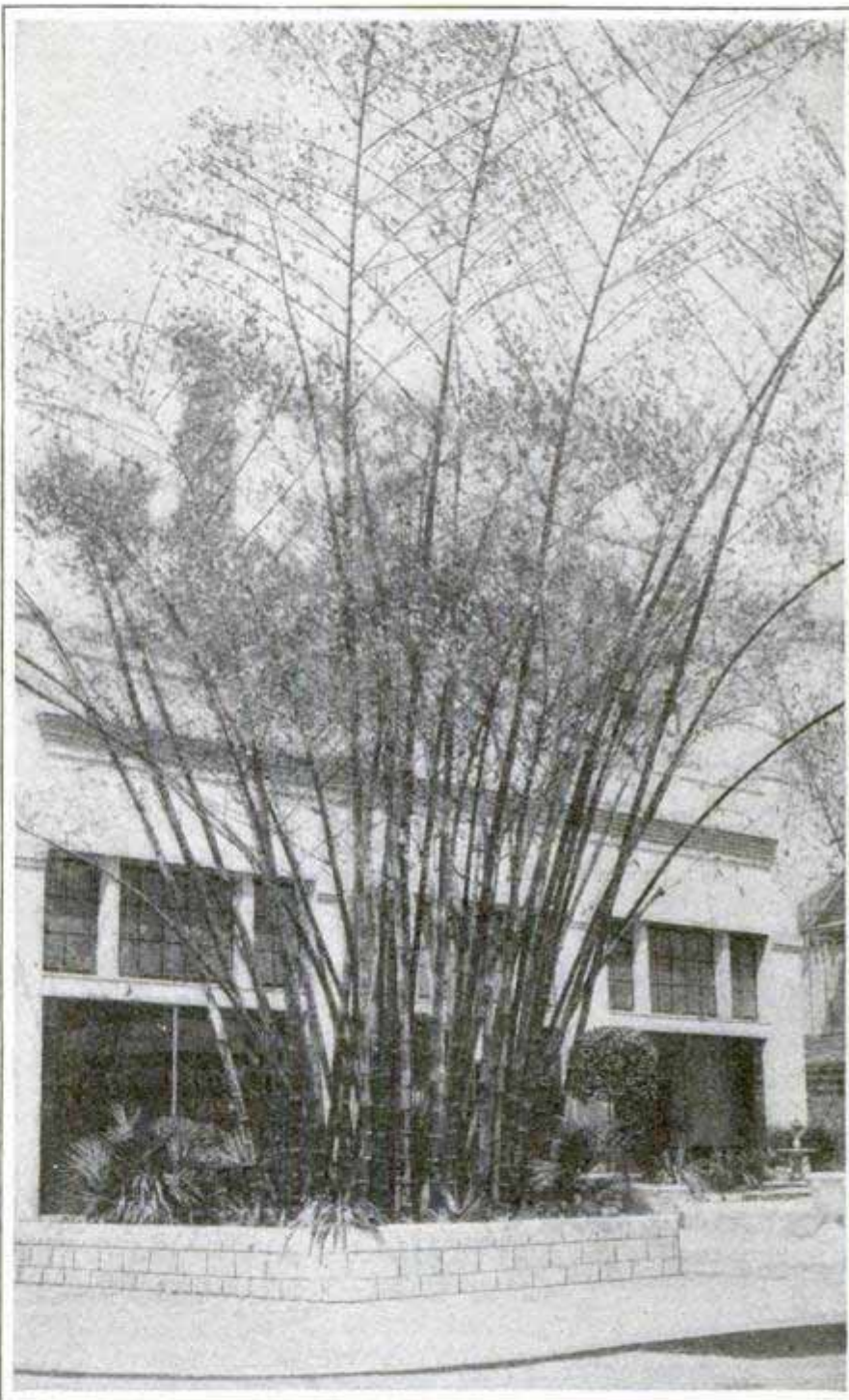

Nursery Building Set Back 10 Ft. from Street Line to Preserve Largest Bamboo Grove in America

pany in Los Angeles, Cal., set its new salesroom, which has just been completed, about 10 ft. back from the street line, thus sacrificing a considerable amount of valuable building space from esthetic motives.

## NEW COLLIERS FOR NAVY ARE HIGHLY EFFICIENT

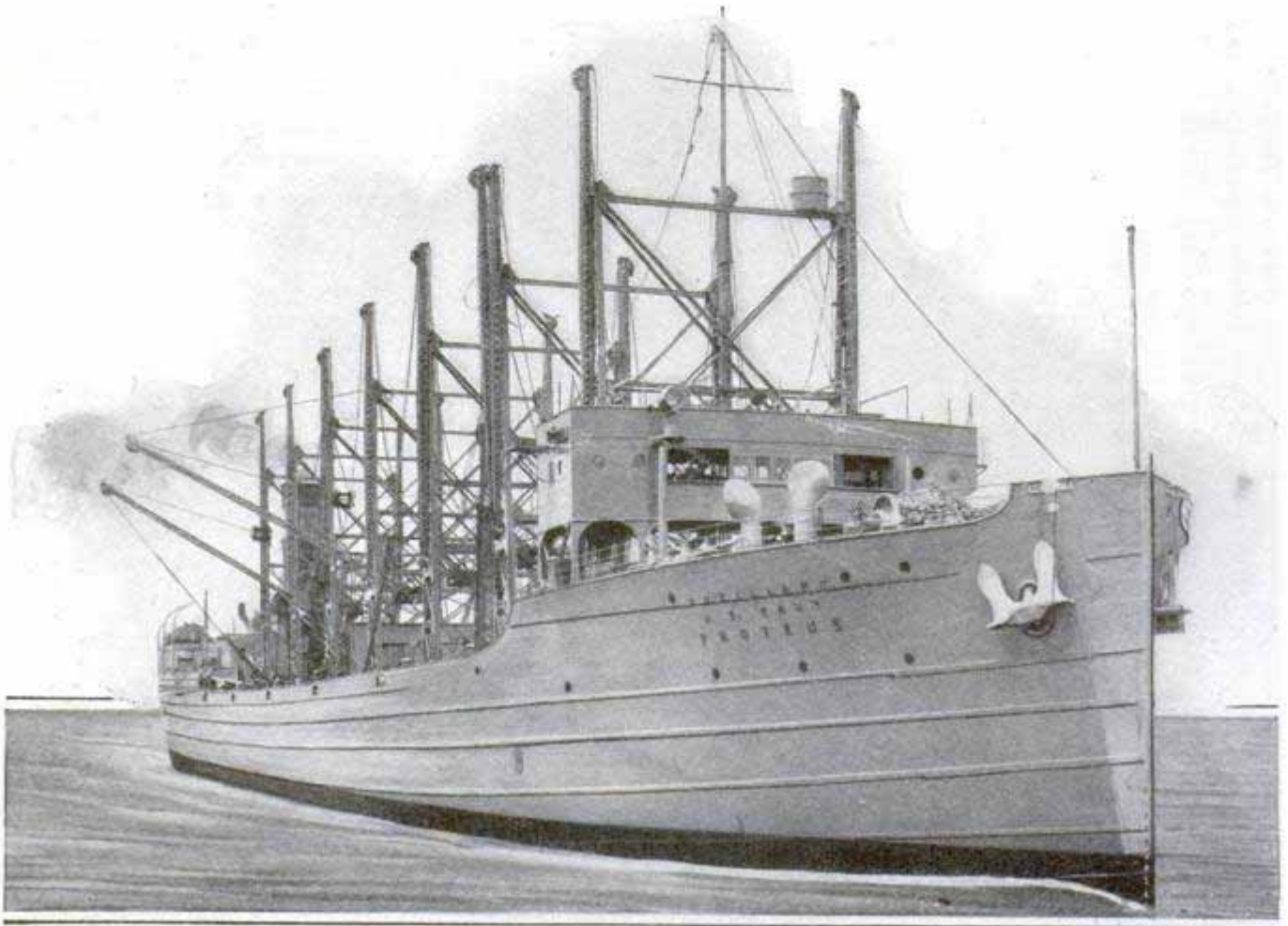

The "Proteus," Latest Type of Collier for the United States Navy

The twin colliers, "Proteus" and "Nereus," of the United States navy, which have just been put into commission, are designed to carry fuel for either coal or oil-burning vessels. These colliers have a cargo capacity of approximately 12,500 tons of coal or 900,000 gal. of fuel oil. In length they are 522 ft.; 62 ft. in breadth, and 40 ft. in depth of hold. They are driven by twin-screw reciprocating engines at a speed of 16 miles an hour, or more than 14 knots.

Each has 14 large hatches and 14 "marine transfers," which, if worked simultaneously, will discharge 1,680 tons of coal per hour. This capacity is sufficient to coal two battleships at once, giving each over 800 tons of coal per hour as long as they can receive it. Placing a collier between two heavy battleships at sea involves much risk, but it has been done, and in time of war probably will occur quite often.

The coaling may even be carried on without slackening speed.

The winches used in operating the clam-shell buckets are reversible and so simplified that one man with a pump handle in each hand and one foot brake operates two winches. In this way the 14 hatches require only 14 men to operate. The buckets carry about 1,600 lb. each, and when worked by an expert, can make the round trip from the hold of the collier to the battleship and back to the hold again in 17 seconds. Sometimes the coal is conveyed directly to the bunkers of the coaling vessel, and again it is landed on the deck and is thence carried to the bunkers through chutes or with hoppers, the shoveling and trimming being done by the crew of the vessel receiving the coal.

The United States navy now has a fleet of about 25 fuel ships, of which 12 or 14 might be classed with the "Pro-



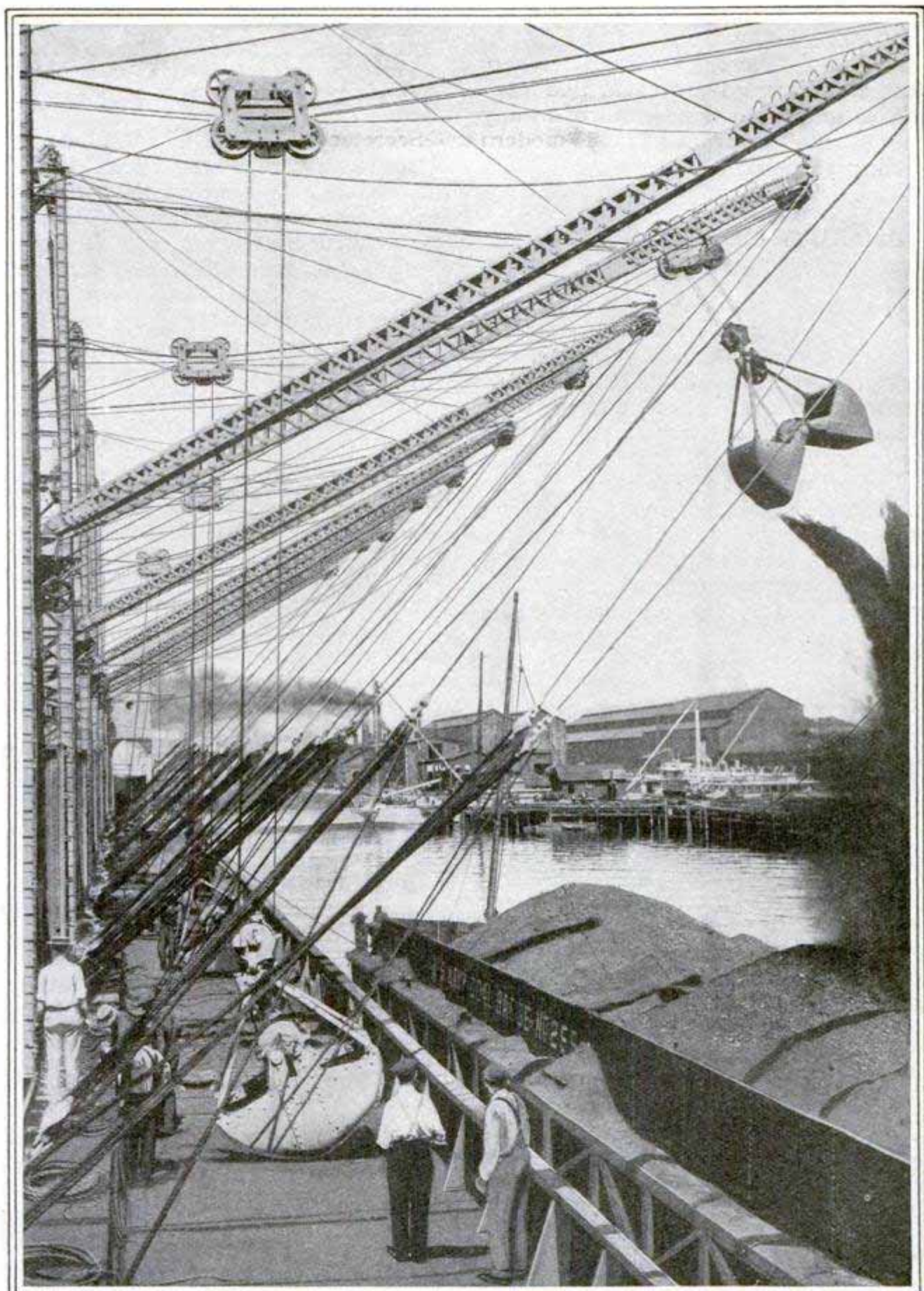

A View along the Deck of the "Proteus," Showing Operation of the Equipment for Coaling War Vessels

teus" and "Nereus." Such colliers cost a million dollars each, and each carries more coal than is stored at any one of the government's 11 modern coaling stations.

### AN AUTOMOBILE SCISSORS GRINDER

A portable machine shop made out of an old automobile travels the streets of New Orleans grinding knives and scissors. All that is left of the car is the front axle and wheels and the two-cylinder gasoline power plant. A third wheel supports the rear end of the sawed-off frame, and the car can attain considerable speed under its own power. Over the engine is a light worktable with a grindstone belted to a pulley on the engine flywheel. When work is scarce, the scissors grinder

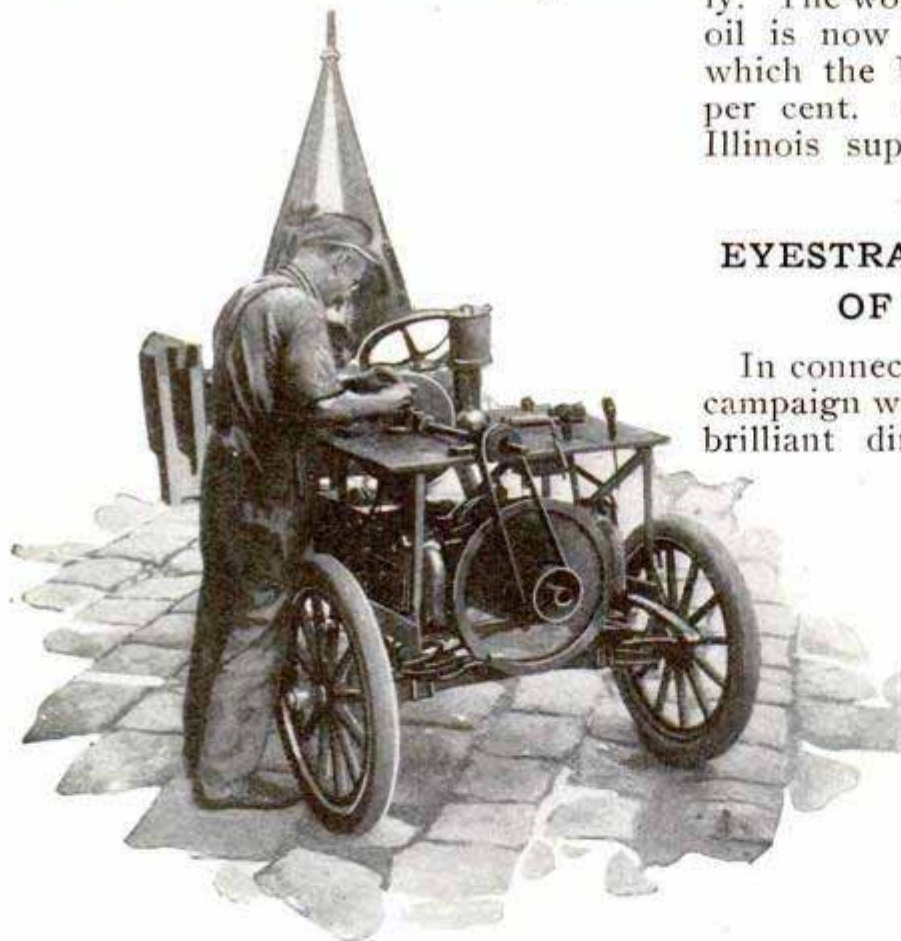

A Scissors Grinder's Traveling Machine Shop Made Out of an Old Automobile

takes pleasure rides in his three-wheeled machine shop with his 17-year-old daughter on the narrow seat beside him.

### SECRETARY OF NAVY SAYS OIL IS FUTURE FUEL

Secretary of the Navy Daniels declares in his annual report for 1913 that oil bids fair to become the principal fuel of the navy in the future. Already the United States employs it exclusively for torpedo-boat destroyers, and likewise has four battleships under construction which will be equipped with oil burners. Rear Admiral Griffen recommends that Congress empower the Navy Department to undertake immediately the refining of its own oil from oil wells driven on public lands. For, it is urged, as foreign navies are taking up the use of oil as fuel, it will not be long before the consumption for naval purposes alone, when all fleets are equipped, will exceed 25,000,000 tons of fuel oil annually. The world's annual supply of crude oil is now about 60,000,000 tons, of which the United States produces 60 per cent. California, Oklahoma and Illinois supply three-fourths of this.

### EYESTRAIN AND THE GLARE OF GLOSSY PAPER

In connection with the country-wide campaign which is being waged against brilliant direct-lighting systems and other kinds of troublesome glare, much study has been made of the glare and consequent eyestrain which results from the use of highly glazed paper in books and magazines. Some persons have gone so far as to recommend that no calendered or coated paper be used in any school books, since glossy paper reflects light rays directly without diffusing them, to save the eyes. The public and the printers, on the other hand, have been demanding more highly glazed paper on account of its richness and

fitness for half-tone work. To prove their point, the antiglare societies have printed a number of pamphlets on mat and even bond paper. While the half-tone work is not so good, beautiful results can be obtained with the offset process, and the higher cost of the paper is compensated for by its lightness. From rough-surfaced paper the study has been carried to tinted paper. Cream and pale-blue tints seem to involve less eyestrain than white paper, and if the tints are alternated throughout a book, each page brings a restful change to the eyes. The thickness of the paper and the presence of too much wood pulp has been considered, along with the question of size and legibility of type. The whole discussion has been brought about by the increase in eye trouble among school children; it is thought that the character of textbooks and copy books is as responsible as poor lighting systems. As a result, many books and magazines are now being printed on machine-finished paper.

### SWIMS THROUGH THE PANAMA CANAL

An American professional swimmer swam through 30 miles of the Panama Canal last November, covering this distance in a total swimming time of 16 hours and 35 min. It is estimated that a vessel will require 10 hours for passage through the 50 miles of the entire canal. The swimming feat required parts of two days for its completion. On the first day the 22-mile stretch from Gatun Locks through Gatun Lake to a point near the north end of Culebra Cut, where the swimmer was compelled to leave the water on account of weeds, was covered. Government regulations prohibit swimming in Culebra Cut north of the Cucaracha slide and, after resting a day, the swimmer started again at the south side of the slide and swam to Balboa, the Pacific end of the canal. On this stretch are the Pedro Miguel Lock, passed in 15 minutes, and the Miraflores Locks, where a rest of 35 minutes was taken.

### IDEALISTS ERECT SIGN IN NEW YORK

A star illuminated by electric lights in Madison Square Park, New York City, which shines every night in the

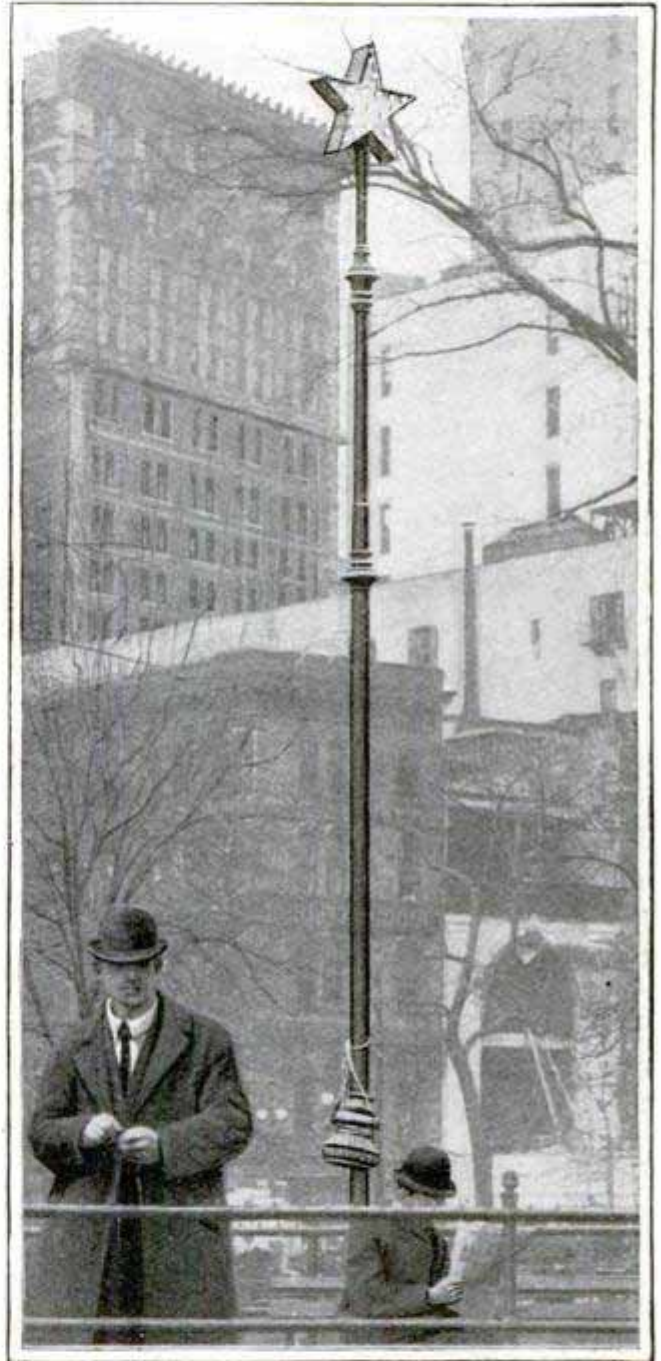

Photo by Paul Thompson

year except during Christmas week, has been erected by a group of idealists who were impressed by the Christmas tree covered with colored lights in the snow-covered square in 1912. When the tree was taken down the park seemed more gloomy than ever, and it was suggested that the tree be replaced by a star which should shine as an emblem of hope, peace, and good-

will throughout the year. During each Christmas week the great Christmas tree will shine forth its message with music, lights, and cheer.

### NEW BELT DESIGNED FOR USE OF AIRMEN

A new belt has been designed for the use of airmen, consisting of a wide piece of leather for the front, secured



Courtesy of The Sphere  
New Belt Holds Fast and Lets Go Quickly

by side straps and strong rubber cords to the back of the steering seat. These cords are very strongly made, but have enough elasticity to take off the shock of sudden stoppage. The airman may release himself quickly by pulling out one of the pins holding the side straps in place.

### NEW RADIUM PREPARATION MAKES METALS LUMINOUS

A German chemist has succeeded in producing a radium preparation making visible certain rays emitted by radium which hitherto have been incapable of being seen. This preparation can be fixed upon gold, silver, and even upon glass, wood, and silk, which thereupon become luminous in the dark, giving out green, red, violet or yellow light of varying tints. These colors, the inventor declares, will remain luminous for 20 years.

### MEASURING THE SOOT IN THE AIR

Birmingham is the "smoky city" of England, and an effort to eliminate this menace to health by the municipal authorities has led to experiments in determining the amount of smoke and dust in the atmosphere. A standard gauge has been installed having a surface area of four square feet, built on the principle of the rain gauge. Solid matter brought down by gravity or the rain passes through a duct into a glass receiver, the contents of which are removed monthly for examination and measurement.

### FRICITION DRIVE USES CONE FOR SPEED VARIATION

In a friction drive for motor cars recently brought out, the friction wheel works against a cone which is so mounted that its side is parallel to the shaft on which the friction wheel is carried. The wheel slides along the shaft and its position is controlled by a system of levers similar to those usually employed in friction drives. Variations in speed are secured by sliding the wheel to engage larger or smaller sections of the cone, as desired, while the reverse is obtained by sliding the wheel to a point beyond

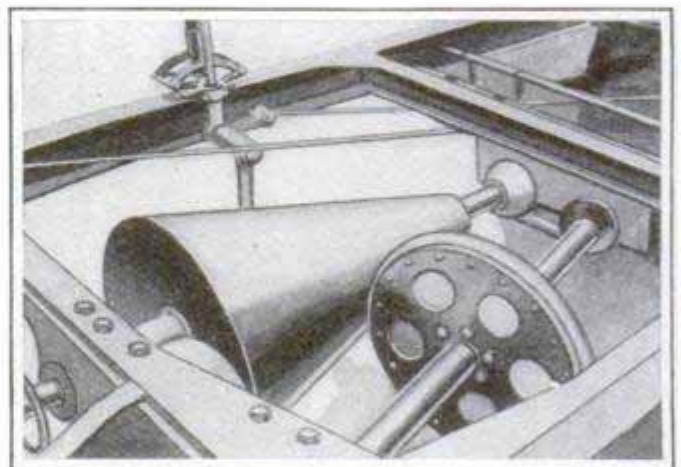

Variations in Speed Secured by Sliding Wheel to Engage Larger or Smaller Sections of Cone

the small end of the cone where it engages a smaller cone, which is geared to the shaft of the large cone and revolves in the opposite direction.

## KITCHEN SINK WITH WASTE RECEPTACLE

Clogging of drain pipes in the kitchen sink may be obviated by the use of a new design, in which a large de-

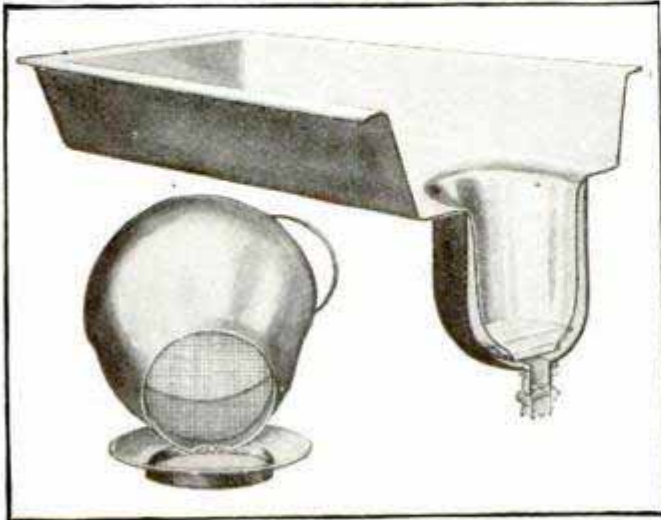

Removable Strainer Catches Grease and Dirt

pression at one end is fitted with a waste receptacle. It is only necessary to remove this strainer to enable the collection in it to be disposed of. The strainer is so made that it can be renewed as required, when worn out.

## FAMOUS PAINTING "MONA LISA" FOUND

Leonardo da Vinci's masterpiece, "Mona Lisa," for which a world-wide search has been made since its mysterious disappearance from the Louvre in Paris, in August, 1911, has been found in Florence, Italy, and is to be returned to the French nation. Both the theft and the recovery of the painting occurred under peculiar circumstances. The painting was stolen, according to the statement made by the Italian who took it and in whose possession it has been for the past two years, "to avenge the thefts which Napoleon I made in Italy," when priceless art treasures were carried away by the cart load. The famous painting had hung in the place of honor in the Louvre in a room which was supposed to be watched constantly, but so deftly was it taken that no clue of any

kind could be found and not even the exact time of its disappearance could be determined. The thief, who knew the Louvre and the habits of the attendants well, simply watched for his chance, took the painting to a space under a stairway where he removed and left the frame, concealed the treasure under his jacket and walked out of the Louvre unsuspected. After keeping it for two years he attempted to have it placed in some museum in Florence, and this led to its recovery. This painting is one of the finest products of the Italian renaissance and is probably the most valuable work of art in the world. It is said that an offer of \$5,000,000 made by the British government for it some years ago was refused by the French authorities.

## A DETACHABLE SIDEWALK LIGHT

Repairing broken sidewalk lights has always been a source of annoyance and expense, for the old glass must be broken out and the old cement setting removed before the damage can be repaired. Recently an invention has been brought out intended to obviate this difficulty. A Los Angeles inventor has constructed a device consisting of a metal shell provided with threads to be set into the cement and

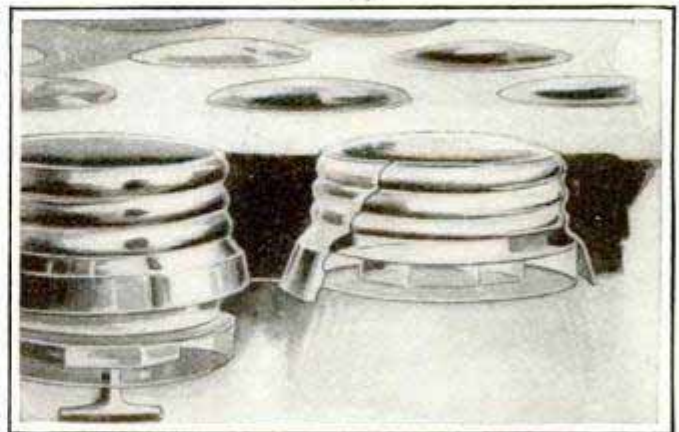

Removable Glass for Sidewalks

using glasses molded with threads to fit the shell. The glasses are screwed in or out from the under side by using a socket wrench.

## ODDS AND ENDS USED TO MAKE "FUTURIST" HOUSE

A so-called "futurist" house has recently been erected at Chester, Pa. "A modest attempt at originality in



Picturesque Effect in Which Old Plow Beam Plays an Important Part



The Most Striking Feature of This Post is the Old Stone Jug Set into One of the Corners

the building line," is the way it is referred to by the owner, who is confident that as good an effect "can be produced by anyone with a little taste in laying out the plan and a little boldness in putting together the material." This house is undoubtedly original in its make-up. From a distance it appears to be a substantial residence with handsome columns of stucco and flanked by walls of the same ornate material. But a nearer approach shows the columns and walls to be built up of a heterogeneous collection of odds and ends, and particularly of a miscellaneous assortment of building material that had become scattered

about the owner's premises during a lifetime in the contracting business. Old sewer pipe, cobblestones, odd bricks, paving stones, old bottles, stone jars, broken crockery, several demi-johns that happened to be empty, old stone doorsteps that were lying around and doing no good, and all kinds of building material, old and new, that

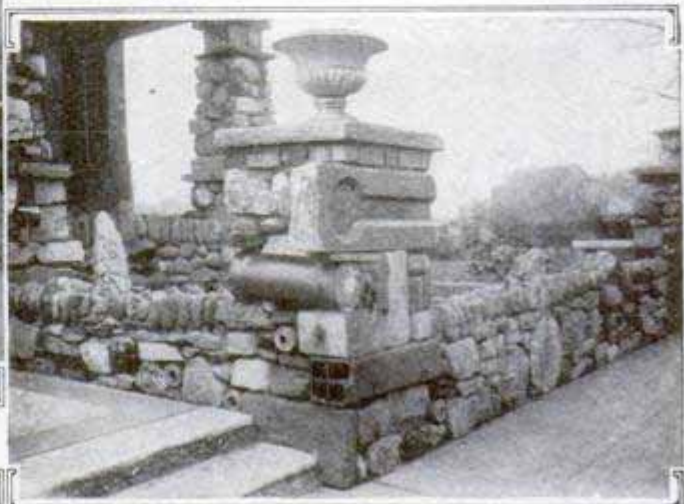

Effect Obtained by the Use of Old Drain Pipes, Paving Blocks, Cobblestones and a Cement Coping



The Front Porch of the "Futurist" House in the Building of Which "Junk" from a Contractor's Yard was Used

the owner had never found a use for, were used in the construction of the walls and columns, all this material being imbedded in a solid mass of concrete. One of the oddest features of the construction is an old plow beam which occupies a conspicuous place in the wall. A curious feature about it all is that, in spite of the amazing nature of the material, the effect from a distance is exceedingly pleasing. It is said that the owner is very proud of his creation and that this feeling of pride has been greatly increased by

the interest of the numerous visitors attracted to the place by this odd construction. Although the material cost the owner nothing, he estimates that a duplicate would cost about \$5,000.

### MONSTER PUMPKIN FEATURE OF INDIANA CORN SHOW

A striking feature of the second annual corn show and industrial exhibition at Terre Haute was a mammoth pumpkin, 18 ft. tall and 22 ft. in diameter, which stood at the intersection of two busy streets. Upon a wooden framework hundreds of pumpkins were fastened by a network of wires, and formed a golden globe which well represented the agricultural wealth of the Hoosier State. The curved stem is a piece of polished wood, and at night the pumpkin was illuminated by electric lights hung from supports attached to the framework.

### GROUP OF MUSEUMS FOR NEW YORK CITY

A group of 20 museums to be known as "The Museums of Peaceful Arts," and designed to become the greatest institution of the kind in the world, will be erected in New York City according to plans that are now practically completed. The cost of this magnificent group is estimated at about \$30,000,000, and the annual maintenance charge, at from \$2,000,000 to \$3,000,000. A site sufficient to meet the needs of the entire project is to be secured at the start, but the buildings will be erected one or two at a time, as required or as funds are available. Each museum is to be devoted to a specific branch of the peaceful arts, while there will be a central library containing books and periodicals relating to subjects covered by all the museums.

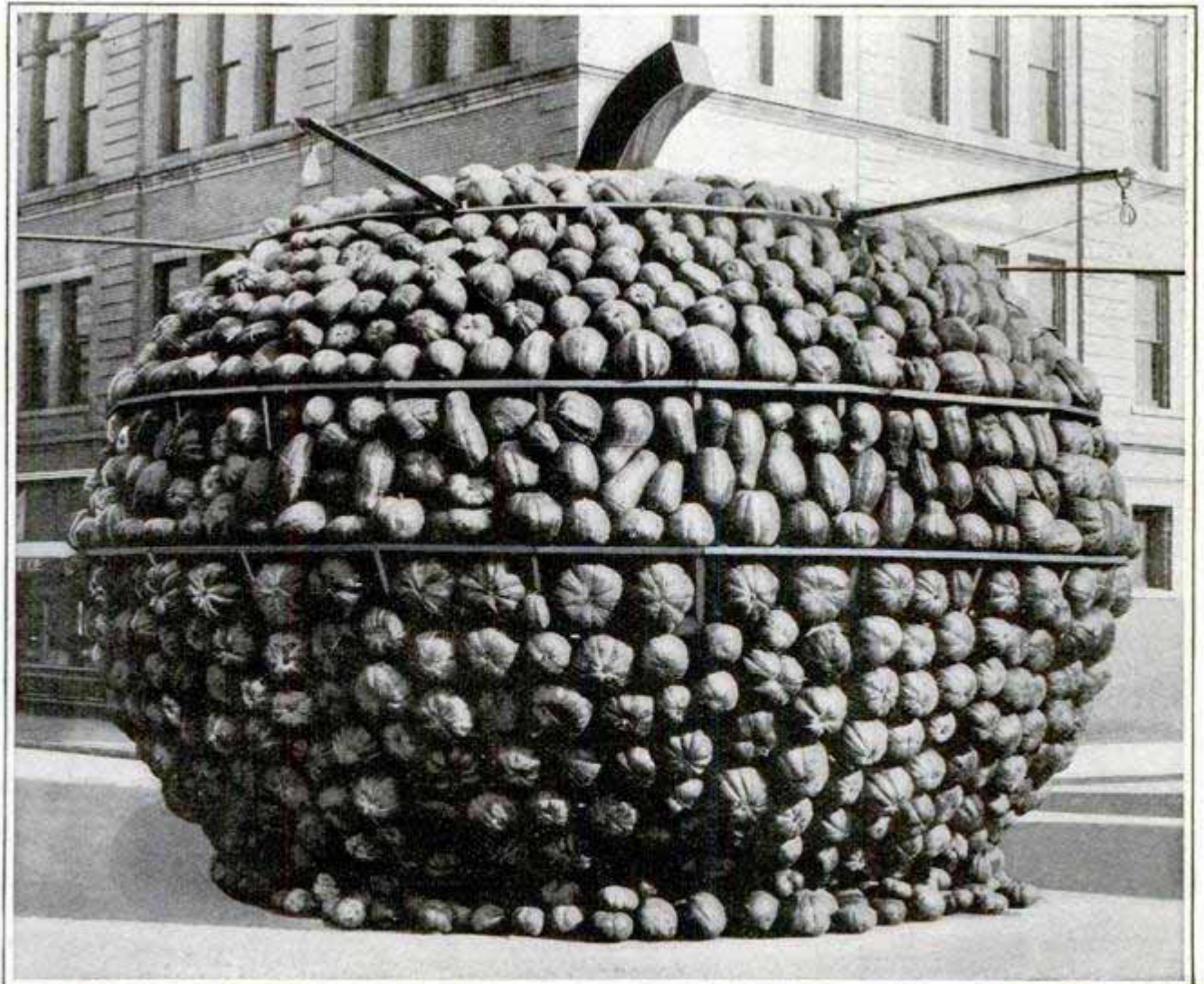

A Pumpkin Monument Exhibited in Indiana

### AUTOMATIC VENTILATING DEVICE

In order to economize in the use of power required for operating the ventilating system, an automatic controlling apparatus has been installed at a Michigan college, where, as in most colleges, many of the recitation rooms are in use only part of the time. With this apparatus the fans driving the fresh air into a room are stopped automatically with the ringing of the bell at the end of the recitation period, and are started again when the instructor turns on the current as the next class enters the room. Thus the maximum load the fan must carry is generally lessened and the average load considerably reduced.

### BRICK-LINED STEEL CHIMNEY 400 FEET HIGH

What is said to be the tallest steel smokestack is being constructed at Jerome, Ariz., reaching upward from the top of the foundation 400 ft. 1 in. It is lined with brick to prevent the flue gases from attacking the steel, and provides the connections for three flues. The chimney is 30 ft. in diameter inside the brick lining, and 30 ft. 9½ in. inside the steel shell. The lining brick is supported on the legs of circular steel angles riveted to the inside of the shell, spaced 15 ft. apart. In this way any section of the lining can be replaced without disturbing other sections. The bell-shaped top is 50 ft. in diameter.

---

## ARTISTIC CONCRETE PILLARS FOR BUNGALOWS

By ALBERT MARPLE

One of the latest improvements to modern bungalows in southern California is the artistic concrete pillar. Up to a comparatively recent date it seemed to be the idea that the pillar should be constructed at the front of the home simply because it was the usual thing, but a short time ago the possibility of beautifying the pillar as well as other parts of the bungalow was realized, and as a result the architects of that section have, during the past few months, been devoting much of their time to creating new designs and ideas for the beautifying of these pillars.

Possibly the latest feature is the flower-holder idea. This consists of an opening or inclosure in the sides of the pillar exposed to the street, suitable for the insertion of potted flowers or ferns of various kinds. These openings are of various sizes and designs and are constructed at from 1 to 5 ft. from the ground. This idea is being widely copied.

Another feature is the raised or indented figures on the sides of the pillars. In one instance these figures

stand out from the pillar for a distance of from 1 to 2 in., while in the other they are indented into the pillars for a similar distance. These figures are made in a variety of shapes and serve to break the plain side of the pillar. They are a decided improvement.

The beam flower stand is another attractive feature. This consists of the beam which serves as the railing for the porch being run through the pillar and out the other side a distance of 6 or 8 in. Upon this little projection the flowerpot is placed. The appearance of the bungalow in general has been greatly enhanced by the beautifying of these pillars.

The adaptability of concrete commends it for decorative treatment and the ease with which it may be applied, even after the completion of the bungalow, makes it possible to secure extremely artistic effects. A wide range of color, through mixing varied tints with the concrete, may enhance the esthetic value of the ornamental pillars, harmonizing perfectly with natural hues of landscape, or striking contrasts accentuate the design.



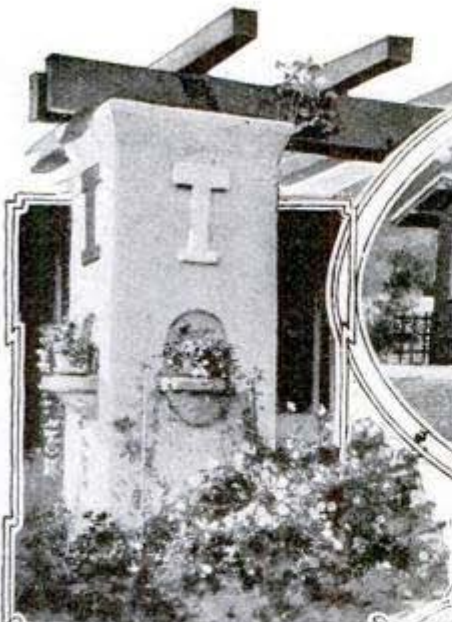

Flower Holder  
in Side of Pillar



Beam  
Projections  
Used as  
Flower  
Stands

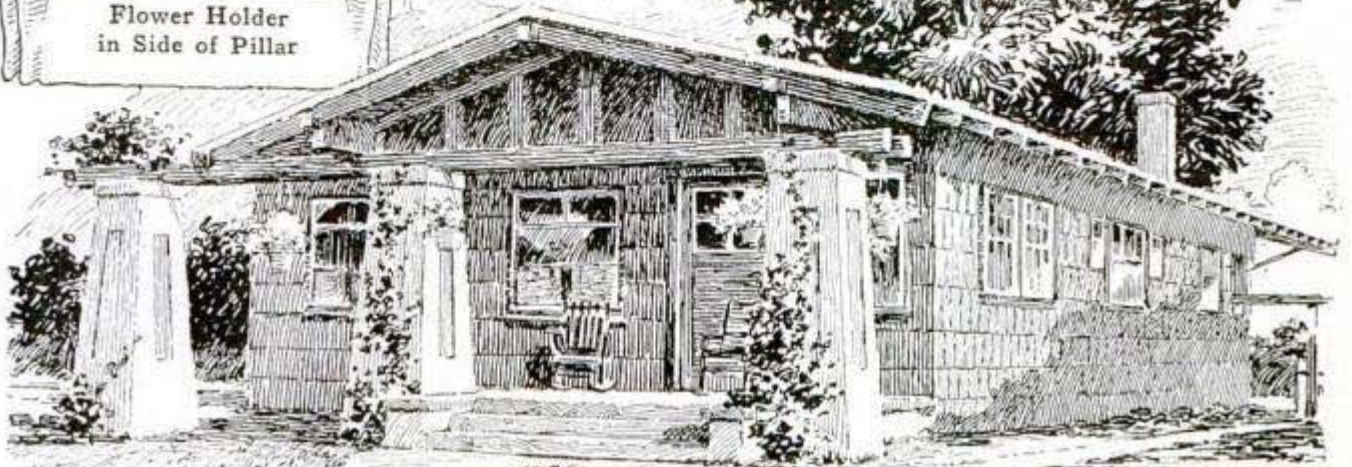

Pillars Ornamented with Vines  
and Flowers



Raised Figures Give  
Individuality to Pillars



Use of Half-Pillar Relieves  
Heavy Corner Pillars

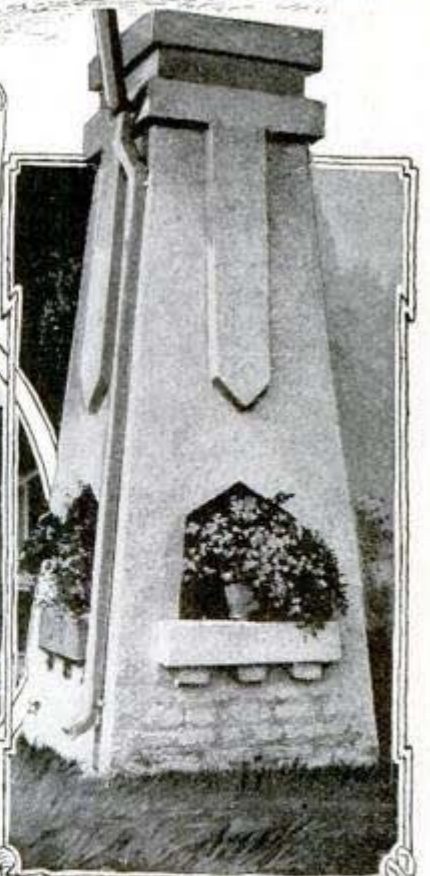

Recessed Flower Stands  
in Concrete Pillar

## HOW COUNTERFEITS ARE DETECTED

The hand is quicker than the eye in detecting fraudulent bank notes. The "feel" of the distinctive paper used by the government is the first warning signal that the money tendered is bad. This paper is distinctive not alone because of the introduction of silk fiber in the bill itself, but because of the treatment the stock receives in printing. The silk threads are sometimes imitated by pen and ink lines, but these do not bear close examination. The engraving has been the greatest protection, for even photo-engraving fails to bring out the proper color values, and retouching by the graving tool makes the lines heavy and irregular. Photography also fails in reproducing the color of the seal, which must be washed in with water colors, the black lines of the engraving showing through in counterfeits. The most dangerous counterfeit is that in which a genuine bill of lower denomination is bleached out and a false plate showing a high denomination placed upon it. Here is a genuine bank bill. It has the "feel." The silk threads are present. If the engraving is fairly well done and the color of approximate correctness, it becomes a dangerous counterfeit, and bankers are at once warned to be on the watch for it. In this connection the "check letter" often comes into play. All government notes are printed of one denomination, four on a sheet, and are lettered respectively, A, B, C, and D. Each note bears a treasury number. If, when that number is divided by four there remains one, the check letter should be A; if two remains, the letter should be B; if three, then C, and if there is no remainder, D. If the result shows otherwise then the numbering is wrong and the note is a counterfeit. All denominations from \$1 to \$1,000 have been counterfeited, as well as all our coins. The most usual method of defrauding when gold coins are handled is to saw the coins in half, extract the interior and fill with base metal.

## WIRELESS FOILS VANITY OF AFRICAN NATIVES

Inhabitants of Darkest Africa who delighted in decking themselves out in bracelets of wire proved a constant menace to the proper operation of the telegraph because they simply could not let the wires alone. They repeatedly cut down the lines and carried away the wire to make ornaments of various kinds for their persons. Several large mining concerns have been obliged to install wireless telegraph communication between the railroad stations and their mines for this reason.

## RAILROAD TO RUN LUNCH- COUNTER CARS

In placing a lunch-counter car in service on two of its fast trains between Philadelphia and New York, a leading eastern railroad has made an interesting innovation in passenger-train service. This car is now being run on trains that also carry standard dining cars. It is to be conducted on exactly the same lines as a lunch room in a big city, with the same quickness of service and the same informality. If the car proves as popular as anticipated, the service is to be extended to include all trains on this system where dining facilities are required.

The new car is 80 ft. long and has the same exterior appearance as an all-steel passenger coach, but the interior is radically different from that of a standard dining car. Instead of tables there is one long mahogany counter extending over half the length of the car and providing room for 21 people, and facing this counter, on one side, are revolving mahogany chairs secured to the floor. Back of the counter against the wall is a row of cupboards for supplies, while shelves for linen and silver occupy the space under the counter. The pantry and kitchen, the latter 11 ft. long, are at the end of the car. The car is lighted by electricity and is ventilated by an electrically operated exhaust fan.

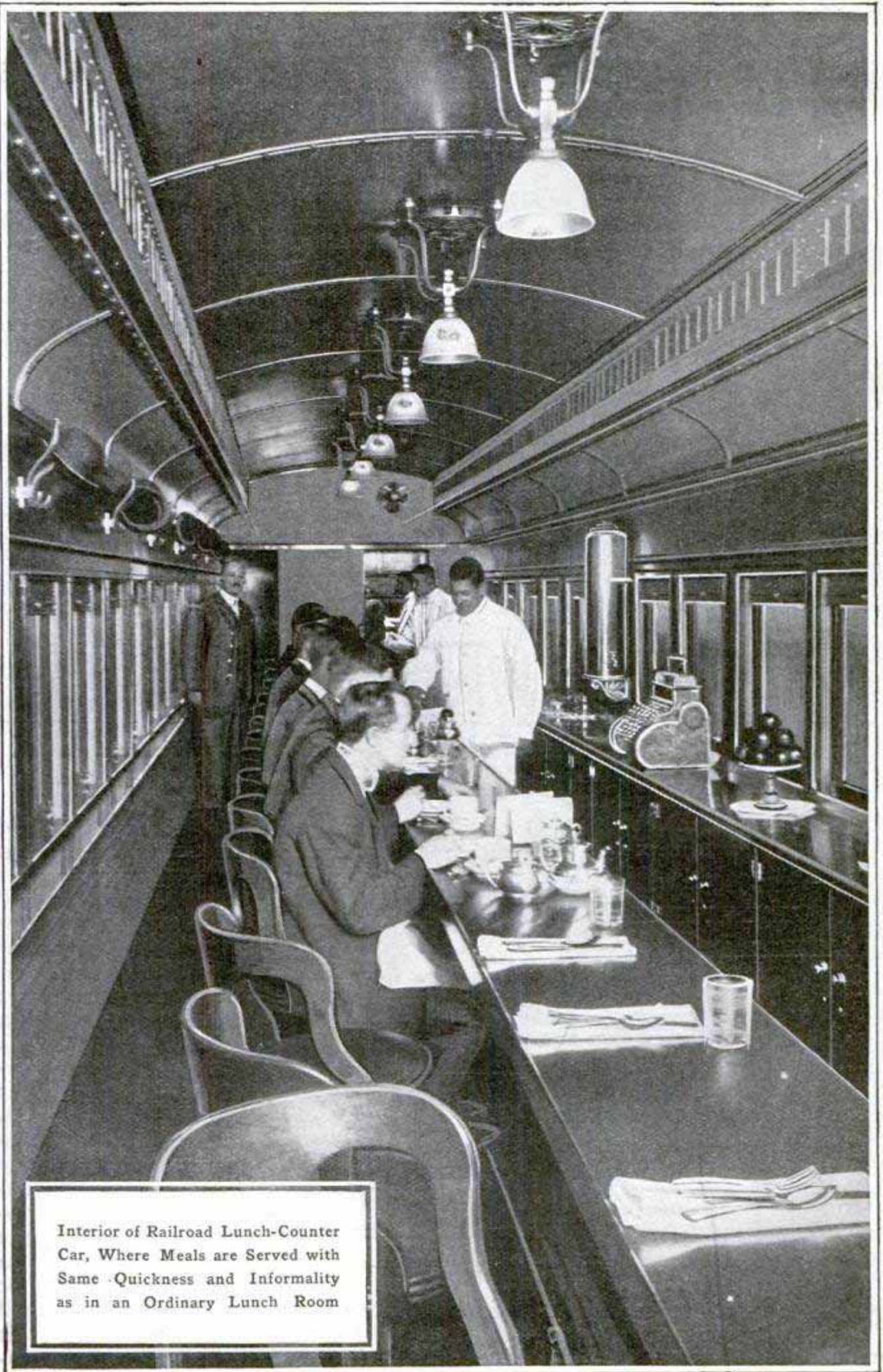

Interior of Railroad Lunch-Counter Car, Where Meals are Served with Same Quickness and Informality as in an Ordinary Lunch Room

## STONE QUARRY MADE INTO LANDSCAPE FEATURE



An Abandoned Stone Quarry Filled with Water to Make an Artificial Lake is the Central Feature of the Landscape Architecture That Makes This Marion, O., Residence One of the Most Attractive in America

An abandoned stone quarry, located in the middle of an otherwise desirable

beautiful garden. This garden is a good example of the modern tendency in

landscape art to accept conditions as they are and either to transform undesirable features into parts of the design or, if the feature is hopeless, mask it in such a way that it does not spoil the composition. In the early days of landscape art in America, this stone quarry, which now gives point and meaning to an artistic composition, would have been filled, or the idea of using the plot for

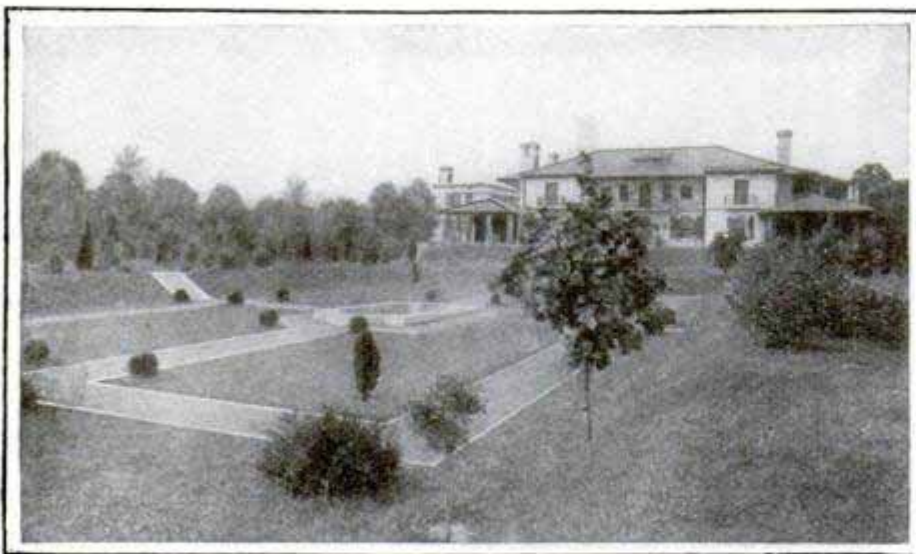

View of Residence from Northwest, Showing Mount Vernon Avenue Gateway at Left

tract of land in the outskirts of Marion, Ohio, was made into a picturesque lake with rock-ledge shores, and now forms the central feature in an unusually

residence and garden purposes would have been abandoned entirely. It is said that the inspiration for this treatment came from the gardens of Mexico.

The tract of land occupies the 266-ft. space between Bradford and Greenwood Streets and is about 700 ft. long, north and south, being bounded on the north by Mt. Vernon Avenue, an important thoroughfare running northwest and southeast. The house is located near the north end of the tract and is provided with a porte-cochère which communicates by walks and driveways with the streets on the east and west, and with an ornamental gateway opening on Mt. Vernon Avenue. Back of the house is a sunken garden and successive terraces leading down to the lake, which extends in an east-and-west direction across the tract, while beyond the lake, closing the view at the south, is a summer house flanked on each side by a pergola. The lake extends eastward into other grounds, which have also been developed into gardens, a succession of abandoned stone quarries having been made into one continuous lake suitable for pleasure boating.

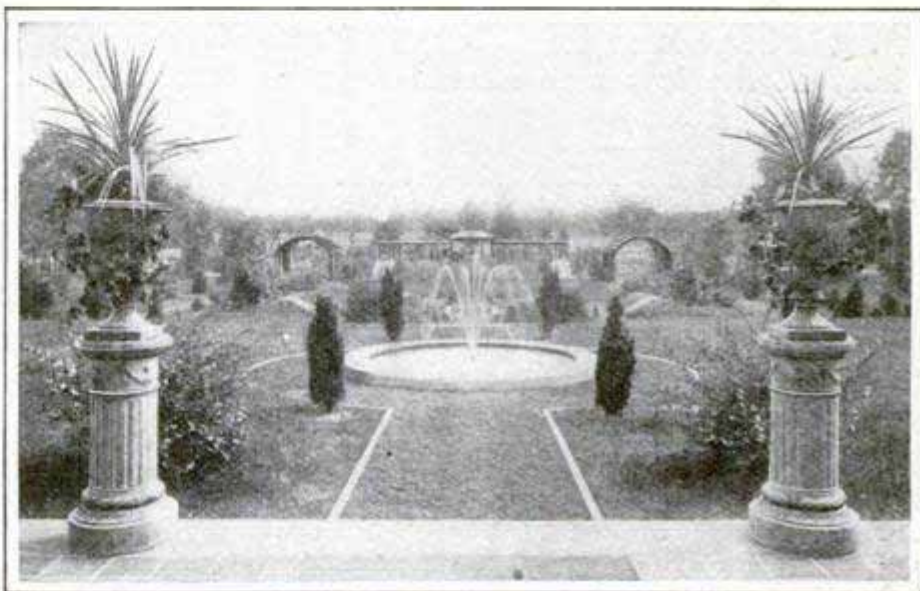

View of Garden from South Veranda of Residence

at 8 ft., the velocity was 30 per cent greater, and at 13 ft., was 37 per cent greater. Owing to the increased velocity of the air the disturbance can be felt at a greater distance and over a much larger area.

### MULTIBLADE FAN GIVES LARGE AIR CURRENT

The study of aeronautics has evolved a novel form of fan, having several blades superimposed and giving an increased efficiency by obviating eddy currents. It is claimed that a larger volume of air can be moved with smaller current consumption by the use of a multibladed fan than by the ordinary type, for while the total air surface of each group is larger than that of a single blade, there is less resistance and the air moves freely through the chan-

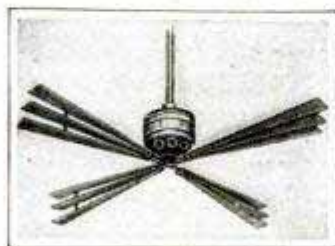

### ELECTRICITY FOR COOKING FOSTERED BY CITIES

A rate of two cents per kilowatt-hour for electricity used in cooking and heating has been authorized by the municipally owned electric-light plant in Jacksonville, Fla., in an attempt to solve the problem of increasing the day load on the equipment. At this rate it is estimated that the cost of cooking one person's food with modern electric-cooking devices should not exceed 40 cents a month. In Kansas City, Kan., a rate of three cents per kilowatt-hour, which is just half the regular lighting rate, has been made for cooking and heating, and, in addition, the authorities will distribute electric cookers among the patrons of the municipal

lighting plant, to be used for a time at the city's expense. An electric-power company, using the deposits of lignite or brown coal at Bitterfeld, Germany, 83 miles south of Berlin, is producing electricity so cheaply that even the poorest families may use the current for lighting in place of kerosene. Its use for cooking and heating in Saxony is said to be assured, for no kind of fuel will be able to compete with electricity at the low rate offered by the company.

### DESTROYING WRECK WHICH MENACED COMMERCE

When the steamer "Ulstermore" ran aground in Crosby Channel, an estuary of the Mersey River, last winter, she was buffeted against a rocky ledge and broke in two. A portion of the damaged steamer remained above the water and became a danger to traffic, and it was decided to remove the wreck with dynamite. The steamer was of 6,400 tons burden, and to clear away the wreck, a large charge and careful

placing was necessary. The explosion under the remains of the vessel was sufficient, however, to remove the derelict and completely clear the channel.

### LARGE COAL DEPOSITS FOUND IN SPITZBERGEN

Spitzbergen, an island in the Arctic Ocean, gives promise of becoming an important coal-producing center as the result of mining operations carried on by an American company which shipped about 35,000 tons of coal to American ports during the year 1913. The limited operations already carried out by this company indicate deposits aggregating over 60,000,000 tons. The mines now being worked

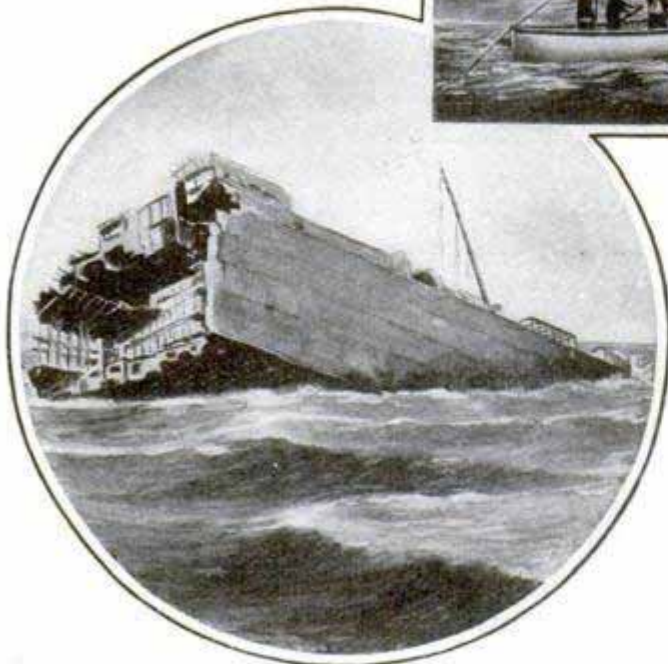
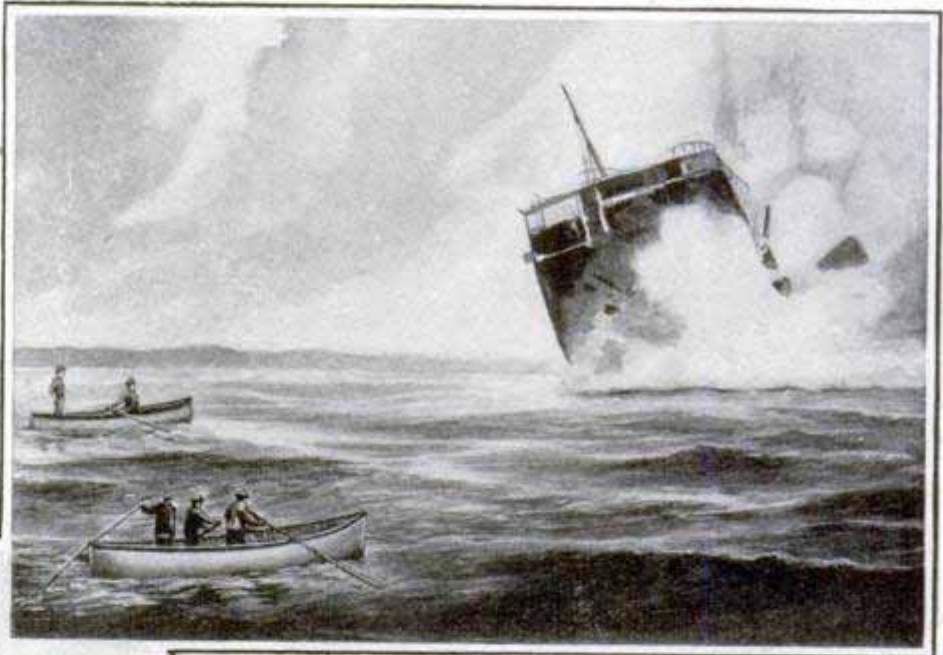

Wreck of the "Ulstermore" Removed from Channel  
by Dynamite

give employment to 250 or 300 men, and, although the shipping season only lasts about three months, the mines are operated continuously throughout the year. The beds are unusually uniform, being about 3½ ft. thick. The mining problem is therefore simple, but the question of ownership of the coal fields is one that is expected to lead to complications, as the sovereignty of this island has never been definitely determined. Title to the coal fields was acquired by the American company from a Norwegian company that claimed title by right of exploration.

## HOMEMADE TRAILER FOR MOTOR FIRE ENGINE

The fire department of Evanston, Ill., has demonstrated that old horse-drawn chemical engines need not be relegated to the scrap heap with the introduction of modern motor-driven equipment. Cutting off the wagon tongue of the old engine they converted it into a trailer which they attach to the motor-driven engine, and find it a very effective combination. In many cases the chemical equipment is all that is needed to put out the fire, but if the blaze shows signs of getting too hot for the chemical, the pin is withdrawn and the motor engine proceeds to the hydrant, paying out a hose as it goes, and is ready when needed. The new engine is a combination pump and hose cart, and the old chemical makes an effective

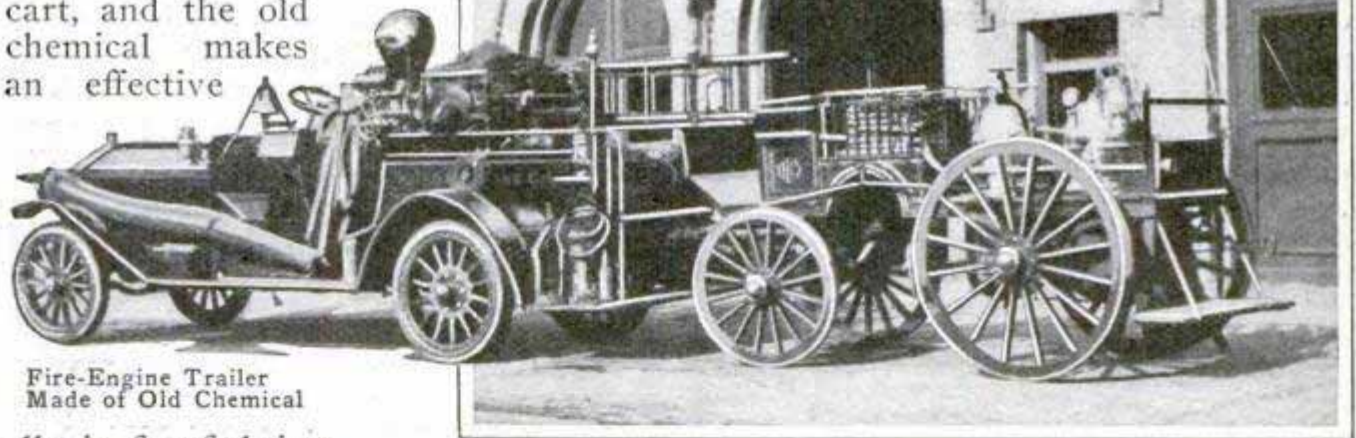

Fire-Engine Trailer  
Made of Old Chemical

ally in fire fighting.

## AMEER OF AFGHANISTAN HAS FIFTY-EIGHT MOTORS

His Majesty, Habibullah Khan, Ameer of Afghanistan, whose official title proclaims him "Light of the Nation and of the Faith," rules over a hermit kingdom twice as populous as Thibet, though scarcely a quarter as large. It is a forbidden land, foreigners being rigidly excluded, or admitted only under almost impossible conditions, and out of a population of over 5,000,000 only six Europeans and two Americans are to be found resident.

The Ameer is a progressive potentate, however, and his palace at Kabul shows the influence of western civilization. In the royal garage are 58 automobiles of various makes, but the Ameer is not restricted in his choice of transportation mediums, as 50 elephants are kept in the royal herd and four gorgeous state carriages presented by Queen Victoria are sometimes used. It is as virtual purchasing agent for the kingdom that the Ameer is unique among sovereigns. While there is but one newspaper published in Afghanistan, the court journal, he is an assiduous reader of foreign catalogs, buying free-

ly anything that strikes his fancy, for the use of the members of his household or for the army. He is guided largely by the illustrations in making his choice, and when he decides he wants anything, he is insistent that delivery be made in the shortest possible time. As royal orders are invariably cash in advance, through a custom established and enforced by thrifty foreign houses, shippers hasten to oblige. Photography is one of his favorite pursuits, and he is an adept at enlargements. Golf, polo, and cricket are popular among the court set, who have adopted European dress except that the turban is universally worn.

## CONCRETE GATEPOSTS FOR FARM FENCES

A pair of concrete gateposts of the type that is used for all the main gates on an 880-acre farm near Hughesville,

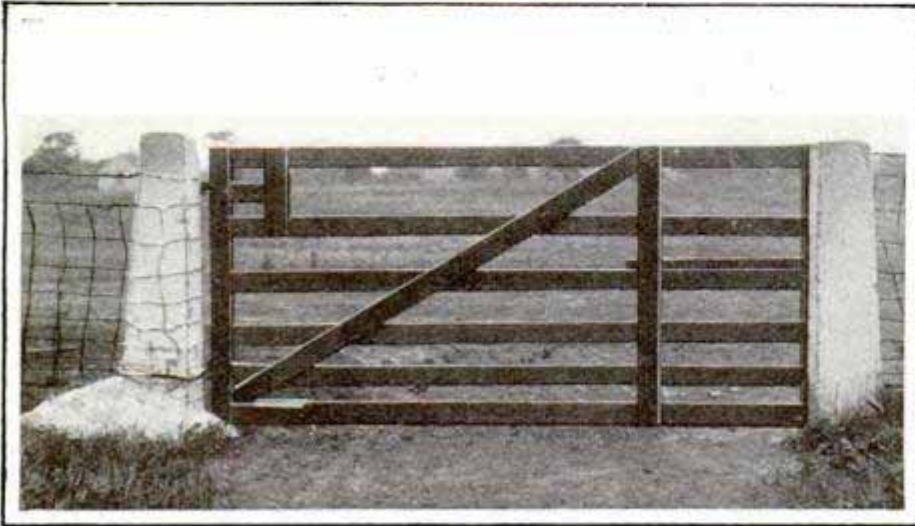

These Concrete Gateposts Keep the Gate from Sagging

Mo., is shown in the accompanying photograph. The additional amount of concrete at the base of the hinge post makes the post steady and keeps the gate from sagging. The latch post, which is not subjected to any strain, does not need the extra concrete base to brace it.

## PLOW AND SILO TO REDEEM FARMS IN INDIA

An American plow driven by a missionary near Allahabad, India, is revolutionizing methods of the farming community thereabouts. It had been the custom for centuries to root out the stubble of previous harvests before plowing the soil for the new crop. This impoverished the soil and added greatly to the labor. An American missionary showed the value of the stubble by plowing it under, an operation easy to accomplish with the heavy American plow. At first he used four draft cattle to pull it, but after building a silo pit he was able to fatten and strengthen his cattle so that only two are required now. These and other experiments are being followed by neighboring farmers with satisfactory results.

## THE PERMANENT BUILDINGS AT PANAMA

To conform with the tropical climate and topography of Panama, the permanent canal buildings have been designed in Italian style, with arcades or exterior colonnades and arched windows. They are to be built of reinforced concrete or hollow concrete blocks, with stucco on the outside and red tile roofs. Fourteen different architectural projects, including the new administration building, the permanent quarters for the white members of the operating staff, the Balboa terminal office buildings, the projection of town sites, and the hydroelectric station and three lock-control houses at Gatun, are now in the draftsmen's hands. The new town buildings for Balboa, which are being designed, comprise a post-office, police station, fire station, dispensary, telephone building, clubhouse, hotel, social hall, church, commissary store, and schoolhouse. Landscape architects are working on parks, streets, and town sites.

## BRICK MADE OF PEAT USED AS WOOD SUBSTITUTE

In Sweden small buildings are being erected of brick made of peat. The brick are either plastered in between cement supports, or are laid in plaster as ordinary building brick made of clay. These peat bricks are being used as a substitute for wood in the construction of buildings of no great size. The process of manufacturing the peat bricks has been patented.

ⒸAbout 56,000,000,000 cu. ft. of gas was produced in Ohio in 1912. Practically all of this, with 65,000,000,000 cu. ft. piped in from West Virginia, was used in the state.



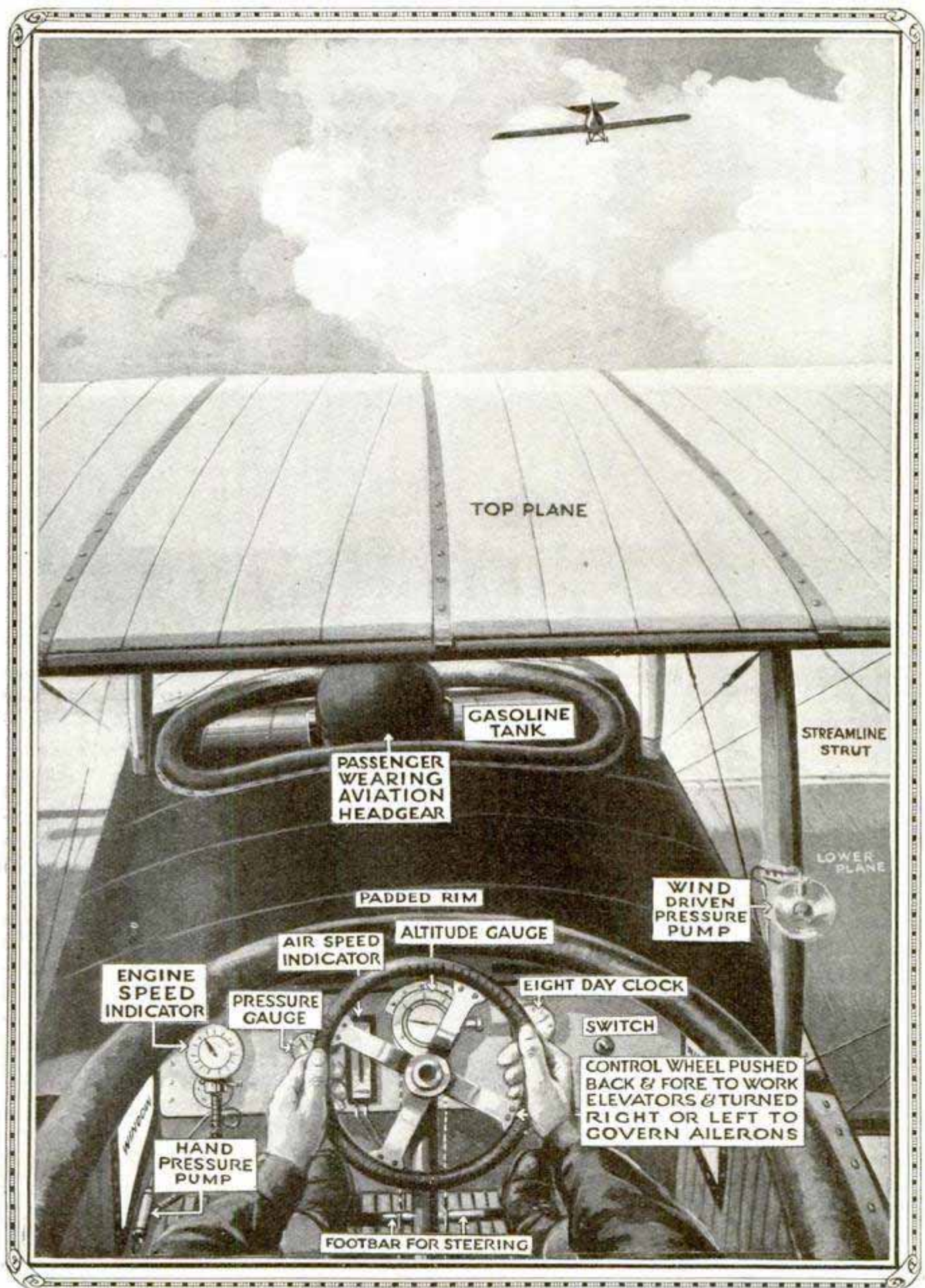

This Shows How an Airman Steers a Biplane. The Pilot is Holding the Wheel, the Passenger Seated in Front. The Wheel is Mounted on a Jointed Pillar. Turning It to Right or Left Controls the Ailerons, by Which the Craft is Balanced. By Pulling the Wheel Toward Him or Pushing It Away, the Pilot Governs the Elevating Planes, Which Control the Rise or Descent. The Footbar Controls the Vertical Rudder, for Turning to Right or Left. Various Instruments Indicate Engine Speed, Altitude, Direction and Pressure in the Tanks, as Well as the Time of Day

## LOUD-SPEAKING TELEPHONE FOR AIRMEN

The difficulty of hearing ordinary conversation above the roar of the motor and the whir of the propeller



Device Makes Conversation Easy Aloft

makes communication between the airman and his passenger or mechanic extremely arduous if not impossible, and a remedy is sought in a telephone with microphone attachment. The speaking device is placed directly against the mouth, and is supported by a curved metal shaft which is of one piece with the receiver, and is held in place by attachment to the helmet. Thus equipped, conversation is easy, and undivided attention may be given to handling the machine. A storage battery furnishes the electric current.

## SHAVING MIRROR WITH ELECTRIC LIGHT

A French novelty of interest to men who shave themselves is shown in the illustration herewith. It is an adjustable mirror, at the lower edge of which an electric light is inset. The lamp is so placed that it does not throw a glare into the eyes, but illuminates the face perfectly. The device may also be used to light up the interior of the mouth and upper throat. It may be placed on any convenient surface or suspended from a hook on the wall.

## OIL WELLS CLOGGED BY PARAFFIN DEPOSITS

After the initial spurt of an oil well, which is due to the sudden relief of pressure under which the gas and oil are confined and which often lasts for a considerable time, an ordinary well settles down to a period of fairly regular production, and this period is followed eventually by a steady decline. That this decline is caused in many wells not by the exhaustion of the supply, but by the clogging up of the pores of the sand so that the passage of the oil into the well is obstructed, is the explanation recently ad-

vanced by the Bureau of Mines. In some oil fields the petroleum consists of hydrocarbons which range from the heaviest oils to the lightest gas, the gas being held in the liquid in much the same manner that the gas is held in a bottle of soda water. The expansion and volatilization of these gases as the petroleum flows into the well has a refrigerating effect exactly like that of the expansion of ammonia in a refrigerating machine. Although this refrigerating process is slow, it is sufficient to chill the liquid petroleum and to cause the heaviest paraffin to be deposited as a sediment, and this results gradually in clogging the sand in the vicinity of the well.



Mirror Lights the Face While Shaving

## RURAL FIRE DEPARTMENTS USE MOTORCYCLES

To reach a fire before it has had time to get a good start is the ideal of all fire departments, and in rural communities especially the need of getting to the blaze while it is still incipient is great. The motorcycle offers to the rural fire fighters quick service over any roads, even where only

carrying two chemical fire extinguishers, a fireman's ax, a small reel

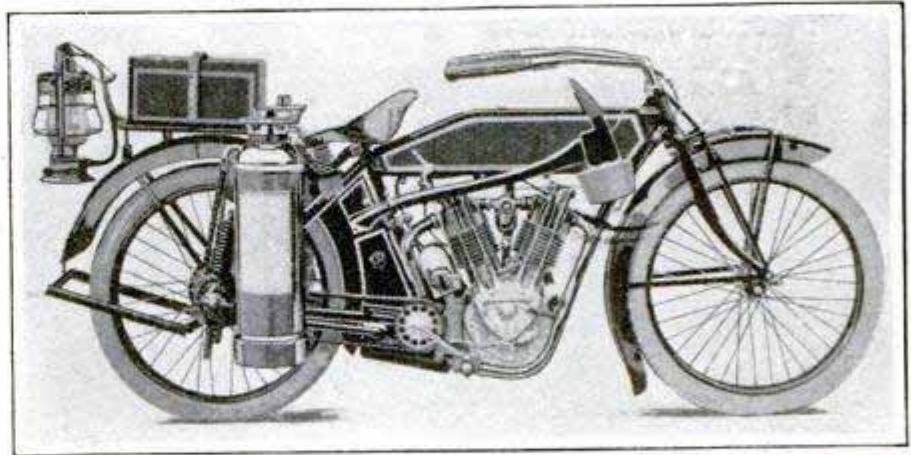

An American Motorcycle Equipped for Fire Service

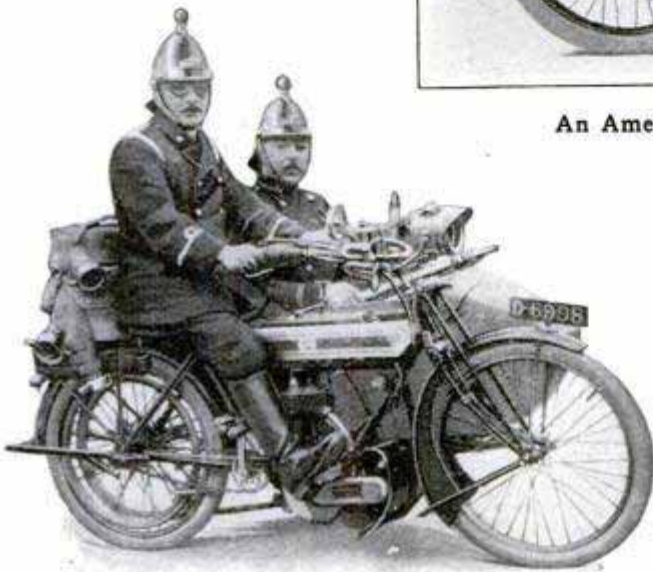

Used in the Fire Department of Sandwich, England

winding paths through woods or across fields lead to the burning building. At the Chicago Motorcycle Show a fully equipped machine was exhibited



An English Rural Fire Brigade of Four That Travels in a Sidecar

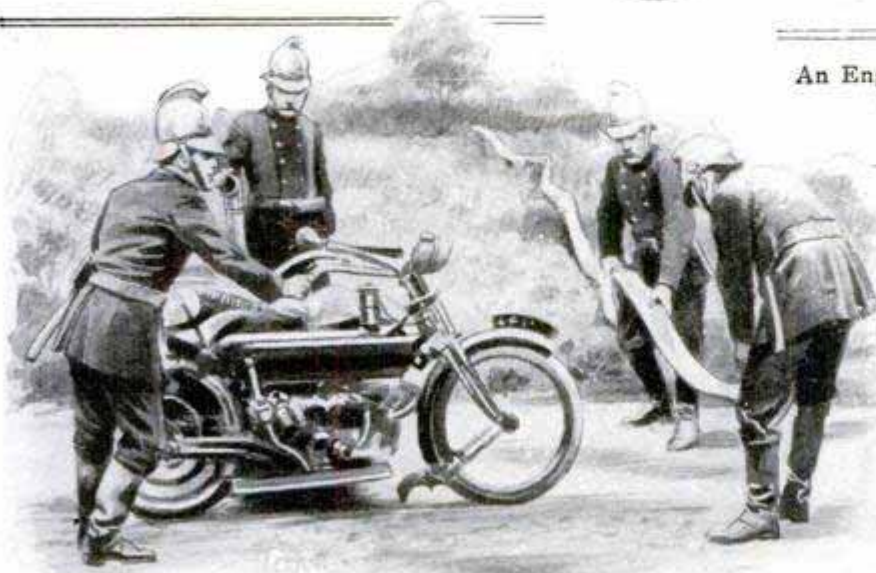

Courtesy The Car

of hose and a lantern. In one English rural fire department, four firemen hurry to the blaze in a single sidecar with hose and necessary equipment. Many rural communities are equipping themselves with these speedy vehicles which

promise that "stitch in time" so much sought after in combating serious conflagrations. The fire brigade at Sandwich is another English department using a motorcycle with a sidecar. Two members with hose and extra

## POISONOUS GASES USED TO DISLODGE DESPERADO

In an attempt to stifle or drive into the open a Mexican desperado who had taken refuge in a mine at Bingham,

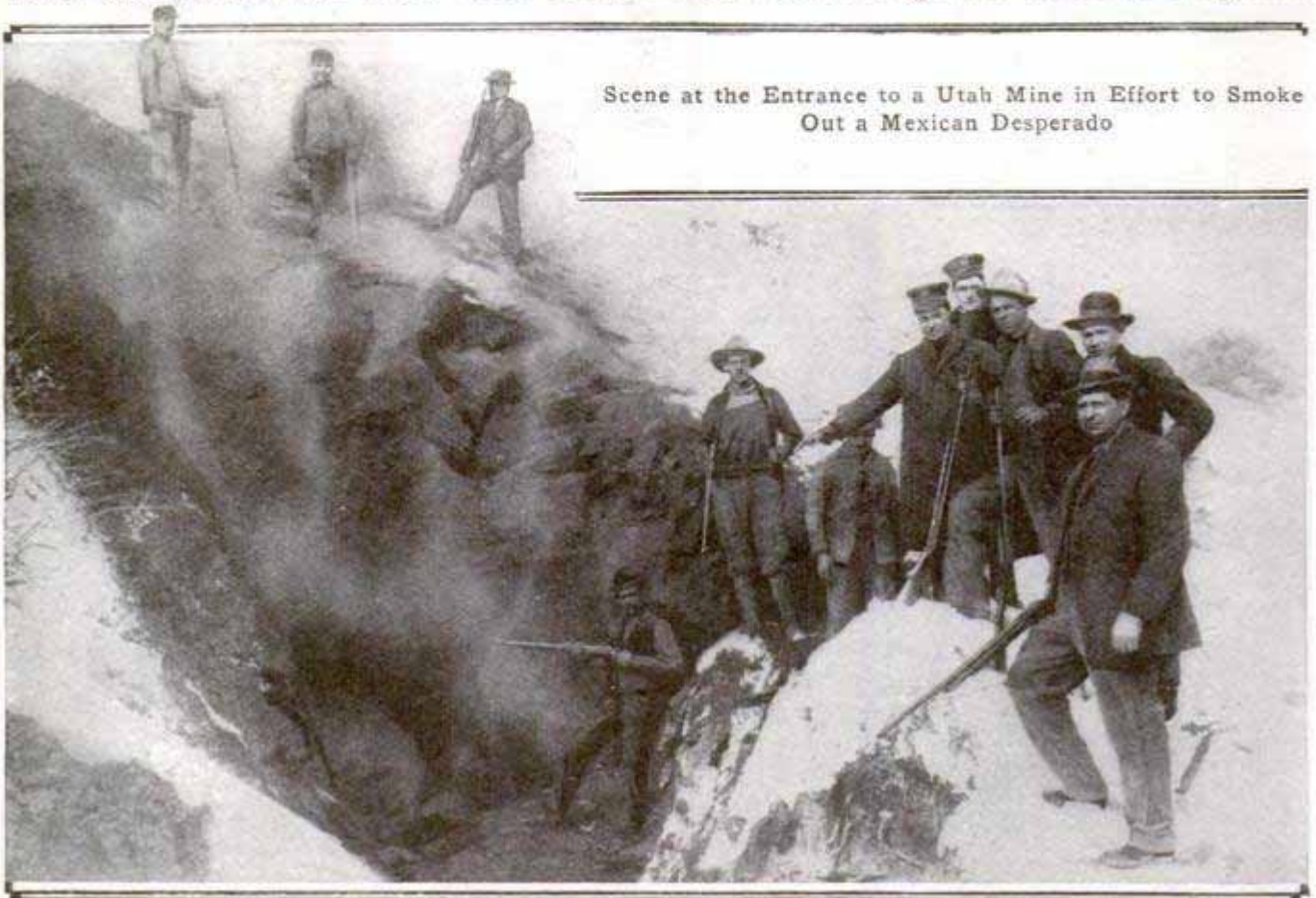

Scene at the Entrance to a Utah Mine in Effort to Smoke Out a Mexican Desperado

Copyrighted by International News Service

nozzles riding this machine invariably reach the fire ahead of the department, and are often able to hold the blaze in check until the arrival of the apparatus, if they do not succeed in wholly extinguishing the flames themselves, as frequently happens when the alarm has been sent in promptly.

Utah, all openings to the mine were closed and poisonous gases were circulated through the workings by the ventilating system. Wet gunpowder was burned to generate what is known to miners as "black damp," and, in addition, large quantities of sulphur, tar, and oil were used.

## DENVER SAVES SNOW FOR SUMMER FETE

Denver was visited by a record-breaking snow storm during the first week in December, 1913, when 42 in. of wet snow fell, blockading street-car lines and railroads. Drifts of 7 ft. were not uncommon, and the task of clearing the streets was a formidable one. Instead of throwing the snow taken from the street into the Platte River, the usual custom, it was decided to deposit it all in one big pile on the Civic Center site, six square blocks of

ground lying at the foot of the State Capitol, which had been recently purchased and cleared for a proposed beauty spot. It is proposed to cover the pile with a thick layer of sawdust and house it with lumber taken from the old grandstand erected for the Knights Templar Conclave last year and uncover it next summer during the Festival of Mountain and Plain, for a few days of tobogganing, skiing and general snowballing.

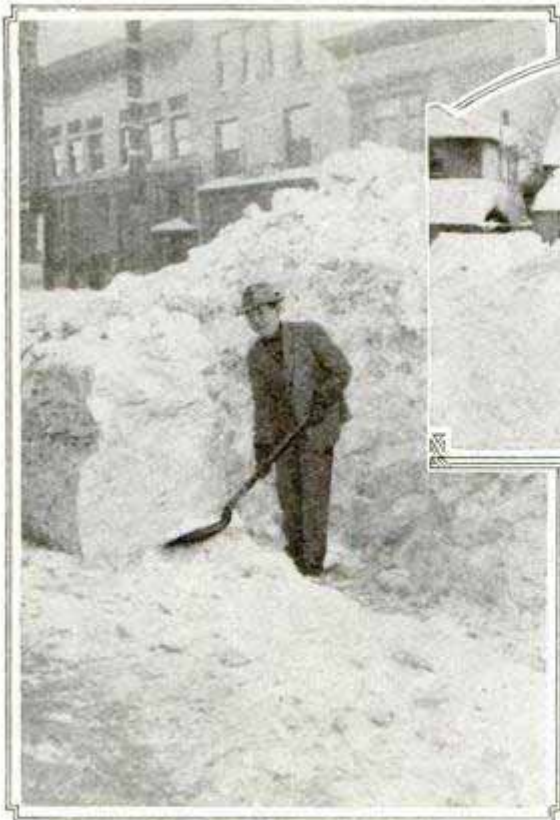

Clearing Off Sidewalks in Business District



Everybody's Back Yard was Full to the Fenceline



Snow Canyon in Denver Street

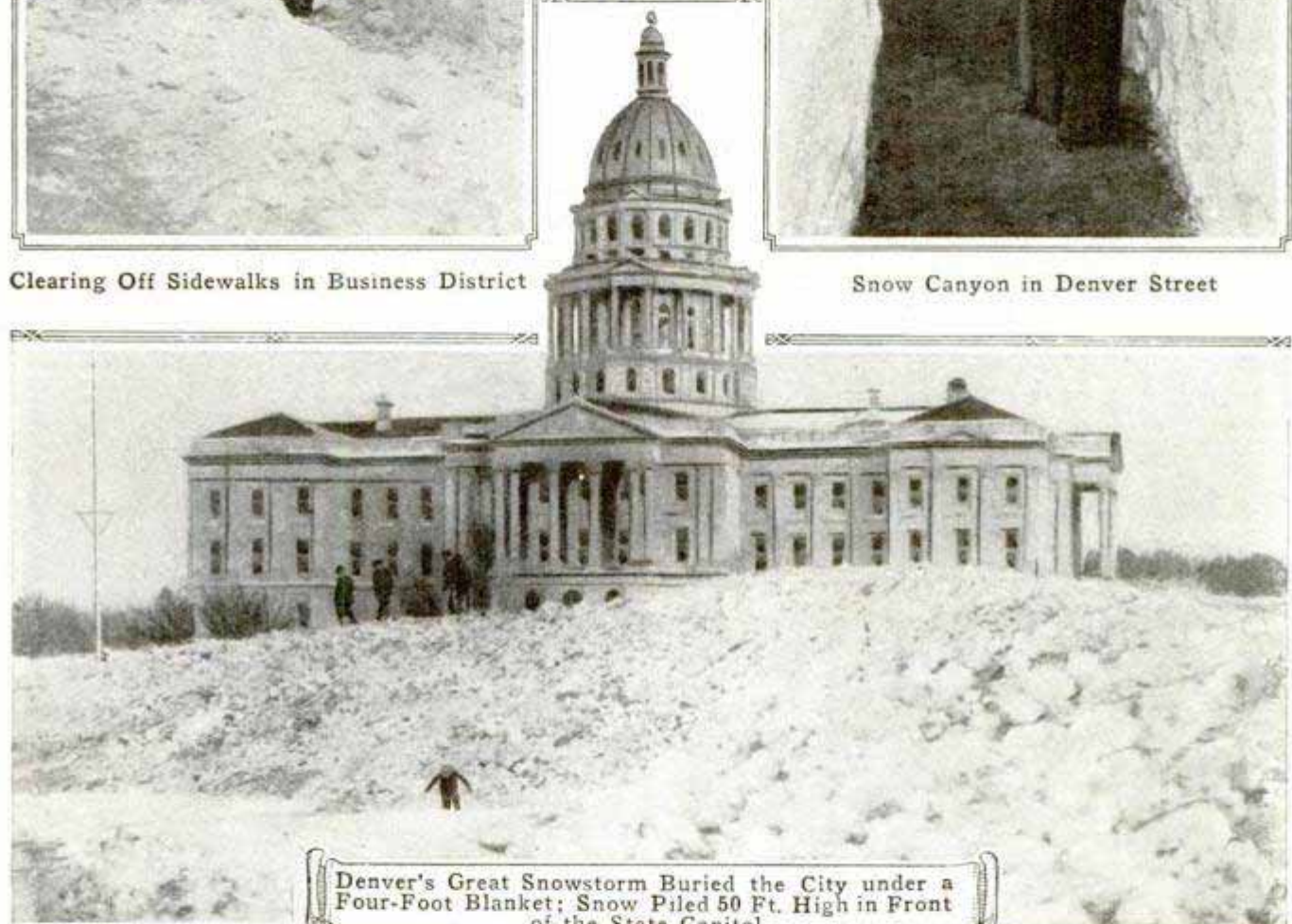

Denver's Great Snowstorm Buried the City under a Four-Foot Blanket; Snow Piled 50 Ft. High in Front of the State Capitol



Snowed In at the Curb



Bungalow Almost Snowbound

## AVIATION'S DEATH TOLL IN 1913 THE HEAVIEST YET

As was to be expected, the year 1913 showed a considerable increase in the number of deaths due to aeroplane accidents. Many more airmen than ever before made flights during the year; many thousands more miles were covered. As against 140 aviation fatalities in 1912, there were 192 in 1913. In all the years before 1912, since the Wrights made the first public flights in a heavier-than-air machine, there had been but 114 deaths—1 in 1908, 4 in 1909, 32 in 1910, and 77 in 1911.

Twenty-six of the deaths of 1913 occurred in the United States, 18 in Great Britain, 61 in Germany, 51 in France, and 36 in various other countries. Twelve airmen fell into the water and were drowned, 157 were killed by the impact of falling to earth, 9 were burned to death and 14 met death in various other ways, 9 of these being spectators who were killed while watching the airmen. One hundred and forty-six of those killed were piloting their machines at the time, 15 were mechanics and 22 were passengers.

September produced the longest list of casualties, 23 fatal accidents occurring in that month. There were 22 in April and an equal number in July, while December was the safest month, with but 6 deaths.

Undoubtedly the best-known airman who was killed in 1913 was Col.

S. F. Cody, an American naturalized in England, who had done perhaps more than any other one man to further the interests of aviation in Great Britain and had won international fame through his inventions. He was killed on Aug. 7 by the failure of a biplane of his own construction. A passenger with him was also killed. Almost equally famous in Europe was M. Vlaicu, a Roumanian pioneer in aviation, who was killed on Sept. 13 at Bucharest. Charles Nieuport, a French airman, famous the world around as a designer and builder of monoplanes, was killed on Jan. 24.

Besides the 192 fatalities due to aeroplane accidents, 50 persons lost their lives in 1913 through accidents to airships or dirigible balloons. Twenty-eight were killed on October 17, when the Zeppelin "L 2" exploded over Johannisthal; 15 died when the "L 1" was wrecked in the North Sea, Sept. 9; 5 French aeronauts were killed by the wrecking of a balloon on April 17, and 2 German soldiers were dropped from a Zeppelin that broke away from its moorings on Sept. 10.

The following tabular list of aviation deaths includes 12 which occurred in 1912 after the list published in the January, 1913, issue of Popular Mechanics Magazine was compiled, and the complete record for 1913.

### AVIATION DEATHS, NOV. 21 TO DEC. 31, 1912

NAME	PLACE	DATE	MACHINE
Quartermaster Jean Laurent	Etampes, France	Nov. 21	
Lieut. von Winterfeld	Johannisthal, Germany	Nov. 22	
Paul Arondel	Juvisy, France	Nov. 30	Monoplane
M. Imbach	Villacoublay, France	Dec. 3	Monoplane
Dr. Jules Constantin	Tchatalja, Turkey	Dec. 8	Biplane
Lieut. Wilfred Parke, R. N. Arnell Hardwick, passenger	Wembley, Eng.	Dec. 15	Monoplane
Horace Kearney Chester Lawrence, passenger	Pacific Ocean in flight from Los Angeles to San Francisco	Dec. 15 or 16	Flying Boat
Lieut. Drausfeld	Mainz, Germany	Dec. 21	
Edward Petre	Marske, Yorkshire, Eng.	Dec. 24	Monoplane
Fung Yue	Peking, China	Dec. 29	

## AVIATION DEATHS, 1913

NAME	PLACE	DATE	MACHINE
Lieut. Bérode	Sainte Anne, France	{ Fell Dec. 31, 1912 Died Jan. 1, 1913	
Mallet, mechanic	{ Drowned in English Channel near Fécamp, France	Jan. 3	Flying Boat
L. F. MacDonald	{ Drowned in the Thames near Dartford, Eng.	Jan. 13	Monoplane
Mechanic Harry England	{ Austrian Frontier	Jan. 18	
Russian officer	{ Near Buenos Aires, Argentina	Jan. 19	
Lieut. Origone	{ Magdeburg, Germany	Jan. 23	Biplane
Lieut. von Scheele	{ Port of Spain, Trinidad	Jan. 23	Biplane
Lieut. Schlegel, passenger	{ Halberstadt, Germany	Jan. 23	
Frank Boland	{ Etampes, France	Jan. 24	Monoplane
Lieut. Robert Waltz	{ Villa Lugano, Argentina	Jan. 27	
Charles Nieuport	{ Aix-la-Chapelle, Germany	Jan. 28	Monoplane
Réné Guyot, mechanic	{ Turin, Italy	Feb. 3	
Eusebione	{ Gulf of Danzig, Prussia	Feb. 7	Flying Boat
Lucien Hild	{ Leipzig, Germany	Feb. 15	Biplane
Joseph Notari	{ Vienna, Austria	Feb. 17	
Lieut. Jenetzky	{ Tegel, Prussia	Feb. 17	
Mate Dieckmann	{ Hangelar, Prussia	Feb. 25	
— Lenk	{ Mühlhausen, Prussia	Feb. 26	
Lieut. Mittner	{ Salisbury Plain, Eng.	Mar. 5	Monoplane
— Priczinski	{ Ambérieu, France	Mar. 16	Monoplane
Bruno Werntgen	{ Somma Lombarda, Italy	Mar. 19	
Helfersreider, non-com. officer	{ Lake Lugano, Italy	Mar. 19	Drowned
G. W. England	{ Avord, France	Mar. 23	
Eugène Mercier	{ Verdun, France	Mar. 28	
Capt. Moreno	{ Tokyo, Japan	Mar. 28	Monoplane
Pietro Primavesi	{ Warsaw, Russia	Mar. 28	
Lieut. Porteau	{ Near Scutari, Albania	Apr. 1	Biplane
Lieut. Brossard	{ Buc, France	Apr. 2	Biplane
Lieut. Tokuda	{ Amiens, France	Apr. 2	Monoplane
Lieut. Kimura	{ ——— Russia	Apr. 3	
Lieut. Pietrowsky	{ San Diego, Cal.	Apr. 8	Flying Boat
Sergeant Petrovitch	{ Gelsenkirchen, Germany	Apr. 10	Biplane
Adjutant Yves Faure	{ Gelsenkirchen, Germany	Apr. 10	
Quartermaster Chauroux	{ Buenos Aires, Argentina	Apr. 11	
Lieut. Alex Cerlovsky (sui- cide)	{ Saïgon, Indo-China	Apr. 13	
Lieut. Rex Chandler, passenger	{ Santiago, Chile	Apr. 14	
— Reimer	{ Monaco	Apr. 15	{ Flying Boat Drowned
Lieut. Lichte	{ Salonica, Greece	Apr. 17	Monoplane
Perez Arzemo	{ Clearing, Chicago	Apr. 19	Biplane
Geo. Verminck	{ Turin, Italy	Apr. 20	
Luiiz Acevedo	{ Villacoublay, France	Apr. 21	Monoplane
Louis Gaudart	{ Eastchurch, Eng.	Apr. 21	
Lieut. Argyropoulos	{ Doeberitz, Germany	Apr. 22	Monoplane
Constantinos Manos, passenger	{ Johannisthal, Germany	Apr. 24	
Otto W. Brodie	{ Johannisthal, Germany	Apr. 25	
François Gallot, passenger	{ Farnborough, Eng.	{ (Fell Apr. 24)	Biplane
Lieut. René de Blaumont	{ Munich, Bavaria	Apr. 28	Biplane
Paymaster E. R. Berne	{ Darmstadt, Germany	{ Apr. 28	
Lieut. Ehlers	{ Darmstadt, Germany	{ (Fell Apr. 23)	
Elia Dunetz	{ Darmstadt, Germany	Apr. 30	Biplane
Vsevolod Abramovitch	{ Oakland, Cal.	May 2	Flying Boat
Lieut. Roger Harrison	{ Saint Cyr, France	May 3	
Lieut. von Germersheim	{ Zurich, Switzerland	May 4	
Lieut. von Mirbach	{ Akron, Ohio	May 5	
Lieut. von Brunn	{ Osaka, Japan	May 7	
Herman Jansen	{ Olive, near Santa Ana, Cal.	May 9	Biplane
(killed while helping start machine)	{ Johannisthal, Germany	May 14	{ Biplane in col- lision with Monoplane
Sergt. André Battini	{ Capljina, Austria	May 17	
M. Rech	{ Near St. Petersburg	May 18	{ Collision of Acroplanes
Charles Carlson	{ Montrose, England	May 27	
Koha Takeishi	{ Johannisthal, Germany	May 27	
Lieut. J. D. Park	{ Johannisthal, Germany	{ (died of heart failure June 1, due to accident)	
Capt. Jucker	{ Johannisthal, Germany	{ (died of heart failure June 1, due to accident)	
Dietrich, passenger, died May 25	{ Johannisthal, Germany	{ (died of heart failure June 1, due to accident)	
Capt. Deodatus Andrich	{ Johannisthal, Germany	{ (died of heart failure June 1, due to accident)	
Russian Airman	{ Johannisthal, Germany	{ (died of heart failure June 1, due to accident)	
Lieut. D. L. Arthur	{ Johannisthal, Germany	{ (died of heart failure June 1, due to accident)	
— Michaelis	{ Johannisthal, Germany	{ (died of heart failure June 1, due to accident)	

NAME	PLACE	DATE	MACHINE
A. Horn	Hanover, Germany	May 28	Monoplane
Lieut. Jean F. Kreyder	Bourges, France	May 30	Monoplane
Lieut. Balabouchkine	Peterhof, Russia	May 31	
James Colovan	Cicero, Ill.	May 31	Biplane
August Bernard } Rose Amicel }	Buc, France	June 5	Biplane
M. Seidi	Aspern, Austria	June 11	
Andrew Drew	Lima, Ohio	June 12	Biplane
Earl Sandt	Grove City, Pa.	{ June 12 (died June 21)	
M. Manio	Lisbon, Portugal	June 13	Monoplane
Lieut. James R. B. Kennedy, } passenger }	Brooklands, Eng.	June 13	Monoplane
M. Debever	Etampes, France	June 18	Biplane
Lieut. Krafft	Johannisthal, Germany	June 19	Biplane
— Gerbitz, mechanician }	Chesapeake Bay	June 20	Flying Boat
Ensign Wm. D. Billingsley	Aspern, Austria	{ June 23 (died June 25)	
Lieut. Nepallek, passenger	Lake Keuka, N. Y.	June 23	{ Biplane Drowned
Fred F. Gardiner	Chalons-sur-Marne, France	June 26	Monoplane
Maurice L. Foulquier	Brighton, Eng.	June 29	{ Burned to death
Robert Wight	Liège, France	June 29	
M. Parisot	Montgenost, France	July 2	Biplane
Two spectators also killed }	Johannisthal, Germany	July 4	{ Collision of two Bi- planes
Capt. Rey	Petaluma, Cal.	July 4	Biplane
Bouchardier, mechanician }	Prosser, Wash.	July 5	
R. Hoelscher, passenger	Kunersdorf, Germany	July 6	
Grover Bell	Near Texas City, Texas	July 8	Biplane
Harvey Crawford	Würzburg, Bavaria	July 9	Monoplane
Lieut. Boeder	Guyancourt, near Versailles, France	July 14	{ Monoplane Burned to death
Lieut. Loren H. Call	Habsheim, Germany	July 14	
— Lendner }	Milan, Italy	July 15	Monoplane
Albert Sénard }	Jüterbog, Germany	{ July 15 (died July 16)	Monoplane
— Bertin, father and son	Chico, Cal.	July 15	Biplane
— Dietrichs	Larkhill, England	July 17	{ Monoplane Possibly burned to death
Robert Fabbri	Neuendorf, Germany	July 17	
Siegfried Stoll	Frankfort-on-the-Main, Ger- many	July 18	Biplane
Thaddeus Kerns	Mourmelon, France	July 18	
Maj. A. W. Hewetson	Châlons, France	July 21	Biplane
Little girl, killed by propeller	Johannisthal, Germany	July 22	Monoplane
Sergt. Westphely	Frankfort-on-the-Main, Ger- many	July 24	Biplane
Lieut. Chaignot	Auterive, France	July 27	{ Flying Boat Not drowned
Malarte Sapper	Freiburg, Germany	July 27	
— Wheelmer	Gatchina, Russia	About July 30	
Stengler, passenger	Johannisthal, Germany	{ Aug. 4 (fell Aug. 3)	{ Died from burns re- ceived in tank explo- sion
— Chambenois	Krasnoe-Selo, Russia	Aug. 5	Monoplane
— Paillard	Victoria, B. C.	Aug. 6	
Lieut. Mathay	Aldershot, England	Aug. 7	Flying Boat
— Broks	Brueck, Germany	Aug. 10	Monoplane
Lieut. Polikarpoff } and mechanician }	Omaha, Nebr.	{ Aug. 15 (fell week before)	
John Bryant	Leipzig, Germany	Aug. 15	Biplane
S. F. Cody	Celina, Ohio	{ Aug. 19 (fell Aug. 13)	
W. H. B. Evans }	Halberstadt, Germany	Aug. 22	Monoplane
Fritz Roessler }	Rouen, France	Aug. 24	Flying Boat
Stephan, pupil }	Villacoublay, France	Aug. 25	Monoplane
Henri de la Roche			
Aug. Ruetgers, passenger			
Milton Korn			
Lieut. Schmidt			
M. de Montalent }			
Métivier, mechanician }			
Lieut. Sansever }			
Lucien Laforgues, sapper }			



NAME	PLACE	DATE	MACHINE
Mme. Richer	La Roche-Bernard, France	{ Sept. 1 (died Sept. 2)	
M. Desvaux de Lyf, passenger	Melun, France	Sept. 2	Biplane
Lieut. Paul Lefranc	Rheims, France	Sept. 2	Biplane
Mme. Lefevre	Rutland, Vt.	Sept. 2	
George Schmidt			
Lieut. Humphries	Salisbury Plain, Eng.	Sept. 3	{ Burned to Death
Non-Com. Officer Kahle	Mülhausen, Germany	Sept. 4	
Lieut. Moss L. Love	San Diego, Cal.	Sept. 4	Biplane
Lieut. von Eckenbrecher	Brieg, Germany	Sept. 4	Monoplane
Lieut. Prinz			
Perry C. Davis	Mauston, Wis.	{ Sept. 5 (fell) Sept. 16 (died)	Biplane
Paul Senge	Cologne, Germany	Sept. 8	Monoplane
Doctor Ringer	Berlin, Germany (Accident due to physical weakness of pilot)	Sept. 9	Monoplane
M. Chomienne	Lyon, France	Sept. 9	Monoplane
M. Druschinin	Sebastopol, Russia	Sept. 9	Monoplane
Four Spectators	Berncastel, Germany	Sept. 11	{ Biplane fell among crowd
Hans Lorenz	Bork, Germany	Sept. 12	
M. Avinas	Gatchina, Russia	Sept. 12	
M. Aurelius Vlaicu	Banesti, Roumania	Sept. 13	
Max Lillie	Galesburg, Ill.	Sept. 15	Biplane
Lieut. Fischer	Sebastopol, Russia	Sept. 19	Monoplane
Lieut. Schulz	Johannisthal, Germany	Sept. 21	
Lieut. Cazes	Mogador, Morocco	Sept. 22	{ Monoplane Drowned
Lieut. Souleillan (suicide)	Oudjda, Morocco	Sept. 24	Monoplane
Capt. Bertram Dickson	Milan, Italy, 1910	Sept. 28 (died)	{ Collision of Biplanes. Death due to injuries received three years earlier at Milan
Ulrich Birch	{ Copenhagen, Denmark (first in Scandinavia)	Oct. 2 (died Oct. 9)	Biplane
Maj. G. C. Merrick	Upavon, England	Oct. 3	Biplane
Quartermaster Hurtard	Rheims, France	Oct. 4	Monoplane
Sapper Laverlochère	Chaumont, France	Oct. 4	Monoplane
Geo. Sivel	Marmande, France	Oct. 5	Monoplane
Miss Ruth Hildreth	{ Fell from roof struck by Beachey's aeroplane, Hammondsport, N. Y.	Oct. 7	Biplane
Lieut. Negel	Bukharest, Roumania	Oct. 11	Biplane
E. W. Cheeseman	Kimberley, So. Africa	Oct. 12	
Albert J. Jewell	Hempstead, L. I.	Oct. 13	{ Monoplane Lost in the sea
Lieut. Koenig	{ Neuendorf, near Berlin, Germany	Oct. 13	
Capt. Haeseler	Near Breslau, Germany	Oct. 17	{ Burned to death
Lieut. Koch	Near Würzburg, Bavaria	Oct. 17	Biplane
Sergt. Mante			
Lieut. Klevchintski	Near Moscow, Russia	Oct. 18	
with mechanician			
Lieut. Garnier	Epinal, France	Oct. 20	Biplane
Sapper Gendreau	Epinal, France	Oct. 20	Biplane
Corporal d'Autroche	Rheims, France	Oct. 28	Monoplane
Quartermaster Canal	Villacoublay, France	Nov. 12	Monoplane
Capt. Denis de Lagarde			
Lieut. C. Perry Rich	Manila, P. I.	Nov. 14	{ Flying Boat drowned
M. Corbon	Chantilly, France	Nov. 24	Monoplane
— Serbinow	Augustovo, Russia	Nov. 24	
Lieut. Hugh M. Kelly	San Diego, Cal.	Nov. 24	Biplane
Lieut. Eric L. Ellington	Buc, France	Nov. 26	Monoplane
Edmond Perreyon			
Lieut. Louis Briault	Epernay, France	Nov. 26	{ Biplane Burned to death
Mechanician Brouillard			
Capt. G. V. Wildman- Lushington	Eastchurch, England	Dec. 2	
Capt. A. V. Philip Giorgi	Malpensa, Italy	Dec. 4 (Fell Nov. 24)	Monoplane
Lieut. Wachsmuth	Libau, Russia	Dec. 6	{ Flying Boat Drowned
— Schutzenheister	Leipzig, Germany	Dec. 8	
Leon Letort	Barbezieux, France	Dec. 10	Biplane
Remus	Johannisthal, Germany	Dec. 20	

## GLARELESS LAMP FOR AUTOMOBILES

A new motor headlight which

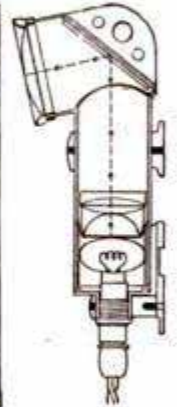
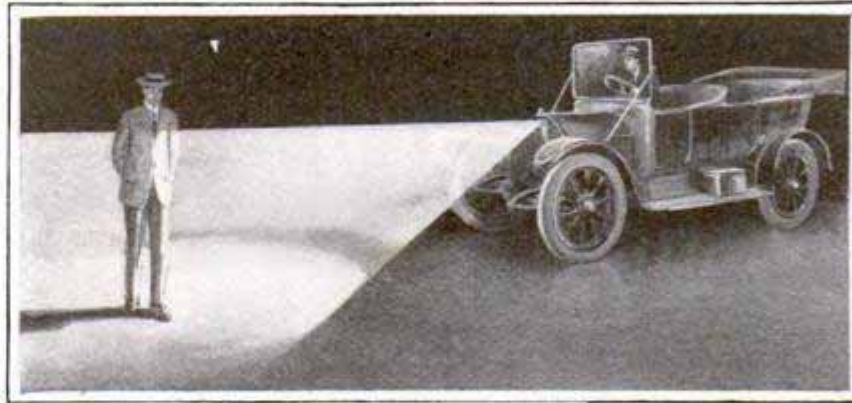

New Type of Automobile Headlight Which Throws Light Beams Forward and Downward Only

brightly illuminates the roadway without throwing a blinding glare into the eyes of the driver of an approaching car is shown in the pictures herewith. It is an electric light, using a mushroom-shaped tungsten bulb, the beams from which pass through two condens-

ing lenses and are then reflected by a mirror through a projection lens to the roadway. Externally, the new headlight is tubular in form, the electric

bulb being at the base, and the light is projected upward through the lenses to the mirror where it is deflected, never striking higher than  $4\frac{1}{2}$  ft. above the surface of the road. The lamp is attached to the radiator by small bolts, and is hermetically sealed.

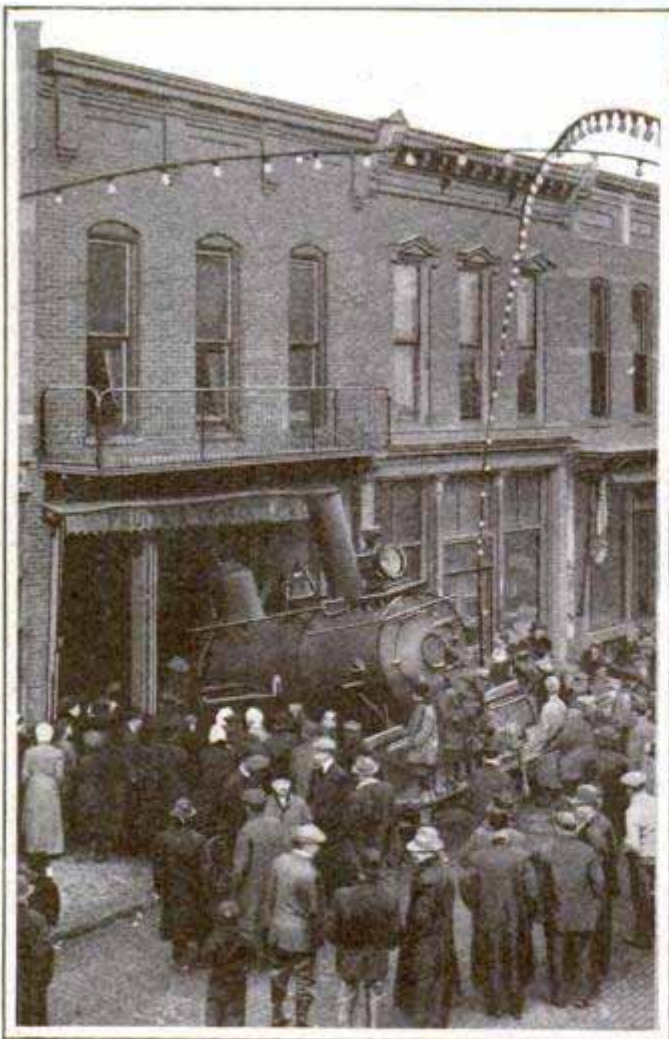

Grand Opening in Grocery Store by Wandering Locomotive

## RUNAWAY ENGINE GOES TO MARKET

An engine which was standing on a coal track in Huntington, Ind., began to back when leaky valves allowed steam to creep into the cylinders, and before it could be caught, had run off the end of the spur, across a brick pavement, and into a grocery. Fortunately the accident occurred at midnight, and no one was injured. Owing to the prompt action of the fire department, which extinguished the fire in the boiler, no blaze resulted. The engine was hauled out by the wrecking crew next morning, none the worse for its midnight jaunt.

## PRESIDENT PLANTS ELM IN WHITE HOUSE GROUNDS

The "Wilson Elm" now occupies a conspicuous position in the White House grounds in Washington, and has as its associates, trees of various kinds planted by nearly every other president of the United States. The latest acquisition of the Executive Mansion's horticultural collection was



President Woodrow  
Wilson Throwing  
First Shovelful  
of Dirt

elms in the country. It stood on the front lawn opposite the east end of the main portico of the White House. It cast a shadow several hundred feet in circumference, and its trunk measured about 8 ft. in circumference. During the storm it was uprooted bodily and thrown across the main driveway. The hole in the ground where the roots had been was 15 ft. deep and about 25 ft. in diameter.

Since the destruction of the old tree, President Wilson several times expressed his regret at its loss. When asked to participate in the planting of its successor, he readily agreed.



Preparing the Wilson Elm for Ceremony  
of Planting

planted by President Wilson about the middle of December, with informal ceremonies, while about a hundred persons looked on. The "Wilson Elm" is 25 years old, having stood for that length of time in the government's horticultural grounds. It was mounted on trucks, after the roots were crated and wrapped with burlap. It towers 40 ft. in the air.

The new elm takes the place of the Hayes elm which was uprooted last July. It was regarded by experts as one of the handsomest specimens of

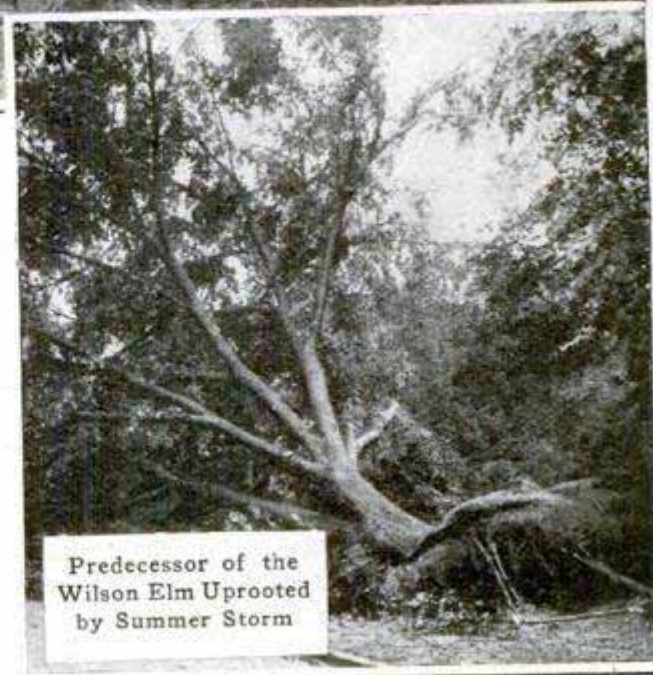
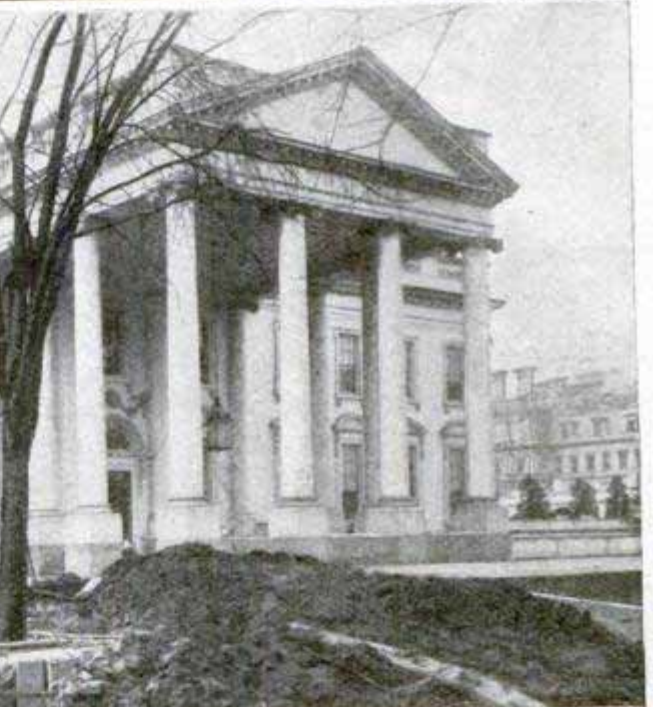

Predecessor of the  
Wilson Elm Uprooted  
by Summer Storm

## PONTOON MOTOR CAR TO CROSS AFRICA

From Cape to Cairo by motor car is a trip now being taken by six Englishmen who regard the expedition as

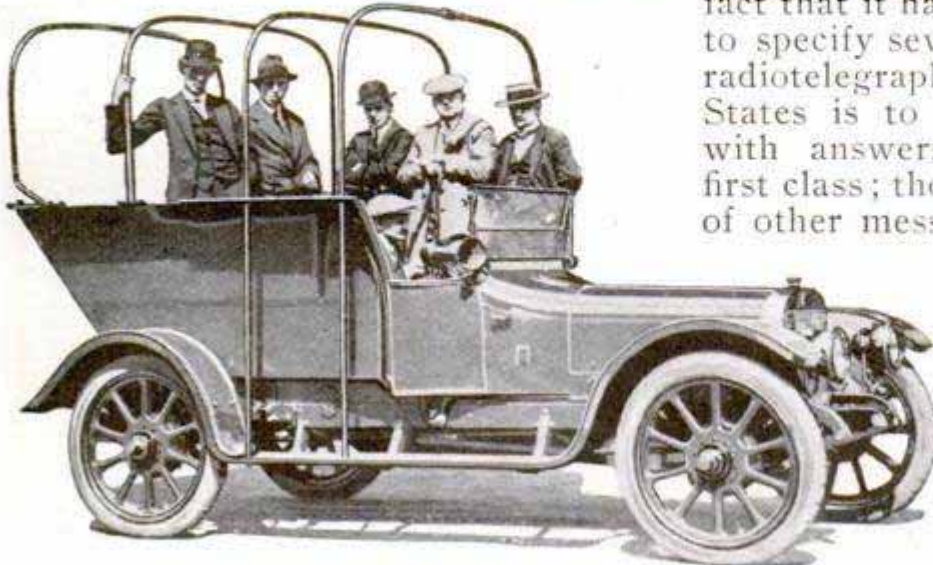

Motor Car in Which English Explorers are Crossing the African Continent

feasible. They have a remarkable car, which is specially constructed, so that one-half is carried within the other when fitted on the chassis. Both portions may be taken off the chassis and bolted together to form a boat-shaped pontoon capable of carrying the chassis and luggage across streams. The car is built to stand hard usage, and uprights carry awnings for protection against the sun. By never getting more than 200 miles from a railroad they plan to be within reach of a supply of gasoline at all times.

## NEW CLASSIFICATION OF WIRELESS MESSAGES

The growth of the wireless message as a commercial medium of communication is perhaps best shown by the fact that it has been deemed necessary to specify seven divisions into which radiotelegraphic service in the United States is to be classified. Messages with answers prepaid constitute the first class; those calling for repetition of other messages for verification, the second; then come special-delivery messages; messages to be delivered by mail; multiple messages, in which the same message is sent to several different addresses; messages calling for the date and hour of transmission of other

messages from coast stations to vessel; and paid service messages, sent to rectify or complete addresses and text in prior messages. The new classification was adopted by the London International Radiotelegraphic Convention, and became effective in the United States upon presidential proclamation, September 1, 1913.

More than 33,000,000 passengers were carried by the passenger steamboats of America during 1913, without the loss of a single life.

## CITY BUILT UPON THE SAND WRECKED BY STORM

The terrific storm which swept the eastern shores of the North Pacific on October 6, 1913, wrought damage almost beyond computation to shipping and to docks. Nowhere was the fury of the tempest more in evidence than at Nome, the once famous mining camp of Alaska. Nome was a city of the flimsiest construction, built upon the beach; a city of boards and shingles, without brick walls or brick chimneys, and entirely unprotected from the sea. Each winter the ice floes piled high upon the sands made harbor im-

provements impossible. When the storm of last October drove the sea over the long, sloping beach, the waves found their progress unimpeded, and beat down the flimsy shacks, destroyed the frame stores and left a straggling line of wreckage along the coast. Boats driven ashore reposed in devastated streets, while houses floated from insecure foundations to adjacent sites, crushing other buildings as fragile as themselves. The loss of life was insignificant when the completeness of the destruction of the city is considered.

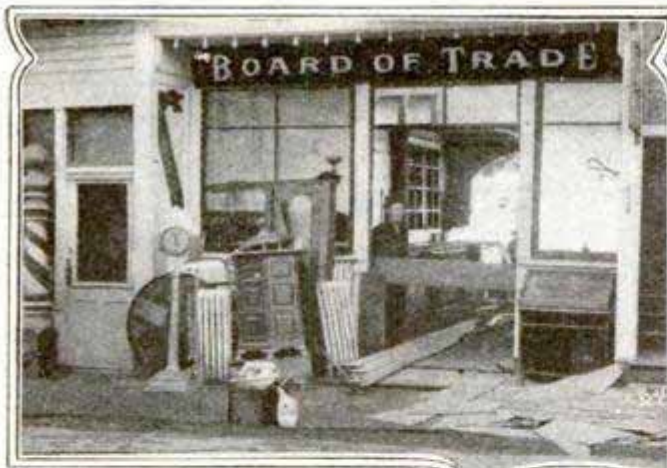

The Wreck of the Board of Trade



Steamer Marooned in Devastated Street

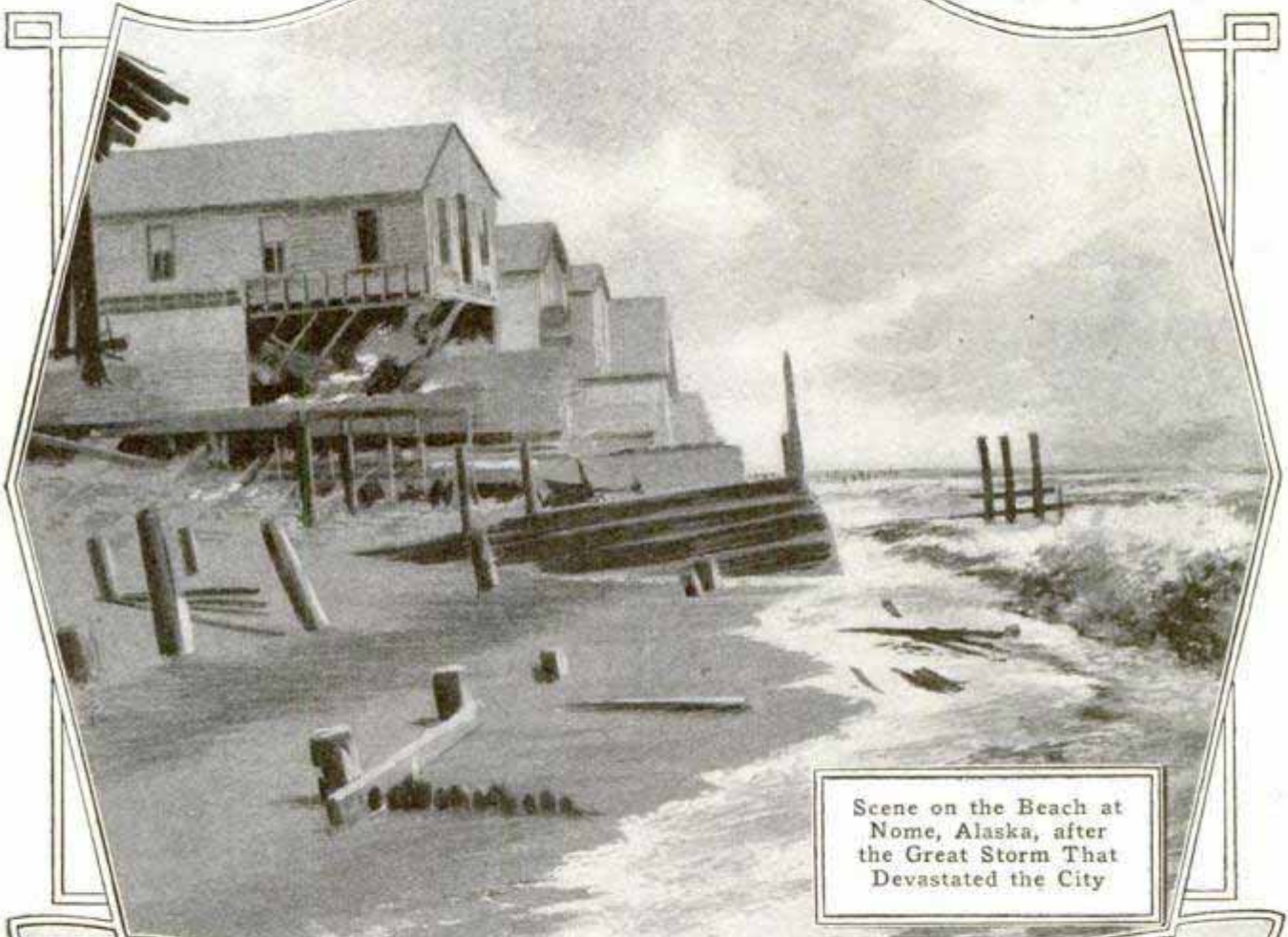

Scene on the Beach at Nome, Alaska, after the Great Storm That Devastated the City

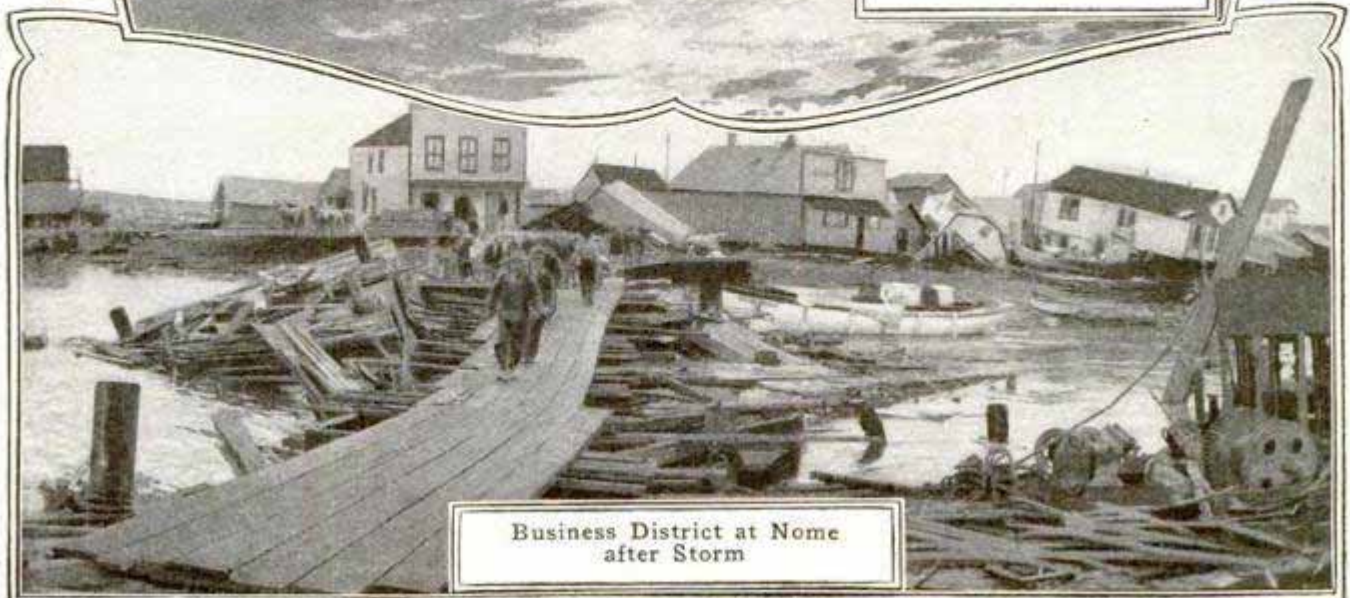

Business District at Nome after Storm

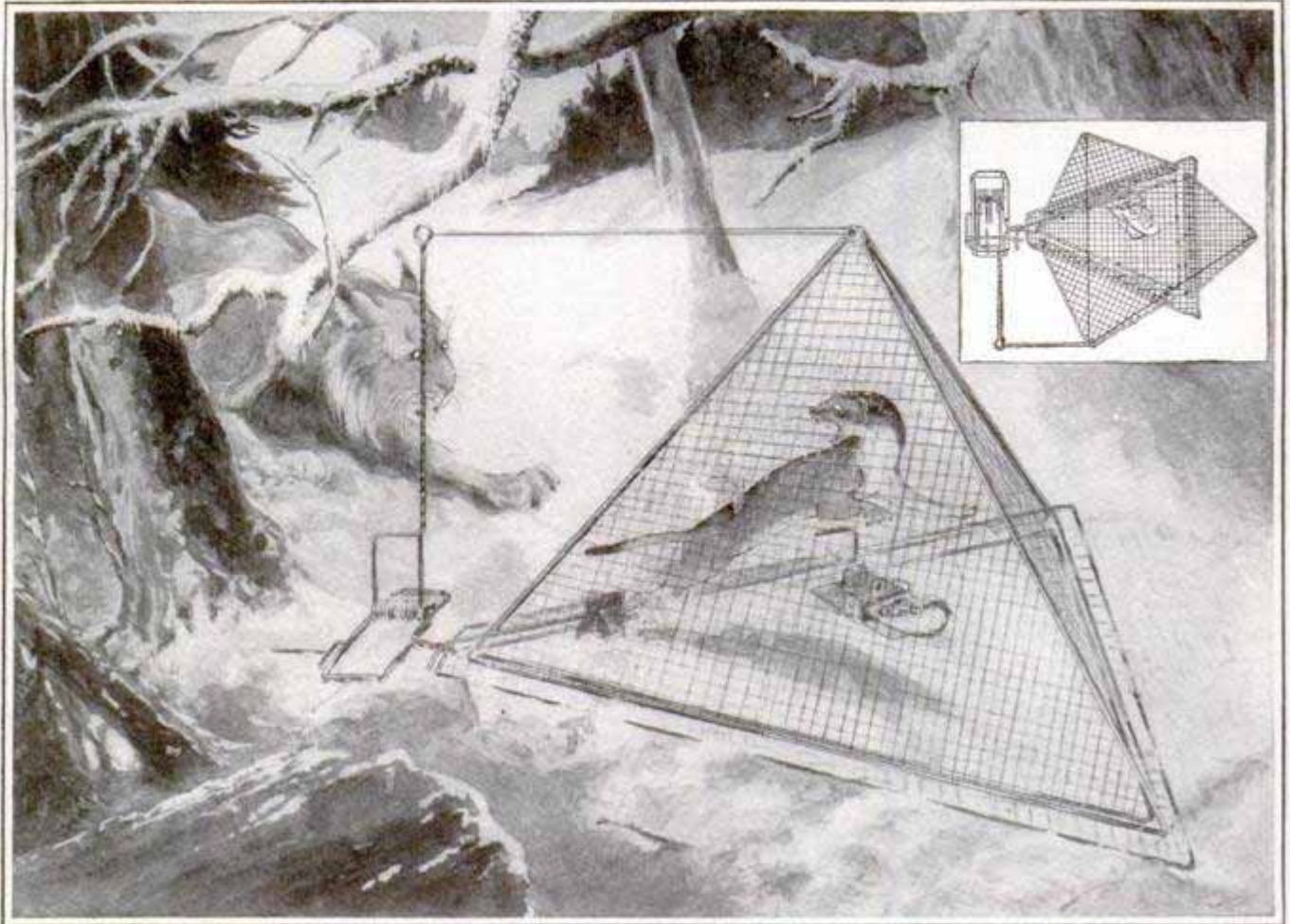

A New Principle in Game Traps

## HUMANE TRAP INVENTED BY HEALTH OFFICER      TEXAS RIVERS RAGE IN DISASTROUS FLOOD

A patent has been granted to a health inspector of Colon, C. Z., on a trap designed to catch animals alive. Primarily it was sought to catch rats alive, for investigation of the bubonic plague developed the fact that the fleas on rats, which constitute the infecting agent in plague, leave the rat soon after it dies. But the trap, as built, admits the capture of any animal, bird or fish. The trap, when closed, forms a pyramidal cage of wire netting; when open, it lies flat on the ground, and may be easily concealed with leaves and grass. A pan in the center contains the bait, and springs throw up the wings of the trap when the bait is disturbed. Inclosed in the cage, the animal is not only not injured, but is protected from attack by other animals while imprisoned. This novel trap, which is made in various sizes, has the endorsement of humane societies.

Central Texas was overwhelmed by a disastrous flood the first week of December, 1913. The Brazos, the Colorado and the Guadalupe rivers rose until many lives were lost and property of great value was wiped out of existence. Levees were washed away, and rich farming lands inundated. Railway traffic was suspended, in some counties every bridge being either badly damaged or destroyed. The path of the flood varied from 50 to 150 miles in width, and extended from the Red River on the north to the Gulf. Waco, Hearne, Bryan and Houston were among the cities of the state which bore the brunt of suffering and loss. Smaller towns and the farming districts were without food or succor for a week or more, while aid from citizens outside the flooded section could be sent to those who needed it only with the greatest difficulty.

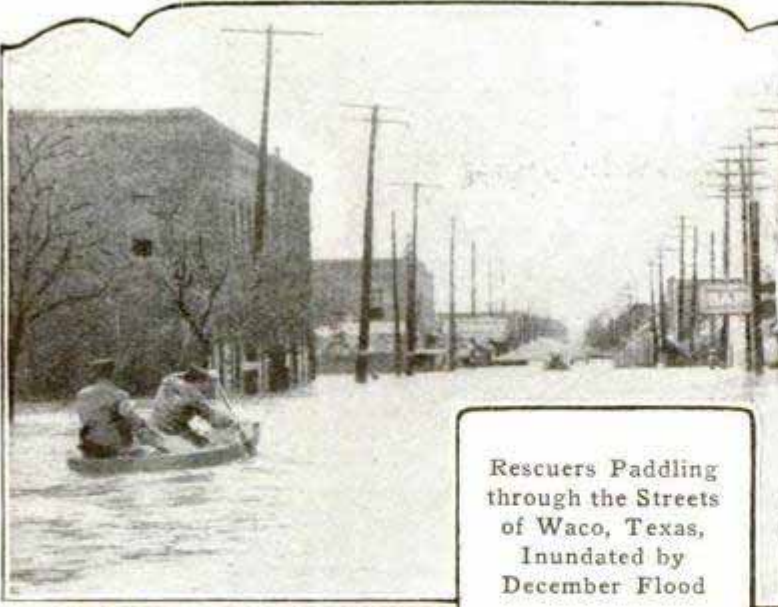

Rescuers Paddling through the Streets of Waco, Texas, Inundated by December Flood

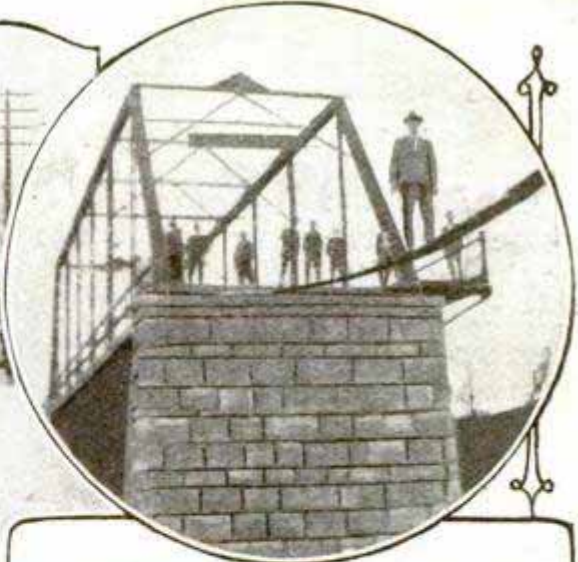

Wire Netting and Planks Used for Temporary Repair of Washed-Out Bridge



Castaways of the Texas Flood: A Dog and a Hen Afloat on Driftwood. Above, View of Flooded District, East Waco



Marooned by the Flood: A Family Seeking Refuge from the Waters on the Roof of Their Cabin



Launching Lifeboat from Railway Train

## POST-OFFICE CLERKS USE ROLLER SKATES

Clerks in the Chicago post office and some of the carriers have been equipped with roller skates in the belief that the innovation will result in greater speed in the transaction of routine business and the elimination of considerable effort in walking. An article in a recent issue of this magazine told of the use of roller skates by stockroom employees in a large factory, and this suggested their use in the postal service. The post-office check room is in the basement and has a clear stretch of concrete floor space 300 ft. long. Here the clothing, uniforms, hats, and shoes of 1,400 clerks

are hung, and the running back and forth amounts to several miles every day. Several pairs of roller skates were bought and given to the employes in the check room. It was soon found that they did their work with less effort and in one-third of the time it had taken them to run back and forth. The roller skates proved so great an aid on the inside that the postmaster decided to experiment further, and several of the special parcel-post carriers were also equipped with skates.

## RUSSIAN DESTROYER SETS NEW SPEED RECORD

The torpedo-boat destroyer "Novik," recently built for the Russian navy, made a maximum of 37.3 knots on her trial trip. A nautical mile or knot is 800.27 ft. longer than the statute mile, and the new boat attained a speed, therefore, of nearly 43 miles an hour. This is a new record for a boat of this type.

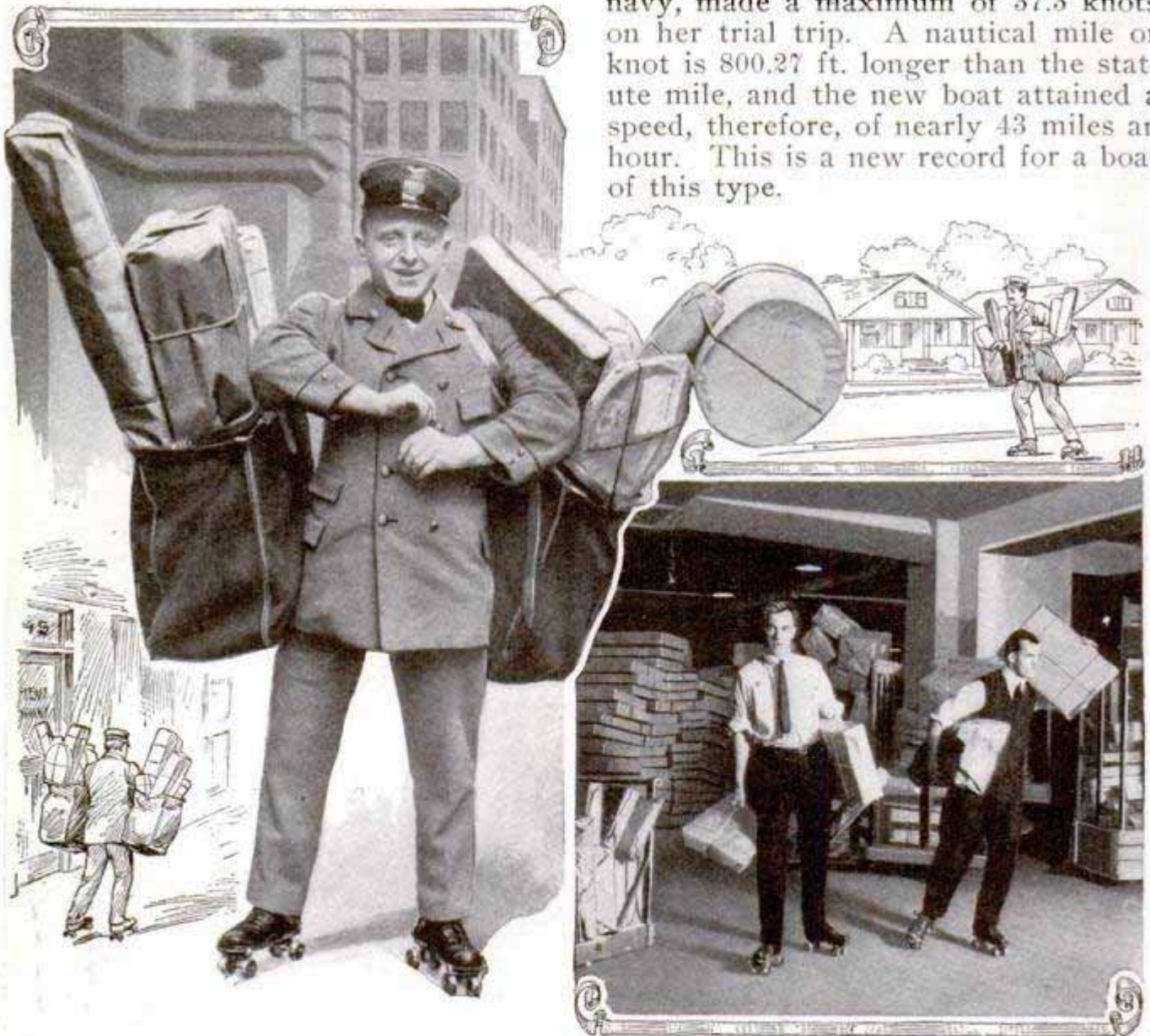

Roller Skates Prove Useful Both Inside the Postoffice and for Parcel-Post Carriers



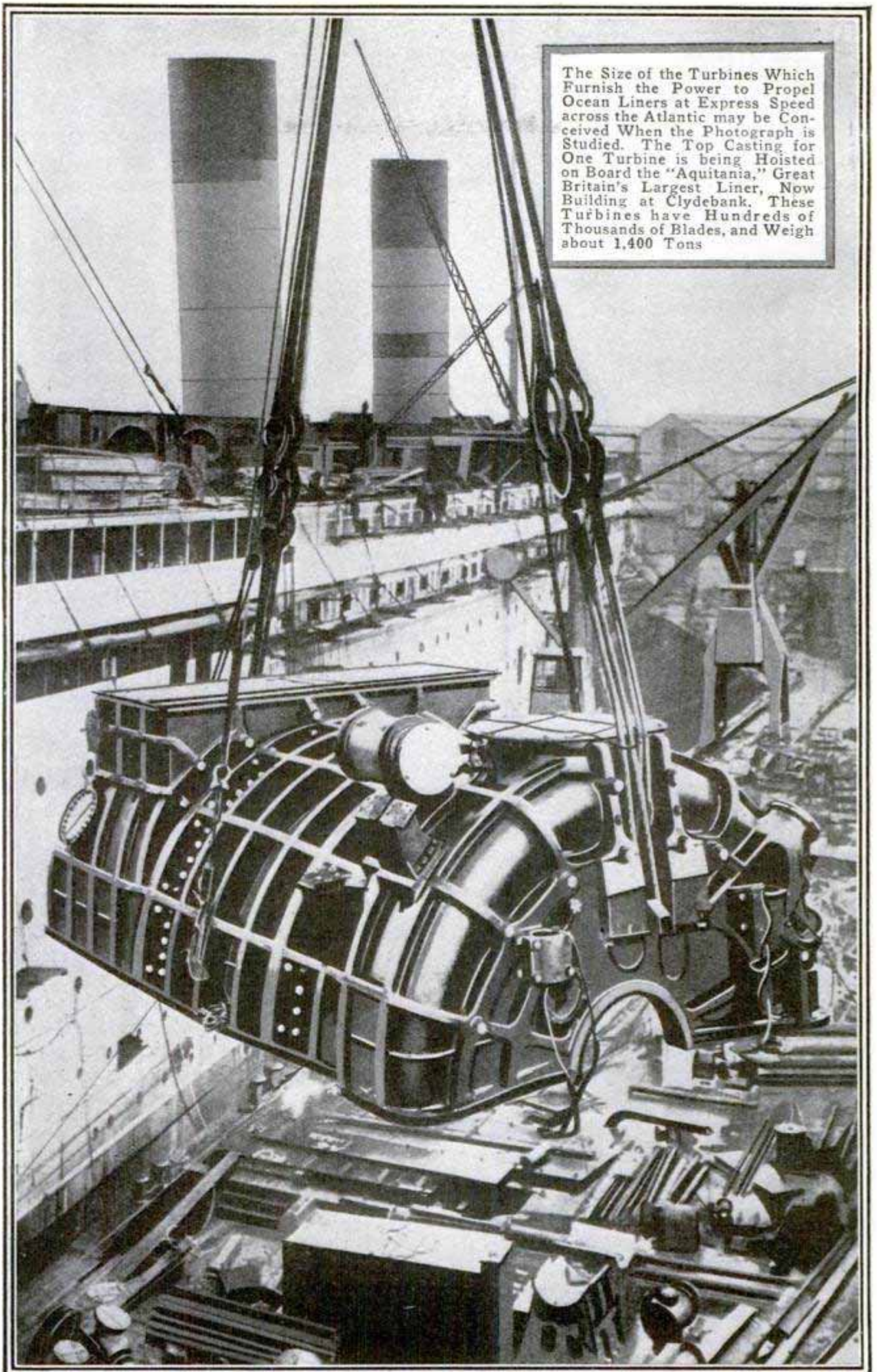

The Size of the Turbines Which Furnish the Power to Propel Ocean Liners at Express Speed across the Atlantic may be Conceived When the Photograph is Studied. The Top Casting for One Turbine is being Hoisted on Board the "Aquitania," Great Britain's Largest Liner, Now Building at Clydebank. These Turbines have Hundreds of Thousands of Blades, and Weigh about 1,400 Tons

Photo by International News Service

## FLEXIBLE SIDECAR FOR MOTORCYCLES

Designed to relieve the motorcycle of all strain, and to insure comfort and safety for both rider and passenger,

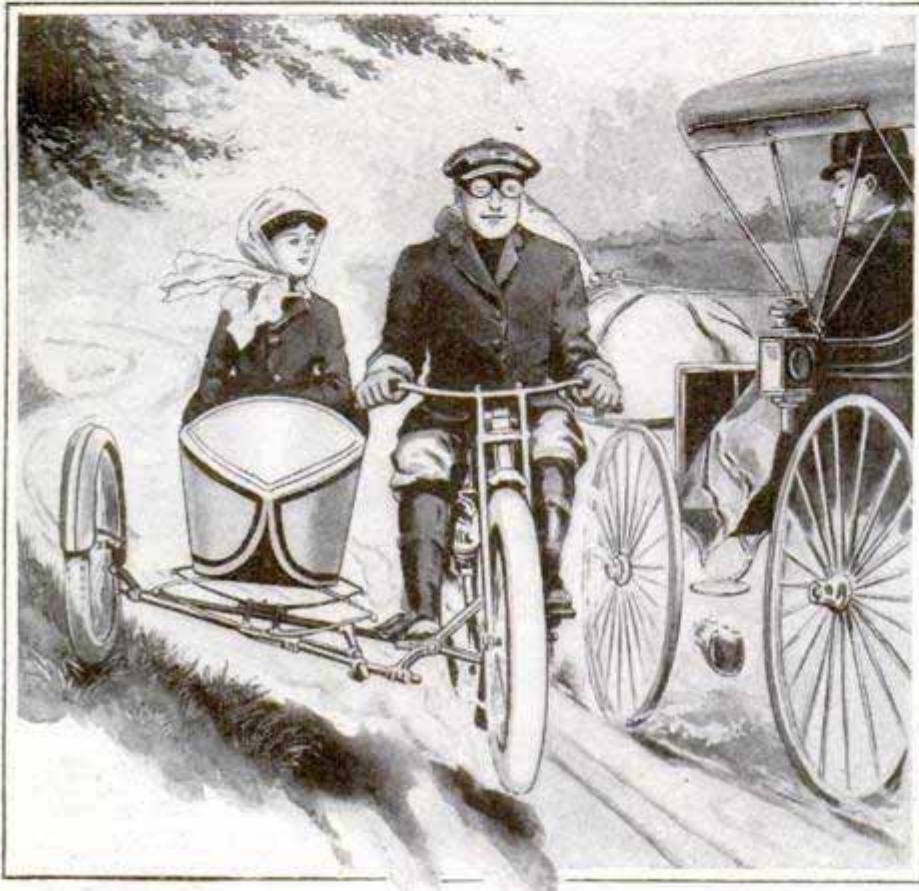

New Sidecar with Flexible Connection, Permitting Easy Adjustment to Rough Roads

a new type of sidecar has been invented. The new design avoids the difficulty met with in ordinary types, in making right and left-hand turns, riding over rough, muddy and slippery roads, by means of a flexible connection to the motorcycle and a compensating device with floating-spring action. This controls the sidecar's wheel, relieving side pulls and skidding.

## DEMAND FOR IRIIDIUM INCREASING

As an alloy for hardening platinum, iridium, which was formerly used only for the points of gold pens, is now being extensively employed. Pure platinum is now rarely used, and iridium, which was once less costly than platinum, has now almost doubled in price.

## TUNNEL LINKS CONTAGIOUS WARDS WITH HOSPITAL

In the newest hospital for the treatment of contagious diseases, built at Evanston, Ill., barriers as intangible as those separating Canada from the United States divide patients suffering from one communicable disease from those afflicted with another. A famous Paris hospital recently demonstrated that patients might be treated in the same ward without cross-infection. The plan adopted at Evanston is an application of this discovery. White lines painted on the floor between the beds mark areas from which nurses and physicians must not step into any other areas without observing certain precautions.

Thus, a nurse, after treating a patient suffering from one infec-

tious disease, must change her infected robe, wash her hands and don a fresh robe before stepping into another area in the same ward, to handle or treat a patient afflicted with a different communicable sickness. The idea that disease germs are capable of locomotion is combated. Germs are shown to be quiescent, increasing only on certain media, but in no sense propelling themselves to a distance, or rushing out like a bulldog to bite an intruder. In the new hospital at Evanston, the contagious-disease building is separate but not isolated from others in the group. A tunnel, 298 ft. long, connects the new building with the others. It is open from one end to the other with a free flow of air throughout, and no fear is felt that contagious disease will be communicated to patients in other buildings.

## JAPANESE CROSS PACIFIC IN SMALL BOAT

The sampan is an Oriental craft of from 10 to 15 ft. in length, housed over and often used as a permanent habita-

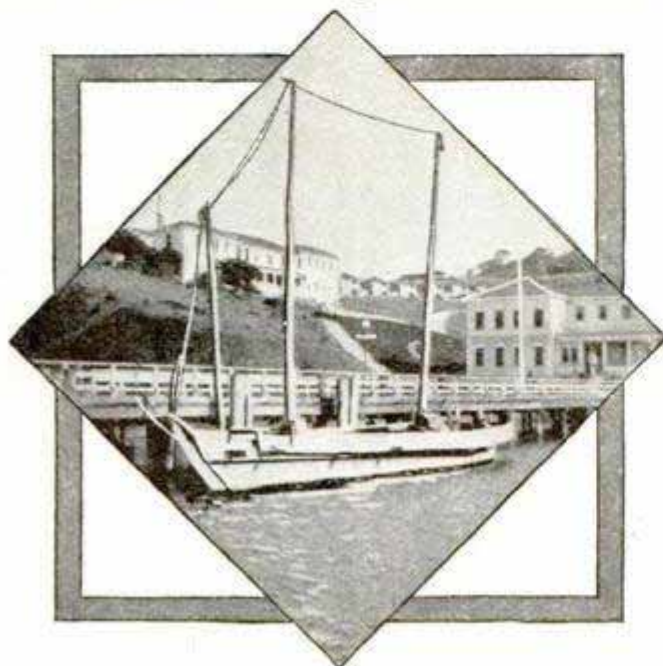

Japanese Sampan Which Carried 16 Men across the Pacific

tion in inland waters. Recently 16 Japanese sailed in a sampan from near Yokohama for America, and crossed the Pacific in 53 days, landing near Point Arena. Immigration authorities, however, took them in charge and brought their boat down to San Francisco. The picture shows a frail craft to dare a passage of 5,000 miles.

## MAN-EATING LIONS MENACE TO RAILWAY BUILDERS

Frequent danger from man-eating lions has proved to be a serious thing in the construction of the Cape to Cairo Railway in Africa, and work on one important structure, the big bridge over the Tsavo River, was actually brought to a stop and kept at a standstill for a considerable period by the inroads of these persistent beasts. Shortly after the construction camp had been formed on the east bank of this river a number of man-eating lions appeared on the scene, attacking the sleeping natives during the night and bearing them off into the jungle. Elaborate precautions and defenses

proved ineffective, and the natives refused to work on the bridge or remain in the neighborhood. It was finally necessary to organize a campaign, on the order of a military campaign, and hunt down the lions in their fastnesses in the jungle. Before the vicinity had been cleared of this terror, 29 Indian workmen and an unknown number of natives had been killed.

## NARROW DRIVEWAY FOR A MOTORCYCLE

Needing a driveway for his motorcycle to save the lawn back of his bungalow, a resident of Tropico, Cal., has designed and built a concrete pathway especially fitted for the purpose. His motorcycle driveway is just wide enough for safe riding—18 in.—and stretches across his lawn for 90 ft. The total cost of the runway, built like an ordinary cement sidewalk, was only \$12, about one-fourth the cost of the usual wide driveway. In laying it, the

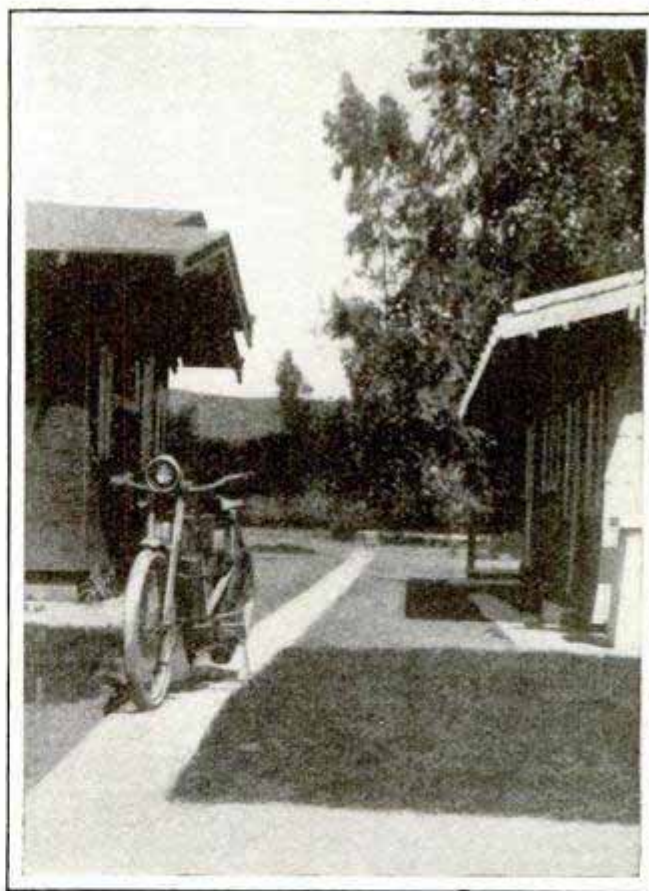

Cement Driveway Especially Designed for a Motorcycle

builder has left room for a parallel strip at the proper distance, to form an automobile driveway.

The Camel is the Only Traction Engine Known to Millions of the World's Peoples. - In India the "Ship of the Desert" is Harnessed to Wagons, Hauling Heavier Loads Than Any Other Animal Except the Elephant

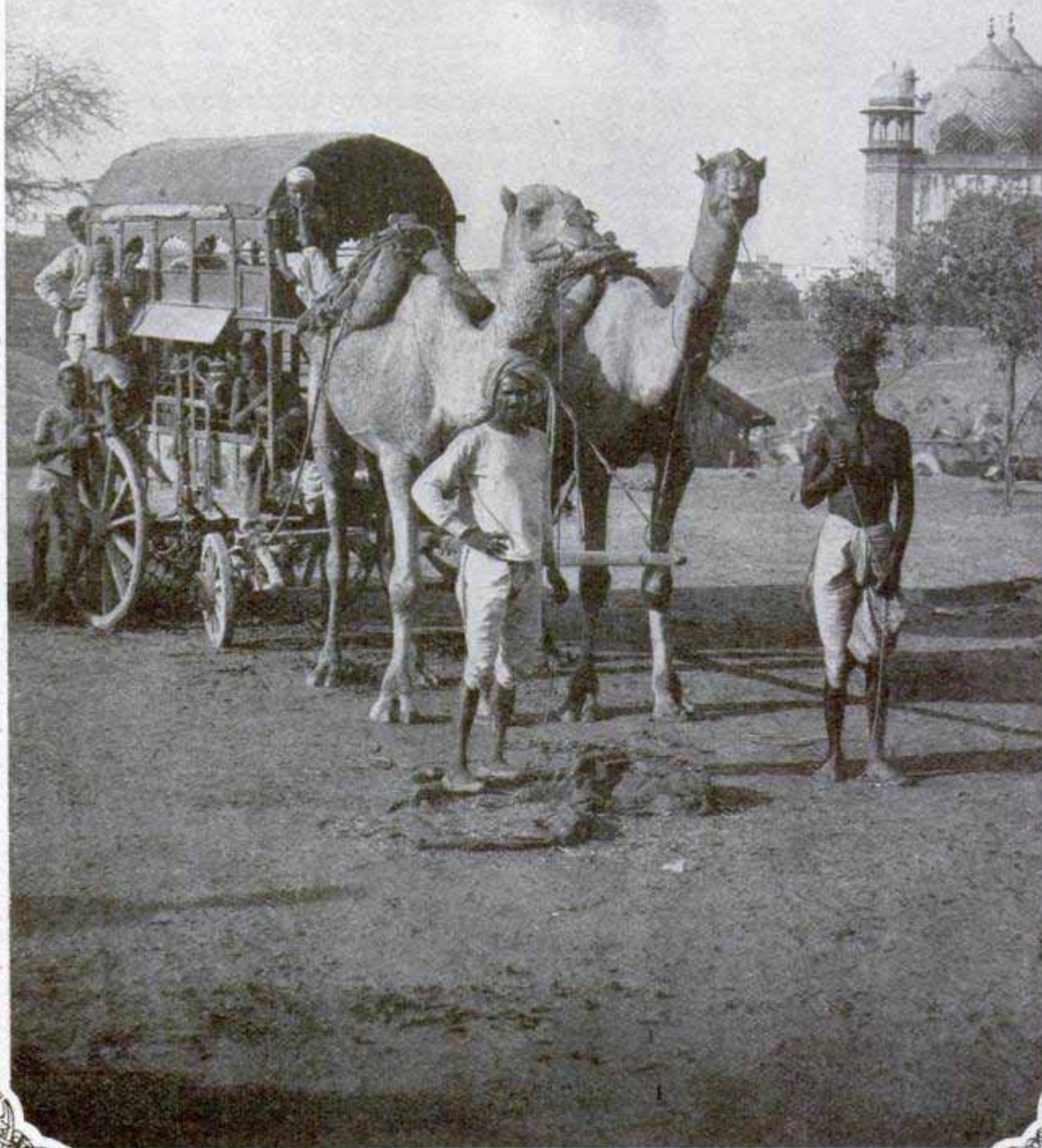

Although Irish Horses are Famous for Their Speed, the Humble Donkey Still Furnishes the Motive Power for the Vehicles of the Common People of Ireland. Two Donkeys Harnessed in Tandem as in This Photograph is an Unusual Combination

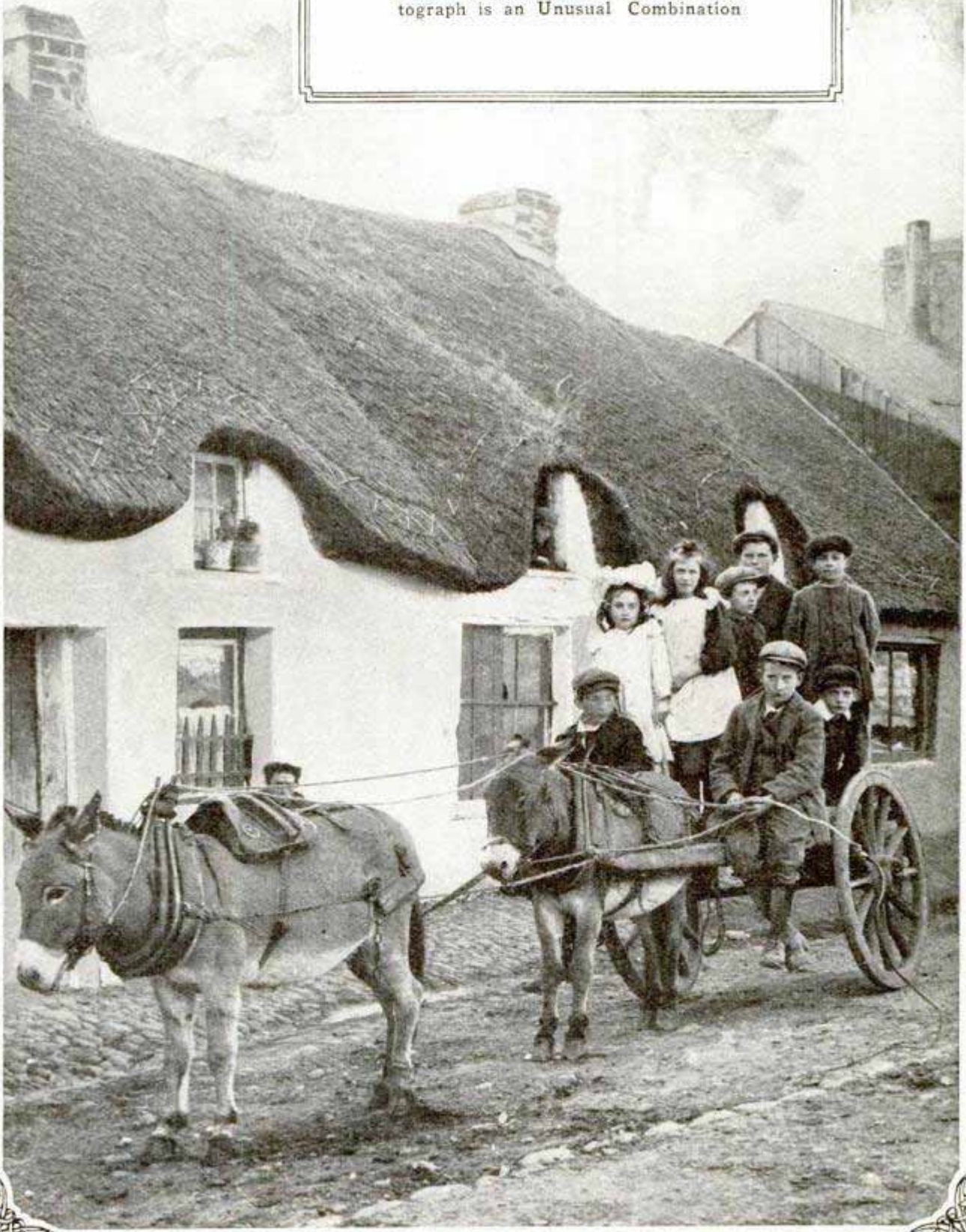

### NEW TYPE OF COMPOUND ARMOR PLATE

The demand for armor plate that will offer protection against the fire of modern military rifles and still will be light enough to be readily transported by troops on land has led to the development of shields and armor of many types. One of the latest inventions in this line is the work of a German, who combines a nickel-steel plate with one of duralumin, and joins the two tightly by a great number of steel bolts. The double plate is very much lighter than would be one of steel of the same thickness, while the duralumin backing is said to add toughness and freedom from splintering to the hardness of the steel facing.

### MORE STEAMSHIP LINES FOR THE ATLANTIC

A new line of steamers is planned to run from Blacksod Bay, Ireland, to Halifax and Boston. The scheme contemplates harbor improvements at the Irish port and a channel ferry between England and Ireland for the conveyance of cargo to Blacksod. Another line proposed is between Gothenburg, Sweden, and the United States, consisting of two 18,000-ton steamers, with the American terminal at Boston. A freight and passenger service is projected between New Orleans and Italian ports, Naples and Palermo, under the auspices of the Navigazione Generale Italiana, with first sailing early this year.

### A NEW TYPE OF RAILWAY LOCOMOTIVE

While steam and electric locomotives are contending for supremacy on American railroads, an entirely new type of railway locomotive has appeared in Germany and has been put into regular service hauling express trains between Berlin and Magdeburg. It is called the Thermo Locomotive and is propelled by a Diesel internal-combustion engine fed on crude oil. The locomotive has a four-wheel

driving truck in the center and a small pilot truck at each end. Mounted on the driving truck is a powerful V-shaped Diesel motor operating a shaft from which power is carried to the driving wheels by short connecting rods. Driving cabs have been built on both ends so that the locomotive can run in either direction, and oil tanks are carried on each side of the two cabs.

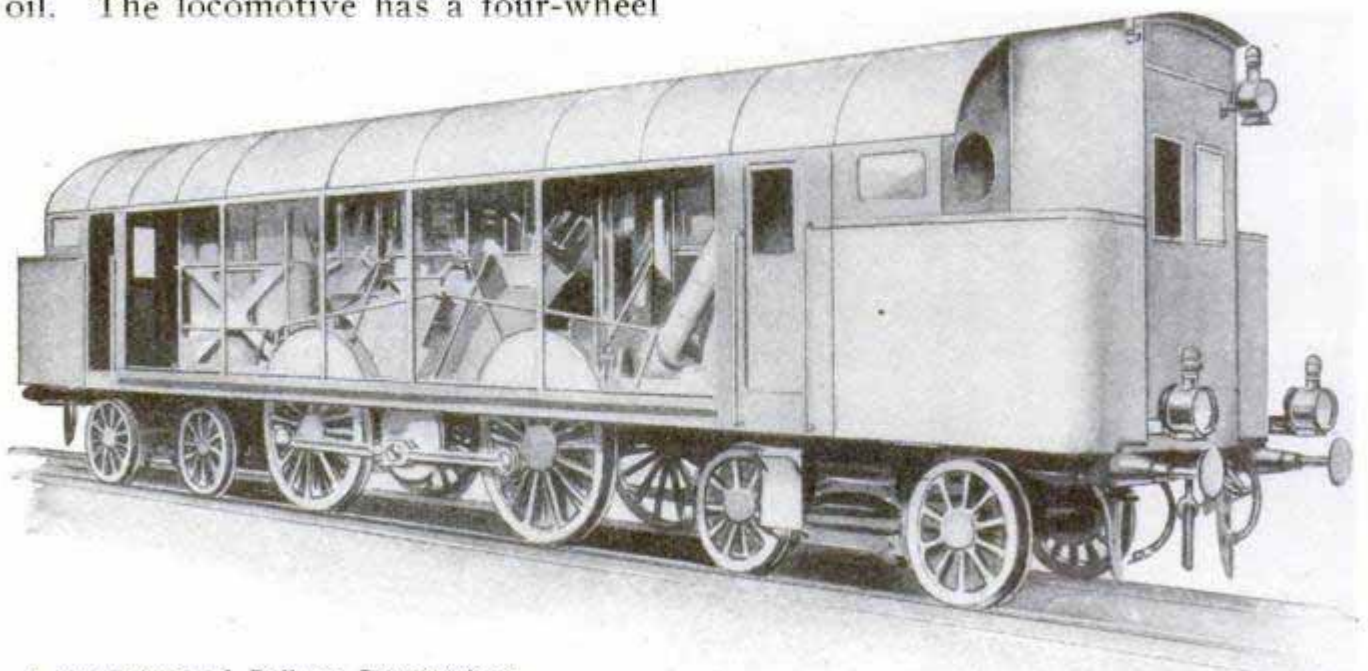

A New Type of Railway Locomotive:  
The Thermo Locomotive Propelled by an Internal-Combustion Engine

## PLATING WITH A SPRAY OF MOLTEN METAL

Metal spraying is a new process which has recently appeared in Ger-  
 ter of the flame in the form of a wire passing through the nozzle. As the



Apparatus Used in New Process of Plating with a Spray of Molten Metal

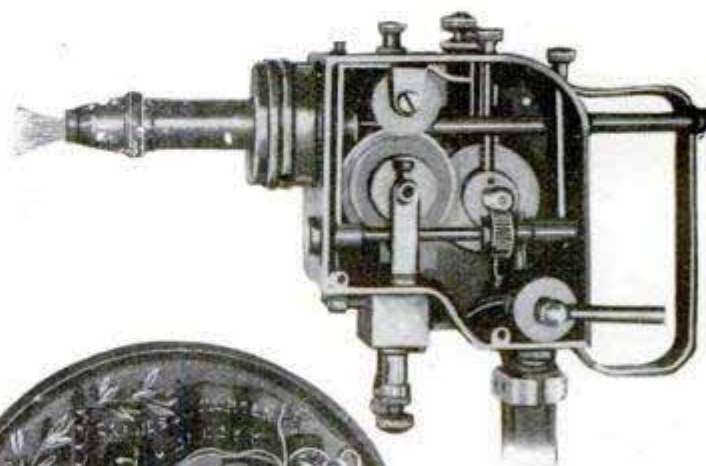

The Nozzle Consists of an Oxyhydrogen Flame Which Melts and Sprays Small Particles from the End of a Wire



Medal Made by Spraying Metal upon a Hollow Mold

many to take the place of electrolytic metalplating. It is not limited to metalplating, but can be used for depositing a film of metal or glass upon wood and other substances. The special apparatus used in the process is a nozzle, like a blowpipe, for producing an oxyhydrogen flame. The metal or glass to be sprayed is fed into the cen-

ter of the flame in the form of a wire it melts off small particles of the metal and deposits them in the form of a spray upon the object to be plated. Besides its industrial use in metalplating, the process has a place in the arts in the making of medals and bas-reliefs.

### MARINES TO HANDLE TRAINS IN ENEMY'S COUNTRY

In order to have men available in the military service for handling trains in the transportation of troops in an enemy's country, the War Department has arranged to have the marines stationed at Panama systematically trained in all features of train operation. Marines are now riding back and forth across the isthmus on the regular passenger engines of the Panama Railroad and are being instructed by the engineers in everything relating to engine running, air-brake operation, and the handling of trains.

### MOVING PICTURES REVEAL LIVING-CELL FORMATION

The Society of Biology in Paris recently watched a moving-picture film in which the formation of living cells was shown. Tadpoles which had been subjected to a fast for several weeks were fed and drops of their blood placed under the cinematograph. The pictures plainly showed the blood corpuscles forming and then dividing, revealing the phenomena of the growth of animal matter.

⌈The ordinary crew of one of the big transatlantic liners numbers over 800.

## NEW TYPE OF MAIL BOX RECENTLY ADOPTED

A distinct saving of time is claimed for a new quick-emptying mail box lately adopted after exhaustive tests



Quick-Emptying Mail Box  
Adopted by the Post-  
Office Department

by the postal authorities. Somewhat larger than the boxes it is designed to supersede, its principal point of difference is that when fully opened, the bottom drops down at an angle of  $25^\circ$  so that the contents will slide, without handling, into the waiting automobile or carrier's bag. The

box, filled with mail, can be emptied in 12 seconds, while the old box, from which the mail must be taken by hand, requires fully two minutes. Another departure is that the letter drop is pivoted so that a slight pressure will open it. A handlebar extends across the top, instead of the small protrusion on the old boxes, and with this handle the drop may be opened with an umbrella or the pressure of a package. The opening of the drop is larger, admitting an envelope 12 in. long. Within the box is a guard which prevents robbery when the drop is open.

## TO BUILD HIGHWAY TUNNEL UNDER HUDSON RIVER

A highway tunnel under the Hudson River at New York City, connecting the highway systems of New York and New Jersey, is proposed by the Bridge and Tunnel Commissions of the two states instead of a bridge. There is but one bridge across the Hudson, south of Albany. That is at Poughkeepsie, 75 miles above New York City. The project for a bridge from Manhattan Island to the New

Jersey shore has been agitated for a hundred years, but the great height at which it would have to be built to give sufficient clearance for shipping, and the value of the land that would have to be taken for terminals, would make a serviceable bridge cost \$50,000,000, the commissions estimate, while a tunnel with two tubes, each having a 17-ft. roadway, could be built for \$11,000,000. The average number of vehicles crossing the Hudson in ferry-boats is 19,660 per day. All but 2,000 of these cross below Twenty-third Street, and to make the highway tunnel accessible to this traffic it will have to be built below that point. A tunnel such as proposed would have a capacity of 5,000,000 vehicles a year, or about the number now crossing the river. Mechanical ventilation and means for maintaining perfect cleanliness are included in the plans.

## ELECTRIC SHAVING DEVICE FOR SAFETY RAZOR

An invention which is devised to facilitate shaving with a safety razor has an electric attachment by means of which the razor blade is given a vibratory motion, cutting the hair by blows, instead of the usual sliding stroke. The small motor may be set to give a very large number of revolutions per second, and it does not take more than two or three minutes for a clean shave. No lather

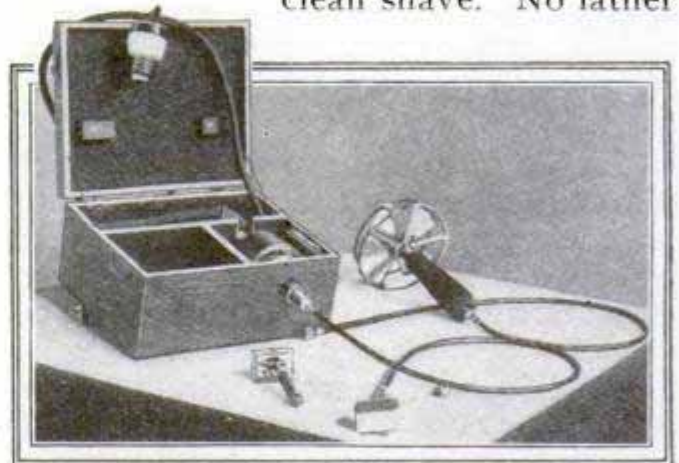

Novel Toilet Set, with Safety Razor and Fan  
Attachments

is necessary, a wetting of the skin being sufficient. The motor plugs into any lamp circuit.



## GERMAN RAILROAD TO BE BUILT ON SAND DUNES

A railroad is to be built from Cranz to Schwarzort, in Prussia, along the Kurische Nehrung, a narrow spit of land that separates the Baltic Sea from a salt-water lagoon known as the Kurisches Haff. This peculiar land formation is 72 miles long and from one to two miles wide, and is fringed with sand dunes, many of which rise to a height of 200 ft. The railroad is remarkable in that it will be built for the greater part of the distance on these sand dunes, which show a constant tendency to shift their position. On the Kurische Nehrung are located a few fishing villages and a great many summer resorts, and it is to serve the latter that the railroad is to be built.

## GLASS ROOF NOVEL FEATURE IN MOTOR BUS

An innovation in motor-bus design is shown in Boston where a recent model, replete with new features, has a roof of wired glass, flooding the interior with light. The bus has a capacity of 22 passengers and all seats are built transversely. Opposite each row of seats is a window which is detachable, and when not in use is stored

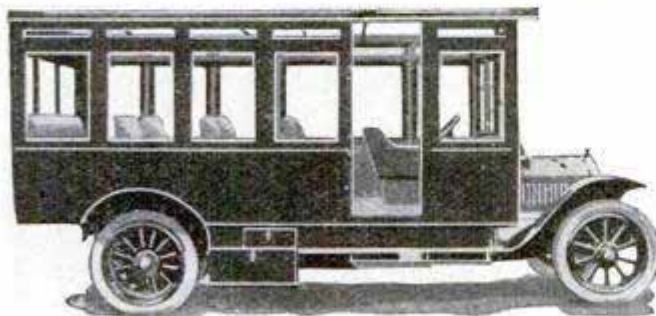

Courtesy Motor Age  
Well Lighted Motor Bus with Glass Roof

in a special cabinet beneath the chassis frame. Extra tires also are carried in a cabinet instead of on the frame.

## MOTOR SLEIGH BREAKS SNOW ROADS

A motor sleigh, designed expressly for the "breaking" of snow roads, was placed in operation last winter in and

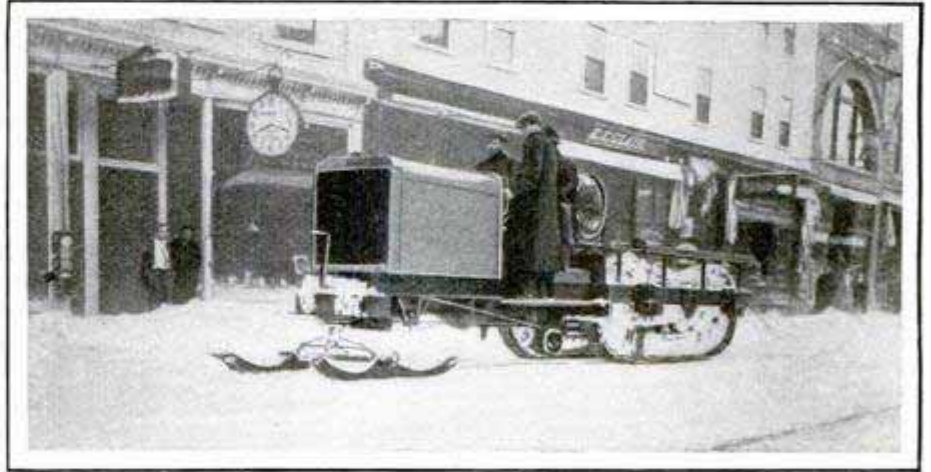

Cleaning Roads of Snow with a Motor Sleigh

around Waterville, Maine. The road breaker is mounted on runners at the forward end and has endless-chain, spiked wheels at the rear. A snowplow, hitched to the rear, throws the snow many feet away, making a clear surface. The machine, driven by a 60-hp. engine, makes 12 miles an hour.

## PARCEL POST WILL HANDLE LARGER PACKAGES

A ruling of the Postmaster-General, recently approved by the Interstate Commerce Commission, increases the weight limits of parcel-post packages, in the first and second zones, from 20 to 50 lb.; admits books to the parcel post, and reduces rates in the other zones materially. The maximum weight for parcels in all zones beyond the second was increased from 11 to 20 lb. From the already published rates the reductions are as follows: In the third and fourth zones, 1 cent less on the first pound and 3 cents less on each additional pound; in the fifth and sixth zones, 1 cent less on each pound sent. Parcels containing books weighing 8 oz. or less will be carried anywhere for 1 cent for each 2 oz., and on those weighing more than 8 oz., the parcel-post rate for the zone shall apply.

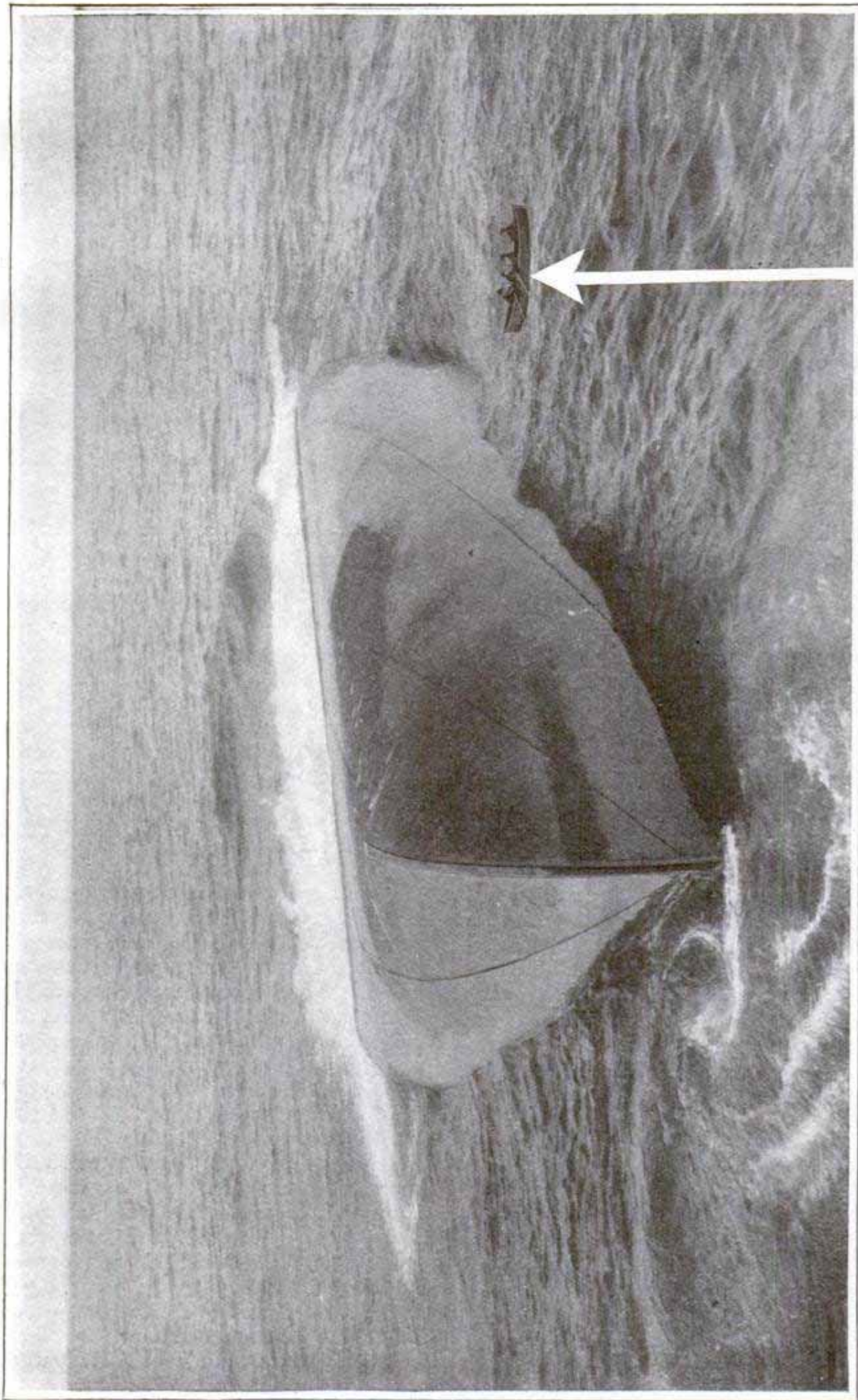

A Tragedy of the Great Lakes — Wreck of the 500-Ft. Freight Steamer "Charles S. Price," Floating Keel Up in Lake Huron. The Small Boat to Which the Arrow Points Gives a Good Idea of the Immense Size of the Capsized Vessel

## AUTUMNAL STORMS SCOURGE GREAT LAKES

With every autumn come disastrous gales sweeping the Great Lakes and often bringing heavy loss and many deaths in their train. The storm which swept the lakes in November, 1913, was, however, the most severe in the history of steam navigation on the lakes. A gale of hurricane force came out of the north without warning and sent a score of vessels to the bottom, while 244 sailors lost their lives and property valued at many millions was destroyed. Practically all the damage was done in Lake Huron, "the graveyard of the Great Lakes." The lost ships had no wireless equipment.

Eight miles north of Port Huron, Mich., a huge steel freighter was found half submerged, bottom upward, only part of the forward end above water. A hundred feet of steel keel and sheathing could be seen, but no name nor marks by which she could be identified. Strewn on the shores of the lake was wreckage from a half dozen large lake craft telling grim tragedies of the storm, but giving no clew to the mysterious ship which had "turned turtle" in the gale.

It required the services of a diver to solve the mystery. After the waves had subsided and the fog had cleared away, a vessel with proper equipment approached the unknown wreck and a diver was sent down to explore the interior. He brought back word that the vessel was the "Charles S. Price," a modern steel freighter, 504 ft. long, originally carrying a crew of 28 men. Investigation proved that the hatches had been washed away and the water, pouring into the hold, turned the ship on its side, when the force of the gale sent the whole ship over. While she did not sink at once, every soul on board was lost, her firemen and engineers drowning in the engine room. The wreck floated for 48 hours after being discovered and identified, then sank as the confined air in the hull gradually leaked out, which alone had kept the wreck above water.

## BEAUTIFUL MONUMENT TO COMMEMORATE MIRACLE

In granite and bronze a memorial shaft has been raised in Salt Lake City by the descendants of the Mormon pioneers who fled across the Great American Desert to found a colony in the wilderness, commemorating the providential appearance of a flock of gulls at a moment when a plague of crickets had threatened the very existence of the infant colony. The monument consists of a slender shaft rising from the pedestal and crowned by a huge granite ball, surmounted by bronze gulls, without stretched wings.



Suitable tablets on the base of the monument portray the dramatic rescue of the pioneers from famine, and a fountain, 40 ft. in diameter, surrounds the base. A simple tablet bears the legend: "Erected in Grateful Remembrance to the Mercy of God to the Mormon Pioneers."

## MODERN THEATER TO BE BUILT IN MANILA

A modern theater to cost about \$250,000 when fully equipped, and having a seating capacity of about 1,500, is to be built at Manila, P. I., on land leased from the government. The building will be a five-story structure with roof garden and will have the most modern equipment. The auditorium is to be automatically cooled by chilled air.

## AUTOMATIC MACHINE FOR MAKING STEEL TUBES

A new machine does away with the numerous operations now necessary in making seamless steel tubes and combines all in one continuous operation. Each step

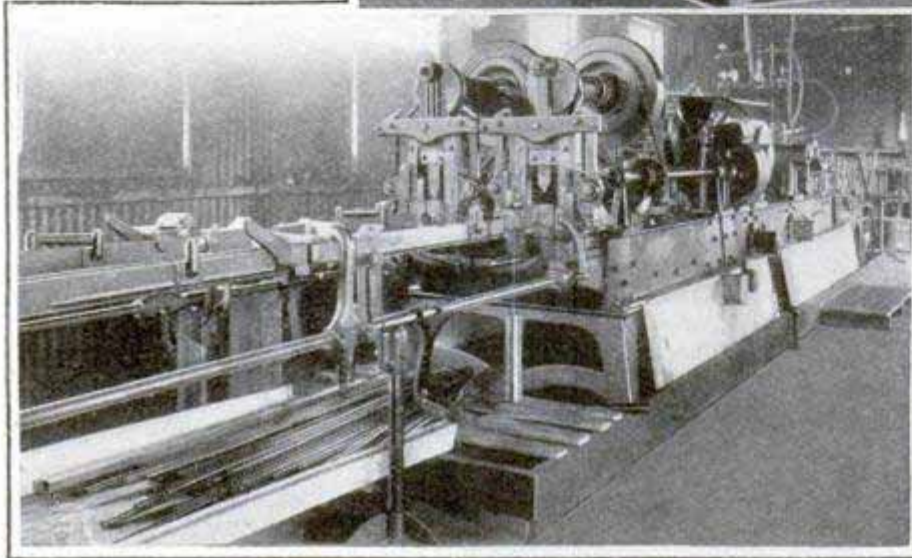
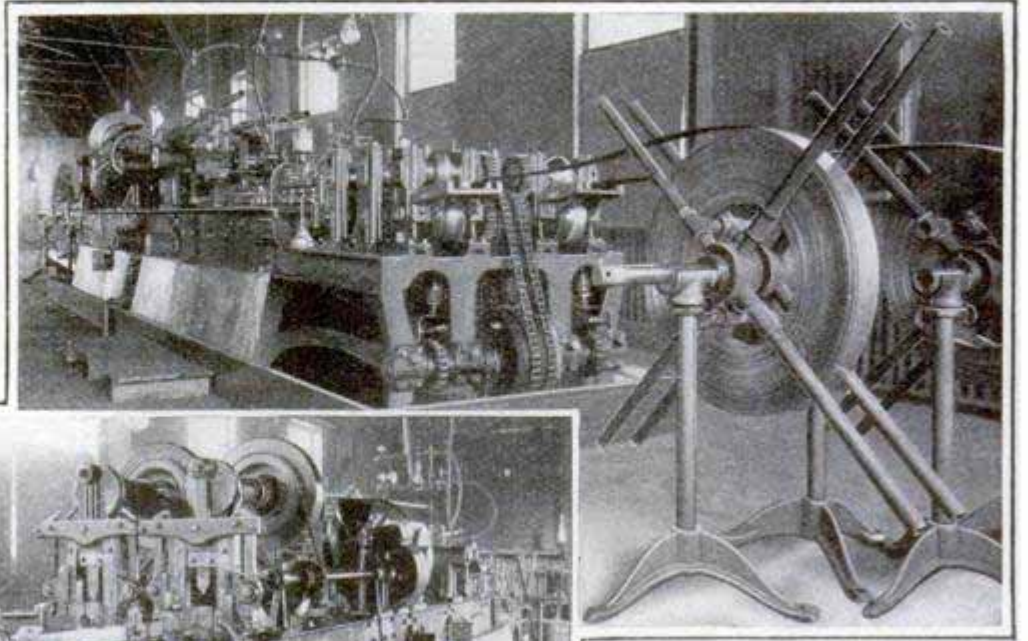

How the Sheet Metal is Fed into the Tube Machine

The Other End of the Machine, Where the Finished Tubes are Deposited

in the process of manufacture is automatic, from the forming and welding to the final cutting of the tubes to the required lengths. This machine will, it is claimed by the inventor, turn out finished tubes at the rate of 4,000 ft. per day, while, by adjustments easily made, any shape of tube desired, in diameters ranging from 1 in. to 7 in., may be made. The flat metal strip is first drawn through a series of small rollers and formed into tube shape with a small mandrel on the inside, and

emerges from these rollers to all appearances a seamless tube, the edges being even and tight. It then passes through a device which holds it in position while the edges of the metal are welded together by the oxyacetylene process, after which the burr is removed with a knife and the tube is smoothed with an emery wheel. The next process is that of sizing and polishing, which is done by cold-rolling with water. The tube then passes through a straightening device and is finished by being cut to the required length. These operations are all performed by the one machine, which occupies a floor space 3 ft. wide and 20 ft. long.

### COOLING GAS ENGINES WITH INJECTED WATER

A new system of water-cooling for internal-combustion engines has been developed recently by an English engineer, as a substitute for the water jacket. The cooling is effected by squirting water on the inside surfaces of the cylinder from a spray in the

cylinder head. It goes further than introducing water with the charge of gas, as is done in some oil engines, for that merely lowers the temperature of the gas without cooling the cylinder walls; it sprays water in a stream of sufficient size to strike the metal in liquid form. The water is injected through a hollow "rose" casting, with 25 holes of  $\frac{1}{40}$  in. diameter on all

sides, and a pump connected with the cam shaft. As the most heat is transmitted to the cylinder walls at the moment of explosion, the spray is not continuous, but is regulated to flow just at the point of ignition when the piston is near the head of the cylinder. The temperature of the metal is also kept above 212° F. so that the water boils as soon as it strikes the metal. In this way no water touches the lower part of the cylinder or any of the sliding surfaces, and the spray causes no corrosion or lubrication difficulties. Cooling of the lower part of the cylinder is accomplished by convection of heat through the piston into the cooler cylinder head. The new system of cooling has been tested on a 40-hp. gas engine, with a cylinder of 21-in. stroke and 11½-in. bore. The water-

jacketed cylinder was replaced by a smooth-bore casting with a water jet in the head. During the last two years the engine has run some 5,000 hours and has developed from 43 to 50 hp. without overheating and with no more than the usual corrosion or wear. Besides cooling the engine the spray reduces the pressure of the charge enough to make the explosions almost inaudible.

☞A jelly for table use is made from the waste resulting from the manufacture of ivory into various articles. This ivory dust is boiled 8 or 10 hours, and the product, when strained, is a clear jelly which may be flavored to taste.

☞The refrigerator ships of the world number 171.

### THREE-WHEELED DELIVERY TRUCKS

Light three-wheeled motor trucks, driven by a single rear wheel, are beginning to take the place of horses in light-delivery work where other heavier vehicles have failed. The latest type, with two wheels in front, is the last stage in the development of the motorcycle into a commercial vehicle and comes after many experiments with unwieldy sidecars, complicated drive by two rear wheels, etc. In England, the three-wheeler

has appeared in the form of a converted automobile with the seat over the wheels and a single driving wheel behind. In America, the type is

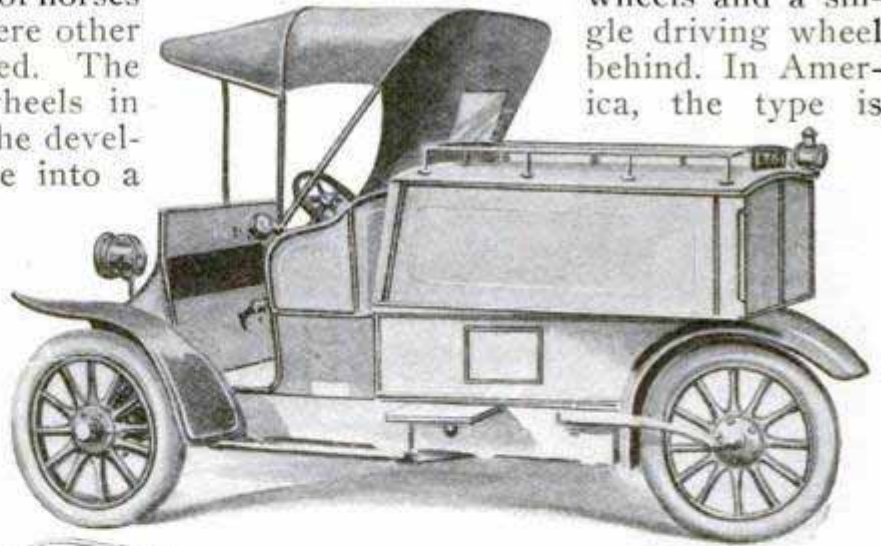

English Three-Wheeled Light Truck, Driven by the Rear Wheel

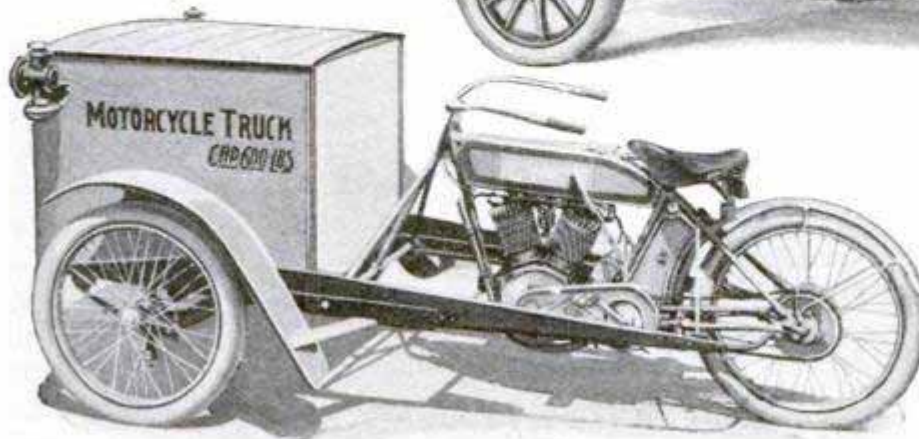

American Motorcycle Converted into a Three-Wheeled Light Delivery Truck

represented by a motorcycle in which the front wheel is replaced by two wheels and a carrier box. The American machine is built to carry 600 lb. in addition to the driver and has a wheel base of 76

in., a tread of 56 in., and 3-in. tires. It has two-speed gear and a free engine clutch, so that the engine can be started with the pedals. While the carrier box is placed over the front wheels, an underslung chassis distributes the load evenly. The truck will run from 40 to 45 miles on a gallon of gasoline, and in a recent test it was able to cover a 14-mile parcel-post route in half the time used by the regular horse and wagon.

### ANOTHER GREAT IRRIGATION DAM COMPLETED

Second only to the great Roosevelt Dam, near Phoenix, Ariz., is the barrier erected in the Medina Valley, near San Antonio, Texas, whereby a tract of 60,000 acres in a plain country will be brought to productiveness

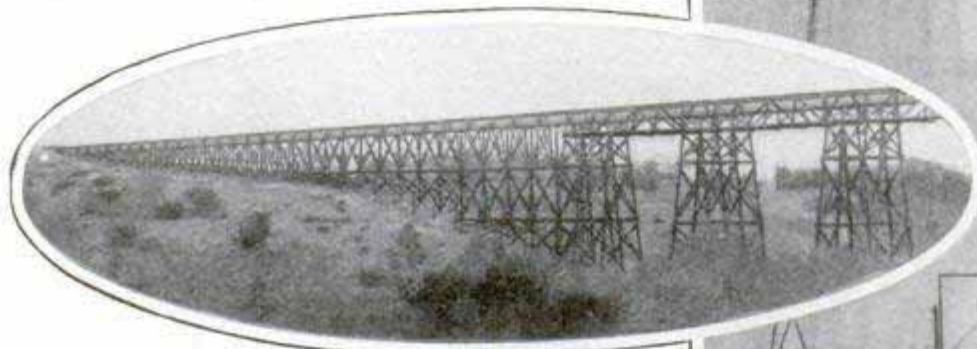

Concrete Siphon and Flume Carrying Canal across the River

through irrigation. Towering 164 ft. above water level of the cañon, the Medina Valley Dam contains over 300,000 cu. yd. of concrete. The flood waters of the upper Medina River emerge through a comparatively narrow cañon into the rolling coastal plains of southeastern Texas. The torrential nature of the stream makes necessary an enormous storage capacity of the main reservoir, which is designed for a capacity of 300,000 acre-feet. The project is far-reaching in its plan and the task has been adequately accomplished. The foundations of the main dam lie in the massive level-bedded limestone which forms the cañon walls and all the hills of this district. From the bottom of the lower trench to the crest of the concrete, the dam measures 180 ft. The spillway,

1,200 ft. in length, is over the saddle into an adjoining ravine. The materials, save for the cement, were found at the site. No sand being available, the fines and dust from the crushers were used, and huge boulders, up to 10 tons in weight, were imbedded in the concrete, 10 to 15 per cent of the mass at the bottom consisting of these plums, though toward the top the percentage gradually decreased. Cableways transported the concrete and gravity was used wherever possible to bring the material down to the workmen. Progress was rapid without be-

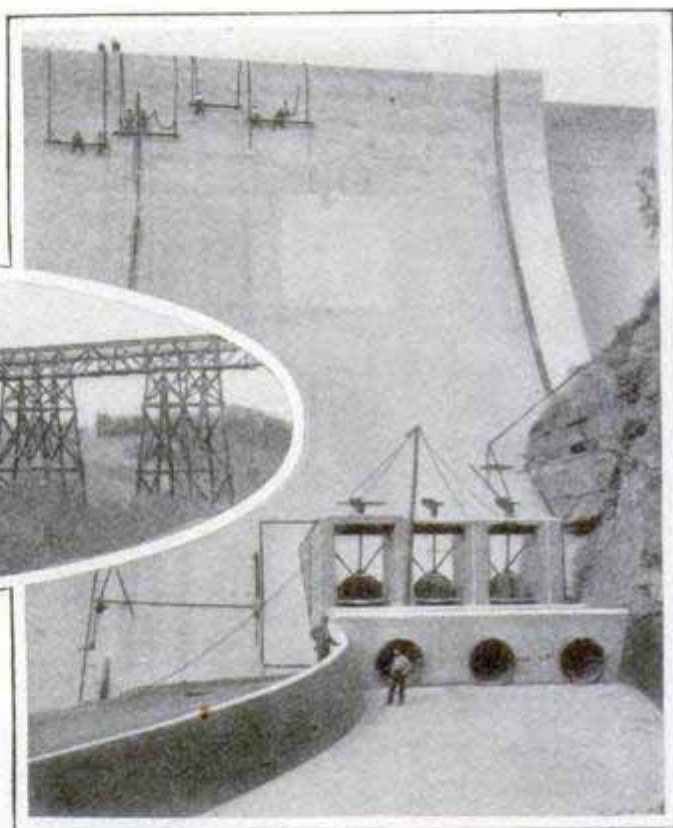

Main Outlet Gates of Medina Dam

ing hurried, and a record of 40,303 cu. yd. in one month, on 10-hour shifts and with no Sunday work, indicates the speed with which the construction was pushed. The monumental character of the project is seen in the length of the crest, the Medina Dam being 1,580 ft. long, while the width at the base is 128 ft., and at the top, 25 ft. A secondary dam, 50 ft. high, converts the main channel of the river into a narrow lake, four miles in length, and conducts the water from the main dam to the lands along the river bed. From this diversion dam the main canal

extends 24 miles to the head of the distributing system. Siphons of reinforced concrete carry the water the first mile and a half on the west bank, and the canal is then carried across the river in two concrete bores, 8 ft. in diameter, on a creosoted-timber trestle of long-leaf Texas pine, with concrete pedestals.

### A REMARKABLE HACKSAW TEST

The exceeding toughness and strength of the steel used in making hacksaw blades was demonstrated recently in an unusual manner. A hacksaw was suspended and from the blade, by means of hook and tackle, a board was swung underneath. Upon this two men, whose weight aggregated 282 lb., stood, the narrow band of steel supporting the burden without breaking.

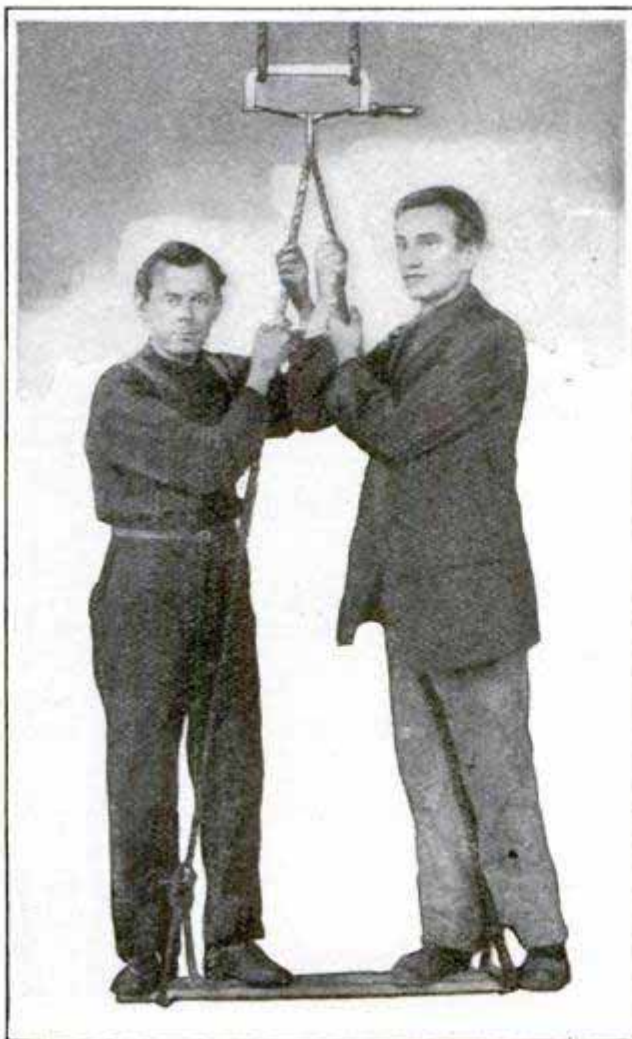

Slender Hacksaw Blade Sustains Heavy Weight

### CHINESE HAYSTACKS ON STILTS

The Chinese farmer must protect his hay crop from floods. And this photograph, taken just outside of the



How the Chinese Keep Their Hay from Floods

village of Tien Tai, three days' journey inland from Ningpo, shows how he does it. Tall, straight trees are selected in convenient localities and the hay is formed in stacks, or nests, about the trunks at a distance from the ground varying with the locality. These queer haystacks are thatched on top and are impervious to the rain, while all the ground underneath may be covered with flood waters without injuring the hay crop of the neighborhood in the slightest. Some villages have a common stacking ground, which at a distance looks like a village of tree dwellers or the abode of some particularly ingenious wasps.

### COHERENT SPEECH SENT ACROSS ATLANTIC

The first coherent spoken message successfully sent across the Atlantic was transmitted by wireless from Neustadt, Hanover, Germany, to Tuckerton, N. J., recently. The tall wireless tower at the latter place, described in the January number of this magazine, was the receiving station, and the high-frequency Goldschmidt wireless apparatus was used.

☐ In Philadelphia alone there are about 1,400 stationary gas engines in use, aggregating about 12,500 horsepower.

## ACCIDENT TO FRENCH INTERURBAN

An electric interurban train near Nice, France, consisting of a motor car with three passenger coaches

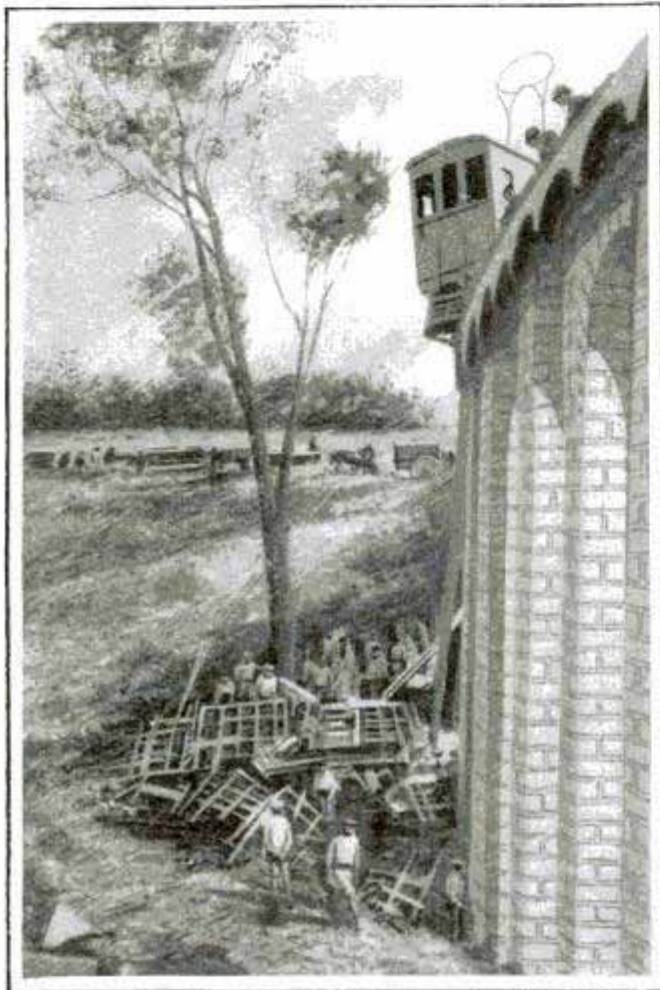

Courtesy L'Illustration  
Scene of Derailment in France Which Caused  
Nineteen Fatalities

carrying a number of soldiers, had just reached the viaduct at Torcirol at the end of a curve on a steep grade, when the motor car was derailed. It swung against the parapet, demolishing it. The couplings broke and the passenger coaches plunged down into the ravine, 40 ft. below, while the motor car was left hanging perilously, on the edge of the viaduct. Nineteen soldiers lost their lives in the accident.

☞The first commercial wireless message between America and Asia was sent recently from the U. S. Army station at Nome, Alaska, to the Russian government station at Anadyr, Siberia.

## UNIQUE HOUSE-BOAT REPLICA OF COLUMBUS CARAVEL

Desiring a house boat which should be more picturesque than the box-on-a-mud-scow type so often used, a Boston business man has built the "Halcyon" which reverts to the time when "in 1492, Columbus sailed the ocean blue." In length this craft is 76 ft., and is 21 ft. wide, with a draft of a trifle less than 4 ft. It is three-masted, with a lateen sail on the mizzen, and has figurehead, fighting top and high lantern aft, in the last detail of the old-style ship of the fifteenth century. While it is proposed to use the sails in favorable winds, a 6-cyl., 70-hp. motor has been installed so that the boat will not be at the mercy of calms. The interior arrangement provides the comfort of a house boat, and exceptional convenience has been found possible in this type boat. By carrying out the high quarter-deck and running the sheer well aft, an excellent stateroom has been provided with plenty of light from the large windows at the side and from a transom. Forward of this are two large staterooms for guests, each with toilet facilities. The large main saloon is in the center of the boat, under the main deck, with ample headroom. The galley is just ahead of this, with a stateroom for the captain and steward on the port side. The "Halcyon" is probably the first ship built on these lines since the fifteenth or sixteenth centuries, save for the Columbus caravels built for the World's Fair in Chicago in 1892.

## LUBRICATING OIL MIXED FOR WINTER USE

Graphite mixed with cylinder oil until the mass is of the consistency of paste, and then reduced with kerosene until it flows freely, is recommended by an engineering authority for outdoor use in winter where lubricating oil is required. It is claimed that this compound will not stiffen at a temperature of 14° below zero.



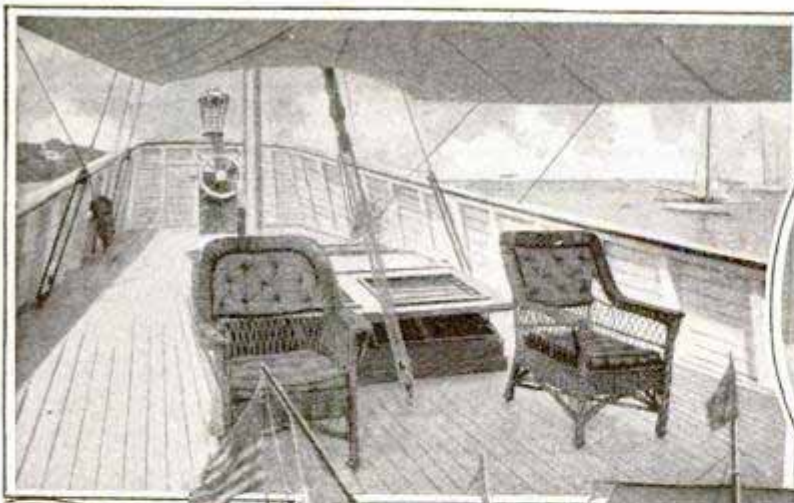

Quarter-Deck  
on the House  
Boat

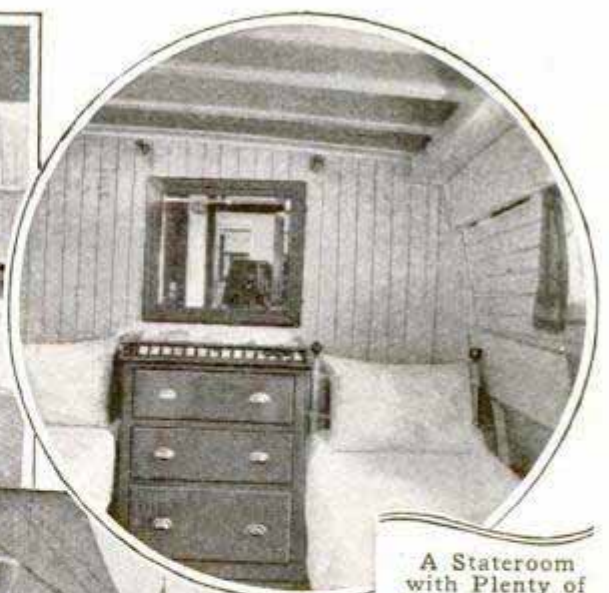

A Stateroom  
with Plenty of  
Light and Air



The  
Motor Caravel  
"Haleyon"

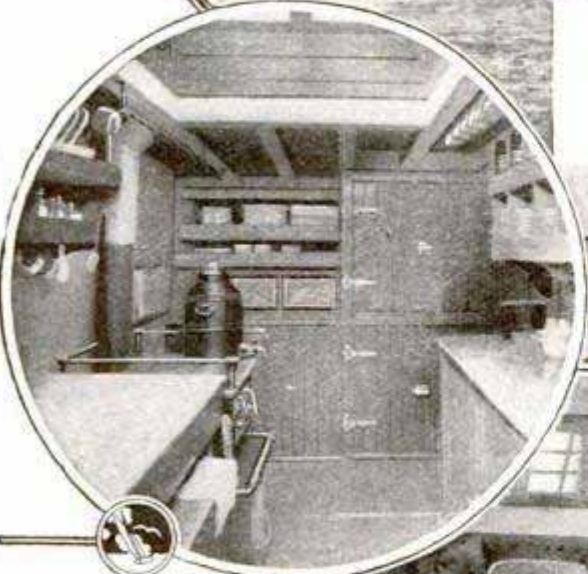

The  
Commodious Galley

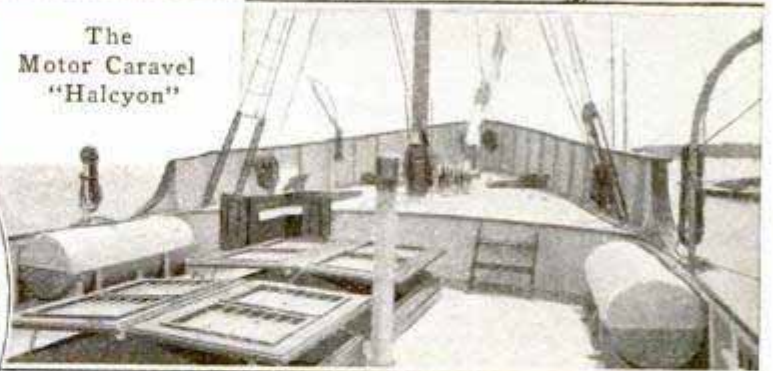

Looking Forward  
on the Main Deck

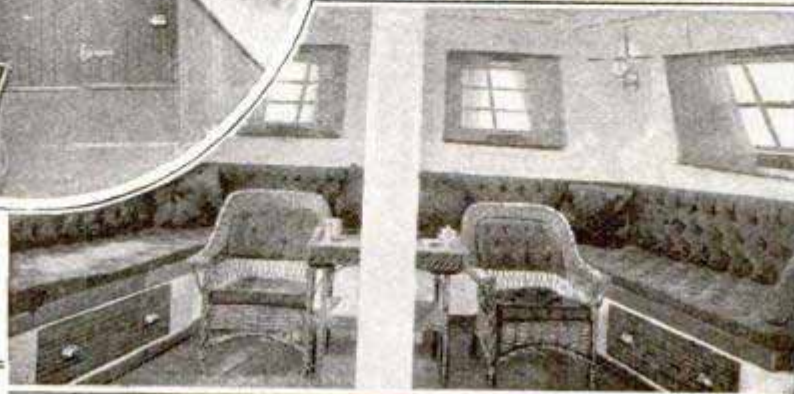

The  
Main Saloon

### HOUSING THE SPARE TIRE

A false back panel of a limousine is used in a late model shown at an automobile show, to serve as carrier for



Cupboard Formed in Limousine by False Back Panel two spare tires. This cupboard is so arranged that when the doors are closed it is almost impossible to tell that the panel has hinged joints. Besides the tires sufficient room is given to store inner tubes, spare rims, or such other extras as experience shows are most necessary on a tour.

### DEVELOPMENTS IN NAVY AVIATION SERVICE

The use of the flying boat and the establishment in this country of a national aeronautical laboratory have been the principal subjects of interest in the development of aviation in the navy during the past fiscal year, according to the annual report of the Chief of the Bureau of Navigation. The success of the flying boat is now practically assured, while a broad scheme of coöperation is in effect, whereby all institutions in the country, public and private, are enabled to work together in harmony with the government laboratory and to avoid unnecessary duplication. At the end of August, 1913, 2,118 flights, aggregating a distance of about 27,097 miles, had

been made from the naval camp of aviation at Annapolis, and one officer of the navy had been up 546 times. Much is expected of experiments to be conducted at Washington, where an apparatus has been installed for determining the best scientific and practical method of control of aircraft, these activities being simply a part of a comprehensive plan looking to the development of an adequate aviation service for the navy.

### ELECTRIC SELF-STARTER ON FLYING BOAT

An electric self-starter has been installed on a flying boat operating at Marblehead, Mass. This innovation is in line with late practice in automobiles, which relieves the driver of the necessity of cranking up the engine, and obviates the very real danger ensuing when an engine goes dead at critical points. To the airman the idea appeals especially, because engine trouble a couple of thousand feet up in the air is an unpleasant prospect.

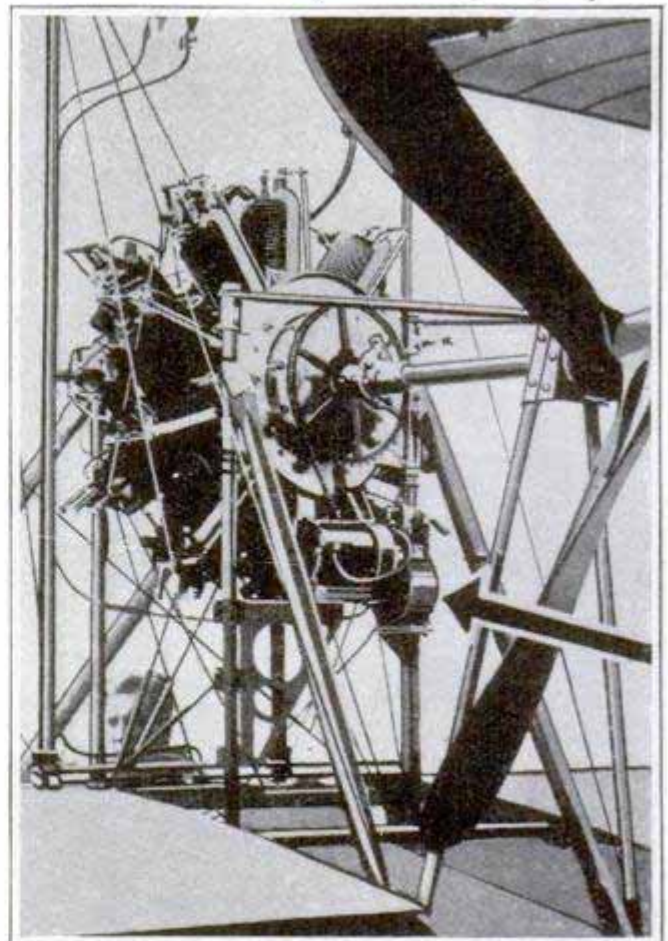

Arrow Shows Electric Starter Installed on Flying Boat

## STRENGTH OF THE SUCTION BETWEEN SHIPS

The danger of collision between passing ships as a result of the "suction" or interaction between them was

other vessels. Ahead of the bows there extends a fan-shaped region of increased pressure. Back of this, amidships of the vessel, the water flows inward and backward and there is a region of reduced pressure. At the stern

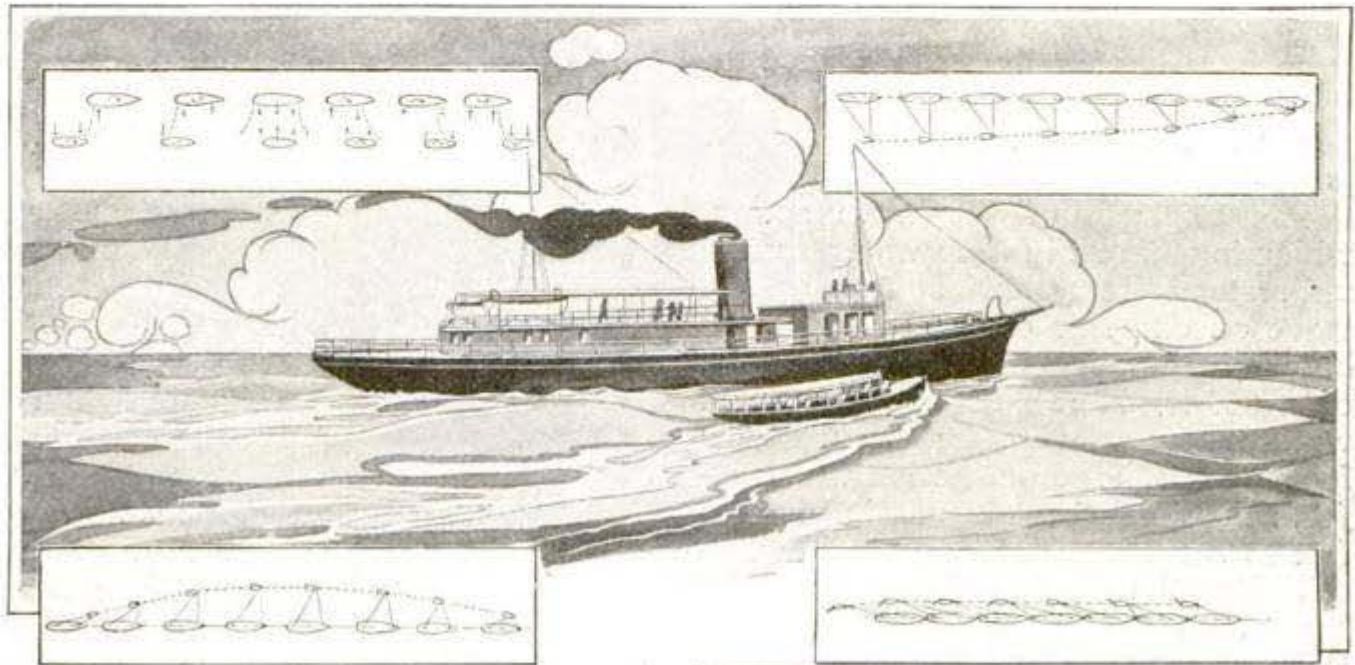

The Suction between Passing Ships Which Causes Them to Collide: Forces Exerted on a Launch Passing a Yacht Traveling in the Same Direction

recently studied in a series of experiments with real vessels. Previously tests had been made with small models, but in this case a 96-ton steam yacht and a 2.6-ton gasoline launch were used. The yacht was 88.5 ft. long, with a beam of 13 ft. and a draft of 5.66 ft., and the launch was 29.33 ft. long, with a beam of 6.75 ft. and draft of 1.37 ft. In one set of experiments, the vessels were propelled past each other in parallel courses at various relative speeds with their helms lashed, so that the change in their courses caused by suction could be noted. At the same time, the strength of the suction was measured by pressure boxes set in the launch's sides. In later tests, the rudders were used as the vessels passed each other and the helm angle necessary to keep the launch in a straight course was noted.

Both methods confirmed the theory that there is a general circulatory motion in the water about a moving vessel which has certain definite effects on

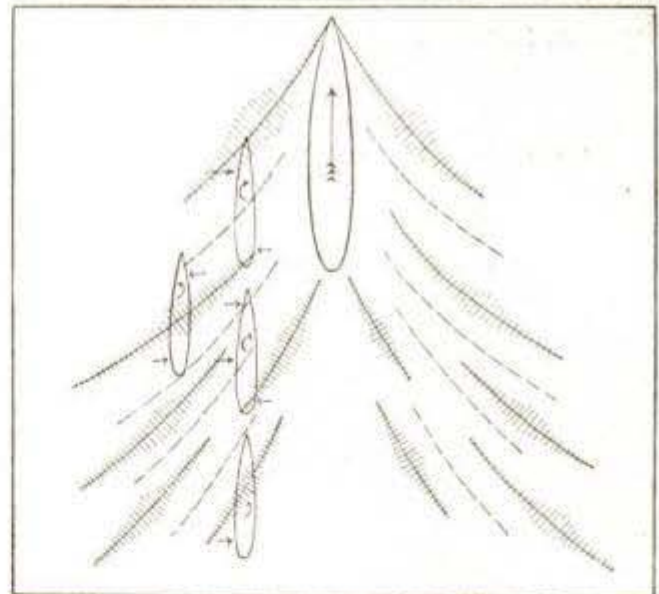

Effect on a Smaller Boat When a Larger Vessel Draws Past It

there is another region of increased pressure which is augmented by the propeller. The effect of this pressure is illustrated by the attempt of the launch to draw past while the yacht was moving in the same direction. As it entered the pressure region behind the yacht, it tended to sheer off because of outward pressure on one side of the bow. Farther ahead, the outward pressure on the stern and the inward pres-

sure on the bow caused it to sheer in toward the yacht. Directly amidships it tended to drift bodily against the yacht's side. If it succeeded in passing without collision, the outward pressure beside the yacht's bow caused it to sheer off at first and then to drift bodily away. At the same time, the bow and stern waves of a large boat have an effect on a small boat which tends in general to augment the effect of the pressure.

The strength of the wave action, which is greatest in deep water, can be understood from the fact that a 1-in. wave on one side of the bow and another on the opposite side of the stern of a 360-ft. vessel, drawing 20 ft. of water, exert a leverage action of 1,500 foot-tons. The same suction which affects the small boat in passing is also felt to some extent by the larger vessel. But the action indicated in these experiments is, of course, modified by the relative sizes and speeds of the vessels, and the distance between them. There is usually less danger when they are both traveling at high speed, especially if there is a great difference between their speeds, but if a larger vessel tries to draw past a smaller boat the danger of collision is very great. While the suction is diminished as the distance between the boats is increased, it was found to be in effect if the launch came as near the yacht as three and one-half times its own length. These were deep-water tests. In shallow water the suction is stronger.

### MOVING PICTURES FOR THE CHINESE

The Far East has indorsed the "movies," and there are already successful motion-picture establishments in Hongkong, Shanghai, and other open ports of China. The films, however, are foreign films with no adaptation to Chinese manners, language, or customs. Hongkong, by reason of its central location, has come to be an exchange center of film distribution, the

### HUB REGISTERS THE MILES IN NEW DEVICE

An attachment called the hub odometer is the latest thing in distance-

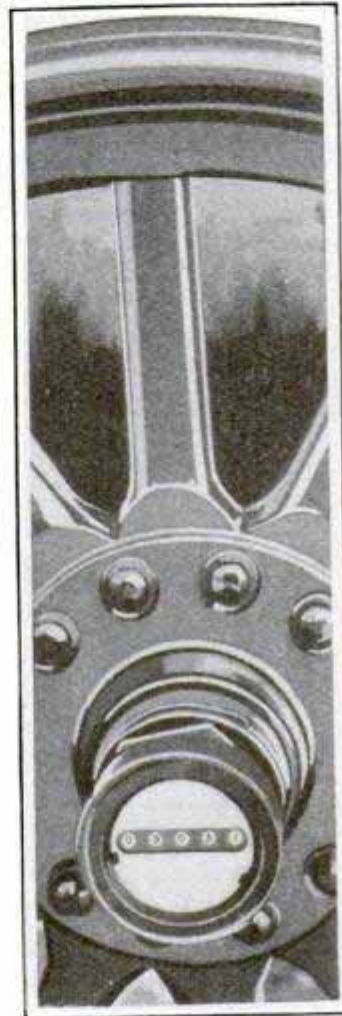

recording devices. Situated in the right hub of a motor-driven vehicle it is an out-of-the-way contrivance, extending but an inch beyond the end of the hub proper. It has a width of 2 in., is dustproof and registers from 1 to 99,999 miles. The main portion of the face is white-enamelled, while the narrow section in which the numbers appear is brass. Its operation is simple, consisting of a set of two gears. One of these is located on the spindle and is

stationary, while the other is on the hub, which turns. Each time these gears meet they turn and register on the face of the instrument, as shown in the picture.

films being rented or exchanged as in this country. American films with Chinese adaptation having descriptive matter and other features in the Chinese language are now being imported, as the machines made here are standard in oriental countries. Films and supplies are being sent from Hongkong to cities all over that part of the world, notably in the Philippines, Indo-China and the Malay States, Burmah, Siam, and to North China.

## WHERE HUNTERS STILL USE THE LONG BOW

Bows and arrows are still in use in some parts of the world. Even now there are a few tribes of savage Veddahs, running wild in the jungles of the southeastern part of the Island of Ceylon, who make their living by snaring birds, catching fish, and shooting small animals with bows and iron-headed arrows. They are the descendants of the aboriginal inhabitants of the island and number less than 4,000 persons, representing a little over .1 per cent of the population of Ceylon. But, although they dwell in caves or bark huts and lead the wildest kind of savage lives, they are shy, simple folk, and anything but dangerous. In stature, they are slight, seldom more than 5 ft. tall, and have extremely small heads. There are few, if any, other savage tribes that do not now use firearms.

## SIMPLE DEVICE PREVENTS MINE-SHAFT ACCIDENTS

The distressing accidents occasioned by the breaking of the rope used in raising and lowering cages in the shafts of coal mines may be eliminated if the device recently patented in England fulfills its mission. Two extra chains coming from the base of the rope are run down the sides of the cage and are fastened to four strong pieces of wood at its bottom. When, as in ordinary use, the weight of the cage comes upon these chains, these movable wooden pieces are pressed in beneath the bottom of the cage, but should the rope break and the tension on the chains thus be removed, strong springs project these pieces outward, where they at once engage the wooden supports at the side of the shaft, quickly stopping the cage and holding it securely until repairs are made.

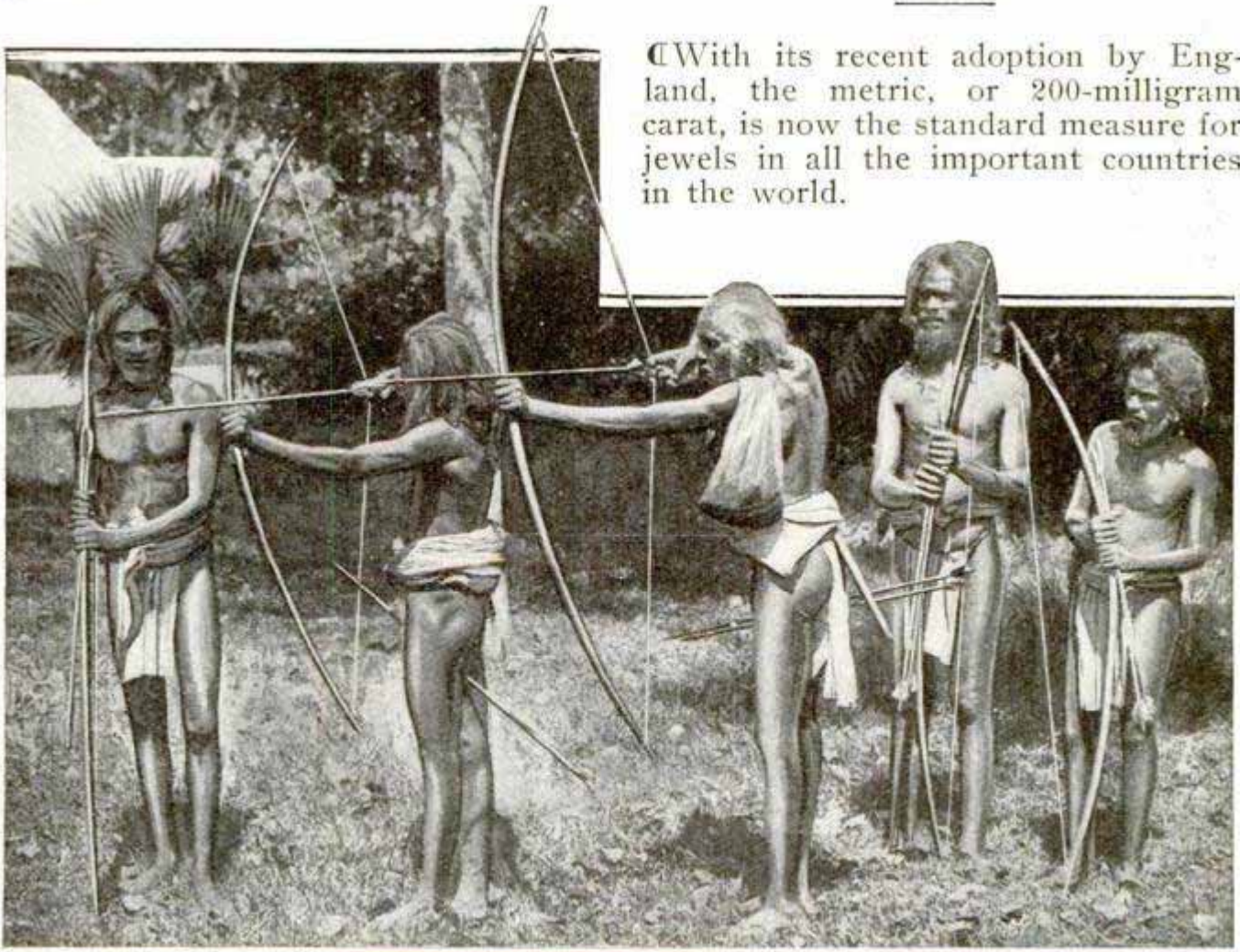

☐ With its recent adoption by England, the metric, or 200-milligram carat, is now the standard measure for jewels in all the important countries in the world.

Photo by Underwood & Underwood

Aboriginal Savages of Ceylon Who Still Use the Bow and Arrow in Their Hunting

## CURIOUS FLAT BRICK ARCH IN PANAMA

In the ruins of the Church of St. Dominic in the old city of Panama, there is a curious flat arch which has stood for generations in spite of the fact that it looks impossible. It stretches across the front of the church in a long, low

the monks who built the church had great difficulty in erecting it. Three times the arch fell as soon as the sup-

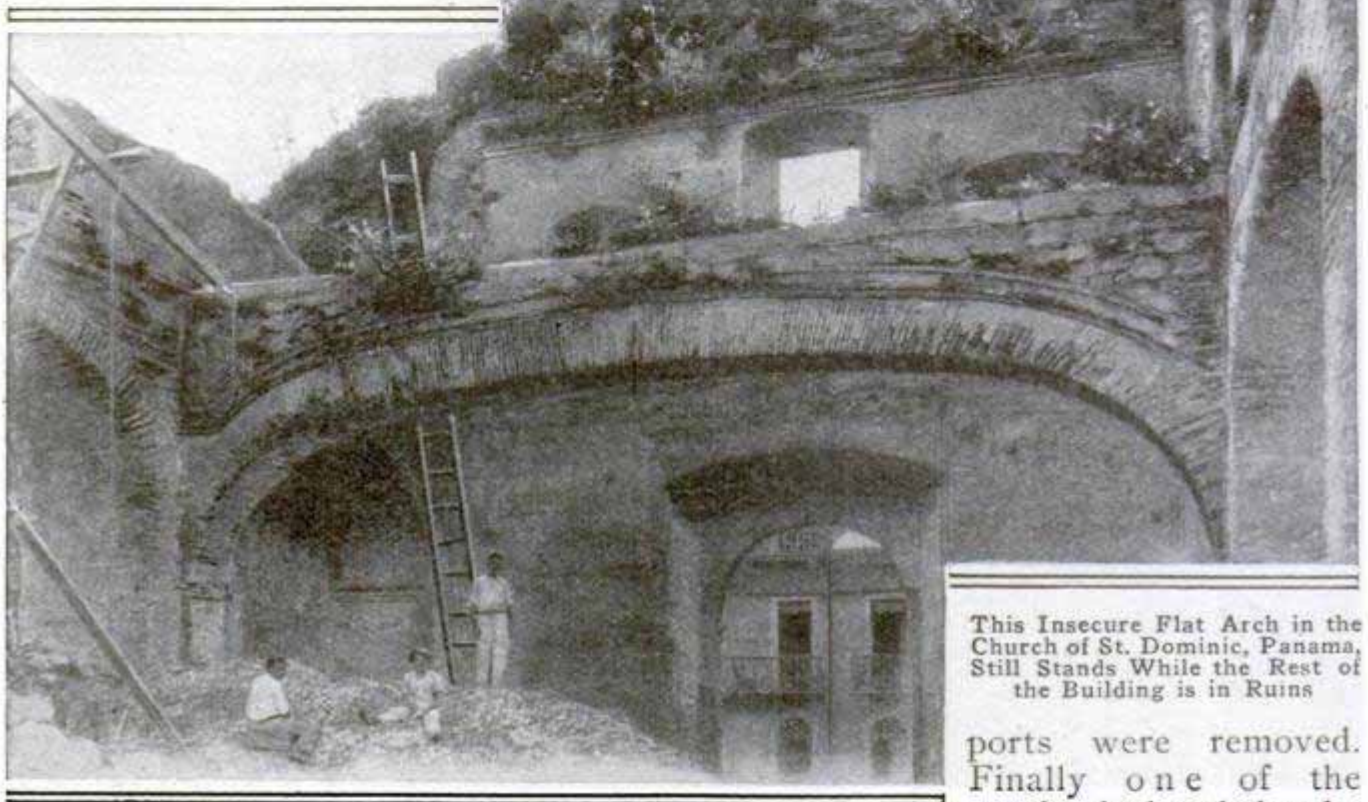

This Insecure Flat Arch in the Church of St. Dominic, Panama, Still Stands While the Rest of the Building is in Ruins

span, just back of the entrance and is made entirely of brick. No architect would attempt to build such an arch today, and, according to the legend,

ports were removed. Finally one of the monks declared that he was told in a dream how to build an arch that would stand and he was allowed to experiment. The arch which he constructed is still standing.

## SAND-BOX EQUIPMENT FOR AUTOMOBILES

Sand boxes are the latest devices brought out to keep automobiles from slipping and skidding on slippery city pavements. The outfit, as it has appeared on the market, consists of two boxes, about the size of tool boxes, to be carried on the running-boards

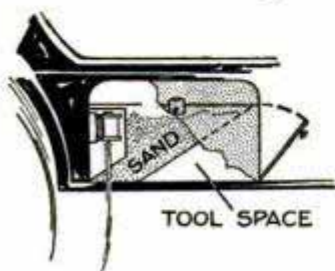

just ahead of the rear wheels. The flow of sand is regulated by electromagnets which raise plungers and open the sand outlets when the driver presses a button. Enough sand to last a season can be carried in the boxes, and space for tools is provided below the sand bin.

Powerful motor vehicles are coming into common use in Australia to serve as feeders to the railroads in freight transportation. The most suitable type appears to be kerosene tractors with large wheels and wide tires.

## NEW METHOD TO CHEAPEN COST OF RADIUM

By treating low-grade radium ores with strong alkali solution, a German scientist converts the silica into a soluble compound, subsequent flushing with water removing the large bulk of waste. The residue, containing barium and radium chlorides, is concentrated by the usual processes, and the pure radium chloride separated without delay. This treatment permits using ores heretofore neglected.

## AIR-PROPELLED ICE BOAT NEWEST MOTOR VEHICLE

Although ice yachts have been sailed for years and amazing speeds have been attained, a Chicago inventor

## NEW PULLEY HAS NOVEL FEATURES

A new type of cast-iron pulley has recently been introduced which is designed particularly to overcome the effects of shrinkage in casting. The arms are odd in number and are attached to the hub tangentially instead of radially, as is the common practice, so that



considerable shrinkage can occur without breaking the casting. The rim is of light section, but is strengthened by a web placed between the arms. The pulley is said to be both light and strong.

Air-Propelled Ice Boat: Close View of Motor and Aerial Propeller Below



has constructed an ice boat equipped with gasoline motor and aerial propeller. Mounted on three steel blades, the chassis carries seats for three, and a 12-hp. motor drives a 4-ft. propeller similar to that used on an aeroplane, which makes 3,200 revolutions per minute. With three passengers a speed of 80 miles an hour has been made. European engineers have established the fact that the same power applied to an aerial propeller gives greater results than when applied to water propellers, and American practice seems to bear out fully their findings in this respect.

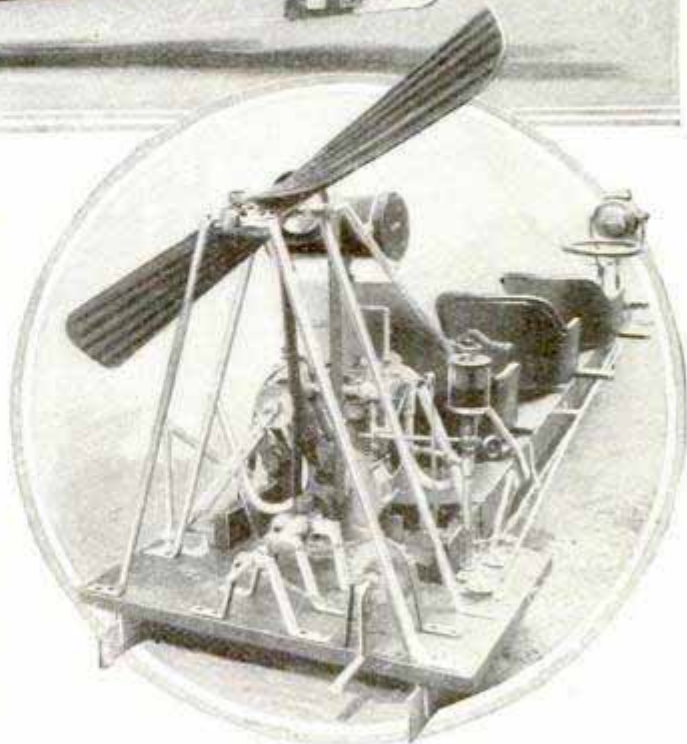

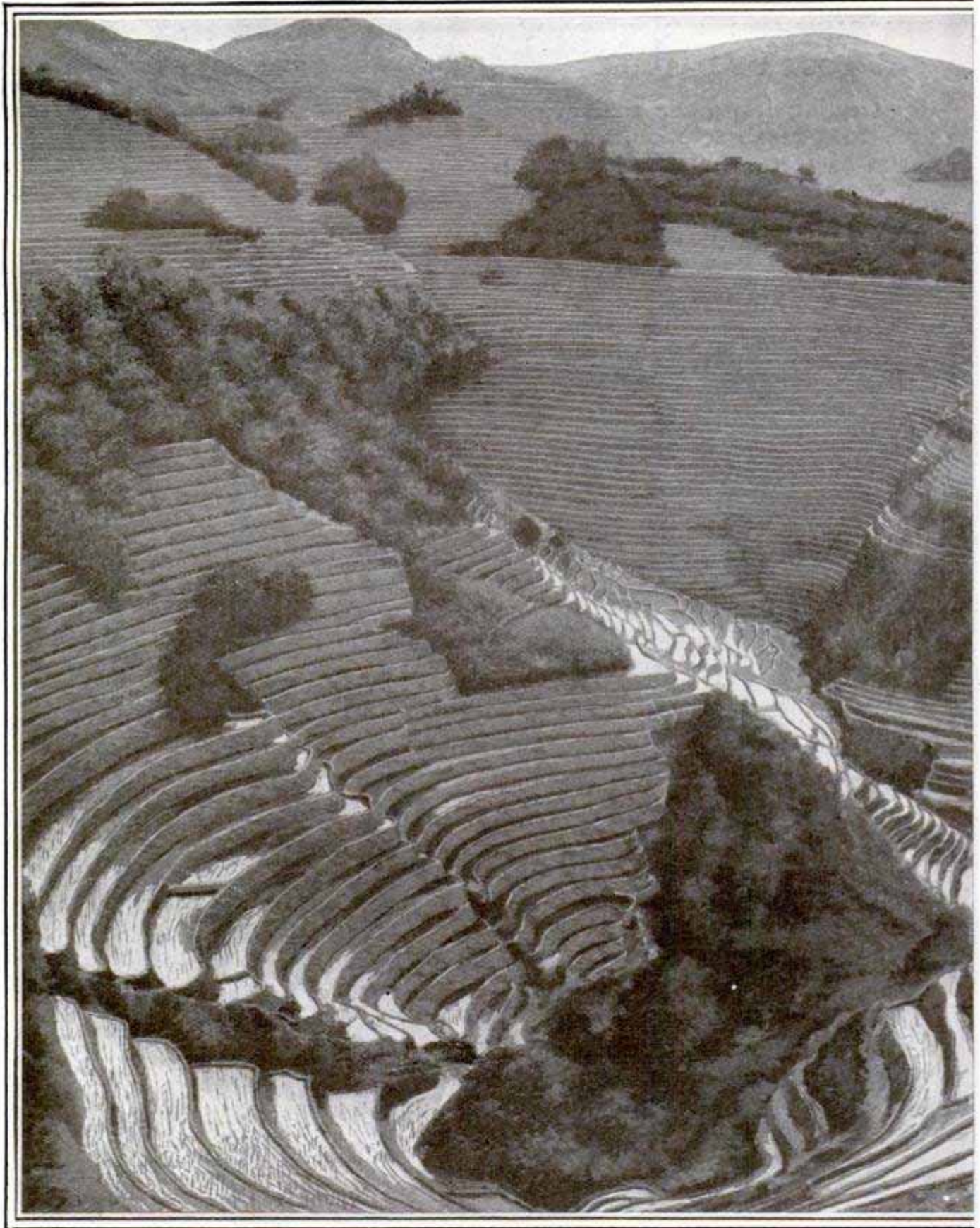

Courtesy L'Illustration

A mountain side terraced from top to bottom and having the appearance of an enormous amphitheater is one of the curious things to be seen back in the mountains of Luzon, in the Philippine Islands. This section of the

island is inhabited by Bontoc Igorotes, a tribe of savages who have resisted all attempts at civilization, but who, owing to necessity and in spite of primitive tools and methods, have become skilled agriculturists.



## SIDES AND CONVERT THEM INTO RICE FIELDS

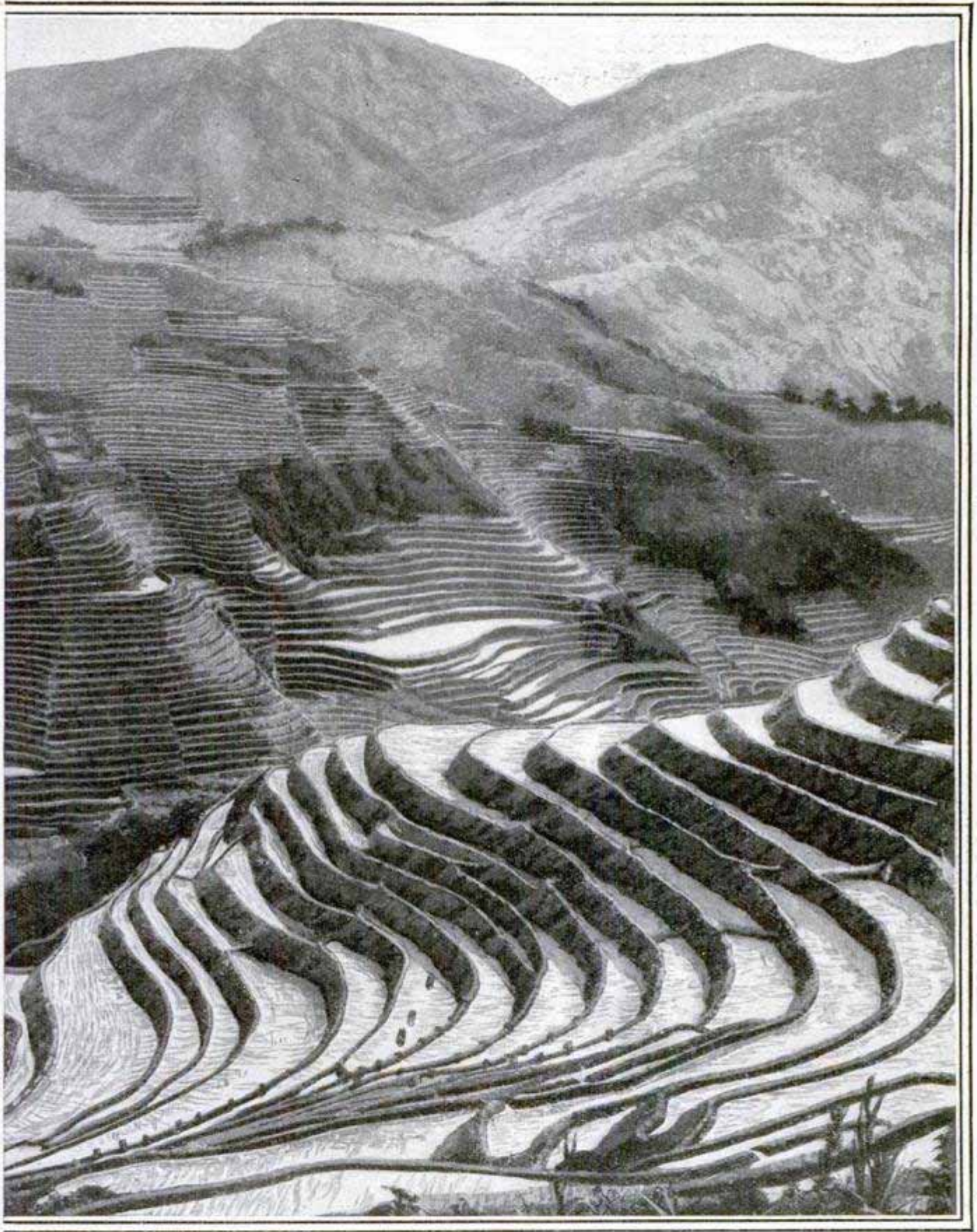

Having practically no farm lands available but steep mountain sides, the Igorrotes have made these suitable for rice culture by elaborate systems of terracing. The terraces are connected by irrigation ditches taking water from

points high up in the mountains, and in this way a regular water supply is assured, without which rice farming is impossible, since the grain requires the literal flooding of the land while the young plants are growing.

## ELECTRIC HEATERS USED IN PRESERVING FRUIT

A California concern cooks preserves, marmalades and jellies on a large scale by the use of electric heat-

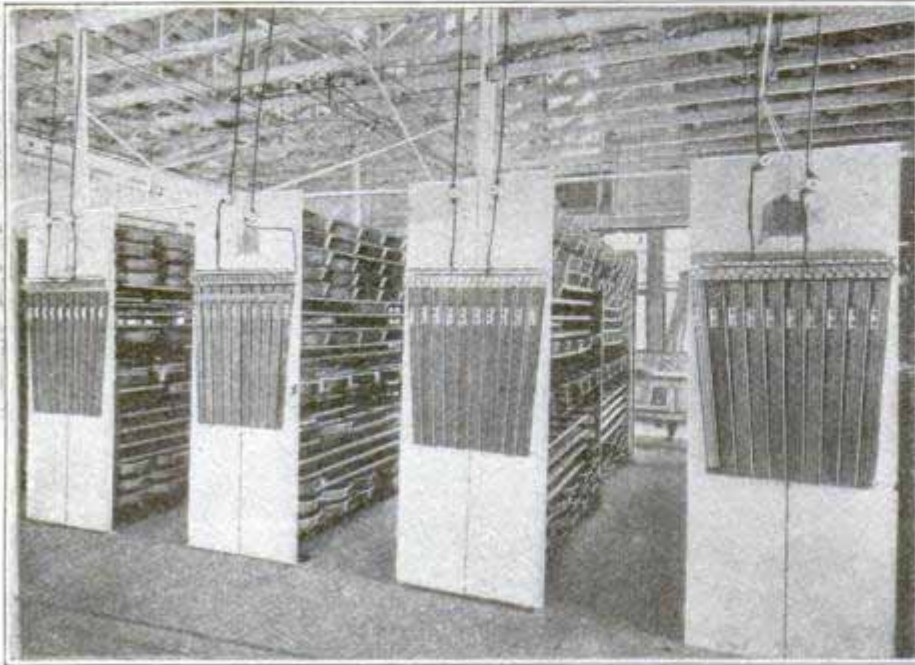

Electric Kitchen Where Fruit is Cooked in a Way Which Preserves the Flavor

ers. The kitchen is arranged with broad, low shelves on which shallow pans are placed, the heating units so spaced as to serve as rests for the pans. Placing the ripe fruit in these pans and regulating the heat gives slow cooking, bringing out full flavor values and avoiding overheating and discoloration.

## LOOKING DOWN ON THE ELEPHANTS

It is very rare that a photographer has an opportunity to "catch" 20 elephants at one shot. And rarer still when the herd files beneath him in as

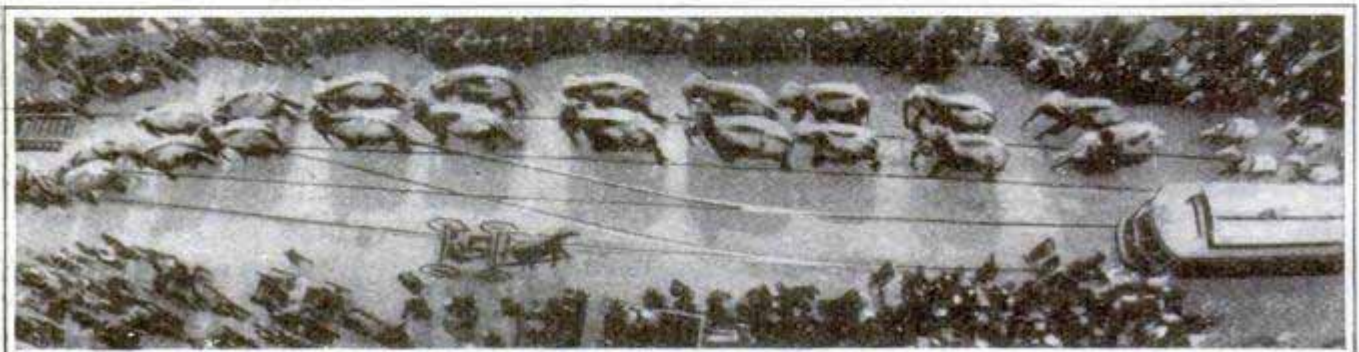

A Herd of Elephants Seen from Above

## MACHINE ON NOVA SCOTIAN COAST COUNTS WAVES

A complete record of the waves which beat upon the shores of Nova Scotia is now being made by means of a machine recently invented and which is called the "Undagraph." An iron pipe, 625 ft. long, is led into the sea to a depth of 15 ft. below the trough of the wave at low tide. The sea end of the pipe is left open, the other end opening into a box, in one side of which a leather diaphragm is fastened. The passage of the waves over the sea end of the pipe causes the water to rise in the pipe and compress the air in the box at the shore end, whereby the

leather diaphragm is moved and electric contact made. A toothed wheel is pushed forward by means of the armature of an electromagnet, one tooth for every wave, actuating a recording pen on a paper-covered cylinder. The record is a finely serrated or saw-edged line, showing the number of waves per minute, hour and day.

orderly a manner as shown in the picture. An airman crossing Africa might have such an opportunity, but here in America an amateur photographer located on the fifth floor of an office building secured the unusual view shown herewith.

## VINE BRIDGE ACROSS MEXICAN RIVER

Tropical plants abound in Mexican forests, and vines overtop the tallest trees, binding whole forests together in a maze of living network. Such lianas, or vines, can be made to do

duty as suspension bridges, their tenacity being great enough to permit the

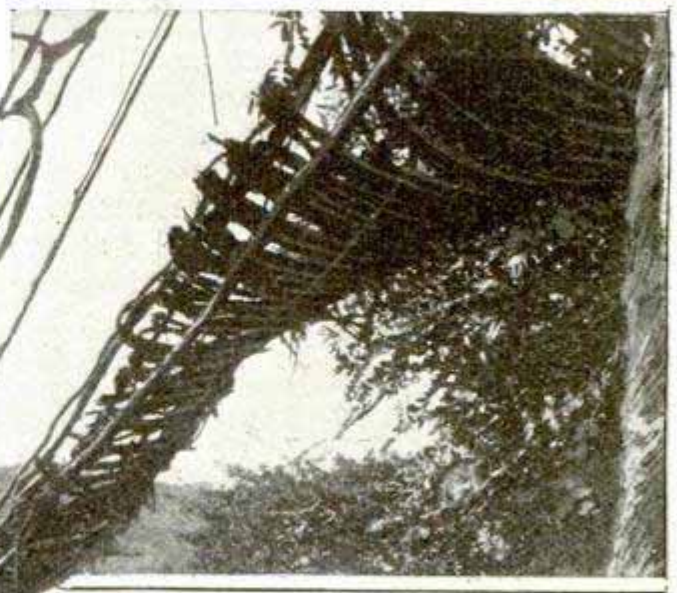
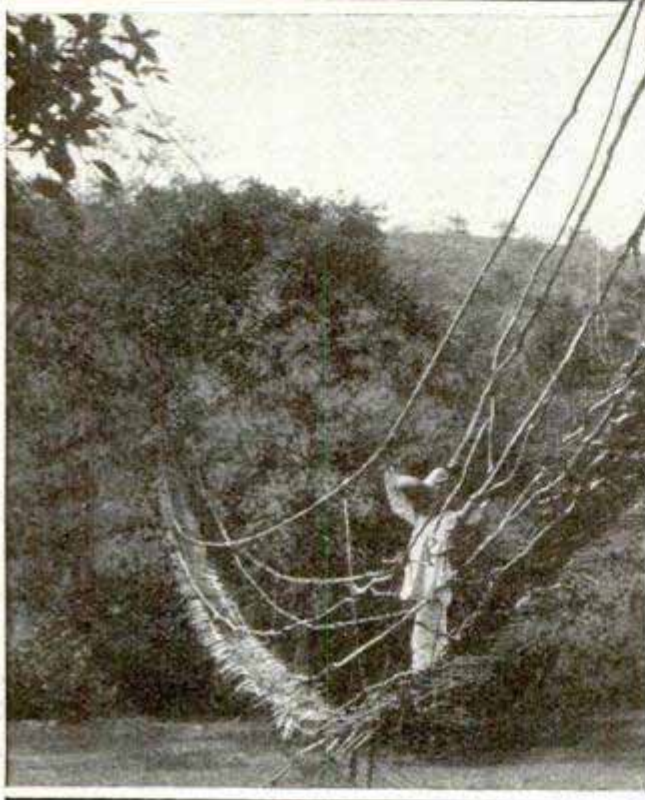

Mexicans Weave Vines into Suspension Bridge

traverse of travelers bearing heavy loads. The picture shows how vines may be interwoven to form a substantial bridge and pathway with hand guides across a river of considerable width. Throughout Central and South America these bridges are frequently found, usually the work of Indians, but sometimes built by white settlers.

## NEW AUTOMATIC ELECTRIC COOKER

An electric cooking device, automatic in its temperature control, is shown in the accompanying picture, which combines an active electric heating unit with inclosed and thoroughly insulated cooking space. A metal container, with tightly fitting lid and apertures for the entrance of electric wires, incloses another metallic container, the space between being carefully insulated. The heating units are attached to the bottom of a double-walled steam chamber. Here a small quantity of water is boiled and partly changed to steam, which fills the space between the walls of the steam chamber, heating all portions evenly. The bottom of the steam chamber is sprung, like the bottom of an oil can, and when the pressure of the steam is sufficient

to overcome the spring it snaps downward, operating a pin which forces

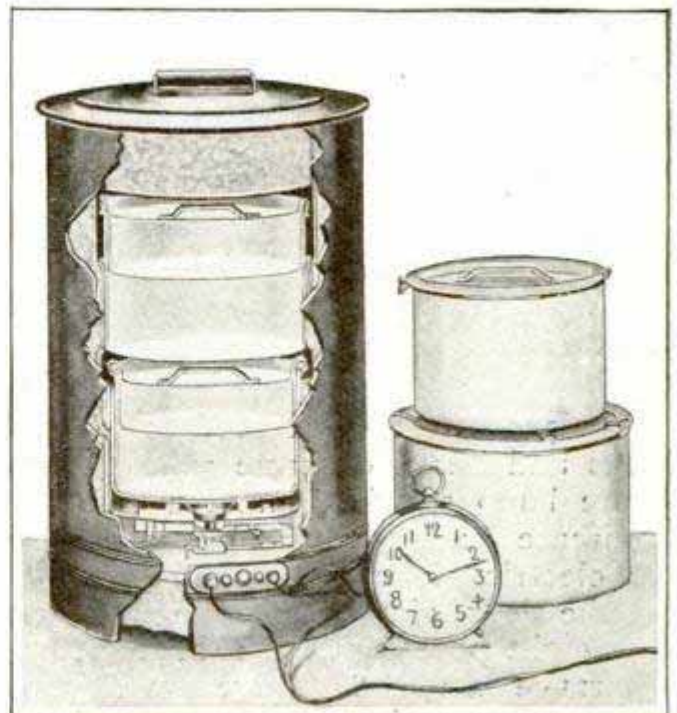

Electric Cooker with Time Switch

open the switch contacts, cutting off the electric current. When the walls slightly cool the pressure is reduced and the bottom snaps back, again switching on the current and heat is again produced controlling the temperature within narrow limits. The cooker may be connected to an ordinary lamp socket, and by means of a time switch the cooker may be set to start at any hour desired, so that breakfast, prepared and set in the cooker the night before, will be ready in the morning.

### CONCRETE BAND STAND BUILT IN A DAY

Only one day's labor by volunteer workmen was required to build the ornamental band stand, of massive con-

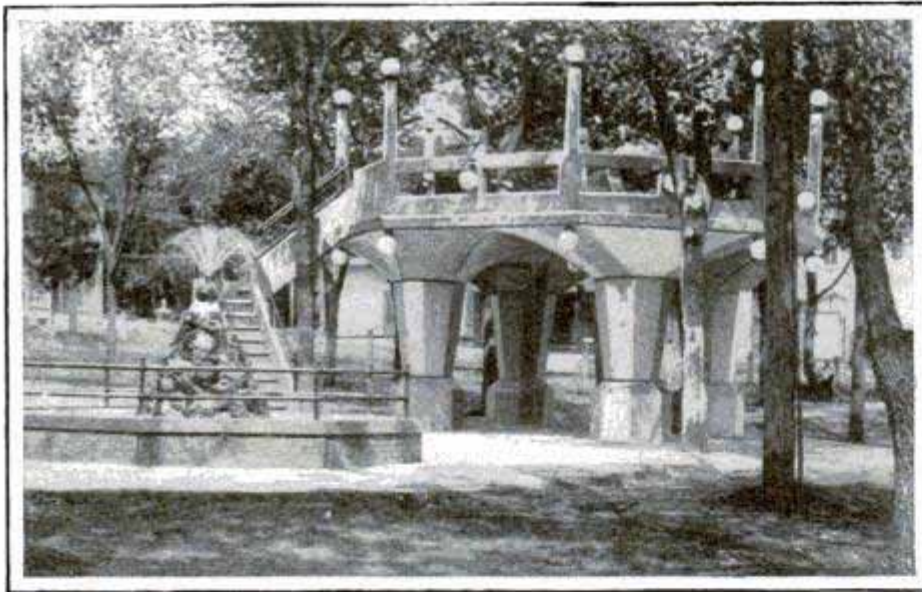

Ornamental Concrete Band Stand Built in One Day  
by Volunteer Workmen

crete construction, which stands in a park in Humboldt, Neb. In form it is like a huge table standing on four heavy concrete legs. Its deck, supported by low cloistered arches, is large enough to accommodate 40 persons and has a concrete railing, concrete lamp standards, and a concrete staircase leading to the ground. The 25 electric globes set round the edge of the deck, along the railing, and on the eight posts, give it a brilliant appearance at night. There are 75 tons of concrete and two tons of steel-rod reinforcement in the structure.

### ALUMINUM UTENSILS SAFE FOR COOKING

Experiments conducted by a Scotch scientist to ascertain if aluminum cooking utensils were in any way affected by the food prepared in them, have proved that no injurious results were obtained. Oranges, lemons, Brussels sprouts and tomatoes, when prepared in aluminum utensils, dissolve some of the metal, but in so very small quantities that the resulting formations are perfectly harmless.

### GREAT ASSUAN DAM PROVES EFFECTIVE

Egypt has already received the benefits of the increased capacity of the great Assuan dam in the Nile, because the river above the dam was lower last year than it had been for 50 years. At Halfa, 200 miles above the dam, the Nile fell 5 ft. below the average of the last 13 years, which meant a flow of 650 tons of water a second instead of the usual 1,500 tons at that time of the year. The rains in Abyssinia and the annual flood of the Blue Nile and Atbara Rivers were a month late, but there remained as much water stored in the reservoir

as there was 36 days earlier the year before the dam was enlarged. The recent improvements have increased the storage capacity of the Assuan reservoir from 800,000 to 2,000,000 acre-feet. The cycle of operation is as follows: In November, when the Nile is falling, the closing of the sluice gates begins and, by January, the water in the reservoir has reached its top mark, 70 ft. Toward the end of March the reservoir begins to help the lower river and continues to empty gradually until the July floods arrive. From July to November, the gates are wide open

and the silt-laden water is allowed to pass through freely. Much study of rainfall conditions is necessary for a proper regulation of the sluices.

### CARRIAGE OVER 200 YEARS OLD STILL IN USE

Imported from France two and a quarter centuries ago, and now in use on the streets of Petersham, Mass., a carriage which may have been considered the last word in fashionable equipage during the reign of Louis XIV, is now a unique spectacle. The upholstery was made upon a hand loom from wool and linen; the curtains, too, were made of linen, and painted. The top is of very thin wood, covered with linen canvas and painted. The axles are of wood, the hubs turned by hand and the spokes were hand-made with a draw-knife. Linchpins fasten the

wheels. The body is swung upon thorough-braces of leather. Tires, axles, bolts, and even the little tacks used to fasten the upholstery were hand-made, the product of the old-time blacksmith. This veritable old "One-Hoss Shay" has been in the possession of various Petersham families for generations and is still used behind "Old Dobbin," while shining limousines whirl past at high speed, disdainful of



Copyrighted by J. W. Baldwin

Oldest One-Horse Carriage in America

this product of the time of "The Grand Monarch."

### RUBBER CLINGS TO STEEL IN NEW PROCESS

Rubber may be firmly attached to steel by a new process in which the

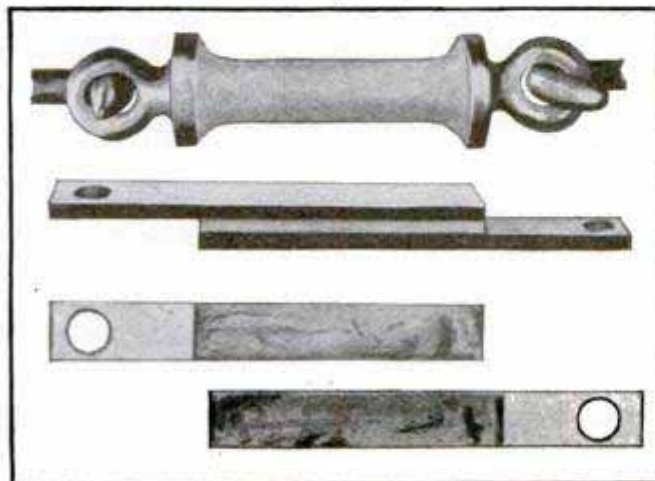

Steel Disks Vulcanized to Round Piece of Rubber—  
Rubber Vulcanized between Steel—Steel Pieces  
Torn Apart, Rubber Adhering to the Steel

rubber is vulcanized directly to the metal. Two tests are shown, in one of which the rubber appears between two flat pieces of steel, considerable force being required to wrench them apart, the rubber adhering to both surfaces. In the other, the rubber was vulcanized to two steel disks and when tension was applied the rubber stretched to two and a half times its normal length without parting. This problem has been studied for years and heretofore has eluded solution. Its application is obvious in the electrical industry.

Separate compartments, or stalls, for each toe is the latest Parisian style for stockings. It is said these prevent those corns which are caused by the rubbing of the skin against the next toe.

## RESIDENCE WRECKED BY FALLING TREE

An unusual accident occurred recently in a New Jersey town when a huge tree which was being removed

throughout the city and immediately sends a car to the waiting customer. The coin which has been dropped in the machine is credited toward the payment of the fare. The system is extended to residences as well.



House Wrecked in Peculiar Manner

by a contractor from a vacant lot fell upon a near-by house, almost demolishing it. The ground about the tree had been dug, the tree guyed and stayed, and a block and tackle rigged to pull the tree in the desired direction when, just as the contractor gave the word and the horses threw themselves forward, a heavy gust of wind from an opposite direction blew the tree against a neighbor's residence. The horses were pulled over backward, the upper floors and porch of the house were wrecked, and the housewife and a child were buried in the ruins, from which they were shortly rescued by workmen.

## PUBLIC CALL STATIONS FOR TAXICABS

Automatic machines, which look like letter boxes, have been placed at every cab stand in Hamburg, Germany. Anyone who desires to call a motor car and finds none at the stand, may insert a coin in the machine, whereupon a signal is flashed at the central station. The central station is at all times advised of the location of waiting motors

## BALL-AND-SOCKET JOINT USED IN STAY BOLT

An English inventor has designed a flexible stay bolt, in which the spherical head and the similarly shaped

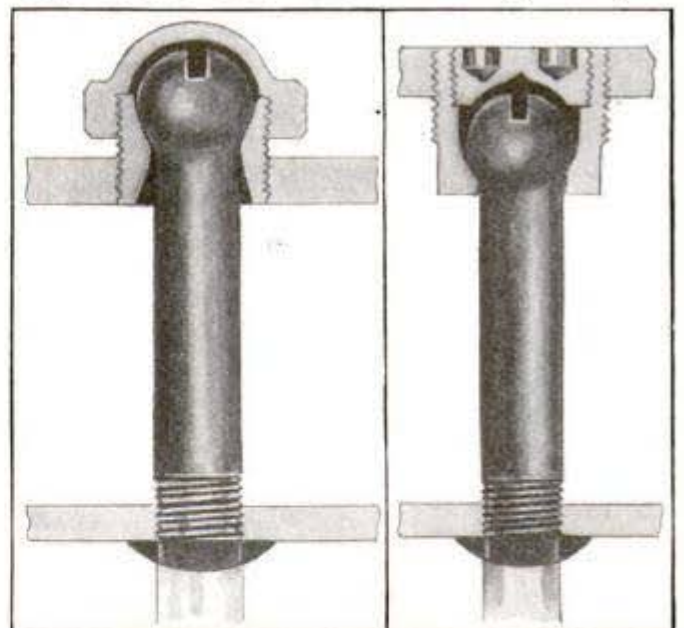

recess for it in the sleeve and cap provide a ball-and-socket joint, permitting the bolt to adapt itself to various strains without shearing. The bolt is made in two types, with outside head and with inside head, so that it can be used in a large number of positions.

**THERMOMETER IN RAILROAD OPERATION**

Temperature affects the performance of locomotives, the loading and unloading of trains and the movement of freight. It is thus important to know just how hot or how cold it is at any given place on the line. An eastern railway line has placed thermometers at frequent intervals along its lines and keeps a careful record of changes in temperature. The thermometers are inclosed in wooden boxes carefully painted, and are not affected by drafts and reflections.



It is estimated that the export of moving-picture films, counting both developed films and negatives, from the United States for the year 1913 amounted to over 25,000 miles. For the nine months ended with September the value of these exports was \$3,467,000.

**SUBSTITUTE FOR CEMENT USED IN TURKEY**

Slaked lime, thoroughly incorporated with linseed oil and cotton fiber, is used in Turkey as a substitute for cement in some instances with good results. The mixture is as satisfactory under water as in exposed places, but must be allowed to dry thoroughly before submergence. A hollowed-out stone is used as a mixer, the oil being first poured and cotton fiber kneaded in, while lime is dusted in as the process continues.

**SAFETY SOUGHT THROUGH COLLISION CARRIAGES**

For the transition period between wood and steel trains an English inventor suggests the use of buffer coaches whose function it will be to take up the first blow of the collision. These special cars, as may be noted from the pictures, will be so arranged that they telescope into themselves against heavy springs. They may be built heavy enough to resist the usual crumpling up and at the same time have enough resiliency to dissipate the striking blow. One of these buffer coaches at each end of the train would absorb so much of the energy of a collision that the passenger coaches would escape destruction. Such, at least, is the contention of the inventor, who insists that the day of the all-steel train must be delayed until the wooden cars can be replaced with economy.

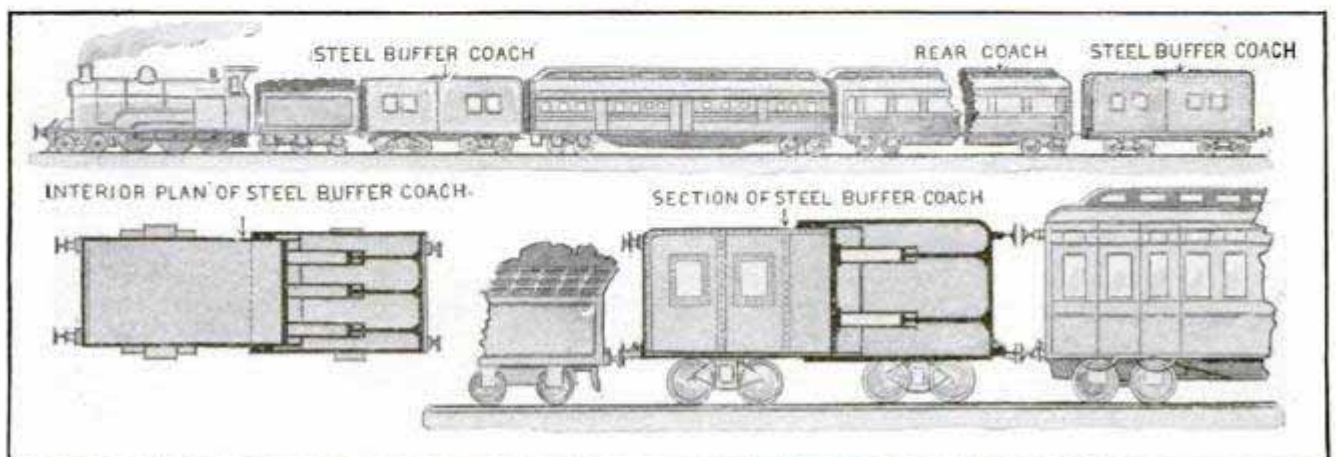

Courtesy of The Sphere

Suggested Device for Minimizing Collisions

## RAILROAD INSPECTION CAR USES GASOLINE POWER

A new railway-inspection car, for use of contractors and railway officials, is of two-ton capacity, with a wheel base

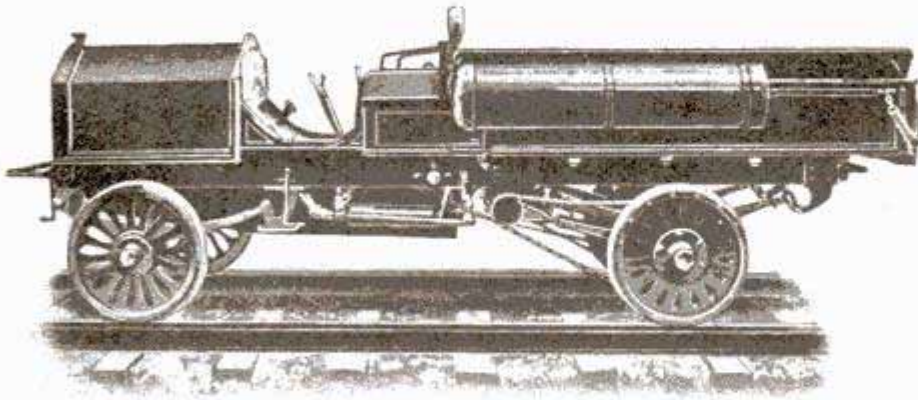

Speedy Little Motor Car for Railway Work

of 108 in., and is capable of reaching a speed of 25 miles an hour. There is a drawbar hitch at either end, and the car runs equally well forward or reverse. The entire mechanism is mounted on springs. The wheels are 26 in. in diameter, of standard flange type, and surplus fuel is carried in the tank at the side, for long hauls. A trailer may be attached when desired.

## FRENCH USE AEROPLANE IN POSTAL SERVICE

The success of the first experiment in France of an aerial post which resulted in a saving of 24 hours in dispatching transatlantic mail, has so pleased the minister of commerce that it has been decided to continue and extend the service. It is proposed to send an aerial messenger to Nice, stopping at Lyon and at Marseilles. Leaving Paris in the morning he is expected to reach Nice in 12 or 14 hours.

With favoring winds it is hoped to deliver newspapers from Paris in the evening instead of in the morning, as at present. This service will also shorten the time for the evening mail from London, as letters sent from that point at night, and reaching Paris the next morning, would be delivered at Nice the same evening. The added tax on letters will be about four cents.

## SECTION OF BUSY CHICAGO STREET COLLAPSES

An accident of an unusual nature occurred in Chicago recently when a section of one of the busiest streets in the loop district of that city suddenly crumbled and sank to a depth of about 8 ft. below street level. This collapse, which extended from curb to curb and along the street for half a block, is attributed to the failure of a wall of steel-sheet piling driven along the south side of the street to keep the earth out of the deep excavation made for a new skyscraper then under construction. The area covered by the building had been excavated to a depth of about 48 ft. below street level to allow for a basement and two sub-basements. Owing to some weakness in the sheet piling or to some increase in pressure not anticipated by the builders, the steel-sheet piling was

bent inward by the load and a large amount of the material under the street "flowed" into the excavation, causing a corresponding sinking of the street surface. The force of the movement was such as to seriously damage the steel frame of the new building. A contributory cause of the cave-in may have been the weight of the Masonic Temple, half a block away, which, like many of the earlier Chicago skyscrapers, rests on the old-style "floating" foundation, and which may have caused considerable pressure to bear against the slender steel wall. The accident occurred about midnight, at a time when the street was comparatively deserted, and no one was injured. The damage to the street, building and underground conduits is estimated at about \$100,000.





Repairing the Street and Car Tracks after the Collapse

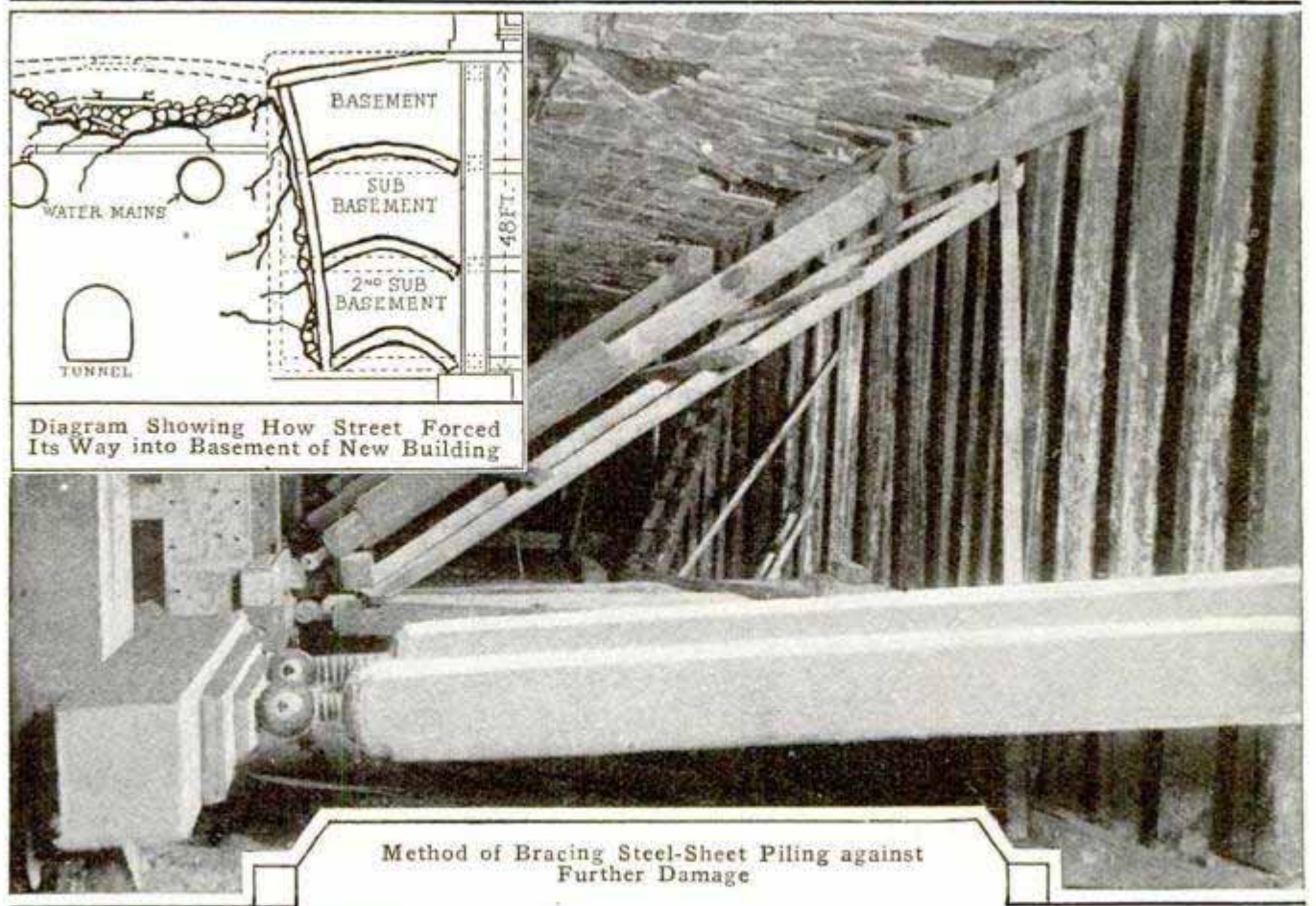

Diagram Showing How Street Forced Its Way into Basement of New Building

Method of Bracing Steel-Sheet Piling against Further Damage

## SHORT CURVE ON RAILROAD IN THE HIMALAYAS

The railway from Calcutta to Darjeeling, the summer capital of the province of Bengal, is an interesting engineering feat from one end to the other. Three standard gauges are maintained in three separate sections; one of 5 ft. 6½ in., one of 3 ft. 3 in., and

on the 51 miles from Siliguri to Darjeeling, one of but 2 ft. It is on this latter section that the extremely sharp

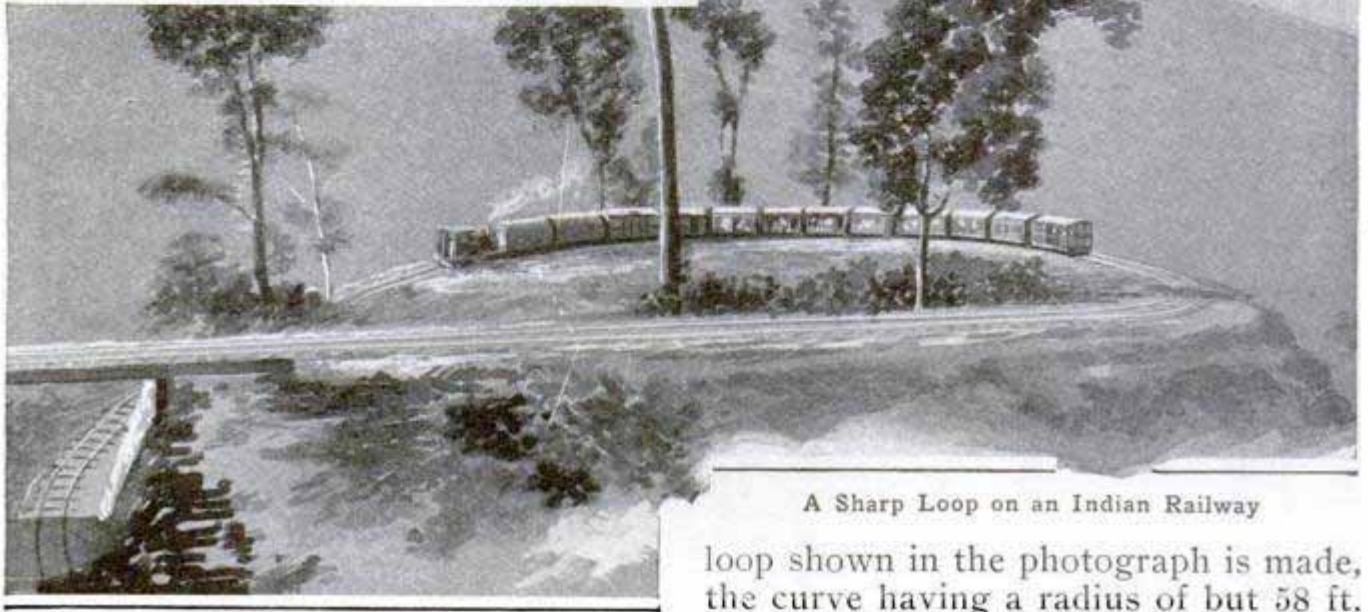

A Sharp Loop on an Indian Railway

loop shown in the photograph is made, the curve having a radius of but 58 ft.

## A STEEL STAIRCASE FOR TEST- ING MOTOR CARS

A device designed to test motor cars consists of a steel structure with a 50-per-cent grade, 100 ft. long, built like a staircase at one end for ascent, and cleated at the other end, by which the cars descend. The general appearance of the structure suggests a bridge, or viaduct, and presents such difficulties that a car which could negotiate it successfully need little fear any hazard presented by a cross-country run.

## FILM SEIZED AS EVIDENCE OF STRIKE BATTLE

A motion-picture film, depicting an actual battle between mine guards and strikers at Ludlow, Colo., has been confiscated by the adjutant general of that state. The motion-picture operator was in such position that his camera caught the faces of men engaged in the battle on each side. The film may be enlarged and is expected to show the faces of the men engaged so that they can be identified.

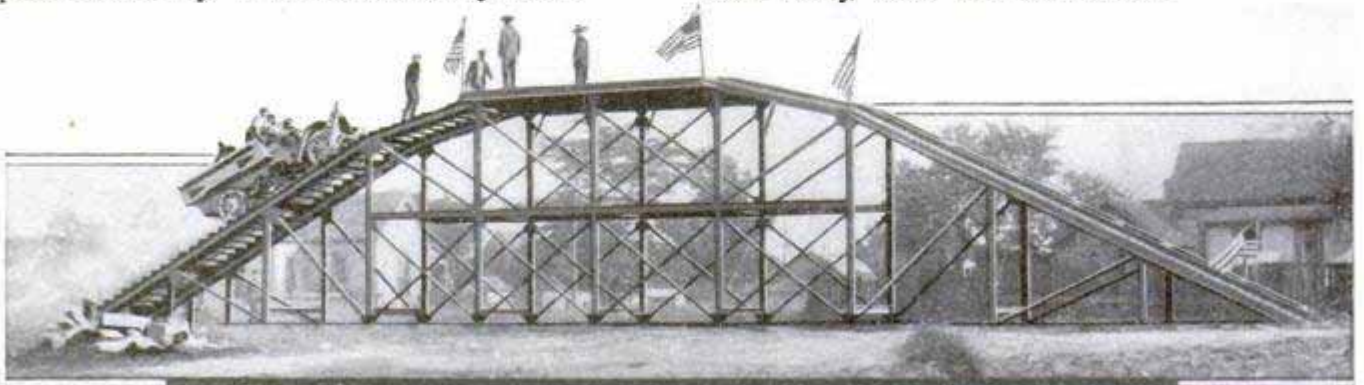

Bridge for Testing Motor Cars

## NEW COLLIER LOADS SHIP ON BOTH SIDES AT ONCE

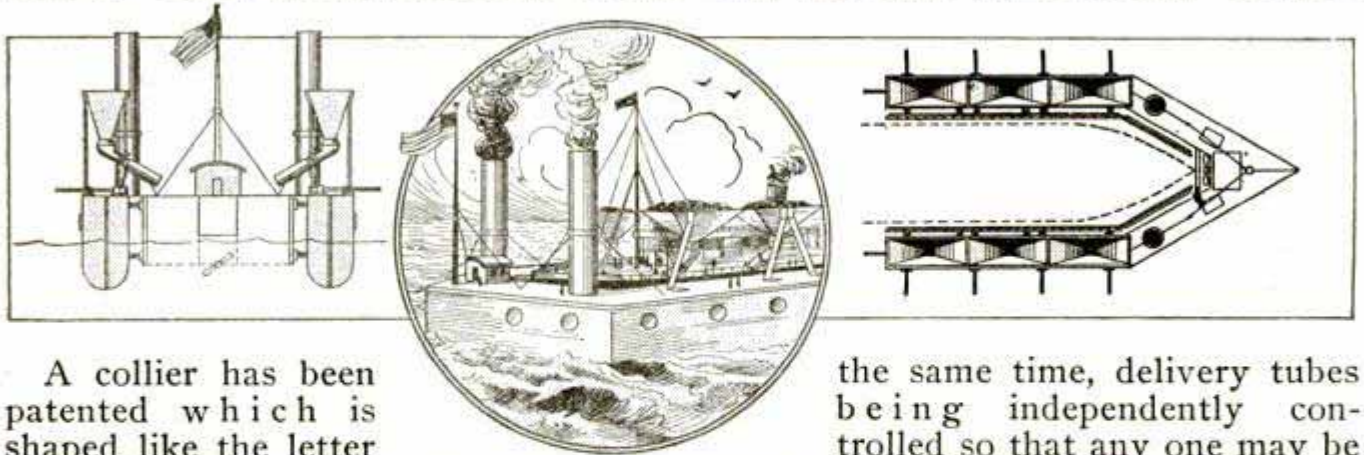

A collier has been patented which is shaped like the letter U. The ship to be coaled enters the open end, is held by adjustable buffers and clamps, and the bunkers are filled by gravity from coal pockets in the collier. This enables the coaling to be done in short time, as one or more bunkers on either side may be filled at

New Collier Coals Ship Quickly by Surrounding It

the same time, delivery tubes being independently controlled so that any one may be shut off as desired. Built for the largest-size ships, the collier will also accommodate smaller vessels by means of the adjustable buffers and clamping strips, which hold the ship steadfast. The motive and operating power of the collier is contained in the bow portion.

## DANGER-LESSENING DEVICE FOR CARBOYS

A practical device for lessening the danger and trouble involved in handling large and clumsy carboys in which chemicals are usually stored is here shown. The attachment eliminates the danger of the carboy being broken through dropping, and the rockers are curved in such a way that, should the handle slip from the operator's

hands at any time, the carboy will assume an upright position. The invention, which is known as an inclinator, is adjustable and can be attached to a carboy in less than a minute.

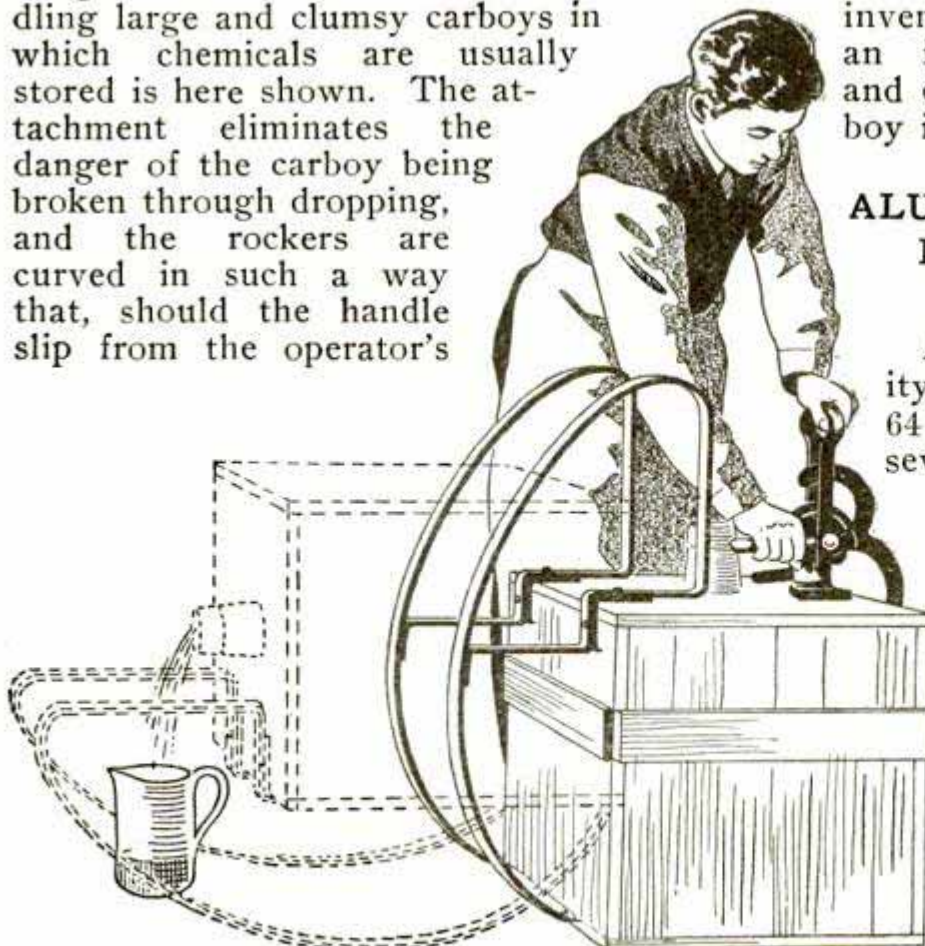

Device for Handling Heavy Carboys with Ease

## ALUMINUM-WIRE COILS FOR ELECTRICAL APPARATUS

Although the conductivity of aluminum wire is but 64 per cent of that of copper, several experiments have recently been made with it as winding for various types of electrical apparatus. The coils made of it have to be increased in size, and this results, of course, in a considerable increase in bulk, but the weight being in favor of the aluminum, an aluminum coil weighs a little less than half as much as a copper coil.

## UNIQUE TRAP FOR BURGLARS

A burglar trap, consisting of a false floor constructed in front of the office safe, a counter in a jewelry store, or similar places, has been invented by an Englishman. The floor covers a pit and is supported by projecting pins, so adjusted each night that the weight of

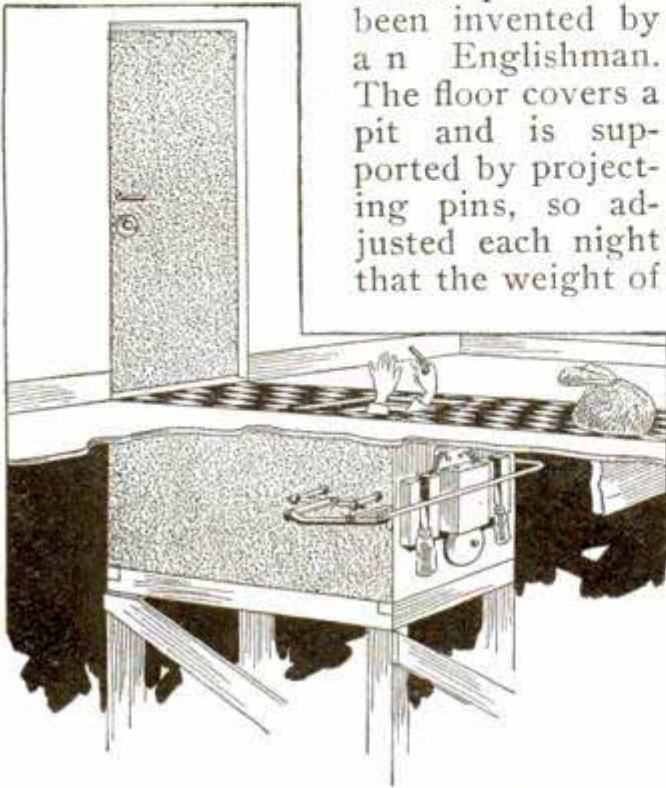

A Novel Floor Trap for Catching Safe Blowers or Store Thieves

a person upon the floor will cause it to fall, dropping the intruder into the pit, where he alights upon springs or pneumatic shock absorbers, provided so that he may not be injured. The dropping of the floor operates a lever which causes a sliding door to close over the mouth of the pit.

## SAFEGUARD FOR POISON BOTTLES

A very simple device for conveying a warning that a bottle contains poisonous substances has been patented. It

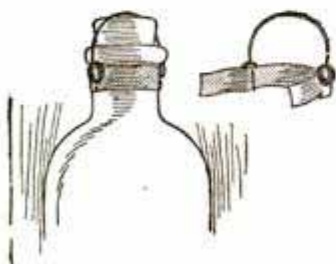

consists of a gummed band carrying a wire loop, the ends of which, terminating in spring coils, are firmly fastened in the texture of the band. The wire loop is normally held

over the top of the cork, but may be pulled back with the forefinger when the cork is to be removed, and springs back to upright position. It is obvious that the cork cannot be removed without indicating the nature of the contents of the bottle. The device is applied by simply moistening the gummed side of the band and sticking it around the neck of the bottle.

## EFFECT OF ELECTRICITY ON HUMAN BODY

Late investigations into the effect of electric currents on the human body indicate that direct currents contract the vessels and increase blood pressure, while alternating currents dilate the vessels and the blood pressure is consequently reduced. Currents with voltages over 200 are dangerous and those over 500 usually fatal. The resistance between two points in the human body varies largely, from 16,000 to 80,000 ohms being observed. The skin alone is responsible for the far larger part of this resistance, or from 15,000 to 79,000 ohms. The intensity of the current passing through the human body is, of course, dependent upon the amount and form of contact, and whether the skin be moist or dry. In the former case the skin resistance is practically eliminated. When the frequency of an alternating current reaches 150 periods a second the heart action stops immediately. The fluids of the body expand, exerting pressure on the nerve centers in some cases, and in an accident of this kind the head of the shocked person should be raised, as otherwise the pressure on the brain would further increase. The heat generated in the body by the passage of the current is not inconsiderable, after-death temperatures of 104 deg. F. and more having been observed.

☞ Honey put up in collapsible tubes, like artists' colors or tooth paste, is the latest novelty on the German market.

## GRADE FLATTENED TO HELP DOWNHILL TRAINS

A double-track railroad line down the west slope of the Wasatch Mountains in Utah has been rebuilt on a new location and the grade reduced from 211 ft. to 105½ ft. to the mile, not to help uphill traffic, as is usually the case in such improvements, but to make the operation of trains down the hill safer and more practical. By far the heaviest movement of freight in this section is westward. Although the pulling of trains up the hill has always been a serious proposition, letting heavy freight trains down the hill safely has been, owing to the limit in capacity of air-brake equipment, a big and uncertain job. To minimize the danger of runaway trains, three safety switches, designed to take trains from the main track and turn them on an upgrade along the side of the mountain, have been maintained on the old line. These were always set to switch a train off the main line, and in approaching these switches the engineer was required to give a whistle signal indicating that he had his train under control before the switch could be thrown and the train allowed to proceed down the main line. In addition to this precaution, the air brakes were always adjusted before a train left the summit so that they could not be entirely released, but would exert a pressure on the wheels at all times. The necessity for these precautions has been done away with by the construction of the new line, which is 4½ miles longer than the old and much more crooked, and is laid on a grade only half as steep.

## NEW TYPE OF RAILROAD REFRIGERATOR CAR

A refrigerator car that can be cooled in summer, heated in winter, or simply ventilated during the mild weather of spring or fall, without any change in apparatus or even the necessity of entering the car, is one of the latest developments in cars used for the shipment of perishable freight.

## THIEF-PROOF SATCHEL FOR PAYMASTERS

A satchel with a burglar-alarm attachment is one of the latest ideas for protecting bank messengers and pay-

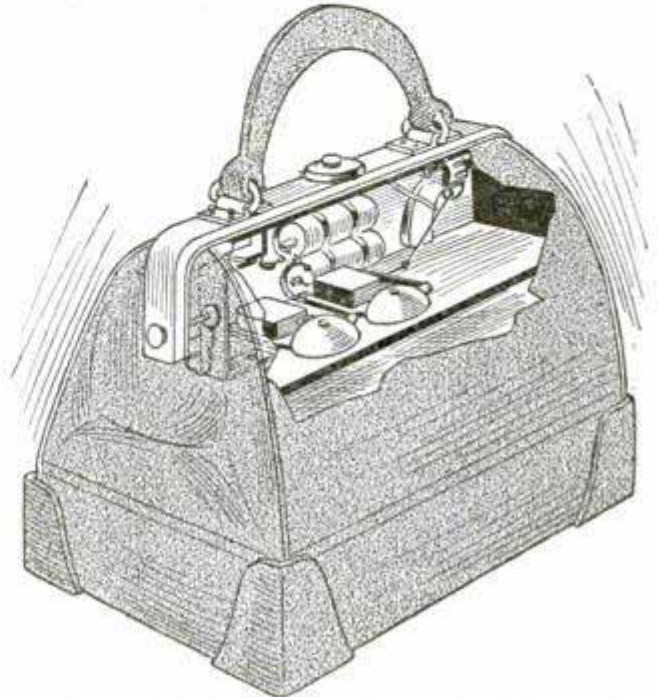

The Alarm Makes a Big Noise When a Thief Tries to Rob the Bank Messenger

masters from thieves. Inside the satchel are bells and a revolver loaded with blank cartridges, under the control of a mechanism similar to the combination lock on a safe. As long as the satchel is in the hands of the messenger, it is quiet; but as soon as he lets go of it, the bells begin to ring and the revolver is fired. Such a thief-proof satchel, weighing 8 lb., has recently been patented.

## PATCH FOR AUTOMOBILE TIRES

A patch designed to prevent blow-outs in automobile tires, of which there is usually sufficient warning, and to keep the tire in running order until permanent repairs can be made, is shown in the illustration. This patch is made of from five to seven plies of heavy fabric and is from 10 to 12 in. in length. No cement is needed in applying it.

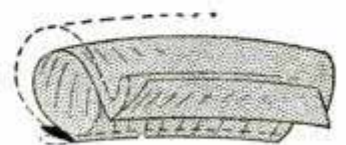

## NOVEL AND PRACTICAL THINGS FOR DAILY USE

One of the newest things making for comfort in motoring is a windshield for protecting the occupants of the back seat. This device automatically locks itself in any position and when not in

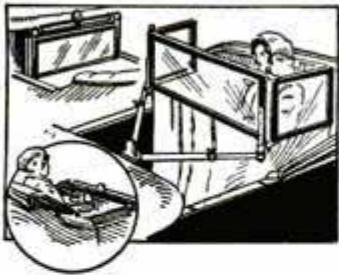

Windshield for Back Seat of Automobile

use is folded compactly against the back of the front seat. The upper part consists of a three-sided glass shield and from this is suspended a cloth shield which hangs to the floor of the car. The device can be readily converted into a table when desired.



Electric Vest-Pocket Lamp Made Like a Watch

An electric vest-pocket lamp, made in the form of a watch and weighing less than 3 oz., is a novelty recently brought out in Germany. Current is supplied by a two-cell storage battery inclosed in the case, while the electric-light bulb is placed in a depression in the side of the case. The light is turned on by pressure on a push button at the top of the stem.

A holder to be attached to the wrist and designed for carrying the spool of material used in crocheting, knitting, embroidering, lace work and needle work of every kind is one of the handy little devices recently placed on the market. The

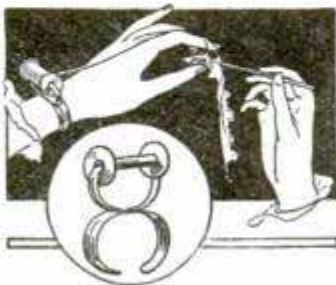

Device Holds Spool in Convenient Position for Crocheting

The spool is held securely by a light pressure of the brackets. The bracelet portion can be instantly attached to the wrist or removed, while the whole device can be adjusted to any size of wrist or spool.

A bread slicer now being introduced consists simply of the old and familiar miter box applied to a new use. The loaf of bread is placed inside the box and the slots in the sides serve as guides for the

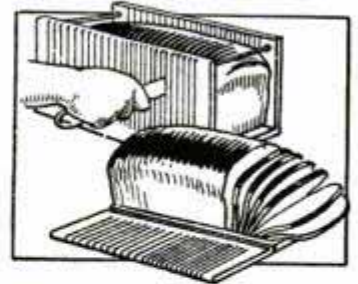

Miter Box for Slicing Bread

knife, with the result that the slices are of uniform thickness. Two spacings are provided in each box, as shown, and the box is readily laid out flat by releasing the hooks at the top.

An electric light that is readily attached to the supports of the folding automobile top for lighting the interior when the top is raised is a new feature designed to add to the pleasures of night riding. The bulb is carried on a strap that is buckled around one of the supports, while the two ends of the cable are connected to an ordinary four-volt

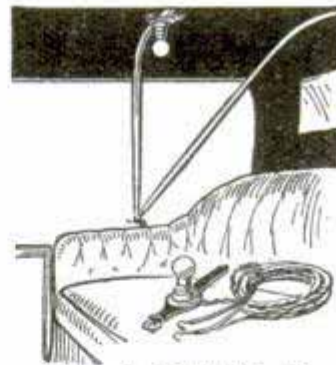

Electric Light That is Readily Strapped to Support of Folding Automobile Top

accumulator or a six-volt dry cell.

To protect the contents of a milk bottle after the paper cap has been removed is always a troublesome matter, and to overcome this a

glass cap made to fit loosely into the neck of the bottle has been designed. The cap is easily cleaned, while its weight is such as to cause a tight seal for the bottle.

A handy device for motorists and picnic parties is a spare seat that can be folded up compactly when not in use and is provided with a handle

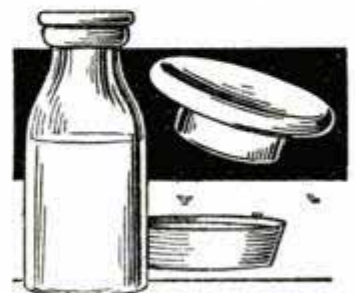

Glass Cap for Closing Milk Bottle after Paper Cap has been Removed

for convenience in carrying. The device is of constructed metal and is light but strongly built.

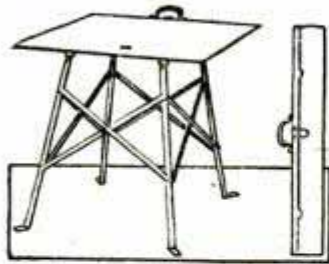

A Handy Folding Seat for Motorists and Picnic Parties

A new bottle closer brought out in France may be attached to any ordinary bottle, but is intended especially for hermetically sealing bottles that contain effervescent liquids. The cap is lined with rubber and is held in closed position by a strong spring. The cap is lifted by pressure on the lever in grasping the neck of the bottle and snaps back into place and closes the bottle the instant this pressure is released.

A nutcracker, now being introduced, has a movable head worked by a screw and applies all the pressure on the ends of the nut, a method that causes the shell to burst at the center without breaking the meat. In using, the handle bar is turned until the nut begins to crack, when a quick turn causes the shell to burst outward at the center. This cracker is made of malleable iron and is designed to be used with hard or soft nuts of any size. It is provided with a screw clamp by which it can be readily attached to any ordinary table.



Device for Closing Bottles That Contain Effervescent Liquids



Nutcracker Bursts Shell at Center and does Not Break Meat

A handy kitchen novelty is a cutter that slices an apple and cuts out the core at one operation. It is made in two forms, one for cutting the apple into eighths and the other for cutting it into twelfths, and is particularly useful in preparing apples for baking. It is pro-

vided with two handles conveniently located at the sides, and in using, the apple is simply set on end on the table and the cutter is forced down through it, cutting the fruit into equal slices. It can also be used for cutting potatoes into shape for French frying.

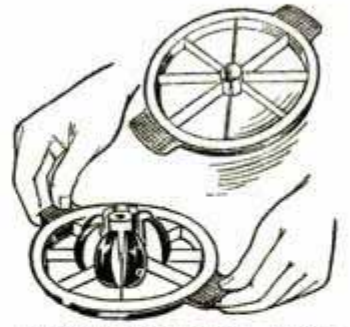

Cutter That Slices Apple and Cuts Out Core at One Operation

Stoning peaches by the ordinary method of cutting the fruit open is a tedious process and is often undesirable for other reasons.

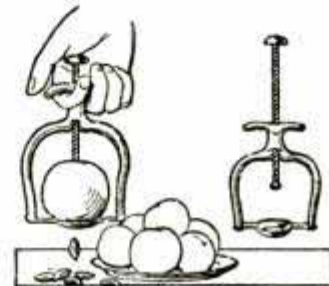

By Forcing Plunger through the Fruit the Peach Stone is Pushed Out

The device shown is provided with a rod or plunger which passes down through the peach and forces the stone out through an opening in the bottom of the holder, leaving the peach practically whole. Although designed to be held in the hand, the device can easily be attached to a table by means of a screw, where large quantities of the fruit are to be handled. The plunger is provided with a spring which forces it back into its original position as soon as released.

A spoon or ladle with an extension handle is a recently invented implement designed for the convenience of the cook in cases where large quantities of soup or other liquids are to be prepared, and especially where varying requirements make a variety of lengths of handle desirable. The extension slides in the handle proper, and is fixed at any desired position by means of a setscrew.



Spoon with Handle That may be Varied in Length

## SPRING-THREAD HOLDER FOR INSULATORS

A spring thread designed to do away with the breaking of electric-wire insulators from expansion and contraction, which frequently occurs when solid threads are used, has been perfected, and is shown in the illustration.

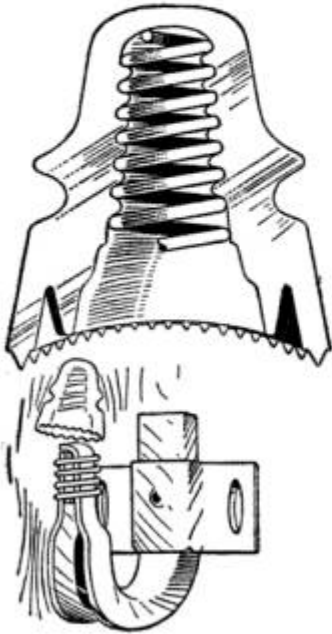

In hot weather this spring thread elongates and creeps further up into the insulator thread, thus preventing destructive pressure on the glass, while

in cold weather it keeps in close contact with the glass and prevents any wobbling. It is also claimed for this device that, owing to its resiliency, it will absorb sudden jerks or strains that might otherwise break the insulator.

## TANK GAUGE MEASURES LIQUID CONTENTS

A mechanical device to measure the quantity of liquid in a tank is becoming popular among motorists. The gauge is made up of a vertical tube and a horizontal dial upon which is indicated the surface height of the contained fluid.

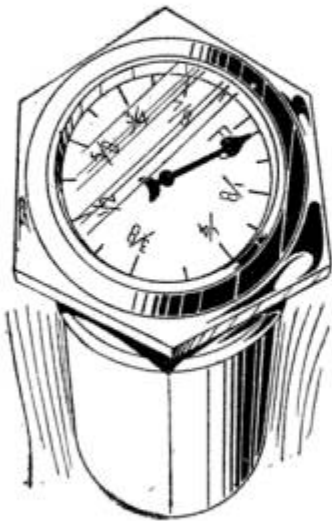

Recent investigations made in England show that 25 per cent

of industrial accidents could be attributed to bad lighting. Many factories were found to have plentiful light, but bad distribution.

## WIRELESS MESSAGES TO GO AROUND THE WORLD

The time when the governor of the Hudson Bay Company had laid before him daily a copy of the London Times exactly one year old, seems very distant now that the wireless gives instantaneous news service the wide world over. An incident in the mining camp of Gowganda, in northern Canada, a day's ride from the farthest tip of the railway lines, is in point. A young engineer who had spent some time in amateur wireless practice in Toronto had rigged up, in that far-off mining camp, an aerial and equipped it with homemade receiving instruments. About him stood a group of rough miners, breathlessly awaiting the completion of a message. "He's talking to the 'Mauretania,'" muttered the engineer. "He says that Mathewson won today's game for the Giants." Instantly the room was filled with uproar. "Hooray!" they cried lustily. "Just you wait till tomorrow," shouted one of the engineers, "and see what Plank does to them Giants!"

The world is now almost and soon will be completely belted with wireless. The United States is preparing to cover the western hemisphere with towers capable of communicating across the Atlantic, and, through the use of relay stations, from one side of the Pacific to the other. At the last International Wireless Congress, at which were representatives from all the civilized nations of the world, it was planned that Great Britain should erect a gigantic wireless tower on the banks of the Suez Canal and another at Calcutta; that Japan should build one at Yokohama, that Italy should construct one near Messina, and these, with the one already working from the top of the Eiffel Tower in Paris and with what this government contributes to world communication at Guam and Honolulu as well as throughout America, will be sufficient to girdle the world, and, by preconcerted arrangement, transmit messages from any part of the world almost instantly.



Plans are now under way in the Navy Department for the erection of a number of stations comparable to the huge masts at Arlington, overlooking the national capital, and their twin spires at Colon and Mare Island, with one inland station, either at St. Louis or Chicago, which will take care of all classes of messages, whether filed in the United States or relayed into our territory by other nations for communication elsewhere. The wireless towers already working have tremendous range. The station at Arlington has often caught time flashes from the Eiffel Tower, and the sending of messages across the continent and from Washington to Panama is of common occurrence. Lately a flash was caught at Arlington from the Samoan group, in the Southern Pacific.

With the placing of powerful stations on the coasts it will be possible for our government to be in touch at all times with individual units of our fleet in whatever waters they may be. Dewey's expedient at Manila Bay of cutting the cable will no longer be effective. Then, in case of disastrous floods, such as that which devastated Dayton, where populous cities were cut off from communication for several days, the rupture of telephone or telegraph wires will no longer isolate the stricken district.

### NEW CLIP FORCEPS FOR CLOSING WOUNDS

A wound-clip forceps has been invented which makes the busy doctor in a large measure independent of sutures and needles and enables him to secure perfect apposition of wound edges without torturing his patient or subjecting him to the danger of stitch abscesses. With the forceps and its magazine of aluminum clips goes an apposition forceps with which the lips of the wound are brought together. The jaws of the suturing instrument then ride the apposed edges and a single pressure of the surgeon's fingers fastens the metal clamp in place. Another movement of the thumb brings

the next clip into position, and it is possible, under favorable conditions, to suture a 4-in. wound in two or three

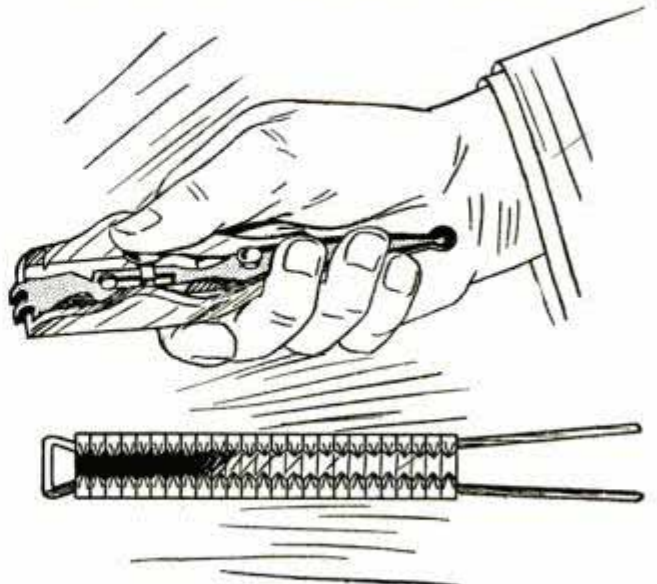

New Wound-Clip Forceps with Magazine Containing 25 Clips

minutes. The clips are flexible and any degree of tension can be secured by elevating or depressing the center of the band.

### SPRING-LEAF SPREADER FOR AUTOS

The difficulty of prying apart the leaves of an automobile spring when oiling is necessary has resulted in the marketing of this simple spreader. It is a screw clamp having a wedge-shaped projection on each side, one on the body of the clamp and the other on a slide acted upon by the screw. In

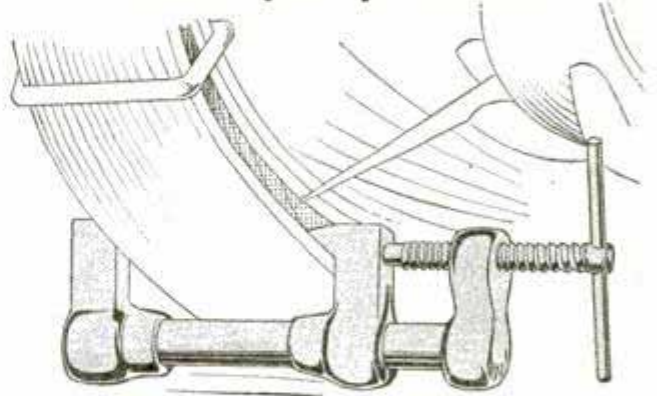

The Leaf-Spring Opener in Use

addition to spreading the leaves for oiling, the clamp can also be used, in the event of a leaf breaking, to hold the spring together while the car is being driven to its garage.

### SIMPLE EXHAUST SILENCER FOR MOTORCYCLES

By using an exhaust pipe arranged as shown in the illustration an inventor is said to have provided an effective exhaust silencer for motorcycles. Pieces of sheet iron placed in the pipe at an angle of 45 deg. with the axis of the pipe act as a baffle for the exhaust gas, while holes drilled in the pipe adjacent to these plates enable the gas to escape into the air in small distributed quantities, doing away with

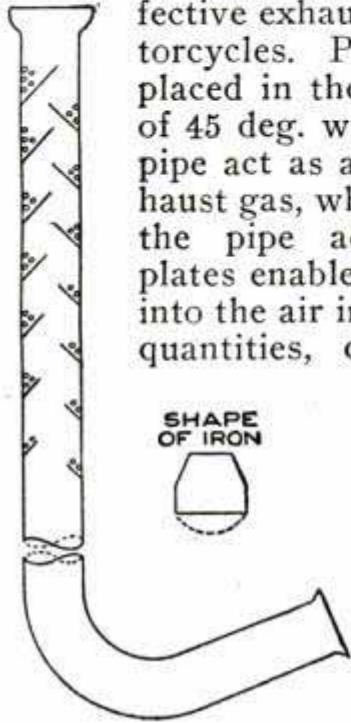

the noise caused by a single blast. This device is said to be so effective that practically no gas escapes from the end of the pipe, all having passed through the holes.

Approximately 110,000,000 horseshoes, or one for each human being of the United States, were made in our country during 1912.

### TELEPHONE MAKES COST KEEPING EASIER

The telephone is used successfully in a Chicago establishment as a means of keeping track of the time spent by employes on repair work and special jobs. Each department in which work outside of the regular routine is done is connected by telephone with a central switchboard, the operator at which has nothing else to do but record the time of employes. A worker, taking up a particular piece of work, calls this switchboard and gives the number of the job on which he is starting. The time is recorded on a job ticket by the operator, and when the work is finished the worker calls up again, announces that the job is done and gives the number of the next one to be undertaken. In this way the exact cost to the establishment of each job is readily computed.

All the machinery for the largest electrical installation in Asia, at the Cauvery Falls, Mysore, has been ordered from America, except the water wheels, which are being made in Switzerland.

### REVOLVING PLATFORM FOR CABLE RAILWAY

A possible means of moving congested bridge traffic is suggested by a cable railway which was used during the international building-materials ex-

hibition in Leipzig, Germany, recently. The principal feature of this line,  $\frac{1}{3}$  mile long, between the exhibition grounds and the little suburban garden

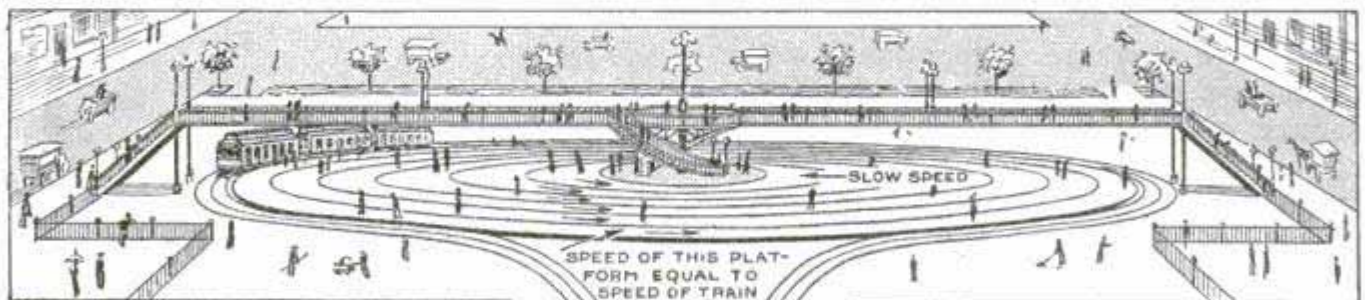

Revolving Station Platform

for German Cable Railway

hibition in Leipzig, Germany, recently. The principal feature of this line,  $\frac{1}{3}$  mile long, between the exhibition grounds and the little suburban garden

city, Marienbrunn, was that its trains ran without stopping and were loaded and unloaded from moving platforms of circular form. Each of the two stations consisted of a circular "island" reached by an overhead bridge, and a ring-shaped platform, 108 ft. in outside diameter, revolving about the

island. Passenger cars, drawn by the same underground cable that revolved the platform, ran on a line between the stations and circled each station around the outside edge of the revolving platform. As the speed of the revolving platform was from  $2\frac{1}{4}$  to  $5\frac{1}{4}$  ft. a second, an easy walking speed of three miles an hour, at the inner edge, and from 9 to 14 ft. a second, the speed of the train, at the outer edge, passengers could step from the stationary island to the revolving platform and then to the moving train without danger. The platform was made of iron and weighed 57 tons. The idea of a continuously moving train, often suggested for bridge traffic, is made more practical by the revolving platform which permits a higher train speed.

### A HANDY DEVICE FOR ELECTRICIANS

A hand-operated device made entirely of celluloid, a fraction of an inch in thickness and small enough to be

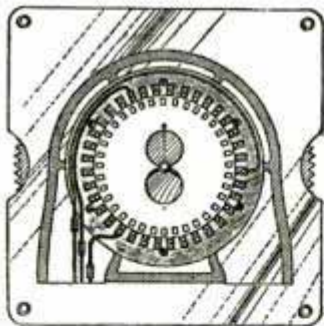

carried in the vest pocket, has just been designed for the purpose of showing electrical students and electricians, in a simple and correct manner, how the so-called revolving field is produced by the action of alternating currents in a three-phase alternating-current induction motor. The indicator is nothing more than a revolving wheel having a toothed edge, for convenience in turning with the finger, marked upon its surface with certain colored lines and inclosed between two square pieces of celluloid upon which are printed the symbols and marks necessary to quickly compute the result for which the device was constructed.

CA course in real estate has been added to the curriculum of Western Reserve University.

### A VALVELESS VACUUM PUMP

In the valveless vacuum pump water or other liquid is lifted by two three-lobe impellers, which work together

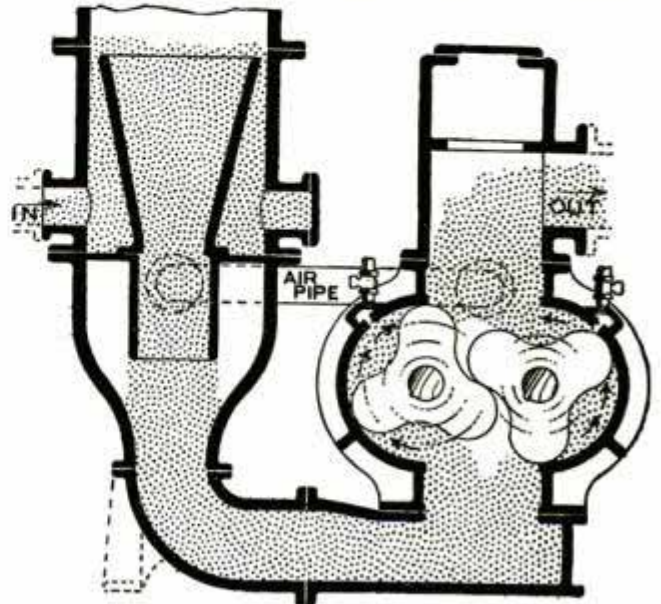

This Vacuum Pump Has No Valves, the Impellers Working Together Like the Parts of a Gear

like the parts of a gear. These impellers, however, are not in contact with each other or with the sides of the chamber, the return water, lying on the tops of the impellers, acting as a sufficient seal. The course of the liquid in passing through the pump is shown by the arrows.

### "TROUBLE" LAMP FOR AUTOMOBILES

A substantial "trouble" lamp that can be used in any position, under or around the automobile, is being marketed by an eastern firm. The handle is in the form of a hook, which can be slipped over any available part of the car when both hands are required for repair work. The outfit is carried in a neat plush case.



## VERTICAL CLOCK DIAL WITH ONE HAND

The vertical one-hand clock dial, which has just appeared, is the first improvement in clock faces since the in-

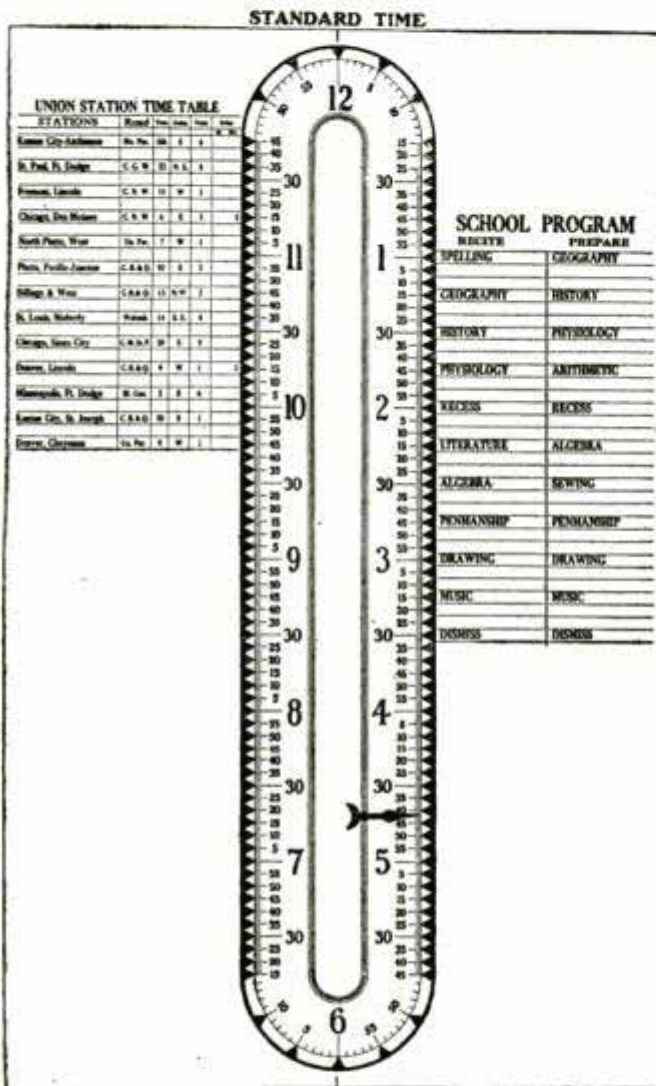

A Clock with a Vertical Dial and Only One Hand Which Moves Up and Down the Sides

vention of the circular two-hand face over 1,100 years ago. The new dial is a long narrow strip with six hours, divided into five-minute sections, on each side. A single hand travels down one side and up the other, making two round trips a day and pointing out the hours and minutes along its path. The chief advantage of the vertical dial is that the one hand, while telling the time, may also follow the numbers in a schedule, program, or time-table, arranged in the space along the sides opposite the proper hours and minutes. The hand is moved along by a sprocket chain passing over the minute wheel of an ordinary clockwork at the lower end and a loose wheel at the upper end.

## ARTIFICIAL PEARLS MADE FROM GELATIN

A new process of manufacturing artificial pearls is said to equal any of the methods heretofore employed in the quality of the finished product, while it is less expensive than some processes now in use. It is based on the fact that certain alkali phosphates have the property of rendering pure gelatin iridescent. Small glass beads are used as nuclei for the artificial pearls. These are dipped into a warm solution of gelatin and then placed on a gelatin-coated glass plate. On the gelatin surface of the plate, forming a ring around each bead, is then applied with a small brush the phosphate solution. This is absorbed by the gelatin, and is soon diffused through the coating of the bead. As soon as the iridescent effect desired has been produced, which must not be accomplished too rapidly, the "pearls" are exposed to the vapors of formaldehyde, which hardens the gelatin and renders it insoluble.

## NEW TYPE OF SHOVEL WITH TOOTHED CUTTING EDGE

An improved type of shovel, which, it seems, possesses many advantages over straight-bladed tools of this kind, has been placed on the market. The main improvement consists in teeth being cut in the blade. These teeth, which project  $1\frac{1}{2}$  in. from the blade, are slightly rounded at the points and it is claimed they are self-sharpening. After the teeth have been worn down to the blade the shovel can still be used, thus making it practically a tool with a double life. It is clear that less labor is required to use the new type of shovel, as its teeth cut their way into the material.



## HIGH-PRESSURE GAS FOR CITY LIGHTING

One of the latest improvements in street lighting consists in using gas at a high pressure, with the result that the lamps have a candlepower enormously greater than that of the ordinary street lamp with which we are all familiar. Following several years of experimenting, high-pressure gas lighting was decided on for the principal streets of Berlin, and visitors in that city are amazed at the abundance of light with which the streets are flooded. With the regular low-pressure gas, the lamps were limited to a maximum of 400 cp. This results when the pressure in the mains is maintained at about  $2\frac{1}{2}$  oz. per square inch. With a pressure of  $2\frac{1}{2}$  lb. per square inch lamps are easily capable of giving from 500 to 4,500 cp. The municipality of Berlin was so well satisfied with the results of the experiment that an appropriation of \$1,660,000 was made for installing the system, the installation being made gradually in accordance with a definite program. The adoption of high-pressure gas lighting requires the installation of special high-pressure mains connecting the lamps with compressor plants at the different gas works. The cost of compression is said to be very low. The pressure is automatically kept constant, and the compressor plants at the different gas works are so connected that one set or all can supply the lamps.

Since the installation of high-pressure gas lighting in Berlin, practically all the principal cities of Europe have adopted the system, the most notable cases being London and Paris. This system will be one of the leading features at the Panama-Pacific Exposition, where it will be used extensively for the lighting of the grounds and concessions. As a safeguard against any possible failure of the electric supply, gas lights will be distributed throughout the electrically lighted sections.

☐ New York City uses about 19,000,000 tons of coal annually.

## ACCIDENT PREVENTERS AND SAFETY TOOLS

Among the many "safety" tools and accident-prevention devices passed upon as having great merit, and given

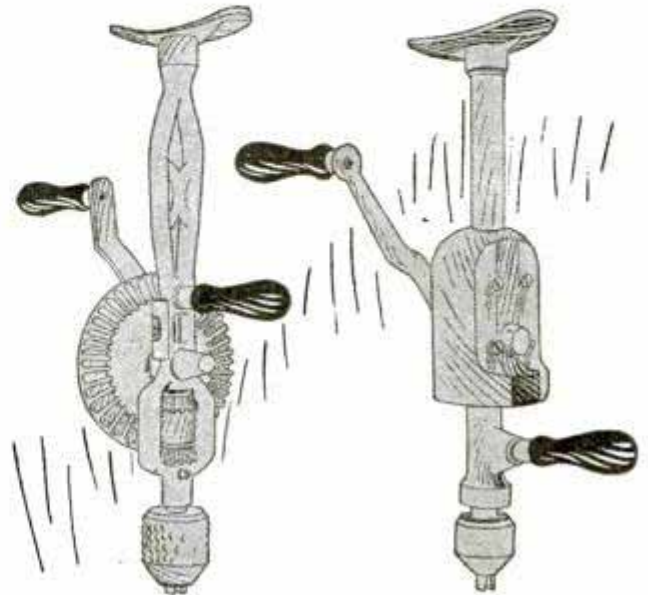

American Breast Drill with Exposed Gears

The "Safety" German Breast Drill

the "hall-mark" of the American Museum of Safety, are the four shown in the accompanying drawings. The "safety" breast drill, which comes from Germany, is shown beside the ordinary American breast drill, so as to accentuate the inferior qualities of the latter. All the gears are inclosed in the German tool, so that, should the

hand slip, there is no danger of the fingers getting mangled. The dangerous construction of the American breast drill is apparent.

The committee which passes upon all new devices submitted to the American Museum of Safety was particu-



A Pickax Whose Head cannot Part Company with Its Handle

larly enthusiastic over the pickax. The means used for holding the head on the handle is very simple, yet such

that it is practically impossible for head and handle to part.

The little handle-and-ratchet arrangement shown at the side of the carboy holder prevents the carboy from rocking and thus splashing its content of acid over the workman, should his hand slip from the rocker handle when the carboy is tipped over for discharge.

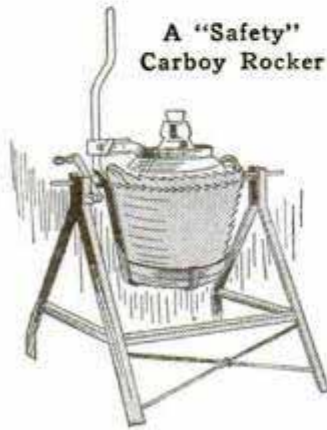

A "Safety"  
Carboy Rocker

The device breaks the force with which the carboy swings back to an upright position and then locks it in that position.

When bundles of steel rods are being transported through the streets of American cities the outer ends usually protrude from the wagon in such manner as to be extremely dangerous should pedestrians approach too close, particularly when the wagon is rounding a corner. In Germany this danger is usually minimized by hooding the protruding ends of each bundle. The hoods used for the purpose are made of leather, and are heavily padded, so that they not only minimize the danger of accident, but also do away with much of the noise of steel clanging on steel.

### STRONG DEFENSES OF THE CANAL ZONE

Recent experiments with the mortars provided by the Ordnance Department for the defense of the Canal Zone, developed a range of 19,300 yd., or about 11 miles. These mortars are expected to give the fleet defending the canal protection against any attacking fleet until they can form in battle line. The former range of 12-in. mortars was but  $7\frac{1}{2}$  miles, and as the navy had been making hits at that distance it was felt the range of the coast-defense guns should be so increased as to keep an enemy at safe distance.

### NEW CLOTHES WRINGER HAS PNEUMATIC ROLLERS

A clothes wringer with pneumatic rollers has been put on the German market. The advantage of the inflated rollers over those of solid rubber lies mainly in the fact that pressure is exerted on all parts of fabrics passed between the rollers even when the garments are not especially arranged. Buttons, hooks and eyes are not crushed by the roller. A bicycle pump is used to inflate this novel wringer.

### PIPE CENTERS ARE FOUND WITH NEW DEVICE

A handy device, known as a center finder, designed to determine the center measurement of pipe fittings, such as elbows, tees and crosses, is now being used by plumbers and steamfitters in this country. It is used with a steel

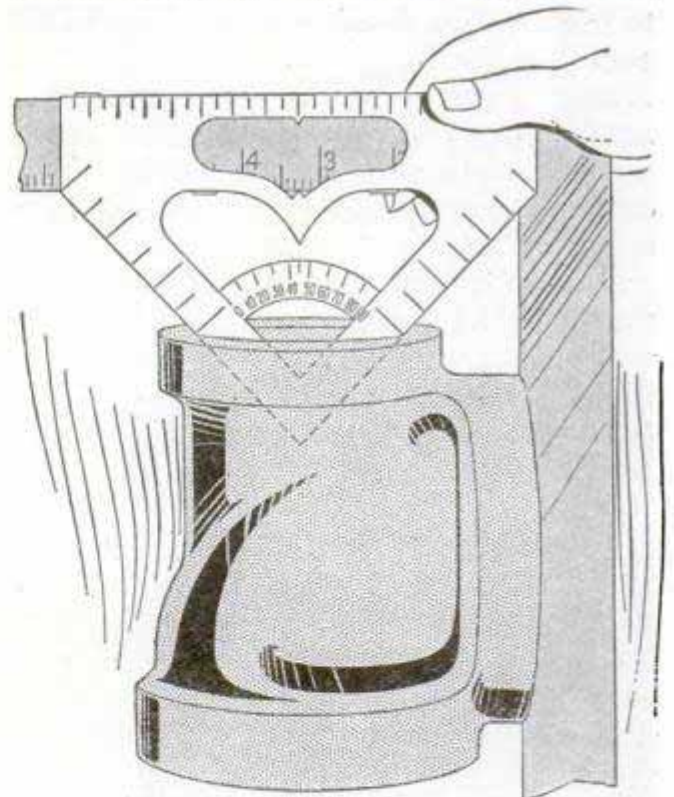

Determining the Center of a Pipe

square for finding the center, a pointer marking the line. This instrument, an application of which is shown in the accompanying illustration, can be used for several other purposes, among which the striking of proper angles in laying out piping is one.

## LIFEBOAT DAVIT WITH LONG REACH

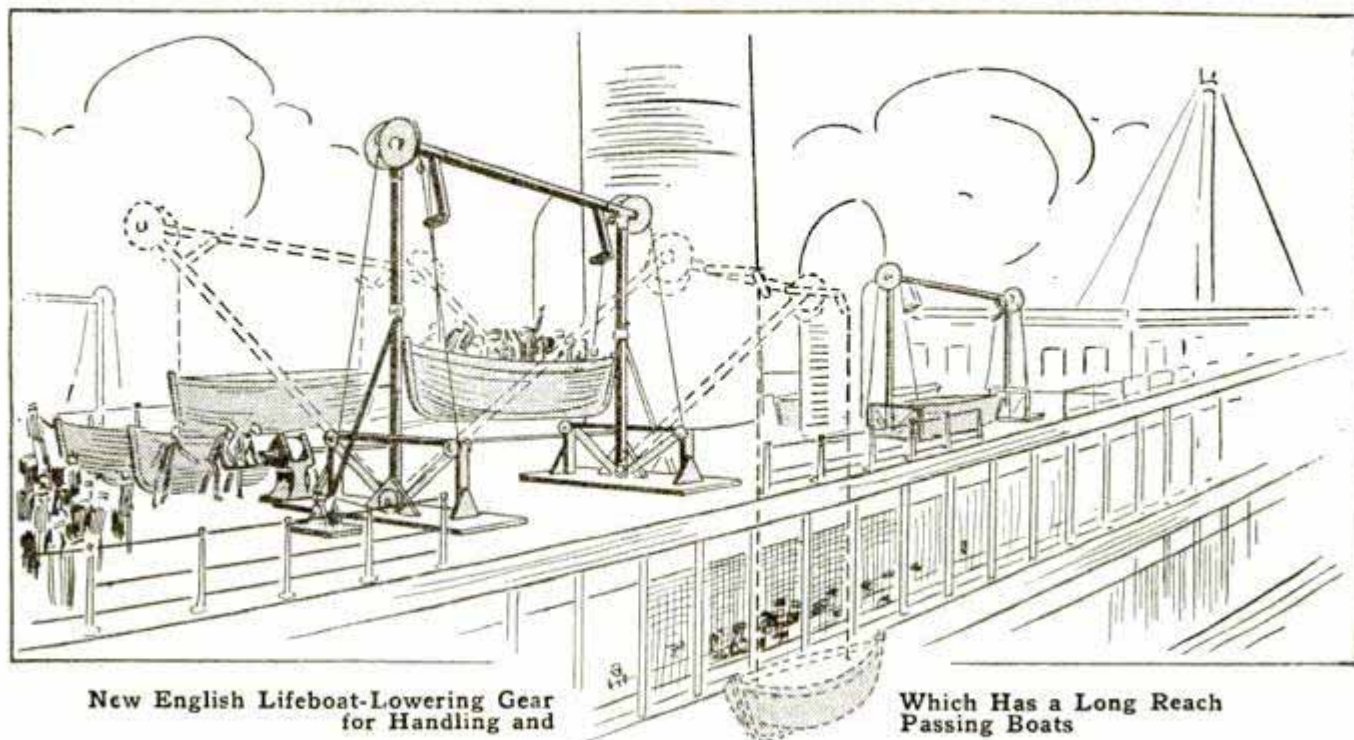

New English Lifeboat-Lowering Gear  
for Handling and

Which Has a Long Reach  
Passing Boats

Among the many devices for handling lifeboats that are being designed to meet the demand for "boats for all," even on the largest liners, there is an English boat-lowering gear that is an adaptation of old methods rather than a radical innovation. It is a lifeboat davit with a "long reach," designed to launch a large number of boats quickly and safely. Standing near the rail of the top deck, it can pick up boats stowed many feet inboard and swing them far out over the ship's side or pass them over within reach of a similar davit at the opposite rail to be launched on the other side.

The long reach is accomplished by pivots near the deck, which enable the upright posts of the davit to tip inboard or outboard, and by additional derrick arms which turn automatically so as to carry the boats in a horizontal line across the deck and extend the lowering gear beyond the ends of the upright posts. All the movements of the davit and lowering gear are operated by one shaft which is turned continuously in one direction by electric or hand power. As the same shaft may furnish power for four pairs of davits and the control levers for the various clutches are in one place, one officer

with a couple of men to hook the falls can launch all the boats stowed in one section of the deck. And he can launch them all on the safest side of the ship. Automatic devices keep the ends of the boats level and insure a launching on an even keel. The passengers can take their seats in the boats before they leave the deck, or from any deck below.

### WIRELESS UMBRELLA BUILT FOR STRENGTH

A new-model umbrella, recently patented, makes use of the ball-and-socket joint for holding the ribs together instead of the old wire fastener. In the new model any rib may be detached without disturbing the rest of the umbrella; there are no holes in the ends of the ribs and stretchers, and no wires to break out and tear through the cover, nor rust and break, and the ribs are so placed that the umbrella cannot "turn wrong side out."

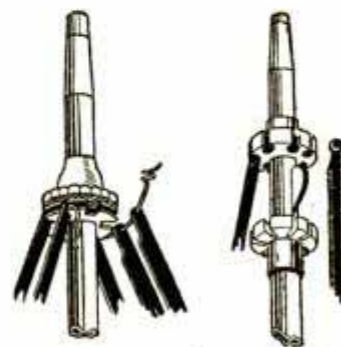

### FRYING A STEAK WITH A NEWSPAPER

A rapid cooker that will fry a steak in a very few minutes with the heat



of a torch made of a folded newspaper has just been brought out by a French inventor. As it will cook other foods with equal quickness and economy, it will probably be very useful to soldiers, campers and travelers.

The little cooker, which weighs less than a pound, consists of two thin metal plates that fit together tightly, a handle, and a metal standard. Its great efficiency depends upon the fact that no heat or vapor can escape from inside and little heat is required to warm the cooker itself.

### CHANGEABLE BRISTLES FOR TOOTHBRUSHES

The use of many sets of bristle holders in a single handle is a new idea in sanitary toothbrushes which has recently appeared.



The handle, made in two pieces pivoted together like a pair of scissors, is arranged to clasp any one of a number of interchangeable brush members. When a new toothbrush is needed, the handle is opened, the old bristle brush is thrown away, and a new one is slipped into its place. Since the handle is permanent, it can be made of gold or silver and ornamented in any way.

More than 22,000,000 tons of coal are consumed annually in the Pittsburgh district.

### FLOATING SIXTY-TON BOILER FROM SHIP TO SHORE

A boiler recently shipped to the Panama Canal was too heavy to be handled by any derricks available on the isthmus, so the furnace and tube holes were securely plugged and the boiler was lowered into the water from the ship and floated ashore. The boiler is 14 ft. long and 15 ft. in diameter, and weighs 60 tons.

### NEW INVENTION MAKES GUN CARRYING EASY

An improvement in the method of carrying a gun on a hunting trip when



not in use has recently been patented, consisting of a leather strap, one end of which is snapped onto a hook near the end of the barrel, and the other mounted on a steel roller

spring. When the strap is not wanted, it may be unhooked and the spring will reel it up on a shaft in the casing, or if not unhooked, it will be firm underneath the barrel of the gun.

### SPIRAL COILS ANCHOR SCREWS IN CEMENT

A new screw anchor for use in cement work has been patented recently. It consists simply of a spiral coil into which the screw is inserted, and is guaranteed to have a holding strength of 2,500 lb. Stock sizes range from  $\frac{1}{4}$  by 2 in. to 1 by 30 inches.

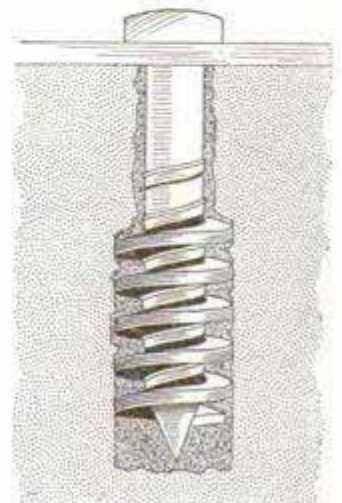



### FLEXIBLE EGG CARRIER SAVES LOSS

Soft-boiled eggs that are "just laid" are possible now that the parcel post is supplemented by a device which is claimed to "really carry eggs in the mails without breakage." In a recent invention, a pasteboard box folds in such a way as to truss the box, giving it unusual strength. The illustration shows each egg suspended in an individual compartment, between upper and lower pyramids, giving eight points of contact. These compartments, being flexible, accommodate themselves to eggs of various sizes, and when the box is tightly tied the eggs do not roll or rattle. The eggs are thus held apart from each other

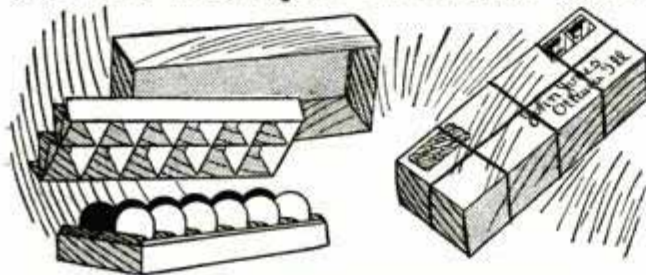

New Device Which Brings the Hen Closer to the Breakfast Table

and away from the sides of the box, so that the box will stand not too rough handling.

### GERMAN NAVY BUILDING TWO MORE DIRIGIBLES

Undaunted by the loss of the two naval Zeppelins, "L 1," which was wrecked in a storm on the North Sea, and "L 2," which caught fire in the air and fell to the ground from a height of 500 ft., the German naval authorities are building more dirigibles. The "L 3," a new Zeppelin, and the "L 4," a Schütte-Lanz, are expected to be completed by April 1, 1914, and will be housed in the double dirigible shed at Cuxhaven. Pending the completion of these airships, the government has leased the two passenger dirigibles, "Sachsen" and "Viktoria Luise," and these are to be used as training ships for the German aerial navy until the new ones are in commission.

### NEW DIRECTION-SIGNALING DEVICE FOR AUTOS

This arrow-shaped direction indicator is mounted on the front of the car and operated by the driver by

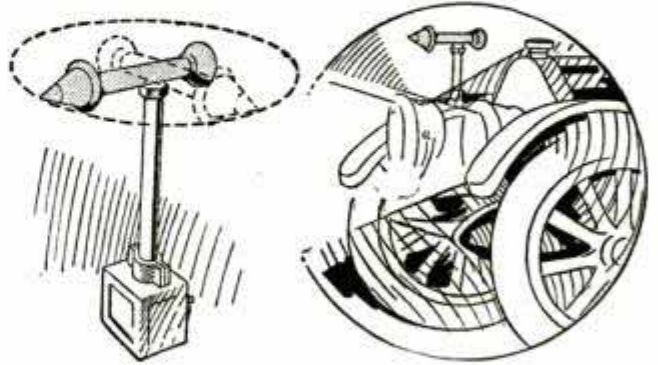

Direction-Signaling Arrow for Front of Automobile

means of a small lever on the steering column. A steel rod passing under the hood, with universal-joint connections, runs to a gear box on the radiator. The pointing of the arrow to right or left indicates to the traffic officer when a turn is to be made. At night the arrow is electrically lighted and can be seen for two blocks.

### FLEXIBLE INSULATED SHAFT COUPLING

A coupling designed for the transmission of power from one shaft to another where electrical insulation and a slight degree of flexibility are desired, is shown in the illustration. The two outside flanges are attached to the shafts either by keys or set-screws. The central disk is made of leather and has lugs cemented or riveted to the sides. The disk supplies the insulation, and the lugs transmit the power to the outside flanges. This coupling will adjust itself to slight imperfections in the alinement of the shafts.

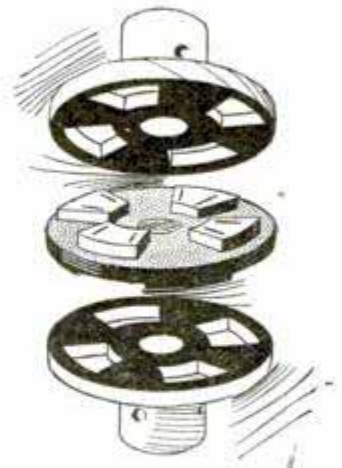

## SECURING WINDOW PANES WITH LEAD

Fastening window panes into their frames with strips of lead instead of putty, thus producing a puttyless

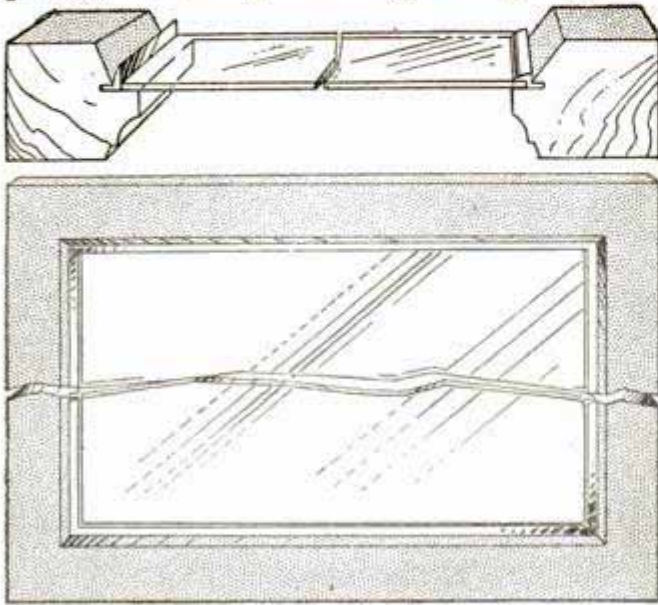

**A Window Glazed with Lead Strips Instead of Putty** window, is one of the latest advances made in building construction. This type of window does away with the use of glazing points and the pressure of the lead inlay on the glass is uniform throughout. The puttyless window is claimed to be waterproof, dust-proof, and air-tight; does not rattle or corrode, and will not peel off. When the glass is broken a new light may be put in by simply bending back the lead strip, dropping another glass into place and pressing down the strip again.

## WIRES USED FOR CUTTING MASONRY AND CONCRETE

A trench for carrying electric-light cables has been cut through the solid masonry and concrete of the Pont Neuf bridge over the River Seine in Paris, France. This trench is 4 ft. wide,  $7\frac{1}{2}$  ft. deep and 550 ft. long. The Pont Neuf bridge has been standing for about 300 years, and on examination it was found that the material was too hard to be cut by tools, while explosives were out of the question on account of the danger of weakening the arches. The work of cutting was finally done with helicoidal wires,

which on account of the spiral ribs on their surfaces, cut into the hard material more rapidly than plain wires would have done. The bridge was divided into three sections, each about 180 ft. long, and the wires for cutting each section were operated as continuous belts by 18-hp. motors. An abrasive powder was used for making the cutting more rapid.

## CLOCK WITH SINGLE HAND TELLS TIME ACCURATELY

A new clock face, or dial, has been patented which may be placed on any clock and by removing the hour hand, and placing the minute hand on the hour spindle, transforms the clock into a one-hand, easy-to-read time teller. Children have difficulty in telling the time by two-handed clocks, and those who have occasion to send a child into the house for the time can hardly ever be sure that the youngster does not confuse the "long" and "short" hands. The accompanying illustration shows how simple is the device by which neither dark days, glare on the glass of the clock face or a child's inability to distinguish between hour and minute

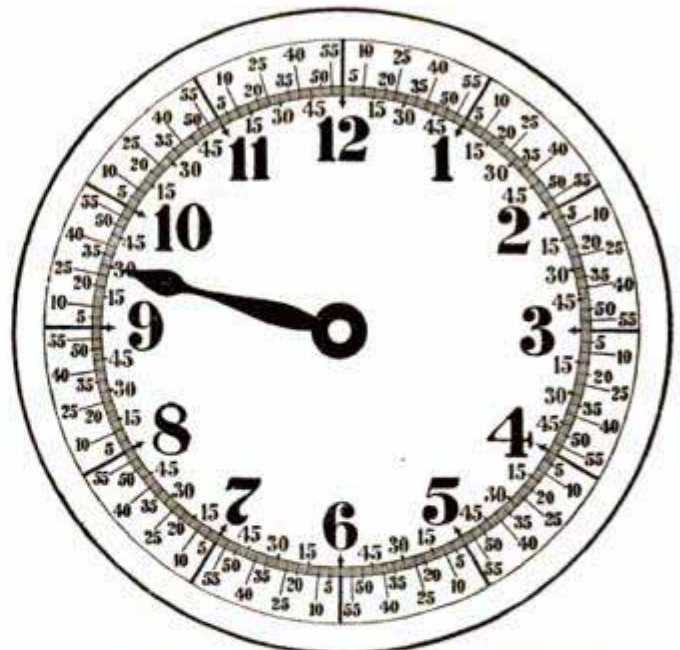

**A Clock Face Which Tells the Correct Time with One Hand**

hands can prevent correct time reading. In this there is no possibility of one mistaking, for instance, five minutes after twelve for one o'clock.

## BUILDING MOVED AND SET BACK ON NEW FOUNDATION

Putting a new foundation under a building as it stands on the old foundation or on underpinning is not an uncommon proceeding, but to take a four-story concrete building, move it to an adjoining lot, install the new foundation and then move the building back into its original position, as was recently done in San Francisco, is an unusual undertaking. The structure handled in this fashion is a four-story hotel and business building with a frontage of 50 ft. and a depth of 85 ft., and weighs about 2,500 tons. Owing to defective foundations one end settled until the walls were about 2 ft. out of plumb. Investigation showed the bed of an old slough underlying the lot, so it was necessary to drive the new foundation through the mud and silt to a solid footing. The building was first cut in two at the second-story level and the upper portion moved to the adjoining lot, after which the first story and foundations were torn out.

About 142 piles were driven to support new piers, on which new walls for the first story were built, and the upper portion was then moved back to its permanent position.

## STYLES IN WOMEN'S DRESS CONTROL AUTO DESIGNS

Upholstering of extreme depth, which not so long ago was considered the acme of comfort in automobile construction, has given way to a design in seats and springs made necessary by the long-waisted, narrow-hipped corset and sheath skirt affected by society women. The shape of the seat today is, therefore, quite different from that in use two or three years ago. The upholstering is of a character suited to present dress models, and lavender seats for day and gray seats for evening are demanded by the ultrafashionable. Not only have the seat cushions been changed, but the body of the car, its springs and the construction of the chassis reflect current styles in women's wear.

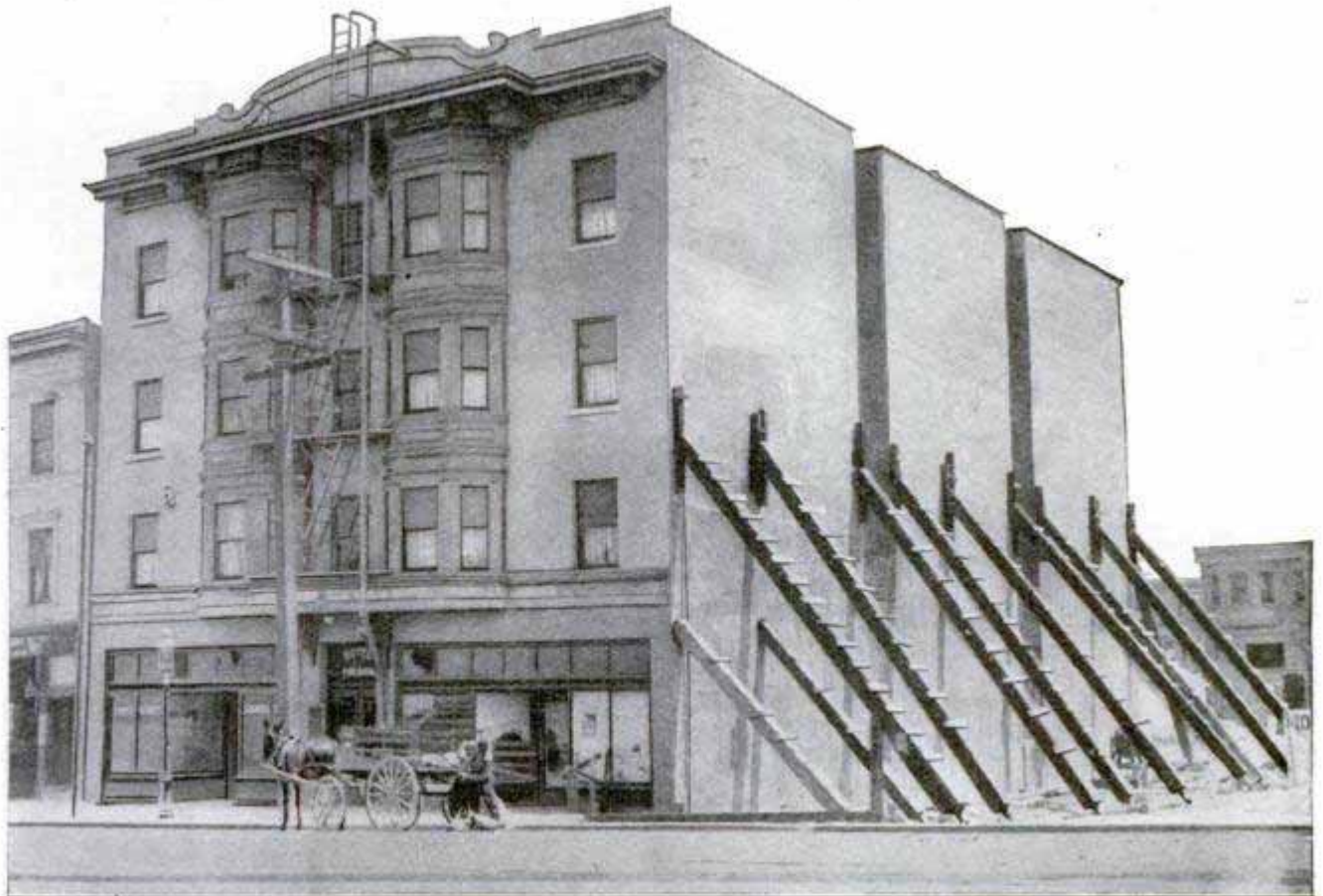

San Francisco Building That was Moved and Then Set Back on New Foundation

## NEW FLYING BOAT ADAPTED TO INLAND RIVERS

Small rivers with their bends and twists, and inland lakes affording no opportunity for long runs have not

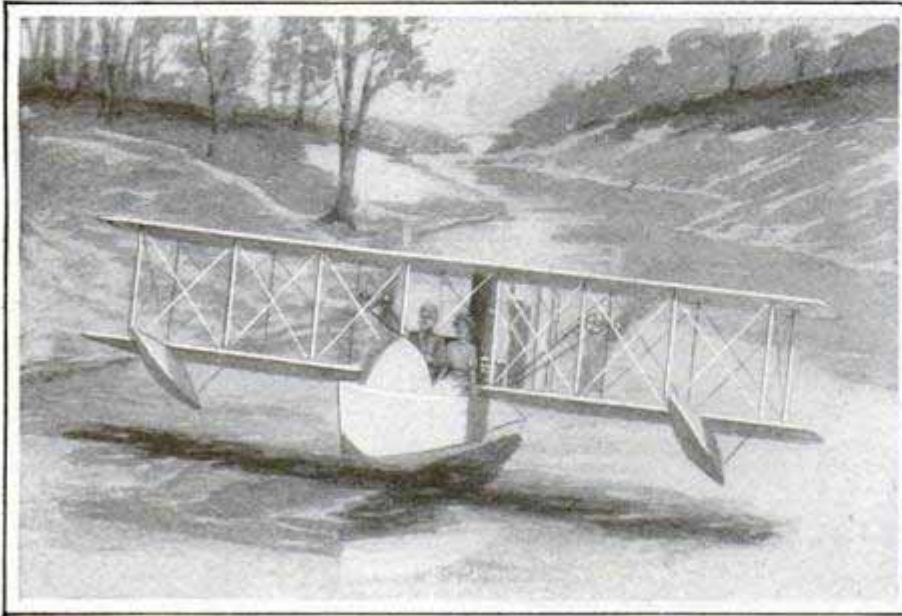

Flying over Small River Lined with Trees

heretofore been available for navigation by flying boats. A recent development of flying craft by Orville Wright makes possible air-water travel in such localities, in that the boat rises quickly, and is under perfect control, thus avoiding trees and high banks with ease. The motor is placed low in the hull, and the seats high, the exact opposite of previous practice. By this method the motor is protected from spray, the operator is in a safer position, and the balance of the machine is improved.

## NEW TYPE OF DANGER SIGNAL BENEFITS COLOR-BLIND

A colored danger signal consisting of a blue circle placed within a yellow rim is being advocated for use in industrial plants. Although red is now almost universally used as a danger signal it is far from satisfactory for that purpose, since of the 4 per cent of all men who are defective in color perception the majority are unable to distinguish red. Yellow and blue are the most luminous colors of the spectrum, and a combination of these colors can be seen at a greater distance in daylight and is more easily distinguishable in poor light than any single

primary color or any other combination of colors. In addition to this it has been found by experiment that this combination appears as red or green to workmen who are unable to distinguish yellow and blue, so that a definite danger indication is given in any case.

¶In the year ended June 30, 1913, 651 new ocean-going vessels were built in the entire world, with total registered tonnage of nearly one and three-quarter million tons.

## COLLAPSE OF REINFORCED-CONCRETE BUILDING

When a section of a new reinforced-concrete building fell recently, in Cedar Rapids, Iowa, it is estimated that more than 2,000,000 lb. crashed down upon the first floor without crushing it down. The concrete roof had just been laid on the section, 40 by 60 ft., when the false woodwork gave way, letting the floors fall, one after another, until the entire mass piled up on the ground floor. This was of heavy concrete construction, weighing more than 100 lb. to the square foot, and it

resisted the shock, breaking only in a few places. The steel reinforcing bars did not break or shear, but pulled out from the concrete and hung down like fringes from each floor. Several fatalities resulted from the accident, which occurred in the afternoon while a full force were at work. The building was 97 ft. high and sufficient warning was given before the roof fell, through the cracking of timbers and concrete, to permit the escape of most of the men at work.

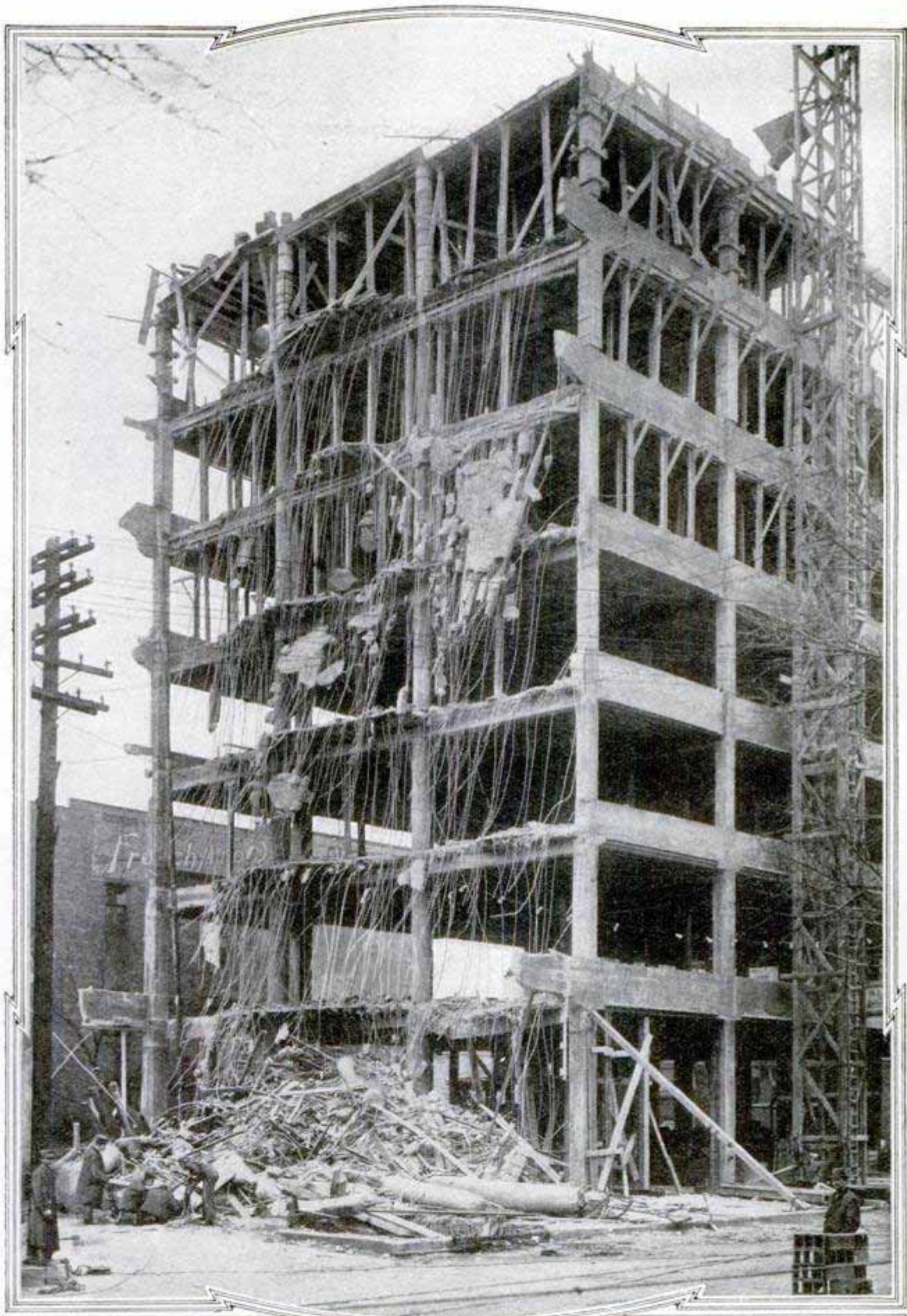

While the Roof of This Building was being Poured, the Supports Gave Way and the Entire Section Fell

## FOLDING PLOW FOR FIGHTING FOREST FIRES

Fighting forest fires calls for quick work and lots of it. One man on the right spot, at the right time, may prevent fire losses running into hundreds of

thousands, but he must be equipped to do the most work in the best way. The supervisor of the Malheur National Forest, Oregon, has invented a collapsible plow for use in the work of the Forest Service, which digs fire lines faster than 20 men with shovels. The plow may be dismantled and folded into a compact form, so that it can be carried on horseback. It weighs only 40 lb., and when in use, one man with a horse can do an amazing amount of protective work, and head off a fire that, unchecked, might lay waste many square miles of standing timber.

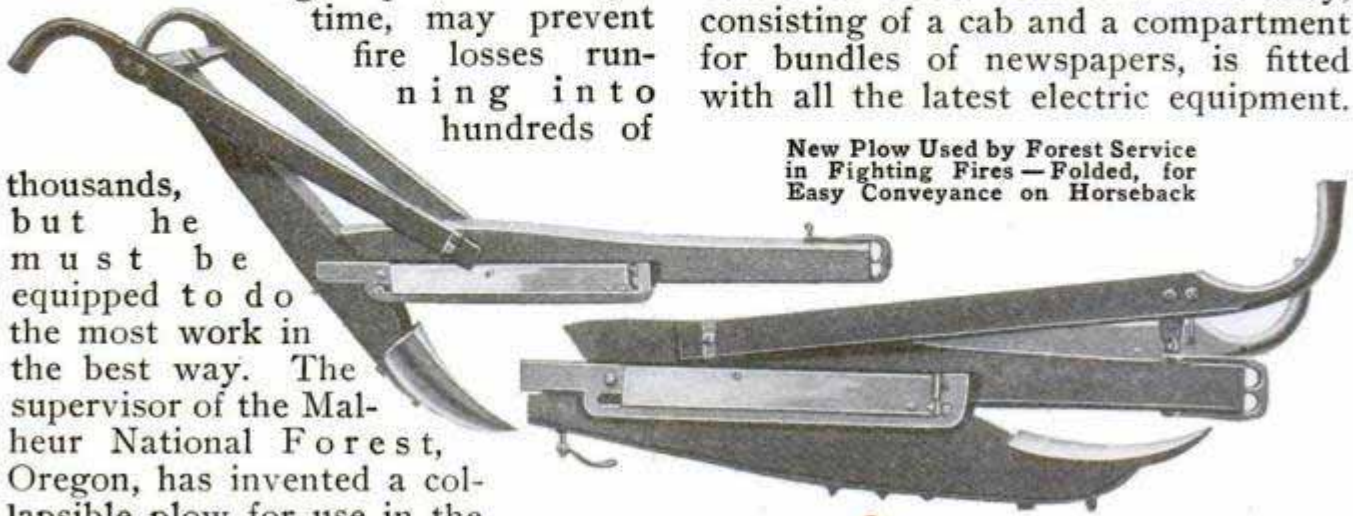

New Plow Used by Forest Service in Fighting Fires—Folded, for Easy Conveyance on Horseback

connecting the two cities, is shown in the photograph reproduced on this page. It is built out of the chassis of a 45-hp. machine which had been used as a pleasure car for two years and then burned in a fire. The new steel body, consisting of a cab and a compartment for bundles of newspapers, is fitted with all the latest electric equipment.

The wheels have wooden spokes and felloes and steel tires turned down from standard engine tires. By the use of two standard transmissions, the car is able to make high speed in either direction. It is painted to match the regular passenger cars on the line and runs on schedule, under dispatcher's orders. On its first trip it made a mile in 62 seconds or a little over 58 miles an hour.

## RAILROAD AUTO CARRIES NEWSPAPERS

A specially constructed railroad automobile, called "The Advertiser Spe-

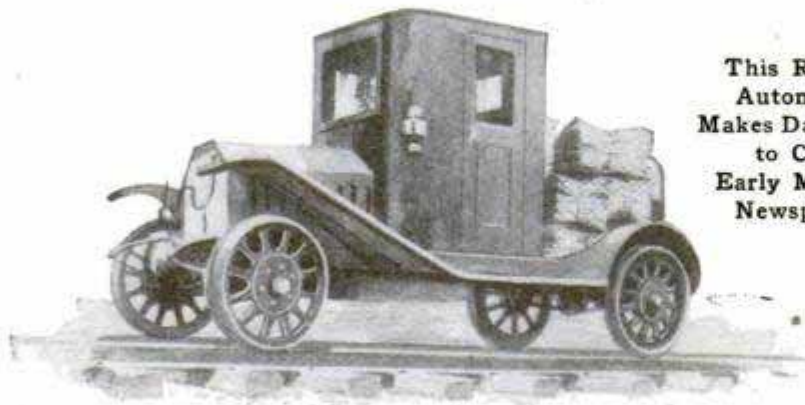

This Railway Automobile Makes Daily Trips to Carry Early Morning Newspapers

cial No. 9" and built to carry the daily issues of a southern newspaper from its place of publication to an adjoining city every morning over the rails of the road

## IRRIGATION OF BOMBAY AN ENORMOUS PROJECT

One of the biggest irrigation projects ever attempted, covering the whole of the Bombay Presidency, is now being considered by the government of India. There are 55 schemes awaiting sanction, but serious consideration will be given only to such as will undoubtedly fulfill all the required conditions, a policy brought about through the fact that many of the earlier irrigation projects have failed to prove remunerative. It is planned to irrigate about 9,980,000 acres of land, involving an estimated expenditure of \$182,493,750.

## IMPROVED METHOD CURES FISH QUICKLY

An improvement in methods of curing fish makes it possible to preserve them so perfectly that two weeks after preservation, which is sufficient time to ship this food from the North Atlantic fisheries to any city in the United States, or to the West Indies and some ports in South America, the fish are as fresh as when first drawn from the water. Based upon the theory that putrefaction of fish is caused by bone taint, the improved method acts as a preventive of bone taint by removing the specific, or animal heat, from the fish. The fish are dumped into a tank holding sea water, filtered through willow charcoal; next brown sugar is added to act as a germicide, and finally the temperature is lowered to 14° F., during which time 16.1 per cent salt is added to prevent ice formation.

## HOUSE MOVED ON FLOATING DRY DOCK

One of the most novel of house-moving methods was that employed in Manitowoc, Wis., recently, when a

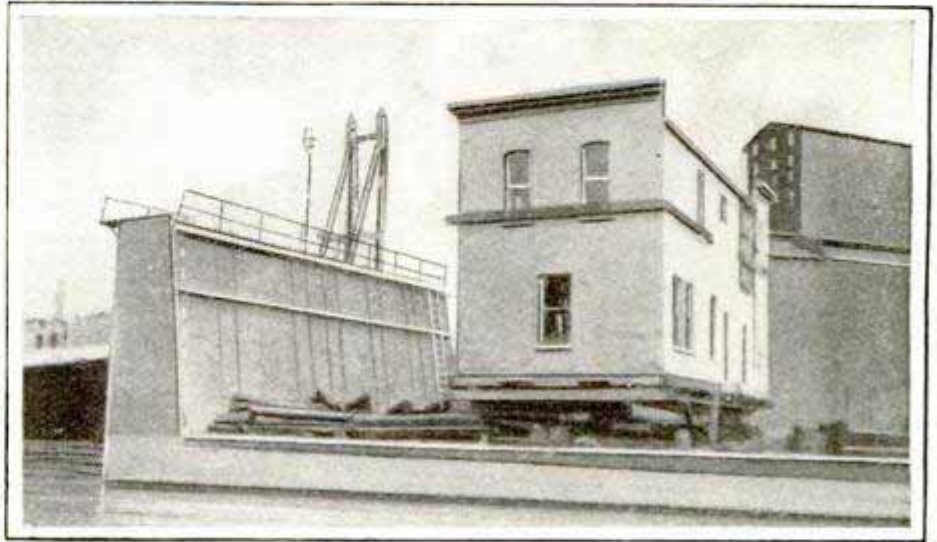

Brick Building Loaded on Floating Dry Dock and Moved to New Site

floating dry dock was pressed into service and used for conveying a solid two-story brick office building from its old location to a new site several blocks away. It is stated that not a brick in the structure was broken and that the office furniture was not disturbed in the least.

## USING AN AUTOMOBILE

In a mine in California an automobile is being used for hoisting the ore to the surface. This unusual method was adopted in order to

## FOR HOISTING ORE

get the work started without loss of time, and it has worked with such success

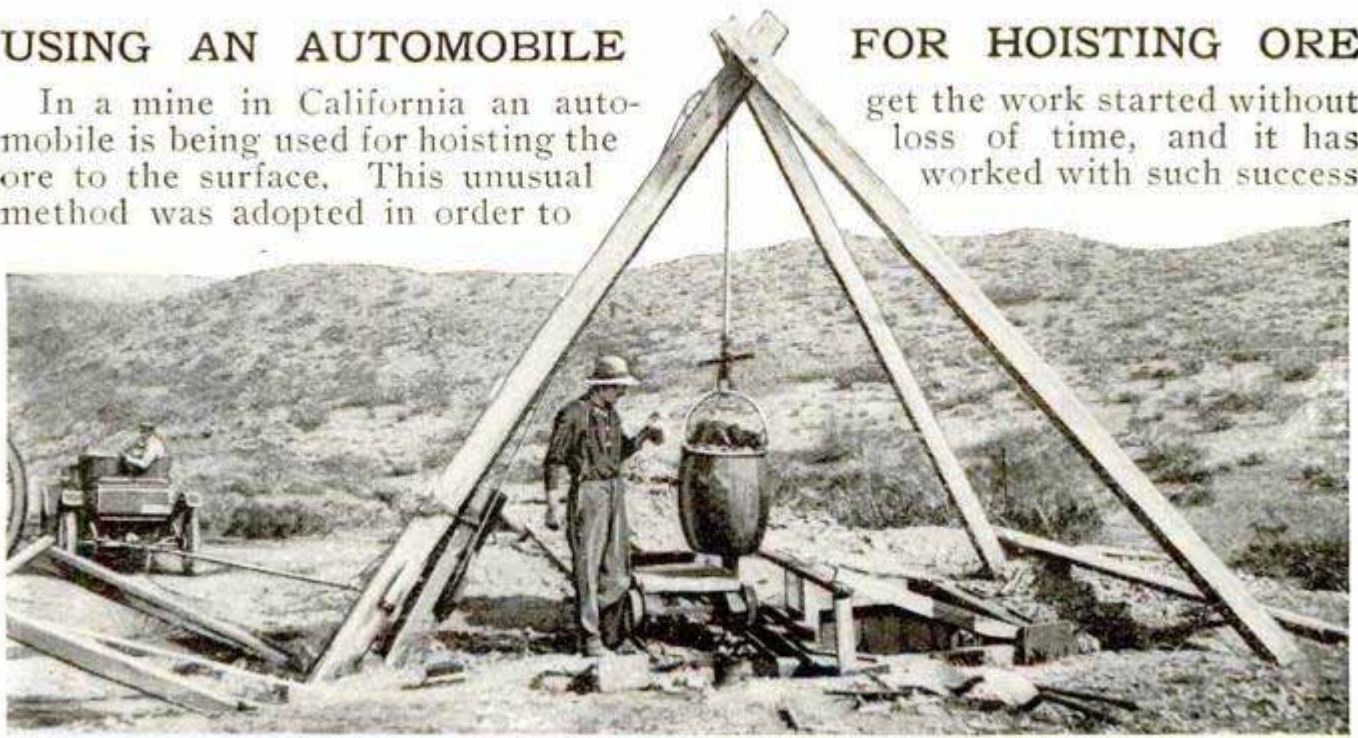

Automobile Supplies Power for Hoisting Ore

that the owners of the mine now expect to go to a depth of at least 400 ft. and to take out many thousands of dollars worth of ore before it is necessary to install hoisting machinery. In sinking the first 20 ft. of the shaft only 1½ gal. of gasoline was used.

### AUTOMOBILES WITH PLENTY OF STORAGE SPACE

"Closet room" in plenty, and to spare, appears to be the last word in automobile designing, if the models shown in the 1913 Automobile Salon at Paris are a criterion. Available space for wraps, for luncheon and dishes, for baggage and accessories and for the knickknacks which make travel comfortable for ladies, has been found and is cleverly utilized in backs of seats, within swinging doors, under and behind upholstery.

Space Gained Back of Driver's Seat for Locker Room

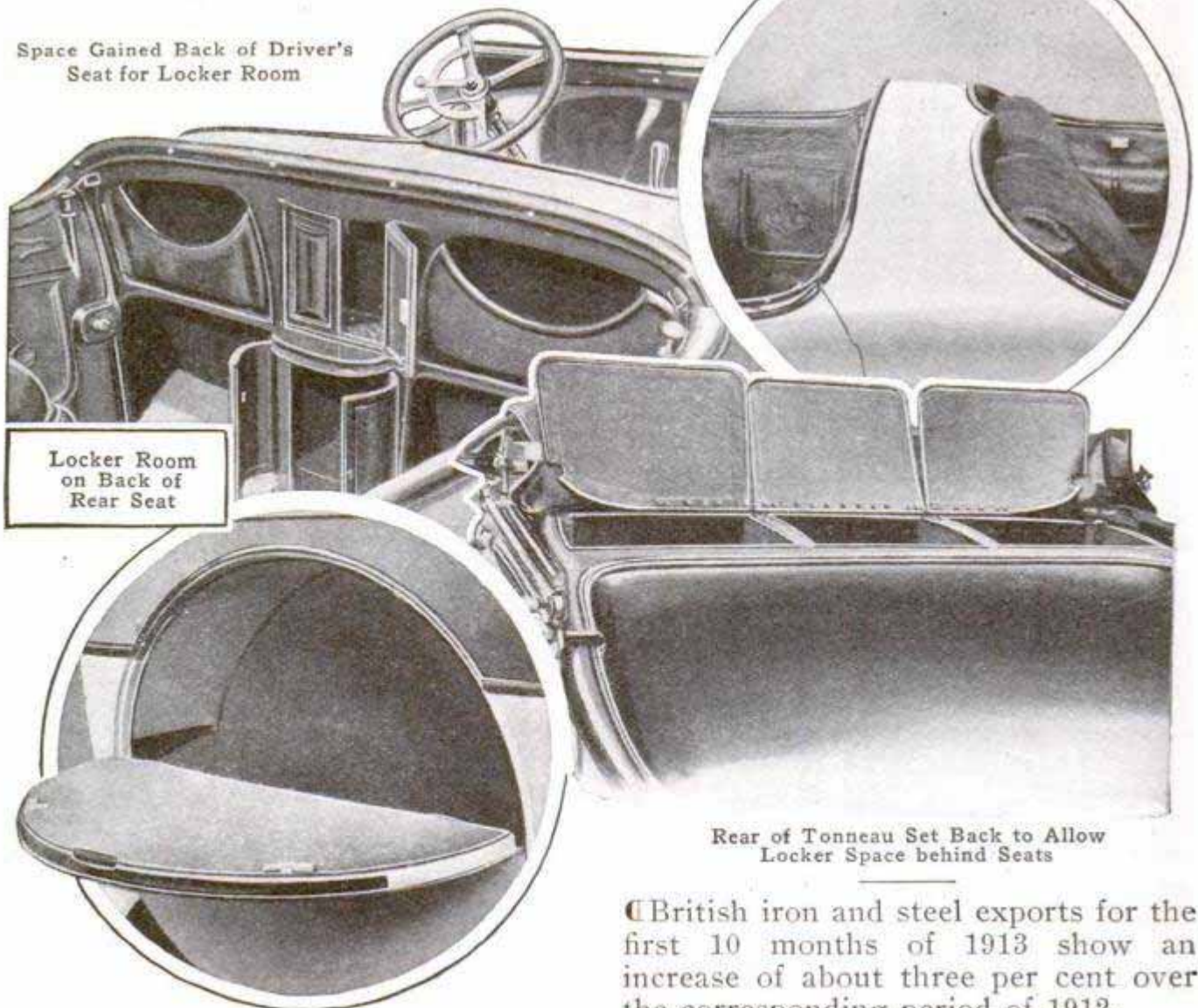

Locker Room on Back of Rear Seat

### NOVEL METHOD OF CLOSING "WILD" GAS WELL

A gas well in Louisiana that had run wild for six years and had been wasting from 10,000,000 to 20,000,000 cu. ft. of gas a day during that period was successfully closed recently by a method that is probably unique in the history of the gas industry. A relief well was first bored close to the old well, and to the same depth. Water and mud were forced down the relief well under heavy air pressure until the gas stratum was choked and the flow of gas shut off. The old well, which had made a crater 225 ft. in diameter and 50 ft. deep, was then permanently closed with concrete.

Forward Wall of Tonneau Appears Like Cowl of Driver's Seat

Rear of Tonneau Set Back to Allow Locker Space behind Seats

British iron and steel exports for the first 10 months of 1913 show an increase of about three per cent over the corresponding period of 1912.



## IMPORTANT POWER PLANT ON SOUTHERN RIVER

A great dam across the Tennessee River at Hale's Bar, 33 miles below Chattanooga, recently completed, is 40 ft. high and 1,200 ft. long. A lock is built against the west

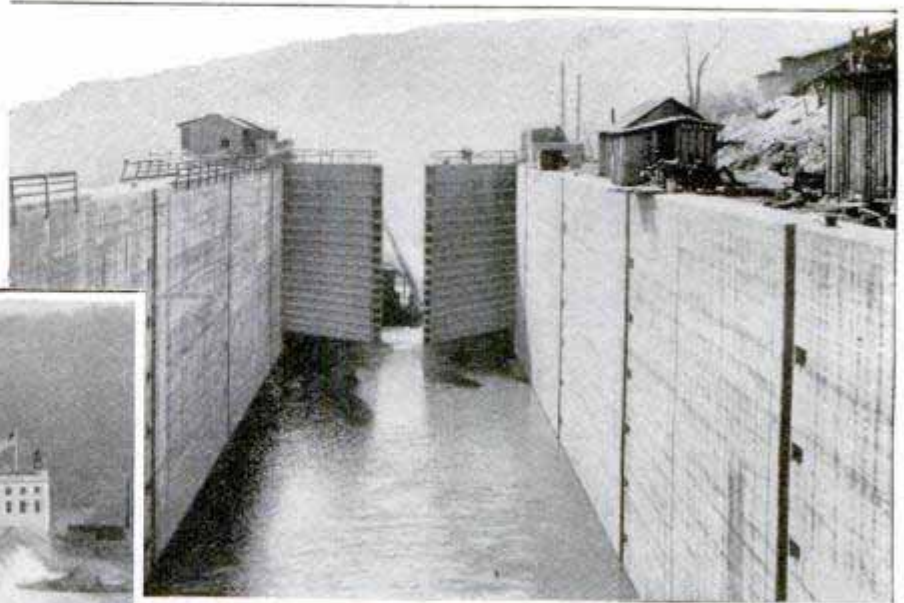
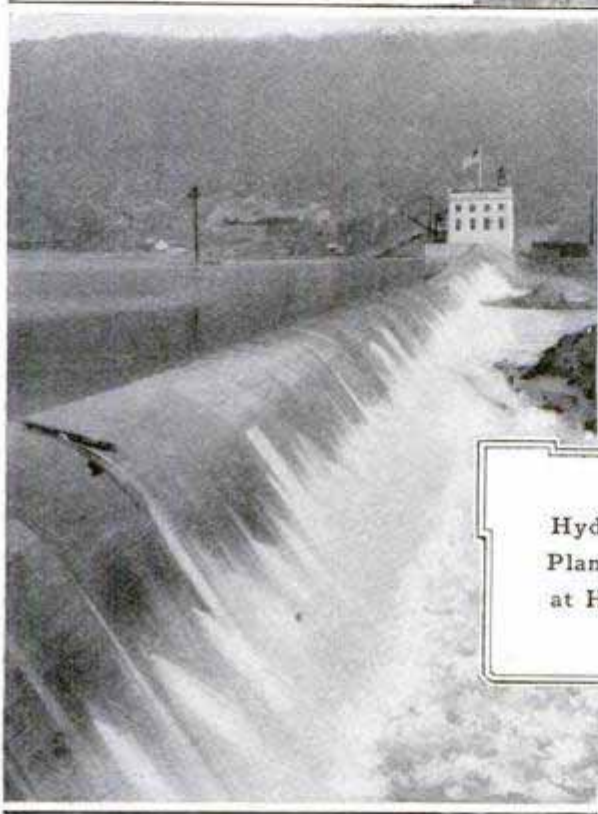

Single-Lock Lift of Nearly 40 Ft.

Hydroelectric  
Plant and Dam  
at Hale's Bar

bank of the river and has a clear width of 60 ft. and is approximately 310 ft. long, inside. The gates, which are of the mitering type, are built of steel and operated by electricity and are remarkable for the head they have to support, the difference between the two pools being about 40 ft. The power station is in two sections,

one an operating building, and the other a switch and transformer house. The operating building consists of seven bays, each containing two turbine units of three turbines mounted on a vertical shaft with a generator on its upper end. These 14 generators have a total capacity of 43,682 kw.

Under ordinary conditions but two turbines will be used in each unit, the third being held in reserve. Alternating currents of 6,600 and 44,000 volts will be delivered over two transmission lines of bare copper cables carried on steel towers to Chattanooga. This plant will supply power for many important industries.

### FIRST VESSEL THROUGH THE PANAMA CANAL

The small steamer "Louise," which passed through the Panama Canal on Nov. 17, 1913, with many prominent canal officials and their wives on board, was the first vessel to cross the Isthmus of Panama. A channel was dredged through the Cucaracha slide, the last obstruction which has been

delaying the work connecting the oceans. The dredges are now concentrated at this point and a large ship could be sent through on short notice.

ⒸThere is only one species of bird known whose bite is poisonous, the Rpir N'Doob, or "bird of death," of New Guinea. Loss of sight, convulsions, and lockjaw are symptoms which follow rapidly after an attack.

### VISIBLE INDEX NEWEST OFFICE HELP

A card index where all the key words are at all times visible, and yet new cards may be inserted readily and

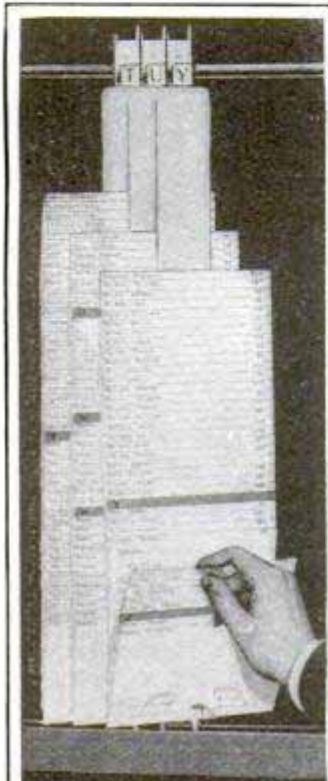

old cards removed without destroying in the slightest degree the alphabetical sequence, has been invented by a Yale professor and is now being placed on the market. Metal strips sliding on a wire at the top, their bottoms in a guiding slot at the base, afford secure grips for index cards having special perforations. This ingenious new



Copyrighted by Irving Fisher  
Novel Index Where Names are Both Visible  
and Insertable

system is elastic, as many metal strips being added from time to time as may be necessary, and cards may be shifted in groups from one strip to another.

From Tahiti a new fungus is being forwarded to Europe, which emits light resembling that of the glowworm at night. It grows on the trunks of trees and is used as a hair ornament.

### MATCHES TO BE SAFE AND NONPOISONOUS

Both the manufacture and sale of matches containing white phosphorus will be brought to an end in this country on July 1, 1915, when the law recently passed by Congress, imposing a prohibitive tax on matches in which this substance is used, will go into full effect. This law was passed after years of agitation and after a long educational campaign that made the public aware of the terrible effects produced on the operatives in match factories through working with white phosphorus, and brought out the fact that there were other forms of phosphorus not of a poisonous nature. Phosphorus is obtained from bones, which consist mainly of phosphorus and lime chemically combined with each other and with organic matter. The two forms most commonly seen are white phosphorus and red phosphorus. The white phosphorus is poisonous, while the red phosphorus is practically harmless.

Under the new law only two kinds of matches will be in use—the so-called “safety” match, which ignites when scratched on a specially prepared surface on the side of the box, and the “bird’s-eye” match, which can be ignited on any dry surface after the manner of the white-phosphorus match. The main ingredient of the “safety” match is chlorate of potash, while the surface on which it is to be lighted is painted with red phosphorus. The substance used for the tip of the “bird’s-eye” match is sesquisulphide of phosphorus, a compound of a comparatively harmless nature. In making these matches, the first dip coats the end of the match with an inert substance which keeps the match burning after it is lighted, while the second dip places on the end of this substance the sesquisulphide tip. A temperature of over 300° F. is required for igniting these matches. They cannot be ignited through being stepped on, they do not spark or fly, and are not explosive. They are therefore much safer than the so-called “safety” match.

### FENCE RAILING SERVES AS WATER PIPE

Using an iron fence railing as a water pipe is the unique means employed in supplying water for a ceme-



Basket in Which the Instruments Were Carried

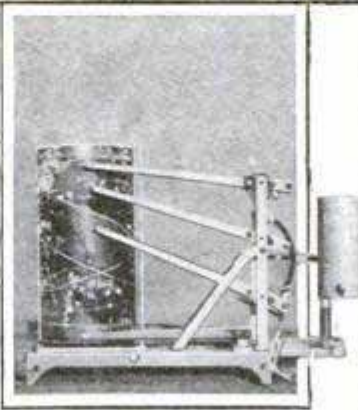

Meteorograph for Recording Temperature, Humidity, and Pressure

tery at Ontario, Cal. The fence is built of concrete with cobblestone posts, as shown, and is of a type much used in that section of the state. The railing, which is a continuous iron pipe running through the posts, is connected with the city water-supply system and is provided at convenient intervals with valves to which a hose may be attached. In winter, freezing is prevented by allowing the water to flow continuously through the pipe.

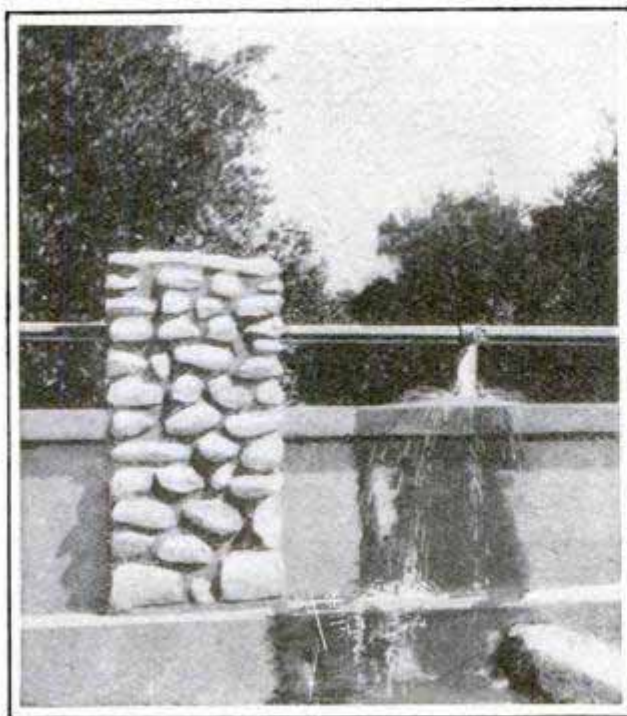

Iron Fence Railing Supplies Water for California Cemetery: Water is Shown Discharging through an Open Valve

### BALLOONS USED IN STUDY OF UPPER AIR

Balloon soundings of the air high above the earth are being used in Southern California by a party of ex-

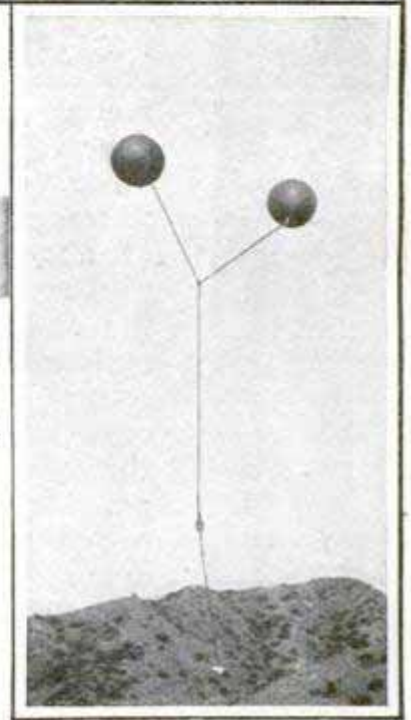

Two Balloons Which Carried the Instruments to an Altitude of 15 Miles

perts of the United States Weather Bureau and the Smithsonian Institution who are trying to discover the cause of the mild, fair weather in that region. By sending instruments carried by balloons into the upper air beyond the influence of mountains and local disturbances, they hope to learn something of the movements of air currents and the conditions which produce storms in fair weather. Among other things, they have found that the temperature of the air 15 miles above the ground in Southern California is 85° F. below zero. The method followed in their first experiment consisted in sending up two 12-ft. balloons fastened together. In a basket carried by the pair of balloons were instruments for registering variations in humidity, pressure, and temperature and recording them on an aluminum cylinder blackened with camphor smoke. As the balloons ascended into the lighter air, they gradually expanded to 20 ft. in diameter. When one of them burst, the other descended, bringing the instruments back to the earth.

## RESULT OF TESTING STEEL USED IN BIG GUNS

That the steel used in making cannon for coast defense is of very remarkable quality cannot be doubted



when the accompanying illustration is studied. In the manufacture of cannon every conceivable test is made. In this instance it was proposed to cut off about an inch from the surplus metal at the end of a 3-in. gun, and test the ring thus formed by forcing a cast-iron mandrel through it. In the tapered mandrel one end, of course, was small enough to enter the ring. This operation would tend to stretch the ring, and any defect, tendency to crack or lack of tenacity would be revealed. The ring was placed in a heavy hydraulic press and the mandrel forced through it. The ring stood the test perfectly, but the mandrel was cracked in every direction, though it still held together. From the fact that a

small ring of steel from the weakest part of the gun could produce such an effect by resistance to stretching, an idea may be formed of the enormous strength of the modern big gun.

ⒸThe "Seward" and the "Wright," army transports now out of commission in the Philippines, are to be sold, if the recommendation of the War Department is followed. Both vessels are old and in need of extensive repairs, and are too small for present transport requirements.

## ARTIFICIAL AMMONIA MADE WITH CATALYTIC AGENT

German chemists have succeeded in producing ammonia on a commercial scale by combining its elements synthetically in the presence of a catalytic agent. The reaction takes place, so it is said, at a temperature of from 752° to 1,472° F., under a pressure of 1,500 lb. to the square inch. This high temperature and enormous pressure necessitated special retorts and a new alloy of iron capable of high resistance. The new process makes possible largely increased use of ammonia salts in agriculture without increased cost.

## HOMES OF AFRICAN CAVE DWELLERS

Burrowing underneath the sand and constructing habitations out of caverns in the underlying rock, certain tribes in northern Africa have just come under the observation of scientists. The only visible sign of these dwelling places are the holes in the ground, which are the entrances, some of which are 13 yd. in diameter. The walls are perpendicular and sometimes supported by rough stones. In the walls are irregular holes, some of them closed by rude doors. In the interior of these houses comparatively large rooms are found, with their ceilings ornamented by rough stucco, the walls hung with carpets or rugs, and seats carved from the rock or earth at the side. The natives belong to the Berber tribes, speaking an Arabic dialect. Tattooing is practiced among the young women, some of whom are quite pretty. The subterranean homes are cool in summer and warm in winter, and the cave dwellers are quite content with their lot. A number of Jewish families were found whose history with regard to the place goes back to the times of the Romans. In Tripoli there are large villages of cave dwellers who are all Jews, and have their subterranean synagogues, their rabbis, and their Talmud schools.

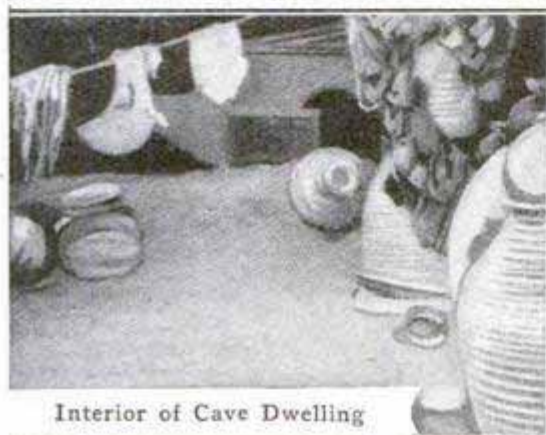
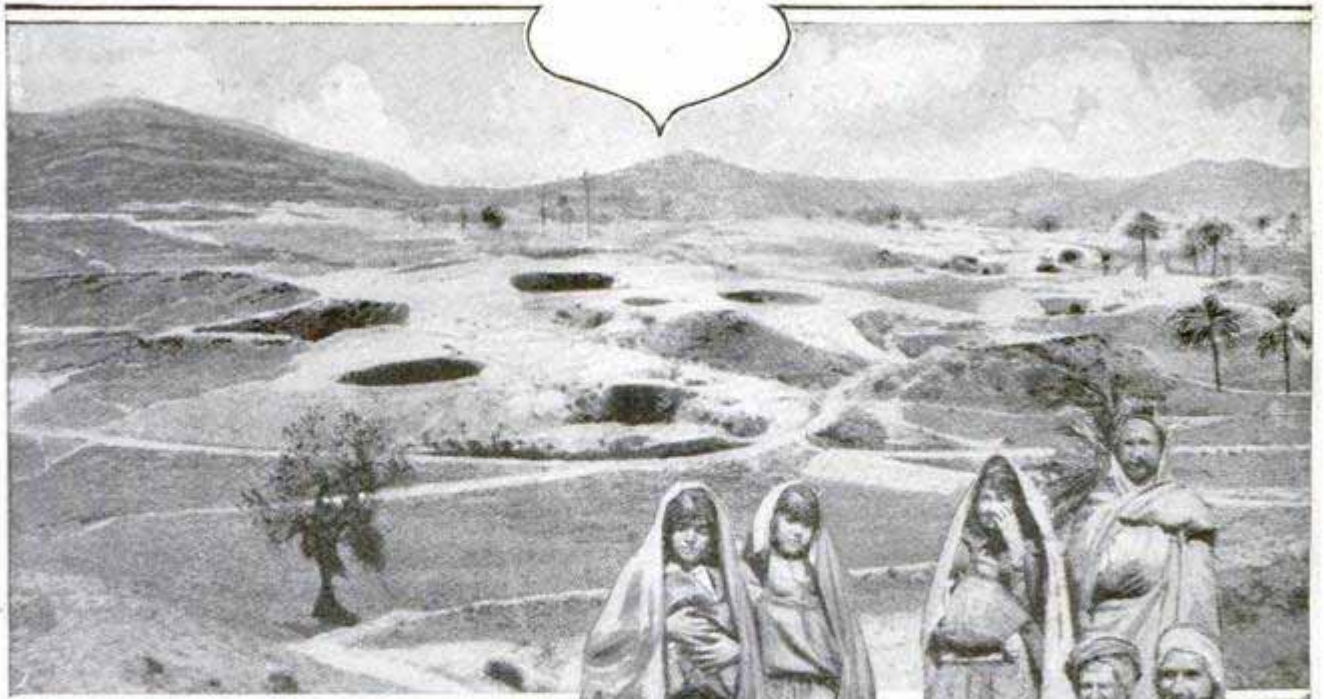

Interior of Cave Dwelling



Subterranean Town in Sahara Desert

Right, Door of Underground Synagogue

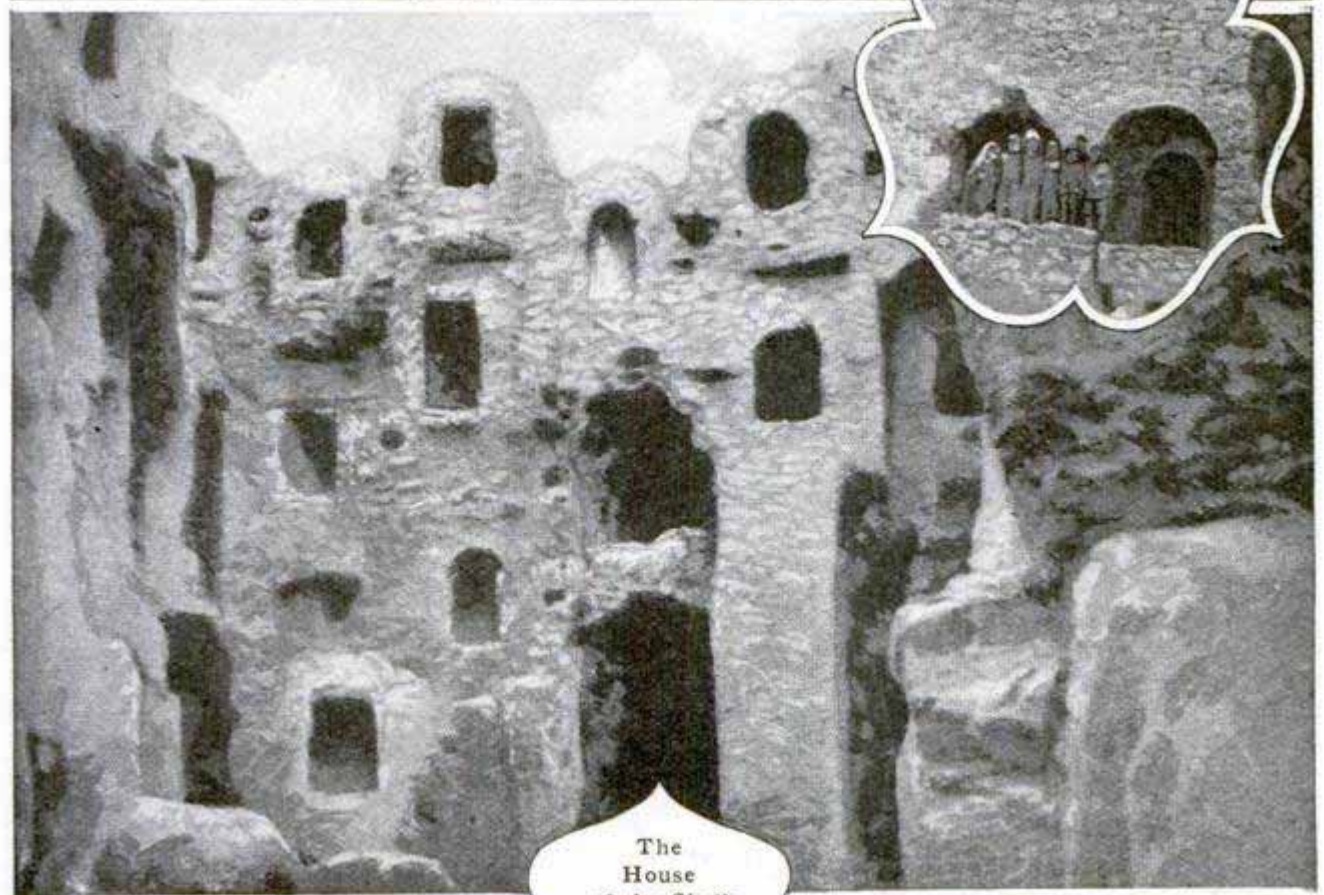

The House of the Sheikh

## HOW OIL ON SEA KEEPS WAVES FROM BREAKING

When the oil steamer "Narragansett" came to the aid of the burning liner "Volturno," and by pouring oil on the raging waters made possible the rescue of passengers and crew, interest was again directed to the important part this simple expedient may play in life saving. Few people have a clear conception of the almost miraculous effect a small amount of oil has on wave motion. A drop of oil will spread itself over 7 sq. ft. of water, and 9 pt. of oil are sufficient to cover a square mile of sea surface. The oil film has effect when it is of the thinness of one fifty-millionth of an inch. The British Board of Trade quotes

admiralty information in its sailing directions, on "Use of Oil for Modifying the Effect of Breaking Waves." The statement is made that on free waves, that is, in deep water, the effect is greatest. In surf or where waves are breaking over a bar the effect of oil is uncertain. The heaviest and thickest oils are the best. All animal and vegetable oils have very great effect. Oil may be poured over the side of the vessel, may be thrown far ahead by means of a projectile filled with oil, or a buoy may be anchored in any desired spot, from which oil is released when necessary by means of valves operated from shore.

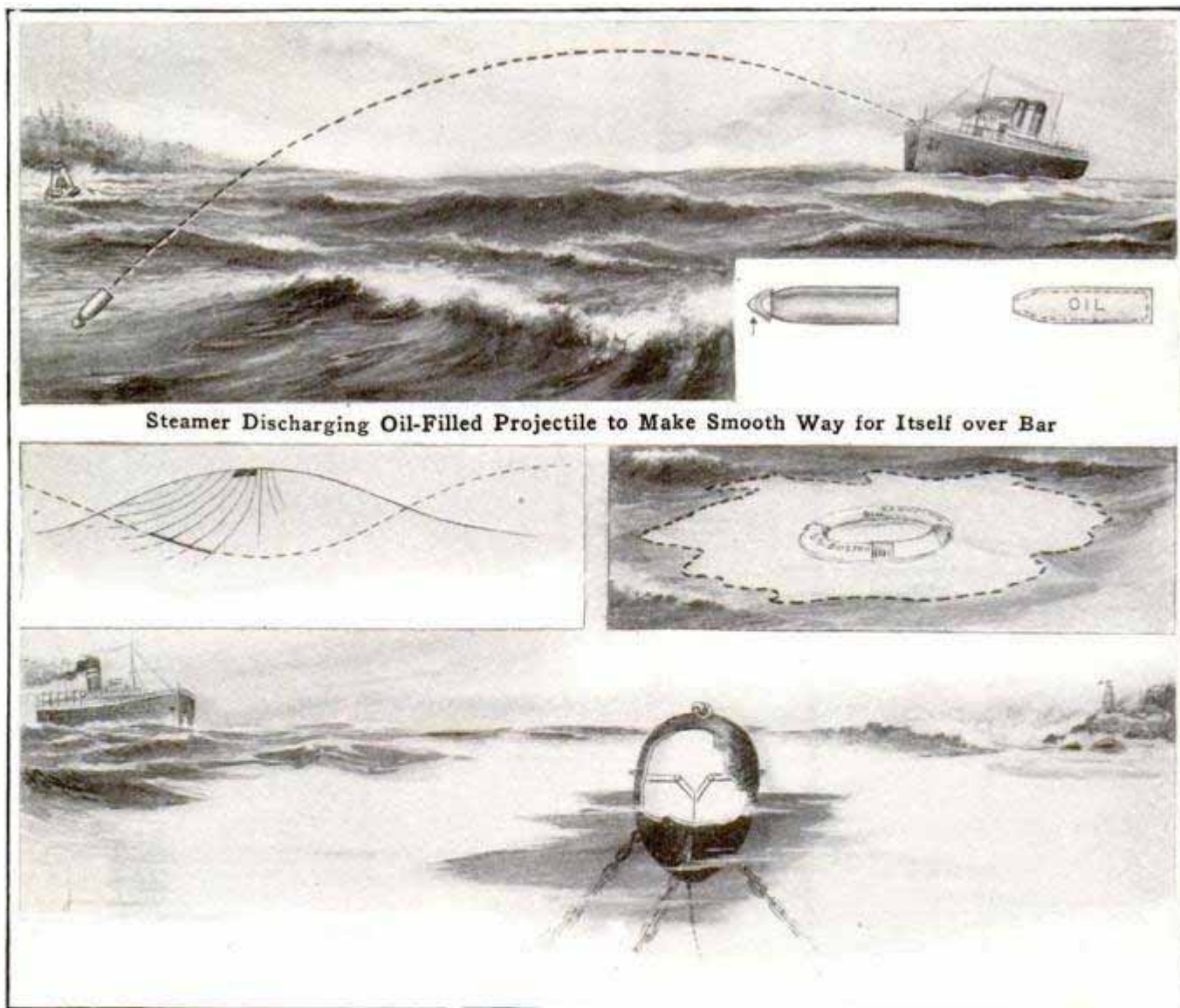

Steamer Discharging Oil-Filled Projectile to Make Smooth Way for Itself over Bar

Courtesy Illustrated London News

How Film of Oil Operates on Wave

One Drop of Oil will Spread over Seven Square Feet

Oil-Discharging Buoy at Entrance to Harbor Provides Easy Passage for Vessels

## BIG AMERICAN DIRIGIBLE IN-PASSENGER SERVICE

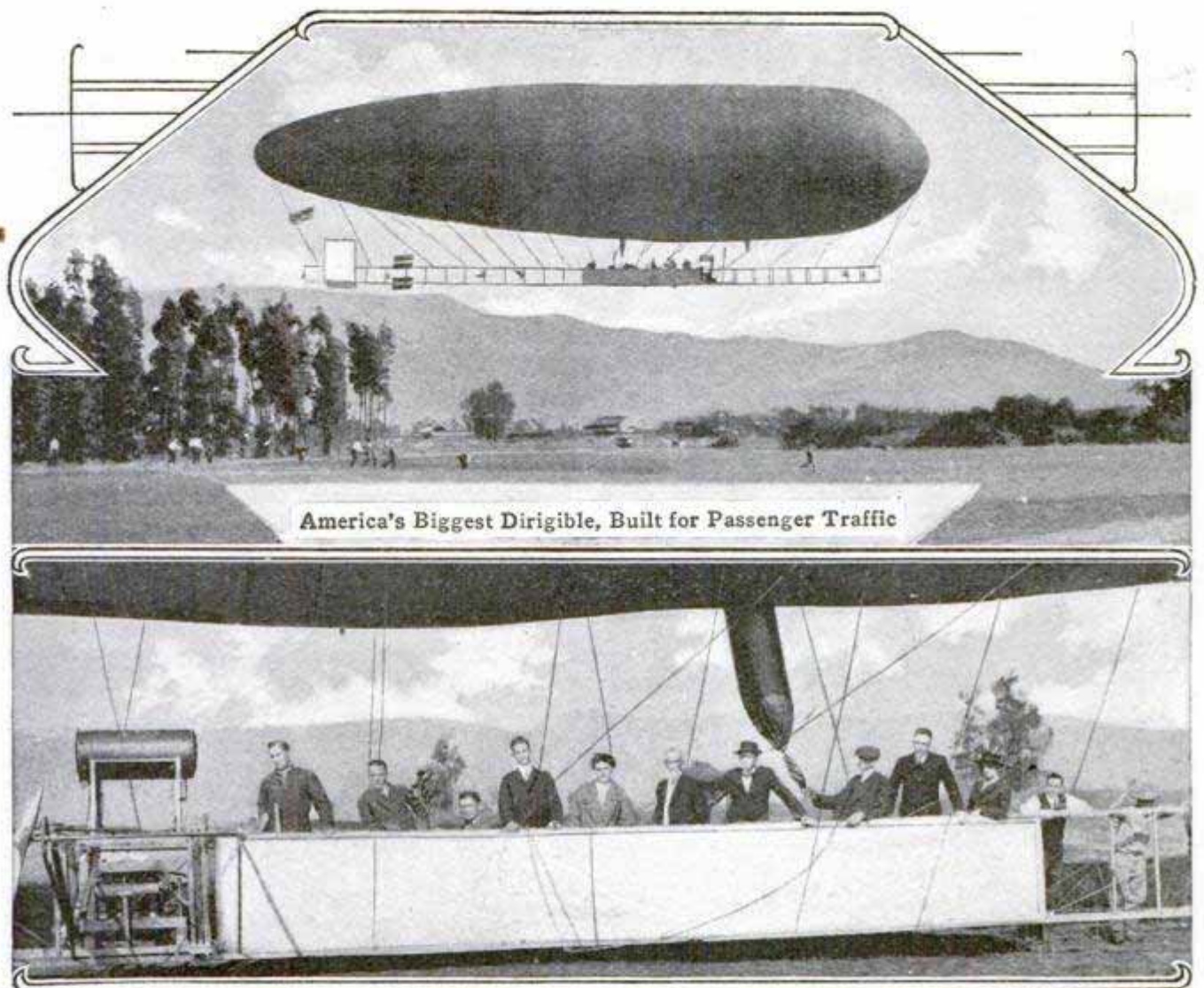

America's Biggest Dirigible, Built for Passenger Traffic

A big dirigible balloon, 150 ft. long, with capacity for 12 passengers, is being given a daily try-out in Pasadena preparatory to a regular schedule between that city and Los Angeles, a distance of some ten or twelve miles. Carrying from five to ten passengers it has been flying over Pasadena and the surrounding country and has dem-

onstrated its entire safety and control to the satisfaction of its owners and those who have enjoyed the experience of air travel. The airship was built in Pasadena, as was also the 30-hp. engine that is used in it. The big bag contains 75,000 cu. ft. of gas, and with the engine, car and frame attached, it has a lifting power of 2,000 pounds.

### STEEL-CLAD APRONS PROTECT MEN AT EMERY WHEELS

Where heavy castings are ground on high-speed emery wheels the violent vibrations and thumping of the castings against the bodies of the operators result in severe aches and pains, disqualifying employes after a short time. The safety inspector of

one foundry has devised a steel and braided-leather apron, made of two thicknesses of sole leather, stuffed with scrap leather and the outside studded with steel rivets, which entirely obviates the difficulty.

On the \$10,000,000 contract for dredging Toronto Harbor, all the machinery will be operated by electricity.

## HANDLING BANANAS BY MACHINERY

A cargo of bananas, often containing 20,000 bunches, is unloaded in about four hours with the aid of modern machinery. Electric cranes equipped with endless belts drop down the hatches of the vessel the moment it is made fast to the wharf. As the bunches roll from the cranes, men catch them, load them on the shoulders of roustabouts; an expert fruit

classifier tells at a glance the grade of the bunch, and directs, by calling a number, the car into which it is to be carried. The bunches are automatically counted and the refrigerator cars, in which they are hung, are removed as soon as loaded, giving way to other cars, quickly shunted into place.

## LUXURIOUSLY FURNISHED MOTOR CARS

Luxuriously furnished motor cars are becoming common among the fashionable set in Paris, some cars having interiors furnished and decorated after the fashion of a drawing room, and others in such a manner as to make them true motor boudoirs. In many of the cars tiny oil paintings by well-known artists are hung around the sides, while the windows have silk curtains with dainty lace blinds. One of the marked tendencies at the present time is the substitu-



Electric Cranes Dropping Endless Belts into Hold of Steamer

Endless Belt on Which Bananas are Hoisted from Hold

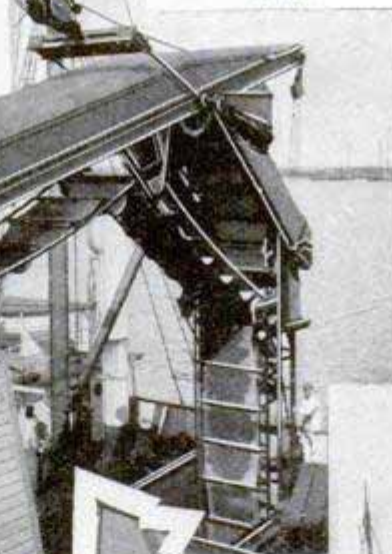

Roustabouts Carrying Bananas to the Cars

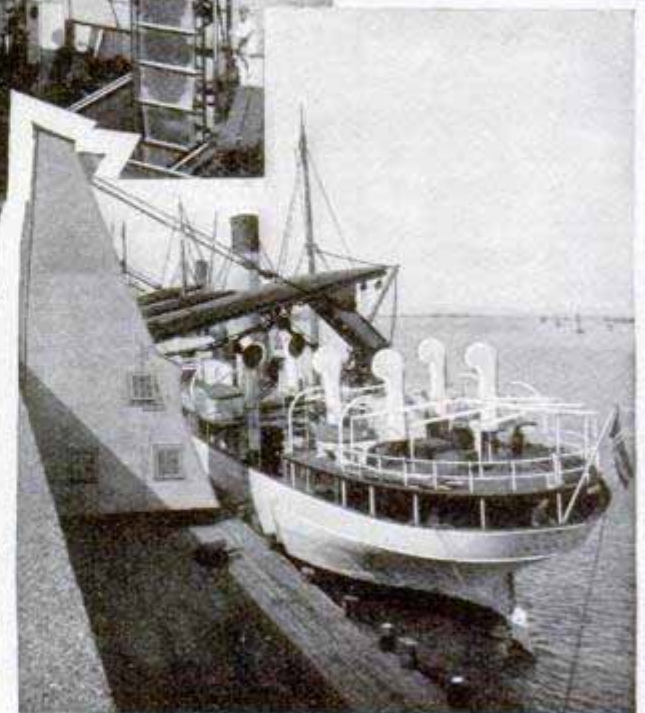

Fruit Steamer at Dock



tion of gilded armchairs with silk-tapestry coverings for the ordinary leather seats, with footstools to match the seats. Brackets along the walls are provided for holding perfume bottles, powder boxes, lip pencils, and other toilet articles. In some of the larger cars, inlaid writing tables that pull out from the wall have been installed, and on these are to be found books that serve to beguile odd moments of waiting. Flower baskets are in common use, and there is tendency in every detail to make the motor car as comfortable and luxurious as the home of the user.

### GREAT PHARMACY IN MOSCOW ESTABLISHED 200 YEARS

What is said to be the largest pharmacy in the world was established over 200 years ago in Moscow. It is known as the old Nikolska Pharmacy and occupies an entire five-story building, furnishing employment to over 700 persons. Only one floor, the second, is open to the public, a marble stairway leading to the large hall. The first floor is entirely given up to prescriptions, the receipts from this source alone amounting to several hundred thousand dollars annually. The third floor contains vaults where the poisons and dangerous chemicals are stored; the fourth floor is devoted to the laboratories and on the fifth floor are libraries, museums, managers' offices, and a lecture hall where members of the faculty of the university give lessons to students in pharmacy.

### BEAUTIFUL HANDIWORK OF SOUTH AMERICAN NATIVES

The aborigines of Dutch Guiana are clever workers in fabrics made from native grasses, which have silky fiber and considerable strength. No manual-training schools prepare these dusky children of the llanos and primeval forests to execute intricate patterns whose texture resembles brocaded silk,

but their handiwork would bear favorable comparison with the goods displayed in many a northern fancy-goods



South American Indians Clad in Cloth Made from Native Grasses, Resembling Silk

house. They are adepts in weaving the white cotton wool of their country in primitive looms, and form substantial garments, the fringes and borders of which are decorated with cords made from the white silk cotton. This is not unlike real silk, being a trifle softer and not quite so glossy in appearance. The standing figure in the picture wears a garment made from the threads of a certain palm leaf, extremely strong and lasting. All the tools used in preparing these garments are made from wood and stone; the needles are produced from the heart of one of the hardest forest trees, and vary from 2 to 12 in. in length.

## AMERICAN SPONGE FISHERIES WORKED BY GREEKS

By LEONORA BECK ELLIS

Fifty years ago practically all sponges came from the Mediterranean Sea, but large quantities are now produced in Honduras, Mexico, the Bahamas, and Florida, and the output from the waters of the United States is so great that comparatively few sponges, even of the finer varieties required in surgery and chemical experiments, are imported. Along the Florida west coast sponge fishing is one of the oldest industries, having had its beginning several years before the civil war. From a small industry in which fishing was confined to the shallow waters about Key West, it gradually spread northward along the west coast and out to the better sponge beds in the deeper waters of the Gulf, resulting in a demand for more skill among the sponge fishers and greater investment in sponge craft and equipment. By the year 1892, a fleet of over 100 taut schooners were busy gathering sponges from these waters, pressing as far north as the Anclote River, 50 miles above Tampa Bay, and this activity resulted in the discovery of the most prolific beds in American waters. Key West remained the center of this expanding industry.

But during all this half century the sponge fishers continued to use the clumsy hook-and-pole method of harvesting these valuable marine products. The sponges were torn loose from their bed and brought to the surface by means of three-pronged hooks, shaped like the talons of a bird of prey and attached to long poles. Where the bed of the sea was rocky this method was ineffective, while the fishers were rarely able to work to a greater depth than 35 feet.

In the past two years a complete revolution has taken place, and this industry is now almost entirely in the hands of Greek fishers. This revolution is the old story of the contest that always goes the same way—the contest between skill and clumsiness, and

between adequate and inadequate equipment. The native hook-and-pole spongers had little chance against the trained divers from the Mediterranean, with their diving suits of the latest "cut" and their thoroughly efficient boats and apparatus. The center of this invasion of Greek sponge fishers is at Tarpon Springs. There are now over 3,000 Greeks in this picturesque little town. Many of them have brought their families over, and all have apparently come to stay. Tarpon Springs has become Hellenized—and so has American sponge fishing. The total value of the sponges handled at this point during the year just closed was \$750,000, and it is estimated that this will be more than doubled next year, as boats and general equipment are being improved all the time and the number of men employed is increasing daily.

The Caicos Islands, a group that forms the southeastern corner of the Bahamas, also produces a large portion of the world's supply of sponges, the sponge beds being located on a submerged bank which is 50 miles long, 10 miles wide, and from 12 to 30 ft. below the surface. Here the hook-and-pole method is still the most important feature of the industry, but where the bed of the sea is rocky the sponges are obtained by divers who cut the sponges loose with wooden spoons. In the bottom of each boat, protected by a boxlike inclosure, is a sheet of glass through which the fishers examine the sponge bed. At the end of the day the sponges are placed in a position to drain and dry and are left in this position until the animal tissue dies. They are then ready for the "crawls," which are simply rocky inclosures on the sea shore where the dead animal matter is washed out by the tide and the sponges are bleached. Following this, defective parts are clipped off, and the sponges are packed and are ready for the market.



Disappearing under the Water

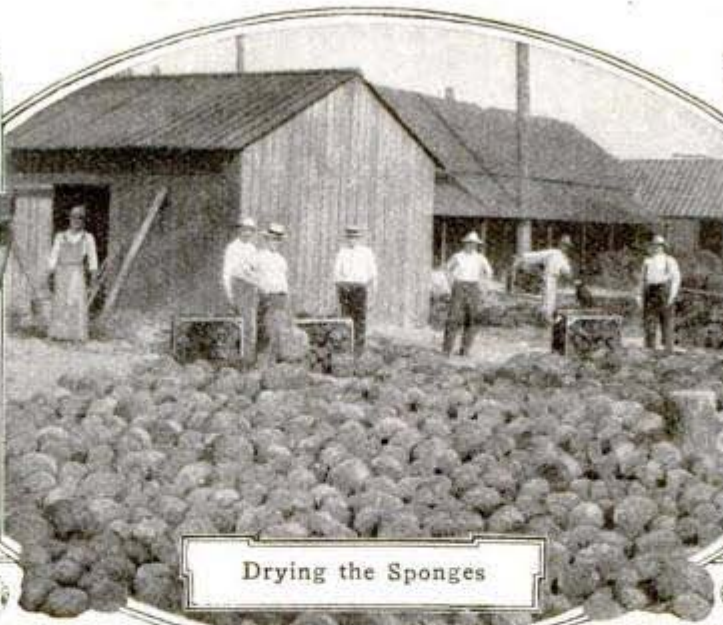

Drying the Sponges



Greek Sponger under Sail



Greek Sponge Fleet in Harbor on the Florida West Coast



The Landing at Tarpon Springs



Greek Diver Ready to Descend



Interior of a Sponge Warehouse



One of the Favorite Sports of the Divers

## WRECKS HIS LOCOMOTIVE TO SAVE THE TRAIN

Running his limited flyer 50 miles an hour, the engineer of a Santa Fe train saw an open switch ahead, as he

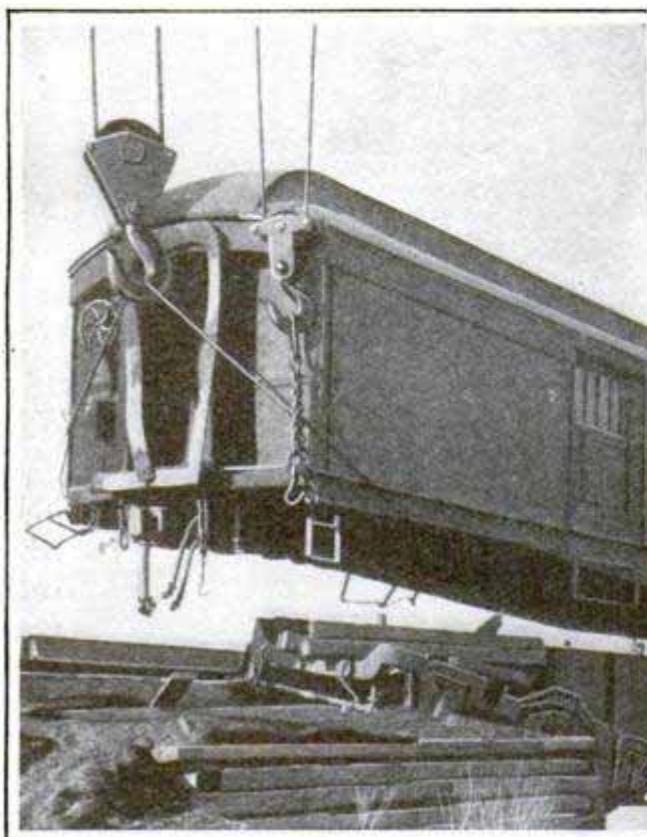

Photo by International News Service  
What Happened When the Locomotive of a Santa Fe  
Train Jumped the Track at Joliet, Ill.

was approaching an overhead street crossing at Joliet, Ill. He threw on his air brakes, then opened his throttle, full speed ahead. The locomotive, tender and an unoccupied baggage car leaped over the embankment, the coupling between the first and second baggage cars giving way, while the passenger coaches were checked on the brink of the wall. When the startled train crew and passengers hurried to the overturned engine, the engineer was found, unconscious but alive, his hand still grasping the throttle. The photograph was taken as the wrecking crew was lifting the unoccupied baggage truck back on the track.

West Virginia is the greatest producer of natural gas in the country, the output for 1912 being 240,000,000,000 cubic feet.

## THE POWER EXERTED BY GROWING PLANTS

The remarkable force exerted by growing plants, capable of overcoming almost any obstacle hindering natural growth, has often been illustrated by the ease with which tree roots disrupt sidewalks and curbs. They have been known to raise boulders weighing 18 tons and there is a record of a sapling that grew through the hole in a millstone and carried the stone into the air. In addition to the natural

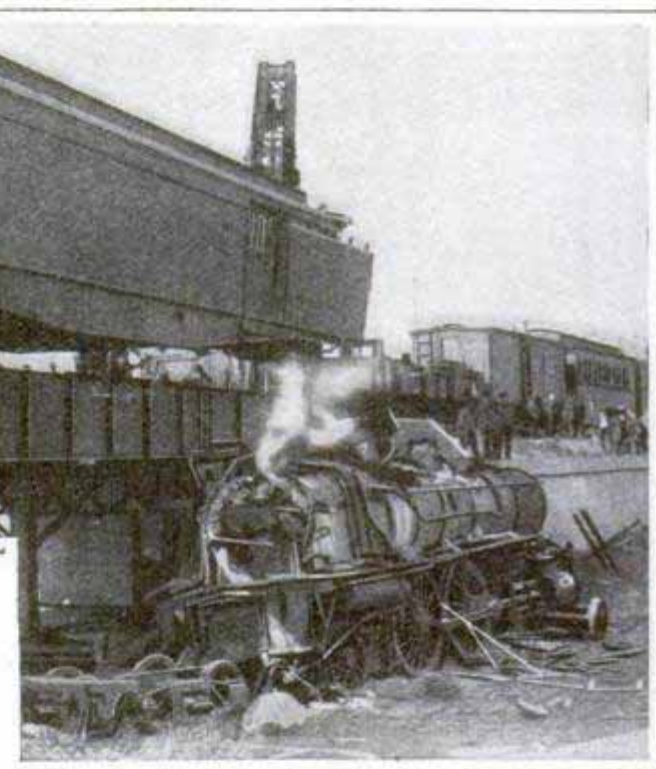

cell pressure of several atmospheres, mechanical hindrance seems to act as a stimulus resulting in incredible strength. A squash, harnessed to a lever in one experiment, succeeded in raising a 5,000-lb. weight. The squash itself grew to weigh 47½ lb. and developed about 80,000 ft. of roots in the 80 days of the test. In many instances mushrooms have grown through hard-tar sidewalks, 2 or 3 in. thick, and ostrich ferns have ruptured solid, brittle concrete, as if it were putty. Three large mushrooms have been known to raise an 80-lb. flagstone and a subsequent examination of the plants showed no signs of damage or scars on their tender surfaces. Attempts to reproduce by

means of levers the steady pressure exerted by the plants in growing through concrete walks show that a

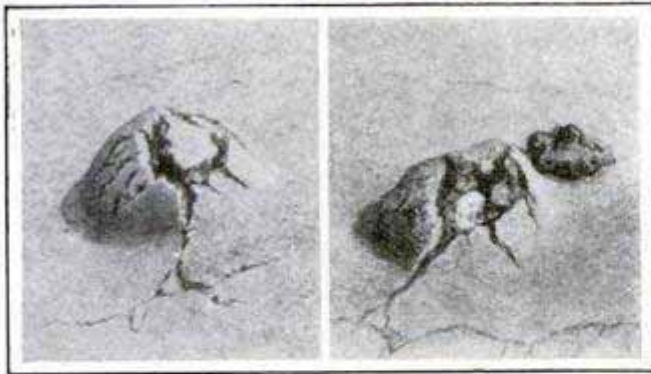

Mushroom Forcing Its Way through a 2-In. Concrete Walk

force of 262 lb. is required to break through a walk in the 10 days used by ferns, and 189 lb. in the 13 days required by mushrooms. A calculation of the area of the concrete surface affected shows that each plant exerted a pressure of from 525 to 750 lb. The manner in which the concrete breaks under the pressure of a mushroom growing underneath is illustrated by two photographs on this page.

### PHOTOGRAPHING CONTENTS OF SEALED ENVELOPE

A British scientist has succeeded in adapting X-ray processes to the photographing of very thin substances, such as a sheet of paper, a leaf or an insect's wing, through which, under former methods, the rays passed without making any impression. Letters written on an ordinary sheet of paper were sealed in envelopes and radiographed by means of "low" tubes, giving out "soft" rays, and the negative showed the words inscribed in the letter clearly, although they had been written in common ink. The details were all clearly defined, the edges of the piece of paper and the gum on the flap of the

envelope showing plainly. By this means it is possible to ascertain the contents of important letters and sealed documents without leaving any evidence of tampering.

### BLOCK OF STORES ONLY SIX FEET DEEP

Built of steel and concrete, an unusual structure has been erected at the corner of Carrell and Pender Streets, Vancouver, B. C., 95 ft. in length and only 6 ft. deep. It is a business block, being occupied by six stores on the street level and two suites of offices on the second floor, while the basement contains a restaurant, with kitchen, lavatories, etc. The stores have windows which open up so that customers may be served from the street by the proprietors. The inside dimensions of the stores are 13½ by 5 ft.; the offices are 42 ft. long and 7½ ft. wide, the overhanging balconies giving additional space. The restaurant is given room by extending it under the sidewalk, light being secured from glass set into the pavement. This extremely narrow building was made necessary when the city widened Pender Street, taking 24 ft. off a 30-ft. lot. A difference of opinion regarding the



One of the Shallowest Buildings in the World

value of the remaining portion led to its use as a store building by the owner.

## CONCRETE BRIDGE WITH SUSPENDED FLOOR

A bridge of reinforced concrete offering some new features has been erected in Ohio between the little

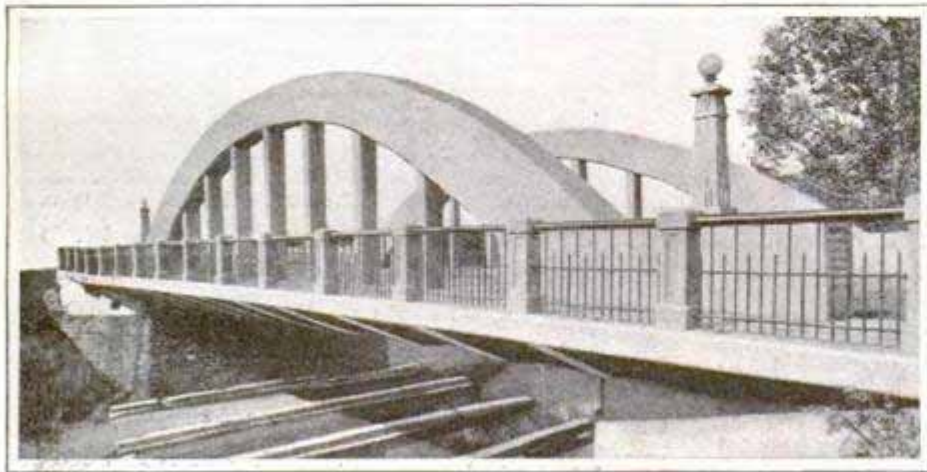

Substantial Bridge of Reinforced Concrete of New Type

towns of Lockland and Reading. The concrete floor is suspended from reinforced-concrete arches, no structural steel being used. Beneath are water guides of concrete placed in the bed of the stream to make the water run parallel with the façade of the abutments and without swirling motion during flood times. The bridge is nearly 200 ft. long, and has a roadway 25 ft. wide, with a 6-ft. sidewalk on either side.

## UNIFORM ROAD RULES FOR AUTOMOBILES

A circular has been sent by the Automobile Club of Germany to affiliated clubs in other countries seeking to enlist their aid in securing the adoption of uniform road rules for all countries. Vehicles turn off in meeting to the left and pass from behind to the right in England, Luxemburg, Portugal, and Sweden, while in all other countries the opposite rule obtains.

☞The number of establishments in this country engaged in the manufacture of electrical machinery and supplies is about 1,100, furnishing employment to about 110,000 persons.

## SPOIL MEMORIAL BELL TO SAVE HUMAN LIFE

A huge temple bell, being cast in Japan for a memorial to Emperor Meiji, was ruined when the engineer in charge shut off the flow of molten metal to save employes from possibly fatal injuries. Water from a conduit leaked into the mold, causing an explosion when the casting was nearly completed, and the crucible was closed before the entire melt had run. When the mold was opened three days later the bell was found to have no neck by which to suspend it, the charge being shut off too soon for the metal to reach the head of the casting. The association which undertook to promote the memorial has decided to recast the bell entirely.

## NOVEL CASE OF TREE SURGERY

Two years ago mice girdled the young trees in a Maine orchard so badly that they seemed beyond hope of recovery. An



orchardist from the Maine Experiment Farm succeeded, however, by means of bridge grafting, in restoring most of the trees to health and strength. He took some live branches from other trees for scions, and in the usual way spliced one end into the

main root of the tree and the other beneath the bark above the girdled zone. This was done at two opposite points of each tree, and in the two

years which followed, only three of the trees so treated died, while the others are bearing bountifully.

### BIRD MUSCLES AND AERONAUTICS

A French investigator of bird flight has made a study of the muscle and heart development of birds in relation to total weight; or, in terms of aviation, the relation of the motor equipment of birds to their weight. It is interesting to note the extent of difference in the proportional weight of the muscles and heart of the two types of birds. The pectoral or breast muscles of the night hawk, which is a "planing" bird, comprise 10.5 per cent of the total weight, and the heart .07 per cent, while for the type of birds that fly by flapping the wings, such, for instance, as the common domestic fowls, grouse, quail and the like, the corresponding figures are 26.37 per cent and 1.34 per cent respectively.

### NATURAL BEAUTY OF CANAL TO BE ENHANCED

Although the Commission of Fine Arts has found the Panama Canal devoid of ornament and with no evidence of the esthetic in the architectural features of the construction work, it does not minimize the natural beauties of location, the tropical foliage, the broken skyline and the glimpses of ocean, lake and bay through the purple haze. The commission has outlined a plan for the erection, at suitable points along the canal, of monuments and arches, commemorative of the completion of the project, which, it is urged, shall give a touch of the es-

thetic to an otherwise crude, although impressive, engineering feat. A monument 100 ft. high is proposed for Culebra, where the canal passes through the continental divide, and another at Gold Hill, the highest point in the Culebra Cut, and some suitable structure in the form of an arch at the point where the channel from Limon Bay ends and the canal actually begins, with a replica at the Pacific end.

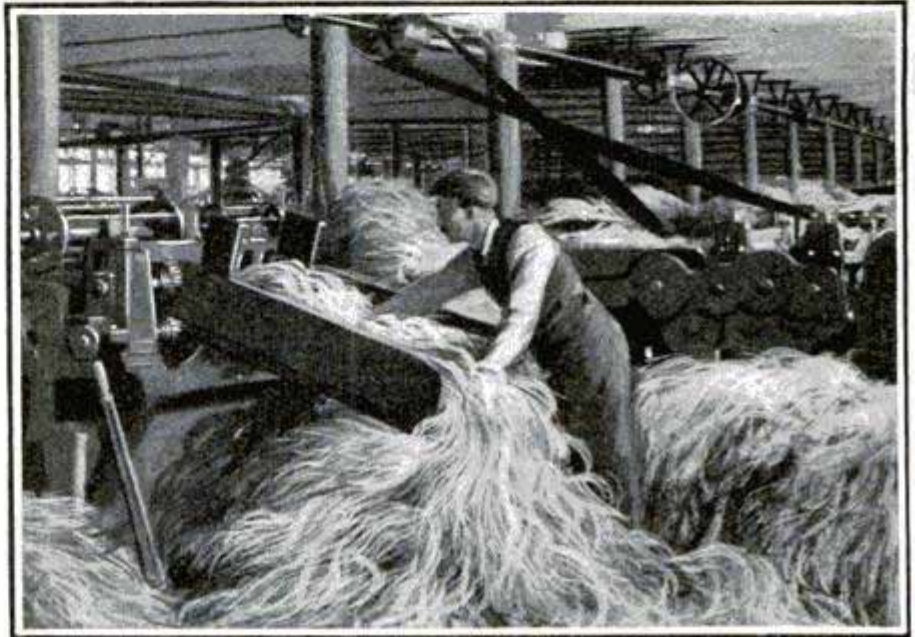

Making "Sliver" or "Roping," the First Mechanical Process in the Manufacture of Rope

### MUCH CARE NEEDED IN MAKING ROPE

The process of making rope is a comparatively simple operation, but the manufacture of the best quality demands close attention to each of the little, but important operations involved in the process. The raw hemp is first fed into machines that form the "sliver" or strand. Steel pins attached to a moving endless chain catch the mass, while another set of pins pulls out the fibers, one by one, and combs them into the proper form for feeding into the other machines. One of the most important of the preparatory processes of rope making is the softening of the hard fibers with oil, which is usually applied immediately after the machines have combed out the snarls, loose tow, and dirt. The best hemp for rope comes from Manila.

## EVERY LITTLE TREE HAS A FURNACE OF ITS OWN

Protecting orange trees from frost has been a strenuous task. "Smudging," by building crude-oil fires to the



windward, covers both fruit and foliage with a black, dirty coating, but a new heater has been invented intended to do away with this difficulty. It consists of a sheet-iron cover, with appropriate perforations about 2 1/2 ft. high. It is some 14 in. in diameter at the bottom and 6 in. across at the top. A

grate fits in this device, several inches from the bottom, and on this a stove, burning crude oil, is placed. A heater is placed near the trunk of each tree and the heat rises into the foliage, raising the temperature and maintaining it above the freezing point. No sooty deposit is noticed, and while a little more expensive at the start than smudging, this individual-furnace method is considered cheaper in the end.

## ARTESIAN WELLS FURNISH HYDROELECTRIC POWER

An enormous artesian basin underlies a large part of Queensland and the northwest portion of New South Wales, in Australia, and in Queensland alone there are nearly a thousand artesian wells. These wells were originally driven to supply water for irrigation and other purposes, but it has been found that the pressure of water coming from some of them is great enough to furnish power for running hydroelectric machinery. At Thargomindah there is one well hav-

ing a jet that develops, theoretically, 6,500 kw., after allowing the necessary losses of transformation. Turbines and dynamos have been installed and the town is now lighted by current secured from this source.

## QUAINT STONE FIGURES OF OLD-WORLD GARDENS

Four gnomelike figures engaged in a game of cards and two dwarfs guarding the entrance to the grounds, form one of the quaint garden features of the Hilder estate at Ingatestone, England. These figures are all in stone, and were brought from the royal residence at Hampton Court. At one time



Gnomelike  
Figures  
Enjoying a Quiet  
Game

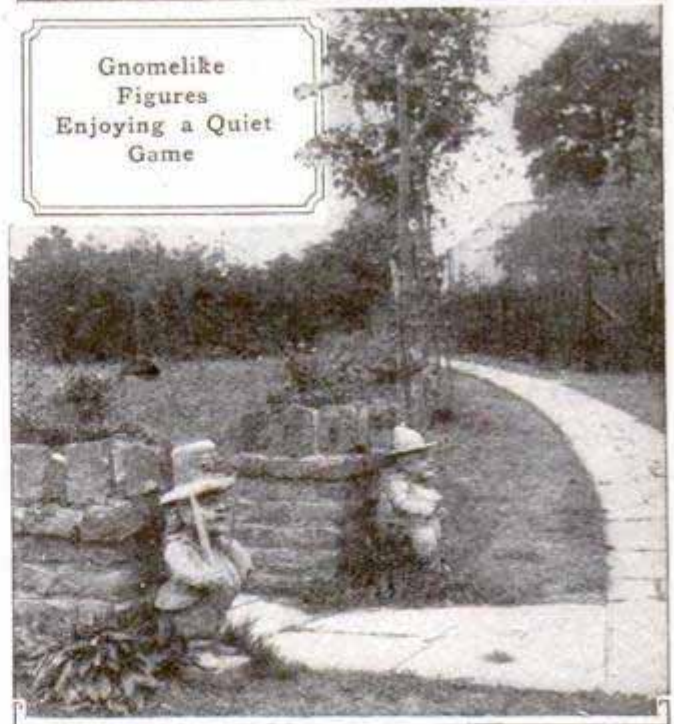

Two Stone Dwarfs Guarding the Entrance

such figures were a common feature of old-world gardens, but they are now exceedingly rare.



## MOTOR TRUCK CROSSES ALASKA

Engineers and army officers motored to within 2 deg. of the Arctic Circle last summer in a 1,500-lb. truck of the standard design already used in the United States army. The trip was undertaken primarily to demonstrate the practicability of motor transportation in Alaska, but the result showed a route which saves at least one month in the time required to reach the larger interior towns, particularly those on the upper Yukon, and the headwaters of the Tanana River. The truck left Valdez with a load of supplies and a quantity of mail for camps along the military telegraph line. Considerable mail was carried to points where none had been received for a year. The trails, some of which had been opened by the Alaska Road Commission, were scarcely adapted to motoring, being in some cases corduroy trails, in others merest bridle paths which had to be blasted and graded before the heavy truck could pass. In all, 826 miles were negotiated in 19 days.

## ACETYLENE LAMPS KILL IN- SECT PESTS

In the vine and fruit-growing districts of France and Germany insect pests often menace the harvest, and recently it has been found that acetylene lamps are valuable in destroying them. A number of lamps are lighted, attracting the insects which fly into the bare flame, singeing their wings. Circular troughs are provided, filled with water and covered with a film of petroleum, into which the insects fall, and by which they are killed.

More than 99 per cent of Alaska is owned by the government, and this vast area was bought by the government for less than two cents an acre. For developing the territory, about 10,000 miles of railroad will be required.

## NEW ANGLE INDICATOR AN AID TO AIRMEN

An angle indicator has recently been brought out which is designed for the use of airmen, and which

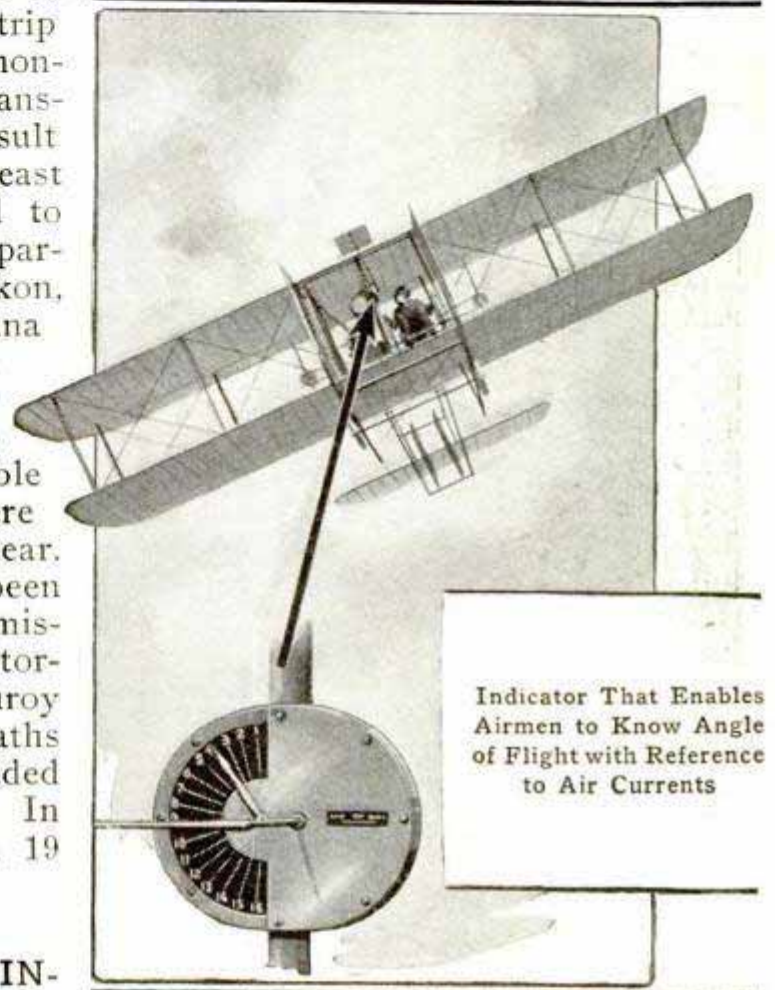

Indicator That Enables Airmen to Know Angle of Flight with Reference to Air Currents

shows at all times the exact angle of the aeroplane with reference to the air currents through which it is moving. With this device an airman who knows the limiting range of angles of his machine can always be sure of remaining within safe flying positions, and in this way avoid the dangers of climbing or diving at too steep an angle. The particular value of this indicator is that it shows the angle with reference to the air currents, which are not always horizontal, and which determine the position the planes should take. The indicator consists of a light air vane which operates a pointer on a dial and which is so made that it is not affected by the force of gravity, thus making it superior to the usual clinometer, which is uninfluenced by air currents.

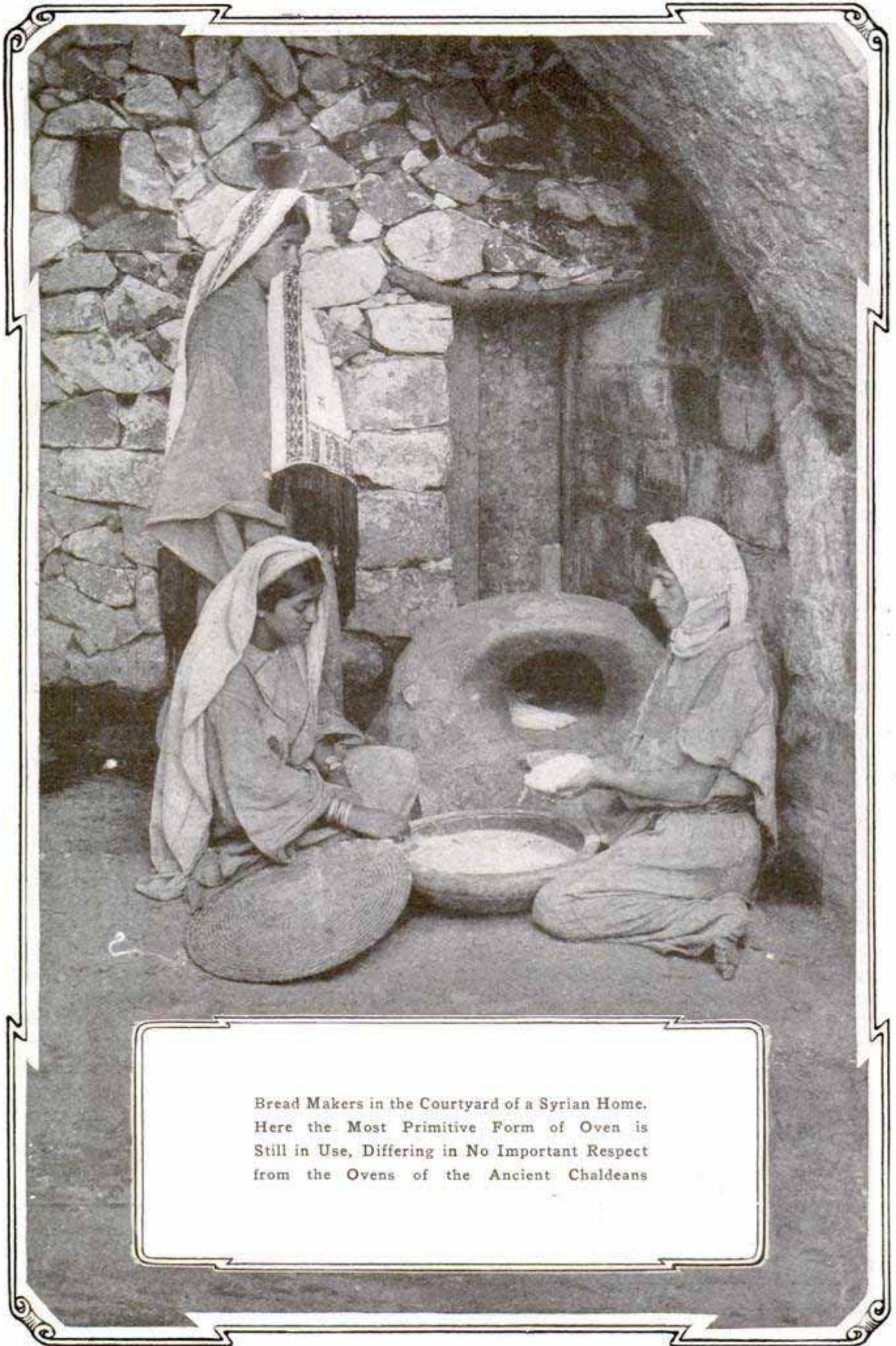

Bread Makers in the Courtyard of a Syrian Home. Here the Most Primitive Form of Oven is Still in Use, Differing in No Important Respect from the Ovens of the Ancient Chaldeans



New Zealand Natives Cooking with Nature's Fire. The Innumerable Boiling Springs and Geysers of the New Zealand Alps are Used to Boil Food. This Photograph Shows the Whakarewarewa Geyser So Used

## A LAKE SUPERIOR COAL-HANDLING PLANT

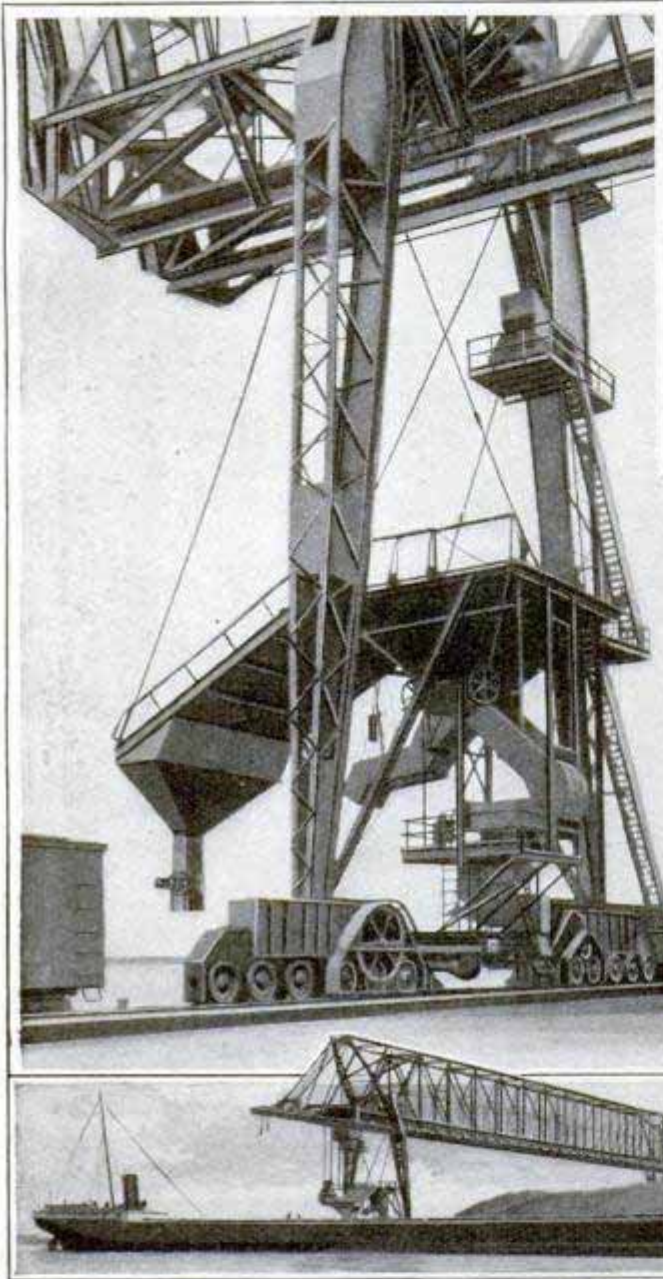

Traveling Crane Used in Unloading Coal from Ore Ships at Lake Superior Port  
The Seaward End of the Traveling Crane

Coal-handling equipment of enormous capacity is required at the ports at the head of Lake Superior, to which the big lake freighters, after taking a load of ore from the mines in that region to Buffalo, return loaded with coal destined for distribution throughout the Northwest. One of the biggest of these installations is at Superior, Wis., where the largest clam-shell bucket in the world, capable of lifting over 12 tons of coal at one time, is in use. This bucket is suspended from a traveling crane which is 130 ft. high

and has a span of 710 ft. This is the type of crane commonly used in large industrial plants, but is one of the largest in the world. It consists of a steel truss supported near the ends on steel towers which in turn are carried on trucks running on tracks that extend the full length of the storage yard. The clam-shell bucket is suspended from a truck that runs on the truss, and by this means every part of the storage yard is easily reached. In unloading a ship the clam-shell bucket is let down through enormous

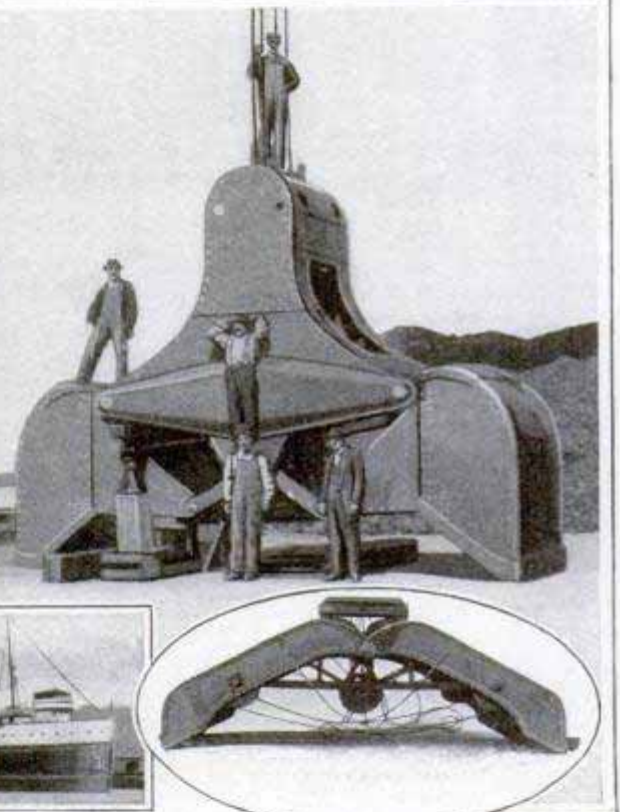

Bucket That Picks Up 12 Tons of Coal at One Time  
The "Trimmer" Bucket Used for Cleaning the Hold after Bulk of Coal has been Taken Out

hatchways, picks up the coal directly from the hold, and is then run out over the storage yard and dumped. For cleaning up the hold after the bulk of the coal is taken out, the "trimmer" bucket shown in the illustration is used. With this equipment a 10,000-ton ship is unloaded in about 20 hours.

—  
**C**An allowance of one elevator for each 15,000 sq. ft. of rentable area is the usual practice in planning office-building equipment.

### ELECTROLYTIC BATH USED IN LEAD POISONING

An interesting case was related to the Royal Institute of Public Health in London recently where a workman suffering from lead poisoning was placed in an electrolytic bath for treatment. After three or four baths the morbid symptoms disappeared, while lead was found in the water and on the electrode. If the method is found successful in general application, lead poisoning will lose its terrors.

### HIGH-SCHOOL BOYS BUILD SCHOOLHOUSE

The boys of the manual-training department of the Fullerton, Cal., high school built a small schoolhouse to accommodate an overflow of pupils in the local grammar school. As shown in the picture, the building has no windows, the light entering through open spaces in the side which are covered with wire netting. The upper portion of the schoolhouse is covered with canvas, the lower portion boarded and sheathed as usual in frame buildings. The roof is thatched with palm leaves, and the cost of the entire building was \$50, accommodating 60 pupils. In the summer time the house is always at a comfortable temperature, and windows and a small stove are put in during the cold season.



An Overflow Schoolhouse That Cost \$50

### GLASS THAT CRACKS BUT WILL NOT SPLINTER

Serious wounds in automobile accidents sometimes occur through cuts received from splinters of glass. A

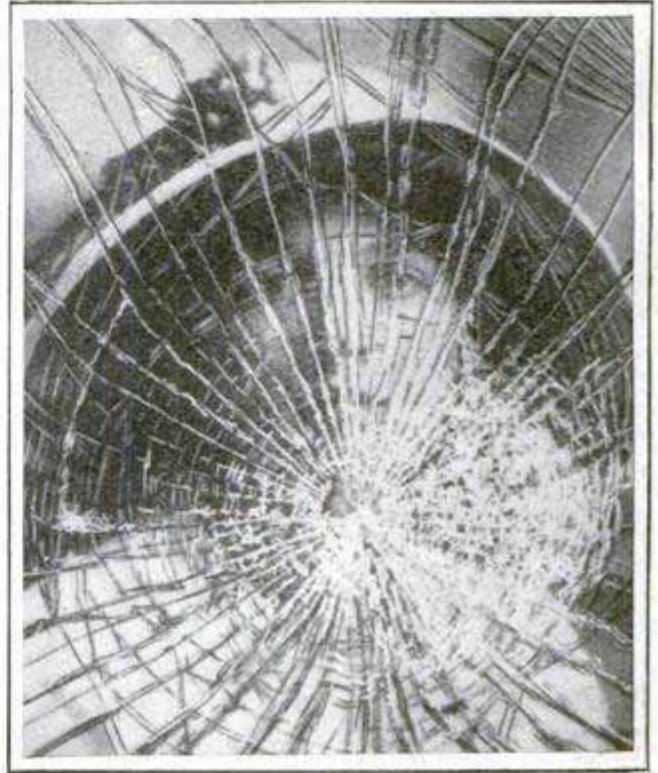

Very Severe Blow Fails to Splinter Glass

material for windows and windshields has been brought out in Europe, consisting of two layers of glass between which a celluloid layer is hydraulically pressed. The picture shows the effect of a very severe blow on this new glass, cracking it badly but without producing splinters. Besides its high resistance powers, the new glass is sound-proof, making it of value in construction of office and business buildings as well as in motor-vehicle construction.

### NAVY MAN FLIES 40 MILES WITHOUT USING HANDS

While trying out a gyroscopic stabilizer for an aeroplane, Lieutenant Bellinger of the United States navy recently flew from Hammondsport, N. Y., to Penn Yan and return, a distance of 40 miles, without using the manual controls. Hundreds of flights were made during the recent series of navy tests.

## CONCRETE TROLLEY POLES OF NEW DESIGN

Concrete telephone and trolley poles of a new design which makes them strong and flexible and at the same time unusually light in weight are now being built. The new patented pole differs from other monolithic concrete poles in that its section is neither square nor round, but in the shape of a cross. It has four flanges projecting from a square central core,

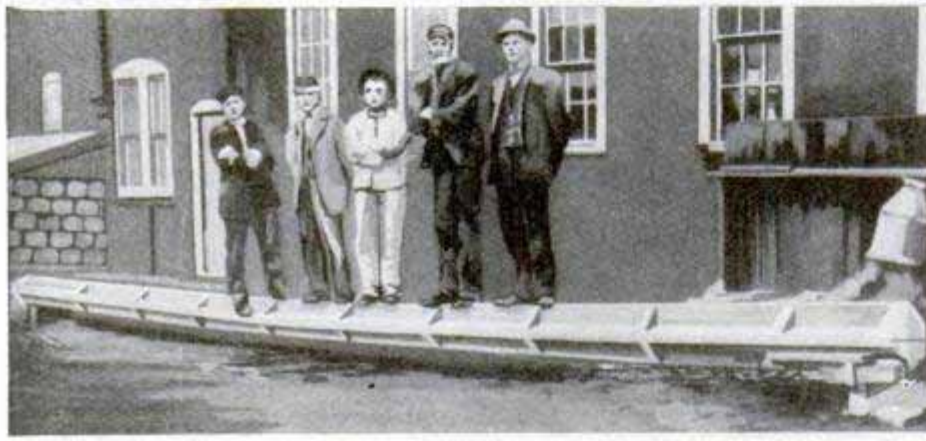
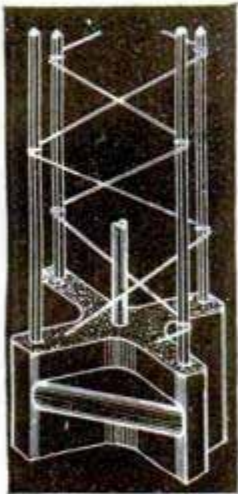

30-Ft. Concrete Trolley Pole of New Design, Supporting a Load of 800 Lb., and Cross Section Showing Reinforcing

all cast in one piece and reinforced with iron rods and webs. Cross ribs, connecting the corner flanges at short intervals, give additional strength and furnish steps for climbing. Holes are provided near the top of the poles for cross-arm bolts. A 30-ft. pole, weighing only 1,900 lb., is as strong as wood or solid concrete.

## WORLD'S SAFEST PLACE IS IN A RAILWAY CAR

While railroad accidents are all too frequent, it is nevertheless true that when the vast number of journeys undertaken are considered, the safest place in the world is in a railway car. A New York statistician has estimated that the average length of the railway journey in New York state is 34 miles, and that 2,275,122 such jour-

neys are made in safety to each journey which results in a fatal accident. A man who started out to ride these 2,275,122 trips at the rate of two a day, should prepare himself for continuous commuting for 3,792 years. In other words, in order that he might meet his death in a railway accident during 1914, he must have started traveling in 1878 B. C.

## IMPROVING THE AMERICAN SARDINE INDUSTRY

In an effort to reestablish and improve the American sardine industry, which, on account of destructive competition, has fallen to a low state in recent years, the Department of Agriculture has established an experiment station at Eastport, Me., where a thorough study will be made of the fish caught in the Maine sardine waters and the best methods of packing them. The new laboratory has already discovered one important point in the packing process which causes considerable loss. The Maine packers pack as large fish as they are able to get into a box, and to make the fish fit the cans, the head, a small part of the tail and from  $\frac{1}{4}$  to  $\frac{1}{4}$  of the best part of the fish is cut off with a pair of scissors. To eliminate this loss the whole subject of economical packing will be carefully studied.

## USE OF DIESEL ENGINES ON SEAGOING SHIPS

The use of the Diesel internal-combustion engine, which operates with crude oil as fuel, for the propulsion of ocean-going vessels, is increasing rapidly. There are 12 such vessels now in commission, and more than 25 others, of varying tonnage, are now being constructed in European shipyards.

## NEW LOW-PLATFORM MOTOR TRUCK

Through the elimination of axles and springs a motor truck which has just appeared is made very rigid and carries its load close to the ground. The loading platform, made of steel channel beams and I-beams with a boiler-plate floor, is only 21 in. above the ground and has a clearance of 11 in. The motor and cab are carried on a separate framework mounted on three suspension points, one point of which is a spiral spring to take up vibration. This subframe with the power plant can be removed for repairs and another substituted so that the chassis need not be idle. Power is transmitted through a jackshaft and two main shafts mounted within the channels of the outside frame beams; worm gears are used at the junction of the shafts and on the rear wheels. A loading winch in the cab can be thrown into gear with the engine.

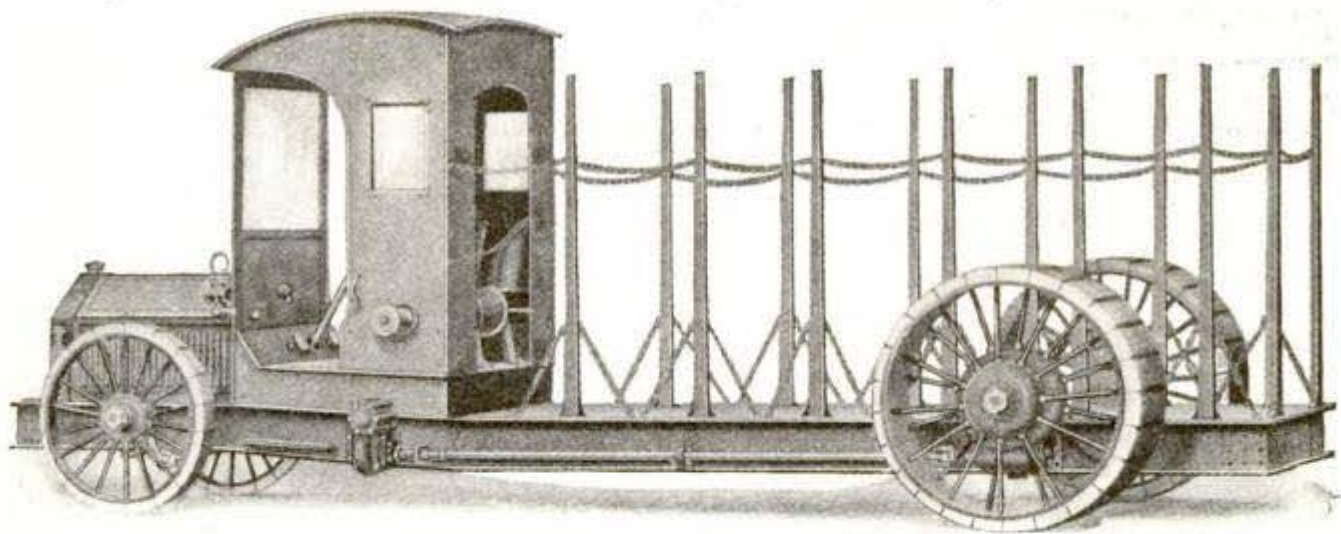

New Motor Truck Which Has No Springs or Axles

## NEW EMERGENCY LIGHT FOR ELECTRIC-LIGHTED CARS

When cars, railroad or motor, are dependent upon electric lighting an auxiliary system is necessary for use in the event that the primary light is impaired or destroyed. This, reduced to a simple unit, is provided in a European invention illustrated herewith. A metal case, hinged at the lower end, holds securely a candle which may be instantly lighted if the electric light fails. When not in use the case folds up out of the way.

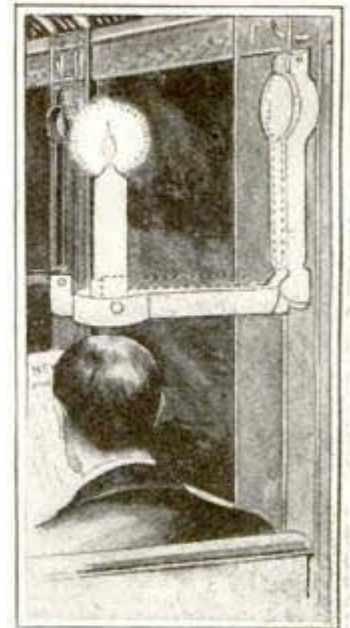

## GERMANY ADDS TO WORLD'S SUPPLY OF PLATINUM

Through the discovery of platinum in large quantities at Wenden, a village in Prussia, it is expected that the world's supply of this valuable metal will be greatly increased. Platinum is now the most valuable of all metals which have industrial use. It is heavier than gold and sells for about

twice as much. Its greatest value lies in its heat-resisting qualities, in the fact that it cannot be oxidized and that only aqua regia will dissolve it. Smelting crucibles for laboratory use are almost exclusively made of platinum. Heretofore the supply of this metal has come mainly from the Ural Mountains in Russia, but it has been found in smaller quantities in Peru, Colombia, Borneo, and California.

## TERRACED WATERCOURSES OF THE ALPS

Many of the watercourses in the Alps of southern France have been terraced with a series of small masonry dams



A Watercourse in the Alps, in Which Erosion is Reduced by a Series of Small Masonry Dams

so constructed and located as to control the flow both at high and low water, and this method is meeting with success as a means of flood control. These dams are effective not only in limiting the flow, but serve to minimize erosion in the steeper watercourses by breaking the fall into a series of smaller falls, thus robbing the water of its destructive force.

## APPARATUS FOR MEASURING PRESSURE OF CONCRETE

For finding the actual weight that the different parts of a form used in the construction of concrete columns will have to resist, a new and apparently reliable apparatus for measuring the pressure of the wet concrete has been developed. The importance of this apparatus lies in the fact that it furnishes exact data so that the builder can make his forms of the required strength without the risk of wasting

material in making them excessively strong. The apparatus is simple, and is in effect an improvised mercury barometer. Ordinary hot-water bottles filled with water and located at vertical intervals of about 3 ft. are placed in the test column as it is being poured. Each hot-water bottle contains a test tube nearly filled with mercury and held in a vertical position with the open end up, and into this tube is inserted the open end of a graduated glass tube which passes through the rubber stopper of the hot-water bottle and is bent in such a way as to pass outside the concrete column so that readings can be made. The pressure of the concrete on the hot-water bottle is transmitted through the water to the mercury, and this in turn is forced up in the graduated glass tube to a height corresponding to the pressure of the concrete. The glass tube is marked with graduations in advance of the test by means of preliminary experiments that show how much the mercury rises for different pressures. The pressure in inches of mercury which is obtained by this means is, of course, readily translated into pounds per square inch.

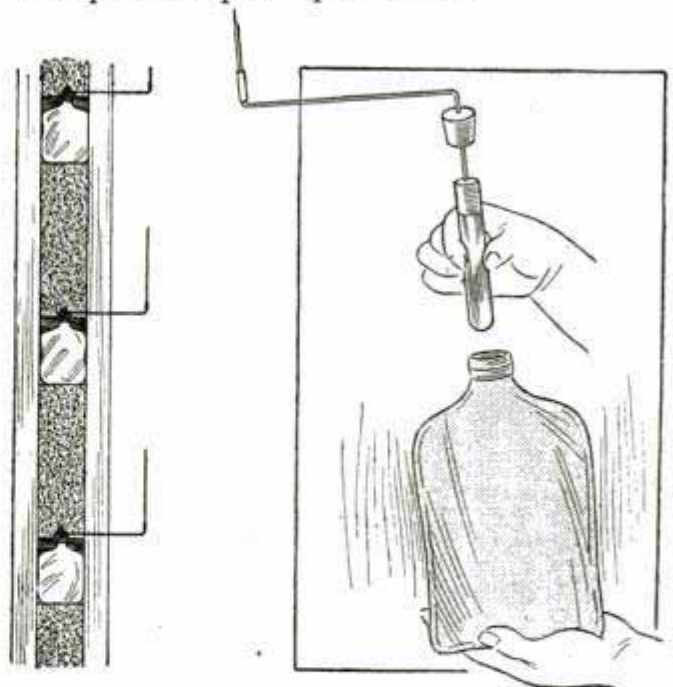

Arrangement of Hot-Water Bottles in Concrete Test Column

Hot-Water Bottle with Glass Tubes Used in Measuring Pressure of Wet Concrete

There are 10,466 merchant vessels sailing salt water registered at Lloyds.





### Setting a Kitchen Sink with Concrete

In removing an old galvanized-iron sink to replace it with a new white-enameled one it was found that the boards covering the rim had rotted so that they could not be used. A more sanitary plan than replacing the decayed boards with new ones was desired, and as concrete was suggested, we proceeded to carry out the idea with gratifying results. The hot and cold-water pipes were first firmly anchored to the wall behind by means of a board notched out to fit them. Where necessary other light boards were fastened for a form to hold the concrete. The new sink was then set in place over the bare framework and the concrete poured in. The concrete consisted of a rich mixture using about equal quantities of cement and as fine sand as was possible to obtain. This mixture would smooth up nicely and when worked with the back of a spoon, to

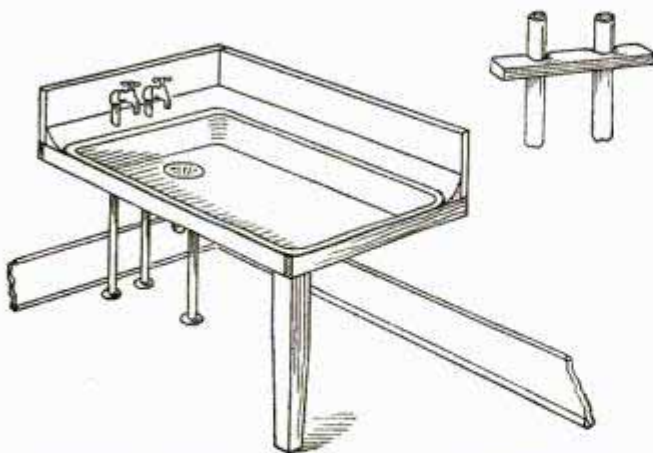

Concrete Filling and Support for a Kitchen Sink That is Sanitary and Bug-Proof

form the gentle curve between the splashboard and the inner edge of the sink, and painted it proved a highly satisfactory job.—Contributed by Mrs. Paul S. Winter, Greenville, Pa.

### An Adjustable Folding Ladder

While trying to paint the roof of my bungalow I found that the pitch was too great to walk upon comfortably,

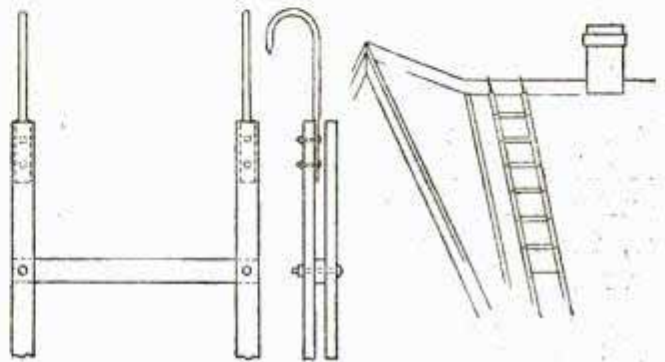

An Adjustable and Folding Ladder to Fit Any Slope or Angle of a Roof

and this caused me to devise the ladder shown in the illustration. A ladder of any length can be made on the same principle. The materials necessary are 2 hooks, 2 bolts for each rung, and sufficient lumber, 1 in. thick and 2 in. wide, to make the length of ladder desired.

The uprights consist of two pieces, separated to admit the rung material. The rungs are placed at the proper intervals between the sidepieces, and a bolt is run through them and the end of the rung. The nuts of all bolts, including those in the hooks, should be on the same side. If this ladder is properly made, it can be adjusted to any angle of the roof and also folded for carrying or for storage.—Contributed by R. R. Williams, Colchester, Illinois.

☞ Grease stains may be removed from cloth with benzine, ether, chloroform, or carbon tetrachloride. The latter is nonflammable and is, therefore, the safest to use.

### Two Pulleys Driven by One Belt without Idler

The illustration shows a way of driving two smaller pulleys from one wheel by means of one belt without an

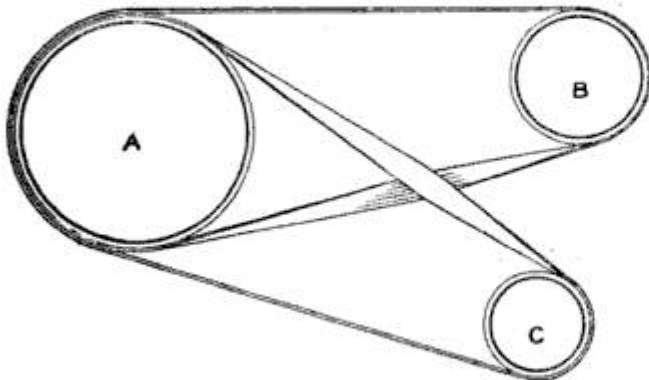

One Belt on One Driver Runs Two Small Pulleys without an Idler between Them

idler for the purpose of securing the required arc of contact on the small pulleys. The belt is placed on the driver A, then twisted as a crossed belt between the pulleys B and C, and passed over them in the manner shown. This will produce the effect of running two belts on A, one over the other.—Contributed by James E. McCormack, Haliburton, Ont.

### Adjustable Template for Making Taper Keys

The making and fitting of taper keys is usually guesswork, as there is no means of accurately ascertaining the taper of the slot, for instance, in a piston rod. The sketch is descriptive of a simple jig that will be found quite efficient for this work. I made one of discarded hacksaw blades, 6 in.

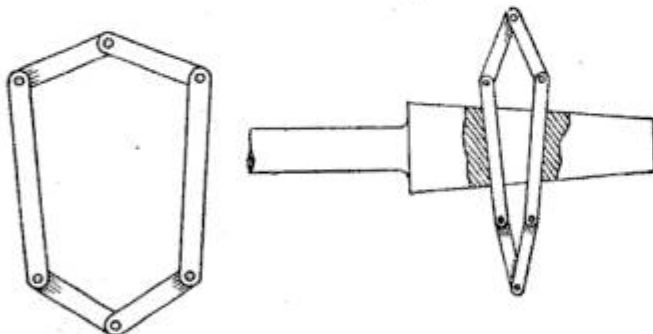

Template Made of Discarded Hacksaw Blades for Obtaining the Shape of a Taper Hole

long. When the jig is placed in the slot and spread to the inside faces of the ends it affords a perfect template to

lay off the key for machining. The length of the key can be marked lightly with chalk on the template, allowing no chance for a mistake nor for waste of material.—Contributed by F. W. Bently, Milwaukee, Wis.

### Cleaning Iron of Burned and Caked Grease

In cleaning molds or iron ladles that have grease burned and caked on them the following solution works well. A few ounces of potassium dichromate is dissolved in water. The article to be cleansed is placed under the surface of this solution, and then 1 oz. of commercial sulphuric acid is slowly added. Never pour the solution into the acid, but always pour the acid slowly into the water after the article to be cleansed is in position. This gives off a gas that attacks the burned grease and removes it. It is also good for cleaning kitchen pans that are caked with grease or black carbon. The solution should be placed in a glass jar for future use. It is harmless, but must be kept from the hands or clothing, as it burns and discolors the skin and removes the color from cloth and causes holes. The articles are left in the solution a short time and then washed and dried.

### Painting Figures on the Dial of a Gauge

The paint or enamel figures on a steam-gauge dial will in time become almost invisible, because of the effect of the heat from the boiler which dries the paint, causing it to crack and drop off. The figures on these dials are first stamped in with steel dies and the sunken portion filled with enamel or paint.

A good way to recolor them is to daub the paint well down into the sunken figures, paying no attention to the paint that is apt to get on the dial face. After painting, take a piece of heavy cardboard and press its edge to the surface of the dial to wipe off the

surplus paint. The cardboard edge cannot touch the paint in the sunken portions, and the figures will show up in full color, while the face of the dial will be clean and bright.

### Pointing Rod Ends

Where it was necessary to bevel-point the ends of several thousand pieces of cold-rolled steel rods, each 6 in. long, true and concentric with the stock, a special tool for doing the work had to be constructed. This tool was made of two pieces of metal,  $\frac{1}{4}$  in. thick and  $\frac{1}{2}$  in. in width, secured together as shown and having the ends centered and a  $\frac{5}{16}$ -in. shank turned on one end. Then a slot,  $\frac{3}{32}$  in. deep and  $\frac{3}{8}$  in. wide, was cut in one member, to admit the cutter A, which was held in place by the fit and two screws. The hole B was made the size of the

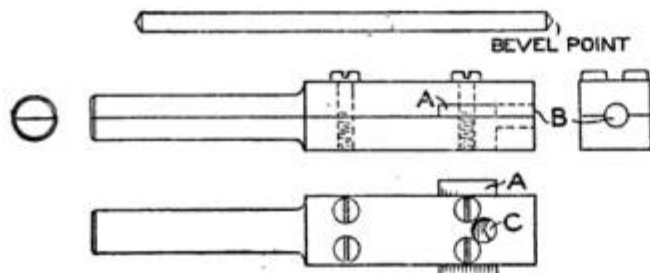

An Inexpensive Tool Used in a Drill Press the Same as a Drill for Pointing Rod Ends

rods and the hole C was drilled for clearance of the chips. The beveling edge of the cutter is plainly seen in this hole. The tool was held in a drill-press chuck and fed on the ends of the rods in the manner of drilling holes. The tool can be taken apart for sharpening. It was inexpensive and did its work quickly and satisfactorily.—Contributed by Donald A. Hampson, Middletown, N. Y.

### Wagon Wheel Used for Grate over Sewer Opening

In a small village the problem of constructing an inexpensive sewer drop was solved by the mayor in the manner shown in the sketch. The spokes of a discarded wagon wheel were sawed off about 10 in. from the hub and the hub part set into the flange of a ver-

tically placed sewer tile. This is a very efficient grate as it stops all drift-wood, twigs, leaves, and other solid ob-

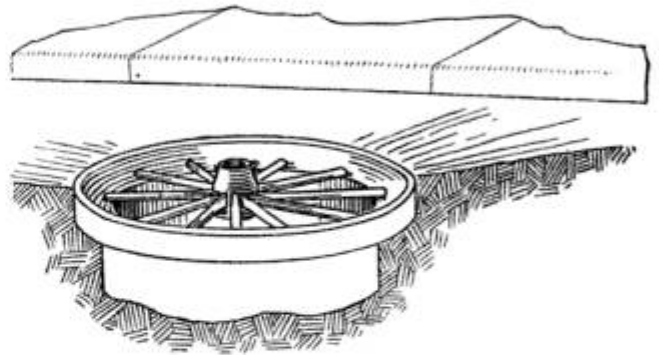

The Hub and Spokes of a Wagon Wheel Forming a Grate Covering for a Sewer Opening

jects, but allows the waste water to run into the sewer. When necessary to clean or repair the drain the wheel is removed.—Contributed by C. M. McClave, Pittsburgh, Pa.

### Gold Varnish

Equal parts, by weight, of shellac and concentrated alcohol make a good gold varnish. A .5-per-cent solution of boric acid in alcohol is added to the solution to give the varnish proper consistency. This varnish is colorless, but if a golden shade is wanted, picric acid is added until the desired color is reached.

### Long Envelope Made of Two Small Ones

Occasionally a person has use for a long envelope and if none is at hand, two smaller envelopes will answer the purpose as well. Cut the right end from one and the left end from the other and place one inside of the other so that the open ends will lap, and paste them at the edge. In this way an



A Long Envelope is Quickly Made by Joining the Cut-Off Ends of Two Small Ones

envelope of the desired length may be made.—Contributed by W. M. Braly, Blackwell, Okla.

### Laying Off Parallel Keyways

The following is a simple method of laying off keyways of any width and length, any distance apart, and all parallel with one another, on round stock.

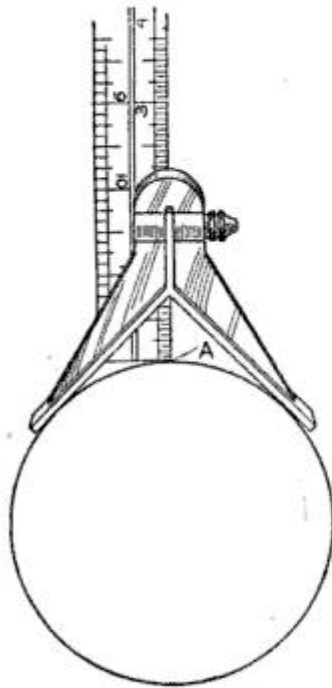

Arrange the square head and center head as shown. After the square head is set level, scratch a line at A. This line will be the center of the keyway. Any number of keyways may be scribed by repeating this operation without

moving the shaft.—Contributed by James Connor, Alton, Ill.

### Solder Connections for Copper or Iron Wire

To prevent corrosion it is not considered good practice to make an unsoldered joint where the copper wire is connected to iron wire. Such connections must be made in telephone work where an insulated copper wire is attached to the iron drop wire.

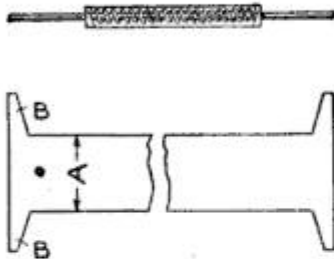

The following device may be of help to those who have not become skilled in the methods generally used.

A piece of tin, the size of which depends on the length of the joint and size of the wires, is cut as shown in the sketch. For a joint where No. 19 gauge copper wire is wrapped around a No. 12 gauge iron wire the width, A, should be  $\frac{1}{2}$  in. Bend the body A over the joint and crimp the projections B at both ends over, to hold it in place. The

space in the tin is filled with melted solder. This will make a well soldered joint that will not corrode.—Contributed by Earl Daniel, Kewanna, Ind.

### Gasoline-Tank Gauge

After making a search along the side of the road and in the tool chest to find something for measuring the amount of gasoline in the tank of my automobile it occurred to me to make a device for the purpose, which resulted in the construction of the one shown in the accompanying illustration.

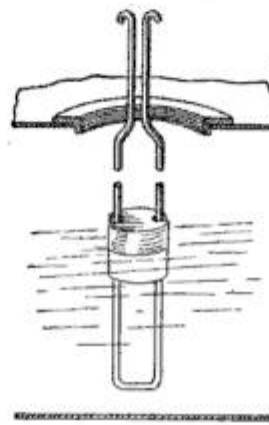

A wire is bent as shown, and a cork float slipped in between the branches so that it will rise and fall easily, except when the ends are pinched together, in which case it will be held for measurement. The wire is run through the opening in the tank,

and down to its bottom, and the cork allowed to float on the gasoline, then the ends are pinched together and the whole withdrawn. The cork will then be in the exact position where it floated on the gasoline and the amount of fluid in the tank thus easily gauged. Notches can be filed into one of the upright branches of the wire denoting inch marks, and will save bothering with a rule.—Contributed by Richard Russell, East Lynn, Mass.

### Protecting Bolt Threads While Passing Through Cored Holes

Machines not requiring accurate work usually have cored bolt holes. If more than two pieces are to be fastened with bolts it is difficult to enter a bolt without injury to the threads. Where there is a  $\frac{1}{2}$ -in. clearance this can be readily remedied by making a point for the bolt,

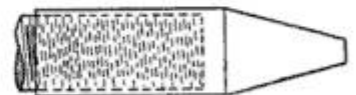

as shown in the sketch. The one illustrated was for a  $2\frac{1}{2}$ -in. bolt entering a hole 3 in. in diameter through two stands and a machine base. In this instance it was difficult to get the three pieces so that the holes would line up accurately. The point protected the threads, also made it easy to drive the bolts into place.—Contributed by Fred W. Fravel, W. Homestead, Pa.

### Emery-Wheel Arbor for Lathes

The owner of a small lathe who has no emery-wheel stand can make an arbor for use in a lathe that will do all the grinding necessary for a small workshop. The shaft A is made of  $\frac{3}{8}$ -in. steel rod of any length suitable for the lathe, both ends being threaded to receive two nuts, two washers, and the wheels to be used. A length of gas pipe, B, is fitted with a brass bearing in

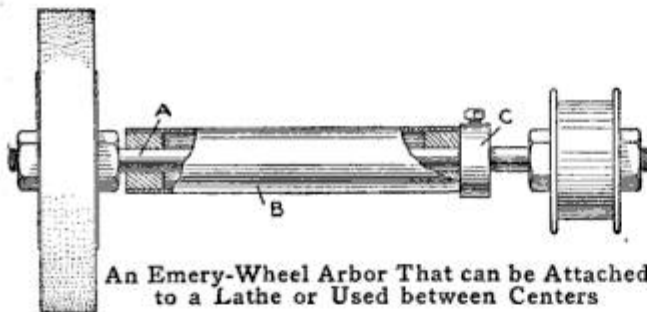

An Emery-Wheel Arbor That can be Attached to a Lathe or Used between Centers

each end to receive the shaft. The collar C is used to keep the shaft from slipping endways where it is necessary to have the pipe B shorter than the shaft.

The arbor can be used on the lathe centers or clamped to the lathe where it can be driven with a belt from a countershaft or from the main drive wheel.—Contributed by Arthur Jennings, London, Eng.

### Ventilating Front Apartment of Automobiles

By the way of solving the somewhat troublesome problem of properly ventilating the front apartment of closed automobiles, one ingenious car owner hit upon the scheme shown in the sketch. The fan is arranged to be run by gearing from the engine. Its direction of rotation is such that a contin-

uous draft of air is forced out. As its rate of rotation is very rapid, it does not obstruct the view of the driver,

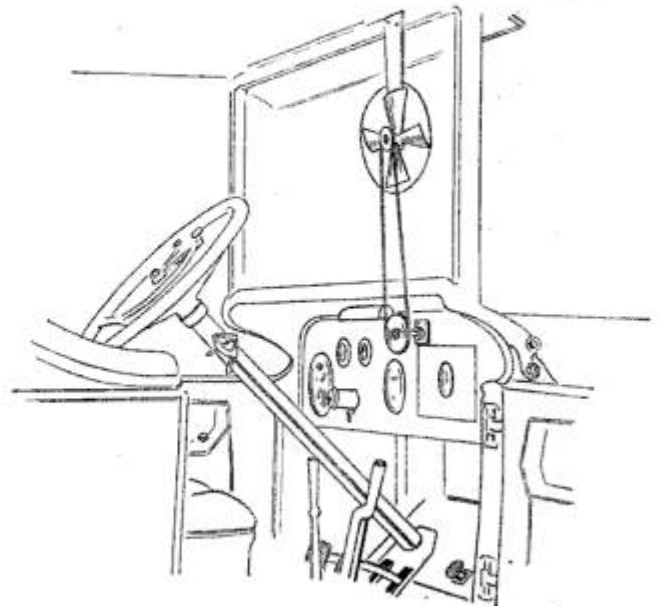

The Revolving Fan does Not Obstruct the View but Prevents Rain or Snow from Entering

and the current of air is sufficient to prevent the ingress of rain or snow.—Contributed by S. P. McMinn, Brooklyn, N. Y.

### Keeping a Boat on an Even Keel Out of Water

To keep a boat on an even keel when the tide goes out and leaves it high and dry upon a mud shore, construct a frame of four strong planks and slip it over the bow while the boat is afloat. This frame should fit tightly

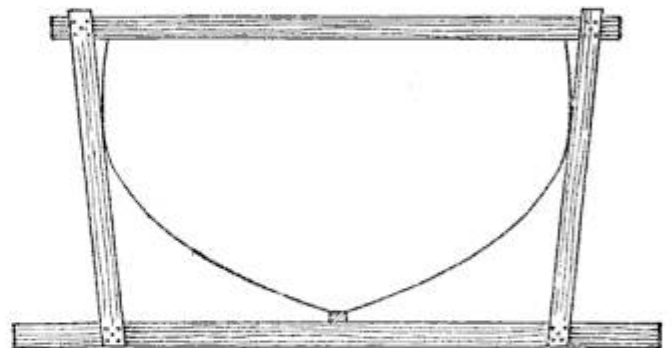

Holder to Keep a Boat on an Even Keel When the Tide Goes Out

around the boat amidships, as shown in the sketch.—Contributed by Forrest Clark, Coronado, Cal.

☞ Banana oil or turpentine is excellent for pasting tin foil on transmitting condensers.

### Handling Large Chucks on Lathes

A chuck on a large lathe, almost the full size of the swing, can be easily handled with the use of a piece of

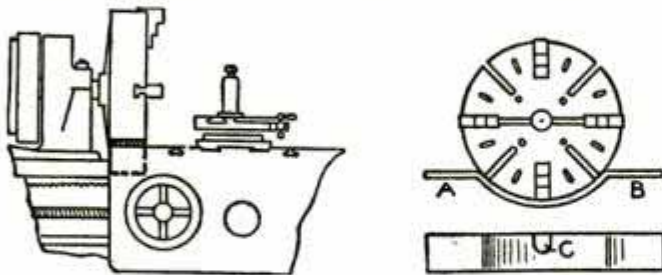

The Chuck Rests on the Metal Which is Supported on the Lathe Ways

metal on the ways, as shown. The flattened ends, A and B, rest on the ways, and the center part is bent to fit the edge of the chuck. If the chuck jaws project, a slot is cut in the metal, as shown at C, to receive one jaw end. The chuck can be easily slipped along on the ways when turning it from the threads of the spindle.—Contributed by J. Harger, Honolulu, H. I.

### Screwdriver Made of a Bicycle Pedal

The screwdriver illustrated was constructed especially for turning in loose screws and nipples on bicycle spokes. It can be used for a great variety of work, however, where machine screws

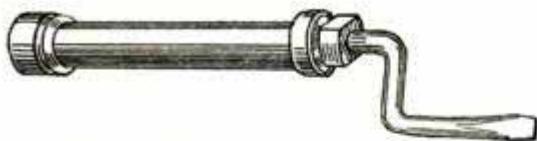

A Crank-Type Screwdriver with a Ball-Bearing Shaft for Light Work

are used. The screwdriver is made of an ordinary hub of a bicycle pedal. The frame part is removed and the threaded shank of the pin is cut off, then drilled centrally and tapped to receive the end of the screwdriver blade. The blade is made of steel wire bent as shown.—Contributed by W. E. Nolan, San Francisco, Cal.

ⒸCrossing the belt that runs the radiator fan on an automobile will reverse its motion and force the warm air from the engine through the radiator and prevent freezing in severe cold weather.

### Truck Wheel on a Grindstone Frame

A very convenient way of moving an ordinary grindstone from place to place is to make a small frame at the bottom of the posts and attach a small wheel, similar to a wheelbarrow wheel, with the lower part slightly above the surface of the ground. This will easily touch the ground when the other end of the frame is raised, and the stone can be pushed about in wheelbarrow fashion.

### Care of Striping Pencils

Striping pencils, used by wagon painters and decorators, should always be thoroughly cleaned and greased with tallow after being used. A match box, or a similar box, cut as shown,



A Holder Made of a Match Box to Provide a Place for Keeping Striping Brushes

makes a good receptacle for these articles and also makes it easier to find them when wanted.—Contributed by James M. Kane, Doylestown, Pa.

### Guard Attachment for a Long Ladder

The ladder attachment shown in the sketch serves as a guard for gutters and will enable the painter to paint back of the ladder. It can also be used on the roof of a building as a roof ladder. The attachment consists of two hardwood arms, 1 in. thick, 2 in.



wide, and about 1 ft. long, fastened to the ladder stringers and joined together with a board nailed on their top edges. The board serves to hold the paint pot. When not in use the attachment folds against the ladder.—Contributed by J. V. Loeffler, Evansville, Indiana.

## Practical Telephony

By HAROLD HINTON

### Part XI—A Rural Telephone Line

Rural telephone lines are of two kinds: bracket and cross-arm. They are arranged for ground return and full metallic circuits, the latter being the best type of construction, under most conditions, for the ordinary rural line. The following costs will give an idea of the expense per mile of constructing the different kinds of lines:

#### FULL METALLIC CROSS-ARM CONSTRUCTION

26 poles, 25 ft. by 6-in. tops....	@ \$1.50	\$39.00
4 poles, 30 ft. by 6-in. tops....	@ 2.15	8.60
30 6-pin cross arms.....	@ .17½	5.25
180 1½-in. oak pins.....	@ .70 per 100	1.26
30 20-in. cross-arm braces, galvanized.....		1.44
60 ½ by 7-in. lag screws, galvanized.....		1.20
30 ½ by 6-in. lag screws, galvanized.....		.49
3½ by ¾-in. carriage bolts, galvanized.....		.51
60 ¾-in. galvanized washers.....		.25
No. 9 Pony insulators.....		.95
165 lb. No. 12 B. B. galvanized iron wire @ .03		4.95
Labor setting poles and stringing wire.....		28.00
Total cost per mile.....		\$96.85
Each additional pair of wires to cost about		\$27.00
per mile.		

#### SINGLE-LINE CROSS-ARM CONSTRUCTION

26 poles, 25 ft. by 6-in. tops....	@ \$1.50	\$39.00
4 poles, 30 ft. by 6-in. tops....	@ 2.15	8.60
30 6-pin cross arms.....	@ .17½	5.25
180 1½-in. oak pins.....		1.26
30 20-in. cross-arm braces.....		1.44
60 ½ by 7-in. lag screws, galvanized.....		1.20
30 ½ by 4-in. lag screws, galvanized.....		.49
60 ¾ by ¾-in. carriage bolts, galvanized.....		.51
120 ¾-in. galvanized washers.....		.25
30 No. 9 Pony insulators.....		.48
165 lb. No. 12 B. B. galvanized iron wire @ .03		4.95
Labor setting poles and stringing wire, etc....		20.00
Total cost per mile.....		\$83.43
Each additional pair of wires to cost about		\$15.00
per mile.		

#### FULL METALLIC BRACKET CONSTRUCTION

26 poles, 25 ft. by 6-in. tops....	@ \$1.50	\$39.00
4 poles, 30 ft. by 6-in. tops....	@ 2.15	8.60
60 12-in. oak brackets.....		.72
60 No. 9 Pony glass insulators.....		.95
330 lb. No. 12 B. B. galvanized iron wire @ .03		9.90
10 lb. nails.....	@ .03	.30
Labor setting poles and stringing wires.....		29.00
Total cost per mile.....		\$88.47
Each additional pair of wires to cost about		\$27.00
per mile.		

#### SINGLE-LINE BRACKET CONSTRUCTION

26 poles, 25 ft. by 6-in. tops....	@ \$1.50	\$39.00
4 poles, 30 ft. by 6-in. tops....	@ 2.15	8.60
30 12-in. oak brackets.....		.36
30 No. 9 Pony glass insulators.....		.48
165 lb. No. 12 B. B. galvanized iron wire @ .03		4.95
5 lb. nails.....	@ .03	15.50
Labor setting poles and stringing wire, etc....		18.50
Total cost per mile.....		\$72.04
Each additional pair of wires to cost about		\$16.00
per mile.		

It will be readily seen by these figures that the single-line bracket con-

struction is the cheapest, while the full metallic cross-arm construction is the most expensive. Where the telephone stations are more or less concentrated, the single-line type of construction using a ground return is all right, but where the stations are some distance apart, as is usually the case on rural lines, the full metallic construction is much more satisfactory in operation. The figures given in the above tables are for a straightaway run over level land, but when a line makes sharp turns, steep ascents or abrupt descents the poles should be guyed. This guying should not cost more than about 40 cents per guy. Galvanized iron wire, size No. 6, may be used for guying, instead of the galvanized strand which is used in the cities, because the construction is much lighter and the No. 6 wire may be run double or triple if necessary. If the poles are set to a depth of 4 ft. on the straightaway, and 5 ft. on corners or turns, very little guying will be found necessary except on hills. The guys in that case may be run as shown in Fig. 80, and the corner poles, when necessary, can usually be guyed as in Fig. 81, which will save the cost of planting an anchor or placing a guy stub. The 30-ft. poles, mentioned in the cost tables, are to be used when crossing roads, etc., where the wires should be high enough to clear a load of hay, for instance. A distance of 20 ft. in the clear, from the crown of the road to the wires, is usually sufficient for this purpose.

One of the most peculiar kinds of construction was a line in a rural district about one mile long with four stations, the instruments being of the local-battery type with a magneto ringer. No switchboard was, of course, used, as each station had its "ring." These four farmers were pretty well fixed financially and all had fences upon which they had strung two rows

of barbed wire, so they naturally hit upon the scheme of using these barbed-wire fences for their "line."

After the line was connected up all went well until evening when they ex-

during the winter months when the swamp was frozen, but when the thaw came the poles either toppled over or sank out of sight, naturally putting the line completely out of business, and

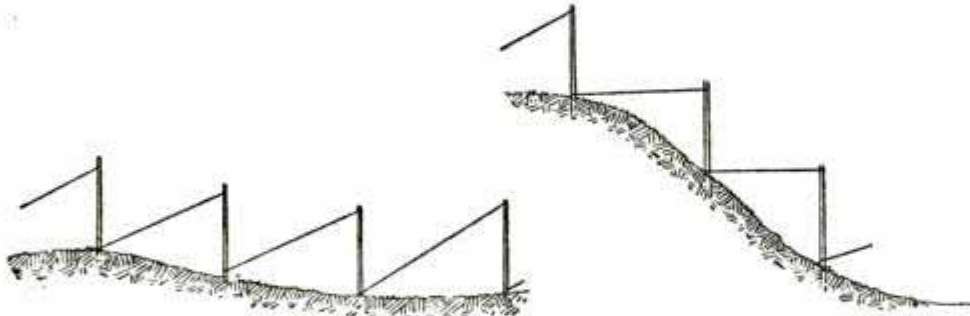

FIG. 80

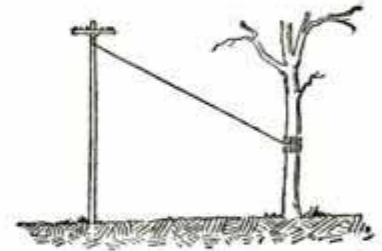

FIG. 81

Method of Guying Poles on Hill Sides, and an Inexpensive Way to Support a Corner Post

perienced their first case of trouble. The line was situated in a valley where a heavy dew fell at night, thus grounding the wires stapled to the posts. In exchange for a right of way of another telephone line old insulators were procured and the wires of the fences fastened to them, with the result that no further trouble was experienced from this source.

It is a common occurrence through rural districts to see telephone wires carried along fences as shown in Fig. 82, but to see a rural submarine is the privilege of but few. In a certain locality two farming communities were separated by a swamp about 900 ft.

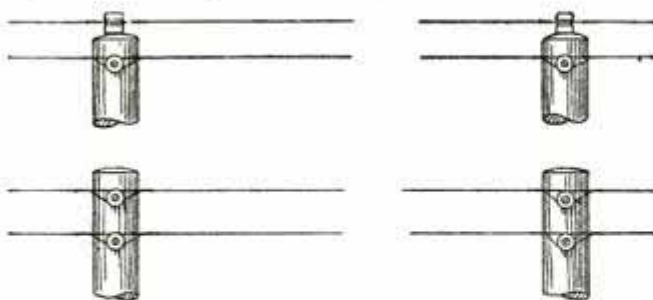

FIG. 82

Two Ordinary Methods of Securing Line Wires to the Posts of a Farm Fence

in width at the point where the two "systems" could most readily be connected together. There were only seven stations on one line and six on the other, so they wanted to bring the two together and thus connect the two settlements. The farmers put in poles

preventing communication between the two points until the following winter. The next step was to string insulated wire along through the swamp for the following winter, attaching it wherever they could. This did not succeed very long, however, as the falling leaves from the rapidly decaying trees very quickly broke down the wires. It was the third winter that a young man suggested a "submarine cable" and, after another collection was taken up with which to purchase the materials, he set out to put his idea into practice. About 1,000 ft. of No. 12 rubber-covered, triple-insulated, weather-proof copper drop wire, commonly called twisted-pair, 50 lb. of friction tape, and 2 gal. of insulating varnish were purchased. The friction tape was wrapped around the twisted pair for the full length and then given a good, heavy coat of varnish. This was allowed to become thoroughly dry and a second layer of tape was rolled on, then more varnish and a third layer of tape. The remainder of the varnish was spread on the outside layer until the surface was pretty hard and absolutely waterproof. Some old scrap wire was "requisitioned" from the junk heap and securely fastened to about 20 large, flat stones. These stones were then fastened to the cable at about 40-ft. intervals, just before placing it on the ice in the swamp. The cable was



then connected up at each end and service was again restored. It worked all right, but the wise ones said "wait till the ice goes out." They waited and the ice went but the service was still uninterrupted. They finally went down to take a look at the cable and failed to find it, as it had sunk out of sight in the soft slime. The man who had thought out the scheme had worked on the principle that the great danger to anything that must be in water lies "between wind and water" and he therefore placed the weights on the cable to sink it down deep in the ooze. That homemade submarine has been in service for several years and is still giving good service. This method may also be used when crossing wide streams, etc., and 5 or 6-lb. window



An Inexpensive Way  
of Making a Road  
or Gate Crossing  
for Line Wires

FIG. 83

weights may be used instead of the cumbersome stones.

(To be continued)

### Watering a Dry Well

A well that goes dry in summer because it was dug only to the rock may be watered successfully by a process used by me, as follows: A hole was drilled by hand with a churn drill, 7 ft. deep in the rock. This was accomplished by one man in less than one day. The hole was thoroughly swabbed out and cleaned of sand, and a piece of galvanized-iron pipe driven into it. A good flow of water was struck at this depth and what had been an unreliable well became a valuable one.—Contributed by Hollister Sage, Waterbury, Connecticut.

When making road and gate crossings with the fence lines, the best way is to get some heavily insulated wire

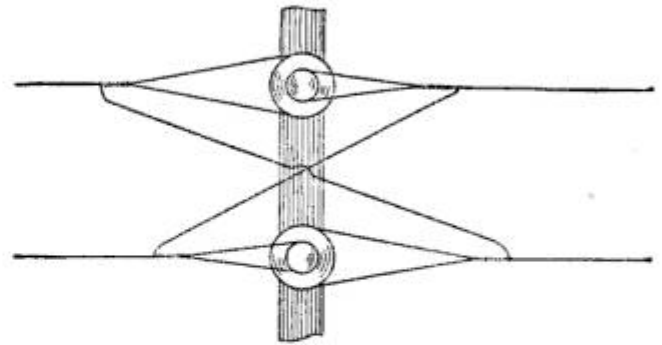

FIG. 84

A Transposition to Reverse the Sides of the Circuit  
by Means of a Grooved Insulator

of the same gauge as the line wire and run it through a  $\frac{3}{4}$ -in. or larger pipe. This method is shown in Fig. 83. Another point to remember is to always securely tie the line wires to the insulators whether they are glass, porcelain, or broken-off bottle necks. It is also advisable to put a lightning rod on about every tenth pole and thoroughly insulate the ground wire from the pole.

When the line is a long one, having two or more pairs of wires, it is often, in fact usually, advisable to run in a transposition about every 1,300 ft. This transposition simply reverses the sides of the circuit and is accomplished by means of a double-groove insulator. A transposition is shown in Fig. 84

### Starting Nails in Inaccessible Places

When driving nails in inaccessible places I found the following arrangement quite handy: I drilled a  $\frac{3}{8}$ -in. hole,  $1\frac{1}{2}$  in. deep, in the end of the hammer handle. The nail to be driven is placed head first in the hole which holds the nail so that a jab of the hammer will start it in places out of reach of the hand. The hammer is then withdrawn and the nail driven as usual.—Contributed by Patterson Merrill, Chicago, Ill.



### Substitute for a Snow Shovel

Having no snow shovel at hand I made a good substitute by fastening a board to a dung fork, as shown. Wire

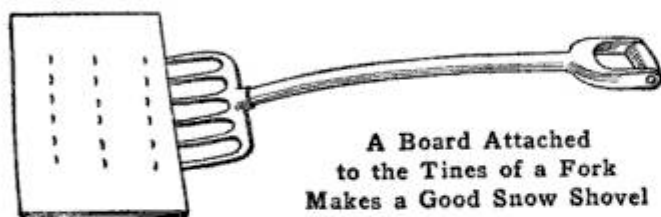

A Board Attached  
to the Tines of a Fork  
Makes a Good Snow Shovel

nails were used, clinched on both sides of the tines.—Contributed by J. Morton, Cochrane, Mass.

### Homemade Toggle Bolts

The necessary toggle or twin bolt for use in metal was not at hand when I wanted to fasten a robe rail to the metal back on the front seat of my automobile.

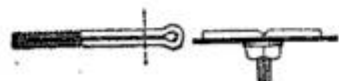

I made substitutes by threading the ends of two spring cotters, cutting the heads off and bending them as shown. They served the purpose as well as the regular toggle bolt.—Contributed by Chas. H. Sanders, Glendale, Cal.

### Repairing a Scarf Pin

When soldering the pin tongue in place on a scarf pin, use a piece of card-

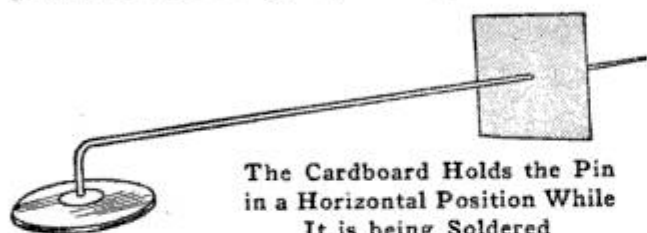

The Cardboard Holds the Pin  
in a Horizontal Position While  
It is being Soldered

board as shown, and it will be kept level.—Contributed by W. A. Jones, Raleigh, N. C.

### Trousers Guards an Aid to Drawing on Overalls

When a person's work demands the use of overalls, I find it very handy to keep a pair of bicycle trousers guards in the pockets, and have them ready to place on the regular trousers before

the overalls are drawn on. This will keep the legs of the former from being drawn halfway to the knees, as is often the case. After the overalls are on, the guards can be removed and placed in the pocket.—Contributed by R. B. Strong, Homer, Mich.

### Blower for Removing Dust in a Watch

Never blow the breath into a watch movement to remove dust, as the moisture from the breath will in all probability rust the hairspring. Use a

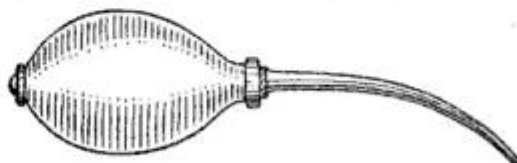

A Dentist's Blower is a Good Device to Use in  
Removing Dust in a Watch

blower, such as dentists have for blowing out cavities in teeth, as illustrated.

### A Revolving Lathe Center

The revolving center has the advantage of keeping the work true though run at a high speed, such as soft iron, brass and wood. The center is



A Revolving Lathe Center That will Prevent Wear  
on Work Running at High Speed

made of carbon steel and is bored a snug fit to receive the revolving center, which is grooved on the shank to run freely on the pin that holds it in place. An oil hole must be provided to lubricate the shank.—Contributed by G. Barrett, Hamilton, Ont.

### Polishing Glass

Calcined magnesia, rubbed down with pure benzine, makes an excellent preparation for cleaning and polishing the surfaces of fine glass, such as costly mirrors, etc. The mass formed must be sufficiently soft to allow drops of the liquid to be squeezed out of it. The mixture should be kept in closely stoppered bottles, and, in use, a little of it is placed on a bit of cotton or a soft rag with which the glass is rubbed.

### A Torsional Wire Galvanometer

The work at hand required a sensitive galvanometer and as the cost of such an instrument was beyond my means, I constructed a very good one from parts of a two-bar telephone magneto ringer. The sketch gives an idea of its appearance. The brass bearing heads of the magneto were drilled out and brass tubes, A and B, soldered into them. The top of the tube A was fitted with a brass cap, a long adjustment rod, and a small brass rod with a setscrew for holding the coil-suspension wire. The tube B was fitted with a black fiber cap, brass bushing and thumbscrew, to which was fastened the other terminal from the coil.

The instrument is mounted on a well varnished base, C, with three brass bushings and leveling screws, D, with rubber thumb wheels. It was fastened in place by a bolt through the base C to a vertical bar, E, supporting the binding posts F. One binding post is grounded to the instrument and the other is connected by a wire to the terminal on the top of B. A core, G, for the coil, was made from  $\frac{3}{4}$ -in. water pipe, turned up smoothly and held centrally in place by a short stud from a brass plate, H, fastened across the pole faces.

The suspended system was next in order. A coil mount was made of thin strip brass, bent to a rectangular shape, the ends being butted and soldered. A small brass-wire hook was soldered in the center of one end for suspension. A coil of No. 40 gauge enameled wire was wound upon the mount, leaving the ends long enough to suspend the coil from the top of the tube A and for a "pig tail" terminal connection at the bottom of the tube B. The coil was wound to a resistance of about 2,000 ohms. A small piece of mirror, J, was cemented to the hook. The coil was given a coat of shellac.

This type of an instrument must be used with a scale on the wall and a source of light, the light being reflected onto the scale by the mirror. If extra resistance is added and calibrated with a standard instrument, it

can be used as a voltmeter. This instrument was inexpensive to construct

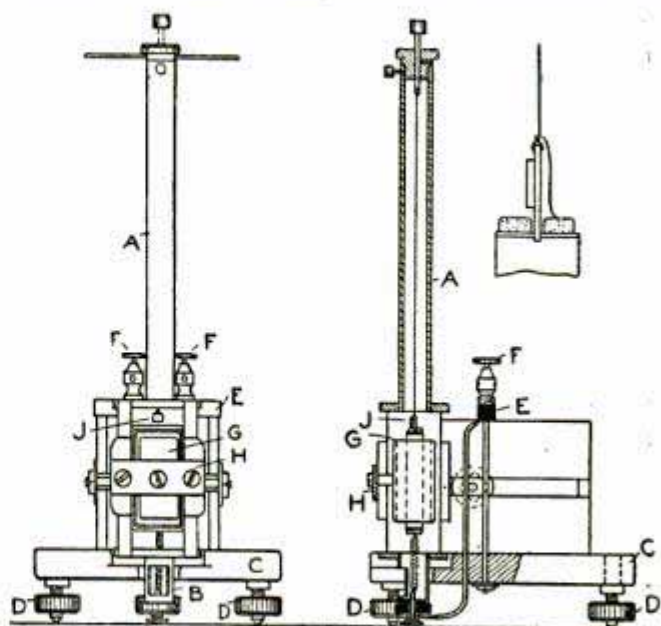

Galvanometer Constructed of Parts Taken from a Two-Bar Telephone Magneto Ringer

and it served its purpose admirably.—  
Contributed by P. K. McGall, W. Orange, N. J.

### Counterbalance for a Cellar Door

The raising of a cellar door can be made quite easy if there is a counterbalance of almost the same weight as the door. One farmer attached this balance in the manner shown, with a rope running over a pulley in the upper end of the post on which the door rests

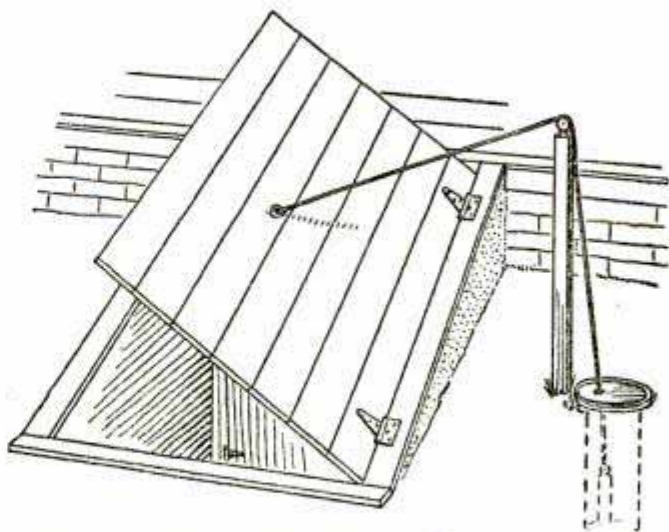

The Weight is Swung from the Rope in the Tiles Where It is Out of the Way

when open. To make room for the weight, two tiles are sunk into the ground at the right place.

## Temporary Repair on an Automobile Spring

While making an extended tour in an automobile I had the misfortune to break a front spring through the cen-

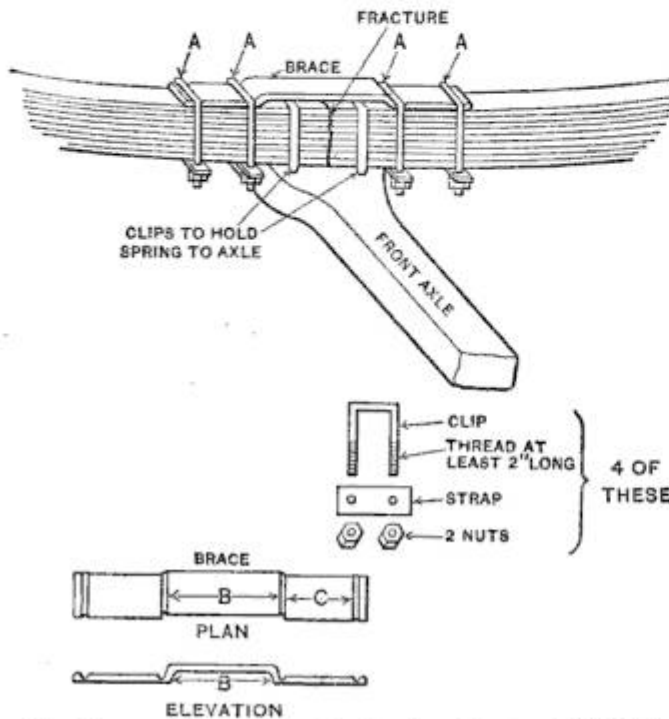

The Brace Clamped to the Broken Parts will Hold the Spring Temporarily Until It can be Repaired

ter. As there was no garage near, I had a blacksmith make a brace, and clips, AAAA, to go over the broken parts, as shown. The width of the brace should be equal to the width of the spring and the part B long enough to lay over the clips holding the spring to the axle. The ends C should be about 3 in. long. Such a brace will effectually repair either a front or rear spring.—Contributed by L. L. Llewellyn, Hayward, Cal.

### A Homemade Valve Tool

A cheap and very serviceable tool, for compressing and holding the spring while removing or inserting the valve



A Tool for Holding Springs While Valves are Being Removed for Repairs

stem on an automobile or other gasoline engine, is easily and quickly made where one may have access to a forge. The tool is forged from an ordinary worn-out, flat 10-in. file. Carefully

draw the temper, then flatten it out and shape the end as shown, making the slot  $\frac{1}{2}$  in. wide and  $\frac{3}{4}$  in. deep for ordinary use, or any other dimensions to suit special cases. A notch is made in the side,  $\frac{3}{8}$  in. wide and  $\frac{1}{2}$  in. deep, with a projecting prong.

The second member of the tool is a simple hook made of  $\frac{3}{8}$ -in. stock of equal strength, having an opening of about 4 in. and a length of 6 in. A piece of dog chain, or any chain having flat links, about 18 in. long, the closed end of which is slipped into the notch on the side of the tool, is attached to the hook.

To use the tool, attach the hook to the exhaust manifold, or other part, of the engine, allowing the chain to hang in front of the spring to be raised. Insert the notch at the end between the coils of the spring near the lower part so that the valve stem will be between the prongs. Hook a link of the chain in the notch at the right height, and by bearing down on the handle the spring is easily compressed.—Contributed by C. F. Heizer, Falfurrias, Tex.

### A Twist-Drill Driver

When a hole must be drilled in a deep groove, recess, or place, and an ordinary drill is not long enough, it is quite common practice to forge a

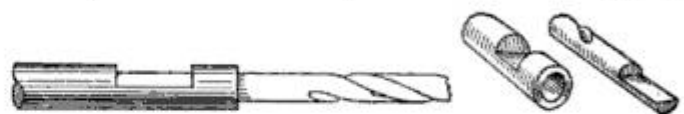

An Extension Twist-Drill Driver for Drilling Holes in Places That a Short Drill will Not Reach

former or flat drill on a length of tool steel, leaving a shank long enough to reach the required distance or more. But a flat drill cuts slowly and takes more power than a twist drill and it is apt not to drill the proper size.

If a twist drill is at hand, a strong and simple driver can be made for it by using a piece of machine or cold-rolled steel, and at a cost no greater than the forging of a flat drill. First make a saw cut through the center of the metal on the shank end and then cut out the piece so formed, about  $\frac{1}{2}$

in. long as shown. This leaves a positive driving-shank end on the drill. Drill a hole in the bar of steel, about 1 in. deep and having the same diameter as the drill to be used. Above this drilled hole cut a notch through one-half of the steel bar, making the notch fully as long as that on the drill-shank end and so that it will meet the end of the drilled hole. Slip the shank of the twist drill into the hole, passing its extending end up over the notch in the bar, and a combination tool will be had that is very good.

### Temporary Leather Bearing Replaces Babbitt in Automobile Engine

While cross-country motoring, the crank case of the motor ran out of oil which resulted in the babbitt of the lower half on the connecting rod melting out, and we were left in the middle of a river with a badly disabled engine. I unscrewed the connecting bolt, cut off a short piece of my belt and clamped it in the place of the babbitt. The crank case was filled with the right amount of oil and we proceeded to our destination, 6 miles, then back 14 miles without any trouble, the motor running very quietly all the time. When arriving home the leather was removed and found to be in good shape, sufficient for another run. The sketch shows where the leather was used.—Contributed by Fred B. Stoner, Mason-town, Pa.

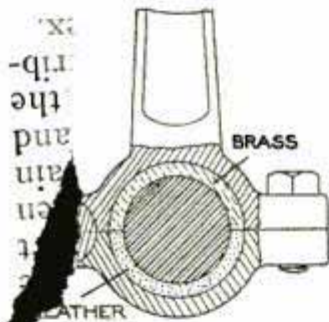

### Handy Arrangement of Bench Drawers

A good method of arranging drawers to hang under a bench, and one which permits any one working at the bench to sit down, is shown in the sketch and, as may be seen, consists of a small drawer, in which can be kept

the small and most-used tools, and a large drawer, to hold work under construction, or other things which would

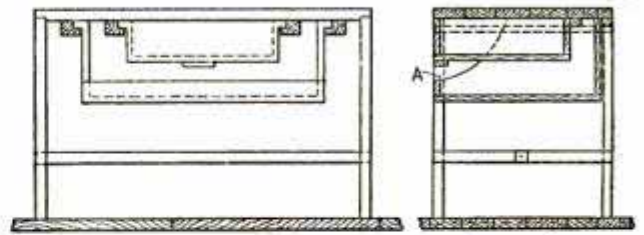

To Place One Drawer within Another under a Bench Top is Handy and Saves Space

otherwise have to be kept on the bench.

Another purpose for which the edge A of the large drawer can often be used is to rest work on while sitting down and filing, holding the work with one hand and filing with the other. This drawer is both handy and space-saving.

### Cutting Spline Grooves by Hand

Having occasion to cut some grooves in segments for a pattern at a time when the power was temporarily removed, I found the following method very effective:

A fine-toothed rip saw, A, and a board of the proper thickness were clamped to a flat surface so that the edge of the saw projected beyond the edge of the board a distance equal to the depth of the groove. The ends of the segments B were

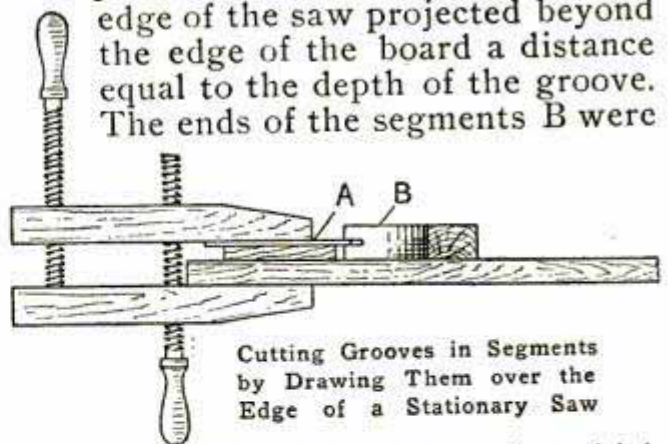

Cutting Grooves in Segments by Drawing Them over the Edge of a Stationary Saw

drawn across the saw teeth which readily cut the grooves.—Contributed by Alden T. Stubbs, Malden, Mass.

When the notches in a glass cutter become worn or the glass happens to be a trifle too thick for them, use a monkey wrench. The wrench is better to use where a narrow strip is to be cut and chipped away.

dw-  
ted.

### An Emergency Burglar Circuit

Often a burglary might be prevented if it were possible for the watchman to turn on all the lights in a building at the same time from some more or less

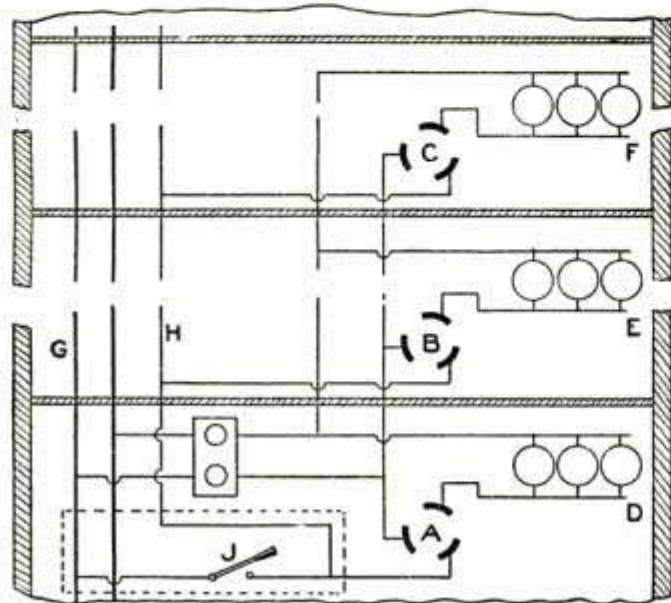

A Separate Light Circuit for Applying Current to All Lights of a Building from a Secluded Switch

protected and out-of-the-way place. The same arrangement will prove quite useful in cases of fire, as the firemen may easily turn on all the lights in the building by simply closing a single switch. The circuit shown diagrammatically in the accompanying sketch accomplishes the desired results, and, at the same time, it is impossible to turn any one of the individual groups of lights off so long as the master switch is closed. Referring to the diagram it will be noticed that each of the switches, A, B, C, etc., controlling the individual groups of lights D, E, F, etc., are of the two-way type, with one point connected to the main lead G; another to one side of the group of lamps the switch controls, while the third point of the switch is connected to the main H, which in turn connects with the main G through the switch J. The switches A, B, C, etc., are so constructed that the lead from the lamps into the switches will always be connected to either the main G or H. It is thus obvious that so long as the switch J is open the lamps will not light when the switches A, B, C, etc., are in one position, but will light

for the other position. If the switch J is closed, all the lamps will light, and it will be impossible to turn any of them out by operating the switches A, B, C, etc. Such a circuit can be installed so as to meet the underwriters' requirements and may pay for itself in a few minutes at some unexpected time.

### Taper Attachment for Lathes

To turn a taper on a lathe not equipped with a compound rest necessitates shifting the tailstock, which, however, is not the best method for doing the work. The proper way is to have an attachment for controlling the feed of the tool, and this device can be easily made and attached to any lathe. Two bracket castings, A A, are bolted to the rear part of the lathe bed after they have been machined so that the surfaces can be lined and leveled up true with the ways. One end of a bar, B, is pivoted to one bracket, and the other end is provided with a bolt that swings in a slot in the other bracket for adjustment. The block C slides on the bar B and carries with it the rod D which is inserted in a hole in a piece of metal, fastened to the cross slide of the carriage. The rod is adjusted to the work in hand by slipping it through the block E, and when set, it is clamped with two setscrews.

In turning tapers, the attachment is

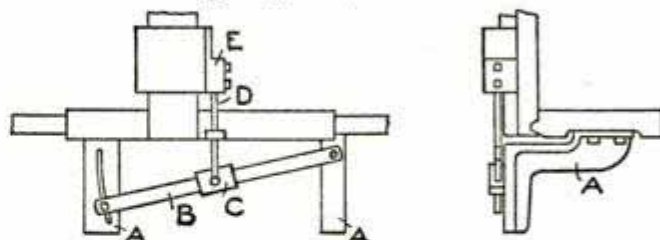

The Slide on the Bar Controls the Cross Feed So That a Taper Cut is Taken

applied and the cross-feed screw or nut is disconnected. The travel of the carriage lengthwise in taking a cut causes the tapering slide to control the cross feed in accordance with the taper for which it was set.

Rough castings should never be slid on machine beds.

### Dispelling the Odors from Cooking

To do away with the odors from cooking and the impure air in restaurants, just before serving the meals fill a bowl with steaming hot water, place it in the center of the room and pour in a few drops of oil of lavender. The oil is easily handled, is nonpoisonous and can be purchased at any drug store. It is inexpensive, as a few drops in each bowl is sufficient to deodorize a large room. The bowl may be removed after all the oil is evaporated. The process works equally well in private kitchens and dining rooms.—Contributed by Loren Ward, Des Moines, Iowa.

### Substitute for Carpenter's Clamps

A very good substitute for clamps can be made as shown in the illustration. It consists of two side boards

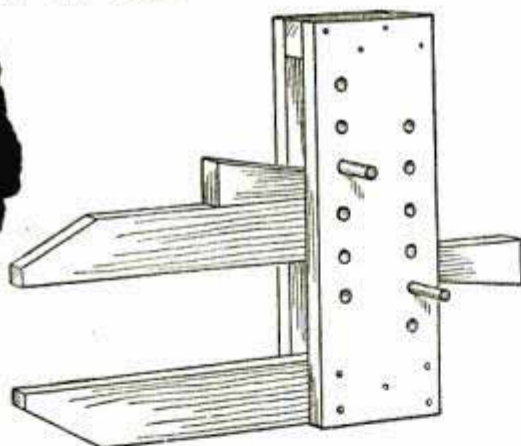

The Clamp is Actuated by Wedges and Pins for the Adjustment to the Width

fastened together with one fixed jaw and a piece between their ends. The other jaw is loose so that it can be set as desired and clamped on the work with the pins and wedges. The size of the pieces will depend on the size of the clamp.—Contributed by A. S. Thomas, Amherstburg, Ont.

### Cutting Thick Metal with Hand Shears

If it is necessary to cut a thick piece of metal with a pair of hand tinner's shears construct a shear holder of wood, as shown, and the cutting will be made quite easy. Place the holder on the bench, or floor, with the lower

handle of the shears in it. Pressure is applied only to the upper handle, and a clean cut can be made. The

The Holder Prevents the Shears from Turning Sideways under Pressure When Cutting Heavy Material

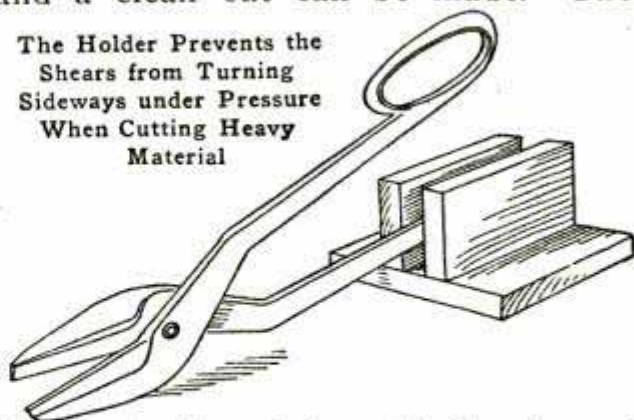

holder consists of three blocks of wood nailed or screwed together, the upright pieces being placed just far enough apart to receive the handle snugly.—Contributed by U. B. Gilroy, Marysville, Cal.

### How to Make a Felt Buffing Wheel

In making a felt buffing wheel of about 3-in. diameter, construct a center disk, A, of wood, about 1½ in. in diameter, and mount it on a straight wood hub, B, of sufficient length for the width of the wheel face. Two washers, each 1 in. in diameter, are fitted to the ends of the hub and three holes drilled through their outer edge for rivets. Holes are punched through the felt disks to coincide with the holes in the washers. An even number of felt disks are placed on each side of the wooden center disk and all are fastened together with the three rivets through the washers. The felt disks extending beyond the edge of the center disk are sewed together by making two seams, one near the edge and one close to the

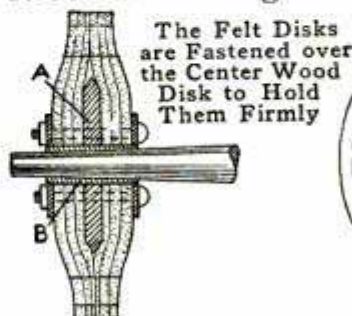

The Felt Disks are Fastened over the Center Wood Disk to Hold Them Firmly

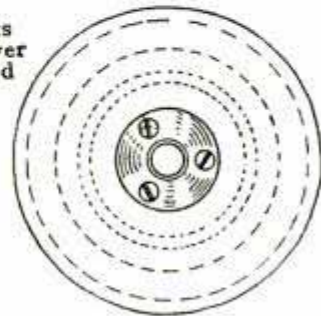

edge of the wood disk. Other sizes can be made by relatively changing the proportions.—Contributed by W. A. Henry, Galesburg, Ill.

### A Wagon Feed Box for Horses

A teamster who is obliged to feed his horses during the noon hour at the wagon has devised a feed box to take

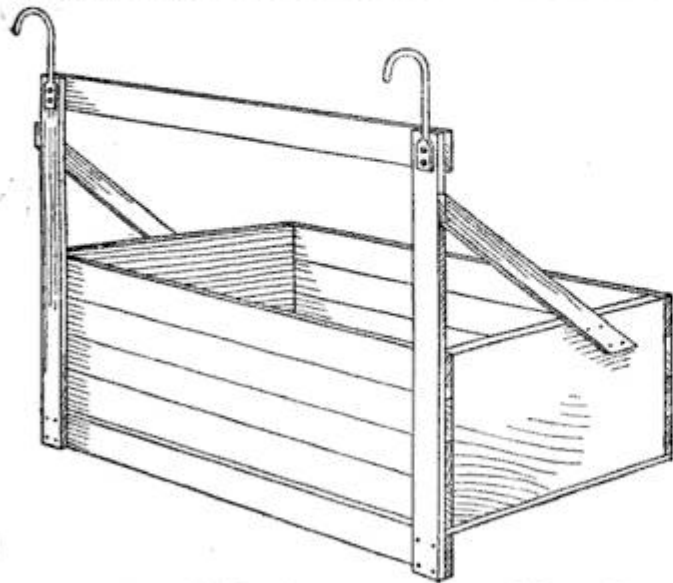

The Feed Box is Easily Attached to the Wagon Box When It is Time to Feed

the place of a nose bag. When the box is hooked over the top edge of the wagon box the height is just right for the horses. The box prevents waste of grain and provides a better way to feed the horses than in the wagon box.—Contributed by Vinton V. Detwiler, Manhattan, Kan.

### End Gauges

A very useful set of end gauges that have proven satisfactory and flexible for the manufacturer of machine tools was made of tool steel,  $1\frac{1}{8}$  in. in diameter, as described by a correspondent of American Machinist. A piece of the steel was centered in a lathe and knurled the entire length, then pieces were cut off, faced, drilled and tapped,



Gauges Cut from Tool Steel, Hardened, Then Their Faces Ground True to Size

and the ends turned down, as shown, so that they would have a flat surface for gauging. The tapped holes allowed

them to be turned on a stub arbor so that, after hardening, the surfaces could be ground to size. The use of headless screws permitted any number of gauges to be connected together so that almost any length could be obtained.

### Removable Head on a T-Square

Having occasion to carry a T-square with me on daily journeys, I usually found it knocked out of true as it, being an unwieldy package, was always striking some obstacle. I overcame the difficulty by devising a demountable T-square, as shown. The square was taken apart and then screwed together again, using round-head brass screws. In the center of the head and blade a hole was bored to admit a bolt having a knurled nut. The heads of the screws were then filed off to make them into studs. The head of the T-square is thus easily taken off and replaced, and it always

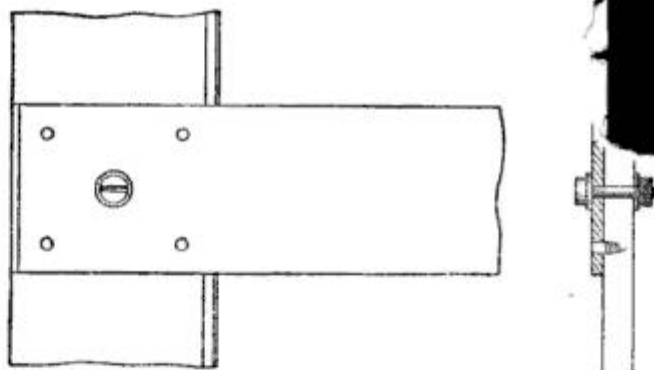

The Head can be Removed and Replaced and It will Always be Square with the Blade

adjusts itself to the original position.—Contributed by Edwin E. Hahn, Philadelphia, Pa.

### An Emergency Nut

In doing some repair work I found that I had two bolts and only one nut. The nut happened to be of a good thickness and in order to make a temporary job of it, the nut was split with a hacksaw to make two nuts of one.—Contributed by Wm. A. Murray, Cold Spring, N. Y.

CA lathe bed having a scale is handy for some classes of work.



## Bonding and Grounding Aerial Cables

By GEORGE LITTEL

While electrolysis proper does not attack aerial cables, it is equally important that these cables are bonded and grounded in the same manner as for underground work. The large number of high-potential circuits which run parallel with, and across the telephone, telegraph, light and power cables makes the bonding and grounding necessary. The high-potential wires often drop upon the cables below, and the current jumps through the underground fuses, runs down into the underground cable and makes its way through to the heat coils on the main distributing frame in the central station. Also, in damp weather, where the high-potential circuits and the telephone cables are on the same poles, the induction will often seriously interfere with the proper working of the latter. Lightning also is liable to damage aerial cables and for these three reasons the aerial cables must be properly protected, as an accident may come to them at any time. The following instances of troubles caused and diverted by improper and proper insulation of cables show that too much care cannot be taken to reduce the maintenance expense.

In one instance the cable was struck by lightning, which jumped through the underground box, followed down the cable, and finally, about  $\frac{1}{2}$  mile from the underground box, jumped through the sheath to ground. The interesting part of this case was that the lightning had confined itself to one pair of wires all the way in the cable until it went to ground, where it fused off about 75 pairs of wires and burned a hole in the sheath about the size of a lead pencil. The second case occurred in a cable that ran parallel with an interurban trolley feed and on the same pole with it. In this instance the aerial was properly bonded and the damage was limited to that part of the aerial between the start of the trouble and the ground connection. The feeder dropped across the aerial

and melted the armor completely for over 300 ft., but there was not one single station, out of over 50 party lines, that was put out of commission.

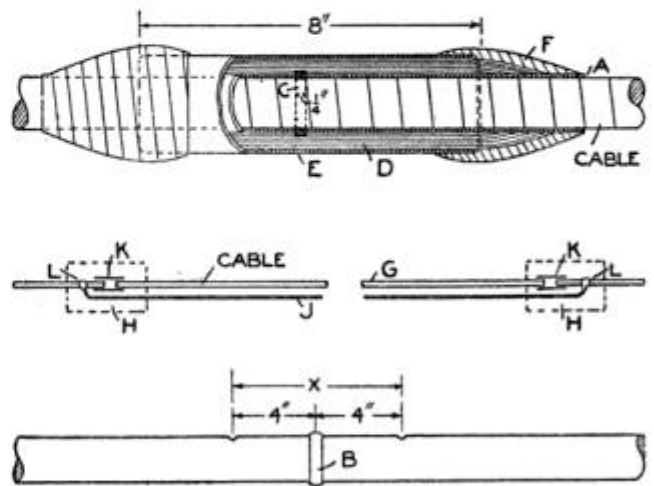

FIG. 1

Method of Insulating the Cable Sheath and Manner of Connecting the Bond Wire in the Manholes

It can be readily understood that the lack of bonds and ground in the first case caused a large repair expense, and that the proper bonding and grounding, in the latter, saved twice as much as otherwise would have been destroyed.

When cables are run across iron bridges the best plan is to insulate them at both ends. This can be easily accomplished, even though the cable is run in an iron pipe, with the aid of insulating joints, as shown in Fig. 1, in which A represents the cable sheath. This insulating joint is not made at a splice in the cable but a piece of sheath, B, about  $\frac{1}{4}$  or  $\frac{1}{2}$  in. in width, is removed all the way around the cable. This cut is not made, however, until the cable is soaked with paraffin at that point. This is done by cutting small holes, about 4 in. each side of the place where the cut is to be made, as shown at X, and into which melted paraffin is poured until the cable is thoroughly saturated with it. The cut proper is then thoroughly boiled out with paraffin and the opening completely filled by winding candle wicking, C, around the cable until the slot

is more than full. The wicking is then boiled out with more paraffin and the holes X closed with solder.

The entire cable is then tightly wrapped, for 4 in. each side of the cut,

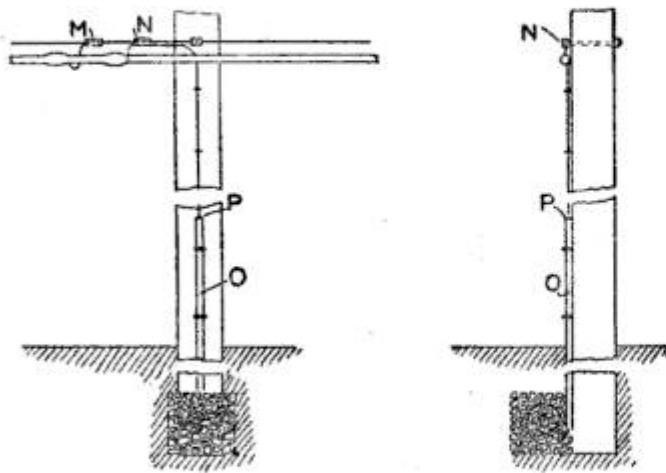

FIG. 2

An Aerial-Cable Bond to the Messenger and a Ground Connection at a Pole

with alternate layers of common friction tape and okonite tape, using four layers of each and painting each layer with a good asphaltum paint, as shown at D. A lead sleeve, E, is then slipped over the cable and the ends dressed in to fit the tape tightly, so as to aid in excluding moisture in case the splice is exposed to dampness. The joints of the sleeve are then built up with tape, as shown at F, and given two coats of asphaltum paint. The part of the cable touching the bridge is shown at G, while HH are the manholes at each end in which the joint is made. The bonding wire, the size of which depends on the amount of current flowing into the cable, is shown at J. The position of the insulating joints in the manholes are shown at KK, and the point of connecting the bond wire with the cable sheaths, at LL. The ends of the bond wire should be securely soldered to the sheath. The object of these joints is to break the connection of the cable sheath and at the same time maintain a continuous circuit for the prevention of electrolytic action.

The proper method of bonding an aerial cable is shown in Fig. 2. This bond should be made every 1,000 ft., and a ground connection every 5,000

ft. The method of attaching the messenger to the cable is shown at M, where three bolt clamps are fastened to the messenger and also to a piece of messenger wire, about 3 ft. long. The far end of this short piece of messenger wire is then fanned out, placed around the cable and fastened with a small piece of copper wire. A solder joint is wiped over both the cable and the fanned-out wire, and a neat appearing as well as a mechanically perfect job is the result. When the ground wire is run, the bond and ground connection are made as shown at N, and the wire must be continued from the clamp, down the pole, and into a  $\frac{1}{2}$ -in. galvanized-iron pipe, O, which extends about 3 ft. above the ground. The wire should be a 6M guy wire and is fastened to the pole with galvanized staples, about 2 ft. apart, and the pipe is held to the pole with clamps. Where the wires enter and leave the pipe, at P, the openings in the pipe must be closed with solder to exclude all dampness. A hole, about 18 in. square, is then dug at the base of the pole and 4 ft. below the surface of the earth. The hole is filled with coke or charcoal and a 15-ft. coil of ground wire placed in it.

### Taper Gauge for Boring Mills

The fact that the boring mill is one of the most difficult machines to set for a true taper, brought about the making of the gauge shown in the sketch for this work. It consists of two pieces of steel,  $\frac{1}{32}$  in. thick, 1 in. wide, and 15 in. long, jointed like a blacksmith's rule. A true center is left in the jointing screw and from this point a center line is drawn on each blade. The upper blade is cut along this line to within about 2 in. of the joint, and the edge is trimmed and beveled so that it coincides with the line on the other blade. An arc of a circle is marked on both blades 12 in. from the center of the joint, and the space between is graduated as fine as desired, but for ordinary purposes a fine center-

punch mark at a corresponding point on each 12-in. arc of the two blades will be sufficient, if accurately measured.

To use the tool for any machine, set the dividers to 60 deg. of the graduated arc and lay out that distance on both blades. When the points at 12 in. are the required distance apart, the distance through which the zero mark on the machine must be moved is found at the arc which represents the circle of the machine, and it is only necessary to transfer this distance with the dividers. The distance A is equal to one-half the required taper per foot, and the distance B is the distance to move the zero mark to cut the required taper. It must be remembered that the boring

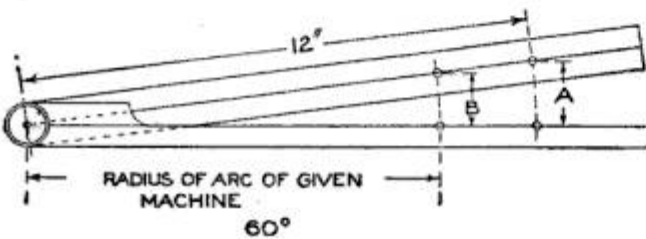

Gauge for Setting Boring Mills or Other Machines to Do Accurate Taper Work

head is set just one-half of the total taper per foot, and it is most important that the cutting point of the tool be kept on the taper line parallel to the center line of the work. —Contributed by Thomas M. McKelvey, Ohio.

**L. Guard**

A guard placed on a lathe tool, as shown in the sketch, is a great aid in preventing injury to the workman's eyes, especially where the work must be closely watched. The guard consists of

a piece of celluloid, about 2 in. square, cut as shown and slipped over the tool with the tongue folded in between the tool top and the end of the setscrew. The guard being transparent, the work can be seen through it.—Contributed by Jos. J. Kolar, Maywood, Ill.

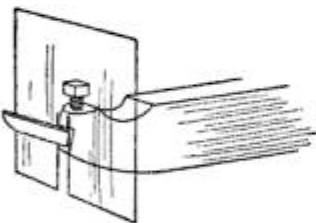

**Tongs for Holding Flat and Round Stock**

These tongs differ from the ordinary kind in the jaws only, having side projections with curved inside surfaces to

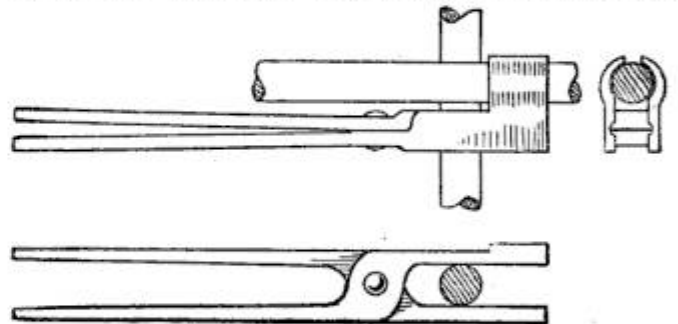

The Jaws' Shape is Such That Either Flat or Round Stock may be Held in Them

hold the round stock. They will be found especially useful in welding short pieces of iron with a jump weld, as the stock can be held either sideways or endways, as shown.—Contributed by Edward Miller, Northampton, Massachusetts.

**Measuring Tubing with an Ordinary Micrometer**

A little inexpensive attachment for any ordinary micrometer can be made for accurately measuring the walls of tubing. The attachment is made as follows:

A piece of  $\frac{5}{16}$ -in. cold-rolled steel is drilled to make a push fit

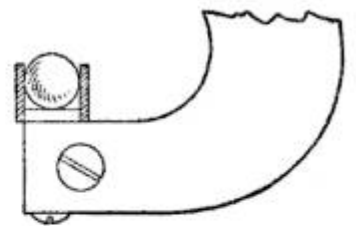

for a  $\frac{1}{4}$ -in. hardened steel ball. The steel is fitted snugly on the anvil of the micrometer. The steel ball is adjusted in the bushing so that it will protrude  $\frac{1}{16}$  in. The bushing is then placed on the anvil of the micrometer so that the ball touches it. In measuring the wall of a tubing all that is necessary is to subtract  $\frac{1}{4}$  in., or .25 in., the exact size of the steel ball, from the amount designated on the scale.—Contributed by Walter Butz, Pearl River, New York.

Heat the drill when drilling frozen earth for blasting purposes and the drill can be easily withdrawn.

### Shifter for Overhead Belts

Overhead belts at a considerable distance from the floor are hard to throw from the pulley, when necessity requires it, without stopping the entire machinery in the shop.

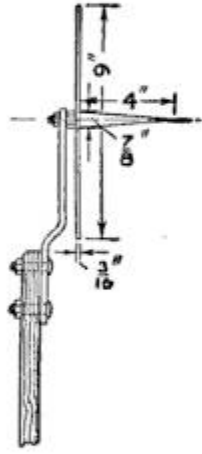

The sketch shows a device consisting mainly of a pointed or tapered prong and a circular plate behind it, to engage the belt. Attached to a long wood handle, the arrangement is very handy and convenient as

a safe means for throwing overhead belts. The prong and plate engage the belt at the same time, in throwing a belt, no matter which way the pulleys may be turning.

### Coloring Copper

Copper and brass lend themselves readily to a coloring process and may be worked to all shades imaginable, excepting the lighter shades, which are lost on a copper surface, as that metal cannot be given a tint lighter than its natural color, says a correspondent of Sheet Metal Shop. Zinc colors fairly well sometimes, through a narrow range, while tin is a hard metal to handle as regards oxide colors.

Copper can be carried through the entire range of shades, from a very light copper color to the darkest brown, or even black, by merely oxidizing the surface of the metal. Make a paste of iron oxide and graphite, with wood alcohol or with plain water, and apply this to the article, which is then heated in an oven or over a gas flame. It is better to use alcohol, as it dries out much quicker. The color obtained will depend on the amount of iron oxide mixed with the graphite, and the length of time the heat was maintained. The more oxide in the coating, the darker the shade given to the copper.

The remains of the coating should be removed with a brush or cloth

moistened in alcohol, and when the surface has become quite clean, the color should be protected by applying varnish, lacquer, or pure wax, which may be laid on with a brush while the copper is heated. Some brown colors are obtained by using a mixture of verdigris, sal ammoniac and vinegar, using two or three times as much verdigris and sal ammoniac as vinegar. The heat treatment is the same as in the previously related process and the color obtained can be made much darker by adding some blue vitriol to the solution.

A red brown may be given by using a vinegar paste containing equal parts of verdigris and cinnabar, together with two and one-half times as much each of sal ammoniac and alum. The heat treatment is the same as for the other coatings.

A wide range of colors, comprising shades from blue-black to blue-gray, may be given to copper by dipping it in a hot "liver of sulphur" solution and then washing thoroughly, redipping or scratch-brushing and again dipping and washing according to the tint desired. This can only be learned by experience.

### Holding Thin Brass Tubing for Turning

In cutting off, turning, or filing thin brass or copper tubing much trouble will be experienced from its buckling or crushing under the pressure of chuck jaws or vise jaws. To prevent this trouble use a plug of wood driven lightly into the hole. Where a number of pieces of the same size are to be handled, a metal plug or arbor can be made; and if a still greater number are to be worked, it will pay to have an expanding arbor which may be made by splitting the metal plug, making a taper hole in it and fitting a plug in the hole.

☞The part of a metal post that is set in the ground may be kept from rusting by painting it over with a coat of cement.

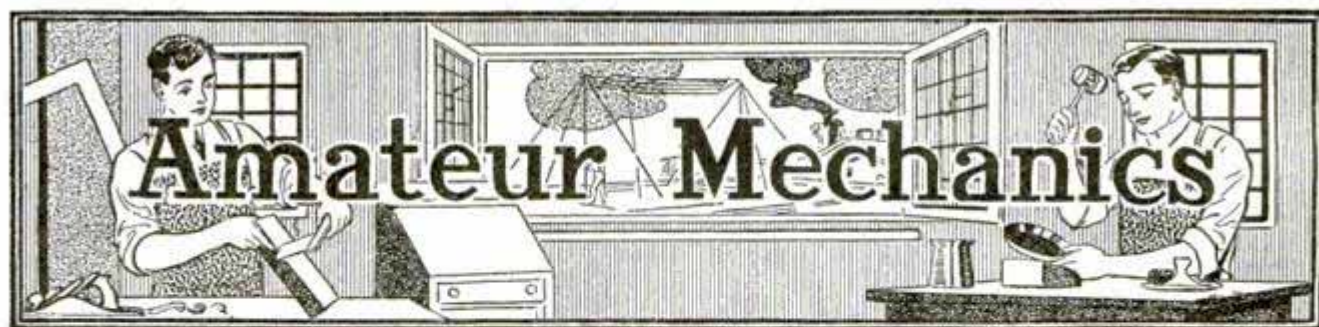

## Drill Press on an Ordinary Brace

As the greater part of the energy required for drilling metal by hand is used for feeding the drill, I made what I term a drill box in which the brace is held perfectly true and pressure is applied by a weight. The feed can be changed for the different metals and sizes of drills, also for drilling the hard outside of castings and relieving the drill for the softer body. The constant feed will cause the drill to turn out a long chip, and a number of holes may be drilled to a uniform depth by using the same feed and counting the turns of the brace handle.

To build the box, first find the dimensions of the brace, as shown in Fig. 1: the diameter of the head *A*, the clearance *B* from the top of the head to  $\frac{1}{4}$  in. above the top of the handle *C*, and the over-all length *D* when the longest drill is in the brace. Make a box having an inside length equal to the dimension *D*, plus whatever additional height may be necessary for the work. Make the inside width twice the distance *C*, plus 6 in. for clearance; and the inside depth the length *C*, plus one-half of the dimension *A*, plus 3 in. Use material  $\frac{7}{8}$  in. thick and nail the parts together to form a rectangular frame. Cut a piece of broomstick as long as the dimension *B*, and two pieces of wood as long as the inside width of the box and as wide as the dimension *B*. Cut two pieces  $\frac{1}{16}$  in. longer than the dimension *A* and as wide as the length *B*. Nail these latter pieces together as shown in Fig. 2, leaving a square space in the center. This frame is to be nailed inside of the top of the box flush with the front,

but before doing so lay it on top of the box to determine where the center of the square space will come, and bore a hole, large enough for the round

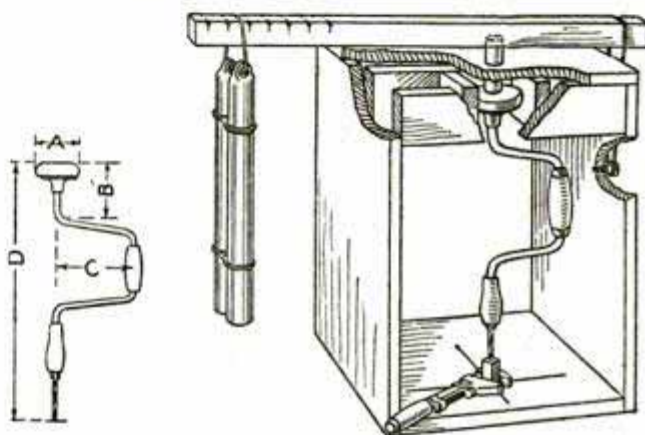

FIG. 1

FIG. 2

The Weights Apply a Constant Pressure to the Drill, Which can be Easily Turned

stick cut from the broom handle to slip through easily, then nail the frame on the under side of the top piece.

Procure a tough piece of wood,  $1\frac{1}{2}$  in. square and long enough to project 2 in. over the right and 10 in. over the left side of the box top, and when in this position, locate the hole bored for the round stick and bore a hole in the square stick,  $\frac{1}{8}$  in. deep, to coincide with it. Place the head of the brace in the guide and push it up until it touches the top of the box and block it up in this position, then drop the round stick through the hole and rest it on the head of the brace. Place the socket in the lever over the top of the round stick. Make a loop, 8 in. long, of heavy wire and hang it over the right end of the lever and mark the box at the lower end of the loop. Turn in a large screw  $\frac{1}{2}$  in. below this mark

allowing it to project enough to hook the loop under it. Remove the round stick and put a screw at the point the bottom of the loop reaches when the lever is flat on the top of the box. Another screw turned in between these two will be sufficient to hold the lever in position. Different-sized weights, of from 5 to 10 lb., are used on the lever, but for small drills the weight of the brace alone is sufficient.—Contributed by Maurice Coleman, W. Roxbury, Mass.

### Homemade Picture-Frame Miter Box

Any person wishing to make a picture frame, or to cut down an old one, requires a miter box for that purpose,

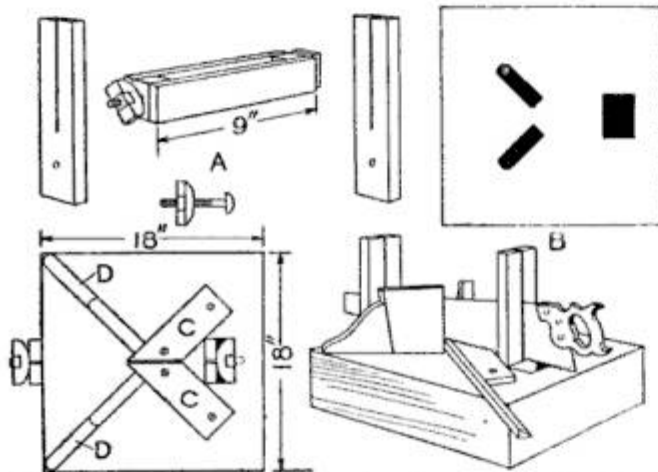

Homemade Miter Box for Sawing Frame Molding and to Hold the Parts for Fastening Together

so that the molding may be properly held while sawing it, and also for nailing the corners together. I made a miter box, as shown, and found it to be just the thing for this purpose. It is built on a base similar to an overturned box, the saw guides being held on the ends of a piece, constructed as shown at A. Holes are cut in the top, as shown at B, for one of the guides and for the two wedges. Two pieces, C, are fastened with their outer edges at perfectly right angles on the top.

The frame parts are clamped against the pieces on top with the wedges driven in between the frame parts and the brackets DD. After cutting the frame parts they are tightly held in place while fastening them, in any manner desired.—Contributed by A. S. Thomas, Amherstburg, Can.

### Tank-Development Methods Used in Tray Development

If there are a number of plates to be developed, place a rubber band, about  $\frac{1}{8}$  in. wide, around the ends of each plate and put them together in a tray. The bands keep the plates apart. The developer is made up as for a tank and poured over the plates, then another tray, or dark covering, is placed over the top. Allow this to stand, rocking the tray from time to time, the same length of time as is required for tank development.—Contributed by Earl R. Hastings, Corinth, Vermont.

### A Pushmobile Racer for Ice

The pushmobile shown in the illustration takes the place of the one with rollers that is now so popular with the boys. The materials required, usually found about any home, consist of a foot board, 1 in. thick,  $2\frac{1}{2}$  in. wide and 2 ft. long; two pieces of wood, each  $\frac{3}{4}$  in. thick,  $2\frac{1}{2}$  in. wide and 9 in. long; one steering post, 1 in. thick,  $1\frac{1}{2}$  in. wide and 30 in. long; one handle, 6 in. long; one small hinge; one carriage bolt,  $\frac{1}{2}$  in. in diameter and  $2\frac{1}{2}$  in. long; two  $\frac{1}{2}$ -in. washers; a few screws, and a pair of discarded ice skates.

One of the  $\frac{3}{4}$ -in. thick pieces is fastened solidly to one end of the foot board with the ends flush. The other piece is swiveled with the bolt at the opposite or front end of the foot board so that at least one-half of the piece projects beyond the end. The steering post is hinged to the projecting end. The skates are fastened to the

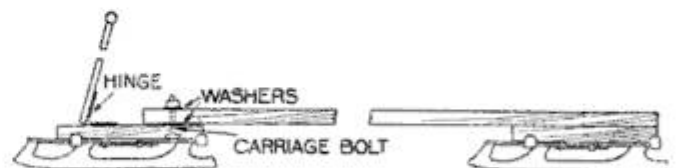

Homemade Pushmobile, Constructed the Same as the Wheeled Kind, with Runners for Snow and Ice

$\frac{3}{4}$ -in. pieces for runners. The manner of propelling the racer is the same as for the pushmobile.—Contributed by W. E. Crane, Cleveland, O.

## A D'Arsonval Galvanometer

A galvanometer in which the moving part of the instrument is a permanent magnet controlled by the action of the earth's magnetic field and the magnetic effect of a current in a coil of wire, that usually surrounds the magnet, has the great disadvantage of having its indications changed, although the current itself may remain constant, due to a change in the strength of the magnetic field in which the instrument operates. The operation of instruments of the above type is satisfactory only in localities where there is a practically constant magnetic field for them to operate in, which it is almost impossible to have, due to the presence of permanent and electric magnets and magnetic materials such as iron and steel.

An instrument constructed as follows will not have the above disadvantage and its operation will be a great deal more satisfactory, as its indications will be practically independent of outside disturbances. In this instrument, the moving part is the coil carrying the current, and it moves in a permanent magnetic field so strong that other disturbing magnetic effects can be neglected. The coil is hung by means of a fine wire and the twist in this wire is the only force acting to bring the coil back to its zero position, after it has been deflected, and maintain it there.

The construction of the magnet and containing case for the instrument will be taken up first. Obtain a piece of Norway iron,  $\frac{1}{2}$  in. square and about 9 in. long. Bend this piece into the form shown in Fig. 1, and file off the inner edges until they are parallel and about  $\frac{7}{8}$  in. apart. Drill four  $\frac{1}{8}$ -in. holes in the ends of this piece, two in each end, as indicated. This piece of iron is first tempered and then magnetized by placing it in contact with a powerful electromagnet. Cut a second piece from some soft iron with dimensions corresponding to those given in Fig. 2. Drill two  $\frac{1}{8}$ -in. holes,

A and B, in this piece as shown in the sketch. This second piece is mounted between the poles of the magnet, as

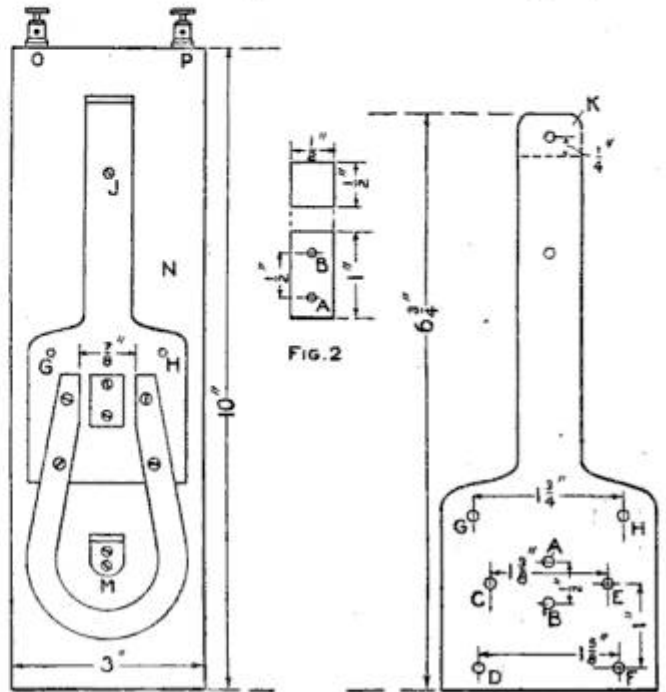
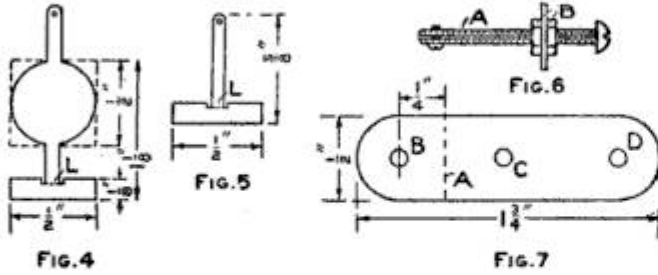

FIG. 1  
FIG. 2  
FIG. 3  
The Permanent Magnet and Its Brass Support, and Their Position on the Base

follows: Cut from some  $\frac{1}{2}$ -in. sheet brass a piece similar to the one shown in Fig. 3. Drill the holes indicated and thread those designated by A, B, C, D, E, and F to take a  $\frac{1}{8}$ -in. machine screw. Bend the upper end of the piece over at the point indicated by the dotted line until it is perpendicular to the lower part. The center of the hole in the projecting part K, when it is bent over, should be about  $\frac{1}{4}$  in. from the outer surface of the main part of the piece. The small piece of iron is then fastened to the piece of brass with two round-headed screws that pass through the two holes in it and into the holes A and B in the brass piece. The magnet is mounted, also with small brass screws, so that the main part of the magnet and the piece of brass extend in opposite directions, as shown in Fig. 1. The assembled parts are then mounted on a wooden board, whose dimensions are given in Fig. 1, with three brass screws that pass through the holes G, H, and J, as shown.

The moving coil of the galvanometer is constructed as follows: Cut from some  $\frac{1}{8}$ -in. pine a piece  $1\frac{1}{8}$  in. long and  $\frac{5}{8}$  in. wide. Cut two other



Upper and Lower Connections to the Coil and Supports, and the Supports for Suspension

pieces whose dimensions, except their thickness, are  $\frac{1}{4}$  in. larger than the first piece. Then fasten these two pieces to the sides of the first, with three or four small screws through each of them, thus forming a small spool. Saw about 16 slots with a very fine saw in the edges of the projecting pieces and a short way into the edge of the center piece. Wind on this spool about 300 turns of No. 38 gauge silk-covered copper wire. Start with the terminal of the wire in the center of one end of the spool, with a few inches of free wire for making connections, and end up with the terminal in the center of the opposite end of the spool. A small thread is then passed through the slots under the coil and tied, thus serving to hold the various turns of wire together when the coil is removed from the form. The coil should be given a coat of shellac as soon as it is removed from the form.

Two pieces must now be attached to the top and bottom of the coil to be used in making electrical connections and suspending the coil. Cut from some very thin sheet brass two pieces whose dimensions correspond to those given in Figs. 4 and 5. Drill a small hole in the center of each of these pieces. Bend the lower part of each piece over at the dotted lines L until it is perpendicular to the main portion of the piece. The bent-over portions of these two pieces are then fastened to the ends of the coil with some fine thread, making sure that they are in the center of the ends before they

are fastened. The terminals of the coil are now soldered to these pieces. It would be best to place a sheet or two of thin paper between the brass pieces and the coil, to prevent any part of the coil, except the ends, from coming into contact with the brass pieces. Obtain a small piece of thin mirror and mount it with some glue, as shown by the dotted lines in Fig. 4.

The upper support for the suspension is shown in Fig. 6 and consists of a  $\frac{1}{8}$ -in. threaded screw, A, that passes through the hole in the part K, Fig 3, and is provided with two lock nuts, B. The lower end of this screw should be slotted a short distance, and a small screw put through it, perpendicular to the slot, so that a wire can be easily clamped in the slot by turning up the screw. Next, take a piece of  $\frac{3}{2}$ -in. brass, as shown in Fig. 7, and bend it at the dotted line A until it forms a right angle. The hole B should be threaded to take a  $\frac{1}{8}$ -in. screw. The holes C and D are for mounting the piece on the back of the instrument. Slot the end of a  $\frac{1}{8}$ -in. screw, about  $\frac{1}{2}$  in. long, and put a screw through the end as for the upper support for the suspension. This piece is mounted below the position the coil is to occupy, as shown by M, Fig. 1.

A case should be made for the galvanometer whose inside dimensions correspond to those of the piece N, Fig. 1, and whose depth is about  $\frac{3}{4}$  in. more than the thickness of that piece. Four pieces of wood can be fastened

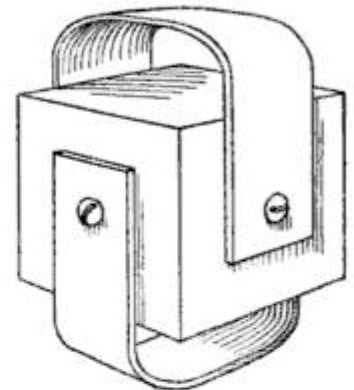

FIG. 8

in the corners that will allow the case to slip just far enough on the piece N to make the edge of the case and the back surface of the piece N flush. Cut an opening in the front of this case, about 2 in. long and 1 in. wide, in such a place that the center of the opening



is about level with the ends of the magnet. Fasten, back of this opening, a piece of thin glass with four small screws whose heads rest upon the edge of the glass. The interior of this case and all the parts should be given a coat of lampblack mixed with a little vinegar. Two small binding posts, O and P, are mounted on the upper end of the piece N and connected to the upper and lower supports for the suspension of the coil.

This galvanometer will work best, of course, when it is in an exactly vertical position and the following simple device, when attached to it, will allow it to assume this position independent of the level of the surface its base may rest upon. Cut from some  $\frac{1}{8}$ -in. brass two pieces,  $\frac{1}{2}$  in. wide and  $2\frac{1}{2}$  in. long. Drill a  $\frac{1}{8}$ -in. hole in the center of each end of them,  $\frac{1}{4}$  in. from the end, and a  $\frac{1}{4}$ -in. hole through the center of each. Bend these pieces to a  $\frac{3}{4}$ -in. radius. Cut from some  $\frac{1}{2}$ -in. hard wood a block,  $1\frac{1}{4}$  in. square. Fasten the two pieces of brass to the wooden block with  $\frac{1}{8}$ -in. screws, as shown in Fig. 8. One of these pieces is fastened to the upper end of the piece N, Fig. 1, so that the galvanometer will hang vertically. The other piece is fastened to a bracket from which the galvanometer is suspended. A suitable bracket for this purpose can be easily made. When the galvanometer is hung in this

way, two binding posts are mounted on the bracket, and connected to the two on the galvanometer. In this way the galvanometer will not be disturbed when making connections.

The suspension is made as follows: Take a piece of small copper wire and roll it out flat. Solder one end of a piece of this wire in the hole in the piece of brass, with the mirror mounted on it. Fasten a piece of the same wire to the lower brass piece, attached to the coil. The upper piece of wire is then clamped in the end of the screw A, Fig. 6, so that the coil hangs perfectly free about the iron core. The lower piece of wire is bent around a small rod several times and its end fastened in the slot in the lower screw.

The deflection of the instrument is read by causing a beam of light from a lamp or candle to be reflected from the mirror to a scale located in front of the instrument. If the light from the lamp is allowed to shine through a small slit in a piece of dark paper, there will be a streak of light reflected upon the scale, instead of a spot.

To use this instrument in measuring larger currents than it will safely carry, connect it in parallel with another resistance which will carry the larger part of the total current. The galvanometer can be calibrated with this resistance, which is known as a shunt.

### How to Make Advertising Lantern Slides

Procure some old discarded photographic films and remove the gelatin coating by soaking them in hot water. When dry, write the desired words on the thin celluloid and place it between two pieces of glass, lantern-slide size, and bind them as in making a lantern slide.

With the use of a carbon paper a very nice slide can be made by writing the words on a typewriter, and it will serve the purpose of an expensive announcement slide.—Contributed by F. P. Dickover, Atkinson, Neb.

### Utilizing Old Brush Handles

The handle cut from an old dusting brush, fitted with the brass end of a shotgun shell, makes a first-class tool handle.



The handle is cut off at A and the wood cut down to fit tightly into the brass shell.—Contributed by James M. Kane, Doylestown, Pa.



ⓘ Tincture-of-iodine stains may be removed from clothing or the skin by using strong ammonia water.

### An Electrically Operated Camera Shutter

It is often quite desirable to operate the shutter of a camera from a distance, especially in photographing birds and

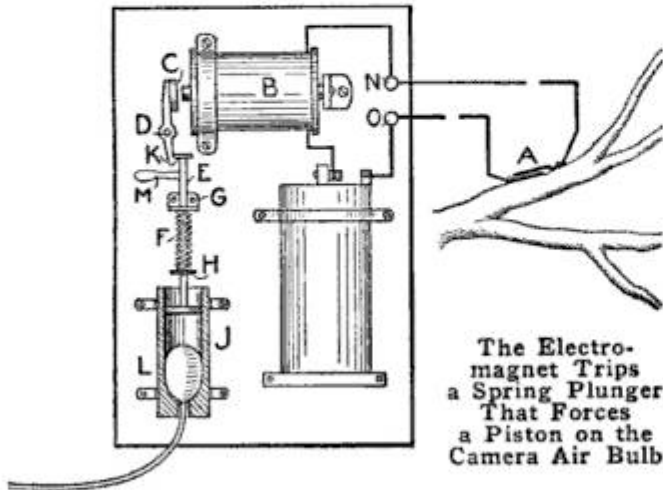

animals. The device shown in the accompanying sketch serves the above purpose very nicely, and its construction and operation are exceedingly simple. In brief, the operation is as follows: The switch A is mounted on the limb of a tree, in such a manner that it is not conspicuous, and connected in series with a magnet, B, and a battery by means of a piece of flexible conductor, such as lamp cord. The magnet B is energized when the switch is closed and attracts the iron armature C, which is mounted on an arm, pivoted at D. The lower end of this arm is in the form of a latch, which supports the rod E when it is raised to its upper position. The rod E when it is raised compresses the coiled spring F, which is held between the gauge G and the washer H mounted on the rod. A small coil spring holds the armature C away from the core of the magnet B. The lower end of the rod E is in the form of a piston operating in a wooden cylinder J. The rubber bulb at the end of the tube leading to the camera shutter is located in the lower end of the cylinder J. When the rod E is released by the latch K, it moves downward in the cylinder J, due to the action of the spring F, and compresses the bulb L, causing the shutter of the camera to be operated. A small handle,

M, may be mounted on the rod to be used in raising it to the upper position. The component parts of this device may be mounted on a small wooden base by means of brass straps, and the terminals of the electric circuit connected to the binding posts N and O, as shown. The switch A may be dispensed with and a push button used in its place, as the operator may station himself several hundred feet away. It may be necessary to use a battery of more than one cell in such cases.

### Electroplating without a Tank

Electroplating without a plating tank is made possible with the following easily homemade apparatus described in a German scientific magazine. It consists of a rubber ball, A, fitted at one end with a glass tube, B, which carries at the opposite end a small sponge. A rod, D, passes through the rubber ball, which is tightly corked at both ends, into the glass tube B and carries at that end the anode E. A small glass tube, F, also connects the rubber ball with the larger tube B. The connections from the battery to the cathode, G, the object to be plated, and to the projecting end of the anode-carrying rod, D, are made as shown. The rubber ball is filled with the electrolyte, and is squeezed so as to force the fluid

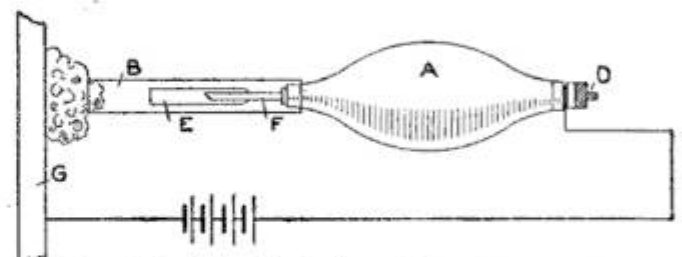

A Hand Tool for Applying a Plate Electrically to the Surface of Metal

through the small tube F, into the larger tube, B, filling it and soaking the sponge C. The current is then turned on, and by moving the wet sponge over the cathode G, the latter will be plated. Not only is this an interesting accessory for the amateur's laboratory, but it can be used in the

industry where only parts of some object are to be plated, and where it is desired to remedy bad spots without putting the articles back into the bath.

### A Milk-Bottle Tray

Bottled milk is difficult to deliver without knocking the bottles together when carrying them or while in a wagon. There are several kinds of wire baskets for carrying the bottles, but they all have the disadvantage of allowing the bottles to strike one another. A carrier not having this fault can be made very cheaply as follows: Procure a board 1 in. thick, 8 in. wide and 2 ft. long, plane and make it smooth, and use ordinary tin fruit or

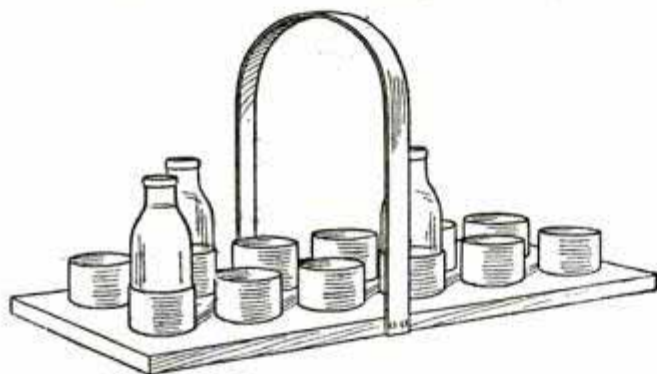

Parts of Tin Cans Fastened to a Board for Holding Milk Bottles

vegetable cans for the bottle holders. Cut each can off  $2\frac{1}{2}$  in. from the bottom and smooth off the jagged edges with a file. Nail these in two rows on the board, starting 1 in. from each end. Attach a segment of a barrel hoop for a handle. The carrier can be painted as desired.—Contributed by G. H. Clemmons, Storm Lake, Iowa.

### A Springboard

Select straight-grained hickory or ash for the springboards. These can be of any width to make up the board to 18 in. wide. The frame part may be of any material of the dimensions given in the sketch. The butt ends of the springboard should be well fastened to the crosspiece with screws, or, better still, small carriage bolts with the nuts on the under side.

The crosspiece at the rear is cut on the angle of the springboard. The

front crosspiece is mortised into the frame, and the one near the center is laid on top of the two side rails.

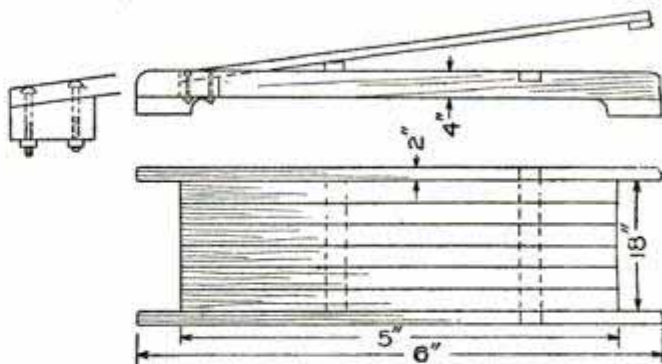

A Springboard for Use in Connection with a Vaulting Pole or for Turning Acts

The rear crosspiece is either fastened with large dowels or mortised into the sidepieces. This springboard will be of use in connection with a back-yard gymnasium for vaulting and doing turning acts.

### Planing Rough-Grain Boards

The surface of a board having a grain that runs both ways is very hard to smooth with a plane. By sharpening the plane iron to a keen edge, then placing it in the plane with the cap reversed and set about  $\frac{3}{8}$  in. from the cutting edge, I find that with a light cut the plane will smooth regardless of the direction of the grain.—Contributed by William Rollins, Wichita, Kansas.

### Braces for Aeroplane Frames

In making model aeroplanes or gliders the brace shown will serve the purpose admirably. The size and strength of the metal used will depend on where it is to be used. The metal is bent

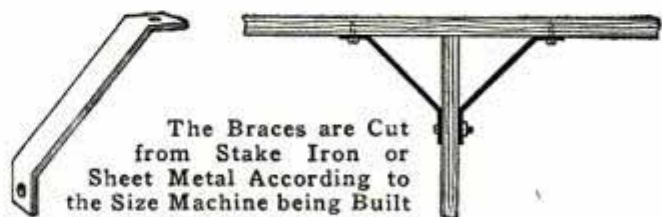

into the shape shown with the use of a vise. The manner of attaching the braces is clearly shown.—Contributed by Francis Chetlain, Chicago.

### Homemade Wing Nuts

A handle taken from a worn-out faucet, drilled out and threaded for a bolt, makes a good wing nut. A dis-

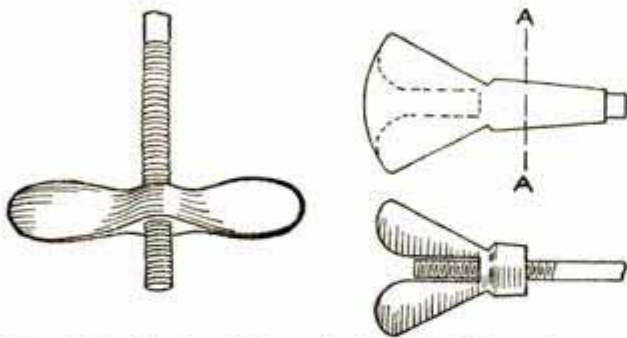

Wing Nuts Made of Discarded Parts Taken from a Faucet or a Gas Bracket

carded gas-bracket key, cut off on the line AA and with the part within the dotted lines filed out, then drilled and threaded, also makes a good wing nut.

### A Spool-and-Ball Puzzle

Procure an empty basting-thread spool and make a hole in its side, at A, just large enough to receive a  $\frac{1}{4}$ -in. steel ball. A piece of celluloid, B, is wrapped around the flanges, as shown, and fastened with small brads. An old

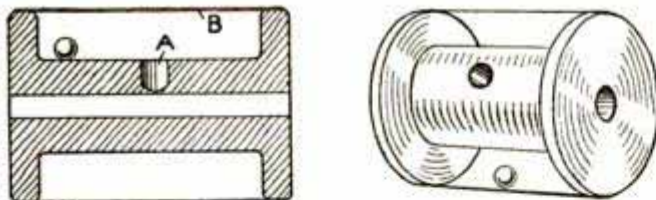

The Steel Ball is Not So Easily Run Into the Hole as It Appears

negative film, well cleaned, is suitable for the celluloid. Be sure to put the steel ball in before fastening the celluloid in place.

The difficulty of the puzzle is to get the ball into the hole.—Contributed by R. C. Knox, Waycross, Ga.

### To Start the Ink Flowing from a Drawing Pen

In order to keep the ink flowing readily from a drawing pen it must be kept clean and not allowed to stand with the ink in the nibs. A good plan is to have a small piece of velvet fastened to the drawing board or upon

a small block, conveniently located where the pen may be drawn across it as in making a line. The tuft of the velvet will clean out the partly dried ink between the nibs.—Contributed by H. L. Woodward, Washington, D. C.

### A Pencil-Sharpener Stick

Do not discard the sandpaper stick or pencil sharpener used by a draftsman just because all the abrasive sheets have been removed. Make use of it indefinitely by fitting a wedge in one edge, as shown in the illustration, to hold fresh sheets of sand or emery

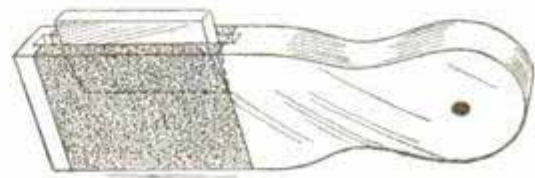

A Wedge Attachment for a Pencil-Sharpener Stick for Changing the Sheets of Abrasive

paper. The wedge should fit tightly so that the ends of the abrasive sheet, when wound around the block, will be held tightly. Worn sheets can thus be removed and new ones applied when necessary.—Contributed by Chas. J. La Prelle, Flushing, L. I.

### Splice for Round Belts

Sash cords or round belts are easily spliced with a coil spring, and for belts this joint will run smooth and noiseless. The coil should be a close fit on the belt, and after turning one end half-way into the spring, the belt itself is twisted in the reverse direction as many times as there are coils remain-



A Coil Spring Used for Splicing Sash Cords or Small Round Belts

ing in the spring, before the other end is turned into it to meet the first.—Contributed by F. S. Cummings, Detroit, Michigan.

ⒸWhen painting wireless instruments use black asphaltum, as it has high insulating qualities.

# Homemade Ellipsograph

By CHELSEA CURTIS FRASER

An efficient ellipsograph is the only device that will make true ellipses of various sizes quickly, and such a machine is in demand on some classes of work in a drafting room. Its cost, however, is prohibitive where only few ellipses are to be drawn, but a person handy with tools can make an apparatus that will do the work as well as the most expensive instrument.

The completed ellipsograph, herein described, will appear as shown in Fig. 1. It consists of two main parts, the base and the arm. The former is a hardwood piece, A, Fig. 2, to the side center of which is attached another hardwood piece, B. This latter piece may be dovetailed into A, but an ordinary butt joint will suffice, as a one-piece base, C, also of hard wood, is glued to the bottom surfaces of the pieces A and B, thus securely holding them together. Before gluing, however, care must be taken to see that the piece B is exactly at right angles with the piece A. This can be done with

swivel head. Sheet brass plates, D and E, are cut from  $\frac{1}{16}$ -in. stock and attached to the top of the piece A with screws. The plates F and G are of the same material and fastened in a like manner to the upper surface of the piece B. All plates project slightly where they touch the groove borders, as shown. This is to provide a bearing for the projections on the sliding parts against metal instead of wood. A piece of thin celluloid or brass plate, K, is inserted in the bottom side of the base C so that the point will be exactly in line with the center groove J, and extend outward  $\frac{1}{8}$  in. This point indicates the center of all ellipses to be drawn. In the bottom of the base C, at each end, drive an ordinary pin and cut it off so that a part of it will project beyond the surface of the wood. These extending ends are pointed with a file, and serve to keep the instrument from slipping when in use.

The arm L is shown in Fig. 3. It is made of either maple or birch. Follow

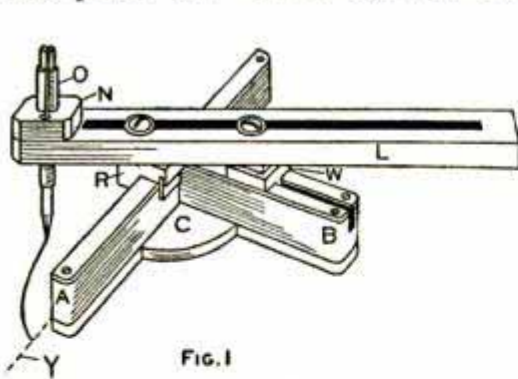

Fig. 1

Practically Any Size or Proportion of Ellipse, from  $1\frac{1}{2}$  to 16 In. Maximum Diameter, can be Drawn with an Instrument of This Size, and Larger Instruments will Work Equally Well

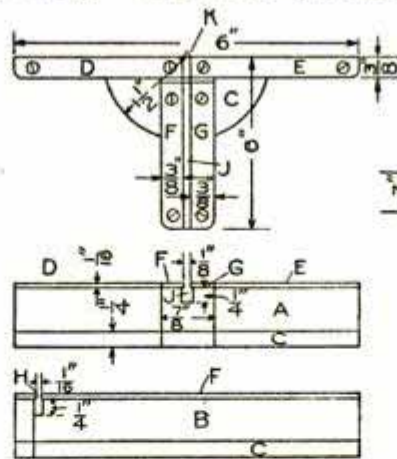

Fig. 2

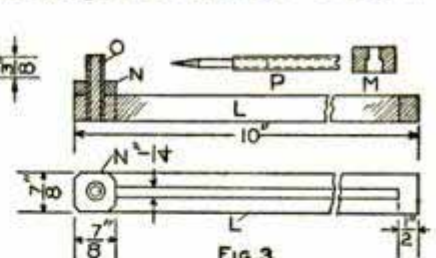

Fig. 3

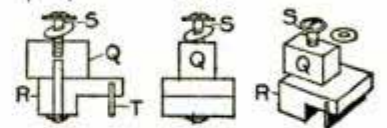

Fig. 4

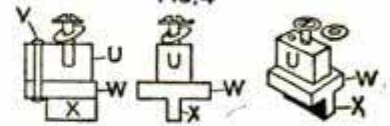

Fig. 5

a try-square. Dimensions are given in Fig 2. The same letters are used throughout for the same parts.

A  $\frac{1}{16}$ -in. groove, H, is cut out at the juncture of A and B, to admit the flange of the minor-axis swivel head. Another groove, J, is made along the longitudinal center of the piece B, to receive the spine of the major-axis

the dimensions given, cutting a slot through it longitudinally, as shown at M, narrower on the upper side than on the lower, the upper being  $\frac{1}{4}$  in. wide. An octagon-shaped piece of wood, N,  $\frac{1}{2}$  in. thick, is glued to the end, to give a good seating for the sleeve O, which is a piece of  $\frac{1}{2}$ -in. solid-brass rod, 2 in. long, drilled to receive closely the

pencil sheath. The latter, P, can be made from a section of brass tubing such as is used in a bicycle-pump valve. The upper end is notched to receive a rubber band, and an ordinary pencil can be cut down to fit closely into the other end. The piece O fits tightly in a hole bored through N and L.

The detail of the minor-axis swivel head is shown in Fig. 4. This swivel head consists of two pieces of brass, one, marked Q, being  $\frac{3}{8}$  in. square by  $\frac{3}{4}$  in. long and the other, R,  $\frac{7}{8}$  in. square by  $\frac{1}{2}$  in. long, with a notch cut out as shown. These parts, as well as the somewhat similar ones for the major-axis swivel head, can be cast cheaply, or block brass may be cut with a hacksaw and filed to the right shape. A shortened dry-cell screw, S, with washer, to fit a tapped hole drilled in the piece Q, serves to bind the head where desired on the arm. The flange T is a piece of  $\frac{1}{16}$ -in. brass driven into a slot cut in the piece R. The piece R is pivoted to the piece Q, as shown, by means of a piece of wire nail which engages Q, by friction, the lower end being fitted with a washer and riveted loosely so that the parts will turn freely.

The major-axis swivel-head detail is shown in Fig. 5. The piece U is the same size as Q, Fig. 4, with its screw set a little farther forward to make room for the pivot V, which loosely joins U and W together. The pivot is made of a wire nail, riveted on both

ends. The piece W is of brass,  $\frac{1}{2}$  in. thick,  $\frac{3}{4}$  in. wide and  $\frac{7}{8}$  in. long. The spine X is made just thick enough to pass freely in the groove J, Fig. 2. A screw taken from a discarded dry-battery cell is used to bind the head to the arm.

To operate the ellipsograph, draw a line, Y, Fig. 1, on the paper, which is to mark the major axis of the ellipse. About midway of its length make a point to represent the center. On the latter set the point K, Fig. 2, and adjust the bottom forward edge of the base C parallel with the line Y. Set the minor-axis swivel head at such a point on the arm L that, when the latter is directly on top of the piece B, the pencil will touch the paper at a distance from the center, marked by K, equal to half the minor axis of the proposed ellipse. To secure the major axis swing the arm until it is parallel with the piece A, leaving the major-axis swivel head unset, and set it when the pencil point has been adjusted to the proper major radius.

Grasp the arm with the right hand between the swivel heads and bearing down, swing the pencil end from right to left. The rubber band will keep it constantly on the paper with even pressure. When half of the ellipse is completed detach the rubber band and reverse the instrument to the opposite side of the longitudinal line Y and draw the other half in the same manner.

### Protector Cap for a Chisel Handle

The ordinary chisel handle will soon split and break under the continuous blows of a mallet. A very good and inexpensive method of preventing this is to procure an ordinary patent bottle cap and place it on the end of the handle. It is advisable to shape the end of the handle like a bottle top in order to firmly hold the cap in place.—Contributed by Bert Verne, San Diego, Cal.



### Sweeping Compound

A good sweeping compound may be made as follows: Mix  $\frac{1}{2}$  pt. of warm paraffin oil with 2 oz. of melted paraffin wax and add 2 oz. of artificial oil of sassafras. Then pour the mixture into 10 lb. of sawdust and work the whole thoroughly together. Add to this mixture 4 lb. of clean sand and  $\frac{1}{2}$  lb. of coarse salt. Each article mentioned is comparatively cheap, and the compound can be kept in an open container.—Contributed by Loren Ward, Des Moines, Iowa.

### Rubber Bumper on a Water Faucet

Sometimes a dish is broken by striking it on the faucet. This is easily remedied by cutting a rubber washer from a rubber-boot heel with a sharp chisel and a hammer. The washer is pushed into place on the end of the faucet, and the dishes may strike the rubber without being broken.—Contributed by Harriette I. Lockwood, Philadelphia, Pa.

### Boring a Clean-Edged Hole

When boring a hole in wood, withdraw the bit as soon as the worm shows, then start the worm in the hole on the opposite side and finish boring the hole. It will then have clean edges on both sides of the wood. Often the bit pushes splinters of wood ahead of it, when passing through, but by using the method described this is avoided.

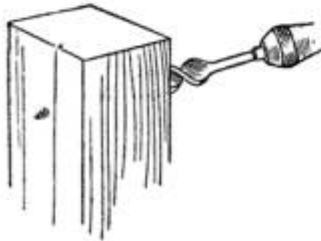

### Drilling Thin Metal

In drilling very thin stock the drill, if not properly ground, will tear the metal and leave a ragged edge. To cut a hole through neatly the drill should be ground as illustrated. The center A should extend about  $\frac{1}{8}$  in. beyond the points B. The point A locates the center and the sharp points B cut out the disk of metal. Holes have been neatly and quickly made with this drill grinding in metal measuring .002 in. thickness.—Contributed by Joseph J. Kolar, Maywood, Ill.

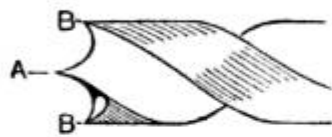

Ⓒ A pencil may be kept from falling out of the pocket by wrapping a couple of turns of tape around it or by wrapping it with a small rubber band.

### Flexible-Cord Adjuster for an Electrical Flatiron

When using an electrical flatiron the flexible cord frequently gets under the iron, causing much trouble for the user, and mussing up the clothing. The cord can be kept out of the way by fastening a pulley to the ironing board and attaching a coil spring to the electric cord between the pulley and the electric-fixture socket. A coil spring that will draw out about 3 ft. should be used.—Contributed by Herbert Blandford, Elmira, N. Y.

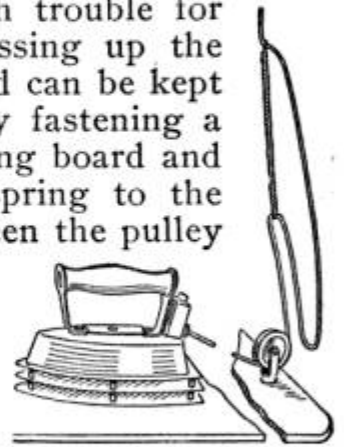

### A Wood Clothes Peg

If clothes that are slightly damp are hung on a nail or metal peg, a rust stain that is almost impossible to remove will be the result. To prevent this, drive a nail with the head removed into the wall or cleat, and place a wood peg over it. The peg may be turned up or whittled out with a pocket knife and the hole bored with a hand drill.—Contributed by Wm. A. Robinson, Waynesboro, Pa.

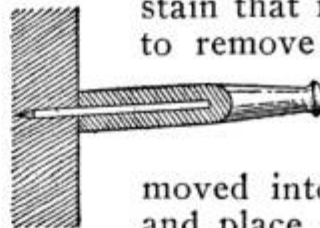

### To Make Scratch Pads of Old Labels

Labels and blank paper of uniform size, that would otherwise be cast aside, can be turned into handy scratch pads by placing them between blocks of wood, secured by a wood clamp, and applying paste on two edges, then pressing a strip of paper on the pasted portions. The edges to be pasted should project a trifle beyond the edges of the blocks.



## INTERESTING NEW PATENTS

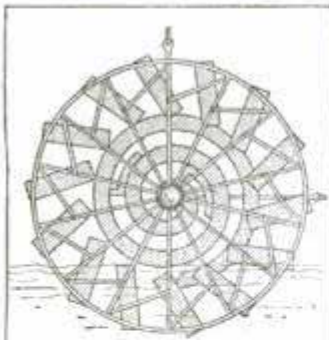

FIG. 1

**WHEEL FOR RAISING WATER FROM RUNNING STREAMS** (Fig. 1)—The wheel is rotated by the impact of the flowing water against the paddles, and at each revolution a quantity of water is scooped up by the open end of the spiral pipe. As the wheel continues to revolve, the water follows around the pipe until it is lifted to the center of the wheel, when it passes out through the hollow shaft. The wheel may be raised or lowered to suit the stage of water.

**SHOWER-BATH PAIL** (Fig. 2)—This device, designed to take the place of the usual shower-bath equipment, consists of a pail with a perforated bottom above which is a solid false bottom. A buoyant stopper is used to close the opening in the center of the false bottom, and this is released by pulling the lever, to which it is attached by a cord.



FIG 2

**SELF-PLACING TROLLEY** (Fig. 3)—It is the purpose of this invention to do away with the delay and inconvenience caused when the trolley wheel of an electric car jumps from the trolley wire. When the wheel jumps from the wire the latter falls to one side on the conical shaft. With the car in motion the wire works down against the wheel, is lifted by the cam, and falls back into the groove of the wheel.

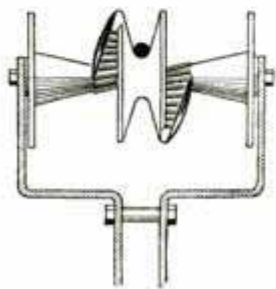

FIG. 3

**FOOT CLAMP AND BROOM HANGER FOR DUSTPAN** (Fig. 4)—This wire attachment serves as a support and foot clamp when the dustpan is in use, and is provided with a small loop by which it is hung to a nail or hook when not in use. The larger loop is of such size and shape as to hold a broom securely, as shown.



FIG 4

**OFFICE-HOUR INDICATOR** (Fig. 5)—This neat and easily operated device is designed for the convenience of lawyers, physicians, and others, who are compelled to be away from their offices intermittently. The indicator portion slides on horizontal guide wires and may be shifted to make the arrow point to any hour of the day. The indicator is then fixed in position by a setscrew.



FIG 5

**STOVE AND FURNACE LIGHTER** (Fig. 6)—This lighter has a wedge-shaped tip so that it is easily forced into the coal. Along the top is a deflecting bar which holds the coal away from rows of gas orifices and prevents it from smothering the flames. In using, the lighter is connected with a gas tip by a flexible tube, the gas is turned on and lighted, and the lighter is thrust into the coal and left until the coal fire is well started.



FIG 6

**CLOTHES RACK WITH PIVOTED HANGERS** (Fig. 7; American patent by a Canadian)—One of the best features of this clothes rack is that the parts may be folded up compactly against the wall when not in use. The frame, which is designed to be attached securely to the wall, has ends consisting of a series of ledges, or steps, as shown. Each hanger consists of a U-shaped rod with ends pivoted to the ends of the frame in such a way as to be supported in the down position by two opposite ledges.

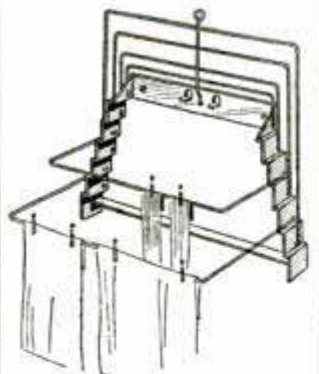

FIG 7

**COMBINED PLOW AND HARROW** (Fig. 8)—The harrow is carried on a shaft supported on the plow, and is provided with an adjustment for raising or lowering as desired. To avoid the danger of breakage, the shaft is left loose in its bearings and the harrow is held in vertical position by a spring connecting an extension of the shaft to one of the plow handles.

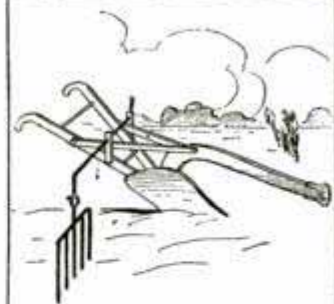

FIG 8

**ILLUMINATED NUMBER PLATE** (Fig. 9)—Figures are painted on glass plates which form the outer face of a hollow space. This space is illuminated by a light at one end, from which the rays are directed upon the plates through a circular flexible hood.

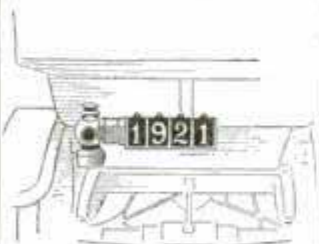

FIG. 9

**PAPER BOTTLE** (Fig. 10)—This bottle is formed by an ingenious cutting and scoring of a single sheet of paper. One set of score lines provides for the formation of the body of the bottle, while the tapered portion and the neck are formed by a combination of vertical and diagonal cuts and score lines.

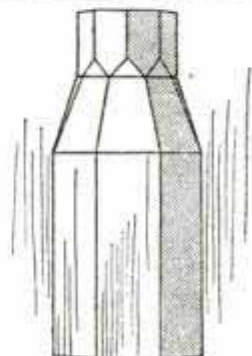

FIG.10



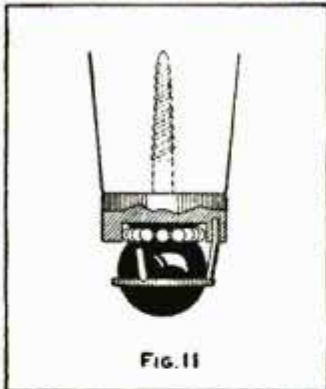

FIG. 11



FIG. 13

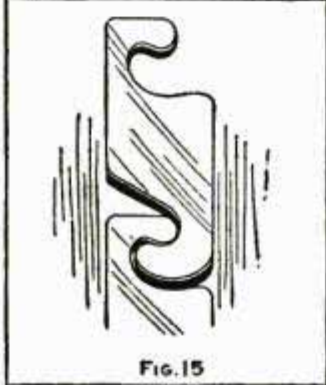

FIG. 15

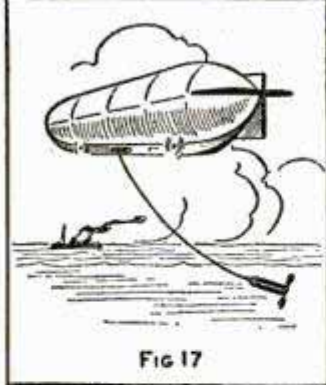

FIG. 17



FIG. 19

**FURNITURE CASTER WITH BALL BEARINGS** (Fig. 11)—The small anti-friction balls are held in correct position by the flange of the cup casting and the curve of the main ball, which by this arrangement is free to roll in any direction. A wire retainer, attached to the casting by arms, encircles the main ball below its center and prevents it from working out of position.

**TRACTION WHEEL THAT GRIPS GROUND SURFACE** (Fig. 12)—This novel wheel is designed particularly for working in loose ground where a plain rim would be subject to slip. The ends of a U-shaped piece of steel are pivoted to the rim at the end of each spoke. These pieces swing down and engage the ground surface, but lie flat against the rim when at the top of the wheel. Stops are provided for limiting the swing to the proper amount.

**SLED RUNNERS FOR GOCARTS** (Fig. 13)—The runner is in two sections with an adjustable connection between the wheels. The front portion is curved to fit around the forward part of the front wheel and is secured in place by a clamp. The rear wheel fits into a slot in the runner, as shown, an arrangement that permits the gocart to be turned readily on the rear wheels when tilted backward.

**INDICATOR FOR NOTIFYING TRADESMEN** (Fig. 14; British patent)—Small cylindrical tablets, pivoted to revolve horizontally in slots in the indicator board, carry on their rims such inscriptions as "Call," "Not Today," etc. These tablets are set daily to suit the needs of the housewife, the purpose of the device being to prevent unnecessary calls by tradesmen.

**SECTIONAL SASH WEIGHT** (Fig. 15)—The idea of this invention is the use of just enough of the sections to counterbalance the window exactly. The point of contact between two sections is a pivot that permits free swing in any direction. The hooklike form prevents displacement in one direction, while shoulders placed to engage each other prevent displacement crosswise of the sections.

**MOTOR VEHICLE USES PRINCIPLE OF TREADMILL** (Fig. 16)—In this vehicle a motor-driven truck runs on the inner flanges of the traction wheels, climbing the front of the traction wheel as it moves forward. This throws the center of gravity ahead of the support, with the result that the traction wheel moves forward. A seat for the operator is suspended above the truck.

**DEVICE FOR SECURING WATER BALLAST FOR AIRSHIPS** (Fig. 17)—This device consists simply of a flexible hose carrying an automatic pump on its lower end, which is let down into the water and towed by a cable. The pump is operated by the impact of the water as the airship moves forward, and water is forced by the pump through the hose into the ballast chamber of the airship.

**MACHINE FOR CLEANING BOTTLES AND JARS** (Fig. 18)—Water is forced into the vessel through a water pipe which terminates in a nozzle. A hollow shaft, which forms a sleeve over the water pipe, carries a collapsible frame, to the outer portions of which are attached brushes for cleaning the vessel as the shaft and frame revolve. The frame is opened or collapsed by levers that extend through the neck of the vessel.

**SLED WITH FOOT SUPPORTS** (Fig. 19)—The foot supports are mounted on a bar that runs transversely across the front end of the sled, and are placed in convenient position for use in coasting. The supporting surface is shaped to conform to the heel and sole of the shoe.

**NOVEL FORM OF LIFEBOAT** (Fig. 20)—This lifeboat is intended to be safe in any sea against danger of swamping. The main body of this boat is open at the top, the opening being protected from the ingress of water by the hood, as shown. Entrance is made through this opening, which is reached by ladders.

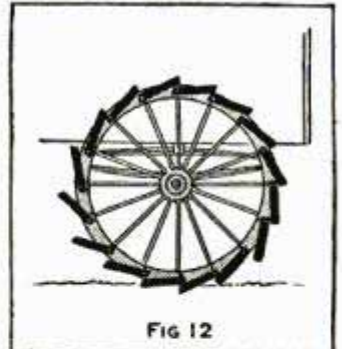

FIG. 12

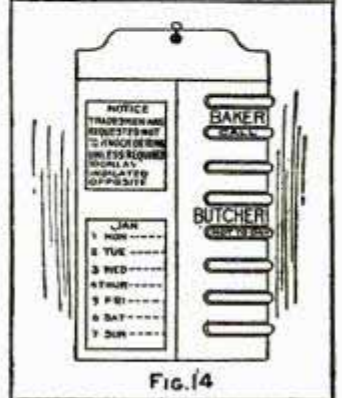

FIG. 14

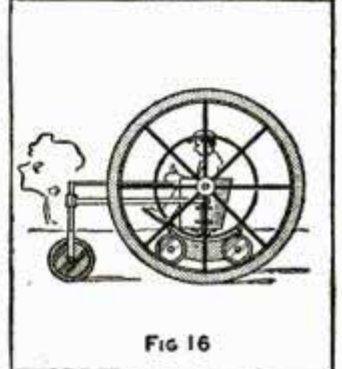

FIG. 16

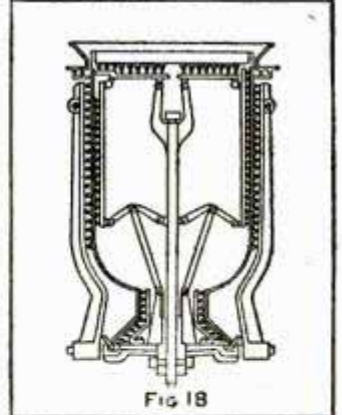

FIG. 18

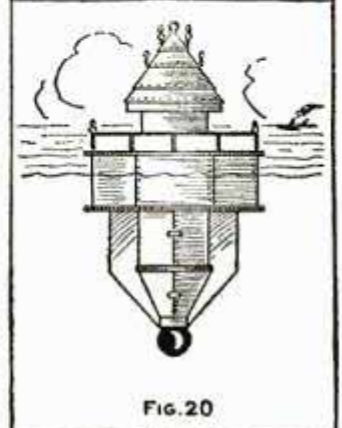
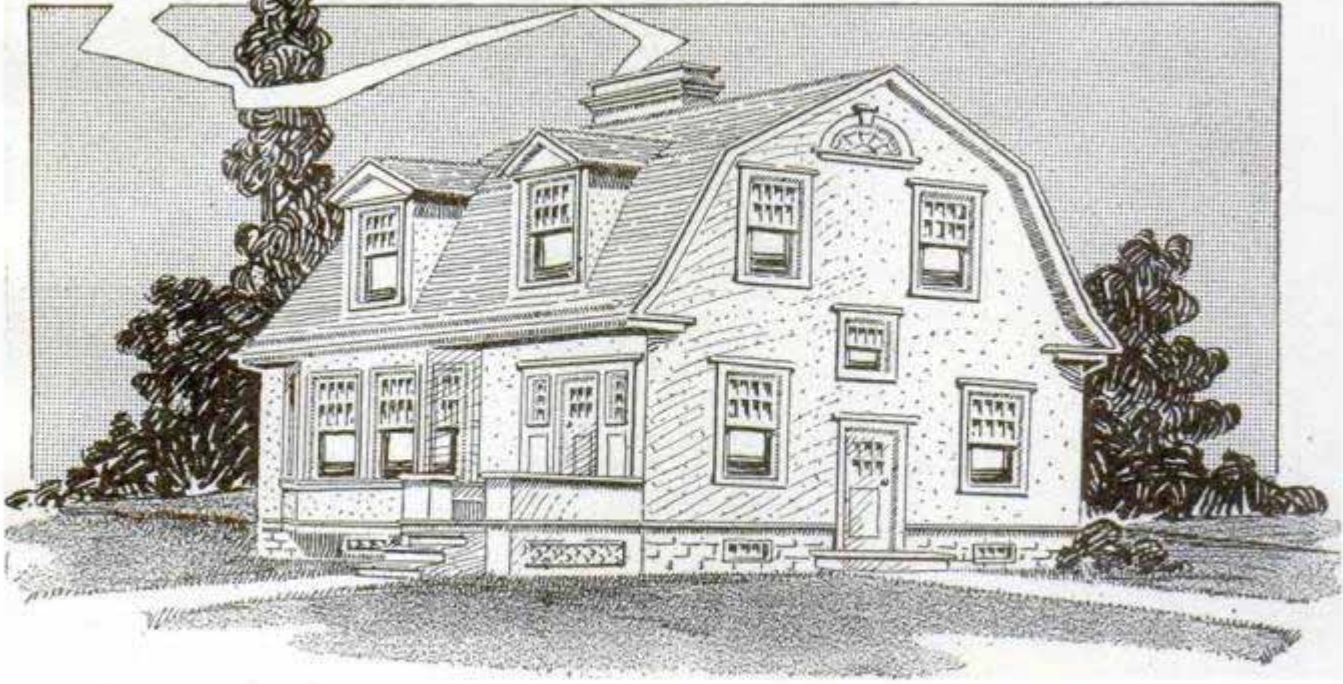

FIG. 20

## A CONVENIENTLY ARRANGED SIX-ROOM COTTAGE



Temple &amp; Burrows, Architects, Davenport, Iowa

View Showing Front and One Side of Six-Room Cottage

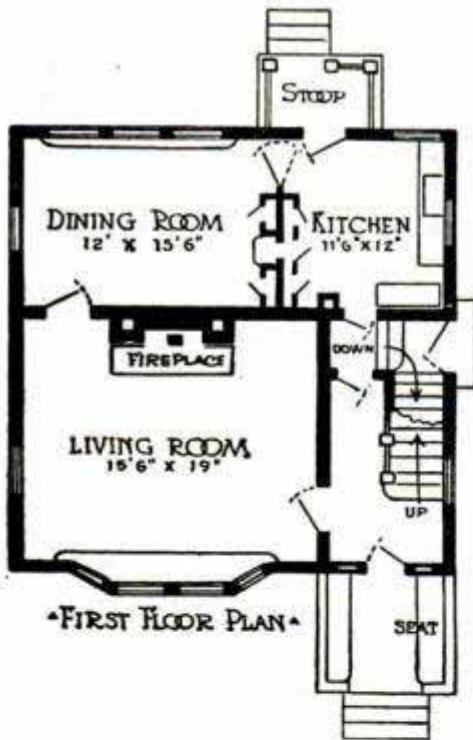

This compact and well-planned six-room cottage is an example of the result that may be secured at moderate cost in building a house suited to the typical suburban or country-town lot. The arrangement is convenient throughout and all the space in the building appears to be utilized to excellent advantage. The hallway on the first floor leads directly to the rear of

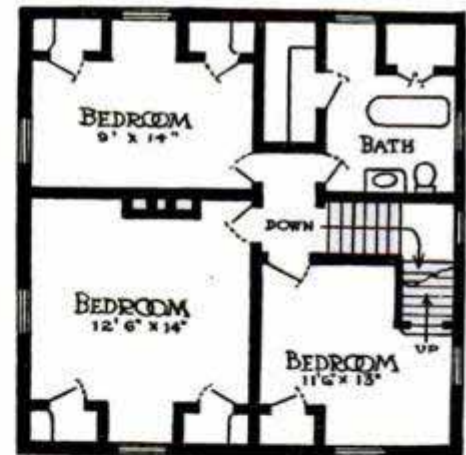

the house, and from this hallway, in which the stairway to the second floor is also located, there is direct access to the living room, and through this to the dining room. On

the second floor the space required for a large hallway is saved by having the doorways open on the stairway landing. All rooms, including the hallway on the first floor, are well lighted.

This cottage is of frame construction with an exterior of cement plaster laid on metal lath. The basement, which occupies all the space under the building, has concrete floor and walls, the latter extending up to the level of the first floor. The exterior woodwork of the doors, windows and cornices, as well as the shingles of the roof, is brown, a color that produces a pleasing contrast with the gray surfaces of the concrete walls. The gambrel roof with its dormer windows adds much to the general effect of the exterior while increasing the space in the bedrooms of the second floor. Stained yellow pine is used throughout for interior finish, while both stories have floors of yellow pine. One of the decorative features of the living room is the mantel, built of red paving brick with oak shelf. The building is heated by a hot-air furnace, is fully provided with plumbing, and is wired for electric lighting. The cost of this building fully equipped was \$4,100.



# Melba and Kubelik

The present joint tour of Melba and Kubelik is acclaimed one of the greatest musical sensations of recent years—and it is a truly noteworthy event.

But to hear these two famous artists is an *everyday* pleasure where there is a Victor or Victrola in the home.

Melba and Kubelik are among the world's greatest singers and musicians who make records exclusively for the Victor.

Any Victor dealer in any city in the world will gladly play any Melba or Kubelik records you wish to hear. No more beautiful rendition of Gounod's "Ave Maria" can be imagined than Victor Record 89073, sung by Melba with violin obligato by Kubelik.

Victors \$10 to \$100. Victrolas \$15 to \$200.

**Victor Talking Machine Co., Camden, N. J., U. S. A.**

Berliner Gramophone Co., Montreal, Canadian Distributors



make records  
only for the **Victor**

New Victor Records demonstrated at all dealers on the 28th of each month

Quality  
Is  
Economy

*Manufacturers Save  
Money by using  
Murphy Varnishes.*

Why? Because Murphy Varnishes are cheap by the gallon? No, indeed: it is the cheap-by-the-gallon varnishes on which Manufacturers *lose* money.

Murphy Varnishes are money savers because they save gallons and save labor and save time.

They have no dregs, no waste; every drop can be used. Fewer gallons do the job.

They work easy and smooth under the brush. They require fewer brush strokes, with less effort on each stroke. They enable the Finisher to increase his daily output.

They are uniform. Each varnish is always the same: always gives the same result with the same treatment—saves all the time that is wasted in pottering with variable varnish.

**The Varnish  
That Lasts  
Longest**

**Murphy Varnish Company**

FRANKLIN MURPHY, President

Associated with Dougall Varnish Company, Ltd., Montreal, Canada

NEWARK,  
N. J.  
CHICAGO,  
ILL.

# First of all—

you buy a jimmy pipe. Get one that chums-up with your spirit right off the bat, natural like. Then lay a dime against a tidy red tin of Prince Albert tobacco that's all pleasing and fragrant and fresh. A match!—and you're off!

P. A. can't burn your tongue—can't parch your throat! Just mellow and cheerful. Why, men, to open up the A. M. with some P. A. is like getting money from home in the first mail—just punches a smile right into your system!

*Get under this:*—Prince Albert is made by an exclusive patented process that cuts out bite and parch. P. A. has made it possible for thousands of men to smoke a pipe who never could endure the tongue-sting brands. *And realize:* No other tobacco can be made like



# PRINCE ALBERT

Copyright 1914  
R. J. Reynolds Tob. Co.

*the national joy smoke*

You can buy Prince Albert down in the village, on Broadway, anywhere, everywhere — afloat or ashore! In toppy red bags, 5c; tidy red tins, 10c; also in handsome pound and half-pound humidors. You get it fresh and fragrant—the real P. A. flavor—wherever you drop in, because Prince Albert is the national pipe smoke and cigarette makin's brand.

R. J. REYNOLDS TOBACCO CO., Winston-Salem, N. C.

*Please Mention Popular Mechanics*

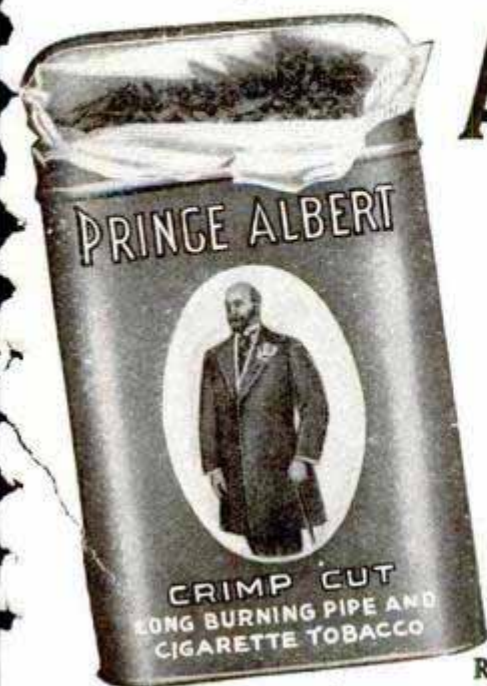

"P. A. makes a fellow feel so fine and dandy," says Pap, "that I don't care what the weather is so long as there is P. A. in the near vicinity."  
"Smoke P. A. red hot as if old jimmy was an engine and she can't touch your tongue. Go to it like sixty and she is there good and true, like a high top thoroughbred."

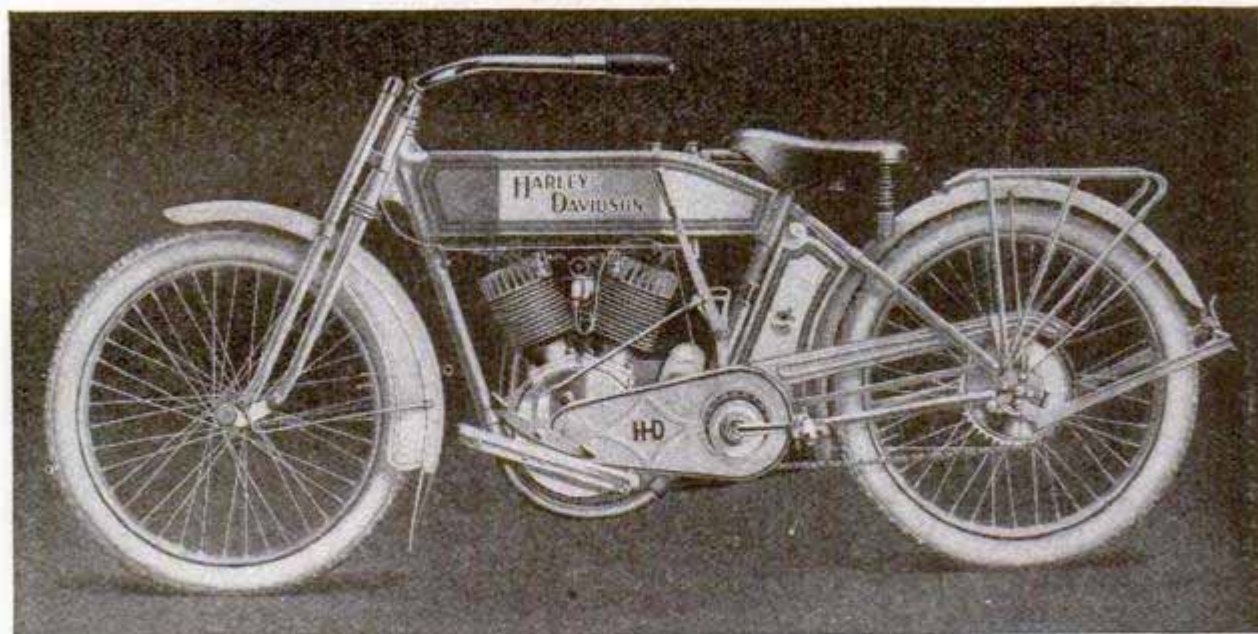

# The 1914 Harley-Davidson

*has every desirable feature to be found in the Motorcycle Field and in addition it is the only Motorcycle with Step-Starter—Double Clutch Control—Ful-Floteing Seat and Free Wheel Control.*

## **The only Motorcycle with a Step-Starter**

The Step-Starter in case of an accidental stalling of the motor, does away with the necessity of getting off in the mud or holding up traffic while the rider finds a level place on which to lift or lurch the machine onto the stand in order that he may pedal the motor to start it. Instead, the rider sits in the saddle and gives either pedal a downward push—when the Step-Starter does its work and the motor again begins to throb.

## **It is the only Motorcycle with Double Clutch Control**

The clutch can be operated either by hand lever or by a pedal lever convenient to the foot. It is no longer necessary to remove either hand from the handlebars in order to operate the clutch, a decided advantage when negotiating sand, mud or rough roads.

## **It is the only Motorcycle with a Ful-Floteing Seat**

A device which assimilates all the jars, jolts, and vibration due to rough roads, etc.

*We tell you all about these many improvements in our new advance folder which will be sent on request*

**HARLEY-DAVIDSON MOTOR CO., 366 B Street, Milwaukee, Wis.**

Producers of High-Grade Motorcycles for More Than Twelve Years

## **It is the Motorcycle with a Protected, Selective Two-Speed**

A Two-Speed that the rider can shift from low to high or high to low or neutral at any time whether the machine is standing still or in motion. A Two-Speed that shifts only when the rider shifts it. A Two-Speed that is located in the rear hub away from dirt, dust or damage and withal the most efficient Two-Speed ever manufactured.

## **It is the Motorcycle with Automobile Control**

The Brake, the Clutch and the Step-Starter can all be operated by the feet, leaving only the spark and throttle for hand operation making the control the same as that of the highest priced automobile.

Then there is the *Free-Wheel Control*, Folding Foot Boards, and nearly forty other refinements which help to make the Harley-Davidson the greatest motorcycle value ever offered.

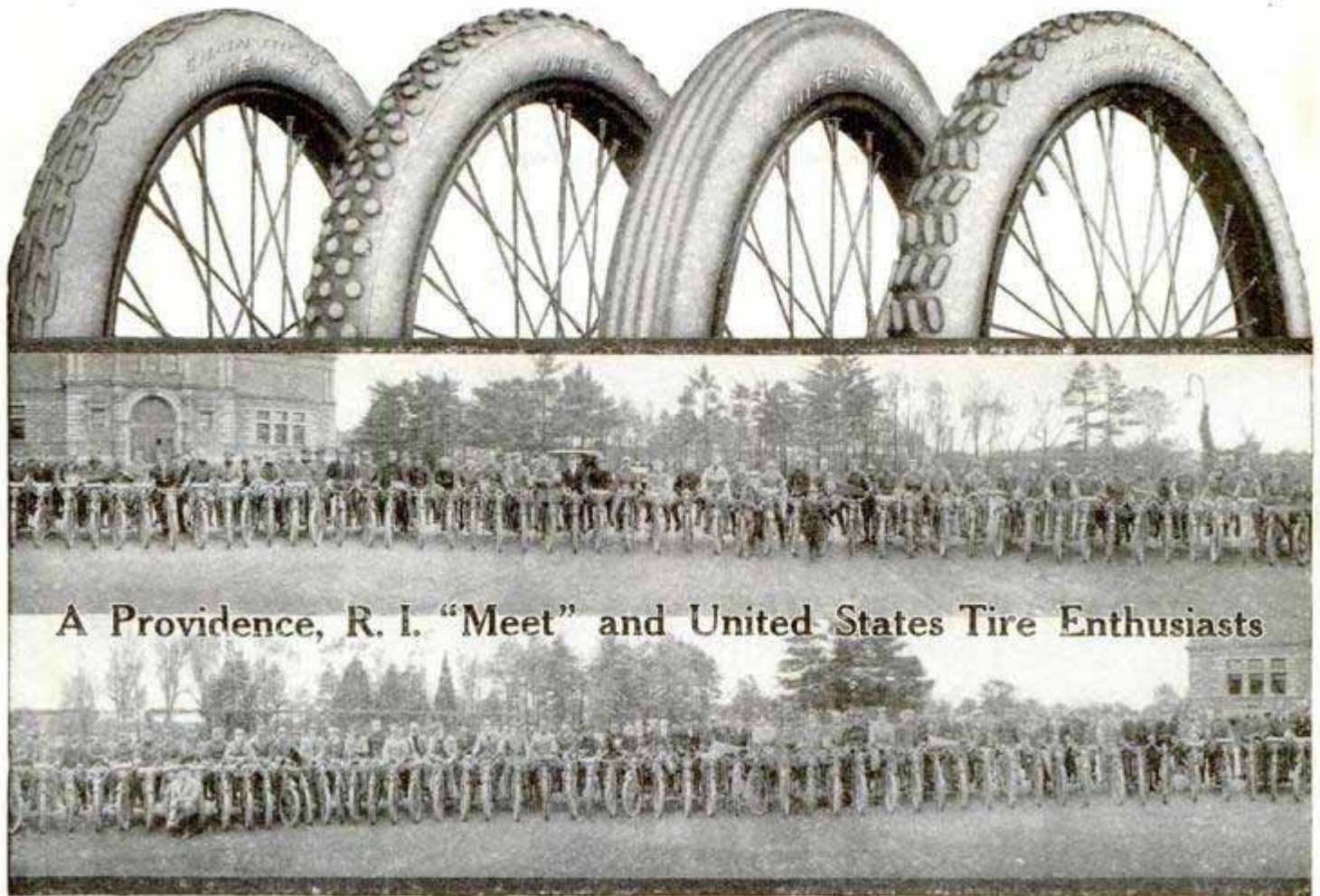

A Providence, R. I. "Meet" and United States Tire Enthusiasts

## The Motorcycle is today one of Man's most economical and useful servants, and United States Tires have done much to make it so

The motorcycle of today is a thing of joy in its simplicity—its economy of operation—its sturdiness—its pleasure and its usefulness.

We, the makers of UNITED STATES TIRES, have kept step with the advance of the motorcycle.

We have constantly studied the tire requirements of the motorcycle from every point of view.

We have built our tires to meet every condition of motorcycle tire wear.

We have solved the motorcycle tire problem.

Today UNITED STATES MOTORCYCLE TIRES stand alone, in a class absolutely by themselves, and are acknowledged to be the standard motorcycle tires.

Their overwhelming popularity is a known fact.

**In one year—1913—the sales of UNITED STATES MOTORCYCLE TIRES increased 139 per cent.—an increase that is without a parallel in motorcycle history**

**NOTE THIS:—Dealers who sell UNITED STATES MOTORCYCLE TIRES sell the best of everything**

# United States Motorcycle Tires

Made by the

**Largest Rubber Company in the World**

# Williams' Shaving Soaps

Use Williams' Shaving Soaps and you will be

## Saving Time



because they give a quick and copious lather that speedily softens the beard and remains cool and moist as long as you need it.

## Saving Energy



because they prepare the beard perfectly for the razor and make shaving a relaxation.

## Saving Worry



because you will anticipate your shave with a smile of satisfaction and not with a frown of annoyance.

## Saving Temper



because they will make your razor and yourself the best of friends and leave a happy face soft and velvety as a boy's.

## Saving Money



because so little soap is required to make a big, thick, creamlike, lasting lather.

**THE J. B. WILLIAMS CO.,**  
Dept. A, Glastonbury, Conn.  
After Shaving use Williams' Talc Powder

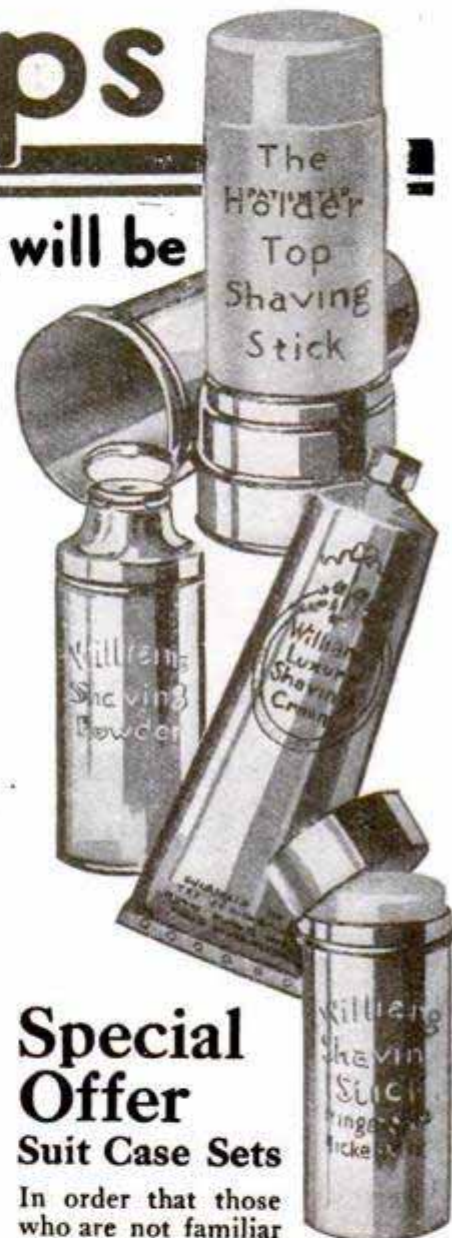

## Special Offer

### Suit Case Sets

In order that those who are not familiar with our new toilet requisites may have an opportunity to try some of them, we have prepared very attractive sets of samples which we call "Men's Suit Case Sets" and "Women's Suit Case Sets." These are handsomely decorated boxes, each containing five trial size reproductions of our regular packages. Either set will be sent for 24 cents in stamps if your dealer does not supply you.



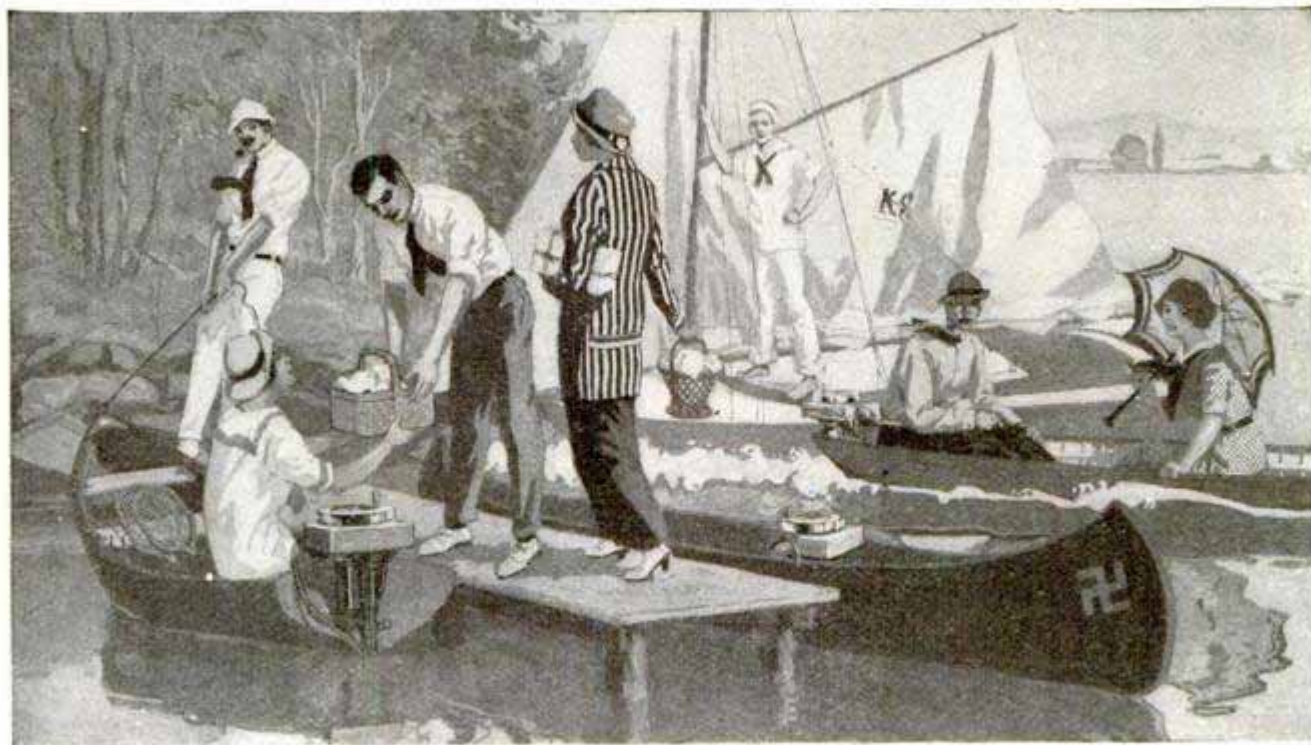

# EVINRUDE

The Coming of the *Evinrude* Created a Better Summer for 25,000 People

This detachable portable rowboat motor, which attaches to any rowboat in less than one minute, has created new pleasures for lovers of water sports in all parts of the world. Its very simplicity has enabled not only women and children to use it, but has offered greater possibilities for a better vacation on any body of water. The

Drives a rowboat 8 miles an hour—a canoe 12



Weights 50 pounds carries like a satchel

## Adopted by Ten Governments

and Theodore Roosevelt has purchased one for his South American trip. Other prominent explorers and sportsmen use them in all parts of the world.

The great Evinrude plant has a capacity of over 200 detachable rowboat motors per day. But even with this tremendous output we have been compelled, in the height of the season, to refuse orders, so great has been the popularity of "Evinruding". Warehouses are maintained in the principal cities of the world for the purpose of furthering "Evinrude" service; a feature never before even attempted by any marine engine builder.

## Magneto on 1914 Models

It was impossible to improve the basic construction of the "Evinrude" therefore we added to it. One of the most striking additions which identify the 1914 models and contribute an epoch in gasoline motor construction is the **Built-In Reversible Magneto**

No batteries to carry, no danger of wet contact points, as rain, waves or even complete submersion will not affect it.

Evinrude motors are on sale at Hardware and Sporting goods dealers throughout the United States.

*Illustrated Catalog Sent Free Upon Request  
Lest You Forget—Write for a Copy Today*

**Evinrude Motor Co.**  
233 M Street Milwaukee, Wis.

### BRANCH OFFICES:

SAN FRANCISCO—423 Market Street  
NEW YORK CITY—69 Cortland Street  
PORTLAND, ORE.—106 Fourth Street

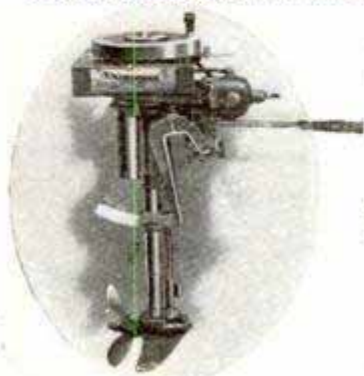

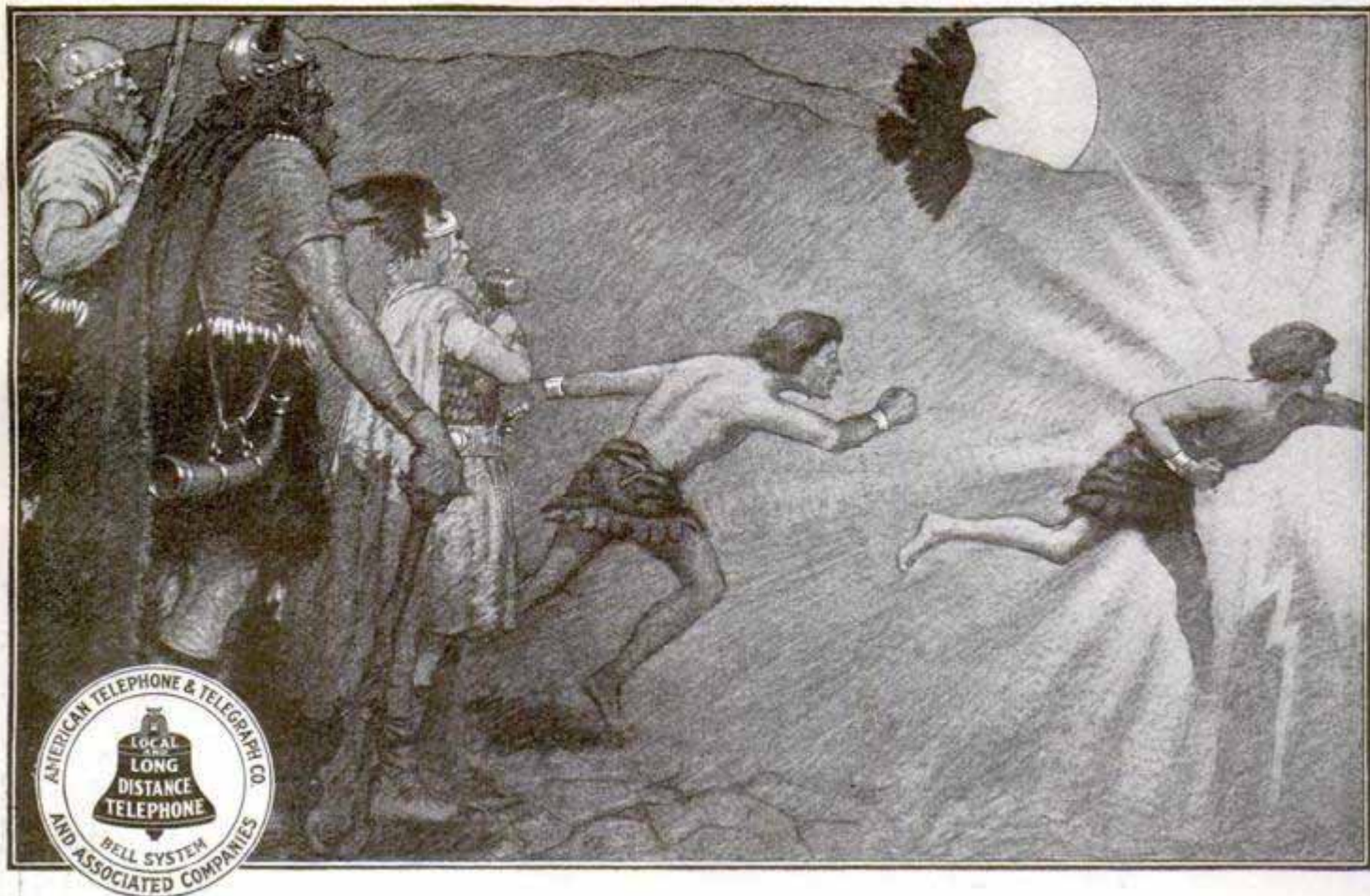

## The Magic Flight of Thought

**A**GES ago, Thor, the champion of the Scandinavian gods, invaded Jotunheim, the land of the giants, and was challenged to feats of skill by Loki, the king.

Thor matched Thialfi, the swiftest of mortals, against Hugi in a footrace. Thrice they swept over the course, but each time Thialfi was hopelessly defeated by Loki's runner.

Loki confessed to Thor afterward that he had deceived the god by enchantments, saying, "Hugi was my thought, and what speed can ever equal his?"

But the flight of thought is no longer a magic power of mythical beings, for

the Bell Telephone has made it a common daily experience.

Over the telephone, the spoken thought is transmitted instantly, directly where we send it, outdistancing every other means for the carrying of messages.

In the Bell System, the telephone lines reach throughout the country, and the thoughts of the people are carried with lightning speed in all directions, one mile, a hundred, or two thousand miles away.

And because the Bell System so adequately serves the practical needs of the people, the magic of thought's swift flight occurs 25,000,000 times every twenty-four hours.

**AMERICAN TELEPHONE AND TELEGRAPH COMPANY  
AND ASSOCIATED COMPANIES**

*One Policy*

*One System*

*Universal Service*

*Please Mention Popular Mechanics*



**45c  
Coupon  
Free—Use it**

**Johnson's  
Wood Dye**

In 17 shades—for the artistic coloring of wood—*soft and hard.*

**Johnson's Prepared Wax**

A complete finish and polish for all wood—*floors, woodwork and furniture.*

**Use the Coupon**

# Is the Money

**Y**OUR special training—or lack of it—hits you right in the money pocket. With everything going up but the salaries of *untrained* men, with competition becoming keener all the time, with the many wants that each day brings, and the time when there'll be nothing coming in—with all these conditions staring you in the face, you've got to decide mighty quick whether you're a success or not—and if *not*, how you *can* make friends with success and bid failure “good-bye.”

**I**T's a serious proposition when you stop to think about it—this *big* spending and *little* earning. Yet, it needn't worry you one bit if you can increase your *earning* capacity far beyond your *spending* requirements. It's simply a matter of making your brain work instead of your body. Head work earns more than body work. *You've* got some good ideas—and you know it. The International Correspondence Schools will help you turn those ideas into cash.

**S**ELECT from the attached coupon the well-paid occupation you like best, mark the coupon as directed, and mail it today. That's all you have to do to learn *how* the I. C. S. can train you at home and in your spare time—no matter where you are, what



# Always There?

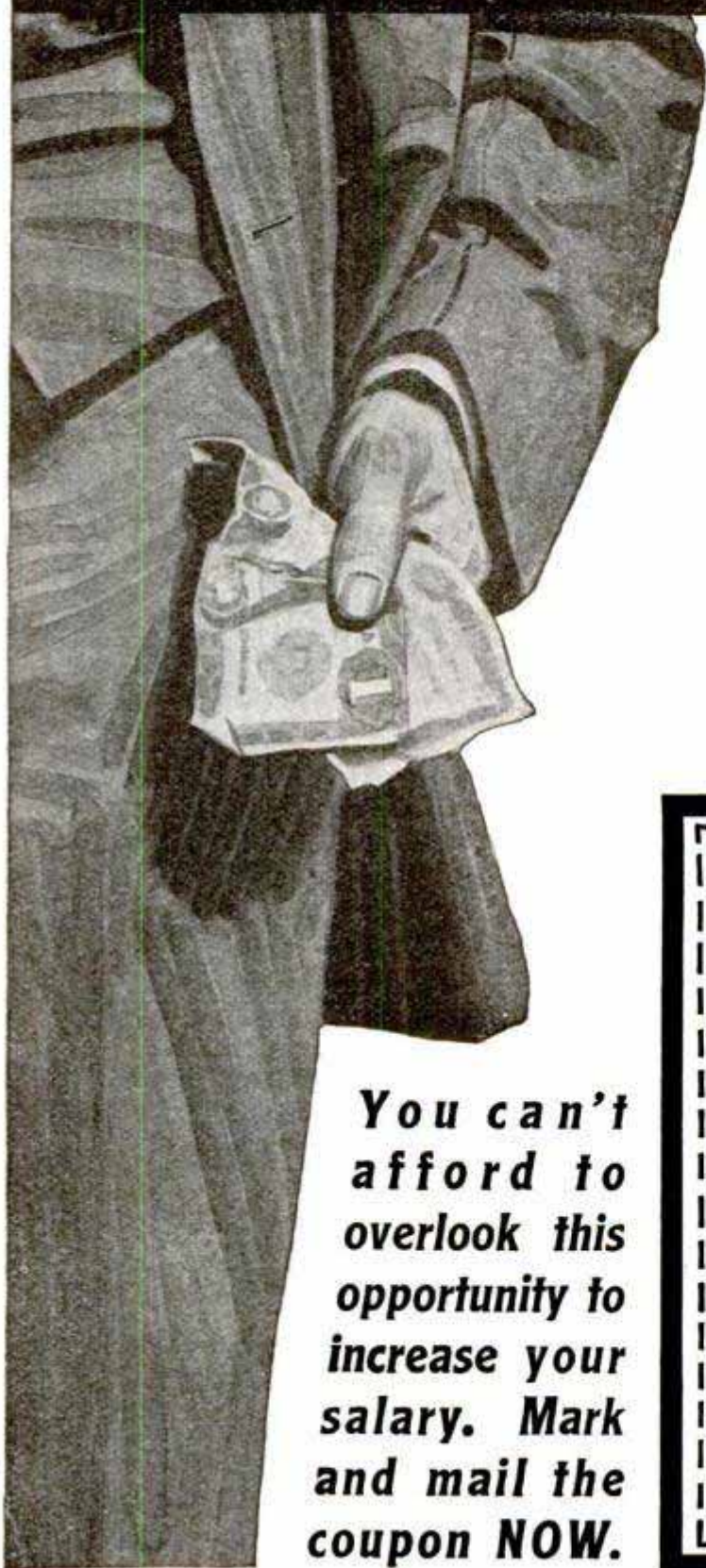

you do, what your age. *If you can only read and write, the way is open.*

**D**ON'T worry as to *how* the I. C. S. can help you. The I. C. S. has already helped so many other ambitious men that it surely can do the same for *you*. The I. C. S. removes all obstacles—makes everything easy—smooths the road.

**Y**OU'VE got to look this *earning* and *spending* proposition squarely in the face *some* time. Do it **NOW** and *decide* now how to get the better of it. Let the I. C. S. advise and *help* you. Earning with your head is far more congenial and profitable than toiling with your body. Which will you choose?

**You can't afford to overlook this opportunity to increase your salary. Mark and mail the coupon NOW.**

**INTERNATIONAL CORRESPONDENCE SCHOOLS**  
 Box 872, SCRANTON, PA.

Explain, without further obligation on my part, how I can qualify for the position before which I mark X.

Electrical Engineer Elec. Lighting Supt. Electric Car Running Electric Wireman Telephone Expert Architect Building Contractor Architectural Draftsman Structural Engineer Concrete Construction Mechan. Engineer Mechanical Draftsman Refrigeration Engineer Civil Engineer Surveyor Mine Superintendent Metal Mining Locomotive Fireman & Eng. Stationary Engineer Textile Manufacturing Gas Engines Automobile Running	Civil Service Railway Mail Clerk Bookkeeping Stenography & Typewriting Window Trimming Show Card Writing Lettering & Sign Painting Advertising Salesman Commercial Illustrating Industrial Designing Commercial Law Teacher English Branches Good English for Every One Agriculture Poultry Farming Plumbing & Steam Fitting Sheet Metal Worker Navigation Languages Chemist
---	---

Name \_\_\_\_\_

Present Occupation \_\_\_\_\_

Street and No. \_\_\_\_\_

City \_\_\_\_\_ State \_\_\_\_\_

# FREE

No matter what tobacco you are now chewing, if you will try PIPER Heidsieck you will become a permanent user of this famous tobacco. To induce you to make a trial, we will send you, free, this genuine leather

## Tobacco Pouch

strongly made of fine tan leather, with a flap and patent snap clasp. Every man who loves a good chew will prize this handsome, handy leather pouch to carry his tobacco in.

PIPER Heidsieck is the *highest type* of chewing tobacco in the world. Every leaf of ripe, golden brown tobacco used in "PIPER" is carefully selected from Nature's choicest crops, clean, sweet and mellow.

*Pouch is 3¼ x 3 in. size.*

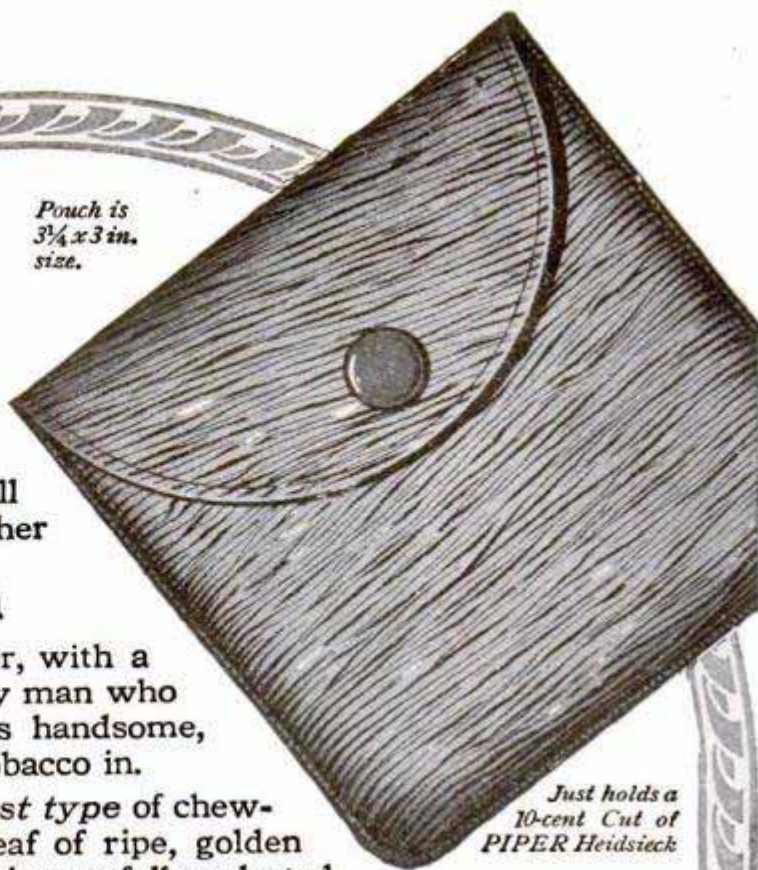

*Just holds a 10-cent Cut of PIPER Heidsieck*

# PIPER Heidsieck

## CHEWING TOBACCO—Champagne Flavor

*Sold Everywhere in 5c and 10c cuts*

The flavor of "PIPER" is different from all other tobaccos made — a rich wine-like, delightful taste which never fails to make a friend.

### We Want You to Try PIPER Heidsieck

Send 10 cents and we will send a full-size 10c cut of "PIPER" and this handsome leather pouch FREE.

The tobacco, the pouch and mailing expenses will cost us 20 cents—and we are glad to spend the money to get you to try "PIPER" just once. We know that once you have started, you will become a permanent friend of this wonderfully wholesome, healthful and satisfying tobacco.

In writing us please tell us the name of the dealer of whom you buy your tobacco.

THE AMERICAN TOBACCO CO.

111 Fifth Avenue  
New York City

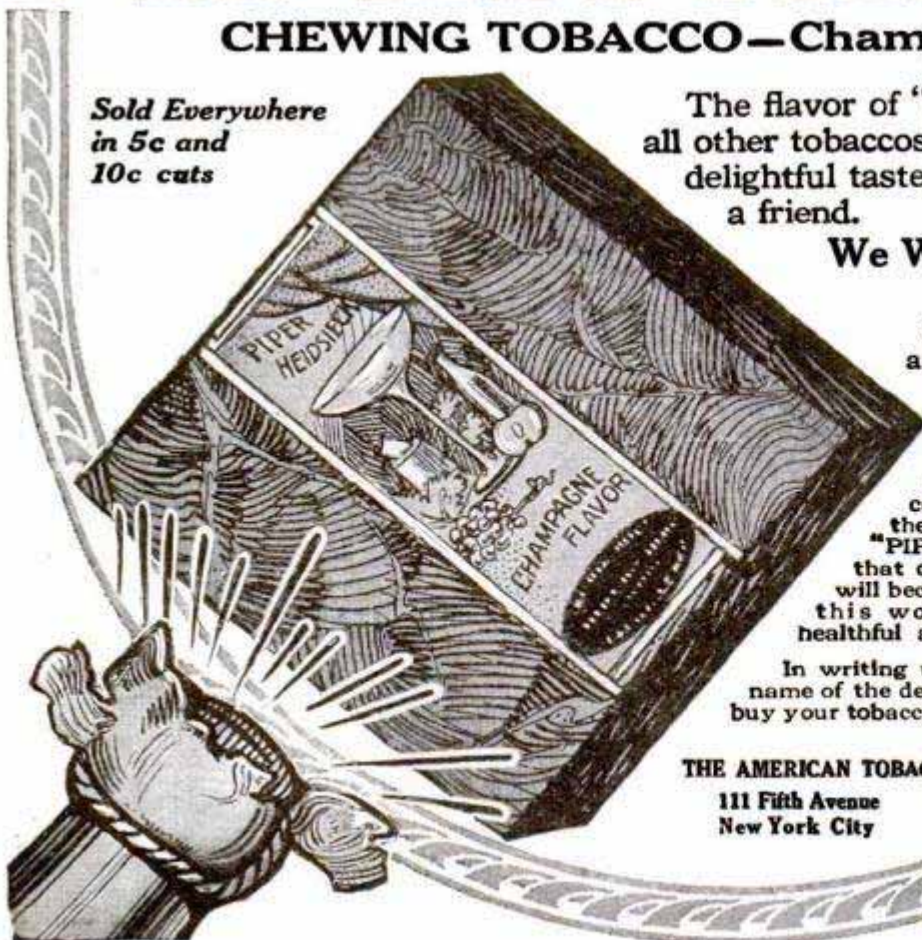

# Hartman Will Trust You Requires No References Asks No Advance Payment

No. 0F899—Seamless Brussels Room Rug



9x12 ft. elegant seamless Brussels Rug of very new pattern with medallion center, artistic border. Woven of selected worsted yarn with tan, brown, red and green colors predominating. Price, \$8.95.

**75¢ Per Month**

No. 1F545 Bargain Dining Chairs



Built of selected hardwood finished American quartered oak. Have shaped saddle seats and neat panel backs finished with Colonial scroll legs. Price \$8.45.

**75¢ Per Month**

No. 3F679—Complete Bed Bargain Offer



Complete Bed. Outfit consisting of continuous 1-16 inch post iron bed with 3-8 inch fillers; all metal woven wire springs and elastic felt top, fibre filled mattress. Outfit comes in all size (4 ft. 6 in.) only. Colors: white, pea green and vermillion. Price \$7.85.

**75¢ Per Month**

## Remarkable Bargain SALE Now On

It's just impossible to exaggerate the importance of this great, Price-Smashing Sale of Guaranteed, Dependable Quality Home Furnishings. Now is your chance to get any of those home furnishings you've wished for so long—now is the time, because the opportunity is truly remarkable. Never before has this great Hartman's Establishment, from which millions of orders are shipped, been able to equal these present values.

### Better Home Furnishings For YOU

Hartman's has brought the necessities, the comforts and even luxuries, here-to-fore found only in the homes of the rich and prosperous, within the reach of even those of very limited means by these remarkably low prices and very liberal Deferred Payment Plan. Send today for the Big, Special FREE Hartman Credit Bargain Book, showing everything in home-furnishings, colors, patterns and designs photographed from the original. It will be like bringing into your home an enormous stock of home furnishings, many times the size of the largest city store including—

- |                 |                  |          |            |
|-----------------|------------------|----------|------------|
| Furniture       | Stoves, Ranges   | Dishes   | Jewelry    |
| Carpets         | Refrigerators    | Clocks   | Tinware    |
| Rugs            | Silverware       | Go-Carts | Mattresses |
| Curtains        | Portieres        | Springs  | Bedding    |
| Sewing Machines | Washing Machines |          |            |

### Hartman Trusts Everyone

Asks No Reference—Send No Money on any of these bargains. To the millions of home-lovers, everywhere, who find it more convenient or necessary to pay in small easy payments Hartman says: "I will trust you. Just as I am trusting a million of others who are buying their entire household needs from Hartman. During this big sale you can order any of these special advertised bargains without sending us any advance payment."

Hartman's transactions with you are strictly confidential, no references are asked—no embarrassment. Your neighbors need not know your business—you'll like the Hartman plan when you know all about it. Send for Big FREE Bargain Book and full particulars.

### Hartman Makes Easiest Terms

No matter who you are or where you live, your credit is good at Hartman's. No matter how small your income Hartman meets your requirements without any red tape whatever. No extra charges, no mortgage, no security. The Hartman modern credit system is free from ALL objectionable features. With long time credit as easy to get as it is from Hartman there is no reason for anyone to live in a meagerly furnished home.

### 30 Days Free Examination

Every Hartman Bargain must actually sell itself on its own merits, after you see it in your own home. At the end of a month you are privileged to return the articles if you do not find them perfectly satisfactory. Hartman has made good millions of times under such tests.

You must see this Mammoth Hartman Credit Special Bargain Book—you must compare the remarkable offerings—nothing else like it. Send your address today on a postal—It's Free.

## HARTMAN

Furniture & Carpet Co.  
3945 Wentworth Ave.  
CHICAGO, ILL.

### Hartman's Rocker Bargain

A large, comfortable\* rocker made of selected hardwood finished American quartered oak and upholstered in Imperial leather. Is strongly built and has stout runners. Side panels and front posts are of neatly carved design. Seat is set over full spring construction. Top of back has ruffled edge. Price \$3.69.

No. 1F544  
**50¢ Per Month**

No. 4F457 Kitchen Cabinet



Convenient solid Oak Cabinet with large sanded whitewood table top 42x26 inches. Has sliding bread board, china cupboard with doors, utility drawers, cake box, cutlery drawer and two 40 lb. capacity flour bins. Price \$8.75

**75¢ Per Month**  
No. 4F458—Solid Oak Dining Table



A beautiful table, made of fine quality Solid Oak with rich golden finish. Has large 42 in. top which extends to 6 ft. when opened. Massive round pedestal is supported by strong legs with carved claw feet. Price \$7.85

**75¢ Per Month**

No. 6F507—Gold Coin Porcelain 100-Piece Dinner Set.



Price 50 Pieces Set \$4.85

Has heavy coin gold decorations warranted not to come off. Double fired, elegantly glazed; consists of complete service for 12 persons. Price \$9.65

**75¢ Per Month**



The Big Credit SPECIAL BARGAIN Book FREE

**HARTMAN'S Legal Guarantee**  
We Unreservedly Guarantee every article sold by us to be exactly as represented and described in our catalog.  
We Guarantee our prices to be lower than those of any other concern for goods of equal quality.  
We Guarantee to ship each and every article on approval, and if within 30 days from receipt of the goods, anything is not perfectly satisfactory, FOR ANY REASON WHATSOEVER, we will accept their return and when the goods are returned to us, we will refund all moneys paid on them including payment of freight charges both ways.

# MAKE \$250.00 A MONTH

## Repairing AUTO-TIRES

### MOBILE

Sounds like a lot of money  
—IT IS—A WHOLE LOT OF MONEY  
to be earning CLEAR every month—yet it's  
what hundreds of men we have established in the  
Automobile Tire Repair Business are making.

You let down the DRAW BRIDGE for SUCCESS to enter into  
your career by getting into business for yourself. The business for  
you is the one where investment is small—the returns quick and for cash  
—where the margin of profit is large—the demand for your PRODUCT or  
SERVICE constant and ever on the increase.

### A Haywood Tire Repair Equipment

answers to all of these requirements of Old Dame Fortune—the certainty of success in this  
business is as sure as anything in this world can be—Each year adds thousands of new  
Automobile Owners—they need YOU to keep their tires in service.

### Here Is Your Opportunity!

Be first to enter this new big paying business in your town. Open your pockets. Let the dol-  
lars pour in. Act quick. Every auto sold means more tires to mend. Automobile business is  
growing fast—enormous field for tire repairing. Punctures and blowouts are common. Tires need  
retreading and vulcanizing. Something going wrong all the time. Thousands forced to buy new  
tires because they can't get old ones fixed. Think of the old bicycle days—repair shops on every  
corner—all making money—busy day and night. Autos make same proposition over again—only  
ten times bigger and better. Users of Haywood Tire Repair Plants are making big money. Johnson,  
Tex., writes: "I have made as high as \$18 in a day." Another man who bought a plant Septem-  
ber, 1911, writes he has cleared over \$3000.00. That's going some! Operate a plant as side line  
in connection with auto business—garage or as  
an independent business. Find neighbor-  
hood where there's a bunch of autos—get  
all the steady business besides transient  
work. Experience unnecessary. You learn  
quick. Simply follow directions—practice  
a few days on a couple of old tires and  
you'll be ready to coin money Business  
comes fast and easy.

### Repair Tires At Home.

Young men! and boys repair father's tires—get  
money he pays garage man. Get the neighbor's  
work. Make money to attend college or to start  
a garage and repair business. Auto owners—re-  
pair your own tires—save money—pay for your outfit  
in short time. We have outfits for home use. Any-  
how investigate. Send today for catalogue. See the  
wonderful possibilities in this marvelous field. Learn  
of the enormous money-making opportunities in  
this fascinating new business.

**Haywood Tire & Equipment Co.**  
658 N. Capital Avenue  
Indianapolis, Indiana

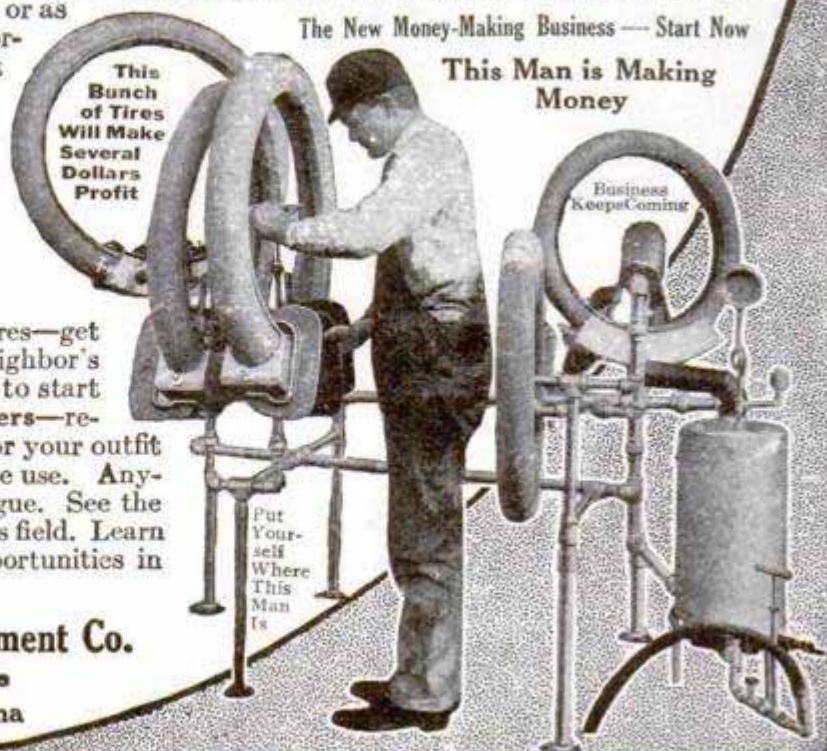

The New Money-Making Business — Start Now

This Man is Making Money

This Bunch of Tires Will Make Several Dollars Profit

Business Keeps Coming

Put Yourself Where This Man Is



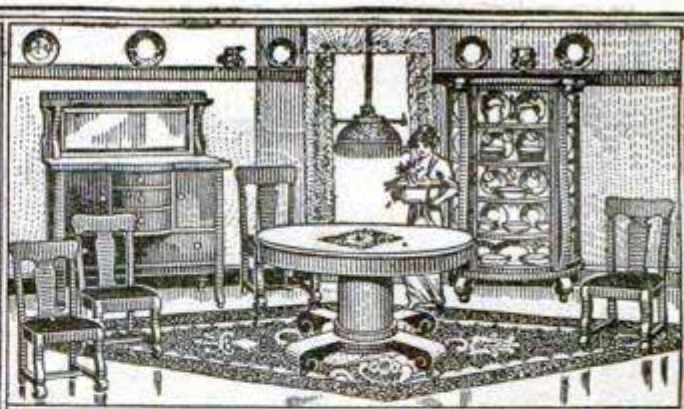
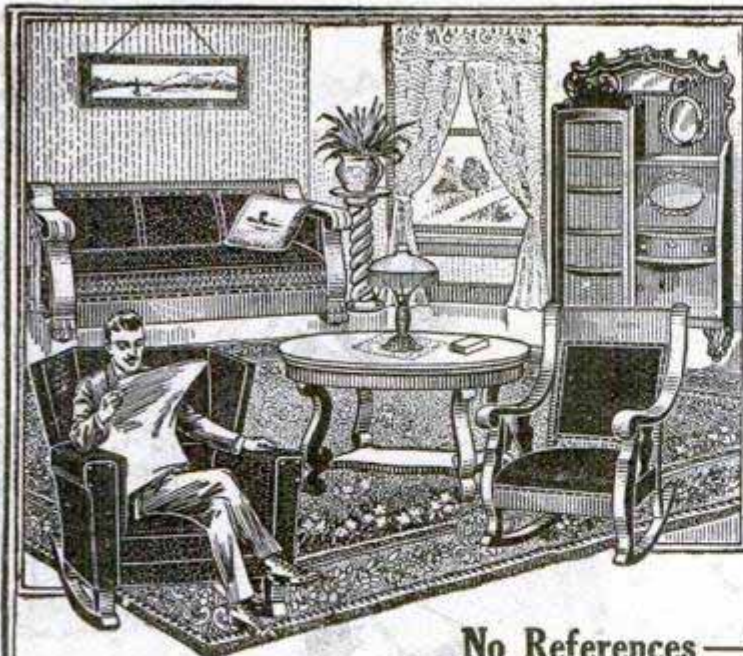

## A Gentleman's Credit

No References — No Contract — All the Time You Want

### 1,666 Homes Daily Now Furnished This Way

We now give credit to home lovers without any red tape. No references, no contract, no security. Ask for our catalog and your credit card will go with it. You will then have an open charge account and can order what you wish.

We furnish an average of 1,666 homes per day for people on these easy terms.

#### Pay 3 Cents a Day

Goods are all sent on 30 days' approval. You have a month to return anything not wanted, and we'll pay freight both ways.

Take a year to pay for the goods you keep. Pay as

#### This Kitchen Cabinet

**\$8.95**

Monthly 75c

Send Only \$1.00, but be sure to order from this paper. Notice the china closet top with good-size sugar bins and shelf; table top with removable breadboard. Base is 42 by 26 inches, fitted with drawers and flour bin.

No. 3D4B111.

Price...\$8.95



30 Days' Trial

# Spiegel, May, Stern Co

969 W. 35th Street, Chicago

convenient—a little each month. If sickness comes or loss of work we will gladly extend the time.

You can furnish a home in beautiful shape by saving 2 or 3 cents a day.

#### What You Save

We sell at cash prices on credit, and no interest is charged. We guarantee to save you from 15 to 50 per cent under any cash prices in catalogs or stores. If we don't do that, return the goods.

We do this by enormous buying, and by selling direct to an average of 1,666 homes a day. We take whole factory outputs, buy up surplus stocks. We sell hundreds of things at just one-half store prices.

#### Five Costly Books Free

Our Spring Furniture Book pictures 5,112 things for the home. Many are pictured in actual colors. This mammoth book costs us \$1 per copy, but we send it free.

We issue four other big catalogs, named in the coupon. Ask for any you want. See our styles, our variety, our prices. You will be amazed.

Mail this coupon for the books you want and your credit card will go with them. Do this today. Cut out the coupon now.

### 5,112 Things TO CHOOSE FROM

Furniture	Silverware
Carpets—Rugs	Chinaware
Oilcloths, etc.	Sewing Machines
Draperies	Bicycles—Toys
Blankets—Linens	Cameras—Guns
Baby Cabs	Pictures—Clocks

#### A YEAR TO PAY

Get Martha Lane Adams' Book of  
Spring Styles for Women

SPIEGEL, MAY, STERN CO.  
969 W. 35th Street, Chicago

(655)

Mail me free your Spring Furniture Book.  
Also send me books marked below.

Stove Book.  Dress Goods.  
 Watches and Jewelry.  
 Spring Styles for Women.

Name.....

Address.....

Write plainly. Give full address.  
Check which catalogs you want.

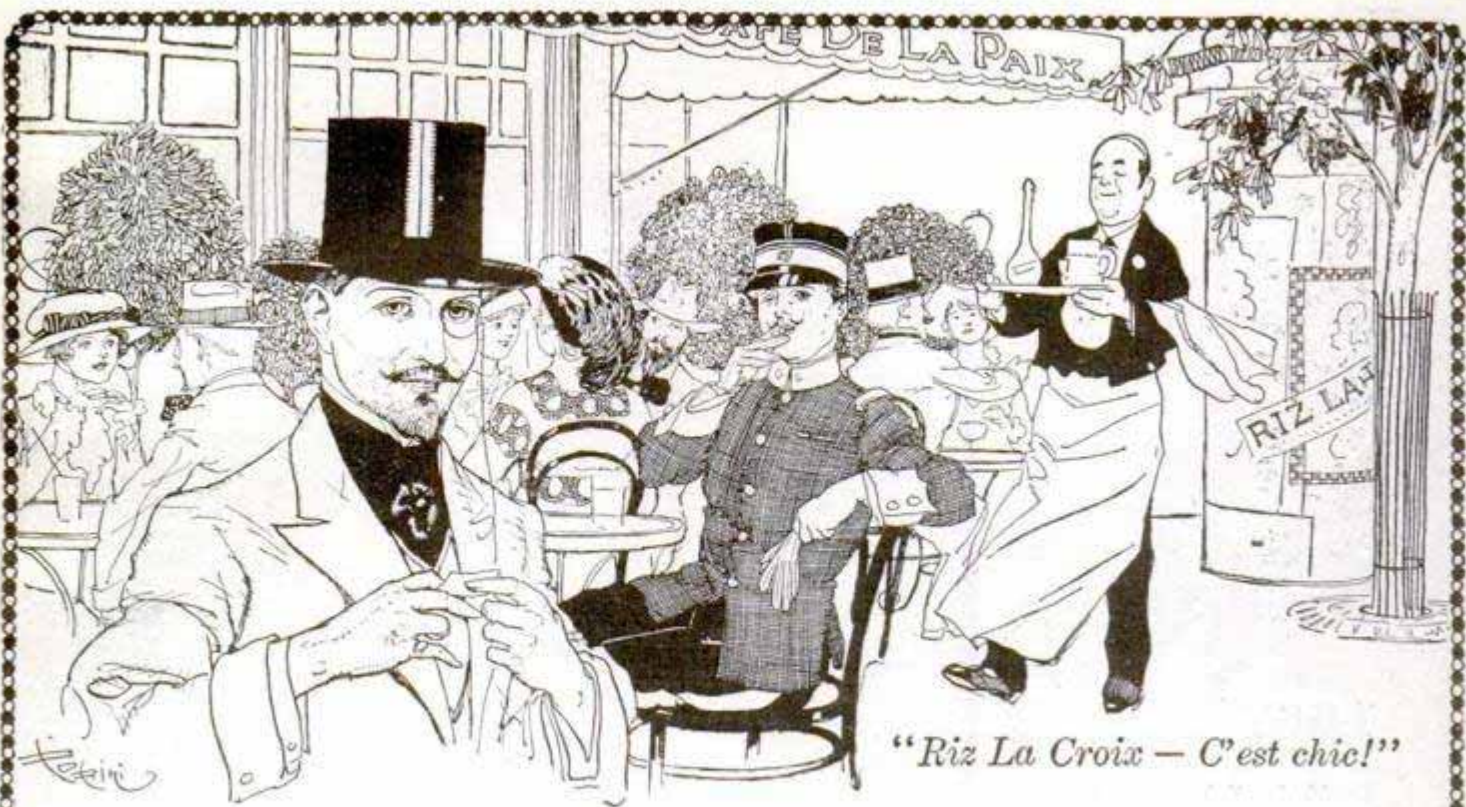

## THE TRUE PARISIAN

is a man of *chic* and elegance in his habits, a cosmopolite whose twin perfections are *savoir faire* and *ton*. As *boulevardier*, *café* lounge, artist in idleness, the true son of the city by the Seine has a keen eye for the best things of life. Even in trifles light as cigarette papers, he appreciates supremacy. He uses Riz La Croix.

# RIZ LA CROIX.

(Pronounced: REE-LAH-KROY)

## FAMOUS CIGARETTE PAPERS

are a striking example of the French passion for perfection, neatness and efficiency. For decade after decade the manufacturers of the La Croix family have been improving and perfecting this remarkable paper.

Riz La Croix is firm: your cigarette does not burst while being rolled in Riz La Croix.

Riz La Croix is light: it does not char easily, burns freely—above all, it completely submerges its identity in the tobacco, leaving no "paper flavor."



FREE

A sample book of Riz La Croix papers and a booklet illustrating the best way to roll a cigarette, on request.  
Address LA CROIX FILS, 111 Fifth Ave., New York

## Vegetables between rows of Orange Trees Start You

Plant your grape fruit and orange trees. Then grow vegetables between the tree rows. The vegetables earn your living and pay for your land. Your first investment is small. Your land has practically paid for itself. That's because it's

## Wauchula Florida District

**Combination Soil** that supports citrus trees and vegetables equally well. The wonderful fertility of this soil, the plentiful rainfall, the good drainage, the pleasant, healthful climate, make it clear why you find \$500,000 bank deposits in three towns within a radius of five miles.

## A Guarantee by Bankers A Year to Decide

The Wauchula Development Company has its main office here in Wauchula. It is composed of bankers, men who live here.

In brief, this is their offer to you:

"Start payments as soon as possible to get the best choice of location. Come down and see your plot any time within a year. If you're not satisfied we return your money with six per cent for the time we've had it."

## New Settlers Making Good

Settlers have been coming here during the year that the Wauchula Combination Soil has been on the market. They're making good. They're building for success. They're satisfied. They're enthusiastic. Their prosperity proves the soil. Write today for literature.

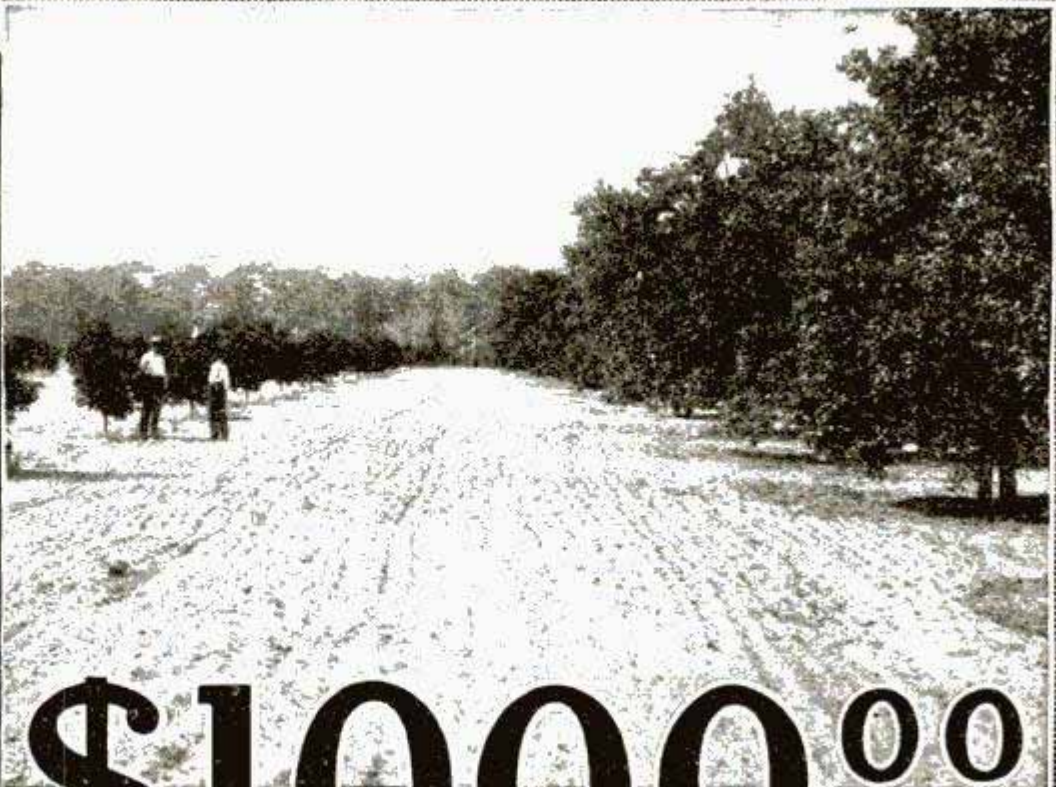

# \$1,000<sup>00</sup>

per acre from 4 acres of grape fruit and orange trees. Over \$6,000 from 15 acres.

That's what Mr. Steve Griffin makes this year from part of his grove, 5 miles East of Wauchula, Fla.

Mr. Griffin isn't worrying about the high cost of living. He has a comfortable home, a motor car, money in the bank. The picture above shows part of his new grove. He has planted corn between the tree rows, but it had not begun to show when this photograph was taken, April 2, 1913. The edge of the old grove shows at the right of the photograph.

How would you like an income like this? You can have it. You can come down here, plant your trees, grow any one of a number of vegetables between the tree rows. The vegetables support you and your family until the grape fruit and orange trees begin to bear. From then on your income can be increased practically as you wish.

Our land entirely surrounds Mr. Griffin's property. It's the same Wauchula Combination Soil that has built fortune after fortune. The soil and climate have proved their worth year after year.

You don't need much money to start. Steve Griffin came here with practically nothing. He worked at any job until he could begin growing vegetables. Then he bought land on time. Today he enjoys a really big income.

Last year for the first time the public learned about Wauchula Combination Soil. The result has been the sale of thousands of acres. Wauchula, already a thriving town of 1,500, has grown to 2,000 within twelve months. Vandolah, a new center of shipping and business, has sprung up. New settlers are proving that they can make big money here.

You won't be a pioneer. Hundreds of other men with their families have demonstrated what can be done. They find the right sort of neighbors, churches, schools, lodges. There are banks and stores, live cash markets and good transportation for crops.

**If YOU want to know how to earn a yearly income of \$3,000, \$5,000, \$8,000, let men here tell you—WRITE FOR FACTS**

If you were going to buy land in any other state you'd want to know first what others in that locality were earning from the same kind of soil.

Men who live here will tell you. In booklets composed of their experiences you learn the actual figures acre by acre of their profits. Beautifully illustrated.

Study our entire offer, our low prices, easy terms, bankers' guarantee, year's time to investigate. Get this information NOW—today. Send a letter, postal or the coupon.

**WAUCHULA DEVELOPMENT CO.**  
Box 71 Wauchula, Florida

Wauchula Development Co., Box 71 Wauchula, Florida  
Please send me actual facts regarding your combination vegetable and citrus fruit land. Also prices, terms, guarantee, letters from settlers, etc.

Name.....  
St. No. or R. F. D.....  
Town.....  
State.....

# TYPEWRITER SENSATION!

## 2 DOLLARS A MONTH



FREE TRIAL

**Buy a Genuine Standard**

**No. 2 SMITH-PREMIER Typewriter and at \$71.20 less than the original price.**

Never before has anything like this been attempted. Dealers get \$3.00 a month rent for this make of machine, not nearly as perfect as the one we will send you, and you pay only **TWO DOLLARS A MONTH AND OWN IT.**

**A Guaranteed Typewriter \$28.80**

Perfect machines only, complete outfit, nothing extra to buy, no strings of any kind to this offer. Just think of buying such a typewriter for \$8.80 down and \$2.00 a month. Cash price \$27.40. Thousands of people have paid \$100.00 cash for Smith-Premiers. It's standard, by many considered the best typewriter ever built. A key for each character, so each character is always the same, a type brush for cleaning the type built into the machine; the tilting carriage throws all previous writing in plain sight of the operator. Comes to you with two color ribbon, complete operating instructions, tools, waterproof cover, practice paper, everything, ready. It runs beautifully. Writes as perfect and clean cut a letter as quickly and easily as any machine bought for \$100.00. It's wonderfully simple, a child can operate it with half an hour's practice and rapidly attain speed. It's strongly built and will give you years and years of honest service and complete satisfaction.

**Send the Coupon and We Will Ship You this Smith-Premier Typewriter**

When the typewriter arrives, deposit with the express agent \$8.80 and take the typewriter three days and try it. If you find it to be the best typewriter you ever saw, satisfactory in every respect, keep it and send us \$2.00 each month, until our special price of \$2.80 is paid. If you don't want to keep it, return it to the express agent, and he will give you back your \$8.80, and return the typewriter to us. We will pay the return express charges.

You won't want to send this machine back after you have seen it and tried it. You can't imagine the perfection of these machines till you see one, and the price is \$71.20 less than the catalogue price, and it is guaranteed just as if you paid \$100.

**Only 200 orders will be filled on this offer. Act today to be sure**

This coupon states the terms. Fill it out, send it now, today. You can't lose, and it's the greatest economical typewriter opportunity you will ever have.

### COUPON

**HARRY A. SMITH, No. 180 N. Dearborn St., Chicago.**

Ship me a No. 2 Smith-Premier, f.o.b. Chicago, as described in this advertisement. I will pay you the \$20.00 balance of the special \$28.80 purchase price, at the rate of \$2.00 per month. The title to remain in you until fully paid for. It is understood that I have three days in which to examine and try the typewriter. If I choose not to keep it I will carefully repack it and return it to the express agent. It is understood that you give the standard guarantee for one year.

Name .....

Address .....

Pop. Mech. Feb.

Please Mention Popular Mechanics

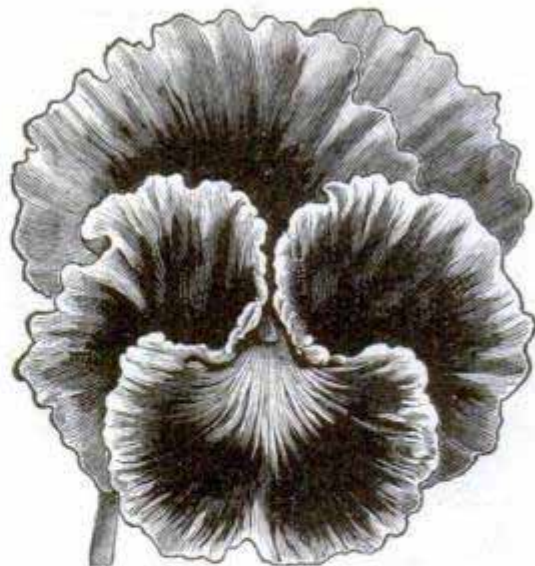

Once Grown Always Grown

## Maule's Seeds

Endorsed by more than 450,000 progressive gardeners as the best ever

My new Seed Catalogue contains everything good in seeds, bulbs, small fruits and plants. 750 illustrations; 176 pages. Free to any one sending me a request for it. *Send for it today.*

WM. HENRY MAULE

21st and Arch Sts., Philadelphia, Pa.



Send 10 cents, mention this paper, I will enclose in the catalogue a packet of the above GIANT pansy.

### WEAR

Trade Mark

Registered

**B.V.D.**

U. S. Patent Office

and Foreign Countries

### UNDERWEAR

**SIBERIAN BREAD USED FOR MANY PURPOSES**—The native Siberian bakes a bread, or hard-tack, which is not only a substantial article of diet but has many other uses. It is molded into small white



### Amazing Profits In Mushrooms

Anybody can add \$8 to \$40 per week to their income, in spare time, entire year growing mushrooms in cellars, sheds, barns, boxes, etc. I tell you where to sell, at highest prices.

Free Illustrated Instruction Booklet

**HIRAM BARTON**

Desk 2, 329 W. 48th St., New York



I will send for a short while my 25c. book

### Improve Your Eyes

For 10c., stamps or coin

A high-grade exercise and method that quickly strengthens and beautifies the eyes.

Also a most beneficial system of exercises that will improve the muscles of the temples of face, thereby facilitating clear and vocal pronunciation. Illustrated. Entirely without cost.

**PROF. ANTHONY I.**

4640 Barker Blvd.

110 W. 42d St., NEW YORK

Established 28 years in New York



They Will Set Their Watches by *Your* Watch

If Yours Is — **The Burlington Watch**

*The Masterpiece  
Among Watches  
Men's and Ladies' Sizes*

*New Ideas in Watch Cases*

*These are just out: Inlay Enamel Monograms, Block and Ribbon Monograms, Diamond Set, Lodge, French Art, Dragon Designs. Open face or hunting cases, all sizes. All these designs and many others to choose from.*

**Special Direct Offer!**

The Superb Burlington Watch **now** at the *direct* rock-bottom price—the same price that **even the wholesale** jeweler must pay—and in order to encourage everybody to secure this watch at once, pay this rock-bottom price, either for cash or \$2.50 a month on this great special offer! We send the watch on approval, **prepaid**. You risk absolutely nothing—you pay nothing, not one cent, unless you want this *exceptional* offer after seeing and thoroughly inspecting the watch. Read the coupon below.



*Adjusted to Temperature, to Positions, to Isochronism*

*25 Year Guaranteed Gold Strata Cases*

*New Book on Watches!*

**Send the Coupon.** Learn the inside facts about watch prices, and the many superior points of the Burlington over double-priced products. Just send the coupon or a letter or a postal. Get this offer while it lasts.

*Book Coupon*

Burlington Watch Co.  
19th St. & Marshall Blvd.  
Dept. 1192 Chicago, Ill.

Please send me (without obligation and prepaid) your free book on watches with full explanation of your cash or \$2.50 a month offer on the Burlington Watch.

Burlington Watch Co.  
Dept. 1192  
19th Street and  
Marshall Blvd.  
Chicago

Name.....  
Address.....



# Play Billiards at Home!

Under our easy payment plan, the expense is scarcely noticeable. You will be surprised to find how easily you can own a

## BURROWES Billiard and Pool Table

No special room is needed. The Burrowes Table can be set on your dining-room or library table, or mounted on its own legs or folding stand, and quickly set aside when not in use. Burrowes Tables are splendidly made and correct in every detail. The most expert shots, calling for skill of the highest order, can be executed with the utmost precision. Some of the leading professionals use Burrowes Tables for home practice.

Sizes range up to 4½ x 9 ft. [standard]

### The Cost is Trifling

A few cents a day (far less than it costs to play in a public poolroom) will soon make you the owner of a handsome Burrowes Table. You can play on the Table while paying for it. Why not own your Table and play with family and friends in the home atmosphere instead of spending a greater amount, with nothing to show for it, for rental of a public table?



**\$100 DOWN**

Terms are very easy—\$1 or more down (depending upon size and style selected), and a small amount each month. Prices from \$15 up. CUES, BALLS, ETC., FREE

E. T. BURROWES CO., 164 Spring Street, Portland, Me.

Please send catalog of Billiard Table offers.

Name .....

Address .....

#### FREE TRIAL—

#### NO RED TAPE

On receipt of first installment we will ship Table. Play on it one week. If unsatisfactory return it, and on its receipt we will refund your deposit. This insures you a free trial. Write today or mail the attached coupon.

## Cannot Possibly Leak

Our new idea cap locks pen when not in use, making leakage impossible.

An Ideal Pen for general use

**FREE**

liberal supply of ink free with retail orders.

J. C. ULLRICH & CO. 27 Thames St., New York

### Independent Safety Fountain Pen

Two lengths, 4 and 5 in. Can be safely carried in any position in pocket or bag.

No. 202 with No 2 gold pen, \$1.50

No. 205 with No. 4 gold pen, \$2.00.

Postpaid

Agents Wanted

## Remington Arms—Union Metallic Cartridge Co. Arms and Ammunition

299 Broadway, New York

### HOFFMAN'S PAT'D DRAWING BOARD BRACKET FOR Artists, Illustrators, Designers & Draftsmen

Attach to table or desk. Adjust any height, to draw standing or sitting. Adjust any angle. The board revolves. A strictly first-class article. Neat, Strong, Firm, Durable. Made of steel and iron, handsomely finished. Weighs 6½ lbs.; will support a board 30" square. 30 days free trial. Write for booklet H 25. A. HOFFMAN & CO., 51 Kenwood Ave. Rochester, N. Y.



### DRAWING OUTFIT COMPLETE. Special \$3.80

Outfit consists of Board, T-Square, Triangles, Fine Set of Instruments, Scale, Tacks, Pencils, Rubber, Curve, etc. Buy your boy this outfit and start him off to become an Edison or Westinghouse. Don't waste your good money on instruction, unless you yourself can see that the boy has mechanical ability. Better outfits for \$5.80, \$8.75 and \$12.50. Sent on receipt of price. Send for circular. Agents wanted in every town to represent us. E. G. RUEHLE & CO. Largest Manufacturers. 30-32 Clinton St., Newark, N. J. 119 Fulton St., New York, N. Y.

rings, without salt or yeast, and is first submitted to a process of steaming, after which it is baked lightly, the finished product being very hard and tough. The natives drop the rings into hot tallow and this tallow bread is used for soup or eaten with tea, but can also be utilized for candles, and travelers sometimes employ it as an impromptu fuel for boiling coffee. Another



## TYPEWRITERS ALL MAKES

All the Standard Machines SOLD or RENTED ANYWHERE at ¼ to ⅓ MFR'S PRICES, allowing RENTAL TO APPLY ON PRICE. Shipped with privilege of examination. Write for Illustrated Catalog L.

TYPEWRITER EMPORIUM, 24-26 W. Lake St., CHICAGO

### Greatest Bargains in History of Typewriters



Underwoods, \$30.00; Oliviers, \$25.00; L. C. Smiths \$37.00; Remingtons, \$15.50; Smith Premier, \$16.50 and other makes \$10 and up. Expert repairing and rebuilding. Every machine in perfect condition and guaranteed two years. Write for our liberal free offer and cut rate prices.

All-Makes Typewriter Exchange Co., 157 N. Clark St., Chicago

## ABOUT MUSKROO



How to really make big money in mushroom rooms, is fully explained in the new book, "The Truth About Mushrooms," a great revolutionary improvement on many growers never knew before. Explained from A to Z, at first by the greatest practical authority in America, \$70 a week to your income. Demand ever growing in cellars, sheds, boxes, etc. Start now. Profits bigger and quicker. Anyone can do it. Women and children can do it.

Now is best time. Send for free book.

Bureau of Mushroom Industry, Dept. 115, 1342 N. Clark St., Chicago

Over 80,000 in Use Mostly sold by recommendation. For Personal Desk or General Office.

It checks mental calculations. Handsome Morocco case free. Buy Thru Your Stationer. Write for 30 day trial offer. E. Gancher, A. A. M. Co., 119 W. Broadway, New York City.

### Golden Gem Adding Machine



Multiplies - Subtracts

Agents Wanted

# MY NEW PLAN OF SELLING

Any honest man, no matter where he lives in the U. S., can have a WITTE engine suitable to his needs, on any easy, reasonable terms.

Sizes are 1½, 2, 4, 6, 8, 11, 12, 15, 20, 25, 30 and 40 H-P. Styles—Stationary, Skidded, Portable, and Special Sawrags. I ship on

**60 Days Free Trial**  
AND GIVE A  
**5-Year Guaranty**

with every engine. I have manufacturing advantages (among them, Natural Gas from my own well, that gives me free power, heat, and light), that make my cost of production less than in any plant I know of.

I share my advantages with every customer, in lower prices for strictly highest-standard engines.

I can and do give a more definite and binding guaranty than any I have seen from any other manufacturer.

No man can say he can't afford an engine, until he has read my new book and considered my selling plan.

**Ed. H. Witte**



Why pay two prices for a good engine, or take chances on a poor or unknown engine, when the WITTE costs so little?

# Engine Prices D-O-W-N-Another Notch!

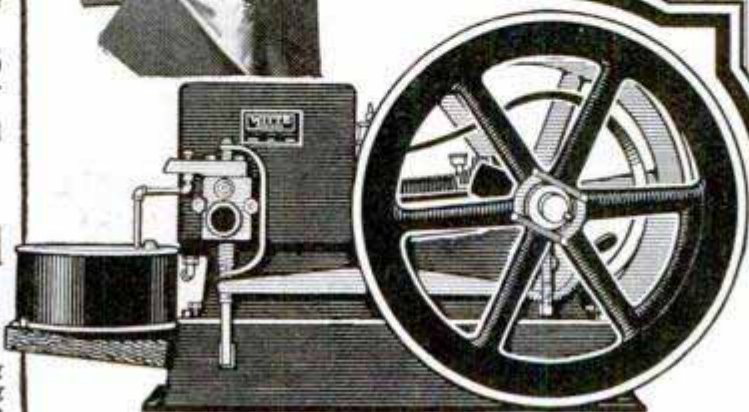

## WITTE ENGINES Kerosene, Gasoline, Gas.

**Sold only Direct from my Factory Doors to the User's Hands!**

Get your engine from an engine specialist. All my life I have done nothing but make engines. **The success of my customers and nothing else, makes my success.**

My factory is the only one, that started in the engine business 27 years ago, which has come through successfully under the same management with which it started.

Only WITTE engine-quality has made that possible. I challenge anyone to show stronger proof of reliable engine-quality.

The test of time on a business, is the most severe that can be applied. Time tests, not only engine-quality, but it also tests the manner in which a concern lives up to its contracts and promises.

I take special pride in the fact that over 75 per cent of all my orders come from and through my old users—customers. (I have no agents). I have had no trouble to keep in the lead in engine-quality. I had only to be honest, to hold the respect and good-will of my customers. But I needed an extra-well equipped factory, to lead in low prices. Now, after many years' struggling, I am able to make engine prices **lower** than anyone has ever done, for dependable engines. I have "revised prices downward," while WITTE quality still leads.

## Get My Complete New Offer— All Sent FREE with My New Book!

I don't consider any sale closed until the engine has made good—sold itself under actual test in the user's hands. Under my New Plan, you are sure of knowing what any engine ought to do, besides knowing what my engine can do, before you finally decide to buy. You know, when you get a "WITTE," that its 5-year guarantee will be good in the fifth year, as well as in the first year, and that the engine will give life-time service.

### MOST UNDERSTANDABLE ENGINE BOOK FREE.

Let me show you by my Great New Book, how to judge an engine; how to pick out the engine that is best for your work; in short to lay bare to you the secrets of the engine business, by which double prices are charged and collected for lowest grade engines. If you don't say it is worth dollars, I'll pay postage to get it back. Write me now for your FREE BOOK.

**ED. H. WITTE,**  
**Witte Iron Works Co.,**  
1749 Oakland Ave., Kansas City, Mo.  
Pronounced "Wit-tee" to rhyme with "City"

NAME.....  
ADDRESS .....

SOME OF THE NEW PRICES	
2 H-P.	
4 H-P.	\$ 39.45
6 H-P.	75.50
8 H-P.	99.35
11 H-P.	149.90
20 H-P.	218.90
	389.50
OTHER SIZES PROPORTIONALLY LOW UP TO 40 H-P.	

### FREE BOOK COUPON

**ED. H. WITTE,**  
**Witte Iron Works Co.**  
1749 Oakland Ave., Kansas City, Mo.

Without cost to me, and with no obligation on my part, I should like to receive your latest and finest Engine Book, and to investigate your New, Liberal Selling Plan!

SEND THE FREE BOOK COUPON TO-DAY.

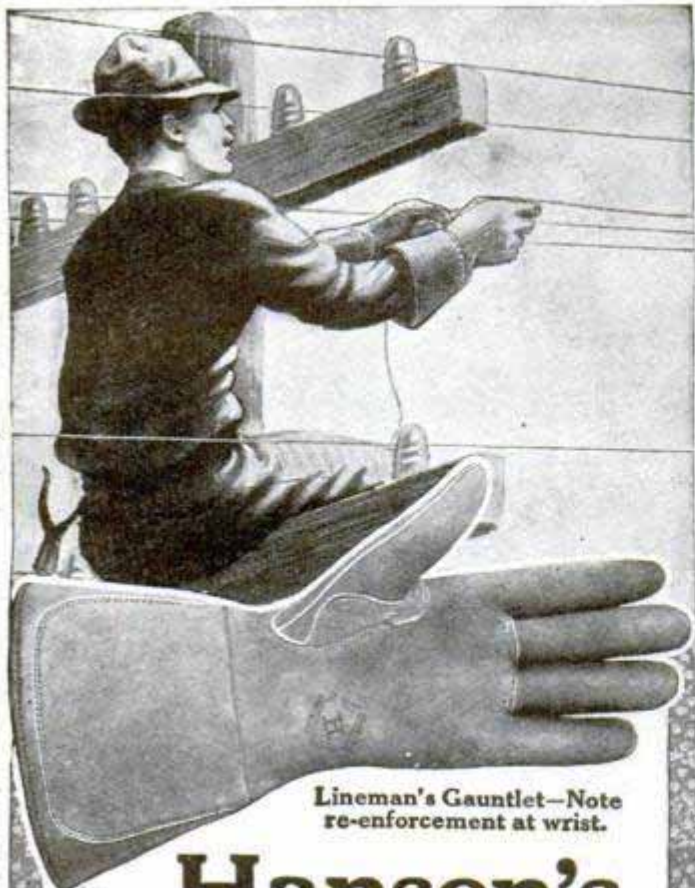

Lineman's Gauntlet—Note re-enforcement at wrist.

# Hansen's Is the Glove of Independent Action

The specialized build of Hansen's Gloves for every man at every work allows automatic and instant control of fingers and fist.

They amply protect you from injury and weather. 500 styles and all sizes for autoists, cyclists, railroad men, farmers, miners, iron-workers, etc.

Hansen's leather is specially tanned horsehide, which will not shrink, shrivel, crack or peel. Gives long wear, a perfect fit and flexible control. Washing in gasoline leaves them soft and shapely.

Our Free Book describes the line, a line of individual comfort; gloves built for you. If your dealer is not a Hansen man, we will tell you where to buy.

**O. C. HANSEN MFG. CO.**  
291 Milwaukee St., Milwaukee, Wis.



**FREE TRIAL**  
No DEPOSIT  
No OBLIGATION

VICTOR

VICTROLA

Choose any Victor or Victrola and **six double face records** (12 pieces to play), from my complete illustrated catalog and I'll send just what you have selected to your home for a **FREE** trial.

Send no money—make no deposit—there are no strings to this offer. I want you to learn that you **need** Victor or Victrola music in your home. I can convince you of this by sending you the machine and the records of your selection, on free trial. And further—when you decide to keep it, pay for it on

## My Easy Payment Plan

As little as \$2.00 a month will buy a Victor or Victrola my way, and you pay me no more for it than if you paid spot cash anywhere else, for I charge you no interest and no premium.

Please understand—if you don't want the machine after the free trial, all you have to do is to ship it back **at my expense**—you are under no obligations to buy.

## My Complete Free Catalog

sent on request. Handsomely and fully illustrated—detailed descriptions of all machines and full list of records. A card will bring it—it is free. Write **now**.

**PETER GOODWIN, Pres.,**  
**PETER GOODWIN MERCANTILE CO.**  
Victor and Victrola Distributors.  
222 Century Bldg., St. Louis, Mo.

native custom is to bore holes in these hard rings and set wax tapers in the holes, thus constructing a primitive contrivance which will light and heat a small tent for an hour. The ringed bread is also used by

**HELP BOOST!**  
**PANAMA PACIFIC EXPOSITION**  
WEAR ONE OF THESE BEAUTIFUL SAN FRANCISCO 1915 WATCH FOBBS.  
SEND 25¢ TO E. M. JACOBS, 114 SANSOME ST., SAN FRANCISCO, CAL. AND RECEIVE ONE BY RETURN MAIL.

**\$200 and You Get This Superb Cornet**  
An astounding offer. Pay the balance at the rate of 10c a day. Free trial before you decide to buy.  
**WURLITZER FREE Band Catalog!**  
Send us your name and address. The 250-page book is free. Thousands of instruments are shown. Rock-bottom prices, easy payments. Generous allowance for old instruments. We supply the U. S. Gov't. Write today.  
**THE RUDOLPH WURLITZER CO.**  
Cincinnati, O. Dept. 1152 Chicago, Ill.

# There's Money in Agricultural Blasting

WE TEACH YOU FREE

Our extensive national advertising yields thousands of inquiries from farmers, orchardists, etc., who need blasters to clear land, blast ditches, holes for tree planting, tight subsoils, etc. More than twenty million pounds of agricultural dynamite used in 1913. We refer all inquirers to nearest blaster, supply free advertising matter and help you get the business. We want to start in this independent business, reliable men who have \$200 capital for tools, magazine, and running expenses. Write for free booklet No. 248-B.

Agricultural Division, Du Pont Powder Company, Wilmington, Del.

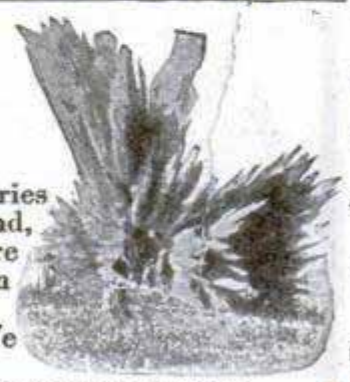



# GOING TO BUILD?

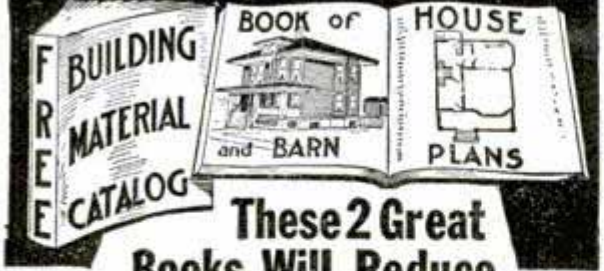

## These 2 Great Books Will Reduce Your Building Expense

A big 224-page Catalog of Millwork and Building Material, containing cuts and net prices of 8,000 money-saving bargains. A handsome Plan Book of Modern Houses, bungalows, summer homes, barns and ready-built garages, showing 60 splendid exterior views with floor plans, priced from \$30 to \$4000. Don't pay dealers' prices—we sell direct, factory to user. You can save money.

**\$1.75 for three by six feet Hot Bed Sash, Glazed.** Our catalog describes everything. Profit and pleasure in early vegetables.

Everything in lumber, flooring, roofing, doors, windows, mouldings, porchwork, building paper, lawn and home furnishings, hardware, paints, plumbing, heating, fancy hardwood floors, metal ceilings, etc., all at wholesale prices.

Don't build, repair or remodel without these valuable books. We guarantee quality, safe delivery, satisfaction or money back. Write today for Catalog No. 103 and if you intend a new home, also get Plan Book No. 118. Both are Free.

**CHICAGO MILLWORK SUPPLY CO.**  
AMERICA'S GREATEST SASH AND DOOR HOUSE

1444 West 37th St., Chicago, Ill.

# Learn the new profession Tree Surgery



Not overcrowded and offers splendid and unusual opportunities to honorable young men. Ages 20 to 28. Students must have attended high school, be physically sound, and of good character. After completing two years' course, good men make large annual incomes. Positions guaranteed to good men after graduation. Every city, park, orchard and private estate needs an Expert Tree Surgeon. Positions open also with established companies or State and National Governments. Special attention to Fruit Growing. Tuition moderate, including first year's board. We pay salary second year. Write promptly for full particulars. Address the Secretary

**DAVEY INSTITUTE OF TREE SURGERY**  
Box 301, KENT, OHIO

# STILLWELL CALIFORNIA HOMES



FOR ANY CLIMATE

POSSESS STYLE, COMFORT AND REAL INDIVIDUALITY  
Practical. Save Steps.

## 3 BUNGALOW BOOKS FOR \$1

- "REPRESENTATIVE CAL. HOMES" 128 Modern One & Two Story Homes
  - "WEST COAST BUNGALOWS" 50—\$1600 to \$6000—Price 50c
  - "LITTLE BUNGALOWS" 28—\$300 to \$1400—Price 25c
- Inexpensive to Build  
Easy to Sell

Each book fully illustrated: photos, floor plans, descriptions, costs, etc. SEND TODAY. MONEY REFUNDED IF NOT SATISFIED  
**E. W. STILLWELL & CO., ARCHITECTS**  
4165 HENNE BLDG., LOS ANGELES

# Over 1/3 Off

This \$40.00 Set—Now \$24.80

Are you interested in Civil Engineering? Then take advantage of this great opportunity. Save over fifteen dollars on this complete and extensive work—the only books ever published covering the entire "Civil" field. These eight volumes cover the four great branches of municipal, structural, railroad and reclamation engineering, and constitute in themselves an engineering reference library which has found favor with colleges, technical schools, libraries, engineers and students throughout the country. From these books the beginner can fit himself to make a successful start in this field; the experienced engineer and the consulting expert will find them invaluable for ready reference.

## Cyclopedia of Civil Engineering

Contains 3,900 pages, 7 x 10 inches, 3,000 illustrations, full page photographs, plates, folding maps, diagrams, etc.; hundreds of valuable tables and formulas, carefully cross-indexed for quick, easy reference. Printed in large, clear type on special quality paper and bound in half red morocco, gold stamped.

### What These Books Cover

- Plane Surveying—Mechanical Drawing—Plotting and Topography—Railroad Engineering—Statics—Strength of Materials—Roof Trusses—Mill Building Construction—Cost Analysis in Relation to Engineering—Masonry and Reinforced Concrete—Steel Construction—Practical Problems in Construction—Bridge Engineering—Highway Construction—Hydraulics—Water Supply—Irrigation Engineering—Water Power Development—Sewers and Drains—House Drainage and Sanitation—River and Harbor Improvements, etc., etc.

**Shipped Free** Examine this great work before you send a penny. We want the books themselves, not what we say, to help you decide whether you need them. Merely on receipt of the attached coupon we send you the complete set, express prepaid. Take a whole week to look them over. Test them on some problems that have been bothering you. Then if you decide you want the set, send us \$2 within seven days after receipt and then \$2 a month until you have paid the introductory price of \$24.80. Otherwise tell us and the books come back without a penny of expense to you. But remember—it may be your last opportunity to get these famous books at this specially reduced price.

### Free Consulting Service

Besides the practical value of the library itself, you get a year's Consulting Membership free as a holder of these books. Our staff of civil engineers takes up and solves your problems and special difficulties, absolutely without cost to you. This privilege, which regularly sells for \$12, is yours for a full year free, if you take the cyclopedia. To find out how useful these books will be to you, you must see them. It costs nothing to look the set over. It does not obligate you in any way. We stand ready to take the books back without expense to you, if you are not pleased with them. Get the books. Examine them. Then make your decision.

### FREE COUPON Worth \$15.20 to You

American Technical Society, Chicago, U. S. A.

Please send me Cyclopedia of Civil Engineering for 7 days' free examination. If I decide to buy, will send \$2 in 7 days and balance \$2 a month until \$24.80 has been paid, when \$40 books and \$12 Consulting Membership will be mine. Otherwise will notify you and hold books subject to your order. Title not to pass until fully paid.  
Pop. Mech. 2-14

NAME .....

ADDRESS .....  
As I have had no previous dealings with you, I refer you to



Please Mention Popular Mechanics

# 2c a Week Pays Wash Bill!

Write for  
FREE Book

## Electricity or Water-Power Does the Work

### Just a "Twist of the Wrist" Starts or Stops the Machine!

The 1900 Motor Washers are now at work in thousands of homes. They are doing the work formerly done by women, at a cost of 2c a week for power! Saving thousands upon thousands of dollars in wash bills. Saving worlds of wash-day troubles. Leaving the women free to do other work while the machines are doing the washing.

## The 1900 Motor Washer



Doing the wringing with 1900 Electric Motor Washer

1900 Water Motor Washer Can be connected with any water tap instantly

### Washes a Tubful in Six Minutes!

Handles Heavy Blankets or Dainty Laces

The outfit consists of the famous 1900 Washer with either Electric Motor or Water Motor. You turn on the power as easily as you turn on the light, and back and forth goes the tub, washing the clothes for dear life. Then, turn a lever, and the washer does the wringing. All so simple and easy that it is mere child's play.

### A Self-Working Wringer Sent With Every Washer!

The motor runs Washer and Wringer. We guarantee the perfect working of both. No extra charge for Wringer, which is one of the finest made. Write for FREE BOOK and 30 Days' FREE TRIAL OFFER! Don't doubt! Don't say it can't be done. The free book proves that it can. But we do not ask you to take our word for it. We offer to send a 1900 Motor Washer on absolute Free Trial for an entire month to any responsible person. Not a cent of security—nor a promise to buy. Just your word that you will give it a test. We even agree to pay the freight, and will take it back if it fails to do all we claim for it. A postal card with your name and address sent to us today will bring you the book free by return mail. All correspondence should be addressed to



**1900 WASHER CO., 6133 Court St., BINGHAMTON, N. Y.**

OR, IF YOU LIVE IN CANADA, WRITE TO THE CANADIAN WASHER CO., 355 YONGE ST., TORONTO, CANADA.

(23)

## FACTORY TO YOU CLASS PINS

For College, School or Society  
Catalog with attractive prices mailed free upon request. Special offer, either style of pins here illustrated with any three letters and figures, one or two colors of enamel. STERLING SILVER, 30c each, \$3.00 dozen; SILVER PLATE, 15c each, \$1.50 dozen.  
BASTIAN BROS. CO., 278 Bastian Bldg., ROCHESTER, N. Y.



Siberian merchants as a counting apparatus for calculating small sums. The bread rings are strung on a cord and suspended above the dealer's counter. There are usually three lines of these, one representing rubles, and the other two, kopeks.

## Rapid Fireless Get My Cooker 1914 Special



A big saving in food bills, fuel, work—and food tastes better.

### 30 Days FREE Trial

Complete outfit aluminum utensils free. Covers and cooking compartments lined with pure aluminum. Dust-proof, odorless. Write for Free Book and direct-from-factory prices.

**WM. CAMPBELL CO.**  
Dept. 64 DETROIT, MICH.



**EVERYTHING** in Guaranteed Plumbing and Heating Supplies at wholesale. Our \$200,000 establishment behind our Guarantee. Send for complete Catalogue 61.

**J. HARDIN CO.,** 30 years at 4533-35-37-39-41-43 Cottage Grove Ave., CHICAGO

## BUY YOUR FURNACE \$10 DOWN \$10 A MONTH



Our monthly payment plan of selling direct saves you the dealer's profits and charges for installation. The

### Jahant Furnace

with the patented "Down Draft System" is best for residences, schools, hotels, churches, etc., because it delivers plenty of heat wherever and whenever desired at a saving of 1-3 to 1-2 in fuel bills. Install the Jahant yourself. We send complete outfit, freight prepaid with special plans, detailed instructions and all necessary tools for installation. Satisfaction guaranteed or money refunded.

Write for free illustrated book.

**THE JAHANT HEATING CO.**

168 Mill Street

Akron, Ohio

## Save 1/3 to 1/2 on Fuel Bills

## THE RANGE THAT BAKES

### The IMPERIAL



is the only range with Stone Oven Bottom "No-Odor" Hood and Dustless Ash Sifter

A perfect baker and fuel saver. Try it in YOUR OWN HOME—30 days—no expense to you. Freight prepaid—Credit if desired. No Dealers' Profits.

Write today for factory prices & free book on Ranges & Heaters.

The Imperial Steel Range Co.  
659 Detroit Ave., Cleveland, O.

## LIKE MOTHER BAKED

# POWER for YOU!



Power from within! Strength that is **more** than mere muscular strength—the strength of perfect health, abundant nerve force—the strength of the **perfect man** now within your reach through **Vibration!** Nine people out of every ten are only **half alive**. They exist—they do not really live. How about yourself. Listen—

## All the Benefits of Life—Strength—Youth

may be returned to you through **Vibration**. For **Vibration is Life itself**. It will chase away the years like magic. Every nerve, every fibre in your whole body will fairly tingle with the force of your own **awakened power!** Stagnation simply cannot exist. You are made over—new—from head to foot. Your blood is sent humming along through every vein, artery and tiny capillary. Poisonous matters in your system are **washed away**. Your self-confidence—your **self-respect**—are increased a hundred fold. Yes, **Vibration** will do all this and more, **much more**. And it is within your reach. You can enjoy its wonder-working powers right at home, right in the privacy of your own room. You can give yourself the same identical treatments that you would receive in the offices of the world's most famous specialists—all without extra charge.



**The White Cross Electric Vibrator**

is the result of years of work and experiment. It is absolutely perfect. If you have your house wired for electricity, you can connect it up as easily as an electric lamp; if not, it will run perfectly on its own batteries.

You may give yourself Swedish Movement, Vibrating Chair Treatments, Electric Baths, Faradic or Galvanic Electric Treatments—just such treatments as you would have to pay from \$2.00 to \$3.00 for—yours without charge through the White Cross Electric Vibrator.

### Special Offer for a Limited Time

For a short time only we are making a remarkable Special Introductory Offer on the White Cross Electric Vibrator, in order to place at least one of these splendid instruments in every city, town and village in the country—an amazing offer to those who write at once—amazing discounts—actual rock bottom prices direct if you act at once.

**FREE BOOK** Sign coupon and mail it today. Get our splendid big **FREE** book telling you all about the marvels of **Vibration**. Read what great scientists say. Post yourself on what it will do for you. Learn all about the **White Cross Electric Vibrator** and our limited offer. No obligations at all—send coupon, post card or letter today.

**LINDSTROM-SMITH CO.**

1100 S. Wabash Ave. Dept. 1192 Chicago

*We also manufacture electric irons, electric hair driers, electric stoves, etc., etc.*

Send for  
This Book

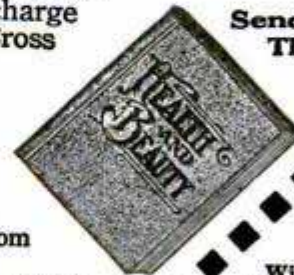

**FREE  
BOOK COUPON**

**LINDSTROM,  
SMITH CO.**

Dept. 1192  
1100 S. Wabash Ave.

Chicago, Ill.

Without any obligation at all, please send me, free and prepaid, your free book on **Vibration**, full particulars of the **White Cross Vibrator** and your **Special 60 Day Offer**.

NAME .....

ADDRESS .....

My Electrical Dealer's Name is .....

# One Day's Pay One Man's Work \$28.<sup>50</sup> With **This**

made by Jos. Hancock, Lamoni, Iowa. Schearer, Montana, made \$22.35 in 5 hours. Miller, Iowa, Made \$13.65 in one afternoon. We have **proof** of this and hundreds of similar reports. No matter who you are or where you live, here's your chance to double your present salary or income, working during spare time or permanently as a **one minute photographer**. No experience needed. A new, live business of big cash profits. You can work at home or travel, enjoy the healthful, outdoor work and become independent in your own business. Invest one cent for a postal—ask us for proof of what others are doing—of what you can earn with a

## Mandel Post Card Machine

A portable post card gallery. Takes, finishes and delivers photo post cards and buttons in a minute's time—makes five different styles of pictures in 3 sizes. No plates, films or dark-room. One minute pictures sell like wildfire. Everybody buys. Picnics, fairs, carnivals, busy corners, small towns and large cities—Big Money Everywhere.

## This Picture-Taking Outfit

gives you a complete, ready-made business that produces profits for you at once. You can make 100 to 200 sales a day, easy. Each sale brings 8c to 16c clear profit. Small capital. Sale of first supplies brings back practically your entire investment. Write at once for full particulars FREE.

The Chicago Ferrottype Co.

51 Ferrottype Bldg., Chicago; or  
Dept. 5A Public Bk. Bldg., New York



## Your Picture in a Postal Card IN ONE MINUTE

The pictures are developed, toned and finished in a single developing solution. No experience is necessary. Price of machines \$7.50 and \$15.00—circulars describing our machines sent free. We are also headquarters for supplies for all minute picture machines.

AMERICAN MINUTE PHOTO COMPANY  
Desk E 695, 2214 Ogden Ave., Chicago, Illinois  
The largest manufacturers and distributors of minute picture machines and supplies in the world.

## AGENTS: \$6 PER DAY AND UP

### MEN AND WOMEN

Out of work? Got a lot of spare time? Handling a poor line now? We want an active man or woman in each town to open an agency for our famous

## NON-ALCOHOLIC FOOD FLAVORS

Colors, Soaps, Perfumes, Toilet Preparations, Etc. Over 100 different varieties. Flavors put up in tubes, not bottles. Fast sellers, steady repeaters. Every home a customer. Commissions paid in real money—\$4, \$6, \$8, \$10 a day. Little or no capital required. Experience unnecessary. Full instructions for beginners. Fine light sample case furnished. Write for full particulars FREE.

American Products Co., 5469 Sycamore St., Cincinnati, O.



ACT  
QUICK  
WRITE  
TODAY

## \$8,000 to \$10,000 YEARLY



## Make Money Out of Others' Fun

Pleasing the Public Pays Big Profits and owners of our famous attractions frequently make from \$8,000 to \$10,000 every year. We make everything in the Riding Gallery line from a hand-power Merry-Go-Round to the highest grade Carouselles. Bring in hundreds of dollars daily. It is a delightful, attractive, big paying, healthful business. Just the thing for the man who can't stand indoor work, or is not fit for heavy work.

Just the business for the man who has some money and wants to invest it to the best advantage. Our goods are the finest appearing, easiest running, and most attractive line manufactured. They are simple in construction and require no special knowledge to operate. If you want to get into a money-making business write today for catalog and particulars.

## HERSCHELL-SPILLMAN CO.

Park Amusement Outfitters  
333 Sweeney St., N. Tonawanda, N. Y., U.S.A.

## ORIGIN OF SATURDAY HALF HOLIDAY—

The Saturday half holiday, although usually regarded as a modern innovation and attributed to the work of the trades unions, is in reality only a revival of old laws of the 15th century, when, because cleanliness was regarded as an essential of godliness, workmen were allowed the Saturday afternoon to clean up for church-going on Sunday.

## Make \$25 a Day—Be Your Own Boss

\$7.50  
and up



You can easily do it with our wonderful new invention. Every dime you take in, you make 8c net profit. The

### DIAMOND POST CARD GUN

is an unique metal camera—takes official size post cards and button photos, 4 sizes, without the use of films, dry plates or dark room.

Just Click the Bulb, and Deliver the Picture takes one minute—it's easy.

BIG MONEY awaits you at Beaches, Parks, Fairs, etc. No experience needed. Send for FREE Illustrated Booklet at once.

International Metal & Ferrottype Company  
2230-A, West 12th St. Chicago, Ill.



## FREE TRIAL ASTLEY'S LAMP

in your own home. One cent per night gets a wonderful 300 c. p. light. The Rich Art Glass Dome, brilliancy, and economy make quick, easy sales—big profits. Agents coinng money. Write Dept. 10 for Special Advertising Offer on first lamp sold in new localities. Numerous styles.

ALLEN-SPARKS GAS LIGHT CO., Lansing, Mich.

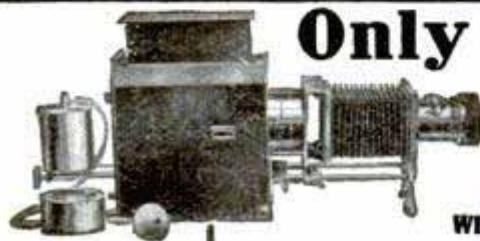

## Only \$36.00

## The Wonderful ILLUSTRATOR LANTERN

With our improved famous ALCO RADIANT LIGHT.

This new 1913 Model has many improvements and double brilliancy. Write for illustrated circular of this and Lanterns of all styles and lights at bottom prices.

IF YOU OWN A LANTERN we should have your name to mail to you our regular announcements of new slides and lecture sets. 75,000 Lantern Slides to rent.

POST CARD MAGIC LANTERN reflects image of postcard or any other picture or object. Prices, \$2.75, \$12.50, \$25.00, \$60.00, express paid.

WILLIAMS, BROWN & EARLE, Inc., 918 Chestnut St., Philadelphia, Pa., Lantern Dept. 20  
Engineering, Microscope, Optical, Scientific, Photo Lantern Slide Supplies

# WANTED-IDEAS

Manufacturers are constantly writing me for patents procured through me. The demand for good ideas

## Protected by Owen Patents

is greater than ever before. Send for my free books and read the letters from the greatest manufacturers in this country. Read their requests for Owen Patents and see for yourself what ideas they want. You can help supply the unceasing demand for good inventions.

My clients are provided with manufacturing facilities, and I aid them in many ways, without charge, to sell their patents. Applications filed through me advertised free.

You will get a strong patent or I will get no compensation. Your interests are my interests.

# FREE!

A simple request will bring you the following three finest patent books published absolutely free—you will incur no obligation by writing me.

"SUCCESSFUL PATENTS"—a new 72 page guide book; tells how to proceed to be successful; describes my advantageous business methods.

"STEPPING STONES"—gives lists of over 200 inventions wanted; gives forecasts from interviews of Edison and many other authorities; tells the plain truth about prizes of millions of dollars for inventions.

"PATENT PROMOTION"—tells you how to promote your invention; why some inventors fail; the value of your rights, etc.



Write for these books today—NOW! Advice costs nothing

### VERY HIGHEST REFERENCES

Columbia National Bank,  
Washington, D. C.  
National Locktile Co.,  
Washington, D. C.  
The Carnahan Press,  
Washington, D. C.  
Lightning Gun & Cycle Works  
Oklahoma City, Okla.  
Antholene Mfg. Co.,  
Hutchinson, Kans.

National Rack Co.,  
61 Hannover St.,  
Boston, Mass.  
The C. J. Loftus Co.,  
13 Spring Common,  
Youngstown, Ohio  
Whitehead Hosiery Mills,  
Burlington, N. C.  
Dickinson Mfg. Co.,  
Des Moines, Iowa.

And an immense number of others whose letters are printed in my booklets.

### SPECIAL!

Send me a sketch or model of your invention and I will make a search of the U. S. Patent Office Records **FREE OF CHARGE** and report to you concerning patentability, practicability, etc.

Your work will receive my **PERSONAL** supervision—but my fees are no higher than others.

**RICHARD B. OWEN** 9-303 OWEN BLDG.  
WASHINGTON, D. C.

Inventors submitting their inventions to me are protected in a tangible manner until their applications are filed.

# PATENT YOUR IDEAS



*—There is a Constant Demand  
for Good Inventions*

Thousands of the biggest money-making inventions have been the "little" things that have made people wonder why they were never thought of before.

## "WHAT TO INVENT"

*and*

## "HOW TO OBTAIN A PATENT"

*These Books Sent Free*

If you have an invention send us a sketch, photograph or model of it. We will give you a report as to its patentability absolutely free. If you have no invention send for our book, "What to Invent." It contains hundreds of valuable suggestions. We are recognized authorities on patent matters and have helped hundreds to find a ready and profitable market for their ideas. We can prove it. If you wish to sell your patent we will advertise it in manufacturers' journals at our expense.

*Don't Wait—Find Out NOW!*

Your idea will never do you any good if some one else patents it ahead of you. Act quick! Let the other fellow say "he thought of it a long time ago." You reap the profit. Let the others wish they had.

*Advice Free—All Matters Confidential*

We have secured patents for thousands of inventors and have many letters proving the value of our services. Write us. Send rough drawing or model of your invention for our opinion. We will guard it carefully and report quickly. You are under no obligations to proceed further. Our plan is simply a square deal to all. Our books, "What to Invent" and "How to Obtain a Patent" are the best publications written for the man who has an idea to patent, or who is of an inventive turn of mind. They show just how to proceed with your idea and tell of hundreds of things to invent. We gladly send these books free. The sooner you write for them the sooner you will know all about patents and the many different lines in which new inventions or improvements may be made.

*If you have an invention send us a sketch of it for report and ask for the books at the same time.*

**CHANDLEE & CHANDLEE, 945 F Street, Washington, D. C.**

REGISTERED ATTORNEYS

(Combined with H. Ellis Chandlee & Co.)

# Patents

**Trade Marks and  
Copyrights Secured  
or Fee Returned**

## Special Offer—Free Search of Patent Office Records

Send us a model or sketch and description of your invention, and we will make a *Free Search* of the *Patent Office Records* to ascertain if it is patentable. If we report the invention patentable, we will guarantee to obtain a patent or return our fee, and furnish a certificate of patentability backed by a bonded contract to that effect. **This Certificate of Patentability will protect the inventor and serve as proof of the invention until the case can be filed in the U. S. Patent Office.**

### Obtaining Assistance for Inventors

Our certificate is of great assistance to inventors who require financial aid to obtain patents.

### Our Five Books Mailed Free

(SEE COUPON BELOW)

to any address. Send for these books—the finest publications ever issued for free distribution.

#### How to Obtain a Patent

Our illustrated eighty-page Guide Book is a book of reference for inventors, and contains 100 mechanical movements illustrated and described.

#### Money in Patents

Tells how to invent for profit, and gives history of successful inventions.

#### What to Invent

Contains a valuable **LIST OF INVENTIONS WANTED** and suggestions concerning profitable fields of invention; also information regarding prizes offered for inventions, among which is

#### Prize of One Million Dollars

offered for one invention, and \$10,000 for others.

#### Patents That Pay

Contains letters from our clients who have built up profitable enterprises founded upon patents procured by us; also endorsements from prominent inventors, manufacturers, Senators, Congressmen, Governors, etc.

#### We Advertise Our Clients'

#### Inventions Free

In a list of Sunday newspapers with two million circulation, in manufacturers' journals and in the *World's Progress*. Sample Copy Free. We save you time and money in securing patents. After the patent is granted we assist you **TO SELL YOUR PATENT.**

#### Foreign Patents

**WE HAVE DIRECT AGENCIES IN ALL THE PRINCIPAL FOREIGN COUNTRIES** and secure **FOREIGN PATENTS** in the shortest possible **TIME** and at the **LOWEST COST**. Write for our Illustrated Guide Book on Foreign Patents, sent free to any address.

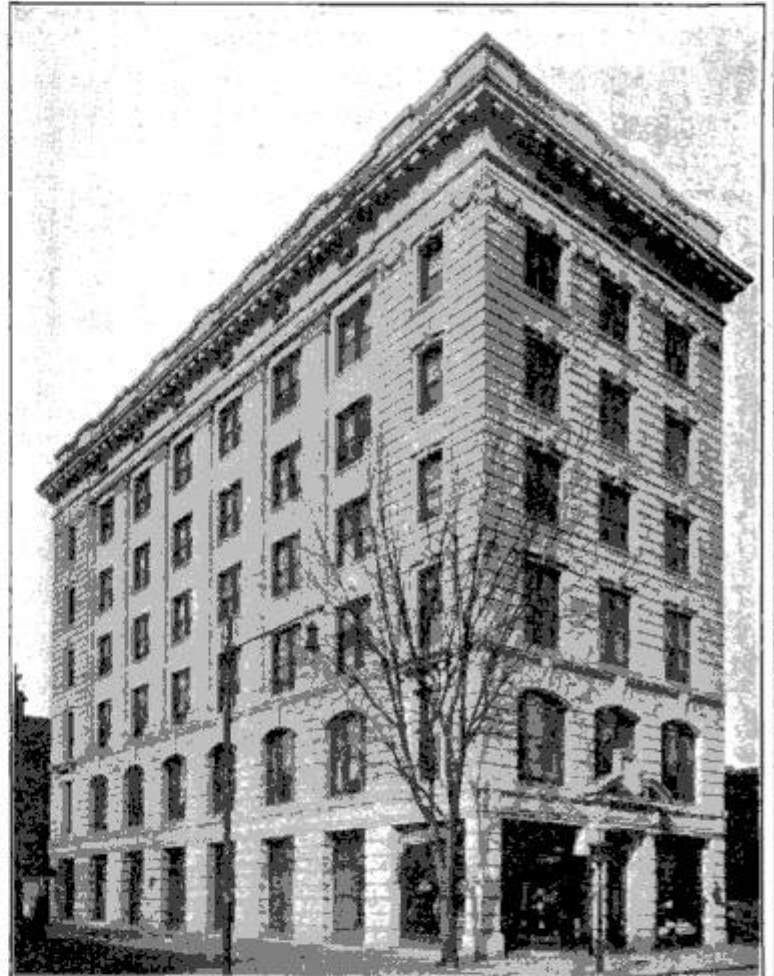

**VICTOR BUILDING**

Our new \$200,000 building opposite U. S. Patent Office  
SPECIALLY ERECTED by us for OUR own use

## WANTED NEW IDEAS

Send for **LIST OF PATENT BUYERS** who consult us when purchasing patents. Contains requests from **MANUFACTURERS, MAIL ORDER HOUSES** and **PROMOTERS** for patents secured by us, and suggestions as to **New Ideas** they wish to purchase. We invite manufacturers and promoters to address our Sales Department regarding the purchase or leasing of a number of meritorious patents secured by us.

### REFERENCES

Second National Bank, Washington, D. C.; Union Savings Bank, Washington, D. C.; Chamber of Commerce, Washington, D. C.; Pitner Gasoline Lighting Co., Chicago, Ill.; R. G. Dun & Co., Washington, D. C.; Smethport Glass Co., Smethport, Pa.; The Melvin Gauge and Signal Co., Scranton, Pa.; M. Winter Lumber Co., Sheboygan, Wis.; National Savings and Trust Co., Washington, D. C.

### FREE COUPON!

**VICTOR J. EVANS & CO., Patent Attorneys**

NEW YORK OFFICES: 132 Nassau St.

PHILADELPHIA OFFICES: 1429 Chestnut St.

**Main Offices: 724-726 9th St., N. W., WASHINGTON, D. C.**

GENTLEMEN: Please send me **FREE OF CHARGE** your **FIVE** Books as described above.

NAME..... ADDRESS.....

# PATENTS THAT PROTECT and PAY

Advice free. Terms reasonable. Highest references. Best results.

Send sketch or model for FREE examination and opinion.

Recommended Patent Lawyer in the Bankers' Register and special list of selected lawyers. Also in Martindale's Law Directory, Sharp and Alleman's Directory of Lawyers, The Gast-Paul Directory of Lawyers, and Kime's International Law Directory.

**ALL BUSINESS GIVEN PROMPT AND PROPER ATTENTION**

A large list of strong recommendations furnished free

**WATSON E. COLEMAN, Patent Lawyer, 622 F St., N.W., Washington, D.C.**

## PATENTS

**C. L. PARKER**  
Formerly Member Examining  
Corps, U. S. Patent Office  
**PATENT LAWYER**  
210 MCGILL BLDG.  
WASHINGTON, D. C.

Patents, Trade Marks, Copyrights, Patent Litigation

Handbook for Inventors, "Protecting, Exploiting and Selling Inventions" sent free upon request.

For Interesting and Valuable Information about  
**PATENTS WANTED**  
and bought by Manufacturers, send 6 cents postage for  
large illustrated paper *Visible Results* and Terms Book.  
R. S. & A. B. Lacey, Dept. Y, Washington, D. O. Estab. 1869.

**PATENTS TO BUILD ON**  
**H. L. WOODWARD, ATT'Y. WRITE FOR**  
**300 C. WASHINGTON. MY BOOKS**  
WHAT TO INVENT—WHAT NOT TO INVENT—HOW TO PROFIT



## AGENTS—BIG MONEY

Selling Guaranteed Steel Mantle Burners. Make coal oil produce gas. Every home buys. Experience unnecessary. Sample 25c. Particulars FREE. Write today.  
**STEEL MANTLE LIGHT CO., 396 Huron St., Toledo, O.**

Active Powers of Inventive Genius



**INVENTORS** Our Brain Belongs to You. Our Ideas Are Free of Charge.

All we want in return is to build your model, special machinery, dies, tools and figs to manufacture sheet metal goods, etc. We are expert mechanics, over thirty years experience and have one of the best equipped shops in the country. Ask for Booklet No. 17. Consultation free. Experimental work strictly confidential.

**A. NACKE & SON**  
236-242 S. 9th St., Philadelphia, Pa.



## BRASS GEARS

Cut by an entirely new process. The most accurate made and at prices that cannot be equalled by others. Every gear has a hub, center painted ebony black, edges turned true, highest grade red brass, and much heavier than others. We carry the largest stock in the world and every gear listed is always shipped on date of order.

SEND FOR CIRCULARS

**CHICAGO STOCK GEAR WORKS**  
16 S. Fifth Av. Chicago



The rapid development of Wyoming makes it safe for us to pay 6 per cent—because Wyoming legal 'nt. rate is 8 to 12 per cent. Our stringent banking laws give you the same protection you get at home. Why be content with 3 to 4 per cent when we will pay you 6 per cent. Resources over \$100,000. Write today for booklet.

**PIONEER TRUST and SAVINGS BANK** 12 Pioneer Street Basin, Wyo.



**MECHANICAL SUPPLIES and MATERIAL** of all kinds. EXPERIMENTAL AND LIGHT MACHINE WORK to order.  
132 MILK STREET. BOSTON

**GROWTH OF THE UNITED STATES IN CENTURY**—A century survey of the growth of the United States in population, commerce, and industry in the period 1800-1913 is given in a recent pamphlet by the Bureau of Foreign and Domestic Commerce.

In area the United States has increased from 892,135 square miles, in 1800, to 3,026,789, in 1913, and in population from 5,308,483 to 97,028,497, exclusive of the island territories now under the American flag. Meantime the production of basic articles of industry shows marked growth: coal, from 20 tons in 1814 to

## PATENTS THAT PAY—\$561,530 Made

by my clients. List Free of PRIZES OFFERED. 127 Page Patent Book—"What and How to Invent—Proof of Fortunes in Patents"—FREE.

**E. E. VROOMAN, Pat. Atty., 871 F St., WASHINGTON, D. C.**

## PATENT POINTERS

Things to know before applying for a patent:

1. Is my invention perfected or complete?
2. Is it new and patentable? If so, what will a patent cost?
3. Does it infringe any patent?
4. Is there a demand for such an invention?
5. Can a demand be created at reasonable expense?
6. What will it cost to demonstrate the utility of and demand for my invention?
7. Who are likely to be interested in the manufacture and sale of such inventions?
8. Where can I get reliable information and advice on the above points?

We will be glad to demonstrate to your satisfaction that we can render the service required to fully post you upon the above points.

**BENJAMIN AND BASSETT**  
Patent Attorneys and Mechanical Experts  
Provident Savings Bank Bldg., WASHINGTON, D. C.



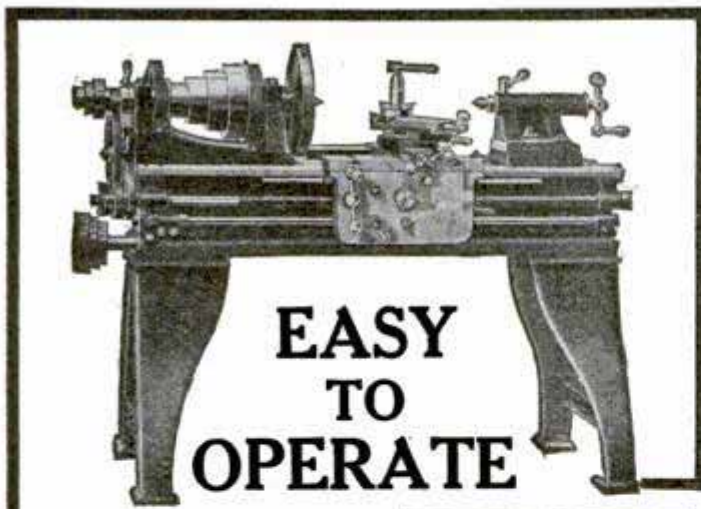

## EASY TO OPERATE

One doesn't have to be a machinist of long experience to operate a "Sebastian" Lathe. It is simple; has few parts; is easy to operate.

Particularly adapted for Garage, Automobile & General Repair Work.

### Lowest in Cost

We make nothing but Lathes. We are Lathe specialists. As the result we offer high grade Lathes at the lowest prices to be had. Investigate!

DROP A CARD FOR FREE CATALOG

## The Sebastian Lathe Co.

107 Culvert Street

CINCINNATI, OHIO

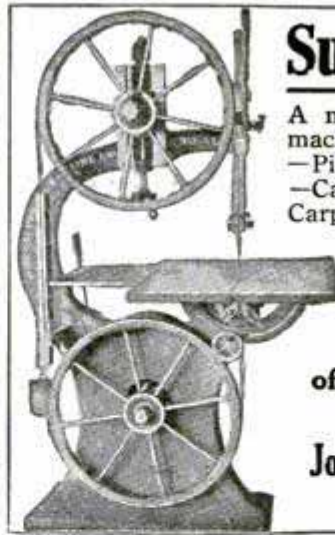

## Superior Woodworking Machinery

A modern line of woodworking machinery for Furniture Factories — Piano Factories — Box Factories — Cabinet Shops — Pattern Shops — Carpenter Shops — Wagon Shops — Repair Shops — Contractors — Manual Training Schools, etc. If interested write for our catalogue and net prices.

Largest manufacturers of woodworking machinery in Chicago.

Jones Superior Machine Co.

1266 W. North Ave., CHICAGO



## Jones Machine Moulded PULLEYS and GEARS

Clutches, Sprockets Shafting and Hangers

THE LARGEST LINE OF Power Transmitting Appliances IN THE COUNTRY

SEND FOR GENERAL CATALOGUE A 18 W. A. JONES FOUNDRY & MACHINE CO. 1400 North Ave. CHICAGO

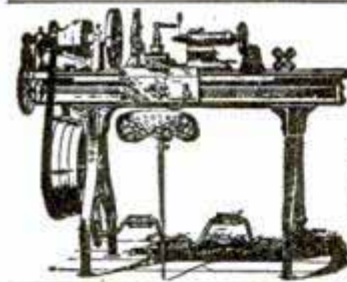

## LATHES

9 to 13-inch Swing

List price \$75 and up according to size. When ready to buy send for Lathe Catalog and prices.

W. F. & John Barnes Co. 100 Ruby Street, ROCKFORD, ILL.

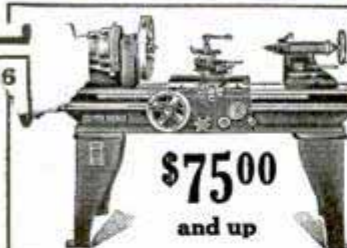

## South Bend Lathes

9 to 18" Swing Foot Power, Steam Power Electric Motor Drive Straight or Gap Bed

\$7500 and up

Write for Catalog and Price SOUTH BEND MACHINE TOOL CO. 423 Madison St., South Bend, Ind.

## Crescent Wood Working Machinery

satisfies particular users of band saws, jointers, saw tables, planers, shapers, swing saws, borers, planers and matchers, variety wood workers, Universal Wood Workers, disk grinders, band saw blades. Send for catalog giving complete description. It is free for the asking.

THE CRESCENT MACHINE COMPANY 3 Columbia St., Leetonia, Ohio

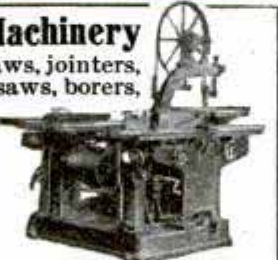

## STATIONARY Vacuum Cleaner \$115

Complete for house or flat. Last a life time. Same as we make for U. S. Government. Powerful frictionless, rotary pump. Motor 1/2 H.P. Noiseless, installed in basement. KOCH VACUUM MACHINE CO., Ann Arbor, Mich.



## A Splendid Oil in a Handy Can

The handiest thing a man can have within hands' reach is a Handy Oil Can of 3-in-One. With it he can "ease" a tight bearing, clean and polish steel or wood, and "slip one over" on rust and tarnish anywhere.

### 3-in-One oil

makes everything go easier and look better. All housefurnishing stores, drug stores, grocery, hardware and general stores keep it. 10c for 1 oz. bottle; 25c for 3 oz.; 50c for 8 oz. (1/2 pt.). The Handy Oil Can shown above holds 3 1/2 oz. and sells for 25c. If your dealer hasn't it, we'll send one by parcel post, full of good 3-in-One for 30c.

A Library Slip with every bottle. FREE — A generous sample and the 3-in-One Dictionary by mail. THREE-IN-ONE OIL CO. 42 CNG. Broadway New York



# \$300<sup>00</sup> IN ONE SEASON

Make it sharpening Lawn-mowers on the "Ideal" Lawn-mower Grinder.

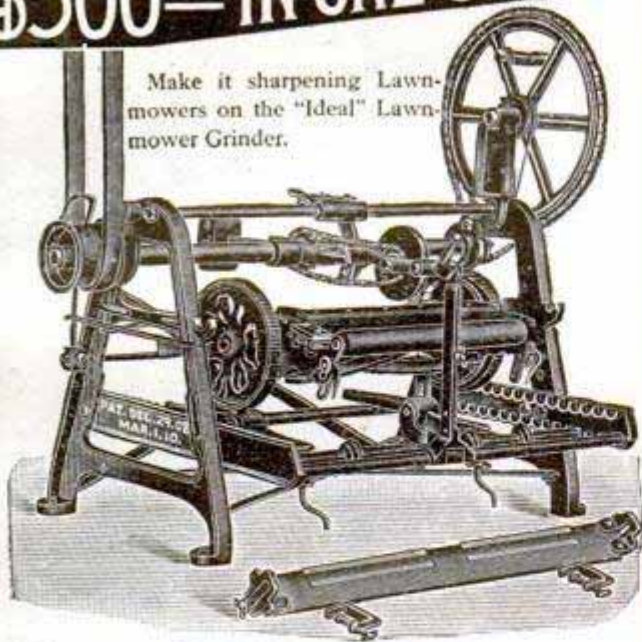

"You Grind It As You Find It"

Many have done better. Mr. Zabst, Mich., writes: "I sharpened 2178 mowers in 3 seasons at 75c to \$1.50 each." Mr. Stoy la., writes: "I ground over 500 mowers this season and expect to do better next year." Sharpens skates in winter, too. The best money maker you can have in your shop. Nothing like it on the market. Sharpens all makes of mowers perfectly in fifteen minutes. Over 6000 in use. Fully warranted. Write today for catalog and full information.

The ROOT-HEATH MFG. CO., Plymouth, O.

## STEEL Shingles

### Astounding PRICES!

Give size of roof and we'll quote, by return mail, the lowest price ever offered on STEEL Shingles. And these are the genuine Edwards. Can't burn or rot. Can't rust (due to Edwards "Tightcote" Process and patent Interlocking Device). Many times easier put on than wood, cost less and last four times longer. Over 125,000 satisfied users. Sold direct from factory to user. Freight prepaid. Write Edwards at once. If you can't give roof size, get prices anyhow. Ask for Booklet 250. (141)



### This Brings Big Offer

THE EDWARDS MFG. CO.  
200-250 Lock St., Cincinnati, Ohio

Please send Book on your Steel Shingles, together with latest Freight-Paid prices.

Name .....

Address .....

Please Mention Popular Mechanics

DO YOU HAVE KNIVES TO GRIND, SILVER TO POLISH, SMALL TOOLS TO OPERATE, WASHING MACHINES OR WRINGERS TO RUN? LET THE RED DEVIL

DO YOUR WORK

Attached to any water faucet will develop up to 3 Horse Power according to size of pipe and water pressure. Only perfect small motor made. Improved bucket wheel construction.

6 in. Motor for Mechanics and Tradesmen. Washing Machine, 1/2 H. P. on 1/2 in. pipe, 80 lbs. water pressure; 1 H. P. on 3/4 in. pipe, 2 in. pipe. Net price \$5, cash with order.

No. 1492 - 4 in. Motor for grinding, polishing, fans, sewing machines; for Doctors, Dentists, Druggists, etc., with emery, buffing wheel, silver polish and pulley, \$3.

No. 1493 - 4 in. Motor and pulley only \$2.50, cash with order. Money back for any reason. Order your motor from dealer or from us. Send your water pressure and size of supply pipe. Active Agents wanted. Catalog free.

Only Motor to do this work



DIVINE WATER MOTOR CO.  
DEPT P. UTICA, N.Y.

## A Water Supply without operating expense and at low first cost may be secured with a RIFE RAM

The ram is operated automatically by the flow of 3 or more gallons per minute from a stream, artesian well or spring having a head or slanting fall of 3 or more feet. It will deliver any quantity of water where you want it. Free information on request.

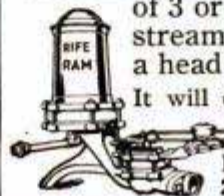

RIFE ENGINE COMPANY  
2131 Trinity Bldg., New York City

477,000,000, in 1912; pig iron, from 54,000 tons in 1810 to 30,000,000, in 1912; copper, from 100 tons in 1845 to 558,000 in 1912; petroleum, from 84,000 gal. in 1859 to over 9,000,000,000 gal. in 1912; cotton, from 73,000 running bales of 500 lb. each in 1800 to 14,000,000, in 1912; wheat, from 84,000,000 bu. in 1840 to 730,000,000, in 1912; and corn, from 378,000,000 bu. in 1840 to over 3,000,000,000, in 1912; while similar increases are noted in other products of agriculture, mining, and manufacture.



LEIMAN BROS. ROTARY VACUUM-PUMPS AND BLOWERS for Vacuum Cleaning, Melting, Forging, Soldering, Sand Blasting. Take up their own wear. LEIMAN BROS., 62P John St., New York

OVER 65 YEARS' EXPERIENCE

# PATENTS

TRADE MARKS  
DESIGNS  
COPYRIGHTS, &c.

Anyone sending a sketch and description may quickly ascertain our opinion free whether an invention is probably patentable. Communications strictly confidential. **HANDBOOK** on Patents sent free. Oldest agency for securing patents. Patents taken through Munn & Co. receive special notice, without charge, in the

## Scientific American.

A handsomely illustrated weekly. Largest circulation of any scientific journal. Terms, \$3 a year; four months, \$1. Sold by all newsdealers.

**MUNN & CO. 359 Broadway NEW YORK**

Washington Office, 625 F St., Washington, D. C.

# Could You Improve Your Work?

Maybe you could if you are not a thoroughly experienced mechanic, but we know you could do more work and keep the quality up to your requirements if you had a complete equipment of

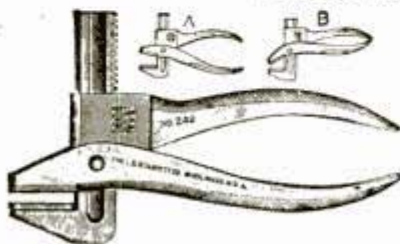
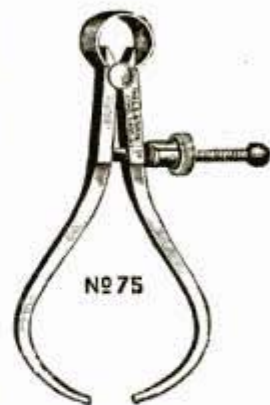
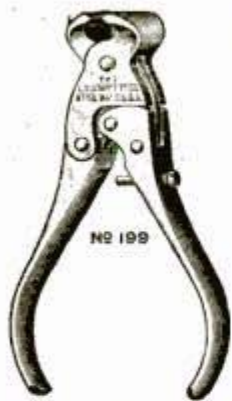

There is a Starrett for nearly every purpose. There are micrometers, rules, and gages for fine measurements; protractors, squares, levels for laying out work; and expansion pliers, cut nippers, screw-drivers, and ratchet wrenches for your various other needs.

No ad. can do these tools justice nor give you any conception of the variety of tools we make. Send us your name and we will mail you our 320-page free catalogue No. 20A.P., because it shows the full line with the prices. Write now.

ALL GOOD HARDWARE STORES CARRY STARRETT TOOLS

**THE L. S. STARRETT CO., Athol, Mass.**

42-180



## Portable Cases

FOR TOOL MAKERS AND MACHINISTS

Twelve styles, felt lined drawers, solid brass trimmings, best of material, beautiful finish, low prices, satisfaction guaranteed. Ask for booklet of cases built for service.

**The Pilliod Lumber Co.**  
SWANTON, OHIO

**\$1.00**

Postpaid  
**Myers' Wonderful Sewing Awl**  
sews leather, canvas, shoes—anything, heavy or light. Complete repair shop in itself. Saves many trips to town. Mends harness, saddles, wagon covers, blankets, buggy tops, belts, etc. Can't get out of order. Original and only awl with diamond point full grooved needle to protect the thread. **BIG MONEY FOR AGENTS.**  
**C. A. MYERS CO., 6339 Lexington Ave., Chicago, Ill.**

**YOU** can dig 40-foot wells quickly and in any ground with our outfit costing but \$12.00 delivered, east of the Mississippi.

Write today for our large descriptive circular, enclosing 2c stamp

**STANDARD AUGER CO.**  
1128-A Newport Ave., CHICAGO, U.S.A.

**Duplicate Keys for all Pin Tumbler Locks can be made in a minute with The Harrison M. I. P. Key Filing Machine**

Invaluable for Machinists, Building Superintendents, Hardware and Repair Shops, Locksmiths, Carpenters, Electricians, Garages, etc. Anyone can make a perfect duplicate key without injuring the original. A customer writes:—"We made 60 keys in one hour and 15 minutes. Can you beat it?" Every machine unconditionally guaranteed, money refunded if not entirely satisfactory. Price \$3.00 net. Send us P. O. order or N. Y. draft and receive the complete machine by return Parcel Post. Special diamond shaped files for angular keys 35c each or 4 for \$1.00. Testimonials sent on application.

**HARRISON & COMPANY, 81 1/2 New Street, NEW YORK**

## BENCHES

For the Shop and Home Use

Many designs shown in our catalog. The best of material and construction is used, making our benches the highest quality.

**Grand Rapids Hand Screw Co.**  
1620 Front St., GRAND RAPIDS, MICH.

**"AMERICAN" Key Cutter**

**ADD TO YOUR INCOME** With little effort you can make **\$5 to \$10** a day

The "AMERICAN" is the only machine on the market (barring none) that sharpens, hones, and strops razors, sharpens all kinds safety razor blades, scissors, clippers, pocket knives, surgical instruments, etc. No previous experience required. REMEMBER THE "AMERICAN" Key-Cutter is a little wonder. Cuts Square, Angular or Round slots.

**AMERICAN SHARPENING MACHINE CO. (Inc.)**  
Dept. 2 184 W. Washington St. CHICAGO

**"AMERICAN" Sharpener**

# Draughtsman! Do You Want

an accurate and reliable protractor that can be quickly set to any angle, can be used either side up; and on either of the two outside edges of the frame? If so, ask the nearest hardware dealer to show you a Brown & Sharpe, one like the cut. It is indispensable in dividing a circle, transferring or laying off a given angle, without resetting on either side of a line. It also forms a convenient T square and frequently takes the place of 45° and 60° angles.

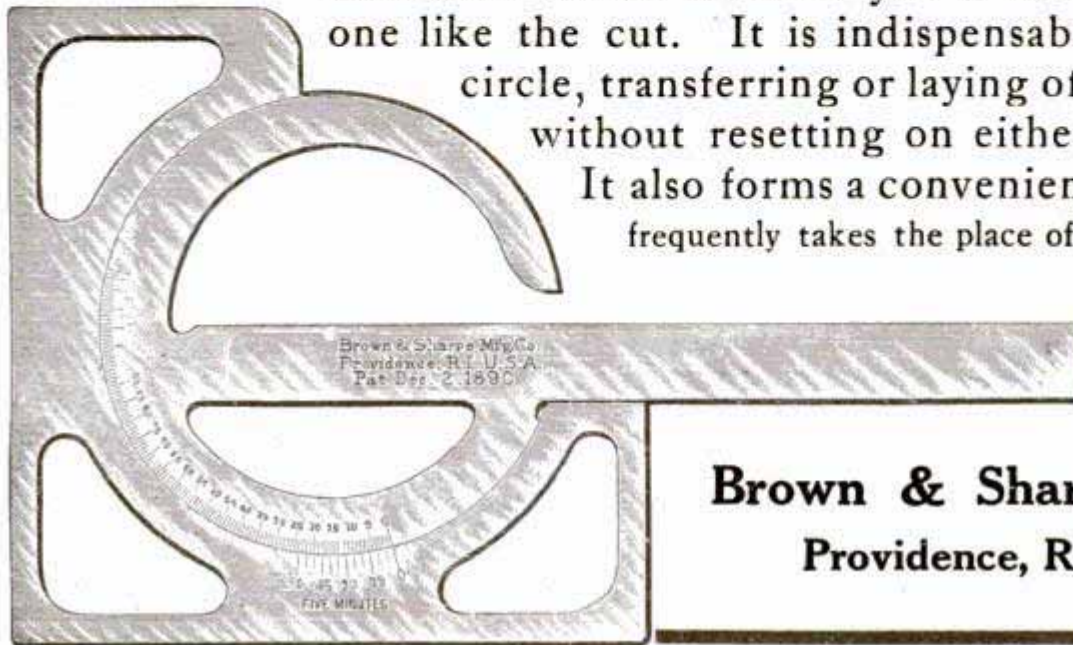

365 page catalog  
free for the asking.

Send for copy today

**Brown & Sharpe Mfg. Co.**  
Providence, R. I., U. S. A.



## HASKELL'S PATENT UNIVERSAL THREE JAW CLAMP

This Clamp will be found very useful to Pattern Makers, Cabinet Makers, Picture Framers, Carpenters and Machinists. The Sliding Jaw makes it very useful as you can hold any irregular work very firm, and the Clamp is worked by just a turn of the handle. You can remove the Sliding Jaw and use it as a Two-Jaw Clamp, the Toggle Jaws adjust themselves to any angle you wish to grip. By reversing the Toggle on the Sliding Jaw, you can grip any round article. This is a first class tool, all made of steel and finely finished.

MANUFACTURED BY

**M. A. HASKELL & CO.**  
12 Summer St., SOUTH BRAINTREE, MASS.

Price List Sent on Request  
AGENTS WANTED

## Red Devil Thin Nose Slip Joint

The  
Handiest  
Plier  
Ever  
Made



No. 1025

A drop forged steel plier, 6½" long, light in weight but substantial in construction; checked handles. Gun metal finish. ITS THIN NOSE is the new wrinkle. It will get into narrow places the old style could never get. You want it for your spark plug work and a million other occasions. It's a genuine RED DEVIL Tool. You can get it at your local dealer's, or to introduce we will send one sample pair only postpaid on receipt of 50c.

**SMITH & HEMENWAY CO.**  
151 Chambers St. NEW YORK, U. S. A.

**LARGE RUBBER BELT FOR CEMENT CONVEYOR**—A belt which is 700 ft. long, 2 ft. wide, and weighs 5,140 lb. was recently manufactured for use as a conveyor of hot cement. When rolled up, preparatory to shipping, the belt measured over 5 ft. across.

(ESTABLISHED 1873)

## Charles Buck Tools

Highest Award World's Columbian Exposition  
Highest Award World's Centennial Exposition

Send name of dealer and four cents  
in stamps for new art catalog.

**Charles Buck Edge Tool Co., Millbury, Mass., U. S. A.**

## THE MASTER SLIDE RULE,



the only RULE IN THE WORLD whereby inside measurements of doors and windows, etc., can be taken rapidly and accurately. Also superior to any other rule for outside measurements of walls and ceilings, etc., as it can be extended and closed instantly. **MECHANICS, BUILDERS, AND ARCHITECTS, TRY ONE TODAY! DON'T WAIT.** Ask hardware dealer for it.

On receipt of 15 cents per lineal foot, a 4, 5, 6 or 8 foot rule will be sent to you prepaid. Large profits to agents. Write for circulars and particulars. **DAHL MFG. CO. 51-A East 42nd St. NEW YORK CITY**

## GROBET SWISS FILES



Are the standard of excellence in files, and have been for over 100 years. We send post paid as an introducer 48 files especially adapted for tool makers and machinists on receipt of \$5.00. This is a chance to get a set of files you'll appreciate and we'll get future orders.

**MONTGOMERY & CO.**  
111 Fulton Street NEW YORK CITY

## Pete Says

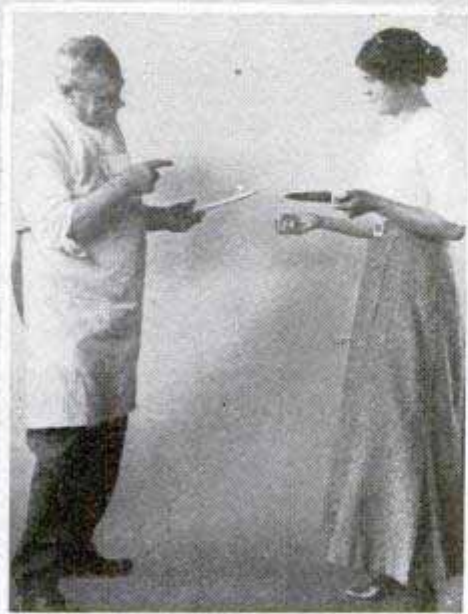

### “Introduce Carborundum Sharpening Stones Into Your Household”

**Y**OU who have used Carborundum Stones in your work-shop know how quickly they give a keen, smooth edge; how they always cut free and clean.—Introduce Carborundum into your home. The housewife will find the same cutting qualities in the Carborundum knife-sharpener — it will make every knife in the house a sharp knife.

A little combination bench stone, too, is mighty handy for all edge household tools. A good sharpening stone is a household need.

*From your hardware dealer*



**The  
Carborundum  
Company**  
Niagara Falls, N. Y.

*Please Mention Popular Mechanics*

## Adjustable Tension!

That's what makes this

### “YANKEE” No. 44 Automatic Push Drill

the great saver of drill points — time — trouble.

Turn the cap on the handle in this way—



and the spring is compressed or extended, making the point feed with more or less pressure as needed when working with large or small drills, or in hard or soft woods. Observe that the magazine in the handle holds the drill points upwards — they don't tumble out.



They're made for working efficiency, these clever —

## “YANKEE” TOOLS

*Make Better Mechanics*

Eight “Yankee” Drill-points  $\frac{1}{8}$  in. to  $\frac{1}{4}$  in. supplied in magazine in handle.

### “YANKEE” Automatic Drill No. 44, \$1.75

Your dealer can supply you.

*Write for “Yankee” Tool Book”  
for mechanics and handy men, or  
“Yankee” Tools in the Garage”  
for motorists.*



**NORTH BROS. MFG. CO.**  
PHILADELPHIA

## A dependable drop-forged Clamp for every purpose

You can't have had a cast Clamp without paying for its failures. "What's the use!" A Williams' "Light Service" Clamp may be had at a price which you must pay for most any kind of a cast Clamp. Go to your dealer for Williams' help.



"Light Service"  
7 sizes, Capacities 0 to 12"  
Quick acting, square thread Screw



Heavy Service  
"VULCAN"  
11 sizes,  
Capacities  $\frac{1}{4}$  to  
12 $\frac{1}{2}$ " U. S. Std.  
thread Screw  
Unyielding grip



Medium Service  
"AGRIPPA"  
7 sizes,  
Capacities  $\frac{3}{4}$  to 18"  
U. S. Std. thread  
Screw



"VULCAN"  
Tool Makers'  
Clamp  
4 sizes,  
Capacities 0 to 4"  
Removable  
Swivel Screw

Get Catalogue of dependable tools—see pages 119 to 134 and learn some of the story.

**J. H. Williams & Co.**

47 Richards St.  
BROOKLYN, N. Y. CITY

32e So. Clinton St.  
CHICAGO, ILL.

## You ought to have one of our Insured - "VANDOR" - Hammers

"VANDOR" Hammers are drop forged from Vanadium Steel, tempered in oil and are **Warranted Against All Defects for a Lifetime**

Attached to every "VANDOR" hammer is a numbered guarantee certificate, insuring lifetime service.

A "VANDOR" will bite and draw a headless nail that defies the claw of an ordinary hammer.

**Sent by Parcel Post Anywhere** - "VANDOR" -

Send us \$1 and your dealer's name. We'll ship the postpaid by return mail. Please state whether wanted for light or heavy work.

**VAN DOREN MFG. CO., Dept. 102, CHICAGO HEIGHTS, ILL.**  
Reference 1st Nat. Bank, CHICAGO



## "Ohio" Edge Tools

are made from specially selected tool steel, by careful and skillful workmen. They are tempered by the most improved process and are sold with a money back guarantee.

Insist on "Ohio" Tools when buying Planes, Chisels, Drawing Knives, Auger Bits, Screw Drivers, etc.

CATALOGUE FREE

**OHIO TOOL CO.** (Dept. 3)  
Columbus, Ohio



**INTERNATIONAL TRADE OF THE PACIFIC**—Two and one-third billion dollars' worth of imports entered the various ports of the entire Pacific in 1912 and their exports aggregate another two billion. These figures, compiled by the Bureau of Foreign and Domestic Commerce, relate exclusively to international trade and do not include the domestic traffic. Of the imports of these Pacific frontages, other than our own, the United States now supplies about 12 per cent; the United Kingdom, about 25 per cent; continental Europe, about 15 per cent; and India, about 10 per cent.



## Tool Cases for Toolmakers and Machinists

Keep your tools orderly arranged in a Gensler Portable Tool Case. There's a place for every tool in one of the felt lined drawers. Every up-to-date mechanic needs one and you'll find our Cases the best built, neatest and most practical on the market. We guarantee to please or refund all money.

*Gensler & Sons*

Mfrs. of Mechanic's High Grade Tool Cases  
818 Columbia St. DAYTON, OHIO

Write for our free booklet

## Makes Talking Machines Sound Life Like

## This is the Original and Genuine Morse Clarifier

A remarkable little device made to fit in tube adjoining reproducer of any make of machine. It renders the sound loud, clear, life-like and eliminates that unpleasant metallic effect. Easily inserted without marring or adjusting machine. Is everlasting.

**\$1.00 MAILED PREPAID**

Send dollar bill, 2c stamps or check at our risk.

**GUARANTEED** Absolutely satisfactory or money refunded.

Reference, any bank in Minneapolis. In ordering state whether for Victor, Victor-Victrola, Edison Cylinder with metal or rubber connection, Edison Disc, Columbia Disc, with new bayonet or former tone arm or Columbia Cylinder. Information matter free. Buy our extra fine imported needles, medium and loud. 5 cents per hundred postpaid.

**MORSE BROTHERS, Mfrs. and Distributors**  
550 Lincoln Building, MINNEAPOLIS, MINN.



# Stanley Tools

## "No. 34"

A Hand-Book full of interesting information for

- |                   |                       |
|-------------------|-----------------------|
| <b>Carpenters</b> | <b>Pattern Makers</b> |
| <b>Machinists</b> | <b>Cabinet Makers</b> |
| <b>Masons</b>     | <b>Millwrights</b>    |
| <b>Plumbers</b>   | <b>Wheelwrights</b>   |
| <b>Amateurs</b>   | <b>Householders</b>   |

It not only illustrates and describes over four hundred **Stanley Tools**, but also contains a number of very handy tables.

Convenient size to carry in the pocket.

Sent postage prepaid to any part of the United States or Canada without charge.

Ask for Catalog No. 34A

Address

**STANLEY RULE & LEVEL CO.**  
NEW BRITAIN, CONN. U.S.A.

**FAMILY EVENTS RECORDED IN MOVING PICTURES**—A number of French families have indulged in picture machines, and any number have called in professionals to take scenes at tea parties, family gatherings, and so on, the films of which are kept by the families and shown only to friends. This is a new development which, predicted last year in the Popular Mechanics Magazine, will no doubt find many supporters in this country.

### WE START YOU IN MOTION PICTURE BUSINESS

A Postal Card or Letter is all that it costs to learn how we do it. Many of our clients whom we started

#### WITH SMALL CAPITAL

are among the most successful exhibitors in the country. The business is just at the height of its prosperity—its profits are now the greatest—you can't fail to get your share if you start at once. **\$35 to \$50 and More Daily Profit.** Write today for our Plan & full Details.

**ATLAS MOVING PICTURE CO.**

Room 230, 508 South Dearborn Street, Chicago, Illinois

## NEW SLIDE RULE—MULTIPLIES—DIVIDES—ADDS—SUBTRACTS

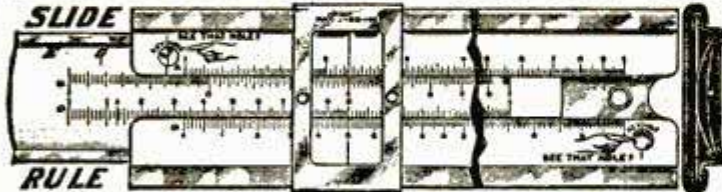

come up for solution by the Banker, Broker, Auditor, Inventory and Insurance Man, Cost Estimator, Paper Mfr., Contractor, Salesman, Manual Training Teacher, Time-Keeper, Bookkeeper, Lumber, Land, Marine, and other merchants too numerous to mention.

This Slide Rule will multiply, divide, add and subtract, solve proportion, extract the square and cube roots, find the decimal equivalent of vulgar fractions or "vice versa," calculate interest, percentage. Also the mensuration of superficies, and the rule of three. For Engineers, Electricians, Draftsmen, Superintendents, Master Mechanics, etc., the rule is indispensable in their work. It is one of the most valuable instruments ever offered to mankind. For Electricians it is a complete wire table in itself. The Richardson Direct Reading Slide Rule is specially designed for those who wish to learn its use, its operation being very simple. You simply place the key to the problem wanted in the keyhole. (The key is printed in red on slide, see cut) and answer is given direct; such as the Horse Power of Engines, Pumps, Boilers, Belts, Water Falls; size of duct for ventilating; radiation and size grate, and steam main; change gear and pulley problems; areas, circumference and diameter of circles. This Rule is my 1914 type now on the market for the first time. Made in two sizes, coat and vest pocket 10"x1 1/2"x1/4" and 5 1/2"x1 1/2"x1/4". 10" has Sine, Log, and Tangent scales. No wood in their construction, scales white celluloid, printed from engine divided plates in two colors, and washable, secured by an improved locking device in Metal framing. Blackened to ease the eyes.

Price 10" Rule, (non Add or Subt.) \$2.50—10" Rule, Add, Subt., Multiply and Divide, \$3.00. Full leather 10" case, 50c extra. 5" Rule (non Add or Subt.) leather case \$2.50 postpaid. 10" Dummy Rule, Bristol board scales, \$1.00. If ordered now the book, **The Slide Rule Simplified** goes FREE with each rule. If interested in forming Clubs write for large list of tools GIVEN FREE.

## The newest big-seller is the littlest Oster



**No. 81**

This little all-in-one die-stock is the season's sensation. It wasn't thought possible that one small pipe-threading tool could contain all its good features. We've had to get out a special folder to describe No. 81 and No. 3B, a large all-in-one die-stock. If you would like a copy of this, together with our booklet "The Bulldog Tale" (both free), just fill out the coupon and mail it to us. You will get a new idea of what a pipe-threading tool can be.

**THE OSTER MFG. CO.**  
2100 E. 61st St. CLEVELAND, O., U. S. A.

Kindly send me by return mail the No. 81 folder and "The Bulldog Tale."

Name .....

Business .....

Address .....

City.....State..... (2100)

## BING'S CONSTRUCTOR

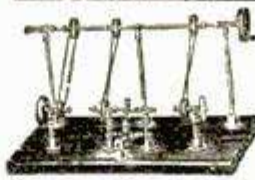

Most fascinating building toy. No screws or rivets. Build anything you want—Machinery, bridges, towers, wagons, machine shops, etc. Outfits \$2, \$4, \$6, up to \$60. Ask your dealer about them, or write to us for full particulars.

Made with Bing's Constructor **BING BROTHERS, Manufacturers**  
**JOHN BING, Sole Representative, 382 Fourth Ave., N. Y.**

## GASOLINE SOLDERING IRON BLOW TORCH



IT'S SIMPLICITY COMPOUNDED  
Address Dept. 1. EMMELMANN BROS. MFG. CO., INDIANAPOLIS, IND., U.S.A.

**GEO. W. RICHARDSON, 4218 24th Place, CHICAGO, U. S. A.**

You Pay Only For  
Quality - So Our  
Price is \$39.80

Salesmen, dealers, agents and their salaries, commissions and expenses do not add to the quality of *any* typewriter. But an expensive selling system *does* add to the *price*. That is why *other* standard typewriters cost from \$60.00 to \$100.00. And because we sell *direct* to you, by mail only, we offer in our Harris Visible the equal of any typewriter in the world at the epoch making price of only \$39.80,



Direct From  
Factory  
30 Days Trial

**HARRIS VISIBLE**

Be your own judge of the Harris Visible Typewriter. Try it alongside of any \$100.00 machine made. The Harris has the Universal keyboard with twenty-eight keys, eighty-four characters, two sets of shift keys, shift lock, release key, complete and perfect tabulator, back spacer, marginal release, light touch, 11-inch carriage with 9-inch writing width, excellent filling in and manifold features. It's the greatest front strike visible writing machine ever made. Regulation size and shape.

Write for Our New Book  
of Typewriter Facts

You can't afford to pay more than our price—and anything less cannot buy a standard machine. We sell the Harris for \$39.80 cash, or to responsible people on easy terms which we will quote when we hear from you. Write for our Book of Typewriter Facts and our 30 Day Trial Offer. Please request Typewriter Book No. 80P30.

**SEARS, ROEBUCK AND CO., CHICAGO**

## **TYPEWRITER BARGAINS!**

**WE ARE EQUIPPING OUR BIG CHICAGO STORE AND BRANCHES WITH THE HARRIS VISIBLE TYPEWRITER EXCLUSIVELY AND HAVE ABOUT EIGHT HUNDRED (800) TYPEWRITERS of VARIOUS STANDARD MAKES to DISPOSE of**

These typewriters are second-hand. They have been used from a few months to three and one-half years. Instead of disposing of these to second-hand dealers, we will sell them direct to users at the same price the dealer would pay. All these 800 typewriters are in good operating condition and will be tested by our typewriter repair expert before shipping. If you can use one or more, write for our Second Hand Typewriter Bargain List No. 80P47. At the prices we quote, they will be quickly sold.

**SEARS, ROEBUCK AND CO., CHICAGO**



**MONEY  
IN  
MUSHROOMS**

### **MAKE BIG INCOME**

Men and Women can do this all the year at home growing mushrooms in cellars, stables, sheds, boxes, etc. Crop sells for \$.50 to \$1.00 a lb. \$20.00 a week easily made. Great demand, markets waiting. Start Now. Write for big 32 page Free Illustrated Booklet and learn how to do it. NAT'L SPAWN CO., Dept. 12, BOSTON, MASS.

## **I WILL START YOU**

earning \$4 daily at home in spare time, silvering mirrors; no capital; send for free instructive booklet, giving plans of operation. G. F. REDMOND, Dept. 308-A, BOSTON, MASS.



### **Boy Electrician** with 75 illustrations for making Batteries, Dynamos, Motors,

Telegraph apparatus, Telephone, Lights, Bells, Alarms, Coils, "Wireless" Current Reverser, Electric Engine, Etc. By Electrical Experts so that anyone can understand it. With Cat. All 10c Ppd.

**J. C. DORN, 705 So. Dearborn St., Dept. 21, Chicago, Ill.**



### **Big Entertainer** 320 Jokes and Riddles, 153 Parlor Games and

Magic, 15 Tricks with Cards, 73 Toasts, 7 Comic Recitations, 3 Monologues, 22 Funny Readings. Also Checkers, Chess, Dominoes, Fox and Geese, 9 Men Morris. All 10c. postpaid.

**J. C. DORN, 709 So. Dearborn Street, Dept. 17, Chicago, Ill.**



### **Boys' Own Toy Maker**

Tells how to make a Talking Machine, Camera, Electrical Motor, Bicycle Boat, Canoe, Boomerang, Bobbed, Wind Mill, Microscope, Water Wheel and Motor, Stilts, Toboggan, Snow Coaster and Sail Boat, Telephone, Electric Bell, Railroad Wind Mobile, Paddle Raft, Traps, Kites, etc. All 10c, postpaid.

**J. C. DORN, 707 So. Dearborn St., Dept. 38, Chicago, Ill.**

**Shirley  
President  
Suspenders**

For well dressed  
comfort-lovers

**50¢**

"Satisfaction or money back"

Be sure "SHIRLEY PRESIDENT" is on buckles  
The C. A. Edgarton Mfg. Co., Shirley, Mass.



# Chauffeur's Law Book FREE!

The first and only book of its kind ever compiled. Contains vitally important information about the laws governing chauffeurs in every state—When and how to register—How to get a license in each state—What the fees are for the first year and renewals—Driving laws and regulations—Rights and privileges of the chauffeur—And scores of valuable facts every chauffeur should know. This book, at any book store, would sell for 50c. But send us 10c for a copy of the **American Chauffeur** and with it we will send you this book free.



This offer is made for a limited time to get you acquainted with the **American Chauffeur**—the liveliest magazine in the automobile field and the only one published exclusively in the interest of the beginner, the professional chauffeur, and the man who drives his own car. Every issue crammed with valuable articles that will make you a better chauffeur and help you make more money. Write your name on the margin of this page and send it with 10c in stamps or coin, and we will forward the **Chauffeur's Law Book** and a current copy of the **American Chauffeur** by return mail.

THE AMERICAN CHAUFFEUR PUBLISHING CO.  
251 Butler Building CINCINNATI, OHIO

# Paint Without Oil

Remarkable Discovery That Cuts Down the Cost of Paint Seventy-Five Per Cent.

A Free Trial Package is Mailed to Everyone Who Writes

A. L. Rice, a prominent manufacturer of Adams, N. Y., has discovered a process of making a new kind of paint without the use of oil. He calls it Powdrpaint. It comes in the form of a dry powder and all that is required is cold water to make a paint weather proof, fire proof and as durable as oil paint. It adheres to any surface, wood, stone or brick, spreads and looks like oil paint and costs about one-fourth as much. Write to Mr. A. L. Rice, Manuf'r, 47 North St., Adams, N. Y., and he will send you a free trial package, also color card and full information showing you how you can save a good many dollars. Write to-day.

**WORLD ACTIVITY IN PORT DEVELOPMENT**—The approaching opening of the Panama Canal is undoubtedly responsible, in great part, for the enormous expenditures now being made the world over for port development. The investment made to take care of the

## THIS BUNGALOW \$900 CAN BE BUILT FOR

This and many others in my new book, **Building Plans for Modern Homes**, will save you hundreds of dollars. One of the most complete and comprehensive books of plans ever published by any architect. Fifth edition just off the press. One hundred and fifty floor plans and photographs of bungalows, etc., costing from \$350 up; gives sizes and cost to build. Sent postpaid for \$1.00



FREDERICK H. GOWING ARCHITECT  
18 Tremont St., BOSTON, MASS.

# Big \$1 Offer—KEITH'S



80 page monthly magazine for 6 months with Keith's BOOK  
**100 PLANS Bungalows—Cottages**  
Keith's Magazine is the recognized authority on building and decorating artistichomes. Each issue contains 6 to 10 Plans by leading architects. Subscription \$2. News-stands. Any one of Keith's Arch. Studies, giving

No. 1065—\$2200. One of the 100 Views, Costs, etc., FREE with a year's subscription to Keith's Magazine, \$2  
Keith's Famous Plan 136 Plans of Bungalows 175 Plans estd. below \$6000  
Books, direct or thru 104 .. Cottages 125 .. over \$6000  
Newsdealers, \$1 each 125 .. estd. below \$4000 100 .. Cement and Brick 25000 50 Garages, 40 Duplex & Flats

M. L. KEITH, 505 McKnight Bldg., Minneapolis, Minn.



One of the 38 Styles

# Shipped FREE To You—Superb Wing Piano

Yes, we will ship you free—absolutely free to you—a Genuine highest-grade Wing player-piano DIRECT from our own factory freight prepaid. The most amazing piano offer ever made. We will allow you to use any Wing piano—your choice of 38 superb new styles—in your own home for 4 full weeks at our expense.

## No Money Down—Freight Prepaid

We ask no money down—no security—no bank deposit—no C. O. D.—no obligations. Just choose any Wing from our large catalog. We'll ship the instrument no money down, freight prepaid. Use it just as if you owned it. Let your friends play it. At the end of 4 weeks' trial, if you wish, you may return it at our expense. You alone are the judge. We employ no salesman to visit and annoy you.

## Rock-Bottom DIRECT Offer

You will be amazed at our rock-bottom direct-from-our-factory proposition on the genuine highest-grade Wing, guaranteed 40 years. No other manufacturers dared to meet our baffling offer. Let us quote you prices that local dealers cannot approach. Cash or easiest monthly payments as you prefer—but first four weeks' free trial. Since 1868—for 45 years—we have been building Wing pianos—renowned everywhere for their sweetness of tone and sterling merit. The Wing has all the fine qualities and every improvement of any strictly high-grade piano and a superior tone.

## Valuable Book on Pianos Free

"The Book of Complete Information About Pianos"  
The N. Y. World says: "This is a book of educational interest every one should own." Tells you all about pianos, how to judge the fine points of quality and price in buying a piano. You will be astonished at the amount of information about piano quality and piano prices, and how to answer the arguments of piano salesmen. The Coupon brings this 136-page book FREE. This magnificent book, a complete encyclopedia on the piano, posts you on the making of a piano from start to finish. Free and prepaid, provided you write at once. With this piano book we will send free our beautiful catalog showing new art styles and full explanation of our Rock-Bottom Prices on the Wing Piano. Just drop a postal or a letter, or mail the coupon—today.

WING & SON, Dept. 1192, (Estab. 1868)  
Wing Bldg., 9th Ave. and 13th St.  
New York  
N. Y.

Piano Book COUPON  
WING & SON (Est. 1868) Wing Bldg.  
9th Ave. & 13th St. Dept. 1192, New York, N. Y.  
Gentlemen:—With the understanding that I am not buying anything, you may send me the 136-page Piano Book containing the ten tests, also your free shipment offer on the Wing Piano.

Name .....

Address .....

Please Mention Popular Mechanics

# New KEROSENE LIGHT BEATS ELECTRIC OR GASOLINE

10 Days FREE—Send No Money

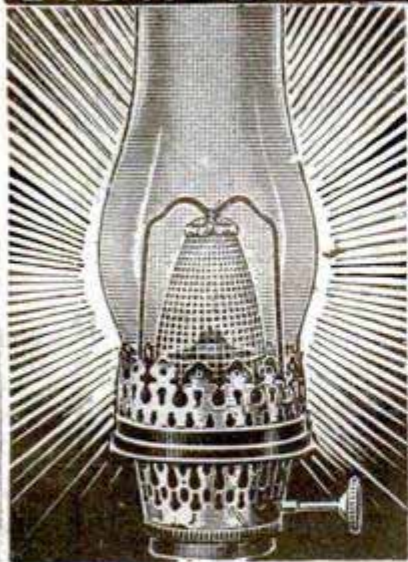

We don't ask you to pay us a cent until you have used this wonderful modern light in your own home for ten days, then you may return it at our expense if not perfectly satisfied. We want you to prove for yourself that it gives five to fifteen times as much light as the ordinary oil lamp; beats electric, gasoline or acetylene. Lights and is put out just like the old oil lamp; costs

**ONLY 1 CENT FOR 6 HOURS**

Gives a powerful white light, burns common coal oil (kerosene), no odor, smoke or noise, simple, clean, won't explode. Guaranteed.

**\$1000.00 REWARD**

will be given to the person who shows us an oil lamp equal to this Aladdin in every way (details of offer given in our circular). Would we dare make such a challenge to the world if there was the slightest doubt as to the merits of the Aladdin? We want one person in each locality to whom we can refer customers. Write quick for our 10 Day Absolutely Free Trial Proposition, Agents' Wholesale Prices, and learn how to get **ONE FREE**.

**MANTLE LAMP CO., 448 Aladdin Bldg., Chicago, Ill.**

## AGENTS WANTED

to demonstrate in territory where oil lamps are in use. Experience unnecessary. Many agents average five sales a day and make \$300.00 per month. One farmer cleared over \$800.00 in 6 weeks. You can make money evenings and spare time. Write quick for territory and sample.

## Sunshine Lamp 300 Candle Power FREE!

To Try in Your Own Home

Turns night into day. Gives better light than gas, electricity or 18 ordinary lamps at one tenth the cost. For Homes, Stores, Halls, Churches. A child can carry it. Makes its own light from common gasoline. Absolutely SAFE.

**COSTS 1 CENT A NIGHT**

We want one person in each locality to whom we can refer new customers. Take advantage of our SPECIAL FREE TRIAL OFFER. Agents Wanted.

**SUNSHINE SAFETY LAMP CO.**

902 Factory Bldg. Kansas City, Mo.



## I Want to Send FREE You This Lamp

TO USE AND TRY AT MY RISK Recommend this marvelous light to your neighbors. Show them how it beats gas, electricity or 18 ordinary lamps.

**COSTS 1 CENT A NIGHT**

A miniature portable lighting plant for every purpose. 300 candle power from common gasoline. Absolutely safe. A wonder in the home or for agents. Write quick for my amazing offer.

STANDARD LAMP CO., 614 Standard Bldg., Kansas City, Mo.



## Beacon Burner FREE!

Fits Your Old Lamp **100 Candle Power Incandescent** pure white light from (kerosene) coal oil. Beats either gas or electricity. **COSTS ONLY 1 CENT FOR 6 HOURS** We want one person in each locality to whom we can refer new customers. Take advantage of our Special Offer to secure a Beacon Burner FREE. Write today. AGENTS WANTED. **HOME SUPPLY CO., 11 Home Bldg., Kansas City, Mo.**

There are more than 200 different styles of

**The "BEST" LIGHT**

Any one of them is as great an improvement over the gas-jet, as the ancient kerosene lamp was over the tallow-dip. Brighter and lower in cost than electricity, acetylene, gas or oil. Agents make money easily selling "Best Lights."

Write for Catalog.

**THE BEST LIGHT CO.**  
324 East 5th St.  
Canton, O.

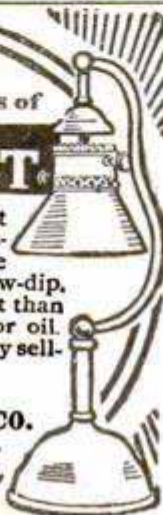

## THE IMPROVED MONITOR

AGENTS \$10 A DAY



**MAKES ironing easy and a pleasure.** Pronounced "The World's Best" by over 575,000 satisfied customers. No hot stove. Easy to operate. Heat regulated instantly. Satisfaction guaranteed. Highest in Quality, Lowest in Price. Highly polished and nickel plated. Quick, easy sales. **Exclusive rights and territory free.** Write for illustrated circular; explains everything.

**The Monitor Sad Iron Co.**  
400 Wayne St. Big Prairie, O.

## BUY PLUMBING and HEATING SUPPLIES



at WHOLESALE

Will Save You 30%

Don't pay retail prices. Full stock on hand for prompt shipment. Send for free catalog.

**B. P. KAROL, 768 to 772 W. Harrison St., CHICAGO**

anticipated growth of ocean commerce is close to one billion dollars. In the United States, Seattle, Los Angeles, San Francisco, New Orleans, Boston, Philadelphia and Mobile have either begun or are contemplating large

## WHITE FLAME

**BURNERS** make your old kerosene lamps and lanterns give a brilliant white light better than electricity or gas. Doubles your light. Saves oil. **NO MANTLE TO BREAK.** Guaranteed Safe and Reliable. Delights every user. Send now for complete sample postpaid 35 cts., stamps or coin. 3 for \$1. **MONEY BACK IF NOT SATISFACTORY.**

Live Representatives Wanted. Exclusive Territory.

**WHITE FLAME LIGHT CO., 68 Clark Bldg., Grand Rapids, Mich.**



## TRIUMPH LAMPS

Everyone knows that the New Triumph Gasoline Gas Lighting System and Lamps are the cheapest, safest and most satisfactory lights made.

**REAL COMFORT HEATER**

An Instantaneous Heater, burns gasoline instead of kerosene and heats a room in a jiffy without smoke or smell at less than 1/4 the cost of kerosene. Write for P. O. P. Catalog, Dept. 1. It tells all about them.

**BRILLIANT GAS LAMP CO.**  
1009 S. Wabash Ave., Chicago, Ill.



## DISHWASHING DRUDGERY GONE FOREVER

The Kitchenette Family Dishwasher takes the place of the old dishcloth, dishpan way. Washes and sterilizes in a few minutes. Will not break the most delicate china. Hands do not touch the water. No red, rough, chapped, dishwater hands. Approved by Good Housekeeping Institute of N. Y. and guaranteed by us. Send no money. 30 days free trial and easy payment plan. All freight prepaid. Address **CARY-DAVIS CO., INC., Dept. P-A., 42 Pearl St., Buffalo, N. Y.**



# KEROSENE AND GASOLINE

## LIGHTING SYSTEMS

Our WIZARD and "DREADNAUGHT" lamps and lighting systems are constructed to burn kerosene and gasoline.

The lamps constructed to burn kerosene are an achievement surpassing all other known methods of artificial lighting. Besides being very attractive in design and of very simple construction, same are very convenient to operate and reliable.

The cost of operating a kerosene lamp is very small, as a single mantle inverted lamp will only consume one gallon of kerosene in about 62 hours.

Our gasoline lamps are the most perfect and up-to-date on the market, while certain styles can be lit with an ordinary match and operated with almost the same convenience as city gas.

For exclusive agency and further particulars, also complete illustrated catalog, describing the above and other styles of lamps and systems, address

The Nagel-Chase Mfg. Co., The largest manufacturers of artificial lighting devices in the world, 158 E. Erie St., Chicago

improvements. The smaller gulf ports are all perfecting their dock facilities. Canada has undertaken extensive developments at Halifax, Montreal, Toronto, Vancouver, and Victoria. In Europe, similar work is going on at the ports of London, Hamburg, Havre, Boulogne and Calais; and all the principal ports in South America are devoting large sums to the same purpose.

### MONEY IN POULTRY and SQUABS

Start small. Grow BIG. Get winter eggs. Keep healthy fowls. Save your chicks. Foy's big book tells how. Describes largest poultry and pigeon farm. Mailed **Free**. F. FOY, Box 39, DES MOINES, IA.



### Greider's Fine Catalogue

and calendar of pure-bred poultry for 1914, large, many pages of poultry facts, different breeds in natural colors, 70 varieties illustrated and described. Incubators and brooders, low price of stock and eggs for hatching. A perfect guide to all poultry raisers. Send 10c for this noted book.

B. H. GREIDER Box 19, RHEEMS, PA.

### Guaranteed Used Pianos

A large number of fine instruments at exceptional bargain prices, many like new, exchanged for **Kimball Player Pianos**, thoroughly overhauled and guaranteed to be in splendid condition in every way.

Examples:	Schaefer Upright	\$140	Hallet & Davis	\$190	
Briggs Upright	\$ 70	Hinze Upright	145	Kimball Upright	220
Coiby Upright	90	Fisher Upright	165	Steinway Upright	275
Emerson Upright	110	Whitney Upright	185	Kimball Upright	275
Decker Bros. Upright	135	Chickering Upright	175	Knabe Upright	175

We ship anywhere to reliable people on easy payment terms. Write Today For Complete List, Prices, and Terms and Beautiful Illustrated Musical Herald **FREE**, and catalogue New Kimball Pianos. W. W. KIMBALL COMPANY, 1292 Kimball Hall, Chicago, Ill.

### SHOEMAKER'S BOOK ON POULTRY

and Almanac for 1914 has 224 pages with many colored plates of fowls true to life. It tells all about chickens, their prices, their care, diseases and remedies. All about incubators, their prices and their operation. All about poultry houses and how to build them. It's an encyclopedia of chickendom. You need it. Only 15c.

C. C. SHOEMAKER, Box 1107, FREEPORT, ILL.

### Money Making "Hatching Facts"

Free Send for Jim Rohan's new book of money making "Hatching Facts."

Thousands of 100% perfect hatches made with

**Eight Times World's Champion Belle City Hatching Outfit**

276,000 in use. Personal money back guaranty. My low price will surprise you. JIM ROHAN, PRES.

Belle City Incubator Co., Box 164, Racine, Wis.

### Get My 1914 Incubator Prices

#### Take no chance this year.

Let me put the facts in your hands and tell you why the "RELIABLE" is the SAFEST buy and SUREST hatch. No better at any price. My iron-clad guarantee on Reliable Incubators and Brooders gives money back if not satisfied. Write tonight for catalog.

J. W. MYERS, Pres., RELIABLE INCUBATOR & BROODER CO., Box B-81, Quincy, Ill.



Heating System is INSID Machine.

No. 57  
83c

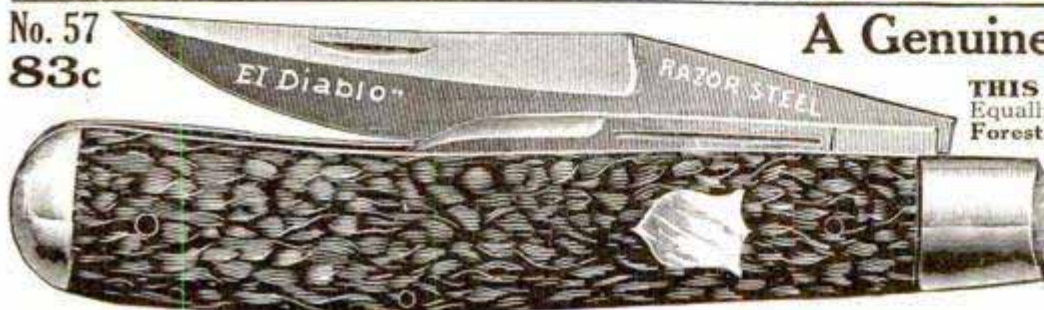

### A Genuine \$2 Knife for 83c

**THIS KNIFE HAS BRAINS IN IT.** Equally good in the Shop, the Farm, or Forest; light but extra strong; resharpened easily. Stag handle, German silver finish; blades file tested, hand forged razor steel and warranted. Sample 83c, 3 for \$2, postpaid. Choicest Pearl, \$2 each.

Send for 80-page Free List and "How to Use a Razor"

MAHER & GROSH CO. 106 A St. Toledo, Ohio

MAKE MONEY HERE

**AGENTS! DROP DEAD ONES. AWAKE! AGENTS!**

LEARN the NEW WAY

Get started in an honest, clean, reliable, money-making business. Sold on a money-back guarantee

World's magical gift realized by this new invention. The **BLACKSTONE WATER POWER VACUUM MASSAGE MACHINE** for the home. No cost to operate. Lasts life-time. Price within reach of all. No competition. New field. New business. That's why it's easy. Removes blackheads, wrinkles, rounds out any part of the face or body and brings back Nature's beauty. Endorsed by leading doctors and masseurs. Listen: Parker, Okla., says, "8 orders first day." Margwarth, Pa., writes, "I am making \$19.00 per day." Shea, "First order 12, second 35, third 72." Schermerhorn, Ia., orders eight dozen machines first month. Shaffer, Va., "selling 4 out of 5 demonstrations." Vaughn, Wash., orders one dozen. Four days later wires "Ship 6 dozen by first express." Spain, Tenn., started with sample. Orders one dozen, then 2 dozen, next 3 dozen. Lewis, Ind., sells 3 machines first hour. Says "Best article he ever saw for merit and money-making." No experience necessary. Territory with protection given free to active workers. Nothing in the world like it. Best agent's article ever invented.

We own all U. S. and foreign patents. Big book entitled, "The Power and the Love of Beauty and Health" Free. Investigate now, today. A Postal will do. A big surprise awaits you. Address **BLACKSTONE MFG. CO.** 855 Meredith Bldg. TOLEDO, O.

**YOU want work—I want YOU**

\$30 a week to start, steady work all year and a chance to work up to local manager at \$3,000 a year

You need no experience or training. My agents were farmers, mechanics, clerks, doctors, merchants, school teachers, laborers, railroad men, barbers, teamsters, and some were just out of school. I make the swellest line of Soaps, Perfumes and Toilet Articles you ever saw.

**Will you take this job?**

My goods sell at half ordinary retail price, and they are well known. I have customers in every town, and my sales are growing bigger every day. I've simply got to have more agents to supply my customers. I need a hundred new agents right away and this is YOUR chance to make big money quick.



To get the Job—Write me TODAY

Don't lay this offer aside. Just take a pen or pencil NOW and on a postal or in a letter simply write, "I am looking for steady employment as agent. Please mail full particulars." Address

**E. M. DAVIS, Pres., E. M. DAVIS SOAP CO.**  
Dept. B 14, Davis Block, Chicago, Ill.

**Deafness**

Perfect hearing is now being restored in every condition of deafness or defective hearing from causes such as

Relaxed or Sunken Drums, Roaring or Hissing Sounds, Perforated, Partially Destroyed Drums, etc.

**Wilson Common-Sense Ear Drums**

"Little Wireless Phones for the Ears"—

require no medicine but effectively replace what is lacking or defective in the natural drums. They are simple devices, which the wearer easily fits into the ears where they are invisible. Soft, safe and comfortable to wear at all times.

Write today for our 168 page FREE book on DEAFNESS, giving you full particulars and plenty of testimonials.

**WILSON EAR DRUM CO., Incorporated**  
626 Inter-Southern Building LOUISVILLE, KY.

**\$50.00 A WEEK CLEAR PROFIT FOR YOU**

In the minute picture business. Everybody buys. Fairs, picnics, parades, and all busy places offer you an unlimited money-making field. No experience needed.

**\$12.00 Starts You**

in your own business that will easily bring you \$50 weekly profit. W. C. Cox, Ind., made \$48 in 2 days. Nichols, Pa., made \$21.36 in 5 hours. This chance is yours with a

**One Minute Camera**

Makes finished photos on post cards and buttons in one minute. Detailed information free. Write at once.

**THE ONE MINUTE CAMERA CO.**  
Dept. 393-533 So. Clark Street, CHICAGO

**ERICKSON LEG**

Arms, Braces, Wheel Chairs, Stockings.

**SOLD ON EASY TERMS**

**E. H. ERICKSON ARTIFICIAL LIMB CO.,**  
17 Wash. Av. N., MINNEAPOLIS, MINN.

Does not chafe, overheat or draw end of stump.  
**SEND FOR CATALOG**



Largest Limb Factory in World.

Platinum is now worth \$46 an ounce, against \$20 five years ago. The world's output of platinum in 1912 is estimated at 314,751 troy oz., of which Russia supplied 300,000 oz.; Colombia, 12,000 oz., and the United States, 721 oz.

**TOBACCO HABIT BANISHED**

In 48 to 72 Hours Yes, positively permanently banished almost before you know it. Pleasant, easy to take. Results quick, sure, lasting. No craving for tobacco in any form after first dose. Not a substitute. Harmless, no poisonous habit forming drugs. Satisfactory results guaranteed in every case or money refunded. *Tobacco Redeemer* is the only absolutely scientific and thoroughly dependable tobacco remedy ever discovered. Write for free booklet and positive proof.

**NEWELL PHARMACAL CO., Dept. 25, ST. LOUIS, MO.**

**NO MORE BALD HEADS**

When our **VACUUM CAP** is used a few minutes daily. We accept no pay until you have tried the Cap 60 days and are satisfied. The Vacuum Cap is an appliance that draws the blood to the Hair Roots and starts a new healthy crop of hair. It stops Dandruff, stops the hair from falling out. Bought by Doctors and men who

know that it is the only reasonable **HAIR GROWER** known to science. No Drugs Used. Write for application blank, testimonials, and booklet on "HAIR," sent sealed in plain envelope, FREE.

**THE MODERN VACUUM CAP CO.**  
C. 559 BARCLAY, DENVER, COLO.

# FREE



Yes, we will send you a genuine Lachnite Gem for you to wear for 10 full days absolutely free. This is the most astounding jewelry offer ever made. See a genuine Lachnite for yourself. Wear it for 10 days. Then if you can tell it from a genuine diamond send it back at our expense. They are cut by the world renowned diamond cutters of Europe and their dazzling fire last forever. A superb gem set in solid gold. Write today for our big new catalog.

## Open An Account

Don't save up your money for months and months before you wear beautiful jewelry. Open an account with us. Have all the genuine Lachnites and other handsome jewelry you want. Write today for the big new catalog. We trust you. No red tape. Your credit is good.

## Pay As You Wish

Just a small amount down. Take your time about paying for the rest. Your choice of any of the superb Lachnites and all sorts of other superb, elegant jewelry. All at the rock bottom price. Astounding prices never equalled before. Pay as you are able. The most liberal of terms. Get the free book that tells you all about it. Write today—now.



### Free Book—Write Today

Do not delay an instant. Put your name and address on a postal or a letter and send it in to us at once. We'll send you our big new catalogue of all the finest jewelry absolutely free. Find out about genuine Lachnites. Find out how you can wear one of these superb gems for 10 days absolutely free. Do not delay an instant. Send in your name and get the big new jewelry book absolutely free.

**HAROLD LACHMAN CO.**  
Dept. 1192, 12 N. Michigan Ave., Chicago, Ill.

TEN YEARS OF RAILWAY GROWTH IN THE UNITED STATES—In the 10 years between June 30, 1902, and June 30, 1912, the total trackage in miles increased 31 per cent; the number of locomotives, 48 per cent; the number of freight cars, 42 per cent; and the number of passenger cars, 37 per cent. The total operating expenses increased 63 per cent, but total operating ex-

# Yours for \$2 a month. This \$35.00 set now only \$19.80!

Here's a real opportunity! You can buy at almost half price, the most complete and comprehensive work on electricity ever published—the world's greatest electrical library is now offered to you on the easiest of monthly payments. This plan brings these great books within the reach of all. Take advantage of this opportunity. Be an Electrician—start now. These books and our wonderful consulting privilege will give you a complete electrical education. Whether worker, engineer or expert, these books will add to your knowledge, add to your job and add to your salary.

## Cyclopedia of Applied Electricity

Contains 3,200 pages, 7x10 inches; 2,600 illustrations, full page plates, diagrams, etc.; hundreds of valuable tables and formulas; carefully cross-indexed for quick, easy reference. Printed in large, clear type on special quality paper and bound in half red morocco, gold stamped.

### Read These Subjects Carefully

Theory, Calculation, Design and Construction of Generators and Motors—Electrical Measurements—Electric Wiring—Electric Welding—Types of Generators and Motors—Management of Generators and Motors—Storage Batteries—Electric Lighting—Alternating Current Machinery—Station Appliances—Power Stations—Power Transmission—Central Station Engineering—Electric Railways, including Single-Phase—The Electric Telegraph—Telephone Equipment, Systems and Operation—Wireless Telegraph and Telephone—Telautograph, Telephonograph, etc., etc.

**Shipped Free** The complete seven volumes, not a sample volume, will be sent, express prepaid, for seven days' free examination; returnable at our expense if they fail to meet with your expectations. If you keep them, pay \$2.00 seven days after receipt and then \$2.00 a month until you have paid the introductory price of \$19.80. Fill in and mail the coupon—today. It won't cost you a cent to examine the books, so get them into your home and look them over at your leisure. Remember, if you don't like them they may be returned at our expense.

## Consulting Service Free

With every set is included a year's Consulting Membership, regular value \$12.00, entitling you to the free advice of a staff of electrical experts. This will give you practical help in handling your difficult working problems. There will be no limit to this service—ask as many questions as you wish for an entire year. This service alone may be worth more than the first cost of the books. Don't wait. This means \$15.20 saved if you act now. You take no chances whatever. It costs nothing to inspect and you are nothing out if you do not care to buy. Mail the coupon today.

## FREE COUPON Worth \$15.20 to You

**American Technical Society,  
Chicago, U. S. A.**

Please send me Cyclopedia of Applied Electricity for 7 days' free examination. If I decide to buy, I will send \$2 in 7 days and balance \$2 a month until \$19.80 has been paid, when \$35 books and \$12 Consulting Membership will be mine. Otherwise will notify you and hold books subject to your order. Title not to pass until fully paid.  
Pop. Mech. 2-14

NAME.....

ADDRESS.....

As I have had no previous dealings with you, I refer you to

Please Mention Popular Mechanics



Send  
me  
1  
8

## \$25 to \$40 Week



Sells on sight. Instant hit in every home. Smith, Ohio, sold 38 one day. Profit \$19.00. All metal bread and pastry board and rolling pin. Can't rust, absorb dirt or disease germs. Lasts lifetime. Endorsed by Good Housekeeping Institute. Agents get good appointments. Make Big Money.  
**UNION MFG. CO.**  
129 Main St. Cambridge, O.

## \$4 PER MONTH BUYS THIS VISIBLE OLIVER TYPEWRITER

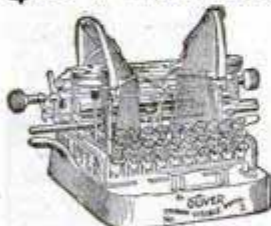

Nothing Down—Free Trial. Less than Agents' Prices. Shipped on approval. If you want to keep it, send us \$4 a month. Our booklet is worth sending for because it tells you how to save \$41.50. It's FREE.

Typewriters Distributing Syndicate, 166 M 89 N. Michigan Blvd., Chicago

## 3 YEARS TO PAY



**Meister Piano** 30 days free trial in your own home  
**\$1 A WEEK or \$5 A MONTH Price \$175.00**  
No cash payment down. No interest—no extras. Piano stool and scarf free.  
**ROTHSCHILD & COMPANY**  
Dept. M16 CHICAGO, ILL.

# DUCK'S CATALOG

## Big 325 Page Electrical and Wireless

Supplies mailed for 8c, stamps or coin, which you may deduct from your first order of \$1  
Great cost of catalog and low prices prohibit distribution except to those interested  
**20% to 33% is Saved in Purchasing from Us**

Whether you are interested in an experimental or commercial wireless outfit, a flashlight or a lighting plant, we can save you money and at the same time guarantee you the highest quality.

### WHAT OUR CATALOG CONTAINS:

125 pages wireless insts. for commercial and amateur use, with over 30 diagrams; 10 pp. raw material for wireless insts.; 15 pp. telegraph insts.; 35 pp. toy and commercial motors and generators; 15 pp. flash-lights and miniature lamps and 125 pages ammeters, voltmeters, storage batteries, transformers, vibrators, switchboards, lighting plants, tools, air rifles, pocket knives, radiopticans, miniature railways, mechanical and electrical books, and general electrical supplies.

**THE J. J. DUCK COMPANY, Arcade Building, TOLEDO, OHIO**

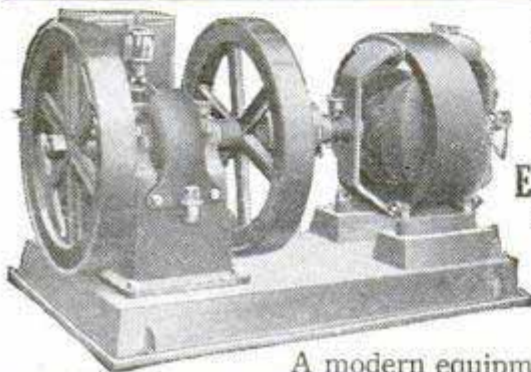

### LIGHT YOUR HOUSE WITH ELECTRICITY

Put in a Direct Connected Gasoline Engine and Dynamo.

A modern equipment at small cost for farm and house lighting and small isolated plants. Dynamo has an output of 42 volts, charges the battery during the day, and 32 volt lamps are used to light the house. Operation steady and quiet. Write for circular.

THE CARLISLE & FINCH CO., 244 East Clifton Ave., CINCINNATI, OHIO

### Working Models

WE MAKE AND SELL



Model Torpedo Destroyers, Warships, Sailing Yachts, Steam Boats, Launches, Steam Engines, Boilers, Locomotives, Turbines, Dynamos, Motors, Flying Machines.

Also we supply all the castings, materials and parts for making and fitting the above working models.

Send for our large copyright Catalogue, 900 illustrations. By mail, 10c. You will then see what we can do for you.

**STEVENS'S MODEL DOCKYARD**  
22Q, ALDGATE, LONDON, ENGLAND

### A Complete \$9.65 WIRELESS STATION

Receives 1200 Miles  
Sends 12 to 15 Miles

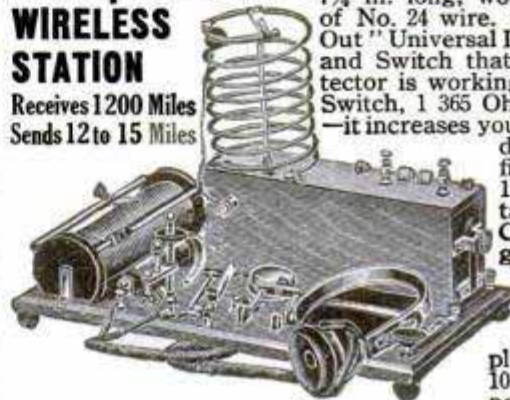

Consists of 1 DOUBLE slide tuner 7 1/4 in. long, wound with 150 feet of No. 24 wire. Our "Don't Jar Out" Universal Detector, 1 Buzzer and Switch that tells if your Detector is working, 1 DPDT Aerial Switch, 1 365 Ohm Potentiometer—it increases your phonetone and distance 30%, 1 fixed Condenser, 1 non-fusible Contact Key, 1 Spark Coil guaranteed to give 1 1/2 in. spark, 1 Helix & Cord, 1 machine turned Spark Gap, 1 flat plate Condenser, 1000-ohm double pole Receiver

Cord, 1 nicked Headband, 6 Insulators and Diagram. Stamp for Bulletin "P" for other remarkable values.

NICHOLS ELECTRIC CO., 35 Frankfort Street, NEW

penses increased 76 per cent. The net operating revenue, excluding taxes, increased 42 per cent, but taxes increased 107 per cent. Wages paid to employees increased 87 per cent. These figures, says a man of high standing in the country's steel industry, tell the

### Electric Flashlight Pistol

Complete with two batteries and tungsten light. Gun metal finish, handy to carry, never in the way. Size 3x3 1/4. It's no toy, but a neat, handy flashlight. Protect yourself in the dark.

Price, prepaid, \$1.60

SEND FOR CIRCULAR

MOHR BROS., 2809 N. Halsted St., CHICAGO



## Send for Copy of Our New Wireless Manual P1

It contains 96 pages and tells how to erect and maintain wireless telegraph stations. Shows a number of diagrams. Has the Morse and Continental Telegraph Codes. Illustrates the best instruments to use; tells what they are for and how to use them. Do not wait until some other time, but sit down now and send your name and address, and get one. It costs you nothing.



## Send for Our Pocket Catalog P26

It contains 212 pages, with over 1,000 illustrations and describes in plain, clear language all about Bells, Push Buttons, Batteries, Telephone and Telegraph Material, Electric Toys, Burglar and Fire Alarm Contrivances, Electric Call Bells, Electric Alarm Clocks, Medical Batteries, Motor Boat Horns, Electrically Heated Apparatus, Battery Connectors, Switches, Battery Gauges, Wireless Telegraph Instruments, Ignition Supplies, etc.

It Means Money Saved to You to have our Manual and our Catalog when you want to buy

**MANHATTAN ELECTRICAL SUPPLY CO.**

NEW YORK, 17 Park Place

CHICAGO, 114 S. Fifth Ave.

ST. LOUIS, 1106 Pine St.

SAN FRANCISCO, 604 Mission St.

# Cheap Electric Light

The cost of operating a private electric light plant is little more than the cost of fuel for the engine. The engine furnished with the

## Fairbanks-Morse Lighting Plant

will develop as much power on a gallon of kerosene as on a gallon of gasoline. Kerosene (coal oil) can usually be bought for less than half the price of gasoline.

Fairbanks-Morse Lighting Plants are complete, compact units, especially designed for farm and suburban houses, country clubs, small hotels, etc. Everything furnished complete ready to run, except wiring. Illustration shows standard 50 light equipment.

Write for Catalog DW 449

## Fairbanks, Morse & Co.

NEW YORK CHICAGO SAN FRANCISCO

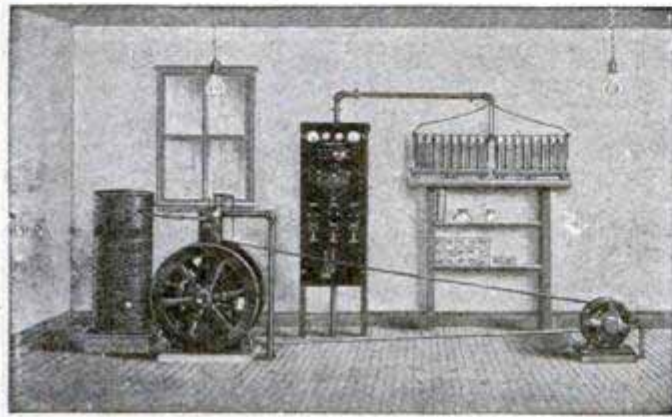

story and explain, in a large measure, why a considerable amount of stocks and bonds pay no interest or dividends.

**ELECTRIC LIGHT PLANTS** Complete gasoline engine, dynamo, switchboard and storage battery \$240. Agents wanted. American Battery Co., 1139 Fulton St., Chicago (Estab. 1889.)

**ELECTRIC HOME, FARM, THEATER or STORE LIGHTING PLANTS.** Wonderful Economy. Flash, Xmas Tree, Bicycle & Carriage Lights, Railways, Engines, Dynamos **MOTION PICTURE THEATER COMPLETE EQUIPMENTS** Start YOU in the Most Profitable Business in America with **BIG ADVANTAGES.** Small Audiences Pay. Catalog 3c. **OHIO ELECTRIC WORKS, D8, CLEVELAND, O.**

**SUPPLIES FOR THE WIRELESS EXPERIMENTER** This little ad is just to catch your Eye. Our Catalogue "B" is sure to catch your Fancy. A 2 cent stamp brings it by return mail. Send for it NOW. **WINGER ELECTRIC & MANFG. CO., 711 So. Dearborn St., CHICAGO, ILL.** Successors to Dawson & Winger Electric Co.

**ELECTRICITY**

This is your "elbow book." It's the latest edition of the **VOLTAMP ELECTRIC Catalog—128** pages full of cuts, complete description and prices of latest experimental apparatus—Dynamos, Motors, Rheostats, Transformers, Wireless Coils—Electrical Repair Material; Raw Materials; Telephone, Telegraph and Wireless Outfits; Handbooks; **Miniature Electric Railways** and parts, Toys, etc. 6c in stamps or coin will bring you this book (with valuable coupon)—you'll find it worth dollars. (No postals answered.)

**VOLTAMP ELECTRIC MFG. CO.** Voltamp Block, **BALTIMORE, MD.**

**GET YOUR CAMERA NOW PAY FOR IT 50¢ A WEEK**

**EARN A BIG INCOME WITH THIS FILMLESS POST CARD CAMERA**

You can simply coin money with it. Fine, sharp post cards five sizes, also photo buttons finished and delivered on the spot. **NO FILMS—NO PLATES—NO DARK ROOM—NO EXPERIENCE NEEDED**—We start you in this wonderful business—we trust you with the camera—pay for it later out of your profits. **Other operators making \$50 to \$100 weekly.** You can do the same. **WRITE TODAY—NOW**—for full details of our liberal proposition.

**FILMLESS POST CARD CAMERA WORKS**  
2230-M, West 12th St., **CHICAGO, ILL.**



# Use This Camera 10 Days FREE

Do not send us a penny, merely send your name, address, etc. on coupon below, and the genuine Folding Naco 3-A, the camera with a national reputation, will be sent to you Parcel Post prepaid. Try it for ten days, see how splendidly it works, note the high grade rapid symmetrical lens, Naco automatic shutter, brilliant reversible finder that works either horizontally or vertically, two tripod sockets, and improved spool holder—for either six or ten exposure films. This is an ideal camera, high grade, post card size— $3\frac{1}{4} \times 5\frac{1}{2}$ ; use it for pleasure or profit; take pictures for making money, or take pictures for fun or study. It is a great pastime and a liberal education.

If at the end of ten days, you find that it's just the camera you want, send us \$2.00, and thereafter \$2.00 a month for nine months—\$20.00 in all. If you do not want it, simply return the camera at our expense. You take no risk.

## This is the Greatest Camera Offer Ever Made in America

This celebrated Naco 3-A Folding Camera sells for \$20.00 cash everywhere in the world, that's the standard price—we offer it to you at the same price on the easy-payment plan, only \$2.00 a month. This is the first time you have ever had the opportunity to buy a standard high grade camera on the easy-payment plan.

**Special Film Offer** You will need one or more rolls of film to try out this camera, and we are making a special offer: Send us 50c and we will send you a roll of films that will take 6 pictures; after you have taken the pictures, send the roll to us and we will develop and print them and send them to you without any additional charge.

**Fill Out This Coupon Today** and try the wonderful Naco 3-A for 10 days, free. We will send it to you prepaid. You take no risk.

**National Camera Company**  
1415 Chestnut Street  
St. Louis, Mo.

Send me for ten days' free trial the Naco 3-A Camera. If I am satisfied with it, I will send you \$2.00 as first payment, and then \$2.00 per month for nine months. If I do not wish to keep the camera, I will return it to you within ten days at your expense. (I enclose 50c for your special film offer.)

NAME .....

ADDRESS .....

CITY .....

AGE.....OCCUPATION.....

**National Camera Company**  
1415 Chestnut St.  
St. Louis, Mo.



# MONEY FOR YOU!

**IN EVERY HOME, OFFICE,  
HOTEL, CHURCH OR PUBLIC BUILDING**

**GO INTO THE VACUUM CLEANING  
BUSINESS. NAME YOUR OWN INCOME**

Join enterprising men who are earning \$2,500.00 to \$3,000.00 yearly. Better your condition! Become master of your own time—your own income! Write now, for complete information regarding the little giant "B. B." POWER VACUUM MACHINE. Your profits quickly pay for your investments.

Take it on 30 days' trial offer—pay for it on easy terms. Go into the Vacuum Cleaning Business.

## Your Neighbors Become Regular and Profitable Customers

Each year the hard work, worry, and health destroying labors of housecleaning time, is dreaded more and more by every housewife. All is in your favor! ANY ONE WILL GLADLY PAY YOU HANDSOMELY TO HAVE THIS WORK DONE—you can easily earn

# \$15 TO \$30 DAY PROFITS

You should make even more than this. Establish your business, employ men to do the work. As your business grows, YOUR INCOME CAN BE DOUBLED—TREBLED—QUADRUPLLED! It is a source of countless opportunities—

### Magnificent Profits

Cleaning **must** be done repeatedly! This means steady contracts for you the year around! With the "B. B." Power VACUUM CLEANER you can revolutionize present methods to your own profit! Rugs, carpets, matting, upholstered furniture can be cleaned in a few hours—One woman engages you—then her neighbors WANT YOU! EVERY DAY—EVERY HOUR—YOUR WORK ADVERTISES YOU! BRINGS YOU BIG PROFITS.

### CONVINCING PROOFS

#### Pay Own Way Through College

"The B. B. Machine has given perfect satisfaction. Second day we cleared \$22.00. Work comes to us. We have almost paid for the machine this spring and passed in all our studies. We expect to have two machines next spring." Montgomery & Porter, Missouri

**McCREERY MFG. CO.**

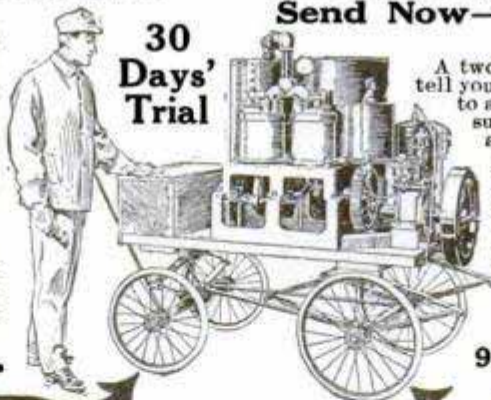

"The B. B. will do all that you claim for it—and more. Make from \$20 to \$25 in six hours easy. It is all to the good. Have even cleaned horses and dogs. It soon gets the dirt and loose hair off horses and even the fleas off of dogs." A. O. Rainbow, N. Mexico

Your business grows by leaps and bounds of its own accord. We will assist you—launch you properly—furnish you cards—and working plan—supply you with a price list that will net you a good profit—and at the same time WHOLLY SATISFY YOUR PATRONS.

You can pay cash—or buy on easy installments. Your machine can be PAID FOR OUT OF YOUR PROFITS. WE WILL SEND IT TO YOU ON 30 DAYS' TRIAL. WE HAVE CONFIDENCE IN ITS POWER TO FULLY JUSTIFY EVERY CLAIM WE MAKE FOR IT.

Our new "B. B." machine consists of a powerful two cycle, gasoline, valveless engine, perfectly adjusted, inspected—tested. It is conveniently mounted on a strongly constructed four-wheeled wagon—steel or rubber tires—so well balanced that it can be moved from place to place with the smallest effort.

The machine is completely equipped with vacuum condenser water tank, vacuum gauge, high pressure suction hose, observation glass and cleaning tools, all adjusted and ready for immediate use. Simple—easy to operate—small upkeep expense.

## Send Now—To-Day—for Interesting Booklet

A two cent stamp will bring it to you. It will tell you much. How to get on the path that leads to a big and profitable business—to bring you success. How to earn \$2,500.00 to \$3,000.00 a year—AND ONLY WORK PART OF THE TIME.

### "\$20 a Day Is Good Enough

For Me. I can make \$20 a day, which I think is good for the investment. It is good enough for me. I would not sell it for twice the price. Customers are well pleased with my work. Have three or four regular customers by the month."

A. W. Staley, Illinois

907 Dorr St., TOLEDO, OHIO

**Let Me Start You In  
the Poultry Business**

**DELIVERED**

I WILL show you how to add \$150 a year to your income in spare time, for each Peerless-60 incubator you operate in back yard or vacant lot. This new and better incubator is large enough for you, yet it is most economical to run. It's part of the wonderful Sheer Unit System of Poultry Culture which you can use, requires no large runs or expensive poultry houses. No other incubator has the features of this—fireproof metal, everlasting. Let me send you full particulars now. There's more money than ever in poultry—this incubator makes it profitable for you. Write tonight.

H. M. SHEER CO., Dept. 120, QUINCY, ILL.



## Do Your Printing!

Cards, circulars, books, newspaper. Press \$5. Larger, \$18, Rotary \$60. Save money. Big profit printing for others. All easy, rules sent. Write factory for press catalog. TYPE, cards, paper, out-fits, samples. THE PRESS CO., Meriden, Conn.

### I BUYS THIS PRINTING PRESS

The "Ideal" is an absolutely practical printing press, suitable for store, office or home. It's a wonder—always ready for work. Save dealers' profits. Write for a copy of our free catalog of printing presses and supplies.

IDEAL PRESS CO., 2011 N. Lawndale Ave., Chicago, Ill.

## Get a Broader View of Life in Bitter Root Valley

Arrange with us to join one of our coming low rate, first-class excursions and see with your own eyes the money making, health making and home making opportunities in this famous scenic environment, with good roads, hunting, fishing, and mountain climbing. Learn on the ground how you can obtain a return of \$200 an acre or more annually from a Bitter Root Valley fruit orchard. For excursion dates and particulars, address Robert S. Lemon, General Sales Manager, BITTER ROOT VALLEY IRRIGATION COMPANY, 849-855 First National Bank Building, Chicago, Ill.



# WATERLOO BOY TRACTORS GASOLINE ENGINES CREAM SEPARATORS



**Waterloo Boy Farm Tractors, Engines and Separators** are the best for the money the world has ever produced. Any one of these machines will increase the production of your farm at a big saving in labor.

Our light Farm Tractor is a wonder. It turns short and will go anywhere you can work with a team. Our tractors sell at such reasonable prices that you cannot afford to be without one.

**All Our Machines are Sold Under Our Strong Five-Year Guarantee**

Write today for our catalog and let us tell you about our tractors, engines and separators.

**Waterloo Gasoline Engine Company**

Waterloo, Iowa

**This Marvelous Tractor and Plows only \$1,050.00**

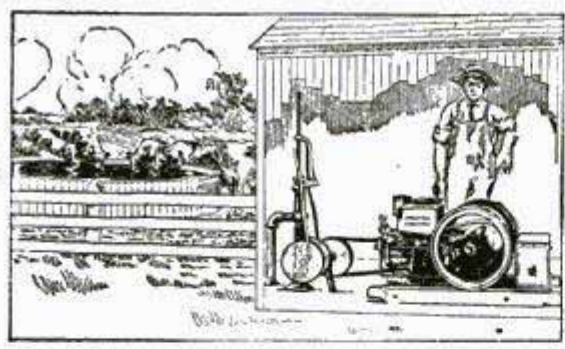
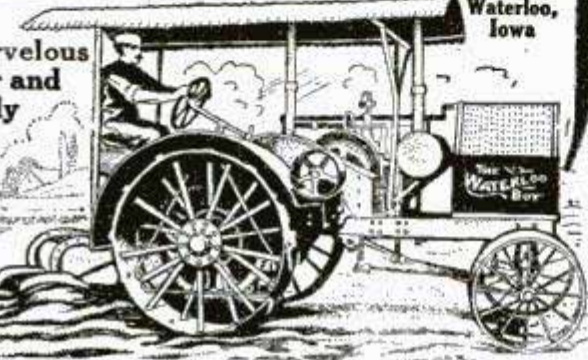

## International Harvester Oil and Gas Engines

**A** LITTLE careful observation will show you that the most satisfactory, economical engines are International Harvester engines. No doubt is left when features like the following are studied: Detachable valve guides, offset cylinder head, fuel pump, split-hub fly-wheels, extra large intake and exhaust valves, etc.

Ask the men who have used and know International engines. That is the best test. They will explain the excellence of International Harvester construction, simplicity, strength and durability.

International Harvester engines are of all styles, and range in size from 1 to 60-H.P. They operate on both low and high grade fuels.

Write for our catalogues and learn more about these engines

**International Harvester Company of America**  
(Incorporated)

16 Harvester Building CHICAGO U S A

# LAW

**ANYONE CAN LEARN LAW AT HOME NOW. NO NEED TO GIVE UP YOUR OCCUPATION.** This wonderful new law course brings the class room instruction, lectures, examinations, etc., to you right in your own home.

## New Course—New Text—New Method

Sixty handy law volumes. The **ONLY** complete series of law text books **EVER PREPARED FOR CORRESPONDENCE INSTRUCTION.** Written especially for the American School of Correspondence by 56 of America's greatest legal authorities, including deans and professors in leading resident law schools, judges of federal and state courts, and prominent practicing attorneys. **HARVARD, YALE, PENNSYLVANIA, OHIO, WISCONSIN, ILLINOIS, MICHIGAN,** and other great universities have contributed to this wonderful aggregation of legal talent. No other school can furnish these remarkable law texts. Far superior to studying from a "Law Library" or "Cyclopedia of Law."

## America's Newest and Best Correspondence Law Course

The last word in American Law and Practice. Every branch of the law thoroughly covered. Stripped of all non-essentials and useless technicalities. Written in plain, simple, easily understood language. All legal terms thoroughly explained and made perfectly clear. 100% efficiency in law instruction. Simplicity of method makes it possible for you to get **ALL** the knowledge contained in the complete course. Handy pocket size text books enable you to study under any and all conditions. Have your lesson always in your pocket. Take advantage of every spare moment. Saves time. Means quicker admission to the bar.

## The World's Greatest Correspondence School

For sixteen years the American School of Correspondence has stood at the head of all non-resident educational institutions. The only correspondence school in the United States chartered solely as an educational institution for the benefit of its students, not as a commercial enterprise for the benefit of stockholders.

Enjoys the proud distinction of having graduated a higher percentage of its students than any other correspondence school in the world. Positively the best school for YOU.



**These 60 New Pocket Size Text Books Yours With This Great New Law Course**

**Bar Examination Guarantee**  
The American School of Correspondence guarantees to coach and instruct you, without additional expense, if you fail to pass the bar examination after completing the full course.

## FREE BOOK COUPON

**American School**  
of Correspondence, Chicago, U.S.A.  
58th St. and Drexel Ave.

Gentlemen: Please send me your **FREE** Law Book, "How To Acquire a Legal Training," and full particulars regarding your wonderful new system of correspondence law instruction.

**SENT FREE** Special Law Book, "How To Acquire a Legal Training," explains all about this wonderful new system of law instruction. Send for it today. Get full particulars regarding this great course at once. Eliminate all possibility of failure. Be Sure of Success. Fill in the coupon and mail it today. Better do it **RIGHT NOW!!**

NAME.....

ADDRESS.....

Pop. Mech. 2-14

Please Mention Popular Mechanics

**TERMS TO SUIT** **FREE TRIAL FOR 30 DAYS** **NON-CRANKING** **KEROSENE ENGINE**

Write for Catalogue A3

*"The Masterpiece of the Largest Makers of Two-Cycle Engines in the World"*

The astounding success of Bessemer Kerosene engines is based upon the perfect Bessemer Universal Fuel Feeder, controlled exclusively by us.

### The Wonderful Bessemer Kerosene Engine

This perfect fuel feeder has sounded the death knell of carburetors, and is the only thoroughly successful device for feeding kerosene, gasoline, distillate, etc., without change of equipment. It is revolutionizing the engine business. It is the one big, right idea; we discovered it and control it—you cannot get it in any but a "Bessemer." "Bessemer" two-cycle engines are simple—only three moving parts—are constant and steady as clocks, 2 to 350 H. P. Immediate shipment. Fuel and crude oil engines up to 165 H. P.

WRITE FOR CATALOG A3

**THE BESSEMER GAS ENGINE CO., 121 Lincoln Ave., Grove City, Pa.**

**BEST FOR ELECTRIC LIGHTING**

**Pays for itself in fuel saved**



**GET THIS CATALOG**

FULL OF VALUABLE INFORMATION TO EVERY BOAT OWNER ON

**RACING PROPELLER WHEELS, REVERSE GEARS AND MARINE ACCESSORIES**

LARGE CATALOG FREE. SEND TODAY

**MICHIGAN WHEEL CO.**

1139 MONROE AVE., GRAND RAPIDS, MICH.



## HUNTERS—TRAPPERS

If you want an ideal lamp for night fishing, trapping, hunting or for work about farm or machinery, send to-day for a

### BALDWIN LAMP

Projects a 14 candle power light 150 feet. Burns Acetylene Gas. Weight 6 oz. Height 3 1/2 in. Can be carried in hand or worn on cap or belt, leaving both hands free. No oil, soot or glass. Absolutely safe and simple. Fifty hours' bright light costs 25c. Useful as well during Automobile repairing. Catalogue free and instructive booklet, "Knots and How to Tie Them" mailed on request.

At all dealers or by mail prepaid, \$1.00

**JOHN SIMMONS CO., 162 Leonard St., NEW YORK CITY**

**AUSTRIAN ARMY'S POWERFUL GUN WAGON—**

The new 12-in. siege mortars of the tubular-recoil type, with the tube 14 ft. in length and capable of projecting an 800-lb. shell nearly six miles, which have recently been introduced in the Austrian army, will be transported on motor trucks. The trucks, which are of the four-wheel-drive type, are equipped with 100-hp. engines and also with winches operated by the motor to assist the vehicles over heavy ground. In addition each hauls a special winch wagon for working the guns into difficult positions.

## Don't Buy an Engine

until you investigate the famous **TEMPLE Gasoline-Kerosene**, slow speed, heavy duty, all-purpose engines. Built and weight less than horizontal engines; cylinders built low, close to base, eliminating shock and vibration, increasing strength and durability, and giving scientifically correct distribution of strain. Pay for themselves in fuel saving alone. Have won five 1st premiums for low operating cost, stability and steady power. Old reliable pioneer concern (manufacturers for 61 years) guarantees these engines. Write today for catalog and particulars of 30-day trial offer.

**THE TEMPLE ENGINE & PUMP CO., 435 Meagher St., Chicago, Ill.**

**\$50 to \$300 SAVED**

**Just Write!**

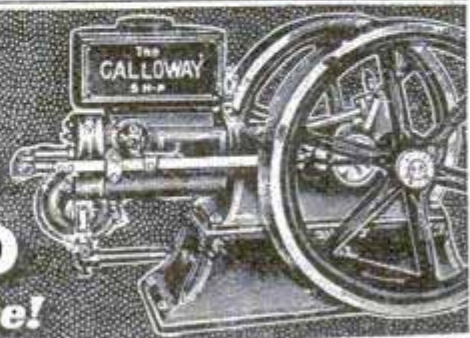

Get my prices—my new offers—get them right away. If you're going to buy an engine I'll put \$50 to \$300 in your pocket sure. All the dealers' profits cut off—you get them. You buy direct from my big factory.

**30 Days' Free Trial** Satisfaction guaranteed or your money back without a word. Any size from 1 3/4 to 15 H. P. Galloway Engines will run on gasoline, kerosene, naphtha, distillate, natural gas or motor spirits. Write for my Big Engine Book and Special Offers today.

**William Galloway, Pres., WILLIAM GALLOWAY CO.**  
965 Galloway Station, Waterloo, Iowa

## PRICES SMASHED!

**GREATEST WATCH BARGAINS KNOWN** We have knocked the day-lights out of watch prices—everybody's prices—killed competition—revolutionized the watch business—set a wonderful example—we have made it simple and easy for YOU to own at a low price the best watch made.

**WE BEAT THEM ALL** No matter what style of men's or ladies' watch you want—no matter what price you intended paying—The Fredro Watch Co. can save you money. No other house can do it—you get **SQUARE TREATMENT** from US. You can't duplicate our prices for high-grade watches any place else in the world. Everybody wonders how we can do it—and still let you take your own time to pay us. We sell you on credit

**THE BEST WATCHES ON EARTH** and save you money. We give you ours and the big manufacturers' ironclad 25 year **GUARANTEE** with each watch for accuracy, quality of material and perfect workmanship. You can't buy better watches at any price if you search the whole earth. You can get any style you want from us and be sure it is perfect. We sell

**DIRECT TO YOU** and save you all middlemen's profits. This is the only way you should buy a watch. We beat them all because we are one of the largest direct watch houses in the world and buy in large quantities. We **SELL** to you as **CHEAP** as any **DEALER** can **BUY**—you save his profits—enjoy his buying advantage.

**ON CREDIT** We let you try any watch for 30 days, deliver it to your door **CHARGES PREPAID**. It's our way—no red tape. **DON'T** confuse us with other houses—we make no statement we can't fulfill—we have been selling watches over 36 years—we are big, reliable.

**NO MONEY DOWN** That's how we do business—that's how we trust you. Get our big catalog, order any watch, and you need not pay a single penny down. You risk nothing with US. Take your own time to pay—we make it easy for ANY man or woman to own and wear the handsomest, finest watch made. Nobody can afford to be without one now.

**WRITE** for **FREE** catalog—see the many men's and ladies' handsome guaranteed gold watches we offer you at price-busting savings—read our easy terms—liberal offers, iron-clad guarantees and why we are **THE** house to buy your watch from. Send a postal **NOW**—see how easy we make it for you to own a watch.

**FREDDRO WATCH CO., Dept. 315, St. Louis, Mo.**

**SMALL EASY PAYMENTS**

**FREE TRIAL**

We let you actually try—wear—any watch in our massive catalog—30 whole days before you decide to keep it. This is a wonderful, big, friend making offer. You risk nothing. Get our big **FREE** catalog of handsome watches and read details of this liberal offer. **Don't wait**—we make it easy for you.

Send on approval, express prepaid.



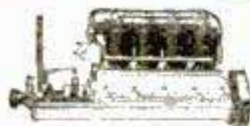

**THE SCRIPPS**  
COMPLETE MARINE POWER PLANT



## No Power for Ships Eclipses Scripps

Naval architects, boat builders, yachtowners, experienced seamen, work boat men, all will tell you that the Scripps Complete Marine Power Plant is the most dependable gasoline outfit that you can buy.

It has repeatedly demonstrated its reliability in tests of the most hazardous kind, driving a 35 foot motor boat from Detroit to St. Petersburg, successfully traversing the Niagara Rapids and Whirlpool not only once, but again this year.

That it can adapt itself to varying conditions is proved by the service that it is giving in Alaska and in South America.

Government experts have specified it, foreign engineers have endorsed it, all because of its known quality to stand up under hard, continuous usage.

Scripps Motors are made in 1, 2, 4 and 6 cylinder sizes. Medium and Extra Heavy Duty Types. Send for catalogue and information about starters, kerosene motors, and the \$500 7-horsepower Scripps Midget, a High-Grade Tender Motor.

### SCRIPPS MOTOR COMPANY

637 Lincoln Ave., DETROIT, MICH.

SCRIPPS MOTORS ARE CARRIED IN STOCK BY

- New York.....Bowler, Holmes & Hecker Co., 141 Liberty Street
- Chicago, Ill.....O. L. Cosgrove & Co., 215-219 Englewood Ave.
- Philadelphia.....W. E. Goehenaer, 631 Arch Street
- St. Louis, Mo.....Chas. J. Pettill, 1860 W. Market Street
- Jacksonville, Fla.....Gibbs Gas Engine Co., Foot of Main Street
- Seattle, Wash.....S. B. V. Miller, 72 Marion Street
- San Francisco, Cal.....Ellery Arms Co., 583-5 Market Street
- Los Angeles, Cal.....Marine Engine & Supply Co., 109 East 7th Street
- Duluth, Minn.....Kelley Hardware Co., 118-120 W. Superior Street
- Toronto, Ont.....Schofield-Holden Machine Co., 2 Carlow Avenue
- New Orleans, La.....Arthur Duvic, 130 Chartres Street

EXPORT OFFICE — 17 Battery Place, New York City

**Toledo MARINE MOTORS** NONE BETTER

"Nothing Cheap but the Price"

3 H.P. 1 cyl. complete	\$ 65.00
6 H.P. 1 " "	84.00
6 H.P. 2 " "	125.00
12 H.P. 2 " "	160.00
18 H.P. 3 " "	250.00

Fully guaranteed by a responsible concern. 2 cycle, 2 port, 2 1/2x3 1/2 and 4 1/2x4 1/2. Send for free catalog "C."

THE UNIVERSAL MACHINE CO., Pike Ave., Bowling Green, O.

**DUNPHY K D FRAME S** MAKE BOAT-BUILDING EASY

**Satisfaction Guaranteed**

Our K. D. frames are "different" from the ordinary—choicer material, heavier frame work, classy up-to-date designs, speedy and seaworthy. Complete line of finished boats in stock. Send 4 cts. postage for 1914 catalog.

**DUNPHY BOAT MFG. CO. EAUCLAIRE WIS**

AMERICA'S STANDARD 12-H.P. MARINE MOTOR

**KERMATH** 4 Cycle 4 Cylinder

Made in one size only by specialists in engine building. The Kermath hasn't an equal in this size and type, absolutely regardless of price. Catalog on request

**KERMATH MFG. CO.**  
Dept. P  
DETROIT, MICH.

\$180 to \$260, depending on equipment

# Wonderful Offer



**30 Days' Trial FREE**

A positively startling offer—tell your friends about it. For the first time—NOW—you can have a free home trial of any strictly high-grade violin or 'cello. Make your own choice from our famous collection—any one an instrument the best artists would be proud to own. Our large stock is carefully graded—not one ordinary violin of common quality.

## Finest Collection in America

We offer you — at astonishing low prices — representative old and modern violins from the best of the foreign makers — Herman Todt, Joseph Corretelli, Ernest Roth, Wilhelm Duerer, J. F. Straube, Franz Weidler and others. These geniuses have made our name famous as their violins are honestly made and honestly sold.

**Learn to Play** Take advantage of the long Winter evenings to master the violin — the sweetest of all musical instruments. Choose a high-grade instrument at the price you would pay elsewhere for ordinary quality.

We MAKE and IMPORT all our Own instruments and SELL DIRECT, giving you the benefit of the regular middlemen's discounts.

## Free Violin Book

Write Today for Free Copy of the new Lewis Catalog of Violins, Cellos, etc. Don't think of buying a Violin, Viola, 'Cello or other stringed instrument until you've seen this book. It will post you thoroughly on violin varnishes; tells you how to judge a violin by the wood, varnish and construction, and why we send our instruments on free trial. Write now for this book. Don't pay enormous profits to jobbers, brokers and dealers. Every one of these gets part of your money when you buy a violin in the regular way.

Our instruments are all fine, hand made, tone violins for professional use, sold at exceptionally low prices. Some models are wonderful copies of celebrated old violins belonging to the greatest artists. They are far superior in quality and power of tone to the average old violin at four times the cost. We want you to test the instrument you choose, right in your own home and at our expense.

Violins of our own Chicago make sold so rapidly this past season that we fell far behind in orders. Try one and see for yourself why this statement is a fact.

### Send Coupon NOW

DON'T DELAY — Send the Coupon NOW for our Free Violin Book. If you have an idea of ever buying a violin you need this book. Write NOW.

**WM. D. LEWIS & SON** (Est. 1869)

Makers and Importers  
225 So. Wabash Ave.  
CHICAGO, ILL.

Violin Makers — We make a specialty of Imported Woods, Varnishes and Tools.

Write Us Today

Name .....

Address .....

### 10 to 30 Days' Trial Free

Try any instrument in our stock before you decide to buy. Don't buy any kind of a musical instrument any other way. You can't tell anything from a printed description or a few minutes' trial in a show room. We insist that you shall be satisfied and we will pay the express charges both ways on all returned instruments.

**Wm. D. Lewis & Son** (Est. 1869)  
Makers and Importers  
225 So. Wabash Ave.  
Chicago, Ill.

Gentlemen: — With no obligation whatever upon me you may send me free and postpaid one copy of the new Lewis catalogue and full particulars of your Great Free Trial Offer on High Grade Violins.



## This 1914 New Motive Power Engine

No gasoline  
No electricity  
No steam

No exhaust  
No explosion  
No batteries  
No springs  
No valves

This New Thermo Engine is positively the most wonderful and interesting small power engine ever invented. Its motive power is the application of heat to compressed air. Each stroke of the pistons compress the air in the cylinder, forcing it to the bottom where a small alcohol lamp creates a rapid expansion, developing sufficient power to run the engine at high speed besides operating several mechanical toys, advertising devices or a large fan which can be used by stores in winter to keep frost off the windows, and in summer to keep cool. There are hundreds of uses this little machine can be adapted to and its cost is cheap. No intricate parts to get out of order and will run continuously as long as heat is applied. Built of heavy cast iron and steel, strong and durable. It stands 16 1/4 inches high and weighs 12 lbs. Perfectly safe for any child to operate and an interesting machine for anyone. We guarantee delivery in perfect running condition and to be just as represented or money refunded. (Agents Wanted.)

# \$5.00

Order Today

THERMO ENGINE CO., R. 216, No. 9 S. La Salle St., CHICAGO

## Sport-Without Work

THIS little motor does away with oars and paddles. It enables you to "chug-chug" to the hunting or fishing grounds without exerting a muscle except to steer the boat. It attaches to the rear of any square or pointed stern row boat by simply turning two thumb screws, and will drive it seven to nine miles an hour or slow enough to troll. The

### Caille Portable Boat Motor

weighs but fifty-five pounds. Develops 2 horsepower. Is steered by a rudder—not the propeller. Rudder is of our folding, stone-dodging type, (pat. applied for.) Weedless propeller is protected by a substantial fin. Motor can be easily adjusted to any angle or depth of stern. Half a turn of the fly-wheel starts it. Can be used in salt or fresh water. A postal brings our beautiful catalog. Send to-day.

**We Also Build** marine engines from 2 to 30 H. P. for boats of all descriptions. If interested, ask for large engine catalog. Caille Perfection Motor Co. 1418 Caille St., Detroit, Mich.



2-0-6 H. P.

## ROBERTS MOTORS

FOR BOATS  
FLYING BOATS  
AEROPLANES  
AUTOMOBILES

Cannot be excelled for reliability and lasting qualities. The only motor which gains in power with use.

CATALOG FREE

The Roberts Motor Co., 1419 Columbus Ave. SANDUSKY, OHIO

## GRAY MOTORS FOR BOATS



Largest Builders of 2-cycle Motors in the World. Over 1000 responsible dealers.

3 H.P. with Complete Outfit ready to install \$55 ALSO 4 1/2 TO 36 H.P.

Guaranteed by a big responsible concern. Write for big catalog—tells and shows you all about these high grade motors and how they are made.

GRAY MOTOR CO., 288 Gray Motor Bldg., Detroit, Mich.



## WATKINS' SPECIAL MOTOR

3 H. P. Single Cylinder . . . 30 lbs.  
6 H. P. Double Cylinder . . . 60 lbs.  
12 H. P. Four Cylinder . . . 100 lbs.

A strictly HIGH GRADE Motor that will give CONSTANT and EFFICIENT service. Especially adapted for CANOES and LIGHT BOATS. Aluminum base, copper water jacket, steel shaft, bronze bearings.

THE WATKINS MOTOR CO.

837-839 West Sixth Street CINCINNATI, OHIO

**LA**  
Marine Motors  
Direct from Factory  
to You

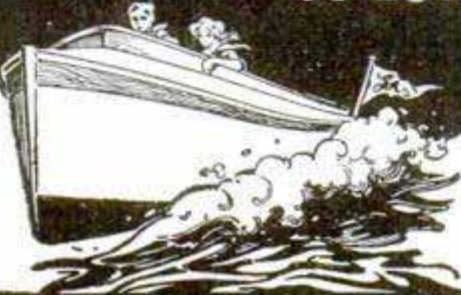

## Save the Dealer's Profit

It won't cost you as much as you thought to enjoy the pleasure of motor boating this summer. The old, reliable, "keep-going" Lockwood-Ash motors are sold direct from factory to you at a big saving. No dealer's profits to pay.

**Immediate Delivery** Six models, all guaranteed for one year, and sold on 30 days' trial. No strings to this offer, no freight to pay. Just send for any of our complete outfits, and if it doesn't delight you send it back at our expense.

The 1 1/2 H. P. Motor and Outfit complete, shown in illustration, freight paid, only \$36.25—a clear saving of at least \$13.75. Post yourself on motor boating and the safest, cheapest way to buy by writing today for our 1913 catalog. It's soon time to start—get busy. Lockwood-Ash Motor Co., 236 Horton Ave., Jackson, Mich.

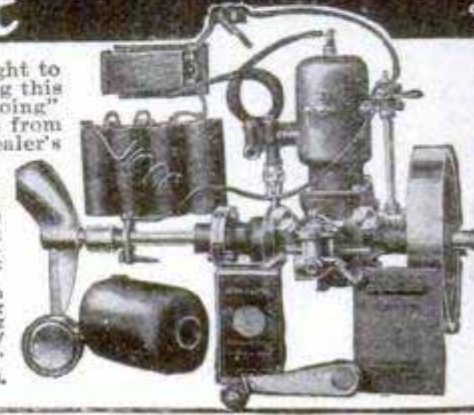

# ELLIS ENGINES

develop more power on kerosene than other engines on gasoline. Will also operate successfully on distillate, petrol, alcohol or gasoline without extra equipment. Strong, powerful, easy to operate—only three working parts. No vibration. Ellis Engines are low in price and the most economical engines made, as they

## Cut Fuel Cost in Two

34c will run a 6-H. P. engine for 10 hours on cheap kerosene. Patent throttle makes three engines in one. Force-feed oiler, automobile muffler, speed-changing governor and many other exclusive features. We'll send it to you on

### 30 Days' Free Trial

Test its strength, simplicity and economy. You'll be surprised at their low cost—we sell direct—you save the agent's profits. Guaranteed 10 years. Send today for new 1914 catalog describing latest models and quoting lowest prices. **ELLIS ENGINE CO.**  
66 Mullett St., Detroit, Mich.

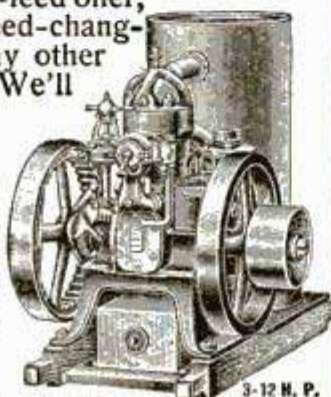

3-12 H. P.

## Simple, Safe, Sure and Serviceable

—the four principal features of the speedy little Redemotor Engine. No experience in operating gas engines necessary. Runs on almost any adjustment of the carburetor. Easy for a woman or child to start, the

## REDEMOTOR ENGINE

is absolutely safe and sure. Uses gas, gasoline, kerosene, or alcohol. **Runs fine on city gas.** Made in 3 sizes,  $\frac{1}{4}$ ,  $\frac{1}{2}$  and 1 horse power. **Silent running**—as noiseless as an electric motor—and much cheaper to operate.

### Positive Satisfaction Guaranteed

or your money back. Write today for **Free Booklet 142.**

**ELGIN WHEEL & ENGINE CO.**  
ELGIN, ILLINOIS



## Waterman PORTO does it

1914 Model  $2\frac{1}{2}$  to 3 H. P.  
59 pounds

Makes any boat a motor boat  
Sold direct from factory to you

Has Carburetor; 3 Piston Rings; removable Phosphor Bronze Bearings; solid Bronze Skeg; water cooled Exhaust Manifold; noiseless under water exhaust; bronze gear Pump for water circulation; Spun Copper Water Jacket highly polished;  $10\frac{1}{2}$  in. by 16 in. propeller; steers with tiller lines from all parts of the boat. No other portable motor has this equipment. Get the Waterman Porto Motor, costs you no more than you pay for the inferior kind—compare for yourself.

Ninth year, over 20,000 in use. Guaranteed for life.

Write today for catalog.

Waterman Marine Motor Co., 230 Mt. Elliot Ave., Detroit, Mich.

# STEAM ENGINEERING

## THIS \$35 EDITION



## Now \$19.80—\$2.00 a Month

You men in charge of stationary, locomotive or marine engines and boilers—men who operate gas or gasoline engines—central station engineers—young men ambitious in the electrical field:

Here's your chance to own the famous **Steam Engineering Library**, written by 27 of the biggest and best known engineering experts in America, at a simply phenomenal price. The regular \$35.00 Edition for a short time at \$19.80 complete—\$2.00 a month.

Seven big, handsome books; bound in half red morocco, gold stamped; 3,300 pages; 2,500 absorbing illustrations, full page plates, diagrams, etc.; hundreds of valuable tables and formulas; cross-indexed so that you can get at any subject instantly, at an astounding introductory price.

### SHIPPED FREE

Look this entire set over for a whole week **FREE**. See if it really does fit in with your needs. Then decide whether or not you want to keep them. And don't send us any money until you decide. We'll ship the set absolutely free, express paid by us. See coupon below.

### These Subjects Covered

Construction of Boilers—Boiler Accessories—Fuel Economizers—Mechanical Stokers—Steam Pumps—Steam Engines—Indicators—Valve Gears—Steam Turbines—Gas and Oil Engines—Fuels—Automobiles—Carburetors—Locomotive Boilers and Engines—The Air-Brake—Single-Phase Electric Railway—Elevators—Marine Boilers—Marine Engines—Heating and Ventilating—Compressed Air—Transmission—Absorption and Compression Refrigeration—Ammonia Machines—Direct Current Dynamos and Motors—Management of Dynamos and Motors—Electric Wiring—Electric Lighting, etc.

## FREE!! \$12.00 Consulting Membership

Our big board of consulting experts, men actively engaged with engineering departments of prominent Chicago concerns, will answer any question or solve any problem you have for a whole year absolutely free when you own these books. This privilege alone sells for \$12.00, but you get it free if you keep the books.

### SEND THE COUPON

Merely send us this coupon. Books shipped at once free, express paid. Send us no money. Study the books a whole week. Then make up your mind. Then pay only the special price—\$19.80—at the rate of only \$2.00 a month, if you wish. But first see the books. The coupon brings them quickly. Mail it today. You take no risk, for we take the set back if you say so, and you are not out a penny.

**AMERICAN TECHNICAL SOCIETY**  
CHICAGO, U.S.A.

## FREE COUPON

Worth \$15.20 to You

American Technical Society:

Please send me 7 volume set Cyclo-pedia of Steam Engineering for seven days' free examination. If I decide to buy, will send \$2.00 in seven days and balance \$2.00 a month until \$19.80 has been paid, when \$35.00 books and \$12.00 consulting membership will be mine free. Otherwise will notify you and hold books subject to your order. Title not to pass until fully paid. Pop. Mech. 2-14

NAME.....

ADDRESS.....

As I have had no previous dealings with you, I refer you to

## BUILD YOUR OWN BOAT



# Saw-Plane-Hammer-Screwdriver All the Tools You Need



You can saw straight, drive a nail and a screw. You can assemble a boat by the Brooks System.

You need know nothing of designing or of the fine points of boat building—the materials for the boat come to you all ready to put together.

Thousands of people assemble their own boats by the Brooks System every year. Simple directions tell you every move to make. You can't go wrong for all the fitting of parts has been done by our experts, which gives you as good a boat as any professional could make and better than most.

## Write for the Brooks Catalog and Learn About the Brooks System —Saves Two Thirds Boat Builder's Price

The materials alone are all you pay for. Many professional boat builders make use of the Brooks System to get the latest ideas in designs.

Why not start now? Build a new "V" bottom model—the popular, speedy model that is so easy to build.

Write for the Brooks Boat Book. See illustrations and descriptions of speed boats, family launches, hunting boats, sail boats, row boats, sailing, paddling and power canoes. Many styles and sizes in each class.

### BROOKS MANUFACTURING COMPANY

Largest Plant of its kind in the world. Originators of the Pattern System of Boat Building.

8202 Rust Ave.  
SAGINAW, MICHIGAN

\$33

buys patterns and knocked down frame for this handsome 23-ft. boat

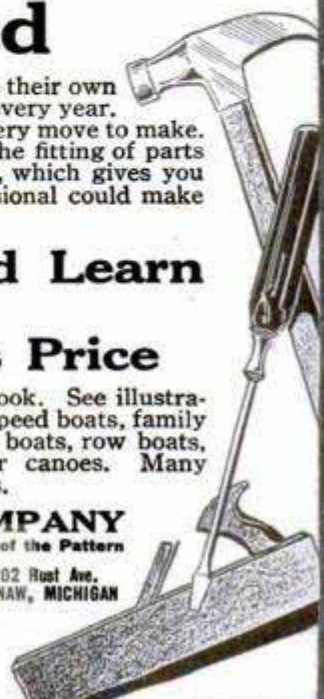

**GLASSY ART PORTFOLIO** Contains 17 rare beauty poses by famous French and other artists. Each vividly described. Handsomely bound. Send 2c stamp for complete illustrations and special offer.

HICKS PUBLISHING CO., Dept. 14, Schiller Bldg., Chicago, Ill.



## EXPERIMENTERS

This is the **Experimenter's Reference Book**

It's the latest edition of the famous **Amco Catalogue**, 128 pages, fully illustrated, complete description and prices of the latest electrical and experimental apparatus—Storage

Batteries, Rectifiers, Transformers, Induction Coils, Wireless Apparatus, Lamps, Flashlights, Meters, X-Rays, Books, Tools, Electric Railways, Steam Engines, Water Motors, Dynamos, Motors, Telegraphs, Telephones, Electrical Supplies, Model Aeroplanes, and Parts for building your own apparatus. 4c in stamps will bring you this wonderful book. *The best catalogue of Wireless Apparatus, etc., published.*

ADAMS-MORGAN CO. "The Experimenter's Supply House" Box 72 M, Upper Montclair, N.J.



## \$2850 NEW VIM ENGINE



No valves, cams, gears, or complicated parts. Has sensitive governor, silent muffler, hopper cooled cylinder, automatic lubrication, nothing to get out of order. Runs washing machines, churns, separators, spray pumps, pump jacks, light farm and shop machinery, etc. 15 days' free trial. Money back if not satisfactory.

Write today for catalog. Agents and jobbers wanted. THE VIM MOTOR CO., 102 Water St., SANDUSKY, OHIO

## ELECTRICITY

Electric light plants from 6 to 50 lights. All prices. All kinds of electrical apparatus. Motors, Dynamos and Batteries. Gas, Gasoline and Steam engines from 1/4 h. p. up. Get our No. 12 Toy and Engine or No. 20 Engines and General Catalogs. Ten cents each. (Coin preferred.) Refunded on first order.

AMATEUR MECHANICS SUPPLY CO.

330 G South Dearborn St., CHICAGO

## \$130 The Greatest Motor Boat For The Money Ever Built

**MULLINS** 16 foot special steel launch will afford you the pleasures of motor boating, and provide a safe, seaworthy, dependable motor boat, with graceful lines and beautiful finish—**Absolutely Guaranteed Against Puncture**—Safe as a life boat, with air chambers concealed beneath

decks in bow and stern—Can't warp, split, dry out or rot—No seams to calk—No cracks to leak.

**MULLINS \$130 Special Launch** is equipped with 2-cycle, 3-H. P. Ferro engines, that can't stall—Speed 8 1/2 to 9 miles an hour

—One man control—Fitted with **MULLINS** silent under-water exhaust.

This 16 footer seats 8 people comfortably—

has 4 foot beam and 11 foot 4 inch

cockpit—Positively the great-

est launch value ever offered.

Write today for beautifully

illustrated motor boat

catalog, containing full

particulars.

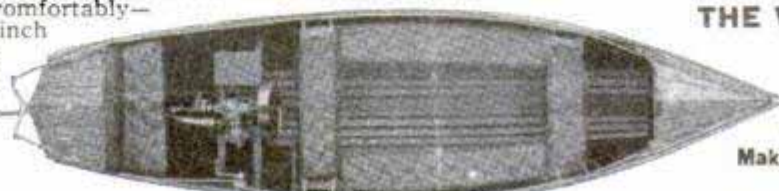

THE W. H. MULLINS CO.

151 Franklin St.

SALEM, OHIO, U. S. A.

The

World's Largest Boat Builders  
Makers of MULLINS Famous Steel  
Boats and Cedar Canoes

## MULLINS STEEL BOATS CAN'T SINK



The 1914

# EXCELSIOR LAUTO-CYCLE

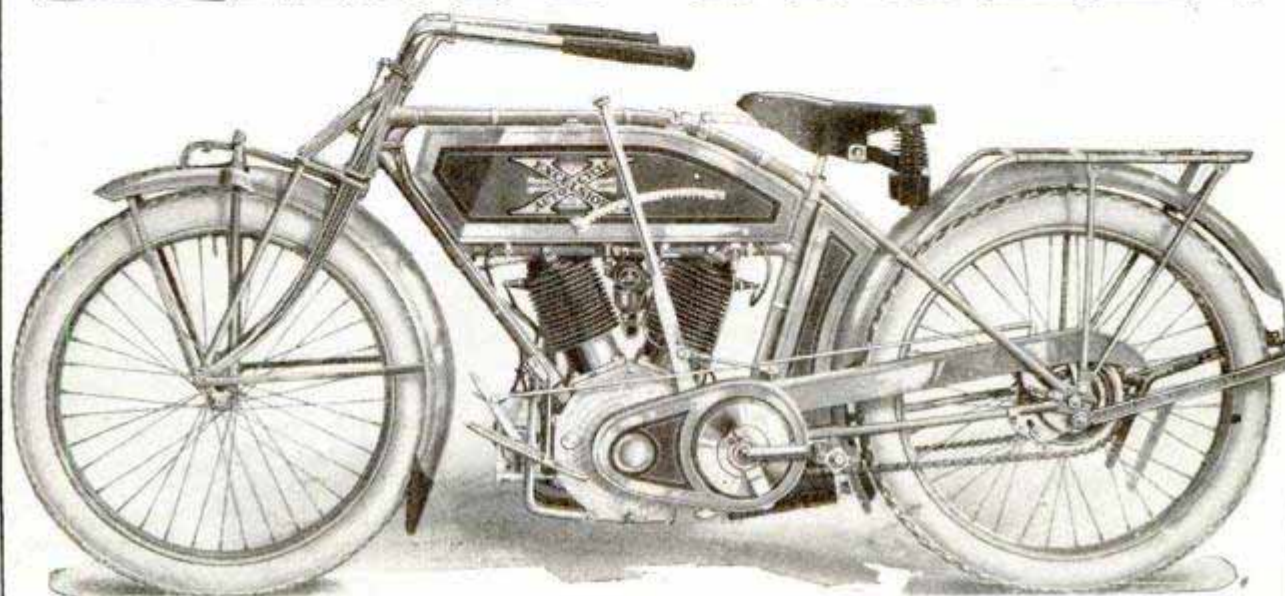

## Model 7-T. S. Price \$260.00

**T**HE machine that meets the enthusiastic approval of discriminating mechanics and engineers.

☐ No experimental frills, but every modern feature of real practical value that has been brought to the EXCELSIOR standard of efficiency.

☐ A machine that has been built for seven years without radical changes in design, but with every element developed to the highest degree of mechanical perfection.

☐ A machine that was right in the beginning, has been kept right regardless of cost of production or selling price, and has

## ALWAYS MADE GOOD

☐ The EXCELSIOR Two Speed is simple, positive and reliable, with no springs to weaken or get out of adjustment. Gears are always in mesh, but running only at low speed or when the motor is running free.

☐ Gear control is by a single movement of one lever, one movement engaging either speed or shifting from high to low, or vice versa.

☐ Many other points of unquestionable superiority, all described in our 1914 catalog, which will be freely mailed upon request.

☐ Seven models, Singles, Twins, Two Speed, Chain and Belt Drive.

**The machine you ought to have at the price you ought to pay.**

Write today for catalog or see the nearest EXCELSIOR Dealer.

**Excelsior Motor Manufacturing & Supply Co.**  
2202-2250 South Union St., CHICAGO

# Ask For "Champion" Priming Plugs

## Don't Accept Any Substitutes



**Champion Priming Plugs** start any motor, in any weather, on the first quarter turn.

They are so good that, of course, they were promptly imitated.

If the name "**Champion**" isn't on the porcelain, you may be sure it isn't genuine.

The "**Champion**" is the only priming plug which sends the gasoline down a special channel, **through** the wall of the plug.

That's why it won't "soot up" or break the porcelain.

It puts the few drops of gasoline needed right at the firing points, and explodes them with a hot, fat, "**Champion**" spark.

**Champion Priming Plugs** cost \$1.25 each. They are guaranteed to work perfectly—or your money back.

If your dealer is not yet supplied, send us \$5 for a set of four **CHAMPION PRIMING PLUGS**—prepaid—and we will add **FREE**, a handsome nicked wrench fitting the plug, bushing and needle valve.

They are made in a special size for motorcycles. Send name and year of your motorcycle with your remittance.

(Licensed under the Canfield Patent No. 612,701, Oct. 18, 1898)

**Champion Spark Plug Co., 404 Avondale Ave., Toledo, Ohio**



### Ten Days' Free Trial

allowed on every bicycle we sell. We **Ship on Approval** and trial to anyone in the U. S. and **prepay the freight**. If you are not satisfied with the bicycle after using it ten days, ship it back and **don't pay a cent**.

**FACTORY PRICES** Do not buy a bicycle or a pair of tires from anyone at any price until you receive our latest **Art Catalog** of high grade bicycles and sundries and learn our **unheard-of prices and marvelous new special offers**.

**IT ONLY COSTS** a cent to write a postal and everything will be sent you **FREE** by return mail. You will get much valuable information. **Do Not Wait; write it NOW!**

**TIRES, Coaster-Brake, rear wheels, lamps, parts, repairs and sundries of all kinds at half usual prices.**  
**MEAD CYCLE CO. Dept. S108 CHICAGO**

## MAKE YOUR BIKE A MOTORCYCLE

at a small cost, by using our attachable outfit. Fits any Bicycle. Easily attached. No special tools required.

### "It is Cheap Riding"

Mr. Greenfield, of Texas, writes: "The motor I ordered from you some time ago has given good satisfaction. Carries me up any hill and against any wind. It is cheap riding." Mr. Dunning, of Illinois, writes: "The motor I received from you last fall has given perfect satisfaction and is all and more than you claim it to be. I am a man weighing 180 lbs., and it takes me anywhere that could be expected. It took me seven miles over rough and hilly roads in fifteen minutes. I will be glad to recommend it to anyone."

**FREE BOOK** Write today for bargain list and free booklet, fully describing the **SHAW Bicycle Motor Attachment**. Motorcycles all makes, new and second-hand, \$35.00 up.  
**SHAW MANUFACTURING CO.**  
Dept. 6 **GALESBURG, KANSAS**



### \$40 Motorcycle

We have the largest line of new and used Motorcycles in the country at the lowest prices. We also have a thoroughly equipped repair department and are in position to furnish repairs for any machine. Send us your machine to be overhauled. We pay cash for second hand motorcycles. *Send for Catalog.*  
**HARRY R. GEER CO., 888 McLaran Ave., ST. LOUIS, MO.**



### Morgan Gas Lighter

Agents wanted everywhere to handle this Specialty. **LARGE PROFITS** Increasing Demand. Send for Territory and Sample.

**B. MORGAN, Bellevue St., Newport, R. I.**



### Solar Motorcycle Lamps

are the neatest looking, strongest and most efficient lamps made. The product of light specialists, makers of 90% of the automobile lamps used on the high grade cars of America. Catalog shows many styles—gas, oil and electric. Write for it today.

**BADGER BRASS MFG. CO.**

**Kenosha, Wis. New York City, N. Y.**

**5 H. P.**

**1914 Peerless Motorcycle**

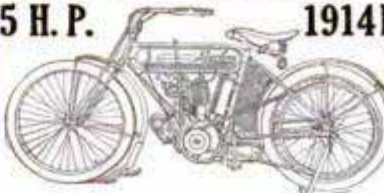

With **Free Engine Idler** and **Bosch Magneto**, together with the best there is in motorcycle construction—**Power, Silence, Endurance**, and those **Wearing Qualities** so essential for low cost of maintenance.  
**5 MILES FOR ONE CENT**  
Agents Wanted—Liberal Discounts

**PEERLESS MOTORCYCLE CO., 179 Huntington Ave., BOSTON, MASS.**



# Prest-O-Lite

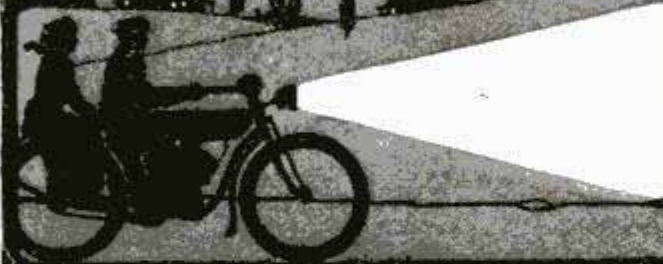

## The Only Practical Light for Motorcycles

Prest-O-Lite is the only lighting system that makes night riding possible, pleasant and SAFE.

This ready-to-use gas costs no more—usually costs less—than the carbide a generator consumes.

The first cost is low [\$10]. Prest-O-Lite never gets to be second-hand, and is always a READY CASH ASSET.

You can easily afford it. You cannot afford to be without it if you ride at night. One accident might cost you more than years of Prest-O-Lite service.

Easily attached to any motorcycle. We will arrange for immediate exchange service for anyone, anywhere.

**DON'T ACCEPT AN IMITATION!**

The genuine Prest-O-Lite, when empty, can be immediately exchanged for a full one, ANYWHERE AND ALWAYS. Imitations cannot.

Ask for our free book on ALL lighting systems.

THE PREST-O-LITE CO., Inc., 265 Speedway, Indianapolis, Ind.

Contributor to Lincoln Highway

Branch offices and Service Stations in all principal cities. Charging plants in all parts of the country.

Exchange Agencies Everywhere

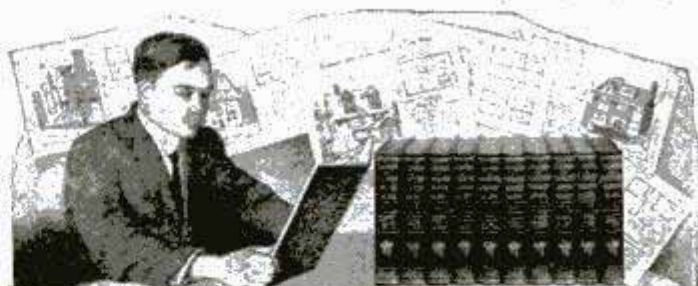

## FIRST AID to Carpenters, Contractors and Builders

Here's a wonderful plan book that will help you land the orders. It contains complete plans and specifications for 168 different structures, including excellent interior and exterior views, detailed estimates, etc. Designed by the leading architects of this country. Includes city, country and suburban homes, bungalows, farm houses, summer cottages, tent houses, camps, garages, apartment houses and various public buildings. Contains 224 pages, 9½ x 12¾ inches, and 426 illustrations. Printed on heavily enameled paper and substantially bound.

This is your opportunity to become a leader in your field. With this great plan book in your office you are prepared to figure on any job, no matter how large. No need for the prospective builder to consult an architect when you can offer him his choice of practically every style of the modern American home. Your ability to save him the usual architect's fee will enable you to get the business. This new and useful plan book, "Modern American Homes," and the complete **Cyclopedia of Architecture, Carpentry and Building** will give you in the most accessible form that knowledge of present day architecture and building construction so necessary to the success of the up-to-date carpenter, contractor or builder.

## The Cyclopedia of Architecture, Carpentry and Building

consists of ten massive volumes: 4,760 pages, 7x10 inches; 4,000 illustrations, full page plates, building plans, diagrams, etc.; hundreds of valuable tables and formulas; carefully cross-indexed for quick, easy reference.

This great work covers everything in the building professions, from the first rough sketch of the architect to the acceptance of the finished structure. It includes wood, stone, steel, and reinforced concrete construction; estimating and contracting; a study of the Greek and Roman Orders; interior finishing and decorating; and modern house lighting and sanitation.

### Partial Table of Contents

Mechanical, Freshhand, Perspective and Architectural Drawing, Lettering, Pen and Ink Rendering, The Orders, Superintendence, Strength of Materials, Masonry, Reinforced Concrete, Carpentry, Steel Square, Stair-Building, Hardware, Steel Construction, Roof Trusses, Practical Problems, Estimating, Contracts, Specifications, Building Law, Sanitation, Sheet Metal Work, Electric Wiring and Lighting.

### We'll Send the Plan Book FREE

With every order for a Cyclopedia we will include the Plan Book, absolutely free of charge and send you the Cyclopedia and the Plan Book, express prepaid, for seven days' free examination. You keep the books a full week—examine them thoroughly at your leisure—and if they don't meet with your expectations they may be returned at our expense. Remember—the complete set, Cyclopedia and Plan Book, are sent free upon receipt of the coupon below and we pay express charges both ways if they are not satisfactory.

**Another Free Offer** With each set is included a year's Consulting Membership, regular value \$12.00, entitling you to the free advice of a corps of Expert Architects. This will give practical help in handling your difficult building problems. This service alone is worth more than the first cost of the books.

**AMERICAN TECHNICAL SOCIETY, CHICAGO, U. S. A.**

### FREE PLAN BOOK COUPON

**AMERICAN TECHNICAL SOCIETY, Chicago, U. S. A.**

Please send Free Plan Book, also Cyclopedia of Architecture, Carpentry and Building for seven days' examination. I will send \$2.00 within seven days and \$2.00 a month until I have paid \$24.80 for Cyclopedia (Plan Book included free), or notify you and hold books subject to your order. Title not to pass until fully paid. Pop. Mech. 2-14

NAME .....

ADDRESS .....

As I have had no previous dealings with you, I refer you to .....

**ROCK BLASTING ON GIGANTIC SCALE IN ITALY**—Nearly 400,000 cu. yd. of rock, weighing upward of 750,000 tons, was detached from the mountain side by one single blast, at the quarries of Chiappella, which supply the stone used in the construction of the new "Vittorio Emanuele" basin at the port of Genoa. The explosion was fired by electricity in presence of the port authorities, a number of artillery and engineer officers, and a large crowd of spectators.

## Motorcycles EXCELSIORS

State Distributors for  
Everything for  
the Motorcycle

Harry Svensgaard Sales Corporation  
471-473 Woodward Ave. Detroit, Mich. Telephone Grand 671

## YOU CAN NOW GET Diamond Automobile Squeegee Tread Tires ON YOUR MOTORCYCLE OR BICYCLE

You have exactly the same tire problems as the automobilist. Realizing this, we have built for you a tire made of the same Vitalized Rubber, the same fabric, the same principle of construction, and built in exactly the same manner as the automobile tire. Diamond Vitalized Rubber Motorcycle Tires are made with the Squeegee or Studded Tread and Perfect 3-Point Rim Contact; also the "More Mileage" Strip on the tread, an exclusive Diamond feature. They "won't slip—won't slide—won't skid—but grip and hold."

YOUR DEALER CAN SUPPLY YOU

## Garage \$49.50

Genuine "Edwards." Ready-made, fire-proof garages. Quickly set up any place. Direct-from-factory prices—\$49.50 and up. Postal brings illustrated 64-page catalog.



THE EDWARDS MFG. CO., 320-370 Eggleston Ave., Cincinnati, Ohio

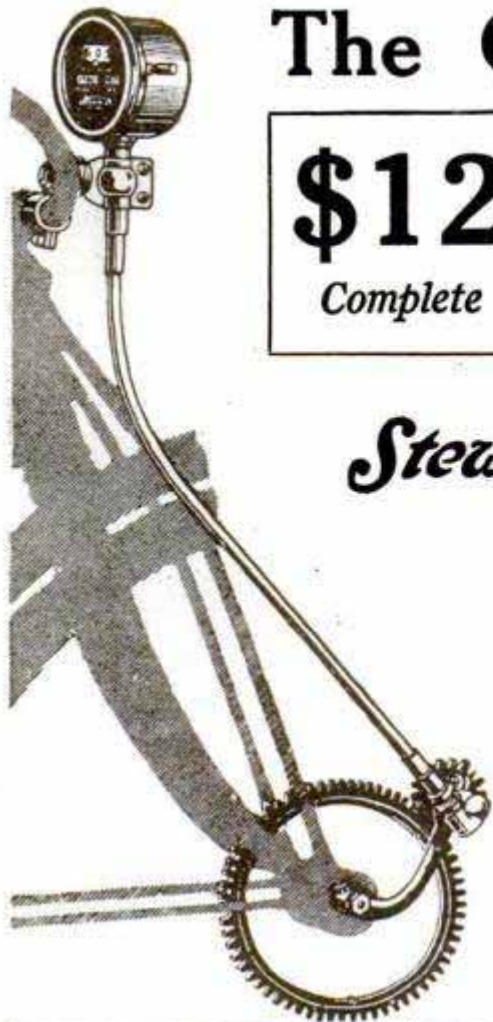

# The Only Satisfactory Drive for a Motorcycle Speedometer

## \$12

Complete

THE front wheel is the only proper place to drive a Motorcycle Speedometer. The rear wheel slips under power and revolves when "tuning up." It gives false mileage—yet has always been furnished because no former front drive could survive the destroying lash of the front fork. We, alone, have mastered the difficulty and are furnishing our accurate, everlasting new Front Wheel Drive with the

## Stewart Motorcycle Speedometer

Magnetic Principle

In this new Stewart, the drive chain operates through a rigid steel tube. This tube supports the bracket that holds the angle joint and fibre pinion. This bracket moves free on the axle of the front wheel and, consequently, absorbs without injury all the deadly spring fork action.

We make a Rear-Wheel Drive Stewart. It is the best of its kind on the market. But we recommend the new Stewart with Front-Wheel Drive as more accurate, more durable, more satisfactory and more practical. And the price—\$12—is the lowest at which a magnetic speedometer has ever been made.

For sale by dealers everywhere. Have yours put on today.

**Stewart-Warner Speedometer Corporation**

Factories: Chicago, Ill., and Beloit, Wisc.

Branches and Service Stations in all principal cities.

### Pope Motorcycles

The modern time and money savers 15.4 H. P. engines, Pope spring suspension, twin stem handle bars, low saddle position, two speed—positive simple gear change, special formulae metals, automobile type construction, roller bearing connecting rods. Complete Line, Regular Models, \$150.00—\$200.00—\$215.00—\$250.00—\$285.00

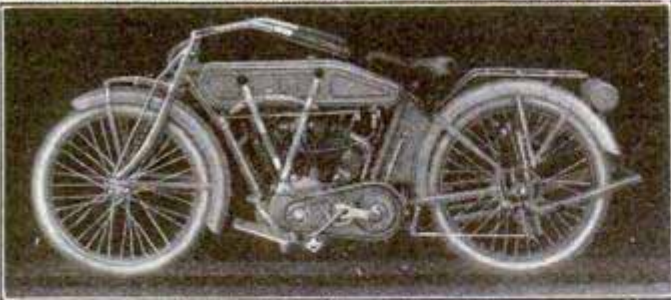

POPE TWO-SPEED MODEL R-14, \$285.00

WE MAKE THE FIRE FIGHTING MOTORCYCLE

POPE MANUFACTURING COMPANY, Westfield, Mass., U. S. A.

### Our business is making gloves—



in a score of different styles. And it is our hobby to make each style, of the finest possible quality. That makes our gloves pay you, and it makes our business pay us. Everything, from handsome dress gloves to sturdy work-gloves, is of the best; —material (rawhide to velvet "Reindeere") and workmanship.

## Grinnell Gloves

Sold with a bond

give the utmost in satisfaction. Write for glove book, samples, and our "free pair to you" offer.

MORRISON-RICKER MFG. CO.

153 Broad St. Established 1856 Grinnell, Iowa



### RIDER AGENTS WANTED

in each town to ride and exhibit sample 1914 model. Write

for Special Offer. Finest

Guaranteed 1914 Models \$10 to \$27

with Coaster-Brakes and Puncture-Proof Tires.

1912 and 1913 MODELS \$7 to \$12

ALL OF BEST MAKES.....

100 Second-Hand Wheels

All makes and models, good as new

Great Factory Clearing Sale. \$3 to \$8

We Ship on Approval without a cent

deposit, pay the

freight & allow

TIRES coaster-brake wheels, lamps, and

sundries, half usual prices. DO NOT

BUY till you get our catalogue and offer. Write now.

MEAD CYCLE CO. Dept. 5108 CHICAGO

## HENDERSON

4 cylinder, 8 horse power . . . \$325

Two speed model . . . . . 365

Tandem attachment complete 20

LITERATURE UPON REQUEST

HENDERSON MOTORCYCLE COMPANY, DETROIT, MICH.



## The SIEVERKROPP

to run your washing machine, will make wash day a pleasure. A simple, reliable, easily operated little engine to do the hard work.

### Our Washing Machine

Special is strictly high grade

and it will cost you

no more than the ordinary engine.

Don't continue in the same old way,

but investigate our proposition. En-

close a stamp for catalog and prices.

SIEVERKROPP ENGINE CO.

1224-18th St. RACINE, WIS.

Please Mention Popular Mechanics

# I SMASH The Terms

Watches  
on  
**CREDIT**

16 Size Thin Model



ELGIN  
HAMILTON  
HOWARD  
ILLINOIS  
**Any Watch  
You Want**

on

## 30 Days' Free Trial

**No Money Down**

**Express Prepaid in Advance by Me**

That's the way I smash terms. That's the reason why I am doing the greatest credit watch and jewelry business. I am "Square Deal" Miller and I trust the people.

I do business on your terms, send you what you want. Suppose it is a watch. I have it for you, **no money down**, express prepaid by me, and a full month to carry it in your pocket. **That's the test that tells.** All these watches

**Guaranteed 25 Years**

**Now for Business:** Send me your name and address and I will send you my

### Costly Catalog FREE

I want you to have our catalog. It is a gem, it illustrates all kinds of valuable watches, diamonds and jewelry on the easiest and most liberal terms ever offered.

**You Take no Chance** My terms are made to suit your convenience. I assume all the risk, you are the sole judge of value and quality. I prepay the charges, trust you, give you the easiest, best and squarest terms and live up to my title as "Square Deal" Miller. Write for this catalog today and get a letter from me that will make you a friend of mine from the start.

**"Square Deal" MILLER, Pres.**

MILLER-HOEFER CO., 234 Miller Building., Detroit, Michigan



**Silk Remnants** for patching Crazy

Quilts, Sofa Cushions, Bedspreads, Large pieces, all colors. Big Bargains in Pound Boxes. Send 10 cents for large package and 140 Quilt Designs. 3 for 25c. 1 lb., \$1. Star Silk Co. 1103 Monroe, Chicago.



## 8½ Pound Electric Suction Cleaner

At last a suction cleaner a woman can handle as easily as a carpet sweeper. Weighs **no more**. Takes up only two-thirds as much room. Is absolutely guaranteed. Rolls on rubber-tired wheels without effort. As powerful as many big unwieldy machines.

The **Morrow**

**10 Days Free Trial** We take all the risk. write to-

day for our Free Book. Just send a postal with your name and address. Do it now—before you forget.

**THE MORROW COMPANY, Dept. 1192, Waukegan, Ill.**

Good Territory Still Open—Agents and Dealers Write

## Almost ½ Price

**This \$35.00 Set—Now \$19.80**

If you have anything to do with metals, tools or machines—get these books. Get them today, now, at a saving of over fifteen dollars and on the easiest of easy payment plans. This great work was planned especially for the use of the mechanic. It covers the design, construction and operation of steam and gasoline engines, and of machines in general; and the manufacture and working of all metals used in the mechanical trades. Contains hundreds of practical ideas on the management and operation of the Modern Shop. Get these books now—have them ready when you need them. They'll solve every shop problem quickly and correctly—no waiting—no asking—just a little time and study will make you the expert man on the job.

**Cyclopedia of**

### Mechanical Engineering Gas Engine Operation and Modern Shop Practice

Contains 3,092 pages, 7x10 inches; 2,327 illustrations, full page plates, diagrams, etc.; hundreds of valuable tables and formulas; carefully cross-indexed for quick, easy reference. Printed in large, clear type on special quality paper and bound in half red morocco.

**Subjects Thoroughly Covered**

Machine Shop Work—Vertical Milling Machine—Motor-Driven Shops—Shop Lighting—Forging—Electric Welding—Tool Making—Metallurgy—Manufacture of Iron and Steel—High-Speed Steel—Flaws in Castings—Electric Lifting Magnets—Magnetic Clutches—Making a Machinist—The Ideal Foreman—Pattern Making—Foundry Work—Automatic Coal and Ore Handling Appliances—Machine Parts—Construction of Boilers—Types of Boilers—Boiler Accessories—Steam Pumps—Air Compressors—The Steam Engine—The Steam Turbine—Indicators—Valve Gears—Refrigeration—Gas Producers—Gas Engines—Automobiles—Elevators—Sheet Metal Work—Practical Problems in Measurement—Mechanical Drawing—Drafting Room Organization—Machine Design, Etc.

**Shipped Free** Seven volumes, not a sample volume, will be sent, express prepaid, for seven days' free examination. If you keep them pay \$2.00 seven days after receipt and then \$2.00 a month until you have paid the special introductory price of \$19.80. Remember, you save almost half by buying the set now. Examine these great books at your leisure and in your own home. It won't cost you a cent and the books may be returned if they do not meet with your expectations.

### Free Consulting Service

Every man who takes advantage of this offer now gets absolutely free a complete Consulting Membership, under which our entire staff of experts answers all questions and solves all engineering and shop problems a whole year absolutely free. One question answered may be worth more than the entire cost of the books. Usual price—\$12.00—now free with this set. Fill out and mail us the coupon. Books go to you at once, express paid. Our liberal offer protects you. You take no chances. You are not bothered. If the books cannot sell themselves to you strictly on merit, don't keep them. But first inspect them. Mail the coupon today.

**FREE COUPON** Worth \$15.20 to You

American Technical Society,  
Chicago, U. S. A.

Please send me Cyclopedia of Mechanical Engineering for seven days' free examination. If I decide to buy, will send \$2.00 in seven days and balance \$2.00 a month until \$19.80 has been paid, when \$35.00 books and \$12.00 Consulting Membership will be mine. Otherwise will notify you and hold books subject to your order. Title not to pass until fully paid.  
Pop. Mech. 2-14

NAME .....

ADDRESS .....

As I have had no previous dealings with you, I

refer you to .....

Please Mention Popular Mechanics

SECTIONAL FURNITURE **COME-PACKT**
SECTIONAL FURNITURE **COME-PACKT**

# Why Pay \$89.50?

## You Can Buy These Pieces Direct From Our Factory—In Sections—For LESS THAN HALF Retail Store Price

**The New Idea That Reduces Price and Guarantees Quality**

We build Come-Packt furniture in sections—ship direct from our factory to you in compact crates, at knock-down freight rates—you set it up in your own home in a few spare moments—you save over half what you would pay at a retail store. Furthermore, your protection in quality is absolute—you see each section separately before it is assembled. Nothing can be covered up—no flaws could escape notice—you get full 100% quality. Three such pieces at any retail store would cost you \$89.50—our price, only.....

**Each Piece Is of World's Finest Genuine Quartered White Oak**

Not red oak, or any other cheap grade of oak, or imitation. Any cabinet maker will confirm the fact that there is but one oak of quality—Genuine Quartered WHITE oak. Years of hard usage will enhance the beauty of Come-Packt furniture—it is solid worth and character throughout. Built in modern designs with the care and skill of the old master cabinet makers—possessing an individuality and charm befitting the home of quality. We ship to you at actual factory price of lumber and mill work. All you need is a screw driver and a few moments of spare time. Eight different shades of finish from which to select. Every piece sold on a full year's guarantee. If you are not satisfied, your money will be immediately returned, including freight.

**New 1914 Catalog FREE** Shows over 400 other beautiful examples of Come-Packt craftsmanship in living, dining, bedroom and den furniture—in sections—at a saving in some instances of even 60%. Color plates showing exquisite finish and upholstery. Sent free—postpaid. Write for it today. A postal will bring it.

**COME-PACKT FURNITURE CO.**  
201 Derr Street Toledo, Ohio



\$18.90



\$8.95



\$14.50





## Made-to-Measure

### Express Prepaid **\$275**

Pants cut in the latest style. Made to your individual measure. Fit, workmanship and wear guaranteed.

**No Extra Charge**

for peg tops, no matter how extreme you order them.

**Agents Wanted**

A good live hustler in every town to take orders for our celebrated made-to-measure clothes. Samples of all the latest materials **FREE**.

**We Pay Big Money**

to our agents everywhere. Turn your spare time into cash by taking orders for our stylish clothes. Write today for beautiful **FREE** outfit.

The Progress Tailoring Co., Dept. 602, Chicago

Please Mention Popular Mechanics



## 375 for 10 Cts

This wonderful bargain contains 375 Valentine Post Cards, Motto & Greeting Cards in gorgeous colors and gold, new Valentine Favors for parties—Hearts, Cupids, Pretty Girls, Scotch Lassies, Doves, Bows and Arrows etc. Greatest and prettiest collection of Valentine Cards, Souvenirs & Favors you ever saw. More than satisfaction guaranteed. The entire 375 postpaid for 10 cents; 3 sets 25c. Address **U. S. CARD CO, CHICAGO.**



## Classy Den Pictures

**EXQUISITE STUDIES IN BEWITCHING POSES**

Every one a genuine photo from living models on double-weight stock. 3 swell cabinets, 25c; 6 for 50c, with fine 6 1/2 x 8 1/2 photo **FREE** with order for 6. **Our Dollar Special:** 6 cabinets, two 6 1/2 x 8 1/2, and over 50 small photos, all for \$1.00. 10c extra for sealed postage. Money back if not as represented.

**KING CO., 2805 P. M., ANDOVER, OHIO**

# 22 Handbooks of Practical Information

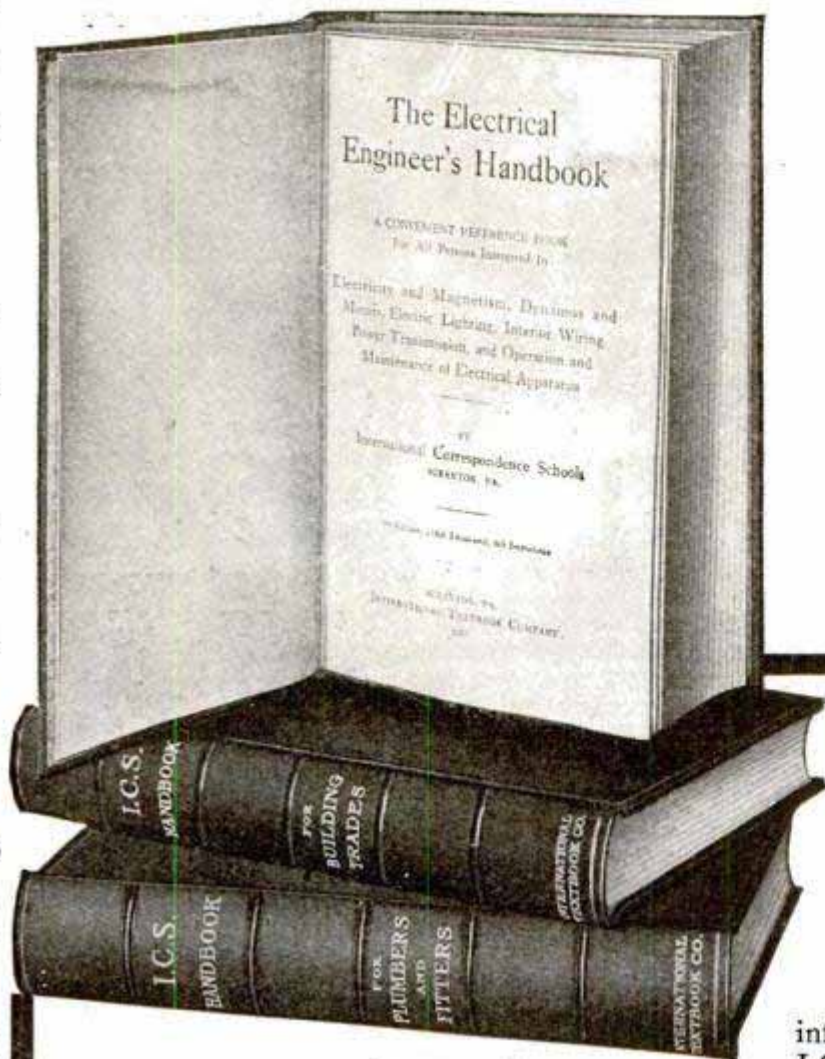

**W**HEN the boss asks a puzzling question—when an unusual piece of work comes along—THEN it pays to be able to put your finger on the exact rule, formula, or bit of information that holds the key to the situation. For it's at these critical moments that the boss finds out who is "onto his job"—who is in line for promotion.

No books in existence contain as much information in so small space as these I.C.S. Handbooks. One book is devoted to each trade or profession. They contain all the rules, formulas, and other data that you've got to have right off the bat. They are thoroughly indexed—any desired information can be located instantly. They have been compiled from the "Easy to Learn, Remember, and Apply Home-Study Courses" of the International Correspondence Schools. Every fact and formula is clearly stated. They are indispensable helps to quicker and better work. Bound in silk cloth they retail regularly for \$1.25 each.

**Mechanics'**: Tables; formulas; measurements; belting; mechanical powers; hydromechanics; specific gravity; strength of materials; shafting; boiler design; care of boilers; power of boilers; chimneys; exhaust heating; machine design; machine tools; slide valve; pulleys; horsepower; cylinders and steam chests; pistons; gearing; dynamos and motors; batteries; transit surveying; curves; radii and deflections; earthwork; trackwork; etc. Contains 330 pages and 174 illustrations.

**Electrical Engineers'**: Tables; chemistry; mechanics; electricity; electrical units, symbols and quantities; physical and electrical properties of metals and alloys; wire gauges; magnetism; dynamos and motors; armature winding; electrical batteries; alternating current apparatus; alternators; transformers; wattmeters; transmission; electric lamps; wiring; electric heating and welding; electromagnets; controllers; car wiring; etc. Contains 414 pages and 238 illustrations.

**Chemists'**: Definitions and fundamental laws; atomic weights; pressure; volume and temperature of gases; weights and measures; specific gravity; hydrochloric-acid, nitric-acid, and sulphuric-acid solutions; solubilities of chemical compounds; heat measurement; qualitative analysis; special tests of acids; general table for analysis; classification of rare metals; the spectroscope; nitrogen; blowpiping; determination of gold and silver ores; methods of assaying; composition of alloys; tables; antidotes of poisons, etc. Contains 332 pages and 11 illustrations.

### Other Handbooks Now Ready

Automobile	Plumbers and Fitters'
Air Brake	Poultryman's
Civil Engineer's	Farmers
Steam Engineer's	Textile Worker's
Telegraph and	Business Man's
Telephone Engineers'	Bookkeeper's
Mariners'	Stenographers and Corres.
Coal Miner's	Salesman's
Concrete Engineer's	Advertiser's
Building Trades	Window Trimmer's

**International Textbook Co.**  
Box 872-F, Scranton, Pa.

### Special Offer

For a limited time we will sell these regular \$1.25 Handbooks, durably bound in silk cloth in a convenient pocket size, at a price for each Handbook of only—

## 50c

**TEAR OFF HERE**  
International Textbook Co., Box 872-F, Scranton, Pa.

Enclosed find \$ \_\_\_\_\_  
Handbooks \_\_\_\_\_

Name \_\_\_\_\_  
St. & No. \_\_\_\_\_  
Town \_\_\_\_\_  
State \_\_\_\_\_

for the following I.C.S.



### 3 Books FREE!

I want to send you my three latest books—one the story of "The Diamond"—its discovery, where and how mined, cut and marketed—the other, "Facts vs. Fanc" or all about the Watch Business both at home and abroad, also our big Free Watch and Diamond Catalog.

P. Stephen Harris, Pres.

# SPECIAL THIS MONTH!

## 17 JEWEL ELGIN ON CREDIT

### HAND ENGRAVED

## 25 YEAR GOLD CASE

# 30 DAYS FREE TRIAL \$12.75

Now—during this Special Sale—is a splendid time to buy a fine Watch. We would like to send you this 17-Jewel Elgin in hand engraved 25-year gold case for your inspection. It sells regularly at \$20.00. We save you nearly one-half. If you answer this advertisement you can buy it for \$12.75.

**NO MONEY DOWN** We don't want you to send us one cent. Not a penny. Merely give us your name and address that we may send you this handsome watch on approval. If after you receive it and want to keep it, then we ask **\$2.00 A MONTH.** If you don't want to you to pay us only our expense. You assume no risk whatever in dealing with us. You do not buy or pay one cent until we have placed the watch right in your hands for your decision. We ask **No Security, No Interest.** No red tape—just common honesty among men. If this offer appeals to you write today for **Our Big Free Watch and Diamond Book.**

**HARRIS-GOAR CO.**  
Dept. 1167  
KANSAS CITY, MO.  
*The House that Sells More Elgin Watches than Any Other Firm in the World.*



We want every dealer and rider to get our 1914 free Catalogue of our latest designed **ELECTRIC AND BICYCLES** Park Row Special. Get a pair of our wonderful new improved "everlasting" tires. To introduce them **\$5.00 a pair** PARK ROW BICYCLE CO., 36 Vesey St., New York  
Largest Supply House in the East.

**U. S. MINT TO USE GAS FOR MELTING BULLION**—It has been decided to use gas instead of oil for melting bullion at the United States mint at Philadelphia in order to reduce operating expenses. About 30,000,000 cu. ft. of gas a year will be required for the purpose, as against 240,000 gal. of oil previously consumed annually.



**YOU!  
YES, YOU  
CAN GET IT**

## \$60 A WEEK and Expenses

That's the money you should get this year. I mean it. I want County Sales Managers quick, men or women who believe in the square deal, who will go into partnership with me. No experience needed. My folding Bath Tub has taken the country by storm. Solves the bathing problem. No plumbing, no water works required. Full length bath in any room. Folds in small roll, handy as an umbrella. I tell you it's great! GREAT! Rivals \$100 bath room. Now listen! I want YOU to handle your county. I'll furnish demonstrating tub on liberal plan. I'm positive—absolutely certain—you can get bigger money in a week with me than you ever made in a month before—I KNOW IT!

### Two Sales a Day—\$300 a Month

That's what you should get—every month. Needed in every home, badly wanted, eagerly bought. Modern bathing facilities for all the people. Take the orders right and left. Quick sales, immense profits. Look at these men. Smith, Ohio, got 18 orders first week; Meyers, Wis., \$250 profit first month; Newton, California, \$60 in 3 days. You should do as well. **2 SALES A DAY MEANS \$300 A MONTH.** The work is very easy, pleasant, permanent, fascinating. It means a business of your own.



### Demonstrating Tub Furnished

Little capital needed. I grant credit—Help you out—Back you up—Don't doubt—

Don't hesitate—Don't hold back—You cannot lose. My other men are building houses, bank accounts, so can you. Act then quick. **Send No Money.** Just name on penny post card for free tub offer. **Hustle!**

H. S. ROBINSON  
President

249 Vance St., Toledo, O.

Walkerville, Ont., Canada

## Get Your Canadian Home From the Canadian Pacific



The Home Maker



WE will make you a long time loan—you can move on the land at once—your Canadian farm will make you independent and

### We Give You 20 Years to Pay

Rich Canadian land, \$11 to \$30 per acre—*one-twentieth down*. Long before final payment comes due your farm will have paid for itself.

### We Lend You \$2000 For Farm Improvements Only

No other security than the land. You are given twenty years to pay with interest at 6%. In case of approved land purchaser, we advance live stock to the value of \$1,000 on a loan basis.

Or if you want a place already established, you will find one on our Ready-Made-Farm. All planned by our experts, and our service and advice is yours free.

### This Great Offer Is Based on Good Land

Finest on earth for general mixed farming—irrigated and non-irrigated lands. Located on or near railway. The famous Canadian West has magnificent soil, good climate, churches, public schools, good markets, good hotels, unexcelled transportation—and 20 years to pay. Time is precious.

WRITE TODAY

G. E. THORNTON, Colonization Agent

### Canadian Pacific Railway

Colonization Department 112 West Adams Street, Chicago, Illinois

FOR SALE—Town lots in all growing towns. Ask for information on industrial and business openings.

## WIN NEXT \$1,200

We tell you how; \$40,000 already won by ten inexperienced people. Stoneman received \$1,200 one month; \$15,000 to date; Korstad \$2,200 in two weeks; Schleicher \$195 first 12 hours. Strange invention, startles the world. Gives every home a bathroom with hot and cold running water for \$6.50; abolishes plumbing, water works; self-heating; little wonder Hart sold 16 in 3 hours, \$5,000 to date; Lodewick 17 first day. Credit given; investigate today. Beat others to exclusive sale; means fortune. ALLEN MFG. CO., 3649 Allen Bldg., Toledo, Ohio

## NOTE THE SIMPLICITY



Of making perfect duplicates with the Daus' IMPROVED Tip Top Duplicator No intricate mechanism. No printer's ink. Always ready. 100 copies from pen-written and 50 copies from type-written original. Useful in any business. Sent on Ten Days' Trial Without Deposit. Complete duplicator, cap size (prints 8 3/4 x 13 inches). Contains roll of "Dausco" Oiled Parchment Back duplicating surface \$5.00 which can be used over and over again. Circular of larger sizes free on request.

VELIX A. L. DAUS DUPLICATOR CO., Daus Building, 111 John St., New York

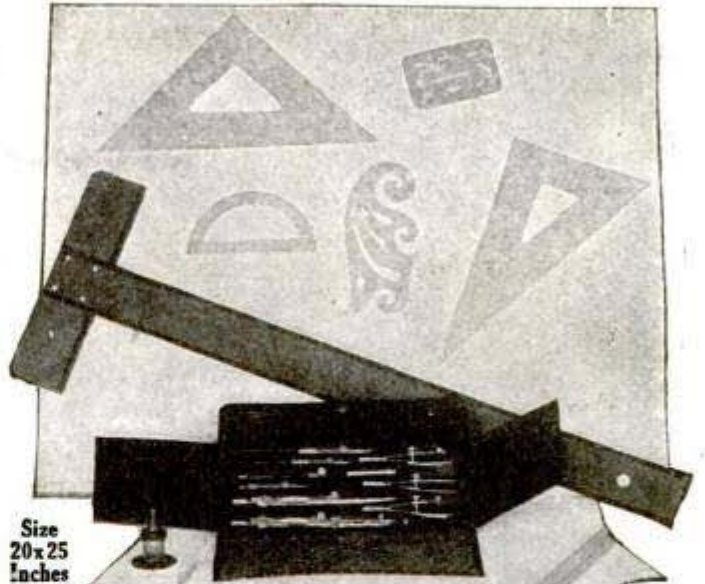

Size 20x25 Inches

## FREE This \$20 Draftsman's Outfit

The complete outfit, exactly as illustrated, sent absolutely free if you enroll now. Consists of german silver instruments in morocco case, T-square, transparent triangles and French curve, protractor, triangular scale, ink, pencil, pencil pointer, erasers and erasing shield, drawing paper and thumbtacks.

## Draftsmen Get Big Pay

Draftsmen earn from \$75 to \$200 per month, depending on the kind of instruction they've had. The work is pleasant and the hours short—it is the only profession where the demand exceeds the supply. Learn drafting—the foundation of all engineering professions—in your own home and without giving up your work. Our new, easy method will make you an expert draftsman in a short time.

**FREE** Our complete four volume Cyclopedia of Drawing, illustrated below, included free if you enroll in this course now. These books cover completely the work of the architectural and mechanical draftsman. Students will find them of great value as a reference work in connection with the personal instruction received from our expert engineers. The books are bound in half red morocco, gold stamped, and contain 1,720 pages, 7 x 10 inches; 1,037 illustrations, full page plates, diagrams, designs, etc. Remember, these books do not cost you one penny—they are included without charge with the course.

### Seize Your Opportunity

Fill in and mail the coupon today—now! Let us tell you how easy it is to fit yourself for a big job and big pay as a draftsman. Remember, we send you a \$20 drawing outfit and a four volume reference work of the same value absolutely free when you enroll. Isn't this worth investigating?

AMERICAN SCHOOL OF CORRESPONDENCE CHICAGO, U. S. A.



Pop. Mech. 2-14

A. S. of C.

Gentlemen: Without any obligations, please send me full particulars regarding your complete course in drafting. Also tell me about the draftsman's outfit and four volume reference work which are included FREE with this course.

NAME .....

ADDRESS .....

Please Mention Popular Mechanics

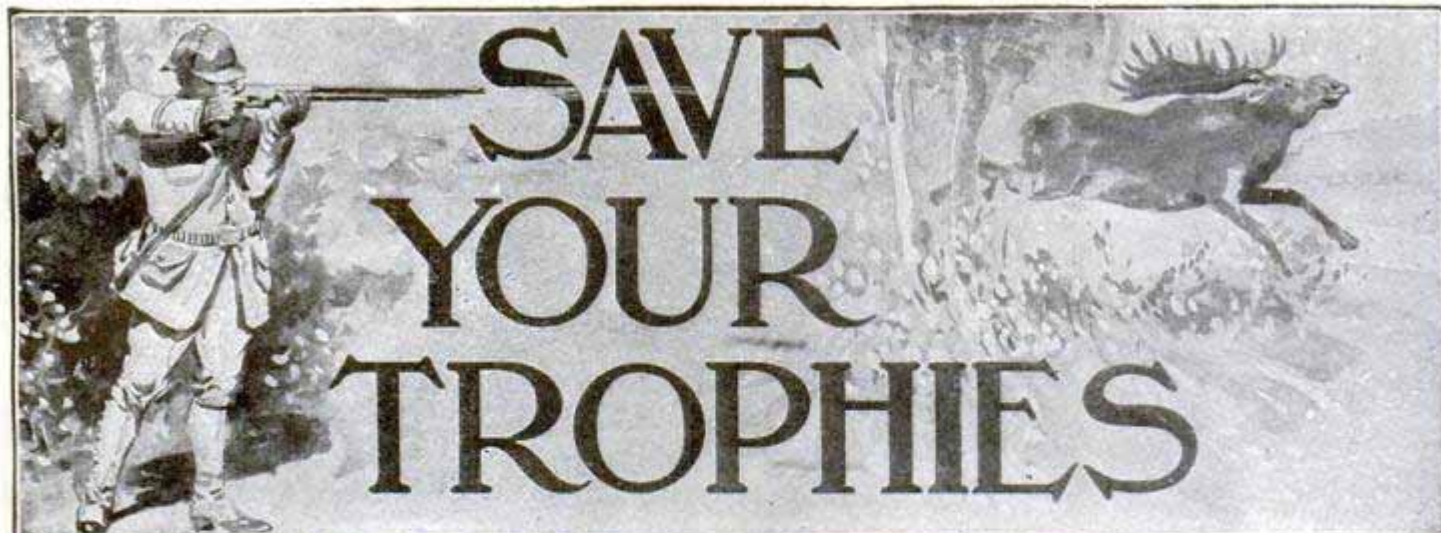

## Beautiful Specimens FREE

Yes, you can save all the beautiful trophies of your hunting or fishing trips free. They are the choicest of Nature's art and unexcelled for decoration. Wouldn't you like that moose-head in your dining room? No need of paying a taxidermist a large sum for having it mounted. You can do it yourself—free.

**Learn to Mount Birds and Animals** We can teach you

in your own home during your spare time by mail—how to mount all kinds of birds, animals, fish, etc. Our school is endorsed by all the leading museums, naturalists and sportsmen. 35,000 graduates—every one an enthusiastic, successful taxidermist.

**Big Profits** You can easily make from \$30 to \$60 a month during your spare time doing mounting for others, or \$3000 to \$5000 yearly if you go into the profession. Hundreds are doing much better than this. Exceptionally attractive openings are now offered to taxidermists.

**Write Now for Free Book** We will send you our big new book on taxidermy, absolutely free and prepaid, if you write at once. It tells you all about this most fascinating profession, and how you can get the complete course of instruction on our great, new, rock-bottom offer. We will also send you the Taxidermy Magazine if you write at once. Do not delay—but write to us at once—now—while we are making this special offer.

NORTHWESTERN SCHOOL OF TAXIDERMISTRY

1192 ELWOOD BUILDING, OMAHA, NEBRASKA



## Health? Take Turkish Bath at Home—Only 2c



Exhaustion and many other ills means that waste matter has over-accumulated in your body. Drugs do not drive them out. Exhausted men and women have been remarkably strengthened, right at home, in a few moments' time, by the use of

### Robinson's Turkish Bath Cabinet

Prominent physicians in many cases are abandoning drugs for this new treatment. If your mind or body is tired, open your pores, and feel the rapid change in your condition, right at home, at cost of 2c a bath. The Robinson Bath Cabinet is the only scientifically constructed bath cabinet ever made, a model of ingenuity. **Great \$2 Book Sent FREE**—"The Philosophy of Health and Beauty" represents lifetimes of thought of well-known scientists and is written plainly so that anyone can understand every word. Write in time—today. Agents wanted in unoccupied territory.

ROBINSON MFG. CO., 681 Robinson Bldg., TOLEDO, OHIO

**AMERICAN MACHINERY FOR ASIATIC ELECTRIC-POWER PLANT**—The greatest long-distance power transmission in southern Asia is in the native state of Mysore, power being transmitted from the Cauvery falls to the Kolar goldfields, 92 miles away, and to the cities of Mysore and Bangalore, about 40 and 86 miles away, respectively, for electric-lighting



Be Your **OWN BOSS**  
**AGENTS EARN BIG MONEY**

selling **Golden Rule** genuine hand forged English Razor Steel Knives. We will put any photo or lodge emblem on one side of the transparent handle, and name and address on the other. We have a complete, fully guaranteed line of knives, razors, strops and cutlery specialties. Quick sales. Big profits. *Experience unnecessary.* Write today for catalog and terms.

Golden Rule Cutlery Co., 552 W. Lake St., Dept. 111, Chicago

## I WANT 200 SALES AGENTS AT \$1200 TO \$3600 A YEAR

To introduce my new **Compress and Vacuum Washing Machine** to every home in the country, I want 200 additional representatives to begin work at once in their home counties. I consider this machine the most brilliant inventive achievement of the age in household necessities. It is selling faster than anything I have ever heard of—going like wildfire.

### PROFITS START FIRST DAY

No waiting or guessing. The price of only \$1.50 makes a sale at every house—cash business at 200 per cent profit to you. The biggest opportunity ever offered. I want hustlers—men and women who want to make money quick and fast. No large investment needed—business supplies the capital.

**NO EXPERIENCE REQUIRED** Just follow instructions. Failure impossible. **Success assured.** Frank Greene sold 45 first three days—profit \$45. Mrs. L. C. Marrick made \$90 first three weeks in spare time only. J. H. Goddard took 18 orders first three hours. **No talking necessary.** Just show it—the order is yours right on the spot.

H. E. WENDELL, Pres. Wendell Vacuum Washer Co., 147 Oak St., Leipsic, Ohio



The Wendell Compress and Vacuum Washer  
Washes Tub of Clothes in Three Minutes

**\$1.50**  
Selling Price

Every machine sold on money-back guarantee. A child can use it. Abolishes labor of wash day. Women discard \$15 and \$20 machines for it.

**MAIL YOUR APPLICATION TODAY**

Don't delay. Get your county under contract. No charge for territory. To wait means to lose. Write me a letter or a postal card today. If you are honest and willing to work I will give you the position. **Do not let someone else get in ahead of you.** I want agents, general agents and managers. Write today—then you will have done your part. **Do it right now. Address**



# Chickens

## And Their Profits!



All told about in latest Old Trusty Book mailed free—gives real ABC of poultry profits. Write quickly for copy—learn how you can make big profits anywhere, any time, in any weather with



### Old Trusty

Insures a safe and sure income the whole round. Half a million in use—three or four times more than any other. 30 to 90 days' trial—20 years' guarantee—Old Trusty fulfills every promise or we trade back. Less than \$10 buys it. Freight prepaid east of Rockies—just a trifle more delivered clear to Pacific Coast. Write—get chickens making money for you. Address

**Johnson, Incubator Man, Clay Center, Neb.**

## Biggest Poultry Profits in Sight—Take No Chances!

With the best incubators and brooders that can be built you make sure of the largest hatches and the most and healthiest chicks. Every egg and chick means money this year. Big profits are at stake on your equipment.

### CYPHERS INCUBATORS and BROODERS

World's standard. Self-regulating, self-ventilating. Fire-proof, insurable. Highest records for big, continuous hatches. Get Cyphers Company's 244-page catalog and poultry guide before you buy. 8 vitally helpful chapters. We will send you facts about Free Bulletin and Personal-Letter Service. Address today



Cyphers Incubator Co., Dept. 161 Buffalo, N.Y.  
Write for Big FREE Book.

**150 VALENTINE and EASTER CARDS,** Seals, Stamps etc. with Lovers, Mottos, Cupids, Hearts, Eggs, Rabbits etc. in colors, 10c. \$ lots 25c. CARD HOUSE, 1108 Monroe St. Chicago.

and power purposes. All the hydroelectric installation for this great enterprise was made in the United States, except some waterwheels imported from Switzerland. An important extension of this great enterprise has recently been started, and the contract for all machinery, with the same exception, has gone to the United States. Power is sold to the mining companies at \$48 per horsepower-year.

**Natural Hen Incubator \$3.** No freight. Actual hen contracts everything. No lamps, no costly mistakes. Over 600,000 sold. Agents wanted. Free catalog. Special Introductory Offer. **Natural Hen Inc. Co., Sta. H, Dept. 27, Los Angeles, Cal.**

## Prof. Edward Amherst Ott

The noted Author and Lecturer is the man who found the easy way to raise poultry. He invented the Ott-Omatic Fountain, Ott-Omatic Feeder, Cheap Mash Feeder, designed the Feeding Guide. He plans for economical, time-saving, easy labor.

**POULTRY FLATS:** Ott's interesting 96 page book tells the Easy Way to do the work and save money. Send 50 cents for one year's subscription to the journal that reports each month the results of his experiments and get a copy of *Poultry Flats* FREE. **Inland Poultry Journal, 102 Cord Bldg., Indianapolis, Ind.**

## HILDEBRANDT BAITS HOOK AND LAND 'EM

The choice of experienced anglers. A small outfit, interchangeable, catches any fresh water game fish. "Standard," "Slim Eli," "Idaho" shapes—nickel, copper, brass, aluminum, black and gold finishes suitable for bright or dull days. Ball bearing "spin so easy" blades—reversible.

**FREE NEW 1914 CATALOG** Actual sized illustrations, new flies, spinners, rods, lines, etc. 2c stamp brings it.

**THE JOHN J. HILDEBRANDT CO., 1312 High St., Logansport, Ind., U.S.A.**

# Elgin 17-Jewel



20 Year Gold Filled Case  
A Superb Watch

Only \$11.75

Think of it! Only \$11.75 for a genuine 17-Jewel Elgin in a 20 year gold filled case. Sold to you on terms on a great sweeping watch offer. Write at once for our new catalog and Special Bulletin, showing not only this splendid opportunity but hundreds of other jewelry chances.

### Monthly Payments

Only \$1.00 per month and you can become the owner of a genuine Elgin 17-jewel watch—\$2.00 down and \$1.00 a month—total price of \$11.75. Remember, this is not an ordinary watch, but a genuine 17-jewel movement—incased in a 20 year gold filled case—one of the greatest time-keepers ever made—at a price far below that asked by your local jeweler.

## Genuine Diamonds

Pure color flashing stones now offered along with our other jewelry opportunities. Here are two resplendent, solitaire, genuine diamond rings; selected, glittering, pure color diamonds, in 14 karat gold rings.



Sold to you on the easiest terms—only a small amount down, then a very small payment each month. Wear these magnificent jewels—look prosperous—while paying for them. Besides, remember that diamonds are constantly going up in price—a diamond is a good investment.

**No. A104—14 karat solid gold Men's ring, set with beautiful, scintillating, perfectly cut diamond, \$5.25 down, \$2.50 per month. Price \$34.50**

**No. A103—Ladies' solitaire 14 karat solid gold ring, set with genuine, extra fine diamond, a splendid offering, \$5.25 down, \$2.50 per mo. Price \$34.50**



**Free Trial!** We give you a positive 30-Day Free Trial on any article bought from us. 30 entire days to make up your mind whether you wish to keep it. And if for any reason you are not satisfied return to us and we will return every cent you have paid most cheerfully.

**Big Jewelry Book FREE**

Send today for our big jewelry catalog and special 30-Day Bulletin. These show the most remarkable offers on high grade Elgin watches, genuine pure colored diamonds and other high grade jewelry. And all sold on terms of \$1.00 a month and up.

### STRAUS & SCHRAM INC.

Dept. 862  
35th St.  
CHICAGO

Name.....

Address.....

(If you wish to order any of these extra special bargains, send only the small first payment.)

### FREE COUPON

STRAUS & SCHRAM Inc.  
Dept. 862 35th St. Chicago

Without any obligation whatever on my part, you may send me free and post-paid your Special Wholesale Jewelry Catalog of watches, diamonds, etc.; also your special offers.

Please Mention Popular Mechanics

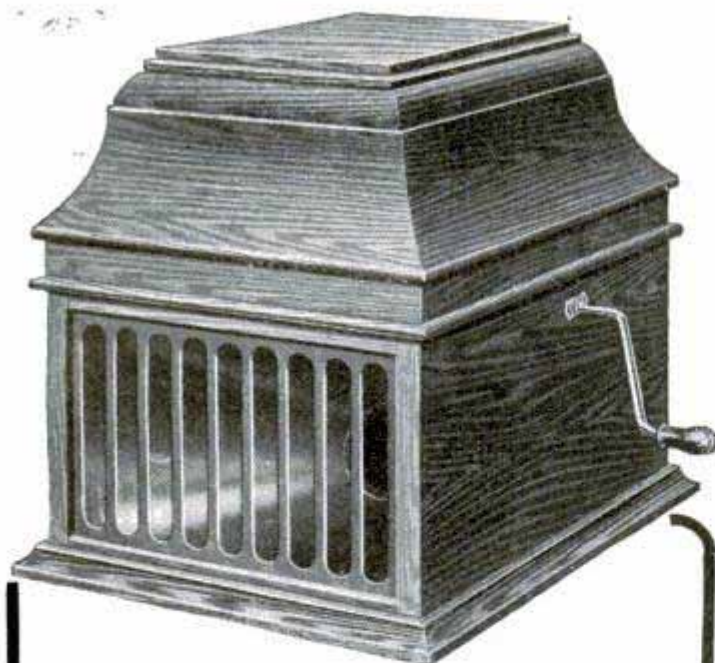

## New Edison Phonograph (Mr. Edison's LATEST Invention) Now Shipped Free

Write *today* for our *new* Edison Catalog—that tells about the superb *new* model Edison with Mr. Edison's *new* diamond stylus reproducer and our *NEW* Edison offer. Now read:

**The Offer:** We will send you the *new* model Edison and your choice of all the brand new records on an **absolutely free loan**. Entertain your family and your friends. Then, when you are through with the outfit you may send it back at our expense.

**The Reason:** We are tremendously proud of this magnificent new instrument. When you get it in your town we **know** everybody will say that nothing like it has ever been heard before, so we are sure that someone will want to buy one of these **new style** Edison's, especially as they are being offered now at the most **astounding rock-bottom price** and on **easy terms** as low as **\$2.00 a month**.

*REMEMBER, not a penny down—no deposit—no guarantee—no C.O.D. to us—no obligation to buy—A FULL FREE TRIAL in your own home—DIRECT from us—DIRECT to you. Returnable at our expense or payable (if you want to keep it) at the actual rock-bottom price direct from us.*

### To F. K. Babson Edison Phonograph Distributors Dept. 1192 Edison Blk. CHICAGO, ILL.

### Our NEW Edison Catalog Sent FREE!

Your name and address on a postal or in a letter, (or just the coupon) is enough. No obligations in asking for the catalog. Get this offer—while this offer lasts. Fill out the coupon today.

GENTLEMEN:—Please send me your New Edison Catalog and full particulars of your free trial offer on the new model Edison Phonograph.

**F. K. BABSON**  
Edison Phonograph  
Distributors  
1192 Edison Blk.,  
CHICAGO, ILL.

Canadian Office  
355 Portage Ave.,  
WINNIPEG,  
MAN.

NAME.....

ADDRESS.....

## DO YOU LIKE TO MAKE THINGS?

This new book

### AMATEUR MECHANICS No. 5

tells how to make scores of interesting and practical devices and is similar in style to Nos. 1, 2, 3 and 4 previously issued.

It contains

**334 Articles—272 Illustrations—128 Pages**

Size 6½ x 9½ in.—Paper

**Price 25 Cents, Postpaid**

These are only a few of the good things:

Aeroplane Kite—Amateur Mechanics' Combination Lathe—Lawn Tennis Marker—Electric Anemometer—Playground Ferris Wheel—Novel Wind Vane—Camp Provision Box—Wind Vane with Electric Indicator—Hand Drill Press—Dry Cell—Picture Frame and Triangle Clamp—Enlarging Photographs—Wet Battery—Electric Furnace—Electric Shaving Mug—Electric Lamp Flasher—Combination Lock—Multiplying Attachment for Camera—Electric Score Board—Galvanometer—Paddle Wheel Boat—Electric Time Light.

For Sale by Newsdealers or the Publishers

**Popular Mechanics Book Dept.**  
318 W. Washington St., CHICAGO

## SHOP NOTES ANNUAL

**FOR 1914 IS READY**

IT SHOWS

**519 EASY WAYS TO DO HARD THINGS**

224 Pages

462 illustrations

Price 50 Cents, Postpaid

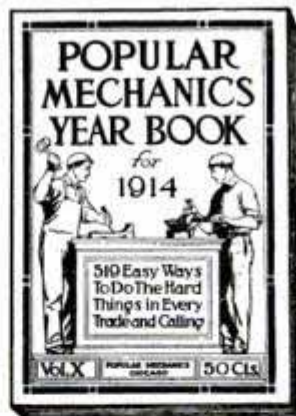

This is a reprint of all the articles which have been published during the year past in "Shop Notes Dept." of *Popular Mechanics Magazine* and is Vol. X of the series.

That it is one of the best numbers we have ever published is shown by the following list of special feature articles which appear in addition to the hundreds of practical time and labor saving helps our readers are familiar with:

Oxyacetylene Welding Outfit—Tile Sewer Construction—Special Molding Jobs—Electric Soldering Irons—Cost Systems for Small Shops—Motorcycle Garage—How to Build a Greenhouse—Slide Wire Bridge—Methods of Fitting Hinges—Short Cuts in Pattern Shops—A Private Ice House—Fluting Machine for Small Columns—Slide Rule—Homemade Concrete Mixer—Electrical Water Level Indicator—Homemade Ditch Digging Machine.

The seven page index facilitates reference

For Sale by Newsdealers or the Publishers

**POPULAR MECHANICS BOOK DEPT.**  
318 W. Washington St., Chicago

# \$10.00 A DAY

**State Legislatures Everywhere  
Passing Laws Makes It Possible  
For You To Earn \$10.00 Per Day**

First three days work more than pays for your equipment. The next days profits and of the 300 other working days in the year \$3,000.00 or more — are yours.

A postal card to us brings you full detailed information about this entirely new contracting business in a NEW UNWORKED FIELD.

The investment is so small — the returns so large — not a man who reads this but can get into this lucrative big paying business —

State Law requirements upon property owners create a demand for the services you can give them

## WITH A SPRAMOTOR

It is your duty — YOU OWE IT TO YOURSELF and to your neighbor to investigate this new business. Don't wait — you may delay but time will not — WRITE TODAY.

Don't let a postal card — a postage stamp stand between you and prosperity. Get the book IT'S FREE — read it — then pass judgment — You'll know that you and OLD DAME FORTUNE have at last met — that you are on speaking terms with her — that the goals INDEPENDENCE — PROSPERITY are in the near distance — REALIZED — Write.

**IMPERIAL SPRAYER CO.**  
106 Erie St., Buffalo, N. Y.

156 King St., London, Ont.



\$10.00 a Day,  
\$3,000 a Year  
can be made  
with this  
machine

## BUILD A

We have accurate scale drawings and knock-down parts of all man-carrying aeroplanes for class-room demonstrations, exhibition purposes, etc. Students of aeronautics, everyone with an inquiring turn of mind, should construct one of these fascinating models.

PRICES OF 3-PI. MODEL SCALE DRAWINGS — Curtiss Flying Boat, 25c; Nieuport Monoplane, 25c; Bleriot Monoplane, 15c; Wright Biplane, 25c; Curtiss Convertible Hydroaeroplane, 35c; Cecil Peeli Champion Racer, 25c  
Complete Set of Six \$1.25 Postpaid

## 3 FT. CURTISS FLYING BOAT

50 pp. Ideal Model Aeroplane Supply Catalog 5c.

IDEAL AEROPLANE & SUPPLY CO., 82-88 West 87th St., N. Y.

**BARODA DIAMONDS** Flash Like Genuine

ANY STYLE

at 1/40 the cost — IN SOLID GOLD RINGS

Stand acid test and expert examination. We guarantee them. See them first — then pay.

Special Offer — 14k Tiffany ring 1 ct. \$5.98. Gents ring 1 ct. \$6.98. 14k Stud 1 ct. \$4.88. Sent C. O. D. for inspection. Catalog FREE, shows full line. Patent ring gauge included, 10c. The Baroda Co., Dept. H5, 4711 No. Clark St., Chicago

## Why Pay the Dealer to Select Your Range?



YOU know what you want better than he does. Don't depend on his taste. Get the Kalamazoo book of 400 stoves and make your own choice.

Pay Cash or Take Your Time — 30 Days' FREE Trial — Save \$5 to \$40!

In 250,000 delighted homes Kalamazoo ranges are praised 3 times a day. They make cooking a pleasure and results a pride. Write for Catalog No. 473.

**KALAMAZOO STOVE CO.** Kalamazoo, Mich.  
We make a full line of Stoves, Ranges, Gas Stoves and Furnaces. We have three catalogues — please ask for the one you want.

**"A Kalamazoo Direct to You"** And Gas Stoves Too

Deaf People Now

# HEAR



Distinctly!  
Clearly!  
Perfectly!

In The Hollow of Your Hand

every kind of sound with aid of the latest marvelous invention the remarkable

## New 8-Tone Mears Ear Phone

— the final triumph of the inventor of the first successful multi-tone ear phone. Eight Tones! Eight different adjustments to suit every condition of the ear. Sufferers from deafness everywhere welcomed the Mears Four-Tone as the first perfected hearing device. It was a scientific marvel. But all its wonderful powers have been Doubled in the amazing new Eight-Tone Mears — just out! The new Eight-Tone ear phone makes every kind and "shade" or sound as distinct to the deaf as shades of color are distinct to the perfect eyes.

## Our Direct Offer

If you write at once we will make you our lowest net price direct from our laboratory to you — an offer that saves you all middlemen's profits. But don't make up your mind to keep the instrument on any terms until you have first tested and tried it thoroughly at our risk. Then, if you are satisfied, you can pay the laboratory price in small monthly payments if desired. Don't miss this opportunity. Take advantage of it today. Already more than 40,000 Mears Ear Phones have been sold.

Notice: We have discontinued all our agencies. The New 8-Tone Mears is sold direct from our New York office only.

## Sent on Free Trial

Every Mears Ear Phone is sold only on Free Trial. Ask about our great free trial offer. Test this amazing instrument on your own ears, under any conditions of service for 15 days. Nothing to pay for the trial. The Mears Ear Phone is the only scientific and perfect hearing device for the deaf. Write today for our valuable free book.

## Send Coupon Now For Free Book

If you live in New York call at our office for free demonstration.

The Mears Ear Phone book explains all the causes of deafness; tells how to stop the progress of the malady and how to treat it. Send the coupon at once for Free Book and our Special Limited Introductory Offer. Send at once.

**Mears Ear Phone Co., Dept. 1192**  
45 W. 34th Street  
New York, N. Y.

## COUPON

Mears Ear Phone Co.  
Dept. 1192

45 W. 34th Street  
New York, N. Y.

Gentlemen: Please mail me, free and post-paid, your Mears Ear Phone Booklet and particulars of your Special Introductory Offer on your new model Eight-Tone Mears Ear Phone and Free Trial Offer.

Name \_\_\_\_\_  
Address \_\_\_\_\_



# Wouldn't You Like to Own a Store Like This?

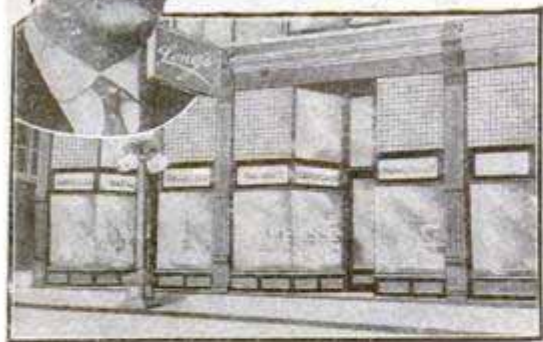

## Like This?

Wouldn't you like to be proprietor of a money making business? Once I was just a struggling candy maker. The profits from Crispettes, the new, delicious popcorn confection, built this big business for me. The very same proposition that made me, should do the same for you. **Start in the Crispette Business for yourself.** Build a business of your own as I did. Get a window—a small store—a cozy nook where the rent is low. Keep all the profits. I'll teach you the Crispette business—tell you how to succeed—show you how to make Crispettes by my special secret formula. I'll do it right here in Springfield—personally or by mail. But the thing for you to do is to

## Come to See Me At My Expense

Don't say you're coming. Just drop in quietly. Call on a banker or merchant. Ask them about Long—about my store—my crispette business. Look into my reputation. See if folks think I'll give you a square deal. Then come and see my store—see that it's just like the picture. See the machine. See crispettes made—make a batch yourself. Learn the business. Get my pointers on how to succeed. Up to a distance of 300 miles I'll pay all your traveling expenses, if you buy a machine. You'll see—know—learn everything. It's simple—easy. Won't take you a day. I'll be glad to see you—glad to show you the store and have a good talk with you. You'll go home ready to make more money than you ever made in your life.

Ask them if what I say isn't the truth—right from the shoulder. Look into my reputation. See if folks think I'll give you a square deal. Then come and see my store—see that it's just like the picture. See the machine. See crispettes made—make a batch yourself. Learn the business. Get my pointers on how to succeed. Up to a distance of 300 miles I'll pay all your traveling expenses, if you buy a machine. You'll see—know—learn everything. It's simple—easy. Won't take you a day. I'll be glad to see you—glad to show you the store and have a good talk with you. You'll go home ready to make more money than you ever made in your life.

**This is the Money Making Machine**



Send for Free Book

## Every Nickel You Take in Nets You Almost Four Cents Profit

Think of it! Think of the fortunes made in 5 cent pieces. It's one business in a hundred. Everybody likes crispettes—children—parents—old folks. One sale always means two—two means four. So it goes. It's a great business. I found it so—so should you. **Send for my big free book "How to make money in the Crispette Business"**—48 pages illustrated—complete information and story of how I built my business. Read it and then come to Springfield.

W. Z. LONG, 826 High St., Springfield, O.



This is a recent picture of the man who made \$1500 in one month with a Long Crispette machine, in a store window.



**Frank Gotch uses the Swedish Rhythmic Vibrator and says:**

"For limbering up, keeping in condition and strengthening the muscles, there is nothing that equals or exceeds the use of the Swedish Electric Vibrator. I always use one in my training and I certainly find it a wonderful help. It reaches the seat of all stimulation and gives me a perfect circulation. Its use gives all the muscles elasticity, makes one powerful, quick and active."



Frank Gotch  
Champion Wrestler of the World

# Wanted AGENTS & SALESMEN

**One Sale a Day Means \$90  
Profit a Week for You**

No experience necessary. No delay. No charge for Territory. No competition. **Exclusive field.** Success assured. **Remarkable offer.** Read every word carefully. Get an appointment and get started without delay.

We are appointing men every day to manage our business in local territories. **We need good, honest men who are willing to work.**

It is the chance of a lifetime. You will be in business for yourself. **You will be your own boss—Independent, abundant money, pleasant position**—and your time will be your own. **At home or traveling—all or spare time**—get an appointment immediately and commence earning money next week. We will give you today this opportunity to **Make a Big Income this year.**

## Make \$5,000.00 This Year

We will commission you our representative to introduce **THE SWEDISH VIBRATOR**, a most amazing seller. An instrument for home vibratory massage treatments. **Needed by every man, woman and family.** Endorsed by the highest medical authorities in the world. Sells to the home, to physicians, masseurs, osteopaths, chiropractors, barbers, beauty parlors—**unlimited market.**

**Don't Delay** Throw away the little novelties upon which you have to make ten or twenty sales a day to pay expenses. Become a real salesman and make real and quick and big money. Many averaging four, five and even ten sales a day. **This is actually the**

**most brilliant, easy and high class proposition that has ever been offered to wide-awake agents, general agents, and managers.**

**Investigate** Get free literature and complete information at once. Send just your name and address on a postal card and all will be mailed **FREE** immediately. **Agent's sample furnished at wholesale price. Investigate.** It costs you nothing to find out. Territory being rapidly assigned. **But one man allowed in a field.** Give the name of your county. Send your name and address today. This is a brilliant opportunity. Do not neglect. Do not put it off. **Act immediately.** Address

**SWEDISH RHYTHMIC VIBRATOR CO., 111 Vibrator Bldg., CHICAGO, ILL.**  
211-215 Schiller St.,

# Quick Drilling Where You Want It —by Electricity



Attaches to any Electric Light Socket.

Saves time and labor. It doubles efficiency.

## A Portable Machine Shop

Handiest device ever known for drilling, tapping, grinding valves, sharpening tools, etc.—quickly and easily. Does away with tiring hand work.

# TEMCO Electric Portable Drill

Weights only 11 pounds. Perfect balance between handles makes it seem doubly light and free to place and hold. Has famous Temco motor. Connect with any lamp socket (A. C. or D. C.) Costs only 1 cent per hour to run. Reverses instantly on full speed. Changes tap to drill in one minute. Has multitude of uses. Saves cost quickly in time and hard work. Guaranteed not to burn out.

**Ten Days' FREE Trial**

Mail postal or letter quick—get descriptive CATALOG FREE. Address

**The Temco Electric Motor Co.**  
277 Sugar St., Leipsic, Ohio

Special Designers and Mfrs. of 1-50 to 1-6 H.P. Motors.

**AGENTS** to spend part or entire time selling high grade scientifically tempered pocket knives and razors.

## Photo Transparent Handles

(something new). No experience necessary. We teach you. Big profits. Now is just the time. Always a demand. Sells when you can't sell anything else. Write today for special Agency Proposition. Address Dept. 59.

**CANTON CUTLERY CO., Canton, Ohio**

Blades of high quality as to cut nails or hair



Territory Going Fast.

# MONEY IN MUSHROOMS

Add \$10 to \$50 a Week to Your Income  
Grow Mushrooms

at home in your basements, barns, sheds, etc., without interfering with your regular occupation. Small beds, 5 x 10 ft., costing practically nothing to start, often produce 60 to 100 lbs., selling at 50c to \$2.00 a lb. Your whole family can help in raising them. Others are making money growing mushrooms. Why don't you? My illustrated booklet telling how to start, how to sell, etc., sent free. Write today.

A. V. JACKSON, Palmouth Mushroom Cellars, Inc., 196 Gifford Street, Falmouth, Mass. The largest modern mushroom farm in the world.

# This Portable Typewriter

sent on approval—saves time, work and money—\$18 in United States.

Here is an efficient, portable typewriter that writes as clearly as \$100 machines and saves \$82. Standard keyboard—visible writing, makes carbons

—takes full size letter sheet; low cost because simple. Has only 250 parts. Others 1700 to 3700. Our guarantee says "Money back if not satisfactory." Try the Bennett at our risk. Can be mailed parcel post; send for catalog.

AGENTS WANTED

**CHAS. M. BENNETT  
TYPEWRITER CO.**  
1302 Cedar St., Harrisburg, Pa.

\$18

Thin Model  
17-Jewel  
Movement

25-Year  
Guaranteed  
Gold-Strata  
Case

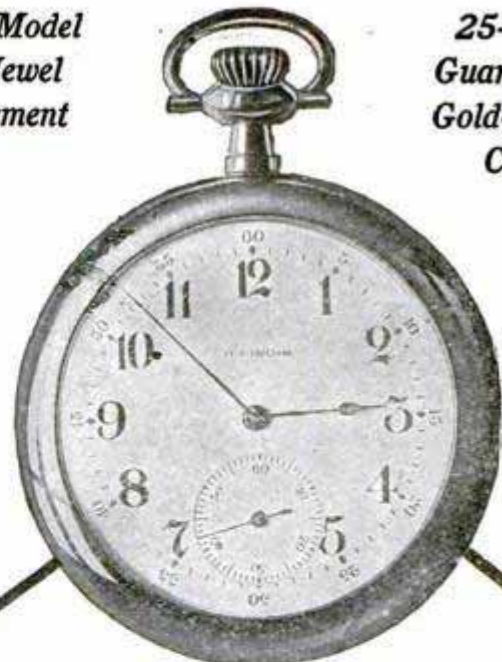

# Send for This Watch On 7 Days' Free Trial

To Popular Mechanics readers who mail coupon below at once, we will send this beautiful "Thin Model" 25-year guaranteed gold-strata watch, on 7 days' approval without one cent in advance—but YOU MUST BE QUICK.

This superb Watch is indeed a triumph in the art of watch-making. The photograph above shows the actual size of the Watch. The movement is the famous guaranteed 17-Jewel Illinois Movement. This Watch is not only a perfect time-keeper, but the graceful thin model gold-strata case lends it a beauty and distinction which will make it a constant joy to you every time you look at it.

## Payments—Only \$2 a Month

This is the greatest "watch value" in America, but we do not ask you to take our word for it. Our plan is to send you the Watch on approval so that you can see the Watch itself, examine it carefully and wear it for a week before paying us any money or obligating yourself to keep it. We do not want you to send us one cent now. Just fill out and mail coupon below and we will then send you the Watch carefully packed, by registered mail. After you have worn this beautiful Watch a week, if you decide to keep it, you may send us only \$2 cash and then \$2 a month till our special price of \$22.50 is paid. But if the Watch is not satisfactory and you do not wish to keep it, then you may return it to us "express collect." So, you see, you take absolutely no risk.

## Free Monogram Offer

To those who mail coupon below promptly, we offer to engrave by hand, their initials on the back of this Watch in exquisite ribbon monogram letters. So then, if you answer promptly, you may have your own initials handsomely engraved by hand on the back of this superb Watch, free of charge. Jeweler's regular charge is from \$1.50 to \$2.00, but if you are prompt, we will do it for you FREE. This is a great opportunity—one that you must not miss. Tear off and mail coupon at once.

## LACLEDE WATCH CO.

1127-29  
Pine St.  
St. Louis,  
Mo.

LACLEDE  
WATCH CO.  
1127-29 Pine St.  
St. Louis, Mo.

Send me for examination your 17-jewel 25-year guaranteed gold-strata Watch, 12 size, by registered mail. If the Watch is satisfactory I will send you \$2 as first payment and \$2 a month thereafter until your special price of \$22.50 is paid. If the Watch is not satisfactory and I do not wish to keep it, I will notify you within 7 days and the Watch is then to be returned at your expense, as offered Popular Mechanics readers. (NOTE: Print initials you wish engraved in monogram, on edge of coupon.)

NAME.....  
ADDRESS.....

**5,000 ONLY AT \$1.00 - THEN REGULAR PRICE - \$2.40**

**SPECIAL INTRODUCTORY OFFER TO PROVE THEIR MERIT TO EVERY MAN, WOMAN AND BOY.**

The minute the first 5,000 go the price returns to the regular retail price--\$2.40. **NOT A TOY.** 8 in. long--

projects a strong, penetrating beam 200 feet. A practical, safe searchlight with intermittent or continuous flash. First all-metal searchlight--no fibre or pasteboard used. Flashes under water--cannot be short-circuited.

**NIAGARA ELECTRIC SEARCHLIGHT**  
**WITH MAZDA BATTERY**  
**AND DRAWN WIRE LAMP** **\$1**  
PREPAID

Adopted by U.S. Gov't for Battleships and Army Posts.

Unlimited Usefulness for

- The Home
- Boy Scouts
- Women
- Police
- Deliverymen
- Messengers
- Hunters
- Mechanics
- Auto-Repair Men
- Farmers
- Reporters
- Motorists

**NIAGARA SEARCHLIGHT CO., NIAGARA FALLS, N.Y.** **MANUFACTURERS OF THE WORLDS HIGHEST CLASS SEARCHLIGHTS**

Below Manufacturer's Cost.

If not among first 5,000, your money returned. **ACT QUICK.**

**GUARANTEE.**

If not, in every respect, the finest electric hand-searchlight in the world, bar none, return lamp and get money back.



**Hurt yourself \_\_\_\_\_?**  
 It's easy to fall—and easy to break the skin—but sometimes not so easy to prevent infection.

# New-Skin

kills germs. It covers the cut or scrape with a waterproof coating—that prevents infection from without, and allows the wound to heal. The smallest cut or bruise should not be neglected. Have New-Skin on hand for emergency use.

All druggists carry New-Skin, in convenient 10c size, and 25c bottles for the home. **NEWSKIN CO., NEW YORK**

*When you need it you need it badly.*



## You Can Always Tell a Good Mechanic by his Tools and the best Mechanic because he is sure to have our

# Hand Drill No. 5

A Drill unequalled in strength, durability, easy action and all-around excellence. Has cut gears, ball thrust bearing, and carries 8 wood boring points ranging from 1/16" to 11/64". The way this tool is made insures long and satisfactory service—try one. Write us for a copy of our Catalog.

**MILLERS FALLS CO.**  
 28 Warren St. **NEW YORK**



*Please Mention Popular Mechanics*

# ELECTRO

Can you imagine anything more excitingly interesting than sitting in your attic and listening to Wireless messages "coming in" over your E. I. Co. set? We sell sets from \$2.85 up that receive clear messages 100 miles distant; our best set, receiving messages 2000 miles off, costs only \$24.00. Can you afford not to afford one of these modern marvelous instruments? We have made thousands of people happy with "Wireless" since 1905. **We don't make toys; our goods satisfy, or Money Back.**

No Factual answer

We have issued a new magazine, **"The Electrical Experimenter,"** 50 cts. a year, 5 cts. the copy. Send 5 cts. for sample copy. Send today 3c postage for our great 212 page electrical cyclopedia No. 12 with 450 illustrations and 1600 electrical articles, valuable information and loads of experiments on wireless and electrical subjects.

**THE ELECTRO IMPORTING CO.**  
 223A Fulton Street **NEW YORK**  
**"EVERYTHING FOR THE EXPERIMENTER"**

## OWN A BUSINESS WHERE THE CROWDS ARE ALWAYS WAITING TO HAND YOU MONEY

**The Motion Picture Business is the Business.** It's the greatest Money making business of the times, and our free book "How to Make Money in the Moving Picture Business" tells you how you can start with a very small capital, and begin making money from the very start.

**ABSOLUTELY NO EXPERIENCE NEEDED**  
 This book is a guide for the inexperienced; it tells everything pertaining to the business and how to conduct it profitably. Don't wait, send for your copy today. It's free.

**P. & W. SALES COMPANY, 741 Como Bldg., Chicago, Ill.**

Go into **THE MOVING PICTURE BUSINESS.**

Write for **FREE Catalog**

**Earn \$30-\$50 Per Night**  
**No Experience Necessary**

A small investment will start you in this great money making business. We furnish Machine, Film, Lighting Equipment and complete traveling and stationary outfits.

**ACORN MOVING PICTURE CO.**  
 173 N. Green St. Dept. C, Chicago



## Sell Automatic Gas Lighters

Lights any gas or gasoline. Guaranteed two years. **Price 50c.** Sells itself everywhere.

Handier, cleaner and cheaper than matches. Agents making **BIG MONEY.** Send 25 cents for agent's sample and start now to **MAKE MONEY FAST.**

**STEEL STAMPING CO., 143 W. Austin Ave., CHICAGO**



# Typewriter Prices Smashed



Yes, smashed to rock-bottom. Our factory price is less than others ask for second-hand machines. Try this marvelous typewriter **ten days free**. It's the only typewriter good enough to put out on a **ten year iron clad guarantee** and **easy payment plan**. We give the first buyer in each locality a handsome leatherette carrying case free. Write today.

**GALESBURG WRITING MACHINE CO., Dept. 135, Galesburg, Illinois**

# Learn to Write—Manage—Solicit ADVERTISING!

Course and text by more than 60 big experts. Covers entire field. Learn by mail in home or office. Apply daily in your own work. Endorsed by large agencies. Earn \$50 to \$100 and upwards weekly. Introductory **Free Tuition Offer** open now. Act **Quick!** Text books and supplies only cost. Easy Terms. Address:

**CHICAGO UNIVERSITY OF COMMERCE, Dept. 1032, CHICAGO, U.S.A.**

## Searight MECHANICS SNIPS MADE IN FIVE SIZES



7" to 14" long  
 Out shows No. 7, price \$1.00  
 Larger sizes No. 8" . 1.50  
 Drop forged No. 10" . 2.25  
 Crucible No. 12" . 3.00  
 Tool Steel No. 14" . 3.50

If your dealer cannot supply you send your order direct to us.

**BARTLETT MANUFACTURING CO.**  
 40 Champlain St. DETROIT, MICH.



## STOP SNORING

Dr. Page's Snore-Mute stops snoring. Insures correct breathing while sleeping. Light and small. Only 25c. Booklet on snoring free. Dr. Page & Co.'s Best Spearmint Tooth Paste, a preservative, only 25c. Dr. Page's Suggestion for the Eye, strengthening, corrective, only 25c. Special offer. All three only 50c. Money back if not delighted. Send today.

**Dr. C. S. Page Co., Dept. 5246, Ironwood, Mich.**

**NO REAL SKYSCRAPERS IN EUROPE**—The limits prescribed for the height of buildings in European cities are much more stringent than in any city in America. Berlin permits a maximum height of 72 ft., but no building can exceed five stories or rise higher than the width of the street. The maximum height allowed in Cologne and in Dusseldorf, known as the "Park City" of Europe, is 65½ ft. Munich draws the line at a building having a ground floor and four stories, not counting a mansard. In London, in a street less than 50 ft. wide, all buildings are limited in height to the width of the street. In wider streets, the limit is 80 ft. Paris does not permit a facade higher than 65 ft., and in Rome the limit of height is set at 78½ ft.

## There's Big Money in Crispettes

We Teach You the Business FREE! Our kettle popped Popcorn is seasoned while popping. GREAT—BIG—LIGHT—FLUFFY KERNELS that melt in your mouth. 20 per cent more bulk corn per pound than from any other machine. Makes CRISPETTES far superior to others. Enormous profits with our WORLD BEATER Machines. Write for catalog.

**E. C. DELLENBARGER, 625 Jackson Street, CHICAGO, ILL.**

## Make this car your office—

there is \$900.00 to \$1800.00 a year in it for you

Spring Examinations will likely be held everywhere soon

Rapid advancement to higher Government Positions. "No layoffs" because of STRIKES, FINANCIAL FLURRIES or the WHIMS OF SOME PETTY BOSS. THE POSITION IS YOURS FOR LIFE. Country residents and city residents stand the same chance for immediate appointment. Common-sense education sufficient. Political influence NOT REQUIRED.

We will prepare 25 candidates FREE! Write immediately for schedule showing the places and dates of the SPRING examinations. Don't delay. Every day you lose means the loss of just so much coaching before the rapidly approaching examinations.

**FRANKLIN INSTITUTE, Dept. D 174, Rochester, N.Y.**



Hundreds of Parcels Post Railway Mail Clerks Needed NOW!

### COUPON

Franklin Institute (The pathway to plenty), Dept. D174, Rochester, N. Y.

The coupon, filled out as directed, entitles the sender to free specimen questions; a free copy of our book "Government Positions and How to Obtain Them," a list of positions now available, and to consideration for Free Coaching for the examination here checked.

- .... Railway Mail Clerk (\$900 to \$1800)
- .... Bookkeeper (\$900 to \$1800)
- .... Postoffice Clerk (\$800 to \$1200)
- .... Postoffice Carrier (\$800 to \$1200)
- .... Rural Mail Carrier (\$500 to \$1100)
- .... Customs Positions (\$800 to \$1500)
- .... Stenographer (\$800 to \$1500)
- .... Internal Revenue (\$700 to \$1800)
- .... Clerk in the Departments at Washington (\$800 to \$1500)
- .... Canadian Government Positions.....

Name..... Address..... D174  
 Use this before you lose it. Write plainly.

# DIAMONDS ON CREDIT

Of the many fashionable Diamond Rings for Gentlemen's wear, the 6-prong Tooth Mounting is the most popular. The large illustration shows the graceful lines and deep groove, enhancing the beauty of the diamond setting. The heavy prongs afford absolute protection and safety.

Extra heavy 14k Solid Gold.

Beautiful white Diamond, perfect in cut and full of fiery brilliancy. Specially Selected by our Diamond Experts.



The Young Man's Favorite Diamond Ring

Write for Catalog Today. It is Free to You.

Our large 100-page Catalog (sent free on request) shows the various diamond sizes and prices of this favorite ring. Marvels of beauty as low as \$25, \$60 and \$75. Others at \$85, \$100, \$125, \$150, \$175, \$200 and up. Make your selection and let us send it to you for your examination and approval, shipping charges prepaid. If you are perfectly satisfied that you have an unusual bargain, send us one-fifth of the purchase price and keep it; balance divided into eight equal amounts, payable monthly. If not just what you wish, return at our expense and ask us to send you another selection. Our Catalog contains over 2,000 handsome photographic illustrations of diamonds, watches, artistic jewelry, silverware, etc. We give better values and easier terms than any house in America. Send for Catalog today.

## LOFTIS BROS & CO. EST'D 1868

THE RELIABLE ORIGINAL DIAMOND AND WATCH CREDIT HOUSE

Dept. K894, 108 N. State St. CHICAGO, ILL.

Branches: Pittsburgh, Pa., and St. Louis, Mo.

## HAVE RUNNING WATER ALWAYS ON "TAP"

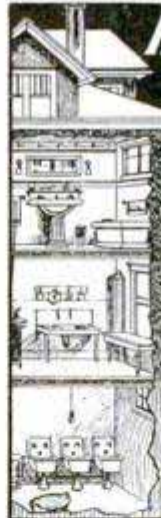

—All you want—wherever you want it—an unlimited supply of pure, fresh water without work, waste or worry! If you have a well or cistern all you need is a

### JARVIS POWER PUMP

Everything is supplied for quick, easy installation—pipes, fittings, fixtures, etc. A wonderful convenience for country and suburban homes! Runs by electric motor or gasoline engine at trifling cost. Send for catalog No. 21 today; a valuable guide to correct water supply. It is FREE.

Dealers Wanted

JARVIS ENGINE & MACHINE WORKS  
 Lansing, Mich.

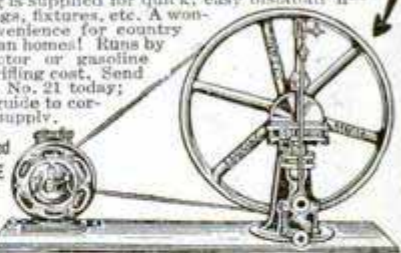

# CONGRESS

GOLD EDGES  
PLAYING CARDS



50¢ PER PACK

## For Social Play

A card party—old friends meet—new friendships formed. Dainty Congress Cards with their beautiful backs add spirit and tone.

**Air-Cushion Finish**

THE  
OFFICIAL RULES  
OF  
CARD GAMES  
Hoyle up-to-date  
SEND 15¢ IN STAMPS

ISSUED  
YEARLY

# BICYCLE

CLUB INDEXES  
PLAYING CARDS



25¢ PER PACK

## For General Play

Bicycle have the slip and finish, the playing and wearing qualities for general play in the club or home. They make and hold customers.

**Ivory or Air-Cushion Finish**

THE U.S. PLAYING CARD CO., CINCINNATI, U. S. A.

## Two million typewriters need this new invention



DISTRICT MANAGERS WANTED

Install a **Dowd** roll on your typewriter for a week's trial. It will cut down the noise of the type as they strike the platen from 50 to 75 per cent. Substitute the

# DOWD TYPEWRITER SILENCER

Profits waiting—Live managers wanted to handle the DOWD in every city. Sells on sight at a good profit.

for the rubber letter feed-roller on any machine. It is easy to install—simple—scientific—fool-proof—unbreakable and inexpensive. Full particulars on request.

**DOWD TYPEWRITER SILENCER CO.**  
705 Schofield Bldg. Cleveland, Ohio

**Dowd Typewriter Silencer Co.**  
705 Schofield Bldg. Cleveland, Ohio  
Kindly send full details of the DOWD TYPEWRITER SILENCER.

Name .....

Address .....

City..... State.....

Describe agency proposition..... (P.M.)

## Rent This Level 9 Months—Then It's Yours

### BUILDERS—CONTRACTORS—ARCHITECTS

High price and cash payments are eliminated. For the first time it is possible to obtain a high grade Level on terms so easy that you can not afford to be without one.

### Convertible Level

Besides its use as a Level it can also be used for running straight lines, getting angles, taking vertical sights, etc. for which ordinarily a Transit is required.



For more than fifty years Aloe's surveying instruments have been recognized as standard instruments. This Level is offered to you with an absolute guarantee that is backed by a ten day free trial offer.

**FULL PARTICULARS** and details of our extraordinary selling plan will be sent on request.

**A. S. Aloe Co., 515 Olive St., St. Louis, Mo.**

## Start to Save Agents Wanted



**Get a Grab's Automatic Keyless Bank**—cannot be opened until you have saved \$5 in dimes—or multiple of five—automatically registers and shows deposits—a little beauty—size 2 1/4 x 3 1/4 ins.—made of solid steel—oxidized copper finish—a splendid gift for boy or girl—Price \$1.00—parcel post prepaid—Address

**VICTOR M. GRAB & CO. CHICAGO**  
8700 Ashland Block

## Let Us Give You This Hat



This rich imported Austrian Velour Hat—very finest hare fur; Softer and Glossier than plush—Extra heavy, pure grosgrain silk band—has fashionable bow. Russia Leather sweat band—Silk Lined, absolutely newest and swiftest style, \$7.00 value.

### We GIVE IT To Our Agents

All that we require is that you show our samples and take a few orders for our special made-to-measure clothes. We pay highest cash profits—give presents besides, choice of 628 valuable premiums such as Suit Cases, Pipes, Watches, Guns, etc. Write for elegant FREE outfit and full particulars.

**SPENCER MEAD CO. Dept. 738 CHICAGO**

6034-\$50.

Only 20% down

and 10% a month

6038-\$75.

6258 \$25.

6226 \$35.

6211 \$100.

16026 \$175.

6188 \$175.

6261 \$35.

## DIAMONDS ON CREDIT

Buying a high grade Diamond is saving money, not spending it. The "Lyon Method" makes it easy for you to save. Lyon Diamonds are Blue-white and perfect. A written Guarantee Certificate with each Diamond. All goods sent prepaid for inspection. No security required. Write now for Catalog No. 3.

**J. M. Lyon & Co.,**  
71-73 Nassau Street  
NEW YORK



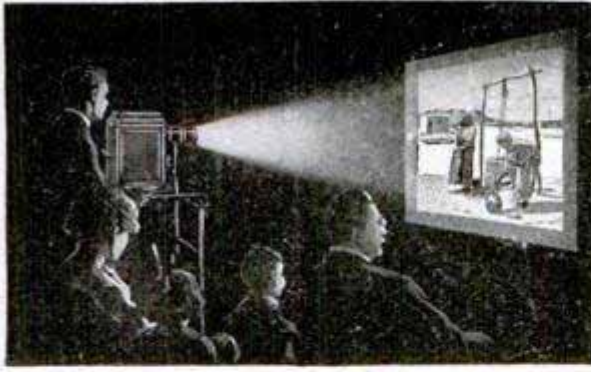

The Home Balopticon—our latest model

Picture Machines  
for Home Entertainment  
are as enjoyable as talk-  
ing machines.

## THE Bausch and Lomb BALOPTICON

Leading manufacturers in America of photographic and ophthalmic lenses, microscopes, engineering instruments, magnifiers, field and opera glasses, and scientific laboratory equipment.

FOR the showing of prints, photos, postals, etc., or for lantern slides, if you prefer.

Many styles to meet every requirement and many advantages over less scientifically constructed instruments. Photographic dealers everywhere will show you Balopticons.

Interesting Balopticon Booklet "Fun and Better" on Request

**Bausch & Lomb Optical Co., 576 St. Paul St., Rochester, N. Y.**

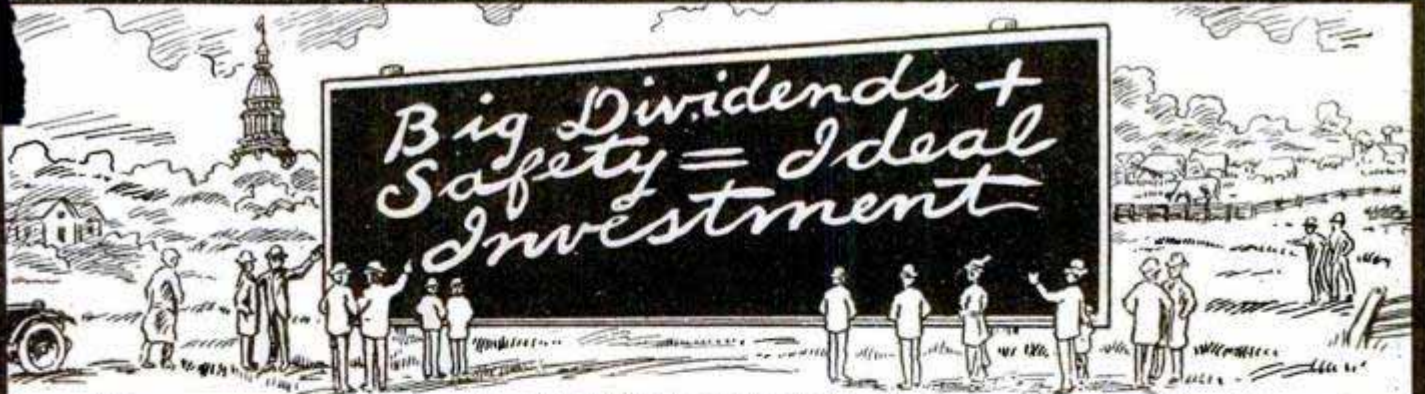

These are assured factors, in "CONSERVATION." If, in an investment, you require *safety*—Fire Insurance Stock will bear most searching scrutiny. If *unusual returns*, again it will meet utmost requirements. *Unequaled*: for *stringent legal safeguards*—for positive, prolific dividends—it surpasses, in *market value* and *earning power*, every other legitimate investment. And

### 30% to 250% Now Being Earned

by large Eastern fire insurance companies, proves these statements. Last year, 25 stock fire insurance companies earned 30% to 250% (the latter in one instance) on *original capital*; while average *dividends* for all in United States, for past six years, has been 34%. Can it be disputed, then, that for *stability*, Fire Insurance stock measures up to the highest conservative standard—while for *profitable returns*, it easily out-classes every other safeguarded investment? Realizing this, wealthy Easterners have held it close. But—

### THE CONSERVATION FIRE INSURANCE COMPANY

—now organizing—offers *Westerners* their first equitable opportunity in this rich investment field, hitherto all but monopolized by wealthy Eastern and European financiers. While full paid-in capital and surplus will reach near \$2,000,000, Company will begin *actual operation*, when \$200,000 is subscribed—assuring generous *earnings* long before capital is fully paid in. And—

### Not A Cent to Pay, until This \$200,000 Has Been Raised

This removes every shadow of risk. Let nothing keep you from *facts* regarding this superlative investment. Mail Coupon, secure *full evidence*. No obligation. Address:

STATE SALES CORPORATION, 318-25 So. Sixth St., Springfield, Ill.

STATE SALES CORPORATION 318-25 South Sixth Street, Springfield, Illinois  
Gentlemen—Without any obligation or cost to you,  
send information regarding first issue investment in "CONSERVATION."  
Name.....  
Town.....  
Street.....  
State.....



# EVERYTHING for the GARDEN

is the title of our 1914 catalogue—the most beautiful and complete horticultural publication of the day—really a book of 204 pages. 14 colored plates and over 800 photo engravings, showing actual results without exaggeration. It is a mine of information of everything in Gardening, either for pleasure or profit, and embodies the results of over sixty-seven years of practical experience.

To give this catalogue the largest possible distribution we make the following liberal offer:

## Every Empty Envelope Counts as Cash

To every one who will state where this advertisement was seen and who encloses Ten Cents we will mail the catalogue And Also Send Free of Charge

### Our Famous 50-Cent "HENDERSON" COLLECTION OF SEEDS

containing one packet each of Ponderosa Tomato, Big Boston Lettuce, White Tipped Scarlet Radish, Henderson's Invinible Asters, Mammoth Butterfly Pansies, and Giant Spencer Sweet Peas, in a coupon envelope, which when emptied and returned will be accepted as a 25-cent cash payment on any order amounting to \$1.00 and upward. With the Henderson Collection will be sent complete cultural directions together with the Henderson Garden Plans.

## PETER HENDERSON & CO. 35 & 37 CORTLANDT ST. NEW YORK CITY.

**BIGGEST DIAMOND BARGAIN Ever Offered "Mechanics" Readers**

Our enormous importations as one of America's greatest diamond houses, enables us to sell diamonds at less than the average retail dealer pays for them. Our world-beater bargain is this magnificent \$70 Gentleman's Ring for only \$50—on easy credit terms. The stone is genuine blue-white, perfect in cut and proportions, firmly set in new tiger-claw 14K solid gold mounting. Satisfaction guaranteed or money refunded. Write for big illustrated catalog of diamonds and watches. Free. Address

**RYER JEWELRY CO. 648 Ryer Building KANSAS CITY, MO.**

**\$5 Down Balance \$5 Month!**

**\$15.00 to \$35.00 Per Day Easily Made**

Taking photographs with our **ONE MINUTE TINTYPE and POSTCARD CAMERAS**. Pictures made direct without use of negatives. Toned, fixed and developed in one solution. No experience or dark room necessary. **Cameras from \$10.00 up to \$35.00 each.** Complete photos cost 1c to 2c each, sell for 10c, 15c and 25c each.

Send for Free Catalogue and Price List today.

**THE NEW YORK FERROTYPE CO., Dept. III, 168 Delancey St., New York City, N.Y., U. S. A., 1113 S. Halsted St., Chicago, Ill., U. S. A.**

**This \$3 THIN MODEL Watch \$1.96** The popular thin model 14 size for men and boys. Adjusted finely finished movement, hard enamel dial, stem wind and pendant set, nickel silver case, dust proof. A correct and reliable timekeeper. Fully Guaranteed 5 Years. To advertise our business and introduce our catalogue of watch bargains we will for a short time send this \$3 watch by parcel post upon receipt of \$1.96, or we will send it C. O. D. by mail and you can pay your postman. Order today. **MONEY BACK IF NOT AS REPRESENTED.** Address **DIAMOND JEWELRY CO., 09, 189 W. Madison St., CHICAGO, ILL.**

**\$1.96**

**Guaranteed 5 YEARS**

## Mechanics For Young America

A book which tells how to make scores of articles which delight the heart of the average boy. Price 25 Cents Postpaid

**POPULAR MECHANICS BOOK DEPT. 318 W. Washington Street, CHICAGO**

# MAKE FURNITURE LIKE THIS

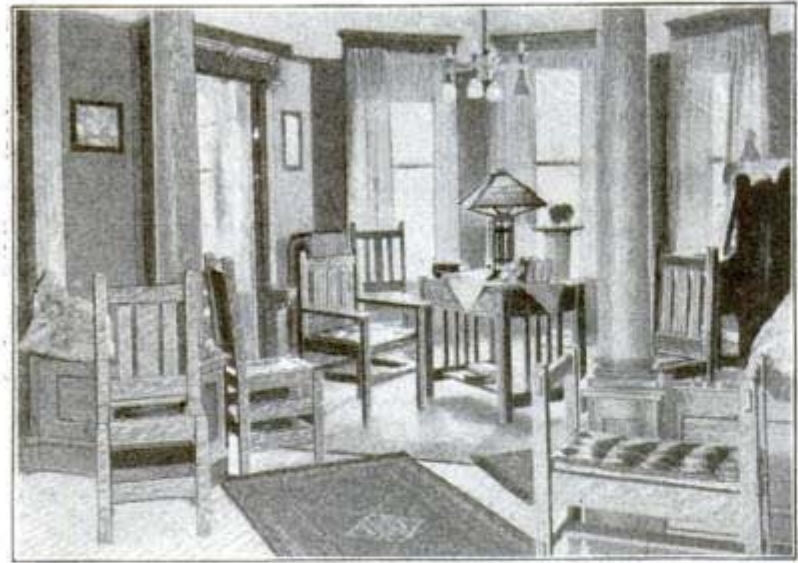

**Shown in the Photograph**

ONE of our readers, who is strictly an amateur with tools, experienced no difficulty in making and finishing every piece of furniture, with the exception of the piano, shown in the accompanying picture. It is impossible in a small space to display all the different designs in Mission Furniture which we have published, but this picture shows something of the variety of pieces and how well they go together. The

## MISSION FURNITURE SERIES of 3 Volumes

Comprises 98 Attractive Designs, all different

**MISSION FURNITURE, Part 1**  
New Enlarged Edition 128 Pages, 30 Designs

**MISSION FURNITURE, Part 2**  
Recently Issued 128 Pages, 32 Designs

**MISSION FURNITURE, Part 3**  
New Book—Just Out 128 Pages, 36 Designs

**Cloth, Size 5x7 inches Price 50 Cents Per Vol., Postpaid**

**THESE** books describe how to make furniture for every room in the house as well as swings for porch and lawn. Whether you need a complete set or only some special article to fill in with here and there, you will find full directions, dimensions and working drawings for making it in these books. The instructions are easy to follow and even the amateur can obtain most satisfactory results as related above. A complete list of the designs in each book will be furnished free upon request.

**ASK YOUR BOOK DEALER or address the publishers**  
**POPULAR MECHANICS BOOK DEPARTMENT, 318 W. Washington St., CHICAGO**

# The Farm YOU Want

is compact, easy to pay for, and enormously productive  
—and it *must* be suburban to a big live city

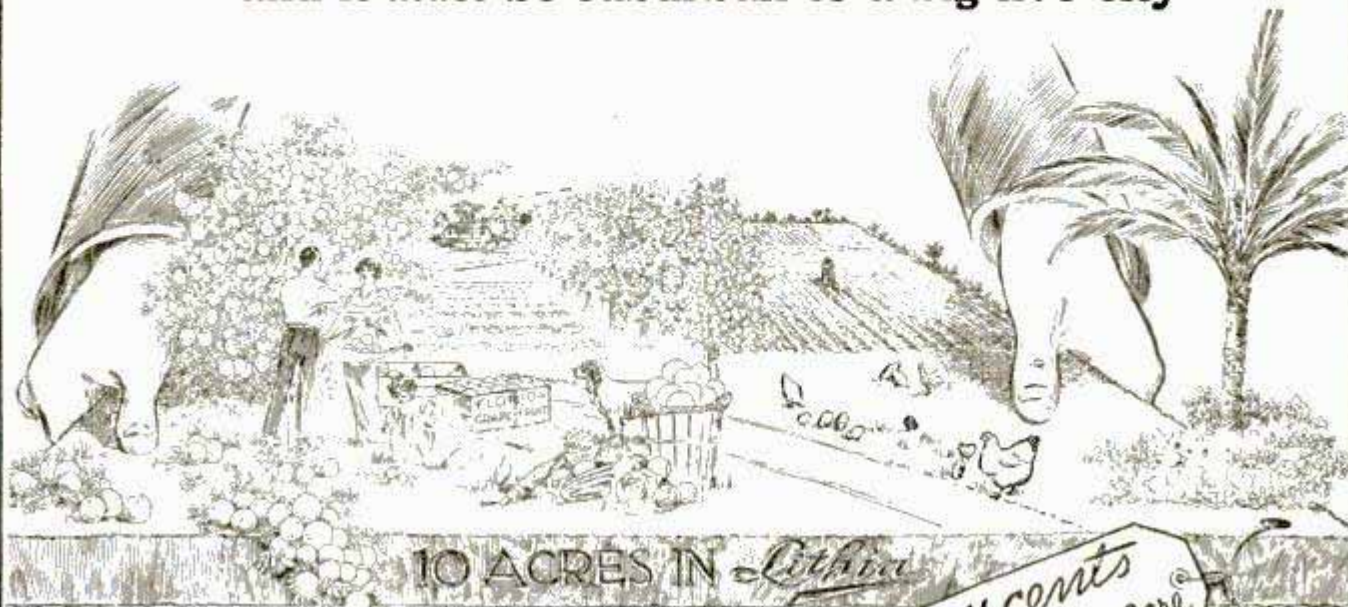

Here it is — and it's yours for

*3 1/3 cents per day per acre*

**IN OUR NEW LITHIA TRACT SUBURBAN TO TAMPA, the metropolis of South Florida. It is one of the few choice suburban farm tracts left in Hillsboro County, the recognized center of Florida's grape fruit and orange belt.**

This is the third great Hillsboro County tract that has been developed suburban to Tampa by our old established, responsible, thoroughly experienced organization. Over 2,500 families are now rejoicing because they bought at opening prices in our two former tracts. Every family can tell you they got a square and generous deal.

Our new Lithia Tract now offers you the same wonderful opportunity — and more, because of the rapid growth and development on all sides within the past four years. Our surveyors have completed their work of subdividing the Lithia tract into 10, 20 and 40-acre Citrus Fruit and Truck Farms, and it is now being thrown open to home-seekers and investors.

Hillsboro County is building ONE MILLION DOLLARS' WORTH OF NEW BRICK COUNTRY ROADS. Improvements of all kinds are going rapidly forward. Already buyers are building homes on our new Lithia Tract, and values are due to rise here just as they have in our two former suburban farm tracts in this same county.

The visible supply of select Hillsboro County grape fruit land is melting away very fast. Prosperous homes are scattered around the Lithia Tract—grape fruit and orange groves are flourishing on all sides.

Get our big new Florida book and look at the map—four big railroads intersect these suburban tracts—all the comforts of modern life right at hand! The completion of the Panama Canal throws the spotlight on Tampa, the nearest deep water port, and the traffic of the whole maritime world will pause at Tampa's door.

Think of it—a 10-acre farm suburban to a city like this—a farm big enough to keep you in comfort all your lives, yet one you can pay for at the rate of just 3 1/3 cents per acre per day!

Get the facts now. The coupon brings them to you without cost or obligation. Get your 1914 opportunity clearly before you while prices on this newly opened tract are still low and terms easy. Today \$1.00 per acre per month buys you independence and a future. Tomorrow—who can say?

We have prepared a special bulletin and a large illustrated book which we will gladly send you free on receipt of the coupon. Tear it off and mail it NOW and we will lay before you, by return mail, full and complete information showing how you can easily become the owner of one of these beautiful suburban farms, and why it is sure to prove the shrewdest, most profitable investment you can possibly make.

## North Tampa Land Co.

C. E. THOMAS, President  
1128 Commercial National Bank Bldg., Chicago

One judicious investment, remember, means more to your bank account than years and years of labor. Honestly, now, what have you to show for that little 3 1/3 cents per acre per day that might just as well be buying you a beautiful 10-acre farm suburban to Tampa? Where else could you put aside a few odd dollars so safely, so securely, and with such surety of seeing your modest savings fund develop into a great big investment?

No use trying to make yourself believe that savings bank interest will ever make you independent, nor 6% loans make you rich. Your money isn't working when you tie it up in such ways—it's LOAFING. Make your money work for YOU; right here in these rich suburbs of Tampa is your opportunity—here where a few dollars put to work NOW will reap all the benefit of development work constantly being done by the fast increasing population.

If you do not wish to improve your farm, you can in a few years, cash in on it from the investment standpoint without a stroke of work on your part. Think of it—two or three cigars a day, or the cost of a few car fares laid by—and a magnificent piece of suburban property is the result almost before you know it!

North Tampa Land Co., Pop. Mech. 2-14  
1128 Commercial National Bank Bldg., Chicago

Please send me, FREE, your latest and best Illustrated Book on choice Citrus Fruit and Truck Farms suburban to Tampa, Florida.

Name.....  
Street No.....  
City..... State.....

# Cut the Cost of Furniture in Two

We can help you do it! Because we are manufacturers. Because we sell direct and save you every cent of the dealers' and jobbers' profits. Government and state institutions, where only *the best* is considered, buy Brooks famous "MASTER-BUILT" Furniture. For years we have been furnishing the Home, Club and Office Furniture for Army and Navy Officers, as well as for hundreds of thousands of homes all over the world.

## Buy Direct from Our Factory—Largest Plant of its Kind in the World

We are simply straight manufacturers—who turn raw materials into finished furniture. Not a mail order house. Not a jobber or wholesaler. Moreover, we have devised a twentieth century method of reducing the size of the package. All "MASTER-BUILT" Furniture is

## Shipped in Sections—Assembled in 10 Minutes by Anyone

Hundreds of dealers are assembling Brooks "MASTER-BUILT" Furniture in their stores and selling it for from 20 to 50 per cent above our prices. They recognize the superior quality.

**Our Original Sectional Method Saves  $\frac{3}{4}$  Packing Costs —  $\frac{2}{3}$  Freight Costs —  $\frac{1}{2}$  the Floor Space Usually Required**

(See illustrations to the left)

Is it any wonder that we can save you one-half the usual cost of furniture? The wonder is why you haven't taken advantage of this money saving plan before. Delay no longer. Get posted. Mail postal for Free Book of our furniture.

**Brooks Manufacturing Co.**  
2702 Rust Ave. Saginaw, Mich.

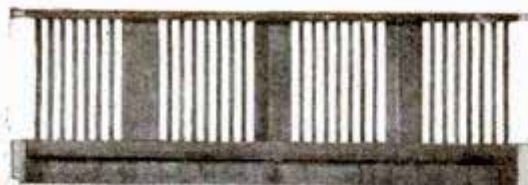

Back Section

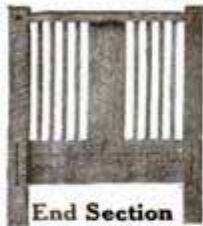

End Section



End Section



Front Rail



Cushion

In 10 minutes you can assemble these sections into this Settee

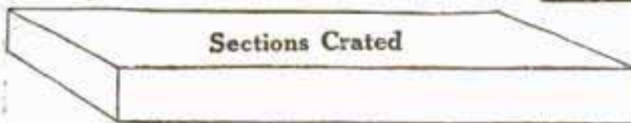

Sections Crated

Save  $\frac{3}{4}$  Crating Costs

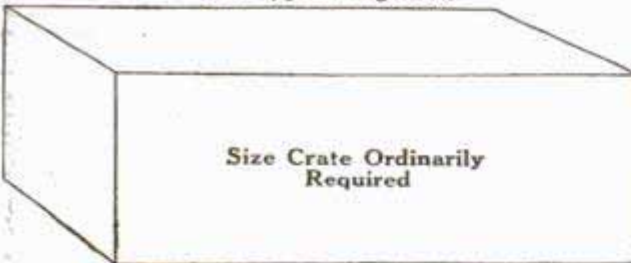

Size Crate Ordinarily Required

Save  $\frac{1}{2}$  Factory Floor Space Usually Required

Relative Size Floor Space Brooks Method Needs

Relative Size Floor Space Usually Required in Ordinary Factory

Saves  $\frac{2}{3}$  Freight Costs

This Size Car of Brooks Furniture

Size Car it Would Need if Not in Sections

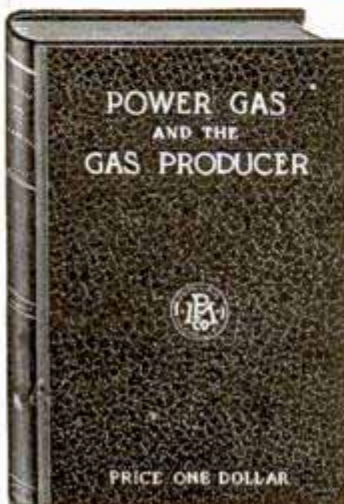

## ARE YOU INTERESTED IN Cheaper Power?

To meet a demand for information which has not been hitherto available except by the employment of an expert, we have been fortunate in securing the services of an eminent gas power engineer, Mr. J. C. Miller, M. E., who has written a book on this subject which we have recently published. It gives **just the information a man wants to have**, comparing the first cost of steam engines and boilers with the gas producer and gas engine, and the comparative cost of maintenance and operation. It tells all about the advantages and troubles of gas producers, and gives full details of how to run them. It is written in an absolutely impartial manner, and not with a view to increase the sale of gas plants, leaving the decision as to the advisability to the individual reader. It will also enable the **Steam Engineer** to understand thoroughly the working of the new system if the change is made, and to handle a plant competently and with confidence.

## POWER GAS AND THE GAS PRODUCER

has 200 pages, is printed on the best book paper, profusely illustrated with half-tones from photographs, diagrams, etc., and durably bound in extra cloth.

SENT POSTPAID TO ANY ADDRESS FOR \$1

Popular Mechanics Book Dept., 318 W. Washington Street, Chicago

# \$2430.00 IN 90 DAYS

**\$27 A DAY** actual clear cash profits is what one man made in just three months with a Helm Press in a little town of 375 inhabitants. He saw a big opportunity in manufacturing pressed cement brick and blocks, was quick to grab it and is realizing big money now. Look round about you. See how concrete is taking the place above all other materials in building construction. Realize what a chance is yours now to get in this big industry on the ground floor. \$20 to \$50 a day profit is easily made with the Helm Press. You will be turning out a product that is as staple as sugar, as much in demand as the clothes on your back.

## TEN BILLION BRICK

are used every year in the United States. Thirty-three and a half million every working day of the year. Consider how enormous the demand, how contractors are crying for more brick. Be the one to supply this demand in your locality. You can start in this business. Be a manufacturer of pressed cement brick and make money from the start. No experience is necessary and very little capital needed.

### THERE ARE BIG CONTRACTS WITH THEIR BIG PROFITS READY FOR YOU

No matter where you are, how little the town or how big the city. Builders are turning to this product because it solves the problem of high cost of building. Concrete must take the place of wood, stone and clay. Here are experiences which you can duplicate in your community:

I landed a \$90,000 government contract with Helm pressed cement brick.

Just landed a contract for 400,000 Helm pressed cement brick.

We are working on a contract for half a million pressed cement brick.

Made a million brick this season on one of your Helm presses.

My daily manufacturing profits on pressed cement blocks average \$25.

Working on a contract for a quarter of a billion pressed cement brick.

Made 17,000 pressed blocks for one contract in less than a month.

Six weeks behind on Helm pressed cement brick and block orders.

We want you to know more about these manufacturers who are landing the big business and making the big money. We want to show you how they started with but little capital.

**FACTORY OWNERS** are the biggest money makers in America and this machine will place you in their ranks. You can start with little capital and even without experience. This is the machine for you because it makes pressed cement brick and blocks under 80,000 pounds pressure. No tamping, and easy work. It makes 1,000 blocks or 10,000 brick daily. No burning required. Ready for the market in a few days' time. Eventually someone will make pressed cement brick and blocks in your community, but now the opportunity is yours. No matter if cement products are now made there—these brick and blocks made by pressure will be demanded. The possibility of failure in this business is almost eliminated. You can enter it with almost a dead certainty of meeting success. Costs you nothing to learn all about it. Fill in the coupon here, mail it today and receive free, full information of the Helm Press and money to be made in the cement brick business.

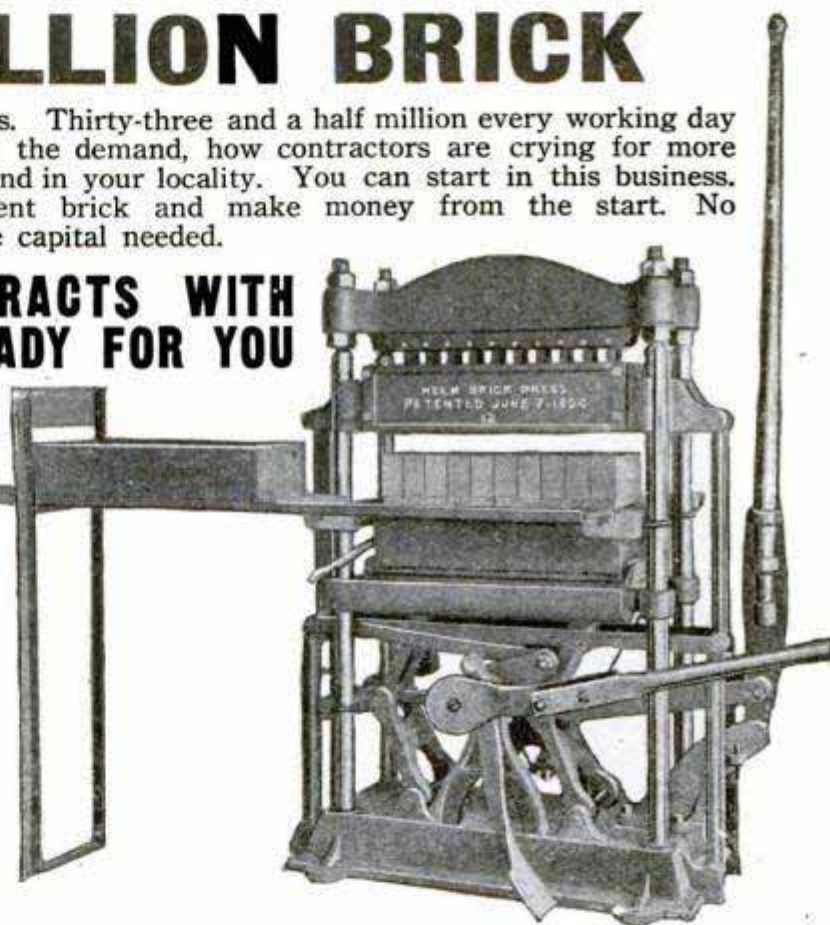

QUEEN CITY  
BRICK MACHINE CO.  
122 Bank Bldg.,  
TRAVERSE CITY, MICH.

Please send FREE the book on concrete and Helm presses.

**QUEEN CITY BRICK MACHINE CO.**

122 Bank Bldg.

TRAVERSE CITY, MICH.

Name.....

Address.....



## Put Yourself in His Place

**T**HIS MAN inside the fire lines is watching his property burn. What does it mean to him? What would it mean to you if you were in his place? Would you be face to face with disaster or would you watch the smouldering remnants of your property with your mind occupied with plans for business rehabilitation, because somewhere in the ruins is the safe containing the indestructible financial soul of your business—your fire insurance policy in the Hartford?

If your property burns, you can plan with absolute certainty, because for more than a hundred years the

### Hartford Fire Insurance Company

has been furnishing just this kind of business protection and has never failed to make good an honest loss.

Since its organization it has paid over 165 Millions for claims on property of its policyholders. This is larger indemnity than has been paid by any other American Company.



**When Next You Insure  
Insist on the Hartford**



"Baby Grand" Pocket-Billiard Table

# Do You Play Billiards?

The "Baby Grand," Prince of Entertainers, is now at your command—at low price and on easy terms. Ready to transform that bare "spare room" into an enchanted realm of wholesome amusement.

Experts and amateurs, boys and girls, will benefit by playing billiards *at home*.

The physical and mental recreation—the concentration, self-control, excitement and fun—combine to make billiards the one best tonic for tired bodies and brains.

Let the "Baby Grand" solve the problem of keeping the boys at home.

## The "Baby Grand" Table Prince of Home Entertainers

The "Baby Grand" is a superb home-size Mahogany Billiard or Pocket-Billiard Table.

Has the accurate angles, fast cushions and playing surface of the world-famous Brunswick Regulation Billiard Tables. Provided with concealed Cue Rack and Accessory Drawer, which holds complete Playing Outfit. Furnished as a Carom Billiard or Combination Carom and Pocket-Billiard Table. Sizes 3x6; 3½x7; 4x8.

## Brunswick "Convertibles" — For Any Room

We also build "Convertible" Billiard Tables, used also as Dining Tables, Library Tables or Davenport. These popular tables are equal in playing qualities to the "Baby Grand" styles.

### Moderate Prices and Easy Terms

We sell all styles and sizes of Brunswick Billiard Tables direct from factory to home at exceptionally low prices. Easy terms of payment—extending over a year.

### Playing Outfit Free

Outfit including Cues, Balls, Bridge, Rack, Markers, Chalk, Cover, Book "How to Play," etc., etc.—*all free with any table you buy.*

### Color-Illustrated Book

Our beautiful book "Billiards, The Home Magnet," shows all styles of tables in actual colors and gives full information. Send coupon or letter.

**The Brunswick-Balke-Collender Co.,** Dept. O R, 623-633 S. Wabash Ave. CHICAGO, ILL.



Billiard-Dining Table

(190)

The Brunswick-Balke-Collender Co.  
Dept. O R, 623-633 S. Wabash Ave., Chicago, Ill.  
Please send me the free color-illustrated book  
"BILLIARDS—THE HOME MAGNET"

Name.....

Address.....

Town..... State.....



## A Familiar Sight the World Over

Enough "Bull" Durham is sold in a year to roll approximately 32,000,000 cigarettes every day.

"Bull" Durham is distinguished from all other tobaccos by a wonderful, sweet, mellow *flavor* and *fragrance*, irresistibly attractive and satisfying. No other tobacco product *can* have this "Bull" Durham flavor and fragrance. They are produced by a generations-old process known only to the manufacturers of "Bull" Durham. Every visitor who approaches Durham, N. C., where "Bull" Durham is manufactured, is impressed with this delightful, distinctive fragrance that envelops the whole city. There is nothing else like it in the world.

# GENUINE "BULL" DURHAM SMOKING TOBACCO

(Enough for forty hand-made cigarettes in each 5-cent sack)

Enough "Bull" Durham is sold in a year to make approximately 12 *BILLION* cigarettes—as many as all brands of ready-made cigarettes in this country *combined*—and the sales are steadily *growing*. Proof that millions of smokers *prefer* the cigarettes they roll for themselves from "Bull" Durham, to any ready-made kind.

Ask for *FREE*  
book of "papers"  
with each 5c sack.

Get a sack of "Bull" today and "roll your own" for complete, healthful *enjoyment* and lasting *satisfaction*.

**FREE** An Illustrated Booklet, showing correct ways to "Roll Your Own" Cigarettes, and Book of cigarette papers, will both be mailed to you, *free*, on postal request. Address "Bull" Durham, Durham, N. C.

THE AMERICAN TOBACCO COMPANY





# GENUINE PERFECT CUT DIAMONDS \$97.50 PER CARAT

DIA. CUTTERS

## The Old Way—4 Middlemen's

profits, expenses and losses added to the first cost! More than \$50 per carat wasted for which you get no value in return! And even if you pay the local price, you get no MONEY BACK protection; no chance to compare value because no carat weight quoted; your choice of size and quality is small; your own ideas of artistic mounting cannot be fulfilled!

Read how the **BASCH PLAN** has standardized the purchase of a diamond; how you are as sure to receive 100 cents in VALUE for the money you invest, as a life-long diamond expert.

IMPORTER

BROKER

WHOLESALE  
OR JOBBER

RETAIL  
JEWELER

## How we save you over \$50 per carat

DIA. CUTTERS



YOU

We import direct to you from the diamond cutters of Europe through our own offices at Antwerp and Amsterdam; we buy and sell for cash; the tremendous world-wide volume of our sales justifies a single small profit; our losses are *nothing*, for we open no accounts; our expenses are a *trifle* compared to the "overhead" of a jewelry store. And yet you send **NO MONEY**; you see before you buy!

### PROTECT YOUR INVESTMENT WITH THE

## Basch Money Back Guarantee

— nothing like it in the whole diamond business: an **UNANSWERABLE ARGUMENT** that has given us the world's business after we have shown that our values are the world's best! Written legal guarantee to refund the full price in cash, less 10%, any time within 2 years and to allow the FULL PURCHASE PRICE IN EXCHANGE any time! Carat weight, quality and value legally certified in writing.

### A Few Examples of Our Wonderful Values

14K. Engagement Solitaire Ring. Complete with



- 1/8 carat dia. \$ 12.00
- 1/4 carat dia. \$ 21.25
- 1/2 carat dia. \$ 48.75
- 3/4 carat dia. \$ 71.25
- 1 carat dia. \$101.25



14K. 6 Prong Tooth Ring. Complete with

- 1/8 carat dia. . . . . \$ 13.75
- 1/4 carat dia. . . . . \$ 23.00
- 1/2 carat dia. . . . . \$ 50.50
- 3/4 carat dia. . . . . \$ 73.00
- 1 carat dia. . . . . \$103.00



Solid Gold Tie Clasp Guaranteed, patent spring

1 diamond \$1.00

WE SEND YOU ANY DIAMOND, SET IN ANY MOUNTING, FOR

## Free Examination

We ship by any express or in care of any bank in your city; allow full inspection; permit any comparison; — all without expense to you or obligating you to buy. If not acceptable for any reason — return at our expense.



## This 128 Page DE LUXE BASCH DIAMOND BOOK FREE!

Tells you in simple language Diamond Facts that it has taken our experts a lifetime of study to acquire! Explains how direct importing, cash methods and low expenses enable us to save you more than 1/3 on any diamond. Describes our factory facilities for furnishing anything you wish in solid gold and platinum mountings. 10,000 illustrations of the latest fashions in Diamond, Platinum, Gold and Silver

Please mail me Free Diamond Book as per your offer in Popular Mechanics.

Jewelry, Watches, etc., at factory prices. Money Back Guarantee with every piece. An authoritative book that is well worth owning. Sent Free on receipt of your name. Write now or mail this coupon.

L. Basch & Co., Dept. L247 State & Quincy Sts. Chicago

Name.....  
Address.....  
Dept. L247  
State & Quincy Sts.  
CHICAGO



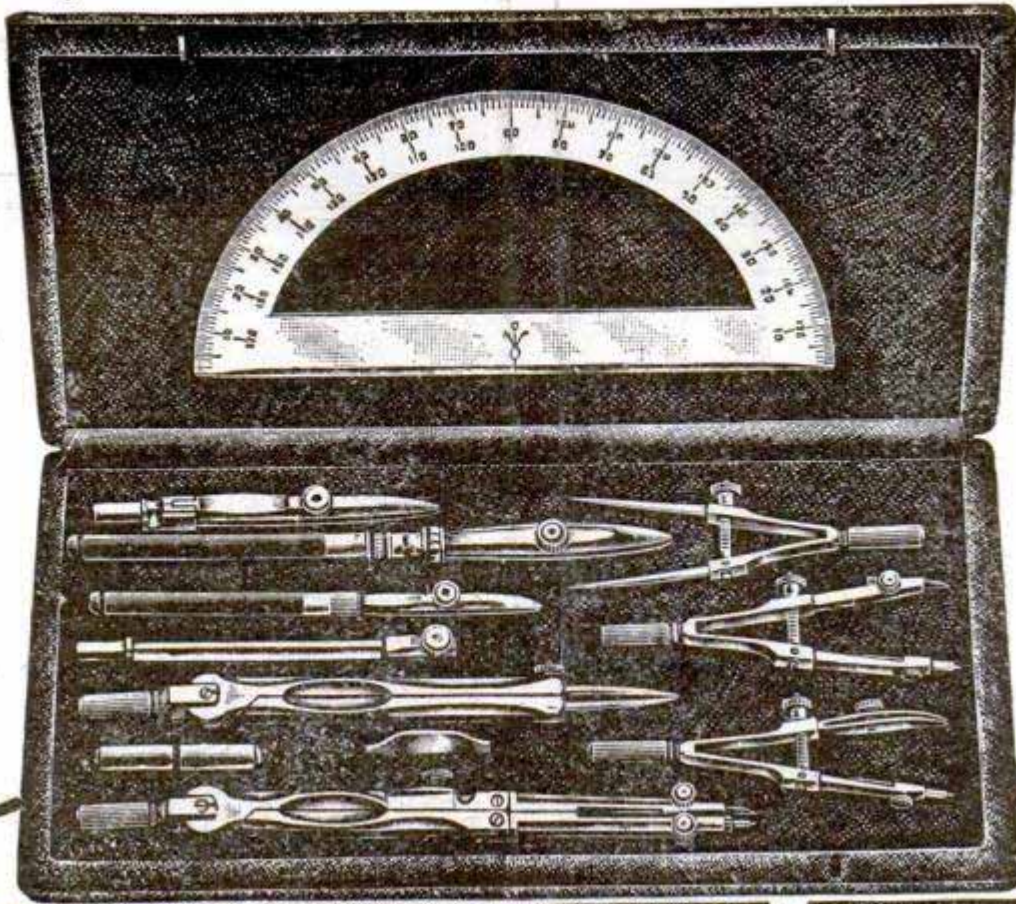

# FREE

## \$15.00 Draftsman's Complete Working Outfit

Yes sir. I will give you a complete draftsman's outfit absolutely free. Besides these German Silver Draftsman's Instruments shown here I also give you absolutely free a 20x25 inch drawing board, a 24 inch T square, 12 inch rule,

supply of drawing paper, 2 triangles and French curve, pencil and eraser, drawing ink and thumb tacks, etc., etc. These are genuine working instruments. Just the kind of an outfit I use myself. You couldn't get this outfit anywhere for less than \$15.00. I give it to you **free**. But you must hurry. Send the free coupon now—today.

## Be a Draftsman

### Earn \$125 to \$175 a Month at Once

Thousands of positions paying big money are open right along. All over, concerns are constantly wanting trained men. They pay big money. Hundreds of positions open paying from \$75.00 to \$100.00 weekly. A prominent chief draftsman will give you personal instruction, practical training, the kind demanded by firms that pay the biggest salaries. You can learn to become a draftsman in your own home—during your spare time—by mail.

## You Can Earn While Learning

I have perfected a plan that gives you an opportunity to begin earning money as soon as you become my personal student. I want ambitious men. This offer enables ambitious men to pay their way while they are learning. Send me the coupon and get my proposition.

**I Guarantee**  
To instruct you until competent and in a position at a regular salary paying from \$125.00 to \$175.00 per month and furnish you free \$15.00 Working Outfit at once.

## Chief Draftsman Will Instruct You Personally

For 20 years I have been doing the highest paid expert drafting work. I will train you personally and give you practical training. I will give you this kind of training as long as required during your spare time, in your own home.

### Free Outfit Coupon Chief Draftsman

Div. 9192, Engineer's Equipment Co., Chicago

Please send me your book, "Successful Draftsmanship" and also full particulars of your liberal "Personal Instruction" offer to a few students. It is understood that I am obligated in no way whatever.

### Pay As You Wish

Don't bother about the money. If you are ambitious and want to become an expert draftsman, don't worry about the money. Write to me now—at once for full particulars.

## Send the Free Coupon NOW

### For Big New Free Book

Just fill out the free coupon and mail it in to me at once. I will send you absolutely free and prepaid a new book, "Successful Draftsmanship." Tells you all about the profession and about the wonderful opportunities that are now open. I'll tell you how you can start earning big money as soon as you enroll. Here is your chance to get into the big money class. The first step is to send the free coupon. Send it **now**.

Name .....

Address .....

## CHIEF DRAFTSMAN

Div. 9192, Engineer's Equipment Co., Chicago, Ill.

# Any Tool Sharpening Easy with this Ball-Bearing "Running-in-Oil" Grinder

**LUTHER**  
"Best Maide"

## TOOL GRINDERS

will put a keen edge on your tools speedily and with absolute accuracy. Improved and exclusive features of construction insure easy, silent running and make the Luther "Best Maide" the most satisfactory grinder for all tool sharpening purposes. Several different special attachments extend its usefulness to many other shop and farm operations.

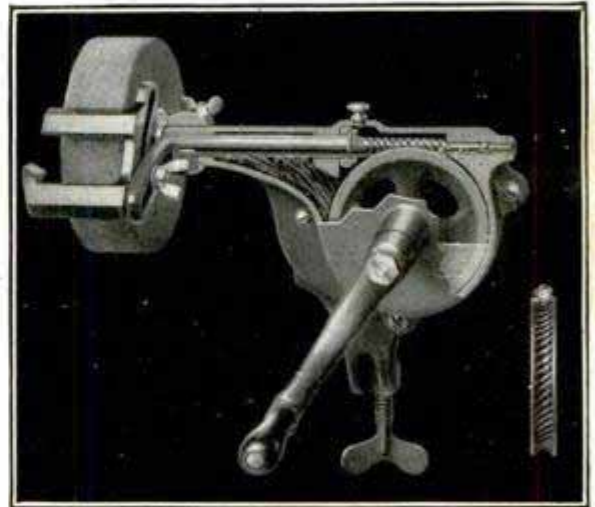

### Double Faced Sharpening Wheel

In "Best Maide" Grinders the grinding and finishing are both done on one wheel. Tool is brought to an edge on the medium grit body and is smoothed off and finished on the fine grit side face. No other grinder performs both these operations on a single wheel.



Upright

### DIMO-GRIT—"The Wheel for Steel"

Luther Grinders are the only tool sharpeners equipped with wheels of Dimo-Grit, the marvelous, new, artificial diamond sharpening substance. Dimo-Grit cuts the hardest steel as easily as emery does copper. **No water needed. No danger of drawing temper.** Lasts longer and sharpens tools many times faster than emery. Increases your own efficiency as well as that of your tools. All Dimo-Grit wheels are guaranteed for five years.

Hand Power Breast Drill

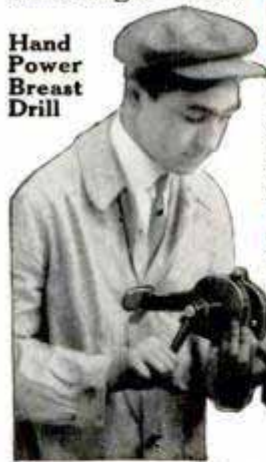

### Hand and Power Drills

Drilling can be easily done with the "Best Maide" Grinders by means of special attachments for bench use and for free hand work. Both these attachments are illustrated below.

### Improved Swiveling Device

The new patented Swiveling Device used in Luther "Best Maide" Grinders permits quick and accurate adjustment of the frame to any desired angle, horizontal or vertical, and holds machine rigidly in position. The most difficult and awkward job of tool grinding is made easy by this exclusive improvement.



Power Bench Drill

### Perfect Worm Gear

The worm gear and shafts of these "Best Maide" Grinders are cut from solid steel by special machines of our own designing. They are of extra large diameter, which provides great wearing surface and makes the grinding wheel run true and without vibration. Ball bearings assure wonderful ease, speed and quickness in operation.

### Sharpening Attachment for Twist Drill

A special attachment enables you to sharpen twist drills perfectly on the "Best Maide" Grinder. This easy operation will keep your drill sets in perfect working order.

**If Your Hardware Dealer Can't Show You Luther Grinders, Mail Back the Coupon for FREE HONE**

Luther "Best Maide" Grinders are sold by nearly all leading hardware dealers. If on inquiry you find that your dealer does not handle Luther Grinders, tell us his name and the line of grinders he does handle and we will send you a handy little Dimo-Grit Pocket Hone free for your trouble. Use the attached coupon and get our descriptive folder telling about "Best Maide" Grinders.



**Luther Grinder Mfg. Co.**

774 Point St.

MILWAUKEE, WIS.

## FREE HONE COUPON

Luther Grinder Mfg. Co., 774 Point St., Milwaukee, Wis.  
In compliance with your condition for Free Hone, I make

the following report: .....

Dealer's Name .....

Grinder Handled.....

Please send me Free your Special Folder illustrating and describing Luther's "BEST MAIDE" Tool Grinders.

Name .....

Address .....

# COLGATE'S

## RIBBON DENTAL CREAM

TRADE MARK



Good teeth  
Good health

**L**et us all remember those four words—make them our watch-word and join the crusade for better care of the mouth.

Your teeth should last you all your life. With good care they will. Brush them twice-a-day with Ribbon Dental Cream. Such care, and a twice-a-year visit to the dentist, make for clean, white, sound teeth. Such care gives better digestion and better health.

Every member of every family should have an individual tube of this *delicious* dentifrice.

*There are boxes of half dozen tubes at your dealer's. Get the children to join the crusade too by sending 4c in stamps for a trial tube and our instructive booklet, "Oral Hygiene."*

**Free box of Colgate Comforts.** While your memories of Christmas are still fresh we should like to hear how you used Colgate Comforts in making gifts. To those who write telling us, we shall be glad to send a box of trial sizes of Colgate Comforts.

**COLGATE & CO., Dept. 81, 199 Fulton St., N. Y.**

*Makers of Cashmere Bouquet Soap—  
luxurious—lasting—refined.*

