

POPULAR MECHANICS MAGAZINE

WRITTEN SO YOU CAN UNDERSTAND IT

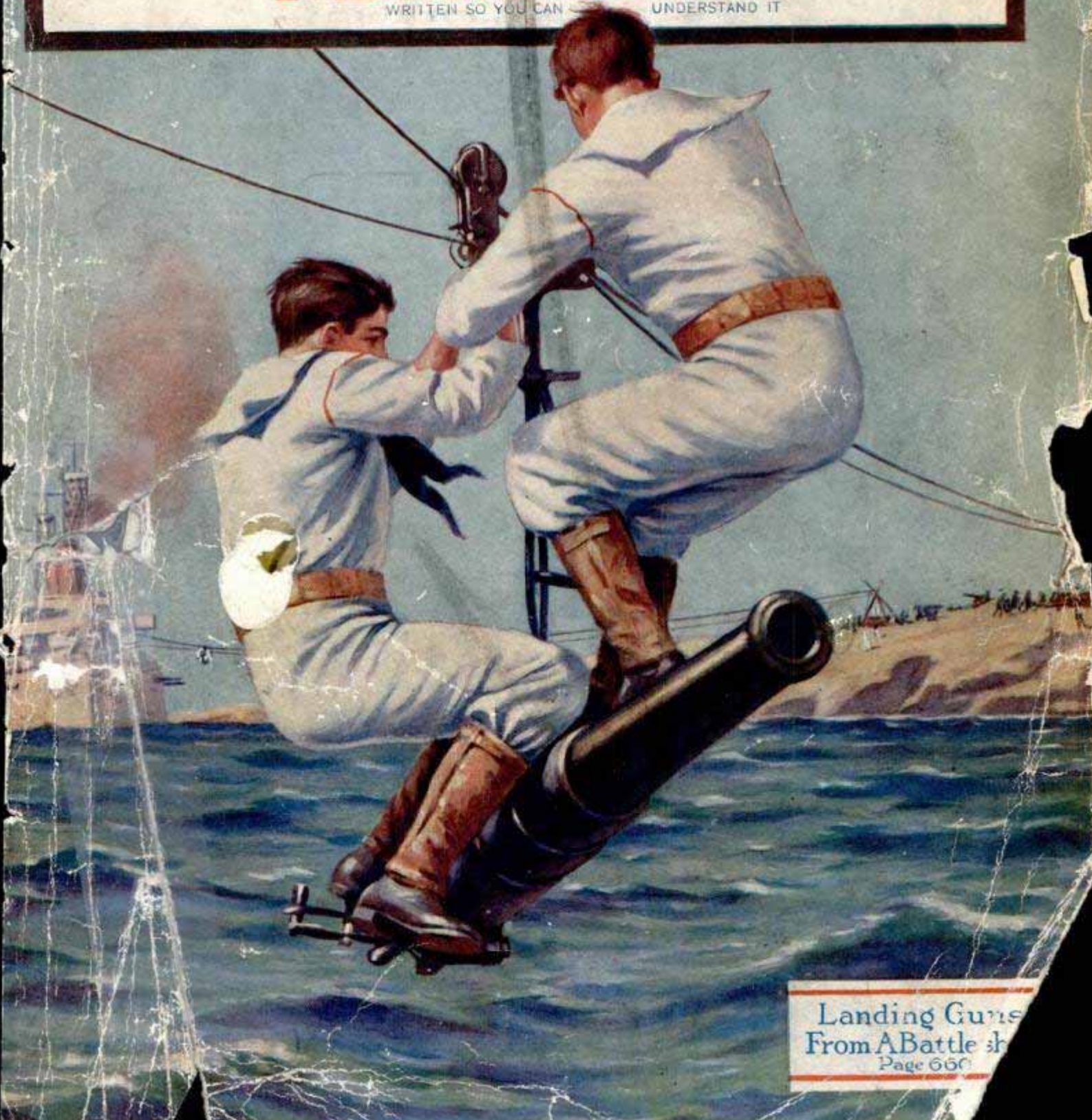

Landing Guns
From A Battle ship
Page 660

We Pay The Freight On These Houses

Design No. 73
Eight Rooms and bath all rooms convenient and roomy. Size 28x24 feet.



\$890

Design No. 93
Seven Rooms and bath, very attractive exterior; sleeping porch, balcony. Size 30x22 feet.



\$899

Freight Prepaid No Money Down

Here is an opportunity for any man to own a home of his own, no matter how limited his means. Even if you have not definitely settled on any building plans, it will pay you big to take advantage of this sensational offer. Order the material NOW and build later. We are determined that the Fall of 1913 shall be the biggest, busiest

season in the history of this company. Hence these unprecedented offerings, the like of which have never before been made in the history of building material business.

Think of the Enormous Saving

Nowhere else in all the world, can you duplicate these prices. We will save you from 1/2 to 3/4 what you would have to pay elsewhere. Look well at the illustrations of the 4 homes here shown—note the brief descriptions. We will furnish you the material needed to construct any of these homes strictly according to our Plans, Specifications and Material list at the prices quoted for each. But that is not all. We will deliver all this material right to your railroad shipping point, FREIGHT PREPAID BY US—no charges to be paid by you at all. You are not even required to pay one cent down. We ship subject to examination wholly at our own risk. We positively guarantee every item we send you to be high grade, brand new stock. We would not dare ship from \$500 to \$1,000 worth of material on these liberal, no-money-down, freight prepaid terms, were it otherwise.

Special Notice: These freight prepaid prices for all points in Illinois, Indiana, Ohio, Southern part of Michigan and Wisconsin and Eastern part of Iowa and hold good for these 4 designs only. Special freight prepaid prices to any point outside of above territory.

These Prices Good Only For 30 Days

Please remember, these prices quoted in this advertisement hold good only for 30 days. After that they will positively be withdrawn. If you are wise you will not let this chance go by as it may never come again. So be sure to write us today.

50c Buys Complete Set of Blue Print Plans

This is the first time we have ever offered a complete set of plans for only 50c. Plans offered at this price are only for the designs shown in this advertisement. This is a part of the building material offer and like it, is good for only 30 days. Usually when you go to an architect, plans like these would cost you about \$50. You buy the bill of material from us we will absorb the 50c charge and the plans will cost you nothing.

Plumbing Material



Write for price on our complete bath room outfits. We guarantee a saving of 30% to 50%.

Heating Plants

Steam, Hot Water, and Warm Air. Let us estimate on your requirements. Big saving.



\$10,000 Book of Plans Free

The houses here shown are four of our regular designs taken from our Wonderful Book of Plans, containing 100 pages of beautiful, modern homes. Let us send you a copy of this magnificent book FREE. Not only do we save you from 25% to 50% on your complete building, but we give you all the assistance you need for its proper and economical construction free of charge.

Our Guarantee Your Protection

We guarantee all brand new stock, sufficient quantity, prompt shipment. \$10,000,000 capital backs Guarantee.

\$736



Design No. 57.

Six Rooms and Bath. Note the handsome exterior appearance of this design—the well arranged front porch and manner in which gable ends are finished. Sloping front and rear and the dormers give a most pleasing roof effect. Large living room with cased openings to reception hall and dining room. All bed rooms have square ceilings—no cut-off corners. Plenty of closet room. Size 24 ft. x 26 ft.

\$762



Design No. 60.

Five Rooms and Bath. Large living room; private porch. Designed to be built without waste, either in material or labor. Splendidly arranged interior. Exterior, with its gables, exposed rafters, wide projecting eaves that keep out wind and weather, and ample porch room, has all the charm of a modern California bungalow. Size 37 ft. x 38 ft.

CHICAGO HOUSEWRECKING CO.

Prominently known to the public for 20 years as the great "Price Wreckers," and now owned by the Harris Brothers Company, have decided that their best interests require that the name of the principal owners of the company be more prominently brought to the public's notice. There is no change in our business, except that the four Harris Brothers will, in the future advertise and sell their goods, heretofore advertised and sold under the name of THE CHICAGO HOUSEWRECKING COMPANY, under the name of the Harris Brothers Company.

Harris Bros. Co. 35th & IRON Sts. Chicago

Dept. BR-7

PRINCE ALBERT

the national joy smoke

NIX on this "Indian-silence-under-torture" bunk. Believe us, his brand of endurance is counterfeit compared to that of the boys who smoke live-coal-on-the-tongue brands of pipe food and let on to be gleeful. But why put your tongue to the torture test, brother? P. A. can't bite, can't singe your lining. The bite's removed by our wonderful patented process.

P. A. is sold everywhere in tippy red bags, 5c; tidy red tins, 10c; pound and half-pound humidors.

R. J. REYNOLDS TOBACCO CO.
Winston-Salem, N. C.

American Horse
Sioux Warrior
and Orator

PRINCE ALBERT



CRIMP CUT
LONG BURNING PIPE AND
CIGARETTE TOBACCO

This One



Here's a "dandy" Free Text Book for **"Home Carpenters"**

12 WORKING DRAWINGS
VOL. 36
CYPRESS
POCKET LIBRARY
"THE WOOD ETERNAL"

"SHORT CUTS" TO
GOOD CARPENTRY

"Short Cuts to Good Carpentry"
(Vol. 36, Cypress Pocket Library)

48 pages of authoritative instruction (simple, clear and stimulating) fully illustrated and with big Supplement, 24 x 36 in. with detailed Working Drawings that show how to make twelve "hard jobs" easy, safe and economical of both labor and Lumber. Read what "Rural Life," (Rochester, N. Y.) says of

"SHORT CUTS to,
GOOD CARPENTRY"

"It is a guide book for the man or boy who can handle a saw or hammer and wants to know how to use them to the best advantage."

Ten topics pertaining to the house and 4 about barns. Sent free with our compliments.

WE TRUST YOUR OWN JUDGMENT and SELF-INTEREST to INSURE CYPRESS on YOUR job. "The Wood Eternal" keeps value going up by keeping the place from running down."

BOX SILL CONSTRUCTION

SELF SUPPORTING

JOIST

2x4

BARN FRAMING

ROOF TRUSS

CORNICE DETAIL

CYPRESS SHINGLES



When planning a Mansion, a Bungalow, a Farm, a Sleeping-Porch or just a Fence, remember—With CYPRESS you BUILD BUT ONCE. TRY IT.

Let our "ALL ROUND HELPS DEPARTMENT" help YOU. Our resources are at your service with Reliable Counsel,
SOUTHERN CYPRESS MANUFACTURERS' ASSOCIATION
1219 HIBERNIA BANK BUILDING, NEW ORLEANS, LA.

INSIST ON CYPRESS AT YOUR LOCAL DEALER'S. IF HE HASN'T IT, LET US KNOW IMMEDIATELY.

Popular Mechanics Magazine

318 W. Washington Street, Chicago, U. S. A.

EDITED BY H. H. WINDSOR

ISSUED MONTHLY

SUBSCRIPTION:

SINGLE COPY, 15 CENTS

In United States, and its possessions, Cuba and Mexico, per year, postpaid - - - - \$1.50
To Canada - - - - - 1.75
To all other countries in the Postal Union - - - - - 2.50

All subscriptions are discontinued at expiration. Please examine the date printed on your wrapper.

Entered as Second Class Matter Sept. 15, 1903, at the Postoffice at Chicago, Illinois, under Act of March 3rd, 1879.

Published monthly by POPULAR MECHANICS CO.

Copyrighted 1913, by H. H. WINDSOR.

The attention of prospective advertisers is called to the policy of this magazine in accordance with which the publisher waives all claim for payment of any advertisement appearing in any issue where the number of copies actually printed and circulated is less than the number printed on the front cover page.

Contents for November, 1913

| | | | |
|---|-----|---|-----|
| Towing a Subway Tunnel on Harlem River..... | 617 | Lottery Machine for Retiring Bonds..... | 659 |
| The New Boston Customhouse..... | 618 | Circular Barn and Silo Combined..... | 660 |
| "Hockey-Mo," the New Motorcycle Sport..... | 619 | Weather Forecasts from Study of Sun..... | 660 |
| Coal Pockets under the Panama Canal..... | 619 | Landing Field Guns from a Battleship..... | 660 |
| The Hell Gate Steel Arch Bridge..... | 620 | Handy Picking Bag for Fruit Growers..... | 662 |
| Memorial to the Pilgrims Unveiled..... | 622 | New Lineman's Torch for Soldering Joints..... | 662 |
| Hardening Soft Fats with Hydrogen..... | 622 | Photograph Made from Flying Boat..... | 663 |
| "Shooting Up" the Movies..... | 623 | Motor Handcar Supplies Branch-Line Service..... | 663 |
| By Wendell Phillips Dodge | | Symbolical Statuary of Panama-Pacific Exposition..... | 664 |
| New Long-Flight Record Established..... | 624 | Circular Saw to Trim Car Roofs..... | 666 |
| Automobile Wheel with Spring Spokes..... | 626 | New Sixteen-Inch Gun Tested..... | 666 |
| Large Stadium Built in a Month..... | 626 | Mooring Aeroplanes on a Cable..... | 666 |
| A Searchlight to Attract Flying Fish..... | 627 | An Electric Truck for Hauling Poles..... | 667 |
| Paper Model of Gasoline Engine..... | 627 | Machines for Counting Coins..... | 668 |
| Hitching England to Europe..... | 628 | New Wireless Station Has 3,000-Mile Radius..... | 668 |
| By Joseph E. Murphy | | New Statue Is Largest in the World..... | 668 |
| Portable Dining Room for Automobilists..... | 632 | Topiary Gardening being Introduced in America..... | 670 |
| New Explosive Stronger Than Dynamite..... | 633 | By L. William Thavis | |
| Burning Cubes of Solid Alcohol..... | 633 | Lookout Tower of Novel Construction..... | 672 |
| Concrete Sidewalk Made into Fence..... | 633 | Hitching an Automobile to a Plow..... | 672 |
| Statue of a King Carved in Granite..... | 634 | Army Aviation Service to be Developed..... | 673 |
| Airman Flies Safely Upside Down..... | 634 | Reclining Chair That Is Automatic..... | 673 |
| The Long-Tailed Roosters of Japan..... | 636 | Windmill to Withstand Sahara Winds..... | 673 |
| Changing the Composition of Iron..... | 637 | Automobile Transports Nitroglycerin..... | 674 |
| New Trap for Destroying Moths..... | 638 | Whaleback Climbs Ashore on River Bank..... | 674 |
| Ball Game and Canoe Race on Same Grounds..... | 638 | Latest Type of Crane for Heavy Service..... | 675 |
| Comment and Review..... | 639 | Ravages of Hawaiian Book Worm..... | 676 |
| By H. H. Windsor | | Flying Boat Beats Fast Motorboat..... | 676 |
| Palace of Peace at the Hague Dedicated..... | 643 | To Find a Use for the Ailanthus Tree..... | 676 |
| Train Destroyed by Burning Bridge..... | 644 | French Automobile with Skiff Body..... | 677 |
| Airman Flies across the Mediterranean Sea..... | 645 | Flowering Plants Used as Memorials..... | 677 |
| Machinery Hall Last of Its Class..... | 645 | Locomotive in New Haven Wreck..... | 679 |
| Semaphore for Regulating Street Traffic..... | 645 | Desert Roadway for Motor-Truck Service..... | 679 |
| Lincoln Highway Follows Historic Trails..... | 646 | The Woman Who Keeps the Bees..... | 679 |
| Sidecar Hood for Stormy Weather..... | 647 | Signs to Give the Rules of the Road..... | 680 |
| A Wooden Water Tank That Burst..... | 648 | Airman Fails in Flight around Britain..... | 680 |
| Oakland's New Prison Is Up in the Air..... | 648 | Ribbon-Inking Machine for the Office..... | 680 |
| Corn Stalk as Tall as Three Men..... | 650 | Aerial Cable to Carry Milk Cans..... | 681 |
| The First Oil-Burning Superdreadnought..... | 650 | Apparatus for Detecting Defects in Glass..... | 681 |
| Bird Caught in a Piece of Bread..... | 650 | Largest Searchlight in Europe..... | 682 |
| Russian Biplane Largest Ever Made..... | 650 | The Goldschmidt Wireless Apparatus..... | 682 |
| Announces X-Rays Are Rays of Light..... | 651 | Motor Sled That Travels at Great Speed..... | 683 |
| Keeping a Statue Clean with a Hose..... | 652 | Funeral of a Japanese Airman..... | 683 |
| Elevator Service in the New Skyscrapers..... | 652 | Stereoscope for Piano Students..... | 684 |
| Automobile Climbs Open Bascule Bridge..... | 653 | Round-the-World Tickets Now Sold Cheaply..... | 684 |
| Sliding Bed for Outdoor Sleeping..... | 653 | Device for Loading Coal Trucks..... | 684 |
| Accident to Largest German Dirigible..... | 654 | Lives Lost in Wreck of German Dirigible..... | 685 |
| Big Wireless Station at Honolulu..... | 655 | Steam Shovel Converted into Pile Driver..... | 685 |
| Extension Baggage Trucks Carried on Shoulder..... | 655 | New Fast Mail Exchange System..... | 686 |
| Monster Horse a Feature of Denver Street..... | 655 | Explosion Forms Cavity for Pile Base..... | 686 |
| Lens for Railway Signal Throws Wide Beam..... | 655 | Electric Propulsion for Fire Engine..... | 688 |
| Tuberculosis Treated with Ultraviolet Rays..... | 656 | Storage-Battery Cars on German Railways..... | 688 |
| Use of Aluminum Foil Increasing..... | 657 | Overflow Dam to Prevent Escape of Fish..... | 688 |
| Monument to Fire Heroes of New York City..... | 657 | New Device for Hoisting Building Material..... | 689 |
| Sewing Chair with Hidden Drawer..... | 658 | Novel Intake for Water-Supply Main..... | 690 |
| Diminutive Engine Marvel of Workmanship..... | 658 | The Skyscraper of the Future..... | 690 |

[Continued on Page 6]

Popular Mechanics offers no premiums; does not join in "clubbing offers," and employs no solicitors to secure subscriptions. It is for sale by nearly every newsdealer in the United States and Canada.

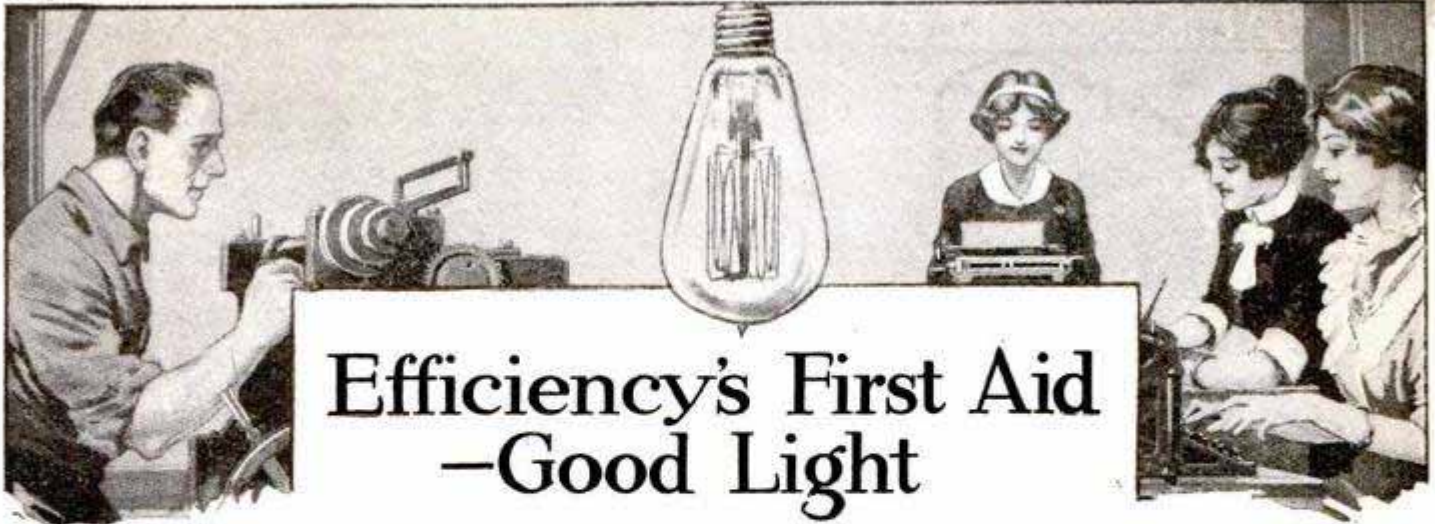

Efficiency's First Aid —Good Light

"You're working in the dark!" said a Western plant manager to his friend who had asked him to visit the latter's publishing offices in an Eastern Ohio town.

"How do you make that out?" asked the publishing man with a little astonishment. "We've had electricity here for five years."

"That may be," said the Western man. "And I don't mean that you can't see your hand before your face. But you haven't really emerged from the dark age. Honest, have you changed your lighting arrangements in those five years?"

The publishing man admitted that he hadn't.

"I thought so," said his frank visitor. "They were pretty poor to begin with, and they're entirely out of date. They're out of date because we're living in an age of really good light. More than half of your floor space is gloomy, partly because you use old-fashioned lamps—the Edison Mazda gives three times as much light with the same amount of electricity that is used in these ordinary carbon lamps—and partly because they are not placed to advantage. You're handicapping yourself and your entire force. You're putting a check on your office efficiency, which is bad business and you're wasting money on old methods which is bad business again. Good light is a big factor—it's efficiency's first aid. It would be worth all it costs even if it cost a lot of money. And yet it's cheaper than ever it was—been going down in price while the cost of everything else has been going up."

The result of this plain talk was that the publishing man got into communication with the local lighting company next day, and found himself keenly interested in the plans laid out by the electrical engineer who called to see him. Seven months later when he saw his friend again he declared: "You put it bluntly about my lighting, but you saved me money. My system now costs me no more, and you wouldn't know the place as it is now. It has put snap into all our work—I think we turn out fully thirty per cent. more

than we did, and we do it with fully fifty per cent. more comfort. I'm a light enthusiast from now on."

This incident reflects an experience in a certain type of business, but there is no sort of business to which the outspoken philosophy that stirred this particular manager might not apply with equal force. For manufacturer and merchant, banker, broker or business man anywhere, good light is a basic business factor.

Good light is good business. It brings people into a store, for example, and helps sell goods to those people. It helps the display of goods, and it affects not only customers but the selling force.

It affects equally the brain output and the physical output of every sort of business. It raises the percentage of sheer efficiency in every unit of a force, whether it is a small office force of a dozen or a large force of a thousand. That percentage of increase in efficiency would be considered highly important in a group of machines. It is even more so in a group of men or women.

Perhaps you have realized this fact in your business without guessing exactly how the thing might be worked out to meet your special needs and opportunities. It is possible that you have not ascertained the cheapness and facility of modern wiring—that you may not know of the growing cheapness of electric light itself.

These are matters which an electrical engineer knows, and can lay before you.

The electrical expert will tell you about the Edison Mazda lamp. He will show you the comfort—for you personally and for your force—and—he will show you the real economy that lies in modern ways of lighting.

Take up the matter today with your electric power and light company, or any General Electric Company agent in your vicinity. You will find them more than glad to co-operate with you, and no matter how complex your problem may be, they have at their command the service of any part of our organization that may be most helpful to them and to you.

*The Guarantee
of Excellence on
Goods Electrical*



GENERAL ELECTRIC COMPANY

Atlanta, Ga.
Baltimore, Md.
Birmingham, Ala.
Boise, Idaho
Boston, Mass.
Buffalo, N. Y.
Butte, Mont.
Charleston, W. Va.
Charlotte, N. C.
Chattanooga, Tenn.

Chicago, Ill.
Cincinnati, Ohio
Cleveland, Ohio
Columbus, Ohio
Davenport, Iowa
Dayton, Ohio
Denver, Colo. (Office of Art.)
Detroit, Mich.
Elmira, N. Y.
Erie, Pa.

Largest Electrical Manufacturer in the World

Hartford, Conn.
Indianapolis, Ind.
Jacksonville, Fla.
Joplin, Mo.
Kansas City, Mo.
Keokuk, Iowa
Knoxville, Tenn.
Los Angeles, Cal.

Louisville, Ky.
Madison, Wis.
Mattoon, Ill.
Memphis, Tenn.
Milwaukee, Wis.
Minneapolis, Minn.
Nashville, Tenn.
New Haven, Conn.

New Orleans, La.
New York, N. Y.
Omaha, Neb.
Philadelphia, Pa.
Pittsburg, Pa.
Portland, Ore.
Providence, R. I.
Richmond, Va.
Rochester, N. Y.
Salt Lake City, Utah

San Francisco, Cal.
St. Louis, Mo.
Schenectady, N. Y.
Seattle, Wash.
Spokane, Wash.
Springfield, Mass.
Syracuse, N. Y.
Toledo, Ohio
Washington, D. C.
Youngstown, Ohio

For Texas, Oklahoma and Arizona business refer to Southwest General Electric Co., (formerly Hobson Electric Co.)—Dallas, El Paso, Houston and Oklahoma City
For Canadian business refer to Canadian General Electric Company, Ltd., Toronto, Ont.

LEARN THE AUTOMOBILE TRADE

Be an Auto Mechanician

Do work at homes of auto owners or if you prefer drive a car, tester or salesman. We will teach you and show you how to start.



NOW RUNNING A GARAGE WAS A CONTRACTOR



NOW AN AUTO MECHANICIAN DOING WORK AT HOMES OF AUTO OWNERS WAS A CLERK (BERT TIPPEY)

Everyone in the business is making money and every year it grows four times. **DON'T DELAY—START NOW.**

YOU DON'T HAVE TO BE A MECHANIC—It's in knowing the principle and construction and how to diagnose troubles and adjust—**knowing how**—that's the key note.

NEW ADDITION TO OUR FAMILY OF MODELS

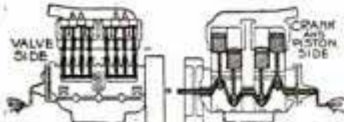

4 CYLINDER ENGINE MODEL

IT WORKS. ALL MOVING PARTS REAL METAL. OTHER MODELS ARE: MAGNETO, CARBURETOR, CLUTCH, GEAR BOX, DIFFERENTIAL.

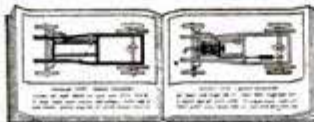

THE PROGRESSIVE CHART

OF THE MANIKIN, SHOWING HOW THE CAR IS ASSEMBLED FROM THE GROUND UP

It's easy to learn—easier than working in a shop—**YOU LEARN THROUGH THE EYE** and see the **INSIDE** operation and get actual practice on the **REAL Working Models**. A boy twelve years old can learn—**IF OTHERS CAN—YOU CAN.**

LET US
DESCRIPTION OF
DYKE'S
NEW IDEA
WORKING MODEL
SYSTEM
ONE OF
THE
BEST
WORK
TEACHING BY MAIL

TESTIMONIALS
PROOFS SAMPLE
PAGES, CHARTS
OPPORTUNITIES
MOTOR BUSINESS

SHOW YOU
EMPLOYMENT
A NEW PLAN
HOW WE START YOU

FREE

SEND FOR THEM

MANY SAY THEY LEARN A LOT FROM THE 32-PAGE, FULLY ILLUSTRATED BOOKLETS ALONE

We Will Show You— how we can teach **YOU**, how we have taught **hundreds** of others— how we can start **YOU** to making money even before you complete Course— how we have started **hundreds** of others who *knew no more than you do right now*—

We Will Further Show You— endorsements of the *leading motor authorities of the world*, men who could not afford to endorse this system if it was not absolutely satisfactory in every respect.

YOU DEAL WITH A RELIABLE FIRM

Mr. Dyke has been identified as a pioneer inventor, supply man, etc., with the auto industry since the beginning. He originated the first auto supply company and published the first book on autos in America. No other man with such experience is today teaching others. And all the experience and inside information of the auto business he has thus gained, is embodied in this Course and Employment Plan.

On Trial—You are allowed a trial examination of the Course—If it isn't perfectly satisfactory you can return it within two days and get your money back. The Course is all sent to you at one time.

SPECIAL PRICE—Right Now—
Complete Course—only . . . **\$15.00**

WRITE



DYKE'S CORRESPONDENCE SCHOOL OF MOTORING,
Box 188, Roe Bldg., ST. LOUIS, MO.
NOTE—Beware of Imitators—Deal with the Originator

CASH PRIZES

FOR

Our Young Readers

The following cash prizes will be paid for the 20 best original articles suitable for publication in the Amateur Mechanics Department of Popular Mechanics Magazine.

| | |
|----------------------------------|------|
| First Cash Prize | \$35 |
| Second Cash Prize | 25 |
| Third Cash Prize | 20 |
| Fourth Cash Prize | 15 |
| Fifth Cash Prize | 10 |
| Sixth Cash Prize | 10 |
| Seventh Cash Prize | 10 |
| Eighth Cash Prize | 10 |
| Ninth Cash Prize | 10 |
| Tenth Cash Prize | 5 |
| Eleventh Cash Prize | 5 |
| Twelfth Cash Prize | 5 |
| Thirteenth Cash Prize | 5 |
| Fourteenth Cash Prize | 5 |
| Fifteenth Cash Prize | 5 |
| Sixteenth Cash Prize | 5 |
| Seventeenth Cash Prize | 5 |
| Eighteenth Cash Prize | 5 |
| Nineteenth Cash Prize | 5 |
| Twentieth Cash Prize | 5 |

Contest Closes December 10, 1913

To be available, the descriptive articles must be new, original and suitable for publication in the Amateur Mechanics Department. Where necessary to a better understanding by our readers, photographs, plans, or pencil sketches should accompany the manuscript. We do not want mere descriptions of things that have been done, unless they are such as young people generally would be likely to make and that can be built with ordinary tools and materials.

Contributors may submit as many articles as desired, but no one will be awarded more than one prize.

Articles failing to win one of the prizes, but suitable for publication, will be promptly paid for at usual rates; all others will be returned.

On December 15th, 1913, the articles will be judged and the prize money sent at once. Publication of the names of the winners will follow in the February, 1914, issue.

Mark your article "For Prize Contest Amateur Mechanics Dept.," and mail to Editor

Popular Mechanics Magazine
318 W. Washington St., Chicago

"The Chaldean Story of the Flood"

**Dug Up From the Ruins
of Ancient Chaldea**

DO YOU KNOW that there has been dug up from the ruins of old Chaldea a complete story of the Flood—the same in every detail as Moses' account in Genesis—and that it was written thousands of years before his version appeared? Hardly one in a million has ever had an opportunity of seeing this startling story—**HAVE YOU?** But it is one of the many thousand curiously interesting accounts in

The Library of Original Sources

Canadian Orders Shipped from Toronto

now for the first time available to the general public. Up to the present this remarkable Library has only been sold by subscription, but by taking over the *entire unsold edition* from the publishers we secured it at an *absolutely unheard of reduction*. Therefore we can offer the few remaining sets to POPULAR MECHANICS readers at an

EXTRAORDINARY BARGAIN

Send us the attached coupon **AT ONCE**, and we will tell you how to get the Library on **EASY MONTHLY PAYMENTS**, and mail you **FREE** a book of rare documents. Remember there are only a limited number of sets, so act quickly. Mail the coupon **NOW**. You assume no obligation. No salesman will call. The book is **FREE**.

THIS MARVELOUS WORK is revolutionizing modern thought. It's turning upside down old notions and ideas. It gives the authoritative, rock-bottom sources of our knowledge on **ALL SUBJECTS OF HUMAN INTEREST** from the earliest civilization down to to-day—the inside facts which the average person has never even heard of.

OVER 100 RESEARCH SPECIALISTS spent 10 years gathering the contents of this great work. Ancient and remote and forgotten civilizations in all parts of the globe were uncovered, and age-buried hieroglyphics on monuments, tablets, sun-baked bricks and palimpsests yielded their secrets; untiring workers ransacked the hidden literature of every age, ancient, mediæval and modern, to find the "original documents" that shaped the civilizations and influenced the thought and life of the world. Nothing like it has ever been attempted or thought of before. You'll be amazed at the wealth of information this unique library contains.

DO YOU KNOW that the old Egyptians, 5000 years B. C., had a Bible which they called the "Book of the Dead"?—Do you know that the Assyrian sacred literature gives the story of the Creation?—Do you know that books and newspapers were printed in Asia thousands of years before printing was invented by Gutenberg?—Did YOU ever read Columbus' personal log of his great voyage—filled with strange happenings and ominous forebodings?—Do you know that there occurred in Mediæval England a great Socialistic protest—the first of its kind ever known?—Do you know by what unique process Harvey demonstrated that the blood does not stand still in the veins, as everyone then thought?—Do you know who Machiavelli was, or what world famous treatise he wrote?

YOU'LL FIND THEM ALL—and thousands of others equally as curious and important—in The Library of Original Sources. Every document is in the exact words of the original, translated; every contribution is from the actual eye-witness or person who took part; every idea is in the words of the thinker, investigator, discoverer or inventor.

JACK LONDON SAYS:—"It is a whole library in itself, I certainly never could spare these books from my shelves."

10 sumptuous, massive volumes, bound in rich, deep red Morocco; full page illustrations, pure silk headbands, printed in large, clear type on hand-made paper, gold tops—a veritable triumph of the bookmaker's art.

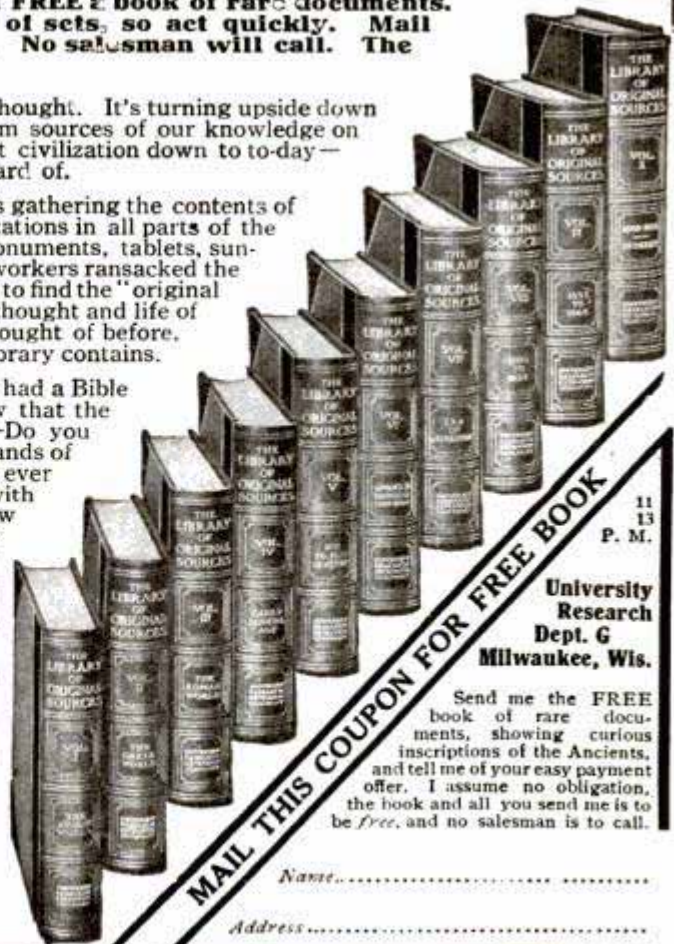

11
13
P. M.

University
Research
Dept. G
Milwaukee, Wis.

Send me the **FREE** book of rare documents, showing curious inscriptions of the Ancients, and tell me of your easy payment offer. I assume no obligation, the book and all you send me is to be free, and no salesman is to call.

Name.....

Address.....

MAIL THIS COUPON FOR FREE BOOK

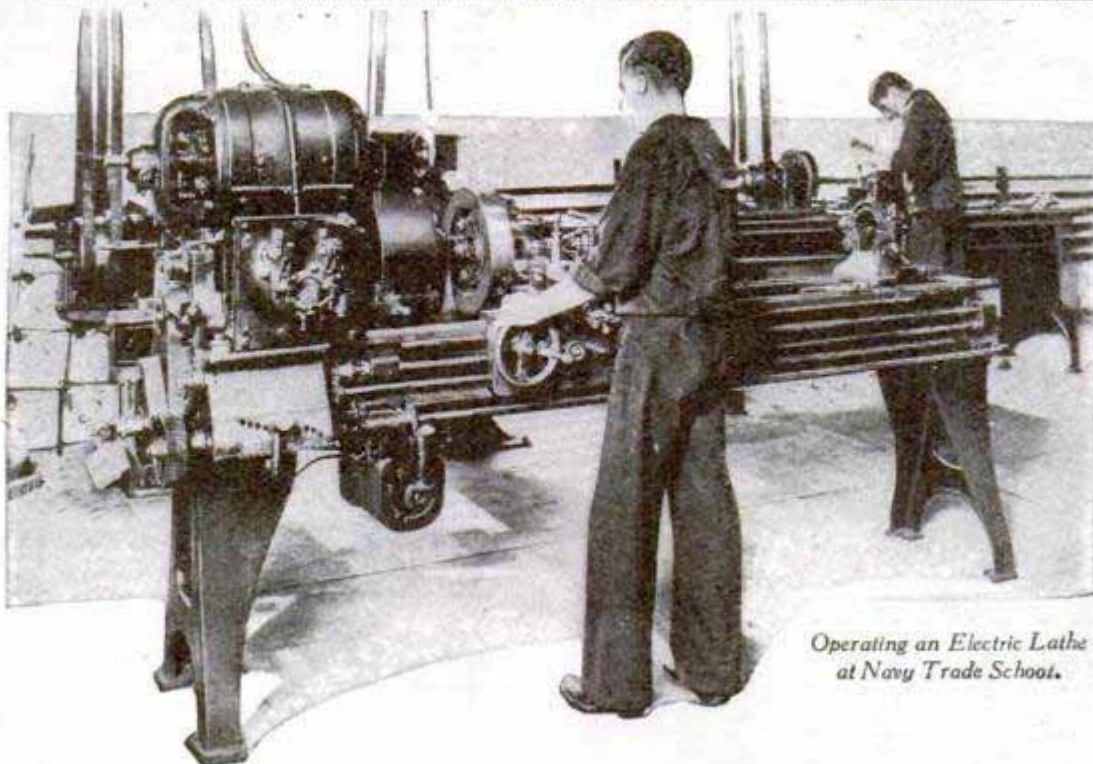

Operating an Electric Lathe
at Navy Trade School.

Put Yourself in Their Place

THESE young men are learning a valuable trade. They are learning it thoroughly, under the best kind of expert instruction. And they are getting *actual* use of it, under practical conditions.

They are *getting paid* while learning—and paid *well*. They will be advanced in pay and responsibility as fast as they become proficient. And their trade will bring them good pay in later life, wherever they practice it.

Furthermore—these young men have practically all their living expenses free. They eat the best of food. Sleep in good beds. Live a healthy, open-air life. And have the steady companionship of clean ambitious young men.

They have a chance to travel—without expense—and to learn much by seeing other parts of the world.

And they have the incentive to *save money*.

Put yourself in their place and you will know what advantages a man has in the mechanical branches of the

UNITED STATES NAVY

Below is a list of a few of the high-wage trades practiced and taught in the Navy. If over 17, ambitious, and self-respecting, and interested in any of these trades—investigate. Call at Navy Recruiting Station near you, for full information. Get the address from the Want Columns of your Sunday paper.

Or, if at a distance, send us a postal for free illustrated booklet, "The Making of a Man-o'-Warsman." Tells everything you want to know about daily life in the Navy. Write today.

BUREAU OF NAVIGATION, BOX 69, NAVY DEPT., WASHINGTON, D. C.

A Few of the Navy's Different Trades

Electrician
Machinist

Carpenter
Blacksmith

Cook
Clerk

Fireman
Shipfitter

Besides Many Other Trades and Special Pursuits

\$1

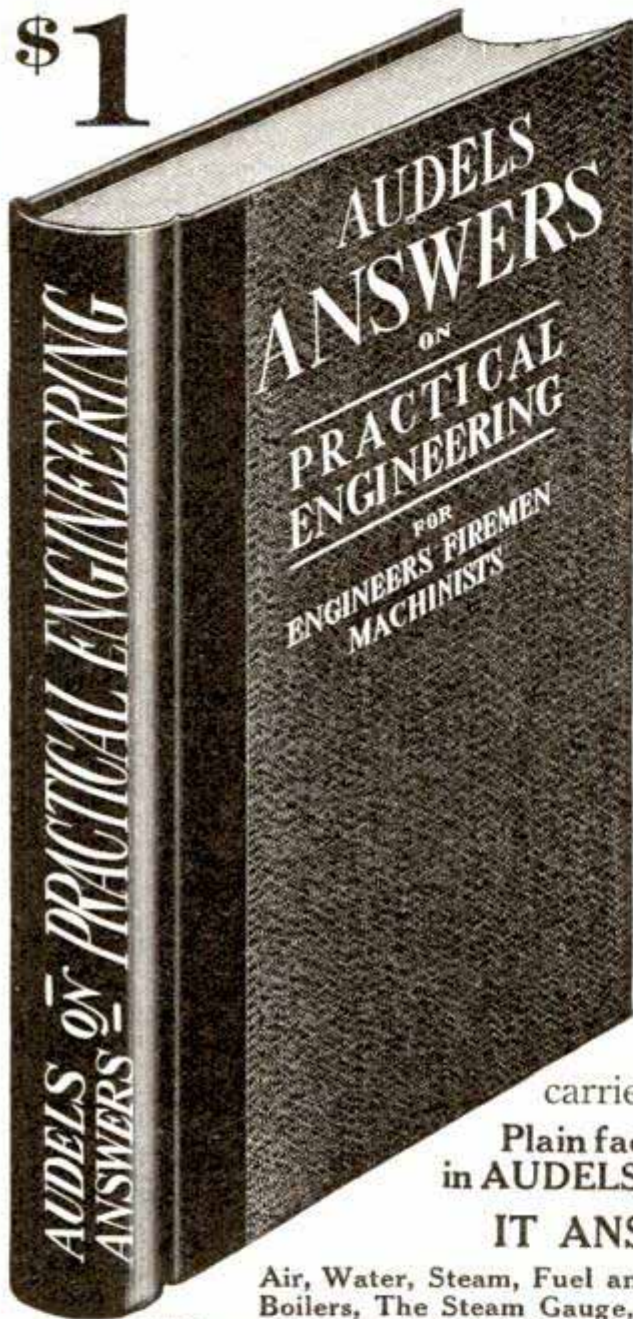

ENGINEERS

This Book Will Help You

Audels Answers on Practical Engineering

When you spend your good hard earned money for books, always make sure that you are going to receive something that will assist you in bettering your position

THIS book deals largely with the foundation principles which govern the practice of steam engineering. Nothing so soon condemns the applicant as want of knowledge of the every day practice and simple laws relating to the care and management of a steam plant.

No one is expected to know everything, but all are required to be familiar with certain facts which may be called "the beginning of things."

The lack of knowledge of the small things carries conviction of the same lack in the larger.

Plain facts, that you should know, are plainly explained in AUDELS ANSWERS ON PRACTICAL ENGINEERING.

IT ANSWERS YOUR QUESTIONS ON

Air, Water, Steam, Fuel and Heat, Steam Boilers, Boiler Construction, Water Tube Boilers, The Steam Gauge, The Safety Valve, Properties of Steam, Installation of Boilers, Management of Boilers, Engineers' Law, Firemen's Law, Steam Engines, The Valve and Valve Gear, The Corliss Engine, Engine Arithmetic, Lubricators, Installation and Operation of Engines, Steam Pumps, Injectors, Feed Water Heaters, Steam Heating, Steam Traps, Belts, Gears and Pulleys, Steam Turbines, Refrigeration, Practical Electricity, Elevators.

Understand the framework of which your work is but a cross bar. Know something of the cause of which your work is but an effect. Know something of the effect of which your work is the cause. And, above all, know why it is done one way and not another.

LEARN THE THEORY UNDERLYING THE WORK. Practical Engineering contains 288 pages fully illustrated, handsomely bound and printed and is in every way a first class book.

Examination Offer

If You Are Interested sign and mail the coupon, and it will bring to your plant a book of sterling merit, for free examination. You can have one week in which to dig out the mine of valuable information contained in its 200 or more pages.

Carry It in Your Pocket for One Week

and at the end of the time, if you do not think the book is worth one dollar, mail it back to us. If it is, you can mail us \$1.00 in payment for your copy. If you fail to consider this liberal offer you are not dealing fairly with yourself. We take all risk that "Audels Answers on Practical Engineering" is a book you should own. Act now before you forget it.

THEO. AUDEL & CO., 72 5th Ave., NEW YORK

Please send me for examination one copy
Audels Answers on Practical Engineering \$1

If I keep the book, I promise to send you within 7 days after receiving it ONE DOLLAR, in full payment; if I do not keep it, I will mail it back to you within 7 days.

Signature.....
 Occupation.....
 Address..... P.M. Nov. '13

THE IDEAL CHRISTMAS GIFT

For Every Wide-Awake Boy

700
THINGS
FOR BOYS
TO DO



480 PAGES
700 ARTICLES
800 PICTURES
PRICE \$1.50

The Boy Mechanic

A book that describes how to make all the things every boy likes to build or experiment with.

The Most Interesting Boys' Book

Unlike so many other books of a somewhat similar nature, it is not confined to only one or a few subjects but describes 700 different things boys can make and do in the fields of mechanics, electricity, sports, arts and crafts work, magic, etc. It is an unusually generous book; size 7 by 10 in. and 1½ in. thick; printed from large, clear type on high grade book paper and durably bound in cloth. Attractive four-color cover design.

Wholesome, Practical, Instructive

Besides telling how to make scores of things useful about the house, full and complete directions are given for constructing the following and hundreds of other things which appeal to the heart of every boy:

Many Electrical Appliances—Steam and Gas Engines—Turbines—Motors—Wireless and Morse Telegraph—Self-Propelled Vehicles—Toboggans—Ice-Boats—Canoes—Paddle Boats—Punts—Camping Outfits—Tents—Fishing Tackle—Magic Lanterns—Searchlights—Cameras—Telescopes—Gliders, Kites and Balloons—Electric Furnaces—Lathes—Pottery Kilns, etc.

Sent fully prepaid to any address upon receipt of the price

POPULAR MECHANICS BOOK DEPARTMENT

318 W. Washington Street, CHICAGO

"A Real Pleasure to Use it!"—
the new India-Paper Edition of

WEBSTER'S NEW INTERNATIONAL DICTIONARY

Only half as thick, only half as heavy as the

Regular Edition. Printed on expensive, thin, strong, opaque, imported India Paper. Excellent printing surface. Clear impression of type and illustrations. So light, so convenient, that you will use it at every opportunity. Size, $12\frac{3}{8} \times 9\frac{3}{4} \times 2\frac{1}{2}$ inches. Weight, only 7 lbs.

Regular Edition. Printed on strong book paper of the highest quality. Size $12\frac{3}{8} \times 9\frac{3}{4} \times 5$ inches. Weight 14 $\frac{3}{4}$ lbs. Both Editions are from the same plates and have the index.

More than 400,000 Vocabulary Terms.

12,000 Biographical Entries.

Nearly 30,000 Geographical Subjects.

Thousands of other References.

Over 6000 Illustrations. 2700 Pages.

Colored Plates and Half-Tone Engravings.

The only dictionary with the *new divided page*, "A Stroke of Genius."

Keep abreast of the times. To *Know* means to win *Success*. Let us tell you more about the New International—

The Merriam Webster



India-Paper
Edition

This *New Creation* is far more than a dictionary, being equivalent in type matter to a 15-volume encyclopedia. It answers with final authority *all* kinds of questions in language, history, geography, biography, trades, arts, and sciences, sports, foreign phrases, abbreviations, etc. *Get the Best.* Supreme Court Judges concur in its favor. The Government Printing Office at Washington uses it as the authority. These statements can be made of no other dictionary.

WRITE for specimen pages, illustrations, etc. FREE set of pocket maps if you name this magazine.

G. & C. MERRIAM COMPANY, SPRINGFIELD, MASS., U. S. A.

For over 70 years publishers of the Genuine Webster Dictionaries.

Per Advt. in Popular Mechanics

Send sample pages, maps, etc.

Name.....

Address.....

Mathematics Made Easy

FOR ALL, BY

ROPP'S CALCULATOR

Shows the Answer as quickly as a Watch shows the Time, to all practical Examples likely to occur in the Office, Store, Shop, Bank, Farm or Factory. Over 20 sections—each adapted to some special line of business.

Elucidates and *simplifies* the science of Arithmetic, Mechanics and Mensuration.

Greatest Time and Labor-saving work on *Figures* ever used in the commercial world.

Desk size, \$1.25; Pocket, leather, \$1.00; Pocket, imitation leather, 50c; Vest-pocket, 50c. New 1912 copyright edition.

POPULAR MECHANICS BOOK DEPT.

318 W. Washington St., CHICAGO

No Better Christmas Present for \$1.50

than a year's subscription to

Popular Mechanics Magazine

containing nearly 4000 illustrations
and 2000 pages of reading matter.

Much of it Interests Everybody.

Most of it Interests Anybody.

All of it Interests Somebody.

Order through your newsdealer or address the
publishers, POPULAR MECHANICS, CHICAGO

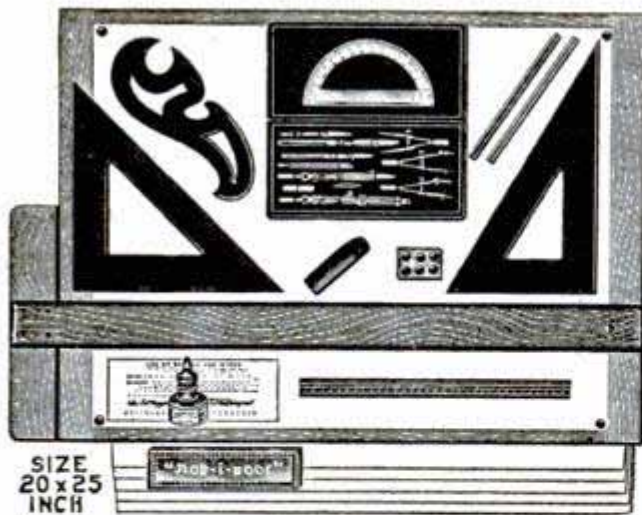

SIZE
20 x 25
INCH

FREE

This \$15 Draftsman's Outfit

But you must write at once. This offer is limited. I make this most exceptional great offer only to a limited number of selected students.—Just think of it! A complete, regular Draftsman's \$15 Working Outfit with high grade Imported German Silver Set of **INSTRUMENTS—ALL FREE**

You Can Earn While Learning

Yes, that's exactly what I mean. As soon as you become my student you can begin earning a handsome income while learning at home. Send the free coupon to me today and I will tell you just exactly how you can begin. I mean just what I say. This is a great extra special offer I am making. You should write at once. Absolutely no obligations of any kind in sending the coupon. But you must write at once. I cannot make this offer broadcast to everyone. So I will take the names in the order that they are received. Get yours in early.

Be a Draftsman!

Draw \$125 to \$175 per month at once

There is an urgent demand always for skilled draftsmen. Big companies are issuing calls every day for men to fill positions paying from \$125.00 to \$175.00 per month. Many positions paying Big Money always open. Work is light, pleasant and profitable. Unlimited opportunities for expert draftsmen and designers. Mail coupon for valuable book, "Successful Drafting." It explains how you can become a skilled draftsman in a short time. It's free—Just think :



Chief Draftsman Will instruct you personally

A most wonderful opportunity for a limited and selected number of ambitious men! For over twenty years I have been doing the highest paying expert drafting work. I am Chief Draftsman of a large and well known company. Long ago I saw the urgent demand for practical, trained draftsmen and I organized my practical method for ambitious men whom I trained personally. Each month the demand for

I Guarantee

To instruct you until competent and in a position at a regular salary, paying from \$125.00 to \$175.00 per month and furnish you free \$15 Working Outfit at once.

practical, trained draftsmen is growing—higher salaries are being paid right along. Never before have we felt the need as we do today for men who really know practical drafting—the way I am training my students. At this time I can accommodate a few more men (from the ages of 16 to 40) in my spare time. If you write me at once I will send you my book, "Successful Drafting," with full particulars—all free. But you must write to me—or send coupon now.

FREE Outfit Coupon

Chief Draftsman:
ENGINEER'S EQUIPMENT CO.
Div. 1198 CHICAGO, ILL.

Without any obligation to me, please mail your book "Successful Draftsmanship" and full particulars of your liberal "Personal Instruction" offer to a few students. It is understood that I am obligated in no way whatever.

Mail Free Coupon Now

Mail this Free Coupon at once and I will send you my book "Successful Draftsmanship" and full particulars—all FREE.

I will send my book if you write at once, absolutely free—also particulars about my offer to a few ambitious men who want to make from \$2,500 to \$5,000 a year. No obligations whatever on you in sending the coupon.

NAME

ADDRESS

Address **CHIEF DRAFTSMAN**
Div. 1198, Engineer's Equipment Co. (Inc.) CHICAGO, ILL.

CLASSIFIED ADVERTISEMENTS

We have records to prove that a classified ad in these columns will find a buyer for almost anything which can be sold. Doubtless you have some article of value to some one else which you no longer need. Why not turn it into money?

Advertisements in this section, 15 cents per word, each insertion, minimum 10 words, payable in advance. To insure ads being inserted under proper classified head in the December issue, copy must reach this office not later than November 1st.

South Boston, Mass.

Popular Mechanics Magazine, Chicago, Ill.

Gentlemen: It affords us great pleasure to inform you that our small 23-word ad in the Classified Columns of the April issue of your Magazine has brought us 127 replies, and they are still coming in. We consider this a remarkable result from such a small and inexpensive ad. The orders received through following up these inquiries prove that your valued Magazine is read by a good class of people that appreciate a good business proposition. We are composing an ad for your next issue which will be forwarded in the course of a few days. Wishing Popular Mechanics Magazine the success that it so richly deserves, we are,
Very truly yours,
THE A. R. KAY COMPANY.

AUTOMOBILES

A WRITTEN guarantee for 5,000 miles without puncture. French and German motorists are getting 10,000 miles out of their tires by increasing them about one-half inch in their size. In eight months 20,000 American motorists have followed their example. It's so easy you can do it in your own garage in thirty minutes, no matter what condition your tires are in. Send for free catalogue, sample and copy of guarantee. Colorado Tire and Leather Co., 1112 Karpen Bldg., Chicago, Ill., 451 Golden Gate Ave., San Francisco, Cal., 1326 Acoma St., Denver, Colo.

AUTOMOBILE Instruction—\$55.25. Four weeks' course. Best equipped school in the country. Men enrolled from all parts of the U. S. Booklet P. M. on request. West Side Y. M. C. A., 318 West 57th Street, New York.

PAINT Your Car Yourself.—Save \$25 to \$75 by doing the work at home with the Arsenal system. Our big free booklet "The Car Beautiful" tells how. Send for it today. Arsenal Varnish Co., Dept. P, Rock Island, Ill.

FOR Sale—30 h. p. Mitchell Runabout with double rumble seat, in first-class working order; will sell for \$300 cash. Inquire Ward Hdw. Co., Glenwood City, Wis.

A 1911 SIX cylinder, seven passenger Lozier, with an extra limousine body; price, \$1,560. Youngs & Co., Inc., Newburgh, N. Y.

NATIONAL Electric Runabout, in whole or part. Also Electric Drill, Hathorn Auto Co., Mason City, Iowa.

REBUILT and repainted pleasure and commercial automobiles, prices from \$100 to \$150. Eureka Auto Co., Beavertown, Pa.

COLUMBIA Seven forty-five, \$475. Franklin four-cylinder roadster, \$140. Sharpe & Co., Joliet, Ill.

FOR Sale—Stanley Steamer, splendid condition, seats two. Ofeldt Boiler, \$300. Lucas & Son, Bridgeport, Conn.

HUDSON, Buick, Overland, Ford and others \$100 up. Also tires, bodies, engines. United Motor Sales Co., Dept. 101, Detroit, Mich.

WORLD'S best self-educational books. Automobile driving, repairing, construction, engines, ignition, etc. Catalogues free. Explain subject fully. C. Higene Co., 2441 Post Street, San Francisco.

FREE information on automobile and accessory buying, new or rebuilt. Folder: "Foresight in Buying," free. Professional Information Ass'n., Hartford, Conn.

FOR Sale—Light 6-cylinder racing car, just overhauled; 2 extra demountable rims and tires. Will make 75 miles per hour. 834 E. 43d St., Chicago.

REGROUNDING the cylinders, and fitting new pistons and rings, will make your motor as quiet and powerful as it was when new. The cost is moderate. Advise bore diameter if desire quotation. We also expertly weld broken parts. Send for booklet. Waterbury Welding Corporation, Waterbury, Conn.

THE Last Word in Automobile Literature—New Book, "The Modern Gasoline Automobile," 700 (6x9 in.) pages, 500 illustrations, is superior to any treatise heretofore published. Deals with every modern improvement. Price, \$2.50 postpaid. Popular Mechanics Book Dept., 318 W. Washington St., Chicago.

FREE. Catalogue. Automobile Books. Nelson Book Co., Barton, Vt.

NEARLY new 6 cylinder Chalmers roadster; snap at \$1,750; complete with all equipment. Fred W. Wolf, 243 Railway Exchange, Chicago.

AUTOMOBILE model. Every part shown and named. You can to all intents and purposes take off the wheels, raise the hood and remove the body, exposing to view the vital parts. The only practical method of studying the automobile. Price, 50 cents postpaid. Popular Mechanics Book Dept., Chicago.

AUTOMOBILE Instruction. A complete home study course that shows you exactly what you want to know about the automobile. 220 page book giving definite, thorough, authentic and practical detailed information about every part of the automobile as well as thorough instruction in regard to driving, repairing and general care of the complete car. 190 illustrations, \$1.50 postpaid. Popular Mechanics Book Dept., 318 W. Washington St., Chicago.

"THE How and Why of the Automobile"—A 200-page book of practical information for seekers after the fundamental facts regarding the gasoline engine and its application to the motor car. Interesting and instructive to both the beginner and the expert. Bound in full cloth—250 illustrations. Price, \$1 postpaid. Popular Mechanics Book Dept., Chicago.

AUTOMOBILE SUPPLIES

COMPLETE "Vulcan Process" of oxy-acetylene welding plants from \$175 for the blacksmith and garage plant up to largest made. Torch light weight. No backfiring in ordinary work. Write today for our booklet on welding. Vulcan Process Co., 25th and University Ave. S. E., Minneapolis, Minn.

ELECTRIC Lights for Ford Cars self-contained system, including rectifier and battery. Storage batteries and all sizes rectifiers to charge from alternating current. American Battery Co., 1129 Fulton St., Chicago.

SILVERING Polish \$1; electro plating outfit, nickels lamps without removing, \$2; new principle warning signals, \$4. Buell Auto Company, Chicago.

TIRES, Tires. I will sell you good wrapped tread clincher tires cheaper than any one in the United States. New 1913 stock, 34x4 case, \$14, all other prices accordingly. Write for prices. D. Ogden, Columbus, Ind.

ONE Dollar paints hood and fenders like new—single coat does work. Send for can Lustrine, our wonderful new paint. Dries over night. Specify color. Guaranteed. Agents wanted. Specialty Sales Company, Box 26, Indianapolis, Ind.

FOR Sale—New 4-cylinder automobile engines, electric generators, magnetos, windshields and bodies at less than cost. Closing out sale of manufacturers' overstock. Address, Box 1182, Springfield, Mass.

FOR Sale—Ford Automobile Chasses. Model 8, 20 hp. engine, 2 new tires, other tires good condition; seat tank, etc.; a bargain for the price. \$68.00. Glen Smith, c/o Brown Transfer, St. Joseph, Mo.

BURGLAR alarm attachment for your electric horn, \$5; or complete with Sampson Electric horn, \$15. Anyone can install. Electric Service Co., Dallas, Texas.

CYLINDERS reground and fitted with new pistons and rings for \$7 to \$11 per cylinder. The Crown Machine Shop, Crown Point, Ind.

IGNITION and Lighting Specialties. Fellets Magneto Exchange, 1463 Michigan Avenue, Chicago, Ill.

GASOLINE Engine Trouble Chart—a sectional view showing clearly all parts of a typical four-cylinder gasoline engine of the four-cycle type and outlining distinctly all parts liable to give trouble. Also details the derangements apt to interfere with smooth engine operation. Invaluable to motorists. Size, 25x38 inches. Mailed on receipt of 25 cents by Popular Mechanics Book Dept., 318 W. Washington St., Chicago.

KEROSENE For Automobiles—Our new Model B. uses successfully half and half mixture lowest grades kerosene and gasoline. Satisfaction guaranteed or money refunded. Greatly increased power, very slow speed on high. Starts easy at Zero. Special Agents' prices. Dept. P. M. The Air-Friction Carburetor Co., Dayton, Ohio.

BIG money vulcanizing at home. Easy learned. Book 25c. Vanderpool's, Springfield, O.

NEW Pressed Steel Frames, 34x163", each \$10. Automobile boilers bought, sold and repaired. New 3 ton chassis and wheels \$100. Lucas & Son, Bridgeport, Conn.

TIRES. New, Standard Makes. 28x3—\$7.20—Tube, \$2.30; 30x3—\$7.65—\$2.40; 30 x 3 1/2—\$11—\$3.50; 32 x 3 1/2—\$12—\$3.60; 34x4—\$17.25—\$4.75. Other sizes, prices accordingly. Write for complete catalog. 10% with order. Balance C.O.D. Examination allowed. Para Auto Tire Co., 1417 Michigan Ave., Chicago, Ill.

STEAM auto boilers bought, sold and repaired. J. L. Lucas, No. 2 Fox St., Bridgeport, Conn.

MOTORCYCLES, BICYCLES & SUPPLIES

YOUR cylinder rebored and carefully ground with new piston and rings, ground to a perfect fit, not only make your old motorcycle run better than when new, but actually increases your H. P. We do it expertly; regular price complete \$15; our special 30-day offer, only \$10.50. Ship your cylinder and piston to us express or parcel post; prompt service and absolute satisfaction guaranteed. Peerless Motorcycle Co., 32 Bradlee St., Dorchester, Mass.

MOTORCYCLES, everybody rides them. You're next. Second-hand and rebuilt motorcycles, Singles and twins, \$25 to \$100; buy now. Get the lowest fall prices. Save money. Send for catalogue. Denninger Cycle Co., Rochester, N. Y.

N. S. U. TWIN, two speed motorcycle, \$75.00, snap. Heizer Carburetors Model H, new, \$3.50; Battery Coils, \$2.50; Motorcycle grips, 25c; Spark plugs, 25c. W. E. Wandersee Co., 129 Gratiot Ave., Detroit, Mich.

1912 MODEL Indian—4 H. P., guaranteed O. K. Ridden 4,500 miles, experienced rider; Purdy whistle, Simplex Combination Carrier, Prest-o-Lite lamp. Cost \$235, sell for \$150. L. E. Hamersly, Washington, Ind.

1910 V BELT 4-hp. Flying Merkel. Good condition, \$80. Pearl Satterthwaite, 1201 Oak St., Muscatine, Iowa.

EIGHT horsepower twin Harley Davidson. Like new, \$190. Write Wm. L. Blucke, Springfield, Illinois.

1912 HARLEY-Davidson, single, fully equipped. Guaranteed, \$125. L. E. Webster, 15 Wayland St., Dorchester, Mass.

FOR SALE—Twin and Two Speed Indian Motorcycle like new, side car. Fischer Bros., Beardstown, Ill.

FOUR hp. Haverford in perfect condition, used three months, \$75. L. Cornog, Concordville, Pa.

PIERCE four cylinder, \$110 cash. Milton Stewart, Santa Barbara, Calif.

FOR Sale—Brand new 1913 Twin Indian Motorcycle, with lamp, Prest-o-lite, tandem and whistle, \$225. Earl L. Hartman, R. R. 6, Box 8, Freeport, Ill.

MOTORCYCLES Cheap. Big clearance sale of new and second hand machines, ask for list "M" just out. American Motor Co., 2724 Michigan Ave., Chicago, Ill.

FOR Sale—New 1913, 8 hp., Harley-Davidson Twin; never uncrated. \$215. Box 61, Watson, Mo.

FOR Sale—1911 Indian, Tandem, 2-cylinder, magneto, 90 miles, \$175. H. H. Stuessel, 2401 So. Broadway, St. Louis, Mo.

FOR Sale—Two Harleys, Single and Twin. Must sell. Write quick. J. A. Cuthbertson, La Salle, Ill.

1913 POPE Twin, \$195, excellent condition; run only 400 miles; \$30 with order. Banking Loan Trust Co., Jonesboro, N. C.

1912 FLAT Belt, 4 hp., like new. Best offer. V. Winters, Hutsonville, Ill.

NEW Pierce, 4-cylinder two-speed, accessories, perfect condition—\$290. C. Aufmolk, Jr., 49 Wall Street, New York City.

1913 YALE Twin; fully equipped, \$180 cash, will ship C. O. D. Fowler Keith, Washington, Ind.

MOTORCYCLE—Reading 1909 Model. Tires almost new. Good running order; \$50. Want screw-cutting lathe. Karl, 1305 Market, St. Louis, Mo.

BARGAIN—\$115 buys Twin Indian, excellent condition; original shoe on front wheel; must sacrifice. Roy Rinehart, Bound Brook, N. J.

MOTORCYCLES—\$19 down and \$10 monthly for only 7 months, buys a thoroughly rebuilt, M.M. 4½ hp. battery type Motorcycle with brand new tires, fully guaranteed; send for Circular "B" only a limited number on this basis, quick action necessary; first come first served; we reserve the right to return any deposit if received after this lot have cleaned up. Peerless Motorcycle Co., Boston, Mass.

FOR Sale—1913 spring frame Indian, run about 950 miles and in best of condition, will sell for \$165. Glen Smith, c/o Brown Transfer Co., St. Joseph, Mo.

200 MOTORCYCLES. Standard makes guaranteed for season, \$50, \$175. Accessories; heavy carrier, \$3; headlight, \$3.50; Speedometer, \$10; tires, \$5. Chicago Motorcycle Works, 738 Sheridan Rd., Chicago.

FREE—Largest Bicycle and Motorcycle Catalog in the South. Geo. W. Beardsley, Houston, Texas.

MOTORCYCLES at cut prices. We guarantee to save you \$25 to \$50 on your motorcycle. Second-hand and rebuilt motorcycles \$25 to \$100. Indians, Harleys, Kultures, Thors, Excelsors, Mercks, Readings, Hendersons. Buy direct. Save dealers' profits. Send for catalogue. Denninger Cycle Co., Rochester, N. Y.

FOLDING Bicycles, Modern telephones; hands free. Kallajian Mfg., Boston, Mass.

BIG bargains in good motorcycles we have taken in exchange on new ones. Send for special bargain list. Shaw Mfg. Co., Galesburg, Kansas.

A-B-C of the Motorcycle—250 page "Show How" book for owners and operators of motorcycles. Fully illustrated, cloth binding. Price \$1, postpaid. Popular Mechanics Book Dept., 318 W. Washington St., Chicago.

WE want you to have our 1913 Motorcycle Supply Catalog. Ask for Catalog 14. Give the name of the motorcycle you ride and ask for the Yellow Sheet. Save money by getting acquainted with us. Saunfey Supply Company, Kansas City, Mo.

BIG bargains in second-hand motorcycles, \$25 up. Indians, Harleys, Thors, Excelsors and Mercks. Write for descriptions. Howard A. French & Co., Baltimore, Md.

DON'T buy a Bicycle Motor Attachment until you get our catalog and prices. Shaw Mfg. Co., Dept. 27, Galesburg, Kansas.

PERSONAL

COMBINATION egg separator, egg beater and cream whip. 25 cents coin. Box 380, Galesburg, Ill.

BROTHER—Accidentally discovered root cures tobacco habit and indigestion. Gladly send particulars. F. Stokes, Mohawk, Florida.

CYCLECARS

CYCLECAR building easy—If you get our parts—transmissions, frames, axles, wheels. Use only such parts from us as you really need—build the rest yourself. You can have a speedy, dependable, economical, comfortable cyclecar at a price so low that you'll be astonished. Write stating what parts you need and we'll take up individual requirements, give you rock-bottom prices and valuable suggestions on how to build—free, no obligations whatever. Now write fully at once. Ward Butler, 646 Fullerton Ave., Chicago.

AERONAUTICS

WE are the Largest, hence the best and cheapest. Everything for aircraft. For wheels, propellers, tanks, steering wheels, control pulleys, aluminum fittings or what you need. Turnbuckles—all kinds and sizes. Blue prints of all standard machines, \$1.75 per set. 6 red stamps for world's largest aeronautical catalogue. Heath Aerial Vehicle Co., Chicago.

COMPLETE working model, seven-cylinder rotary, gasoline engine "Gnome" type. This model actually works 1½ in. bore, 9 in. diameter. Price 50 cents (silver) prepaid, complete with charts, blue prints and instructions. Bert Wychoff, Lyons, Colo.

AVIATION motors, all makes and hp., from \$250 up. Complete machines, all types, from \$400 up. Send for list. Aero Exchange, 38 Park Row, N. Y. City.

CURTISS Type Biplane for Sale, \$100. Particulars free. John Knapp, 69 Lafayette St., Winona, Minn.

BLERIOT monoplane, also Curtiss engine, cheap. Burns Bros., Williamsport, Pa.

AEROPLANE motors of reliability. New and used. Kemp Machine Works, Muncie, Ind.

CHICAGO Aero Works, 143 North Wabash Ave. Stamp brings catalog, etc.

\$1 BICYCLE Monoplane Prints, 30c coin. Thomas Hohneister, Overlea, Md.

PARTNER wanted with \$500 to \$1,000 to build hydroaeroplane for school. Fick, 822 S. Oakley, Chicago.

BENOIST Flying Boat and Benoit Tractor Biplane exhibition machine. Both used for demonstrations only; in perfect condition. For sale at a bargain. Benoit Aircraft Company, St. Louis, Mo.

MODEL Aero Quarterly (12 pp.)—10c year. Sample 3c. William Hewitt, 111 East Durham, Philadelphia, Penn.

BUILDING and Flying an Aeroplane—160-page handbook covering the building of small models and full sized gliders and machines. In both biplane and monoplane models the well-known Curtiss and Bleriot types are followed. Fully illustrated with detail drawings. Price, \$1 postpaid. Popular Mechanics Book Dept., 318 W. Washington St., Chicago.

HOW To Make a Biplane Glider—Our book "Amateur Mechanics No. 2" contains a complete detailed description of how to make one. Price of book, 25c postpaid. Popular Mechanics Book Dept., 318 W. Washington St., Chicago.

BOOKS AND PERIODICALS

BUILD yourself a boat. A racing cat or speed launch. Send for catalogue. Yacht and Boat Building Books, Rudder Publishing Co., 2½ Hudson St., New York, New York.

TOY-MAKER, greatest boy's book. Tells how to make Steam Engine, Camera, Microscope, Electric Telegraph, Magic Lantern, Telephone, Toys, Kites, Wagons, etc. Over 200 pictures. 15c prepaid. P. S. Bureau, 3311 Belleplaine Ave., Chicago.

STAGE Beauties—Show girls, stars, play scenes. Handsome footlights magazine. 10c copy. Trial sub. 3 months, 25c. Stage Pictorial, 1493 Broadway, N. Y.

ACROBATIC Art, illustrated, explained, 35c. Robert Lamb, Grand St., Springfield, Mass.

DANDY Books—"Three Sisters," 25c. Catalogue, 2c. Paul J. Duff, 2713 Mozart, Chicago.

"STRUCTURAL Drafting," \$1; "Lettering," 25c; both \$1. National Book Co., Collinwood, O.

WANTED—Experimenters to purchase illustrated book of directions. "How to Make a Transformer." Sent for 25 cents. Educational Extension, Lock Box 41, Hanover, N. H.

DON'T guess; find out. Books that deal with any inventive subject under the sun; patented or otherwise; written by men who have been through the mill; everything that covers your own idea completely. State your subject plainly. Brown Co., 99 Nassau St., New York, N. Y.

MAGAZINES—Big 40-page catalogue of magazine bargains ready November 10. You save, we lose. Keystone Subscription Agency, C. R. Williams, Mgr., 106 Packer, Sayre, Pa.

"THROUGH Arkansas by Footpower," by Jim Whighams. Middle-sized Gal and Polzy County Tom. It will turn your funny cup over. Yes, it tickles the ladies, too. 25c postpaid. The Midnight Press, Portland, Oregon.

GAS Engine Troubles and Installation. Cloth, \$1; flexible leather, \$1.50; Auto mobile Troubles and How to Remedy Them Cloth, \$1; leather, \$1.50. Eight other practical and reliable mechanical books. Send for circular. Chas. C. Thompson Co., Dept. C, 1126 S. Wabash Ave., Chicago.

FREE—Descriptive list of world's most popular fiction priced at 50 cents per volume. Write for list to-day. Popular Mechanics Book Dept., 318 W. Washington St., Chicago.

HOW to Run a Lathe. A 50-cent book for 10 cents postpaid. S. B. Lathe Works, South Bend, Ind.

FASCINATING books and pictures, samples and catalogue, 2c. Normal Specialty Co., L. Englewood, Chicago.

MECHANICAL books, 250 titles; prices right; send stamp for catalogues. Crescent Book Store, 329 South Halsted, Chicago.

WE sell Civil Service Books. Lamont's Agency, Matteawan, N. Y.

ENGINEERS' questions and answers for license, by Hobson, for twenty-five cents, postpaid. Send stamps. Reilly's Book Store, Philadelphia, Pa.

SHOP Notes—Many valuable kinds for blacksmiths are contained in our series of Shop Notes books, 9 volumes, 50c each postpaid for \$4.50 per set prepaid. Popular Mechanics Book Dept., 318 W. Washington St., Chicago.

3000 SELECTED Pictures for \$3. A Panorama of World Events. Political—Industrial—Social—Humorous—Tragic—all of intense human interest. A wonderful collection of 3,000 cartoons reproduced from the newspapers of the United States, Canada, Mexico, Cuba and the cities of the Old World, has been made by Cartoons magazine from more than one hundred and fifty thousand published cartoons, and, bound in an artistic and durable cover, are now ready for your library table. Vol. I, Jan.-June, 1912—\$1. Vol. II, July-Dec., 1912—\$1. Vol. III, Jan.-May, 1913—\$1. Cartoons, 318 W. Washington St., Chicago.

GAS for power is taking the place of steam for reasons of economy. Learn all about this great change by reading our new non-technical book on this subject, written by a first-class authority for the practical man. 192 pages, profusely illustrated, cloth binding. Price, \$1 postpaid. Popular Mechanics Book Dept., Chicago.

"METAL Spinning" is the name of the only book published on this interesting art. A concise working manual both for those who desire to spin metal as an art recreation and to follow this work as a trade. 80 pages. 33 illustrations. Price, 50 cents postpaid. Popular Mechanics Book Dept., Chicago.

DUPLICATORS AND DEVICES

FULL Instructions, "How to Make a Duplicator," on receipt of \$1. Geo. Silver, Gdensburg, N. Y.

HOW to get a Hektograph that will make 150 copies in 10 minutes; letter size, \$2. Write for circular. Hoyer Duplicator Co., 118 No. La Salle St., Chicago.

THE Modern Duplicator, made without glue or gelatine, is the World's Standard. Fifty to seventy-five exact duplicate copies can be made from each one you write on draw with pen, pencil or typewriter. \$2.40 to \$6.00 according to size. Booklet Free. Durkin, Reeves & Co., Mfrs., 339 Fifth Ave., Pittsburgh, Pa.

COLLECTIONS

COLLECTIONS—Any kind, anywhere commission basis. Great Eastern Mercantile Agency, New Bedford, Mass.

EDUCATIONAL AND INSTRUCTION

WANT to go to College? Students fully prepared for entrance to Medical, Law, Engineering, Pharmacy schools and Civil Service courses. Write for information regarding our "New Plan" Residential and Correspondence courses. Brooks Classical School, Dept. P.M., Schiller Bldg., Chicago.

FREE Tuition by Mail. Civil Service, Normal, Academic, Business Engineering, Drawing, Agricultural, English, Law, Real Estate and Physical Culture Courses thoroughly taught by mail. Matr. \$5 tuition free to first applicants. Address Carnegie College, Rogers, Ohio.

BE Successful—Train your mind; failure impossible; Correspondence course Mental-success training. Send 10 cents for remarkable book, "Masters of Destiny." Chicago Institute of Mental-Culture, North American Building, Chicago.

DECORATIVE Pictorial Art and Theatrical scene painting taught by mail. Only courses in existence. Everybody can learn and make big money. Send 6c in stamps for Free, Illustrated Book. Write today. Enkeboll Art School, 2709 Ogden St., Omaha, Neb.

DON'T go through life with a scrawly handwriting. I can teach you by mail. Illustrated Journal free. Francis B. Courtney, Box A 492, Detroit, Mich.

DRAFTING in all branches, Art Drawing and Mathematics (teaching), Classes, Sundays 9-12, 824 North Clark St., Chicago. Tel. Lincoln 2623. H. Hanstein & Son.

SHORTHAND by mail. Gregg or Pitman. H. Vordermark, Shorthand Expert, Washington, D. C.

CIVIL Engineering, Railroad and Concrete Engineering, Surveying and Mapping, taught by correspondence by a practical and thoroughly experienced engineer. This is an unusual opportunity for you to acquire engineering knowledge first hand. Write for particulars to Civil Engineer, 25 Bushnell Place, Mount Vernon, N. Y.

BECOME a Commercial Writer spare time; handsome profits. Eight new ways. If you possess any writing ability whatever, write for particulars. J. P. Burdette, 608 East 4th Street, Brooklyn, N. Y.

COMPLETE courses in Bookkeeping and Accounting taught by correspondence. Beginners having no previous experience given special attention. Tuition reasonable. Send for outline of courses. E. H. Smith, 1007 E. 60th Street, Chicago.

WANTED—Young men, learn the Linotype business. Biggest field today. Big pay. Short hours. Pleasant work. We prepare you at home. Keyboard furnished. Positions easily secured. Particulars, National Linotype Institute, Mansion Bldg., Rochester, N. Y.

LEARN how to make business-bringing show cards. We teach practical lettering by mail. Prospectus and sample cards free. Address Thompson School, Pontiac, Mich.

LEARN Showcard Writing. We offer \$50 course for only \$5. Particulars free. E. C. McCarry & Co., Bethany, Miss.

GROW Brain Power and Nerve Force by simple, wonderfully effective exercises. One dollar. Money back if dissatisfied. Keystone Utility Co., 15 Chester, Pa.

GOLD Plate Jewelry. Practical instructions 25 cents. Webster, Box 1074, Providence, R. I.

SHORTHAND—Forty ten-minute lessons. Sample free. Easy Shorthand Co., Arcade, Providence, R. I.

\$25 ORIGINAL Cross Real-Estate Course, \$1. Satisfaction guaranteed. Prospectus, 4c. Healy, 1-1401 Wall, Joplin, Mo.

SHORTHAND by Mail. Osgoodby's Phonetic Shorthand best for beginners and dissatisfied stenographers. State system used. Booklet M 10 free. Osgoodby School Stenography, Rochester, N. Y.

OXYACETYLENE welding—How construct and use plant from materials handy. Scale drawings, fluxes, formulas, 50c. American, Aberdeen, S. D.

DRAFTING taught by expert draftsman; \$16 drawing outfit free. Terms easy. Free booklet write. American Drafting Co., Suite 11, 1358 E. 47th St., Chicago.

RAPID Calculation. Shortest methods known. Price 50 cents. Satisfaction or money back. Stanley Spurrier, Alva, Okla.

STUDY Sanitary Engineering under the directorship of Prof. Arthur Bateman, M. Inst. S.E., A.R. San. I., M.I.P., R.P.C., Eng. Courses in Plumbing, Sanitary Science, Engineering and Hygiene. Booklet free. Anglo-American Sanitary Correspondence College, 10-12 W. Ontario St., Chicago, Ill.

\$1—COMPLETE instructions, manufacturing interior, exterior decorations, garden furniture, statuary, mixing, casting artificial marble, concrete, plaster, papier-mache, composition, marble-dust, soft metals. Making elastic, rigid moulds, modeling, gilding, coloring, stuccoing frame houses. Mail name, address, for Free booklet, illustrations, beautiful art casts. Mabler, 117 Russell St., Brooklyn, N. Y.

CHIROPRACTIC Doctors make big incomes; be independent; work for yourself; complete correspondence course, including diploma, only \$25. National College Chiropractic, Grand Rapids, Mich.

THE Seven Wonders of the Modern World—What are they? Do you agree with the selection resulting from the international poll of greatest scientists taken by Popular Mechanics Magazine? The complete result of this vote showing the selection of the wonders together with a historical sketch of each one reprinted in pamphlet form mailed to any address for 10 cents in stamps. Popular Mechanics Co., 318 W. Washington St., Chicago.

WOOD-Working for Amateur Craftsmen—128-page book, profusely illustrated, giving every essential step in wood-working. Valuable for either self-instruction or for use in manual training courses. Cloth, 50 cents, postpaid. Popular Mechanics Book Dept., Chicago.

YOU can write 100 words a minute without knowing Shorthand. My new method, Abbreviated Longhand, simpler than the simplest shorthand, tried and approved by thousands. Your money back if not delighted. Sample lesson 20c. Full particulars free. Write today. A. B. Weaver, Court Reporter, Dept. C., Buffalo, N. Y.

RAILWAY Mail Clerks get \$900 to \$1,800 a year. Vacations with pay. Interesting work. We coach you to pass civil service examination. Not expensive. Free booklet C-32. Lincoln Civil Service School, Rochester, N. Y.

TRADE SCHOOLS

MAKE \$5 to \$8 a day as skilled Electrician, Plumber, Draftsman, Bricklayer, Moving Picture Operator. We teach you in short time at small expense, profitable trades. Free employment bureau places graduates in good jobs. Special limited offer now. Write at once for catalogue and full particulars—no obligations. Dept. 8198, Coyne National Trade School, 51 E. Illinois St., Chicago, Ill.

LEARN A TRADE—The plumbing, heating and ventilating trade offers excellent opportunities. Instruction from practical work. Send for booklet. Litchfield Trade School, Libersville, Ill.

PAINTING, Decorating, Paper Hanging taught by actual practice. Free catalogue. Chicago School of Painting, 414 Dearborn Ave., Chicago.

WANTED—Young men learn Architectural Drafting. Salary \$25 to \$75 weekly. Big demand, short hours, pleasant work. Instruments free. Particulars. Keystone Architectural Institute, 202 Mansion Bldg., Rochester, N. Y.

OUR experts train you on real automobiles to become a successful Chauffeur, Repairman, Tester, Demonstrator or Salesman. Practical experience guaranteed. The next 5 weeks' course starts Nov. 3rd, conducted under the personal direction of Mr. H. F. Edwards. Write today for catalog and full information. Peoria School of Motoring, Dept. D., Peoria, Ill.

\$35 PAYS for a complete, unlimited, practical course in automobile driving and repairing. We have the best equipped school and most up-to-date shop in Chicago. Guarantee satisfaction or will refund your money. Day and evening classes. Call or write Dept. 1, Academy of Automobile Engineering, Calumet 4707, 1452 Michigan Ave., Chicago.

PICTURES AND POSTCARDS

ART Studies from Life—Lovely Women, Pretty Girls. Real photos. Three cabinets, 25c; seven, 50c; fifteen, \$1. All different. Money back if not exactly as represented. R. King Co., Andover, Ohio.

25 COMIC Postcards and Book of Flirtations, 10c. A. H. Kraus, 421 Kraus Bldg., Milwaukee, Wis.

OUR members in China, India, Norway, Holland, etc., would like to exchange postcards with you. Membership 10c. Elite Exchange, R19, 3827 Kenneth Ave., Chicago.

LOVERS of Art, Natural Photographic Poses. Beauties for the den. Six for one dollar; twenty-five cents each. A. J. Graham, Box 96, Tulsa, Okla.

JAPANESE pretty postcard. Beautiful girl, famous place of view, custom of Knight and another. Sample 5c. Nikko Co., 921 San Julian St., Los Angeles, Cal.

If you really want to exchange post cards, try our splendid club. Lists circulate in many countries. Membership, 10c. Halcyon Club, Box 133, Erie, Pa.

LADIES and gentlemen of good character join this Postcard Club for pleasure. Trial membership 10 cents. Solar Exchange, Box 1342, Jacksonville, Fla.

CARDS exchanged for results, 10c membership. Pacific Exchange, Bryn Mawr, Wash.

ART Lovers—Beautiful girls. Samples, 25c coin. Imported France, hand colored, 5c. Both 70c. Bronxart, 3866 3rd Ave., N. Y.

44 LOVER'S Cards and Book of Toasts, 10c. A. H. Kraus, 329 Kraus Bldg., Milwaukee, Wis.

8 CLASSY Postcards, 10c. Literary Enterprise, 3348 Lowe Ave., Chicago.

TRANSPARENT Pictures. French models. Four, 15c. S. Wra, Council Bluffs, Iowa.

3,000 SELECTED Pictures for \$3. A Panorama of World Events, Political—Industrial—Social—Humorous—Tragic—all of intense human interest. A wonderful collection of 3,000 cartoons reproduced from the newspapers of the United States, Canada, Mexico, Cuba and the cities of the Old World, has been made by Cartoons magazine from more than one hundred fifty thousand published cartoons, and bound in an artistic and durable cover, are now ready for your library table. Vol. I, Jan.-June, 1912—\$1. Vol. II, July-Dec., 1912—\$1. Vol. III, Jan.-May, 1913—\$1. Cartoons, 318 W. Washington St., Chicago.

FREE—1914 art calendar with 12 Thanksgiving-Christmas postcards, 10c; 10 hand-colored 25c; silk-embroidered. All greetings, 20c each. Tepper, 146 Marcy Ave., Brooklyn, N. Y.

26 PHOTOGRAPHIC Beauty Poses, 10c. Catalogue free. Taylor Brothers, 2233 Clifton Ave., Chicago.

BEAUTIFUL Niagara Colored Postcards. Send dime for five views. Martin, Box 697, Buffalo.

SEPTEMBER Morn; her sister, September Night; large, hand-colored, 50c each. Bathing girls, 25c. All for \$1.25. Importer, Box 592, Minneapolis, Minn.

FIVE Evelyn Nesbit cards, hand-colored, 25c. Durso, 25-M, Mulberry St., N. Y.

REAL Photos—French models. Catalog and samples 10c. P. Leop, New Dorp, N. Y.

HONEST Card Exchangers listed free. Follow crowd to Systematic Exchange, 79 Sixth Street, Bridgeport, Conn.

REAL Photos of the prettiest girls we can find in Chicago. We make use for Calendars, Advertising and Artists' use in their art work. See our display ad, page 151 of this issue. Mellen Photo Co., 102 N. 5th Ave., Chicago.

POSTALS—Just Girls; 10 fifty poses, 12c. 25, 25c. Assorted postals, 100, 35c. Bailey, 110 Maple, Napanoch, N. Y.

JOIN the Oxford Postcard Exchange and receive cards from faraway lands. Membership 10c. Keniston, Publisher, South Paris, Maine.

RECEIVE pretty postcards and jolly letters from everywhere. Very best club. Membership 10c. Jolly Card Exchange, Box 132, Deatur, Ind.

ONE dozen assorted photograph post cards. Curtiss latest flying boat, thirty cents, postpaid. Benner's Studio, Hammondsport, N. Y.

18 PRETTY postcards, 10c; 40 for 20c. J. R. Dickey, Box A9, Smuggler, Colo.

24 ARTISTIC miniature beauty poses, woman beautiful, 10c. Normal Specialty Co., J6, Englewood, Chicago.

YOU'LL get cards from everywhere. Membership 10c. Idaho Card Exchange, Dept. K, Box 906, Boise, Idaho.

CAMERAS AND PHOTO SUPPLIES

FORMULAS for eight of the very latest wrinkles and fads in photography. 25c. Includes instructions for making Magic Disappearing Photos (real money makers), Photo Sofa Pillows and Neckties, beautiful transparent colored pictures on watch cases, chinaware, etc., and other novelties. P. Benson, Stewartville, Minn.

TRIAL Offer—Buy Instanto, the best developing paper, direct from manufacturer; big saving; better, fresher, quality guaranteed. One full gross 4x6 or smaller and one-half gross postal cards for \$1, for three sample dozen postal cards or 4x6, 25c. The Photo Products Co. (Dept. J), 6100 La Salle Street, Chicago.

ROLL Films developed 10c. Printing Post Cards, 3 cents each. 15 years' experience. Send for complete price list. F. C. Hoyt, Sac City, Ia.

1914 CALENDARS from your negatives, 25c (coin). Enterprise Photo Co., Box 1057, Springfield, Mass.

LEARN Photo-Tinting, a pleasing and fascinating art. Quickly learned at small cost to you; colored photographs make ideal gifts. Booklet free. Sample hand-colored card 10c. Keil-Burr Co., 56P, Pine Street, New York City.

FILMS developed free. Photographic post cards, 4c each; 12 of same subject, 30c. \$1.50 per hundred. Fred Marvin, Kane, Pa.

STEREOSCOPES, cameras and supplies, enlarging, finishing, lantern slides. Price list on request. T. H. Knight, Racine, Wis.

BIG Money Saved on Photographic Lenses and Apparatus—goods exchanged; repairing done. Ralph J. Golsen, 65 East 46th St., Chicago, Department P.

1-A GRAFLEX, new, with Zeiss Anastigmat Lens, \$65. S. 56 North Franklin St., Delaware, Ohio.

POSTCARD enlargements from small negatives 5c. M. Stockwell, Geneva, N. Y.

MAKE magic disappearing photographs. Instructions for stamp. Greenhalgh, Brightwood, Ind.

ENLARGEMENTS from films, 1/2c per square inch; 8x10, forty cents; 4x5, ten cents. Developing and printing. Send for list. O. E. McLaughlin, Detroit, Mich.

HAVE you a Camera? Write for samples of my magazines, American Photography and Popular Photography, which tell how you can make better pictures and earn money. F. R. Fraprie, 231 Pope Bldg., Boston.

FREE to every one with a kodak. A beautiful picture postal brings it. Lake Photo Studio, 1713 East Lake St., Minneapolis, Minn.

FILMS Developed, ten cents roll, any size; 4x5 prints and postcards, four cents; all smaller prints, three cents. Satisfaction guaranteed. Sehall Photo Finishing Works, Decatur, Illinois.

COLOR Photography. Print your landscape views in colors. Send 2 stamps for circular. Rud. Isenmann, 385 Bergen St., Newark, N. J.

HYP0 eliminated—immerse prints 5 minutes, wash 10 minutes, saves time and prints. Proven or money back. 1 oz. (dry) chemicals postpaid 50c. Chemical Supply, 144 W. Front St., Missoula, Mont.

PHOTOGRAPHS wanted by publishers. I'll find a buyer for all prints I deem worthy of publication. Send your name on a postal for leaflet of instruction. A. S. Dudley, Photographic Expert, Box 775 G, Philadelphia, Pa.

KODAK Films Developed, 10c per roll, any size. Prompt attention given mail orders. Prints 2 1/4x3 1/4 to 3 1/4x4 1/4. 3c; 4x5 to 3 1/4x5 1/4. 4c. J. M. Manning, Box B, 1062 Third Ave., New York City.

FILMS for your kodak at wholesale prices. Send name and size of camera. A. Camera, Box 28, Portsmouth, Ohio.

WE buy, sell and exchange. Bargains in Microscopes, Telescopes, Binoculars, Cameras, etc. Bargain list sent. Kahn & Son, Opticians, No. 54 John St., New York. Established 62 years.

MAILING LISTS

FREE to business men, copy of our comprehensive "Silent Salesman." Contains over 2000 different classifications of mailing lists with number and price of each list, and information every business man needs. Accept this free offer. Trade Circular Addressing Co., G 164 1/2 W. Adams, Chicago.

MOTION PICTURES

LEARN to write photoplays. Writing motion-picture plays offers a new, easy and fascinating way to earn money in your spare time. Plot all that is required. Literary training or style not necessary. Easily learned. Great demand. Producers pay \$25 to \$100 each. Our short, fascinating course will teach you how to turn your ideas into dollars. Send for free descriptive catalog. Authors' Motion Picture School, Box 130K, Chicago.

FOR Sale—Moving-picture film \$2.50 per reel and up; also features. Send for list. Wichita Film Supply Co., Wichita, Kan.

WRITE moving picture plots. Good pay. We will show you how. Ripless Co., Brockton, Mass.

WRITE Photoplays. Our book tells how. Price 15c. Literary Enterprise, 3348 Lowe Ave., Chicago.

MOTION Picture Outfits bought and sold. National Employment Company, Duluth, Minn.

\$35 PROFIT Nightly—Moving Picture Business—small capital starts you, no experience needed. Teach you—furnish everything. Ralph J. Golsen, 65 E. 46th St., Chicago, Dept. M.

WRITE Photoplays for the Movies! Big demand. Producers pay \$5 to \$100 each. Literary experience unnecessary. Write us. Western Photoplay Co., Box 1646-T, Spokane, Wash.

EDISON Moving Picture Machine; fine condition; \$60. Fredericks, No. 2017 North Twelfth Street, Philadelphia, Penna.

MOTION Picture Work—A large 618-page book covering every phase of the moving picture, its production and its theatre. Indispensable for reference and instruction to the thousands of workers in the motion picture field. Price \$3, postpaid. Popular Mechanics Book Dept., 318 W. Washington St., Chicago.

MOTION picture plays wanted. You can write them. We teach you. No experience needed. Big demand and good pay. Details free. Ass'd M. P. Schools, 601 Sheridan Rd., Chicago.

WRITE Moving Picture Plays. \$10 to \$100 each. Constant demand. Devote all or spare time. Experience, literary ability or correspondence course unnecessary. Details free. Atlas Publishing Co., 304 Atlas Bank Bldg., Cincinnati, Ohio.

FOR ADVERTISERS

MR. MAIL Order Man: Play the game with marked cards. We guarantee our copy to produce results or money refunded. Our attention devoted exclusively to the preparation of form letters and printed matter for mail-order dealers. The Wellington Co., Chicago, Ill.

YOUR 30-word ad in our 32-page postcard monthly, 25c. Display, 50c. incl. Elite Exchange, 3827 Kenneth Ave., Chicago.

PARCEL Post Package Chart shows size packages. Advertising novelty, sample ten cents. Fred Church, Barre, Vt.

ADVERTISE—In Barkley's Medium 1c Word. O. P. Barkley, Blairsville, Pa.

BARGAIN Advertising Rate—Just to get acquainted. 15 words, one insertion; guaranteed 18,000 copies printed, and one year's subscription, 25c. Digest, Grand Rapids, Mich.

25-WORD advertisement in 100 magazines \$1. Send for list. Gem Advertising Agency, 362 Appel Bldg., Denver, Colo.

ADVERTISERS—Here's your opportunity. 25 word classified ad inserted in "Cartoons Magazine" for 50c, one inch display ad, \$1. 23,000 copies. Send in your ad for the next issue. Cartoons Classified Dept., 320 W. Washington St., Chicago.

SALES letters that get business my specialty. Will H. Myres, Norwood, Ohio.

CEMENT

LIKE an everlasting rubber blanket is our Roof and Boat Leak Cement. Make your own repairs. Ten pounds prepaid \$2. Insulative Company, Washington Bldg., New York.

IF you want the best information on cement and concrete construction, subscribe for Concrete-Cement Age, leading cement and concrete monthly. Sample copy, 10 cents. Yearly subscription, \$1.50. Concrete-Cement Age, 135 Newberry Bldg., Detroit, Mich.

BUSINESS OPPORTUNITIES

MAIL Order Dealers! Advertisers! You need our 1913 Advertising Rate Book with the latest Dollar-making feature "Ads That Pay." Hot from the press! Gives you cost of advertising in 2000 recognized magazines and newspapers, location, circulation, closing dates and other useful knowledge. Includes thirty original Mail Order propositions, winners every one of them. A \$10,000 investment at your service. You can make a legitimate profit of 95c on every dollar order. This very valuable manual sent prepaid to you for 10c. Write now! Dearborn Advertising Agency, 521 Dearborn St., Chicago.

LET the parcels post help you. Add (\$15 to \$25 weekly) to your present salary or income. Start during spare time and build up a permanent mail-order business of your own. We show you how and help you make good. No canvassing. Experience unnecessary. The Parcels Post makes success doubly sure. Our new ideas and up-to-date plans bring the money. No so-called "Course of Instruction" to sell. We give that free. Write today. Address Pease Mfg. Co., Inc., Dept. A, 70 Broadway, Buffalo, N. Y.

YOU can make \$50 weekly, in spare time, manufacturing Tip-Top the new delicious, pop corn confection—the finest you ever tasted—simply melts in your mouth. No capital or experience required—great opportunity to start a big business of your own and make money easy and quick! Formula and complete directions for manufacturing ten cents silver. U. S. Specialty Co., Dept. 43, New Philadelphia, Ohio.

BIG money in carpentry contracting. No capital required. Why work for others? Independence lies before you. Learn the rules of the business, how to get backing, how to bid, where to look for contracts. Full instructions sent prepaid to any carpenter for only 50c. Frank Volkholz, 2324 N. Clark St., Chicago, Ill.

YOUNG Man, Go West! Saw mill and sash and door factory for sale or lease. Also factory sites on deep water and rail. Greatest virgin timber supply in United States. Good openings for men with capital and energy. Bay City-Land Co., Bay City, Oregon.

LEARN Candy-making. \$25 will start you, young man, in a business of your own; perhaps there is an opening in your home town. Our book will teach you in four weeks to become an expert candy, ice cream and sherbet maker. Send in your order today. Price \$3.50. Art School of Candy-Making, Box 600, Denver, Colo.

HIGH-CLASS specialty manufacturing business for sale. Well-equipped plant, recognized superior product; assets considerably larger than sale price. Splendid opening for hustler with \$8,000 or more. R. M., 6th floor, 318 W. Washington St., Chicago.

WE start you in big money-making business. We trust you for outfit. It costs money for you the minute you get it. 85c profit on every dollar. Circulars free. F. P. C. Works, Desk 45, 2231 W. 12th St., Chicago.

I WILL start you earning \$4 daily at home in spare time, silvering mirrors; no capital; send for free instructive booklet, giving plans of operations. G. F. Redmond, Dept. 306, Boston, Mass.

BE Independent. Start money-making mail order business at home. New plans. Everything furnished. Only small capital required. Free booklet and particulars tell how. W. P. Miller Co., Box 254, Muskegon, Mich.

BE Independent. Work for yourself with our new invention, just patented. No canvassing. 8c profit on every dime. Free circulars. International Metal & Ferro Co., Desk 42, Chicago.

START a cleaning, dyeing, pressing shop. Profitable business can be started on a small investment. Write today. Advance Agency, Dept. P, Box 2792, Boston, Mass.

I MAKE \$2,000 annually by newspaper correspondence. My book tells what's news, how to get it, where to sell. Newspaper directory included, fifty cents. No further expense. Morris White, 700 Oneida, Detroit.

SEND for Booklet, "How you can become your own master." Without capital. Restoring colors to faded rugs and carpets. Daugherty, 1236 Madison St., Chicago.

BECOME Manufacturer—Big money supplying Bakeries, Restaurants, Groceries with "Substitute for Eggs." Secret (guaranteed) with instructions, \$1. Particulars free. W. C. Delzell, 309 S. Fickett, Los Angeles, Calif.

"WHAT Shall I Sell?" This question, which confronts every mail dealer and beginner, answered in the current **Booster Magazine**—the one bona fide publication in the world devoted exclusively to the interests of agents and all interested in the Mail Order business. More people read "Booster" than any other trade paper—this alone should convince you that today is the day to learn all about "Booster"—its money making suggestions and principles. Join our ranks now—let "Booster" put you next to the best money-making propositions—ones that really get you the money! Ten cents will bring two copies worth dollars to you. If you don't like it, we'll send your dime back. **Booster Magazine**, 304 Northwestern Building, Chicago.

SIX valuable formulas, and particulars of 20 business opportunities, 10c. Van Demark Co., Kyserike, N. Y.

ANYONE earn \$25 weekly silvering mirrors; no capital; write W. T. Abell, Lima, Ohio.

LEARN Electroplating—Practical results may be obtained by following the directions in our book on electroplating. This is a working guide for the beginner written by an old hand at the business. 112 pages, 62 illustrations, cloth, 50 cents, postpaid. **Popular Mechanics Book Dept.**, 318 W. Washington St., Chicago.

EARN \$50 a week operating a candy kitchen. Our \$15 course for \$1. Particulars for stamp. **Wilson's World**, Chicago.

\$15 PER 100 distributing "Nu-Brite." 25c sample and complete instructions 10c. **Nu-Brite Co.**, Oshkosh, Wis.

FREE wholesale price list of fastest selling Mail Order Books. Samples 25c. Circulars furnished. **B. Newham**, Waukegan, Ill.

MAIL Order Dealers—Add a profitable side line to your mail order business. \$5 starts you. No stock to carry—repeat orders, printed matter furnished—profits one-half—particulars free. **The Merford Co.**, 1401 P. Chicago.

ANY man or woman who wants to go into a good paying business that can be run at home in spare time, should write **Merford Co.**, Dept. A-1, Chicago.

A RARE opportunity is offered to parties with sufficient capital to develop three patents of unusual merit. To those sufficiently interested, we will prove that there is a ready market for the articles covered and when properly handled will show unlimited returns. Our reason for inviting you to take advantage of this opportunity is that we are interested in other patents. Only bona fide business propositions considered, Box 678, New Kensington, Pa.

"THE Art and Process of Dry Cleaning." A fascinating and profitable occupation. 25c postpaid. **Auburn Supply Co.**, Dept. D11, 7745 Peoria St., Chicago.

GET into the penny slot machine business. One machine pays \$6 weekly profit. You simply secure suitable locations and make frequent collections. 80 big money-getters (many new and novel), \$12 starts you. My free booklet tells how. **Chandler**, 326-L, Cranston St., Providence, R. I.

WE Start You in Business, furnishing everything; men and women, \$30 to \$200 weekly operating our "New System Specialty Candy Factories," home or small room anywhere; no canvassing. Opportunity lifetime; booklet free. **W. Ragdale Co.**, East Orange, N. J.

MASTER Mechanics and Others wishing to improve position and income, write promptly B-303, Railway Exchange Building, Denver, Colo. Dollar value Psychology wall chart, "Key to the Soul of Man," free. A new and mighty instrument. Enclose twenty cents for mailing.

CASH for names, information, formulas, ideas, etc. Steady home business. Instructive booklet for stamp. **Information System**, 308 Marietta, Ohio.

MAKE big money opening safes and setting combinations. Write **Wayne Strong**, 811 Temple, Los Angeles, Cal.

I MADE \$50,000 in five years with a small mail order business; began with \$5. Send for free booklet. Tells how. **Heacock**, 5074, Lockport, N. Y.

CANDY—"How to make pure candy and start a profitable business." A splendid and complete course, postpaid, 50c. **Auburn Supply Co.**, Dept. C11, 7745 Peoria St., Chicago.

YOU need "Good Results"—Greatest Mail Order Magazine published. Chuck full money-making ideas—plans—practical formulas. Puts you wise—keeps you posted. Three issues for 10c. **Publishers**, 2311PM, North 43d Ave., Chicago.

"MONEY Making Secrets Exposed." shows the way to freedom from wage slavery. Points the way to fortune and prosperity. Particulars free. **Success Co.**, 805 H Street, Northwest, Washington, D. C.

\$5,000 BUSINESS Free—8 other monster money-makers free. Our free plans supply real money to start you in business. \$10 to \$125 actual cash advanced—no borrowing—no debts. Postal brings startling details—overwhelming proof. **Security Service Co.**, 1163 Spitzer, Toledo, O.

\$800 MADE distributing advertising matter in 7 months. Pleasant, healthful, outdoor work. Particulars for stamp. **Pulver Bros.**, Hudson, New York.

MAKE big money during spare time, mailing circulars. Complete instructions 12c. **George C. Fenner**, Louisville, Ky.

MAIL Order Propositions that Get the Money! Samples worth 70c, 25c. Literature free. **Bodolph**, Northwestern Building, Chicago.

MR. Mail-Order Man: Get quick returns. Established corporation supplies fast mail-order sellers; factory prices. Classy proposition. Beginners or established firms. Copyrighted Prospectus free. **Mississippi Valley Co., Inc.**, Box M929, Pittsburg, Kans.

WE start you in high-grade, permanent, profitable business. All or spare time. Any location. Men or women. Experience unnecessary. Write us. **Peerless Candy Co.**, 345 Knickerbocker Block, Denver, Colo.

IF you have \$216 I can show you how to get started in a business which will show you a gross profit of 233 1/3%. Only reliable men and women wanted. Must act as our local sales manager. Most wonderful money-making business. **W. F. Mitchell**, Suite 630, 1011 Chestnut St., Phila.

\$1 STARTS you in a paying mail-order business at home. Full particulars free. **Chapman Supply Co.**, Minneapolis, Minn.

WANTED—An idea for cash. **Patent News**, Washington, D. C.

"HOW to make good in the mail order business." Read our magazine, 10c copy. Three months 25c. The "Lever" Mail Trader, 44 Elizabeth, N. J.

USE your spare time to build up a mail-order business of your own. We help you start for a share in profits. 27 opportunities. Particulars free. **Mutual Opportunities Exchange**, Buffalo, N. Y.

AUTOMOBILE specialty business need in every town. Small capital required. We will start you and guarantee \$5 profit for every dollar invested. Send \$2 for full instructions and exclusive right in your territory. **G. E. Blaylock & Co.**, 2511 W. Pratt St., Baltimore, Md.

I WILL give you the famous \$50 lessons on selling by mail if you will sell my goods. **Fields**, Box 826, Kansas City, Mo.

RESILVER mirrors and make plenty of money. Full instructions, 25c. **Auburn Supply Co.**, Dept. R11, 7745 Peoria St., Chicago.

BE sure to read Miller's ad "Valuable Trade Secrets" in miscellaneous classified column.

BUILD a \$5,000 business in two years. Let us start you in the collection business. No capital needed; big field. We teach secrets of collecting money; refer business to you. Write today for Free Pointers and new plan. **American Collection Service**, 101 State St., Detroit, Mich.

ADVERTISE—28 words in 100 monthly magazines and 58 weekly newspapers for \$2.50. **Monarch Advertising Agency**, St. Louis.

IF you have money to invest in highly profitable manufacturing that is safe. Write **W. L. McLaughlin**, Consulting Engineer, Lomax, Ill.

COMPANIES incorporated anywhere. Stocks and bonds bought and sold. **Rosenbaum Company**, 259 Haight Building, Seattle, Washington.

AGENTS for Altamex Complexion Cream. Liberal proposition. 1819 Addison, Berkeley, Cal.

I WANT to send you proof of the wonderful pulling power of **Popular Mechanics** classified pages. What's your proposition? Write me today. **P. W. Johnson**, Classified Dept., **Popular Mechanics Magazine**, 218 W. Washington St., Chicago.

START in business for yourself, but first read "Mail Order Failures," the guide to the Mail Order Business. Price one dollar. A few dollars invested will make you independent, if you follow the advice given. Nothing else to sell. **Vernon Burr**, Norwich, New York.

"SCIENTIFIC Review," 419 First Avenue, N. Y. Trial subscription, six months, 10c. Before investing money in patents get this paper. Write-up \$7 column including 100 copies.

DO you want to sell quick? That's the secret millions of men and women would give a great deal to know; no school course or book lesson to sell or other fish to fry; I'm in the business; I know how; sell your own farm, business or property of any kind; make \$5,000 to \$25,000 year selling for others; \$1 puts you in now; \$5 if I have to answer correspondence. **Robt. McGinnis**, Nettleton, Ark.

LEARN to collect money by a sure, easy system. Big income. Quick results. No capital required. Send today for instructive free book, "Skillful Collecting." **Collectors' Ass'n**, Long Street, Newark, Ohio.

YOUR 25-word ad inserted in "Cartoons Magazine," 50c. One inch display, \$1. Circulation, 23,000 copies. Send copy now. **Cartoons (Classified Dept.)**, 322 W. Washington St., Chicago.

ANYONE anywhere, \$5 daily replating silverware. Samples free. **E. Fliske**, 101 Sheffield Ave., Buffalo, N. Y.

MAIL-ORDER Dealers: Send for our catalogue for brand new articles to sell. **Gordon Mfg. Co.**, Northwestern Bldg., Chicago.

BEST imported and domestic novelties, tricks, jokers, puzzles, etc., at lowest wholesale prices. Complete assortment, prompt shipments. Catalogue free. **Joseph Methieu**, 203 Court St., Brockton, Mass.

AN intelligent person may earn \$100 monthly corresponding for newspapers. No canvassing. Send for particulars. **Press Syndicate**, 700 Lockport, N. Y.

RAISE Ginseng, \$1 per ft. of ground; 1/2 acre, \$25,000. Write **Ginseng Gardens**, Sheboygan, Wis.

CASH for your business or property. I bring buyers and sellers together. Write me if you want to buy, sell or exchange any kind of business or property. Established 1881. **Frank P. Cleveland**, 1308 Adams Express Building, Chicago, Ill.

MAKE and Sell Mission Furniture—From our instructions one man who was an amateur made and sold \$400 worth of just one article alone. We give you 98 designs and easily followed directions for making each piece in 3 books at 50 cents each or \$1.50 per set, postpaid. **Popular Mechanics Book Dept.**, 318 W. Washington St., Chicago.

ASK Bode about Buying! Selling! Ad- Writing! Anything! Get acquainted "Now" **Bode**, 288p Main, Hartford, Conn.

INDEPENDENCE and fortune quickly attained in the Manufacturing Mail Order business. I furnish Formulas, Manufacturing Processes and Trade Secrets in all lines. Sold under positive guarantee; 18 years' practical experience. Revision and improvement of Formulas and Processes—reduction of manufacturing cost—utilization of waste materials, etc., a specialty. Booklet, Formula List, and Valuable Information Free. **W. L. Cummings**, Ph. D., 127 Standard St., Syracuse, N. Y.

WE Sell Patents. Established 1900. If you wish to add a new product to your line, write us. **Charles A. Scott Co.**, 596 Central Bldg., Rochester, N. Y.

OPERATE Hahn's Premium Machines, the best seller for cigars and candies. **J. Hahn**, 1016 Germantown Ave., Philadelphia, Pa.

WE help raise capital at once to start you in retail, manufacturing, patent, real estate, mail-order, or any legitimate business, by means of "our practical method." Particulars free. **The Business Aid Co.**, K 504, Detroit, Michigan.

WOULD you like to own a good-paying mail order business? We have a line that gets repeat orders all the time. You can start in spare time; invest a dollar or two a week and soon own a nice business of your own; write for particulars. **Nadico**, 1664 Belmont Ave., Chicago.

INCORPORATE your business under Arizona laws. Cost small. No franchise tax. Stockholders exempt from corporate debts. Do business anywhere. Laws and forms free. **Southwestern Securities & Investment Company**, Box D488, Phoenix, Arizona.

STOP Here! Let me start you in a home business that will bring you money every day. Experience unnecessary. Spare time. No canvassing. I furnish everything and guarantee success. Send for proofs. **Voorhies**, Desk C. R., Omaha, Neb.

AGENTS WANTED

AGENTS Wanted—If you know a chance when you see it you'll see one now. Big money—stylish, nifty clothes—little work—no experience or capital needed—can you beat that? We want agents everywhere to take care of our business in their localities and to advertise our nobby nifty suits by wearing them. We furnish everything complete and charge nothing for agents' outfit. The swellest dressers everywhere are our agents and all we ask is that you tell people who inquire about your fine clothes where and how they can get them. You make big money—\$10 a day—without trouble. Just a postal brings you full outfit free. Big, new sample book of up-to-the-minute suitings sent so you can pick out your first suit; also measuring blanks and everything you need. We pay express on everything—not a penny for you to pay. Send quick before some one else gets the agency there—mail postal today to American Woolen Mills Co., Dept. 1114, Chicago, Ill.

\$1,200 COLD Cash—Made, Paid, Banked in 30 days by Stoneman; \$15,000 to date. Join our famous \$1,000 class, which absolutely insures \$1,000 per man, per county. Korstad, a farmer, did \$2,200 in 14 days. Schleicher, a minister, \$195 first 12 hours after appointment. Ten inexperienced men divided \$40,000 within 18 months. Strange invention startles world. Agents amazed. Think what this invention does: Gives every home a bathroom with hot and cold running water for \$6.50. Abolishes plumbing, water works. Self-heating. No wonder Hart sold 16 in 3 hours—\$5,000 altogether; Lodewick 17 first day. Credit given—Come now—Investigate. Postal will do. Exclusive sale—requires quick action, but means \$1,000 and more for you. Allen Mfg. Co., 3781 Allen Bldg., Toledo, Ohio.

\$61.50 WEEKLY introducing and selling a new Gas Light Burner for Kerosene Lamps. Beautiful light. No chimney. No mantle. Perfectly safe. Simple in construction. Nothing to get broken or out of order. Will not burn out. Durable. Will last for years. Low price. Easy to sell. 200 per cent profit. Experience not necessary. Sample free. Why not try one on your lamp. Beware of imitations. No branch offices. Luther Manufacturing Co., Dept. 247, Cincinnati, Ohio.

AGENTS—Every household on farm, in small town, or suburbs where oil lamps are used needs and will buy this wonderful mantle lamp; burns common coal oil (kerosene), gives a light five times as bright as electric; one farmer cleared over \$500 in 6 weeks; hundreds earning \$100 to \$300 per month. Write quick for wholesale prices, territory and sample lamp for free trial. Mantle Lamp Co., 351 Aladdin Bldg., Chicago, Ill.

YOUNG man, would you accept and wear a fine tailor-made suit just for showing it to your friends? Or a Slip-on Raincoat Free? Could you use \$5 a day for a little spare time? Perhaps we can offer you a steady job. If you live in a town smaller than 10,000 write at once and get beautiful samples, styles and this wonderful offer. Banner Tailoring Company, Dept. 560, Chicago.

THE OIL, Dusting and Polishing Mop Industry offers the richest opportunities to Live Crew Managers, General and Local Agents. Annual sales now exceed Two Million Dollars. Our New Invention is rapidly revolutionizing the business. Largest factory in America. Highly remunerative contracts. Prompt action necessary. Frederick Mfg. Co., 465 Marbridge Bldg., New York.

GENERAL Agents—Capable of calling on the big trade themselves and handling canvassers for the house to house and office to office business, to sell the newest electrical specialty on the market; sold everywhere there is electricity, in the home, office, factory, store, hotel, liberal profits; sales-driving sample, weighs a pound, no experience or knowledge of electricity required; shows how to use one light instead of two and get the same results; sells for \$2.50, \$3.50, \$5.00 and saves the purchaser an investment of \$25. Write for particulars. The Handy Light Co., 160 Handy Light Block, Cincinnati, Ohio.

SOAP agents make more money selling the celebrated Linro line. Coffee, flavorings, spices, soaps, perfumes, and 135 other items. Big commissions to you. Exclusive territory. Freight allowed. Handsome premiums to your customers. Free sample case. No deposit required. Free catalog. Linro Company, 13 Linro Bldg., St. Louis, Mo.

LIBERAL salary with cash commission and share in our profits. 50 valuable advertising premiums for customers bring quick sales. Your own 72-page catalogs furnished to start you in mail order business. Experience unnecessary. Best season now. Credit given. Write immediately. Best Manufacturing Co., Div. 13, Providence, R. I.

ENDLESS Neckties (Patented). Sell on sight. Big Xmas seller. Agents start early; write today for Sample Outfit. Look like any stylish necktie—tie in a different place each time; wear 20 times as long. Man made \$5.50 one hour—girl \$87 one week. Endless Necktie Co., Kansas City, Mo.

AGENTS, canvassers, crew managers, salesmen wanted in every community for our famous 7 and 8 cake \$1 soap assortments; advertising price, 25c; costs 12½c; attractive premiums given; everybody buys; lose no time getting our list money-getters. Moore Bros. Co., Manufacturers. Established 1890, 289 Greenwich Street, New York.

VACUUM Cleaner Agents, here it is; absolutely new design in wheel-operated, powerful bellows-type vacuum cleaner; new visible nozzle; exclusive appearance; sells quick at \$7.50; write for particulars about money-back guarantee now. D. Doty Company, Box 500, Dayton, Ohio.

WIEN you sell Feeny Vacuum Cleaners you make pleased customers. New principle—creates wonderful suction. One general agent's total commissions 1912 were \$18,498. Write today for our attractive propositions. Feeny Mfg. Co., H-28, Muncie, Ind.

G. STRATTON, Denver, made net profit \$134.40 on our rugs in 6 days. Working simple these rugs with colored illustrations other patterns, forwarded prepaid for \$1. Reference: Boylston Nat'l Bank, Boston. Dundee Mfg. Co., 46 Chauncy St., Boston, Mass.

BE Independent—Start a mail order business in your own home; we tell you how and furnish everything needed, wholesale; an honorable and profitable business for man or woman. Many make \$3,000 a year. Particulars free. Murphy Mfg. Co., East Norwalk, Conn.

AGENTS—Splendid money-maker. Sell chewing gum to dealers. Clean, profitable business established quickly with our new brands. Four flavors. Novel packages. Write for exclusive territory proposition. Helmet Gum Factory, 39 Opera Place, Cincinnati, O.

I WILL start you earning \$4 daily at home in spare time, silvering mirrors; no capital; send for free instructive booklet, giving plans of operation. G. F. Redmond, Dept. 396, Boston, Mass.

WE manufacture the most complete assortment of novelties, tricks, and puzzles in the world. Agents, dealers, supply houses and jobbers are making big money with our line. Fast sellers. Low quantity prices. Large illustrated catalogue free. Oaks Magical Co., Dept. 8, Oshkosh, Wis.

NECKTIE proposition for holiday trade. Beautiful premium to each customer. Ladies or gentlemen make \$10 a week from now until Christmas. Outfit free to workers. Be first in your neighborhood. D. Wilson Mfg. Co., Lancaster, Ohio.

BE independent. Work for yourself with our new invention. Just patented. No canvassing. 8c profit on every dime. Free circulars. International Metal & Ferro Co., Desk 44, Chicago.

500% PROFIT. Sliding casters. Necessity every home; child can attach. Saves floors, carpets, furniture. Hotels, restaurants buy gross lots. Cost 2½c, sell 15c. Agents making \$25 to \$100 every week. Samples free. H. O. Sliding Caster Co., 19 L.L. State St., New York City.

BIG Profits for You! Manufacture Barley Crisp. New confection. 5c package costs you 1c. Machine, instructions complete \$7.50 prepaid. Send 10c for samples. Barley Crisp Co., 1695 Hyde St., San Francisco.

LEARN Metalizing. Transform Roses, Carnations, Butterflies, etc., into exquisite jewelry novelties. Big profits. Dime brings rosebud pin and particulars. P. Benson, Stewartville, Minn.

GENERAL Agents Wanted—To sell double suction vacuum cleaner; greater suction than electric; special steel construction. Full Nickel Plated. Wizard Mfg. Co., Madison, Wis.

I NEED one energetic, dependable representative in every county to take orders for our new Popular Mechanics book for boys called "The Boy Mechanic." This is not a story book, but a wonderful and interesting collection of 700 things boys love to make and experiment with. A very large attractive book for the price, \$1.50. Every boy's father or mother will want to buy it for their son. Right now is the most opportune time to start on account of the approaching holiday season as this is an unusually attractive gift book. It sells itself. Good liberal commission and exclusive territory. You don't have to be a professional agent to be successful with this highly meritorious proposition. Work in and around your home town during spare time only if you cannot devote all your time to it. Write today for full particulars to Manager Book Dept., Popular Mechanics Co., 318 W. Washington St., Chicago.

AGENTS—Monthly Directory Illustrated contains details newest, best selling specialties, money-making propositions of responsible concerns. Two months, 10c. Robert Butler, 123 Cedar St., N. Y.

AGENTS—Here's a new, better dust mop. Its marked superiority interests every housewife and easy sales come quick. Big money in it for you. Why not get our profitable proposition at once. Dearborn Duster Co., Dept. C4, Chicago, Ill.

MAIL-ORDER Opportunities: 25 new Propositions. No competition! Make 95c profit on dollar order; complete outfit 10c. Mail Dealers Wholesale House, 521 Franklin Bldg., Chicago.

AGENTS—Portraits, 35c. Frames, 15c. Sheet Pictures, 1c. Stereoscopes, 25c. Views 1c. 30 days' credit. Samples and catalog free. Consolidated Portrait Co., Dept. 5243, 1027 W. Adams St., Chicago.

AGENTS for splendid high grade seller; easy to handle; large demand, big profits; particulars free. The Cinch Supply Co., 6 Marlowe St., Dorchester, Mass.

WE start you in big money-making business. We trust you for outfit. It costs money for you the minute you get it. 85c profit on every dollar. Circulars free. F. P. C. C. Works, Desk 43, 2231 W. 12th St., Chicago.

PHOTO Pillow Tops, Portraits, Frames, Sheet Pictures, Photo China Plates. Rejects credited. Prompt shipments; samples and Cat. free to agents. 30 days' credit. Jas. C. Bailey Co., Desk P2, Chicago, Ill.

AGENTS—Kerosene (Coal oil) Self-Heating Iron. Brand new. Absolutely safe, odorless, a winner. Every home needs it. Low priced. Big profits. Your territory open. Thomas Iron Co., 162 Neal St., Dayton, Ohio.

\$5 TO \$20 daily to agents who are hustlers, selling our new and wonderful line of goods. Our big capital backs you. Exclusive territory. Wm. J. Dick, Manager, Dept. C-4, Chicago.

AGENTS make 500% profit selling our gold window letters, novelty signs and changeable signs. 800 varieties in enormous demand. Catalogue free. Sullivan Co., 1238 Van Buren St., Chicago, Ill.

AGENTS, best seller in Christmas season; very rare and newest Japanese novelties that we have ever seen. Sample 25c. Otuska Co., 223 So. Hill St., Los Angeles, Calif.

AGENTS—To sell the newest electric appliance on the market; sold everywhere there is electricity, in the home and office; liberal profits; sales-driving sample, weighs a pound, no experience or knowledge of electricity required; it shows how to use one light instead of two and get the same results; sells for \$3.50 and saves the purchaser an investment of \$25. Write for particulars. The Handy Light Co., 112 Handy Light Block, Cincinnati, Ohio.

STOP Canvassing! Make \$10 a day traveling for us without canvassing or selling to retailers. Splendid new plan. Write quick. Ziebarth, 4210 N. Evans Ave., Chicago, Ill.

AGENTS—Make big profits, high-class seller; every auto owner buys; easy to demonstrate; particulars free. National Supply Co., Box 233, Salisbury, N. C.

AGENTS for household article; good recaper; big profits; 10c for sample. Hayman & Campbell, 146½ View St., New Haven, Conn.

HOUSE-TOPS for milk bottles; self-lighting gas tips. Brand new. \$10 made daily. Write quick. Box 157, Waynesboro, Pa.

I WILL instruct you in the mail order business free if you will handle my goods. Crest Co., A., Atlantic City, N. J.

AGENTS Wanted—Right here is the one big chance of your life. If you want to make good money—\$10 a day or more, as easy as rolling off a log, and get your swell clothes free besides, you can do it by acting as our agent. We are the biggest people in the business and want our agents to make big money and be nifty, stylish dressers. Send a postal today for free \$10 outfit, including a big book of nobby suiting samples to select your swell agent's suit from. Then take orders from people who admire your nifty clothes. They come to you—not you to them. This is the way to get rich—the sure, easy way. Remember you need no money—everything is furnished by us free. We pay express on everything. Just send a postal, but do it today. You can't get started too quick, making this big money and wearing these stylish clothes. Address card to Paragon Tailoring Co., Dept. 1114, Chicago, Ill.

HOUSEHOLD Necessity—Saves 80%. Amazing results. Universal demand. Profit 125%. McLaughlan writes, "Averaged \$8.76 daily this summer." Sample 10c. Craig Brothers, Detroit, Mich.

AGENTS make bigger money selling our up-to-date novelty signs. Catalogue free. Novelty Sign Card Co., Desk A2, St. Louis.

AGENTS Wanted—50% more heat from "Coal" when treated with "Fl-o-lite." Try a 25c box, William Brameld, 22 Hopper St., Paterson, N. J.

OUR embroideries, ladies' apparel, hose and neckwear offer permanent income. Catalogue free. O. K. Novelty Co., Jersey City, N. J.

400 PER CENT profit selling "Rabbit-foot" sewing-machine attachment. Sample free to agents. Bunnell, 605 Blake, McFall Bldg., Portland, Ore.

AGENTS to handle an automobile specialty; sells on sight; large profits. Jones Electric and Engineering Co., Perry, Iowa.

AGENTS—I have best selling article on market; real money-getter; sample 10c. Walter B. Barth, Poughkeepsie, N. Y.

"**BOOSTER**" will show you how to make more money! Operate a good, substantial "Income Mail Business." Our "Silent Salesman" system can easily be worked during spare time. Don't invest any money until you read "Booster"—the magazine that has, for years, actually and accurately started others like you in business for themselves by publishing money-making propositions that get the dollars. Send 10c today for two months' trial—it's worth dollars to you. **Booster Magazine**, Northwestern Building, Chicago.

YOUR profit \$4 each sale. Just out, new gasoline saver for autos and motor boats. Guaranteed to save 25 per cent on gasoline bills. Auto owners buy on sight; nothing like it; a sensation. Just 3 sales a day nets you \$12. Territory now being assigned; write quick. The Parsons Mfg. Co., Toledo, Ohio.

AGENTS—Postal brings free illustrated directory; contains details newest, best selling specialties, money-making propositions of responsible concerns. Philip Butler Publishing Co., 123 Cedar St., New York.

RURAL Agents, write for our "10-day free trial offer to prospective agents" on our New Improved 1914 Model Vacuum Cleaner. We pay all express charges. Best and strongest suction cleaner made. Gets both germs and dirt. Guaranteed 5 years. Postal will bring offer. Warner Vacuum Cleaner Company, Dept. "Z," Muncie, Ind.

AGENTS—125% profit selling "Emanel," the best Vegetable Toilet Soap ever manufactured. Emanel Company, Box 965-X, Pittsburgh, Pa.

HAMMER steel attachment, single hand plants nails way up; everybody wants; agents' bonanza, sell wholesale; street demonstrators make \$5-\$10 hour. Sample dime. Large territories; money back. Guillemet, 3529 Mission St., San Francisco.

HURRAH! It's true. \$100 to \$500 a month sure. Want hustling man or woman in each locality—18 to 50 years. No canvassing—easy to do—makes you influential. Simply recommend us to your friends. You don't need high education nor experience—we teach you everything—all or part time. Valuable prize free to first acceptance from each place. Write for yours quick. The I. L. U., 1204 Covington, Ky.

RELIABLE Sales Agents—To sell and introduce Sterling Vacuum Cleaners. Exclusive territory assigned. Sweeper type, hardwood veneered, compact and efficient. Latest labor-saver. Approved Good Housekeeping Magazine. Appearance attracts; demonstrations clinch sales. Ask for proposition. Sterling Vacuum Cleaner Co., Worcester, Mass.

AGENTS Wanted—Automobile owners buy "Watch Dog" Auto Lock at sight. Nothing to install. Just deliver the lock and get the money. Price \$2 each. Cost to you \$7.50 per dozen. Sample sent prepaid for 75c. S. Breakstone, 1718 Michigan Ave., Chicago.

AGENTS average 200% profit. Territory to workers. New ironing wax; Starch gloss; Washing compound; Bluing. Best continuous sellers. Permanent business. E. Leibman, Richmond Hill, N. Y.

Sign Agents—Painters—Something new and better. Attracto ready-made Gold and Silver letters, 21 kinds, easily applied. Make big money lettering store windows, making signs, and selling our line of flashing, sparkling chipped glass name plates. No experience needed. Write for sample letter and catalogue and start at once. Address Attracto Sign Co., 2655 North Clark Street, Chicago.

SALESMEN making small towns whole time or side-line, should carry our fast-selling pocket side-line. Special sales plan allowing return of unsold goods makes quick, easy sales. \$4 commission on each order. Something entirely new. Write for outfit today. **Burd Mfg. Co.**, 212 Sigel St., Chicago, Ill.

WIDE-AWAKE, active agents can secure special concessions and reap benefit from best money-making agency proposition on the market, by writing immediately for full particulars. **Hugo Manufacturing Co.**, 429 South Dearborn St., Chicago, Ill.

AGENTS—Our Wonderful Luminous Crucifix Solves that Christmas Gift Worry. Each crucifix will be put up in an attractive holly box, making same a most appropriate present. Thousands will be sold during the next two months. Let us show you our new "Dark Room" Demonstrating Carrying Case. Write or wire for prices and territory and start the New Year with a nice bank account. **Pioneer Portrait Co.**, 1259 W. 63rd St., Chicago.

SALESMEN—Traveling in Illinois, Indiana and Wisconsin; Good side line; takes only fifteen minutes to make sale; big commission; sample small and compact, weighing but five pounds. **Universal Sales Company**, 509 Harris Trust Building, Chicago.

DO you want to make money? Men—Women—Children. Fifteen cents stamps or cash brings you sure money maker proposition, sample outfit and article every member of your family can use. **Armagine Products Co.**, 116 Bedford St., Boston, Mass.

\$50 TO \$200 weekly. District supervisors who will appoint men, women, children agents for 20 specialties. Something good for every class of agent. Samples worth \$500 furnished without bond or deposit. **Perrine Associates**, Consumers Bldg., Chicago.

\$3,000 A YEAR guaranteed to five agents. 2132 Michigan Avenue, Chicago, Ill. **John A. Doxy**.

EXPERIENCED Agents. Show women how to do a half day's necessary work in 20 minutes. Unique household preparation and original "Entering Wedge" plan makes sales easy and big profits for you. Reliable men and women only. **Jiffy-Brite Laboratories**, Boston, Mass.

IF you want 100% to 500% profit quick, sell our assortment of practical and necessary articles for the home. Not found in any stores. Entirely new line at popular prices. Send today for descriptive catalog and terms to agents. **Specialty Mfg. Co.**, 20 Brigham St., Westboro, Mass.

AGENTS—Every merchant and professional man is a prospect. Sell our complete line of high quality, low-priced Window Letters, Glass Signs, Name-Plates and Wood Specialties. Write to us now for New 48 page catalogue and Sample Letter—Free. **Attracto Sign Co.**, 2655 North Clark St., Chicago.

MAIL order men, dealers who are now handling lightning sellers, tricks, joker articles, will never regret it. Get our wholesale prices. **Japanese Novelty Co.**, 451 6th Ave., New York.

WE furnish you capital to run a profitable business of your own. Become one of our local representatives and sell high grade custom made shirts, also guaranteed sweaters, underwear, hosiery and neckties, direct to the homes. **Write Steadfast Mills**, Dept. 10, Cohoes, N. Y.

\$7.68 PROFIT in half hour with my Creaso-Razor proposition. 25c package; price 10c. **Rudolph, Manufacturer**, Northwestern Building, Chicago.

AGENTS make big money selling Magic Vacuum Massager. Absolutely new. Sells on sight. Exclusive territory. **LaBrier Manufacturing Co.**, Pekin, Ill.

AGENTS—Something new—fastest sellers and quickest repeaters on earth. Permanent, profitable business. Good for \$50 to \$75 a week. Write for particulars. **American Products Co.**, 6718 Sycamore St., Cincinnati, O.

AGENTS—New 10c sellers furnished at 1c each. Send 12c for 10 10c samples. **Wm. Gaskins**, Gainesville, Va.

EMBOSSSED metallic gold sign letters—Instructions for making. Material cost \$1; 4½ inch, 35c. Why pay more? **Johnston Co.**, Quincy, Ill.

IMPROVED Automatic Razor Stripper. Something very fine for \$2. Agents wanted. **Auburn Supply Co.**, Dept. Z11, 7745 Peoria St., Chicago.

AGENTS—Sell 6 pair 25c socks \$1; six months guarantee. Great holiday proposition. Big profits. Write for samples. **Comer Hosiery Co.**, 1 King St., Dayton, Ohio.

COST 3c, sell 15c to 25c. Families buy 12 to 40 sets. Hotels hundreds. Free demonstrating sets. Anyone can attach. Evergrip gliding casters save carpets, floors, furniture. Carried in pocket. Agents earn \$25 to \$100 weekly. **Evergrip Co.**, 20 Warren St., N. Y., Dept. 104.

AGENTS in every town to sell Cinch Tire Repair Kit. Best selling auto article on the market. Large demand for goods; \$25 to \$50 a week; success assured; write today. **Hamilton Specialty Co.**, 615 S. Warren, Syracuse, N. Y.

WANTED—One high-school boy in each city of over 200,000 population to sell my labels for office binders—they are needed in every mercantile office; sell at 50c a dozen, 25 per cent commission. Particulars sent on request. **T. J. Golden**, Jacksonville, Fla.

MR. Mail-Order Man: Get quick returns. Established corporation supplies fast mail-order sellers; factory prices. Classy proposition. Beginners or established firms. Copyrighted Prospectus free. **Mississippi Valley Co., Inc.**, Box N629, Pittsburg, Kans.

SELL something new and in great demand. Savir Stove Lids save half of coal. Thousands used. Agents making big money. Write for free trial offer. **Pre-Heated Air Co.**, Suite 634, 1011 Chestnut St., Phila.

AGENTS—250% profit. Wonderful little article. Sells like wildfire. Can be carried in pocket. Write at once for free sample. **H. Mathews**, 1962 Third St., Dayton, Ohio.

AGENTS—\$5 daily selling our Handy Tool, 12 articles in one. Lightning seller. Sample free. **Thomas Mfg. Company**, 462 Third St., Dayton, Ohio.

NU-TAN-FIN restores old leather bags or shoes. Wonderful results. Wanted in every family. Get agency for your section. **A. Phelps Mfg. Co.**, Providence, R. I.

CASH for names, information, formulas, ideas, etc. Steady home business. Instructive book for stamp. **Information System**, 309 Marietta, Ohio.

AGENTS—Sell high-grade tools. Every man needs them; quick sellers; good profit. Now being advertised. Write or call. **Mid-City Specialty Co.**, 36 W. Randolph St., Chicago, Ill.

AGENTS—\$200 monthly distributing Newell's needle cases. Sell 115 needles in book for 10c and make 200% profit. Approval Plan envelopes make talking unnecessary. Crew managers write. Send 10c for sample book and particulars. **Newell Company**, 509 N. Grand St., St. Louis, Mo.

AGENTS, make money selling our specialties; fast sellers... 100% profit. **A. H. Busch**, Wilmette, Ill.

AGENTS connect with method for preserving health and add many years to your life. No medicines! Send 25c. **E. Inffland**, 877E, Cauldwell Ave., New York.

AGENTS: Our Sign Letters spell the A B C of business success and prosperity. Easy to apply, easy to understand, and dead easy to sell. Free working outfit for agents. Write for samples. **The Forest Letter Co.**, Parisen Building, South Amboy, N. J.

SAMPLE seven cents, great Christmas present, one dollar. **Rose**, 631 Hanover, Baltimore, Md.

\$5 WEEKLY easily made as our Sales Representative for automobile supplies and devices. No experience necessary. Exclusive territory to wide-awake salesmen. **Economy Auto Supply House**, 613 Crilly Bldg., Chicago.

GOVERNMENT Jobs for men and women. \$65 to \$150 month. Common education sufficient. Thousands of appointments every year. Write for free book of positions available. **Franklin Institute**, Dept W22, Rochester, N. Y.

1,000% PROFIT selling our untarnishable gold and silver sign letters. Hundred 4 1/2" letters 90c. Thousand \$8.00. Other sizes accordingly low. Dime brings five 4 1/2" samples. Instructions, etc. Particulars free. H. Alexander, Manufacturer, 980 Third Ave., New York. Established 1905.

AGENTS—Are you interested in 250% profit in an article used in every home weekly? Send 6c for 2 weeks supply and terms. I. V. Washing Tablet Co., Dept. B, Phila.

DID you ever hear of anyone selling Popular 25c Sheet Music at 5c? You can do it, and make 300%. Four samples and proposition, 10c. Chicago Book & Music Co., 535 S. Wabash, Chicago.

MOST Profit—Best Vacuum Cleaner for least money. Our new extraordinary proposition now ready. Write for particulars. Be representative for full line of hand and power machines. Lace-Ometer Co., Adrian, Mich.

SCIENTIFIC Review, 419 First Avenue, N. Y. Great agents' paper—we expose swindlers. Six months, 10c.

WE want in every city branch office manager who can handle agents on commission. Exclusive territory, large profits. Only clean cut men of executive and sales ability wanted. Electric Star Co., Box 1253, Pittsfield, Mass.

AGENTS—Household necessity, recently invented. Costs quarter. Sells at 75c. Hop to this for easy money. Hugro Manufacturing Co., Chicago.

AGENTS—\$50 weekly. We manufacture the best needle case made; a wonderful seller; 200% to 500% profit; talking unnecessary; our "Trust Scheme" Envelopes do the work; general agents can make \$100 weekly; particulars free; 25c sample outfit for 10c; buy direct from the factory. Paty Needle Co., 102 Davis Sq., W. Somerville, Mass.

HAND Power Vacuum Cleaner, carpet sweeper style, straight from carpet sweeper manufacturers of 13 years' standing and worldwide reputation. Sells on 2-minute demonstration to any housewife. Runs easy as a carpet sweeper and like one. Write for agents' terms. National Sweeper Co., 16 Laurel St., Torrington, Conn.

SALESMEN—Working for us means cash in your pocket every day; Household Device; duplicate orders; profits big, experience unnecessary. Write immediately. Specialties Supply Co., No. 31 Willoughby Street, Brooklyn, N. Y.

WANTED—A man or woman all or spare time to secure information for us. Work at home or travel. Experience not necessary. Nothing to sell, good pay. Send stamp for particulars. Address M. S. I. A., 11 L Bldg., Indianapolis, Ind.

YOU can't afford to accept ordinary proposition while agency for Guaranteed Aluminum Cooking Utensils is open. Answer quick. Protected territory, American Aluminum Mfg. Co., Dept. P.M., Lemont, Ill.

\$35 TO \$100 weekly made easily. Needed in every home and store; enables purchaser to save money and enjoy life. Rapid seller, profit from \$10 to \$50 each sale. Experience unnecessary; exclusive territory to hustlers. Write for full particulars. C. Hemple, Sales Mgr., 174-C, No. Sangamon, Chicago.

REMNANT Store, 1331-E, Linn, Cincinnati. Greatest Dry Goods Bargains on Earth. For agents and store-keepers.

FULLER Dustless Floor and Wall Mop, with adjustable handle, and hand duster are indispensable to housekeepers—sell at sight—100 per cent profit to agents. Write today. Fuller Brush Co., 55 Hoadley Pl., Hartford, Conn.

THEODORE Roosevelt is again writing for Scribner's Magazine. Subscription solicitors can earn big commissions. Inquire Desk 15, Scribner's Magazine, 597 Fifth Ave., New York.

\$20-\$40 WEEKLY selling guaranteed Hosiery, Underwear, Sweaters, Neckties, Handkerchiefs. Credit. Samples free. Sales Manager, Room 811, 366 Broadway, N. Y.

AGENTS Wanted—A brand new 25c household article that will clear you \$10 per day for the next 6 months. Write quick. J. S. Ziegler Co., Chicago.

AGENTS—Weeping Doll, patented, very laughable. Lemon Company, Brighton, Mass.

500% PROFIT selling our wonderful sign letters for office windows, store fronts and glass signs; resembles finest gold leaf; easily applied; samples free. Metallic Letter Co., 406 N. Clark St., Chicago.

HOSIERY; knit ties; sample free. Sutton sold gross each week besides hosiery. 100% profit; appoint sub-agents, develop permanent, profitable business. Credit. Colby Hosiery Mills, 2832 Kensington Ave., Philadelphia, Pa.

BOKARA Diamonds—Agents, everyone, to wear and sell our famous Bokara Diamonds. Write for sample offer and catalogue free. Northwestern Jewelry Co., 2141 Summerdale Ave., Dept. 28, Chicago.

READ the Agents' Magazine. Make more money. 2 months, 10c. Agents' Magazine, Chicago.

SEL' threading needles. 10c a paper. Agents' samples and terms free. Ladies' Art Co., Dept. 41, St. Louis, Mo.

AGENTS—To introduce Oxo-Gas; a wonderful new invention; a complete individual gas plant for lighting, cooking, heating; cheaper to install and operate than any other known fuel. For cooking it is cheaper than coal or wood. For lighting it is cheaper than a common kerosene oil lamp. The most brilliant light known to science. Gloria Light Company, 1281 Washington Blvd., Chicago, Ill.

BE Our Agent. We make the best Vacuum Sweeper manufactured. Women are crazy for them. We will sell you one at lowest agent's prices. Test it at home. Show it to other women tired of sweeping, dusting, etc. Take their orders and make money for yourself. Write at once for agency terms. The Junior Vacuum Cleaner Co., Dept. A, Bradford, Pa.

AGENTS in every city to handle our Triplex Folding Handbag; big profits; exclusive territory. Write for terms and free catalog. Other big sellers, S. V. Diamond & Bro., 35 West 21st St., New York City.

WE are the largest manufacturers of Twisted Wire Brushes in America. Highest grade goods, best service, highest profit. Write for our new catalog. You are sure to win. Fuller Brush Co., 33 Hoadley Place, Hartford, Conn.

(CELLULOSIA) Door Plates, new lettering pure gold. Send for sample case. Nothing invested, 100% profit, sell to every house. Public demands them. La Fontaine, Mfr., Sherburne, N. Y.

AGENTS wanted for a new household labor saver. Quick seller. Big profits. Cary-Dane Co., 102 West 101st St., N. Y.

YOU can be your own boss with our Key Check Outfit. Good for \$5 a day stamping names on pocket key checks, fobs, etc. Sample check, with your name and address, 15 cents. Pease Die Works, Dept. M, Winchester, N. H.

AGENTS—Handkerchiefs, Dress Goods. Carleton made \$8 one afternoon; Mrs. Bosworth \$25 in two days. Free Samples. Credit. Stamp brings particulars. Freeport Mfg. Company, 59 Main St., Brooklyn, N. Y.

400% PROFIT selling our high grade work. Samples free. Gordon Co., Northwestern Bldg., Chicago.

AGENTS—Salary or commission. Greatest seller yet. Every user pen and ink buys on sight, 200 to 500 per cent profit. One agent's sales \$620 in six days; another \$32 in two hours. Monroe Mfg. Co., X 6, La Crosse, Wis.

AGENTS sell rich-looking imported 36x68 rugs \$1 each. Carter, Tenn., sold 115 in four days, his profit \$57. You can do as well. Write for sample offer and selling plan. Sample rug by Parcel Post, prepaid, 98c. A. Condon, Importer, Stonington, Maine.

SILVER'S Ten Best Sellers are big business builders for agents. New, novel; every home a customer. Immense profits for agents who act quickly. Write today. Silver-Chamberlin Co., Dept. M, Clayton, N. J.

ABSOLUTELY Free for 30 days only. One dozen guaranteed U. S. Fire Extinguishers with order for 3 dozen. Special offer to one representative in each section. United Mfg. Co., 1025 Jefferson, Toledo, O.

AGENTS to take orders for visiting and business cards; large commission; outfit free. Forman Printery, Waterbury, Conn.

AGENTS make big money selling our new gold letters for office windows, store fronts and glass signs. Any one can put them on. Write today for free sample and full particulars. Metallic Sign Letter Co., 406 N. Clark St., Chicago.

AGENTS wanted for oriental novelties. Never before introduced. Quick sellers. Repeaters. Immense profits. Particulars free, or samples 25c. Kanematz, Box H-529, Portland, Oregon.

PERFECTION Pocket Adding Machine. Lightning seller. Agents wanted. Cincinnati Specialty Mfg. Co., Dept. R, Cincinnati, Ohio.

AGENTS make \$5.00 to \$10.00 a day on the start. Atkinson writes: "The best proposition I have found in my forty years canvassing." Permanent work. Household necessity. Saving 80%. Write to-day for General or Local Agents terms. Free sample. C. H. Stuart & Co., 16 Union St., Newark, New York.

MEDALLIONS—300% profit. Make up your own goods and be independent. Catalogue free. Resag Co., 1205 Randolph St., Chicago.

AGENTS make \$30.00 weekly selling our 500 Handy Household Articles; catalogue free. Scheff Company, Des Moines, Ill.

AGENTS Wanted—Mechanics and shopmen make over \$100 a month in spare time selling transparent handled novelty knives and razors. Big profits. Sales easily made. Write for terms today. Novelty Cutlery Co., 67 Bar St., Canton, O.

YOU can make \$\$\$\$ as our general or local agent. Household necessity; saves 80 per cent; permanent business; exclusive territory; salary or commission; free sample; credit. J. Pitkin, 113 Redd St., Newark, N. Y.

STOP Here! Let me start you in a home business that will bring you money every day. Experience unnecessary. Spare time. No canvassing. I furnish everything and guarantee success. Send for proofs, Voorhies, Desk C. R., Omaha, Neb.

AGENTS Wanted—Men and women to sell "Sun" Self Heating Irons. An extraordinary opportunity to make big money by devoting whole or part time to a dignified, congenial business, established for years. Strictly high-grade, simple and indestructible. Thousands in use. Every sale makes many more sales. "Sun" Irons sell themselves. Women buy at sight. A penny's worth of gasoline or alcohol is sufficient for an entire family ironing. We manufacture and guarantee every iron. Write quick. Address, The Modern Specialties Mfg. Co., 109 High St., South Bend, Ind.

DIAMONDS, WATCHES AND JEWELRY

RIGHT now is your opportunity—one that occurs but seldom in a lifetime—to secure a diamond at the very lowest price. Act quick before the new tariff law raises the price! Genuine perfect cut diamonds, \$97.50 per carat. Sent on approval without obligating you. Remarkable Money-Back Guarantee given. Read our big ad, page 111. Free De Luxe Diamond Book contains full information. L. Basch & Co., Dept. G240, State and Quincy Sts., Chicago.

RELIABLE Watches and Jewelry from a reliable house. 72-page catalogue for stamp. Kelleher Bros. & Sullivan, 76 Front St., Worcester, Mass.

GOLD Nuggets \$1. Beautifully cut turquoise 50c. From mines to customer. Lists free. Paris Bush, Hanover, New Mexico.

TIME and Its Measurement—An unusual book, being a readable and instructive history of time measurement from the sun dial of remote ages down to the clock period and the present day. Of interest to everyone connected with horology and contains much information not available elsewhere. Written by a great authority who has made this study a hobby. Price in cloth binding \$1.50 postpaid. Popular Mechanics Book Dept., Chicago.

TELEGRAPHY

TELEGRAPHY—Morse and Wireless—Railway Accounting (Station Agency) taught quickly. Railroad and Western Union Wires and complete Wireless Station in school. Big demand. Positions secured. Living expenses low—may be earned. Largest and oldest school—established thirty-nine years. Investment, \$25.-000. Correspondence courses, also. Catalogue free. Write today. Dodge's Telegraph Railway and Wireless Institute, 15th Street, Valparaiso, Ind.

TELEGRAPHY taught in the shortest possible time. The Omnigraph Automatic Transmitter combined with standard key and sounder. Sends you telegraph messages at any speed just as an expert operator would. Five styles, \$2 up, circular free. Omnigraph Mfg. Co., 41 G. Cortland St., New York.

HELP WANTED

YOUNG man, would you accept and wear a fine tailor-made suit just for showing it to your friends? Or a Slip-on Raincoat Free? Could you use \$5 a day for a little spare time? Perhaps we can offer you a steady job. If you live in a town smaller than 10,000 write at once and get beautiful samples, styles and this wonderful offer. Banner Tailoring Company, Dept. 561, Chicago, Ill.

\$3,000 YEARLY in your back yard; no Ginseng, mushroom dope. "Poultry Pointers," with its "Egg Schemes" and city lot "Side Issue Plans," is creating excitement and making money for its subscribers. Nothing else like it on earth; in a class by itself. Let this Magazine and its editors "boost" you to success. Two months' trial subscription, 19c. Poultry Pointers Pub. Co., 55 Fuller Bldg., Kalamazoo, Mich.

MACHINISTS—Mechanics—Rapid Reference. Greatest time-saver ever. For drills, taps and pipe taps threads per inch. Tapers for lathe planer shaper and double-depth threads, 64ths, 32nds, 16ths, 8ths. Registers instantly right down in thousandths. Money-back proposition. Price \$1. Emmelmann Bros. Mfg. Co., Indianapolis, Ind.

I WILL start you earning \$4 daily at home in spare time, silvering mirrors; no capital; send for free instructive booklet, giving plans of operations. G. F. Redmond, Dept. 306, Boston, Mass.

WANTED—Persons to do easy, pleasant coloring work at home. Good pay. No canvassing. No experience required. Illustrated particulars free. Helping-Hand Stores, 5458A, So. Halsted, Chicago.

MAGAZINE Solicitors for subscriptions to leading monthly publications offering premiums of silverware and cut glass. References required; old established house. Justice, 607 Chestnut, Philadelphia.

YOU can earn Big Money in the Cleaning and Dyeing Business; I will start you in your home town. Pleasant work. Small capital. Free particulars, John H. Baylies, Baltimore, Md.

LOCOMOTIVE Firemen, Brakemen, wages about \$100; experience unnecessary. Send age, stamp. Railway Association, Dept. 89, 227 Monroe St., Brooklyn, N. Y.

WANTED—Investigators and Detectives. \$150.00 to \$300.00 per month. Some traveling positions. Free particulars. National Detective Agency, Dept. W17, Chicago.

CIRCULAR Mailing is light, pleasant work for spare time; no experience or canvassing; send name; begin making money at once. Raymond, 100 Roxbury Crossing, Mass.

CAPABLE and efficient man who thoroughly understands the working of automatic screw and thread cutting machines, to represent a large oil company manufacturing cutting oils. Executive and selling ability necessary, so as to be able to approach the larger users of these products. Excellent opportunity to right man. State age, experience and references. Address P. O. Box 404, Newark, N. J.

GOVERNMENT Jobs for Men and Women. \$65 to \$150 month. Common education sufficient. Thousands of appointments every year. Write for free book of positions available. Franklin Institute, Dep't W 21, Rochester, N. Y.

WANTED—Ambitious workmen. Your work on actual jobs pays for teaching trade of electricity, automobiles, plumbing, bricklaying. Only few months required; 700 students last four years. Write for information. United Trade School Contracting Co., Los Angeles.

ANY intelligent person may earn good income corresponding for newspapers. Experience unnecessary. Address Press Correspondence Bureau, Washington, D. C.

MEN and Women over 18 wanted for U. S. Government positions. \$65 to \$150 month. Thousands of appointments this year. "Pull" unnecessary. Farmers eligible. Common education sufficient. Write for free book of positions open to you. Franklin Institute, Dep't W 21, Rochester, N. Y.

GET prepared for Government "Exams" by former United States Civil Service Secretary Examiner. Like Popular Mechanics, I offer no premiums, have no "Positions Guaranteed" or "Coaching Free" Schemes. Straight propositions. Booklet C without obligation. Write now. Arthur R. Patterson, Rochester, N. Y.

GET a Government Job. List of positions obtainable free. Write Franklin Institute, Dep't W 21, Rochester, N. Y.

CASH for name, information, ideas, formulas, etc. Steady home business. Instructive booklet for stamp. Nat'l Information System, 310 Marietta, Ohio.

LOCOMOTIVE Firemen, Brakemen; Wages about \$100; experience unnecessary. Send age, stamp. Railway Association, Dept. 89, Brooklyn, N. Y.

BETTER Light for 1/5 Cost of Electricity. Suitable for home or store. Easily installed, no experience necessary, big demand. Write for Free catalogue. Doud Lighting Co., 174-D, N. Sangamon, Chicago.

I WANT a man as local manager who is accustomed to earning big money. Must be reliable and well connected. Can show such a man how to clear \$100 every week this winter. C. Gilbert, Suite 629, 1011 Chestnut St., Phila.

BECOME Detectives—Earn \$150-\$300 monthly. Easy work. Write Wagner, 1243 Lexington Avenue, New York, Dept. 451.

GET Government Jobs. List of positions free. Franklin Institute, Dep't W 21, Rochester, N. Y.

WRITE for free list Government jobs open to you. \$65 to \$150 month. Franklin Institute, Dep't W 21, Rochester, N. Y.

DO you want to travel and distribute advertising matter? If so, my instruction book, "How to Get on the Road as Traveling Advertiser," will cost you only 25c (silver). P. Breeden, Box 938, Norfolk, Va.

MAKE money writing short stories. Big pay. Free booklet tells how. United Press Syndicate, San Francisco.

A MONEY Proposition: Do you want to co-operate with me in a profit-sharing mail-order business? I will furnish the printed matter, advertise in several papers, furnish goods to fill orders for one-half the profits. Write for particulars. Desk 617, Hazen A. Horton, Tekonsha, Mich.

YOU men who want to succeed. Write today for Free literature. Hundreds of opportunities. E. Jerald Sons, Box 551, Providence, R. I.

OUR clever, workable plans are worth many dollars to anyone seeking a better position. 25c postpaid. Eastern Specialty Company, Addison, Maine.

\$65 to \$150 month paid men and women. Government jobs. List of positions available free. Franklin Institute, Dep't W 21, Rochester, N. Y.

BE a Detective—Earn \$25 to \$75 weekly; chance to see the world with all expenses paid. Loraine System, Dept. 304, Boston, Mass.

LEARN automobile repairing, driving on up-to-date cars; electrical, civil engineering, surveying; methods most practical; room and board while learning; positions secured; satisfaction guaranteed; catalog free. National School of Engineering, 2110 West Seventh, Los Angeles.

WRITE Moving Picture Plays, \$10 to \$100 each. Constant demand. Devote all or spare time. Experience, literary ability or correspondence course unnecessary. Details free. Atlas Publishing Co., 3045 Atlas Bank Bldg., Cincinnati, Ohio.

GO on the Stage. Vaudeville career offered you. Experience unnecessary. Managers endorse my method. Instructive vaudeville book free. Write today. Fredric LaDelle, Sta. 10, Jackson, Mich.

BE a Detective. Earn \$200 monthly, positions open. A practical course in Detective Work taught by mail. American School of Criminology, Detroit, Michigan. Dept. F.

STOP Here! Let me start you in a home business that will bring you money every day. Experience unnecessary. Spare time. No canvassing. I furnish everything and guarantee success. Send for proofs. Voorbies, Desk C. R., Omaha, Neb.

GOVERNMENT Examinations. Most thorough preparation; \$5; returned if not appointed; particulars free. American Civil Service School, Washington, D. C.

ENGINE CASTINGS AND BLUEPRINTS

MECHANICS—and Handy Men, build your own 2 hp. water-cooled gasoline engine. Complete sets of rough or machined castings. Send 10c for photo, blueprint, and catalogue. Vigneau Mfg. Co., 501 Biddle Bldg., Detroit, Mich.

FOUR sizes gas engines—electric vacuum cleaner. Castings and completely dimensioned drawings. J. D. Wallace, 525 W. Van Buren St., Chicago.

GASOLINE Engine Castings, with drawings. Cheap. Catalog for stamp. Novelty Manufacturing Co., 853 West 6th St., Cincinnati, Ohio.

MACHINERY, TOOLS AND SUPPLIES

BELTING—We buy and sell old leather belting. We have a special process for making over old belts. Write us. F. Rantville Co., Leather Belt Makers since 1874. Grand Rapids, Mich.

NEARLY new Efficiency woodworker, with gasoline power. Jig-saw, boring machine, sander, shaper, dado, cross-cut attachments. Cost \$425, will sell \$225. Act quick for this. Howard Cruiser Wks., Westfield, N. Y.

FOR Sale—B. case rock crusher. Used 3 weeks. Cost \$1,250. Take \$900. See or write Mrs. A. Wirz, Seymour, Tex., for information.

14 in. x 5 ft. LATHES, 3 hp. engine, cheap. 1714 Myrtle St., Erie, Pa.

MILLING Machine \$100. Table 5x12. Photograph for stamp. M. Stockwell, Geneva, N. Y.

FOX Lathe, 15x36 in. countershaft, screw-cutting attachment, chuck, \$55. C. C. Heyder, Hansford, W. Va.

PULLEYS, Gears, Sprockets, Shafting, Hangers; see page 139. W. A. Jones Foundry & Machine Co., Chicago.

WANTED—To buy a four-slide wire-forming machine. State name, number and stroke. Carolina Washboard Co., Raleigh, N. C.

FOR Sale—A 30 horsepower steel boiler nearly new; insurable for 100 lbs. steam. It must sell. G. B. & C. M. Griffin, Charleston, Ill.

CONCRETE Mixer—Combination power and hand machine. C. L. Harrison, First National Bank Bldg., Cincinnati, Ohio.

FOR Sale—8-inch Robinson Cornice Brake, No. 14 gauge, nearly new; cost \$415. Price \$185 cash. Western Mach'y Co., Cincinnati, Ohio.

\$25 BUYS a fine little 1 h.p. steam engine and boiler, automatic, or will trade for antique goods. Steinforth, Winthrop, Mass.

FOR Sale—One 13 h.p. Horizontal Gasoline Engine, Charter make. James Gould Co., Albany, N. Y.

ETCHED Brass Name-plates (2x3), 10 for \$1. 40—\$2. 100—\$4. Otto Bonnell, 3847 Calumet Ave., Chicago.

WANTED—Air-cooled and water-cooled gasoline motors 4 cylinder, 4 cycle, about 3 inch bore by 4 inch stroke. Send full particulars and prices to H. C., 6th floor, 318 W. Washington St., Chicago.

HOW to Run a Lathe. A 50-cent book for 10 cents postpaid. S. B. Lathe Works, South Bend, Ind.

WE have 100 steam and gas engines for sale. \$12 to \$300 each. Send for list No. 26. Lucas & Son, Bridgeport, Conn.

PATTERN makers! A book devoted to the principles of pattern and core making and molding. Written by G. H. Willard, a practical pattern maker of years' experience. This book, just published, treats the subject in a much more simple, direct and effective manner than most books along this line. 224 pages, 312 illustrations. Price \$1 postpaid. Popular Mechanics Book Dept., Chicago.

SERIES of 8 lithographic models—Steamship, automobile, locomotive, gas engines, steam engine, steam turbine, wireless telegraph and dynamo. Size 8x14 inches. All parts of these machines are shown and numbered to correspond to printed keys of names. Price each, 50 cents, postpaid, or set of 8, \$3.50, postpaid. Popular Mechanics Book Dept., 318 W. Washington St., Chicago.

ENGINE Lathe, swings 9 1/2", takes 25" between centers. Complete set gears cutting all size threads 3" to 40", \$43.50. Grammes & Sons, Allentown, Pa.

FOR Sale—Gasoline engines, automobiles, marine and stationary, also castings. Second-hand ones taken in exchange and for sale. Apply with stamps. B. W. Richardson, R. No. 36, Peoria, Ill.

REBUILT Engines—We have on hand a number of rebuilt "Buffalo" engines, guaranteed, at greatly reduced prices. Write for bargain list. Buffalo Gasoline Motor Co., 1293-1305 Niagara Street, Buffalo, N. Y.

FLOUR & FEED MILLING MACHINERY

SPECIAL bargains in second-hand: Attrition mills, burr mills, crushers, corn shellers, bran dusters, dust collectors, purifiers, reels, double, single, 2 and 3-pair high roller mills, sieve bolters, receiving separators, scourers, etc. Write for description and prices. Sprout, Waldron & Co., P. O. Box 429, Muncy, Pa.

MANUFACTURING MACHINERY

INVENTIONS Perfected; Working Models Made; Dies, Tools, Special Machinery. Free Booklet. Black Diamond Mfg. Co., Cincinnati, O.

SPECIAL Machinery; Tools; Patterns; Models; Inventions Perfected; General Manufacturing. Regal Model and Tool Works, Chicago.

WIRE Goods, all kinds, made to order. Cooley Mfg. Co., 553 W. Monroe St., Chicago.

MODELS made for inventors; general machine work; designing and perfecting; developing automatic devices and machinery. In a position to do all kind of light tool and machine work. Prices reasonable; estimates cheerfully given. Ideal Machine Works, 62 Ann Street, New York City.

WE make working models for inventors; also dies and stampings of specialties, and carry a complete stock of brass gears and model supplies. Send for catalogue. The Pierce Model Works, 3465 Pierce Ave., Chicago, Ill.

IRON brass and aluminum castings. Metal specialties. Patterns, models, polishing, plating and japanning. Send for catalogue of pattern shop and model supplies. North Chicago Tool Works, 15 Grove Ave., North Chicago, Ill.

MECHANICAL ENGINEERS

MECHANICAL and Consulting Engineer. New Ideas developed, Machines and Jigs designed for special work. Advice given on all Mechanical Devices and Inventions. A. J. Lunde, 510 College St., San Francisco, Cal.

MACHINE designing, working drawings, inventions developed. R. O. Muller, Mechanical Engineer, Star Bldg., Washington, D. C.

BOATS AND LAUNCHES

BACK Rest for boat seats; only practical one made; sheet steel, light, strong, collapsible for grip. \$1 mail. Paragon Specialty Co., South Bend, Ind.

CHART of a modern submarine boat showing and naming over 200 parts. Size, 14x28 inches. Printed on plate paper. Shows clearly and distinctly all the interior. Mailed in a tube for 25c. Popular Mechanics Book Dept., 318 W. Washington St., Chicago.

MOTORCRAFT Encyclopedia—A 150-page book that tells 1001 things every motor boatman should know. How to overcome engine troubles. Price \$1, postpaid. Popular Mechanics Book Dept., Chicago.

BLACKSMITHS

BLACKSMITHS—Learn hand-wrought ornamental ironwork. Our 200-page book "Hand Forging" points out clearly all the guiding principles and methods which underlie all forge work. Written by a practical authority. 122 illustrations, cloth, \$1 postpaid. Popular Mechanics Book Dept., 318 W. Washington St., Chicago.

SHOP Notes—Many valuable kinks for blacksmiths are contained in our series of Shop Notes books, 9 volumes, 50c each postpaid for \$4.50 per set prepaid. Popular Mechanics Book Dept., 318 W. Washington St., Chicago.

BLACKSMITHS—Here is your opportunity to be an expert blacksmith without help as life is short. Try Toy's Modern Methods doing hard jobs easy. Forging and welding all kinds of steel solid, and tempering and hardening all tools to a standard by colored charts. This is real information, not theory. All for one dollar. Send for free samples. W. M. Toy, Sidney, Ohio.

WANTED

WANTED—United Cigar Store Coupons; 90c per hundred paid immediately upon receiving coupons. H. Latz Co., Atlantic City, N. J.

WANTED—Second-hand, twelve-foot Rug Loom. Rug Weaver, Box 87, Millbrook, N. Y.

WANTED—\$7,000 at 6% interest. Payable semi-annually. Security, first mortgage on improved property. Layland Bros., Cleburne, Tex.

WANTED—Capital to manufacture and market great invention. J. S., care Walls, 1358 Ridge Ave., Phila., Pa.

MOVING Picture Outfit. Fred Smith, Amsterdam, N. Y.

PARTNER wanted to assist in developing an invention of merit. Germain Rousset, 801 Diamond Bank Building, Pittsburgh.

FOR SALE

FOR Sale—Electrical Contracting, Supply and Fixture Business at Boulder, Colorado; population 15,000. The Silver State Electric Co., 222 15th Street, Denver, Colo.

\$50.00 WORTH gold plated jewelry, etc., new stock, for \$15. 6x9 side lever printing press, 25 fonts type, complete outfit, fine condition, for \$50. Ross, 378 Front St., New York.

FOR Sale—Manufacturing, Foundry and Plating Business; good reasons for selling. George Addenbrook, 1321 14th Street, Denver, Colo.

PRINTING Press, Typewriter and Post Card Camera, cheap. Advance, Rolling Prairie, Ind.

YOU can purchase a fountain pen for only 55c. Self-filling, unbreakable. Guaranteed absolutely. Sterling Supply Co., Toronto, Canada.

FOR Sale—Fine bull moose and bull elk heads, cheap. Reuben Saylor, 497 So. Broadway, Dayton, Ohio.

FOR Sale—Painters and Trimmers stand, adjustable any position; patented. A. A. Conarroe, Modoc, Ind.

POPE-TRIBUNE, 12-horse, double cylinder, vertical engine, weight 300; all equipment good condition, \$39. Rubel Louisville Ky.

FOR Sale Cheap—Moving picture machine, pipe organ, four-cylinder gasoline engine, 18 hp., 1 K.W. 50-volt D. C. dynamo, all in good order. Emil Meurling, Reynolds, Ill.

POWER blacksmith shop in rich farming country; good business; good prices. C. W. Rowland, La Place, Illinois.

MECHANICAL Movements—Suitable for moving demonstrations, mechanical electric clock switches. Brass gears accurately balanced. No lost motion. Each, parcels post, ninety cents. Six \$4.80. Frasse, Box 801, Brooklyn, N. Y.

FOR Sale—State rights for the great Panama Canal Puzzle, including necessary equipment for manufacturing. Greatest puzzle of the age. Panama Puzzle Co., Catawissa, Pa.

SALE OR EXCHANGE

HAVE set watchmaker's tools; want motorcycle, graflex camera or offer. Howard Rogers, Sidney, Ill.

SALE or Exchange—Cabinet Phonograph, Violin, Dynamo. Wanted—Gasoline Engine. Raby, Norvell, Mich.

SALE or exchange for 1913 motorcycle, patent on household article. H. K. Dial, Tifton, Ga.

PATENT ATTORNEYS

PATENTS secured; reliable service; highest references; personal preparation and prosecution of all cases; don't write if you want something for nothing; terms very reasonable; inventions of merit meet with success; associate offices in Washington, New York, London and Berlin; send sketch today; 4c postage brings my latest book, "The Last Word on Patents," by Sanders, 7 Crilly Building, Chicago, Ill.

ON patents, consult Benjamin Roman, Park Row Building, New York.

PATENTS—\$30 protects your invention 1 year and applies on cost of patent. John J. Thompson, Pat. Atty., Lancaster, Pa.

"MY First Invention" story gives "inside" information on patenting and marketing inventions. Advice worth thousands. Thomson, Patent Attorney, 366 Easton Bldg., Boston, Mass.

INVENTIONS Worth Thousands—Their value is governed by the strength of the patent. Get the advantage of our 39 years' experience in procuring your patent. Clients in your state. Write and send sketch. Louis Bagger & Co., 609 Barrister Bldg., Washington, D. C.

PATENTS Secured—Take advantage of my personal experience; send sketch or model. Get my free book containing 209 mechanical movements. W. N. Roach, Jr., 956 McGill Bldg., Washington, D. C.

PATENT Books Mailed Free—Showing 100 mechanical movements invaluable to inventors and mechanics—and telling what is patentable, how to obtain patent or partner, how to sell, etc. Free on request. Chas. E. Brock, 701 Eighth Street, Washington, District of Columbia.

PATENT secured or fee returned. Send sketch for Free Expert Search and report as to patentability. Books on inventions and patents, and reference book sent free. John S. Duffie & Co., 605 F St., Washington, D. C.

REGISTERED Attorneys make our searches. Send sketch for free report. No Attorney fees until patent allowed. Free books. Fuller & Fuller, Washington, D. C.

PATENTS explained in my free books, telling what you should know—what to invent—what not to invent—how to sell your patent, etc. Write today, H. L. Woodward, 902 G. St., Washington, D. C.

PATENTS, electrical and mechanical a specialty. Book Free. Joshua R. H. Potts, Patent Lawyer, 8 Dearborn St., Chicago; 805 G. St., Washington; 929 Chestnut St., Philadelphia.

FOR honest advice and real patents at low cost, consult John O. Seifert, Patent Attorney, 50 Church St., New York, N. Y.

PATENTS—Herbert Jenner, patent attorney and mechanical expert, 606 F St., Washington, D. C. I report free of charge if a patent can be had and its exact cost. Send for circular.

C. L. PARKER, Ex-member Examining Corps Patent Office, Patent Attorney, 910 G St., Washington, D. C. Inventor's handbook "Protecting, Exploiting and Selling Inventions," sent free upon request.

PATENTS that protect and pay. Advice and books free. Rates reasonable—highest references; best results. Watson E. Coleman, Patent Lawyer, 622 F St., N. W., Washington, D. C.

FOR INVENTORS

BEFORE spending money on patent or model, get free opinion of successful manufacturers. You are fully protected meanwhile. Van Deventer and Warren, Sumter, S. C., Patent Attorneys, Development Engineers especially. Write us first. Electrical inventions especially.

WANTED—A few good inventions to patent and market on shares. Inventors' Mutual Development Association, 303 Potomac Bank Bldg., Washington, D. C.

INVENTORS: My patent made a fortune. Particulars free. Let me sell yours. Eugene Pearl, 23 Union Square, New York.

WANTED—An idea for cash. Patent News, Washington, D. C.

INVENTIONS patented free. Marketed on commission. Address, Inventors' Agency, Chicago.

DRAWING—Patent, mechanical, illustration, map; blueprinting, perspectives. San Jose Drafting Co., San Jose, Cal.

WANTED—Inventions; patents sold; highest references. Higgins, 504 Crilly Bldg., Chicago.

PATENTS without advance attorney's fees. Send sketch for free report. Books free. Fuller & Fuller, Washington, D. C.

PATENTS, Trade-Marks and Copyrights. Our hand book on patents will be sent free on request. All patents secured through us are described without cost to the patentee in the Scientific American. Munn & Co., Patent Attorneys, 359 Broadway, New York, Washington, D. C. office, 283 F Street.

PATENTS sold. We do the business—not merely collecting advance fees. If you own a valuable patent send for a free booklet. "How I can get cash for your invention." No charges made for listing. Patent Advertising & Sales Co., Frankfort, Phila.

PATENTS FOR SALE

MANUFACTURERS: I will sell outright my photographic game board, wonderful novelty. A great trade booster. Particulars free. Albert E. Naldreit, 241 Center St., Bloomsburg, Pa.

BEST offer takes Patent 1031989. Clothes Dryer and Rack; nothing like it. Send for circular. Dudley, 97 High St., Boston.

UNITED States Patent for Waste Pipe Tool, No. 874512, for sale. A good hardware article and a handy tool for plumbers. For information, address Benjamin & Bassett, 140 S. Dearborn St., Chicago.

PATENT 1003802, sanitary closet seat. Original. Cheap. W. Rosenberger, Hagerstown, Md.

TOOL for battered threads on pipe, one piece of metal for five sizes, male and female, good mail-order to sell mechanics. Patent allowed. L. H. Atwell, Grove City, Pa.

PATENTED—Improved Dish-Washer. Sell cheap. Coin money. Krieger, Wooster, Ohio.

COLLAPSIBLE ice creeper, made of spring steel. Nothing on the market its equal. United States and Canada patents. Best offer accepted. Henry Foltz, Sharon, Pa.

ATTENTION, Household Specialty Manufacturers: Patent Lace Curtain Hanger. Very simple. Big demand possible by proper advertising. Cheaper and better than curtain poles. J. Garfield Hughes, Newark, Ohio.

FOR Sale or Royalty—Safety Razor Strop; patent pending August, 1913. solves the stropping problem of safety razor blades. "The best yet." Address: Bowman & Farmer, 24 W. First St., Tulsa, Okla.

FERTILIZER distributor and seed sower combined. U. S. No. 1011071. Canada No. 142439. Spring Railroad Tie, U. S. No. 1046480. Louis Mehlberger, General Delivery, Detroit, Mich.

PATENT for Sale Cheap—Miner's folding adjustable candle holder; practical, excellent decree. Otto A. Poirier, Virginia, Minn.

PATENT on hand-operated vacuum cleaner. Absolutely new principle. Built for \$1, \$2,000. T. R. Sigafos, 824 E. 29th Ave., Denver, Colo.

FOR Sale—Canadian patent No. 144031. Oil Cans for oiling flat surfaces, such as saws. Hans L. Larsen, 1350 W. Erie St., Chicago, Ill.

PATENT Hand Warmer for automobile steering wheel. United States and Canada. \$15,000. A. Youngs, Newburgh, N. Y.

PATENT for sale cheap. Poultry appliance. Money maker. Address Box 55, Amanda, Ohio.

REAL ESTATE AND FARM LANDS

"**FOLLOW** the lead of wise buyers"—Go to Los Indios, Isle of Pines—the beautiful, fertile, American inhabited tropical island only 180 miles from Key West, Fla. June climate year round—no frosts. Abundance of rain—no irrigation. Big profits in oranges, lemons, grape-fruit, pineapples, etc. American stores, schools, churches, banks, newspapers, etc. Our lands surround Los Indios, the only deep-sea harbor on the island. Unusual opportunity for home or investment. 10 acres will make you independent. Easy terms. Prices now low—land rapidly increasing in value. Titles guaranteed. Write for our free publication "The Ideal Home Monthly." Canada Land & Fruit Co., 117 Wisconsin St., Milwaukee, Wis.

FOR Sale—160-acre farm on easy terms, situated near Flasher, Morton county, North Dakota. In energetic hands this property can be greatly increased in value in short time. Present owner has no time to give proper management. For complete information address Mrs. Elizabeth Burt, Apartment E, 839 West End Avenue, New York City.

FLORIDA Home-Seekers and Investors can secure valuable information on Florida crops, climate, soil, schools, etc. Many business openings and some low-priced land in this vicinity. Address, Secretary, Chamber of Commerce, Lake Worth, Palm Beach County, Florida.

SIXTY-Acre farm. Fertile soil, neither rocky nor swampy. Arkansas ten hours from St. Louis; very reasonable. Lohse, 229 W. 46th St., New York City.

DON'T pay rent—Buy Southern Land—buy all you can—prices now extremely low—natural increase will return your money in a few years—well farmed, annual profits will run even more. Dairying, live stock, poultry, fruit and truck—these are a few of the big money-making lines. Write now for "Southern Field" Magazine and land lists. M. V. Richards, Land and Ind. Agt., Room 64, So. Ry., Washington, D. C.

BARGAIN, \$1,800. Must sell; too old to continue business: 1/2 cash, bal. 5 years 6%; two cottages, furnished, large grounds, pumps, pure soft water, good neighbors, good business, good location, pleasant, healthy, cool gulf breeze, no mud, no dust. Particulars on application. E. P. Kinne, Magnolia Springs, Ala.

THE Farmers' Library—Farmers, fruit growers, poultrymen, dairymen, breeders: We have books covering your branch of farming. We have the practical book you have been looking and hunting for. Send for catalog today, now. F. A. Marmax, 2312 South Croskey, Philadelphia.

IRRIGATION in Northwest Texas is showing big results. Unlimited water, fine rich soil, splendid climate, cheap land and favorable terms make it a great opportunity for general farming under cheap irrigation. Send right away for new illustrated folder, "The Shallow Water Belt," free. C. L. Seagraves, Gen'l Colonization Agent, AT&SF Ry., 1917 Ry. Exch., Chicago.

PATENTED State School Land—Opening sale first allotment November 15th. One-twelfth cash, balance ten years' time. Located near Southern Pacific Railroad, only 32 miles from Houston. Ample rainfall; good markets. Big crops corn, cotton, potatoes, fruit, winter vegetables, etc. Free Texas map and particulars Write Dr. C. H. Walters, Trustee, 423 First National Bank Bldg., Houston, Texas.

FARMS for sale or exchange anywhere in the United States or Canada direct from the owners. Information free. American Investment Association, 37 Palace Bldg., Minneapolis, Minn.

MONEY-Making Farms, 13 States, \$10 to \$50 an acre; live stock, tools and crops often included to settle quickly. Big illustrated Catalogue No. 36 free. E. A. Strout Farm Agency, Station 3043, 47 West 34th Street, New York.

WHAT have you to exchange for a new 26-suite Boston, Mass., apartment house rented for \$889 monthly, \$10,608 yearly? Henry J. Steinberg, Webster, Mass.

TEXAS School Lands—\$1.50 to \$5 acre; 1-40th down, balance forty years. Information and Texas map free. Journal Pub. Co., Houston, Tex.

\$3,000, ONE-HALF down, takes two hundred acres good land, half-mile lake shore. Write owner. C. M. Schoonover, Webster, Wis.

PECAN Orchard for Sale—Eighty acres grafted trees. Louisiana. Lee Weber, Whitaker Building, Davenport, Iowa.

WRITE Mrs. A. E. Else of Doland, S. D., for full particulars 320-acre improved farm for sale.

\$40 INDUSTRIAL Addition Lots, \$5.00 Cash, \$5.00 Quarterly. Rosenbaum Company, Owners, 259 Haight Building, Seattle, Washington.

CO-OPERATIVE Homestead Clubs enable people to own farms. Become independent. Club now locating. Edward Miller, Crystal Springs, Fla.

IDEAL Homes—Fruit, vegetables, poultry, live stock. Illustrated booklet. State Board Agriculture, Dover, Del.

DOGS, BIRDS AND LIVE STOCK

SHETLAND Ponies for Sale. Send 2 cent stamp for illustration to Ernest Andrews Sons, Bristol, Tenn.

COONHOUNDS—Thoroughly trained, sent on trial. New book, "Night Hunting" treats breeding, training, handling the night hunting dogs for sport and profit. Illustrated, cloth bound, \$1. Southern Farm Coonhound Kennels, Selmer, Tenn.

ANCORAS—Marvelous Winter Layers Winners of more ribbons at the great Boston show than any other two exhibitors. Circular free. C. A. Martin, Derry, N. H.

FINE Bourbon Red Turkeys, \$4 each. A. F. Bowie, Oxford, Texas.

ARKANSAW Coon Dogs sold on a positive guarantee. Carter & Burrow, Pocatouas, Ark.

SEND for our Special offers on German Canaries, cage, seed, etc., goldfish and aquariums; these make acceptable gifts for mothers, wives, sweethearts, weddings, birthdays. Write today; you'll be pleased. Edwards Bird Store, Detroit, Mich.

2,000 FERRETS. Prices and book free. N. Knapp, Rochester, Ohio.

TRAINED Beagles, Rabbits, Hounds, Fox Hounds, Coon, Opossum, Skunk, Deer, Bear, Wolf-Hounds, Setters, Pointers, and Ferrets. Brown's Kennels, York, Pa.

AIREDALE Terriers and Scotch Collies. State wants? Sales list free. Phil Savage, St. Charles, Ill.

GINSENG

GINSENG—Two and three year roots produce plenty seed and mature in two to three years. Prices reasonable. C. N. Cloes, Akron, Ohio.

GINSENG Journal, Arrowsmith, Ill., 44-page monthly, 50c year. Marketing ginseng, golden seal; vital interest.

FORMULAS

900 FORMULAS, recipes, 30c; 100 money-making secrets, 25c. How to re-silver mirrors, renew dry batteries, transfer photos to glass, make printing cuts, rubber stamps, sneezing powder, invisible ink, 10c each. All above sent prepaid for 60c. Profitable Formula Bureau, 3311 Belle plaine, Ave., Chicago.

FORMULAS—3,999 Formulas and Digest. One year, 50c; or silvering mirrors formula and Digest one year, 25c; or 200 formulas, etc., and Digest one year, 25c. Digest, Grand Rapids, Mich.

CEMENT Concrete Hardener, guaranteed stops dusting. Canvas Canoe Cement, quick repair for leaks; guaranteed. Formulas \$1 each. Dave's, Box 1786, Paterson, N. J.

RECEIPT for removing Superfluous Hair, 50c; big money maker. Carsal Laboratories, 143-147 East 23d Street, New York.

BE sure to read Miller's ad "Valuable Trade Secrets" in Miscellaneous Classified Column.

THE best Furniture Polish made! Make it yourself. Good profits. Sample bottle and formula, 50c. The Anjo Company, Galesburg, Ill.

MAKE Lard just like Butter. Sample and particulars ten cents. Union Lard Co., North St. Paul, Minn.

DON'T buy formula in bulk, but select special ones guaranteed to give desired result. 25c each. List and advice free. H. L. Dessar, Nyack, N. Y.

EXPERT piano finisher's secrets. Two best formulas known, instructions, etc., and big list of others, 25c. Detroit Specialty Co., Dept. C, 435 McGraw Ave., Detroit, Mich.

SEND 35c stamps—Morgan's book of over 500 valuable formulas, trade secrets, etc. The Morgan Press, 17 Harvard Place, Boston.

175 FORMULAS and trade secrets, 10c. Formula Bureau, 3311 Belleplaine Ave., Chicago.

10,000 SELECTED scientific, chemical, technological, and practical recipes and processes, including hundreds of so-called trade secrets for every business, alphabetically arranged in one large volume of 800 pages. Price \$3 prepaid. Popular Mechanics Book Dept., 318 W. Washington St., Chicago.

BEST candy and ice cream formulas and recipes obtainable. Guaranteed Correct. 280 candy and 50 ice cream recipes. Increase your trade by improving your goods. Complete illustrated book prepared by practical expert. Price \$4 postpaid. Popular Mechanics Book Dept., 318 W. Washington St., Chicago.

FOR MEN

RAZOR Free. Send no money. We will give one \$2 Razor free of charge to the first customer in each locality. Send 5c postage and we will send Razor for a 15 days' trial. If you wish to keep it send us \$1.80 for our High-Grade Strop, Hone and Brush and the Razor is yours. Address Geneva Supply Co., Dept. 174, Chicago.

CALABASH Gourds. Genuine. Make your pipe, holder, hanging basket and grow gourds next season from one gourd. Entire gourd, full instructions, prepaid, fifty cents. C. Hopkins, Lamanda Park, Cal.

RAZORS—High-grade, low-priced, triple silvered safety razor, postpaid 30 cents. Peerless Specialty Co., 350 Gordon St., Allentown, Pa.

ELECTRIC Comb and Brush, simple, no wires; will prevent falling hair and dandruff, also baldness. Sent postpaid for \$1.50. C. E. Osterstock, 62 State St., Rochester, N. Y.

SAFETY Blades Sharpened, all makes, 2c. Keen Edge, Oshkosh, Wis.

CLEAR Havana Cigars, the best cigars at factory prices. Write today for particulars. A. Ramirez & Co., Factory, 1616 17th St., Dept. M, P. O. Box 998, Tampa, Fla.

SAVE Shoe Money Buy Men's Fine Union Made Shoes Direct from Factory and save \$1 to \$2 per pair. Satisfaction guaranteed. Prompt shipment. Write tonight for "Booklet P." Pathfinder Shoe Co., Dudley, Mass.

MEN'S Merchant Tailored Clothing direct from Mill less Middleman's profit. Satisfaction guaranteed. Send for samples and self measurement blanks. Philadelphia Woolen Mills Co., 502 Lippincott Bldg., Phila., Pa.

WANTED—Safety razor blades to sharpen. 2c a blade. Box 212, Poughkeepsie, N. Y.

QUIT tobacco entirely, or control amount used, without hardship. Write for free samples of Tobaccocure. The Tobaccocure Co., Carthage, Mo.

SAFETY razors sharpened; two cents each. Guaranteed. Blade box free. Electro Stropping Co., 134 Shelby St., Detroit, Mich.

FOR WOMEN

DEATH to wrinkles and withered skin with our inexpensive vacuum treatment; 10c brings 25c-size Beautibrick. Aztec Remedy Co., Dept. E, Toledo, O.

FOR THE HOME

STICKSALVE, best substitute for court plaster ever seen. Fifteen cents coin or two for a quarter. J. F. Tucker, Pennville, Ind.

LAMP Shade Frames, all descriptions, made to order. Cooley Mfg. Co., 553 W. Monroe St., Chicago.

GAS Bills reduced $\frac{1}{4}$ to $\frac{1}{2}$ by my system. No mechanical device. Send 50 cents in stamps for complete directions. C. S. Cole, 3447 Indiana Avenue, Chicago.

FOR Sale—Alfalfa honey; buy from the producer. Thos. Atkinson, Cozad, Nebr.

GOLDFISH, water plants, aquariums, canaries. Free catalogue. Pioneer Gold Fish Hatchery, Racine, Wis.

MAKE your own mission furniture at the minimum of expense. Our 3 books "Mission Furniture, How to Make It," Parts 1, 2 and 3, tell in plain, simple language just how to make 98 different pieces. Full dimensions working drawings and half tones of finished articles. Price, 50 cents each or \$1.50 for the three volumes, postpaid. Popular Mechanics Book Dept., Chicago.

METAL Work and Etching—A 96-page handbook for art metal workers telling how to make a great variety of useful and ornamental objects, such as desk sets, arts-crafts, jewelry, etc. Price, 50c, postpaid. Popular Mechanics Book Dept., Chicago.

CHRISTMAS SUGGESTIONS

FOR a gift send for one of our Scout's Compass Watches. Accurate time keeper with reliable compass, postpaid \$3. Our new standard dictionary and encyclopedia of 38,000 words and complete with maps, etc., fine, flexible leather binding, postpaid \$2. Keep track of your expenses beginning with New Year with our Daily Expense Record, postpaid 50c. Auburn Supply Co., Dept. XM, 7745 Peoria St., Chicago.

GIVE your wife a Christmas gift that will please her. Our "Electric Suction Cleaner" is just the thing. Satisfaction guaranteed. Write at once for illustrated Booklet, Modern Electric Shop, 3315 Belleplaine Ave., Chicago.

NEW Christmas Cards. Artistic designs. Your name beautifully written on each card, 50c doz. J. L. Teller (Penman), 140 27th St., Milwaukee, Wis.

FOR That Boy—The Best Gift is our big book, "The Boy Mechanic." Describes how to make 700 things every boy likes to build or experiment with. 480 pages, 800 pictures, size 7x10x1 $\frac{1}{2}$ in. Handsome cloth binding. Price \$1.50 prepaid to any address. See front display advertising section of this issue for full description. Popular Mechanics Book Dept., 318 W. Washington St., Chicago.

GAMES AND ENTERTAINMENTS

BOOK "Card Tricks and Sleight of Hand," 182 pages, paper cover, 25c. "Tricks with Coins," 170 pages, 25c. "Practical Ventriloquism," 25c. Elite Exchange, R 19, 3827 Kenneth Ave., Chicago.

ANYBODY can do magic tricks. Apparatus and instructions for full entertainment \$1. Magician, Box 592, Minneapolis, Minn.

MAGIC tricks, 250 for 15c. Puzzle Keys 10c. Good Luck puzzle 10c; all for 30c. Catalog for stamp. P. M. Bureau, 3311 Belleplaine Ave., Chicago.

NEW Book on "Fun, Magic and Mystery." Great entertainer, only 10c. Autophone Free with each order. F. Sherman, Publisher, Dept. A, 2600 Upton Ave. N., Minneapolis, Minn.

VENTRILLOQUISM Taught by Mail—Complete course of eight lessons sent postpaid for \$1. Prof. Lingerman, 3rd floor, 705 North 5th Street, Philadelphia, Pa.

DE LAND'S card tricks. All for 10c. 6 famous sets of mechanical card tricks, including illustrated directions, for 10c. They include phantom, spotter, pickitout, 4-ace trick, disappearing spots, Eureka. All easy to do. Theodore L. De Land, Publisher, 5338 Baltimore Road, Philadelphia, Pa.

MAGIC tricks, books and supplies. Largest line in the world. Old reliable firm. Mammoth illustrated professional catalogue, ten cents. Read & Covert, 821 East 43rd Street, Chicago, Ill.

NEW Magic Tricks! Lowest prices. Souvenir trick, bargain list and best catalogue of magic tricks, books, jokes, puzzles, 2c. Eagle Magic Manufacturing Co., Minneapolis, Minn. Dealers supplied with catalogues and goods.

A SOLUTION—World's greatest puzzle. Has never been solved. Can you? Combines intricacy of chess and depth of mathematics. 10 cents by mail. J. A. Bristow, 507 Newton Claypool, Indianapolis, Ind.

DEAR Magician: We have second-hand magical apparatus that is "brand new." Prices very low. Can only be had of us. Send two cent stamp for lists. Henry Hardin & Co., Box 1413, New Haven, Conn.

TRICKS—We manufacture them for stage and home entertainments. Large, new illustrated catalogue containing all new tricks, puzzles, novelties, sensational escapes, and illusions, free. Oaks Magical Co., Dept. 2, Oshkosh, Wis.

BURLESQUE "Auction Bill," funniest thing printed. Hand to friend or hang in public place; watch fun. 10c each, three for 25c. Box 14, Fond du Lac, Wis.

LEARN to entertain! Wonderful magic trick cards, postpaid 10c. Send for free catalogue. Walwen Company, 150 Nassau Street, New York.

SEND 2c stamp for Illustrated Booklet, "How to Start in Show" Business. Stage Studio, Dept. 10, 249 West 38th St., New York.

TRICKS, jokes and puzzles, catalogs and 25-cent samples, five cents. Gilbert Novelty Co., 11128 Crescent, Morgan Park Station, Chicago.

FREE Magic Catalogue sent upon request. Marvelous pocket card trick sent for 10c. Chicago Magic Co., Dept. B, 72 W. Adams St., Chicago.

TWELVE Gay Love Letters reading two ways, 10c. Publisher, 2324 So. Rosewood St., Philadelphia.

BARRELS of fun. Make a Topsy-Turvy board. Plans and instructions, 50c. A. T. Younglove, 420 Main St., Peoria, Ill.

13 FUNNY Love Letters (reads two ways), dime, silver, J. L. Hardway, Normal, Ill.

THE wonderful Soap Bubble Cone and a Box of magic soap ointment. The box contains a thousand big rainbow Balloon Bubbles that float and bounce. Fun for everyone. Send 10 cts. in silver to Steinmetz & Groh, 317 Northwestern Bank Bldg., Minneapolis, Minn.

PLAYS, Vaudeville Sketches, Monologues, Dialogues, Speakers, Minstrel Material, Jokes, Recitations, Tableaux, Drills, Musical Pieces, Entertainments for all occasions. Make-Up Goods. Large Catalog free. T. S. Denison & Co., Dept. 11, Chicago.

NEW and Novel Jokes—great fun producers. So simple a child can operate them. 1. The Spilt Jam (Look what you've done to the table cloth!). 2. Red Hot Cinder (Drop it on the rug or floor in front of fireplace). 3. Damaged Finger (Deceptive blood-soaked bandage. Great sympathy is expressed by your friends). Price, 10 cents each, postpaid. Address Popular Mechanics Book Dept., 318 W. Washington St., Chicago.

FREE Magic Catalog, 208 pages. Send 6c stamp for New Pocket Trick and particulars. Magic Co., Sta. 10, 249 West 38th St., New York.

STAMP COLLECTING

McKELE'S Stamp Weekly, Boston, Mass., six months, and 205 different foreign stamps, 25c; or 101 different United States.

STAMPS on approval. Try them; you may want more. Reference necessary. Premium, 4 Straits. Mrs. Louise Kellogg, West Hartford, Conn., Dept. C.

3 PARAGUAY 1913 unused, free with trial approvals. References. Sawyer Co., Onset, Mass.

ONE Cent approvals. Many bargains. Better grades also. References necessary. L. Moulton, Boulder, Colo.

FOREIGN Stamps Free; 52 different foreign, including China and Venezuela, to all who apply for our high grade approval selections. Send two cent stamp for return postage. Edgewood Stamp Co., Dept. H, Milford, Conn.

FREE, 200 foreign stamps, including Gwallor, Canton, Morocco and King George issues, 4c (stamp) postage. Buying list. American stamps 10c. Lightbown's Stamp Co., Palmerston Road, Southsea, England.

1,000 FOREIGN mixed, 19c, 50 different, 3c. Approvals, 50-60% discount. Pioneer Stamp Co., 1027 East 40th Street, Los Angeles, Cal.

ONE Thousand Mixed Foreign Stamps, 25c, with New Price List. F. J. Stanton (C), Norwich, N. Y.

1,000 VARIETIES \$2.25, 60% approvals. Lang, 1433 B, 59th Ave., Cicero, Ill.

FREE! 110 Foreign Stamps, Album and Catalog, for 2c postage. Payn Stamp Company, 138 N. Wellington St., Los Angeles, California.

STAMPS, 15 varieties, South and Central America, 4c, sent with our net approvals. Palm Stamp Co., Box 174, Arcade Station, Los Angeles, Cal.

24 VARIETIES Cuban stamps 10 cents. List of 6,000 low-priced stamps free. Chambers Stamp Co., 111 P. Nassau St. New York City

25 DIFFERENT British Colonials to applicants for stamps on approval. Chas. Nickles, 123 Florida Ave., Washington, D. C.

STAMPS, 100, all different, free. Postage 2c. Mention paper. Quaker Stamp Co., Toledo, Ohio.

STAMPS—105 China, etc., stamp dictionary and list, 2c. Bullard, Sta. A, Boston.

PACKET of 23 stamps; no two countries alike, 500 hinges. Set of \$1 and \$2 U. S. Rev., all for 5c. Miami Stamp Co., Toledo, Ohio.

RARE COINS

OLD Coins Wanted. \$1 to \$600 paid for hundreds of coins dated before 1884. Send 10 cents for our coin value book, it may mean your fortune. Rockwell & Co., 3265 Archer Ave., Chicago.

TRADE dollar 1885 sold for \$1,140; 20 cent 1876cc \$250; \$1 gold 1861d \$230; \$3-1870s 1,450. Equally high premiums on thousands of coins, stamps, books, paper money. Illustrated circular free. Vonbergen, Dept. O, Boston, Mass.

ILLUSTRATED selling catalogue of coins and two old bills, 10c. Selling catalogue of stamps and sample, 5c. Buying coin catalogue, 10c. F. L. Toupal Co., Dept. B9, Chicago Heights, Ill.

\$4.25 PAID for 1856 Flying Eagle Cent. Hundreds of other coins bought. Send 10 cts. for buying catalog. A. H. Kraus, 252 Kraus Bldg., Milwaukee, Wis.

OLD coins bought and sold. New Fall Coin Selling Catalog just out, free to collectors only. Buying Coin Catalog quoting prices I pay 10c. Wm. Hesslein, Paddock Bldg., 101 Tremont St., Boston, Mass.

\$1 to \$1,000 cash paid for all rare money to date. Many valuable coins in circulation. Get posted. Send stamp for large illustrated coin circular. It may mean much profit to you. You certainly have nothing to lose. Send now. Numismatic Bank, Dept. H, Ft. Worth, Texas.

\$4.25 EACH Paid for U. S. Flying Eagle Cents dated 1856. We pay cash premiums on hundreds of Old Coins. Send ten cents at once for New Illustrated Coin Value Book 4x7. It may mean your fortune. Clarke & Co., Coin Dealers, Box 15, Le Roy, N. Y.

TO MANUFACTURERS

MR. Manufacturer, we have the best equipped nickel and copper plating plant in Western N. Y. Write for prices. American Plating Co., Hornell, N. Y.

WANTED—Strong line for Pacific coast wholesale or retail trade. Box 633, Seattle, Wash.

ELECTRICAL

ELECTRICAL Bargains—Telephones, receivers, transmitters and magnetos; induction, repeating, retardation and spark coils; interrupters and vibrators; telegraph keys, sounders and relays; battery keys and switches; magnet wire, knife switches and binding posts; lamp brackets, reflectors, shades and sockets; plug receptacles and clusters; motors, dynamos, storage batteries, voltmeters, ammeters, rheostats, starting boxes, power and fuse panels; some new, some used. All good; all at salvage prices. A. I. V. Wilson, 57½ S. Pryor Street, Atlanta, Ga.

SEND 25c coin and receive instruction how to find the polarity of an electric current of any voltage without instruments or liquids. G. W. Kotts, Hope, N. D.

BOYS' Electrical experimental outfits, \$1 to \$5, worth five times our price. Send postal for literature. Premier Electric Co., 4035 Ravenswood Ave., Chicago.

BOYS: Send \$3 only for electric engine outfit complete. W. B. Brooks' Electrical House, Bethel, Vt.

ENCLOSED are lamps, direct current 110 volts; used very little; \$5 each. Clarence Hardage, Syracuse, N. Y.

STORAGE Batteries, all sizes. Write for price list. Krause Bros., 2629 Emmet St., Chicago.

RENEW old dry batteries; 3 best methods with complete instructions, 20c. Guaranteed. Formula Bureau, 3311 Belleplaine Ave., Chicago.

WIRELESS

WIRELESS Set. How to Make—96-page book telling how to construct at small cost an outfit suitable for transmitting four or five miles. Price 50 cents, postpaid. Popular Mechanics Book Dept., Chicago.

PIANOS AND MUSICAL INSTRUMENTS

VIOLINS, old and new, on approval. Violins appraised. F. Waldo, violin expert, Cambridge Station, Boston, Mass.

ELECTRIC piano, with keyboards, \$125, good as new. Guaranteed. J. F. Herman, Washington, D. C.

ELECTRIC Pianos \$100. Terms. Catalogue. Continental Novelty Co., Omaha, Neb.

VIOLIN for sale, cheap. Excellent toned. Sent on trial. Miss Bertha Mardisse, Rosedale, Kansas.

TALKING machines and records at cut prices. 100,000—10 inch records never sold less than 60 cents. Our cut price 20c each. Send for catalogue. Deninger, North St., Rochester, N. Y.

MUSIC

"JUST a Little Keepsake," the new popular song that appeals to every human heart, arranged for piano, will be mailed to any address upon receipt of 10 cents in coin or stamps. Sunny-Songs Pub. Co., Box 373, Chicago, Ill.

DOES one thing only and does it well. McQuade's note reader for memorizing notes. Especially for beginners. Postpaid, quarter. F. J. Pieper, Alton, Ill.

PIANO Playing easily, correctly, mastered. My copyrighted self-instructor shows how. Complete, 75c. J. E. Stroh, 930 St. Nicholas Ave., New York.

SEND 20 cents (coin) for "What Do You Know About That?" Latest and catchiest coon song published. Chas. A. Glenn, Velpen, Ind.

BEGINNERS can play piano or organ selections in 30 minutes without teacher or \$1,000 forfeit. Write Musician Self-maker, (A) Chicago.

SHEET Music, 3 big hits, 10c. Music Lovers' Club, Wyandotte, Mich.

ALL the favorite old songs. Words and music complete in book form with attractive cover; size 7½x9½ inches; good value. Price 50 cents, postpaid. Popular Mechanics Book Dept., Chicago.

SONG-POEMS Wanted. Cash or royalty to you. Needham Music Co., file 615, St. Louis, Mo.

"SWEET Home of Paradise" (new sacred song)—As fine as "The Rosary" or "Face to Face," postpaid 15 cents. Bros. Novelty Co., Dept. 25, Williamsport, Pa.

SONGS of Sunny Southland, "Florida, Florida, You Have Made Me Care," "Way Down South Below the Line," 15c each. O. A. Schmah, Box 188 N. Ashtabula, Ohio.

ALL the new and standard music at cut prices. Sheet music for 5c up. Catalog free. Semple's Music House, Norwalk, Conn.

TYPEWRITERS AND SUPPLIES

TYPEWRITER Bargains, all makes, slightly used and rebuilt; lowest prices, bar none; satisfaction assured. 20 yrs.' experience. Write. Typewriter Sales Co., Ferguson Bldg., Pittsburgh, Pa.

BANKRUPT Sale—Greatest in History; \$100 Typewriters like new. Low as \$10. Get one—save the difference. Send for trial, our expense. Write for catalogue No. 16. General Office Supply Co., 212 E. Fifth St., Cincinnati, Ohio.

TYPEWRITERS at wholesale prices. Rebuilt by manufacturers. Don't miss this opportunity. Supply limited. Minnesota Typewriter Exchange, Minneapolis, Minn.

"FIFTEEN brand new typewriters" never used, latest model, latest improvements, real bargains. Box 260, Wooster, Ohio.

SEE my \$2 a month typewriter sensation on page 116. Harry A. Smith, Chicago.

SAVE \$25 to \$50 on manufacturers' prices. Buy our Factory Rebuilt Typewriters. Nearest-to-new on the market. Have trademark and guarantee like new machines. Are thoroughly rebuilt, highly polished and perfect in appearance. Satisfaction guaranteed. We are the largest rebuilt typewriter concern in the world. Branch stores in leading cities. Write for catalog of standard makes. American Writing Machine Co., Inc., 345 Broadway, N. Y.

ALL standard makes of typewriters, everything else cut out. Big saving. Liberal guarantee. Catalog, bargain list and valuable typewriter information free. A. E. Atchison, 110-12 N. La Salle St., Chicago.

PRINTING AND ENGRAVING

GOOD Printing—Low Prices. 1,000 good letter-heads, \$2.50; 1,000 envelopes, cards, statements, billheads, \$2. Samples. We print for others, why not for you? Thos. M. Weaver, Main and Kilbourne Streets, Bellevue, Ohio.

1,000 **PURPLE** Multigraphed Letters, black heads printed and stock complete, \$2.75; 500, \$1.85. Specimens free. Perfection Letter Company, Muncie, Ind.

GOOD Printing (cheap)—1,000 Bond Letterheads \$2.75; 1,000 Envelopes \$2; 1,000 Circulars \$2.50. Larger quantities cheaper. Label printing a specialty. A few samples free. A. H. Kraus, 521 Kraus Bldg., Milwaukee, Wis.

125 **BOND** noteheads and bond envelopes, \$1. Both neatly printed, sent postpaid. Advertiser, Mansfield, Pa.

125 **BOND** Letterheads and 125 Envelopes, white, pink, blue or green, printed, \$1 prepaid. Samples. W. Kinnier, Box 266, Brooklyn, N. Y.

PRINOGRAPH Typewritten Letters, \$1.50 per thousand. Large quantities less. Write us today. LaCrosse Letter Company, LaCrosse, Wis.

PRINTING—500 100-word circulars 50c. Columbia Printers, Greensburg, Ind.

ALL for \$1, printed, prepaid; 100 Letterheads, Envelopes and Cards, Noble, Box 466, Port Richmond, N. Y.

1,000 **3¼x5½ BOND** Circulars, \$1 prepaid. Write for estimates on printing needs. Samples. B. Newham, Waukegan, Ill.

SPECIAL—500 good white envelopes, noteheads, statements or cards, 90c; 1,000, \$1.25. 1,000 typewriter circular letters, \$1.50. Samples free. J. M. Hunt, Lambertville, N. J.

AUTOGRAPH Rubber Stamp—Your name exactly as you write it—75c. Autograph Stamp Works, 3253 Congress St., Chicago.

YOUR name on 200 gummed stickers, 10c. With address, 15c. Star Co., Clintonville, Conn.

GUMMED Labels, 3,000 \$1. 38 p. catalogue 2c. MacTaggart, 123 Arch, Philadelphia, Pa.

ZINC newspaper halftones, single column, 50c. Rishel Engraving Co., Havana, Ill.

100 **CALLING** or Business Cards, 25c. Shay, 8 W. Van Buren, Chicago.

100 **ENVELOPES** printed to order 30c. Cycle Press, 1081 Jason, Denver, Colo.

FOR printing presses, type, rollers recast, etc., send for catalog, "Model Press," York, Pa.

PRINTING—500 either noteheads, envelopes, statements, cards, \$1; 1,000, \$1.50; 1,000 envelope slips, \$1. 1,000 linen finish letterheads or envelopes, \$2.50, 1,000 typewriter letters, \$2. Samples. Model Company, Manchester, Iowa.

PRINTING Presses, supplies, second-hand, at bargains. List for stamp. Popular Bargains, Richland, Pa.

ALL for \$1.25: 100 Letterheads, (8½x11), 100 Envelopes, 100 Business Cards printed to your order on Bond paper. Prepaid. Samples free. Carter Company, Rochester, N. Y.

GOOD Printing at low prices. 1,000 good letterheads, envelopes, cards, billheads, labels, circulars, \$2.50. Samples free. Catalogues, booklets, and circulars our specialty. Ernest L. Fantus Co., 523 S. Dearborn St., Chicago.

MISCELLANEOUS

THE new coin cuff buttons. Just out. Set with real United States 1913 nickels, Buffalo and Indian head design. Everybody wants to see them. These cuff buttons are double braced. Made of German silver and nickel. Be the first in your locality to own a pair. Be original. Send for your pair today. Postpaid anywhere only 75c. Money order—silver—check. Money back if not satisfied. York Producing Co., Dept. M, Houston, Texas.

SEND for catalogue of real Japanese Things, Menu Cards, Place Cards, Table Covers, Silks, etc. Matsumoto-Do Color Prints, Art Subjects by noted Japanese artist. 50 prints with full description sent anywhere on approval. International postal will do. Matsumoto-Do, Dept. 301, Tokyo, Japan.

TOBACCO-CURE—One box cures. Guaranteed or money back. Established 1894. Write for special offer. Allen Distributing Co., 319 Nelson Bldg., Kansas City, Mo.

I WILL start you earning \$3 daily at home in spare time, silvering mirrors; no capital; send for free instructive booklet, giving plans of operation. G. P. Redmond, Dept. 306, Boston, Mass.

COTTON from the fields just as it grows, white, silky. Beautiful for decorations and souvenirs. Sample ball 10c. Twenty balls \$1 postpaid. Evans & Co., Thomson, Ga.

WANTED—I buy early views of Boston, New York and New England towns and buildings, very old maps, historical pictures, old college views, paintings of old ships. A. Stainforth, Winthrop, Mass.

YOUR Name on "rubber stamp" for marking linen with indelible outfit, 70c postpaid. Catalogue 8c. Buckeye Rubber Stamp Works, South Jefferson, Dayton, Ohio.

COMMERCIAL artists and Show Card writers can not afford to be without a Fountain Air Brush. Write for catalogue B 79. Thayer & Chandler, 913 W. Van Buren St., Chicago.

WANTED—Very old solid silver mugs, tankards, tea sets, porringers, pitchers and curious pieces. Send description. A. Stainforth, Winthrop, Mass.

GREENBACKS! Big bunch of stage bills, 10c. Literary Enterprise, 3348 Lowe Ave., Chicago.

VALUABLE trade-secrets. Don't sleep till you've sent for my red seal lists of valuable, rare meritorious formulas indispensable for the manufacture of toilet, medical, household specialties, etc. I supply reliable formulas and information for soap making, dry cleaning, tanning, varnish, paint and metal working and all trades. Write for free information concerning any formula or product. H. Liscomb Miller, Evach Chemical Company, Marietta, Ga.

CUT down the high cost of living. Form a Parcel Post Club. Save your own money and your neighbors' money. Make \$500 a year in spare time. Descriptive circular free. The Brookline Co., Box 211, Springfield, Mass.

FREE—While 500 September issues of Starr's Yankee Trader and Mixer lasts, to those sending 5c stamps for the large October number. Starr's Novelty Co., 810 Cherry St., Toledo, O.

1,000,000 **FORMULAS**, trade secrets, \$1.50. Ragtime piano self-instructor, \$1. Ell Emm, 667 Ocean Ave., Jersey City, N. J.

FLEXIBLE egg mailing boxes. No breakage. First scientific carrier. "Flexible," Vineland, N. J.

KING 1,000-shot repeating Air Rifle sent postpaid for \$1.35. Satisfaction guaranteed. H. Latz Co., Atlantic City, N. J.

YOUNG Man! Learn Drafting—one of the most practical subjects of study to-day—indispensable in many occupations—engage in individual study successfully with the aid of our new book. "A Practical Course in Mechanical Drawing." 160 pages, 157 drawings, cloth, 50 cents, postpaid. Popular Mechanics Book Dept., 318 W. Washington St., Chicago.

"SEPTEMBER MOON"—An exact reproduction in three colors on a pennant, 10x26, postpaid 30c each—4 for \$1. No stamps. R. G. Trammel, Box 414, Rome, Ga.

LONESOME-PINE Lucky Fairy Stones. Found only in wilds of Patrick Co., Va. Strange natural crosses. Gold mounted, \$1; unmounted 50c. In rough, 25c. M. R. Flynn, A424, Danville, Va.

700 MONEY Making formulas and Trade Secrets, postpaid 25c. Process Company, 415 Ft. Dearborn Bldg., Chicago.

LET us tell you about denatured alcohol in solid form. Used for cooking and heating by sportsmen, campers and travelers. Samples 10c. The Lever Company, 44, Elizabeth, N. J.

TAILORS, dressmakers, and home sewers, use our silver-plated razor-steel Seam ripper. 25c. Circular free. G. Carpenter Co., 223 West 21st St., New York City.

DO you want to go on the stage. Be a Handcuff King. I will teach you how; for particulars address Box 902, Springfield, Mass.

CUTS anybody can make. Simple Etching Process. \$1. Particulars, specimens, for stamp. M. Day, Windfall, Ind.

\$10 RAINCOAT at half price direct from manufacturer. Our "Chesterfield" double-texture raincoat, made of fine woven Asia cloth, plaid lining, cemented seams, vulcanized. Absolutely rainproof, will stand roughest wear. Very stylish; in tan or olive. Sizes 32 to 44. Postpaid \$5. Money back if unsatisfactory. B. & J. Rubber Co., 161-163 Summer St., Boston, Mass.

AMBITIOUS men and women everywhere. My book "Success or Failure" shows how \$5 to \$25 invested brings you \$50 to \$200 monthly. Send 12c for sample copy. Buckland, Box A, 1456, Springfield, Mass.

MATHEMATICS made easy for all by Hopp's Calculator. Figures out, in the twinkling of an eye, every conceivable problem that occurs in the Office, Store, Shop, Bank, Farm or Factory. Greatest time and labor-saving work on figures in the world. Copyright 1912. Price, \$1. Vest pocket size, 50c. Popular Mechanics Book Dept., 318 W. Washington St., Chicago.

TRICKS and traps of America swindlers, quacks and humbugs exposed. Price 25c. Particulars for red stamp. Address Eagle Supply Co., P. O. Box 671, Oshkosh, Wis.

SKELETON Keys—Just what you need. Opens all common door locks. 25c a set. B. & F. Novelty Co., Box 237, Rock Island, Ill.

GRANDFATHER'S Clock Works, \$5. Slightly shop-worn, quantity limited, others with chimes, all prices; also several nice Grandfather's Clock cases, exceptional bargains. Clock Company, 1673 Ruffner St., Philadelphia, Pa.

HAND-BALL players, try Black Cover Ball, hand-made, of best material. Price \$1. W. N. Long, Florence, Ky.

WE DON'T WANT AGENTS

Own a Branch Agency and control the entire business on these Patented Specialties of Sterling Worth. The "NU-PANTZ" Creaser, "New Idea" Hose Supporter, Automatic "Clean" Curry Comb, "Boss" Clothes Rack, "Never Slip" Clothes Line Bracket, "Security" Door Holder, etc. Legal contract given for exclusive County Rights. Large, permanent business, with 100% cash profits, quickly established. No charge for Rights. Write for detailed agreement for your territory, if still open. Address **MODERN SPECIALTY CO.** 26th Avenue Racine, Wisconsin



WHEN YOU WANT ANYTHING AND DON'T KNOW WHERE TO FIND IT—WRITE BUREAU OF INFORMATION, POPULAR MECHANICS, CHICAGO

If I Send You This Suit

made to your measure, in the latest style, would you be willing to keep and wear it, show it to your friends and let them see our beautiful samples and dashing new styles?

Could you use \$5.00 a day for a little spare time? Perhaps I can offer you a steady job. If you live in a town smaller than 10,000, write me a letter or a postal at once and say: "Send me your special offer," and I will send you samples and styles to pick from and my surprising liberal offer.

Address: **L. E. ASHER, President**
BANNER TAILORING CO., Dept. 559, CHICAGO



WHEN YOU WANT ANYTHING AND DON'T KNOW WHERE TO FIND IT—WRITE BUREAU OF INFORMATION, POPULAR MECHANICS, CHICAGO

The Pictorial Review of Current Events

Cartoons

15 Cents a Copy

\$1.50 per Year

[By H. H. WINDSOR, Editor Popular Mechanics Magazine]

Get the November Number

And keep up with the events of this busy world without wasting hours of your time.

In Its New Garb the Cartoons Magazine Becomes the Magazine for Everybody

Its pages are crowded with the best work of the cartoonists of the world and these clever drawings are accompanied by comment gleaned from the columns of editorials penned by newspaper writers trained to follow the questions of the day.

Cartoons Magazine has become the ready reference book of the up to date man. It is not a mere collection of clever pictures but is a magazine that improves and educates.

Ask your newsdealer to show you the November number, or Send your order to **CARTOONS, 318 W. Washington St., Chicago, Ill.**

Bound Volumes One, Two and Three NOW READY

These bound volumes contain more than 3,000 reproductions of the very best cartoons that have been printed during 1912 and 1913. A collection of more than 120,000 cartoons was made in order to secure them. Bound in the three volumes they make an "instant history" of the past months, for they are a pictorial record of the events of the world.

These three books, artistically and durably bound, are now ready for distribution and will be sent all express charges prepaid to any address in the United States or its possessions upon receipt of **One Dollar Each**



MARK ANTONY DELIVERING THE ORATION OVER THE BODY OF CAESAR

CÆSAR'S name has stood through all the ages as the embodiment of imperial power. His untimely end after reaching the pinnacle of earthly glory is one of the great tragedies of history. The picture shown herewith from Ridpath's History is but **One of Two Thousand** in the complete work, and serves to illustrate but **One** event out of all the **Thousands** which make up the history of every empire, kingdom, principality and nation, accurately and entertainingly told in the world-famed publication,

Ridpath's History of the World

Popular Mechanics readers are offered **one more opportunity** to place this splendid History in their homes. A coupon for your convenience is printed in the corner of this advertisement. We offer the remaining sets of the last edition, brand new, down to date, beautifully bound in half-morocco,

At a VERY LOW PRICE and on EASY TERMS

We will name our price only in **direct letters** to those sending us the **Coupon** below. **Tear off the Coupon, write name and address plainly, and mail to us now before you forget it.** Dr. Ridpath is dead, his work is done, but his widow derives her support from his history, and to print our low price broadcast, for the sake of quickly selling these few sets, would cause **great injury to future sales.**

President McKinley

said: "I am familiar with Ridpath's History, and cordially recommend it to the scholar as well as to the people generally."

Hon. Wm. J. Bryan

says: "Dr. Ridpath's History of the World is a lasting monument to the author's intelligence and industry."

Bishop Vincent

says: "Ridpath's History is a permanent college chair of general history in one's own house."

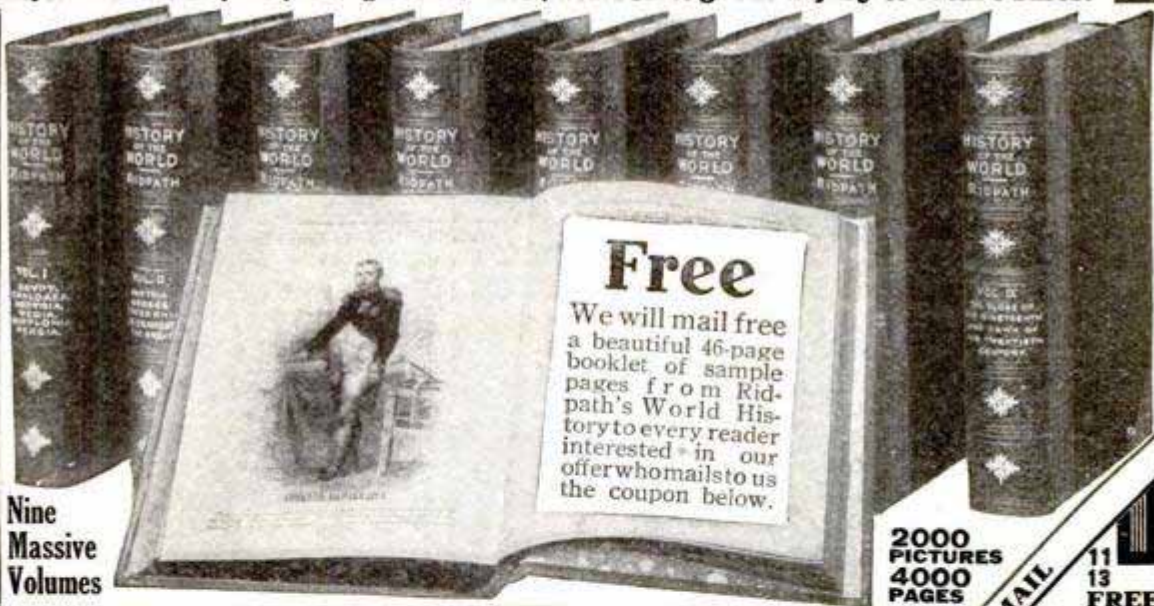

Nine Massive Volumes

**2000 PICTURES
4000 PAGES**

**11
13
FREE
COUPON**

THE REASON for Dr. Ridpath's enviable position as an historian is his wonderfully beautiful style, a style no other historian in any generation has ever equaled. He pictures the great historical events as though they were happening before your eyes; he carries you with him to see the battles of old; to meet kings and queens and warriors; to sit in the Roman senate; to march against Saladin and his dark-skinned followers; to sail the Southern Seas with Drake; to circumnavigate the globe with Magellan; to watch that thin line of Greek spearmen work havoc with the Persian hordes on the field of Marathon. He combines absorbing interest with supreme reliability and makes the heroes of history real living men and women, and about them he weaves the rise and fall of empires in such a fascinating style that history becomes as absorbingly interesting as the greatest of fiction. Hundreds who read this have decided to buy Ridpath some day; now is the time. Mail coupon for free sample pages.

FOLD HERE, TEAR OUT, SIGN AND MAIL

Name.....

Address.....

**Western Newspaper Association
H. E. SEVER
President
140 So. Dearborn St.
CHICAGO, ILL.**

Please mail, free, 46 page sample booklet of Ridpath's History of the World, containing photogravures of Napoleon, Queen Elizabeth, Socrates, Caesar and Shakespeare, diagram of Panama Canal, etc., and write me full particulars of your special offer to Popular Mechanics readers.

**WESTERN NEWSPAPER ASSOCIATION
CHICAGO**

"HELP WANTED"

-Uncle Sam.



Railway Mail Clerks,
Postoffice Clerks, City Mail
Carriers, Internal Revenue and
Customs Clerks

Thousands of appointments coming

**\$800⁰⁰ to \$1800⁰⁰ a Year
for LIFE**

No "layoffs" without pay, because of strikes, financial flurries or the whims of some petty boss. Excellent opportunities for quick advancement to Higher Government Positions. If you want immediate appointment, send **TODAY** for our schedule showing locations and dates of the Fall examinations. Any delay means the loss of just so much time in preparing yourself for examination.

SEND COUPON BELOW

FRANKLIN INSTITUTE
Dept. A 106, ROCHESTER, N. Y.

The coupon, filled out as directed, entitles the sender to free sample questions; a free copy of our copyrighted book, "Government Positions and How to Obtain Them," and to consideration for Free Coaching for the examination here checked.

COUPON

| | |
|---|--|
| Railway Mail Clerk (\$900 to \$1800) | Customs Positions (\$800 to \$1500) |
| Postoffice Clerk (\$800 to \$1200) | Internal Revenue (\$700 to \$1800) |
| Postoffice Carrier (\$800 to \$1200) | Stenographer (\$800 to \$1500) |
| Rural Mail Carrier (\$800 to \$1100) | 4th Class Postmaster |
| Bookkeeper (\$900 to \$1800) | Canadian Government Positions |

We will prepare 25 Candidates Free

Name.....
Address..... A 106

Use this before you lose it. Write plainly.

FOR ALL AROUND WORK

NOTHING EQUALS—Allen Presto Soder

—Stick or Paste. The latest advancement in the art of soldering—Combines Allen—Flux and Solder—Two-in-One. Just heat the portions where connections are intended—Presto-Soder—resulting in airtight joints, made with less effort and quicker. One ounce sample sent for 16 cents in stamps and dealer's name. Worth it—Send for it



L. B. ALLEN CO., Inc., 4530 N. Lincoln Street, CHICAGO

Cut this Out **Mail Today**



NATIONAL AUTO SCHOOL

JUNE & READING RD., CINCINNATI, OHIO

GENTLEMEN:—Send free booklet telling how I can become an Expert Chauffeur or Repairman and be placed, at once, in a GOOD-PAYING position. PM11

Name.....
Address.....

Pay you to cut this out and MAIL TODAY



50c

To Enjoy Carving

Carving is fun when the knife is sharp.
And it's fun to sharpen it if you have a

PIKE INDIA KANTBREAK KNIFE SHARPENER

Don't let Thanksgiving day catch you without one. A few strokes on a Pike "Kantbreak" makes the knife keen for cutting or carving. The "Kantbreak" beats a steel—it's faster and easier to use. Needed in every home for kitchen and paring knives. Reinforced and rubber-mounted so that it "Kantbreak." You need one—every home does, and the price is only 50 cents at your hardware or tool dealer's. Look for "Pike Kantbreak" on handle.

FREE—A Pike India Stone

Send us your dealer's name and 4 cts. for packing and mailing and we'll send our Pike India Vest Pocket Stone for pen knives, ink erasers, scissors, needles, etc., also our famous book "How to Sharpen." You'll be pleased. Write today.

PIKE MANUFACTURING CO., 177 Main Street, PIKE, N. H.



The Stepping-Stone to Wealth

is the systematic saving of money. You and members of your family can easily cultivate this admirable habit by putting a dime in

Grab's Keyless Basket Bank

every day. Your money accumulates rapidly. Deposit of each coin registered automatically. Capacity \$30. Bank opens when \$5 or multiple thereof has been deposited. Cannot be opened otherwise. Made of solid steel, oxidized copper finish. Size 2 1/2 x 3 1/4 in. Price \$1.00, prepaid in U. S. Money Back if not satisfactory. An appropriate Xmas gift. Order now



Victor M. Grab & Co., 118 Ashland Block, Chicago, Ill.

MAKE \$60.00 WEEKLY

Men, yes, and women, too, should make from \$60.00 to \$100.00 per week, acting as county, taking orders. **Robinson Folding Bath Tub**, markable invention

my special sales representative in their appointing agents, and advertising the **Bath Tub**. Undoubtedly the most reformer for the home in 20 years. Solves the



bathing problem. Any room a bath room. No pipes, no plumbing, no expense. Full length baths with the **Robinson Folding Tub**. Folds in roll, handy as an umbrella. Self-Emptying. Cannot leak.

Look Here; Two Sales a Day Means \$60.00 Weekly

Men, that's big money. To show you that this big, easy profit is being made, read these records:

N. T. Smith, Toledo, is making as high as \$90.00 weekly. Meyers, Cascade, Wis., profits, first month, \$250.00. Beasley, Omaha, reported seven sales in four hours, profit \$35.00. Canadian firm wired for prices on 1,000 tubs, now selling 100 tubs weekly through agents.

Come, fall in line. Don't let doubt drag you back. You need little capital, no experience. I furnish everything. Just drop me a post-card. If you're honest and a hustler, I'll give you the job. But act quickly. Write at once. Good for you.

PRES. THE ROBINSON CABINET MFG. CO.
188 Vance St., Toledo, O.

Economize in Heating!

The greatest factor in economical heating is an efficient pipe covering. When steam or hot water are delivered through uncovered or poorly insulated pipes the loss by radiation and condensation, and the consequent waste of fuel, is enormous. Unfortunately, radiation and condensation cannot be observed; consequently, many who realize the necessity of covering pipes do not realize that many pipe coverings are but little better than none and are only deceiving.



Are you sure that your heating system is being operated as economically as it could be, and that your pipe covering is not merely a covering rather than an insulator? Why not let us examine your heating system, without any obligation to you, and give you an expert opinion as to whether it could be operated more economically by covering the pipes with

J-M Asbestocel Pipe Covering

For Hot Water and Low and Medium Pressure Steam

Costs practically the same as ordinary pipe covering, but is many times as efficient, because it is made on a different principle. The insulating properties of pipe covering depend on the amount of dead (motionless) air it confines. J-M Asbestocel is built on the principle of an arch, with the air cells running around the pipe, preventing the circulation of air, while other coverings have the cells running from end to end, allowing the air to

travel back and forth. By actual tests, J-M Asbestocel has shown that it will pay for itself in fuel saved in an average of eight and one-half months. Being made of asbestos, it is light in weight, fire-proof, and not affected by heat, dampness, acid or chemical fumes. It cannot crack, break or lose its insulating efficiency from rough handling or vibration. It is as good an insulator at the end of ten years as when first put on.

May we send you sample and booklet?

H. W. JOHNS-MANVILLE CO.

MANUFACTURERS OF ASBESTOS AND MAGNESIA PRODUCTS

ASBESTOS

ASBESTOS ROOFINGS, PACKINGS ELECTRICAL SUPPLIES, ETC.

- | | | | | | | | |
|------------|------------|-----------|--------------|---------------|----------------|----------------|--------------|
| Akron | Boston | Cleveland | Duluth | Los Angeles | New Orleans | Rochester | Seattle |
| Albany | Buffalo | Columbus | Galveston | Louisville | New York | St. Louis | Syracuse |
| Atlanta | Charlotte | Dallas | Houghton | Memphis | Omaha | St. Paul | Washington |
| Baltimore | Chicago | Denver | Houston | Milwaukee | Philadelphia | Salt Lake City | Wilkes-Barre |
| Birmingham | Cincinnati | Detroit | Indianapolis | Minneapolis | Pittsburgh | San Francisco | Youngstown |
| | | | Kansas City | Newark, N. J. | Portland, Ore. | | |

THE CANADIAN H. W. JOHNS-MANVILLE CO., LIMITED

Toronto

Montreal

Winnipeg

Vancouver

875

When you want anything and don't know where to find it—write Bureau of Information, Popular Mechanics, Chicago

KEYLESS PADLOCK

No knobs to turn—no clicks to count. Press the buttons and it flies open—40,000 combinations possible. Operated as easily in dark as in light. Solid brass. **AGENTS making 100% profit.** Sells on sight—no competition. Write today for terms of free sample. A postal card will do. Address **AMERICAN KEYLESS LOCK CO., 653 W. Jackson Blvd., CHICAGO**



Guaranteed Used Pianos

- | | | |
|------------------------|------------------------|------------------------|
| Examples: | Schaefer Upright \$140 | Hallet & Davis . \$190 |
| Briggs Upright . \$ 70 | Hinze Upright . . 145 | Kimball Upright . 220 |
| Colby Upright . . 90 | Fisher Upright . . 165 | Steinway Upright . 275 |
| Emerson Upright . 110 | Whitney Upright . 185 | Kimball Upright . 275 |
| Decker Bros. Upr't 135 | Chickering Upright 175 | Knabe Upright . . 175 |

A large number of fine instruments at exceptional bargain prices, many like new, exchanged for **Kimball Player Pianos**, thoroughly overhauled and guaranteed to be in splendid condition in every way. We ship anywhere to reliable people on easy payment terms. Write Today For Complete List, Prices, and Terms and Beautiful Illustrated Musical Herald **FREE**, and catalogue New Kimball Pianos. **W. W. KIMBALL COMPANY, 1298 Kimball Hall, Chicago, Ill.**



MONEY SAVED OR MADE. Print Your Own Cards.

Circulars, Book, Newspaper. Press \$5. Larger \$18. Rotary \$60. Saves money. Print for others. All easy, rules sent. Write factory for Press catalog, TYPE, Cards, Paper, Outfits, Samples printing. **THE PRESS CO., Meriden, Conn.**

No Man Can Beat Our "BABY"



At general usefulness about the house or farm. This little gas or gasoline engine weighs only 12 lbs. when built partly of aluminum, but what it will do to a washing machine, churn, grindstone, or tool grinder is a caution. It **Will Drive Any Machine** that can be driven by hand or foot power. Our 1/2 and 1 horsepower differ only in size and power. All of them are **Inexpensive To Buy And To Use**; are absolutely dependable, and so simple a child can run them without the least danger. They operate at very little expense on gas, gasoline, kerosene or alcohol. These small engines regulate closely enough for **Electric Lighting** and as they will operate at high speed continually without undue wear, they make ideal direct connected sets when applied to our small dynamos. Let us send you our Booklet A-1.

ELGIN WHEEL & ENGINE COMPANY, ELGIN, ILLINOIS

MODERN AMERICAN HOMES

FREE Read this special 30 day offer

Here is your chance to secure absolutely **Free of Charge** the most complete and up-to-date plan book ever published. No carpenter or contractor who wishes to be familiar with the latest in building construction—no man who is contemplating erecting a home—can afford to be without it. This great new plan book, "**Modern American Homes**," contains plans and specifications for 168 different structures, including excellent exterior and interior views, detailed estimates, etc. Designed by the leading architects of this country. Includes city, country and suburban homes, bungalows, farm houses, summer cottages, tent houses, camps, garages, apartment houses and various public buildings. 224 pages, 9 1/4 x 12 1/2 inches, and 426 illustrations. Printed on heavily enameled paper and substantially bound.

The Cyclopaedia of Architecture, Carpentry and Building



consists of ten massive volumes; 4,760 pages, 7x10 in.; 4,000 illustrations, full page plates, building plans, diagrams, etc.; hundreds of valuable tables and formulas; carefully cross-indexed for quick, easy reference.

This work covers everything in the building professions, from the first rough sketch of the architect to the acceptance of the finished structure. It includes wood, stone, steel, and reinforced concrete construction; estimating and contracting; a study of the Greek and Roman Orders; interior finishing and decorating; and modern house lighting and sanitation.

Partial Table of Contents

Mechanical, Freehand, Perspective and Architectural Drawing, Lettering, Pen and Ink Rendering, The Orders, Superintendence, Strength of Materials, Masonry, Reinforced Concrete, Carpentry, Steel Square, Stair-Building, Hardware, Steel Construction, Roof Trusses, Practical Problems, Estimating, Contracts, Specifications, Building Law, Sanitation, Sheet Metal Work, Electric Wiring and Lighting.

We'll Send the Plan Book FREE

With every order for a Cyclopaedia we will include the Plan Book, absolutely **free of charge** and send you the Cyclopaedia and the Plan Book, **express prepaid, for seven days' free examination.** You keep the books a full week—examine them thoroughly at your leisure—and if they don't meet with your expectations they may be returned at our expense. Remember—the complete set, Cyclopaedia and Plan Book, are sent **free** upon receipt of the coupon below and we pay express charges both ways if they are not satisfactory.

Another Free Offer With each set is included a year's Consulting Membership, regular value \$12.00, entitling you to the free advice of a corps of Expert Architects. This will give practical help in handling your difficult building problems. This service alone is worth more than the first cost of the books.

AMERICAN TECHNICAL SOCIETY, CHICAGO, U. S. A.

FREE PLAN BOOK COUPON

AMERICAN TECHNICAL SOCIETY, Chicago, U. S. A.

Please send **Free Plan Book**, also Cyclopaedia of Architecture, Carpentry and Building for seven days' examination. I will send \$2.00 within seven days and \$2.00 a month until I have paid \$24.80 for Cyclopaedia (**Plan Book included free**), or notify you and hold books subject to your order. Title not to pass until fully paid. Pop. Mech. 11-13

NAME

ADDRESS

OCCUPATION

REFERENCE

9,059-Word Business Book Free

Simply send us a postal and ask for our free illustrated 9,059-word Business Booklet which tells how priceless Business Experience, squeezed from the lives of 112 big, broad, brainy business men, may be made yours—yours to boost your salary, to increase your profits. This free book deals with

- How to manage a business
- How to sell goods
- How to get money by mail
- How to buy at rock-bottom
- How to collect money
- How to stop cost leaks
- How to train and handle men
- How to get and hold a position
- How to advertise a business
- How to devise office methods

Sending for this free book binds you to nothing, involves you in no obligation; yet it may be the means of starting you on a broader career. Surely you will not deny yourself this privilege, when it involves only the risk of a postal—a penny! Simply say "Send on your 9,059-word Booklet". Send to **SYSTEM, Dept. 81-11 Wabash and Madison Sts., Chicago**

LEARN TO REPAIR AND RUN AUTOMOBILES



Oldest and best equipped School in the West. Modern facilities. Up-to-date methods—Everything practical.

ENROLL NOW AT SPECIAL FALL RATE

and save money. You can enter later. Big demand for trained men. Our graduates receive preferred attention. Write at once for full information.

KANSAS CITY AUTOMOBILE SCHOOL
2188 E. 15th St. KANSAS CITY, MO.

DON'T TRY TO BE A CHAUFFEUR



or go to any school to learn, or part with your hard earned dollars until you have read our valuable guide **FIRST**. It tells what you should **PAY** and what you should **GET**. Do not be deceived by schools, which claim everything and give you nothing. **YOU CAN'T AFFORD TO SPEND ONE CENT TILL YOU GET OUR GUIDE.** It costs nothing and may save you many dollars. Write now for this **FREE** book.

PRACTICAL AUTO SCHOOL, 68 Beaver St., New York

AT LAST! The Practical Advertising Course

Here is the really practical home-study course that will fit you quickly for a fine advertising position. The very **cream** of the experiences of over 60 of America's greatest advertising writers, plan men, solicitors, outdoor men and others who **NOW** are earning big salaries in this congenial profession. You get their knowledge **first-hand**. Everything from type sizes to National campaigns. Simple, practical. **Your terms.** Write today for free catalog which describes it all. No obligation. **Dept. 103A, CHICAGO UNIVERSITY OF COMMERCE, CHICAGO, ILLINOIS**

Be An Expert WRESTLER



Farmer Burns, the greatest of all wrestlers, trainer and manager of the mighty world's champion, **Frank Gotch**, will teach you **by mail**, all the wonderful holds and defenses known to the art. Greatest opportunity ever offered for those who want to become an expert wrestler, or to be a great athlete.

Investigate! Write now—**TODAY**—for full particulars—sent **FREE**. **BURNS SCHOOL of WRESTLING, 1198 Range Bldg., Omaha**

You Young Edison



Yes, do it. Become a highly paid, practical master in this field of wonderful profit. Write today for the Big **FREE** BOOK that tells how this school of expert, face-to-face instruction will both teach you and place you. Send now.

SCHOOL OF ENGINEERING OF MILWAUKEE, Div. 52, MILWAUKEE

CORNET FREE! We guarantee to teach you give you a Beautiful Cornet to play by mail and will absolutely **FREE**. You pay weekly as lessons are taken. Instrument is sent with first lesson. Write today for our booklet and wonderful tuition offer. **INTERNATIONAL CORNET SCHOOL**
894 Music Hall, Boston, Mass.



Glove Progress

The difference between the knight's old glove of mail and Hansen's Protector Gauntlet illustrates the wide step from the clumsy methods of the Middle Ages to the specialized efficiency of today.

The increasing demands in all lines of work are constantly being answered in Hansen's Gloves. In every up-to-date detail they keep and hold the standard of efficiency.

Hansen's Gloves

are of the finest leather, tanned by unique process. Always soft; easily cleaned with gasoline. Different weights—from the Protector Gauntlet of stoutest horsehide for heavy labor to dressy gloves for street wear—but *all soft*, pliable, cleanable, *strong*.

Write for book showing many of our 500 styles—for railroad men, linemen, lumbermen, farmers, etc. For driving, motoring, cycling. There is a design for every man in every line of work or sport.

If there is no Hansen dealer in your town let us tell you where to buy. Address—

**O. C. HANSEN
MFG. CO.
291 Milwaukee St.
Milwaukee, Wis.**



STILLWELL BUNGALOW BOOKS

Homes of the Golden West are the most artistic and scientifically planned in all the world. They solve the high-cost-of-building and servant problems. You can build beautiful Bungalows *anywhere* with built-in conveniences at a surprising economy of space and cost. Our plan books show 128 ideal homes.

"Representative Cal. Homes"—50—\$1600 to \$6000—Price 50c

"WEST COAST BUNGALOWS"—50—\$ 500 to \$2000—Price 50c

"LITTLE BUNGALOWS"—28—\$ 300 to \$1400—Price 50c

SPECIAL—Send a Dollar Bill now for all 3 books postpaid.

E. W. Stillwell & Co., Architects, 4127 Henne Block, Los Angeles

Please Mention Popular Mechanics



**\$5,000
a year!**

How Would \$5000 a Year Suit You?

You could do a lot, couldn't you, with an income like that? A nice comfortable living—your summers at the Lakes or the Sea Shore—acquaintance with big men in business—influence and social position—in fact, you could experience the joy of REAL living.

Don't Turn This Page

—if you are looking for a job of this kind or if progress is slow in your present job. Learn how a legal training will make you a leader of men—will aid you in winning bigger success in business—will quickly increase your earning power.

Learn LAW at Home

By devoting 15 minutes of your spare time each day to study you can master the law *right at home*. No need to give up your present occupation—no costly tuition fees to pay, no expensive Text Books to buy. We offer you the *Leading Law Course in America* at a tremendously low cost. You receive instructions from the greatest array of legal experts ever gathered under the head of a big Law School. We *Guarantee* to coach *Free* graduates failing to pass the bar examination.

Startling Scholarship Offer!

We are making a tremendously liberal offer at this time! Mail the coupon at once! Get the facts immediately. This Scholarship offer is so liberal, so unusual, that we can give you the facts only in direct letters. We are making this great offer for advertising purposes. It is strictly limited. The Scholarship we offer you entitles you to our Complete Three Year Course and Service at the *Tremendous Saving of \$100.00 to You*. Do not hesitate a minute—send coupon today.

Sent FREE! We will send you full particulars of this liberal offer by return mail; also our School Catalog telling how you can become legally trained **at Home** during your spare moments—how you can gain the highest success in the profession of Law or in business. This puts you under no obligation—it costs you nothing—it simply gives you a chance to go over the facts and decide. Clip the coupon—right now—before you turn the page. Mail it **Today**—while this Scholarship Offer is open.

**Free
Investigation
Coupon**

American Correspondence School of Law
Dept. 1198, Manhattan Bldg., Chicago, Ill.

GENTLEMEN: Without any obligations on my part, send me full particulars of your Special Scholarship Offer; also your free catalog. Send everything **free and prepaid**.

American Correspondence
School of Law
Dept. 1198
Manhattan Building
CHICAGO
ILL.

Name.....

Address.....

Become An EXPERT ACCOUNTANT!



\$3,000 to \$10,000 Yearly!

If you remain a clerk or bookkeeper, salary increases are improbable—an independent future impossible. You can't demand a raise—there are thousands awaiting your job. There is one sure way to overcome your handicap: become an EXPERT ACCOUNTANT, by our modern home-training method—**be sought—don't seek.**

There are 500,000 big firms today requiring annual or semi-annual audits—and there are only 1,500 certified public accountants in the U. S. This proves the tremendous, unlimited opportunities for you—the independence—the assured future—the big salary. These firms are willing to pay Expert Accountants with our training \$3,000 to \$10,000 yearly. But they pay clerical workers and bookkeepers only \$12 to \$20 weekly. Become an Expert Accountant and your rise in the business world will be unlimited—many of our graduates are now managers of big firms. Remain a clerk or bookkeeper and you will always be bossed.

WE TRAIN YOU BY MAIL

in your own home, during your spare time, no matter where you live. You don't give up your present position and income—you don't deny yourself pleasures or sacrifice duties. Devote a little spare time evenings preparing for independence and a big income and you will soon master this lucrative profession.

You can readily master our modern method in your own home—you can complete it in less time than any other. In many particulars it offers more advantages than a college course in Higher Accountancy—you are not held back by plodders.

The La Salle Extension University course in Higher Accountancy was prepared by some of the world's most noted accounting experts. It is under the direct supervision of William Arthur Chase, a nationally recognized leader, who is Ex-President of the American Association of C. P. A. Examiners, and Ex-Secretary of Illinois State Board of Examiners in Accountancy.

Our course is thorough—advanced—covering the Theory of Accounts, Practical Accounting, Cost Accounting, Auditing, Business Law, etc., and prepares you for C. P. A. Examinations in any State.

Valuable Book FREE Write at once for "What Every Bookkeeper Should Know"—a free copy of a valuable special book which gives exactly the information you require to become an Expert Accountant, studies, kind of examinations, State regulations, salaries paid, positions to be had.

SPECIAL REDUCED RATE SCHOLARSHIP—Limited Special Offer. Write quick and learn how, for a limited time, we are able to offer a special reduced rate scholarship.

We Show RESULTS! This institution is a strong, conservative organization—with thousands of students and as many letters from successful graduates. There is no other home-study course so thorough—endorsed by America's greatest Accounting Experts. We want you to know facts about the successes of our students and the unlimited opportunities that confront you today by our method of home training, so—

La Salle Extension University,
Dept. 368, Chicago

Send at once, without cost or obligation to me, your valuable book of Accounting Facts, and full details of your Course in Higher Accountancy; also advise me about Special Time-Limited Reduced Rate Scholarship.

Mail Coupon NOW!

Secure valuable book free, and learn how you can advance from a small job with a small salary to distinction, independence, a future, and \$3,000 to \$10,000 yearly. Act Now!

La Salle Extension University,
Chicago

Name.....
Street No.
City..... State.....

Get Into The Pop-Corn, Crispette And Candy Business

Biggest Money-Maker of Them All

Thousands of men are getting rich selling pop corn, crispettes, and candy. Everybody eats them and the profits are enormous. You can make more money in this business than in any other we know of where there is so

Very Little Money Needed

to start. There are hundreds of localities where you can reap a harvest of profits; get your business established right now and see the money come in in a perfect stream—get your

Start on the Road to Wealth

with a Dellenbarger outfit—the outfit that delivers the goods that bring the customer back for more—the popper that makes great, big, fluffy kernels and seasons the corn while popping; the crispette and candy outfit that produces the most delicious confections imaginable.

Don't Neglect Your Opportunity

No other business will net you such handsome profits on your investment—and you don't have to pay all down—we give you time. You Can Pay Us with Part of Your Profits. We teach you the business and help you in every way.

Start Now—Send for Catalogs

Sit right down now and send for our catalogs and complete particulars of our

Easy Payment Terms

A 2-cent stamp may mean wealth for you. You can't afford to neglect it.

No Experience Necessary—We Teach You the Business Free

C. F. DELLENBARGER CO., 617 W. Jackson Boul., CHICAGO, ILL.

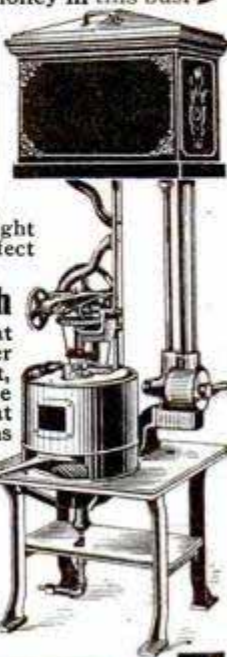

Prest-O-Lite



The Only Practical Light for Motorcycles

Prest-O-Lite is the only lighting system that makes night riding possible, pleasant and SAFE.

This ready-to-use gas costs no more—usually costs less than the carbide a generator consumes.

The first cost is low [\$10]. Prest-O-Lite never gets to be second-hand, and is always a READY CASH ASSET.

You can easily afford it. You cannot afford to be without it if you ride at night. One accident might cost you more than years of Prest-O-Lite service.

Easily attached to any motorcycle. We will arrange for immediate exchange service for anyone, anywhere.

See any motorcycle (or automobile) dealer, or write us.

DON'T ACCEPT AN IMITATION!

The genuine Prest-O-Lite, when empty, can be immediately exchanged for a full one, ANYWHERE AND ALWAYS. Imitations cannot.

THE PREST-O-LITE CO., 265 Speedway, Indianapolis, Ind.

Branch offices and Service Stations in all principal cities. Charging plants in all parts of the country.

Exchange Agencies Everywhere

YOUNG MAN! LEARN DRAFTING

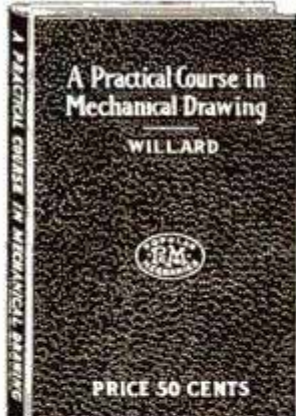

ONE of the most practical subjects of study today; an essential in most lines of engineering; indispensable in many occupations and often the secret of successful advancement; of no less importance to the farmer than the mechanic. There is bound to come a time when you will feel the need of the ability to "lay out" something in accordance with the rules and conventions used in the drafting profession.

Individual Study

may be successfully engaged in with the aid of our new enlarged edition of the book

A Practical Course in Mechanical Drawing

By WM. F. WILLARD

(For several years instructor in Mechanical Drawing at Armour Institute of Technology, Chicago)

160 PAGES — SIZE 5x7 — 157 DRAWINGS — CLOTH COVER

Price 50 Cents, Postpaid

There has been a real need for a book of this kind, as it clinches each problem in the mind of the student by giving the practical application of that problem to every day practice in some phase of the world's work. It meets every modern requirement and is in advance of any other work on the subject. Excellent for use in shop classes, trade or high schools. A complete detailed description of the contents of this book sent free upon request.

Order of your Book Dealer or direct from the publishers

POPULAR MECHANICS BOOK DEPT.
318 W. Washington St., CHICAGO

WHEN YOU WANT ANYTHING AND DON'T KNOW WHERE TO FIND IT
WRITE BUREAU OF INFORMATION,
POPULAR MECHANICS CHICAGO

MONTHLY CASH PRIZES

Until further notice in this magazine the Editor of Popular Mechanics will pay two cash prizes each month for the best original contributions to its

SHOP NOTES DEPARTMENT

\$10 for the Best Contribution
\$5 for the Second Best

THIS IS IN ADDITION to our usual rates for such contributed articles.

Quality, not length counts. Checks will be sent on the last day of each month for the prize articles received during that month. Publication in the magazine will follow in about two months.

PRIZES AWARDED FOR SEPTEMBER, 1913

- First Prize—J. B. MURPHY, Plainfield, N. J. \$10
"Substitute for Brass Castings"
- Second Prize—K. G. RUMMELHOFF, N. Yakima, Wash. \$5
"To Remedy the Grip of an Automobile Clutch"

EXTRA AWARD

On account of there being five contributions this month each of which deserved second prize, we have made an EXTRA AWARD of four additional second prizes, as follows:

- R. J. HEROLD, San Francisco, Cal. \$5
"Graphite Cup Filler"
- D. C. GOFF, Knoxville, Tenn. \$5
"Forging Notch in An Anvil"
- N. M. BALDWIN, New London, Conn. \$5
"Concrete Form to Make Round Inside Corners"
- H. C. HUNT, Pottersville, Mich. \$5
"Strapping Handle for Safety Razors"

All accepted contributions to our departments, "SHOP NOTES" and "AMATEUR MECHANICS," are paid for immediately; checks for prize awards are sent at the end of each month.

Address, EDITOR POPULAR MECHANICS
318 W. Washington St., Chicago

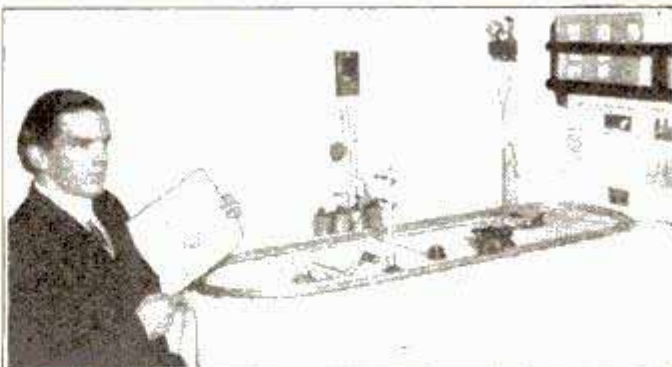

FREE

\$1350 Signal Engineer's Outfit

Yes, absolutely free. We give everyone of our students this complete Signal Engineer's outfit, absolutely free. Operates just like a railroad system. Set up the signals yourself. Do the actual work. Gives you the practical experience that enables you to get the big job. All free to our students. Don't send a penny. Write today.

Be a Signal Engineer

Thousands of positions open. In no other profession are there such exceptional opportunities. Big money is being paid. We must have more men. Great special offer now being made to induce you to start the study of Signal Engineering right away. Send the free coupon for full particulars.

\$2500 A YEAR

is the ordinary salary for a Signal Engineer. Hundreds making more. You can hold down one of these jobs. Hundreds of positions now open. We give you the practical instruction. The kind that the railroads are demanding. The most fascinating profession in the world. Travel from coast to coast without it costing you a penny. Even before you have completed your studies you can get a position under a Signal Engineer, paying from \$75 to \$175 a month. Send the free coupon.

Special

Send in the free coupon at once. Great special offer now being made. But you must hurry! Free outfit and complete course of instruction on a remarkable offer. Send the free coupon.

Send the Free Coupon for Big New Book

Just put your name and address on the free coupon and send in to us at once. Absolutely no obligations of any kind. We will send you absolutely free and prepaid the big new Signal book. Tells you all about the most fascinating of professions—Signal Engineering. Tells how you can become a Signal Engineer at home—during your spare time—by mail. Do not delay. Just fill out the free coupon and send it to us at once.

FREE Book Coupon

DEPARTMENT OF SIGNALING, Dept. 1198
491 Cass St., Chicago, Ill.

GENTLEMEN: Please send me absolutely free and prepaid your big new Signal Book. Also full particulars about your great special free outfit offer. It is distinctly understood that I assume no obligations of any kind.

DEPARTMENT OF SIGNALING
Dept. 1198
491 Cass St.
CHICAGO, ILL.

Name.....
Address.....
Age.....
Occupation.....

Become a TRAFFIC EXPERT

Learn at Home



NEW JOBS OPEN, BIG PAY

Thousands of large shippers and all Railroads need trained Traffic experts and Managers—newly created positions are open everywhere with salaries of \$35 to \$200 weekly. The demand for trained men is greater than the supply. Recently enacted railroad rate laws and interstate commerce regulations have produced new conditions that necessitate trained specialists—men who know how to route shipments, to obtain shortest mileage, quickest deliveries—lowest rates. With such knowledge you can qualify for an important, big-salaried position with a future—quick.

WE TRAIN YOU BY MAIL

at home, in spare time, without giving up your position or income. The cost is small—we make the payments to suit you. All you need, to get into this powerful, big paying occupation is our training. No matter where you live, what you work at now, how small your pay, how long your hours—no matter what your age or education—if you can read and write—our Interstate Commerce Course will train you expertly to handle proficiently a big Traffic Manager's job—to merit and retain influence, respect, power and \$35 to \$200 weekly.

Most Thorough Method Known

The LaSalle method is simple, practical, logical—anybody can readily master it. It is the work of some of the greatest Traffic Experts in America. It covers thoroughly every feature of the profession you will ever need to know—it is different and more complete than any other method of home-training in Interstate Commerce ever known. This is the largest home-study Extension University in the world—our graduates are recognized as real experts—they are trained to do the kind of work that commands big positions.

NEW UNCROWDED OCCUPATION

This is a new uncrowded occupation—there's room for you if you prepare at once. Let us train you now for a big future, with power, dignity, respect and a big income, with almost unlimited opportunities. All you need is a desire and our home training to become a big man with independence and a big income. Don't remain in a small job that thousands of men are constantly after—let us make you the master—the big man—a successful leader among men.

FREE—Wonderful Book

Send the coupon below now and receive free copy of our much talked-of book "10 Years Promotion in One"—learn more about the opportunities afforded Traffic Experts with our training—learn about the big positions now open—learn how easy it is for us to make you a traffic specialist. Remember only trained men can secure the big positions now open—remember that big employers are seeking our graduates because of their efficiency. Send the coupon—no money.

La Salle Extension University, Chicago

La Salle Extension University, Dept. 367 Chicago, Ill.

Send at once, without expense to me, FREE copy of your famous book "10 Years Promotion in One"; also book telling how I may, without interfering with my present position, prepare myself as Traffic Expert.

Name

Address

Occupation.....

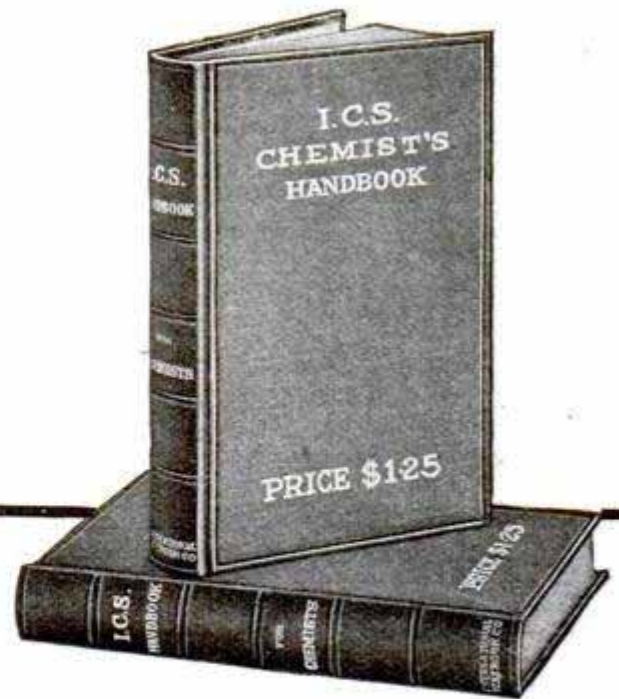

A Handbook of Practical Chemistry

Every man interested in electricity or mechanics should have one of these Chemistry Handbooks. It explains in clear and simple terms the fundamental laws of chemistry, and contains those rules, formulas, and other information that are most commonly used and that you don't want to search for through ordinary textbooks. This Handbook was compiled from the home-study textbooks of the International Correspondence Schools and is $3\frac{1}{2} \times 5\frac{1}{2}$ inches in size, bound in silk cloth, and contains 332 pages and 11 illustrations. Retail price \$1.25. A few of the subjects treated are:

Volume and temperature of gases; specific gravity; hydrochloric-acid, nitric-acid, and sulphuric-acid solutions; solubilities of chemical compounds; qualitative analysis; general table of analysis; classification of rare metals; the spectroscope; nitrogen; blowpiping; determination of gold and silver ores; methods of assaying; composition of alloys, etc.

SPECIAL OFFER: For a limited time we offer readers of POPULAR MECHANICS one of these regular \$1.25 Chemistry Handbooks at a Special Introductory Price of

SEND YOUR ORDER TODAY

50c

International Textbook Co., Box 872-G, Scranton, Pa.

I enclose 50 cents for which please send me one copy of the \$1.25 I.C.S. Chemistry Handbook.

Name

St. and No.

City State

Representatives Wanted in Unoccupied Territory

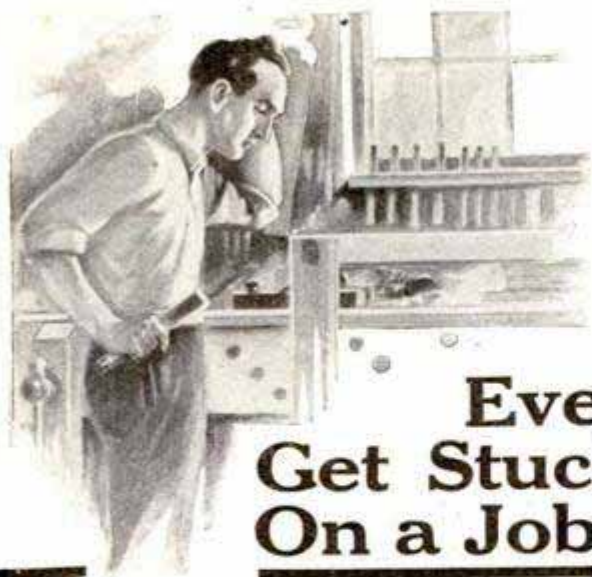

Ever Get Stuck On a Job?

WERE you ever confronted with an emergency job where something unusual had to be done quickly with the few tools at hand or no tools at all? You could have done that unfamiliar job in a jiffy if only some one could have informed you how he did it.

¶ Has it occurred to you that every day, everywhere, men in every department of mechanics, engineers, firemen, carpenters, machinists, plumbers, painters, iron and wood workers, electricians, masons and in fact men in all the trades are meeting and solving these problems in economical, time and labor saving ways?

¶ If a collection of all this useful experience of years, of hundreds of the most successful mechanics could be made, "boiled down" and written so it could be readily understood by anyone who uses tools, would it not be of priceless value to the owner?

¶ This is just what **Popular Mechanics Magazine** has been doing for years, and now our

Series of Shop Notes Year Books

constitutes a veritable encyclopedia of

Easy Ways to Do Hard Things

¶ Naturally these books must be handy of reference to be of value and this feature has not been overlooked as each volume is indexed fully and with great care, so that any subject may be turned to at once.

¶ Why not save yourself the trouble of puzzling out the "kinks" and "short-cuts" when some one has already done it for you? Some one little suggestion may be worth more to you than the price of the entire set of books.

Shop Notes Year Books

VOLS. I TO IX INCLUSIVE

CONTAIN

4595 Articles—1988 Pages—4503 Illustrations

Size 6 x 9 in. Bristol Covers.

PRICE

50c PER VOLUME **\$4.50** PER SET of nine Books in Handsome Case Prepaid Postpaid

Order or complete your set to-day

Popular Mechanics Book Dept.
318 W. Washington St. CHICAGO

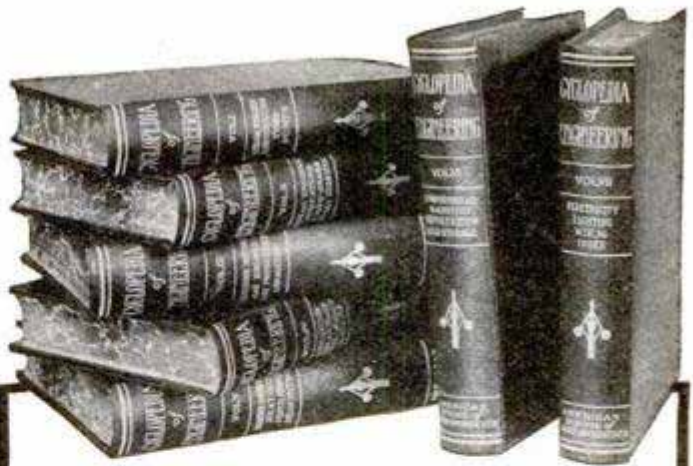

More Knowledge — More Pay

The engineer who gets the money is the one who knows. Get the knowledge you need to put yourself in this class. Prepare yourself at home, with the aid of this complete engineering library, to get the big job and the big pay.

The Seven Volume Cyclopaedia of

Steam Engineering

is written by 27 experts

It will give you a knowledge of steam engineering that cannot be obtained from any other set of books. Every section, every page, every line, is full of practical, up-to-date information just suited to your particular needs.

Contains 3,300 pages; 2,500 illustrations; full-page plates, diagrams, etc.; hundreds of valuable tables and formulas; carefully cross-indexed for quick, easy reference. The seven large volumes are bound in half red morocco, gold stamped, and are printed in large, clear type on special quality paper.

READ THIS SYNOPSIS

Construction of Boilers—Boiler Accessories—Fuel Economizers—Mechanical Stokers—Steam Pumps—Steam Engines—Indicators—Valve Gears—Steam Turbines—Gas and Oil Engines—Fuels—Automobiles—Carburetors—Locomotive Boilers and Engines—The Air-Brake—Single-Phase Electric Railway—Elevators—Marine Boilers—Marine Engines—Heating and Ventilating—Compressed Air—Transmission—Absorption and Compression Refrigeration—Ammonia Machines—Direct Current Dynamos and Motors—Management of Dynamos and Motors—Electric Wiring—Electric Lighting, etc.

Sent Free — Express Prepaid

The complete seven volumes, not a sample volume, will be sent, express prepaid, for seven days' free examination; returnable at our expense if the books do not contain the information you want. If you keep them, pay \$2.00 seven days after receipt and then \$2.00 a month until you have paid the special introductory price of \$19.80. The regular price of this great Cyclopaedia is \$35.00.

Just fill in and mail the coupon. It won't cost you a cent to examine the books. We know they'll be worth many times their cost to you. Mail the coupon now and you'll receive your books promptly.

\$12.00 Consulting Membership Free

With every set is included a year's Consulting Membership, regular value \$12.00, entitling you to the free advice of a staff of Engineering Experts. This will give you practical help in handling working problems which are too specific to be taken up in detail in the Cyclopaedia. There will be no limit to this service. A single problem solved for you might be worth more than the first cost of the books.

American Technical Society, Chicago, U. S. A.

FREE EXAMINATION COUPON

American Technical Society, Chicago, U. S. A.

Please send set Cyclopaedia of Engineering for seven days' free examination. I will send \$2.00 within seven days and \$2.00 a month until I have paid \$19.80; or notify you to send for the books. Title not to pass until fully paid. Pop. Mech. 11-13

NAME.....
ADDRESS.....
OCCUPATION.....
REFERENCE.....



THE OLD RELIABLE SCHOOL
We have successful graduates in nearly every State in the Union.

Delco Instruction

and we are now prepared to give you Delco instruction "right." Our school actually has a Delco system in operation on a motor, and is the **only school** that gives students **ACTUAL EXPERIENCE** in wiring the Delco systems. Factories are paying better salaries for lighting, starting and ignition men than for any other factory men. 150,000 cars (1914 models) will have Delco systems. Delco men are very scarce and those who understand Delco systems will be in great demand at high salaries.

Come to Detroit, the Automobile Center

and learn the automobile business. Sixty-seven out of every 100 autos in the country are made in Detroit's 38 automobile factories. There are greater and better opportunities in Detroit than in any other city in the United States. Why go to some out of way place where they practically don't make autos, when you can go right to Detroit, the automobile center, and learn the business right?

Our 48 page booklet "How to Drive an Auto" sent free on request

Address **Michigan State Automobile School**
Dept. P
11-13-15-17 Selden Ave., Cor. Woodward, DETROIT, MICH.

THE OLDEST AND BEST

Automobile School

In Detroit, the automobile center. The largest, best equipped and **MOST RELIABLE** automobile school. Unlimited practical instruction on everything pertaining to automobiles.

We have recently arranged with a prominent Detroit firm to **build and sell** pleasure cars for them. In addition to these pleasure cars we are also building commercial cars. Our students now get the **actual experience** in **assembling, block testing and in road testing** in addition to the **garage and repair shop experience** which we have been giving them. Ours is the **ONLY SCHOOL** that gives the student such a variety of actual experience. You may write to the different schools in the different cities, but you will not find one that can give you better training than we can.

Our Guarantee

We guarantee to qualify you for a position as chauffeur, repairman, tester, salesman or demonstrator in a short time, or we will refund your money. Have you ever known any other auto school to give this guarantee? We do it, because we have the equipment, the room and the system and the instructors.

And don't forget, we furnish positions, too

On account of being in the auto center, we can furnish positions that schools in other towns cannot.



Piano Tuning Pays \$5 to \$15 a Day

Our TUNE-A-PHONE eliminates all guess work and assures success with or **without** a knowledge of music. Diploma granted. Write today for **free** book. **NILES BRYANT CORRESPONDENCE SCHOOL**, 65 Art Inst., Battle Creek, Mich.



APPLICANTS WANTED FOR OUR SCHOLARSHIP AWARDS

Given to demonstrate our exclusive methods in **Drawing, Painting, Illustrating and Cartooning**. Aid students in qualifying for Home Employment or Salaried Position. We guarantee results. List of Premium Outfits and full particulars **FREE**. Number of Awards limited, so write today. Art Annual included for 6 cts. in stamps.
FINE ARTS INSTITUTE, Studio 218, Omaha, Neb.

DON'T TAKE A COURSE IN Mechanical Drawing

until you have read my proposition. Practical draftsman, regularly employed by the most progressive company in the West, with long experience also as teacher of Mathematics and Drawing, will instruct a few men by mail. **Positively the best way to become a practical well-paid draftsman.** Instruments furnished. Rates reasonable. **Pay a part after in position.** For information write,

DRAFTSMAN, 252 South Corona Street, Denver, Colo.



STAMMER

My book "How to Stop Stammering"—a treatise on "Scientific Talking"—direct to the point.

Write **M. L. HATFIELD**, 1918 Grove St., OAKLAND, CALIF.

LEARN WATCHMAKING AND ENGRAVING



Earn while learning. Most practical watch school. Individual instructions. Graduates in great demand. Book free. **Chicago School of Watchmaking**, 63 E. Van Buren St., Chicago



SHOWCARDWRITERS
EARN FROM
\$21 TO \$50 PER WEEK

LEARN ABOUT OUR FREE COURSE IN SHOW CARD AND SIGN WRITING

A Great Opportunity! We are offering, for a limited time, a complete course in show card and sign writing to those purchasing our assortment of **"Litholia" Ready-to-Use Colors**. This is a great opportunity for ambitious persons, either sex, to increase their earning capacity. Good show card writers in demand at \$21 to \$50 weekly, salary or in business for yourself. Our show card course is not a book of alphabets. It's a complete course in lettering compiled by an expert New York showcard artist. **"Litholia"** is the only liquid pigment water paint ever manufactured, used the same as cake, distemper or tube colors, but far superior to either. **"Litholia"** lasts longer, always ready. **"Litholia"** is the best for the show card writer, the artist, or the interior decorator. A letter of request brings booklet, circulars, and full information.

LITHOLIA P.M. COLOR CO., 71 to 81 W. 23rd Street, NEW YORK CITY

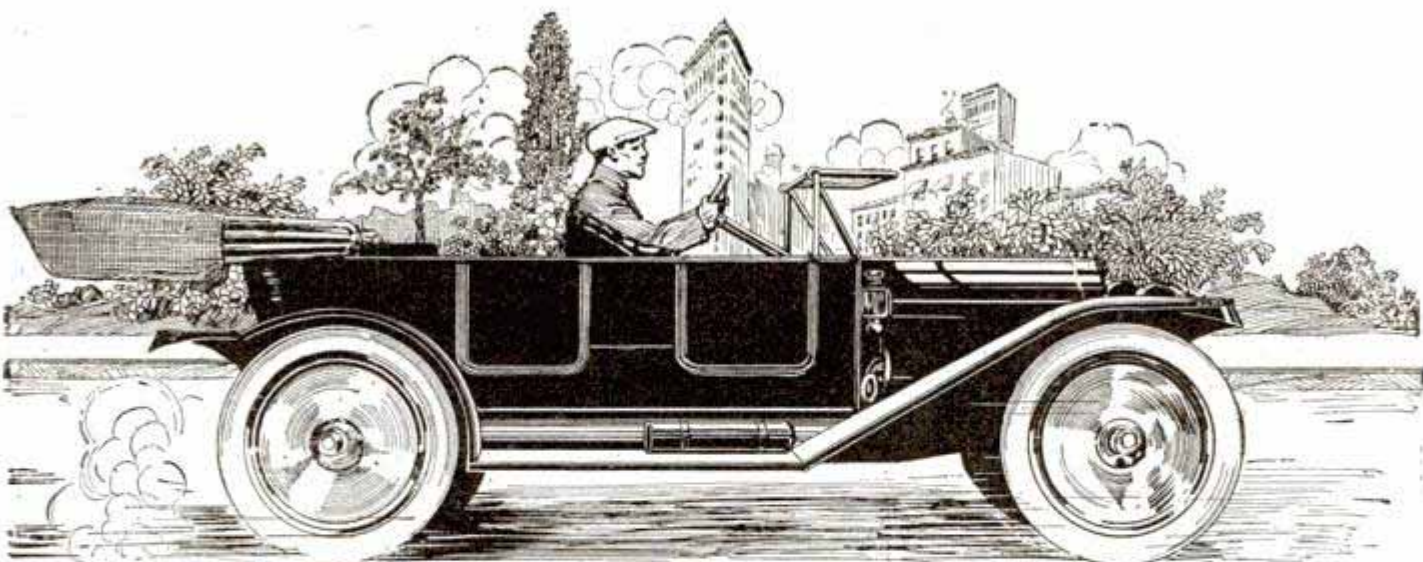

THIS CAR AND \$10,000.00 IN EXTRA PRIZES FREE

This is my latest great sensational offer to young men who want to make from **\$100 to \$300 per month** in the Automobile Business.

FIRST—I will give this big 50 h. p. car—The Coey Flyer to every student who qualifies for the agency. Not one cent in cash—this big \$2000 car is yours to ride in and enjoy—it is yours to keep. This is the most liberal offer I ever made.

SECOND—If you will do a little work for me while you are taking my great **Course in Motoring** I will give you **FREE** a \$150 American Motor Cycle fully equipped. I will give you **FREE** a \$150 Heywood Vulcanizing Plant which will make you oceans of money in your home town. I will give you a Luthur Shop Grinder—14 tools in one. You can win a 40 piece Mechanical Tool kit, Wrenches, Gloves, Books and many other prizes. I will give all these fine prizes **FREE**.

YOU CANNOT FAIL TO WIN ONE OF THESE PRIZES

Every one is worth while—Every one will help you in business—help you make more money—help you be some one—a man of affairs.

Write Me Today—I Will Send This Great Outfit FREE

- FREE**—The first lesson of my great course.
- FREE**—My big catalogue fully illustrated.
- FREE**—Giant Circular describing my practical School.
- FREE**—Sensational Prize Offer showing all the prizes.
- FREE**—How to get a \$2000 Automobile without a cent in cash.

**OLD
Students
Can Win
Prizes—
Write
Me**

**WRITE
TODAY**

Everything FREE

C. A. COEY, President

**C. A. Coey's School
of Motoring**

PRIZE MANAGER

A-1424 Michigan Avenue - Chicago, Ill.



**THESE ADVERTISEMENTS WILL HELP
YOU WIN THESE PRIZES**

This Complete Library of

LAW

IN 6 HANDY VOLUMES

Only \$1 a Month

"Ignorance of the law excuses no man." THAT'S LAW. You can't always "guess" the law. You may not have time to "study" law. Lawyers come high—especially some of them. **BUT YOU MUST KNOW LAW!**

This splendid little handy LIBRARY OF LAW is prepared for the average man—the business man—the doctor—the teacher—the minister—the man who works for others—the man who works for himself—the man who writes—the man who has money and the man who has not—**EVERY MAN**. This Library is a work to read at odd times and a reference work combined. The language is simple, direct, plain, and it covers every subject you need to know about. Here are just a few of them: "Wills"—"Mortgages"—"Deeds"—"Farm Laws"—"Landlord and Tenant"—"Leases"—"Copyrights"—"Trade Marks"—"Partnerships"—"Letters of Credit"—"Trustees"—"Corporations"—"Stockholders"—"Dividends"—"Marriage"—"Parental Relation"—"Employer and Employee"—"Assault"—"Defamation"—"Libel"—"Criticism"—"Self Defense"—"Automobile Laws"—"Patents"—"Contracts"—"Fraud"—"Damages"—"Negotiable Paper"—"Indorsements"—"Promissory Notes"—"Checks"—"Bills of Exchange"—"Bonds"—"Agents"—"Banks"—"Bankruptcy," etc.

Low Price & Easy Terms

We can't begin to tell you all about this splendid set of books, so we are not going to try. We want to send you the books themselves—the COMPLETE SET of 6 handy volumes, measuring 6¼ by 4¼ by ¾ inches, so that you can examine all the volumes and decide for yourself if they are just the books you want—AND NEED. If you decide to keep them, just send us \$1 as first payment, and \$1 a month thereafter for 8 months. But if you do not wish to keep the books after seeing them, then you may send them back at our expense. That's fair. Isn't it? **MAIL COUPON BELOW AT ONCE.**



EXAMINATION REQUEST

THE THOMPSON PUBLISHING CO. 11-13
1127 Pine Street, St. Louis, Mo.

Send me for examination, one set of your handy LIBRARY OF LAW in six volumes bound in Buckram. If I am satisfied with the books I will send you \$1 as first payment, and \$1 a month thereafter until the special price of \$9 is paid. If I do not wish to keep the books, I will notify you in seven days, and the books are then to be returned at your expense as offered Popular Mechanics readers.

NAME.....

ADDRESS.....

LEARN TO PAINT SIGNS and SHOW CARDS

THERE'S MONEY IN IT



I'll teach you personally by mail. 14 years successful teaching. You will succeed. Wonderful field. Thousands of merchants use window cards, price cards, sale cards, banners, and signs in large quantities. They buy new ones weekly. Notice for yourself. Gold lettering on glass and wood valuable feature of the course. Our course teaches everything. This knowledge helps you wherever you are. Pay good, work easy and fascinating, hours short.

Earn \$18.00 to \$35.00 a Week

Many of our students make big money in business for themselves. Natural talent unnecessary. Read what students say. Crawford, B. C., Canada, says: "Earned nearly \$200.00 since taking course." Parrett, Okla., says: "Earned several times cost of course since enrolling." Fritzer, Minn., writes: "Did job recently and got \$10.00, profit \$7.05." Write for large complete catalog, testimonials, pictures, sample of work, terms.

DETROIT SCHOOL OF LETTERING
Chas. J. Strong, Founder, Dept. 211, Detroit, Mich.

Guarantee —

I guarantee to place my graduates in positions paying \$85.00 to \$175.00 when they have graduated and are competent. We have constantly more requests for men at good salaries than we can supply.

Learn to Play the Piano Quickly in Your Own Home

We teach you to play the Piano in one-third the time, at one-third the cost, and with one-fourth of the mental drudgery of any other Conservatory. We teach you thoroughly, by the aid of the Music Master, the wonderful invention that simplifies piano playing. We teach the old standard theory of the masters, but by a new method. It's the wonder of the present age. *Write us for particulars.*

German American Conservatory of Music
Dept. 14, CHICAGO, ILL.

WHEN YOU WANT ANYTHING AND DON'T KNOW WHERE TO FIND IT—WRITE BUREAU OF INFORMATION, POPULAR MECHANICS, CHICAGO

How You Should Exercise



for vitality, endurance, nerve-strength and a perfect physique. MY FREE BOOK, "PHYSIOLOGICAL EXERCISE," throws new light on the question of exercise, building internal strength, nervous energy, vital power, progressive exercise, the question of resistance, pure blood, the germ question and disease, etc. Do you want ENERGY? Freedom from cold and illness? Then learn what my vitalizing building system will do in ten days, ten minutes per day. Just ask for the book. 4c. to cover postage.

THE HENRY VICTOR SYSTEM
Dept. 60, 14 and 16 Fourth Ave., New York

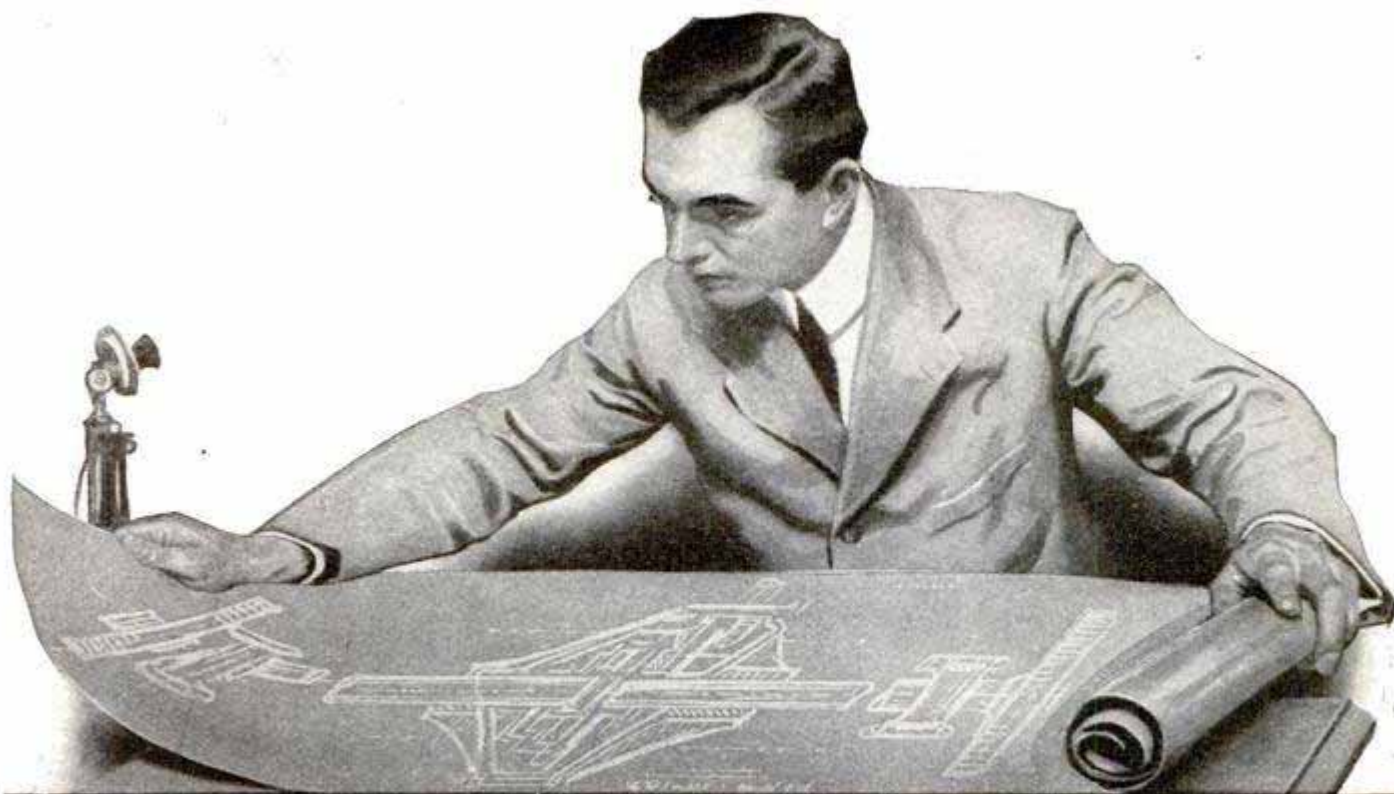

Could YOU Make Good On a *Trained* Man's Job?

Ability counts. *Push*—not pull—is the thing that gets a man ahead. What the business world wants today is men who can DO things—and do them RIGHT. And the *trained* man—the man who can do what the world wants done—can always command a big salary.

Examine yourself. Find out whether you could hold down a job as Foreman, Superintendent, or Chief Engineer if it were offered to you—whether you can do *any* work that would command a big salary. If you can't hold down a really good job now, let the International Correspondence Schools train you so that you can.

You won't have to leave home or give up your position. If you can spare as little as half an hour a day you can get this training right in your *own home* during your *spare time*.

For 22 years the I.C.S. have been going wherever the mails would carry and training ambitious men for better jobs and bigger salaries. *You've* got just as much spare time, just as good schooling and just as strong a determination to make something of yourself as these men had. What they have done *YOU* can do.

If you really *want* a good job and are willing to make a determined effort to get it—just mark and mail the attached coupon and the I.C.S. will show you how they can help you.

Mark the Coupon—NOW

INTERNATIONAL CORRESPONDENCE SCHOOLS

Box 872-W, Scranton, Pa.

Please explain, without further obligation on my part, how I can qualify for a larger salary and advancement to the position, trade, or profession before which I have marked X.

| | |
|------------------------|-------------------------|
| Electrical Engineering | Mechanical Engineer |
| Electric Lighting | Mechanical Draftsman |
| Electric Railways | R. R. Construction |
| Electrician | Concrete Construction |
| Electric Car Running | Architect |
| Dynamo Foreman | Contracting and Build'g |
| Wireman | Architectural Draftsman |
| Mining Engineer | General Illustrating |
| Telephone Expert | Chemist |
| Surveyor | Bookkeeper |
| Civil Engineer | Advertising Man |
| Automobile Running | Civil Service Exams. |
| Agriculture | Salesmanship |

Name _____

St. and No. _____

City _____ State _____

Present Occupation _____

Startling

Read this — remarkable watch book sent free—gives inside facts—send the coupon below—Today.



If you want to know the amazing facts about the watch business, if you want to become posted on the national fight on unfair "price-controlling" contracts with dealers, and high prices charged Americans—then send the coupon below and get the book published by the Burlington Watch Company.

Adjusted to the Second

Thin Model

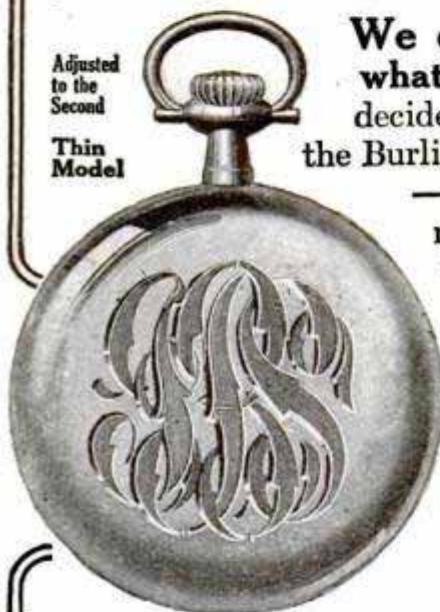

Here is the Exquisite Ribbon Monogram Design. You may have your own initials handsomely engraved by hand on the superb gold strata case—guaranteed for 25 years. Your choice of scores of handsome designs.

We do not care what it costs; we decided to market the Burlington Watch—the world's masterpiece of watch manufacture—at our rock-bottom price DIRECT to the public and at the rock-bottom price—hence our remarkable offer—the opportunity, now to get the masterpiece of watches on an amazing offer!

The Offer: We will ship you the genuine Burlington Special, fully prepaid, on a free approval, at the rock-bottom price. Yes, the same price that even the wholesale jeweler must pay. The world's masterpiece of watch manufacture, adjusted to temperature, position and isochronism; 19 jewels: fitted at the factory into the superb gold strata case. And in order to enable everybody to buy quickly we allow the rock-bottom price either for cash or at \$2.56 a month.

Send the Coupon

Post yourself on the inside secrets of the watch business. Learn how to judge a watch for yourself. Learn, too, the selling secrets the magnates use to force their products on the public. Send the Coupon now for Free Book.

FREE

Book Coupon

Burlington Watch Co.
19th St. and Marshall Blvd.
Dept. 1198, Chicago, Ill.

BURLINGTON
WATCH COMPANY
19th St. and Marshall Blvd.
Chicago, Ill.
Dept. 1198

Please send me (without obligation and prepaid) your free book on watches and a copy of your \$1,000 challenge, with full explanation of your cash or \$2.50 a month offer on the Burlington Watch.

NAME.....

ADDRESS.....

Chauffeur's Law Book!
Get your copy
today

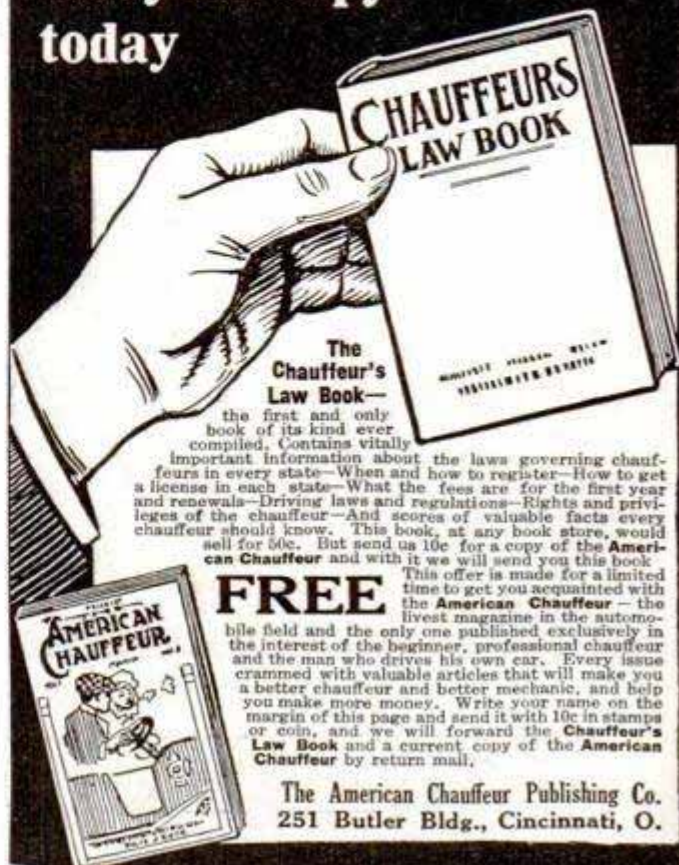

The
Chauffeur's
Law Book—

the first and only book of its kind ever compiled. Contains vitally important information about the laws governing chauffeurs in every state—When and how to register—How to get a license in each state—What the fees are for the first year and renewals—Driving laws and regulations—Rights and privileges of the chauffeur—And scores of valuable facts every chauffeur should know. This book, at any book store, would sell for 50c. But send us 10c for a copy of the American Chauffeur and with it we will send you this book.

FREE

This offer is made for a limited time to get you acquainted with the American Chauffeur—the liveliest magazine in the automobile field and the only one published exclusively in the interest of the beginner, professional chauffeur and the man who drives his own car. Every issue crammed with valuable articles that will make you a better chauffeur and better mechanic, and help you make more money. Write your name on the margin of this page and send it with 10c in stamps or coin, and we will forward the Chauffeur's Law Book and a current copy of the American Chauffeur by return mail.

The American Chauffeur Publishing Co.
251 Butler Bldg., Cincinnati, O.

40 ALPHABETS

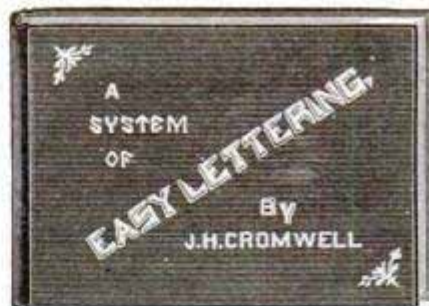

13,000
Copies
Sold
55c
Postpaid

Send for our New
Catalog of Auto-
mobile and Motor-
cycle books Free.

Spon & Chamberlain 125 P. M. Liberty St.,
New York, U. S. A.

STUDY
LAW
AT
HOME

The Correspondence Course Studied by Famous Men

For 24 years bankers, corporation officials, prominent lawyers, educators, labor leaders, city, state and federal officials, ministers, physicians and army officers have been trained by us for highest efficiency. We can do it for you if you've got the "stuff" in you. Complete courses backed up by personal help. Graduates practicing in every state. Takes only spare time and little cash. Write for catalogue and "evidence."

SPRAGUE CORRESPONDENCE SCHOOL OF LAW
359 American Building, Detroit, Mich.

CACHOO! Make the whole family and all your friends "just sneeze their heads off" without knowing why, with Cachoo, the new long distance harmless snuff. Sent anywhere for 10c. 3 for 25c, 1 doz. and special premium for 90c. AMERICAN SUPPLY CO., St. Paul, Minn.



10 Volume Set of De Maupassant GIVEN AWAY

To Popular Mechanics Magazine readers who fill out and return coupon below at once, we will give free, this splendid 10 Volume set of Guy De Maupassant with each order for the 18 Volume "Library Edition" of Balzac's Complete Works.



GUY De Maupassant is King of all Short-Story Writers. His stories never dull, deal with Human

Passion in both its comic and tragic aspects. Stories of Passions, Stories of Youth and Folly, Stories of Happiness and Good Cheer, Tales of Adventure, Tales of Strange Medical Experiences, Tales of Parisian High Life and of that Mystic "Other Side" of the Seine—the "Latin Quarter";—all this marvelous array from his magic pen is to be found in this splendid Set which is yours free, as a "Premium" with your order for the handsome 18 volume "Library Edition" of

BALZAC TRANSLATED FROM THE ORIGINAL FRENCH—UNABRIDGED

NOWHERE in the literature of any country on the face of the globe are there any books like Balzac's. The most brilliant name of his day in the literature of France. Balzac reached the very pinnacle among the world's greatest writers. His marvelous imagination coupled with his intimate knowl-

edge of life, enabled him to scale every height and sound every depth of human passion. Of himself, he said (and said significantly): "*I am the Secretary of Society.*"



IF you would read the great book of life, with its countless thousands of lights and shadows, portrayed by the hand of a master, then you must read Balzac. But if you would read only that which is superficial, then do not read Balzac, for

he deals with things not as they should be, but with things as they are, and his university is the Great University of Human Experience. Balzac's stories literally burn themselves into your brain and memory; they read as though they were his own actual personal experiences, and such is their master-grip and hold upon you that to read them is to live them for yourself. Volumes measure 8¼ by 5¼ by 1½ inches and are bound in deep blue genuine Imported "Library Cloth." Here is your chance to get these wonderful books—at a bargain.

Balzac and De Maupassant —Both for the Price of One

We were fortunate in being able to procure a limited number of Sets of the 10 Volume Edition of Guy De Maupassant at a very reasonable figure. The regular price of this Set is \$9.00, but we do not want to sell these books. Our plan is to give them away as "Premiums" to those ordering our handsome 18 Volume Library Edition of Balzac, as an inducement to prompt action. When the small number of sets of De Maupassant on hand is exhausted, this offer will be withdrawn, but if you fill out and mail coupon at the right promptly, we will see to it that you get one of the free sets of De Maupassant along with your Set of Balzac. But remember, that in order to get the De Maupassant free, you must fill out and mail coupon at the right at once.

MAIL THIS COUPON AT ONCE

To introduce this handsome "Library Edition" of Balzac's Complete Works we will accept orders for our \$54 Library Edition at only \$29.50, on terms of \$2 a month. We do not ask you for any deposit or any guarantee. Just tear off and mail coupon and we will ship you the complete Set of 18 Volumes for 7 days' examination. You can then examine each Volume carefully, and if the books are satisfactory and you wish to keep them, then send us only \$1 as first payment and \$2 a month until the special price of \$29.50 is paid.

To those who answer promptly, we will give as a "Premium," the 10-Volume Edition of De Maupassant, free of charge. So mail coupon immediately.

The Thompson
Publishing Company
1127-29 Pine St.
St. Louis, Mo.

Send me for examination, one set of Balzac's Complete Works in 18 volumes Library Edition. If I am satisfied with the books, I will send you \$1 as first payment, and \$2 a month thereafter until the special price of \$29.50 is paid. If I do not wish to keep the books I will notify you in 7 days and the books are then to be returned at your expense. In consideration of my prompt reply, I am also to receive free, as a "Premium," the 10-Volume Edition of De Maupassant as offered Popular Mechanics Magazine readers. (11-13)

Name.....

Address.....



\$3,000 A Year For YOU

Yes sir! That's exactly what we mean. \$3,000 a year. How would like to have a job like that? **You can have it.** Here is your opportunity. **Get into the New Profession.** It's paying big money. We will give you just the kind of training that you need—the practical training—the kind that is demanded of the men who hold down the big jobs. Read below.

Be a Meter Engineer

The profession of Electrical Meter Engineering is only in its infancy. **Thousands of men are needed.** The Electric Lighting Stations are actually begging for more men. Big salaries are being paid. Here is your chance to get into the new profession and get one of the \$3,000 jobs. Send the free coupon for full particulars.

Positions Created Daily

This coming year over 500,000 new meters are going to be installed. Think of the wonderful opportunities. There are hundreds of positions open now and after the thousands of new meters are installed there will be hundreds of new and greater opportunities. **You can have one of these big jobs.** You can get into the \$3,000 class. Send the coupon now—today.

Special Offer

For a limited time we are making a special reduced price offer in order to induce men to start the study of Meter Engineering right away. Send the Coupon.

FREE Book Coupon

Ft. Wayne Correspondence School
Dept. 1198, Ft. Wayne, Ind.

Gentlemen:—Please send me absolutely free and prepaid your new book on Meter Engineering. Also tell me about your great special offer. It is distinctly understood that I assume no obligations of any kind.

Send the Coupon for Big, New Free Book

Tells you all about the wonderful opportunities you will have in the New Profession. Explains exactly how you can study at home during your spare time and get into the \$3,000 class. Your name and address on the free coupon or a letter or post-card is enough.

Ft. Wayne Correspondence School
Dept. 1198
Ft. Wayne, Ind

Name.....

Address.....

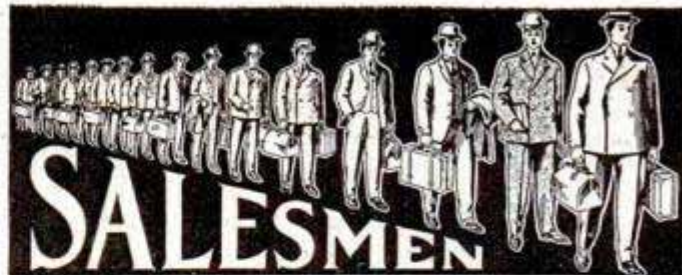

SALESMEN

Are paid Larger Salaries than any other class of men

Hundreds of good positions now open. We will teach you to be a high grade Salesman by mail in eight weeks and assure you offers of good positions where you can easily earn good wages while you are learning. Write today for particulars, list of good openings and testimonials from hundreds of our students who are earning from \$100.00 to \$500.00 a month and expense.

Address (nearest office) Dept. 119

National Salesmen's Training Association
New York Chicago Kansas City San Francisco

A Job with Uncle Sam Is Just Waiting for You

A government position means a job for life with good pay, a liberal vacation, pleasant work, and the assurance that you'll get your pay envelope regularly, in spite of panics or hard times. Wouldn't a job like that look good to you?

Railway Mail, Post Office, Rural Carrier, Custom House, Internal Revenue and Book-keeping "exams" are being held all the time.

Any American citizen, 18 or over, is eligible: a common education sufficient. Decide now that it's what you want, and get your preparation under the personal supervision of a former United States Civil Service Secretary-Examiner. Free Booklet tells all about the details.

WRITE FOR IT TODAY

PATTERSON CIVIL SERVICE SCHOOL

The school with the record for "making good." "Send for Proof."

110 Livingston Arcade ROCHESTER, N. Y.

COPY THIS SKETCH

and let me see what you can do with it. You can earn \$20.00 to \$125.00 or more per week, as illustrator or cartoonist. My practical system of personal individual lessons by mail will develop your talent. Fifteen years successful work for newspapers and magazines qualifies me to teach you. Send me your sketch of President Wilson with 6c in stamps and I will send you a test lesson plate, also collection of drawings showing possibilities for you.

The Landon School of Illustrating and Cartooning
1438 Schofield Building, CLEVELAND, O.



FREE -OF- MAGIC

Giving information on 573 marvelous sleight of hand tricks, magicians' apparatus and books of mystifying entertainments. For amateurs as well as the Great Professionals. Anyone can learn through our instructions. Easy, interesting and entertaining. Mystify and astonish your friends. Give shows and make money. Our wonderful book sent FREE to any address. To cover packing and mailing enclose 10 cts. Read & Covert, 821 E. 43d St., Chicago



Boys' Paper containing fine stories and Departments for 6 months all for 10c postpaid. Send to TRICK CO., 305 E. 51st St., Chicago, Ill.

2336 Different Magic Tricks,

Puzzles, Songs, Stories, Games, Cards, Jokes, Riddles, Money Making Secrets, etc. as Itemized. 283 Splendid Games, 200 Cards, 96 Songs, 89 Fun Cards, Over 200 Magic Tricks, 896 Jolly Jokes and Riddles, 125 Money Making Secrets, and hundreds of other things with a fine



Every Boy His Own Toymaker

Greatest boys' book ever written. Tells how to make a Steam Engine, Telephone, Magic Lantern, Boats, kites, balloons, electrical and mechanical toys, traps, fishing tackle, 200 illustrations; also catalog of 150 puzzles, Keller's Magic Ace Trick Card and "Down's Throat" warbler and bird call all for only 10c. WESTERN PUZZLE CO., ST. PAUL, MINN.



200 Kinds Iron, Wood Puzzles Wire & Steel

Catalog and leader, 10c—3 for 25c
7 for 50c; 15 for \$1—no two alike.

WESTERN PUZZLE WORKS
St. Paul, Minn.

EVERYBODY'S LAW LIBRARY

SENT FREE—EXPRESS PREPAID

Millions of dollars are lost annually through legal loopholes. Every man and woman—especially those in business—should know Law—should know their legal rights—should be able to protect themselves against legal risks on contracts, leases, collections, management, insurance, shipping, mortgages, partnerships, claims for damages, etc. This complete La Salle Law Library enables you to do it as capably as a lawyer—it makes you your own legal adviser—protects you.

Modern, Authoritative, Standard The most noteworthy publication of the century. Used as easily as a dictionary or encyclopedia.



Over 6000 Pages, FULL STANDARD LAW SIZE, 9½ X 6½, ¾ Sheep, 15,000 Citations

Answers Your Legal Questions

This is the most wonderful, non-technical complete Law Library ever published. Nothing is left out—nothing half explained—everything thorough, written in plain language so that anybody can read and quickly understand the law when necessary. Covers each point of law authentically

—giving quick, easy answers to any legal question that may ever arise in your family or business, that affects the rights of individuals, public officials, corporations, schools, churches, societies, etc. You—everybody—should have this authentic Law Library—many need it daily.

Edited By Greatest Legal Authorities This remarkable complete Law Library was written especially for your needs by the greatest legal experts, Law teachers and professors in the big Universities and Law Colleges, such as Harvard, Chicago, Michigan, Illinois, Wisconsin, Iowa and others—it cost us over \$50,000 to prepare.

YOUR QUICK-REFERENCE LEGAL ADVISER

The possession of this massive, authentic Law Library may save you thousands of dollars a year. Thousands of business men and women lose fortunes through ignorance of law that might have been saved with this quick-reference Law Library. Don't hold yourself open to risk—don't lose money—own these books—learn how to act quickly, deliberately, accurately, safely. Sharpen your judgment—don't be imposed upon. These authoritative books make you as capable as a lawyer—save you lawyer's fees. They are a boon to everybody—a necessity to every home and office—a pressing need at last realized—absolute, sound, legal guidance and advice of twenty-six of the world's foremost legal authorities. You consult these books the same as looking up a word in the Dictionary—simple, quick, easy, just like getting the sound, accurate advice of more than a score of the world's greatest legal advisers.

FIREMOST LAWYERS PRAISE IT. America's noted corporation lawyer says: "My examination of the work satisfies me that it possesses great merit as an elementary statement of the body of the law as it exists today. What a boon such a work would have been to an unassisted student like myself." **John F. Dillon**, Counsel for Western Union Teleg. Co., M. P. Ry. and other big interests. Hundreds of similar testimonials. This is the greatest Law Library of the century—absolutely unlike all others—only accurate, thorough, standard, authoritative, complete. Recognized by bench, bar and legal educators as most modern and thoroughly reliable non-technical authority.

Sent Free—Express Prepaid That's what we mean, what we do; sent FREE, express prepaid—the greatest, biggest, most

broad and astonishingly liberal offer ever made on anything of such wonderful value. Don't pay us a cent down—these 14 volumes will be sent you, express prepaid—right in your hands without trouble or expense to you. All you need do is to send the coupon below. Examine the books carefully—satisfy yourself that they should be yours permanently—keep them seven whole days—FREE, before you make up your mind. Then if you wish to own them, simply send us first payment of \$4.00 and PAY \$3.00 EACH MONTH UNTIL PAID FOR. If you decide not to keep them, we will pay return express charges and you will not be out one cent.

1,000 SETS SPECIAL!

This is the most startling offer ever made on Law books. We have set aside 1,000 sets to be sold direct to the public, as a sales test. This cuts out the middlemen's profits which we turn over to the one thousand people who send the coupon now. Thus we knock off exactly \$26 from the regular price which is \$75.00, making the total cost the insignificant sum of \$49.00 which you can pay in sums of \$3.00 monthly.

ACT QUICK—Send the coupon now—do not send a cent—the books will be sent you express prepaid instantly—without obligation and you keep them seven days FREE. When you read them you will want to keep them permanently—everybody does—they are of greatest value to every home and office. Remember, this offer is limited—under this offer positively only 1000 sets will be reduced \$26.00—so be sure of yours—send the coupon now!

FREE—1,000 Set Coupon
Good for \$26 If Used Now

La Salle Extension University,
Dept. 366 Chicago

Gentlemen:—Send your \$75 set of American Law and Proc., 14 vol. bound in ¾ sheep, for 7 days' Free Examination. If I am satisfied you are to accept this coupon as credit for \$26 and I will send \$4.00 within seven days and \$3.00 monthly until I pay a total of \$49. If I decide not to keep books, I will notify you at once and hold same for your orders. Title not to pass to me until books are fully paid for.

Name.....

Occupation.....

Address.....

La Salle Extension University, Dept. 366 Chicago

BOYS

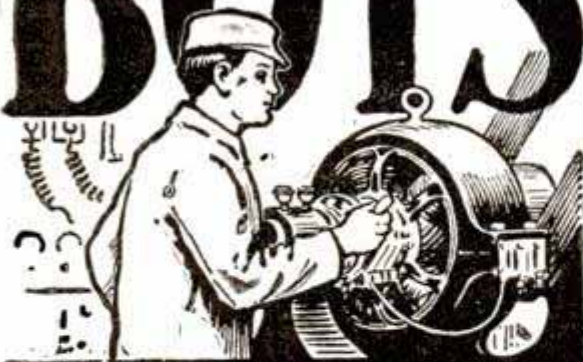

Big Money in Electricity

The electrical field affords a wonderful opportunity to boys with a liking for electrical work. The salaries paid are large—promotion rapid, and, best of all, the profession is not overcrowded.

The International Correspondence Schools of Scranton can make you an expert in the line of electrical work you like best. Hundreds of boys have already won success through I. C. S. help. You can do the same. Everything is made so clear that you can learn in your spare time, regardless of where you live or what you do. No books to buy. See your parents about it—they want you to succeed.

There's big money in electricity. Get after it by marking and mailing the attached coupon to-day. Finding out costs you nothing.

INTERNATIONAL CORRESPONDENCE SCHOOLS Box 872, SCRANTON, PA.

Explain, without further obligation on my part, how I can qualify for the position before which I mark X.

Automobile Running
Mine Superintendent
Mine Foreman
Plumbing, Steam Fitting
Concrete Construction
Civil Engineer
Textile Manufacturing
Stationary Engineer
Telephone Expert
Mechan. Engineer
Mechanical Draftsman
Architectural Draftsman
Electrical Engineer
Elec. Lighting Supt.

Civil Service
Architect
Chemist
Languages
Commercial English
Building Contractor
Industrial Designing
Commercial Illustrating
Window Trimming
Show Card Writing
Advertising Man
Stenographer
Bookkeeper
Poultry Farming

Name _____
Present Occupation _____
Street and No. _____
City _____ State _____

Please Mention Popular Mechanics



**THIS JOB PAYS
\$25-\$50 Weekly**

You Can Be an Auto Expert

We teach you the entire subject by mail in 10 weeks' spare time, and assist you to secure good position. Demand for trained men can't be filled. Simple, practical and personal instruction. **Free auto model to each student.**

Earn While You Learn—FIRST LESSON FREE

Send postal at once to the Original Automobile School

Empire Auto Institute, 267 Empire Bldg., Rochester, N. Y.

Owners—We Supply Competent Men.

A GOOD POSITION

with **UNCLE SAM** is most desirable. Life positions, pleasant surroundings, good pay, steady work, short hours, promotions on merit. Both sexes. No political pull. Thousands of appointments yearly. Most thorough preparation. Returned if not appointed. Full information and questions used by the Civil Service Commission free.

AMERICAN CIVIL SERVICE SCHOOL

WASHINGTON, D. C.

CYLINDER LANGUAGE RECORD **THE ORIGINAL PHONOGRAPHIC METHOD**

LANGUAGES

**German—French—English
Italian—Spanish**

or any other language learned quickly and easily by either the Cylinder or Disc Cortina-Phone Method at home. Write for Free booklet today: Easy Payment Plan.

Cortina Academy of Languages.
1052 Mecca Building, 1600 B'way, Cor. 48th St., N. Y.

**CORTINA
PHONE**

**DISK
LANGUAGE
RECORD**

**BACK
TO THE
FARM**

How To Do It Safely?

Give up struggle for mere existence in city? Plan now safe way out. No cost to investigate. **Free Book** explains plan for man or woman. (No land to sell. No agents.) We teach **Farming by Mail**. All subjects. Which interests you?

American Farmers School 413 Laird Bldg.
Minneapolis, Minn.

IF YOU STAMMER

Attend no stammering school till you get my large **FREE** book and special rate. Largest and best school in the world curing by natural method. Write today. **Leo Wells Millard, Pres., North-Western School for Stammerers, Inc., 917 First St., Milwaukee, Wis.**

ADVERTISEMENT WRITERS WANTED

by department stores, merchants, manufacturers. Big demand, small supply. Our graduates earn \$1,500 to \$10,000 yearly. Write **TODAY** for Free prospectus of our Correspondence System of instruction. **POWELL SCHOOL OF ADVERTISING, Inc. (Est. 1901) 1676 Meyrowitz Building, Fifth Avenue, NEW YORK**

LEARN JEWELRY ENGRAVING

in your own home. Earn \$20.00 to \$50.00 Weekly. Personal instructions. Write for free booklet. **Chicago Engraving School, 612 Athenaeum Bldg., Chicago**

LEARN WATCHMAKING

and become independent. Good-paying positions secured. Easy to learn. Send for **FREE CATALOG**.
ST. LOUIS WATCHMAKING SCHOOL, Dept. 5, ST. LOUIS, MO.

MUSIC TAUGHT FREE AT YOUR HOME

Write Today for our booklet. It tells how to learn to play Piano, Organ, Violin, Mandolin, etc. Beginners or advanced pupils.
AMERICAN SCHOOL OF MUSIC, 50 Lakeside Bldg., Chicago, Ill.

LEARN TO WRITE ADVERTISEMENTS

How to increase your salary. **BOOK MAILED FREE.**

EARN \$25 to \$100 A WEEK

We can positively show you by mail

PAGE-DAVIS CO., 112 Page Building, Chicago, Ill., or 150 Nassau St., New York



**Mechanical, Electrical and Civil Engineering
Highland Park College**

Thorough instruction by specialists. Get your B.S. degree and be working a year before graduates of other colleges. Three years of 48 weeks each.

Special One-Year Courses

Electrical Engineering—Designed especially to prepare young men for responsible positions, such as superintendency of the smaller electric power and lighting stations, power plants, etc. Diploma.
Steam Engineering—Qualifies young men to take charge of steam power or heating plants and to run stationary engines.

Machinists' Course—For those who want to become machinists in the shortest time. Plenty of shop work, not much text-book study.

Automobile Machinists' Course—Arranged especially for those who want to secure a position in an automobile factory or to manage a garage.

Special Courses in Gas, Automobile and Traction Engineering

Three months each. Students work right in machine shops, traction engine house and auto garage; repair and drive engines and automobiles. Gas Engine Course may be taken with the Traction Engine or Auto Course without extra tuition.

Every aid given ambitious students with limited means. Tuition fees small, living expenses low. For catalogue address **GEORGE P. MAGILL, President, Highland Park College, Des Moines, Iowa.**



Learn a Paying Profession

that assures you a good income and position for life. For seventeen years we have successfully taught

PHOTOGRAPHY

Photo-Engraving and Three-Color Work

Our graduates earn \$20 to \$50 a week. We assist them to secure these positions. Learn how you can become successful. Terms easy—living inexpensive. Write for catalogue—NOW!

ILLINOIS COLLEGE OF PHOTOGRAPHY, 999 Wabash Avenue, Effingham, Ill.

EARN TELEGRAPH

Morse or Wireless. Also superior station agency course. Splendid opportunities. Demand greater than supply. Graduates assisted. We own and exclusively occupy two large modern buildings equipped with R. R. and Western Union Wires and Complete \$3000 Marconi Wireless Station. Oldest and largest school—est. 39 years. Investment \$25,000. Endorsed by Railroad, Wireless and Western Union Officials. Expert practical teachers. Living expenses may be earned. Tuition low. Easy payments. Catalogs Free.

Dodge's Telegraph, Railway and Wireless Institute
8th Street VALPARAISO, IND.

LEARN TO BE A WATCHMAKER

BRADLEY POLYTECHNIC INSTITUTE
Horological Department, Peoria, Illinois



Largest and Best Watch School in America. We teach Watch Work, Jewelry Engraving, Clock Work, Optics. Tuition reasonable. Board and rooms near school at moderate rates. Send for catalog of information.
BRADLEY, Dept. S., PEORIA, ILL.

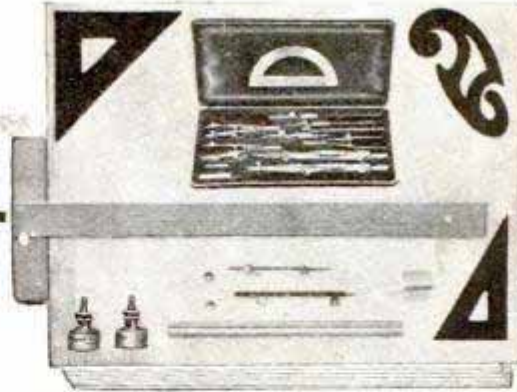

**BE AN
Expert Draftsman
Learn at Home**

Yes, on this great offer you can learn **Drafting and Designing** at home—during your spare moments. I now offer you a tremendous opportunity to enter this interesting and profitable line of work. Never before have salaries been so high—never before such opportunities for advancement. Send the **Free Coupon at once** for my book, "The Road to Success," and full particulars of this **limited free offer.**

Limited Free Offer

If you enroll now I will give you a Tuition Credit, valued at \$25.00. Just think of it! On this offer you save exactly \$25.00. Your expense will be only nominal. I want to supply the increasing demand for expert Draftsmen—hence this liberal offer. I will instruct you personally—give you the **actual and practical** work to do at home—fit you to fill the **best positions.** But you must send coupon **immediately.**

FREE!

If you will enroll within the next 30 days, I will give you **absolutely free** a magnificent set of Drawing Instruments, valued at \$17.50—handy size, leather bound pocket case.

GUARANTEE

I guarantee to instruct you until in a position paying \$75 to \$200 a month. Employment Bureau open free to students.

**\$125.00 to \$200.00
a Month FOR YOU**

That's what you can earn right away as an expert Draftsman and Designer. My graduates are all making good. Go into business for yourself and earn \$2500 to \$5000 a year.

MAIL COUPON TODAY

Yes, mail coupon or postal at once for my **Free Book**, "The Road to Success," and free particulars of my **limited free offer.** No obligations on your part. Everything sent to you **free and prepaid.** Take advantage of this opportunity today. Send coupon or postal **immediately.**

FREE COUPON

Chief Engineer
Room 508
Engineering Bldg.
Chicago, Ill.

Dear Sir—Without any obligations on my part, send me your book, "The Road to Success," and full particulars of your **limited free offer.** Send everything **free and prepaid.**

**CHIEF
ENGINEER**

Room 508
Engineering
Bldg.
Chicago,
Ill.

Name

Address

Please Mention Popular Mechanics

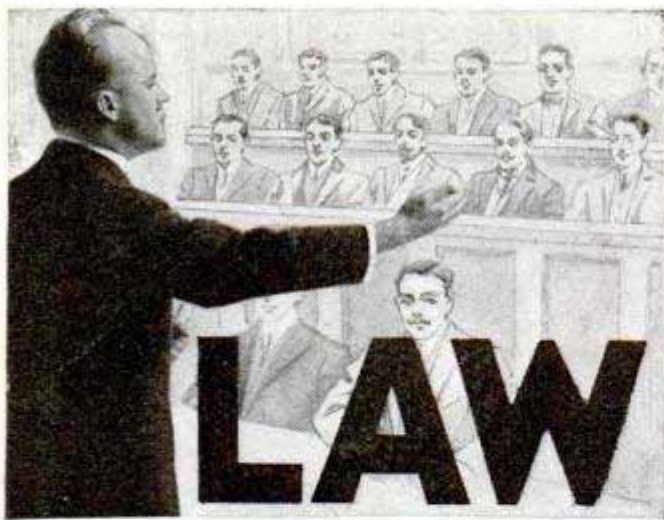

Become A Lawyer

There are thousands of capable men in small positions with small salaries and no future who need only our training to become successful **Lawyers**. The demand for Lawyers is increasing daily—Law is becoming a vital factor in every business—large firms are seeking competent Lawyers with our training for their regular staff, and are willing to pay big salaries.

YOU Can Be a Lawyer Now

It is no longer complex—no education required beyond the ability to read and write. Our instruction is written in plain language—it is the combined knowledge of the world's foremost legal experts—Professors of Law in such big resident colleges as Univ. of Wis., Univ. of Chicago, Harvard, Univ. of Mich., N. Western Univ., and Univ. of Nebraska. It is recognized as the foremost home-study Law method by America's greatest legal and educational authorities—it is the **only** method used in colleges. Advanced—simplified—different absolutely from all others—completely covering every branch of American Laws. It is like having great Professors in your home. Learning Law by our method is fascinating—interesting—you will never give it up until you have completed it.

We Train You At Home **By Mail**

in spare time. You don't give up your present position, income or pleasures. Makes no difference where you live, what you work at, how small your income or how little time you have. The cost is small—we make payments easy. Some of America's greatest Lawyers learned at home in spare time.

We enroll more students every month than any other university home-study Law school in the world. This is a strong, conservative, reliable institution—the largest, oldest and most complete of its kind on earth. Our graduates hold highest records everywhere, and pass bar examinations in any State. We guarantee to coach you **FREE** until successful. This is the school that shows actual results—makes no statements it cannot prove. Our **Diploma** gives you a recognized standing anywhere.

Law Library **BIG SPECIAL OFFER!**

If you enroll now we send our complete, standard, authoritative Law Library—14 volumes of American Law and Procedure, completely covering every branch of Law—a massive, handsome set; over 6,000 pages, 15,000 illustrative cases; a \$50,000 work.

Two Great Books FREE Write quick for **FREE** copy of "Valuable Law Guide"—a book that shows you how to start right—how some of America's most successful Lawyers succeeded—a book everybody should have.

We will also send a copy of our famous book, "EVIDENCE"—evidence of the success of our students and the superiority of our method of home-training. Both these books are **FREE**.

\$100 Tuition Credit—FREE

Write at once and learn how, for a very limited time, you can actually secure a \$100 Tuition Credit Free.

Become An LL. B. The State of Illinois authorizes us to confer on our graduates the Degree of Bachelor of Laws (LL. B.). Every successful man had to make his start **some time—somehow!** This is your opportunity to enter a dignified, lucrative profession. Mail the coupon at once for convincing facts—don't put it off any longer.

La Salle Extension University, Dept. 369 Chicago, Ill.

La Salle Extension University, Dept. 369 Chicago, Ill.

Please send me **FREE**—copy of your two books: "Evidence" and "VALUABLE LAW GUIDE" at once. Also explain how I can secure a \$100 Tuition Credit Free.

NAME.....

ADDRESS.....

CITY.....STATE.....

Please Mention Popular Mechanics



FRENCH—GERMAN SPANISH—ITALIAN

Is Easily and Quickly Mastered by the

LANGUAGE-PHONE

METHOD

Combined with the

Rosenthal Method of Practical Linguistry

This is the natural way to learn a foreign language. You hear the living voice of a native professor pronounce each word and phrase. He speaks as you desire—slowly or quickly, night or day, for minutes or hours at a time. It is a pleasant, fascinating study; no tedious rules or memorizing. It is not expensive—all members of the family can use it. You simply practice during spare moments or at convenient times, and in a surprisingly short time you speak, read and understand a new language.

Disc or Cylinder Records—Send for Booklet and particulars.

THE LANGUAGE PHONE METHOD

961 Putnam Building 2 West 45th Street New York



J. H. JOICE, Pres. Insurance Business.

I Can Increase Your Earnings

No matter where you live, if you are honest and want an independent business of your own, send your name and address and I will mail you our **Big Free 64-Page Book**, showing how you may earn

\$3,000 to \$10,000 a Year

in the Real Estate, Brokerage and

Our system is a positive success. We will teach you by mail and appoint you our

Special Representative

and help you to make money from the start. Write today. **INTERNATIONAL REALTY CORP. 2436 Manhattan Bldg., Chicago, Ill.**

ELECTRICAL ENGINEERING

men with training are always in demand. Having trained over 2000 young men in the past 20 years in the fundamentals of Applied Electricity, **The Bliss Electrical School**, with its well-equipped shops and laboratories, is peculiarly well qualified to give a condensed course in Electrical



including Mathematics, Steam and Gas Engines, Mechanical Drawing, Shop Work, and Theoretical and Practical Electricity, in all branches. Students construct dynamos, install wiring and test efficiency of electrical machinery. Course, with diploma, complete

IN ONE YEAR

For practical young men with limited time. 21st year opens Sept. 24th. Catalogue on request. 17 Takoma Ave., Washington, D. C.

The University of Chicago

HOME STUDY

in addition to resident work, offers also instruction by correspondence.

For detailed information address

22nd Year U. of C. (Div. 20) Chicago, Ill.



DRAWING

Caricature, Cartoon, Comic, Commercial, Fashion, Newspaper and Magazine Illustrating taught by mail. Illustrated book 6c in stamps. **THE BOSTON SCHOOL OF DRAWING, 755M Boylston St. BOSTON, MASS.**



VENTRILOQUISM

LEARNED BY ANY MAN OR BOY AT HOME SMALL COST

Send today 2c stamp for particulars and proof. **O. A. SMITH, Room D 84, 823 Bigelow St., PEORIA, ILL.**

WRITE for
this FREE
BOOK



Expert Electricians Make Big Money

You can learn all branches of electricity at this school—and you will learn them BY DOING the actual work, step by step, personally guided and coached.

The opportunities open to men who understand electricity and have had technical training cannot be exaggerated. There is no limit as to how high you can climb if you have learned electricity at this school.

WRITE TO-DAY FOR OUR FREE CATALOG, or come in and inspect the school at your earliest convenience.

The New York Electrical School
44 West 17th Street NEW YORK



HOW TO TRIM SHOW WINDOWS

Shown in this new book. 150 complete windows for every season of the year illustrated by means of over 200 detail drawings and explained in 256 pages of text matter. Shipped prepaid for \$1.50. This is the 10th year for our

SCHOOL OF WINDOW TRIMMING

CARD WRITING AND ADVERTISING
Best paid and most fascinating professions in the world. A 120 page catalog FREE tells you all about it.

KOESTER SCHOOL, 306 Jackson Boulevard, CHICAGO



Learn Mechanical Drawing and Machine Design at Home in Your Spare Time

Improve your opportunity. Long and varied practical experience has enabled me to prepare a correspondence course which is simple, and easily understood, even by those who have had only a common school education. With fair intelligence you should become an expert in from six to nine months under my tuition. Elegant set of instruments FREE. Premiums for proficiency. I never had connection with the "Chicago Engineering Works," which has been using my name, coupled with my picture, as "Chief Engineer." A postal addressed **ROBT. HARDIE, 621 No. Homan Av., Chicago, Ill.**, will bring full particulars



BE A BANKER

Splendid opportunities. Pleasant work, short hours, all holidays off, yearly vacation with pay, good salary. Learn at home. Diploma in six months. Catalog free. **EDGAR G. ALCORN, Pres.**
AMERICAN SCHOOL OF BANKING, 119 McLane Bldg., COLUMBUS, OHIO



MEN WANTED

Prepare as Firemen, Brakemen, Electric Motormen, and colored Train Porters. Hundreds put to work—\$65 to \$150 a month. No experience necessary. **500 more wanted.** Enclose stamp for Application Blank. Name position you want.
I. RAILWAY C. I., Dept. 35, Indianapolis, Ind.



Try Shorthand On Me!

These are not very dignified words for the General Manager of a high-grade educational institution to use, but they express just what I want to say—"Try Shorthand on me."

I knew a young fellow who would like to have improved his conditions in the world and had thought shorthand a possible vocation, but this young man was under the impression that shorthand was a difficult thing to learn and he doubted his ability to master it.

He did not feel like paying out any of his hard earned money to experiment and so kept along in the rut until I learned of his case. Just to prove to him that he could learn shorthand, I sent him a couple of lessons at my expense. I charged nothing for them and did not ask him to obligate himself in any way.

Within 15 minutes from the time he received the lessons, he understood the simplicity of shorthand, the principles of shorthand, and could actually write some words in shorthand and could read them readily!

His doubts immediately disappeared and he eventually became an expert writer, filling a far better position than he had ever held before.

So I thought that there must be hundreds of other young fellows who were in the same condition—young men who had it in them to make a big success in the world if they were just started, and this is the reason for the remarkable offer that I am now making to readers of this magazine.

If you will write your name and address plainly on the attached coupon and mail it to me, I will send you absolutely without charge—even the postage paid—two lessons in shorthand—enough to enable you to actually write in shorthand and to give you an understanding of the principles.

Please understand that this is not a scheme to send you lessons on trial. There is absolutely no charge for these lessons, they are given to you.

After you have received the lessons and learned how easy shorthand is and learned of the possibilities of shorthand as a stepping stone to a business career, and desire to enroll in my College, I shall be very glad to have you do so, but you are under no obligations nor will you be put to any expense by accepting these two lessons.

These lessons are strictly on me—they are my treat! If you complete my course in Shorthand, I'll get you a job.

Free Shorthand Coupon

W. E. NEWLON, General Manager
Revilo College, 230 Shops Bldg., 17 No. Wabash Ave.
CHICAGO, ILL.

Send me **Free Lessons**, which I will try, returning to you for correction. It is distinctly understood that I do not obligate myself to anything by accepting your free offer.

Name

Town..... State.....

Occupation.....

Learn Electricity!



Earn \$150⁰⁰
TO
\$300⁰⁰
a Month

Electricity is today the great motive power of the world. Its use has extended to every phase of life and industry.

Thos. A. Edison says that the field of electricity is in its infancy—that electrical workers of the future will discover uses for this great force now undreamed of.

Right now there are not enough electrical engineers to fill the big paying positions open. Every day our **Free Employment Bureau** has a call for Electrical Engineers greater than we can fill. Therefore, we are making a **very special offer** to students at this time.

Write today! Send the free coupon for our catalog and free information.

We Teach You in a Short Time —at Small Expense

In order to supply more electrical engineers we are charging a small tuition fee. Your tools and equipment of all kinds are furnished **FREE** by the School. You may have **easy payments if desired**. Our course of instruction is clear, simple and thorough. Our Graduates demand handsome salaries. Don't pass up this opportunity.

FREE TOOLS

We will furnish all the material and tools you use in taking our course — **ABSOLUTELY FREE**. All we charge is a very small amount for tuition. Many of our students earn their expenses while taking the course.

Men Wanted for these Trades
Electricity Plumbing
Bricklaying
Moving Picture Operating
Mechanical Drawing

We also teach the trades mentioned above. There are unlimited possibilities in any one of these trades. When you have completed our course you will be in a position to demand from \$5.00 to \$8.00 a day right at the start. Or go in business for yourself and make from \$3,000 to \$5,000 a year.

Send the FREE COUPON for Catalog and Particulars

No obligations on you at all. Just fill out the coupon and mail it today. Take this step towards **success**. Let us tell you how you can master electricity or any other profitable trade in a short time—make a bigger success than you ever dreamed of making. Fill out the coupon and mail it at once.

FREE COUPON

L. L. COOKE, Director

Coyne National

Trade Schools

39-51 E. Illinois St.

Dept. 1198, CHICAGO, ILL.

GENTLEMEN: Without any obligations on me whatsoever, please send me your school catalog and full particulars of this offer to men—**ALL FREE**.

L. L. COOKE, Director

Coyne National Trade Schools

39-51 E. Illinois St.
Dept. 1198

Chicago, Ill.

NAME.....

ADDRESS.....

Earn \$3000 to \$5000 a Year As a Doctor of CHIROPRACTIC

Easily Learned in Spare Time at Home and in Class
Our Students Surprisingly Successful

Do you seek financial independence and social prominence? Why depend upon a mere job—work for others—and never rise above the level of a wage or salary earner when you can easily capitalize your spare time **now** by fitting yourself to become a Doctor of Chiropractic



The New Drugless Healing Science of Spinal Adjustment

More Scientific, More Simple, Easier to Learn Than Osteopathy

There are 23 million people in this country who believe in drugless healing, and the number is constantly increasing. They are to be found in every community. Splendid openings for Chiropractors everywhere. It's a profession that is far from overcrowded. Immensely lucrative. Dr. Walter, a graduate, made \$500 the third month after starting. R. M. Johnson added over \$3,000 a year to his income. Vern Sharpsteen makes \$40 a day. We taught these men by mail and in class. You can do as well or even better. Treat members of your own family free—earn handsome fees for treating others.

Our simplified home study course, profusely illustrated, and with 14 big free charts and a spinal column, makes it easy to acquire a thorough, practical knowledge of this dignified, profitable profession in a surprisingly short time. A common school education is all you need—our absorbing, easy-to-learn-lessons will do the rest. It means financial independence, social position—a profession that is looked up to, for you.

FREE sample lesson sheets, big illustrated book, also names and addresses of successful students mailed free on request. Write today—a lucrative practice awaits you.

NATIONAL SCHOOL OF CHIROPRACTIC.
Dept. 10 1553 W. Madison St. CHICAGO, ILL.

Learn to be An Auto Expert

Six weeks from the day you commence your studies at this great practical school you will be able to repair any make of automobile and drive any car on the market.

Earn \$75 to \$200 a Month

Many of our graduates make even more than this. Big demand for competent repairmen, demonstrators, garage managers and chauffeurs. All practical work. No books used. No tools to buy. Write today for big illustrated free book. Address,

AUTOMOBILE TRAINING SCHOOL, 1185 Locust St., Kansas City, Mo.



LEARN WATCHMAKING AT HOME



You can learn by our modern and original system of instruction every part of the **Watchmaker's Trade** at home as good or better than at a shop. You can earn money while learning and secure a well paying position or start in business after completing our course of instruction. Good watchmakers are always in demand and earn from \$20 to \$35 per week. For particulars apply to the **WISCONSIN SCHOOL OF WATCHMAKING, Stroth Bldg., MILWAUKEE, WIS.**

LEARN WATCH REPAIRING

Be a watchmaker—you can learn this profitable trade by correspondence in a few weeks in your own home by the DeSelms Chart System. After you complete the course you will know a watch from A to Z. You will know just what the matter is and how to repair one. When you graduate you will be a practical watchmaker and repairer and competent to fill any position. Positions for our graduates.

Ask for our Free Book. It explains our system and terms.

THE DeSELMS WATCH SCHOOL
23 Perry Street ATTICA, INDIANA



EARN \$100 to \$200 Monthly OBTAIN FREE \$25 SHORTHAND

Correspondence course by doing a little work in your spare time. We prepare you for head, commercial, government and court reporting positions. All pay big. Learn in a few lessons. No expense. **THE COPP SHORTHAND INSTITUTE OF AMERICA, 5212-34 Prairie Ave., CHICAGO**

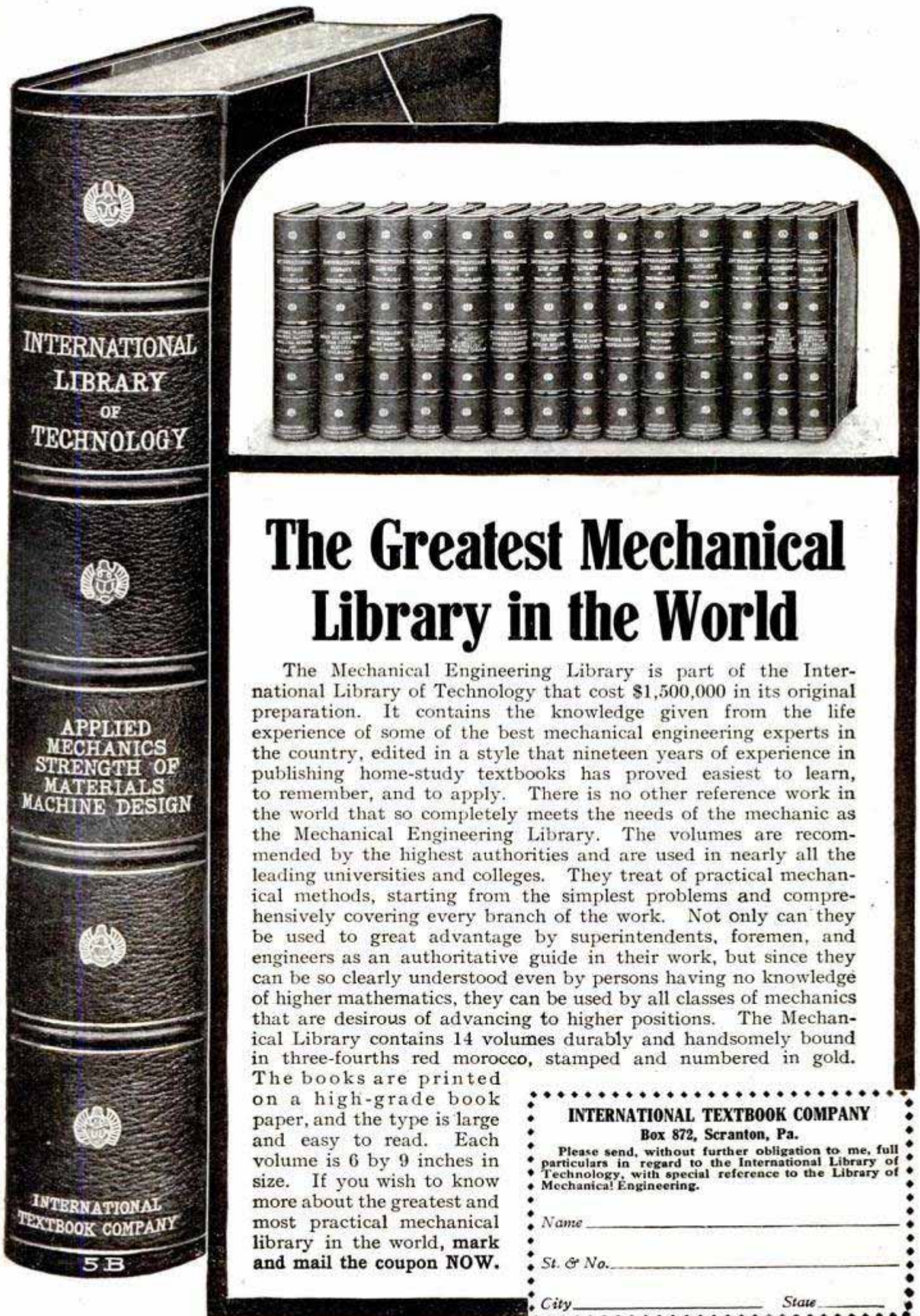

INTERNATIONAL
LIBRARY
OF
TECHNOLOGY

APPLIED
MECHANICS
STRENGTH OF
MATERIALS
MACHINE DESIGN

INTERNATIONAL
TEXTBOOK COMPANY

5 B

The Greatest Mechanical Library in the World

The Mechanical Engineering Library is part of the International Library of Technology that cost \$1,500,000 in its original preparation. It contains the knowledge given from the life experience of some of the best mechanical engineering experts in the country, edited in a style that nineteen years of experience in publishing home-study textbooks has proved easiest to learn, to remember, and to apply. There is no other reference work in the world that so completely meets the needs of the mechanic as the Mechanical Engineering Library. The volumes are recommended by the highest authorities and are used in nearly all the leading universities and colleges. They treat of practical mechanical methods, starting from the simplest problems and comprehensively covering every branch of the work. Not only can they be used to great advantage by superintendents, foremen, and engineers as an authoritative guide in their work, but since they can be so clearly understood even by persons having no knowledge of higher mathematics, they can be used by all classes of mechanics that are desirous of advancing to higher positions. The Mechanical Library contains 14 volumes durably and handsomely bound in three-fourths red morocco, stamped and numbered in gold. The books are printed on a high-grade book paper, and the type is large and easy to read. Each volume is 6 by 9 inches in size. If you wish to know more about the greatest and most practical mechanical library in the world, mark and mail the coupon NOW.

INTERNATIONAL TEXTBOOK COMPANY

Box 872, Scranton, Pa.

Please send, without further obligation to me, full particulars in regard to the International Library of Technology, with special reference to the Library of Mechanical Engineering.

Name _____

St. & No. _____

City _____ State _____

STUDY LAW AT HOME

Become an LL.B.

Only Law School of
Its Kind in America

Special and Exclusive Features

ONLY recognized resident law school in the United States conferring Degree of Bachelor of Laws—LL.B.—by correspondence. ONLY law school in U. S. conducting standard resident school and giving same instruction, by mail. ONLY law school giving over 450 class-room lectures to its extension students. ONLY law school giving a full 3-year, University Law Course, by mail, having an actual faculty of over 30 prominent lawyers in active practice. ONLY law school in existence giving Complete Course in Oratory and Public Speaking, in conjunction with its law course.

Written Bar Guarantee

We give an absolute written guarantee to prepare our students to pass bar examinations.

The Hamilton College of Law IS a regular, thoroughly recognized, bona fide College of Law and NOT an "institute," "correspondence school," etc. It occupies the entire third floor of the New Advertising Bldg., where its large and commodious resident class-rooms and executive offices are located.



Our Degree Bachelor of Law, LL.B.
NOT a Diploma or Certificate

Direct From Class-Room to Student



From Lecture Room to Student
No Other Law School Can Use
This Illustration

is the way we teach law. We are the only school doing this. Our system of teaching is intensely interesting; not dull and dry like the average law course. Our system of conducting examinations is the most thorough, complete and expensive (to us) of any examinations ever given. A student can, if he chooses, take part of our course by mail and finish in our resident school where he will receive full credit for all work done by mail. Our resident school is recognized by all standard law schools in the United States.

The Hamilton College of Law is highly endorsed and recommended by Government Officials, Business Men, Noted Lawyers, Graduates, and Students. We have as students a number of practicing lawyers (not graduates of recognized law schools) who are now earning their degree of LL.B. Many other lawyers are using this course as a review. A probate Judge, (one of our active students) says: "I am delighted with the course prescribed and your method of teaching law. It is far in advance of what I expected to receive."

Our Law Library

consists of 24 volumes of Student's Standard Text Books, two volumes bound together under one cover, making a total of 12 books. These books were prepared at an enormous cost especially for the students of the Hamilton College of Law, by one of the largest and best law book publishers in America. This is the only set of law text books ever prepared exclusively for student's use. We would be glad to have you submit these books to any lawyer or judge in the country and get his opinion regarding them.



These 12 Volumes are Free to Students

Mail Coupon Today

and get our Big, Beautifully Illustrated Prospectus and complete information. Places you under no obligations whatever. This may mean the turning point in your career.

Hamilton College of Law, 327 Advertising Bldg., Chicago, Ill.

Gentlemen: Kindly send me your Illustrated Prospectus and full particulars regarding your method of teaching law by mail

Name.....

Address.....

Write plain and in full

Please Mention Popular Mechanics

A Course of Lessons In Drugless Healing

(Mechano-Therapy)

FREE

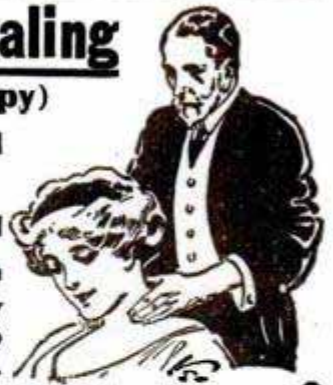

Not one cent to pay either now or later—no obligation of any kind. Just your simple request will bring you this valuable course of 62 lessons by return mail *without cost*. This offer is *strictly limited*. We reserve the right to withdraw it at any time without notice. *So don't wait a minute. Send your acceptance right away.*

Why We Are Making This Offer

We want the public to know the *real truth* about Drugless Healing. Besides, these free lessons will demonstrate just how thoroughly, and in what a surprisingly short time you can master this wonderful new profession, at home or in class, without interfering with your regular occupation.

If You Want to Earn \$2500 to \$6000 a Year

if you want an established profession that is remarkably profitable, if you want to become master of your own and others' health and happiness, then send for the free course and see what Drugless healing has to offer you. Hundreds of successful graduates demonstrate the wonderful efficiency of our methods. How about yourself? Are you satisfied—healthy—happy—making all the money you want? If not, get posted on Drugless Healing *right away*.

Remember—This Offer Is Limited Write NOW for FREE course of lessons. Don't wait to think it over. Get the facts—the real truth—learn what you can earn as a Mechano-Therapist. The FREE 62-lesson course and our free book explain all. Send a postal or letter **RIGHT AWAY**.

AMERICAN COLLEGE OF MECANO-THERAPY
Dept. 876, 81 W. Randolph Street (122) Chicago, Ill.

BE A TELEGRAPH OPERATOR

Learn at home by mail. Earn \$75 to \$250 per month. Big demand for operators. We send you instrument and instruction on 10 days' FREE trial. Write today for Free Book and Telegraph Code.



MUTUAL TELEGRAPH SCHOOL, 827 DWIGHT BLDG., Kansas City, Mo.

Detroit Technical Institute

Y. M. C. A. DAY AND EVENING SCHOOLS

Offers resident courses in Electricity, Plumbing, Mechanical and Architectural Drawing, Drafting, Pharmacy, Civil Service, Watch-making, etc. For detailed information address
SECRETARY, Box 8, Y. M. C. A. Bldg., DETROIT, MICHIGAN

Learn Automobile Driving and Repairing

We give you driving lessons and teach you all the technical parts to prepare you for a good paying position. Write for Booklet P. Day and Evening Class.

NORTHWESTERN MOTOR INSTITUTE, 228-230-232 Wisconsin St., MILWAUKEE, WIS.

BE AN ILLUSTRATOR.

Learn to draw. We will teach you School of Illustration 112 Page Bldg. Chicago, Ill.

by mail how to draw for magazines and newspapers.
Send for Catalog



BE A DETECTIVE

Earn from \$150.00 to \$300.00 per month; travel over the world. Write

C. T. LUDWIG, 133 Westover Bldg., Kansas City, Mo.

ARITHMETIC SELF-TAUGHT

A plain, easily-understood volume for all who have not had the opportunity of learning this subject thoroughly, or who have forgotten what they once learned. 257 Pages. Requires no teacher. This great little book sent postpaid for 60 CENTS. Stamps accepted, leather binding \$1.

GEO. A. ZELLER BOOK CO.
Est. 1870, 4473 W. Belle Place ST. LOUIS, MO.

**SPANGENBERG'S
PRACTICAL
ARITHMETIC
Self-Taught**

"I know a College Graduate who is a Dunce"

Elbert Hubbard



"I know a man who is fifty-five years old. He is a student. He is a graduate of three colleges and he carries more letters after his name than I care to mention, but this man is neither bright, witty, clever, interesting, learned nor profound. HE'S A DUNCE! And the reason is that he cannot remember. Without his notes and reference literature he is helpless," writes Elbert Hubbard.

A Perfect Memory Is The Key To Success

Thousands of intelligent men and women remain obscure because they cannot remember important things. The demands of commercial and professional life are becoming so exacting in their details of facts and figures to be remembered, that to succeed or even hold your own you simply must possess a good memory.

For over 20 years I have been training people to STOP FORGETTING—aiding them to greater business and social success—and I have seen enough and learned enough to know positively that the person with a strong, tenacious memory, though he be far behind at the beginning of the race for success, advances and soon outdistances his forgetful rival.

I prove every day that the great secret of business and social success is the ability to instantly remember experiences and facts and apply them when needed.

Stop Forgetting!

I Can Show You How

Easily, quickly, in your spare time, at home by mail.

Spend 10 minutes daily and I will make your mind an infallible classified index system from which you can instantly select thoughts, experiences, facts, figures and arguments. I will enable you to concentrate your mind on any one subject to the exclusion of others—I will enable you to absorb, weigh, reject and classify ideas, names and faces for instant reference—I will enable you to think rapidly on your feet, to address an audience without hesitating, with that confident, forceful conviction that wins success.

My System Is Easy, Infallible

A good memory is not a gift—it must be acquired like muscle, by training. The capacity of the brain is unlimited. The weakest mind instantly becomes interested in and susceptible to my clear, comprehensive method—there are no difficult exercises to memorize.

If your education has been neglected you will find my method an education in itself, embracing exactly the subjects most necessary in modern business and social life. If you are a college graduate my system will enable you to make practical use of your knowledge.

For 20 Years I Have Trained People To Stop Forgetting

Let me impress upon you emphatically that my system is not a theory—it is scientific and practical—the result of over 20 years of observation while in intimate contact with all kinds of students in schools and colleges where I had been professor. Over 50,000 people all over the world have enrolled for my course.

These Notables Endorse My System: Many of the most intellectual men of the day are troubled with mind wandering and have availed themselves of memory training. My method is heartily endorsed by such notables as Elbert Hubbard, Prof. David Swing, Dr. Latson and thousands of others.

Every Woman as Well as Every Man should have my course—I will give her command of a well-stocked and well-selected vocabulary—I will enable her to adapt herself quickly to the moods of an audience or meet any emergency.

How to Get Free Copy of "How To Speak in Public"

If you wish to be able to think on your feet—to meet emergencies—to express yourself clearly, logically and convincingly whether talking to one person or to a thousand, my book "How to Speak in Public" will explain how. This is my 1913 De Luxe edition handsomely illustrated, richly bound. Price is \$2.00, but I will present a copy absolutely FREE to every student.

Let Me Send You a Free Copy "How to Remember"

Send the coupon at once for your free copy of "HOW TO REMEMBER." Let me show you how to increase your efficiency and income. Don't hesitate—education, vocation, age or residence make no difference.

The Key to Success—Mail It Today



Prof. Henry Dickson, Principal,

Dickson School Memory, 705 Auditorium Bldg. Chicago

Dear Sir: You may send me FREE—my copy of "HOW TO REMEMBER," also full particulars about free copy of your new book "HOW TO SPEAK IN PUBLIC."

NAME.....

ADDRESS.....

CITY.....STATE.....

Prof. Henry Dickson, Principal Dickson School of Memory

"I Will Teach You How to Run a Traction Engine Free"

— EMORY J. SWEENEY, Pres. Sweeney Auto School

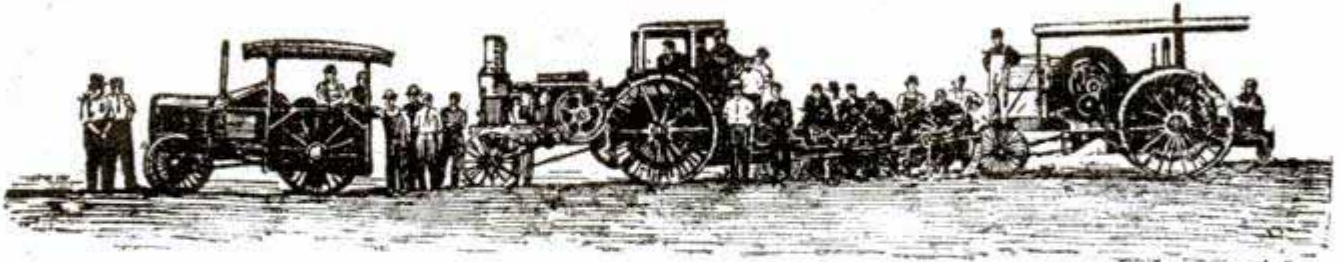

OUR THREE TRACTION ENGINES

THE purpose of this amazing offer is to demonstrate the superior equipment and facilities of this school, and also to celebrate the opening of the fall season in our magnificent new quarters, the finest and largest of the kind in the world. I want every young man mechanically inclined to investigate the **BIG OPPORTUNITY** for making more money that I can give him in a few short weeks, and knowing the demand for traction engineers, I want to give all those who answer this announcement and qualify a **FREE COURSE IN TRACTION ENGINEERING**.

The Sweeney System of Practical Auto Instruction

is now universally recognized as the most thorough, practical and interesting course of automobile instruction, leading to certain and profitable **EMPLOYMENT**. It embraces every point worth knowing, including vulcanizing, brazing, oxyacetylene welding, lathe work, machine shop practice, testing, driving, truck repairing and operating, etc. **AND YOU LEARN** by doing the work on **REAL CARS** under the watchful eyes of skilled instructors. The only school equipped with all types of **self-starters**.



\$50 Course Free to Men Who Answer This Advertisement

You know right in your neighborhood of the demand for traction engineers and mechanics. Factories want workmen and demonstrators. We are in close touch with a great traction factory here in Kansas City. We teach you on three different types of tractors in actual work and also give you **FACTORY** experience no other school can offer. Men are wanted right now for good jobs. Here is a wonderful opportunity for young men. You can learn in a few weeks. We want to start out a few graduates right away and so although the regular price of the course is \$50 you **GET THE COURSE FREE** if you enroll in Automobile School now. Sign and return the scholarship coupon today. No previous experience required.

Learn to Run and Repair Autos and Make Big Money

Think of this. Here's a trade where you are in demand 12 months in the year. Short hours, pleasant work. Outdoor life. Travel. Enjoy the world. Meet nice people. 90 per cent of the cars in use are not in proper adjustment on account of shortage of experienced mechanics. Grasp quickly this chance to make yourself a **SKILLED MAN** who is in demand and gets big pay for his work. No matter who you are we can teach you.

Everybody in the Automobile Business Today is Making Money

Here is your chance. I want you to come to my school and see for yourself how quickly and easily you can learn the business and become a **HIGHLY PAID MAN**. Six weeks after the day you enroll you will be prepared to properly repair any auto made, drive any car or truck or traction engine, or open a garage or repair shop of your own. You can learn the business thoroughly in my school because I have been years working out this system and the **WONDERFUL PROMPT** success of my hundreds of **PROSPEROUS GRADUATES** proves it.

Pick Out a Good Job!

| | |
|---------------------------|-----------------------|
| Chauffeur : | \$60 per month |
| Mechanic : | \$160 per month |
| Salesman : | \$1,500 per year |
| Demonstrator : | \$150 per month |
| Garage Manager : | \$35 per week |
| Stationary Gas Engineer : | \$100 per month |
| Tractor Engineer : | \$5.00 per day and up |
| Repairman : | \$18 per week up |

Eight Trucks in Daily Use Teach Students

We own a truck transportation company operating eight trucks and therefore give our students practical work in handling, repairing and driving trucks as well as giving them an insight into the livery and transportation business. **NO OTHER SCHOOL** in the world offers this valuable service to students and from this alone you can get experience to open up a most profitable business of your own.

Our Men Learn Quickly and Easily, Because Practical Experience is the Best Teacher

FREE COUPON

E. J. SWEENEY, President

SWEENEY AUTO SCHOOL

1162 E. 15th St., KANSAS CITY, MO.

Send free scholarship offer and catalog. Also magazine.

Name.....

Address.....

Study this picture. This is the only way to learn. Do things with your own hands. Practice beats theory. We do not merely tell you how; we show you how, and you then do the work yourself. We have over 40 cars of all makes on our own floor, eight trucks, three tractors, and our **DRIVING TEACHERS** keep out on the road nearly twelve hours a day. **YOU GET PLENTY** of WORK of all sorts.

No Books Used; Tools Furnished Free The tuition is low and after you have paid that there are **NO MORE** expenses or extras you have to buy. If you could learn from a book there are lots published you could read at home, but **PRACTICAL WORK** is the only method, and this is what makes my School different from all others.

Send Today for my big free catalogue and we will also send you our monthly magazine free, the most interesting magazine for young men who want to get on in the world ever published. The catalogue is full of fascinating **PHOTOGRAPHS** almost as good as a personal visit to the school. Send today, this very minute.

EMORY J. SWEENEY, President

Sweeney Automobile School, 1162 E. 15th Street KANSAS CITY, MO.



This Book Will Teach You Practical Electricity

Twenty chapters of plain, accurate, compact facts about electricity. Written in an easily understood style, it carries you from the fundamental principles to where you understand the designing, operation and care of a dynamo or motor. It is

As Good As A School

for it contains questions and answers on each chapter that enables you to examine yourself and fix each subject in your mind as you go along. It tells all about wiring, batteries, lighting systems, and in fact every needful point in practical electricity. It contains one chapter on electric automobiles, their construction, care and operation. Thousands have found it indispensable as

A Handbook for Practical Men

The tables, rules and formulas it contains are invaluable. It has a dictionary of 1500 electrical terms. No one can stump you if you have this book. 36,000 copies sold.

Price \$2.00 Per Copy

and it's sold to you on a money-back guarantee. Send \$2.00 for your copy today, with privilege of examination and return if not fully satisfied.

CLEVELAND ARMATURE WORKS
4734 St. Clair Ave. N. E., CLEVELAND, OHIO

Armatures and Fields wound - Commutators filled.

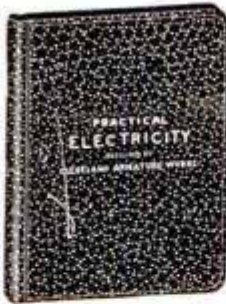

DO YOU LIKE TO DRAW?

That's all we want to know

Now we will not give you any grand prize—or a lot of free stuff if you answer this ad. Nor do we claim to make you rich in a week. But if you are anxious to develop your talent with a successful cartoonist, so you can make money, send a copy of this picture with 6c. in stamps for portfolio of cartoons and sample lesson plate, and let us explain.

The W. L. Evans School of Cartooning
821 Leader Bldg., Cleveland, O.



Learn Write

I TEACH BY MAIL

WRITE FOR MY FREE BOOK

"How to Become a Good Penman"

and beautiful specimens. Your name elegantly

written on a card if you enclose stamp. Write

today. Address **F. W. TAMBLYN, 418 Meyer Bldg., Kansas City, Mo.**

JEWELRY ENGRAVING

We teach you, by our new and original method of instruction, this clean, fascinating and profitable business **right at your home**, and furnish you all tools needed absolutely **free**. Write for free book to the

WISCONSIN SCHOOL OF ENGRAVING, Stroh Bldg., MILWAUKEE, WIS.

LEARN JEWELERS' ENGRAVING

A high salaried and easily learned trade, taught thoroughly by mail. We will teach the beginner better engraving than he can gain in years of rigid apprenticeship. We will also improve the skill of any engraver. Send for our catalog. The Engraving School, 112 Page Bldg., Michigan Ave., Chicago, Ill.



HERE YOU ARE, BOYS

A medallion pin of Foxy Grandpa. Everyone will notice it on the lapel of your coat and try to get a closer look at it. All you have to do is press the bulb.—Foxy Grandpa will finish the job by squirting a fine stream of water over the inquisitive one. Will squirt 20 feet. Greatest joke out. Order one today and fool your friends. Price 15c. Foxy Grandpa and Hooligan both for 25c. 5 for 50c or 1 doz. for \$1.00. A beautiful fountain pen free with every \$1.00 order.

AMERICAN SUPPLY CO., 918 Union St., St. Paul, Minn.

SEND FOR MY FREE BOOKS



DO YOU WANT TO KNOW HOW TO DEVELOP VITALITY, ENERGY, ENDURANCE, NERVE STRENGTH, MUSCULAR STRENGTH, PERFECT PHYSIQUE?

My FREE BOOKS, "The 'Whys' of Exercise" and "The First and Last Law of Physical Culture," tell you, if you are weak or underdeveloped, how to grow strong; if strong, how to grow stronger. They explain how to develop lungs and muscle, the strong heart and vigorous digestion—in short, how to improve health and strength internally as well as externally. Send TO-DAY—NOW—for these FREE BOOKS. Enclose 4c in stamps to cover postage.

PROF. H. W. TITUS, 417 Titus Bldg., 146 E. 23d St., New York City



Try One and you will say

"That's The Most Comfortable Collar I Ever Had 'Round My Neck."

But that isn't all you can say, for it's the most economical collar you can buy. Just think, only 25 cents for a box of 10 at the stores. If you can't get them there we'll mail 10 for 30 cents in U. S. stamps or a single sample free. Tell us what size you wear and whether you want the Raphael, Angelo or Rubens.

These collars are made of fine cloth, starch-finished;—they look just like linen. You can reverse and wear the other side when soiled. For your own comfort and economy you should try them at once. Write us.

Beautiful Catalogue Free

REVERSIBLE COLLAR COMPANY
Department U, BOSTON, MASS.



CIVIL SERVICE

positions are in all parts of the country. Good pay, steady work, life positions, congenial surroundings, promotions on merit, short hours, annual vacation and sick leave with pay. Many thousands appointed yearly. Both sexes. No political pull. Nearly 300,000 classified positions. Common school education sufficient. Full information and questions used by the Civil Service Commission free.

COLUMBIAN CORRESP. COLLEGE, Washington, D. C.

WHY NOT BE AN ARTIST?



STUDY drawing at home under Expert Faculty. We have successful students in every part of the world. Turn your Talent into money. Our Students are filling high salaried positions. 14 years successful teaching. Endorsed by high authorities. 18 Courses in Commercial and Illustrative Drawing. Teachers' Normal and Applied Art, Profit or Culture.

Thoroughly Equipped Residence School

Artist's Outfit FREE to Enrolled Students

SCHOOL OF APPLIED ART, 755 Applied Art Bldg., Battle Creek, Mich.

SHORTHAND IN 30 DAYS

We absolutely guarantee to teach shorthand complete in only thirty days. You can learn in spare time in your own home, no matter where you live. No need to spend months as with old systems. Boyd's Syllabic System is easy to learn—easy to write—easy to read. Simple. Practical. Speedy. Sure. No ruled lines—no positions—no shading as in other systems. No long lists of word signs to confuse. Only nine characters to learn and you have the entire English language at your absolute command. The best system for stenographers, private secretaries, newspaper reporters and railroad men. Lawyers, ministers, teachers, physicians, literary folk and business men and women may now learn shorthand for their own use. Does not take continual daily practice as with other systems. Our graduates hold high grade positions everywhere. Send today for booklets, testimonials, etc.

Chicago Correspondence Schools

969 Chicago Opera House Block, CHICAGO, ILL.



BULLETIN

NOTICE

W.J. Smith is promoted to Superintendent, effective immediately.

H.E. Brown, Pres.

“Wish I had his pull!”

Don't envy the “pull” of the man who gets ahead. It's been a “hard pull” for him, that's sure. The confidence of his employers has been won only after years of hard labor. Training, not pull, has earned Smith his promotion.

A “stand-in” with the boss doesn't amount to much these days unless you can back it up with real service. No man who pays out good money for wages is going to keep, much less promote, the fellow who fails to do his share—who makes no effort to progress. Study the men the boss favors. Aren't they doing a little more than they're paid for? Aren't they training themselves for something better in their particular lines?

Years of hard labor are no longer necessary to fit yourself for success. You no longer need to waste the best years of your life in disagreeable work at low wages, simply to get a start—to secure a foothold on the road to a better job and bigger pay. Young or old, the American School can train you, in a short time and in your own home, for the position you want.

Your Opportunity Coupon

Mark the position you want and mail the coupon now

- | | |
|-------------------------------|-------------------------|
|Electrical Engineer |Lawyer |
|Elec. Light & Power Supt. |Bookkeeper |
|Electrical Wireman |Stenographer |
|Telephone Expert |Private Secretary |
|Architect |Accountant |
|Building Contractor |Cost Accountant |
|Architectural Draftsman |Cert'd Public Acc't |
|Structural Draftsman |Auditor |
|Structural Engineer |Business Manager |
|Concrete Engineer |Fire Ins. Inspector |
|Civil Engineer |Fire Ins. Expert |
|Surveyor |Moving Picture Op'r |
|Mechanical Engineer |Sanitary Engineer |
|Mechanical Draftsman |Irrigation Engineer |
|Steam Engineer |Textile Boss |
|Municipal Engineer |College Preparatory |
|Gas Engine Engineer |Auto. Mechanician |
|Gas Tractor Engineer | |

NAME

ADDRESS

Pop. Mech. 11-13

How the American School can advance you

For over fifteen years the American School has been training men for bigger jobs, giving them the “pull” that advanced them while other men stood still. It has prepared thousands for entrance into the big resident colleges. It has trained even more in all branches of **Engineering, Business and Law**, helping them to better jobs and bigger pay. If you want to get ahead, the American School will give you the training you need, no matter where you live or what you do.

Remember, it's training, not “pull,” that counts. Promotion comes only to the trained man—the man who has fitted himself through study to hold a responsible, well-paying position. The American School offers you the opportunity of taking up the studies you require under ideal conditions—in your spare time and in the privacy of your own home. Not only this, but you can pay for your course as you progress.

Investigate your opportunity today. Fill in and mail the coupon now.

American School

of Correspondence, Chicago, U.S.A.

This school has no connection with any other school using the name “American”

Popular Mechanics Magazine

WRITTEN SO YOU CAN UNDERSTAND IT

Vol. 20

NOVEMBER, 1913

No. 5

From New York Sun for Aug. 30th 5260

Towing a Subway Tunnel on Harlem River

New York
THE first section of the new four-tube tunnel which is to carry the Lexington Avenue subway under Harlem River, New York City, was towed down the river and sunk in place on August 29. The four steel tubes, 220 ft. long, 19 ft. in height, and made of $\frac{3}{8}$ -in. plates, were floated in a wooden

about them. Nine flatboats, placed under the float at low tide, carried it free from the falsework and, after they had been scuttled, it rested on the water ready for its trip. With two tugs towing and one guiding from behind, it moved slowly down the river to 131st Street. The trip of a little over a mile, made against the incoming tide to steady the float, required about two hours. At 131st Street, a trench had been dredged in the bottom of the river with a platform on its bottom,

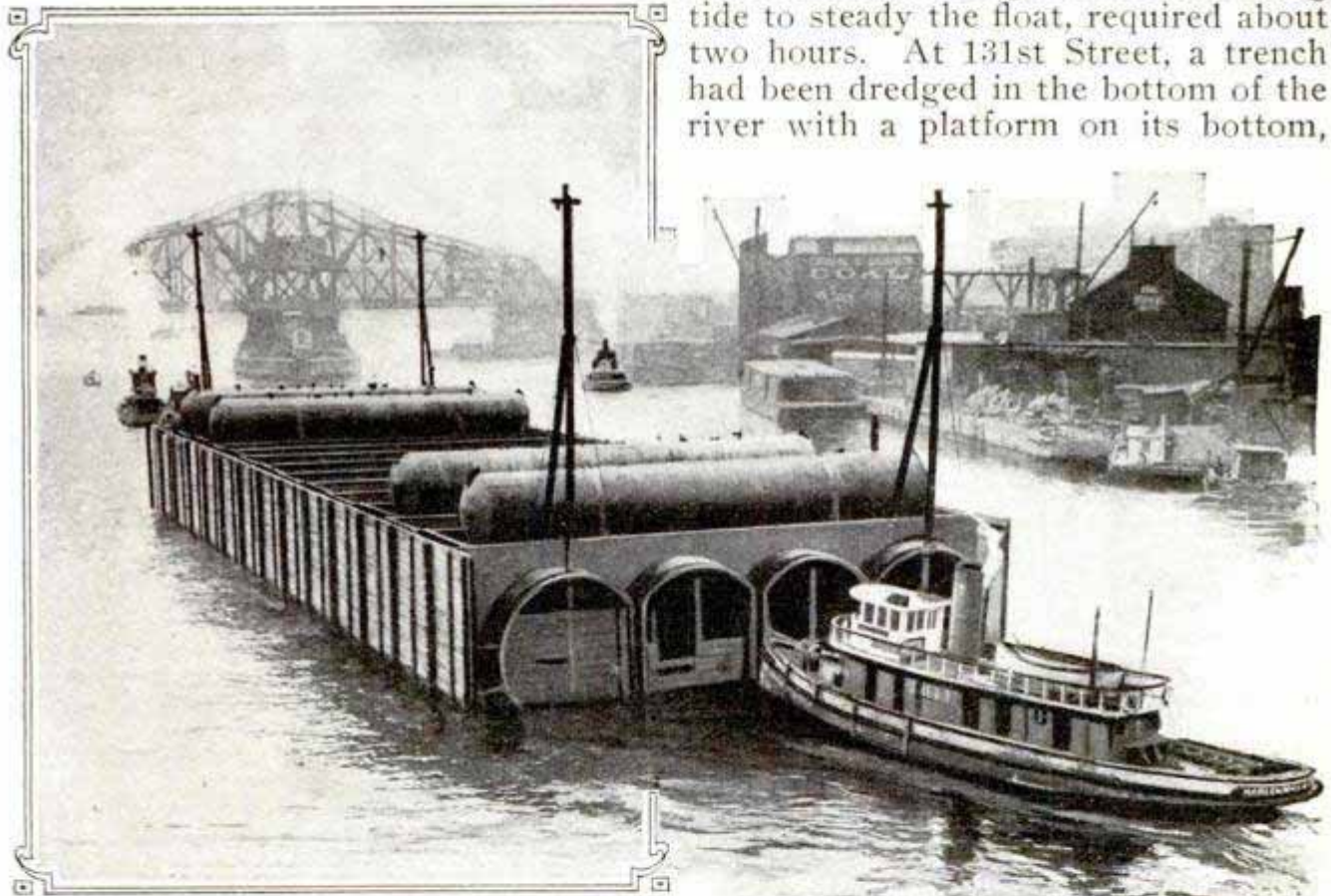

Towing a Section of the Harlem River Subway Tunnel into Position to be Sunk to the Bottom of the River

box, 244 ft. long, 70 ft. wide, and 35 ft. high. They had been constructed on a temporary framework over the water in the slip at 152nd Street with bulkheads in the open ends, and a wooden float, in which some of the planks were 9 in. thick, had been built

58 ft. below mean high-tide level, to support the tunnel. As water was let into the tubes, the sinking was guided by derricks on flatboats and regulated by four air tanks, 65 ft. long and 10.6 ft. in diameter, on top of the float. Four steel masts were left sticking out

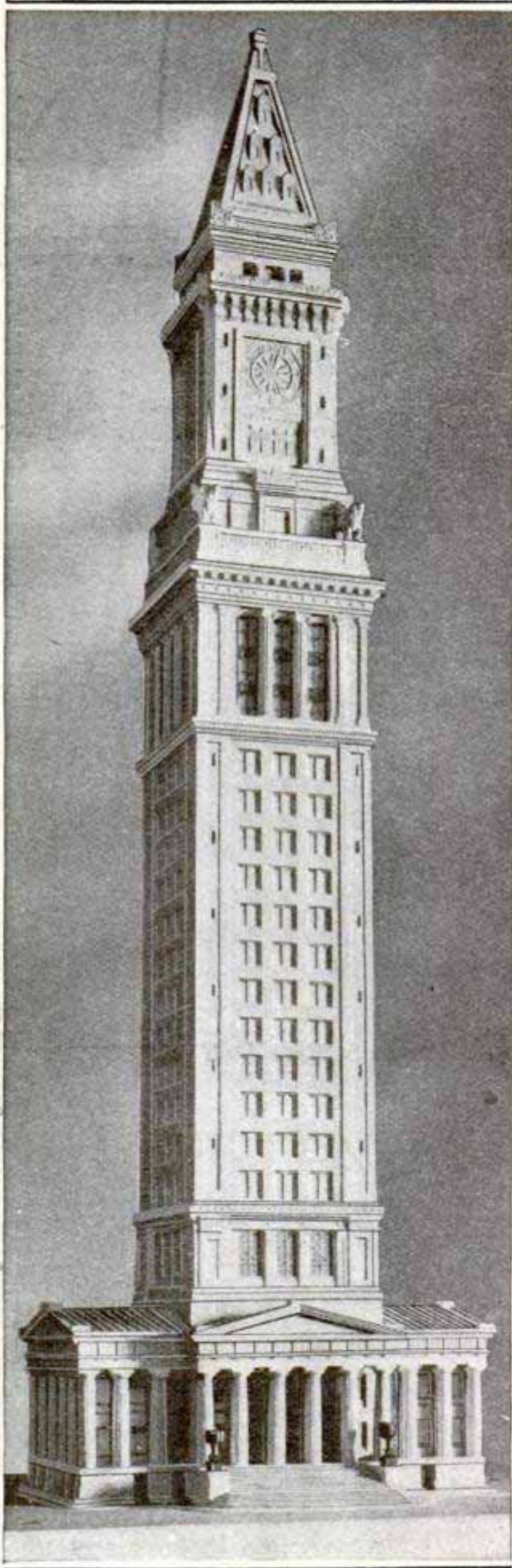

A New Type among Public Buildings:
the New Boston Customhouse

of the water to mark the tunnel's location and guide the engineers in placing the four other sections. The tunnel when it is completed will be 1,080 ft. long. The same method of construction was used in building the Michigan Central tunnel under the Detroit River and in another of New York's subway tunnels, but this is the first time that a four-tube section has been handled in this way.

THE NEW BOSTON CUSTOM- 5153 HOUSE

Unique among public buildings in America is the new customhouse which is being erected in Boston. It is to be a tower, 505 ft. high, and in design is virtually a monument to crown the pyramidal sky line of the city. The old pyramidal shape of the city with the golden dome of the Statehouse at its apex has been destroyed by the building of skyscrapers. Boston's building laws now forbid the erection of private structures more than 125 ft. high, and the new customhouse is designed to rise above its surroundings and form the dominating feature in any view of the city. Although the old customhouse has been torn down, the base of the new tower is an exact reproduction of the old building so that the 505-ft. tower appears to be rising from the roof of the former edifice. The simple Doric style of architecture used in the old customhouse and in its reproduction is followed out in the lines of the whole tower. Very little decoration is used, even in the superstructure that carries the clock faces. In the matter of convenient arrangement of floor space, the building is more or less of an experiment. Since a large amount of floor space is needed, it is thought that the arrangement of various departments on different floors, with rapid elevator service between, will give quicker intercommunication than is possible in a broad, low building. Wherever a department requires more room than one story, its several floors are arranged as galleries over a main floor.

Seabody + Stearns, architects
Exchange Bldg., Boston, Mass.

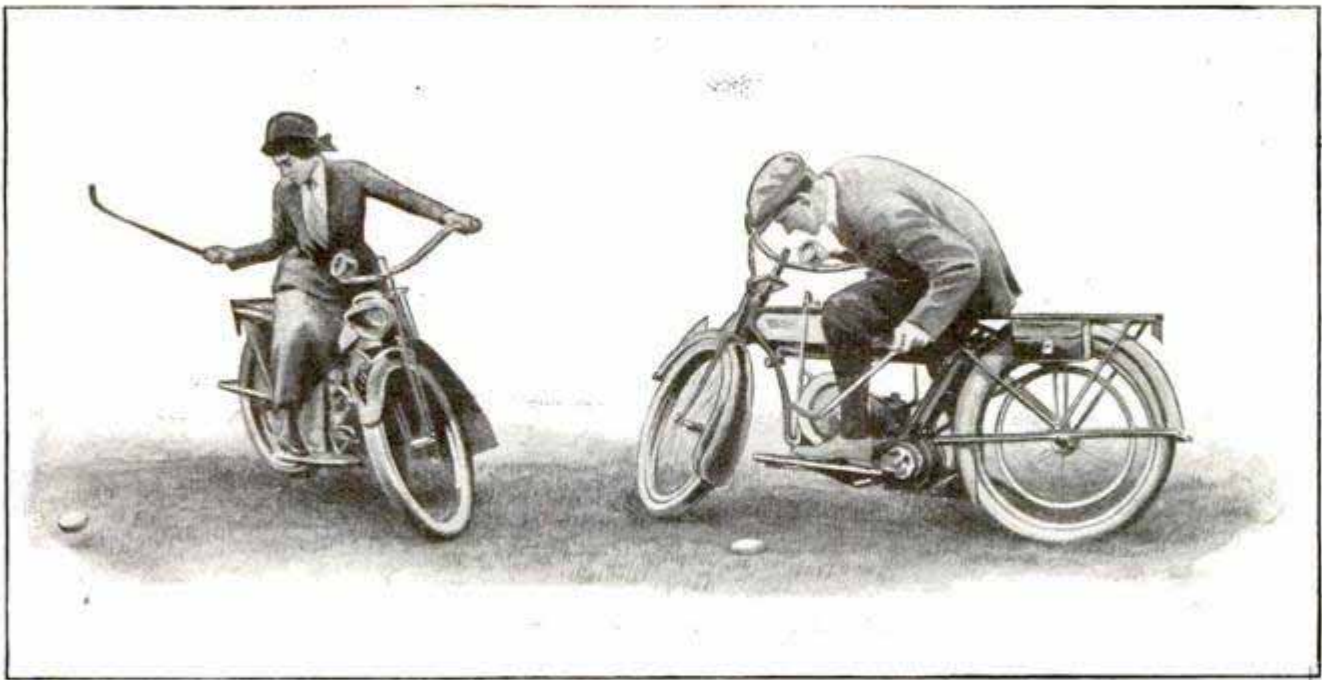

A Collision Narrowly Averted: Incident in the New English Motorcycle Sport, "Hockey-Mo"

5213

copy

"HOCKEY-MO," THE NEW MOTORCYCLE SPORT

from London Graphic
A new sport known as "hockey-mo" is being introduced among English motorcyclists. At the start a ball is placed in front of the machine of each player, and at a given signal the motorcyclists start, each driving his ball forward until it passes through the goal about a hundred yards distant. The game is won by the player whose ball first passes the goal. Numerous possibilities in the way of collisions and upsets accompany the sport.

COAL POCKETS UNDER THE PANAMA CANAL

5128

Storage chambers for coal are being dug in the bottom of the Panama Canal. In time the question of coaling United States war vessels will be a vital one and coal pockets are being prepared now while the machinery is on the ground. The bottom of the canal has been chosen for the storage chambers so that the coal will be safely hidden from any possible enemy. A further advantage lies in the fact that coal deteriorates less rapidly under water than when exposed to the air. Several drills and dredges are now at work excavating the bottom of the canal and building the storage chambers.

ⓄThe largest dry dock in America is being built at Quebec, at an estimated cost of \$2,750,000.

Merrill Street 37th St. New York City

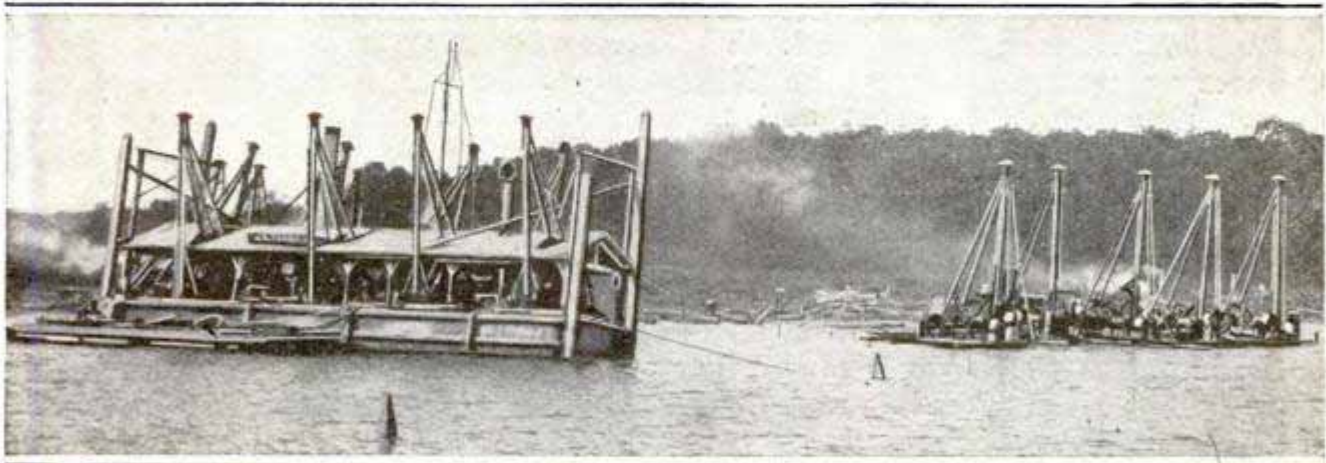

Copyrighted by Underwood & Underwood, N. Y.

These Dredges are Excavating Chambers for the Storage of Coal in the Bottom of the Panama Canal

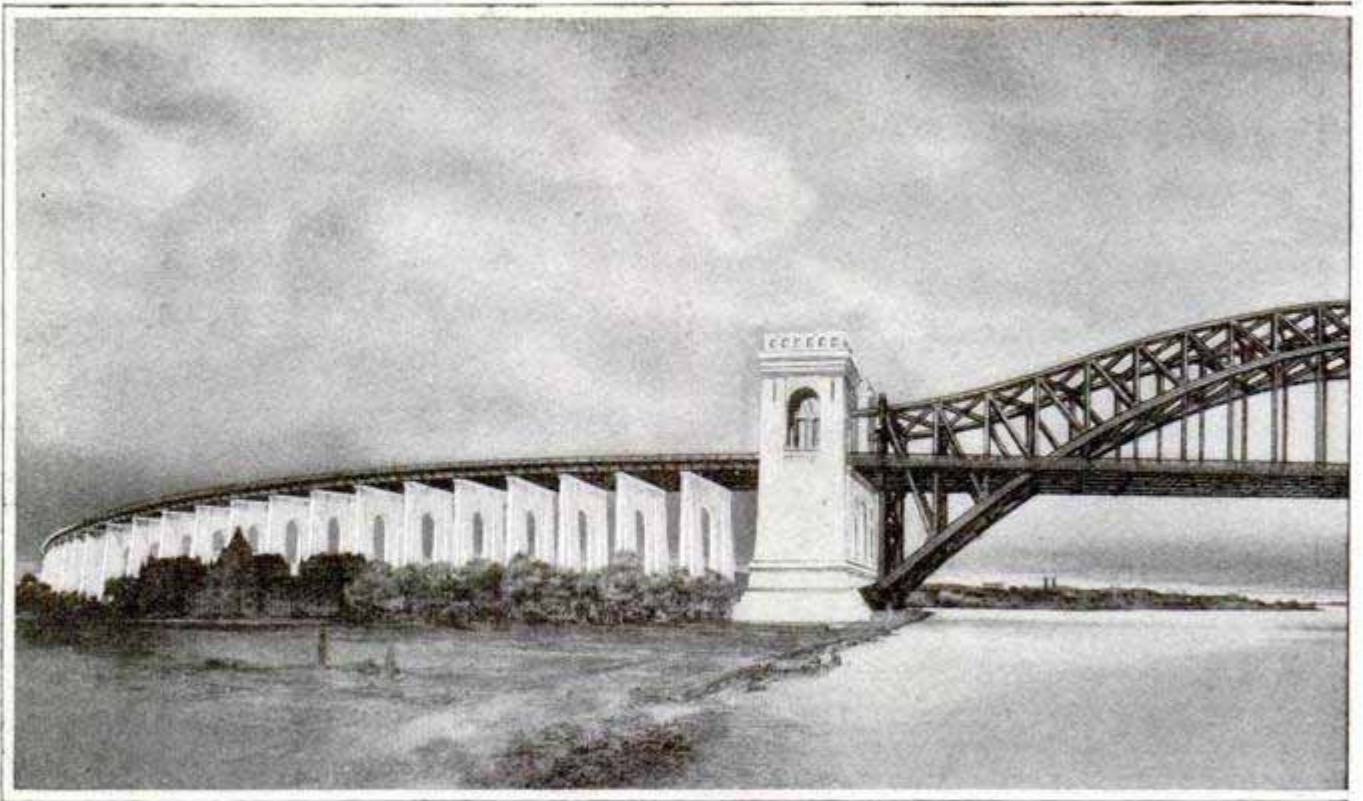

The Hell Gate Bridge Which will Span East River, New York, as a Part of the New Railroad,

4745 THE HELL GATE STEEL ARCH BRIDGE

Hell Gate Bridge, which is now being constructed across East River, New York, as a link to connect New England with the West and South, will contain the longest steel arch span ever built. The bridge is a part of the New York Connecting Railroad, built by the New Haven and the Pennsylvania systems, to carry traffic from north of Harlem River to Long Island, and to relieve the Grand Central Station. The road will have four tracks, will be 10 miles long, and will cost \$30,000,000. About 15,800 ft. of it will be carried on bridges and viaducts from 20 to 135 ft. above the ground. The connecting railroad leaves the New Haven line at 142nd Street and the Bronx on a fill and viaduct, 4,200 ft. long and from 20 to 65 ft. high, swings across Bronx Kill on a two-span bascule bridge, 490 ft. long, and skirts the eastern edge of Randall's Island on a viaduct, 1,960 ft. long and from 65 to 90 ft. high. A four-span truss bridge, 1,153 ft. 6 in. long, takes it across Little Hell Gate, and in a sweeping curve it crosses Ward's Island on a viaduct, 2,650 ft. long and from 105 to 130 ft.

high. From there the Hell Gate arch bridge carries it across East River to Long Island City. Then, for over a mile, it continues on viaducts and fills. The two passenger tracks will join the Pennsylvania lines in Sunnyside Yard, Long Island, and pass back to Manhattan Island through the present tunnel under East River to the new Pennsylvania terminal. Through trains will continue underground across New York, through the Pennsylvania tunnels under Hudson River, and out across New Jersey. The two freight tracks, after leaving the viaduct, will traverse Long Island to Bay Ridge, to meet the car ferries for Greenville, N. J. In these 10 miles of railroad practically all of the 3½ miles west of the river and a large part of the 6½ miles east of the river are carried on steel and concrete viaducts. Some 90,000 tons of steel, 450,000 cu. yd. of concrete, and 5,000 tons of reinforcing rods will be used. Standing at the eastern entrance to New York, the great Hell Gate arch bridge is designed, not only for strength, but for architectural beauty. The steel arch,

Edward S. ...

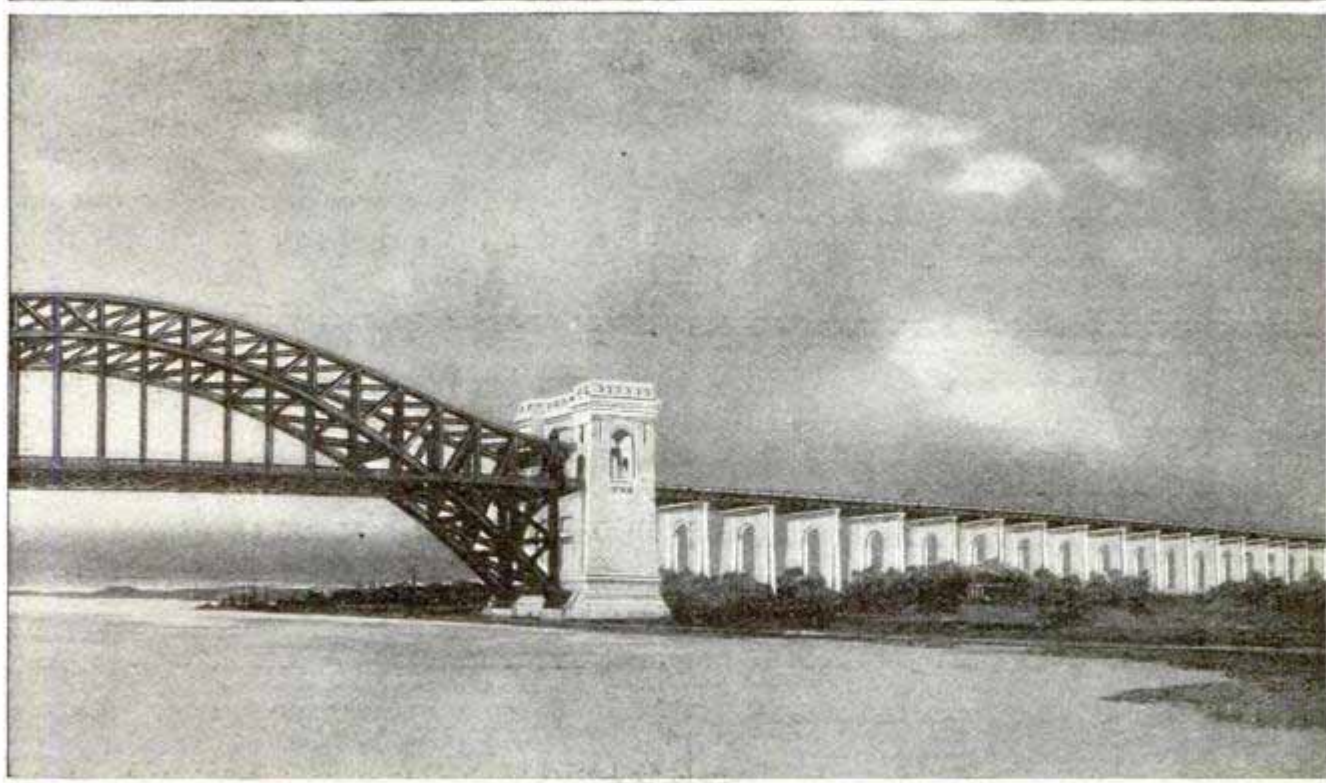

Connecting the New Haven and Pennsylvania Systems, Linking New England with the West and South

1,000 ft. long, is composed of two rigid chords, but the upper one has a reverse curve so that one chord is a pull and the other is a thrust, making the construction cantilever. It will be built out from the two sides toward the center and the floor will be pushed out at the same time to strengthen the towers. The stone and concrete towers will be 250 ft. high and 104 by 140 ft. at the base. The bridge floor will be 60 ft. wide, to carry four tracks, and 150 ft. above the river; the steel arches rise above it to 300 ft. above the river. With approaches, the bridge proper is 3,000 ft. long. Work on the connecting railroad began in the summer of 1912 and it is expected that the line will be complete in 1915. A large number of viaduct piers and abutments are completed, some 1,900 ft. of retaining walls for fills is finished, and work has begun on the towers of the Hell Gate arch.

CALL the white marble to be used in the buildings of the Australian Commonwealth, now being erected in London, will be shipped from Southern Australia. Some 210 tons have been ordered.

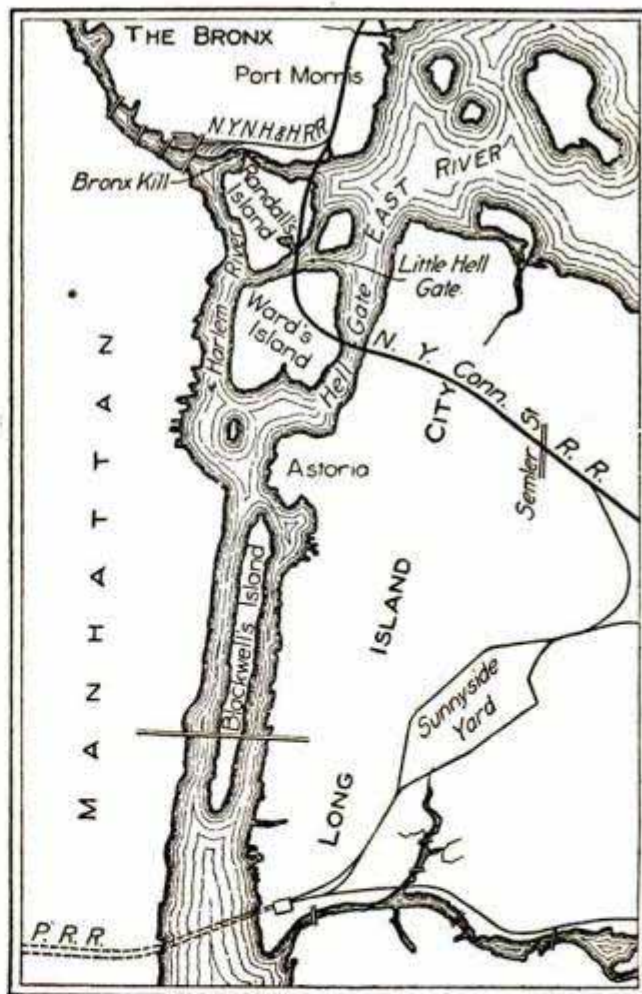

Route of the New York Connecting Railroad:
It is 10 Miles Long and Almost Half of
It is Carried on Bridges and Via-
ducts High in the Air

MEMORIAL TO THE PILGRIMS UNVEILED

A monument to the Pilgrim Fathers, erected at Southampton, England, in

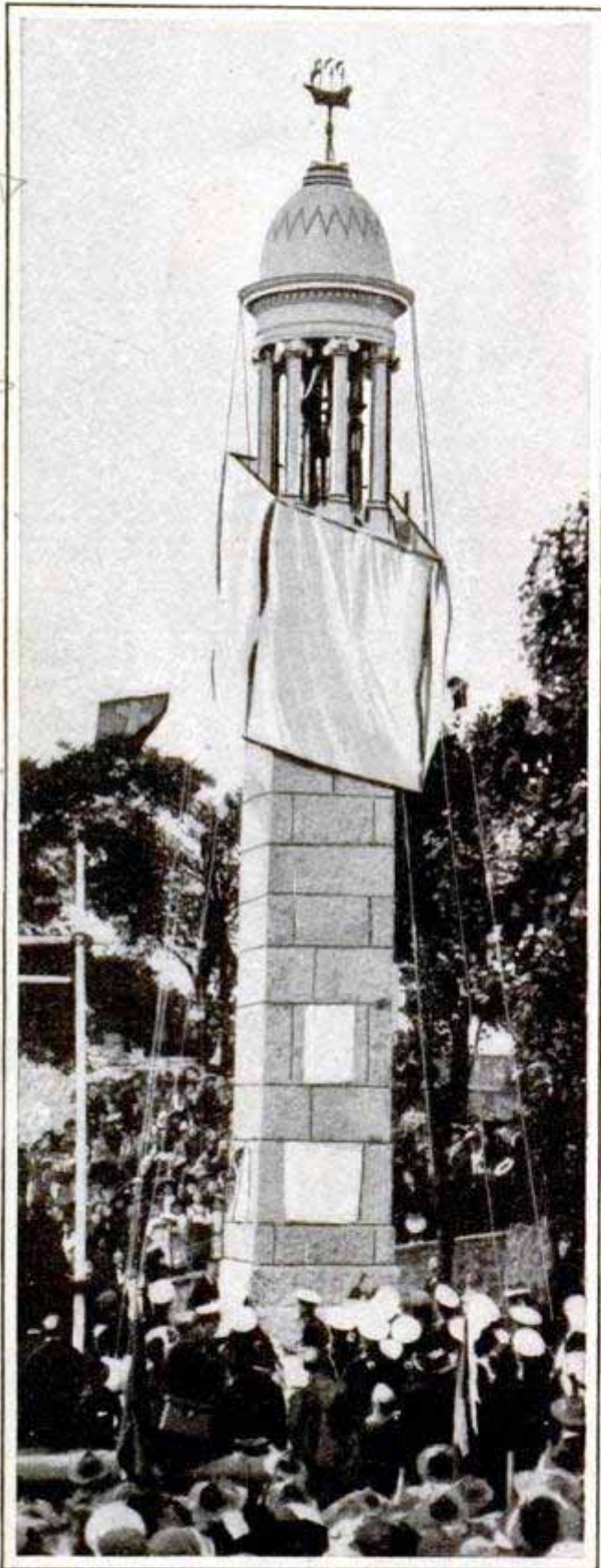

Photo by Paul Thompson

The Dedication of the Memorial to the Pilgrim Fathers at Southampton, England

memory of the departure of the "Mayflower" for America on Aug. 5, 1620, was unveiled on August 15. Ambassador Page represented the United States at the dedication. The tall stone shaft is crowned by a weather vane modeled after the little 180-ton ship in which the 102 venturesome pilgrims made their voyage of 63 days to America. The monument was erected at Southampton because it was from that port that the "Mayflower" and her sister ship, the "Speedwell," first set sail for America. A few days later both put into Plymouth Harbor and the "Mayflower" sailed away alone on Sept. 6, 1620.

5248 HARDENING SOFT FATS WITH HYDROGEN

Catalysis, which is a chemical process in which certain substances provoke or accelerate chemical reactions by their mere presence and without themselves undergoing any perceptible change, is finding constantly increasing use in various industries and has recently been applied in the manufacture of soap, stearin and various edible fats. It makes possible the change of soft, liquid fats or oils into hard fats with a high melting point. Thus an oil of the consistency of ordinary cotton-seed oil can, by catalysis, be converted into a firm, semisolid fat with many of the properties of lard. Incidentally catalysis, as used in this class of work, destroys all coloring matter and odoriferous substances, making further purification unnecessary. This process consists of introducing hydrogen into the soft fats in the presence of nickel or palladium, either in a pulverized form or in aqueous suspension, as the catalytic agent. During the process the fat is heated and in some cases a slight pressure is used. *Scientific American* 7/2

Over 350,000 persons, representing 100 counties, turned out in one day for the work of improving Missouri's highways. They accomplished about \$1,000,000 worth of work.

Catalysis

"Technische Rundschau"

R.- Ing. Dr. Benning

5270
10 Spence St. (no date)
New York City

Mr. M. N. Wood, Mechanical engr.
1405 Broadway New York City (Owns Am. Rights)

"Shooting Up" the Movies

By Wendell Phillips Dodge

5259

SOCIETY this winter will have the delightful experience of shooting wild animals in the drawing room. No

longer is it necessary to go to the heart of Africa, the fastnesses of the Ural Mountains or the crags of the Rockies to shoot big game. This can now be done between office hours and dinner in a business suit or after dinner in evening clothes, with no danger to the sportsman, by means of the motion-picture shooting gallery.

From the point of view of sport, the "life" target excels anything ever seen on any rifle range. The excitement of shooting at birds on the wing, at horses

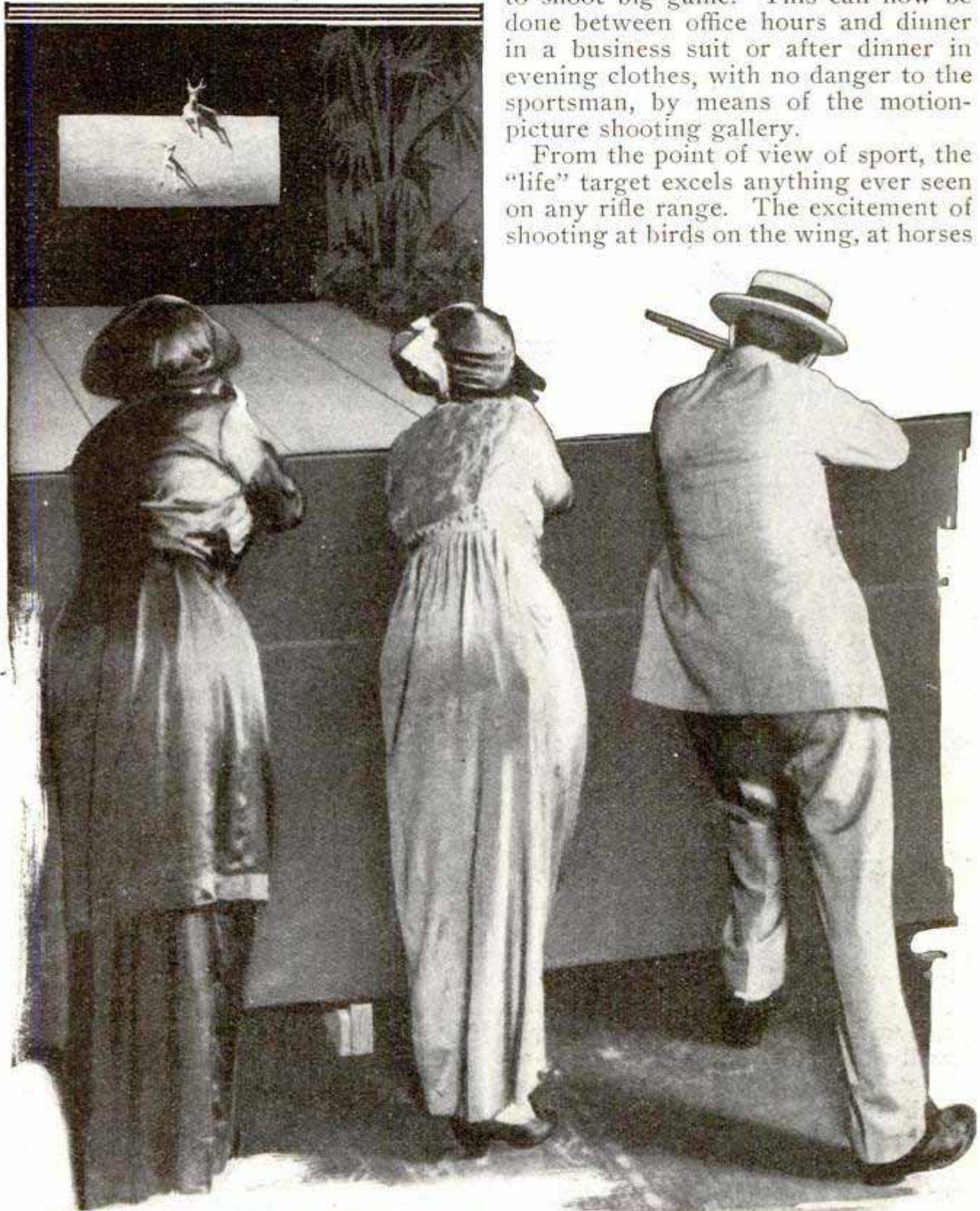

The Motion-Picture Shooting Gallery for Indoor Big-Game Hunting

leaping fences, airmen soaring and dipping, polar bears, Indians in ambush, lions and other beasts in the jungle, motorcycles racing, automobiles speeding, wild ducks taking to the water—almost anything in motion—cannot be appreciated without actual experience.

A New York theatrical manager, hunting for plays on the Continent last spring, fell upon the trail of the life-target shooting pictures. He took his first shot at them in Berlin, and from that day he has not been able to leave a rifle alone. He brought back with him the American rights in this latest "movie" craze.

The novelty of the device is that the instant the rifle cracks the moving film halts for a fraction of a second, just long enough for one to see where his shot has hit. Whether it is a seal slipping into the water from a rock, a springing lion or a leaping antelope, the instant the rifle cracks the moving object stops. Then, where the bullet pierced the white paper screen, a little hole appears, showing a red light. This glows for an instant; then the film resumes its motion.

Electrically and mechanically the cinematograph target is ingenious. The target coordinates four separate patents, each of which was developed originally for quite other purposes. The heart of the mechanism is a relay, originated for use in automatic signaling on railway trains. A telephone receiver is placed well above the firing line. When the shot is fired, the sound acts upon the telephone receiver, which operates the relay, which in turn controls the cinematograph machine by means of a band brake and a magnetic clutch. At the instant the shot is fired, the clutch is released and the brake is applied, bringing the picture to a standstill. To prevent the film from catching fire while stationary, a small direct-driven air compressor maintains a constant blast of cold air on the film.

The switchboard which carries the relay also carries a dashpot which controls the spot-extinguishing movement of the screen and the restarting of the

machine. The screen itself is formed by two sheets of stout paper, on horizontal rollers, and a third sheet, forming a stay, on vertical rollers. These screens are arranged to move a fraction of an inch—roughly the diameter of a shot hole—after each shot, thus obliterating the hole. This is done by a ratchet actuated by a solenoid. When the relay is brought into action by the sound of a shot, it closes the circuit of a timing dashpot, which rises slowly until the upper contacts close the circuit of the screen solenoid. During this interval the shot hole remains visible; but when the solenoid circuit is closed the hole disappears and the cinematograph machine is started again. The screen is illuminated from behind by several flaming-arc lamps hung clear of the firing line.

The life target provides the marksman with objects to shoot at under conditions as realistic as the modern cinematograph can make them. The pictures can be adapted to represent objects at any desired range and at any rate of movement, and the mechanism can be so adjusted as to take account of all the conditions of actual shooting; so that, in firing at a moving object 1,000 ft. away, the marksman must take into consideration the motion of the object between the moment of pulling the trigger and the moment the bullet would reach the mark.

For the training of military marksmen the cinematograph target has been approved by the British War Office.

NEW LONG-FLIGHT RECORD

5292 ESTABLISHED

The world's record for long aeroplane flights with a passenger was broken on August 26 by a German airman, Victor Stoeffler, who flew $77\frac{3}{4}$ miles in one day. Including two stops made on the way, the flight took 13 hours and 45 minutes. The airman, with one passenger, left Mulhouse at 5:45 a. m., in competition for the national aviation prize, and landed near Insterburg at 7:30 in the evening.

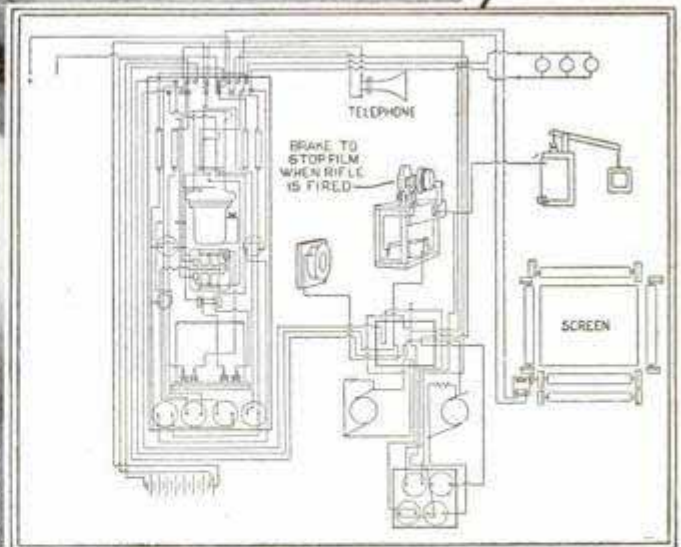
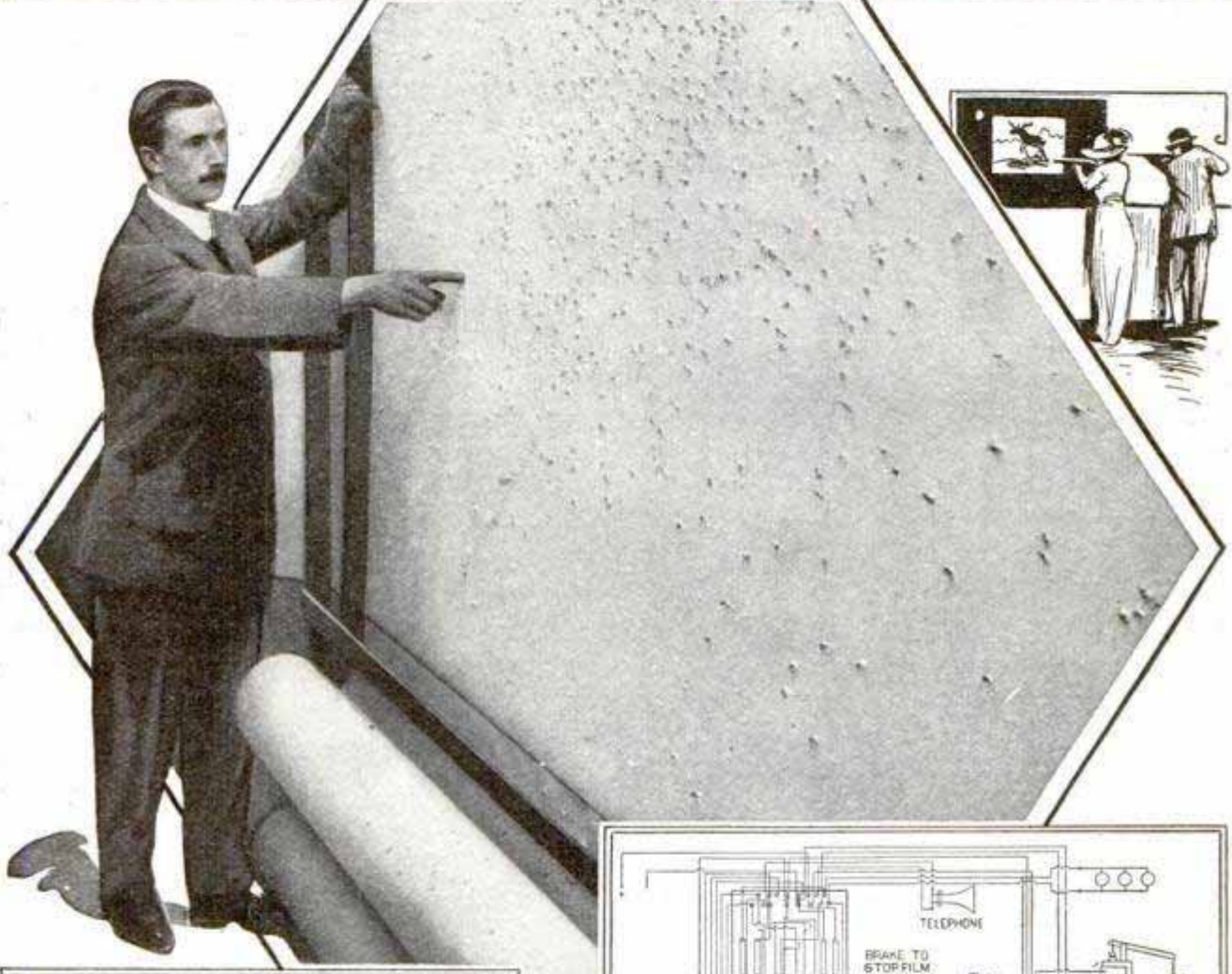
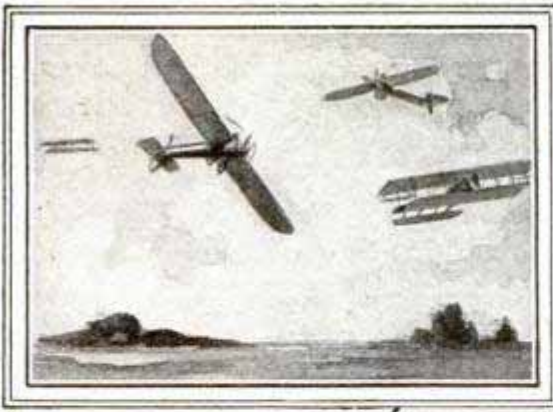

Some of the "Life Targets" for the "Shooting Movies" are Shown Here and in the Two Upper Pictures

Diagram Illustrating the Method Whereby the Sound of the Rifle Shot Stops the Mechanism

Behind the Screen on Which the Motion-Picture is Shown, as Well as the Rollers by Which the

Targets are Shown: the Bullet Holes are Noticeable, as Well as the Paper Screens are Shifted to Cover the Holes



California Tourists Watching Flying Fish Attracted from the Water by a Strong Searchlight Mounted on a Motorboat

conclave early in the summer. It was 710 ft. long, 410 ft. wide, and had seats for about 26,500 persons. Although it cost \$33,000 and contained over 1,000,000 ft. of lumber, it was erected in a little over a month. In comparison, the ancient Greek stadiums were never over 650 ft. long and the concrete stadium at Harvard University seats only 3,500 more spectators than the Denver amphitheater. In the parade shown in the picture, the black horses had silver hoofs, and a white horse ridden by the commander had gold-bronzed hoofs.

A SEARCHLIGHT TO ATTRACT FLYING FISH 4915

Watching flying fish from a motorboat equipped with a powerful searchlight is a new form of amusement provided at Avalon, Catalina Islands, California, to rival its famous glass-bottomed boat in which tourists gaze at the animal and plant life in the water beneath them. A large electric searchlight mounted on the new craft attracts hundreds of flying fish from the ocean, as the boat goes through the darkness, and the passengers can watch them leaping from the water and skimming along ahead of the boat, silvery and

dazzling in the bright light. The motorboat is 50 ft. long and its searchlight receives its current from a dynamo belted to the flywheel of the engine.

PAPER MODEL OF GASOLINE ENGINE 5147

Marcus Westergreen

A paper model of a gasoline engine has been made by a Boston inventor to illustrate the construction of a new type of aeroplane motor which he has devised. Ordinary writing paper and nothing else was used. The engine is a part of an aeroplane device designed to enable a pilot to throw off the motor, propeller, wheels, and gasoline tank of his flying machine in case of accident.

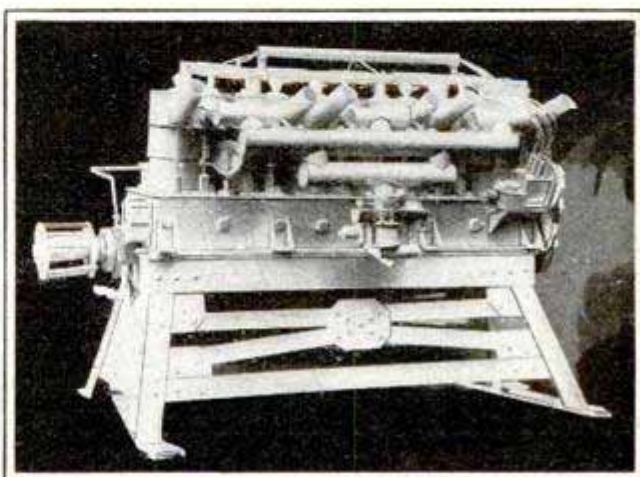

Model of Gasoline Engine Made of Sheet Paper

*Special Machine for
the purpose of
throwing off the
engine, propeller,
wheels, and
gasoline tank*

Standard Oil Co.

5297
no data

HITCHING ENGLAND TO EUROPE

By JOSEPH E. MURPHY

Associate Member, American Society of Civil Engineers

THE building of a tunnel under the English Channel is, like the digging of the Panama Canal, a project that will not down. It has come up for discussion and agitation periodically for nearly a century, and each time it has been defeated because of military considerations. Thirty years ago the tunnel came very near becoming an accomplished fact. Trial headings aggregating about one-tenth the total length of the tunnel were dug. Then the work was stopped on the same old plea that such a connection with the Continent might be used as a means of invasion in time of war.

This project is now being promoted again, and apparently with more likelihood than ever that it will be carried through to completion, owing to a pronounced change of attitude both on the part of the public and of the military authorities of England. Curiously enough, this change of attitude is due, not to any belief in the permanency of peace, but largely, if not entirely, to the development of the aeroplane and dirigible balloon as formidable instruments of war, with the consequent destruction of that "splendid isolation," in a physical sense at least, of which the British have always been so jealous. Dozens of airmen have already made flights over the channel, and it is apparent that in any future war the most serious menace would come from other sources than a tunnel. A bill now pending before the British parliament contemplates the immediate beginning of construction. The building of the tunnel will place London in direct railway communication with Paris and other cities of the Continent and will eliminate one of the most disagreeable features of European travel, the much dreaded channel passage.

The construction of the tunnel would be a big engineering job, but it would not be comparable in cost or in the difficulties to be overcome, with the

construction of the Panama Canal, and the conditions to be met are fully as well known in the case of the tunnel as they were at Panama before work there began. A surprising amount of reliable information has been gathered in regard to this project. The French alone made about 7,000 soundings in the bed of the channel and demonstrated beyond a doubt that the chalk strata that form the prominent feature of both the English and French coasts continue unbroken under the channel. Complete geological maps and sections have been worked out, and these show that favorable conditions exist for the construction of a tunnel.

A great many plans have been proposed, but the one that has been given the most consideration is that proposed by J. Clarke Hawkshaw, the head of the engineering firm that designed the Severn tunnel and carried it through successfully. Underlying the channel and continuing far inland on both sides are various layers of chalk. The top layer is a water-bearing white chalk. Below this is a layer of gray chalk, averaging 225 ft. in thickness, and practically dry and impervious to water, and through this it is proposed to drive the tunnel. This chalk is easily worked, as was demonstrated in 1882 when trial headings were driven successfully by means of a rotary cutting machine operated by compressed air. It was estimated at that time that a circular heading 7 ft. in diameter could be driven out from each shore to a meeting under the center of the channel in two years. In three years the tunnel could have been completed, since the "stopping," or enlarging the tunnel to its full section, and the excavation of ventilation and drainage galleries would have followed closely behind the driving of the headings in accordance with the usual tunnel practice.

The natural place for the tunnel is at the Strait of Dover, where the dis-

tance from coast to coast is only about 20 miles and where the average depth of water is about 120 ft. This narrow strip of water has always been one of the important international highways of the world and the traffic lines on both coasts converge to it. But it is also a most unsatisfactory highway on account of the swift currents and rough seas to which it is subject. The economic importance of the strait as a link between England and the Continent will never be altered, and it is therefore inevitable that a tunnel providing adequate railway transportation will finally be built.

The tunnel, as proposed, will run from the Shakespeare cliffs, near Dover, England, to Sangatte on the French coast, near Calais, and its total length will be a little more than 22

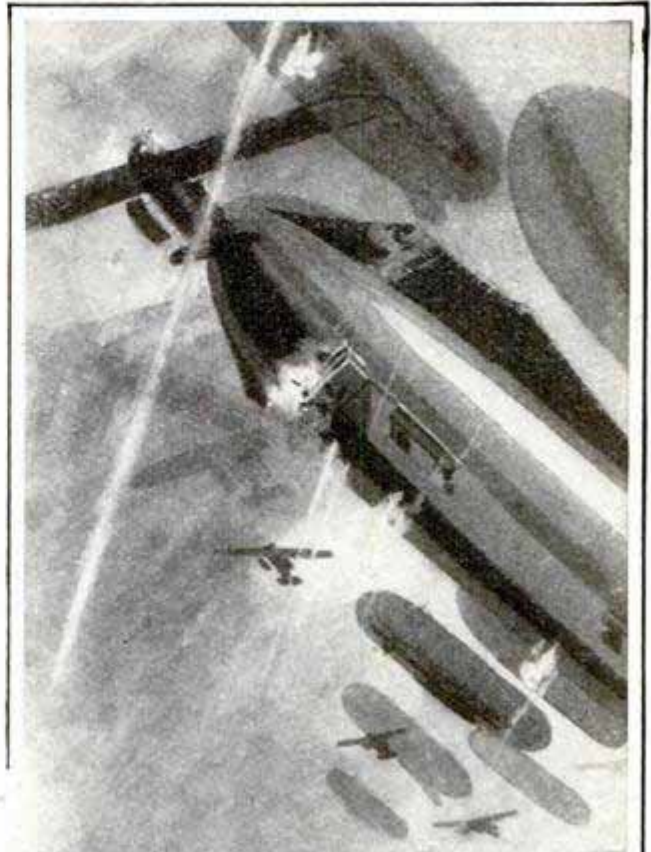

A Sudden Attack by Sea and Air might Make the Fortifications at the Mouth of the Tunnel Untenable for the Defenders





Geological Section Showing How Tunnel Connecting England and France could be

miles. On each side it will enter the cliffs at a short distance from the shore and drop down on a grade of 1 in 80 for about two miles into the impervious gray chalk under the strait. From each of these low points the grade will rise at the rate of 1 in 1,000 to a summit under the middle of the strait, the thickness of the gray chalk being great enough to permit this arrangement. The plan for placing a summit at the middle of the tunnel is solely for the purpose of drainage. Such a plan does away with the necessity for separate drainage tunnels, which would require a rather elaborate arrangement of shafts connecting the main tunnel with the drainage tunnels. At each of the low points near shore a collecting basin will be placed. The water will flow into these by gravity and will be removed by means of force pumps.

The plan now under consideration provides for two parallel tunnels connected by passageways at frequent intervals. It is difficult to see the necessity for this arrangement, since the builders would then have to drive two separate headings and the work of construction would become practically two separate tunnel jobs. The ap-

proved modern practice in building tunnels in rock is to drive one heading, excavate from this a tunnel wide enough for the two tracks and then support the center with a concrete wall, as is being done in the Mount Royal tunnel at Montreal. There is no apparent reason why this process would not be adapted as well to a tunnel in such a stratum of chalk as exists under the strait. The heading could easily be excavated by means of a rotary cutting machine, driven either by electricity or compressed air. If driven by compressed air, the exhaust from the machine, by introducing a constant supply of fresh air into the workings, would go far toward solving the problem of ventilation during the construction period. With such equipment as is now to be had, permanent ventilation after it was placed in operation would not be a difficult matter. The pistonlike action of the trains in passing through the tunnel would practically settle this question, although some auxiliary system of supplying fresh air through ducts to points near the middle would doubtless be necessary. In 1882, it was proposed to use compressed-air engines for hauling the trains, but at the pres-

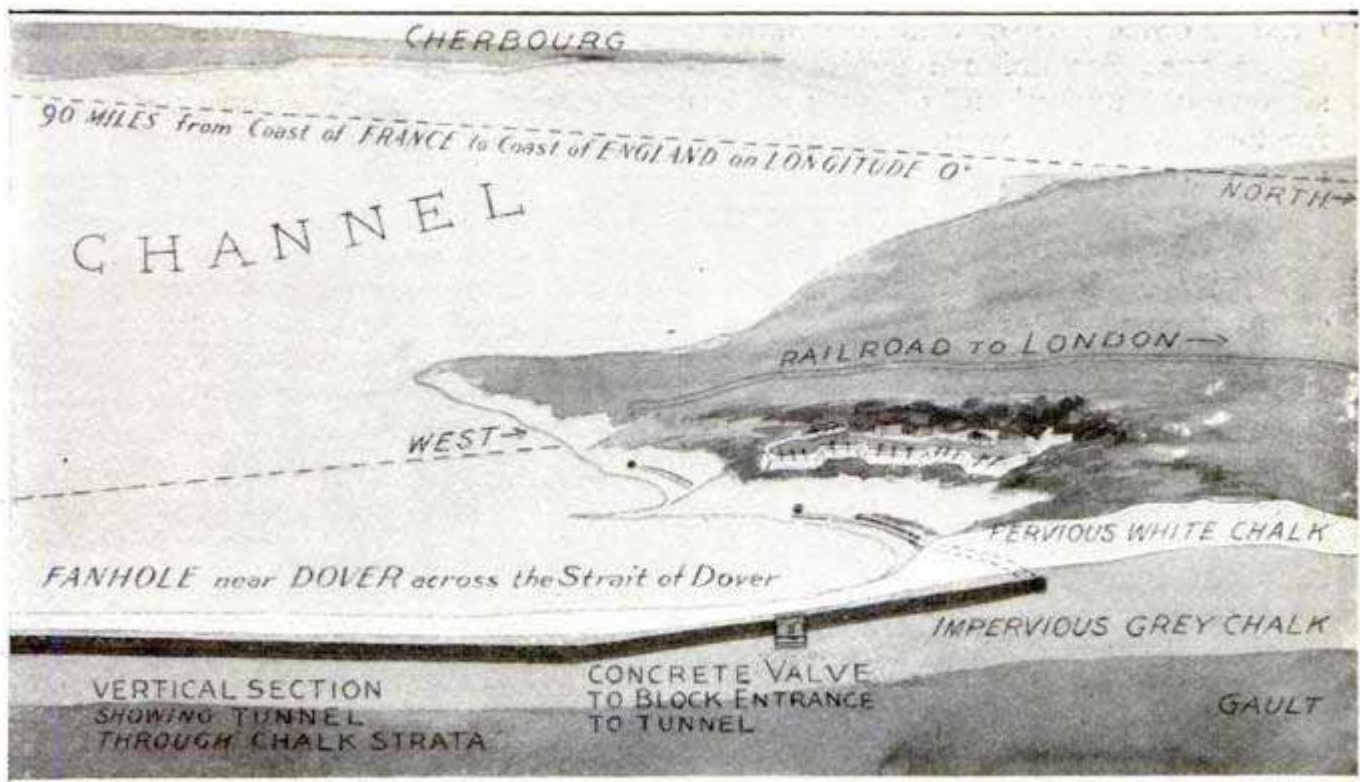

Built in the Stratum of Impervious Gray Chalk Underlying the Strait of Dover

ent time it is not likely that any power other than electricity would be thought of.

A careful estimate places the cost of the tunnel at \$80,000,000. Given the money and the permission to build it, the actual work of construction would not be as difficult as many engineering jobs that attract less attention. The critical feature is that of defense in time of war. Several methods have been proposed for blocking the entrance to prevent invasion. Such a tunnel as that outlined above could be flooded so that it would be impossible for an enemy to pass the low point in the grade. As an additional safeguard it has been proposed to build a device similar to a cross valve, placed within the tunnel at a suitable distance from the entrance. This device would consist of a massive block of concrete operated by a turntable mechanism and pierced with openings corresponding to the openings in the tunnel. Under ordinary conditions this would be set to permit the passage of trains, but in time of war it could easily be turned with the openings at right angle to the tunnel and thus block any attempt at invasion. But no mechanical device has

ever yet been made that it is not possible to tamper with and render inoper-

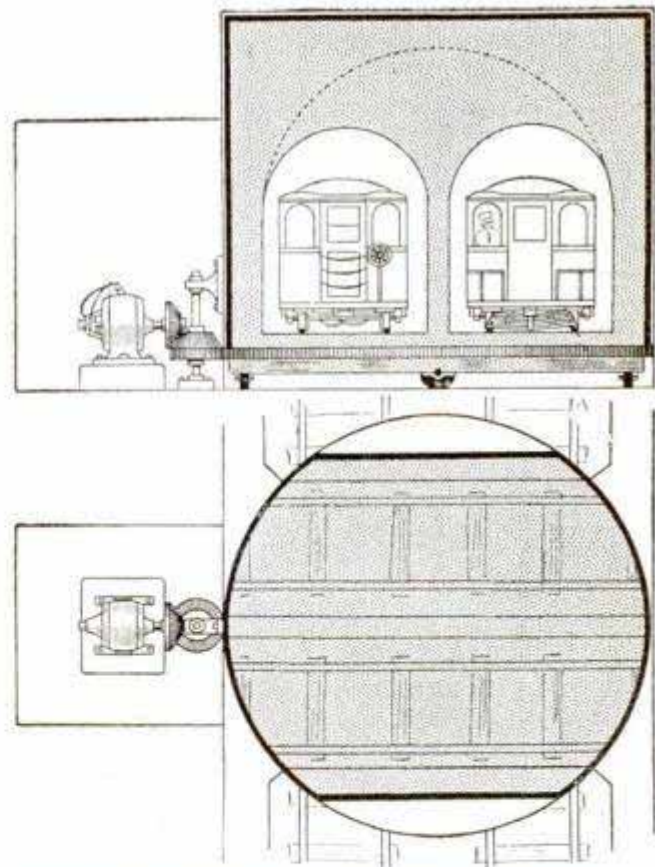

Concrete Valve Working on Turntable Mechanism, Which could be Turned to Block Exit from Tunnel

ative at the critical moment, and, it might be added, there is always the possibility of treachery by some

trusted officer. For this reason final dependence for defense against invasion would undoubtedly be placed on fortifications. It would be an easy matter to arrange batteries in such a way as to command effectually the mouth of the tunnel.

With such fortifications, it is inconceivable that an enemy would attempt to force an entrance into the country through the tunnel. The attack, if ever made, would be made in another way, and in considering the possibility of such a thing, it is well to look two generations ahead to a time when the east coast of the strait may be in possession of a power less friendly to England than is France at the present time, and when the whole art of warfare will have undergone a revolutionary change. The tunnel, while useless as a means for making the initial assault, would provide the best of all avenues for conveying troops into the invaded country, and the first step would therefore be to silence the de-

fenses commanding its entrance. There would be no necessity, in the first assault, for occupying these defenses beyond getting control of the devices used for blocking the tunnel. A sudden attack by air and sea, which would probably be made at night, might make the fortifications untenable for the defenders. With this condition maintained for six hours thousands of troops accompanied by several regiments of the terrible modern field guns could be rushed through the tunnel. The invaded country would then have a truly formidable situation to deal with, especially since the enemy, with full control of the tunnel, would have a practically unassailable base of supplies to draw from. But even with this possibility in view, the English, after the completion of the tunnel, would not have as much of a problem in defending their country as have the other great powers with their hundreds of miles of exposed land frontiers.

PORTABLE DINING ROOM FOR AUTOMOBILISTS

4635

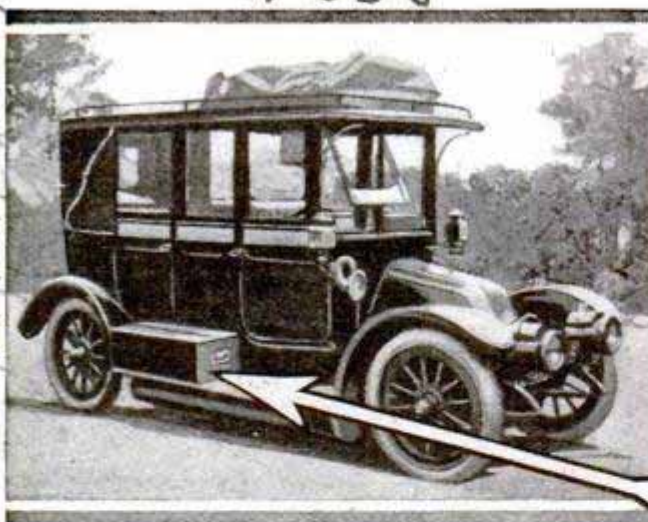

This Complete Luncheon Outfit, Including Table and Seats, Packs into a Snug Little Box for an Automobile Running Board

The luncheon outfit shown in the accompanying picture, almost a complete dining room, packs into a box small enough to fit snugly on the running board of an automobile. Glass, cutlery, crockery, table, and seats for six persons, are included in the set, and

there is ample space for food and drinks. The outfit has been patented in England and was displayed at the International Horse Show. Smaller sets are being made for four and for two persons—the latter is intended to be carried on a motorcycle or side-car. The complete luncheon cabinet contains provision boxes, plates, tum-

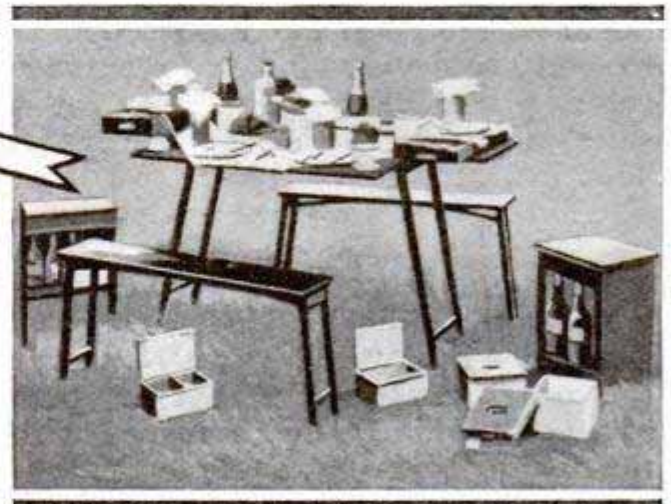

Courtesy of the Car

The "Lundale" 2-4-6 person

Car for sale - 18/13, page 131

blers, condiment bottles, cups, saucers, vacuum bottles, knives, forks, spoons, tablecloth, napkins, and space for two champagne bottles.

NEW EXPLOSIVE STRONGER THAN DYNAMITE 5253

Trotol is the name of a new high explosive which is twice as powerful as dynamite and very much safer to handle. Six ounces of trotol will do the work of 12 oz. of dynamite, but nothing will explode it except fulminate of mercury, and that can be stored within 6 in. of it without danger. When packed in a 12-in. shell and fired at armor plate 1,000 yd. away, trotol remained unexploded in spite of the terrific concussion. In appearance it resembles wet brown sugar and is made up in sticks. Unlike dynamite, trotol can be kept in water for years without deteriorating. The new explosive was discovered by an officer of the New York National Guard through the study of an old German book containing 2,000 formulas for high explosives. From one of these, taken at random, trotol was developed. The discovery is to be presented to the government without reward.

BURNING CUBES OF SOLID ALCOHOL 5180

Cubes of "solid alcohol" are coming into use in Germany and to some extent in America for cooking, heating curling irons or small amounts of water, and for any purpose which requires a small amount of heat for a short time. Put up in pills or small metal containers, solid alcohol is much more convenient than liquid alcohol, because it can be used on a sheet of metal or asbestos without a burner and the user knows just how much heat to expect. Some of the cubes are made of 60-per-cent alcohol worked up in a solid mass which looks like transparent soap, but the flame is not clean. Mixed with collodion, the solid alcohol

is transparent and more cleanly, but rather expensive. The cheapest and

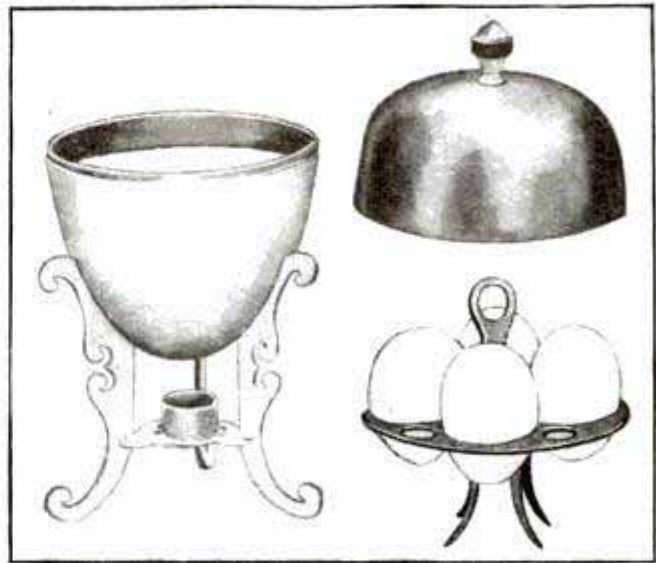

A Cooker Which Uses Solid Alcohol for Fuel, and Eggs Boiled in It

most useful tube is made of sawdust soaked in alcohol and mixed with tar.

CONCRETE SIDEWALK MADE INTO FENCE 5173

The material from an old concrete sidewalk which had outlived its usefulness was used by a resident of California in making a serviceable and artistic fence around his grounds. The concrete slabs were simply lifted from their bed and stood on edge to form the body of the fence. The fence was built in panels, each of which consists of two lengths of slabs, surmounted by a continuous concrete coping. The panels are separated by small piers composed of cobblestones cemented to-

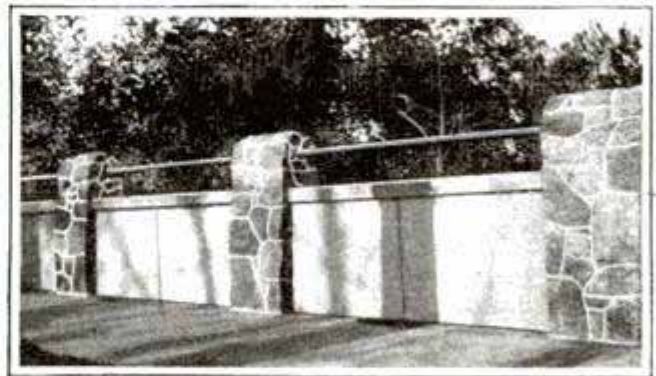

The Panels of This Artistic Fence Are the Slabs from an Old Concrete Sidewalk

gether. The tops of the piers are joined by an iron rod which adds much to the attractiveness of the fence.

Lever Co. 44 Elizabeth N. J. 1880 No. 8 Dr. ch
 (No) 15. 16. Naillette

Mrs. P. M. Rice The woman
 in history, Calif.

STATUE OF A KING CARVED 5172 IN GRANITE

A statue of King Edward VII recently dedicated in Aberdeen, Scotland, is, perhaps, the first granite statue of a ruler erected since the days of the Pharaohs. It is carved out of a solid block of granite and is polished like marble. Aberdeen claims the



distinction of rediscovering the art of sculpturing granite, after it had been lost for 30 centuries, and has developed an industry based upon the discovery. The first granite statue of modern times, a likeness of the Duke of Gordon, stands in Aberdeen. The new statue of Edward the Peacemaker, the finest piece of granite carving ever executed in Great Britain, is 10 ft. 6 in. high and stands upon a granite base and pedestal 14 ft. high. On either side of the pedestal are bronze figures, 6 ft. high, representative of Edward VII's personality.

Statue of Edward VII, the Finest Example of Modern Sculpture in Granite

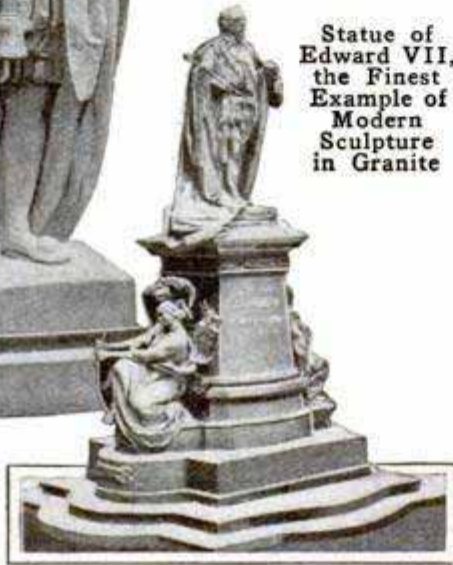

It was the same French airman, Pégoud, who on Aug. 19 made a thrilling drop from an aeroplane in the safety-pack parachute invented by M. Bonnet. With the safety pack secured to the top of his flying machine's tail

AIRMAN FLIES SAFELY

5224 UPSIDE DOWN

By flying upside down in an aeroplane and regaining his original position after describing an S-shaped figure in the air, the French airman Pégoud has proved that the ordinary aeroplane, not fitted with any special device, possesses much greater stability than is generally believed and can usually be righted, if the pilot keeps his presence of mind. Pégoud performed this aerial feat in a Blériot monoplane at Juvisy, France, on Sept. 1, and then repeated it near the Buc aerodrome on Sept. 2, to show that his first performance was not merely a lucky accident. Before rising for the second flight, Pégoud indicated the part of the sky in which he would fly, head downward. Then he rose in a spiral to a height of 3,000 ft. Turning his aeroplane into a vertical position he drove toward the earth like an arrow. When he had descended to an altitude of 1,500 ft. he swung out horizontally, upside down, on the first part of a letter S. For 50 seconds he flew with his head downward and the wheels of his machine pointing up in the air. Then he turned again toward the earth and swung back to a horizontal position with his machine right side up, finishing a huge letter S in the air. An easy spiral brought him to the earth. The flight lasted 10 minutes and the feat was performed with the motor running at quarter speed.

The same feat was performed unintentionally by an English airman, Kent, on Sept. 9. While he was flying at a height of 2,000 ft. near Farnham, Eng., his motor stopped and he lost control of his machine. The aeroplane turned four complete somersaults, but the pilot regained control and righted it in time to make a safe landing in a steep spiral.

It was the same French airman, Pégoud, who on Aug. 19 made a thrilling drop from an aeroplane in the safety-pack parachute invented by M. Bonnet. With the safety pack secured to the top of his flying machine's tail

♣ Toledo recently cut 300 tons, or \$3,600 worth, of hay from unimproved sections of its parks, including 30 acres in Navarre Park and 60 acres in Otawa Park.

and the rope about his shoulders, he flew to a height of 650 ft. over the Chateaufort aviation field. Facing the wind and allowing his machine to

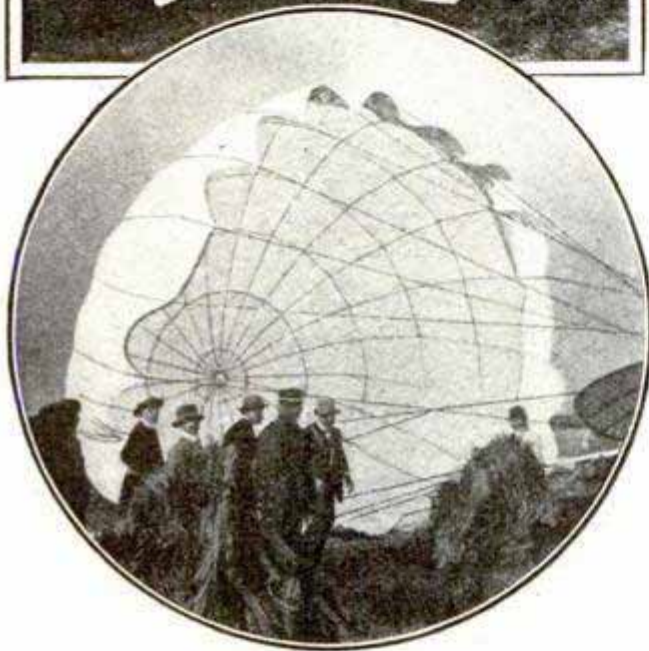
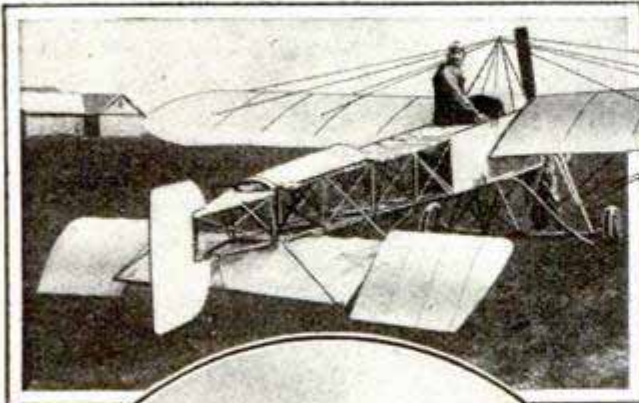

Safety-Pack Parachute in Which Pégoud Dropped 650 Ft. on August 19: During a Flight the Parachute is Packed on the Aeroplane's Tail

slacken speed and drop slightly, he released the parachute and was jerked out of his seat as it opened out. The pilotless aeroplane started ahead and mounted higher than the parachute, then slipped back, recovered its equilibrium, and started ahead again. After repeating this maneuver several times, the machine finally reached the earth without serious damage. The airman, balancing himself in the parachute, floated down and alighted safely in a tree top. A novel feature of this parachute is the method by which it is forced to open, through the explosion of a cartridge, at the instant of release.

CA new process for casting copper is causing cast copper to replace forged copper in much electrical work.

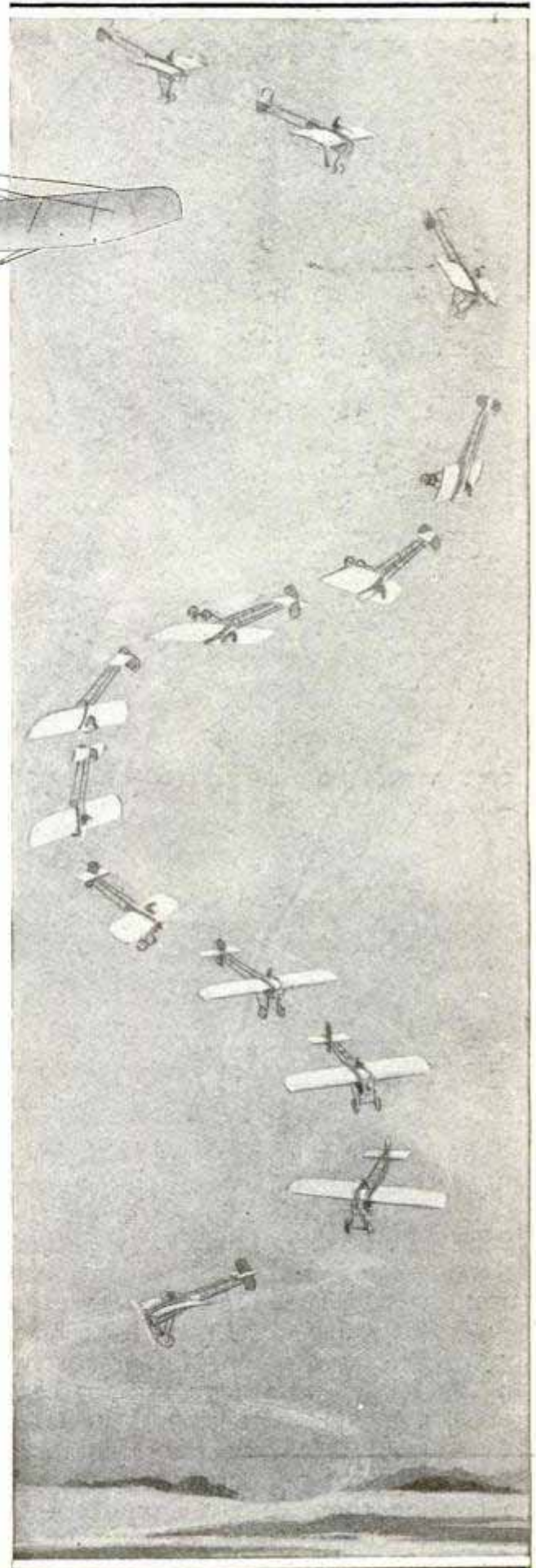

The Path Described by Pégoud While Turning a Somersault in an Aeroplane: On the Horizontal Curve of the S the Pilot Flew Upside Down

not turn around in it. When he is taken out for exercise every day or so, he is carefully watched by an attendant, and from time to time his plumage is carefully washed and dried. The rooster in the picture belongs to a dealer in antiques at the famous mountain resort Miyanoshta, on the island.

MANY ARTESIAN WELLS IN
528 **LONDON** *in date*

Because of the high charge made for water service in London, 52 artesian wells have already been sunk in that city, and this number is likely to



This Rooster, Bred on an Island in Japan, Has Tail Feathers 18 Ft. Long

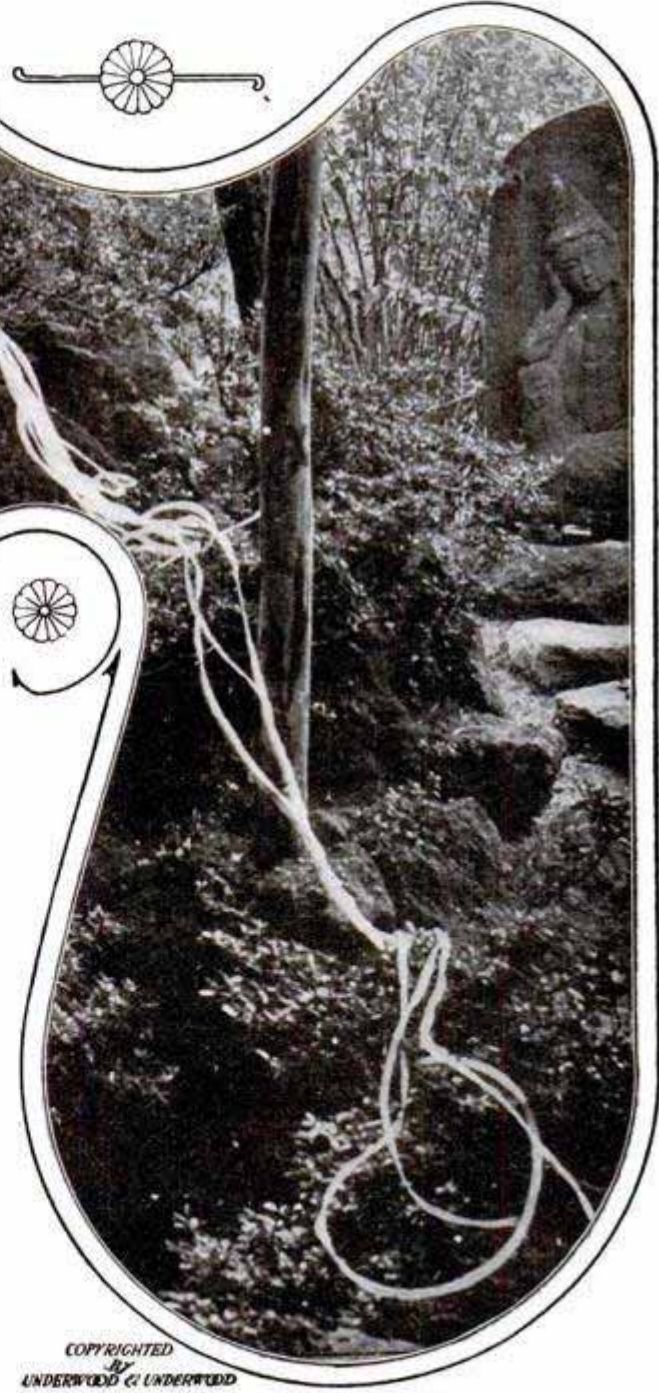

THE LONG-TAILED ROOSTERS
5264 **OF JAPAN**

The breeding of roosters with long tail feathers has long been the pastime of the natives of Shinewara, on the island of Shikoku, Japan. By patient selection of a breed of fowls, continued through 100 years, the tail feathers of the ordinary barnyard cock have been lengthened until some of the roosters on the island now have tail feathers measuring 18 ft. The hens of the same breed have tail feathers only 8 in. long. In breeding the roosters it is necessary to confine them in close quarters so that the feathers cannot wear out or be molted. Through a careful routine, the fowl lives his eight or nine years of life in a cage so narrow that he can-

*Underwood & Underwood
 12-2-23 37-11-27
 new York*

increase greatly in the future, especially since such wells are now included in the specifications for all new buildings over a certain value. It has been thought that some alteration in the water level might result from the increased demand on the water-bearing strata, but so far there is no indication of this.

FRAME HOUSE REPRODUCED IN CONCRETE 4854

Concrete joists, clapboards, window frames, etc., were used in the

CHANGING THE COMPOSITION OF IRON 4993

Castings and forgings of soft iron can be quickly transformed into hard steel by a newly patented electrical process for changing the composition of iron or steel. By the use of an electrical furnace the entire mass of metal or any depth of surface can be hardened and tempered in a few minutes. The old process of changing the composition of iron or steel by cementation is extremely slow; and the more rapid process of casehardening with potassium cyanide, or some other tempering substance, produces only a thin superficial skin of harder metal. Both are faulty because of the difficulty of applying the carbonizing substance while the iron is heated near the melting point. In the new process, the iron or steel is completely inclosed in a hardening mixture in a small furnace and an electrical current passing through it heats it above the welding point so that the change in composition takes place in a few minutes.

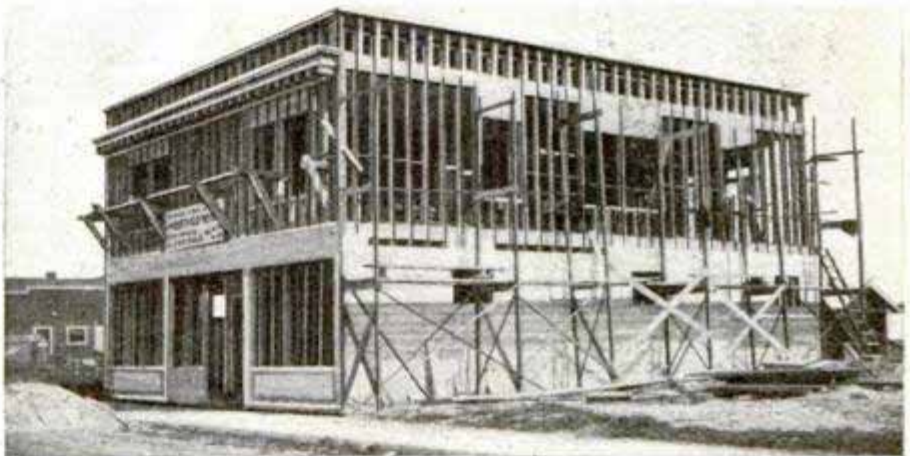
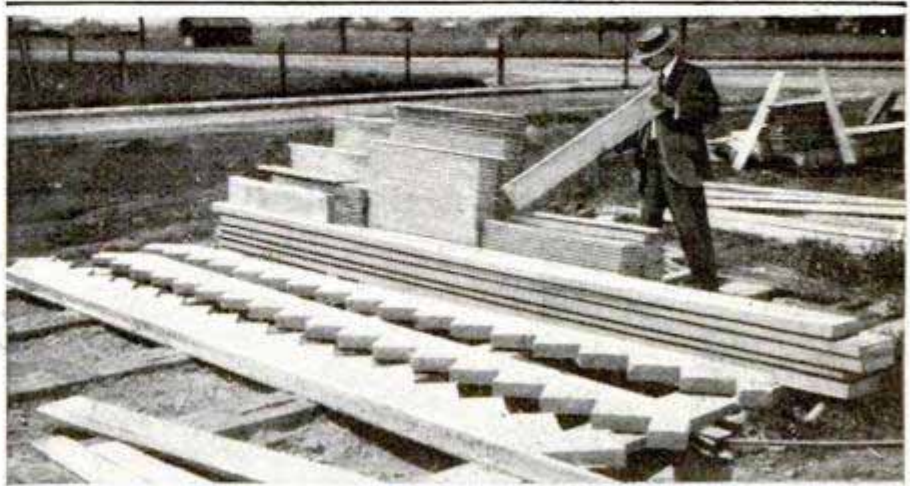

Top View: A Pile of Boards and Timbers Reproduced in Concrete; Center View: A Reinforced-Concrete House Put Together Just Like a Frame Structure Except That All Its Parts are Made of Concrete; Bottom View: Molds for Making Cement Clapboards

construction of a reinforced-concrete house, which was built just like a frame structure, in Los Angeles, Cal., recently. All the parts of a frame house were reproduced in concrete,

at 1,062 r 388
D. W. C. Ford, Chile. Pat. 12/09 471870 (Cl 219-11)

E. R. Ed. ...
4824 ...
St., San Angeles, Calif.

and put together with nails or wire as if made of wood. The joists and timbers, reinforced with twisted iron rods, were fastened together with sockets and pins. Thinner cement boards were strengthened with wire mesh and pro-

vided with nail holes so that they could be nailed to strips of wood wired on the joists. The parts were cast in molds at the building site to save transportation. Much less material was required than for solid poured walls.

**NEW TRAP FOR DESTROYING
5055 MOTHS**

Millions of brown-tail moths were destroyed in Auburn, Me., last July



Traps for Catching and Destroying Brown-Tail Moths

during a two weeks' trial of 45 moth traps of a new design used in connection with arc lights. Each trap consisted of a broad, flat pan with the top

edges turned over inside to keep the moths from crawling out. The pan was half filled with water and placed directly under an arc light. Moths flying about the light were attracted by the mirrorlike reflection of the water, fell into the trap, wet their wings, and could not escape. A night's catch for each of the traps was about two quarts, some 10,000 moths.

**BALL GAME AND CANOE RACE
5144 ON SAME GROUNDS**

A ball ground at Ketchikan, Alaska, is in one way the most remarkable in the world, since it can be used alternately for ball games and canoe races. On one day recently ball games were played early in the morning and late in the afternoon, while during the intervening period, an exciting canoe race was held over the same grounds. The explanation of this seeming paradox is that the grounds are located on the tide flats, and at high tide are completely submerged. *C. R. Fickle*

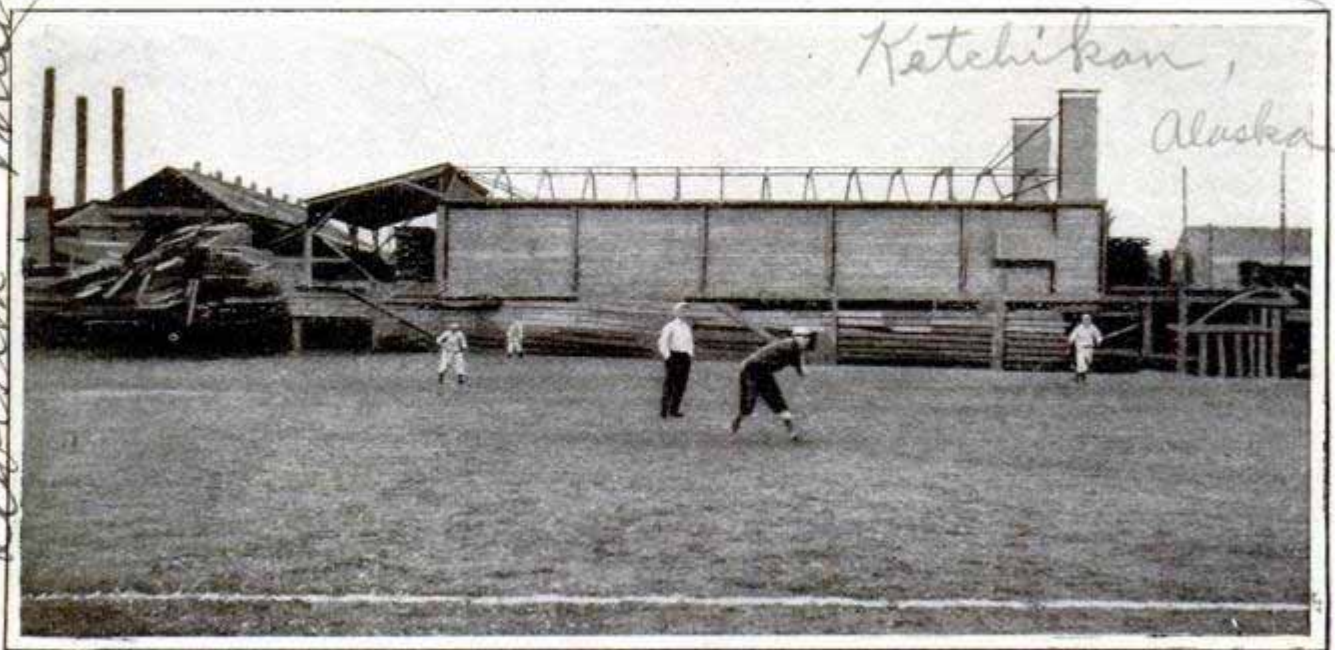

Alaskan Ball Ground Which is Used at High Tide for Canoe Races

180 Sabattus St., Lewiston, Me.
Chas. E. H. Kimball
Lewiston, Me.

Ketchikan, Alaska

COMMENT AND REVIEW

THE world-wide importance of refrigeration and its manifold utilities were presented to public attention when the triennial meeting of the International Association of Refrigeration held its convention in Chicago recently. Every well-known nation was represented, and the delegates who passed through Washington were shown marked attention at both the White House and Department of State.

Growth of Refrigeration

From a limited use in a single industry only a comparatively few years ago, mechanical refrigeration has expanded and developed until it has become one of the great modern necessities. Fruits and food products are carried across oceans and reach their destination in perfect condition; poultry, fish, game and meats are stored during the season of the year when at their best and kept for months and even years, which otherwise could be had during a few weeks only. Our theaters and public dining rooms are cooled even to a degree of discomfort in the hottest weather; towns of moderate size, in places where water never freezes out of doors, now have their dependable daily supply of ice, with the regularity of sunrise and at a price no higher than charged for natural ice in long-winter lands. In modern offices ice water flows from a pipe in every room of tallest skyscrapers, while far below the beds of rivers engineers bore great tunnels through treacherous quicksands, made safe and solid by artificial freezing.

This great engine of beneficence and utility is not in the public eye and mind like the telephone and the electric light, but its loss to the world under present-day conditions of city life would be almost as great a disaster as to be deprived of both. One feature suggesting the tremendous potentiality of the industry was the banquet with which the congress closed its labors. Two thousand plates were spread; 500 waiters served—as many as the entire number regularly employed in cities as large as Cleveland or Minneapolis—and the menu was printed in three languages. Under each dish was given the cold-storage history of the food products used in its preparation, length of time in storage, etc.; for practically everything came out of cold storage. The banquet cost \$20,000.

Surely a long step in progress since the day when mother hung the butter in the well.



BIG business makes in many ways for large economies; at the same time there is such a thing as being so large that fearful wastes occur as a result of size. An interesting example occurred recently which illustrates this.

How Big Business Loses

A certain steamship line, operated in connection with a trunk line of railway, shortened its time to the Orient, and spent thousands of dollars advertising the improvement in daily papers throughout the country. Great quantities of expensive illustrated literature were prepared and sent to all its offices. A gentleman who for some time had contemplated the trip, seeing the announcement, con-

cluded he would go. Accordingly he called at the company's office in Chicago for detailed information. The ticket clerks knew nothing about the change, had not seen the big advertisements in the morning papers, and took no interest in the prospective passenger, whose fare would amount to about \$600 for the round trip. He insisted on a search being made, and the reluctant clerk finally found a circular giving the dates of sailing, which he tossed out with the utmost unconcern. The passenger, an experienced traveler, then called for a printed description of the several ships showing tonnage and the various appointments and conveniences, or lack of them, of each vessel. No, they didn't have anything; but finally the insistent seeker after ocean travel succeeded in having a further search made, which produced an elaborate booklet giving fullest information. Casting this at the passenger, the clerk turned away to avoid further bother from so persistent and annoying a person. But the man examined his literature in vain for the diagram of the cabins, and another tussle resulted before this was found.

As my friend remarked, he believed he could have joined a club, a church or the Army with half the effort he spent trying to become a passenger on one of these ships. Of course somebody, or several of them, had slipped a cog, but how absurd to pour out money in advertising and then fail to have all employes concerned, from the highest to the lowest, instructed in advance, not only of the coming date of the advertising, but schooled in what to say to prospective passengers; for a man seldom makes inquiry at a steamship or railroad office without a fairly definite idea of making a voyage or taking a trip.

Unless he wakes up and changes his methods that young clerk will never get to be an official; in fact, he will not hold his job very long. If he were ambitious he would have seen the advertisement, and, realizing the inevitable result, would have posted himself and been able to promptly answer every question the passenger asked. There are other concerns besides railroad and steamship offices where the young men are asleep at the switch regardless of the fact that the world is full of splendid opportunities for him who is willing to earn and deserve them. All great and successful men became such by application and earnest work, and not by knowing as little as possible about the things they were set to do.



IN contrast to the above incident, one electric corporation has a trouble doctor who is stationed just inside the main entrance, whose sole business it is to smooth out wrinkles. He is keen, discerning and diplomatic, and can tell at a glance whether the customer is leaving in a dissatisfied frame of mind. He must not let anyone depart feeling sore. So far as the company is concerned it is just as unfortunate to let a customer depart thinking he has been misused—even when he has not—as if the company were in the wrong—and often the company finds itself at fault, in which case its policy is to make restitution. In short, corporations are finding it pays them, quite as much as it pays

*The
Trouble
Dispeller*

the individual, to see that its customer as well as itself gets a square deal. And so the trouble doctor diagnoses each case, most of which he can cure with the remedies of his own knowledge, and those aggravated cases which he cannot are taken in to the proper official, who considers no reasonable amount of time wasted in straightening out a tangle. Even the smallest business can adopt this policy; it is not necessary to have an expert specially detailed for the purpose, every one in the place can help; but the man at the head must decide on this policy and live up to it himself before he can get anything of the spirit of a square deal instilled into his employes.



THE New Haven wreck, in which an obsolete signal system and antiquated wooden sleeping cars furnished the reason for such fearful loss of life, cannot fail to shorten the time when those railroads which do not voluntarily remove these risks to human life will be forced by law to provide greater safeguards. Only a few days later, on another road, a passenger train traveling at even faster speed left the track and overturned. Though some of the passengers were injured, no one was killed. The steel cars withstood the shock.

*Standard
Freight
Cars*

While the wreck of freight trains involves a much smaller loss of life and usually money, the losses from this source run into millions of dollars yearly. President Ripley, of the Santa Fe, in a recent article discusses a condition which has not occurred to the layman. As we all know, under the system of interchange of cars in this country, one almost never sees a freight train composed entirely, or even largely, of cars belonging to the road over which it is running. On the contrary, a long passing freight is a kaleidoscope of names and initials of railroads located in almost every state, with cars built by numerous builders; a confusing collection of cars of various sizes, types and age. Under our system of through shipments this is inevitable, and, no matter how careful any one road may be to maintain its own rolling stock in a condition of efficiency and safety, there is the constant danger of a decrepit car from some other line breaking down and causing a wreck. Under the Interstate Commerce regulations this has been safeguarded to some extent by heavy-penalty regulations which require each road to inspect every car received from another before accepting it. If in bad order in certain parts, it must be repaired before proceeding.

This helps some, but, as Mr. Ripley states, there are essentials which no eye can measure. Who can see into a wheel or car axle, for instance, and discern the crystallization which means a break at the first unusual strain or shock? Some roads, short of both money and cars, when in the market for new equipment, naturally get the largest number of cars they can for the funds available. It is self-evident that \$1,200 will build a better car than \$800, yet each is expected to carry the same load. The railroads have been having an anxious time of late years, and it is impossible to throw away the hundreds of thousands of cars which must fall below a certain desirable standard.

The traffic of the country would be blocked. It does seem possible, however, to decide on a certain standard for each type of freight car, and thereafter to require all new cars to be built in accordance. At present each car builder has certain features of his own which differ from the other builders. This largely and unnecessarily increases the cost of repairs, on account of the great variety of parts which must be kept on hand.

Mr. Ripley says: "I suggest a standard car uniform in all essential details, to be arrived at by agreement, if possible—arbitration, if necessary. If in addition we could establish a freight-car pool, or an equipment company, the stock of which should all be owned by the railroads, so much the better."



THE very practical and successful demonstration made by Warden Tynan, of Colorado, of using his better class of convicts for road building, under an honor system in which the men work without guards is beginning to bear fruit. Illinois is trying the plan in a small way, with about 40 convicts, who are improving a road near Dixon. Here also the men are placed upon their honor, and a liberal reduction in their term has been promised by the governor to those who make good. The men fully appreciate the outdoor life and would gladly accept the work if for no other reason. It will be interesting to watch the result of this experiment, because it is being conducted near a city. Warden Tynan purposely took his men—a much larger number—far away from the temptations of town or city.

*Convict-
Built
Roads*

So far the scheme is working satisfactorily, although a condition that the Colorado warden feared arose. Naturally considerable interest was aroused, and numerous visitors came out from town to watch the men at work. Some sentimental citizens thereupon planned automobile rides and a theater party for the convicts. Governor Dunne immediately and very properly issued orders that nothing of the sort be permitted. There is a decided difference between allowing a convict to indulge in outdoor work under conditions calculated to make a man of him again and silly sentiment that would set him on a pedestal. A prison sentence should not be revengeful; it should be reformatory; but reform will not be secured by pink teas. The very object which is aimed at may easily be defeated by what is intended for sympathy. The dignity of the law and the respect for it which the prison sentence contemplates cannot be best attained by rapid steps. It is right and proper that the convicts have reasonable recreation, but let the entertainment be brought to them and not they taken to it. Governor Dunne's prompt and firm orders in this matter are for the good of the men themselves, for a too generous letting down of the bars is likely to deter other states from giving the plan a trial, and every state should use as many convicts as possible in road working. But to make light of a prison sentence would be a very grave mistake.

H. H. WINDSOR

PALACE OF PEACE AT THE HAGUE DEDICATED

5341

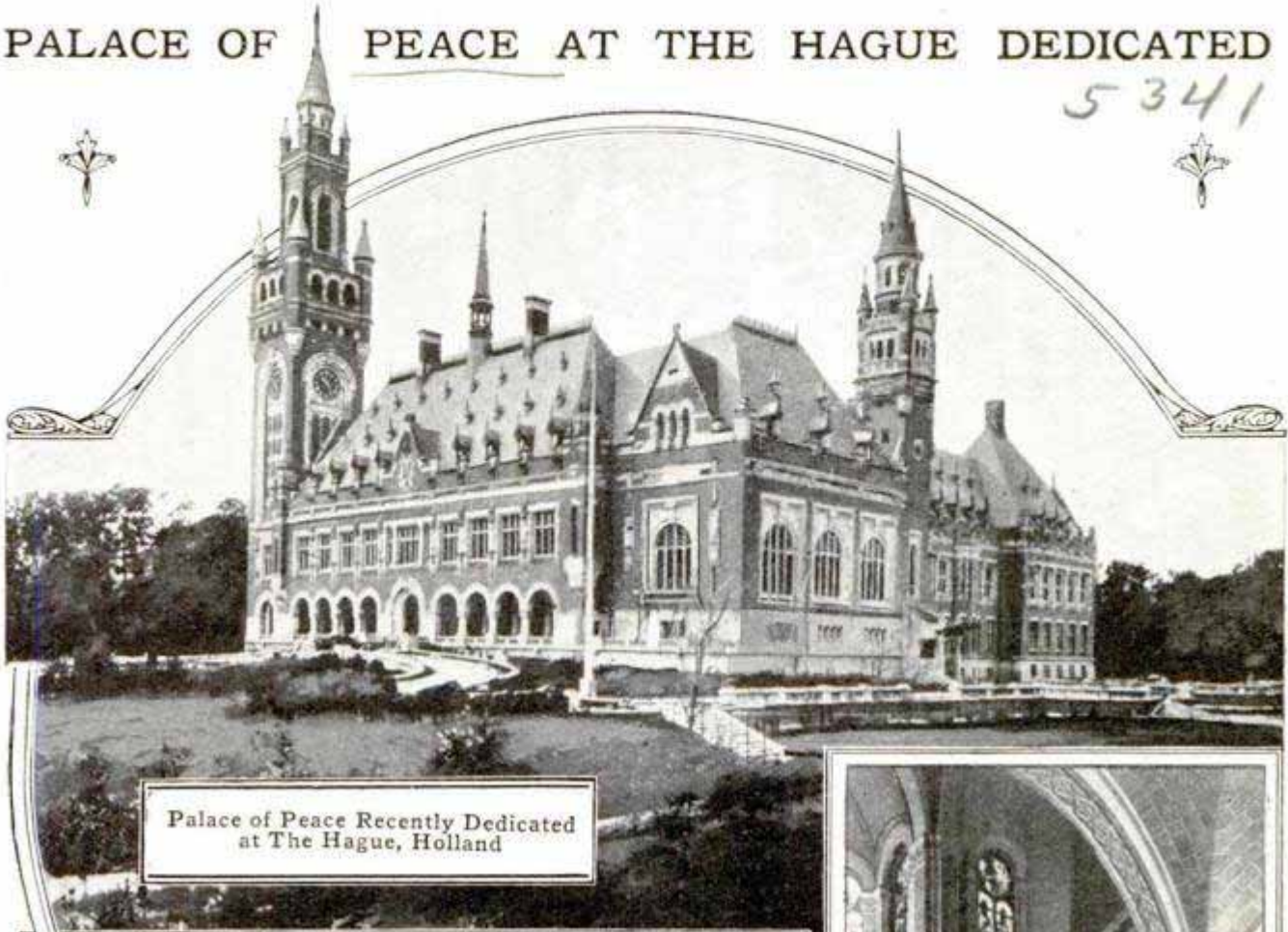

Palace of Peace Recently Dedicated
at The Hague, Holland

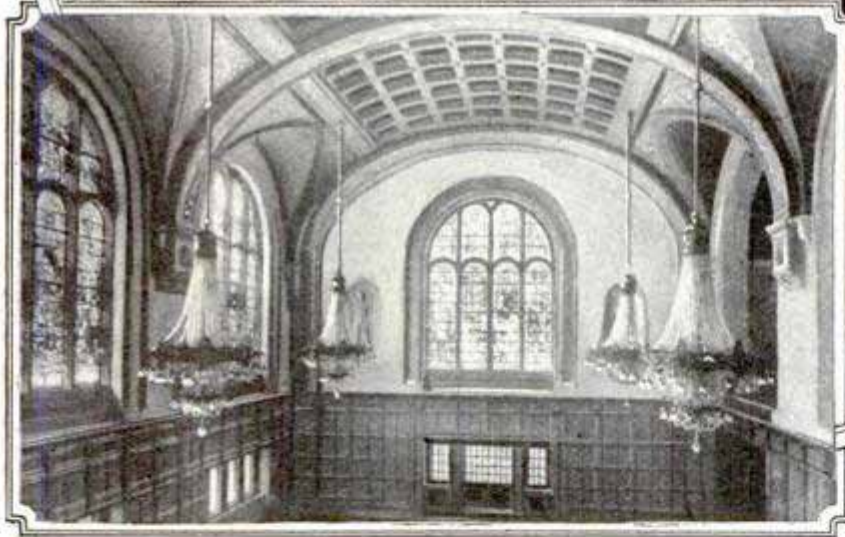

Great Hall of the Palace of Peace, Showing Stained-Glass
Windows Contributed by Great Britain



Stairway at the Main Entrance
to the Palace of Peace

The Palace of Peace, the biggest of the world's monuments to progress, was dedicated at The Hague on Aug. 28, 1913. The provision of a permanent home for the International Peace Conference, which had its beginning in a suggestion of Nicholas II of Russia in 1899, is due to the generosity of Andrew Carnegie, who, in 1903, donated £500,000, equivalent to nearly \$2,500,000, for the construction of the building. The building was erected

from the plans of L. M. Cordonnier, a French architect, following an international competition, held in 1911. The occasion for the dedication of the building was the twentieth Peace Conference, which was attended by 950 delegates representing all the civilized nations of the world.

Although this building was made possible by the fund donated by Mr. Carnegie, many of the leading nations contributed liberally to the construc-

Edwin Lewis

tion, and particularly to the decoration. Great Britain contributed the stained-glass windows, while France contributed tapestries. Granite was contributed by Denmark, Norway, and Sweden, and marble by Greece and Italy. Belgium furnished the forged iron and several of the South American countries sent costly woods, while sculpture was sent by the United States, embroideries by Japan, and

paintings by Holland. The result is that the building is not only as good structurally as it can be made, but is beautifully decorated throughout. The Peace Conference is not confined to the settlement of international disputes, as is commonly supposed, but covers the widest field, devoting much of its time to such questions as the laws and customs of war and the rights and duties of neutrals in time of war.

5431 **TRAIN DESTROYED BY
BURNING BRIDGE**

While running at a speed of 53 miles an hour, and immediately after rounding a curve that prevented the engineer from seeing the danger, a limited train, bound from the Pacific coast to Chicago, ran into a burning bridge a few miles south of Winona, Minn. Owing to the fact that the bridge was only partly burned, the locomotive and baggage car passed over safely, but the first car behind the baggage car was derailed. The train immediately caught fire from the burning bridge with the result that five of the coaches were destroyed. The locomotive

and baggage car were safely out of the fire, and the three rear coaches were saved only with the greatest difficulty. It is said that the financial loss to the railroad company will exceed a quarter of a million dollars. The remarkable feature about this unusual accident was that no one was killed, although several of the passengers were severely injured.

Chemical experiments have brought out the fact that sagebrush contains rubber, alcohol, and acetic acid, and efforts are being made to discover some system of treatment for extracting these constituents, and particularly rubber, in profitable quantities.

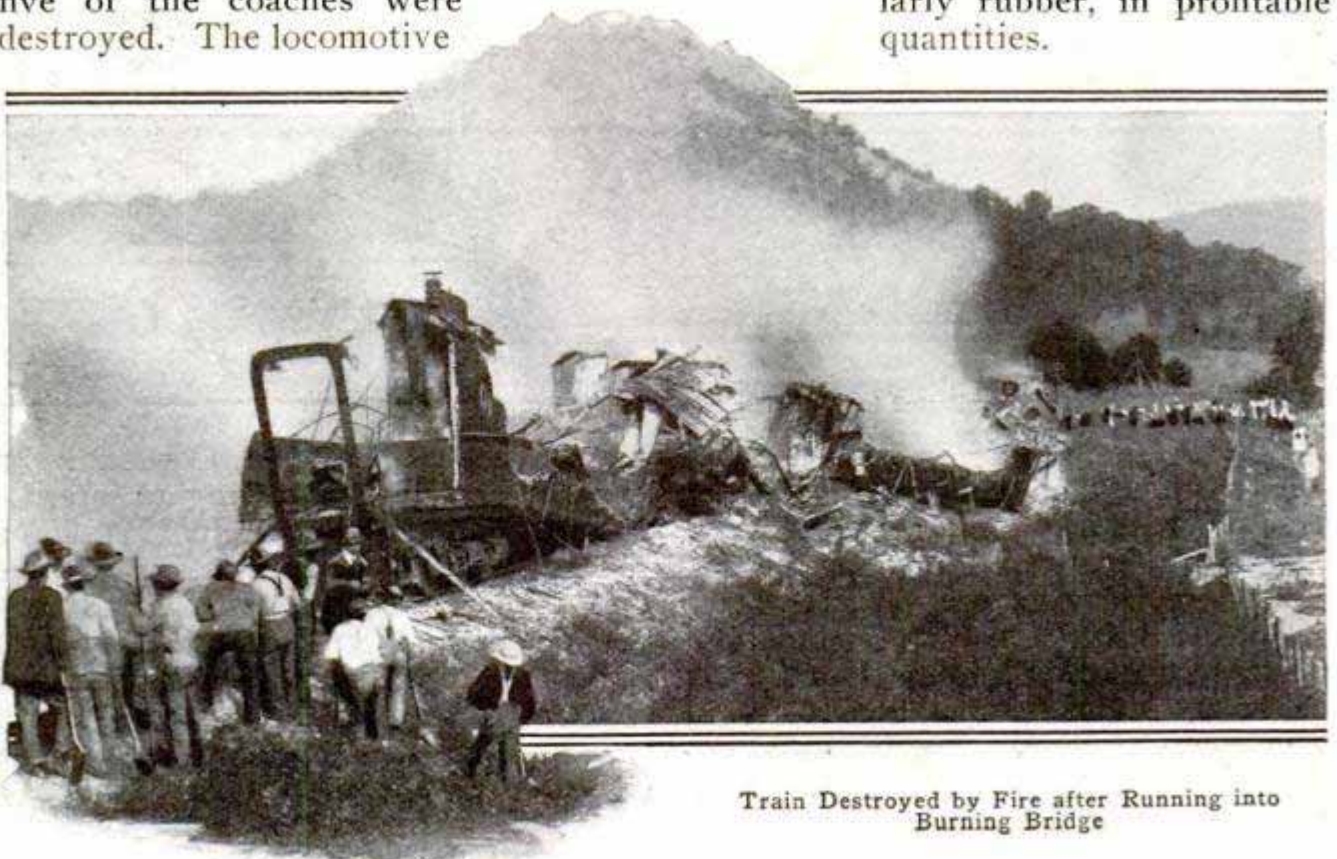

Train Destroyed by Fire after Running into Burning Bridge

AIRMAN FLIES ACROSS THE 5444 MEDITERRANEAN SEA

The world's record for oversea flying was broken by the French airman Garros on Sept. 23, 1913, when he flew across the Mediterranean Sea from St. Raphael, France, to Bizerta, the most northerly port of Tunis. The distance in a straight line between these two points is 484 miles, and the time consumed in making the flight was 7 hours 53 minutes, the airman leaving St. Raphael at 5:52 in the morning and arriving at Bizerta at 1:45 in the afternoon. Garros refused to accept the advice of other airmen that he should affix floats to his aeroplane as a precaution in case he was forced to descend to the water, and also declined the offer made by the French naval authorities to station torpedo-boat destroyers at intervals along the route. The flight is regarded by airmen and military authorities as one of the most remarkable ever made.

MACHINERY HALL LAST OF 5454 ITS CLASS

Machinery Hall, now being built for the Panama-Pacific Exposition, with a floor space of more than eight acres, and an extreme height of 135 ft., will not be constructed of steel and concrete, but of timber! The engineers found that the forests of the coast offered satisfactory lumber at low cost and decided that the vast monumental structure should be built of native timber. Over 7,500,000 ft. of lumber will enter into its construction, and it is more than probable that this will be the last great building in which wood will constitute the constructive material.

SEMAPHORE FOR REGULATING 5409 STREET TRAFFIC

A semaphore signal is being tried successfully in Philadelphia as a substitute for the policeman's whistle in regulating traffic at street crossings. The policeman stands at the base of

the semaphore and halts or starts traffic simply by pulling a lever. The word "closed" painted on the arm can

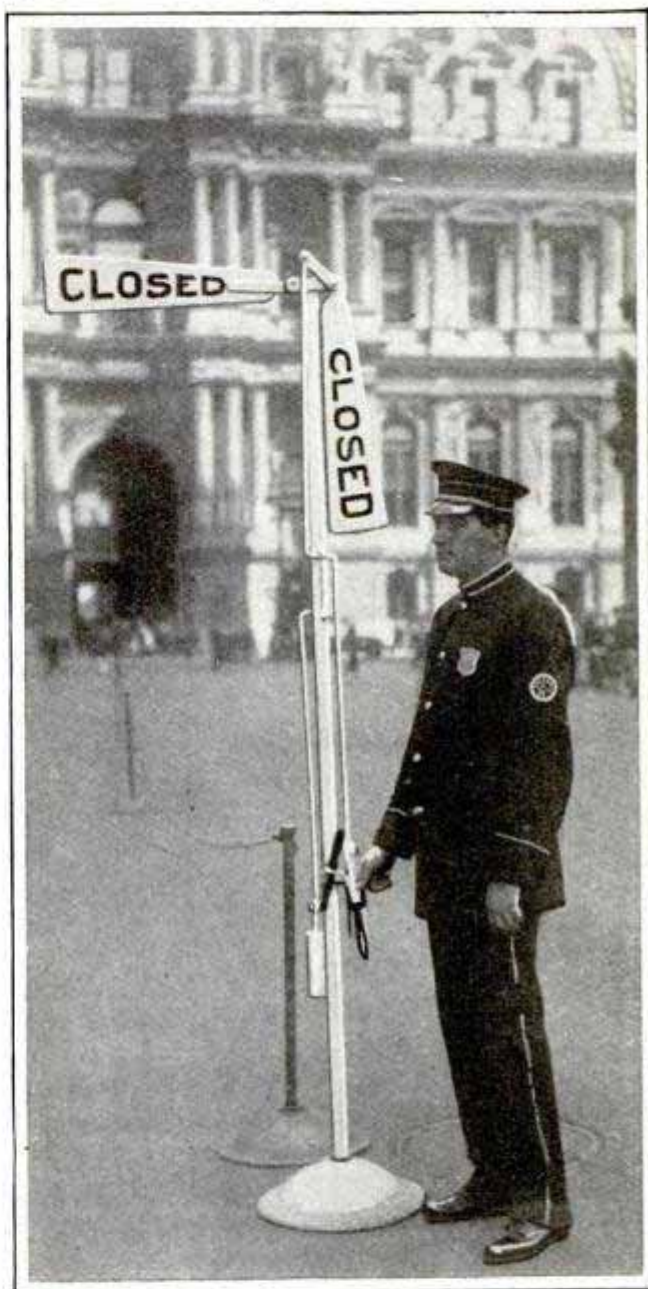

Officer Controls Traffic by Pulling Lever, Which Raises or Lowers Signal Arm

be seen a block away, and the policeman is relieved of the duty of watching individual drivers to see if his signal is understood, as is always necessary when the whistle signal is used.

ⒸThe United States superdreadnought No. 39, to be built at the Brooklyn navy yard, will have a displacement of over 31,000 tons and will be one of the most powerful battleships in the world. The ship will eventually be named after one of the states, probably North Carolina or New Mexico.

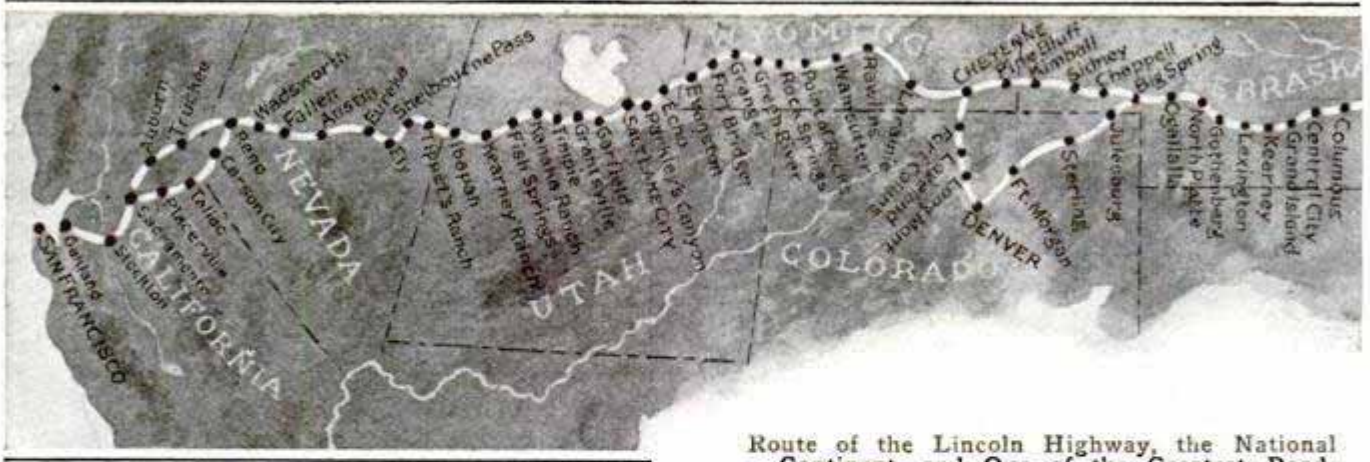

Route of the Lincoln Highway, the National Continent, and One of the Greatest Road-

4844

LINCOLN HIGHWAY FOLLOWS HISTORIC TRAILS

Construction work is soon to begin on the greatest road-building project ever attempted since the time when the Caesars, in building the highways which are still the main thoroughfares of Europe, gave rise to the saying that "All roads lead to Rome." The modern counterpart of these ancient roads is the Lincoln Highway, a national thoroughfare that will extend 3,100 miles across the American continent from New York to San Francisco. Unlike the Roman roads, which were a manifestation of imperial power, the Lincoln Highway is the result of a popular movement and is to be built by popular subscription. After over a year of careful investigation and after numerous conferences with the officials of the different states that the highway is to pass through, the route has been definitely decided on, while, of the \$10,000,000 needed for carrying out the work, over \$4,000,000 has already been subscribed. Twelve states will be crossed by this highway which is to serve to future generations as a fitting memorial to the martyred president whose name it bears.

Although the general route of the highway has been known for some time, the exact location through the different states, owing largely to the rival claims of local communities, furnished a big problem, and has only recently been determined. In each case the final decision was made mainly on the basis of directness of route, but with due regard to scenic and historic in-

terest. Starting at New York City the highway runs in as direct a route as is practicable through the states of New Jersey, Pennsylvania, Ohio, Indiana, Illinois, Iowa, Nebraska, Wyoming, Colorado, Utah, Nevada, and California, to the western terminus at San Francisco. West of the Mississippi a large part of the route lies over the historic Overland Trail. At two points, one in eastern Colorado and the other on the west border of Nevada, the highway will comprise two separate routes. In the first instance the object was to include Denver, which lies off the direct route, on the highway, and a branch was therefore planned to run from Big Spring, Nebraska, through that city and to a connection with the main highway at Cheyenne, Wyo. At Reno, Nev., the highway again divides, one route running north and the other south of Lake Tahoe to a connection at Sacramento, Cal.

There is to be little or no opening of new roads, the whole route being laid out with the idea of connecting a series of local highways into one great transcontinental highway, but it is estimated that on about 2,000 miles of the route it will be necessary to carry out extensive improvements and in some cases complete reconstruction. Such work will be done in cooperation with local communities, which will be asked to bear a fair portion of the expense. Several of the states, including Illinois and Ohio, have agreed to divert a large proportion of their annual

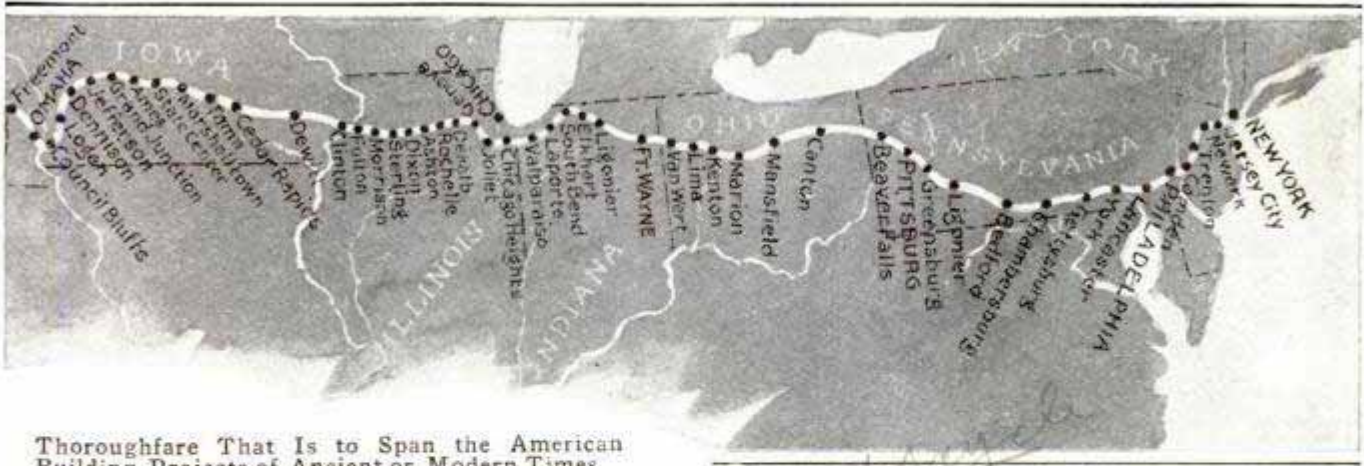

Thoroughfare That Is to Span the American Building Projects of Ancient or Modern Times

road appropriation to the counties along the route. Existing highways that have been improved will be used as they are, provided their condition and type of construction meet with the approval of the engineers of the Lincoln Highway Association, who will consider permanency as well as other important details. The specifications of the association provide for roads of concrete construction, patterned after the concrete roads of Wayne County, Mich., which are said to be the finest in the United States. In any case where the association bears a portion of the expense of improving or rebuilding a road these specifications will be insisted upon, with the ultimate purpose of securing permanent concrete construction from end to end of the highway, excepting sections where a natural rock floor makes such construction unnecessary.

Of the fund already pledged, a large part comes from automobile and cement companies, while the citizens of one city alone, in Indiana, have pledged \$7,500. In addition to this, over one hundred business concerns between New York and San Francisco have each agreed to contribute an amount equal to one-third of one per cent of their gross sales for three years. The remainder of the fund, about \$5,000,000, is being raised by popular subscription. The treasurer of the Lincoln Highway Association is Emory W. Clark, President of the First National Bank of Detroit, to whom contributions may be sent. Membership certificates are furnished to contributors.

SIDECAR HOOD FOR STORMY WEATHER 5194

Sidecar hoods with celluloid windows in front are coming into use in England to protect sidecar passengers from rain. The hood is three-sided and extends down to the shoulders, forming a waterproof covering for the



Storm Hood with Celluloid Front for Sidecar Passengers

head. The square celluloid window in front is held away from the passenger's face by guy ropes running down to the footboard, and the back is open for fresh air. The hoods are designed to be used in conjunction with a storm apron which has a hole for the passenger's head and covers the whole sidecar. In some cases the storm hood

Vertical handwritten text:
 7-1-1913

8/30/13

Fireman's Hand

is sewed upon a second apron that covers the usual storm apron. When not in use, the hood and apron are stowed under the sidecar seat.

A WOODEN WATER TANK

5202 THAT BURST

Rusty hoops caused the bursting of a large water tank in Calmar, Iowa, not long ago. The tank was used in connection with the city's water supply and had a capacity of 60,000 gal. The hoops had become rusty and badly weak-

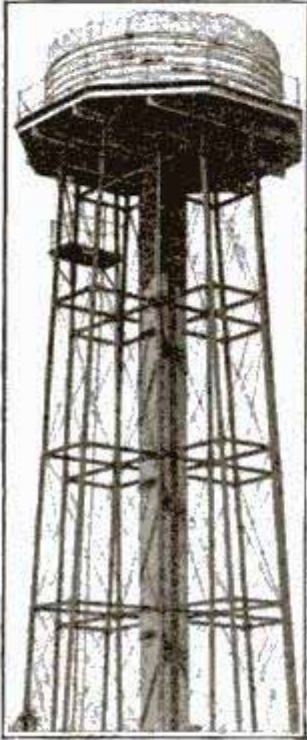

The Lower Part of the Tank Was Unbroken and is Still in Service

ened during its 17 years of service and were being replaced, but before the repairing had proceeded more than a few feet from the bottom, the upper part of the tank burst. The new hoops kept the lower end of the tank water-tight and, after the wrecked upper portion had been cleared away, the sawed-off stub was kept in service. The tank was 20 ft. high, 24 ft. in diameter, and built of $2\frac{3}{4}$ -in. staves. It stood on a steel tower 80 ft. above the ground.

☞ Direction signs for aviators are to be painted on the roofs of gasometers throughout France.



City Water Tank Which Burst Because of Rusted Hoops

STANDPIPE MAKES FIRE

5278 FIGHTING SAFE

An ingenious standpipe that relieves the fireman of the dangerous duty of entering a building to carry the hose to a burning room has been invented and has proved efficient in practical tests. The building in which the test was made is a five-story structure and the standpipe is placed in the center. At each floor is a valve with a $1\frac{1}{8}$ -in. opening, controlled by a lever at the base of the standpipe on the main floor of the building. In case of a fire, the firemen first attach the engine hose by means of a valve at the base of the standpipe. If the fire is on the third floor the valve on the third floor is opened by pulling the corresponding lever, and the engine is started pumping. Each valve is so made that the force of the water causes it to revolve and throw the water in every direction, and in this way has some of the merits of a sprinkler system. The standpipe may also be connected to a water tank on the roof to insure immediate action before the arrival of the fire department.

OAKLAND'S NEW PRISON IS

5388 UP IN THE AIR

Modern penology has largely banished the dark underground cells and gloomy dungeons, except in backward communities, as a place for holding offenders. But the city of Oakland, Cal., has stepped at once into the front rank of up-to-date cities by placing the city prison on the top floor of its beautiful new municipal building, nearly 300 ft. above the street. Here, in sanitary, light and well ventilated quarters the city's prisoners are held in safety, and that criminal must be beyond redemption whose soul is not softened by the view from the windows. The new municipal building rises 14 stories and is visible from points in seven counties. Standing on the upper observation platforms one can observe on a clear day nineteen cities and towns.

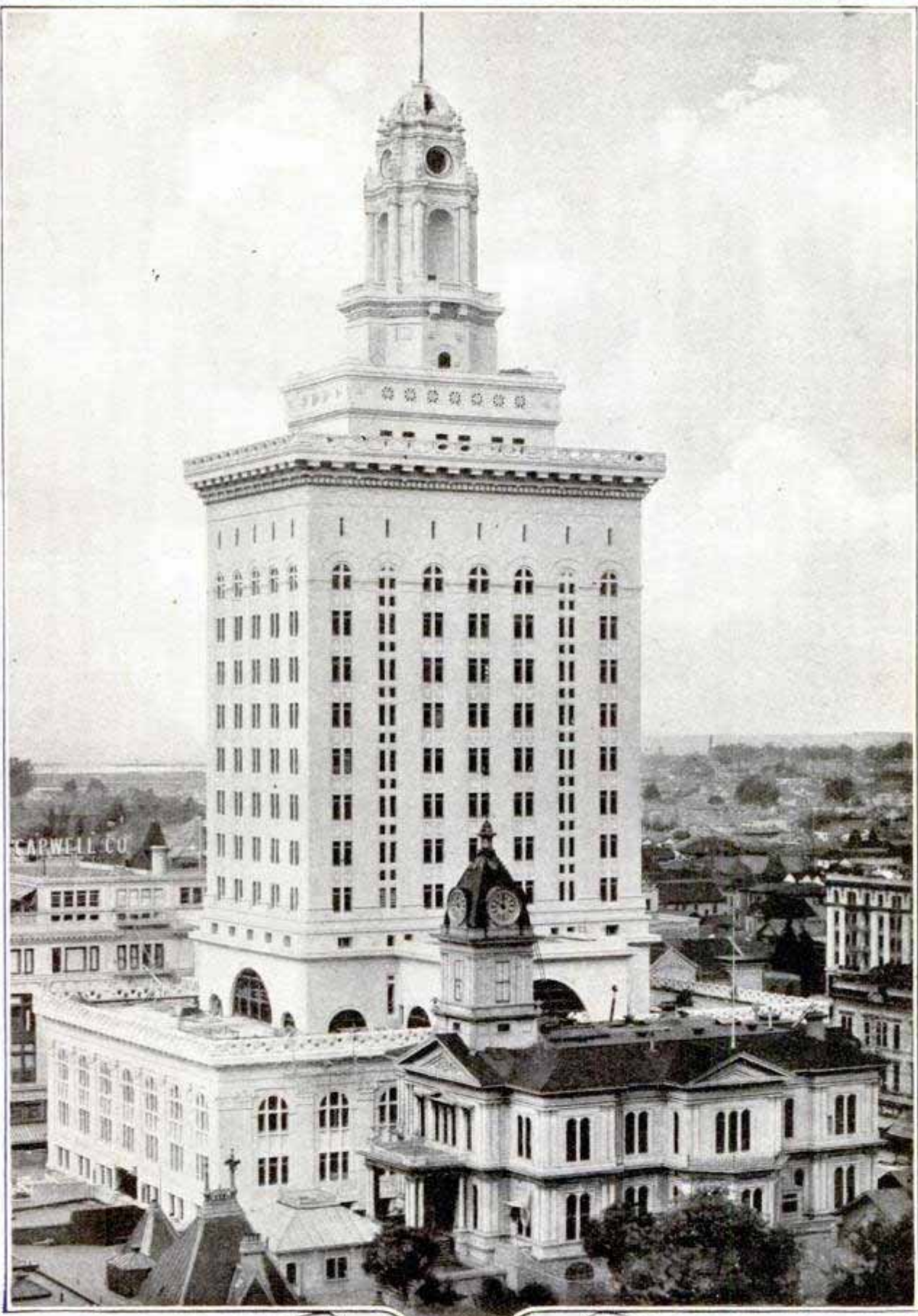

View of Oakland's New Municipal Building, on Top Floor of Which
is Placed the City Prison

CORN STALK AS TALL AS

5407 THREE MEN

The tallest corn ever grown in Illinois was raised last summer on a farm near Downer's Grove. It reached an

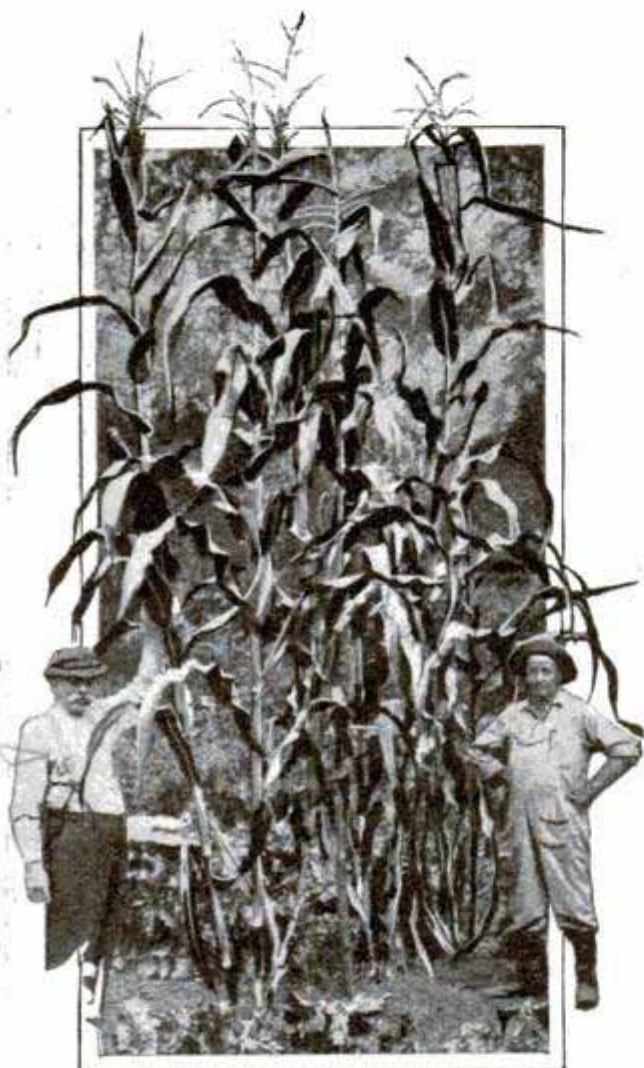

This Corn Is 17 Ft. 2 In. High and Bears About 40 Ears to the Stalk

average height of 17 ft. 2 in., and carried about 40 ears to the stalk. The corn was grown from seed furnished by the government experiment station at a price of 25 cents a kernel. It was Indian corn unearthed in an old Indian mound in Southern Colorado.

THE FIRST OIL-BURNING

5249 SUPERDREADNOUGHT

The first oil-burning superdreadnought in the world will be launched this fall. It is the "Queen Elizabeth," one of the five latest battleships of the British navy, which are to be "oil only." The new battleship is being

built without any coal bunkers and will carry the oil fuel for her furnaces in a sealed double bottom. The furnaces will receive the oil in the form of a thick spray at great pressure and intense heat. She will have funnels like coal-burning battleships, but the space occupied by bunkers for 3,000 tons of coal is given over to more cabin room. The chief advantage of oil fuel for battleships is that a vessel can go 40 per cent farther on oil than on the same weight of coal, and liquid fuel can be transferred by hoses from a tank steamer in much less time than the bunkers can be replenished from a collier. Smoke is also practically eliminated, and stoking and trimming are unnecessary.

BIRD CAUGHT IN A PIECE

5335 OF BREAD

A hard bun, combined with a hearty appetite, made a trap that caught an English sparrow not long ago in Washington, D. C. The sparrow found the bun on the White House grounds and liked it so well that it ate its way in one side and out of the other. By the time it had eaten its way halfway through the bun the bird had swelled up so much that it could not back out and evidently concluded that the only thing to do was to eat its way out the other side. The sparrow had succeeded in gorging itself enough to get its head out when a park policeman found it.

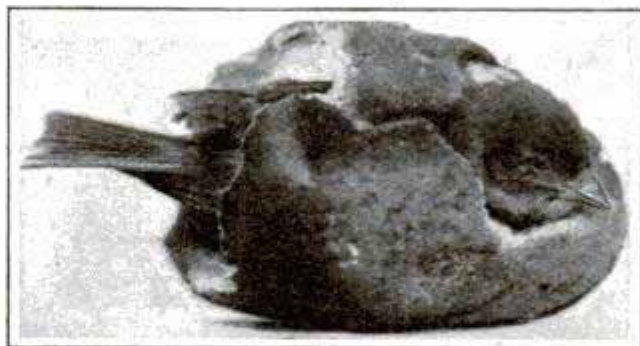

A Sparrow Trapped in a Bun While Trying to Eat Its Way Through

But its appetite was not gone. When the bun was broken open, it fluttered about for a moment and then flew away to join its friends in a feast of peanut crumbs stolen from the squirrels.

Vertical handwritten notes on the left margin, including "W. W. Copple", "422 So. Dearborn", "Chicago", and "7. Edg. in the".

Vertical handwritten notes at the bottom right, including "Louis" and "P. Brown".

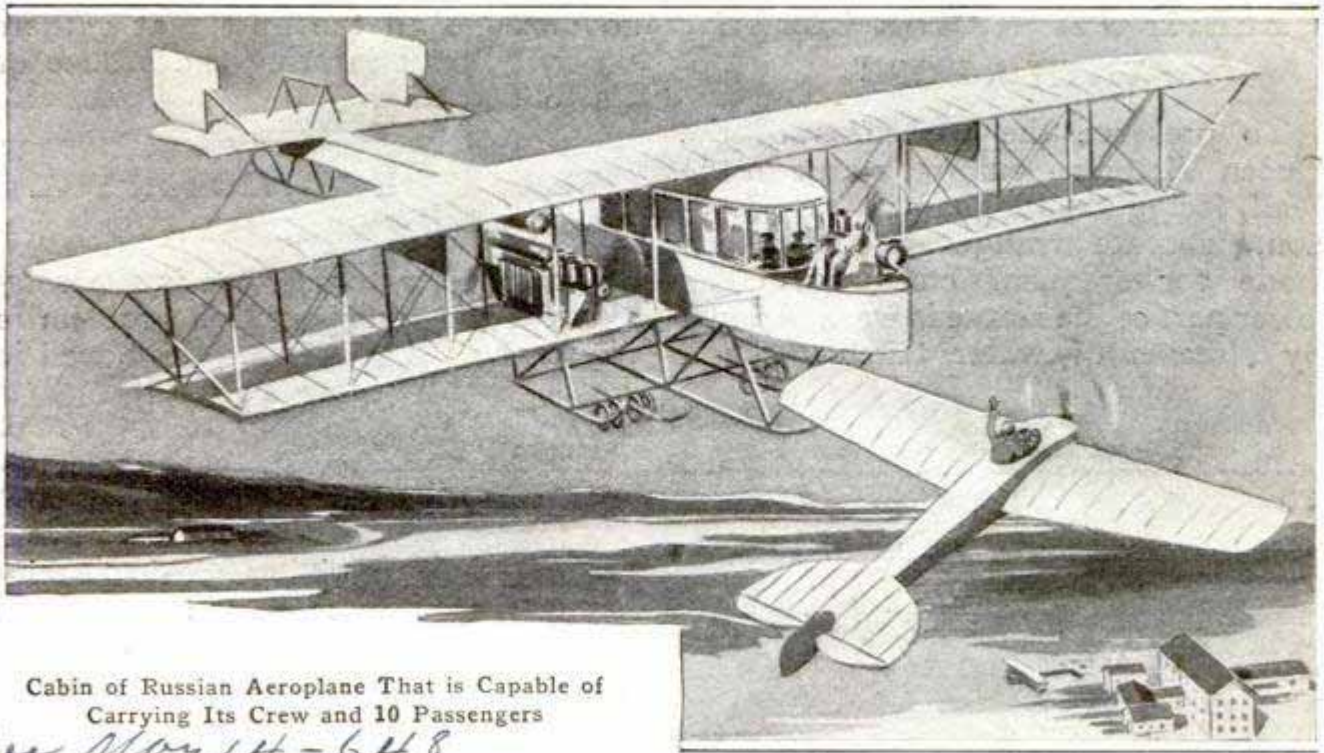

Cabin of Russian Aeroplane That is Capable of Carrying Its Crew and 10 Passengers

See May 14 - 648

RUSSIAN BIPLANE LARGEST 5063 EVER MADE

An aeroplane so large and powerful that the first accounts of its size and performance were disbelieved by the experts has been making a series of remarkable flights in the vicinity of St. Petersburg, Russia, during the past summer. This enormous machine is a biplane of a peculiar type, and its upper plane is much longer than the lower. The upper plane has a span of $88\frac{1}{2}$ ft. and a surface of 1,400 sq. ft., while the total weight of the aeroplane is 6,600 lb. It is capable of carrying, besides its crew and 10 passengers, enough fuel for a flight of 20 hours, and an additional load of 1,760 lb. Four 100-hp. motors which drive four propellers furnish the motive power, the motors being of the tractor type, placed two on each side of the cabin and supported on the lower plane. One of the remarkable features of this craft is the cabin, which provides ample room for 10 passengers and the crew, and is entirely inclosed by glass windows. At the front of the cabin is an inclosed space large enough for two pilots and equipped with duplicate steering and controlling apparatus, while forward of this is an open platform for the lookout. At the rear of the cabin is a space

for the storage of provisions and tools. The framework of the machine is of wood.

This aeroplane can fly with two of the engines out of commission, giving the mechanic an opportunity to examine the machinery and make repairs if necessary while the machine is in flight. In one flight a speed of over 84 miles an hour was made. During a recent flight, lasting two hours and made at a mean height of 1,650 ft., the passengers moved about freely in the cabin and even went out to the lookout platform without disturbing the balance of the machine. Some Russian airmen see in this craft a formidable rival, if not a successor, to the dirigible balloon.

ANNOUNCES X-RAYS ARE RAYS OF LIGHT 5449

Announcement was made at the Birmingham meeting of the British Association for the Advancement of Science that X-rays are the most extreme rays of light in the ultraviolet end of the spectrum. The velocity is the same as light, and the spectral distribution was found to be uniform like fluorescence, and the absorption was found to follow a definite law for all substances.

KEEPING A STATUE CLEAN

5206 WITH A HOSE

To preserve the whiteness of the Queen Victoria memorial statue in the Mall, facing Buckingham Palace, London, elaborate arrangements have been made for frequent cleanings. The lower part of the statue is washed down by streams of water taken through

to dislodge all the dust that gathers on it, without injuring the bronze or its gold coating.

ELEVATOR SERVICE IN THE
5244 NEW SKYSCRAPERS

Graded elevator service is the solution for the transportation problem in skyscrapers that is being developed in

New York City. In a building of 35 to 40 stories, with a work-day population of 8,000 to 10,000 persons, all arriving within 15 minutes of the same time in the morning and departing together in the evening, the elevators must be arranged so as to take each person to his floor, whether it is the 6th or 26th, in the same length of time and with a wait of not more than 30 seconds for a car. To do this, the elevators are divided into groups, each group serving a certain number of floors and running at different speeds. In a 36-story building now under construction, there are to be 48 elevators, divided into six groups of eight elevators each, to handle the 8,300 occupants. One group serves 10 floors, from the 2d to the 11th; another serves the 12th to the 18th; another, the 19th to the 24th; another,



Courtesy of the Graphic

Apparatus That is Used to Clean the Victoria Memorial Monument, London

standpipes and flexible hose from a water main which encircles the entire monument. To reach the gilt figure of Victory on top, 80 ft. above the ground, a special pump driven by an electric motor has been installed. It will throw 100 gal. a minute to the top of the monument with sufficient force

the 25th to the 30th; another, the 31st to the 36th. The last group is auxiliary, carrying passengers to all floors and the roof. The number of floors served and the size of the cars decrease toward the top of the building where greater speed is required. All cars run on schedule and every car

The Graphic
8/2/13

Scientific

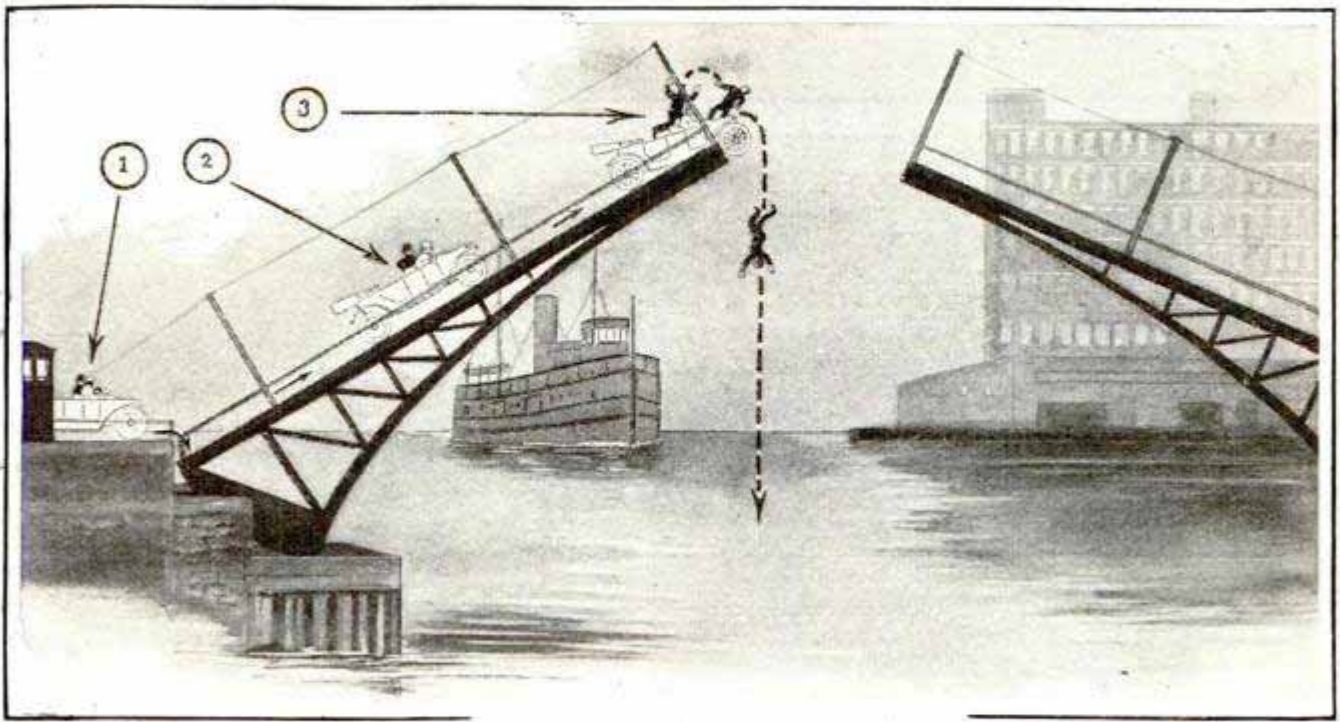

Automobile Hanging by Its Front Wheels on the Edge of a Bascule Bridge After Climbing the Incline While the Bridge was Opening

in the building makes a round trip from the ground to its own floors in the same number of seconds. To increase the amount of office space, each elevator shaft has doors only on the floors that it is intended to serve. Intercommunicating doors in the sides of the cars release passengers if a car is stuck in the shaft. Besides the passenger service, elevators have to be installed to handle 50 tons of coal and 12 to 15 tons of ashes each day.

5296 **AUTOMOBILE CLIMBS OPEN BASCULE BRIDGE**

Perched on the end of one leaf of a Chicago bascule bridge after a dash up the steep incline as the bridge opened, a heavy automobile not long ago hung by its front wheels until the bridge could be lowered. One of its occupants was thrown from his seat by the sudden stop high in the air and was drowned in the river. The driver had not noticed the warning bell and red lights as he approached the bridge at a high rate of speed late at night, and did not realize that the bridge was opening until his machine had started to climb the rising incline. While he struggled with the brakes, the car mounted to the end, 30 ft. above the

river, and stopped with its front wheels hanging over the edge. The bridge tenders reversed the machinery and lowered the bridge slowly so that the car kept its position until it was brought down with its front wheels on one leaf and its rear wheels on the other.

SLIDING BED FOR OUTDOOR SLEEPING 5161

Outdoor and indoor sleeping in the same bed are made possible by a sliding bed which a resident of Tropic, Cal., has built in his bungalow. The



Outdoor Bed Which Slides through a Hole in the Side of the Bungalow

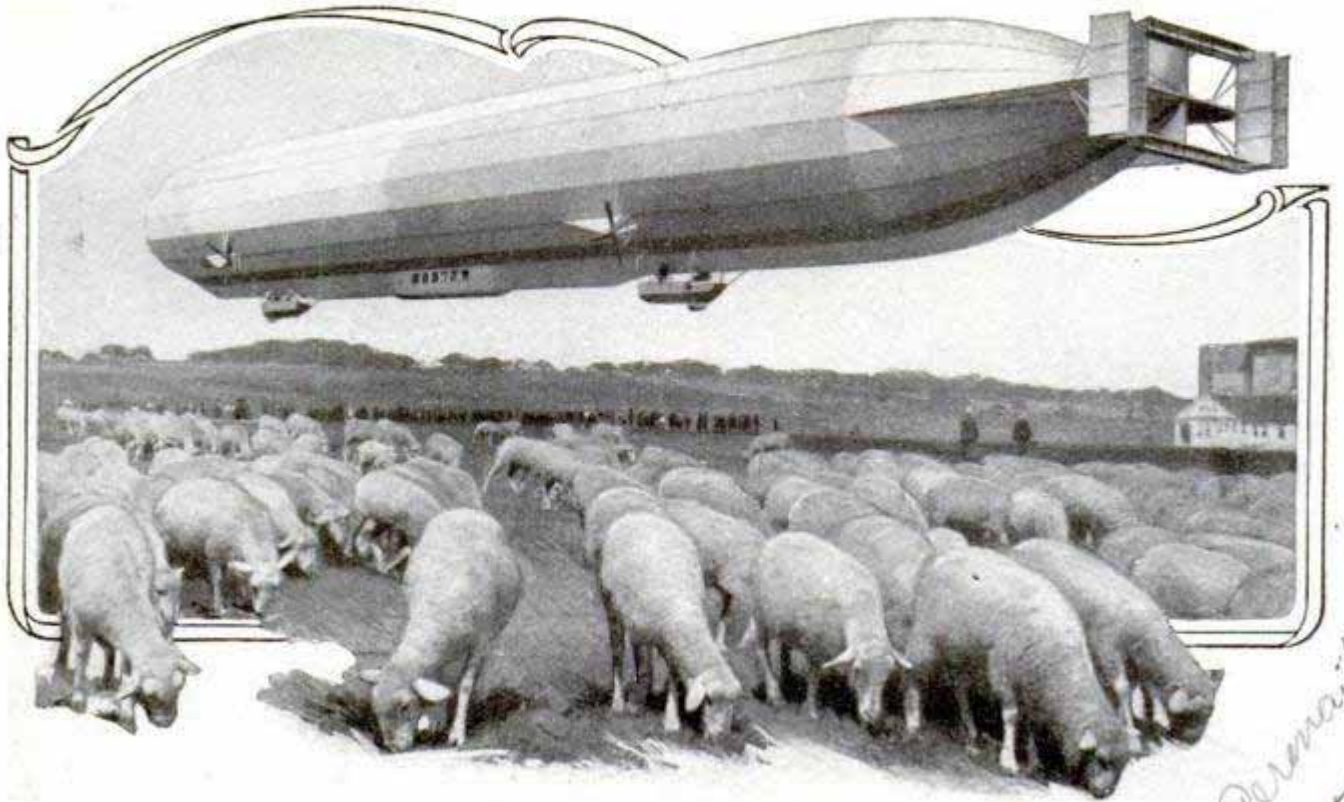

The Largest German Dirigible, the "Z-2," in Flight over the Proving Grounds at Friedrichshafen

bed is arranged to slide through an opening in the wall of a ground-floor bedroom to a concrete platform outside the house. In fair weather the bed stands on the outside platform with no covering, but on stormy nights it is pushed inside. The opening under the wall is beneath a row of three casement windows and, as the headboard and footboard of the bed are the same size, either forms a tight door in the wall of the house. The concrete platform is 7 ft. wide and 10 ft. long, and its top is 18 in. above the ground.

BUREAU OF STANDARDS

5443 TESTS ENGINES

Block tests on aeroplane and automobile engines will now be made at the U. S. Bureau of Standards, where a complete gasoline-engine testing plant has been installed. For a nominal fee the bureau will give each engine tested a certificate, giving the power for varying speeds, and gasoline and oil consumption. The tests will be made on an electric dynamometer, but no flying tests in aeroplanes or flying boats will be made unless so decided by the chief signal officer of the army.

ACCIDENT TO LATEST GER- 5315 MAN DIRIGIBLE

The new German naval dirigible balloon, the "Z-2," narrowly escaped destruction recently when it was wrenched free from the hands of 150 men and carried aloft by a sudden gust of wind, while undergoing a series of trial flights at Friedrichshafen. Four soldiers became entangled in the ropes when the airship broke away. One of these succeeded in extricating himself, another was hauled up into the gondola, while the other two fell to the ground from a height of 500 ft. and were instantly killed. The night before this accident the "L-1," the sister-ship of the "Z-2," was destroyed by a hurricane in the North Sea with an accompanying loss of 13 lives. The new airship is the largest ever built, and carries motors aggregating 900 hp. Its length, practically 500 ft., is the same as that of the other Zeppelins, but its diameter is about 33 ft. greater. The gas capacity of the new airship is 950,000 cu. ft., while that of the "L-1" was 810,000 cu. ft. The crew consists of 19 men, or eight more than is required for the other Zeppelins.

BIG WIRELESS STATION AT HONOLULU

5445

The mid-Pacific station of the Marconi system, located at Honolulu, which is now in construction, will send messages to the Philippines, six thousand miles away. The building of the new station is the first step in the Marconi plan to cross the Pacific from California to the Philippines, thence to Hong Kong, to Bangalore, India; to Aden, to Cairo and to England.

EXTENSION BAGGAGE TRUCK

542 / CARRIED ON SHOULDERS

The steel baggage truck here shown has several interesting features, foremost of which is the fact that it may be hung from the shoulders, resting against the back of the user. It is an extension truck that can be instantly extended or shortened, is made of hard steel and equipped with solid rubber-tired wheels, and weighs but 11 pounds.

The illustration shows clearly the use to which this little truck is put. Carried upon the back, with a trunk as its load, the expressman's hands are left free for the carrying of hand baggage or to steady himself as he climbs stairs. The trunk, so carried, is not likely to do damage to walls, woodwork, and the like.

Extension Hand & Baggage Truck
K. Stone, Box 56
Foster, Calif.

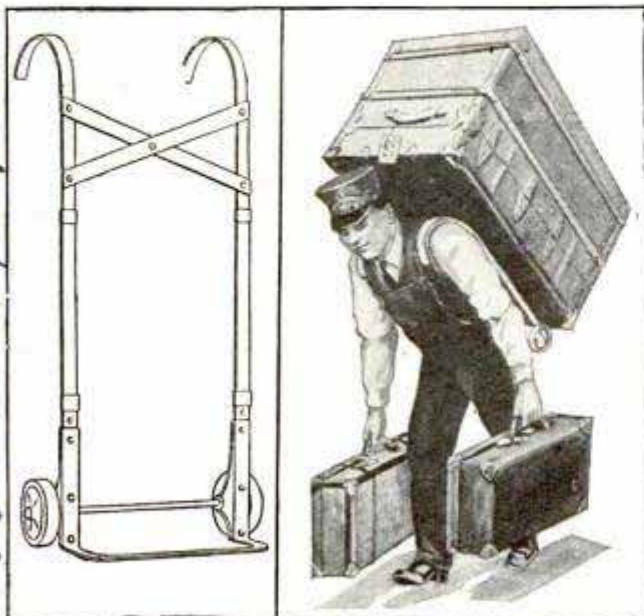

The Extension Baggage Truck and Method of Its Use

MONSTER HORSE A FEATURE OF DENVER STREET

5419

When the Knights Templar gathered in Denver last summer, they were greeted by an imposing array of street



Street Decoration for Knight Templar Conclave in Denver

decorations which were both original in conception and bold in design. Perhaps the one which caused the most comment was a colossal Templar on horseback, forming an archway across the entire street. From the pavement to the top of the helmet was 54 feet, and the horse he bestrode measured 50 ft. from nose to tail.

LENS FOR RAILWAY SIGNALS

497

THROWS WIDE BEAM

A new type of lens designed to be used with railway switch and signal lights, tail lights and engine classification lights has been introduced, and apparently eliminates a serious defect heretofore connected with equipment of this kind. The ordinary lens throws a beam of light having a spread, usu-

E. J. MacLaine
423 Madison St.
Denver, Colo.

The lens for railway signals...
The lens for railway signals...
The lens for railway signals...

ally, of not more than 18 deg. This made it necessary to adjust signal lights with a great deal of care so that

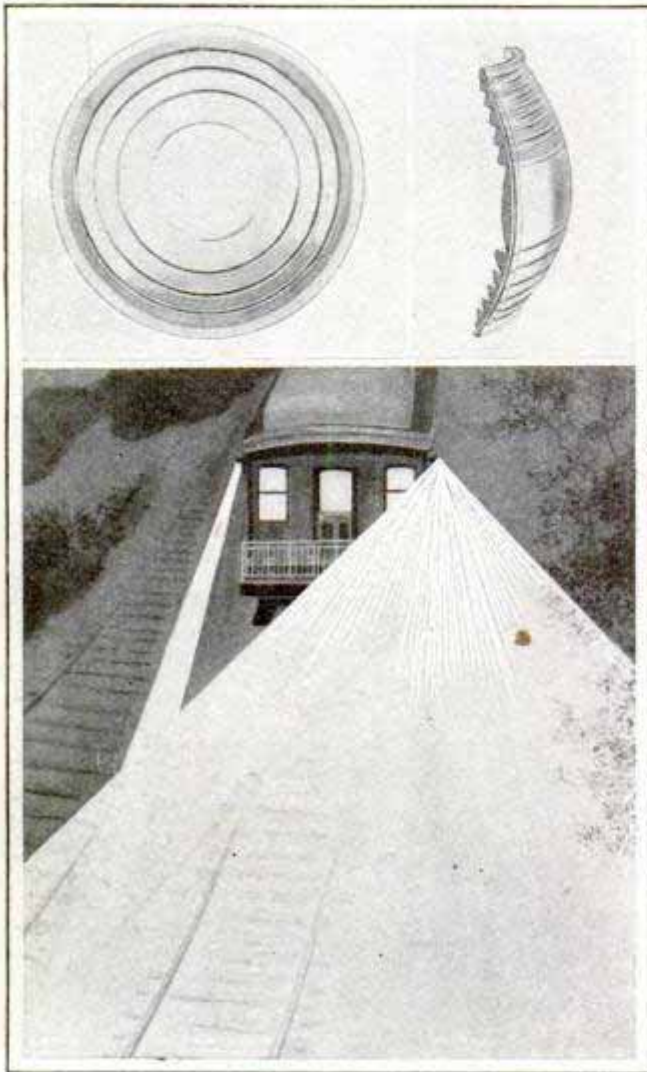

Comparative Effectiveness of Tail Lights Equipped with Old and New Types of Lens

they could be seen by approaching trains, particularly where the track was curved, and often made it difficult for the engineer on one train to see the tail lights of a train ahead. The new lens is so shaped that it throws a beam having a spread of 90 deg., making the light plainly visible under any conditions that are likely to occur, and without the necessity for special adjustments.

NEW FURNACE LINING HAS UNUSUAL PROPERTIES

As a result of a recent discovery a new material that is practically immune to chemical change and resists the highest heat of the electric arc is now available for lining furnaces, re-

torts and chemical containers. This material is known as boron nitride and may be produced by one of several comparatively simple chemical processes. It has an extremely high resistance to the passage of electrical current, even at the temperature of the carbon arc, and has no chemical tendency to unite with any material likely to be used as a charge in an electric furnace. When finely divided, this material has the property of being self-bonding, so that no binder is needed when it is used as a lining for furnace or container.

5064 ULTRAVIOLET-RAY TREATMENT FOR TUBERCULOSIS

An apparatus for treating pulmonary tuberculosis, recently brought out by a Danish physician, utilizes the discovery that air after being submitted to the action of ultraviolet rays contains certain elements that have a healing effect on the skin and mucous membranes. This apparatus, which has met with some success, consists of a cabinet containing a mercury-vapor lamp and having a respiration tube at each corner connecting with the interior. The air inside the cabinet is subjected to the action of the ultraviolet rays thrown out by the mercury-vapor lamp, and is then inhaled through the tubes, while the rays themselves do not reach the membranes of the patient.



Tuberculosis Patients Inhaling Air That has been Subjected to Action of Ultraviolet Rays

General Electric Co.

L. Th. B. ...

USE OF ALUMINUM FOIL INCREASING

Aluminum foil is partly displacing tin foil for wrapping cheese, chocolate sweets, and tobacco, now that improved methods of manufacture have lowered the cost. The rolling is accomplished in six stages, the last of which yields a foil .0016 in. in thickness. Several sheets are laid together and either rolled or beaten like gold leaf, and are finding considerable use in the manufacture of electrical condensers.

MUSIC TRANSMITTED BY WIRELESS TELEPHONE

In connection with experiments in wireless telephony now being carried on at the wireless station at Nauen, Germany, operators at that point have succeeded in maintaining conversations with Cologne, Metz, Strassburg, Wilhelmshaven and Vienna, and with a cruiser in the North Sea. The instrument used in these experiments has also been employed successfully in transmitting songs and instrumental music.

MONUMENT TO FIRE HEROES OF NEW YORK CITY

In acknowledgment of the bravery of her firemen, New York City has erected a memorial monument at 100th Street and Riverside Drive which is at once an appreciation of the heroic sacrifices made by those men who died at the post of duty, and an inspiration to those members of the department, "Soldiers in a war that never ends," in whose instant response to the alarm the confidence of a whole city rests. The monument was designed by Magonigle and executed by Attilio Piccini.



Monument to Firemen Erected by the City of New York. The Inscription Reads: "To the Men of the Fire Department of the City of New York, Who Died at the Call of Duty, Soldiers in a War That Never Ends, This Memorial is Dedicated by the People of a Grateful City"

London Eng 8/27 5441

5280
Ex. rec. J. J. 9-2-13

W. D. ...
527 Street 124th St.
New York

relli. The photo shows the side upon which is the inscription; the opposite side, facing Hudson River, is a bas-relief representing a horse-drawn fire engine, under which a mask spouts a stream of water into the fountain basin.

SEWING CHAIR WITH HIDDEN DRAWER

A very convenient place for needles, thread, and other sewing materials is provided in the new hidden-drawer



A Convenient Drawer for Sewing Materials

sewing chairs. There is a roomy drawer, divided into handy compartments, hidden under the seat ready to be drawn out whenever any article is needed. It slides in and out of the side and fits snugly so that it is unseen when closed. There is no handle on the drawer, but it is opened or closed by a thumbscrew on the side of the chair.

On account of drifting snow, houses, 8 or 10 ft. above ground level and connected by elevated bridges, will be built for the workmen engaged in the construction of the Roger's Pass tunnel through the Selkirk Mountains in Canada.

PRESERVING WOOD WITH GRANULATED GLASS

Coating wood with an imperishable surface of granulated glass is a late method of preservation tried out with success in England. The deposited granules are rolled down to any desired fineness and the surface of the glass is then painted or enameled to the desired polish. This process may be applied to other substances, and has been used on the cylinders of locomotives for the purpose of preventing erosion and heat radiation. The glass coating lasts as long as the metal and corrosion is absolutely impossible.

DIMINUTIVE ENGINE MARVEL OF WORKMANSHIP

Following a fashion that seems now to be much in vogue, that of making the "smallest steam engine in the world," an American inventor has produced a horizontal engine that is truly a marvel, not only because of its diminutive size but on account of the extreme delicacy and refinement of its parts. This engine which is a perfect working model of a horizontal reciprocating engine, is $\frac{9}{16}$ in. long and $\frac{5}{16}$ in. wide over all. The diameter of the flywheel is $\frac{5}{16}$ in., and that of the driving pulley $\frac{1}{16}$ in. Some of the parts are so minute as to be scarcely visible, and were made with the aid of a microscope and the finest of jewelers' tools. The throttle valve is a diminutive globe valve, perfect in shape and finish. While this engine is made as a steam engine, it will be impossible to run it as such, owing to the cylinder condensation of the steam, and com-



Horizontal Reciprocating Steam Engine with a Rating of "One Flea Power"

pressed air will be used as a motive power. It has been given a rating, by the inventor, of "one flea power."

4726 LOTTERY MACHINE FOR RETIRING BONDS

Lottery methods are used in France for the periodical retiring of government and other bonds that do not run for stated periods. Formerly the numbers of the bonds to be retired were drawn by hand from a drum, but a

of the globe is a releasing device, consisting of a plunger, an oscillating tube and a fixed glass tube, worked by electromagnets controlled by an operator, which drops out the boxes one at a time, counting them as they go. On

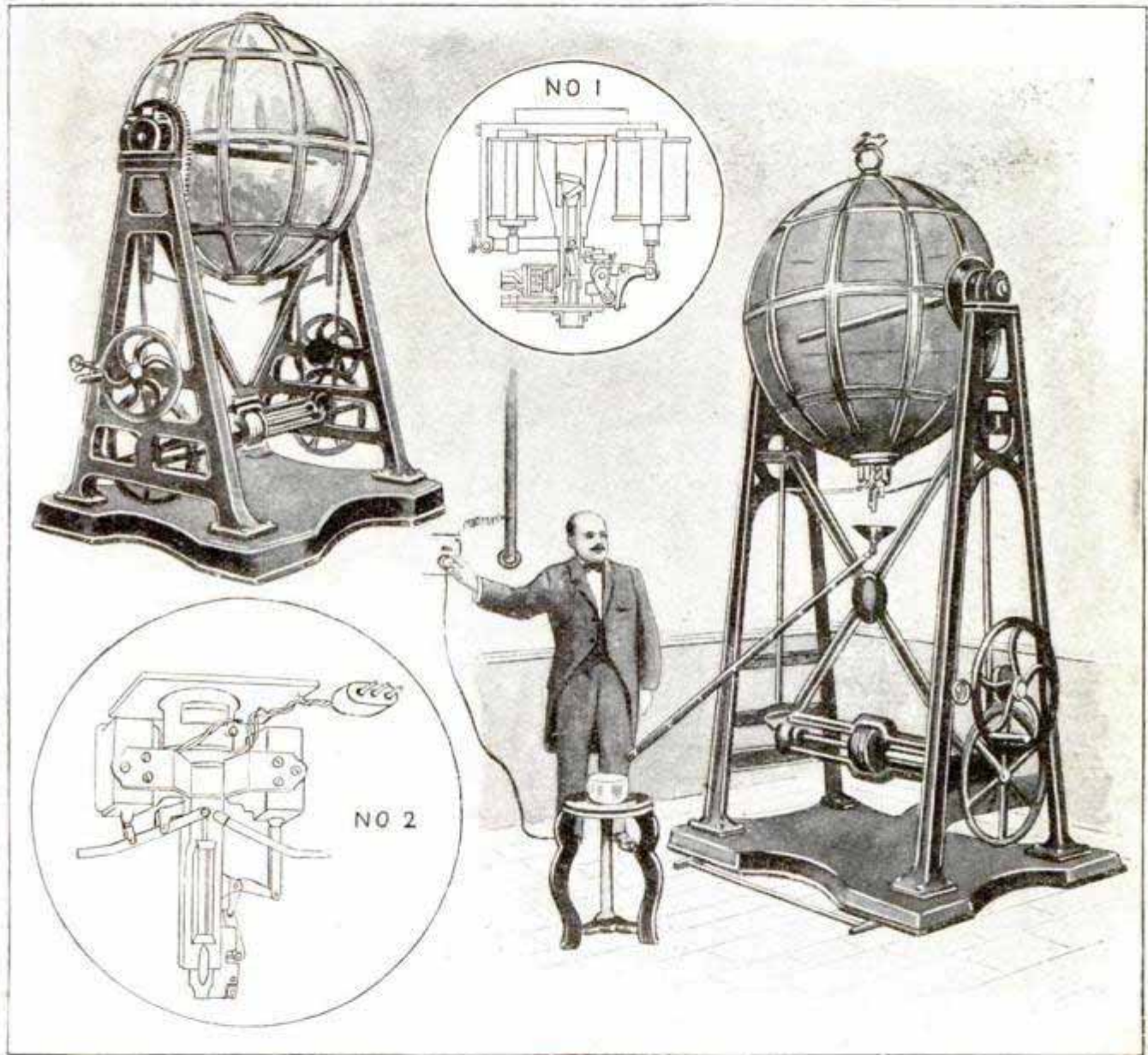

Top, Left: Automatic Lottery Device Full of Bond Numbers to be Drawn
Lower Left: The Electric Valve Which Releases and Counts the Bond Numbers

Top, Center: Cross Section of Release Valve Showing Number Boxes Ready to Drop Out, One at a Time
Lower Right: Drawing Bond Numbers One at a Time

machine has recently been adopted by the city of Paris and the Crédit Foncier for choosing the bonds automatically. It consists of a large glass globe, rotating on a horizontal axis, into which are placed a large number of tiny pasteboard boxes, each containing a bond number. On one pole

the other pole is a smaller globe arranged for delivering the number boxes several at a time. The whole globe is revolved occasionally to shake up the boxes inside. The apparatus is controlled from a distance and the bond numbers are delivered through a tube into a container near by.

CIRCULAR BARN AND SILO 4820 COMBINED

Time and money in the care of cattle are saved by the novel arrangement of a circular barn built by a Maine

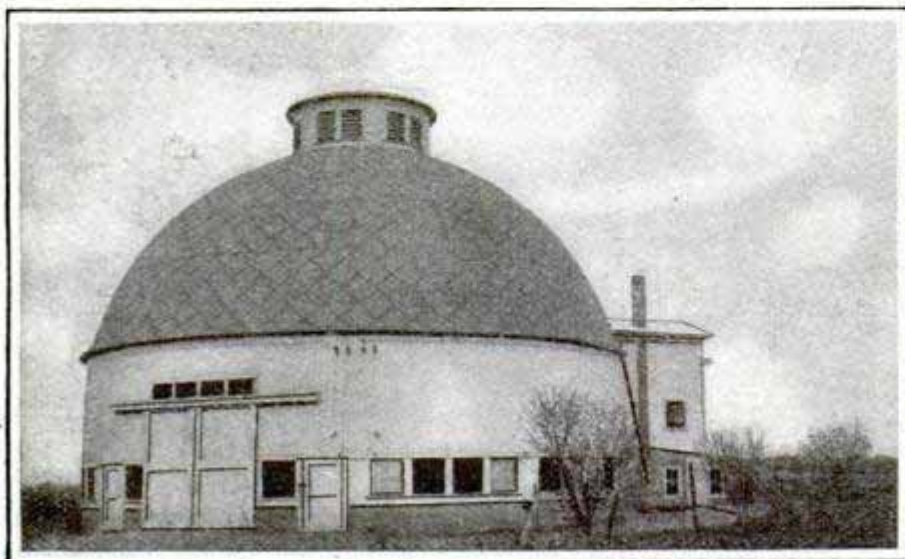

Circular Barn with Cattle Stanchions Grouped around a Central Silo

farmer. In the center of the barn is a silo with plenty of floor space about it, and stanchions for 50 head of cattle are built around the circumference, facing the silo. Only a few steps are necessary to feed all the cattle. The hay loft is in the second story and has a bridge leading over the cattle so that a wagon can be driven in from the outside. The barn is 42 ft. high, and has a diameter of 56 feet.

WEATHER FORECASTS FROM 4913 STUDY OF SUN

That it will soon be possible to determine general weather conditions six months or longer in advance by careful observation of solar conditions is the belief expressed by Professor Frost, of the Yerkes observatory, who has just completed an exhaustive series of studies relating to variations in the amount of heat sent out by the sun. Such advance forecasts would revolutionize agriculture all over the world. The amount of heat sent out by the sun varies slightly from day to

day, but the big variations, which are the ones that affect weather conditions, occur in cycles of months or years. The presence or absence of sun spots is the most important indication of future weather conditions, and these have been found to come in cycles of 11 years. The radiation of heat is high when the sun spots are numerous, and low when the sun spots are few or absent.

5199 LANDING FIELD GUNS FROM A BATTLESHIP

(No data)

The landing of field guns and munitions of war on shores which vessels cannot approach closely is one of the exciting tasks for the men on the warships of the world's great navies. The maneuver is especially necessary in the navies of the colonial powers which must be in readiness to land fighting forces on any of the unapproachable shores of their colonies. British, German and French sailors have long been trained in making such landings and since the United States has become a colonial power the crews of American battleships are likely to be called upon for similar service. Several pictures on the opposite page illustrate the land-

ing of field guns by aerial cableway. The battleship or transport carrying the guns anchors as near the shore as possible and a cable is stretched from the vessel's deck to a tripod derrick on shore. A two-wheeled trolley from which are suspended the various parts of the guns is drawn along the cable by a rope running to the men on shore. The guns are dismantled and several trips are necessary to land all the parts of one gun. The most thrilling part of the work is carried on by the men who ride on the load to keep it from swaying or becoming unfastened from the trolley. In a rough sea this is a truly perilous undertaking.

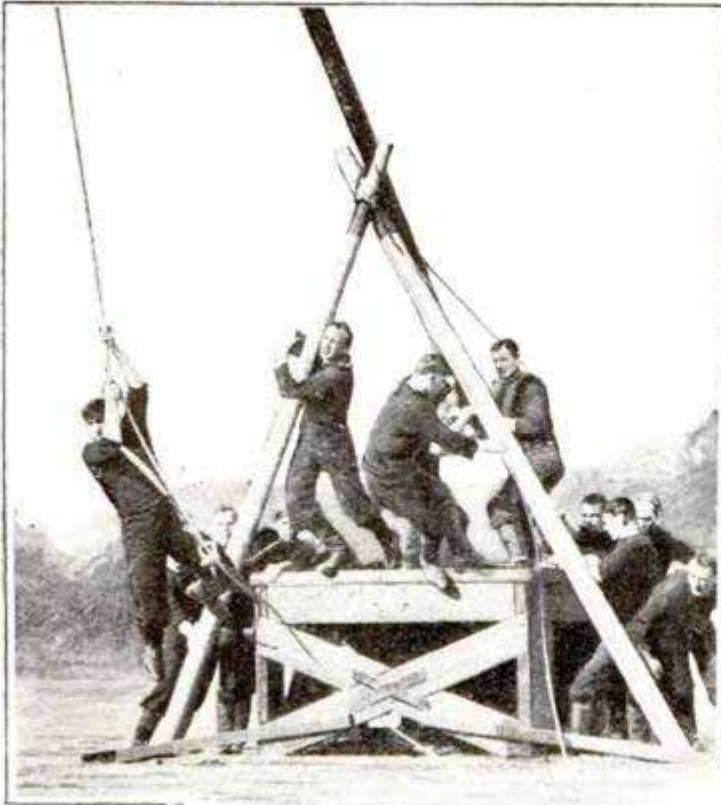

Landing
Field Guns from a
Battleship: Tripod
Which Supports the Shore End
of the Aerial Cableway from
the Battleship's Deck

Riding to Shore on a Field Gun



Hauling Gun into Position After It has been Put Together

The Gun's Two Wheels
Make One Load
for the Aerial Trolley

Photos Copyrighted by Topical

HANDY PICKING BAG FOR FRUIT GROWERS

5200

Many Florida fruit growers are using a new patent fruit-picking bag designed for handling oranges, lemons,

Allen's Patent Fruit Picking Bag



Fruit-Picking Bag Designed for Picking Oranges, Lemons, Apples, etc. The Bag's Contents Just Fill Half a Regulation Orange Box

apples, etc., with a minimum of bruising. The bag is made of tough canvas on an iron frame and holds enough fruit to fill one-half of a regulation orange-field picking box. A carrier strap about the picker's shoulders holds the bag at his side with the open top conveniently near his hands. The open bottom of the bag is wedge-shaped and is closed by a rope and snap which catches it up against the outside of the bag.

INSTRUMENT FOR EXAMINING PRECIOUS STONES

5121

To assist jewelers in examining and testing precious stones, an English jeweler has invented a little device, called the gemmoscope, for holding the various instruments used in the test.

For jewelers to use -

It is a hinged stand with an adjustable arm, attached at right angles, to hold a turntable or push-piece stone tongs. In the upright of the stand is a telescopic holder for a microscope. Below is a disk, black on one side and white on the other. As the turntable and tongs are arranged to revolve, the jeweler can adjust his magnifying glass and then turn the gem in any direction for examination.

5089

NEW LINEMAN'S TORCH FOR SOLDERING JOINTS

To lessen the danger connected with the telephone or telegraph lineman's task of soldering wires near the tops of poles, a safety soldering torch which requires the use of only one hand has just appeared on the market. Ordinarily the lineman has to hold his torch in one hand and his solder in the other, clinging to the post with his legs meanwhile. The new torch hangs upon the wire with the joint to be soldered inside over an alcohol flame, so that the lineman has one hand to hold on with while he applies solder with the other. The torch is held on the wire by two



New Lineman's Torch Which Hangs on the Wire to be Soldered, Requiring the Use of Only One Hand

Two Parts of Torch; Left Is an Alcohol Burner and Right Is the Guard with Slots Which Attach the Torch to the Wire

broken slots in the upper rim; a half turn of the body of the torch secures or releases it.

Not in plain view

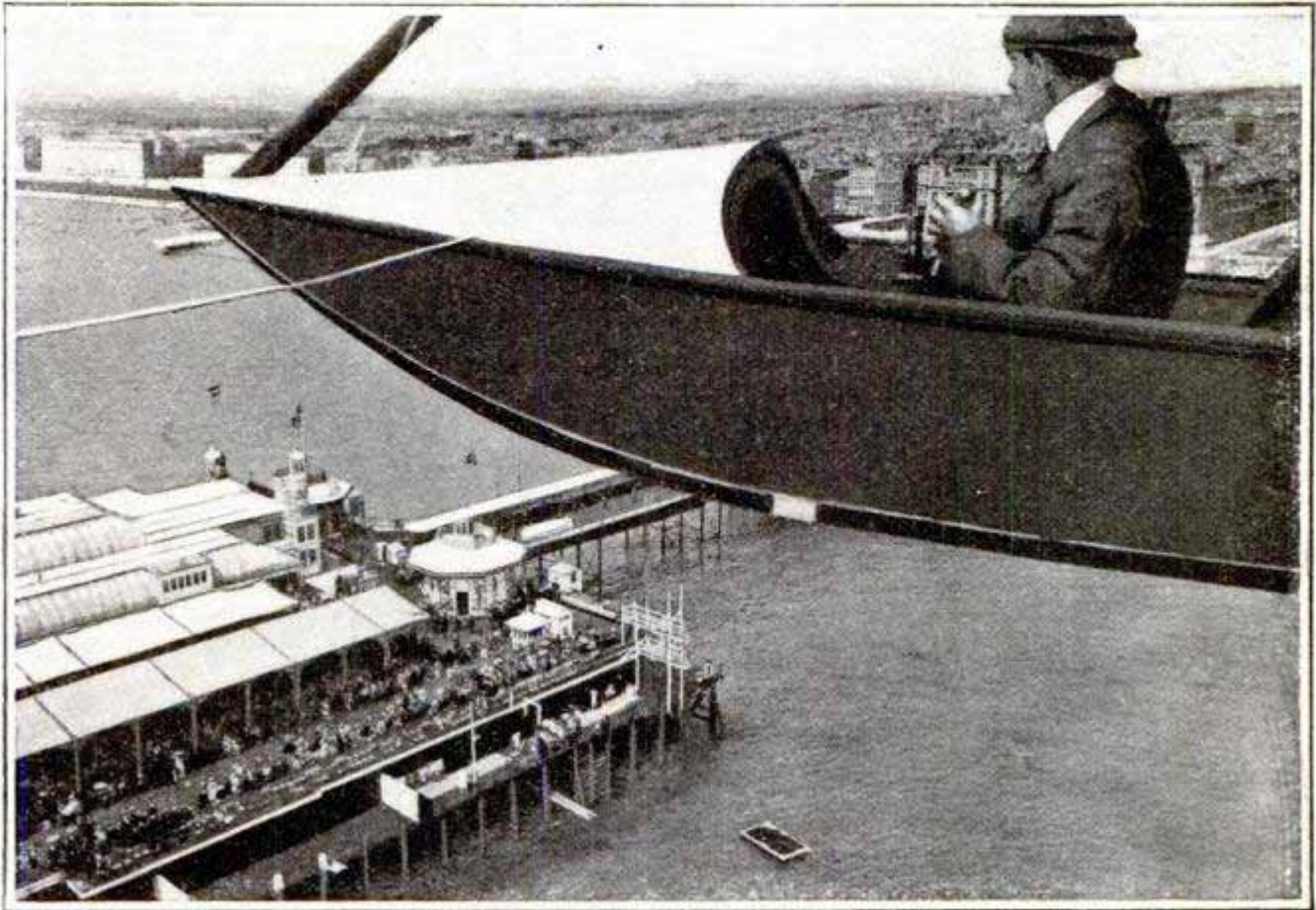

Courtesy Flying

This Photograph of Brighton, England, Taken from a Flying Boat, Shows How Much an Airman can See While Flying

Aerial
PHOTOGRAPH MADE FROM FLYING BOAT

A remarkable photograph was taken from a flying boat recently as it flew over Brighton, England. This flying boat is a biplane, and the photograph was taken by a camera attached to the top plane. The resulting view shows not only the peculiar construction of the boat, but gives a good idea of the true bird's-eye view afforded the airman while flying.

5-156
MOTOR HANDCAR SUPPLIES BRANCH-LINE SERVICE

W.L. Burdette
 A unique branch-line service is in effect on a spur leading from Benson Mines on the main line of the New York Central Railroad to the village of Wanakena, N. Y., in the Adirondack Mountains. Only one train a day goes into Wanakena, while at Benson Mines there is a good train service consisting of several trains a day. To meet the demand for a more frequent service out of the village an ingenious

native secured a handcar, painted it, installed a 6-hp. gasoline motor, and then arranged with the railroad company for permission to operate over the tracks. This unique track automobile will carry six persons at a fair rate of speed and is at the call of anyone wishing to make a quick trip to the city. It is fitted with an automobile horn for use at crossings and is known locally as the "mosquito flier."



Handcar, Converted Into Track Automobile, Used for Branch-Line Service

W.L. Burdette

5027

SYMBOLICAL STATUARY GIVES TOUCH OF BEAUTY



Negro Servitor



Model of Eagle Used Extensively in Decoration of Machinery Hall



Arab Falconer



Colossal Group "Nations of the East." From Left to Right the Figures are: Arab Sheik, Negro Servitor, Egyptian, Arab Falconer, Elephant Repre- senting India, Chinese Buddha Carried in Howdah on Back of Elephant, Mohammedan, Negro Servitor, Thibetan Warrior, Llama.

THESE PHOTOS ARE THE PANAMA-PACIFIC

COPYRIGHTED 1913, BY INTERNATIONAL EXPO, CO



Representative Figures in Group "Nations of the East:" "The Egyptian" at the Left; "The Mohammedan" at the Right

TO BUILDINGS OF THE PANAMA-PACIFIC EXPOSITION



Figure of Rain, over Entrance to Court of the Four Seasons



Spring, One of the in Court of the Four Seasons



Figure of Sunshine, over Entrance to Court of the Four Seasons

THESE PHOTOS ARE COPYRIGHTED 1913, BY THE PANAMA-PACIFIC INTERNATIONAL EXPOSITION CO.



Figure Symbolical of Star, in Colonnade of the Sun and Stars



Arab Sheik, One of the Figures in the Group "Nations of the East"



Chinese Llama, Figure in Group "Nations of the East"

CIRCULAR SAW TO TRIM CAR ROOFS

Portable buzz saws, designed especially for trimming car roofs, have been put on the market recently. Run-

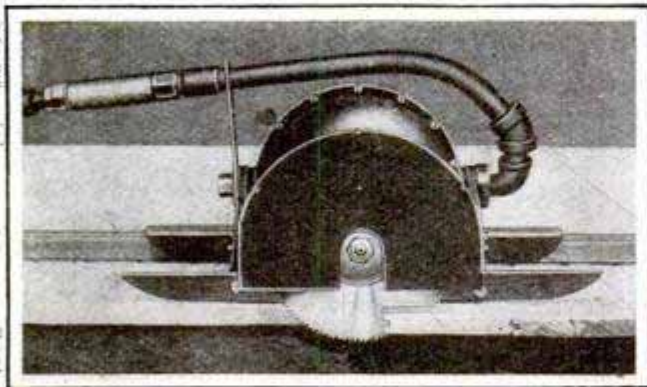

Portable Circular Saw Used for Trimming Car Roofs

ning at a speed of 2,200-revolutions per minute, the 8-in. circular saw trims one side of a 60-ft. roof in 1½ minutes. The saw and its motor rest on two long shoes, one of which is grooved to fit over a guide strip nailed to the car roof at the proper distance from the edge. The equipment shown is run by compressed air, but an electric motor can be used with the saw when compressed air is not available.

NEW SIXTEEN-INCH GUN TESTED

The first 16-in. gun for coast defense at Panama was tested at the Sandy Hook proving ground late in August. The gun alone weighs 127 tons and is 49.25 ft. long. Its powder chamber is 19 in. in diameter and 8 ft. long. The projectile travels through 39.32 ft. of

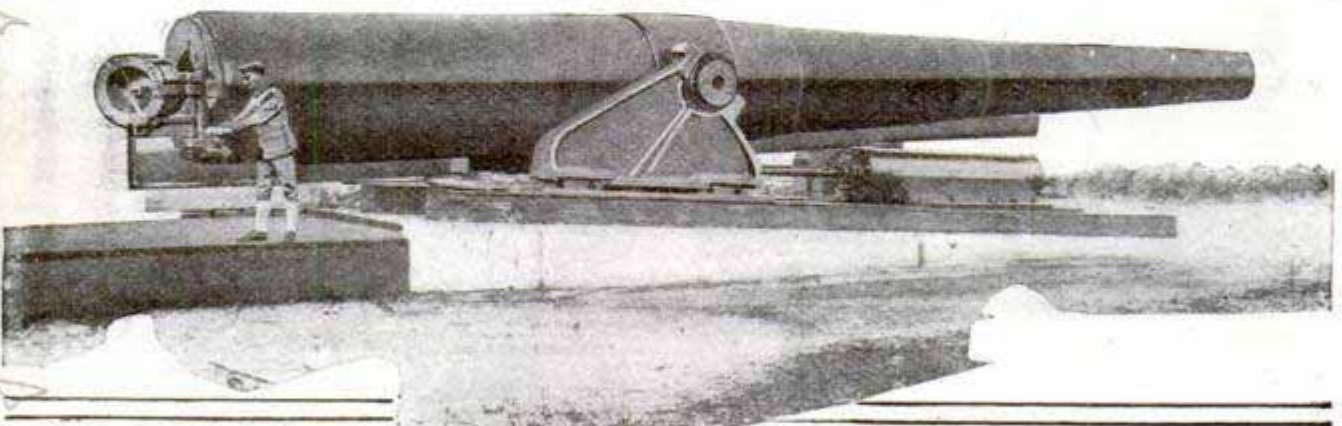

The First 16-In. Gun Mounted on a Proof Carriage at Sandy Hook Proving Ground

the 16-in. bore, which is rifled with 96 lands and grooves having a twist increasing from one turn in 66.6 ft. at the breech to one turn in 33.3 ft. at the muzzle. The armor-piercing shell used in the gun weighs 2,400 lb., is 64.5 in. long, and contains a high-explosive bursting charge of 140 lb. A charge of 650 lb. of smokeless powder, including 16.5 lb. of black-powder igniter, gives a muzzle velocity of 2,250 ft. a second, with a pressure of 38,000 lb. per square inch in the powder chamber and 84,328 foot-tons of striking energy. The shell will penetrate 21 in. of hard-faced steel armor at a range of 5,000 yd. Fired with an elevation of 15 deg., the gun has a range of 11 miles, and at an elevation of 42 deg., a range of 20.9 miles.

MOORING AEROPLANES ON A CABLE

Aerial anchorage on an overhead cable is being tested in France as a possible solution for the problem of stopping and starting aeroplanes or flying boats when no suitable landing place is available. The French aeroplane constructor, Louis Blériot, has conducted several successful experiments with an overhead anchorage device at the Buc aerodrome. The landing place which he uses is a metal cable, about 85 yd. long, stretched tautly a few yards above the ground or along the side of a ship. The anchor carried by the aeroplane is a pair of wooden arms, shaped like an open V and provided with a spring

1010 Fisher Bldg. 1348 W. 1st St. S. A. Sandy Hook Proving Ground, Sept. 11, 1911

5226

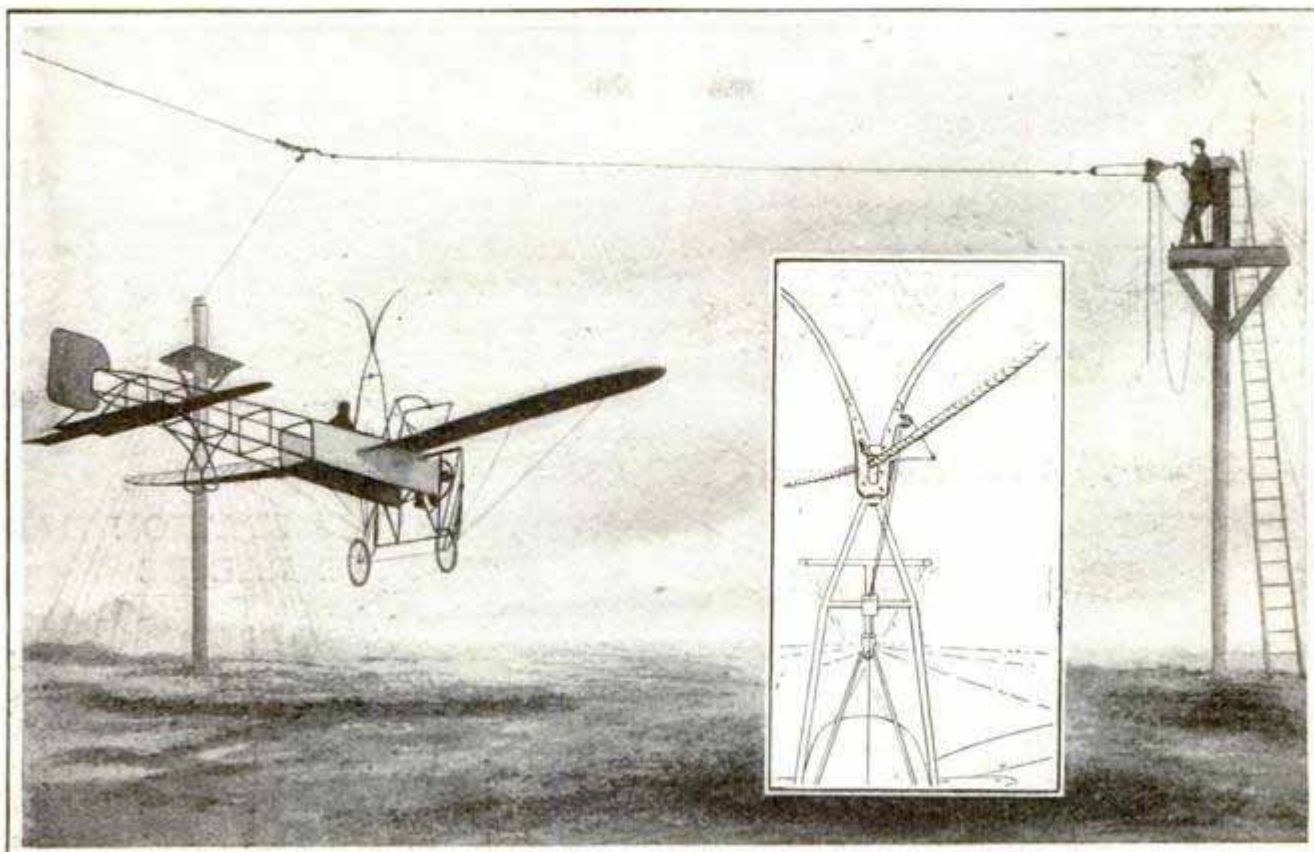

Copyrighted by Topical

Overhead Cable Mooring for Aeroplanes: The Flying Machine is Maneuvering to Catch the Cable with Its V-Shaped Fork. The Catch Which Grips the Cable can be Released by the Pilot

catch in the angle, mounted on top of the flying machine's frame. To land on the cable, the airman flies underneath the anchorage until he catches the cable in the open V; the spring catch grips the cable and the aeroplane hangs in the air. To leave the anchorage, the airman starts his motor and glides along the cable until he has acquired speed enough to fly; then he pulls a cord, releases the spring catch and flies away.

the center. A compartment back of the center is utilized for carrying tools. The length of the truck, over all, is 31 ft. 6 in. The rear wheels are steered by a separate steering mechanism, which enables the truck to make short turns when necessary, but this mechanism can be locked when not in use and the truck steered entirely with the front wheels.

The loading and unloading of poles is accomplished by means of an electric winch located in the center of the truck. This winch is wired so that it

AN ELECTRIC TRUCK FOR 4337 HAULING POLES

An electric truck has been put into service by an electric company of Philadelphia for hauling and distributing poles, which not only compares favorably with the old method of hauling with horses, but is serving as an effective advertisement for the company's central-station service as well. This truck has a capacity of six tons, and weighs, unloaded, about 12,000 lb. It is operated by a 4-motor drive, the batteries being located in a compartment under the bed of the truck forward of

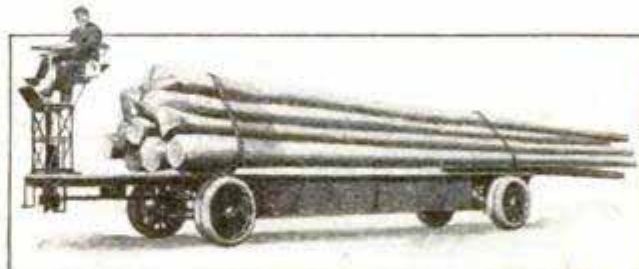

This Electric Truck Hauls All the Poles for a Philadelphia Electric Company and Serves as a Central-Station Advertisement

can be controlled from switches under the seat or from either side of the truck, and when the winch is in operation the control of the truck itself is cut out.

Electric Truck Advertisement

**MACHINES FOR COUNTING
COINS**

4749

For the convenience of banks and other institutions where it is necessary to count coins and inclose them in

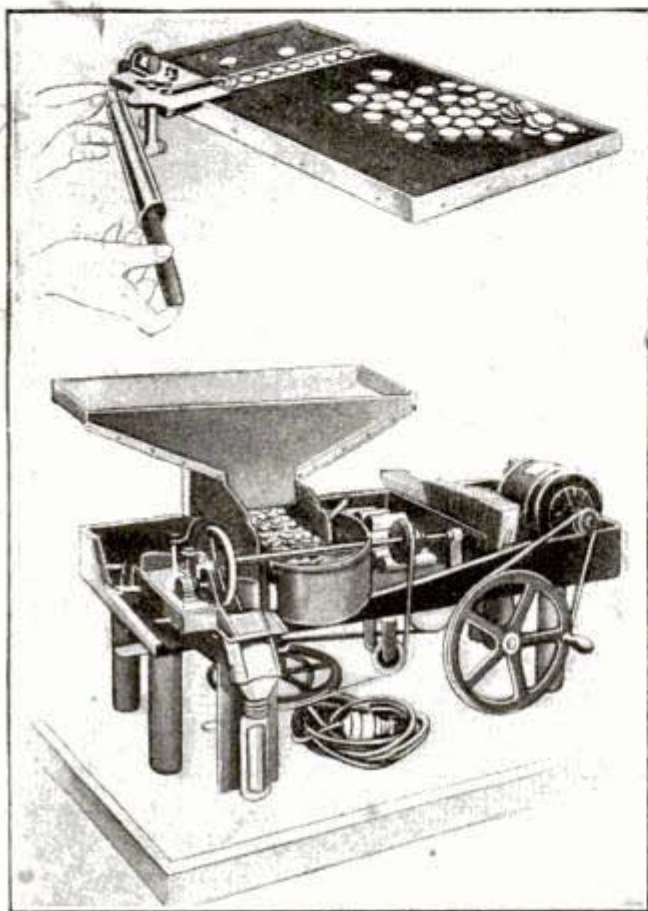

Machine that Counts Coins Automatically and Drops Them into Stacker Tube; Upper View Shows Hand Device for Counting Coins, for Which No Power is Required

wrappers, two machines, one automatic and the other semiautomatic, have been placed on the market. These machines are designed to provide a count that is absolutely accurate as well as to relieve the attendant of the fatiguing labor of handling each individual coin. In the automatic machine the coins are placed in a sort of hopper at the bottom of which is a revolving disk. When the disk is revolved the coins are discharged singly by centrifugal action through an outlet in the wall of the hopper to a rotating carrier wheel which passes them through the counting mechanism and thence to the stacker tube. The machine can be set to stop at any desired number of coins from 5 to 250. At the end of each count the coins are removed from the

stacker tube and the machine started on a new count.

The semiautomatic machine consists of a shallow box having a slot leading to a small counting machine, below which is suspended the stacker tube. The coins are moved along the slot to the counter by hand, no other power being required for operating the device. This machine can also be set to stop after a given number of coins have been counted.

**NEW WIRELESS STATION HAS
5252 3,000-MILE RADIUS**

The Darien wireless station, which is being built at Caimito, Panama, will have a sending and receiving radius of 3,000 miles and will be able to talk to San Francisco or the Arlington station, near Washington. When it is finished, government messages from Washington will be sent to the Canal Zone direct, without the present relay at Key West. It is being built exclusively for government business, principally as a relay station for communicating with ships of the navy in southern waters. It will be able to talk to Valdivia, 421 miles south of Valparaiso, and with Buenos Aires. It could reach a vessel anywhere along the eastern coast of the United States, halfway to Gibraltar, or near the Island of St. Vincent, 500 miles west of Africa. Its antennae will be supported by three 600-ft. towers standing on bases 180 ft. above sea level, and will span an arm of Gatun Lake which will form good electrical grounding. The Poulsen wireless apparatus, using sustained oscillations, is to be installed, making it a 100-kilowatt plant.

**NEW STATUE IS LARGEST IN
5205 THE WORLD**

The largest statue in the world is now being carved in Japan. It is a recumbent effigy of Nichiren, a Japanese patron saint, cut from a natural granite rock on a hillside on the island of Ushigakubi, or "The Cow's Head,"

The Abbott Coin Counter is 107-9 William St., New York City

7-30-10

Patented

London News

Europe

in the inland sea of Seto, Japan. The stone image will be 240 ft. long from head to foot, 60 ft. longer than the Sleeping Buddha statue at Pegu, Burma, and considerably longer than the Sphinx, in Egypt. Nichiren, whose name means "Lotus of the Sun," was a religious teacher who lived during the thirteenth century. At one time he was condemned to death, but the heads-

ENGLAND TO HAVE AIRSHIP SERVICE
5018 SERVICE

Airship service in England, including a regular line between London and Paris, is to be established in the near future by an English company. Sheds are to be erected on the outskirts of

Illustration of the statue of Nichiren

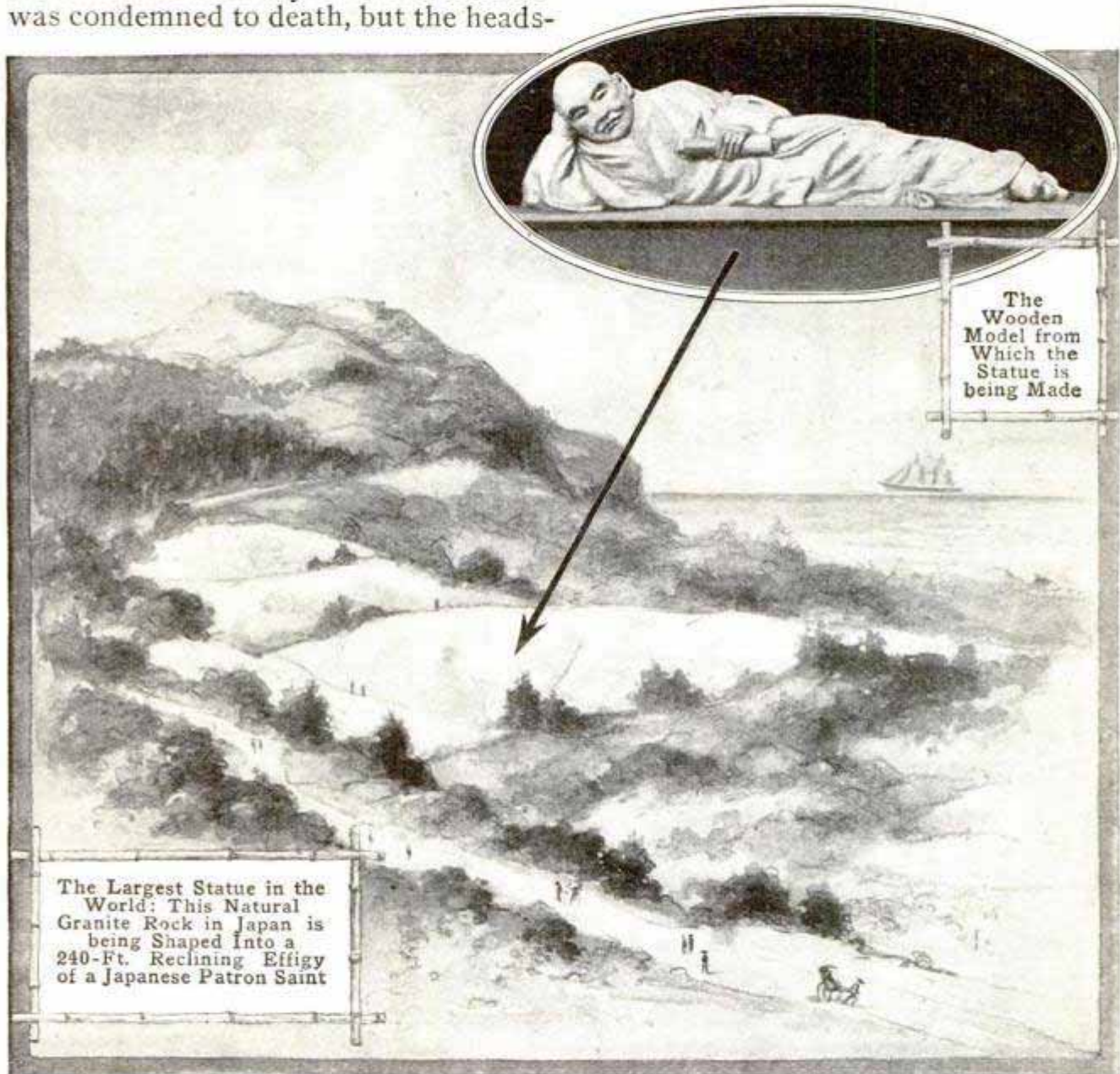

Courtesy Illustrated London News

man's sword was unable to decapitate him. One of his present-day worshippers, a wealthy Japanese, is having the huge statue carved in the saint's memory.

CA system of auxiliary fire protection is to be installed in three of the largest government buildings at Washington to protect valuable records.

London and some of the provincial cities, and other lines from London to Brighton, and to commercial centers, such as Manchester and Birmingham, will be included in the system. The company has a capitalization of \$1,250,000 and a 12-year contract with one of the largest European balloon-envelope makers giving it the sole right to handle the envelopes in the British Empire.

TOPIARY GARDENING BEING INTRODUCED IN AMERICA

5163

By L. WILLIAM THAVIS

One of the most ornate and fantastic schemes in landscaping effects is topiary work in box, yew and privet bushes, which are trained and trimmed to resemble various subjects of nature and art. Although topiary work has been usually associated with the magnificent gardens of England for many years, it is in reality a part of the Roman gardens of antiquity as early as the time of Christ.

In such countries as France, Italy, Greece, and Holland, this kind of "sculpture" is centuries old. There, in numerous royal and private gardens, are seen a great variety of designs and figures carried out in shrubbery, notably specimens of men, women and children, wild animals, hunting scenes, and even whole fleets of ships are shaped by skillful shears. Particularly in English gardens Biblical subjects are notably represented, where a large variety of pyramids, columns, and other creations of yew and box are found. This system of cutting trees invests a garden or park with attractive quaintness.

Topiary work is practically new to this country, Kansas City, Mo., being the only city so far to adopt this form of decoration in beautifying its parks. Comparatively few such specimens are to be found elsewhere, and they are only to be seen on the lawns of private residences, mostly in the eastern and New England states. The United States has decided to adopt this mode of adorning numerous parks, circles and small reservations in Washington, D. C. A number of designs have been imported, including huge birds, peacocks, chickens, swans, spirals looking like large snakes, cones, pyramids, center tables, globes, tankards, vases, etc.

These specimens came from Holland. They were "carved out" of yew, privet and box. It requires from 5 to 25 years for hedges of this variety to fully mature. The branches of the plant, in its infancy, are trained by being

twisted and tied in the shape of the design desired, and constantly trimmed. When the plant reaches its maturity it only requires slight trimming twice a year—spring and late summer. It then survives for many years in almost any climate. This form of decoration is very expensive because of the time and work required to produce intricate designs.

Topiary work should be used in landscape surroundings exactly as sculpture would be used. What is lacking in exactness of architectural line or sculptural form is more than offset by the unusual interest of the material. Topiary pieces always need a formal setting as do statues, and should never be placed at random. They best serve as objects of interest accentuating or emphasizing lines of design. By that it is meant that a topiary piece may be used as a terminal motive at the end of a long walk, in place of a statue at the end of a vista, or in some other well-defined position.

The peacock is the form into which the trees of England are most commonly cut. This fowl, in a velvety green of gigantic size, is frequently seen sitting sedately among the flowers of magnificent gardens and churchyards.

Some of the early topiary work in England represented resemblances of Adam and Eve, Noah's Ark, the Tower of Babel, etc. Near Paris there is today an intricate piece of this kind of work that represents the siege of Troy. In gardens at Chartres, France, the Seven Wise Men of Greece, the Labors of Hercules, and the Three Graces are exquisitely executed in box and yew.

The topiary work being installed in the parks and circles of the national capital has already aroused general admiration, and this innovation of landscape decoration bids fair to be readily adopted generally by the larger cities of the United States, wherever there are formal parks to be embellished.

William Thavis
 514 Murray Bldg., Wash. D.C.

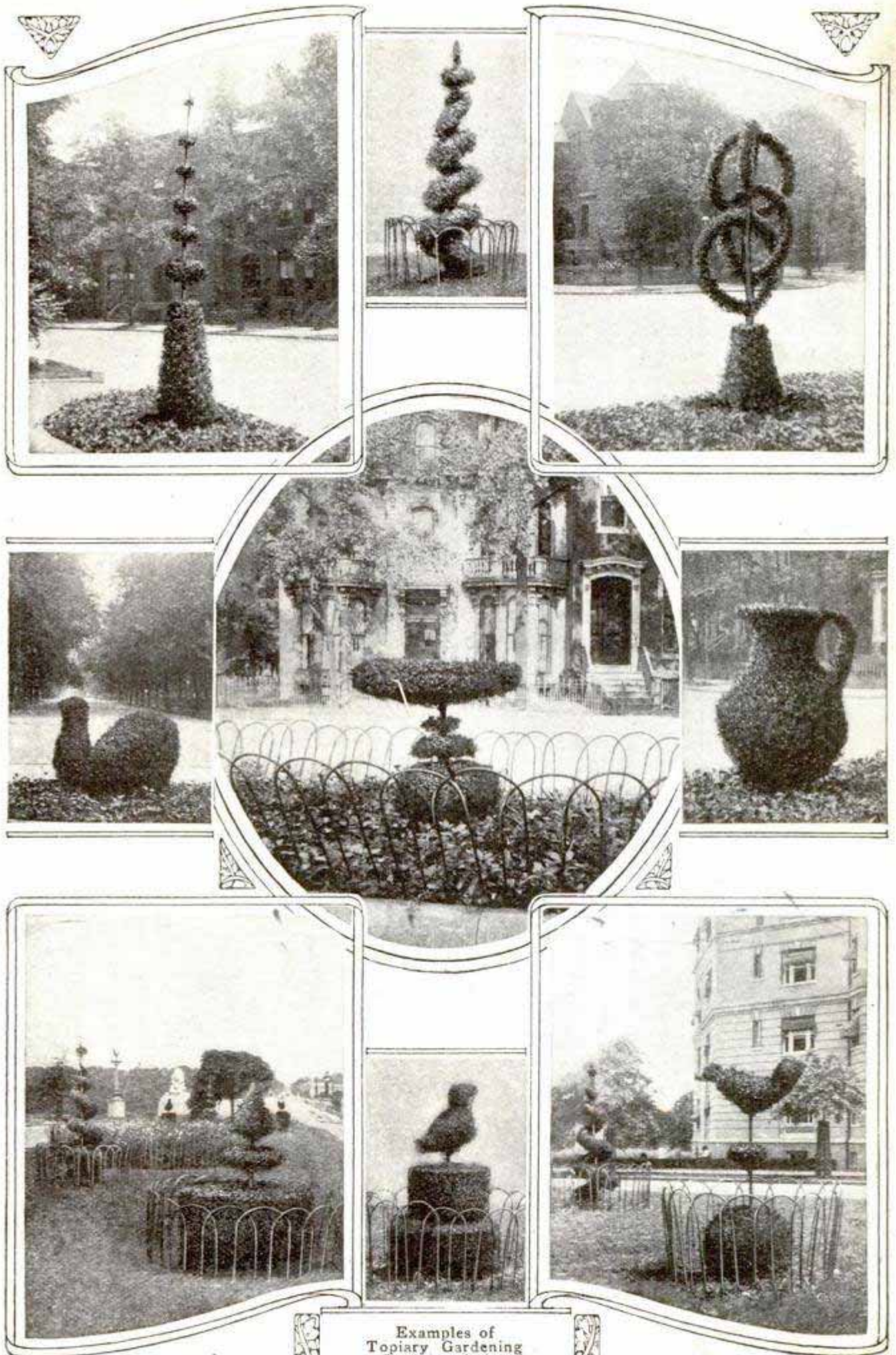

Examples of
Topiary Gardening
as Introduced in the
Parks of Washington, D. C.

LOOKOUT TOWER OF NOVEL CONSTRUCTION

4822

The remarkable qualities of reinforced concrete were shown in a look-



Cantilever Tower Built to Demonstrate Qualities of Reinforced Concrete

out tower which was one of the striking features at a recent cement show at Koeslin, Germany. This tower con-

sisted of two inclined cantilevers, one supporting the other, without pillars or arches of any kind. The lower flight of stairs, terminating in a landing, rests on an underground foundation. The second flight of stairs is supported on this landing and terminates in a roomy pavilion, 35 ft. above the ground. In spite of its light appearance and peculiar construction, this tower has a carrying capacity of 125 lb. per square foot.

HITCHING AN AUTOMOBILE TO A PLOW

5091

Many automobiles have been "hitched" to plows and converted into improvised farm tractors during the last year or two, but in most cases the "hitching" has involved a serious rearrangement of the car and its machinery. A tractor has now appeared which utilizes the power of a pleasure automobile with no alteration of the car except in the rear hubs. The owner simply drives to the field in his car, backs it into the two-wheeled tractor, does his plowing, unhitches the automobile, and drives back home, without changing or injuring the car. The tractor consists of two 6-ft. spiked wheels which support the rear end of the automobile's frame, carrying it 6 in. above the ground. Power is trans-

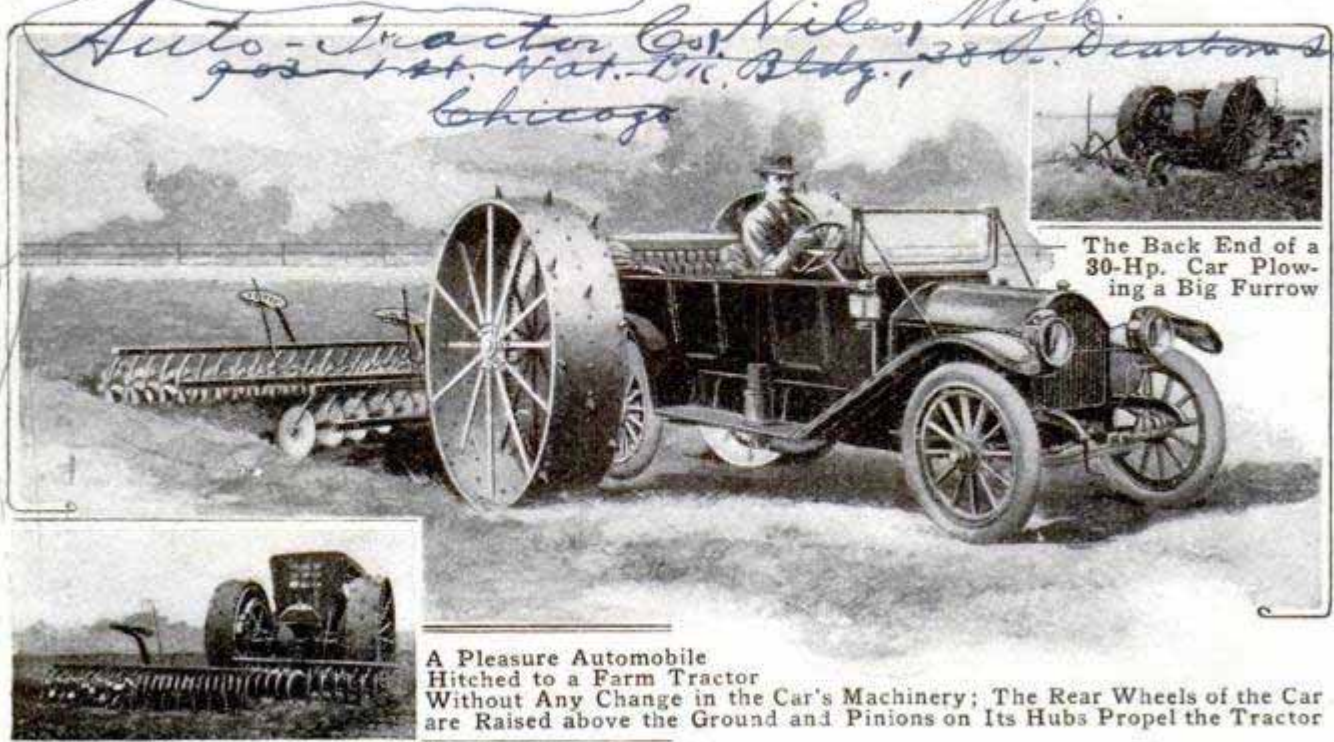

The Back End of a 30-Hp. Car Plowing a Big Furrow

A Pleasure Automobile Hitched to a Farm Tractor Without Any Change in the Car's Machinery; The Rear Wheels of the Car are Raised above the Ground and Pinions on Its Hubs Propel the Tractor

Engineering Record 3-22-13

Tractor Atlas

All May 1913 2684

Auto-Tractor Co., Niles, Mich.
902 1st. Nat. Bldg., 286. Dearborn St.
Chicago

C. J. Edson

mitted by a series of gears on the tractor which mesh with pinions attached to the automobile's rear hubs. When a 30-hp. pleasure car is hitched to the tractor and driven with an engine speed equal to 25 miles an hour on the road, it will draw the tractor two miles an hour and develop enough tractive power to do the work of several spans of horses.

ARMY AVIATION SERVICE TO 5228 BE DEVELOPED

8/23/33
If plans now being perfected are carried out, the army of the United States will be provided with an aviation service comparable with that of the other great powers. These plans provide, among other things, for 30 extra officers for aviation duty, and it is recognized that if officers are to be detailed to the Signal Corps, additional vacancies in the line should be created. The limited experience of the War Department in aviation demonstrates that considerable difficulty will be experienced in securing military airmen and that special inducements must be offered to secure eligible officers for aviation duty, and it is a recognized fact that airmen without some knowledge of military tactics would be practically useless in war. In view of these facts it is urged that officers on aviation duty should be given additional rank as well as increased pay, and that they should be promoted again, after they have secured a military airman's license, at the end of five years. The plans provide not only for an adequate aviation personnel but also for a sufficient number of aeroplanes and modern dirigible balloons.

RECLINING CHAIR THAT IS 5086 AUTOMATIC

No adjusting of levers or back rods is necessary with the new automatic reclining chairs that are now seen in the furniture stores. The back of the chair automatically assumes a reclining position as the occupant leans against it, and comes back to a verti-

cal position when released. The pressure of a button brings out a padded

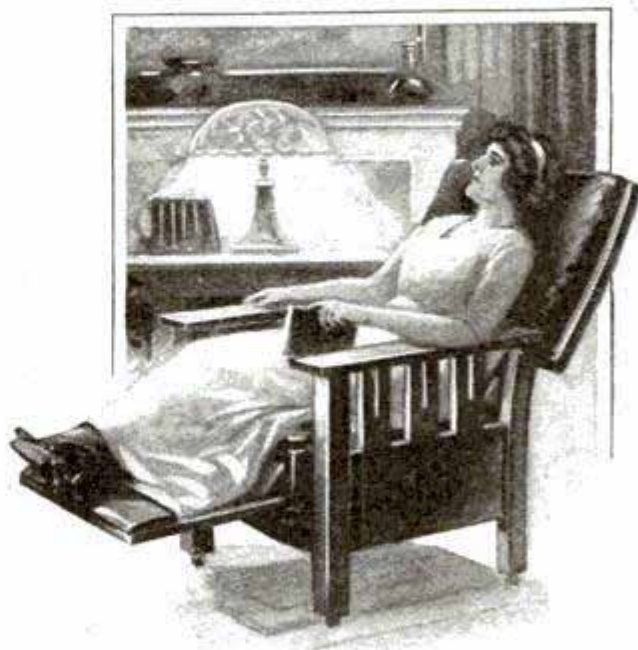

The New Automatic Reclining Chair

rest for the feet; when the foot rest is not in use it is hidden under the seat behind a flap on the front of the chair.

WINDMILL TO WITHSTAND 5101 SAHARA WINDS

A special type of windmill has been invented by the Italians for use in Tripoli, where the hurricane-like winds which blow from the Sahara Desert at certain seasons of the year make it impossible to use a n y ordinary type of windmill. The wheel consists of five blades of exceptional strength, which are widely spaced to allow room for the passage of surplus wind. This is mounted on a steel tower which is specially designed to withstand the high wind velocities of the simoon.



AUTOMOBILE TRANSPORTS

4622 NITROGLYCERIN

An automobile, provided with a special body designed to cushion the jolts

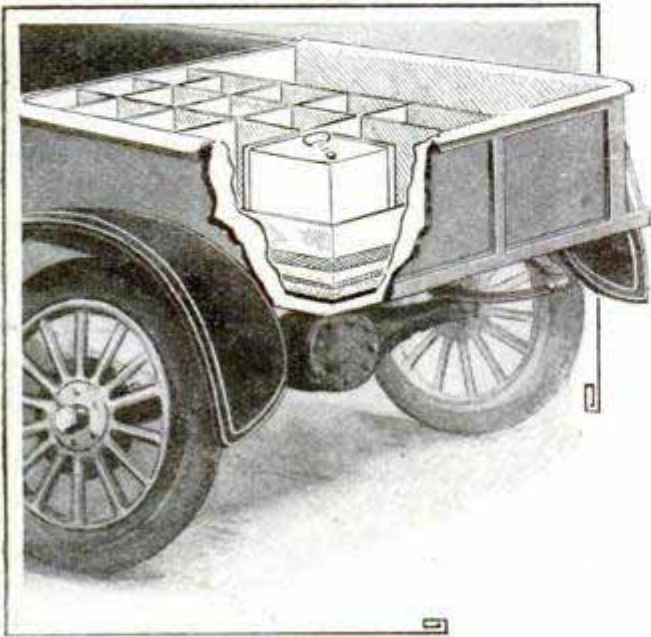

Automobile Equipped for Carrying Nitroglycerin in the Oil Fields of Oklahoma

and to protect the explosive fluid from heat and leaks, is being used in the

transportation of nitroglycerin in the oil fields of Oklahoma. At best the transportation of this sensitive explosive is a ticklish job resulting rather frequently in disastrous explosions, and this automobile is so designed as to minimize this danger to as great an extent as possible. A framework of yellow pine spans the entire loading space of the car. This is covered by a layer of asbestos, for protecting the nitroglycerin from the heat of the engine, and on top of this there is a solid floor of pine. A rubber mat tops the pine floor and on this there is a copper pan with sides 5 in. high, the rubber mat serving to reduce the jolts and the copper pan preventing the fluid from reaching the chassis in case of leakage. The nitroglycerin is contained in small cans which are carried isolated from each other in the cells of a wooden frame resting in the copper pan. In "shooting" a well one of these cans is lowered to the bottom and a weight, called a "go-devil," is dropped upon it, a simple means that always brings about the desired explosion.

5222 WHALEBACK CLIMBS ASHORE ON RIVER BANK

Navigation on land was attempted by a 300-ft. Great Lakes whaleback steamer which swerved from its course



A 300-Ft. Whaleback Steamer Which Tried to Climb Out of the St. Clair River

down the St. Clair River, crashed through a dock, tore off the end of a small warehouse, and drove its bow high and dry on the shore at Marine

City, Mich., on Aug. 17, 1913. As the vessel, the "Antikoken," was passing down the river without cargo, its steering gear became disordered, and before the engines could be reversed, it turned suddenly toward the shore. Striking the dock head-on, it plowed through the timbers, cut away the end of a warehouse in its path, and did not stop until its bow had been pushed high on land. Except for a few dented plates, the whaleback was not damaged and was pulled back into the water by tugs the next day. No one was injured, although the crew of 22 men stood ready to leap overboard should the vessel show signs of rolling over.

4646

LATEST TYPE OF CRANE FOR HEAVY SERVICE

An electric jib crane designed for the heaviest service, recently brought out in England, has a counterbalanced jib and is provided with a system of pulleys arranged in such a way that the load swings level when the end of the jib is raised or lowered. The crane jib is built on the cantilever principle, having an extended weighted arm at the rear end to which is attached the rods for raising and lowering. The lower end of each rod is coupled to a traveling crosshead which is raised and lowered in a vertical line by a screw operated by the motor. The most ingenious part of the device is the compensating mechanism. On the traveling crosshead is a pulley around which the hoisting rope passes as it leaves the hoisting drum. The rope then passes around a sta-

tionary pulley at the lower end of the mast, and from this to the jib. The result of this arrangement is that when the crosshead is lowered, the end of the jib is raised, and, since the distance between pulleys is shortened, the rope is paid out, while, when the crosshead is raised the end of the jib is lowered and the rope is drawn in. This does not interfere with the regular winding and unwinding of the rope on the drum, but is simply designed to keep the load level as it is swung in or out. By means of this compensating gear the ranges of lift above and below the rail level are the same for all positions of the jib, and the crane hook can be lowered to the bottom of a ship's hold when the jib is at a steep angle, as well as when it is extended and lowered for a long reach. The range for the size of crane shown in the illustration is from 35 ft. below

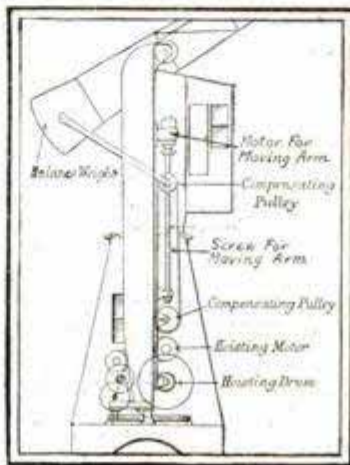
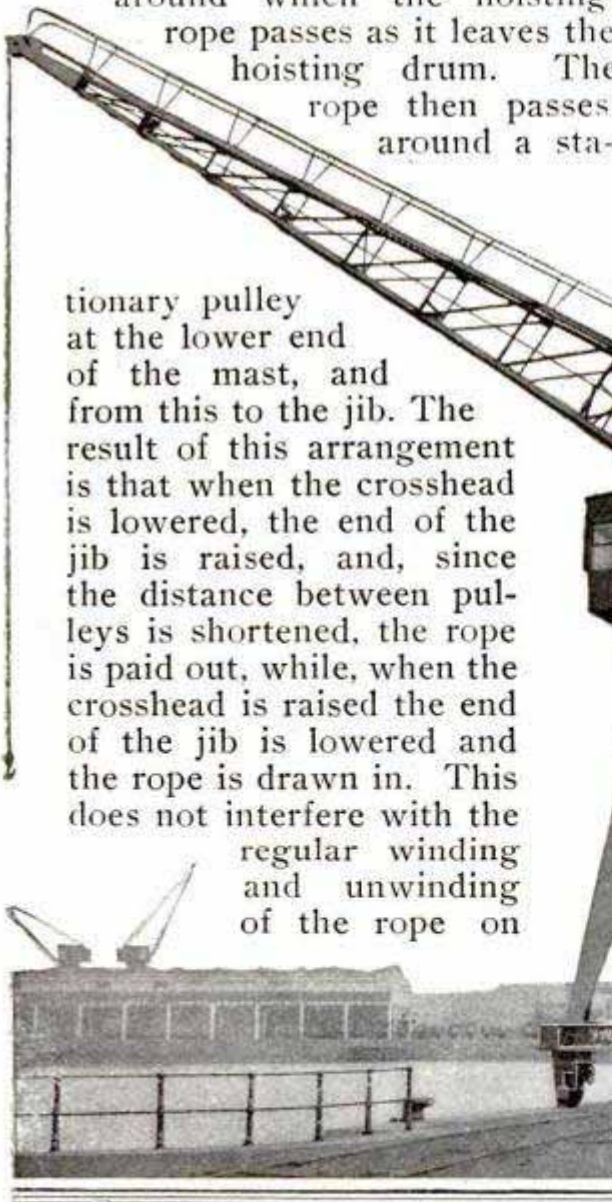

Details of Mechanism Which Causes Load to Swing on Level Line as Jib is Raised or Lowered

tionary pulley at the lower end of the mast, and from this to the jib. The result of this arrangement is that when the crosshead is lowered, the end of the jib is raised, and, since the distance between pulleys is shortened, the rope is paid out, while, when the crosshead is raised the end of the jib is lowered and the rope is drawn in. This does not interfere with the regular winding and unwinding of the rope on

Electric Jib Cranes in Position for Work at Avonmouth Docks

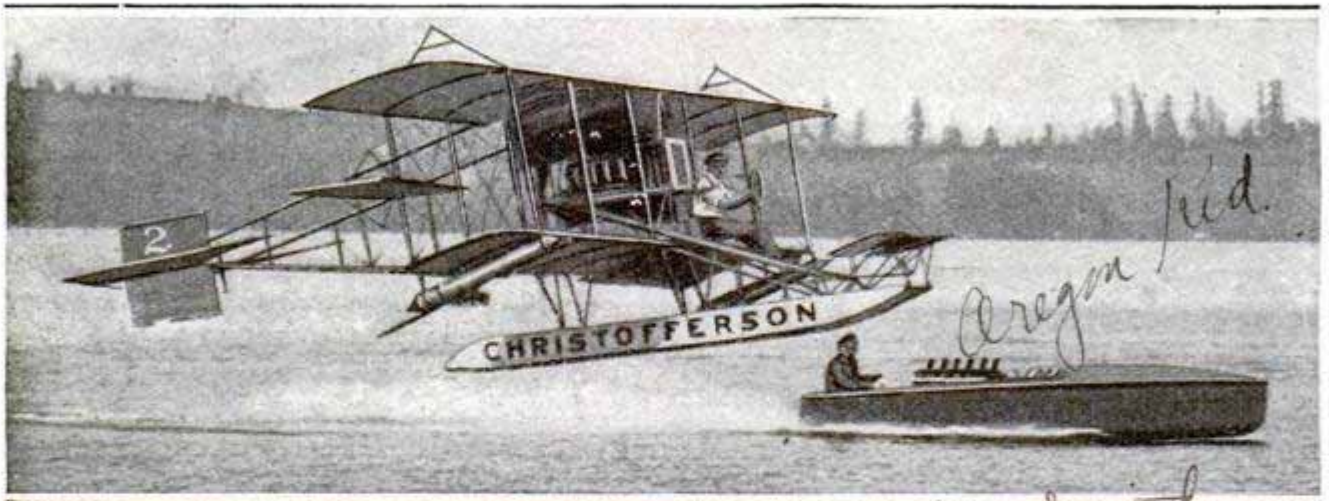

Ten-Mile Race between a Flying Boat and a Racing Motorboat, Won by the Flying Boat in 13 Minutes

quay level to 65 ft. above, or a total lift of 100 ft. This crane is operated by a 40-hp. motor and has a hoisting speed of 200 ft. per minute with a 2-ton load.

Owner - Melton Smith
FLYING BOAT BEATS FAST
5771 MOTORBOAT

A flying boat recently won a 10-mile race with one of the fastest racing motorboats in the United States. The motorboat has developed a speed of 54 miles an hour and holds the record for boats of its class on the Pacific coast. In the 10-mile race the flying boat finished in 13 minutes, just a few seconds ahead of the motorboat.

4772 RAVAGES OF HAWAIIAN BOOK WORM

A book worm which has been prevalent for some time in the Hawaiian Islands has been destroying the books in the public buildings and has damaged the royal paintings, relics of the former monarchy, to such an extent that they are beyond repair. The bound volumes of



the senate journal for 1907, of which an illustration is given, is a good example of the ravages of this worm. The large blotch at the corner of the cover is a space about $\frac{1}{8}$ in. deep eaten out by the worm. From this point channels branch off in different directions. Where these channels seem to end the worm gets down to real business and drills a hole straight through the book, continuing in this way through a succession of books placed together on the shelf.

5254 TO FIND A USE FOR THE AILANTHUS TREE

The ailanthus, sometimes known as the paradise tree or tree of heaven, is becoming so abundant in the east, especially in the Ohio and Mississippi valleys, that the United States forest service is conducting experiments to find a commercial use for it. It has been naturalized from some specimens introduced from China and is now becoming more abundant than some native species. But as yet it has not been used except in small quantities for boxes and crates. The Indiana Board of Forestry tried to use ailanthus for making excelsior, but found that it was not springy enough and tended to break and crumble, perhaps because it was kiln-dried. Further experiments are to be made with air-dried wood. Excelsior is not the product of wood waste, as is usually supposed, but must be made of wood with certain characteristics.

E. D. Brown
 1007 Steam F. St., Seattle, Wash.

See by newspaper Hotel

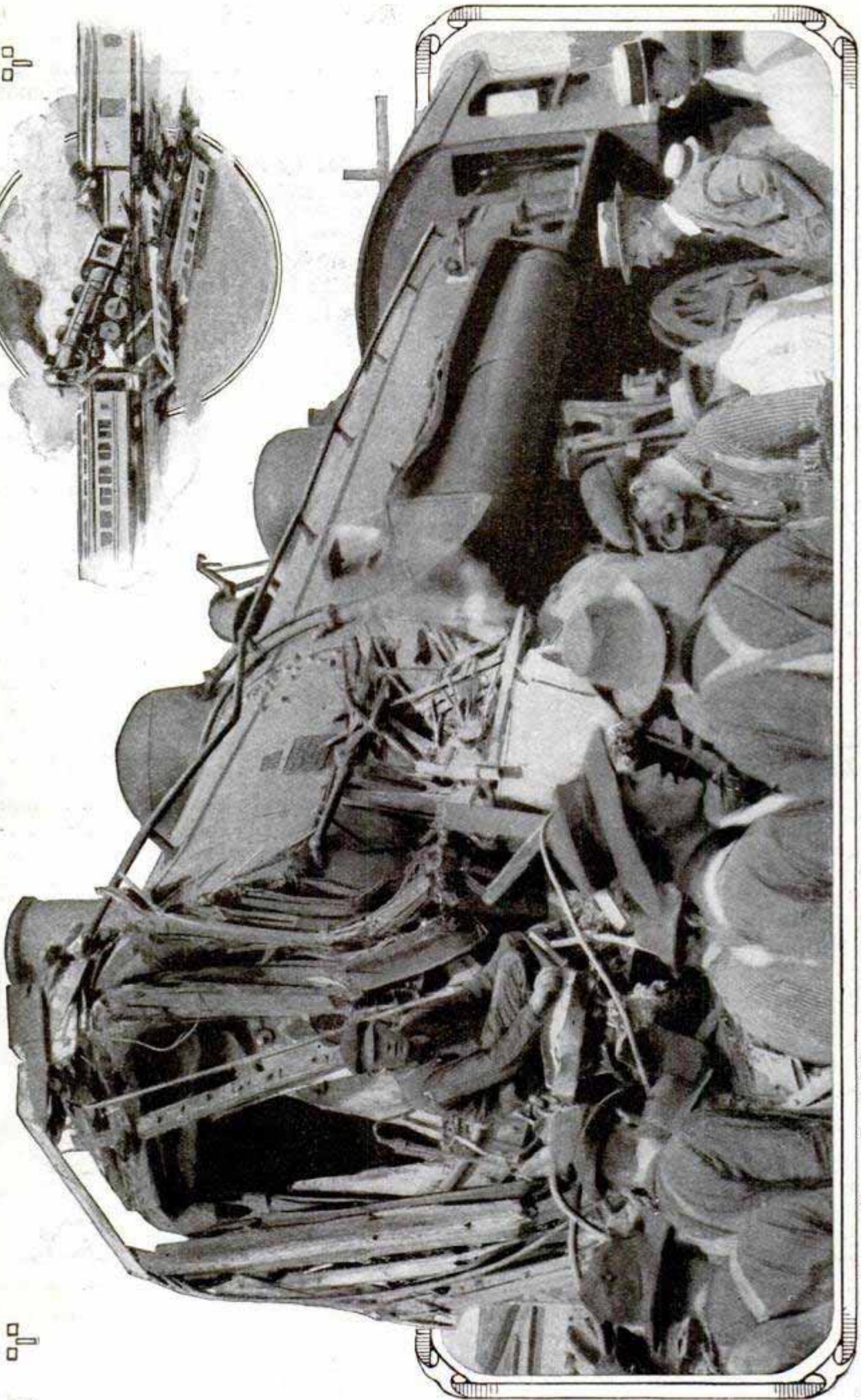

Copyrighted by Brown and Dawson, Stamford, Ct.
 Wreckage of a Wooden Sleeping Car on the Front of the Locomotive of the White Mountain Express Which Crashed into the Rear End
 of the Bar Harbor Express on the New Haven Line on September 2, Killing 21 Persons

LOCOMOTIVE IN NEW HAVEN

5263 WRECK

The terrific destruction resulting from a rear-end collision of modern high-speed trains is illustrated by the picture, on the opposite page, of the locomotive of the White Mountain Express which plowed through the last sleeper of the Bar Harbor Express on the New York, New Haven and Hartford Railroad near New Haven, Conn., on September 2, killing 21 persons and injuring many others. The front end of the engine's boiler is crushed in, laying open the smoke box inside, and the steel framework of the sleeping-car vestibule is pressed about the boiler head as if it had been forged there. The wreck was caused by the failure of the engineer on the White Mountain Express to see the danger signals as he plunged through a fog at high speed. The use of wooden cars on the other train is blamed for the great loss of life.

DESERT ROADWAY FOR MOTOR

4471 TRUCK SERVICE

Road work of an unusual character has been done in preparing a route for motor-truck service between Blythe, Cal., and a railway junction 50 miles away, where a large part of the route lies over a sandy desert. Over the worst section, where there is loose and shifting sand, plank wheel ways supported on railway ties were built, as shown in the illustration, and are giving satisfactory service. When the planks were laid they were given a coating of crude oil, to prevent warping under the intense summer heat and to give a better traction surface for the rubber tires. The cost of this construction was about \$1,500 per mile. On other parts of the route a roadbed was formed by placing a layer of arrowweed brush for a foundation and covering this with sand, a form of construction that is said to form a solid base when compacted by the passage of wagons and motor trucks. Formerly, freight teams required a week to make

the round trip and the charge for hauling was \$20 per ton. Now, a motor

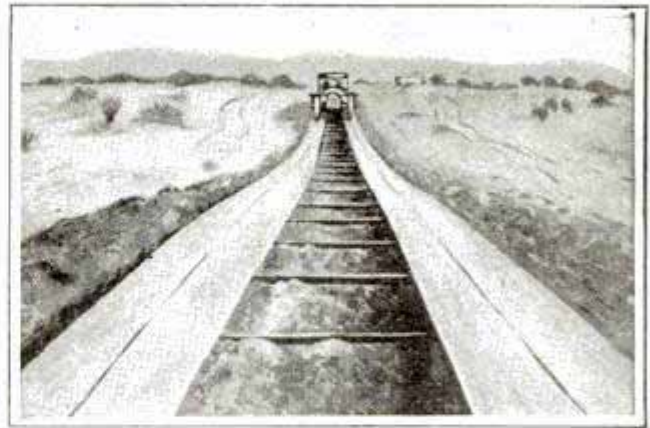

Motor-Truck Roadway across a Desert in California truck carrying 6 1/2 tons makes the trip one way in a day and the charge for hauling is but \$7.50 per ton.

THE WOMAN WHO KEEPS THE BEES

A German beekeeper has resorted to feminine charms to encourage his bees in collecting honey. He has built for his bees a hive in the form of a comely woman. She stands out in the garden with a hat on her head and a basket of flowers in her hand. From the front she looks like an ornamental statue by an unskilled wood carver. But from behind she is nothing but a

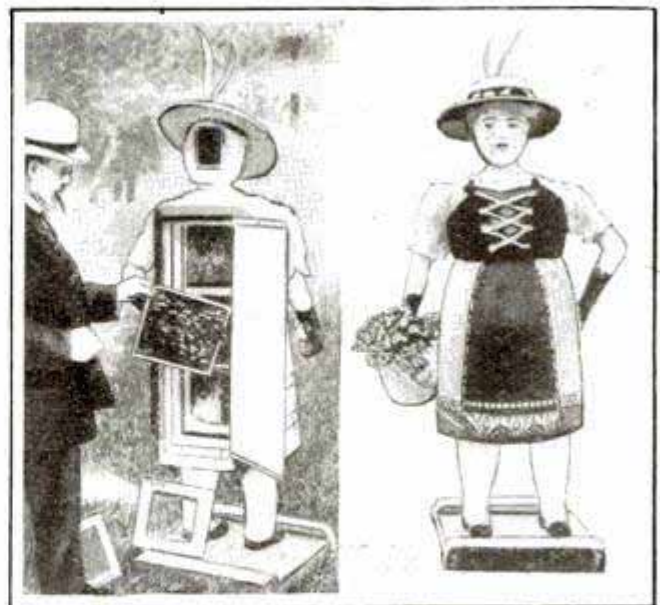

Courtesy of the Graphic A German Beekeeper's Idea of an Ornamental Beehive

beehive. The bees enter the hive through a hole in the back of her head.

Photo - Farmer - Lawson - etc. etc. Blythe Junction, Calif. Eng. Louis, Vol. 69 No. 22 page 1126

the woman who keeps the bees (2/11/13)



SIGNS TO GIVE THE RULES OF THE ROAD

5095

To relieve traffic congestion in the streets of Los Angeles, Cal., an ordinance has been passed forbidding drivers to leave their vehicles standing at the curb within 120 ft. of a street intersection. But the regulation is not simply written on the statute books like the "rules of the road" in many cities. Posted conspicuously on lamp-posts, 120 ft. back from every corner, are large, legible signs, reading: "Vehicles Must Not Stand Between Here & Next Corner."



Los Angeles, Calif.

AIRMAN FAILS IN FLIGHT AROUND BRITAIN

5295

Because his foot slipped off a pedal, Harry G. Hawker, an English airman, failed in an attempt to win the London Daily Mail's prize of \$25,000 for a flight around Britain in an all-British flying boat within 72 hours. After he had covered 1,043 miles of the 1,540-mile journey and had broken all records for oversea flight, he fell into the sea, 15 miles from Dublin, and wrecked his machine. With a mechanic as passenger, he had left Southampton on Aug. 25 and had succeeded in flying around the east coast of England and across the northern end of the island to Oban, on the west coast of Scotland, by the evening of Aug. 26. Waterlogged floats and engine trouble forced repeated landings all the next day. At 1:15 while he was spiraling

down at Lough Shinny, near Dublin, Ireland, his oil-covered rubber shoe slipped off the rudder bar and he fell into the sea from a height of 50 ft. Fatigue probably caused the accident. His machine was shattered, his passenger was seriously injured, but Hawker was not hurt. He received a consolation prize of \$5,000 and England considered the flight a great triumph, since it was made in a British machine with a British engine.

* RIBBON-INKING MACHINE 4793 FOR THE OFFICE

Ribbons for typewriters, adding machines, cash registers, time clocks, etc.,

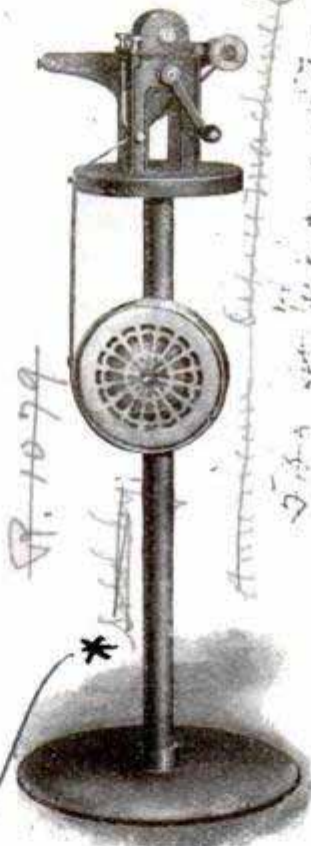

can now be re-inked or manufactured in the office through the use of a ribbon-inking machine that has recently been patented. Typewriter ribbon fabric of any width is fed through the machine by a crank and comes out on a standard typewriter spool ready for use, at the rate of one ribbon a minute. Inside the machine, the ribbon first passes through a reservoir of ink and then between

two rollers that squeeze out the surplus ink. The complete machine occupies less than a square foot of table space and works a considerable saving in office supplies.

ⒸThe Isle of Wight is to be connected with the mainland by an electric subway four miles long. The tunnel will run from Stokes Bay on the mainland to Ryde on the island and will cost \$3,750,000.

** A. J. Hawker*

See later covered ribbon-inking machine



Aerial Cableway for Transporting Milk Cans on a Large Dairy Farm

AERIAL CABLE TO CARRY MILK CANS

An aerial tramway is used for transporting milk cans on a large dairy farm near Biltmore, N. C. The cableway leads from the milking barns to the ice dairy house and twice each day great quantities of milk are sent over the line to be pasteurized and packed away for shipment. Two large cans make one load for the two-wheeled truck which runs along the heavy cable. Gravity furnishes the motive power for the cableway; the supports at each end of the line are arranged so that either end of the cable can be raised or lowered.

APPARATUS FOR DETECTING DEFECTS IN GLASS

Defects in glass due to improper cooling may now be detected and the extent of the defects definitely determined by means of an apparatus recently invented and patented in Germany. This apparatus is based on the principle that glass containing defects of this kind will show, when

placed in a polarizing apparatus, the same color effects as birefractive substances, the depth and nature of the coloring depending on the amount of stress in the glass. The apparatus consists of a cabinet having a dead-black interior and provided with a lens in one end for examining the glass and a small window in the top for admitting light. By comparing the colors in the glass with a color scale the extent of the stress may be accurately determined. While the method may

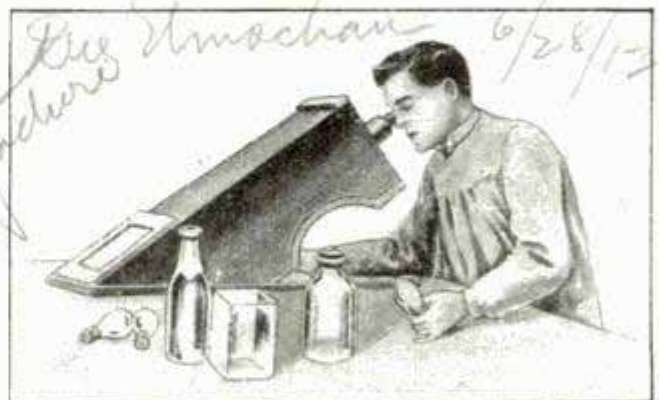

Glass is Studied Through a Lens and Coloring Due to Refraction is Compared with Color Scale

be used for glass of any kind, it is designed for studying glass that is to be used for laboratory purposes.

Asheville, N. C.
5140
for 2.50
Feb. 1913

5065 DEFECTS IN GLASS *manufactured*

transported at

**TARNISHING OF GOLD LEAF
5020 ON LEATHER**

Whether gold leaf can be made so pure that it will not tarnish when stamped on leather is a question that has been much discussed recently by shoe manufacturers. It has been maintained that no gold is so pure that it cannot be tarnished by sulphur, soda, and similar chemicals, and that "solid gold" jewelry will tarnish when worn by persons whose systems have an excess of these chemicals. Gold-leaf manufacturers contend that no metal can be stamped on leather and not tarnish except gold and aluminum, and, if copper is used in the alloy, gold will tarnish if it is less than 23 karats. On the other hand, if pure silver is used in the alloy, gold of 18 karats can be used without tarnishing.

*American Sh...
Fig. 113*

**FUNERAL OF A JAPANESE
4811 AIRMAN**

The funeral of Koha Takeishi, the Japanese airman who was killed near the Fukakusa Parade Grounds in the

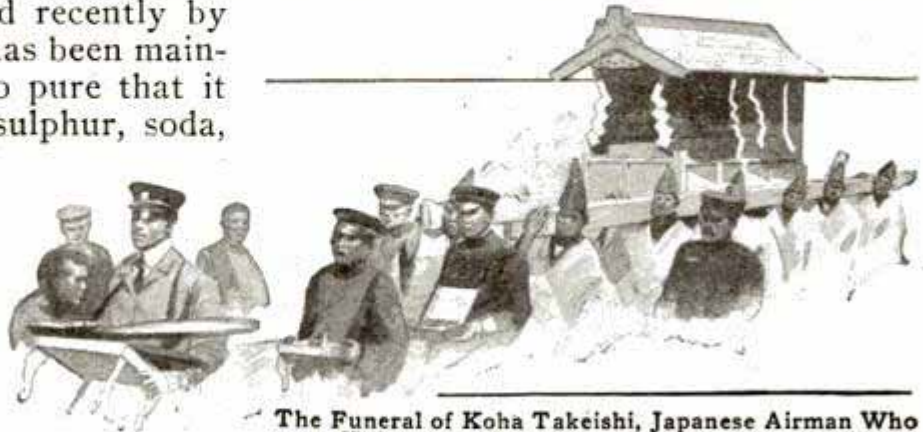

The Funeral of Koha Takeishi, Japanese Airman Who was Killed at Fukakusa, Japan: The Coffin is Borne by 12 Pallbearers and the Airman's Brother is Marching Ahead with a Piece of Broken Propeller

Japanese city-to-city flight, was the occasion for an impressive procession in his honor at Osaka recently. The airman had just returned from America and at the time of his fatal accident had nearly accomplished the city-to-city flight in a monoplane named "Shirahato," or "White Dove." His flight attracted nation-wide interest in Japan.

**MOTOR SLED THAT TRAVELS
1217 AT GREAT SPEED No Data**

A motor sled that is claimed to be capable of traveling at the rate of 40 miles per hour with two passengers, under favorable road conditions, has been constructed by a resident of Illinois. It will be observed that the front

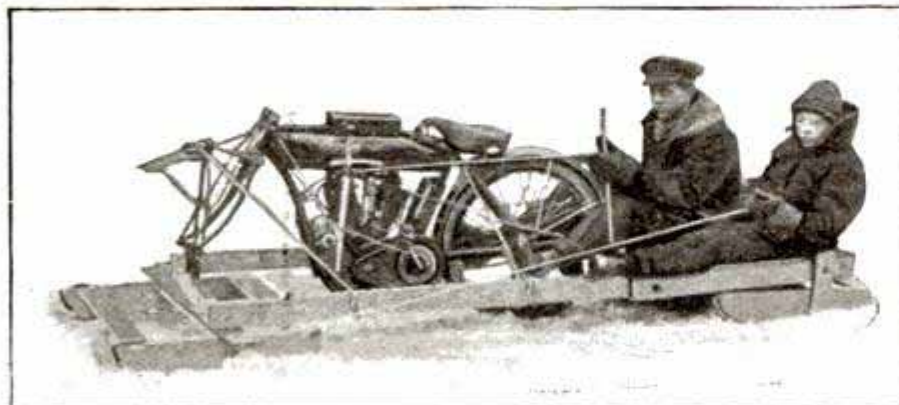

Sled Propelled by a Motorcycle with Its Front Wheel Removed

wheel of the motorcycle is detached, thus throwing more weight upon the rear wheel for the purpose of securing a stronger grip upon the snow.

**LONG SERVICE RECORD OF AN
5255 ELECTRIC BULB**

Over 50,000 hours of service is the record made by a carbon-filament electric bulb in Bancroft, Ontario. For 11 years and 6 months the lamp has been burning at least 12 hours every night. It began service in March, 1901, and was used continuously until January, 1912, when the Bancroft power station was destroyed by fire. In November, 1912, the current was turned on again and the lamp took up its work once more. It was still in use in August, 1913, and showed no signs of breaking, although its light was becoming rather dim.

See in...

Washington, D.C.

STEREOSCOPE FOR PIANO

4861 **STUDENTS**

To show piano students the correct position of the fingers and wrist, when they are studying without a teacher,

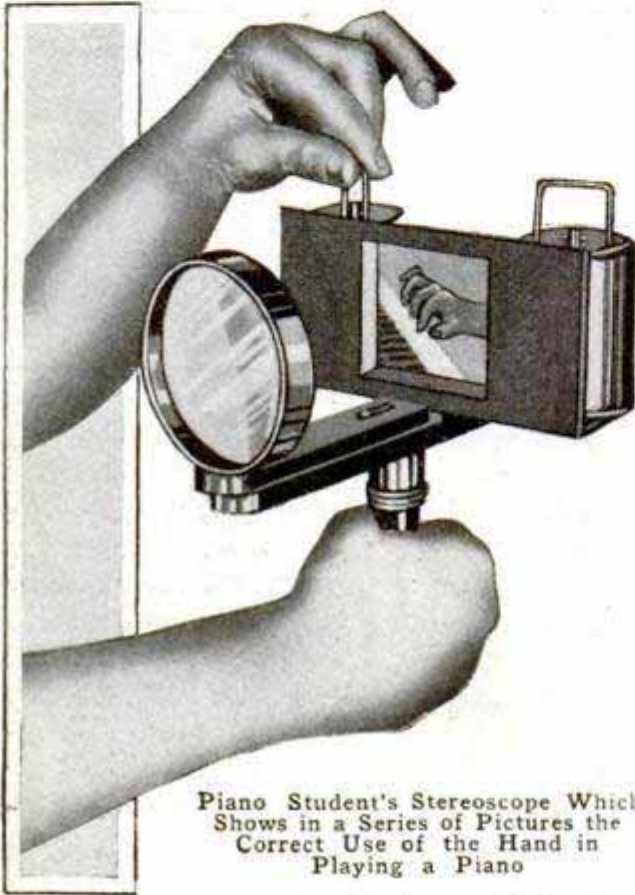

Piano Student's Stereoscope Which Shows in a Series of Pictures the Correct Use of the Hand in Playing a Piano

is the purpose of a device which has recently appeared on the market. In construction, it resembles a small stereoscope with two spools arranged like the spools in a film camera. A series of pictures, showing the various positions and movements of the pianist's hand, are mounted on a ribbon, which winds from one spool to the other and passes across a square opening behind a lens.

ROUND-THE-WORLD TICKETS

5258 **NOW SOLD CHEAPLY**

Through a coöperation of railways and steamship lines, round-the-world tickets can now be bought for very moderate sums. A first-class ticket for a two-year tour, with stop-overs at all interesting points, can be purchased in America at prices varying from \$639.10 to \$827.40, depending upon the route followed and the cities visited.

In general the trip leads from San Francisco to Japan via Hawaii, then to China, Ceylon or Australia, and to England, by way of the Suez Canal and the Mediterranean. Any boat can be taken across the Atlantic to America and any route by rail to San Francisco. Side trips to India can be arranged for a small additional sum, and many variations are allowed in the route. The rates cover passage, berth and meals on all parts of the journey except those taken by rail.

DEVICE FOR LOADING COAL TRUCKS

4525

An ingenious loading device has been put into service in Chicago for loading coal from gondola and flat cars into the motor trucks that haul coal for the various departments of the city government. This device consists of a hopper of peculiar shape, mounted on a pair of steel rails fitted to the top of the side of the railway car, which is filled by the loaders while the truck is away. The rail part of the device is like a pair of shelf brackets, placed over the car-body side as shown, a T-rail forming a connecting rail across the top. The outside bracket is hinged so that, when not in use, it can be folded flat against the car. The hopper is made of steel, the bottom being in the shape of a half circle so that

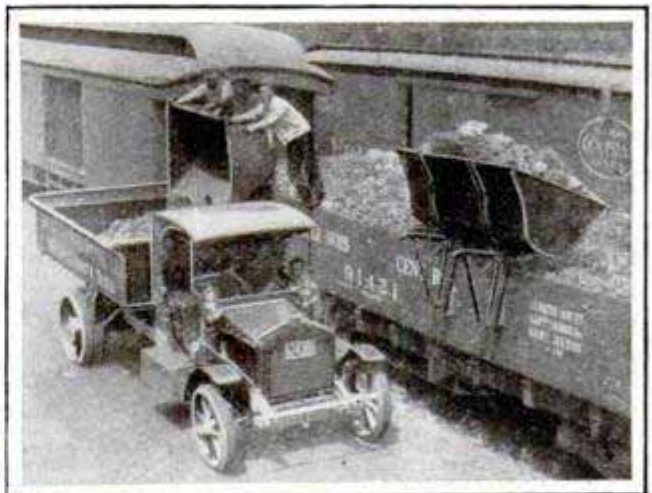

Device for Rapid Loading of Coal Trucks

it can be tipped toward the workmen while it is being loaded. To dump the hopper, the catch is released and a

slight lift on the low side rolls it over, causing it to dump into the motor truck standing at the side of the car. A chain prevents the hopper from rolling too far. Each hopper holds about one ton of soft coal. With several of these hoppers a 5-ton motor truck can be loaded in four minutes.

5276 **LIVES LOST IN WRECK OF GERMAN DIRIGIBLE**

Permanently
 The worst of the many disasters that have overtaken the Zeppelin airships occurred on the evening of Sept. 9, 1913, when the new German naval dirigible "L-1" was wrecked while flying over the North Sea from the German mainland to the island of Helgoland. In this disaster 13 lives were lost, and although it is the twelfth accident to befall the Zeppelin airships, it is the first to be accompanied by loss of life. The "L-1" had been ordered to take part in the night maneuvers of the German battleship fleet off Helgoland, and in spite of stormy conditions the flight to the island was undertaken. According to incomplete reports, the airship, after completing about half the voyage, ran into a hurricane and was either hurled into the sea by the force of the wind or sank to the surface of the water after its buoyancy had been reduced through the contraction of the gas by a sudden drop in temperature following the storm. It is also stated that the airship was carrying a greater number of passengers than it could safely sustain in stormy weather. An hour after the accident wireless signals sent out by the disabled airship were heard at the station on the island and torpedo boats were immediately dispatched to the rescue. The vessel was found broken in two, with heavy seas breaking over the aluminum framework. The airship carried a crew of 20, and of these only seven were rescued. The 13 that were drowned are thought to have been caught in the cabins, which, owing to their position, were submerged the moment the airship touched the water.

4748 **STEAM SHOVEL CONVERTED INTO PILE DRIVER**

A small steam shovel was used successfully as a pile driver in the construction of a covered ditch at Utica,



Small Steam Shovel Converted into Pile Driver for Working in Crowded Space

N. Y. After this shovel had completed the excavation it was found difficult to use an ordinary pile driver owing to the limited working space. The bucket was removed from the shovel and a pair of 26-ft. leads were bolted to the boom and in these a 2,800-lb. steam hammer was mounted. The thrusting arm was bolted to the leads so that when it was fully extended the leads were in a vertical position, and the back end of the shovel was weighted down with about 400 lb. of iron. An average of 19 to 20 piles were driven in a 10-hour day. After the completion of the driving the leads were removed and the bucket replaced in less than three hours.

Maumbury Rings, the old Roman amphitheater at Dorchester, Eng., is being excavated and explored.

U. P. Beebe, Utica, N. Y.

4974 NEW FAST MAIL-EXCHANGE SYSTEM

An automatic mail-exchange system, to take the place of the old catcher arm used on mail cars to pick up mail sacks while going through stations at high speed, has recently been invented and tested in various parts of the country. It not only picks up any number of the largest mail sacks without damaging their contents, but deposits other bags gently in a trough beside the track. The entire operation is automatic and requires no attention from the mail clerks in the car. With this mail-exchange system a train could run from New York to San Francisco without a stop except for coal and water and the postal cars could be loaded and unloaded at every station without the mail clerks going near the doors. The apparatus with which the mail car is equipped consists of a steel delivery basket and a steel receiving chute built into the door on each side of the car and geared to the car axle. On the station platform there are from one to twenty two-arm delivery cranes for holding the outgoing mail bags, and a receiving trough, 150 ft. long, to catch bags dropped off the train. The apparatus on the car is operated by an automatic mechanism geared to the axle and set in motion by a trip placed beside the track, 390 ft. from each station. As the mail train approaches a station, the trip starts the mechanism, and the car door is opened, the mail bags are exchanged and the door closed, without any attention from the clerks. The gearing is such that the car travels 180 ft. while the door is being opened. In the next 180 ft. the receiving chute is extended, in the next 180 ft. the delivery basket drops its mail bags into the station trough, in the next 180 ft. each is returned to its former position, and 180 ft. farther the door is closed. In contrast with the present receiving arm, which cannot receive much more than 25 lb. of mail, the automatic system can handle bags weighing 500 lb., and the number that it picks up is limited only by the number of cranes at the station.

Its chief advantage, however, is that it eliminates all danger to mail clerks and handles the mail bags without damage. The receiving arm is made of three iron bars so shaped that the friction of the mail bags checks their speed as they enter the car, and the chute which receives them guides them into a pile on the car floor. The two-arm station cranes hold the bags by the top and bottom and automatically yield to the motion of the train, so that a large amount of the shock is eliminated. In dropping mail bags, the automatic system deposits them in a wooden trough where their momentum is stopped gradually by friction. In some of the recent experiments, bags containing boxes of eggs have been exchanged without damage to the contents, while the mail car was traveling at a speed of 60 miles an hour.

EXPLOSION FORMS CAVITY

5229 FOR PILE BASE

A novel method of spreading the concrete to form the enlarged bottom of a pedestal concrete pile has been developed and is being introduced in Switzerland. An iron tube containing a wooden pile with an iron point is first driven into the ground to the required depth. The wooden pile is then removed, a cartridge provided with an electric detonator is lowered to the bottom of the hole, and the iron tube is filled with wet concrete. Following this operation the tube is drawn up a few feet to prevent damage from the explosion, and the charge is fired. The force of the explosion compresses the surrounding material and forms a cavity which is filled by the concrete contained in the tube. The tube is again filled with concrete and is drawn up gradually as the filling progresses until the pile is completed to the desired height. It is claimed, apparently on good grounds, that better compression and a larger base can be produced in this way than by any other method.

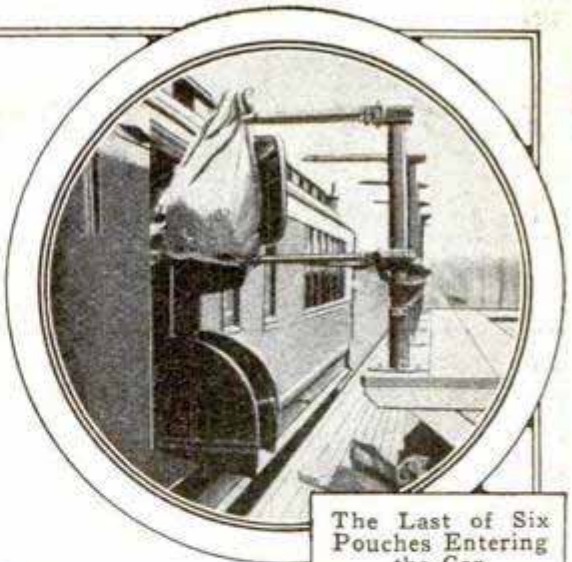
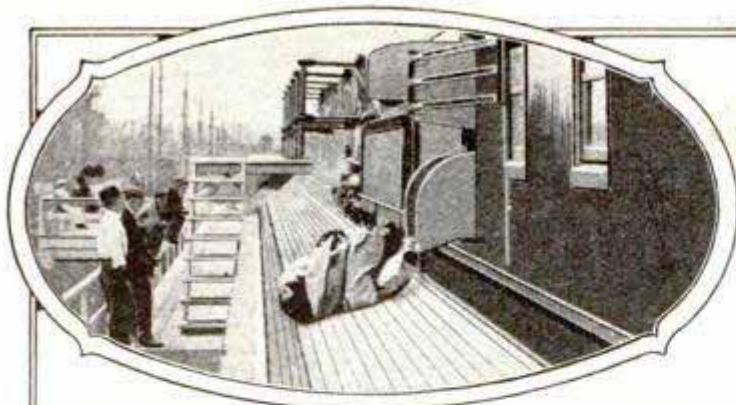

Exchanging Mail at High Speed

The Last of Six Pouches Entering the Car

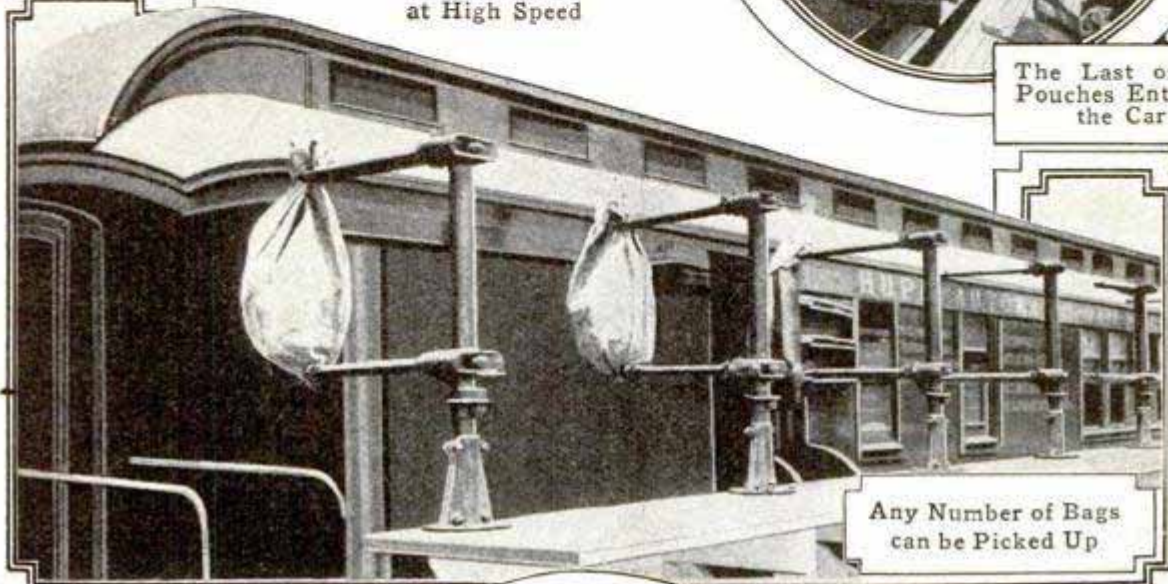

Any Number of Bags can be Picked Up



The Mail-Bag Catcher Arm Now in Use

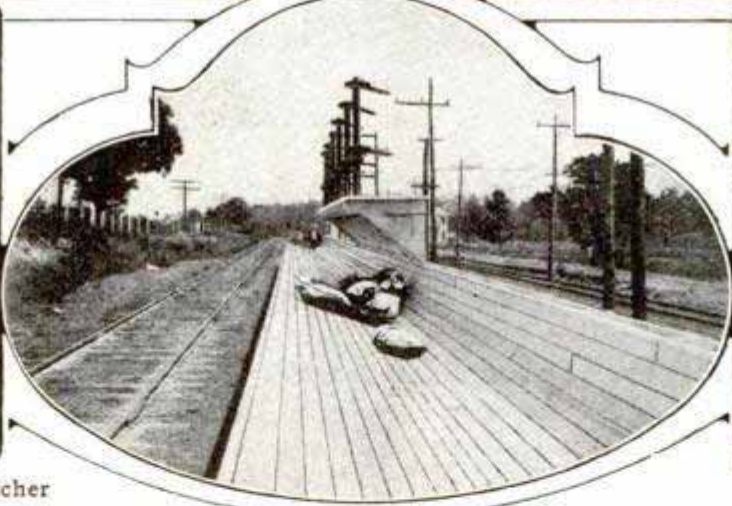

The Mail Car Drops the Bags into a Trough at the Station

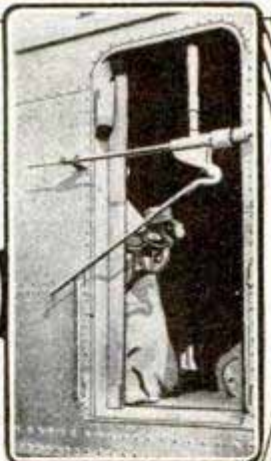

Examining a Box of Eggs Which Was in One of the Bags

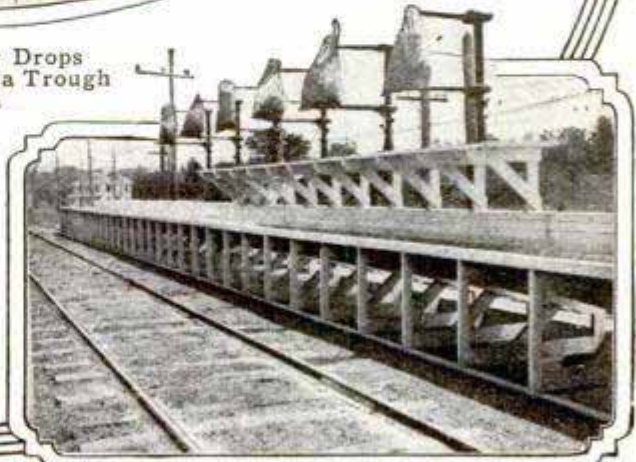

Automatic System of Fast-Mail Exchange: Receiving Trough and Mail-Bag Cranes at Station

ELECTRIC PROPULSION FOR 4935 FIRE ENGINE

A fire engine driven by a storage battery has been in service in the New York City fire department for over a



Courtesy The Edison Monthly
Electrically Driven Fire Engine in Service in the New York City
Fire Department

year and has, in that time, stood all tests satisfactorily. This engine was originally a horse-drawn steam pumping engine of the ordinary type, and had seen 10 years of service before it was converted into an electric machine. Some alterations in the frame were made, and the engine was equipped with an 80-cell storage battery, with driving and steering apparatus and with a controller of the type used with trolley cars. Only the motive power is electric, the pumping being by means of the standard boiler and pump equipment. In a series of speed trials this machine made a 6-mile run through the city streets in 23 minutes, and over one stretch developed a speed of over 20 miles an hour.

Elevators were used in the imperial palace at Rome, 2,000 years ago, archaeologists believe. The kind of power used is not known.

STORAGE-BATTERY CARS ON 5235 GERMAN RAILWAYS

The practicability of storage-battery railway cars is being demonstrated in a striking manner by the practice of the Prussian State Railway. Without any marked change in the design or construction of the cars, that German railway has gradually increased the number of such cars in use from six, in 1907, to 200 at the present time, and it is now maintained that the accumulator cars can be operated at a much lower cost per mile than steam locomotives or gasoline-electric cars. The type of vehicle in use consists of two cars coupled together, with seats for 100 passengers. The storage batteries are carried at the extreme ends of the train, and two of the six-wheel axles carry 85-hp. motors. One charge of the batteries carries the train about 62 miles at a speed ranging from 37 miles an hour, on the level, to 22

miles an hour, on a 2.5-per-cent grade. The two cars weigh about 55 tons, of which the batteries are responsible for about 17½ tons. The cost of a two-car train is about \$18,000. The total cost of operating such a train, allowing for maintenance, depreciation, etc., is about 17 cents per mile, of which about 4.6 cents is charged to current.

OVERFLOW DAM TO PREVENT 4667 ESCAPE OF FISH

An ingenious dam for controlling the overflow of a pond and preventing the escape of the fish is shown in the accompanying photograph. The pond, on a farm near Pilot Knob, Mo., had a habit of washing away the earth dam and overflowing with all its fish after every hard rain, and the owner built this dam to prevent it. The overflow dam consists of a concrete well, 12 ft. deep and 6 ft. in diameter, protected by

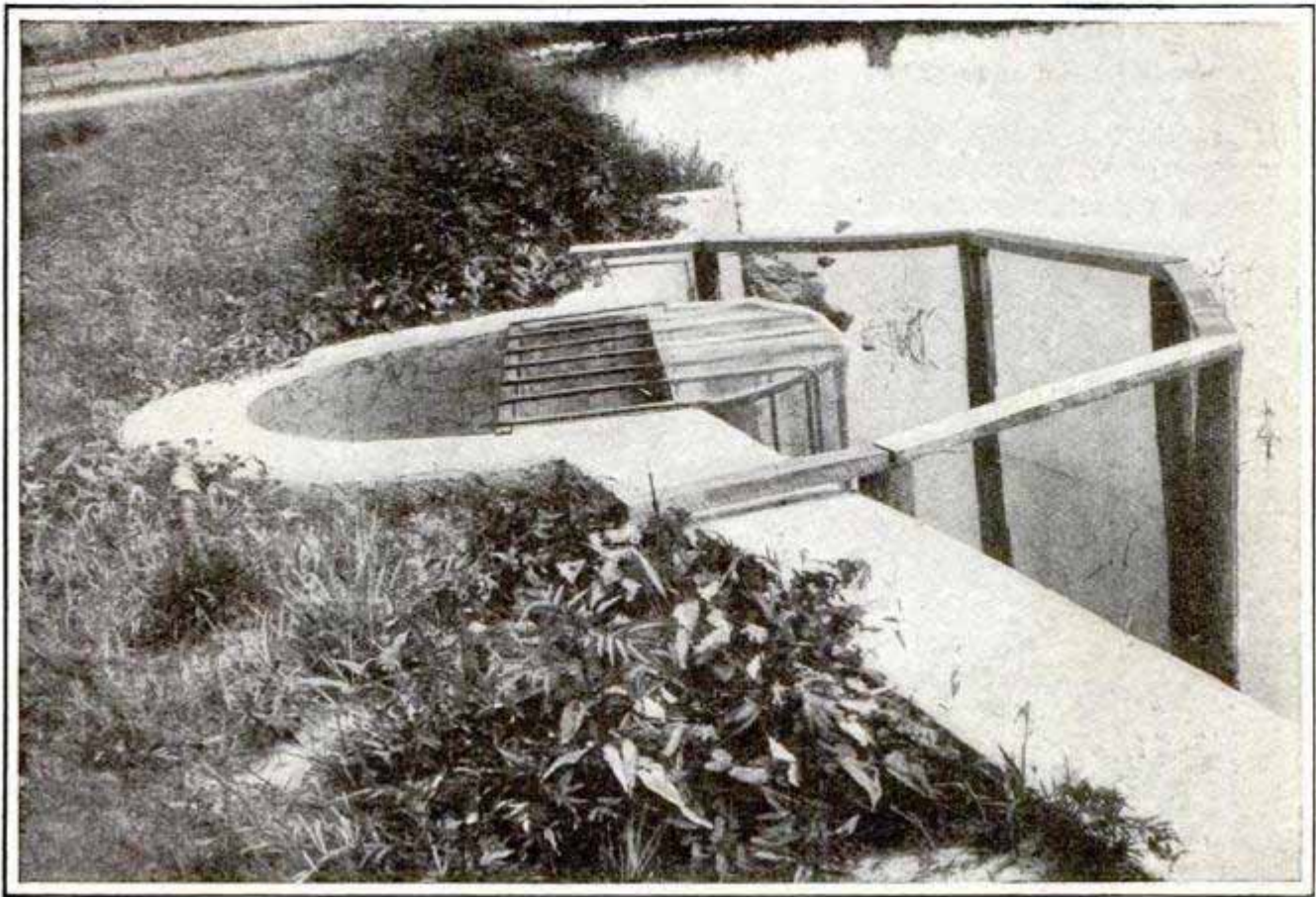

This Dam Controls the Overflow of a Fish Pond

concrete wings on each side. A large concrete tunnel leading from the bottom of the well carries off the surplus water, and an iron door at its bottom, on the pond side, makes possible the lowering of the water level. The receiving side of the well is 2 ft. lower than the top and a large quantity of water can escape in a short time. Two sets of screens keep the fish from leaving the pond. During the last four years the dam has not washed out.

**NEW DEVICE FOR HOISTING
 5154 BUILDING MATERIAL**

A hoisting frame designed to be attached to an ordinary ladder and thus do away with the necessity for erecting a special frame to support block and tackle is one of the latest improvements in building-construction equipment. The frame, weighing only 15 lb., can easily be carried to the top of the ladder by a workman, and is capable of sustaining even more weight than an ordinary ladder. The upper part of the frame has two hooks which hook over the top rung of the ladder. A small

steel beam runs down the side of the ladder, resting on the rungs, and is secured to the ladder at the lower end by means of a cord. The swinging boom on which the block is carried has two arms, one running to the top

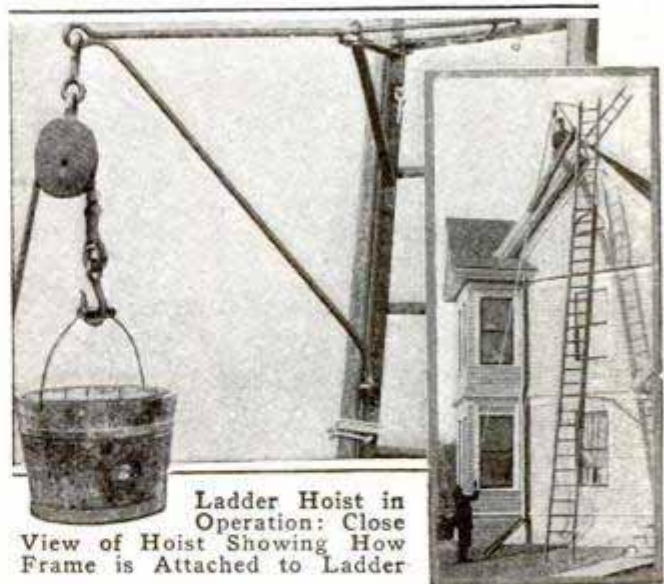

Ladder Hoist in Operation: Close View of Hoist Showing How Frame is Attached to Ladder

and the other to the bottom of the frame. With this device the load is hoisted clear of the ladder, which serves simply as a support for the hoist. When not in use the frame can be folded compactly for storage.

NOVEL INTAKE FOR WATER-SUPPLY MAIN

5155

To insure a free flow of water into the supply main at Marquette, Mich., where the water supply is taken from



Completed Intake for Marquette, Mich., Water-Supply Main: Intake on Scow Ready to be Lowered by Derrick into Final Position

Lake Superior, a novel form of three-way intake has been installed. Each branch of the intake consists of a pipe, 36 in. in diameter, which is the size of the supply main, and has its opening protected by heavy steel-wire mesh. The branches are curved upward so as to stand clear of the lake bottom. The entire intake weighs about 17 tons, and was placed in position on the lake bottom in water 68 ft. deep.

THE SKYSCRAPER OF THE FUTURE

4843

Skyscraper building is changing and progressing so rapidly that the tall buildings of today are evidently in a transition stage. While skyscrapers not yet 30 years old are being torn down because they are out of date

and innovations are appearing in each new building, prophecies of the future city office structure, characteristic of American life, are coming from engineers and architects. That it will be a community building is the common belief—and that it will be large. It will cover half or all of a city block, perhaps 50,000 to 100,000 sq. ft. of area. Its ground floor will be a network of corridors and arcades to accommodate shops, and it will have subway and aerial, as well as street, entrances.

But the change that is most confidently expected is greater lightness and economy of construction. This is to be accomplished first by a change in the steel skeleton. The use of harder steel—nickel, chrome nickel, or vanadium steel—will reduce the weight of the skeleton and probably its cost. Added to this is the abandonment of masonry. The modern skyscraper, it is claimed, needs only a screen to protect it from weather, water, and fire; heavy masonry is useless. A sheathing of from 4 to 8 in. of vitrified clay or concrete will supplant the stone walls and the resulting lightness of the steel framework will reduce the weight of the building by 50 per cent. Foundations will thus be relieved and become cheaper. But a new style of architecture must be evolved, employing smooth, as well as thin, outer walls, for joints in the vitrified sheathing are as unnecessary to the skyscraper as masonry.

The money that will be saved in the economy of materials will be devoted to interior improvements. The future skyscraper will have a climate of its own; its heating, lighting, and ventilating machinery will keep it at a constant temperature. And since the building itself has become fireproof, wooden finishings and furniture will soon disappear.

While the locomotive was crossing a bridge, an English railway employe recently jumped direct from the foot-board of the locomotive into the river below to rescue a boy from drowning.

ATTRACTIVE RESIDENCE OF MODERATE COST



P. O. Andrews, Architect, Mt. Sterling, Ky.

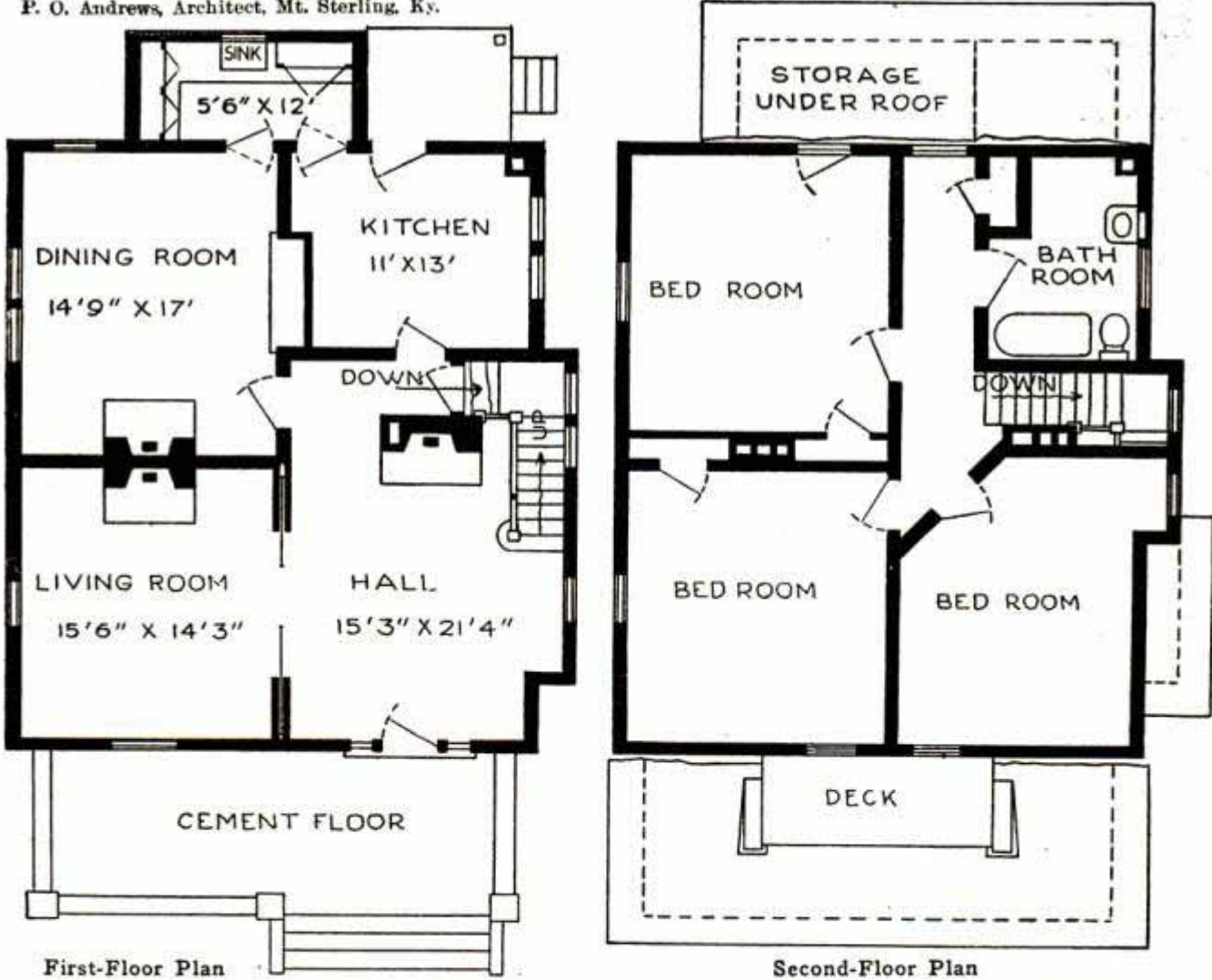

One of the chief merits of the seven-room residence shown above is its simplicity and convenience of arrangement. This building, which cost about \$3,100, has concrete foundations and a base formed of yellow brick laid in cement mortar, the upper portion being of frame construction. The first floor is finished in red oak and the second floor in pine. The floor and steps of the front porch are of concrete.

3478

A WAGON WITH SLED RUNNERS

A vehicle which may be used as an ordinary wagon or converted into a sled has been patented by a resident

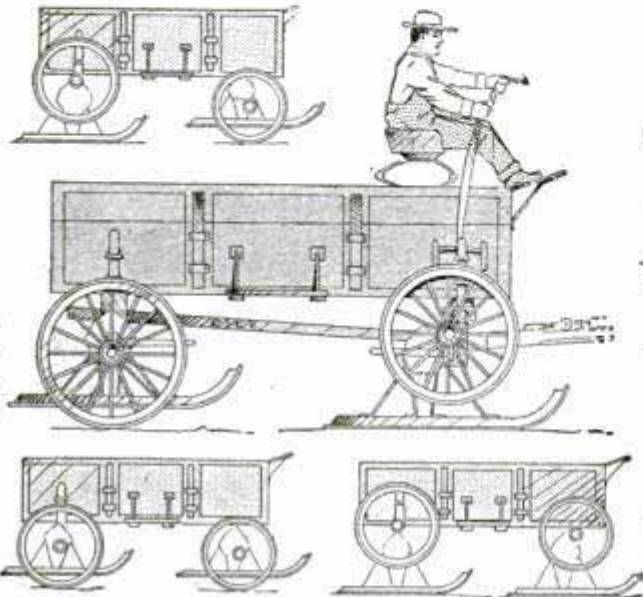

A Combination Wagon and Sled

of Michigan. The wagon has wheels and runners attached to its front and rear axles in such manner that, by simply pressing a lever connected to each axle, the four wheels or four runners may be raised or lowered together, or in pairs, as desired. That is, the front part of the wagon may be made to rest upon runners, while the rear section remains upon wheels, or vice versa, or all four wheels or the complete set of runners may be used.

LIFE-SAVING CREW MOUNTED ON A MOTORCYCLE

Motorcycle life savers have been installed at Redondo Beach, Cal., to rescue drowning persons. The crew consists of two men mounted on a two-cylinder motorcycle with a sidecar and a pulmotor. The rescuing is effected by means of a life-saving reel and 500 yd. of fine steel cable snapped to a light torpedo-shaped buoy, which will support 200 lb. and can be dragged through the water very rapidly. One of the guards swims out to the drowning person to be rescued, taking the buoy along, and then the other guard winds

in the cable on the reel, dragging the rescued and rescuer to the shore. A 7-ft. stretcher on the sidecar furnishes quick transportation to the nearest hospital. In the locker under the stretcher are blankets, first-aid apparatus, and a pulmotor for artificial resuscitation.

PLATINUM-PLATED WARE FOR CHEMICAL WORK

Platinum-plated dishes, crucibles and other utensils for chemical laboratories can now be made to take the place of costly solid-platinum apparatus. Platinumware is necessary in the laboratory on account of its resistance to chemical action, and until the present process of platinum-plating was patented no substitute had been found. In this process platinum is welded to a base of steel or nickel and rolled into a sheet. The resulting plate is then spun into the desired shapes and platinum is fused on the edges to cover up the exposed base metal.

GASKET-CUTTING MACHINE OPERATED BY HAND

A gasket cutter for cutting sheet asbestos, fiber cloth, copper, lead, or other metallic packings, any size from 1 1/2 to 12 in. in diameter, has been patented by a Chicago man. A cast-iron arm supports a hand crank, cutters and

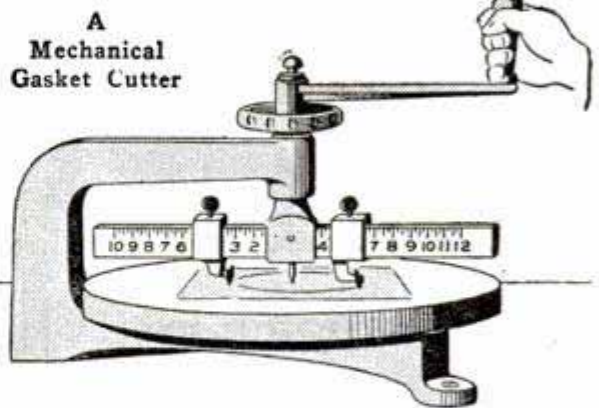

A Mechanical Gasket Cutter

gauge, over a hard-maple table upon which the material to be cut is placed. Turning the crank lowers the cutters and continued motion gives the incision. The cutters, of tool steel, are dished and set at an angle.

Hessell, Trench.
Albert Clements Hill
1,052,059 - Albert
Serial 711,654873
(U.S. 21-96)

5122
Patented in U.S. 1914
Mr. Byron Eldred
Patent Attorney

LOCAL ADVISORY BOARDS FOR FOREST USERS

4926

To give local users of the national forests a voice in the regulation of the forests in which they are interested, local organizations of forest users are to be formed to cooperate with the forest service. A new regulation to this effect has recently been drawn up by the secretary of agriculture to go into effect at once. It permits any local organization which includes a majority of the forest users in the locality to select a committee to confer with the local forest officers in an advisory way. Such an arrangement, it is expected, will insure a more careful consideration of local interests by forest officers and in the end promote the general welfare. The western users of the national forests will thus cease to feel that they are dealing with a far-away bureau over which they have no control, represented by local officers whose actions cannot easily be protested against. The plan will be an extension of the cattle and sheep growers' associations already in existence.

U.S. Dept. of Agriculture

DEVICE FOR PRODUCING STAGE ILLUSION

4502

An ingenious device recently invented enables an actor to go his best pace in chasing a stage train without

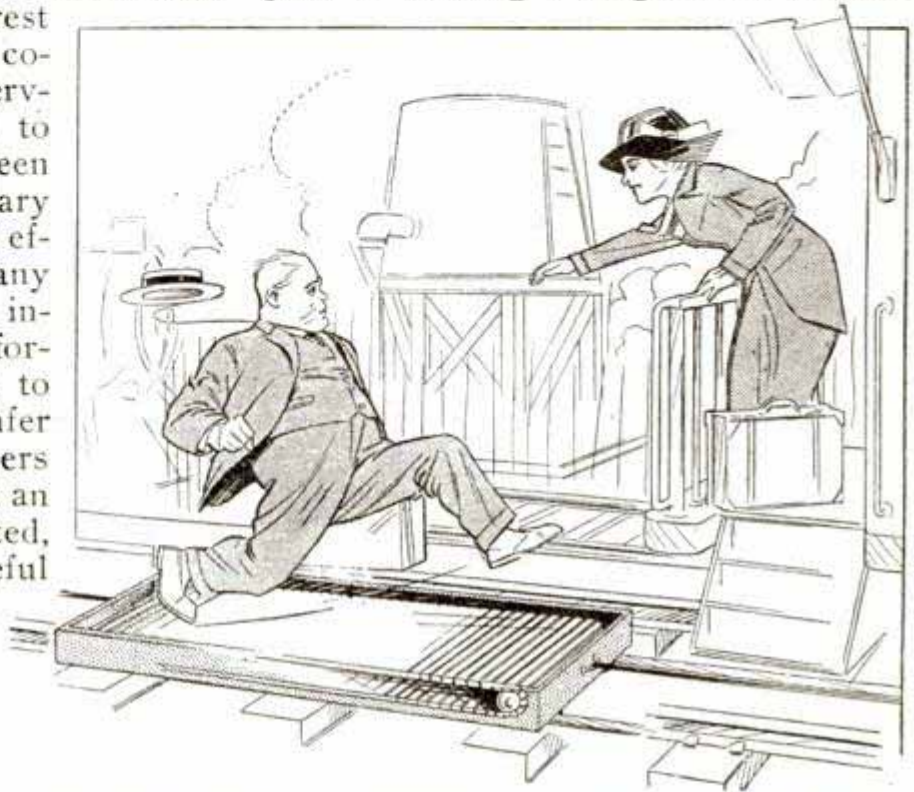

Actor Chasing Stationary Train Which is Apparently in Rapid Motion

any danger of catching up with it, although the train is standing still on the stage throughout the scene. The actor simply runs on a track consisting of an endless band which is adjusted to run backward as fast as the runner goes forward. To add to the illusion the background is made in the form of a translucent screen, on which a moving landscape is projected by a lantern. A foreground screen of open-meshed fabric is placed at the front of the stage, and on this pictures representing rain or snow are projected. The resulting illusion is that of a rapidly moving train.

INCREASED USE OF SILENT GEARING

4991 "Citizen" System

Silent gearing for high-speed and heavy-duty work has been developed to such an extent that it is now being installed on ocean steamships. Work extending all the way from the steering of ships to transmitting power in huge dredges and rolling mills is now being done with gears that will run at a speed of 4,000 ft. per minute with practically no noise. On some of the new turbine battleships, four pairs of silent gears have been installed to transmit 68,000 hp. Some gears of this type have been turned out with a diameter of 30 ft. and a face 10 ft. wide.

A. Citizen et al

A FOLDING STAIRWAY FOR INFREQUENT USE

4805

A folding stairway designed to provide convenient access to attics, lofts and other portions of a building that are infrequently entered, has been patented and placed on the market. The feature of this stairway is that, when not in use,

115/100 A known... advertising

nautilus

it may be folded up into the ceiling, where it fits compactly and has the appearance of a ceiling panel, so that it does not occupy any valuable floor space. The operation is entirely automatic, the stairway being handled by

MARINE PRESSURE RECORDER
4431 OF NEW TYPE

An instrument designed to give an accurate record of the steam pressure maintained during a voyage of any duration is one of the latest developments in steamship equipment. These instruments are made in two types, single and duplex. In the duplex type two recorders are mounted in one case, and make a record on separate charts rotated on the same clock drum. They are arranged so that one instrument records the pressure in the boiler or main steam pipe and the other the pressure in the engine valve casing. In this way the records

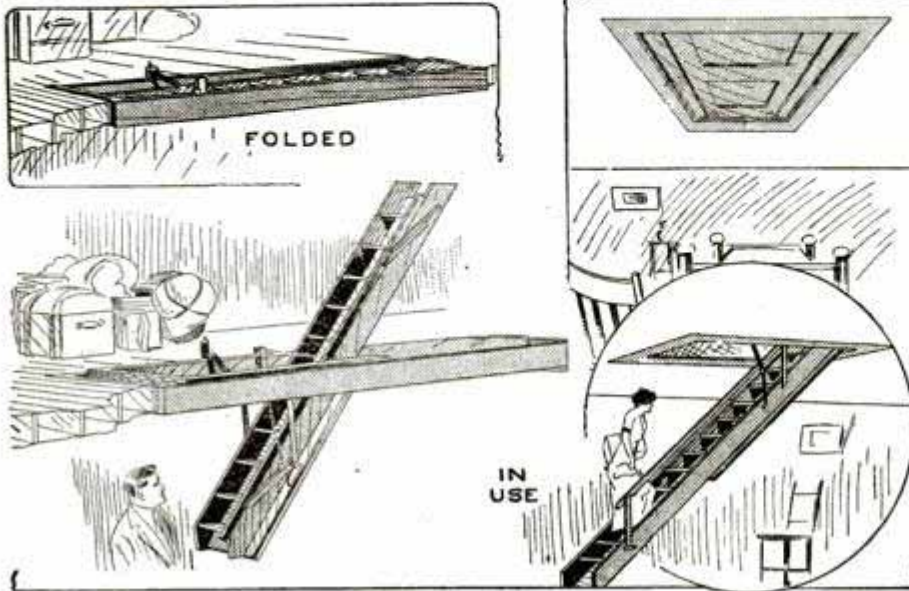

Stairway Which may be Folded into the Ceiling When Not in Use

spring rollers concealed under the landing, which first pull the stairway half-way up and then flatten it into the ceiling through the action of a counterbalance. Friction is eliminated by roller bearings located between the stairs and the ceiling. A light push is all that is needed for folding the stairway, while a pull on a chain brings it down.

show how the steam pressure has been maintained, whether there has been a drop in pressure, and what has been the effective steam pressure at the engines. The clock requires winding every eight days, and can be stopped at will by a special contrivance, so that the recorder can be put out of action when the vessel is in port.

Recorders - Duplex type

5066

A SLIDE RULE FOR CIPHER MESSAGES

The tedious work of writing and translating ciphers and secret-code messages has been reduced to a mechanical operation by a code slide rule now in

use in France. It is adapted to the use of an infinite number of secret codes and its messages are practically undecipherable. The apparatus consists of a ruler,

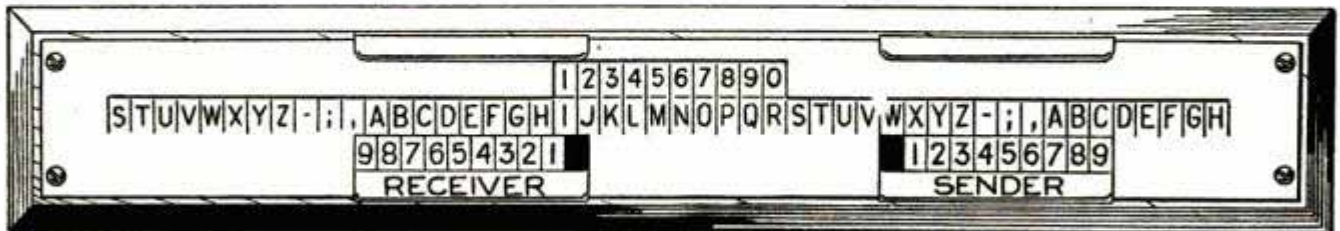

French Slide Rule for Writing and Translating Secret-Code Messages

like an engineer's slide rule, with two movable scales. The letters of the alphabet, punctuation marks, and figures to be used in messages are written

in a long line on the face of the ruler. Below this line are two movable slides, one for writing and the other for translating. Each of these slides contains

France

the figures from 1 to 9 with a blank space, or "finder," next to the figure 1. To use the code slide rule, two correspondents must first decide upon a key consisting of several figures—for example, 2947. This key must be

**AN ADJUSTABLE FOOTRAIL
3609 FOR RADIATORS**

A radiator footrail that can be quickly adjusted to any height and attached to radiators of various lengths is

Secret Key -- 2947

Message to be Sent -- P O P U L A R - M E C H A N I C S - M A G A Z I N E

Key Written under Letters -- 2 9 4 7 2 9 4 7 2 9 4 7 2 9 4 7 2 9 4 7 2 9 4 7 2 9
Resulting Code Message -- R X T ; N J V E O N G O C W M J U G Q H I J A P P N

To Translate Code Message -- R X T ; N J V E O N G O C W M J U G Q H I J A P P N

Key Written under Letters -- 2 9 4 7 2 9 4 7 2 9 4 7 2 9 4 7 2 9 4 7 2 9 4 7 2 9
Translation -- P O P U L A R - M E C H A N I C S - M A G A Z I N E

A Message Written in Secret Code and Translated

known to both correspondents. In preparing a code message, the sender first writes out his message in plain English and then places the key under the various letters and figures, repeating it in succession from left to right, as in the accompanying example. Then he is ready to find the code letters with the slide rule. In this message the first letter is P and its corresponding key number is 2. Accordingly he moves the slide marked "sender" so as to bring the blank space under P and takes the letter over 2 on the slide—in this case it is R. Then he moves the slide until the blank space is under O and takes the letter over 9—in this case, X. And so on through the message. The person who receives the message uses the slide rule in the same way to translate it, placing the key under the code message and finding the letters with the slide marked "receiver."

☐The construction of a new deep-water port on the Atlantic coast of the Republic of Uruguay, to be located near Coronilla, is now under way. It is to be called Atlantida and is to serve as an outlet for the vast interior of the country tapped by a railway extending across the republic.

among the latest appliances for increasing the comfort of the home. The footrail is made of heavy brass tubing, with nickel trimmings, and provides a convenient method of warming the



A Handy Footrail for Radiators

feet without scorching the toes, or defacing the finish of the heater by pressing the shoes against it.

☐One railroad uses old locomotive-boiler tubes pieced together for piping water and air about its yards.

Renters in the United States

LIGHTING STANDARDS FOR PANAMA CANAL

4856

Final designs for the lamp standards, brackets and reflectors to be used in lighting the locks of the Panama Canal

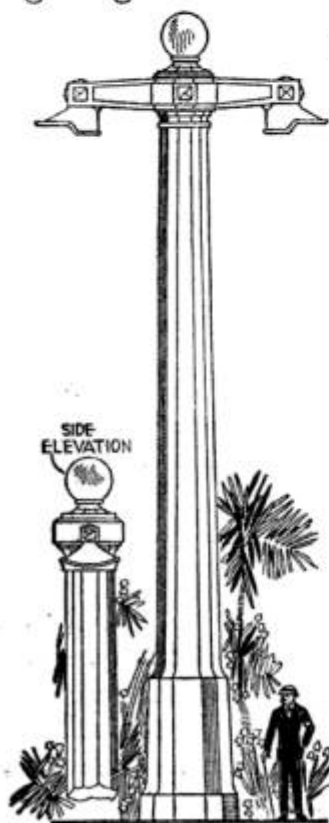

have been made and have received the approval of the Fine Arts Commission. The posts, including the ornamental ball, will be of reinforced concrete cast in iron forms manufactured in the Gorgona shops, and a total of 511 standards carrying single or double-arm brackets will be required. The reflectors will be placed 29 ft. 6 in. above the ground

and 4 ft. 3 in. from the center of the standard. Each concrete double-arm bracket with reflectors will weigh approximately 1,610 lb., and the solid ball, weighing 730 lb., will be used to counterbalance the weight of the single-arm brackets on the middle locks.

PEAT USED PRINCIPALLY AS FERTILIZER

4692

By far the most important use of peat in this country is as a fertilizer, the consumption for that purpose in 1912 being 41,080 tons, while only 1,300 tons were used for fuel, 3,000 tons for stock food, and 2,000 tons in the manufacture of paper. In preparing peat for use as a fertilizer the field bearing the peat deposit, unless it is already under cultivation, is thoroughly drained, and plowed and planted for one or two seasons with some crop which destroys or disintegrates the coarse material and aerates and improves the upper layers of the

peat. The peat is then plowed and harrowed and allowed to dry thoroughly, and, after being scraped into windrows, is hauled to the factory for further drying or storage. The drying is completed by passing the material through long rotary cylindrical driers, through which the heated air and gases from furnaces are forced by fan blowers. This process requires a somewhat expensive plant. In preparing peat for fuel it is made into the form of cylinders.

A NEW RULE FOR FINE MEASUREMENTS

3627

An improved rule for machinists and others having use for a scale graduated down to 64ths of an inch has been placed on the market.

The lines on the new rule are so arranged that the difficulty of obtaining accurate measurements in laying out work requiring fine graduations is entirely eliminated, and all eye-strain formerly incident to reading such graduations repeatedly is done away with. The new rule, although measuring accurately at 64ths, has only 16 lines to the inch.



CA cement-manufacturing concern has been experimenting to ascertain whether or not it is possible to transport cement in bulk, like sand or gravel. A truck load of cement was recently sent out without packing of any kind, the interior of the truck body being first lined with waterproof paper. The truck arrived at its destination with absolutely no signs of leakage.

ALL-METAL FLEXIBLE**3566 GAS TUBES**

A metal flexible gas tube now being marketed in Paris has all-metal connections instead of rubber ends, for attachment to the source of gas supply and to the lamp or gas plate. The metal joints are so constructed that they will not leak when fastened in place upon the gas-fixture nipple by the three screws provided.

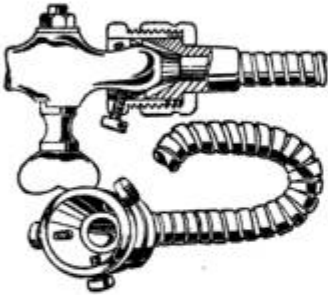
**3611 WAX-FOUNTAIN PEN FOR COLORING FABRICS**

An electrically heated wax-fountain pen has been perfected for use in ornamenting silk, velvet, cotton, and other fabrics, as well as wood, leather, metal, etc., with patterns or designs in permanent dyes and colors. When the fabric is dyed the wax-covered surface is not affected by the dyestuff. The wax is then dissolved in benzine or otherwise removed.

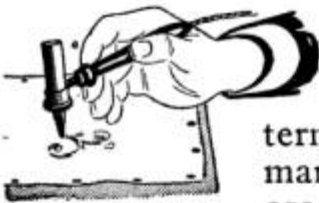
**4312 COMBINED SPRING AND SHOCK ABSORBER**

An automobile spring with a shock absorber built into place in such a way that it becomes a part of the spring itself has been put on the market. The top member is of a special silico-manganese steel, and the two small cylinders at the bottom, upon which the action of the spring depends, are made of cold-rolled seamless steel tubing. They inclose vanadium-steel springs and pistons, and a quantity of oil. The



resiliency of the device is imparted by the steel springs within the cylinders, and its shock-preventing properties result from the comparatively slow passage of the oil past the pistons under the control of a ball check valve.

3603 A CIRCULAR SAW WITH REMOVABLE TEETH

A circular saw, the teeth of which may be removed and others inserted in case of breakage, has been placed on the market. The body of the saw is made of ordinary tough steel and the teeth may be quickly adjusted in position or removed. An automatic sharpening machine for teeth of this type has also been designed by the manufacturers.

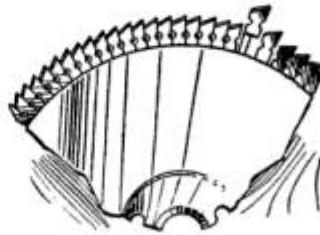

Courtesy Die Export Woche

3610 ELECTRIC CIGAR LIGHTER FOR AUTOMOBILES

This electric cigar lighter is so constructed that it may be plugged into the same socket that is generally used for a trouble lamp on a motor car, and a cigar can be lighted while the vehicle is in motion. The device is small enough to be carried in the vest pocket.

**5075 PERPETUAL CALENDAR IN GRAPHIC FORM**

The perpetual calendar for determining the week day on which any date will fall, or has fallen, is the latest nomographic table that has come from France. Like other nomograms, it is simply the graphic representation, by lines and symbols, of a mathematical or mechanical law, by which certain

results from given data can be found without calculation. The nomographic calendar is made up of four columns of known data—date, month, century, year—and one column of data sought, week days, in the center, as in the accompanying drawing. The two rules without data simply assist in the cal-

NEW MACHINE FOR TESTING STRENGTH OF PAPER

A machine for testing the strength of paper is shown in the accompanying illustration. The paper to be tested is inserted in the clamp and is secured in place by turning the milled disk to

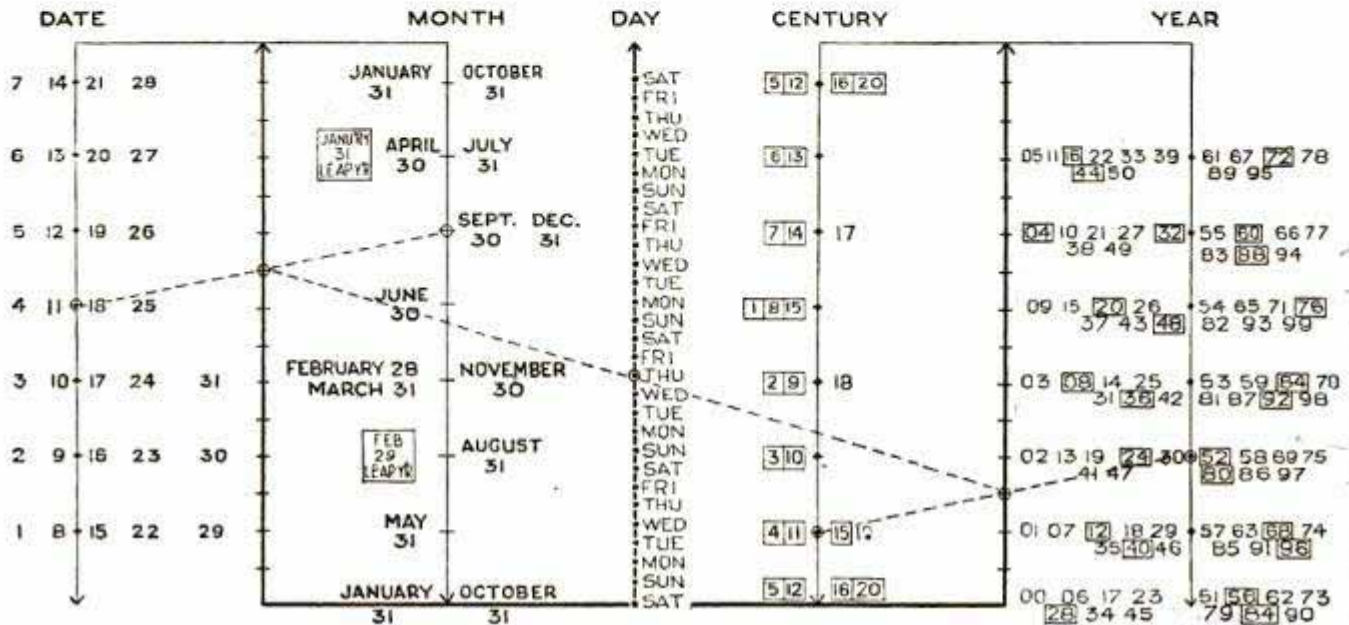

Perpetual Nomographic Calendar for Dates in the Past or Future

ulation, and the figures in squares indicate leap years. For example, to find the day of the week on which December 25, 1913, will fall, draw a straight line from the mark opposite 25 in the date column to the mark opposite December in the month column and mark the point where it crosses the left-hand auxiliary rule. Then draw a line from 19 in the century column to 13 in the year column, marking the point where it crosses the right-hand auxiliary rule. A straight line connecting these two points intersects Thursday in the day column. In the same way any other date in the past or future can be found.

The operation might be reversed; the table would indicate the dates of all the Tuesdays in November, 1913, and other similar data.

the right. This clamp is independent of the registering mechanism. The bursting of the paper is accomplished by means of a metal plunger operated by a crank as shown. The head of the plunger is cup-shaped, so that the paper is broken over a ring of about 1/4-in.

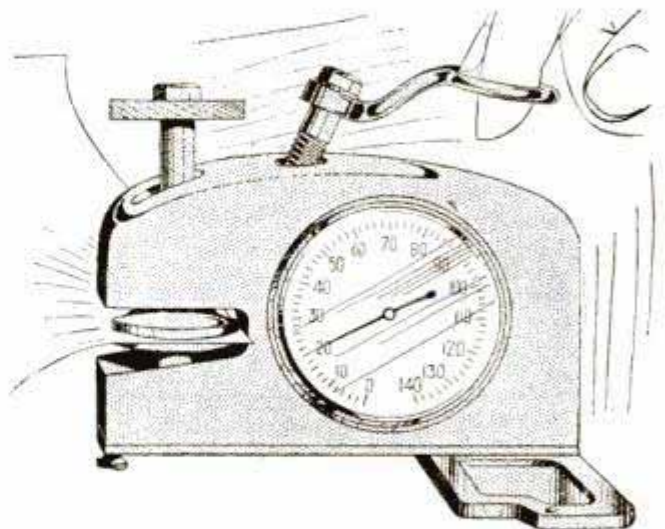

All-Metal Paper-Testing Machine

What is said to be the largest street-car barn in the world is located at Philadelphia. This barn is 611 ft. long and 377 ft. wide.

diameter. Results are indicated on the dial in pounds per square inch. All parts of the machine are of metal.

A NEW BEVELING-SAW GUIDE

3680

A new type of beveling-saw guide recently placed on the market is also adapted to all the purposes for which

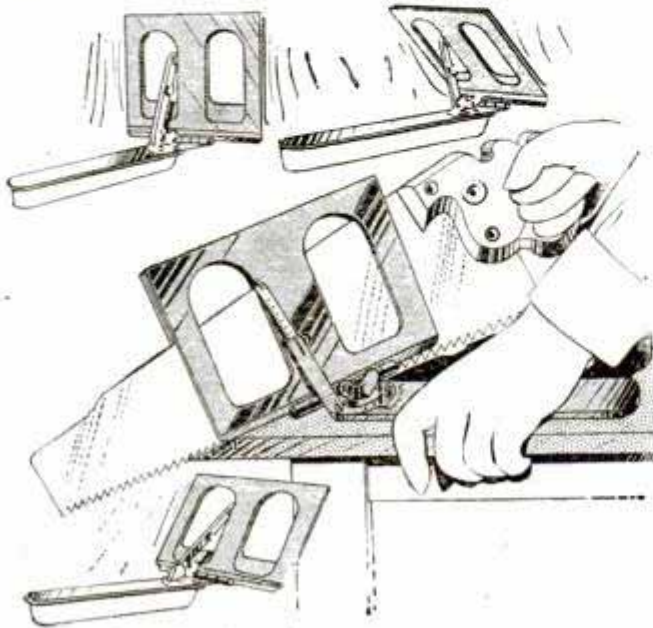

Beveling-Saw Guide for Carpenters

a miter box is employed and can be used on lumber of any width. The illustration shows its operation clearly.

CENTURY-OLD ENGINE STILL RUNNING

5023

For over 100 years, the same steam engine has been at work pumping water out of the mines of the Shipley-colliery, Cornwall, England. It is an old-fashioned beam engine, so ancient that no one knows its exact age nor the name of its builder, but it is still in service and has not been repaired for 23 years. Until recently, it has been running night and day at a rate of eight or nine revolutions a minute, but now it pumps only in the daytime. Its horsepower is about 45, and the two pumps operated by it raise some 53,000 gal. of water per hour to a height of 192 ft. The piston has a diameter of 52.2 in. and a stroke of 84 in. and works on low-pressure exhaust steam from the other mine engines. The beam, which weighs about 10 tons, would be considered rather light now, but it has never broken in its century of service.

STRENGTH OF PULLEYS OF DIFFERENT MATERIALS

4918

As a result of a series of exhaustive tests made at Purdue University for determining the breaking strength and principal points of weakness in pulleys of different materials, the following important conclusions were reached: Rim joints midway between the arms are serious defects and materially lower the speed at which it is safe to run the pulley; the paper wheel with solid web and rim will safely withstand a peripheral speed of as much as 106 ft. per second; wood pulleys with solid rims have an ample factor of safety at a peripheral speed of 90 ft. per second, if the wood is of good quality; steel wheels of the split-rim type are unsafe at greater peripheral speeds than 80 ft. per second.

CONTROLLER FOR MOTOR-CAR HEAD LAMPS

3706

A new appliance has been designed for controlling the light of electric head lamps. The device enables the motorist to reduce the candlepower of the

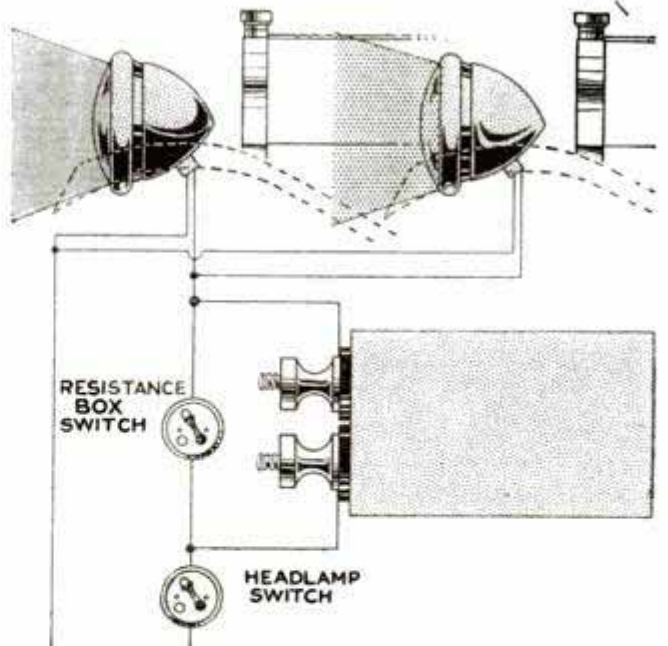

Glare Remover for Motor-Car Head Lamps

lamps by turning a switch mounted near the driver's seat, which sends the current through a resistance coil. The appliance is made for lamps of various candlepower.

No data in file

The... ..

SCHOOLHOUSE BUILT ON UNIT PLAN

4618

A schoolhouse in which the classrooms are distributed among a number of small buildings erected about a play-

PROJECTILE WITH FOLDING TAIL

4614

A projectile equipped with a telescoping tail to prevent the formation of a vacuum behind it to impede its

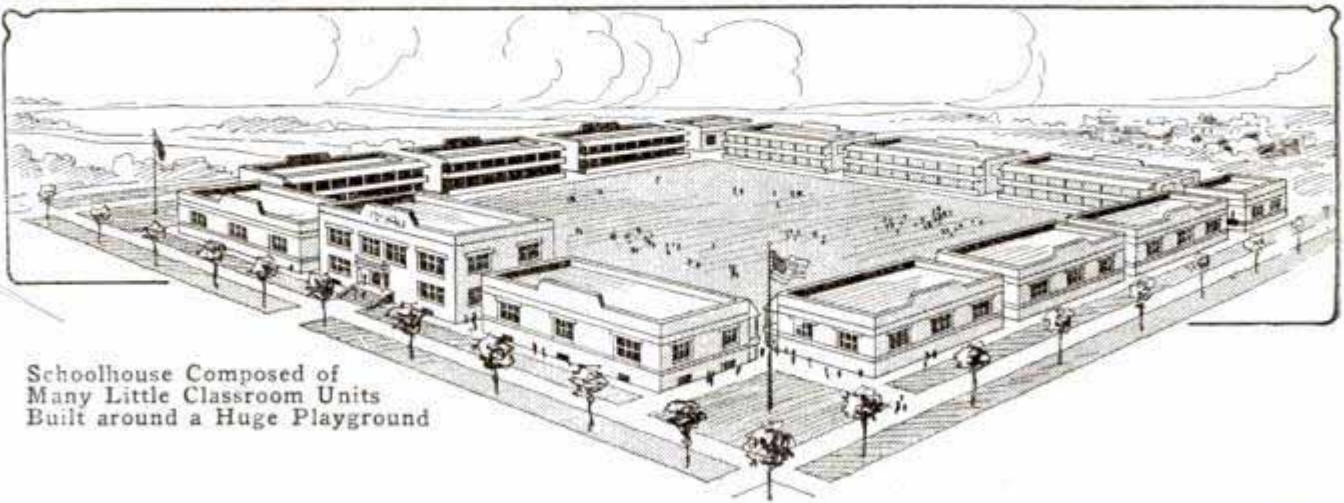

Schoolhouse Composed of Many Little Classroom Units Built around a Huge Playground

ground, 300 ft. square, has been planned for Tulsa, Okla., in accord with the new social-center idea. The two-room, one-story units, built along the four sides, open directly upon the square and have no corridors, halls, or street doors. A two-story assembly hall on the street side and gates at the four corners give entrance to the quadrangle and a concrete arcade around the edge serves as a cloakroom. The heating and ventilating plant is in the assembly building. This plan gives a central playground, 200 ft. square, surrounded by an amphitheater which will seat several thousand people. A swimming pool in the basement is to be open to the public at certain hours.

A FAST-BLACK DYE FOR COTTON CLOTH

4995

Fast-black and fast-gray cotton-cloth prints can now be made by the use of a dyeing mordant that has just been patented. Any shade from light gray to deep black, if printed on cotton or any vegetable fiber with the new dye, cannot be faded by washing or by sunlight; but the same mordant will not make a fast black on woolen cloth. Cotton cloth that is printed with this new dye can be identified by the fact that it yields red to violet solutions in concentrated sulphuric acid.

flight has been patented in England. The tail forms a practically flat base on the shell, when it is closed, and is extended by expanding gases as the shell leaves the gun. The projectile can be used in guns of various calibers, smooth-bore or rifled. The tail is made up of a series of gradually decreasing conical rings, arranged to telescope each other and fold together loosely on the base of the shell, as shown in one of the pictures. Inside the series of rings, is the tail proper which has a spindle and spring inside and a small opening in the end. Normally the opening is closed by the spring, but when the gun is fired gases force their way in, are confined by the reaction of the spring, and in turn act upon the annular grooves in the con-

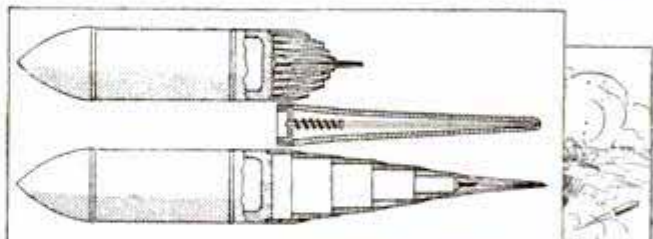

The Folding Tail on This Projectile Extends as It Leaves the Gun and Prevents Formation of a Vacuum behind the Shell



ical rings to force them out and extend the tail, as the shell leaves the muzzle.

Gene Bohm

Manheim

Pat. Linder 6/21/19
Pat. Linder in Journal of Machinery - page 865

"MAN ENGINE" USED IN

4252 CORNISH MINE

In one of the tin mines of Cornwall, England, a curious device, known as a "man engine," is in use for conveying

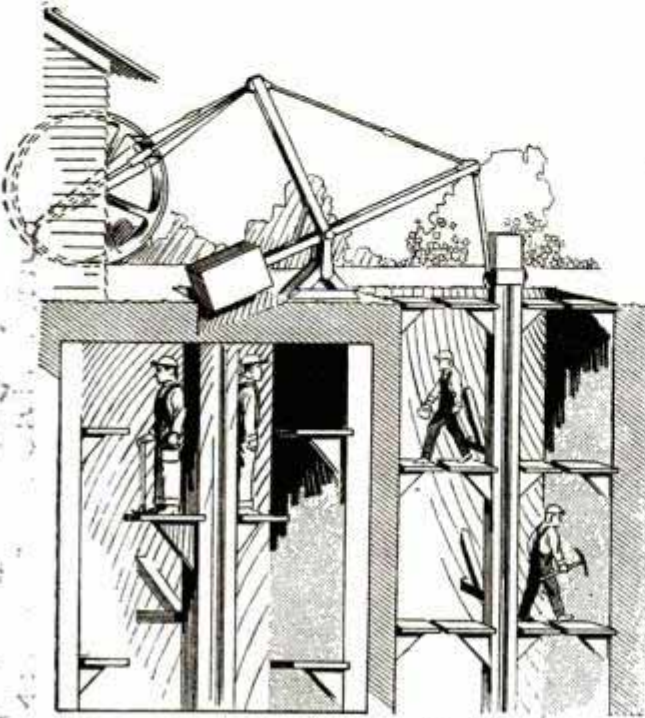

Descending a Cornish Mine Shaft on the "Man Engine"

the miners to and from the deep workings. Near the mouth of the shaft is a large walking-beam engine. To the rim of the flywheel of this engine a driving rod is attached, and by means of a pivoted connection, the motion of the wheel is transmitted to a vertical lifting rod in the mine shaft, as shown in the illustration. The lifting rod has a vertical movement of 12 ft. At intervals of 12 ft. platforms are supported both on the lifting rod and on the side of the shaft, and the sets of platforms are so arranged as to be at the same level at the high and low position of the rod. In descending, the miner steps on the moving platform when it is at the end of the up-stroke, and is carried down 12 ft. He then steps off and waits for the next up-stroke, when he is carried down another 12 ft. This process is continued until the bottom of the shaft is reached. For ascending, this process is reversed. Platforms on opposite sides of the shaft enable one set of men to descend while another set is ascending, without interference.

LIQUID AIR FOR QUARRY

4927 BLASTING

Liquid air, in combination with a combustible material, is being used for blasting limestone in a quarry at Rundersdorf, Germany, and the success of the method indicates the availability of a new explosive that is of great power and safe to handle. The new cartridge is made of pasteboard packed with petroleum and clay, around a narrow tube of gauze which is filled with liquid air. When the liquid air has thoroughly penetrated the clay and oil, the cartridge can be exploded with an electric detonating cap. Increased safety results from the fact that the liquid air soon evaporates if the charge misses fire and there is no danger of a delayed explosion. The scientific basis of the process is that liquefied air under pressure can be exploded by a violent shock, such as that of a detonating cap, and the presence of a combustible material, such as oil, results in a secondary explosion caused by the combination of the free oxygen in the liquid air with the combustible material.

3577 —
A CONVERTIBLE TWO-JAW AND THREE-JAW CLAMP

A three-jawed lifting clamp, so designed that the middle sliding jaw can be removed when only a two-jaw clamp is desired, has been placed on the market. The clamp, which is especially

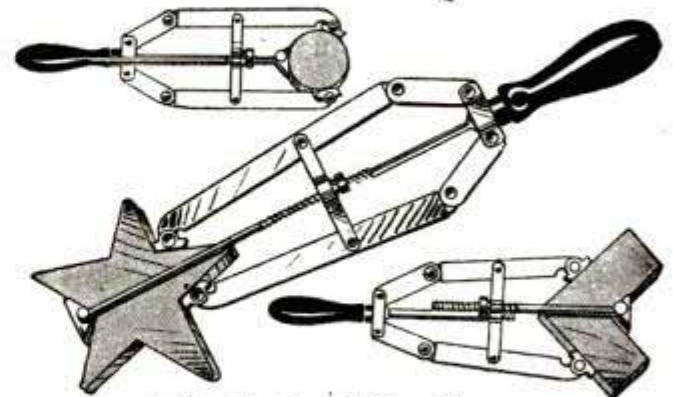

A Combination Lifting Clamp

adapted for gripping firmly irregularly shaped articles of various sizes, is made of steel and is opened and closed by simply turning the handle.

July 16-90
 3671 **DEVICE FOR PULLING AUTOS**

OUT OF DEEP MUD

A device for pulling motor cars onto solid ground when their rear wheels

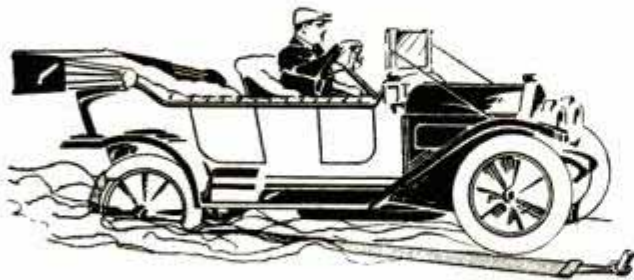

Device for Extracting Motor Cars from Mud Holes

have sunk into mud holes or deep mud, and the car cannot be moved by its own power, is here shown. In using the appliance one end of it is attached to the front of the rear wheel and when the motor is started, the device, which somewhat resembles a large razor strop, is dragged under the wheel. The loose end of the appliance is then carried forward and fastened to a stake in the ground. Upon starting the motor a second time the car is quickly drawn out of the mud and onto solid ground.

June 14-792-4992
FLAMELESS INCANDESCENT

3243 **GAS BURNER**

A gas stove or burner that becomes incandescent but has no flame has made its appearance in Europe and found various applications. The mixture of combustible gases is forced under pressure through a porous, refractory material. When ignited, the gas will burn without flame to a slight depth within this material, thus causing it to become incandescent.

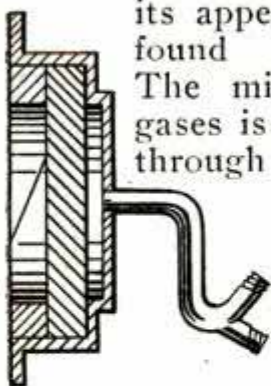

It is a felony for the driver of a motor vehicle to run away from an accident without giving his name, according to a decision rendered in the New York courts.

4928 **WATERPROOFING POWDER**

FROM LILY LEAVES

A waterproofing powder made principally from the leaves of lilies has been invented and is said to be successful as a means of making fabrics of various kinds impervious to water. This invention was suggested by the fact that drops of water or dew are not absorbed by lily leaves, but either evaporate or slide off the leaf, and it occurred to the inventor that the same substance that made the lily leaf waterproof might be used in waterproofing fabrics. In use, the powder from the leaves is mixed with water, and the fabric to be waterproofed is immersed in this mixture.

AIR RIFLE OF HIGH POWER

1143 **HAS SAFETY DEVICE**

This practical, high-power air rifle, which is a take-down model, is provided with a positive safety device that prevents the trigger mechanism from setting the gun off until desired. The



High-Power Air Rifle for Sportsmen

operation of the rifle is comparatively noiseless and all its parts are easily accessible for inspection, repair or other purposes.

APPLYING THE GYROSCOPE

4538 **TO AEROPLANES**

A new device for stabilizing aeroplanes makes direct use of the mechanical force of a gyroscope for holding the aeroplane level or for tilting it up or down, on much the same principle that this instrument is used in stabilizing a ship, and without the intervention of valves or other mechanism for warping the wings. A wheel with a heavy rim, which constitutes the gyroscope, is placed on the shaft with the propeller and is rotated by the same motor as the propeller. The con-

nection is such that if the motor should stop, the gyroscopic wheel is free to rotate independently of the propeller, and will keep on rotating until the force of its momentum is exhausted. The critical feature about this device is that, by means of a flexible shaft and

A NOVEL KIND OF SAFETY
4964 LIFEBOAT

To overcome the dangers and hardships of an open lifeboat, a life-saving vessel has been patented in which a shipwrecked person can drift about un-

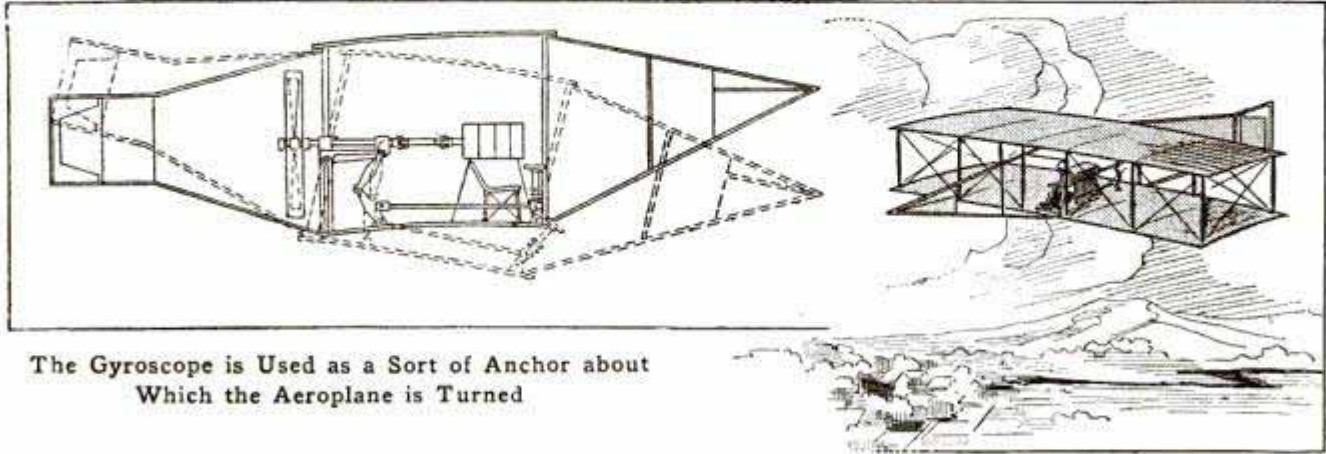

The Gyroscope is Used as a Sort of Anchor about Which the Aeroplane is Turned

a system of levers for controlling it, the gyroscope may be used as a sort of anchor about which the aeroplane is turned up or down or is held level as desired, this being made possible by the mechanical tendency of the gyroscope to remain in its original plane of rotation under all conditions. One of the advantages claimed for this device is that it not only stabilizes the machine under ordinary conditions, but furnishes a quick and certain means of turning the machine to a position for volplaning in case the motor stops or momentum is lost from any other cause.

til rescued. It is a cylindrical metal tank just large enough to accommodate one person lying on a couch inside. A water-tight door in the top gives access to the interior and an automatic

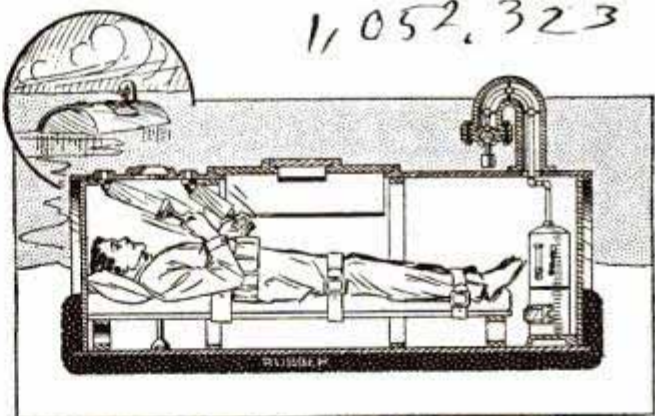

Life-Saving Vessel, Built Like a Cylindrical Tank in Which a Shipwrecked Voyager can Drift About the Sea for Days

SANITARY METAL HOLDER

4906 FOR EGGS

A one-piece enameled-metal egg holder is now being manufactured to be used about the kitchen instead of a bowl or cardboard case. Each holder is large enough for a dozen eggs and as each egg is held in a separate hole the air circulates freely about them. One egg can be removed without disturbing the others, and the high sides protect the eggs when the holder is placed in an icebox.

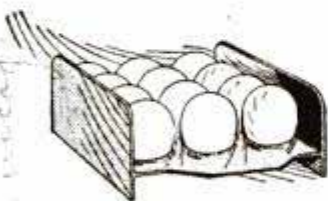

valve admits fresh air without letting in any water. As the voyager lies strapped to the couch, an alcohol stove at his feet keeps him warm, a glass skylight above his head gives him light, and two pumps near at hand enable him to pump out water or stale air. Food is stored under his couch and a rubber pad on the bottom prevents his craft from being dashed to pieces on the rocks.

(About \$6,000,000 worth of diamonds were shipped from Amsterdam to the United States during the first five months of 1913.

For further particulars of this invention...

1,052,323

3881 STOVE THAT USES HOT-AIR PIPES

The heating stove shown in the illustration in a manner combines the advantages both of the ordinary stove, due to radiation, and of the furnace, due to the circulation of heated air. Air is drawn from the room into pipes on both sides of the stove, is heated to a high temperature, and is then discharged, from the top of the stove, either into the room in which the stove is located or into pipes leading to the upper floor.

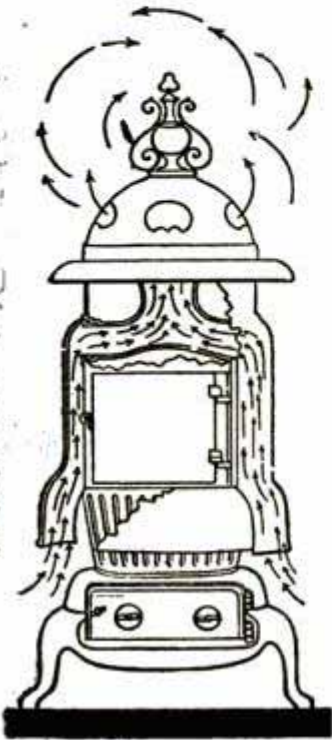

Fig. 8. Tale. H. H. H. H. H.

5036 A STUDY OF FISH BASED ON THEIR SCALES

Year rings on fishes' scales are being used in Norway as an aid in the study of the sardine supply. On every fish scale there is a series of concentric ridges which increase in number as the fish develops, and from these rings it is possible to determine the speed of growth of various kinds of fish. Tables giving the size of fish and the corresponding development of scale rings have been prepared in Norway so that it is possible to tell from a fish scale how old the fish is, whether it has reached complete growth, and when it will spawn. This method has now been adopted also in France.

3574 ADJUSTABLE PENDANT FOR ELECTRIC LAMPS

An improved pendant for electric lamps that may be raised or lowered to any desired degree by simply pressing a spring attached to one end of the device, is being manufactured. The pendant is also arranged so that all the advantages of an indirect light may be had from an ordinary lamp pendant, to which the invention can be attached in a few minutes without any rewiring.

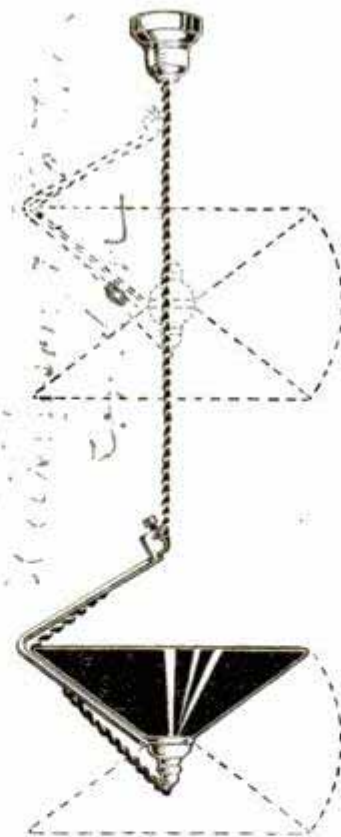

¶The piers of the second largest bridge in Oregon, the

Southern Pacific bridge across Coos Bay, will rest on sand. Test holes sunk 90 ft. failed to strike bedrock, and sand at that depth is considered sufficiently stable.

5107 MAIL CARRIERS FOR SMALL POST OFFICES

The carrier-delivery service in post offices of the second and third class, which was tried on a small scale last year, is to be extended during the coming year. Congress appropriated \$100,000 last year for experiments with one or two mail carriers and one or two deliveries a day in towns that are too small to be eligible for city-delivery service. In the 106 towns in various parts of the country where the service was tried, the results were so satisfactory that Congress has appropriated \$150,000 more for the same purpose. The service was greatly appreciated by post-office patrons and in some cases stimulated the postal business to such an extent that more carriers were needed.

1/1/11. 3. 1/1/11. 3. 1/1/11. 3.

¶A diploma and \$500 have been offered in England as a prize for a safety kerosene lamp for home use.

5094

16 West Street, Berlin - Friedenau, Germany

IRON MONUMENT FOR THE IRONWORKERS

A monument of iron was erected at the International Building Exhibition in Leipzig this summer to symbolize the iron and steel industry of Germany. Its builders were the Association of Steelworks and the Society of German

are lined with black, dead-glazed slabs adorned with maxims relating to iron, spelled in gold-enamel letters. Opposite the entrance, a huge carpetlike decoration, in ceramic work, depicts a Bessemer converter at work. An orna-

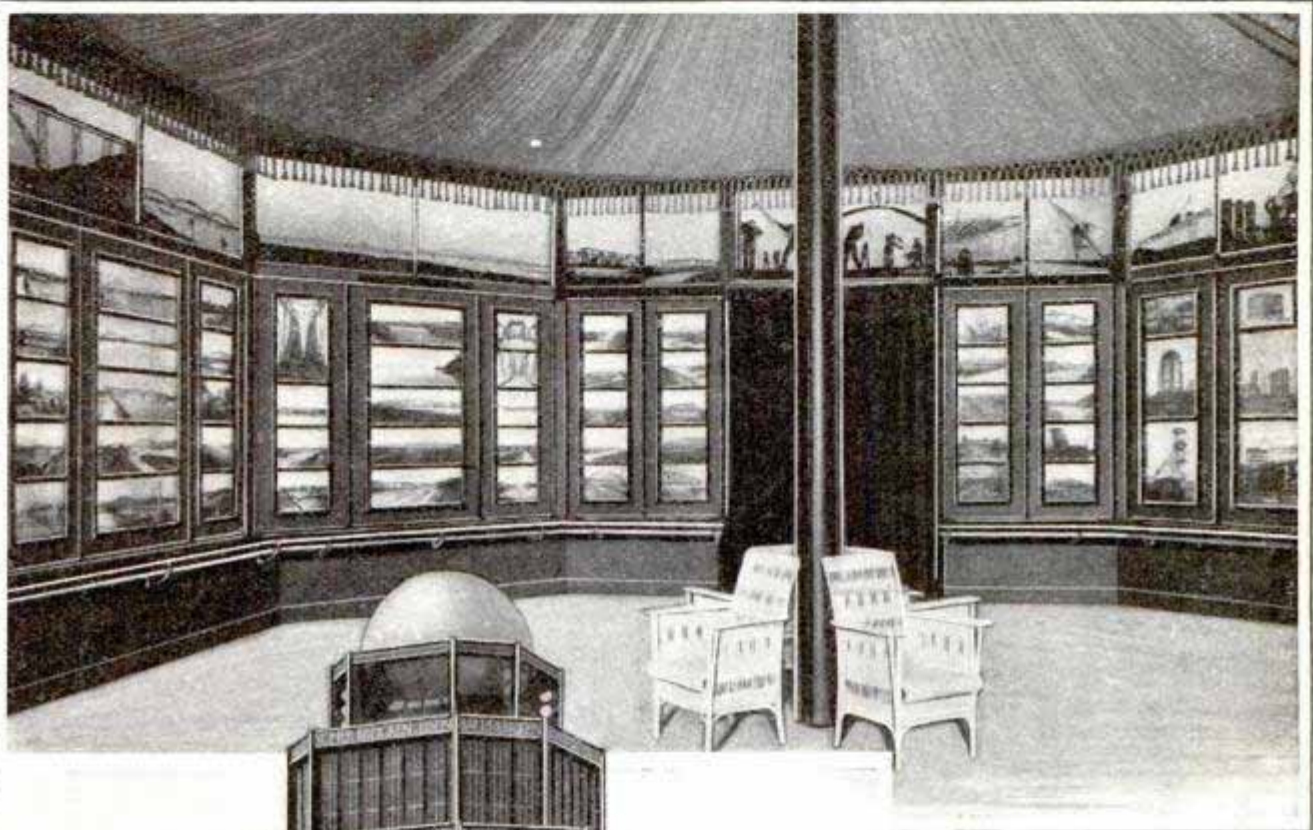

Diaphany Hall on the Main Floor Decorated with Silhouette Pictures on Frosted Glass

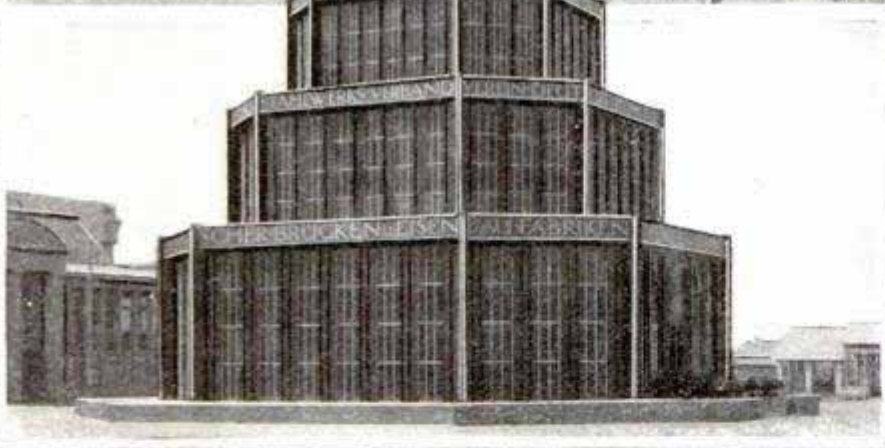

Monument of Iron Symbolizing the German Iron Industry at Leipzig Exhibition: It Is Built of Heavy Girders and Crowned by a 30-Ft. Golden Ball

Bridge and Railway Builders, which, combined, control the entire German iron market. The iron monument is strictly geometrical in design and mainly consists of girders, in the form of a stepped pyramid, about 90 ft. high, crowned by a golden sphere, 30 ft. in diameter. Every line, even in the windows, is intended to express strength and weight. Just inside the main entrance is a large reception vestibule, paved with Skyros marble with rich bronze incrustations. Its walls

mental network of girders, with rich tiles and moldings, forms the ceiling. Adjoining the vestibule is a gallery, 26 ft. wide and 23 ft. high, filled with photographs and diagrams relating to the iron industry. The center of the ground floor is occupied by Diaphany Hall, an octagonal room 34 ft. in diameter. Its walls are covered with large diaphanous pictures and a silhouette frieze in black varnish on frosted glass, illustrating recent iron structures. Above the main floor is a moving-picture gal-

lery with doors leading to the terrace. Its ceiling is supported by eight girders brilliant as silver, and in the center is a convex mirror recalling the golden

sphere above. The hall is 46 ft. in diameter, and its decorations, while rich, are subdued and heavy to typify the massive construction.

APPARATUS FOR ATTACHING 4800 MOTOR-CAR TRAILERS

An apparatus for attaching trailing vehicles to automobiles, invented by



an 18-year-old boy in California, has proved successful in practical tests. This apparatus is simple, consisting of a steel fork, a double-acting spring buffer, and a drawbar with an oscillating joint. One end of the device is attached to the rear axle of the automobile by collar bolts, which can be detached in less than two minutes, while similar collar joints fasten the fork at the other end to the front end of the trailer. The whole device is so flexible that the trailer follows the automobile easily around the sharpest turns. At present this device is used only for hauling picnic parties, but it appears to be adapted as well to the heavier duty of attaching trailers to motor trucks.

WORLD'S LARGEST DRY DOCK 988 FOR NEW LINERS

The Gladstone Dock at Liverpool, the largest dry dock in the world and the only one that can accommodate the "Imperator," or any of the other new 50,000-ton liners, was completed early this summer. It is a part of Liverpool's \$20,000,000 dock-extension scheme to provide loading and berthing space for five 50,000-ton vessels at the same time. The new dock is 1,020 ft. long and 155 ft. wide at the water line, and is entered through a bell-shaped channel, 400 ft.

Flexible Joint by
Which Automobile
and Trailer are
Connected

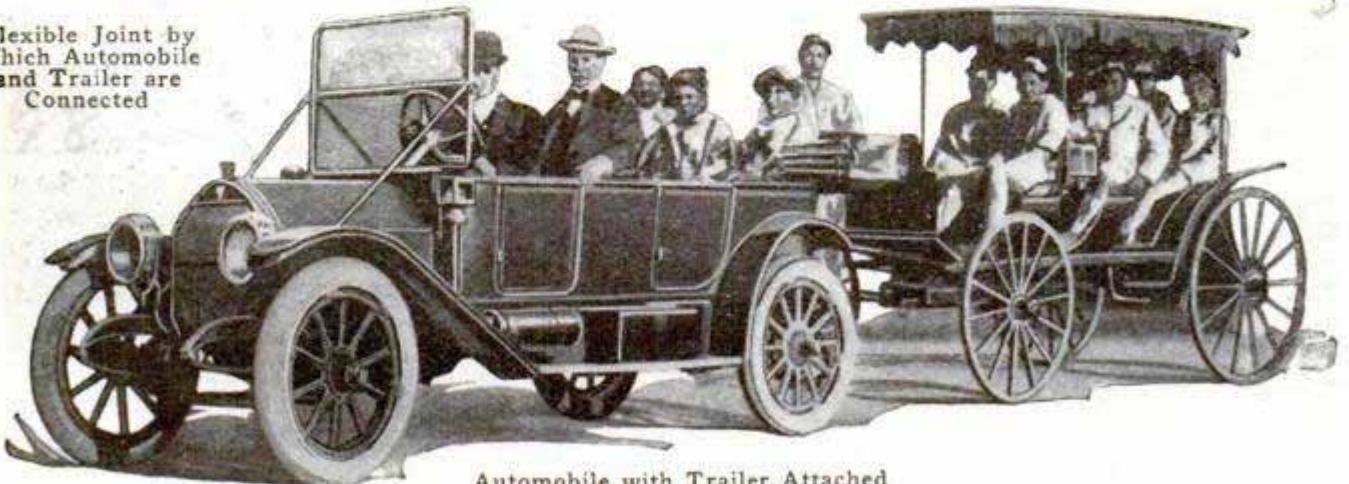

Automobile with Trailer Attached

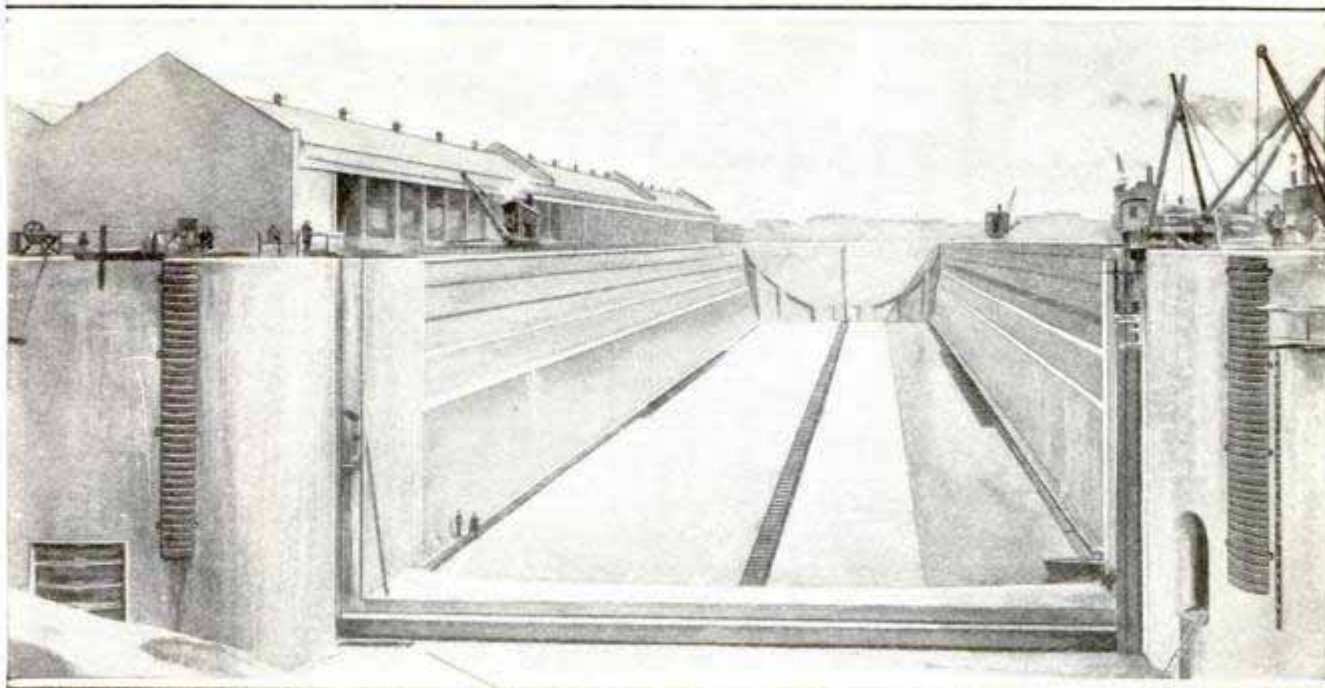

Courtesy The Graphic

The Largest Dry Dock in the World, Recently Completed at Liverpool to Accommodate the New 50,000-Ton Liners

wide, from the river Mersey. When the dock is full, the water stands 45 ft. deep, but the 5,000-hp. pumping plant will empty it in 2½ hours. The caisson, or sliding gate, which closes the entrance, is 132 ft. long, 50 ft. high, 25 ft. wide, and weighs 1,200 tons. It is built of steel girders and plates with greenheart-timber runners to slide on polished granite steps; two 150-hp. electric motors operate the gate. The dock cost \$2,500,000, and two and a half years have been spent in building it. About 1,500,000 cu. yd. of sand and rock were removed from the site. The army of workmen employed received over \$1,000,000 in wages.

EXTRA-STRONG WHEELS FOR
4862 **AEROPLANES**

So many aeroplane wheels have been smashed in difficult landings at high speed or on rough ground, that a heavy-duty wheel and tire especially designed for flying-machine use has appeared on the market. The wheel is 20 in. in diameter and carries a heavy 4-in. pneumatic tire. Three rows of

THIEVES TAKE COVERING OF
5239 **CHURCH SPIRE**

The stealing of a church spire in the German village of Sackheim, near Koenigsberg, Prussia, represents, with the possible exception of the case of the "red-hot stove," the acme of ingenuity in this kind of enterprise. The spire was faced with gilt copper, and scaffolding had been erected for making repairs. Taking advantage of this convenient means of access, thieves stripped off all the copper, carrying off even the weathercock that surmounted the spire.

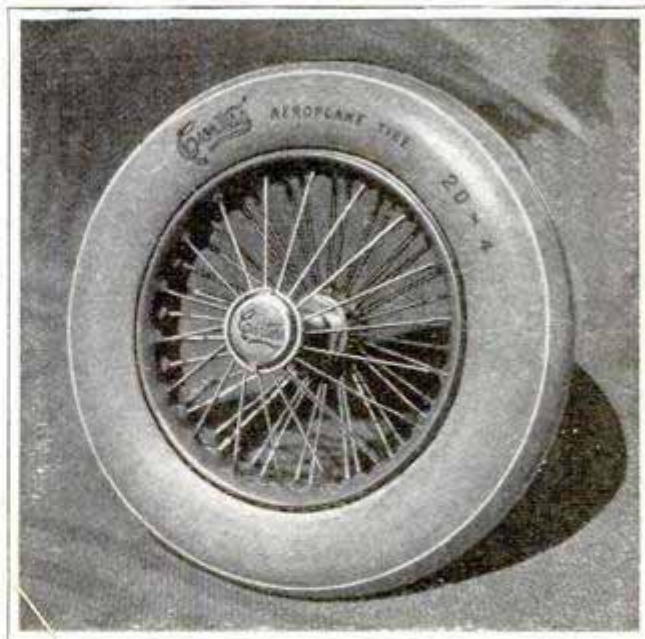

New Heavy-Duty Wheel and Tire for Flying Machines

heavy wire spokes and an extra hub give it great strength. It is designed to be used on a large axle.

*Curtis Aero-Tire
Hammacher Schlemmer*

4634

RAILWAY-CROSSING GATE OF UNUSUAL LENGTH

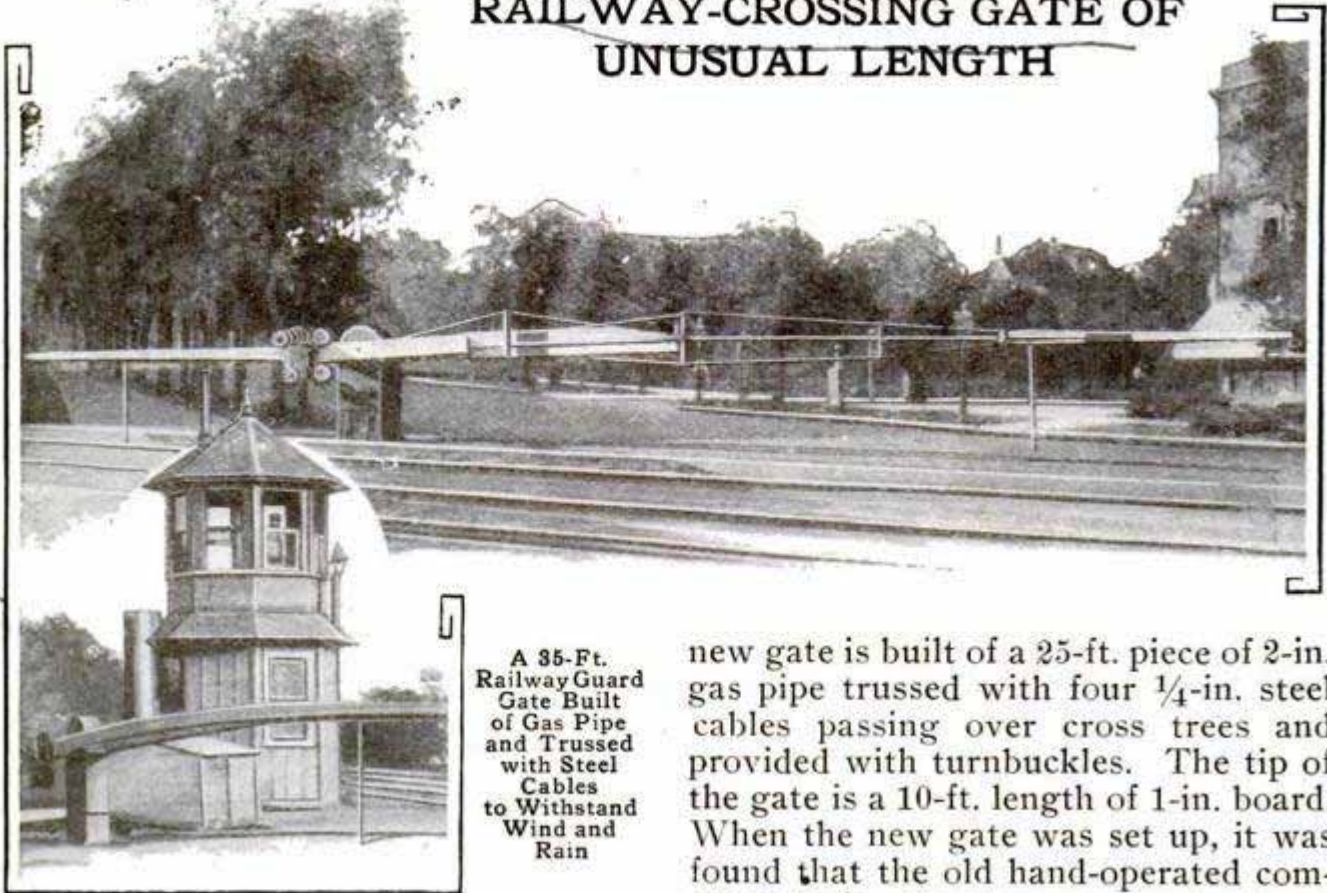

A 35-Ft. Railway Guard Gate Built of Gas Pipe and Trussed with Steel Cables to Withstand Wind and Rain

A railway guard gate of unusual construction is used to span the 35-ft. central drive of a Chicago boulevard. It was designed after many experiments with wooden gates which showed that any gate built of wood in the usual way was sure to be warped by the rain and snapped off by the first storm. The

new gate is built of a 25-ft. piece of 2-in. gas pipe trussed with four $\frac{1}{4}$ -in. steel cables passing over cross trees and provided with turnbuckles. The tip of the gate is a 10-ft. length of 1-in. board. When the new gate was set up, it was found that the old hand-operated compressed-air elevator was not strong enough and the pumping apparatus out of an old electric elevated car was installed in the tower house.

Rotterdam, Holland, will have the largest artificial harbor in the world, with an area of 766 acres and a depth of 28 feet.

5165 SELF-SUPPORTING MANUAL-TRAINING SCHOOL

Vocational training took a step in a new direction in Wisconsin last summer through the initiative of the manual-training students in the Waukesha High School. Sixteen of the students organized themselves into a coöperative company and turned the manual-training rooms of the high school into a manufacturing plant during the summer vacation. The plan was originated and carried out by the students under the advisory supervision of the city superintendent of schools. They furnished their own materials and paid rent for the use of the manual-training quarters. Their training thus became not only self-supporting, but yielded a small profit for the students. The

work carried on consisted in building furniture along mission lines, doing odd jobs as carpenters, and taking contracts to build sheds, chicken coops, farm gates, and other small structures. One boy designed a farm gate which has been patented. Their company was organized along businesslike lines, with officers and directors. Certain students acted as bookkeeper, timekeeper, or purchasing agent, and three others were sent out as traveling salesmen. The workers were paid for their time on the basis of the profits of the company and the head of the manual-training department, who acted as shop superintendent, received a salary in proportion.

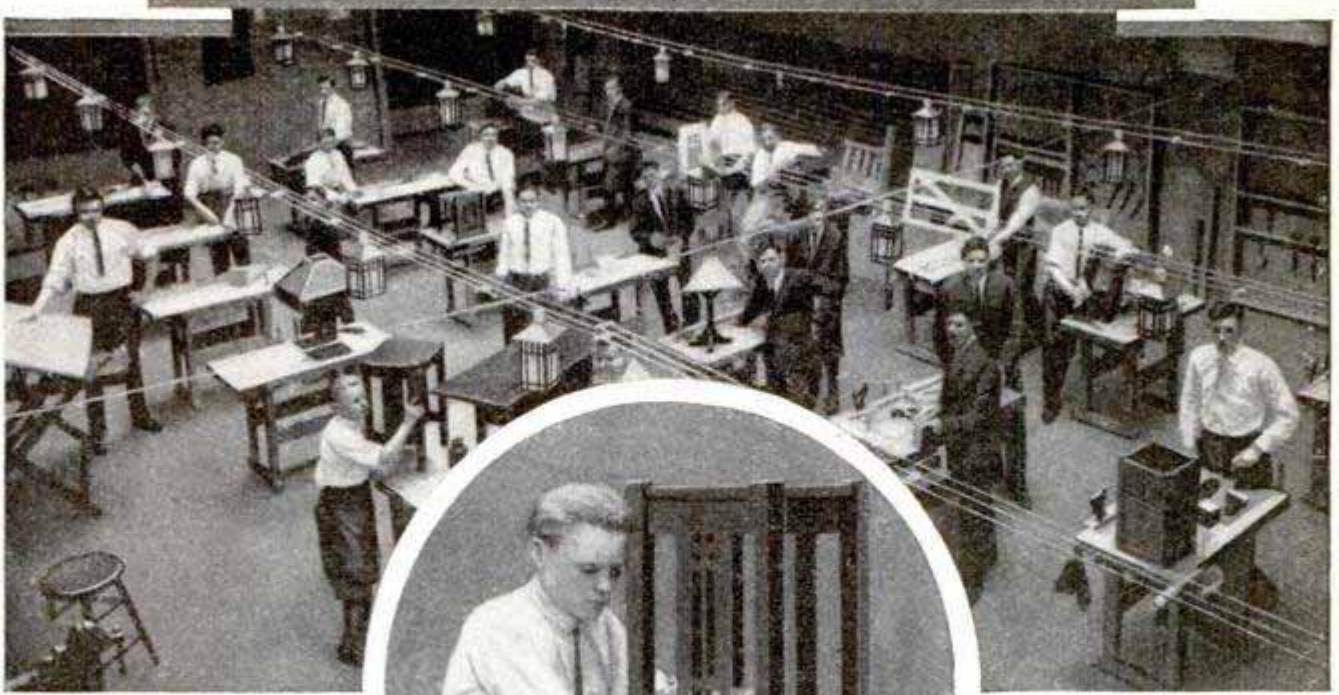

Manufacturing Plant Organized by the Manual-Training Students in Waukesha High School: The Main Workshop of the Students' Company

An Example of the Work Turned Out by the Shop



The Kind of Furniture the Students Build

The Outside of Their Manual-Training Quarters



**MONORAIL SLED BALANCED
3555 LIKE BICYCLE**

This new type of sled has a steering wheel for controlling the runner in front of the two main runners, between

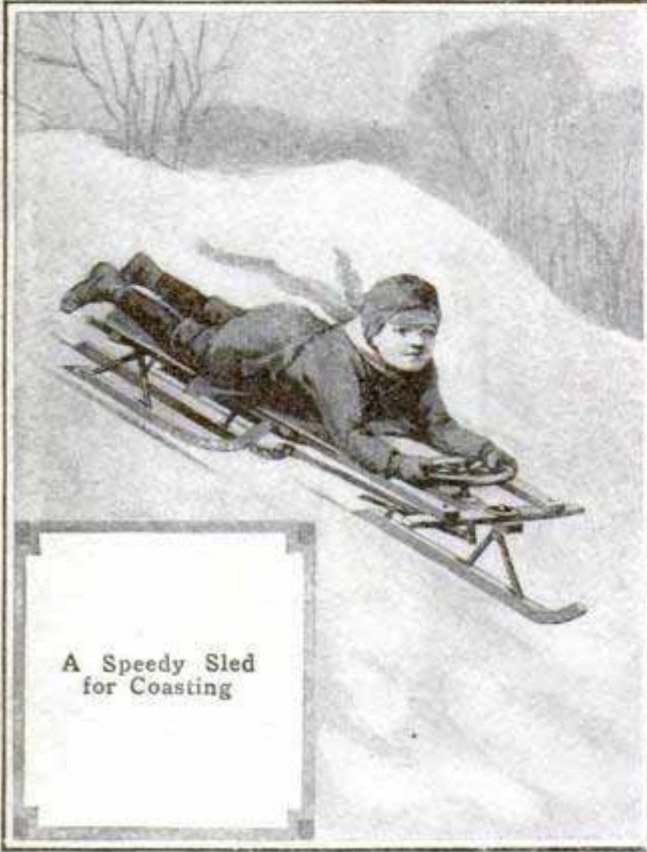

A Speedy Sled for Coasting

which is placed an extra runner for the purpose of permitting the sled to glide downhill upon two runners instead of four. By simply pulling the steering wheel toward him the boy depresses the extra runner and the sled glides along upon the front and extra rear runner like a bicycle, thus reducing the friction and enabling the rider to out-distance his rivals upon the old-fashioned types of sleds.

**SOLDIERS TAUGHT TO FLY
4998 IN AUSTRALIA**

Australia is about to establish a military flying school to train her militia officers to become aeroplane pilots. Four flying machines have already been ordered, and two instructors have been appointed; the aerodrome, power house, and workshop of the school will be located about 20 miles from Melbourne. Six militia officers will probably be in

training at the same time and it is expected that six or eight months of continuous work will be necessary to make them competent airmen. After they have received pilot's certificates, four ascents a year will be required to keep up their efficiency. Permanent officers will be trained as mechanics, and a motor truck will be provided to follow the maneuvers with a full equipment of repair parts.

**4979
COAT FOR SURVEYORS HAS
AMPLE POCKET ROOM**

When engaged in surveying or other fieldwork, civil engineers are usually compelled to carry with them a miscellaneous collection of field books, notebooks, and other articles. An enterprising garment manufacturer has now designed a coat that is intended to meet the resulting urgent need for pocket room. The advantages of the various flaps and pockets are apparent to the experienced surveyor. Two pockets on each side are made of the right size and shape for field and notebooks, while two other pockets of such a size as to take almost anything the wearer is likely to carry are placed across the back of the coat. Even the needs of the smoker are fully provided for, there



Coat Provided with Pockets for Note Books and Other Articles Which Surveyors are Compelled to Carry

Courtesy Engineering News

GENERAL UTILITY POCKET EXTENDS CLEAR ACROSS BACK

12" X 12" CROSS SECTION BOOK POCKET

READING GLASS POCKET

TWO EXTENSION POCKETS FOR TRAUTWINE OR FIELD BOOKS

being inside pockets for pipes, tobacco, etc., on both sides of the coat, with a small inside pocket designed for matches.

(5/26/13) Ser. Am. 7/13/13

(5/26/13) Ser. Am. 7/13/13

Original

5040

NEW SHELL EXPLODES GAS IN DIRIGIBLES

Italy's extensive experiments with guns and projectiles to be used against war dirigibles have developed a new shell, which not only tears a large hole in a balloon but completely destroys it by exploding its gas. Experiments with high-velocity guns fired at captive balloons, towed at a height of 6,000 ft. by torpedo boats going at full speed, have shown that it is not a difficult matter to hit the balloon, if a shell is used which leaves a trail of smoke behind it to assist the gunners in aiming and finding the range. But it has also been found that a balloon is able to escape even after several shots have been fired through it. To destroy the dirigible completely, the new shells are equipped with percussion caps filled with oxygen and platinum-sponge heads that are heated red hot by contact with the balloon's gas. When the projectile enters the balloon, the oxygen in the cap mixes with the hydrogen in the balloon envelope and the mixture is exploded by the red-hot platinum.

McCarthy 7/30/13

3769

PUNCTURELESS TIRE HAS MALTESE-CROSS CORE

An automobile tire having an inner core shaped like the Maltese cross, interlocked with the outer casing, has been brought out recently. There is no pneumatic tube, and the outer shoe is very thick with a fabric foundation. Great resiliency and long-wearing qualities are claimed for the tire which, of course, cannot be deflated through puncture.

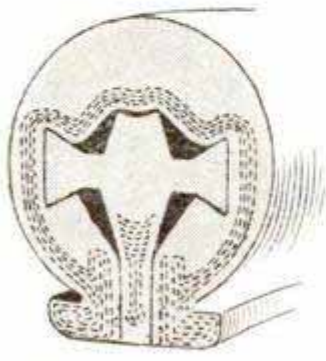

LIBRARY TABLE AND BED 4809 COMBINED

A combination library table and folding bed has just appeared on the market. It is a solid, compact piece of



A Combination Folding Bed and Library Table: As It Looks When Used as a Library Table

The Bed Opened Out Is Large Enough for Two Persons

furniture that can be used as a library table during the day-time, without the slightest

suspicion of its other use, and can be opened out into a strong, comfortable bed for two persons at night. When it is folded up it makes a table 50 in. long, 30 in. wide, and 31 in. high, with a broad bookshelf underneath. The springs, which fold up inside of it, open out into a bed 76 in. long, 48 in. wide, and 21 in. above the floor, with the head resting on the table frame and the foot supported by two pairs of light metal legs. There is space inside the folded bed to store its bedding.

INSTRUMENT FOR TESTING MACHINE BEDS 447

A sensitive instrument for testing the surfaces and grooves of grinding-machine beds, and of other shop machines where great accuracy is necessary, has been invented and is now in practical use. This instrument is known as the pendulometer, and magnifies errors in the machine bed as much as 500 times, so that they are easily read on a scale.

Although the name of this instru-

401 Mc Cormick Bldg. Factory 326 So Clinton St.

ment is somewhat formidable, the device is exceedingly simple in construction and operation. It has an

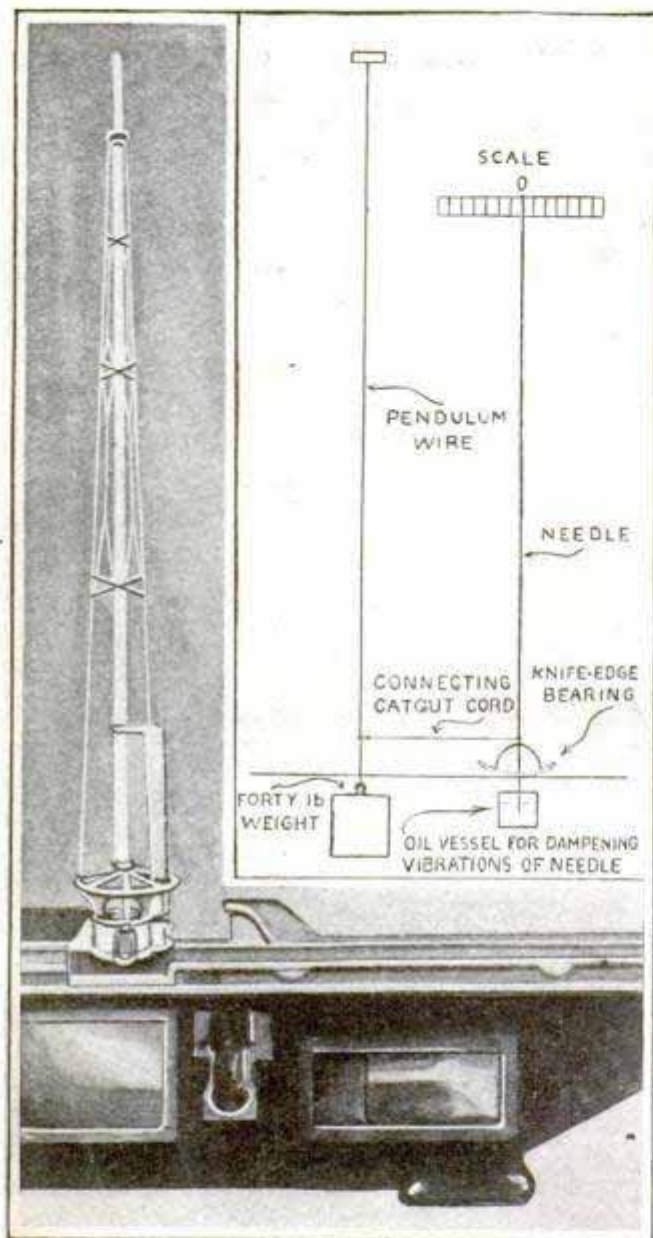

Pendulometer in Place for Testing the Surface of a Grinding-Machine Bed, and a Diagram Showing How the Movement of the Pendulum is Magnified by Needle

aluminum base, provided with three points of support, and carrying a mast of steel tubing some 10 ft. high, which is securely braced. Each support is provided with a hardened and ground steel plate, accurately surfaced, so that the instrument can be moved over a surface plate, or other part, to test its accuracy. Fastened at the top of the mast is a piece of fine piano wire which passes downward through the tube and has attached to the bottom a lead weight of about 40 lb. This is the pendulum feature.

The indicating parts of the instrument consist of two upright needles which magnify any movement of the pendulum due to inequalities of the surface being tested, and which swing in vertical planes at right angles to each other. Each needle is supported on a delicate knife edge at a level just above that of the top of the weight, and projects vertically upward. A short distance above this support a fine catgut cord connects the needle to the pendulum wire, the needle being delicately weighted so that it will swing away from the pendulum except as it is held by the cord. By this arrangement the top of the needle swings in the same direction as the pendulum, and serves to register its deflections. The top of the needle is shaped to a fine point which swings along a graduated scale, and in this way any deflection of the pendulum is read. The distance from the support to the point where the cord is attached is $\frac{1}{50}$ of the total length of the needle, so that any movement of the pendulum, as indicated by the needle, is magnified 50 times. The pendulum, being 10 ft. high and being supported on a base about 1 ft. wide, magnifies inequalities in the surface being tested about 10 times, making a total magnification of about 500 times. In other words, if one of the bearings of the instrument is raised $\frac{1}{1,000}$ in., the needle point will make a distance of $\frac{1}{2}$ inch.

In practice, the pendulometer is used for making selected points on a surface true, and intermediate points are then tested with a straightedge laid between these points.

PARIS BANS THE GASOLINE 5251 AUTOMOBILE

The gasoline automobile has received its first setback in the city which was first to welcome it. Paris has forbidden the appearance of gasoline cars of any kind on its most fashionable drive, the Avenue des Accacias, leading to the Bois de Boulogne, between the hours of eleven and one.

SAVING NATIVE BIRDS ON RESERVATIONS

4752

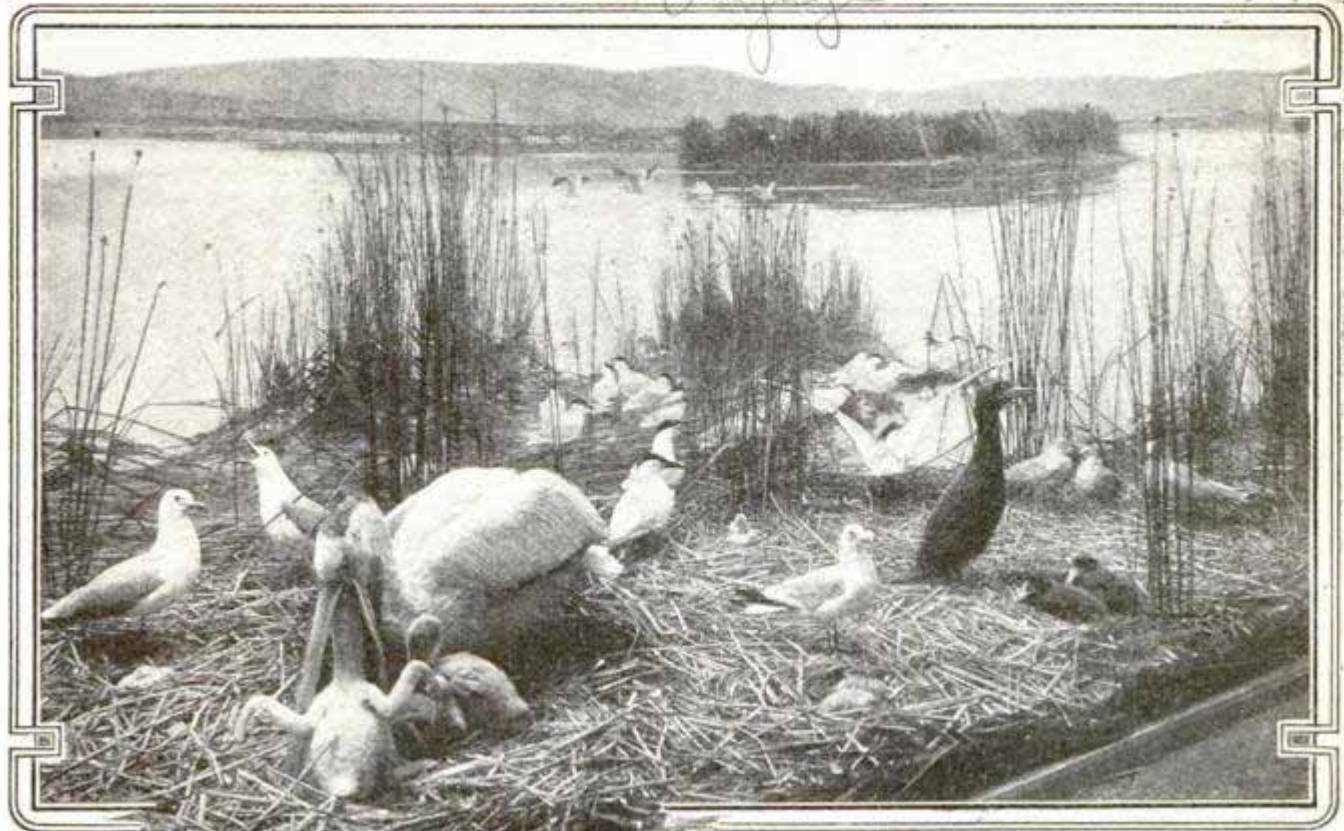

Habitat Bird Group Reproducing the Life of the White Pelican, Caspian Tern and Cormorant on the National Bird Reservation at Klamath Lake, between California and Oregon

Photo by American Museum, New York

Since the setting aside of Pelican Island, Florida, as a national bird reservation in 1903, to protect the brown pelicans and other nongame birds nesting on the island, the saving of native birds has developed into a country-wide movement.

There are now 61 bird reservations in the United States, scattered through 19 states and territories, from Florida and Porto Rico to Alaska and the Hawaiian Islands. They are divided into six districts, each under an inspector aided by wardens. Most of the bird refuges are small, sandy, marshy, or rocky islands, of little agricultural value and attractive to birds because of their isolation. Another type of reservation, which has been established on the reclamation projects of the West, consists of a narrow strip of land bordering on the reservoir to afford a resting place for birds traveling north or south. One-third of the bird refuges belong to this class. In most cases the chief protection is provided by the isolation of the refuge—some of them

are almost inaccessible. But in other instances wardens have been appointed, provided with motorboats, and in some far-away reservations naval tugs and revenue cutters take a hand in repulsing plumage hunters. The birds that are protected are chiefly marsh birds or waterfowl which nest in colonies: gulls, terns, pelicans, herons, grebes, petrels, auklets, and, in the Hawaiian



Map Showing the Districts for Regulating the National Bird Reservations. The Alaskan and Hawaiian Districts are Not Shown

Islands, albatrosses, shearwaters, etc. The reservations afford protection not only to feathered inhabitants, but to



Aleutian Islands Reservation, Alaska, Which Protects Reindeer and Fur-Bearing Animals as Well as Birds

native animals, especially water mammals, as well: seals, porpoises, and even buffalo, deer, and larger game. While preventing the extinction of rare native birds, the safety of the refuges is taming them so that their habits can be studied and recorded. As a result much of the bird life on the national reserva-

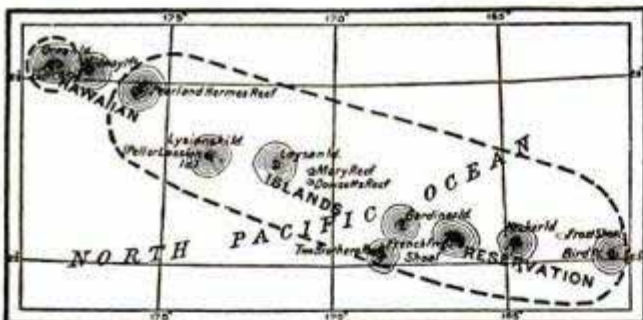

Hawaiian Islands Reservation for the Protection of Birds: It Includes the Reefs and Islands Embraced by the Broken Lines

tions is being reproduced in permanent bird-habitat groups in the American Museum of Natural History, New York.

Hydro-airplane
FLYING BOAT WITH FISHLIKE BODY

5730

Low head resistance is the chief characteristic of the new Gallaudet flying boat which has just been completed. Its body is built in the form of a fish with streamline wings and two propellers, mounted close to the body just back of the wings. The hull is built of $\frac{1}{4}$ to $\frac{5}{16}$ -in. three-ply mahogany, strengthened with steel tubing and divided into 30 water-tight compartments. Above the deck, the body is built of ash ribs and battens covered with varnished linen. One long tubular steel spar, stretching through the body from tip to tip and braced by three stays, supports the two wings. Power is supplied by a 50-hp. Gnome engine. The roomy cockpit has seats for a pilot and one passenger behind him. The flying boat's dimensions are:

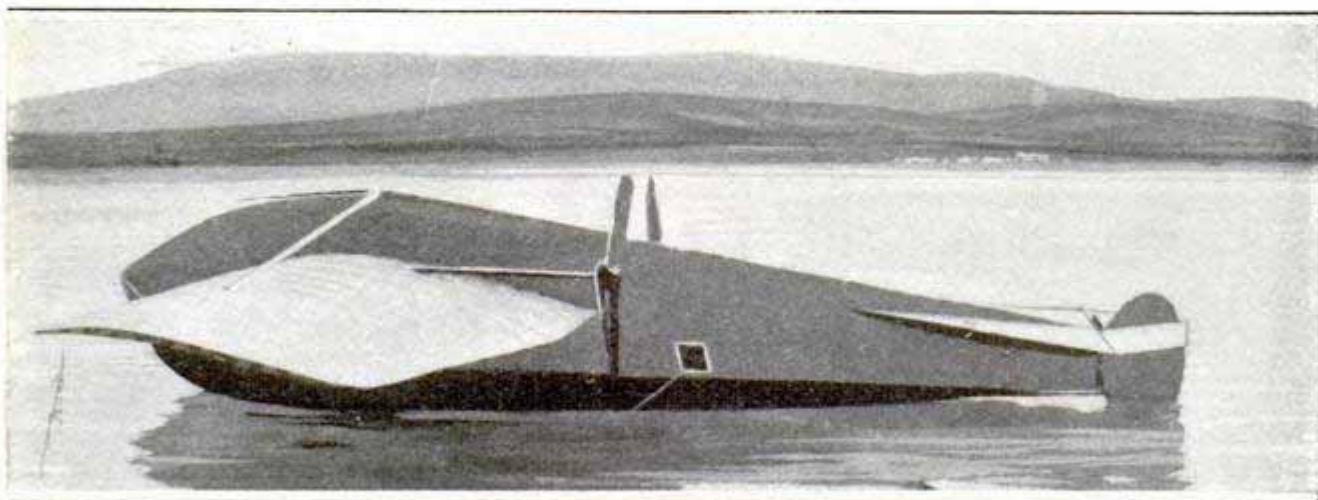

Courtesy Flying

New Gallaudet Flying Boat with Fish-Form Body and Streamline Wings to Reduce Head Resistance

Spread, 36 ft.; length, 27 ft.; wing surface, 234 sq. ft.; beam of boat, 4 ft., and draft at 1,500-lb. displacement, 12 inches.

SILENCER FOR THE NOISY

8256 TYPEWRITER

The noisy clicking of the typewriter will soon be no more than a disagreeable memory, if the typewriter silencer which a Cleveland man has just invented proves a success. It does not make the typewriter absolutely silent, but it reduces the sharp click to a soft, dull thud which is not so hard on the nerves. The noise is so much reduced that an operator can receive dictation given in a natural tone of voice while the machine is running. The silencer consists of a core for the platen which eliminates the greater part of the noise made by the type striking the paper.

MAKING HYDROGEN PEROXIDE

4994 OUT OF WATER

Water is converted into hydrogen peroxide without any consumption of chemicals by a new continuous-cycle process which has been patented by two German chemists. It consists simply in oxidizing water by means of chemicals which, after having given up part of their oxygen, are easily regenerated for continued use. The old method results in a waste of chemicals through the formation of by-products, and the yield is never more than a 20-per-cent solution. In the new process, on the other hand, up to 30-per-cent solutions of hydrogen peroxide are produced with practically no loss.

DANISH FOUNTAIN OF THE

4722 DANCING GIRLS

A fountain in honor of the Royal Danish Ballet, called "The Well of the Dancing Girls," is one of the recent monuments set up in Copenhagen. It was designed by the sculptor Rudolf Tegner, and stands in the gardens of

Rosenborg Castle. Three dancing girls, in bronze, thinly draped and hold-



"The Well of the Dancing Girls" Erected in Copenhagen in Honor of the Royal Danish Ballet

ing hands, are shown dancing about the brim of a large bronze fountain bowl.

DEVICE FOR DETECTING

SLACK TIRES 5097

One of the latest features in automobile equipment is a device for detecting imperfect inflation of tires. This consists of a U-shaped strip of metal, the ends of which form plungers for striking a small bell when the tire is loose, the whole device being placed over the tire as shown in the illustration. As long as the tire is fully inflated the device is held rigidly, but as soon as leakage occurs the tire flattens under the weight of the car and the plunger is forced against the bell, causing a distinct sound which is repeated at each revolution of the wheel.

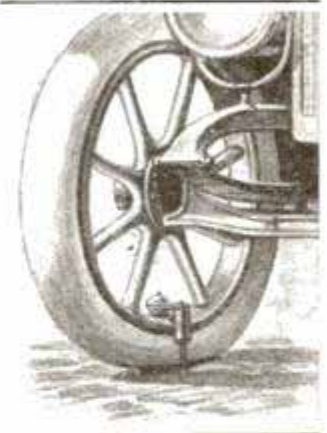

AEROPLANE PROPELLER OF

4472 NOVEL SHAPE

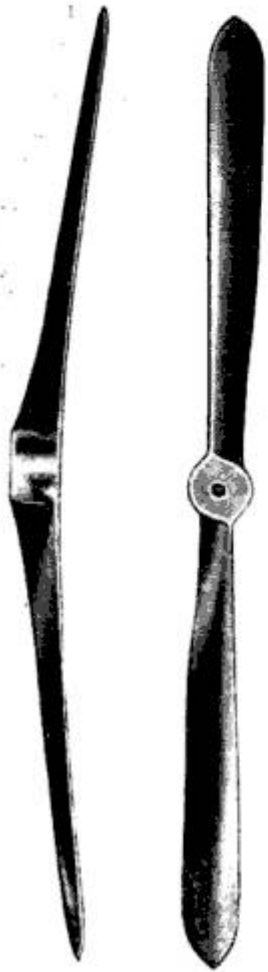

A propeller blade of a novel shape has been developed recently and is being used extensively on German airships and aeroplanes. When viewed from the front this blade is seen to be extremely narrow, but does not appear to be unusual in any other particular. But when looked at edgewise the tips of the blade are seen to have a distinct forward trend or curve, as shown in the illustration. This is the distinguishing feature of the blade. When revolving at full speed the centrifugal force of the blade tends to straighten out the curve at the tip, which, it appears, not only adds to its efficiency, but makes it less likely to be broken by the strain crosswise of the grain of the wood.

4981 MODERN GLOBES FOR THE BUSINESS MAN

To keep pace with the increasing importance of geography in commercial matters, many interesting globes and charts are appearing, intended especially for the business man. As rapid transportation has reduced the distance between various parts of the earth, business men's markets now embrace almost every part of the world. And the modern globe is designed, not so much for the theoretical geographer, as for the business man. One interesting globe, invented by an American railroad man, but manufactured in Germany, is almost a complete commercial geography in itself. It gives not only

the outlines of the various continents, but all the steamship routes, all the sailing routes, all the railroads, all the cables and telegraph lines, and the location of all German consulates. Fourteen different kinds of lines are used to indicate the nationality of the ships sailing various routes. The various dry docks, repair yards, coaling stations, and their capacities are all indicated. Figures on the globe give ocean depths, and enlarged maps, laid out on the broad ocean spaces, show the details of important cities and harbors. Other marks indicate the presence of more or less frequent earthquakes, tidal waves, ocean currents, trade winds. The population of every nation is stamped upon it and heavy meridians follow the changes in time around the world. A movable brass strip, marked in miles and kilometers, is supplied with the globe for determining the great-circle routes between various ports.

Another interesting globe is made in relief to indicate the varying altitudes in different parts of the world. It shows not only the topography of the land but the depth of the ocean bottom, with its shelves and reefs, as far as they are known. For greater clearness the vertical relief is exaggerated to a scale of 16 to 1.

An ingenious sidereal globe is built in connection with a clock so that it makes a revolution a day. A scale around the equator provides means to determine the time at other points in the world corresponding to the time shown by the clock. The globe's axis is tilted to illustrate the changes in seasons and a rotating brass disk gives the date and month. For school purposes, a globe is now provided with pulleys so that it can be hung from the ceiling to give the impression of the earth's position in space.

¶The oldest and slowest ship in the world, the "Anita S.," built in 1548, was recently broken up in the Canary Islands. She was practically a duplicate of Columbus' caravel "Santa Maria."

Chicago

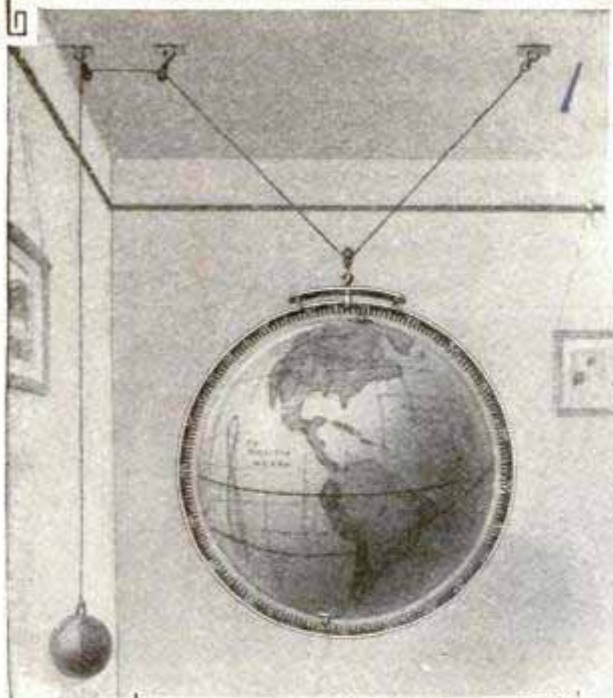

Hanging Globe for Illustrating the Earth's Position in Space



Relief Globe Showing Land Elevations and Ocean Depths

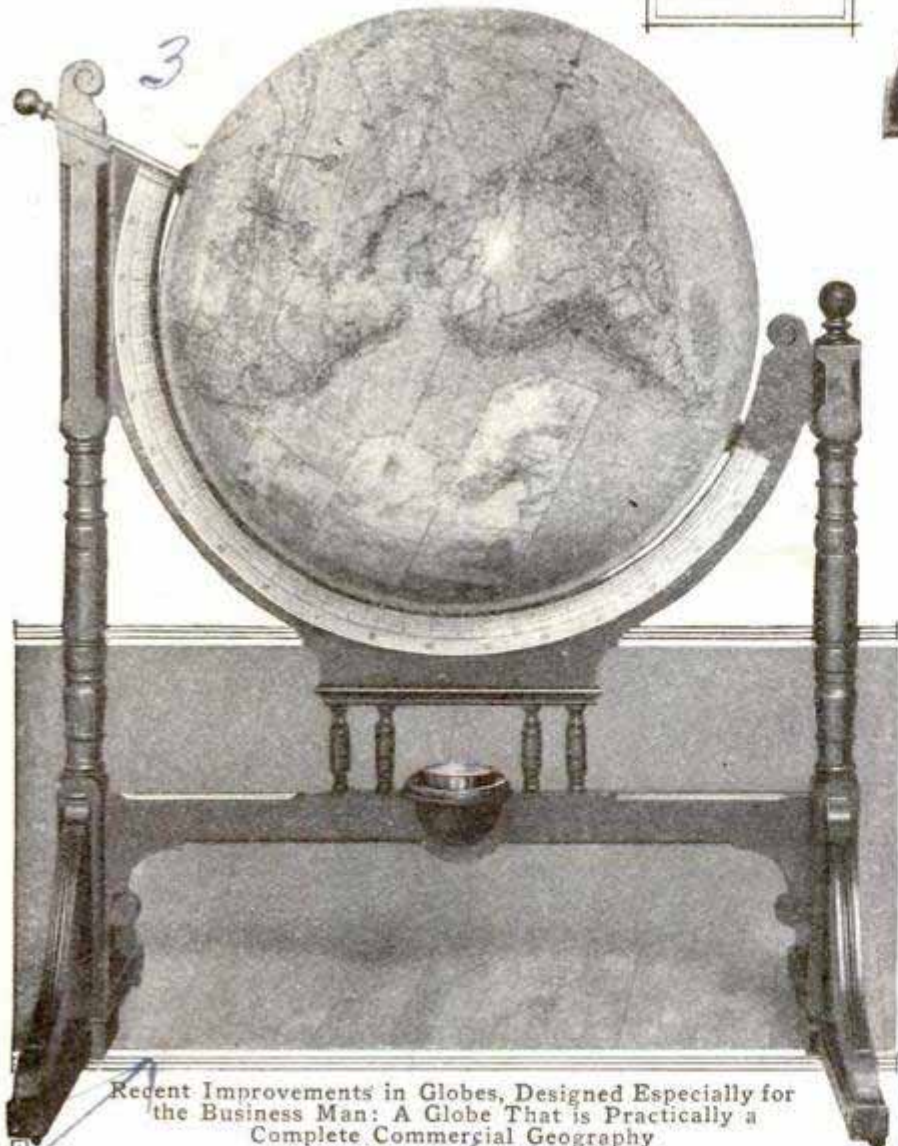

Recent Improvements in Globes, Designed Especially for the Business Man: A Globe That is Practically a Complete Commercial Geography



Sidereal Globe Which Indicates the Time in Various Parts of the World

Mr. John Die & Sons
817 W. Madison St.
Chicago

Samuel Hill
Put them on

BUILDS DYNAMITE-STORAGE HOUSE IN LAKE

5048

As a matter of safety, as well as for complying with the Chicago city ordinance limiting the quantity of ex-

AMERICA'S GUNS FOR AERIAL DEFENSE

5109

All American field guns in the future will be equipped for firing at aeroplanes and other kinds of aerial attack. Other nations are developing special guns for this kind of defense, but the Ordnance Department has decided that a better policy will be to modify all its guns and carriages. Experiments with the Deport gun, which has a split trail and recoil system, indicate that a slight modification of its carriage fits it for firing at an angle of 45 deg., and that a new type of gun and carriage can be developed from it which can be used for an angle of 90 deg. Some modifications in the gun itself will have to be made also. It will be



Storage House in Which Dynamite is Kept at Safe Distance Off Shore

plosive that can be kept within the city limits, one contractor has erected a storage house in Lake Michigan, several hundred feet from the shore, in which his supply of dynamite is kept. Ordinarily, the explosive is transferred to the shore, as needed, in boats, but when the water is too rough for this method of transfer, the suspension footbridge shown in the illustration is used.

given a greater horizontal range and will be mounted in such a way that it can be fired at a greater angle laterally than at present, without moving the carriage.

NEW SCHOOLHOUSES OF SOLID CONCRETE

5212

A new type of school building has been adopted in El Paso, Texas. The new schoolhouses are built of solid concrete and have large windows of

LARGE WATER-POWER PLANT IN ICELAND

5110

Dettifalls, the largest waterfall in Iceland, has been purchased by an English company for the development of power to be used in the manufacture of fertilizer. It is 35 miles from the coast in the River Jökulsa, which flows across northern Iceland and empties into the Arctic Ocean. The company will build a railway from the coast and erect a 400,000-hp. plant at the falls.

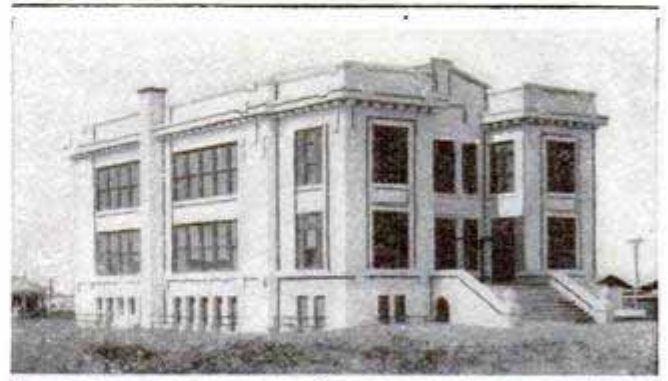

One of the New Solid-Concrete Schoolhouses Recently Built in El Paso, Tex.

Vertical text on the left margin: "Nitrogen Products & Cartridge Co." and "Chicago".

Vertical text on the left margin: "Chicago".

opalescent glass. The walls are very white, the roofs are flat, and the general design gives the buildings a monumental appearance. The raising of the main floor a half story above the ground gives the buildings the floor space of three stories with the main entrance on the second floor.

HOODS WORN BY JAPANESE PRISONERS

4519

An ancient and somewhat barbarous custom that still prevails in Japan is that of compelling prisoners to wear basketlike hoods when taken from the

AN UNDERWATER TELEPHONE FOR DIVERS

By carrying on a telephone conversation from the bottom of the Hudson River, an inventor recently demonstrated the practicability of his telephone apparatus for divers—the first telephone ever used in a diving outfit. With two receivers inside the helmet, fitted over his ears like earmuffs, and a transmitter in front of his mouth, he lay on the bottom of the river, 40 ft. under water, and carried on a conversation for 20 minutes with his helper on the pier. He is designing a telephone cable which will take the place of the old rope life line.

Amsterdam, with over half a million inhabitants, had a death rate of 10.94 per thousand in 1912, the lowest among the large cities of the world.

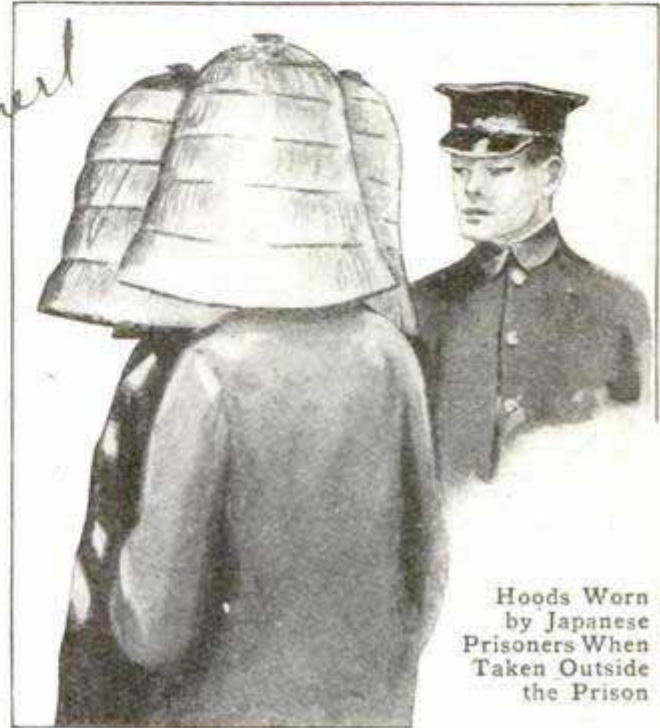

Hoods Worn by Japanese Prisoners When Taken Outside the Prison

prison for any reason. The prisoners shown in the illustration are being taken to court to be tried on a charge of setting fire to police stations.

A RACING AUTOMOBILE "MONSTROSITY"

721

A racing automobile with a hood so large that it is impossible to see the roadway over it has been designed and built by a speed enthusiast of Canton, Ohio. The top of the hood has a height of 5 ft. 8 in. above the ground and is 7½ ft. long. The steering post is so long, due to the unusual length of the hood, that a universal knuckle is required. The only direct view of the road the driver can obtain is to the front along one side, but, by means of a system of mirrors, he re-

ceives a view of all the road in front, as well as a view behind.

Within the monster hood is a specially designed 90-hp. engine which, the owner believes, will make a speed of 137 miles an hour possible.

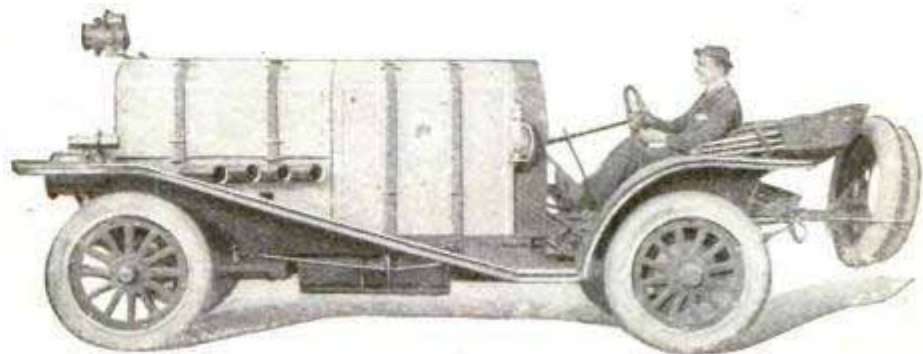

A 90-Hp. Racing Automobile with a Hood so Large That It Is Impossible to See the Road over It

L. P. Blackiston

from S. H. Swearingen

41
See page 8/12/13

6/10/13



"The Best Lighted Building in the World," So-Called, and Its Reflection in a Show Window

PENNY-IN-THE-SLOT TICKET MACHINES

4355

Automatic machines for the issuing of platform tickets have been installed

in a London railroad station, and persons desirous of seeing their friends off in the trains are required to place a penny in the slot and obtain a ticket before they are allowed to pass the barrier. The people call them "Good-bye Tickets."



To reduce the danger to pedestrians and to other vehicles when one motor car is towing another, it is proposed to require the forward car to carry signals, as is done by boats, to indicate that another car

is following not under its own power.

LIGHT EFFECTS CAUGHT BY A CAMERA

4825

Some remarkable light effects are shown in the accompanying photograph of what is frequently spoken of as "the best lighted building in the world" and its reflection in large show windows. The picture was taken during a light rain at 10:30 p. m. with the camera standing under an awning. The double image in the show windows is probably due to reflections from the inner and outer surfaces of the plate glass, and the distortion probably resulted from the vibration of the glass caused by passing cars. The streaks of light in the middle of the street were made by the headlights of passing trolley cars. The building is the Denver Gas and Electric Building and 13,000 incandescent lights, aggregating 200,000 cp., are used in the illumination.

NEW WIRELESS STATION USES EIGHT TONES

5232

A new wireless station established on the Island of Caterina, on the coast of Brazil, is equipped with the alternating "vielton" system and is intended to provide communication with the shipping to Buenos Aires, La Plata and Cape Horn, and with neighboring land stations. Ranges of between 600

*The Fleet Agency
152 Fleet St.
London, E.C. 4, Eng.*

*H. K. Stout
117 So. Logan St.
Denver, Colo.*

Electrical Review

and 700 miles have already been attained and regular communication has been established with Rio de Janeiro. The station differs essentially from most wireless stations in being able to make use of eight different tones in close succession without resort to any complicated arrangement. The apparatus which effects the tone variation is like a piano keyboard, the tones being produced by pressure on the different keys. The command of a number of tones is of great importance in South America on account of atmospheric disturbances, and this station is expected to possess great advantages over stations having command of only one tone.

Illustration

CLOCK CARRIES EMBLEMS OF WINE INDUSTRY 4740

A clock in which each visible feature is an emblem of the wine industry was one of the gifts received by Kaiser

Wilhelm's daughter at her marriage recently. This curious gift was presented by the City of Hamelin, celebrated as the home of the legendary Pied Piper, and the center of an important wine-producing district. The hands of this clock are peculiarly shaped corkscrews, the weights are wine bottles, and the pendulum is composed of

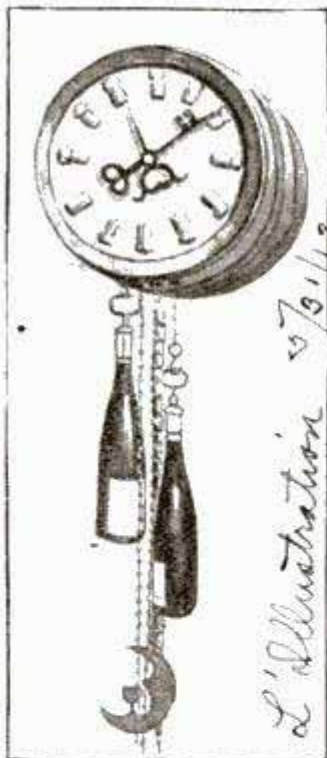

L'illustration 7/3/18

Courtesy L'illustration

corks strung on a rod and carrying a pendulum bob representing the man in the moon with a wine glass. The case consists of half a small keg, the end of which forms the dial. The hour numbers are painted on small raised figures representing champagne corks.

SALMON RUNNING UP AN ALASKAN CREEK 4873

Salmon are so numerous in the little creek shown in the accompanying photograph, that a man could almost walk

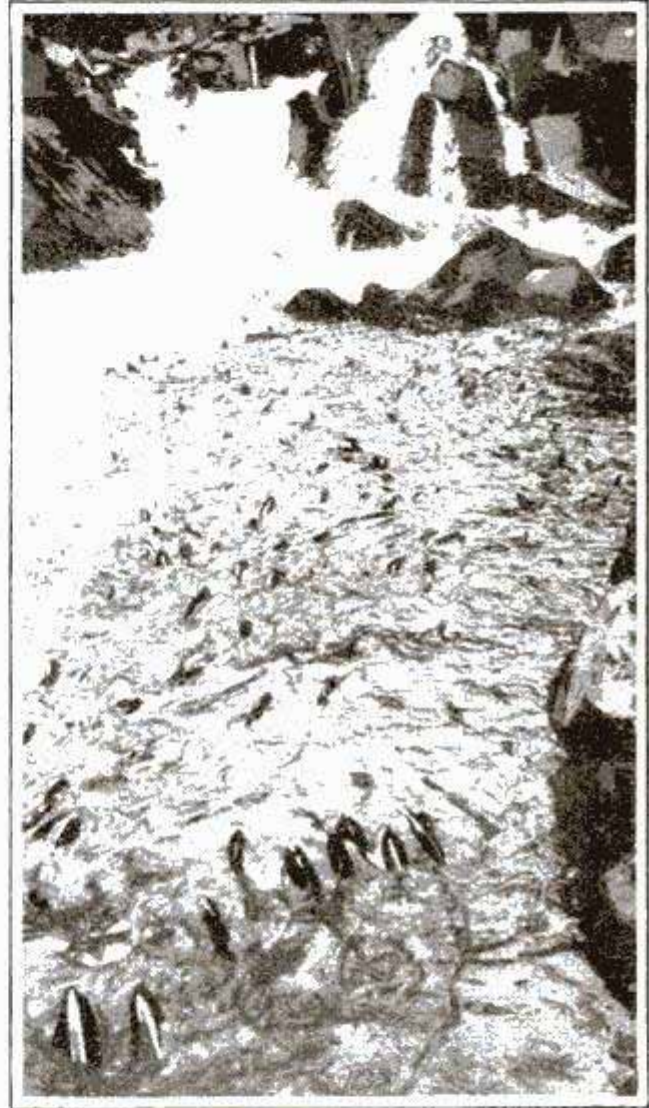

*C. P. Tickle
Ketchikan, Alaska*

A Small Alaskan Stream Congested with Salmon Running Upstream to Spawn

across the stream on their backs. It is a small creek near Ketchikan, Alaska, and the salmon, thousands of them, are running upstream to spawn. At this particular spot they are rather congested because the waterfall ahead impedes their progress; jumping from level to level in the falls is slower work than swimming in the swiftly flowing stream. After spawning, the salmon die and are washed back down the creek into the sea.

Ⓒ No aeroplanes will be allowed to fly over the Canal Zone without written permission from Washington.

**NEW SUPERDREADNOUGHT
IN BRITISH NAVY**

4953
England's latest superdreadnought, the "Ajax," is shown in the accompanying photograph lying at anchor after her arrival at Portsmouth. She is not the largest superdreadnought, for both England and the United States

**BALEARIC ISLANDS NOTED
FOR MESH PURSES**

5017
The making of silver and gold mesh bags and purses is an industry peculiar to the Balearic Islands. The 12 factories on the islands of Majorca and Minorca not only supply the home demand, but export to France,

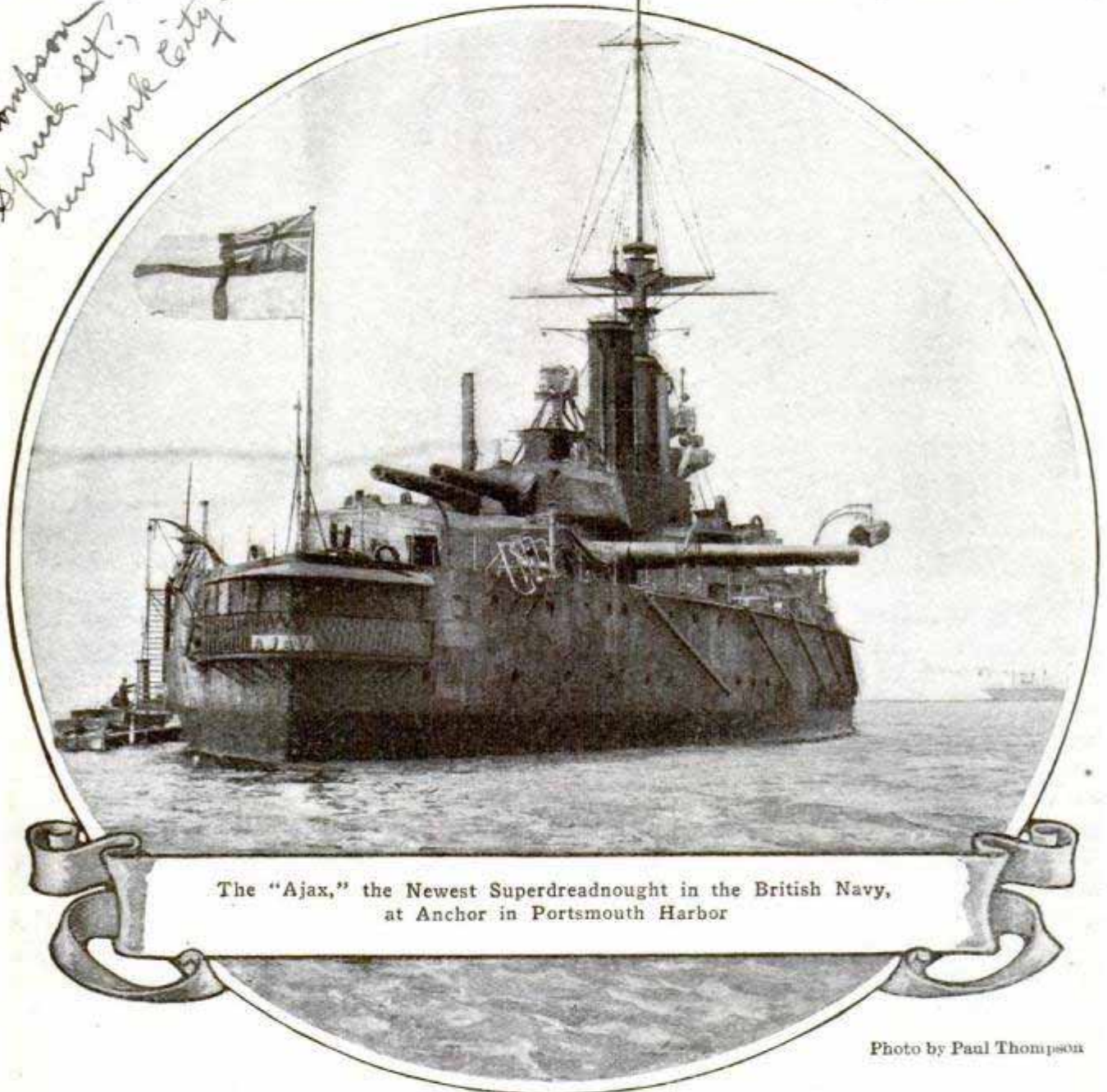

have larger battleships. Her displacement is 23,600 tons and her 31,000-hp. engines enable her to make a speed of 21 knots (24.18 miles an hour). Ten 13½-in. guns, in five turrets, and sixteen 4-in. guns make up her armament.

ⒸAbout 56,000,000 tons of steel rails are now in use in the United States.

America and other countries. Formerly the purses were made by women in small establishments in the country towns and the gold and silver wire and mountings were imported from France, but now the entire process is carried on in the islands, mainly in factories. The annual output is valued at about \$180,000.

THE ART OF MODERN TAXIDERMY

By HENRY L. WARD

Director of the Milwaukee Public Museum

4223

To most people the word "taxidermy" conveys the idea of stuffing the salted skin of an animal, and very little else. This method, however, has been entirely supplanted in modern museum practice. The mounted animals seen in up-to-date museums are hollow papier-mâché forms, covered with the thin-shaved skins of the animals, but so carefully molded and modeled as to convey the impression of life and action.

The mounting of a large mammal group may be taken as exhibiting the modern methods of taxidermic procedure. We will presume that the taxidermist has gone to the Pacific coast to obtain specimens and material for a group of sea lions; for, of course, having seen these animals in their native haunts, having measured and skinned them himself, he is much better prepared to reproduce a lifelike group than if he lacked this intimate, personal knowledge of the species. Having found a good workable rookery, he makes photographs of the herd and of the locality in general that will serve for guides in painting the panoramic background that the group will probably require. Other photographs will show smaller numbers or individual animals at closer range and with more recognizable details such as are required in modeling. Sketches and notes will supplement these photographs and permanently register his observations. When a sea lion is killed for preparation careful measurements are taken before it is skinned so that the exact location of the main anatomical features can be determined with certainty in the model to be later constructed. These measurements are taken as carefully as a tailor measures a man for a suit. They include length of head and body, distances between various recognizable points on the skin, circumferences of head, neck, body, and flippers at various points, sundry diameters, etc. The animal is then skinned, the

necessary cuts being made where they will be most hidden when the skin is mounted, and the skin is freed from blubber and thoroughly salted for transportation.

The requisite specimens having been prepared, samples of rock and any other characteristic features of the rookery are collected for exact reproduction in the laboratory.

If convenient, it would be desirable to make a sketch model in clay of the proposed group and color sketches of the locality, on the spot, and in the presence of the live sea lions; but it is seldom feasible to do this and, therefore, the taxidermist should take back with him detailed records that will leave little to the uncertainties of memory in working up the group.

Back in his laboratory, the taxidermist proceeds to compose the group; making a small scale model in plastic composition which shows the relative placement and attitude of each individual upon the rocks of the rookery, all with sufficient accuracy of detail that the effect of the finished, large group may be seen and all needed adjustments made before the latter is begun. The rock work on which the animals are to stand is then built up in sections: a light framework of wood covered with wire netting and surfaced with papier-mâché.

The skeletons of the limbs, and the skull are then fastened to a wooden frame, so that each occupies its correct position according to the measurements taken in the field. This is accommodated to the surface of the rock section upon which it is to stand, and the rough, approximate contour of the animal obtained by the use of wire netting, stiffened and held in place with stucco or plaster of Paris. Upon this foundation the taxidermist proceeds to build up, in potter's clay, an exact reproduction of the animal as it would appear in the flesh, but making allowance for the modifying effect of

the skin. Every feature that is to show, all wrinkles, muscular swellings, etc., are to be brought out now or never. It is not necessary to model the extremities of the flippers, as these are so thin between the layers of the skin in the interdigital spaces that a cast would be hardly practicable and these parts can be better modeled in place in the skin.

The photographs and measurements taken in the field serve as guides in determining the form of this clay model. During its preparation the clay is kept in workable condition by covering with damp cloths. The model being finished, it is soaped and oiled and a plaster piece mold made from it. These pieces are removed, dried and shellacked. They are then coated with papier-mâché, either directly or with coarse burlap or other fabric intervening between the mold and the plastic material; wire netting to afford greater strength and stiffness is worked into the papier-mâché, and strengthening transverse ribs of netting may be added. When the casts are dry enough they may be removed from the molds and, after thoroughly drying, their interior surfaces are to be shellacked, the pieces wired and glued together and cloth pasted over the seams. In case the mouth of the animal is to be left open, portions of the jaws carrying the teeth are cut away from the skull and inserted in the papier-mâché head. The model is now complete and should be given a heavy coat of shellac to make it impervious to moisture. This model is light in weight but very strong and rigid. There is no possibility of any of its prominences flattening down from ordinary pressure or handling.

The skin has been shaved very thin and soft-tanned by the tanner and is ready to be applied to the form. This is covered with flour paste mixed with glue and arsenic, the skin placed over it and, as it is worked into place, the seams are sewed up, great care being exercised that all parts of the skin are brought thoroughly into contact with the form. It is best to bind or otherwise fasten concave surfaces so that they will remain in close contact with

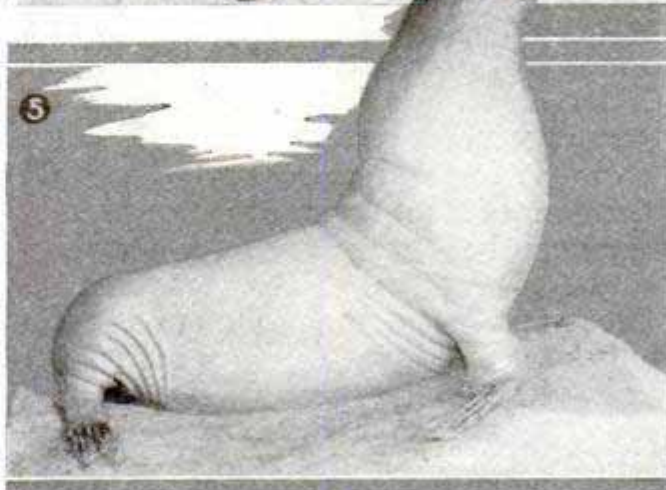
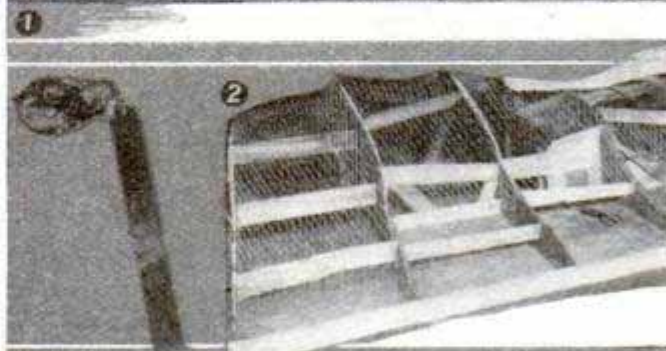

Preparing a Group of Sea Lions for Museum. Some Genuine Bones Attached. 4, Wire Netting and Making the Plaster Mold from the Life-Size Model. the Plaster Mold. 10, The Skin Ready to be Stretched

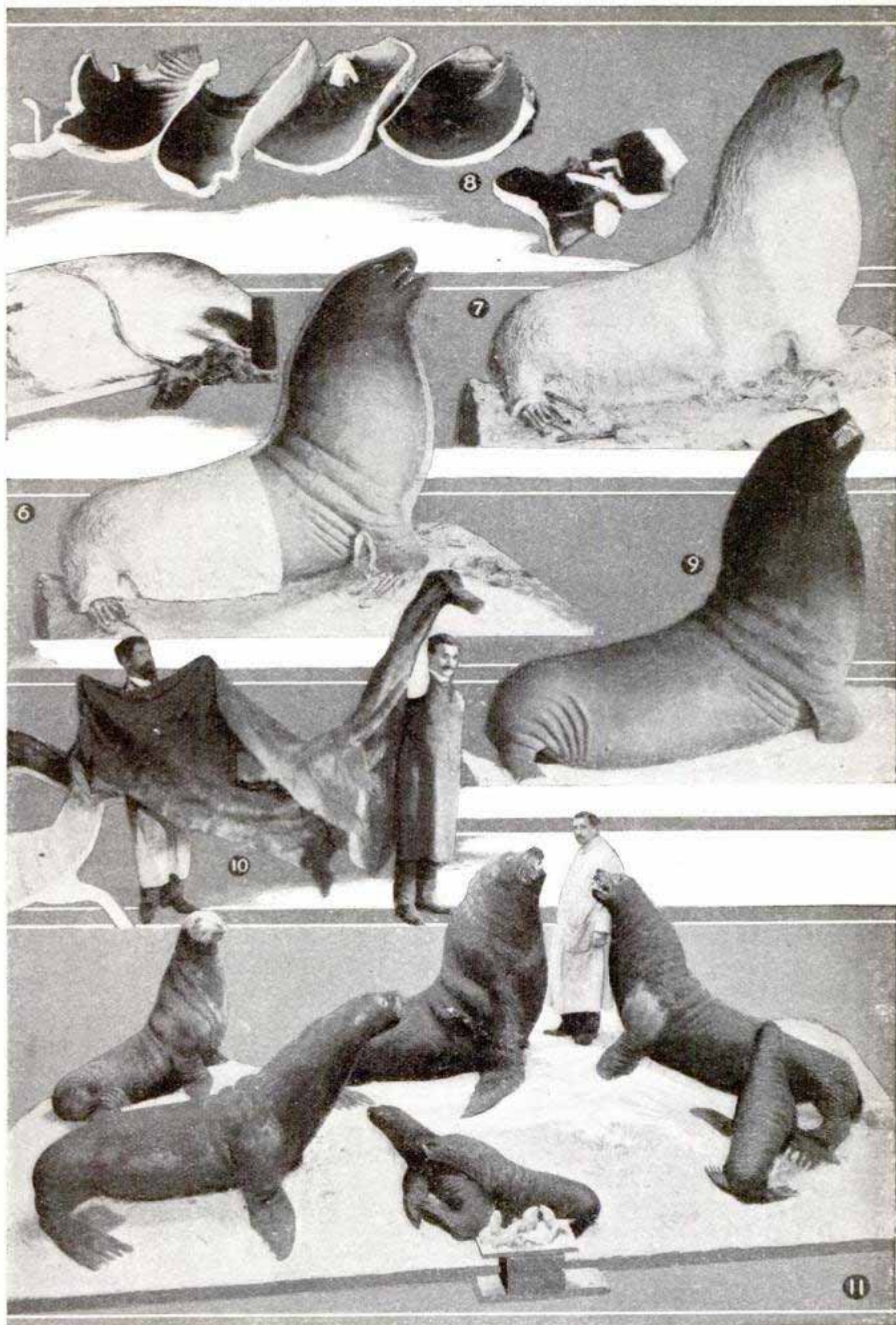

Exhibition: 1, The Small Clay Model. 2, How the "Rocks" are Built Up. 3, The Wooden "Skeleton," with Stucco to Fill Out the Natural Contours. 4, The Life-Size Model, Built to Accurate Measurements. 5, The Plaster Mold. 6 and 7, Sections of the Plaster Mold. 8, Hollow Papier-Mâché Model Formed by Casting a Thin Layer Inside on the Papier-Mâché Model. 9, Finished Group of Sea Lions with Original Small Clay Model in the Foreground

the form while the paste is drying. The glass eyes are placed in their sockets, imbedded either in papier-mâché or in putty. When mouths are left open, their interiors, including roofs, tongues, etc., are modeled in papier-mâché coated with colored wax.

The completed group of sea lions will go into a glass case with a scenic background depicting a particular locality these animals have chosen for a rookery.

It will be readily appreciated that in the type of taxidermy described the operator is not hampered by the necessity of working within an enveloping skin, upon an unstable, yielding base, nor with a skin that will shrink and pull, and change much that he does. His details of form are all made upon

the surface, free from the interference of any covering and with the assurance that, barring the modifying effect of the thin skin and the hair, all of which he has taken into account, they will show and remain exactly as he has modeled them.

The aim of group work is to exhibit some characteristic features in the lives of animals and depict their habitats. The former is attained in the attitudes, individual and relative, given to the animals. The latter is obtained by accessories, as water, soil, plants, and scenic paintings. Swamp, desert, mountain, or plain can be indicated and the few square feet contained within the walls of the museum case may, by a skillful artist, be made to carry the eye over miles of characteristic country.

A MINIATURE BASEBALL

4629 GAME

Real baseball can be played by two persons with a mechanical toy which has just been patented and placed on the market—tiny players representing the contestants pitch, bat, catch, and run bases. The field is a board, 3 ft. square, with a rim around it and a groove following the base lines. The pitcher, batter, and catcher are fixed in their places, but four runners are arranged to run around the groove, guided by revolving arms under the board. Each fielder, with a net in his hands, is equipped to run around a

small circle to catch the ball. When the game is being played, one of the contestants puts a ball in the hollow of the pitcher's hand and twists the manikin's body to wind up his spring; a touch of a trigger at his back causes him to throw the ball. The other contestant in the same manner causes the batter to swing. If the batter makes a hit, one contestant starts the runners around the bases while the other manipulates his fielders to catch the ball. Regular baseball rules are followed.

Over \$16,250,000 has been appropriated for next year's work on the Panama Canal.

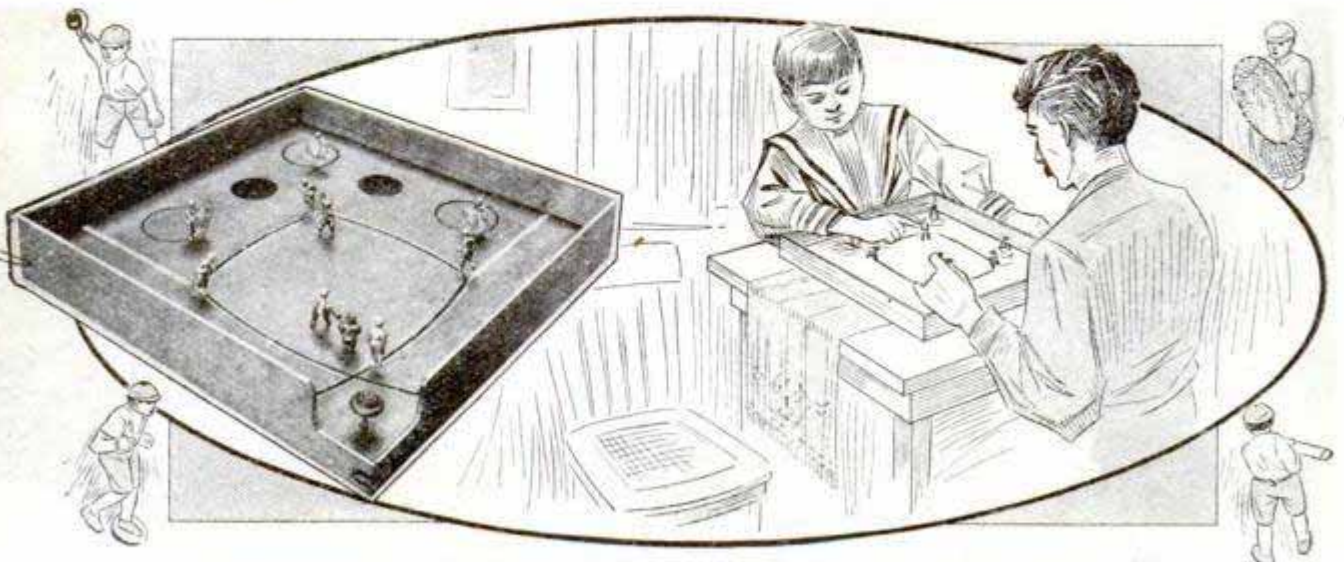

Mechanical Toy on Which a Miniature Baseball Game can be Played

C. L. Dellenbarger, Co.
625 W. Jackson Blvd., Chicago.

WHERE DONKEYS TAKE PLACE OF COMPASSES

746

Fog at high water is considered bad in the Burry estuary, Wales, but even worse at low water, for then there are men as well as ships to become fog-bound, and, at the worst, ships can anchor and wait for the lifting of the fog, while men cannot.

At low water in Burry estuary cockle gatherers ply their trade on the miles of flat sand and mud, and the coming of fog means inconvenience. It is true that the cockle gatherers might, like ships, carry compasses, but they hardly ever do, and it would be no use to wait for the fog to lift with the flood tide making. The cockle gatherer has, however, to the best of his knowledge, a surer means of finding the way in than a compass, and this is his invariable companion, the donkey. When the first of the tide begins to show, he loads up the sacks, catches hold of the donkey's tail, and follows where the beast may lead, which is a fairly straight line for home. The donkey not only heads the right way in the densest fog, but also avoids areas of quicksands.

Shipping World 10/23/13

Burry Estuary Mr. P. R. Slane

MONSTER TRUCK OPERATES IN TIGHT PLACES

No DATA

A powerful gasoline-driven tractor attached to an ash wagon, of 15 tons capacity, the combination making what is said to be one of the largest motor

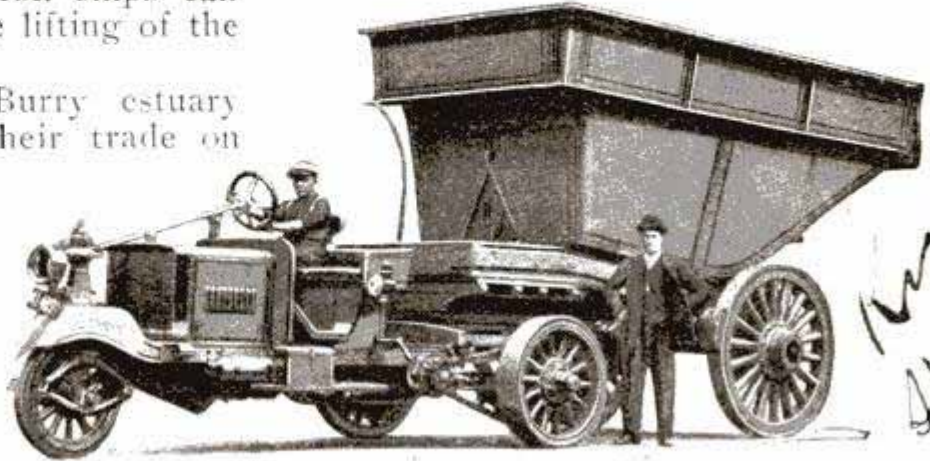

This 26-Ft. Motor Truck Can Dump Loads in a 14-Ft. Alley

trucks in the world, being 12 ft. high and 26 ft. long, is shown herewith.

The motive power of the truck is contained in the three-wheeled vehicle shown in the front, which may be attached to the front axle of any wagon designed to be drawn by horses. The single-wheel steering apparatus enables the driver to manipulate the wagon in narrow places, and it was possible with this truck to drive into a 14-ft. alley and turn so as to dump a load of coal into a chute running to the basement of a building, a feat practically impossible with a wagon drawn by horses. By separating the load-carrying part of the truck from the power section the load is carried on easy-riding springs.

Max Autom... Springfield

NEW FORM OF TELEGRAPH-KEY KNOB

4769

A telegraph-key knob has been patented which, it is claimed, does away with much of the nervous strain connected with the work of the telegraph operator. This device has a finger piece and annular base, as shown, and is so designed as to furnish an easy and natural hold for the fingers. It is made of vulcanized rubber and is readily attached to any telegraph key.

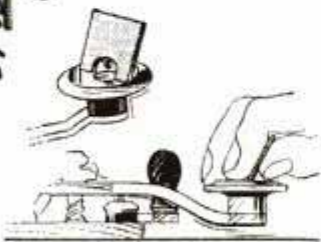

Patented May 17, 1913

Mr. H. C. Dauphinais

AUTOMATIC APPARATUS FOR RESUSCITATION

4737

For resuscitating the victims of drowning or asphyxiation a German scientist has developed an apparatus which compresses and expands the chest automatically, and which places the body in a variety of positions so as to stimulate the circulation of the blood. The victim is strapped securely to the table while it is in a horizontal position. By means of a lever the table

Prometheus 15-17-13

the bar #580 Page 257 "H.W.H."

is brought to a vertical position and the chest is compressed through the weight of the body as it is supported against the straps. This causes the expulsion of the water or gases in the lungs. After 20 or 30 seconds another

INGENIOUS TYPE OF GAS

4719 TURBINE

Much ingenuity has been expended in an attempt to develop an efficient gas turbine, and a machine has been invented recently which appears to solve most, if not all, of the problems connected with this difficult subject. In this device air under pressure from the blowers enters the combustion chamber, clearing out the products of the previous explosion. With the combustion chamber full of air, gas is blown in through another valve, and, by reason of the pressure behind it, eddies and thoroughly mixes with

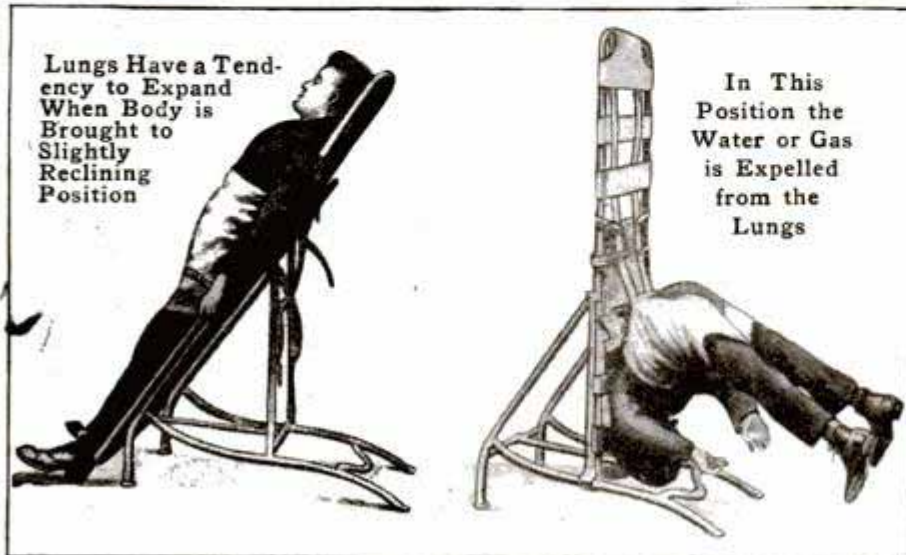

movement of the table brings the body to a slightly reclining position as shown in the illustration, a position in which the chest has a natural tendency to expand. The reversal from one position to the other is continued as long as may be necessary. This apparatus not only applies the proper motion to the chest, but, through the somewhat violent changes in the position of the body, stimulates the heart action.

LEMON-JUICE EXTRACTOR

4868 MADE OF WIRE

The commonly used glass lemon squeezer has been reproduced in wire in a newly patented utensil for extracting the juice of lemons and oranges. A cone of wire, just the size and shape of half a lemon, separates the juice as effectively as glass and is unbreakable. The utensil is sold in two forms: one mounted over a strainer that fits the top of a drinking glass, and the other fastened to the end of a wooden handle.



the air. The mixture of gas and air is exploded by means of an electric spark. Simultaneously with the explosion a flap valve opens allowing the resulting gases to expand and exert their full force against the rotor which is attached to the driving spindle of the machine. In order to secure sufficient rapidity in the explosions several combustion chambers are arranged in a circle, and operate in succession against the rotor. The gases are compressed by a three-stage blower and are exploded at a pressure slightly greater than that of the atmosphere.

TWO-WHEELED AUTOMOBILE

5028 - A NEW TYPE

The latest development of the motorcycle is a heavy three-passenger automobile mounted on two wheels, with small side wheels to balance it. In every detail of design, it resembles a rich, commodious, high-powered roadster. The pressed-steel frame is hung close to the ground, pivoted on a heavy spring fork in front and underslung from springs on either side of the rear wheel. Inside the doors of the aluminum body are seats for three passen-

*"Biantogo" motor cycle
Jac. Scripps Booth Designer*

*W. H. Cook, 1903 A. Atlantic Ave.
Brooklyn, N.Y.*

*the Gas Turbine
by Hans Holger
"H.H. Supplies" - English -
frank. Crosby, Dockwood Co.*

gers, two on a broad transverse seat and the driver on a smaller seat in front of them. When the car is standing still or running slowly it is balanced by pairs of 15-in. wheels on the

They are dry now, of course, but the picture shows how one of them might have looked in Nero's day when the fishermen were dragging out fish for Nero's dinner and a kitchen attendant

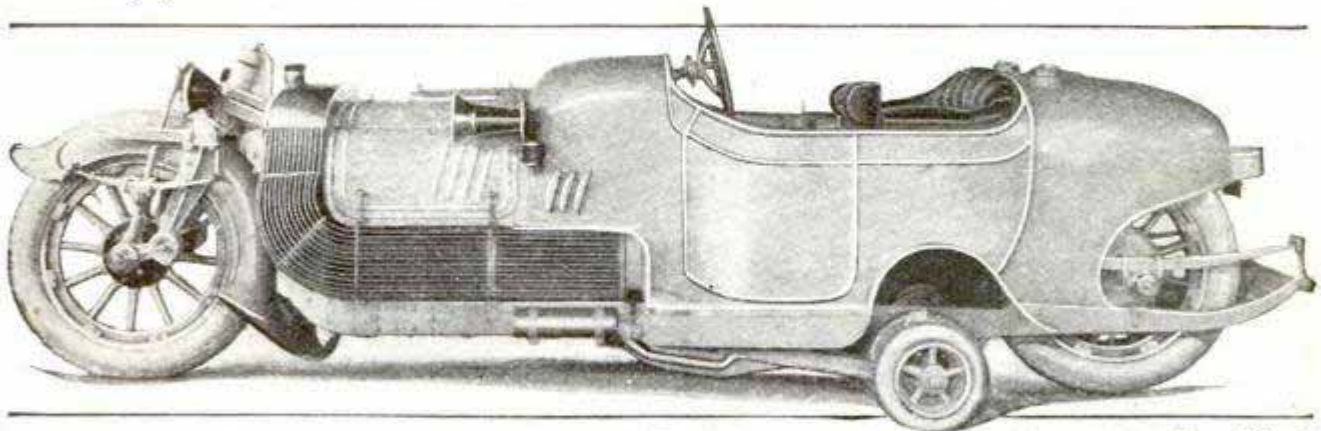

New Motorcycle Which is Really a High-Powered, Three-Passenger Automobile, Mounted on Two Wheels

ends of levers on either side of the body. The side wheels have a caster motion on their levers and are automatically lifted from the ground when the speed reaches 20 miles an hour. The dashboard, steering wheel, and control are designed in imitation of the latest automobiles. Back of the seats are two large tanks for oil and gasoline, on either side of the rear wheel. Power is supplied by an 8-cylinder, V-shaped motor, with cone clutch and transmission for four speeds forward and one reverse. Compressed-air starter, magneto and dual ignition, and a complete electric-lighting system are included. The motor is cooled by water with a radiator consisting of 450 ft. of 1/2-in. copper tubing in coils on either side of the hood. The car is mounted on 37-in. wheels and has a wheel base of 140 in., and a tread of 48 in. with the side wheels down; its over-all width is 50 in., 15 in. less than a four-wheeled car. With its passengers it weighs about 3,200 lb., and its center of gravity is very near the ground.

NERO'S PRIVATE FISH TANK

4723

A reconstructed view of one of the piscinae, or private tanks for live sea fish, which were found in Nero's palace during the recent excavations on the Palatine hill, Rome, is shown here.

Illustrated London News

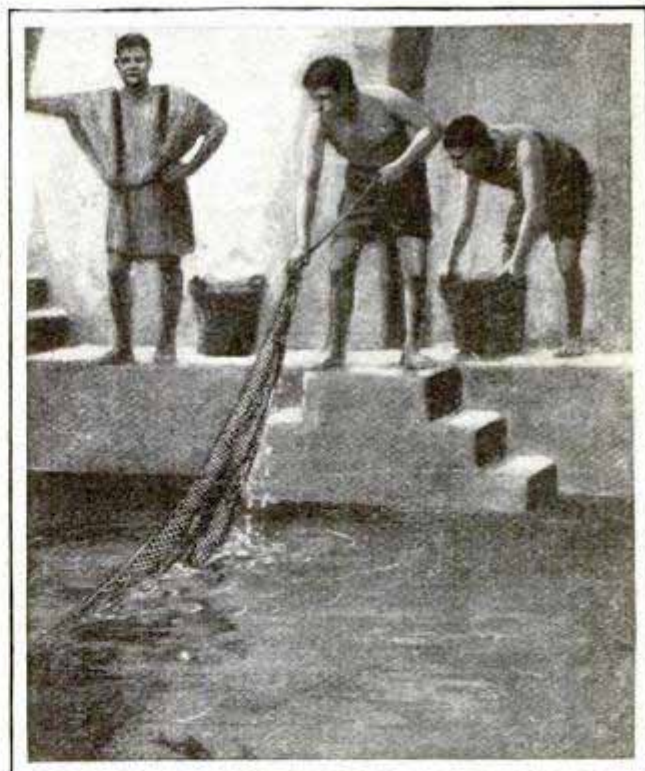

Courtesy Illustrated London News

These Fishermen are Casting Their Nets in the Private Fish Tanks under Nero's Palace; an Attendant is Waiting to Cook the Fish for Nero's Table

their tables. Just how sea water was brought to the piscinae is not now known.

DIAL FOR NEW FRENCH

4732 TIME SYSTEM

The adoption in France of the system of numbering the hours up to 24 has made necessary the use of special dials, of which a number have been invented, for indicating the time in accordance with this method. What appears to be the most practical and satisfactory dial is the one shown in the illustration. The face of the timepiece is provided with openings at the proper places for the hour numerals. Under this is a movable dial bearing the numbers from 0 to 23, which is shifted automatically back and forth between two positions by the clock mechanism. The figures are spaced in such a way that from midnight to noon, when the dial is in the first position, only the consecutive numbers from 0 to 11 are visible. At noon the plate shifts so these numbers are hidden and the numbers 12 to 23 come into view, the dial shifting to the right position at the end of each 12 hours. In this way the use of double sets of numbers on the dial, as well as the necessity for doubling the minute divisions, is avoided.

Illustration



ically back and forth between two positions by the clock mechanism. The figures are spaced in such a way that from midnight to noon, when the dial is in the first position, only the consecutive numbers from 0 to 11 are visible. At noon the plate shifts so these numbers are hidden and the numbers 12 to 23 come into view, the dial shifting to the right position at the end of each 12 hours. In this way the use of double sets of numbers on the dial, as well as the necessity for doubling the minute divisions, is avoided.

NEW WATER-POWER PERMITS
5112 REGULATE RATES

To regulate the price of water power to consumers, the government has established a new policy in granting water-power permits. A maximum charge of six cents per kilowatt-hour is

Christian Science Monitor

7-30

fixed by the terms of the permit, and the lower the power rate charged by the company, the lower will be the water rate collected by the government. Lower rates on water are to be charged for power used for certain purposes, such as making nitrates for fertilizers, and decreasing rates as more power is developed. This will not only protect the consumer, but encourage the fullest development of water power. The first application of the new policy was in the recent permit granted for the development of an electrical project with an ultimate capacity of 350,000 hp. on the Pend d'Oreille River, Washington.

REINFORCED LEATHER

3256 BELTING

An improved type of reinforced leather belting, which is claimed by the manufacturers to be more uniform in strength and to stretch less than belts of ordinary construction, has been placed on the market. It is said that the new belting will pick up the load quicker and also lessens the possibility of slipping or sliding on the pulley faces. The improvement is obtained by reinforcing every other lap of the belt, as shown in the illustration.

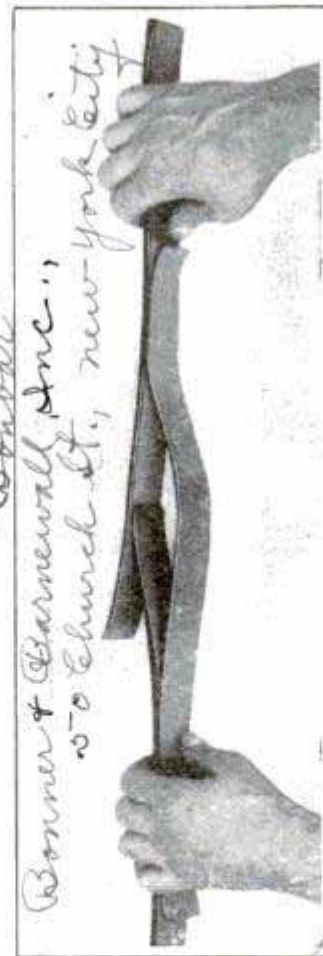

"Bonbar"

*Bonner & Barnwell, Inc.,
50 Church St., New York City*

CA celluloid-like material, said to be much clearer and tougher than celluloid, with a

higher glaze, is being used in England for automobile windshields. It resists scratching to a remarkable degree.

*Dover, Ltd. New York
Northampton, Mass.
Exonite*

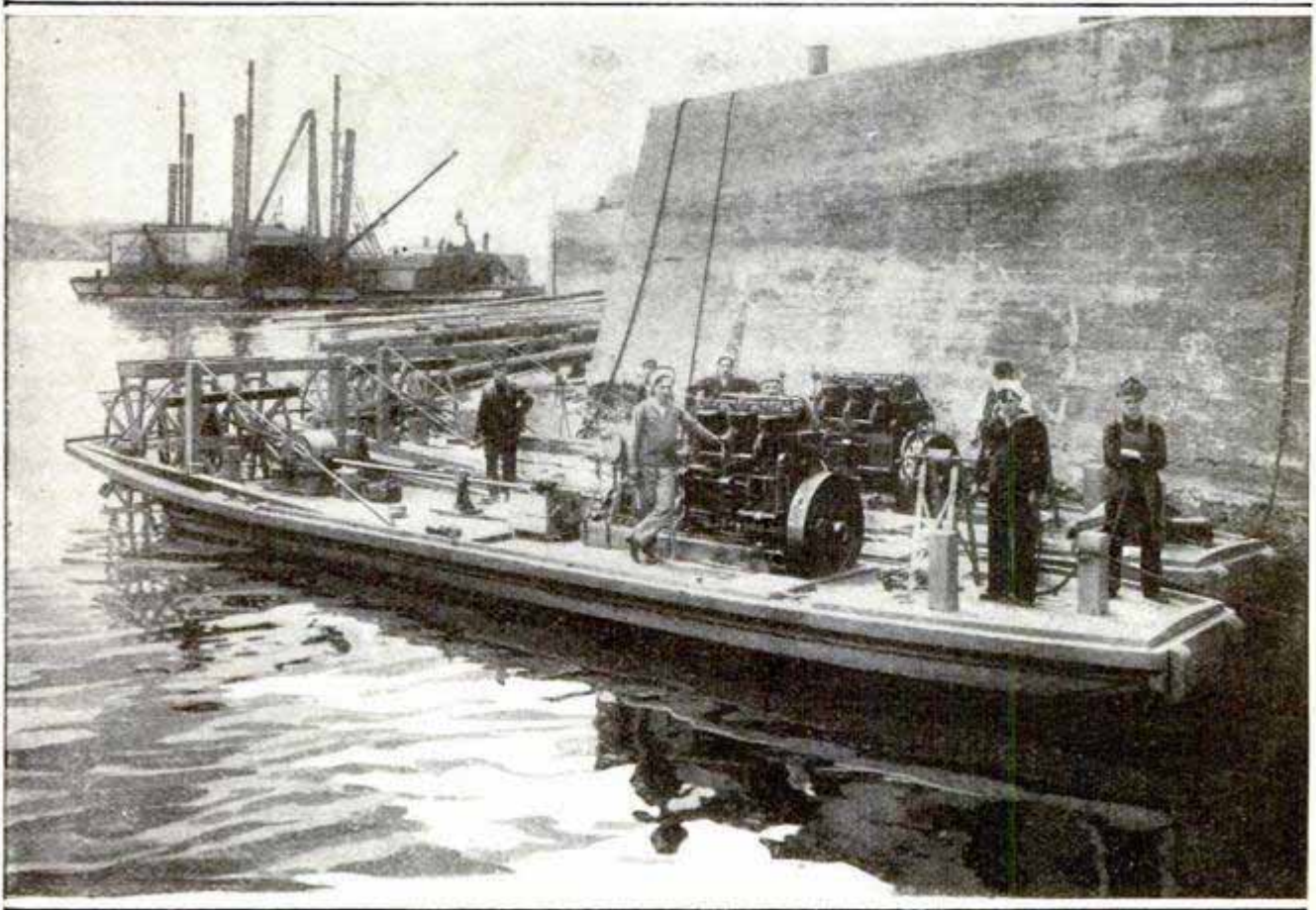

Powerful Motorboats for Towing Barges on Alaskan Rivers

**GASOLINE-DRIVEN BOATS FOR
4444 ALASKAN RIVERS** (no data)

The two stern-wheel river boats shown in the illustration are to be used by the expedition investigating the availability of Alaskan coal for naval uses and are particularly designed for hauling loaded barges in the shallow but swift rivers of Alaska. They are of the flat-bottom type, drawing about 30 in. of water. Each boat is 49 ft. long, with a beam of 10 ft., and is driven by a 50-hp. gasoline engine. In their trial trips each of these boats made a speed of 13.8 miles an hour. Since they are to be used only for towing, all the space in the hulls is used for the storage of gasoline. No deckhouses are provided, the boats being complete as shown in the illustration.

According to the latest statistics there are now 1,100,000 automobiles in the United States, which is an average of about one for every two miles of country road.

**AN ADJUSTABLE COVER FOR
4650 MANY PANS**

A cover that will fit any cooking utensil, pan, skillet, or kettle, of any size, has recently been patented and offered for sale. By extension and contraction, it can be adjusted to any size and takes the place of many covers of various sizes. Instead of resting on top of the kettle, it springs against the inside near the food and keeps all drippings inside the vessel and off the stove. Its dome shape confines the steam and insures even cooking on top. Turned over, it can be used to receive the food.



The Scott-Johnson Co.,
120 & 122 ... to B...

W. L. Tidston, 810 W. 61st St. Seattle, Wash.

NEW FILLER FOR PACKING

5142 EGGS

Another solution of the problem of packing eggs so that they can be shipped without danger of breakage has been offered by an Oregon inventor, who has developed a packing material consisting of sheets of molded pulp board. Each sheet has holes evenly spaced and of such a diameter as to fit firmly over an egg

a short distance from the end. When packed, each egg projects slightly through two adjacent sheets, the spacing of the holes being such that no two eggs are in contact. A case packed with hand-made sheets of this kind was loaded over the rear wheels of an express wagon, hauled rapidly over a rough-plank logging road, and dumped as a package of unbreakable freight would be handled, on the station platform. Only one egg out of the 50 doz. contained in the case was broken, and this, it was claimed, was due to an imperfection in the hand-made sheet. Owing to the stiffness of the pulp board it is possible for a man to stand on the top sheet of a case without breaking any of the eggs.

CA court in Hungary has decided that an aeroplane cannot be seized to pay an airman's debts, as it is a scientific instrument necessary to the owner for his livelihood.

TO STOP LAND SLIDES IN

5247 CULEBRA CUT

An underground system of reinforced-concrete posts and tie rods has been proposed as a possible means to prevent land slides in the Culebra Cut of the Panama Canal. The plan involves setting a row of underground posts in a line parallel with the banks of the canal and bracing them with other posts set at an angle against

them. To set the underground posts, it is proposed to drill holes from the surface of the loose strata to the firm rock below the level of the canal bottom. After the bottoms of the holes had been "sprung" with dynamite to form enlarged cavities in the firm strata for anchorage, steel rods would be placed in the holes for reinforcement. Then cement grouting would be forced into the holes under a pressure of 750 to 1,000 lb. per square inch, so that the concrete would penetrate all the fissures in the rock and form a secure anchorage. The vertical piles would form a secure foundation for a retaining wall and the inclined posts would

act as the diagonals of a strong dam of triangular cross section. Combined with this, adequate drainage and subdivision of the slope and an underground dam to protect the edge of the slope from wave action are

also suggested as means of preventing trouble in the future.

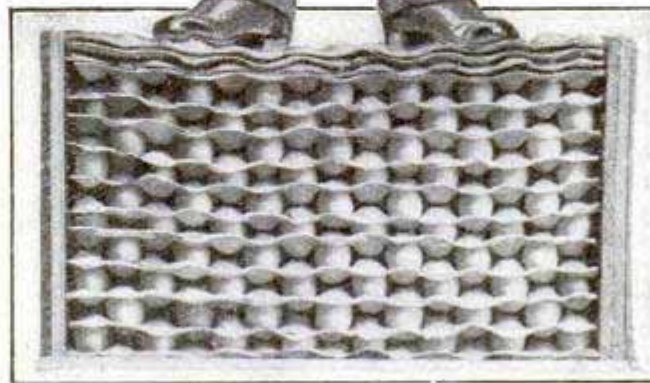

Test of the Efficiency of New Filler for Packing Eggs

Economy copy see page 734
 C. J. Voorhies, Portland, Oregon
 181 - 6th St.
 G. Weatherway, Aberdeen, Wash.
 C. J. Voorhies, Aberdeen, Wash.

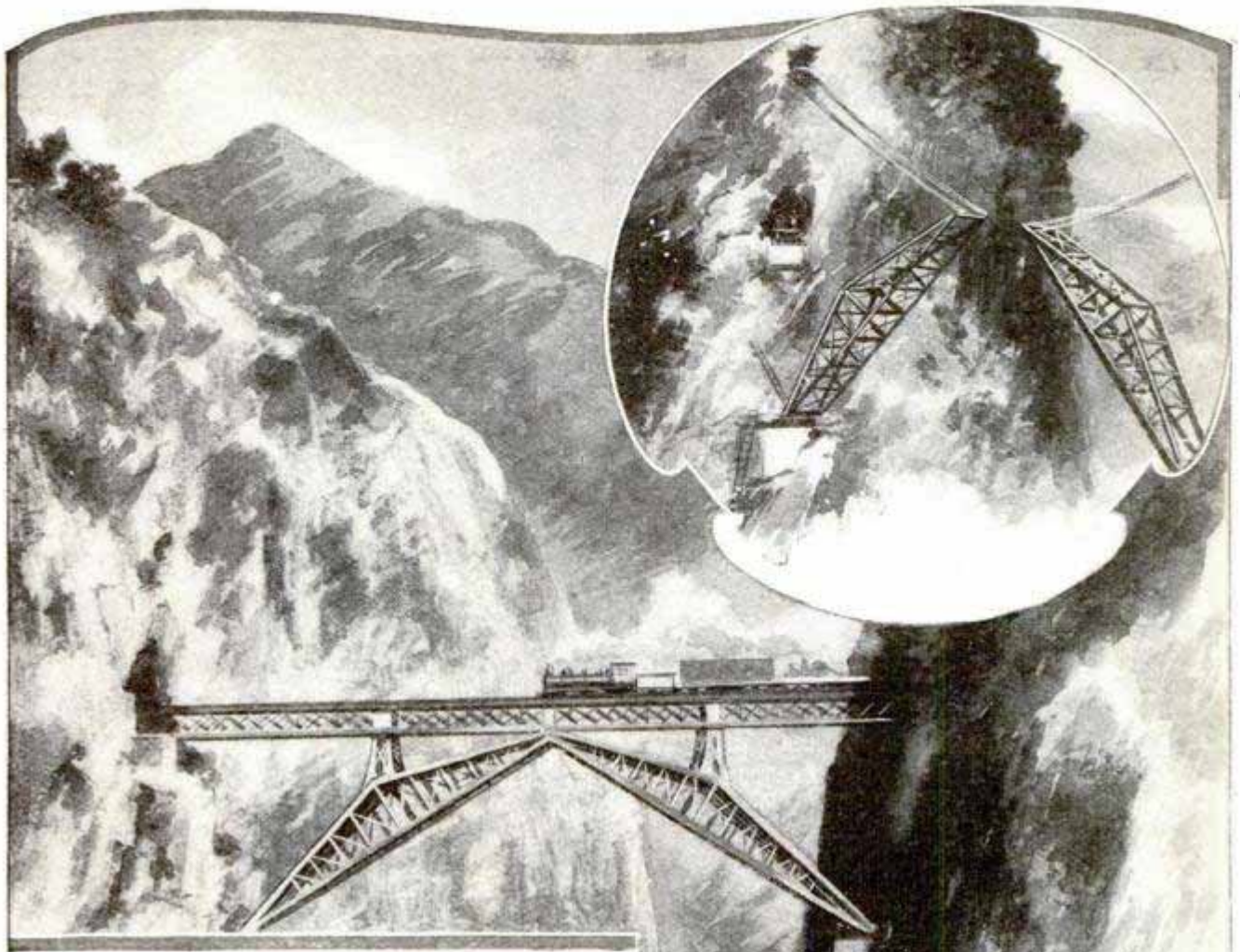

UNIQUE RAILWAY BRIDGE IN 4795 INDO-CHINA

One of the most interesting railway structures of the world is the bridge over the Faux Nam-Ti gorge in Indo-China, where, owing to the peculiar difficulties in the way of building a bridge of any type, it was necessary to adopt a special design suited to the only method of erection that seemed to be possible. The sides of the gorge are practically vertical and give no chance of approach to the bridge from either side except through tunnels. The track grade is 335 ft. above the river, so that no system of falsework could be used in building the bridge, while cantilevers were out of the question owing to lack of "elbow room." The design finally adopted consisted of two steel trusses, each hinged at the cliff side, which were erected in a vertical position and then lowered so that the ends met, forming a structure of

Railway Bridge
over the
Faux Nam-Ti
Gorge
in French Indo-
China;
Top View,
Lowering the
Trusses
into Position
with Cables

inverted V-shape. The ends of the two trusses were firmly connected, steel towers were erected on the humps of the trusses and on this support the steel deck truss carrying the track was placed. At the beginning of the work it was necessary to let the workmen down by ropes from the tunnel mouth to pre-

pare the foundations of the supporting trusses. The track trusses were built in the tunnels and were then moved into position on rollers. From end to end this bridge measures 220 ft. 4 in., while the distance between the heels of the supporting trusses is 180½ feet.

subroad cars

AN ELECTRIC FISHHOOK FOR POLICEMEN

4658

Poles shaped like inverted fishhooks are used to support the new electric police signals in San Diego, Cal. Each pole carries a police-patrol telephone box, a double gong for calling the nearest policeman, and a red light on the point of the hook over the street. When a patrolman is wanted on the police telephone, the gong rings and the lantern, showing red 12 ft. in the air over the traffic, calls him if he is out of earshot.



C. Edholm - 4624 - Figueroa St., Los Angeles, Calif.

test the effect of Antarctic "dark days" on the electrical waves. Night messages were sent 4,800 miles.

Russia imported 600 automobiles from America last year.

STEEL PASSENGER EQUIPMENT INCREASING

5236

In connection with pending legislation in Congress requiring the replacement of wooden passenger equipment with steel equipment inquiries have been made of all railways engaged in interstate commerce in the United States as to progress in the construction of steel and steel-underframe cars. Replies from 247 companies, operating a total of 252,472 miles of line, show that between January 1 and July 1, 1913, orders were placed for 1,064 steel cars and 76 steel-underframe cars, a total of 1,140. In the four years preceding January 1, 1913, the number of steel passenger cars in service increased from 629 to 7,271, while the number of steel-underframe cars increased from 673 to 3,296. The cost of replacing with steel cars all the wooden cars used in passenger trains is estimated at over \$600,000,000.

*8-18-13
C. Edholm - 4624 - Figueroa St., Los Angeles, Calif.*

THE MAKING OF MIRRORS WITH HYDROGEN

4919

Metal-backed mirrors can be produced in 30 seconds by a new process of electrodeposition. A glass plate for the mirror, in juxtaposition to a sheet of metal to be used as backing, is inclosed in a glass bell resting on a ground-glass plate. When, after the bell has been exhausted of air, hydrogen is passed through the bell simultaneously with an electric current, the metal is disintegrated and deposited in a thin film on the glass plate, producing an opaque mirror. Gold, silver, platinum, copper, nickel, iron, palladium, or iridium can be used as the metal backing.

*6/18
Current Topics, Franklin Inst. J. Nov.*

H. Rumelin, Physikalische Zeitschrift, XIII, 1222 - Prof. Dr. Friedrich Krüger,

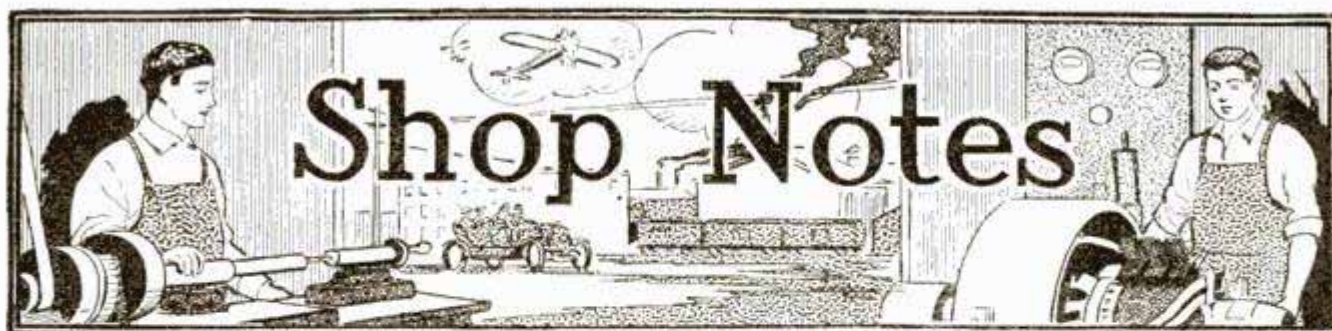

Power-Driven Catamaran

The catamaran shown was constructed especially for use in the waters at a sawmill. The construction permits the shaft and propeller to be lifted out of the water at a moment's notice without stopping the engine. The floats being made of solid cedar logs, there is no danger in running into sunken logs, rocks, or on a beach. These features are of great advantage where the catamaran is used.

The logs are 18 ft. long, cut from dry cedar timber, the bark being first removed and the large end sharpened and smoothed so that they offer the least resistance. Larger logs could be

used, $4\frac{1}{2}$ in. in diameter, being set so that the center of gravity will be over the center of the roller when on a level. The engine is bolted to the roller and the roller is free to turn in sockets on either end, that is, to slightly revolve when the driving shaft is raised, otherwise it is secure. There is one stuffing box used at a point about 18 in. ahead of the propeller, and this box is fastened to the lower end of a vertical rack that slides through a slot and is controlled with a pinion driven by rods, gears and a handwheel at the seat. This construction permits the propeller to be quickly raised clear of

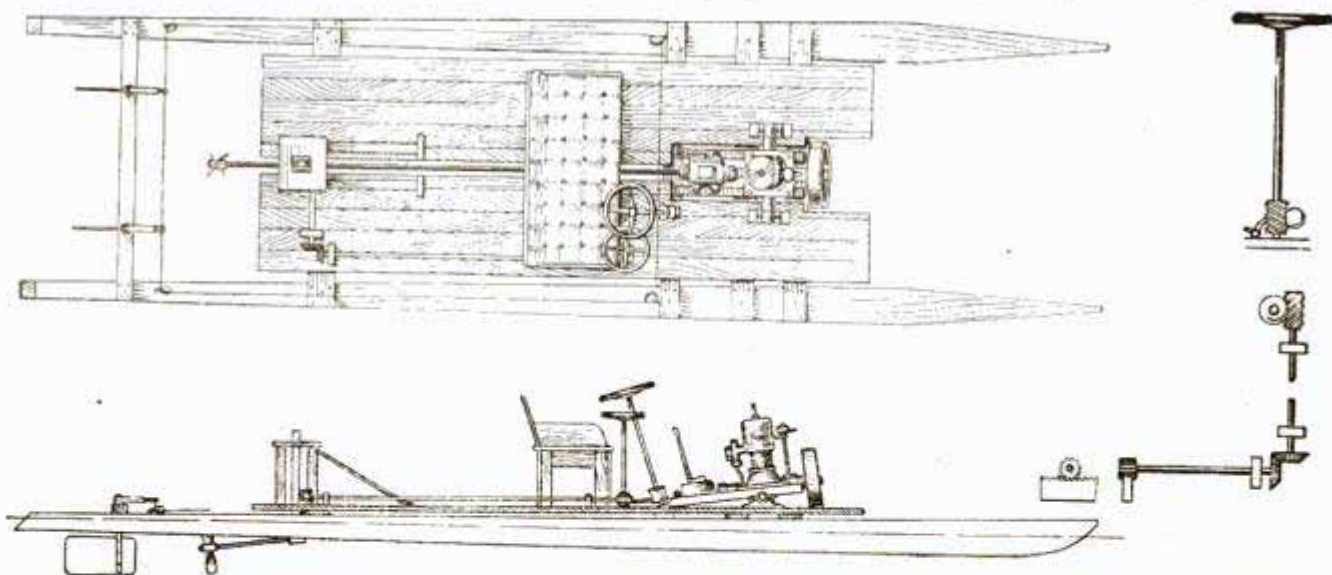

AN Engine-Propelled Catamaran for Use in Shallow Water Where There are Numerous Submerged Obstructions That would Injure an Ordinary Boat and Soon Ruin Its Propeller

used to make a catamaran that would carry more freight or a larger engine. The logs are placed 5 ft. apart and crosspieces bolted on their upper sides. A platform is built on the crosspieces as shown in the illustration, leaving an open space in the center for the driving shaft.

The engine is placed on an oak rol-

ler, the water or lowered to a depth of 18 inches.

The engine, steering and shaft control are all operated from the seat. The rudders are twin, both responding to the same wheel. There is no rail, but one could be placed around the platform to make it quite safe.

The conditions of the body of water

are suited to the craft. It is a lake with narrow shores with a great many curves on the line, suggesting a large river. It is impossible for a heavy sea in a storm. The lake is 10 miles long and has been used for driving logs for at least 20 years and, consequently, there are numerous sunken logs with their ends at or near the surface. Many times these logs cannot be seen until one is near them. An ordinary boat could not stand these conditions.

The catamaran was inexpensive outside of the engine, as the parts were taken from discarded machinery. The boat would be of no use on a large body of water, as a heavy sea would wash over it and a large wave would tend to capsize it, but for use on inland waters it is worth while to make it.—Contributed by Clifford W. Johnston, Parry Sound, Can.

Shingling to Produce a Diamond Shape

There are many carpenters that do not know how to lay shingles in a gable or between windows on side walls in diamond shape. This is very easily accomplished if the shingles are laid as shown in the sketch. It will require but little more time than

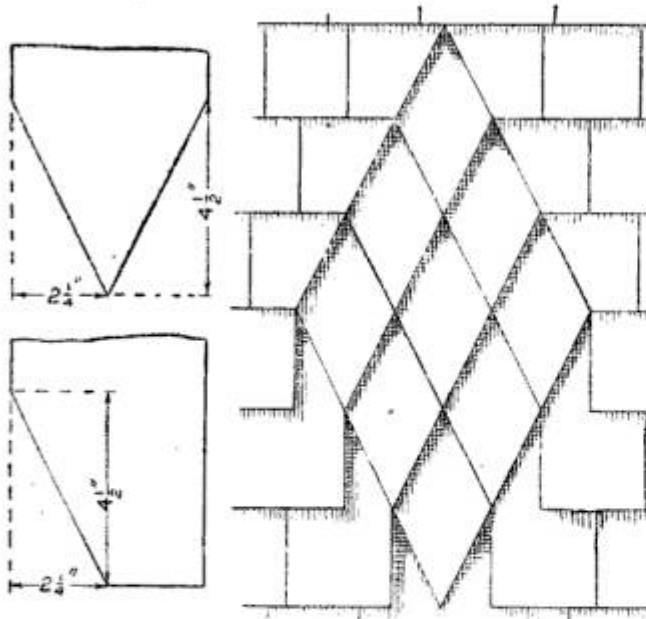

Method of Cutting Shingles so That When Placed They will Make a Diamond Shape

plain shingling. All the joints are broken as in regular shingling. The diamond shingles should be sized, that is, as wide as the courses are laid. The

sketch illustrates a course, $4\frac{1}{2}$ in. to the weather. These shingles are placed in the courses until the required width is obtained. The other shingles joining the diamond are beveled on one side.—Contributed by Ernest S. Yawger, Ithaca, N. Y.

An Alarm for a Lathe Boring Tool

After the boring tool on my lathe had run into the faceplate several times, I devised an attachment that would not only prevent this, but also give an alarm when the tool was almost through the work. I first fastened a small piece of metal, about $\frac{1}{4}$ in. thick and 1 in. wide, with a bolt having a wing nut to the bed of the lathe just ahead of the carriage, and a like piece of metal on the carriage. I procured the hard rubber stem from a discarded tobacco pipe and fastened a piece of this to each of the pieces of metal. The rubber pieces served as insulators on which the ends of insulated wire were attached, and were bored so that a contact would be made when the two came together. Two dry cells and an electric bell were attached in the circuit.

When the metal clip was adjusted to the right location on the bed of the lathe, the metal clip on the carriage would make the contact when the tool in the tool post would be almost through the work, and the bell would sound the alarm.—Contributed by D. G. Hardy, Milltown, Mont.

Reducing the Glare of an Automobile Lamp

The disagreeable glare of the electric headlights on automobiles may be eliminated by covering the upper half of the glass with a cream metal polish and allowing it to dry. When dry, it gives the appearance of frosted glass. To make an even line across the center of the glass, a small piece of cardboard with a straight edge should be held tightly against the surface when applying the substance. Of course, the coating should be applied to the inner surface of the glass so that it will not be

washed off in a rain. This treatment does not in the least affect the amount of light cast upon the road.—Contributed by E. K. Marshall, Oak Park, Illinois.

Setting Bolts in Concrete to Hold a Machine

When anchoring bolts in a concrete pier, I found that the location of the bolts could be more easily determined with a piece of soft pine placed on the bolts of the machine and struck with a hammer than with a rule. Holes were bored at the location of the dents made by the bolt ends and a skeleton base made as shown. This kept the bolts in their right places while pouring the concrete. If this is done in the man-

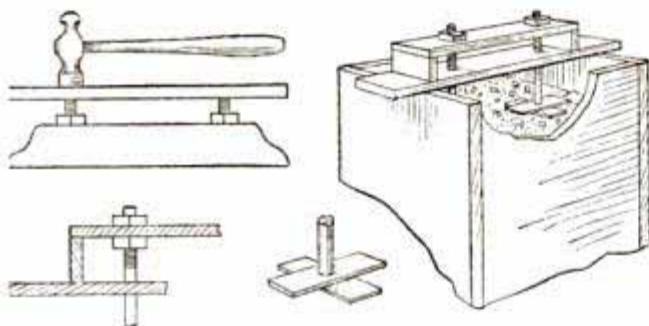

A Skeleton Base for Holding the Bolts in Their Right Places Until the Concrete Sets

ner illustrated, the machine will fit on the bolts perfectly.—Contributed by James M. Kane, Doylestown, Pa.

A Fence-Post Puller

The lower portion of a wooden fence post after it has been in the ground for a long time becomes so set that it is almost an impossibility to draw it out, necessitating the use of a spade or shovel to remove it. When it is necessary to withdraw a considerable number of posts, the usual method is extremely laborious and expensive.

The sketches in general detail illustrate an excellent and simple jig for instantly and easily pulling the posts from the ground, no matter how securely time may have set them into the earth.

A hitch is taken on the post near the ground by means of a small chain, the

free end passing over a fulcrum stick, A, to the doubletree behind a team of horses. The point of bearing, or axis,

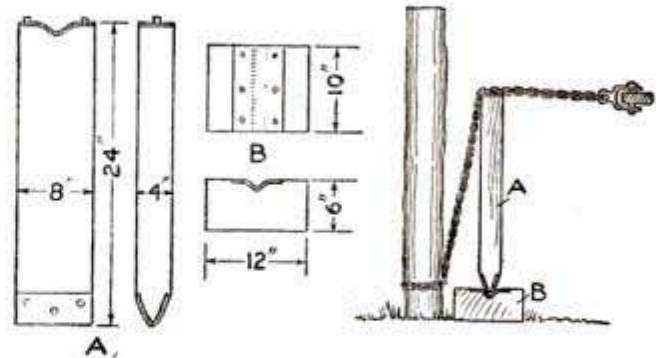

A Fulcrum Stick Used to Draw Out Firmly Set Fence Posts with a Chain

of the stick is supported by the base block B, which is easily thrown with the fulcrum stick from post to post as the work progresses along the fence. A moderate pull on the chain will draw out any post.

Combination Tool Holder and Steady Rest

A tool of the kind shown in the sketch is very handy for turning small and long bars of steel or brass. The steady-rest part is offset from the part that holds the tool. The shank of the tool is set in the tool post so that the steady-rest part is central with the centers on the lathe. The tool is adjusted with a screw in the end of the shank.

The tool is set and a cut taken to reduce the stock to the desired diameter on the end of the bar, then the screws on the steady rest are adjusted on the turned part and the feed of the

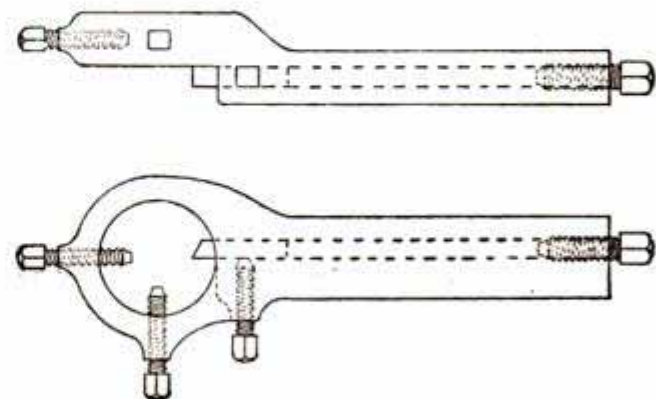

The Steady Rest Being Part of the Tool Holder, Prevents the Stock from Springing

lathe started. It is obvious how the tool works.—Contributed by Chas. Homewood, Cedar Rapids, Iowa.

Homemade Skirt Marker

Procure a piece of $\frac{3}{4}$ -in. gas pipe, 6 in. long with a thread on each end, and two flanges, A and B, to fit on

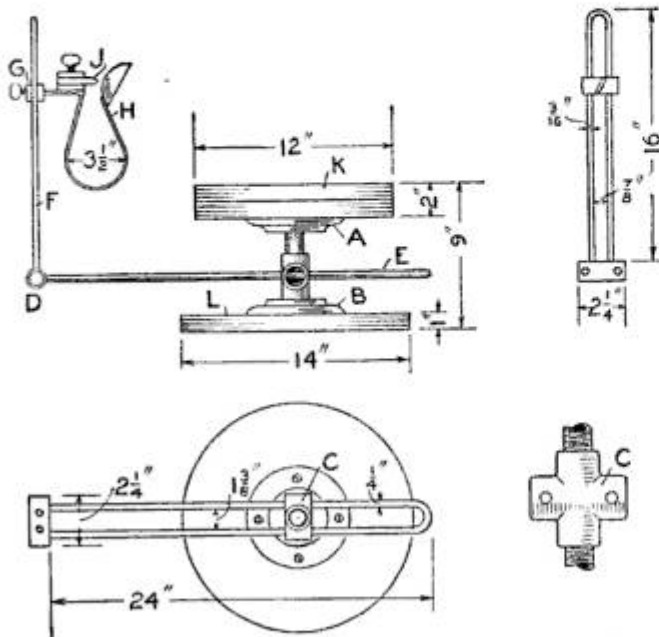

Homemade Skirt Marker for Making a Line on the Goods Encircling the Lower Edge

the threads of the pipe, as shown. Remove the threads from a $\frac{3}{4}$ -in. cross, C, so that it will slip on the $\frac{3}{4}$ -in. pipe. Bore two $\frac{1}{4}$ -in. holes through the ends of one way of the cross, allowing $1\frac{3}{4}$ -in. space between them. A piece of $\frac{1}{4}$ -in. round iron is bent into U-shape and the ends are run through the holes drilled in the cross. A $\frac{3}{8}$ -in. round end piece, D, is drilled to receive both ends of the U-shaped horizontal piece E, also the U-shaped upright piece F, which is made of $\frac{1}{8}$ -in. round iron, and all four ends are riveted in the piece D. Make a clamp, G, with a setscrew to hold the marking device H at any desired position. The marking device consists of a round disk of brass and a chalk holder, J. Two disks are cut from wood, 1 in. thick, the upper, K, 12 in. in diameter and the lower, L, 14 in. in diameter.

The horizontal rods E move through the cross from right to left while the cross turns on the $\frac{3}{4}$ -in. pipe standard. The clamp G holds the adjustment vertically.

The one being fitted with a skirt stands on the upper disk K, and the lower edge of the skirt is placed between the chalk and the brass disk, so

that by taking hold of the chalk with one hand and the skirt with the other and turning the rods E, a line is marked on the outside of the goods at the bottom.—Contributed by Mrs. Harriet M. S. Kerbaugh, Allentown, Pennsylvania.

Cutting Miters on a Band Saw

Where a number of pieces are to be mitered and there is no power-driven miter saw in the shop, the band saw will do the work, if the machine is supplied with an attachment for holding the pieces at right angles while the cut is being made. The attachment consists of a holder made of two pieces of hard wood, each $1\frac{3}{8}$ in. thick, 3 in. wide and 14 in. long. A shoulder is cut on each piece, as shown in Fig. 1, and then they are joined together to make a right angle, as shown in Fig. 2. Adjusting screws are placed in the inside edges of the pieces, as shown at A. Ordinary wood screws are used and they are allowed to project about $\frac{1}{4}$ inch.

The material to be mitered is laid out with a miter square, as shown by the dotted lines in Fig. 3, then it is cut roughly on these lines. The pieces are then placed in the holder, as shown in Fig. 4. The material is sawed two or more times, each time closing the pieces together on the point. It makes no difference if the cut is not straight, the joint will be a perfect fit.

To aid in holding the stock when pushing the holders back and forth on the saw table, two strips, A A, $\frac{1}{4}$ in.

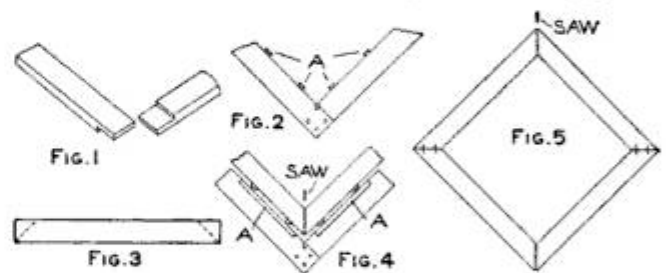

Form for Holding Pieces to be Cut for a Miter Joint on a Band Saw

thick and $\frac{1}{2}$ in. wide, are nailed to the top surfaces of the holder sides. Each pair, as mitered, should be kept together. When finished, they are nailed

together with corrugated fasteners and the halves are placed together, as shown in Fig. 5. These are placed in the holder and jointed in the same manner. In roughing out the material, the joints may not fit perfectly and there is apt to be an opening either at the outer or the inner edges. Always start this opening on the saw when cutting the joint on the two halves.

This same principle can be applied when getting out segments for circles to be turned for patterns, or caps and bases for columns. Dress the material on both sides to make it the desired thickness and mark each segment, as shown in Fig. 6. Cut out the segments on the band saw, place the miters of each pair together and cut through the joint, as shown in Fig. 7. Both sides at the joint are then fastened with corrugated staples. After all the segments are jointed and fastened in pairs, two



FIG. 6

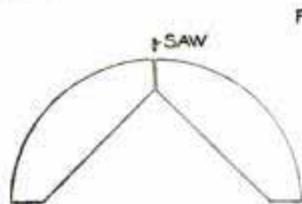

FIG. 7

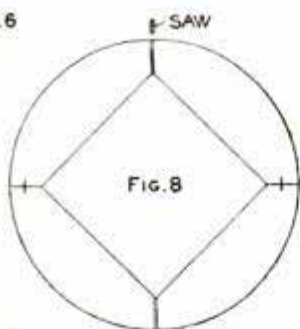

FIG. 8

Segments for Pattern Work or Porch Columns can be Mitered in a Similar Manner

halves are placed together and the joints cut on the band saw, as shown in Fig. 8. When fastened together they are ready for turning.

Repairing Magneto Arm

A magneto that is used quite extensively on automobiles has an extending arm for retarding or advancing the spark, and this arm was broken accidentally. Instead of waiting for a new part the old one was repaired quickly and in such a way that a new piece was unnecessary. The break in the arm was as shown at A. The parts were joined closely and held with a piece of $\frac{1}{8}$ -in. brass, as shown at B. The brass was cut to fit over the extension on

the hub and fitted to the curve of the larger circle. Holes were drilled and tapped for two screws, and holes were

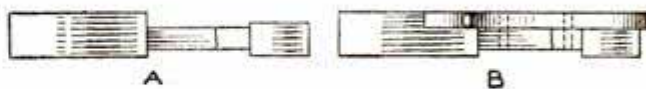

Repairs on a Magneto Arm That Saved Time and the Cost of a New Piece

also drilled and pins inserted to hold the parts together.—Contributed by Donald A. Hompson, Middletown, New York.

Greased Plates Used for Unloading Automobiles

The loading of automobiles into box cars, or unloading of them, is a very difficult job for those inexperienced in handling the large machines, especially where two are placed in together. The turning of a long-wheel-base car will not permit it to pass through the freight-car door, and the ordinary process is to lift it with a force of men or block and tackle. A very easy method is to place sheets of metal—these are usually found about freight houses—on the floor of the freight car where the automobile wheels will run on them, as shown in the diagram. Before running the wheels on the sheets, smear hard grease over their surfaces, and one person can easily push that end of the car over so that it will pass out of the freight-car door, the wheels sliding easily on the grease. Longer wheel

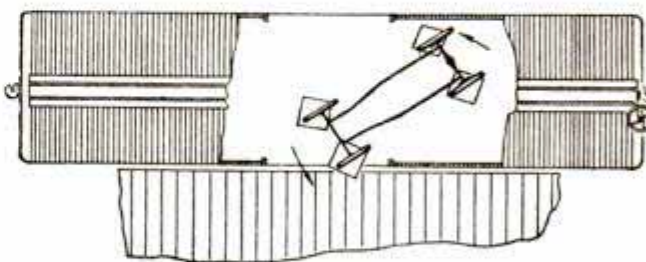

Manner of Placing Greased Plates on a Freight-Car Floor for Sliding Automobile Wheels

bases may require plates placed also under the rear wheels so that they may be slid over in like manner.

Hanger for a Lathe Chuck

One of the best methods of caring for a lathe chuck is to arrange a hanger for holding it when not in use. An

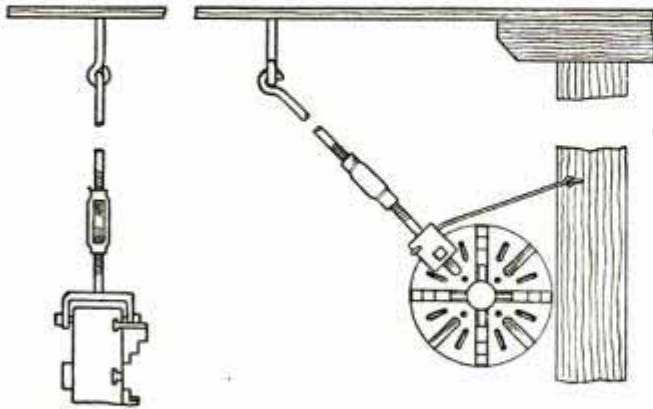

The Chuck is Easily Taken from One Position to the Other as Occasion Demands

eyebolt fastened in an overhead cross-beam or joist, a turnbuckle, and a clevis, or a U-shaped piece of metal with a bolt, to fit over the chuck, not only constitute a hanger for holding the chuck when not in use, but provide an easy means of swinging it into position on the lathe spindle. The illustration clearly shows the hanger as it is used.—Contributed by J. Harger, Honolulu, H. I.

Homemade Micrometer

Desiring to have something a little different in the way of tools from other mechanics, I constructed a very useful measuring device that takes the place of a micrometer. The jaw A is made of $\frac{3}{16}$ -in. square, cold-rolled steel, heated and bent as shown. This is slotted on one side to admit a piece of scale, B, $1\frac{3}{16}$ in. long. Before slotting

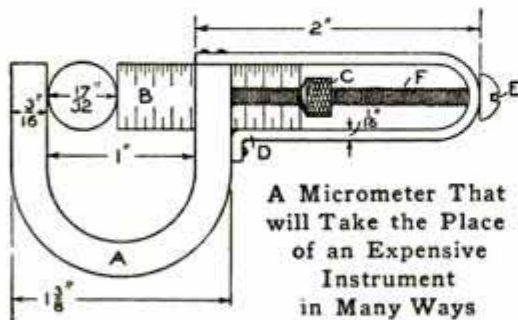

A Micrometer That will Take the Place of an Expensive Instrument in Many Ways

the jaw a hole is drilled centrally in the location of the slot and tapped for a 10-32 machine screw, F. A $\frac{1}{8}$ -in. hole is drilled through the entire

length of the screw in the center and it is also slotted $1\frac{3}{16}$ in. to receive the scale. The head end of the screw is supported by a yoke, D, made of $\frac{1}{16}$ -in. steel, $\frac{3}{16}$ in. wide and fastened with rivets to the jaw A. The knurled nut C is used for adjustment. A small closed spring made of .013 spring wire, wound on a rod measuring .085 in. in diameter, is inserted in the $\frac{1}{8}$ -in. hole in the screw and fastened at one end to the scale and at the other with a pin, E, in the slot of the screw head. This provides a tension on the scale to keep it against the knurled nut C. The measurement is read on the scale between the outside surface of the jaw A and the nut C.—Contributed by J. J. Kolar, Maywood, Ill.

Box-Cover Fasteners for Parcel-Post Packages

Many kinds of packing cases and boxes have been invented for use in the mails after the parcel-post law went into effect.

When packages must be examined it requires no little time, in most cases, to undo the fastenings. The illustration shows a cover that can be quickly detached and re-

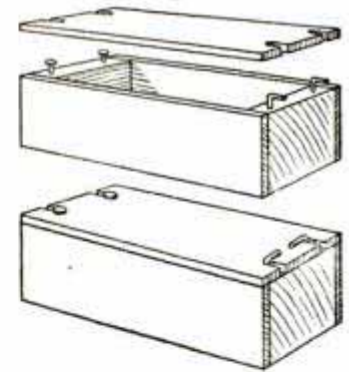

placed. The cover is slotted at its edges to admit the nails on one side of the box, and screw hooks are used at the other side. In making the examination, it is only necessary to turn the screw hooks so that their ends will pass through the slots and then slide the cover off.—Contributed by D. L. Merrill, Battle Creek, Mich.

Cleaning the Hands of Aniline Stain

To clean the hands after handling aniline stain or dye, first wash them with a little bleaching powder, then with alcohol, and follow with a good soap, such as sand or pumice-stone.

Air Circulation in Furnace Heating

The many faults of a hot-air furnace for residence heating usually arise from an inefficient layout, or lacking study of the conditions concerning the house to be heated due to incompetence of the one installing the plant. A few things must be considered in regard to the location of the furnace as well as the circulation of the air currents. One of the most frequent errors is that the fresh-air supply is not adequate, so that the rooms will become overheated with dead air, producing a stuffy atmosphere.

An insufficient air outlet will cause the same trouble. As much heated air must be admitted to a room as that which passes out, whether through leakage around the windows and doors or through an opening provided for its free circulation.

If a hot-air duct has a register opening into a room without other air outlet than cracks at window and door openings, only little air will be in circulation, as shown in Fig. 1. One method of arranging the inlet and outlet is shown in Fig. 2. While this method causes a complete circulation of air, it does not admit fresh, pure air from the outside.

One of the best arrangements to pro-

vide a good circulation is to construct a furnace so that the heated air will pass into the room, or rooms, from the center, while the return air passes back around the outside of the register, as shown in Fig. 3. The returning cold air will be partly heated as it passes over the jacket of the hot-air space in the furnace. In this method the air currents will take the course shown by the arrows. This method, however, while causing free circulation of the air, does not supply fresh air.

Those desiring pure, fresh air in a residence, or, especially, in halls and schoolrooms which are occupied by many people at a time, must provide some means to supply a continuous circulation of air, taken from the outside, heated, delivered to the rooms through ducts, and then expelled to the outside. While this may be an expensive method, it produces an atmosphere in the room equal to that outdoors on a summer day. Such a system may be modified where fewer persons are concerned, only a small portion of the air being taken from the outside, or a sufficient amount to keep pure heated air inside. This system is shown in Fig. 4. The inlet duct A should have the same area as the combined areas of the ducts delivering heated air to the rooms, or even larger. The warm-air ducts B should enter the

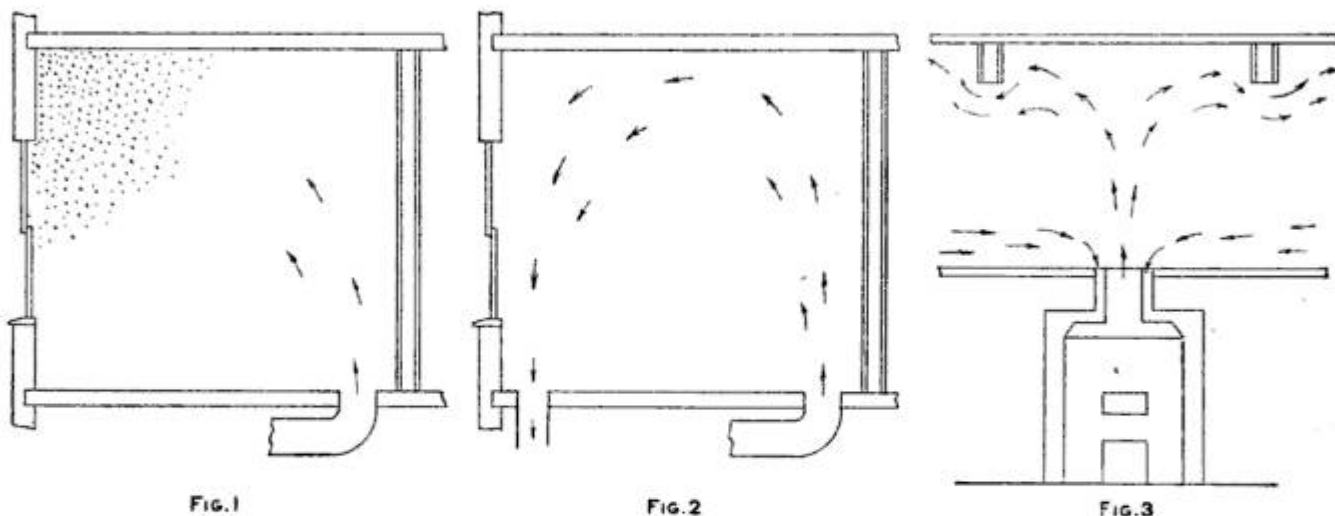

FIG. 1 The Circulation of Air is Impeded by Not Having a Cold-Air Outlet, the Free Circulation being Obtained by a Proper Outlet, Which is Further Aided with Proper Arrangements for Receiving the Cold Air Back into the Furnace

vide a good circulation is to construct a furnace so that the heated air will pass into the room, or rooms, from the

rooms at a height above the average person's head, and the dead or cold, spent air should be expelled through

small registers, C, in the baseboard, into ducts leading to a chimney. This chimney may be one provided for the

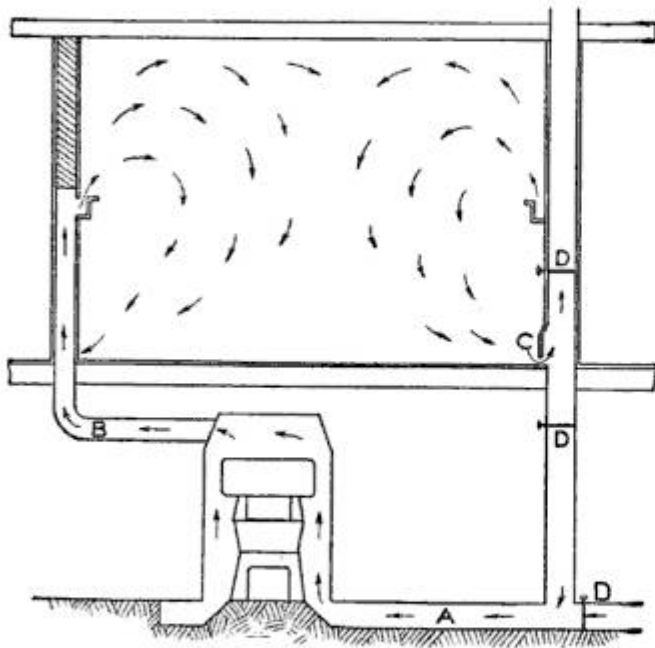

FIG. 4

The Passage of Either Outside or Inside Air, or a Part of Both, through the Furnace is Controlled with Dampers

purpose, but it is better to use a division in the smoke chimney.

The opening into the rooms for the heated air may be made more or less invisible by having them long and narrow, and hiding them with a plate rail or paneling. If the same method is used at the baseboard, nothing will show the presence of the apparatus in the building.

To use only a part of the fresh air from the outside and a part of the cold from within, it is only necessary to have several return ducts from the openings C, to pass the air back to the furnace, and provide dampers, D, to control both the incoming air and the return air.

The outside opening should be located where no high wind can blow into it, and so that the eddies of air will have no tendency to draw the air out of the duct rather than let it pass in freely without being blown in.

Be sure to wipe out a tire casing thoroughly with a damp cloth to remove any grains of sharp sand, as these will scratch and score the inner tube and sometimes cause a leak.

Rubber Cement Used for Pasting Papers

Rubber-patching cement will be found very useful for pasting papers where it is desired to avoid wrinkling or curling, the method being very simple. Use thin rubber-patching cement, which can be further diluted with gasoline or benzine, giving each part to be pasted one or two coats and, when the cement is thoroughly dry, pressing the parts firmly together. It is not necessary to be careful about smearing over the edge, as the dry cement forms a thin film that can be readily removed by rubbing lightly with the fingers.

In making corrections on thin-paper tracings, cut out the part to be changed and fill in with a patch of thin tracing paper, using about 1¼-in. lap. The patch will only show slightly in the finished blueprint. Temporary patches can be removed by moistening with gasoline.—Contributed by H. M. Warren, East Orange, N. J.

An Oil-Hole Cleaner

The gummed and caked oil that plugs an oil hole is not easily removed, and sometimes a bearing runs hot because no oil reaches the moving surfaces. A cleaner for the purpose, much better than an awl, is one having a revolving spindle with an awl or screw point, which can be made as follows: The handle consists of a large file handle to which is attached a spring lever carrying an arc cut from an old egg-beater cog. The spindle revolves in the handle and is kept in place by a washer soldered to it at a point where it will fit



Revolving Spindle will Quickly Loosen and Remove Any Dirt or Caked Oil in a Hole

under another washer fastened to the end of the handle.

The small cog, also taken from the egg beater, is attached to the spindle where it will mesh into the cogs on the arc. The spring to which the arc is

attached is fastened, as shown, in a slot cut in the handle. This allows the arc of the cogwheel to be moved back and forth by finger pressure, and it is readily seen how easily and quickly caked oil can be removed from an oil hole with this cleaner.—Contributed by Roy Kauffman, Goshen, Ind.

A Burring Tool for Brass Tubing

In cutting a large quantity of brass tubing, a bur was formed on the ends which had to be removed and a slight bevel cut with sharp edges. The cutting of this bevel required a special tool, which was made in the following manner: A piece of round cold-rolled steel, 4 in. long, was procured, a $\frac{1}{16}$ -in. slot milled in its center, as shown, and a piece of $\frac{1}{16}$ -in. tool steel was then fitted to it as a cutting tool. The steel had a notch filed in it to shape the end of the tube as desired.

The tool was placed in the chuck of a drill press which was run very fast.

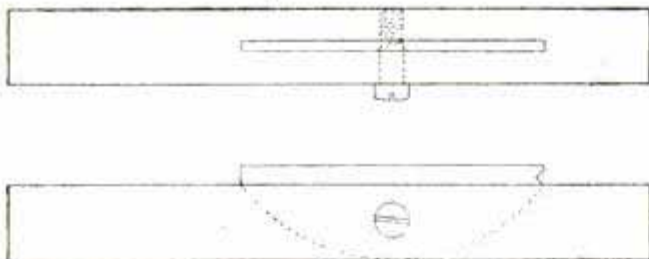

Tool Used for Removing Burs Formed by Cutting Tubing with a Roller Cutter

The pieces of tubing were pushed on over the end of the cold-rolled steel and up against the rapidly revolving tool which removed the bur and beveled the edges.

Boring Holes in Wood at an Angle

The hole to be bored is located by squared lines as in ordinary work, then the jig is made, the thickness A being twice the size of the bit, the other sides depending on the angle, which is cut as required. Lines are drawn on the faces of the block so that it can be readily set on the work where it is fastened with nails.

The device can be used repeatedly, if a dowel point, about $\frac{1}{2}$ in., is in-

serted in the longest face and cut off at the correct angle. The dowel holds the block while the bit starts into

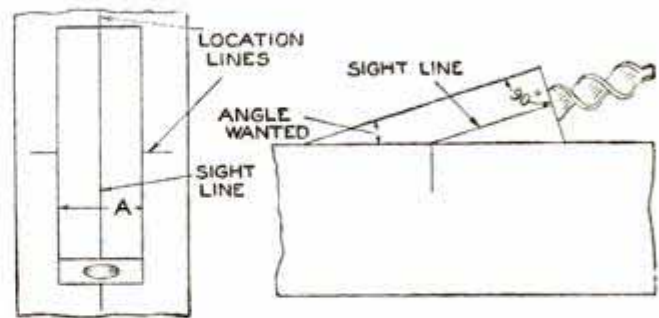

An Angle Block for Holding a Bit to Bore a Slanting Hole in Wood

the work.—Contributed by Edwin E. Hahn, Philadelphia, Pa.

A Support for a Breast Drill

It often occurs that the drill point of a breast drill breaks, especially if it is small, and hard material is worked. This difficulty seems to be effectively overcome by attaching to the drill the device shown herewith. It consists of a clamp having in its upper flattened end a slot through which the handle of the drill is inserted and screwed tightly, and at a lower point a screw clamp fitting just above the drill chuck. In a sleeve, in one piece with or otherwise attached to the clamp, slides a rod, the movement of the latter being controlled by a spring within the sleeve. This rod forms a second support for the drill and as the latter penetrates into the material, the rod is backed up into the sleeve, while the spring, acting contrary to this motion, holds its end firmly against the work or



The Support on a Breast Drill for Preventing the Breaking of Small Drills

some surface beside it. The vibration of the drill bit, which is the cause of breakage, is eliminated by this double support.

CA 5-gal. can with a tapering top and the bottom removed makes an excellent funnel for filling automobile tanks.

A Pneumatic-Tire Vulcanizer

The base of the vulcanizer can be made of a piece of iron, about $\frac{3}{8}$ in. thick, but it is best to make a pattern

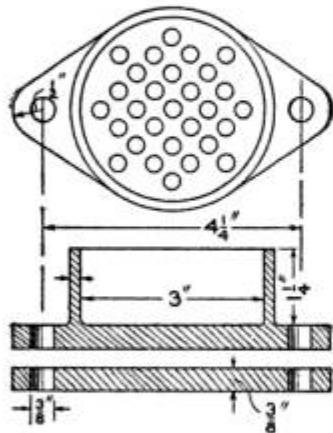

and have one cast so that it will finish to the dimensions given. After being machined, 29 holes, each $\frac{3}{16}$ in. in diameter, are drilled in the base of the cup as nearly equidistant as possible. Pins are inserted tightly in these holes with their upper ends flush with the top. Make a plate, the same size as the base of the cup, and drill holes to match those in the ends of the cup base so that this and the plate can be clamped together with the tube or tire between them. Fill the cup with gasoline and light it, and the heat generated will vulcanize the rubber nicely.—Contributed by G. Crawford, Jr., Schenectady, N. Y.

Temporary Repair on a Broken Valve Spindle

The breaking of a brass valve spindle is of no uncommon occurrence and the break invariably takes place at or near the top of the shoulder that secures the valve seat, or disk, to the spindle.

When such a break happens on a piece of machinery far from a repair shop the repair can be made on the spot, as taps and drills of some kind are almost invariably to be found in the engine room, and with these tools it is a simple matter to temporarily repair the spindles.

File off the lower end of the broken spindle squarely and remove the part remaining on the shoulder plate. Center the two pieces and drill a hole, for the size of tap to be used, through the plate and a short distance into the

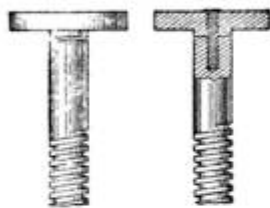

spindle. Tap both holes and connect the parts with the threaded end of a common machine bolt, and cut it off to allow sufficient end for beading over a small portion against the shoulder plate. This method will often permit a valve to give efficient service until a new spindle can be made.—Contributed by F. W. Bently, Milwaukee, Wis.

Grease Cup for Wagon Wheels

Drill a hole, $\frac{3}{8}$ in. in diameter, in the center of each axle and connect it with a hole of the same size just back of the shoulder on the spindle and on the under side of the axle. This is the right size hole to tap for $\frac{1}{2}$ -in. fittings. The center of the spindle is drilled with a $\frac{3}{8}$ -in. drill to make a hole intersecting the horizontal one.

A $\frac{1}{2}$ -in. plug is turned into the end of the hole, and a grease cup fitted on

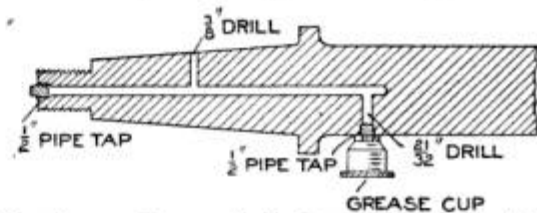

The Grease Cup as It is Attached to the Skein of a Wagon

the under side, as shown. In greasing the wheel, turn the cup down sufficient to force the grease into the axle.—Contributed by W. E. Crane, Cleveland, O.

A Preventive of Grimy Hands

A thorough scrubbing will not remove the grime and dirt that seem to work right into the skin on the hands when handling some makes of electric wires or working about machines that are covered with oil and dirt. A correspondent of Electrical Review uses a coating thoroughly rubbed on the hands before starting to work which prevents the grime from entering the pores of the skin. The preventive consists of 4 oz. of grain alcohol, 3 oz. of glycerin and 3 oz. of water. The mixture quickly dries on the skin, and after work a washing with soap and water will quickly remove all the dirt.

— D. N. X 1 U 5)
2, 15

A Windmill *S. N. X 1 (15) 2151*

By WINTON BALL

A windmill, or motor, that will run in any direction of the wind, and one that requires only ordinary mechanical skill to construct, may be built as hereafter described and, if properly constructed, will prove efficient for all purposes for which a windmill may be used.

Make two semicircular disks of strong boards with a radius one-third of the size of the wheel wanted. Cleat them together securely so that one point of each half will touch at the center of the other, as shown in Fig. 1, the points A, B, C, and D being equal distances apart. The center E is located exactly midway between points A and D, and, consequently, also between B and C. The mill will require four such parts, two of which are fitted with cast-iron flanges with holes to fit on the shaft to be used. One of the flanges is shown in position at F. The remaining two wood parts are bolted together at right angles to each other, as shown in Fig. 2. These two parts can also be fitted with a flange, if desired.

Place the two single parts, one on either side of the double one, allowing a space of about 2 ft. between them,

Fasten them together with ceiling boards, or preferably sheet iron, nailed

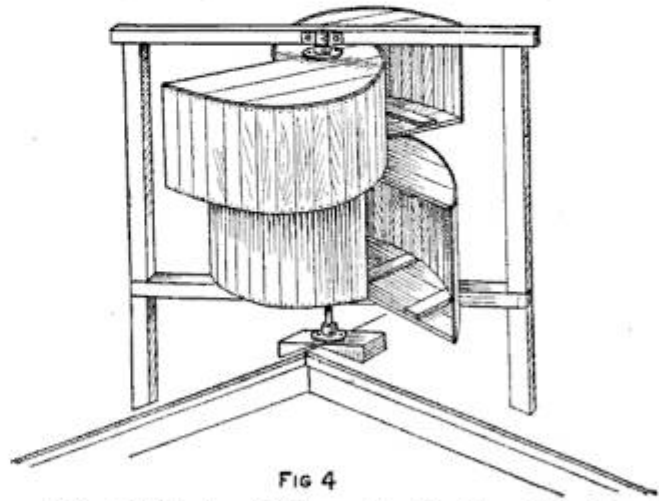

FIG 4

The Mill, being Built on the Turbine Principle, can be Run in Any Air Current

to the periphery of the disks. Good canvas may be used if a flange is fastened to the center part, so that the three parts of the frame can be securely fastened to the shaft.

The straight sides are left open for the air currents to pass through the S-shaped openings, thereby counterbalancing almost all the back pressure on the returning side of the wheel, as shown by the arrows in Fig. 3. The construction of the wheel makes two S-shaped chambers at right angles to

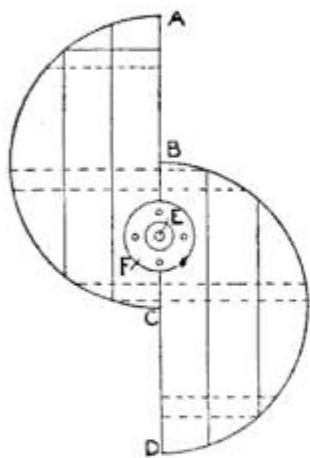

FIG. 1

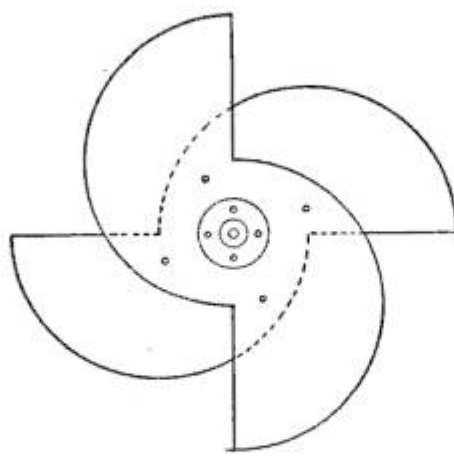

FIG. 2

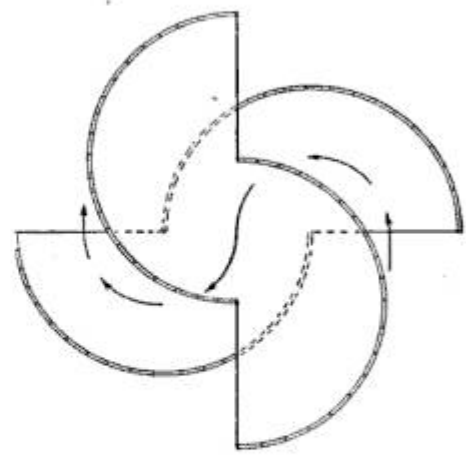

FIG. 3

Detail of the Parts to Construct Air Chamber That Directs the Outgoing Air against the Inner Surfaces of the Part Returning toward the Wind, thus Counteracting the Back Pressure on the Outside

with all the arcs corresponding. The distance these parts are separated will vary according to the size of the wheel.

each other. A large wheel must be assembled on the tower. The windmill complete is shown in Fig. 4.

Scribing a Line Encircling Round Stock

In cutting pieces $\frac{1}{2}$ in. long from round bar stock with a hand hacksaw, it was almost impossible to cut them off squarely, but I found that I could follow a line with the saw blade if it was scribed straight, encircling the bar. This I accomplished with the aid of a visiting or postal card, wrapped on the bar so that one edge was at the right place, and by using a scribe against it as with a straightedge.—Contributed by Robert Adams, Philadelphia, Pa.



Clamps to Hold Rugs While Beating Them

The clamp shown in the sketch is for holding a rug straight on a lawn while beating it. One clamp is used at each corner of the rug. Each clamp consists of two blocks of wood, one spike and a bolt with a thumb nut. The thicker part of the rug at the edge is placed into the notch C, and the bolt A is tightened on the clamp. The spike B is easily pushed into the ground when the rug is laid out flat.—Contributed by H. W. Hahn, Chicago, Ill.

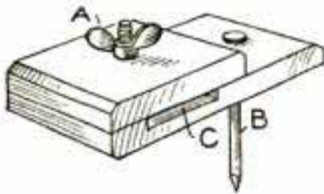

Tile-Outlet Cover

A great deal of trouble is caused by small animals entering the tile at the outlet of drainage systems where they are apt to get stuck in the narrow opening and stop the flow of water. It is very difficult to locate the point of obstruction and much expense is often incurred in finding it. The trouble may be prevented very easily by attaching a wood frame over



the outlet and hinging a wood door to it at the upper edge. This door will be held open by the outflowing water and, while not obstructing the flow, prevent any animal from entering. When there is no flow of water the door covers the outlet completely.—Contributed by Thos. L. Parker, Wibaux, Mont.

Making Section Lines for Patent-Office Drawings

When making drawings for the patent office the conventional symbols and cross-section lines must be closely followed. One of the rules that must be carried out is the wavy line showing earth, and a correspondent of American Machinist draws these lines rapidly by using a piece of bristol board the straight edge of which is nicked with the thumb nail. This is used as a ruler, which draws wavy lines as shown in the sketch.

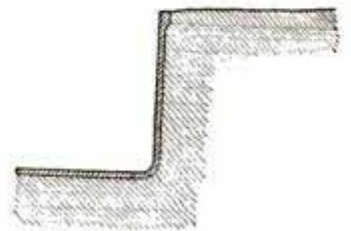

A Gold Front Sight for a Rifle

The salt spray present in the air along our coasts is ruinous to metal gun sights, but an efficient and inexpensive gold-crowned front sight may be made as follows: The top of the plain front sight is filed down about $\frac{1}{16}$ in., as shown by the line AA in the sketch. Two notches are cut in the base of the sight, as shown at B. Using a heavily plated nose piece of a pair of eyeglasses, a bracket, C, is formed to fit the prepared sight snugly. Solder is applied to the ends only. This will prevent any discoloration on top of the sight. A good bead effect is obtained by cutting off the sides of the bracket, as shown at D.—Contributed by C. F. Heizer, Falfurrias, Tex.

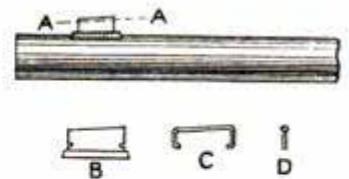

Cleaner for Aluminum Ware

The following formula will be found useful in making a solution for removing the tarnish from the inside of aluminum pots and pans: Dissolve 2 oz. of lump ammonia in 1 qt. of water; 2 oz. of salts of tartar in 1 qt. of water, and a 10-cent can of potash in 2 qt. of water, while boiling. Add to the latter solution the ammonia, then the salts-of-tartar solutions, in order named, and boil the whole mixture for 30 minutes. This solution is kept in jars for use at any time.

Place a small quantity of the solution in the vessel to be cleaned, set it on a fire and allow it to boil, but be careful not to let it boil over on the polished surface. Keep it boiling for about two minutes, then rinse out and use any good cleaner to scour the surface. This will restore the satin finish as when new.—Contributed by Nellie Dempsey, New York City.

Preventing Needles from Rusting

Workmen repairing sails or doing similar work outside can prevent their needles from rusting in the following manner: Fill a brass shotgun shell with a thick grease that will not run and insert the needles in it. If a 12-gauge shell is used, a cover can be made of a 10-gauge shell.—Contributed by Forrest Clark, Coronado, Cal.

Electric-Lamp Tester

Where a large number of incandescent lamps are used a great deal of time is consumed in turning the lamps into and out of an ordinary socket for testing the filaments to see that they are not broken. The following device eliminates the disadvantages of the threaded socket and effects a great saving in time.

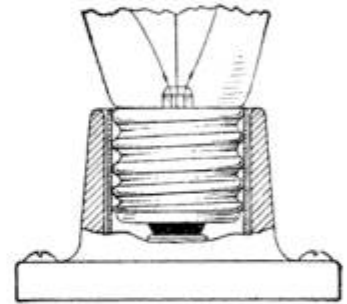

The device consists simply of an ordinary porcelain lamp socket, that has had the inner screw shell removed and the threads hammered out on a piece of 5/8-in. pipe and then replaced. The inside diameter of the shell after it is hammered out should be large enough to permit the threaded base of the lamp to slip into it. Lamps may be rapidly tested by sliding them into this socket and there is no more likelihood of a short being produced on the line than there was before the socket was changed. A partial cross section of such a socket is shown in the accompanying sketch.

Beeswax or soap placed in a screw slot will make it stick to the screw-driver blade for starting.

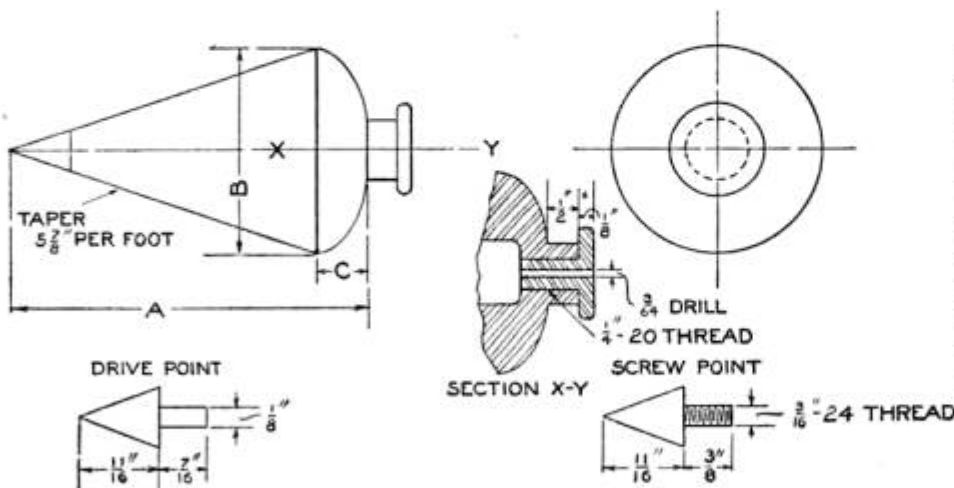

| SIZE | A | B | C |
|----------|--------|-------|-------|
| 4 3/4 OZ | 2 1/2 | 1 1/8 | 7/32 |
| 6 " | 2 3/4 | 1 1/4 | 1/4 |
| 7 1/2 " | 3 | 1 3/8 | 9/32 |
| 9 1/2 " | 3 5/8 | 1 1/2 | 5/16 |
| 12 1/2 " | 3 5/8 | 1 5/8 | 11/32 |
| 14 " | 3 7/8 | 1 3/4 | 3/8 |
| 19 " | 4 3/16 | 1 7/8 | 3/8 |

Drawings, with a List of Dimensions, for Making a Series of Plumb Bobs, Each of Which Has the Right Proportion for Its Size and Weight

How to Remove Large Chucks from Machines

An easy and convenient way to remove a chuck from a turret lathe, or other machine, is to form a sling of belt lacing to hold it

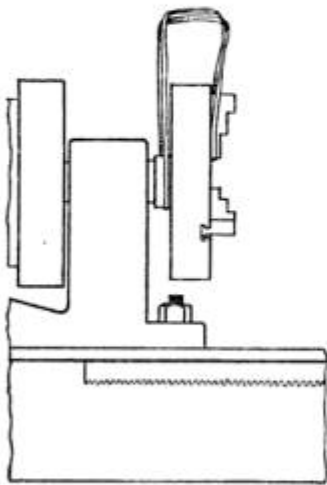

with one hand while the other turns the spindle by the belt.

In the ordinary way one has to hold the chuck while turning the belt. This lets the chuck fall when it comes loose and sometimes results in cutting or bruising the hand.

It is much better and quicker to take two lengths of belt lacing and tie the ends together to form an endless piece. Place one loop around under the flange of the chuck and the other under one jaw. This forms a sling which can be taken in one hand over the chuck while the other pulls the belt to turn the machine spindle to unscrew it from the threads.—Contributed by Chas. A. Thissell, Beverly, Mass.

ing and a piece of rod in the smaller one. The clamping is done in the ordinary manner. I have used such a clamp on pressures up to 200 lb. without a single failure.—Contributed by Wm. G. Toplis, Philadelphia, Pa.

Repairing a Worn Plunger

A pitted or corroded plunger or rod may be repaired by cleaning out the corroded portions and filling them with solder, babbitt metal, or block tin a little higher than the surface of the rod. The uneven portions can then be filed or turned down in a lathe to a level with the surface of the rod. A brass rod can be repaired easier than one of iron, as the solder adheres to it more readily.

Pole-End Clasp for Handling Ceiling Globes

The incandescent globes, comprising a rigid ceiling cluster, or the individual light, are often located at a height from the floor which renders them inaccessible for removal without the aid of a stepladder or scaffolding of some kind.

The sketch shows a simple device by means of which lights, located at almost any distance from the floor, can be easily and readily removed. The four grip fingers are of $\frac{1}{16}$ -in. spring steel and are bolted at their lower ends to a 1-in. pipe coupling. Their upper ends are wrapped with tape, which gives a strong frictional grip on the glass so that the lamp can be turned from its socket in spite even of corrosion which often covers the coarse thread of the screw.



A Hose Clamp

The hose clamp illustrated herewith will hold high-pressure hose securely. It is easy to construct, being made of seamless brass tubing, about $1\frac{1}{2}$ times the diameter of the hose. The wall of the tube should be about $\frac{1}{16}$ in. thick. A section

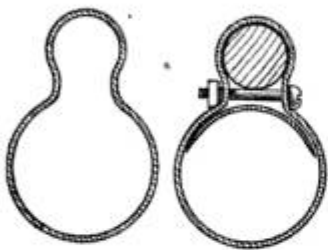

is cut from the tubing about 1 in. long for ordinary sizes and placed on the hose, then bent to fit the latter loosely, making the shape similar to a figure 8. A hole is drilled through both walls of the metal, at the narrowest part, to admit a large stove bolt loosely. The hose is placed in the larger open-

The handle can be made in sections, if necessary, to reach a ceiling of any height. With the assistance of this simple and inexpensive device the removal and application of incandescent globes in any overhead location is an easy task.

Practical Telephony

By HAROLD HINTON

Part VII—Laying Out the Telephone Plant

Laying out a telephone plant is a very complicated operation and requires a great deal of thought, expense, and planning on the part of the engineering force. First it is necessary to obtain a franchise to operate the system within certain boundaries, the franchise usually providing a tariff prohibiting the company from raising its rates after it has gained a foothold in the territory. The franchise procured, a "development study" of the vicinity where the company is to start operations comes next. This development study is made to ascertain and determine, so far as possible, what the future growth of the community will be and what direction, or directions, it will take. From this development study the plans are made for laying out the plant, and these plans must not only take care of the present population, but be so arranged that they can be readily extended to care for the future as well.

When the Bell Telephone Company first entered the field of telephony such things as lead-covered cables were unknown, and almost unthought of, in telephone construction. The method of construction in vogue at that time

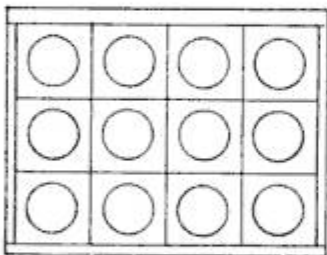
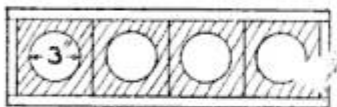

Fig. 43

was simply open-wire, the wires starting from the roof of the central office and being led down the outside walls of the exchange and across the ceiling of the terminal room to the arresters. This method was all right for a time, but with the growth and advancement of the country, it was soon inadequate for the company's needs, and about the year 1883 the first 50-pair lead-covered cable was placed.

This was a great step in advance, and the cable proposition looked so good that it was rapidly developed until now there are, in the larger cities, 800-pair

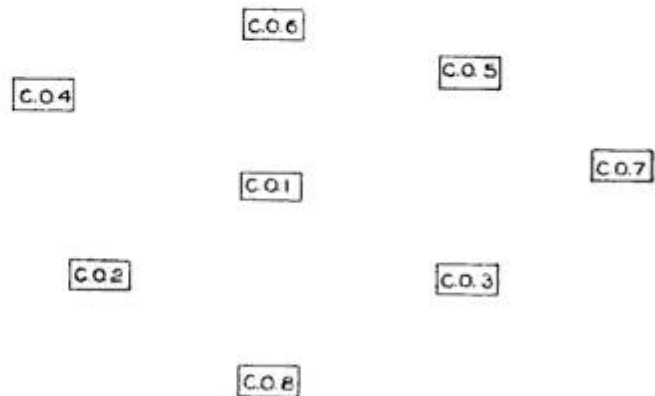

Fig. 44

The Manner of Locating Several Central Offices to Take Care of Increased Business

underground, lead-armored cables. What this means can be realized when one reflects that 800 pairs of wire would occupy one hundred and sixty 10-pin crossarms in open-wire construction, whereas, in cable form, they readily pass through one 3 $\frac{1}{4}$ -in. hole. Of course, when cables first came into use, they were not made as the cables of today, but were heavily insulated with paraffined cotton instead of paper, and, consequently, the old 50-pair cotton-insulated cable was as large as, and a great deal harder to bend and set up than our present-day 200-pair paper-insulated cables. The coming of the cable made necessary the heavy expense of the underground-conduit systems, or subways, in which to carry it, and these were constructed of creosoted-wood ducts, called "pump logs," which were boxed in with creosoted plank, as shown in Fig. 43. These subways were built and the cables drawn in and spliced up as fast as the finances of the company would permit, and the overhead construction was removed as these underground cables were ready for use. This method remained in use until the number of subscribers in the

central office became so great that there was no available room for more equipment, and other exchanges must be

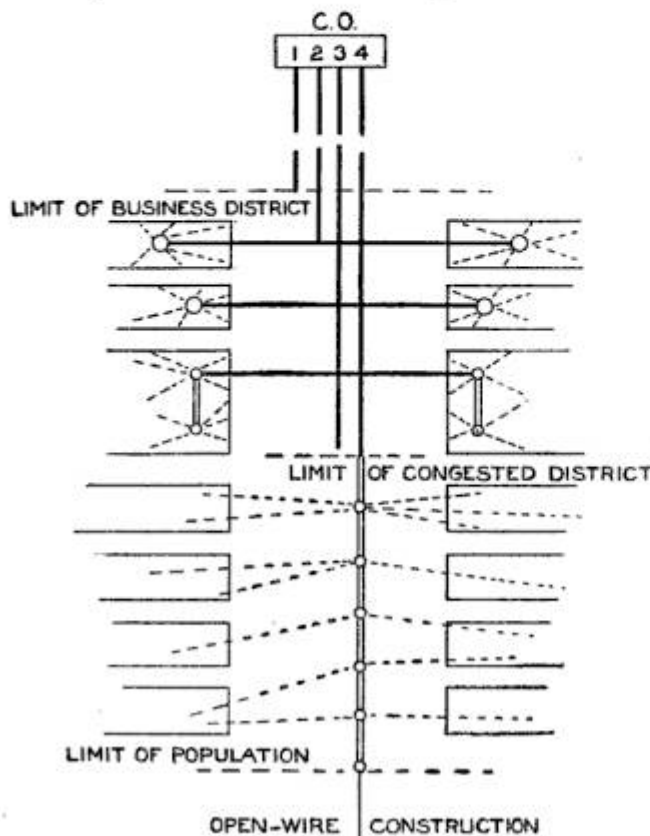

FIG. 45

Underground Cables, Aerial Cables and the Open-Wire Construction in a Straight Line from the Central Office

built, and "trunking circuits" established between them and central. Figure 44 shows the order in which the exchanges were usually built, one at a time, and added to the existing plant. Central office No. 1 is intended to show the original office which was, of course, located in the heart of the old business section, and numbers 2, 3, 4, 5, 6, 7, 8, etc., were added to the plant as the town grew and more telephone equipment and better facilities were required. It is in the laying out of the exchange districts that the experience of the engineer who made the development study is brought into play, as when one central office is built it is necessary to make arrangements for the next one, which may not be built for 10 or 20 years, and see that the ducts and pole lines run in the general direction, so far as possible, of the future exchange.

The layout of the telephone plant, in most cities today, consists of under-

ground cables which are either taken directly into the building to be fed, or run up the rear wall of the building, where the connections are made from a terminal box to the various instruments within the building, the terminal boxes, in some instances, being placed on a pole in the center of the block and all drops in that block run from this terminal; underground block cables in the thickly populated residence districts; aerial cables in the more thinly populated districts, and open-wire construction in the suburbs. A straight-away section of cable from the central office to the far-off suburbs is shown in Fig. 45. The heavy lines represent the underground cables; the double lines, aerial cables; the single lines, open-wire construction, and the dotted lines, the method of grouping the drops, or wires, which run from the terminal to the instrument.

The independent companies, on the other hand, had the big advantage of having the population settled before they started to lay out their plants, and were, therefore, in better shape to arrange things so that the whole equipment could be installed in one central office instead of half a dozen, or more, as is necessary when building up with the town. This naturally means a large saving in the erection and equipment of a number of branch exchanges; places one force of men in charge of the terminal room instead of having separate forces, each consisting of from three to six men, in each branch exchange; does away with all the "trunking operators"; eliminates all but one chief operator; reduces the number of supervisors, etc. The independents also had the advantage of having built up their plants, in the majority of cases, with underground and block-cable construction in the first place, so that they have not the heavy expense of building underground and then cutting over the lines and removing the old open-wire construction. (Cutting over the lines into the new underground cable and removing the old pole line usually amount to from 30 to 50 per cent of the cost of the new construction.) The

independents were also enabled to install, at no greater expense to themselves, a more modern and, in some ways, a more efficient system, and greatly reduce the operating expense, which is one of the largest items of expenditure in connection with any telephone system.

The method of construction which the independents were required to follow in most cities which they entered in the last 10 years is shown in Fig. 45. They were not allowed to run aerial cables or build open-wire leads on any street in the congested or thickly populated districts, nor on any street in the better class of residence streets, but were required to use a system of "block construction" which removes their poles almost entirely from the streets by running branch cables down the center of the block which they desired to feed, and always carrying their cables underground when crossing the street. Blocks, lettered "A," show long blocks where the cable is carried underground to a pole in the interior of the block and then in the air to a pole at the other end of the same block where it again enters the ground. In blocks, marked "B," the cable is carried underground continuously, except at the pole, where

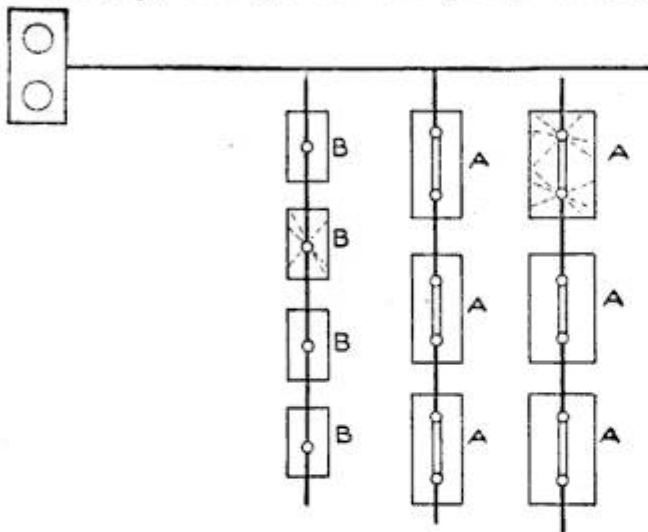

FIG. 46

The Method of Underground Block Construction, Used by Independent Companies in Laying Their Cables

a small manhole, handhole, or service box is constructed so that a cable may be run up the pole to a terminal and spliced into the underground block

cable at the foot of the pole. The meaning of the heavy, light, and dotted lines is the same in Figs. 45 and 46.

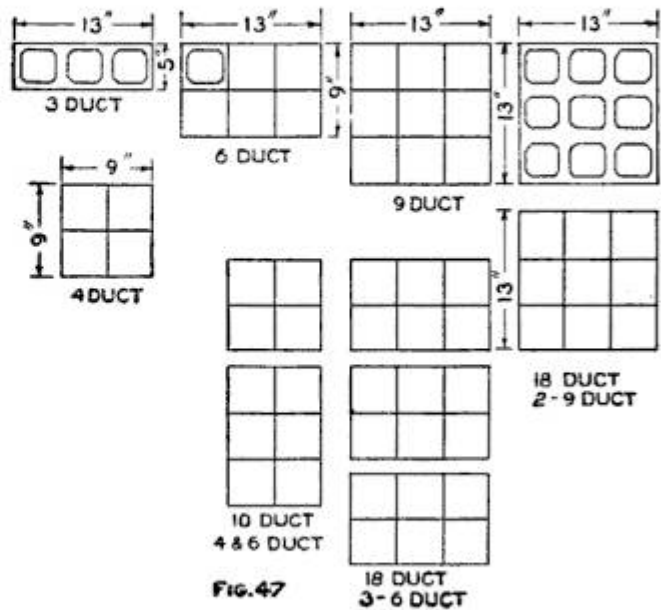

FIG. 47

Vitri-fied-Clay Tile Used to Take the Place of the Old Pump Logs in Underground Ducts

Of course, the system of placing the wire plant underground is the best for all concerned, but the initial cost is greatly in excess of pole-line construction, although the subway will pay for itself in a few years by the saving in maintenance charges and replacement of poles, etc., which is necessary with an open-wire or aerial-cable lead. The writer has, when building new subway of vitri-fied-clay tile, forms of which are shown in Fig. 47, excavated old pump-log subway which has been underground for over 25 years, and was greatly surprised to find it still in excellent condition. The large cables of the present day, however, require a subway which has larger ducts and smoother interior surface than the pump logs, although the latter are still used extensively for small lateral cables, running from the main cable to a pole or building, which are seldom larger than 200-pair, and usually from 26 to 76-pair.

Even when a subway is figured on for running the cables in, there is still considerable work for the engineers connected with it in locating the "run," or position it is to take in the street. Most city engineers try to keep all sub-surface work on one side of the street, and picking a location is a hard propo-

sition, as there is usually a water main; a sewer; one or two gas mains; the opposition telephone company's subway; the electric-light company's subway; the Western Union and Postal Telegraph Companies, each with its own subway; and sometimes the city fire-alarm subway, although the city

usually reserves a duct in one of the telephone company's subways for its fire alarm. Sewers are usually placed in the center of the street with the water main laid in the same trench and will, therefore, as a rule, be encountered only when making a street crossing.

(To be continued)

Reversed Action of Oars

The ordinary oar of a rowboat makes the rower sit facing astern with the back toward the way the boat is traveling. The inconvenience of not being able to see in the direction the boat is going is similar to walking backward. In striving to overcome this difficulty I constructed the device shown in the illustration to give a reversed action to the oars.

The apparatus consists of two wood segments of circles A and B, cut from material 2 in. thick with a radius of 8 or 10 in. The oar C and handle D are attached as shown. Around the two segments, and almost making a figure 8, is a 1-in. leather strap, E, fastened with a buckle, F. This single belt passes around both segments, crossing over itself at the point where the segments touch. The action is similar to a reversed belt connecting two pulleys with their faces close together, but in this case the leather is nailed down on the flat side of each segment. This forces the segments to move closely together without the slightest slip, producing the same effect as a pair of perfectly constructed cog wheels.

These bolts should be long enough to have extending ends which fit into holes bored in the gunwale and of a size to receive them loosely. This will give the up-and-down motion to the oar.

The oars are used in exactly the same manner as in ordinary rowing, and as the leather is quite flexible and there are only two pivots there is little friction. If the leather stretches, it can be taken up with the buckle which is on the slack side. The entire arrangement can be lifted out as an ordinary oar, and it has the additional advantage that it may be folded up, as shown.—Contributed by Sam Gluck, New York City.

Preserving Ox Gall

Users of ox gall in the paper-ruling trades find that, two or three days after dissolving the deodorized ox gall in hot water, it will turn to slime, which will render its further use impossible. For a number of years I have been throwing this mixture away, making a fresh one, but by experiment I put in a teaspoonful of liquid ammonia to each quart of mixture and was surprised to see it clear almost instantly.

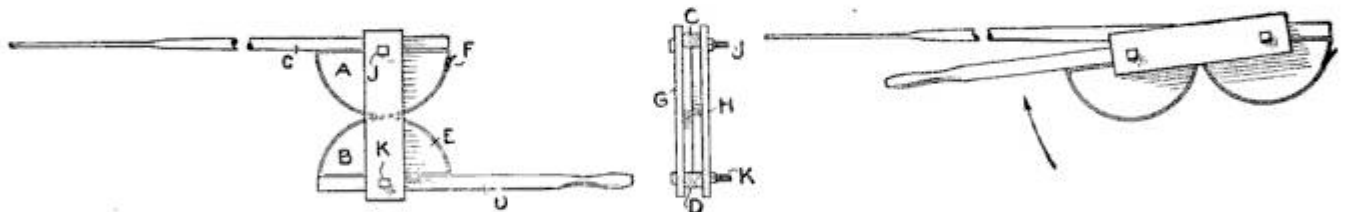

Arrangement of the Parts to Give a Reversed Action to the Oar, Permitting the Rower to Sit in the Boat Facing the Direction of Travel

The connecting or cross strips, G and H, are made of hard wood. The bolts, J and K, hold the crosspieces and each makes a bearing for one segment.

The ammonia seems to increase its efficiency rather than to be harmful.—Contributed by Rudolph I. Wilson, St. John, Can.

Number Holder for Automobiles

A number holder can be cut from a piece of hard wood that will serve the purpose as well as one made of metal, and the work can be done with ordinary tools. The shape of the holder is shown in the sketch, the distance A being the length of the number plate and the distance B wide enough to allow the plate to hang in front of the radiator when the holder is fastened to the radiator neck. A hole, C, is bored through the wood to fit the radiator neck and the wood sawed in two on the dotted line. Bolts, D, are used in

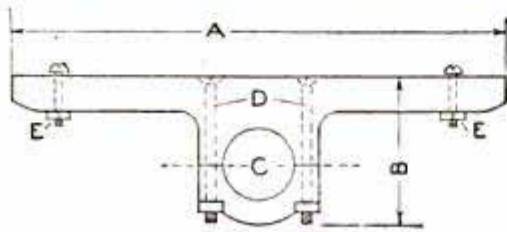

A Number-Plate Holder Made of Hard Wood and Fastened to the Radiator Neck

clamping the parts on the neck. Small bolts, E E, are used to fasten the number plate on the holder.—Contributed by Earl R. Hastings, Corinth, Vt.

Holding Pearls While Drilling Them

Hollow out the end of a piece of peg wood and fill the cavity with gum shellac. Imbed the pearl in the cement as shown in the sketch and, after filing a

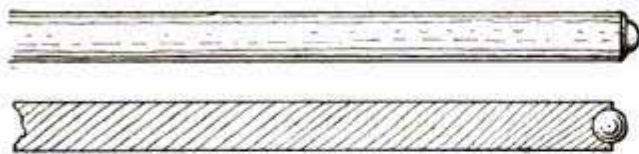

The Pearl is Securely Held in the End of the Wood While Drilling the Hole

little to make a flat surface, the drill is easily started.—Contributed by Wm. A. Jones, Raleigh, N. C.

A Wood-Breaking Block

Firewood, such as scraps of boards, is often more easily broken up into stove wood than if sawn or cut with an ax. I rigged up a block, about 15 in. high, and cut a notch about 8 in. deep, tapering from 2 in. in width at the outside to 3/4 in. at the bottom. By plac-

ing the firewood into the notch, as shown, the pieces are easily broken with an ax or hammer. The block

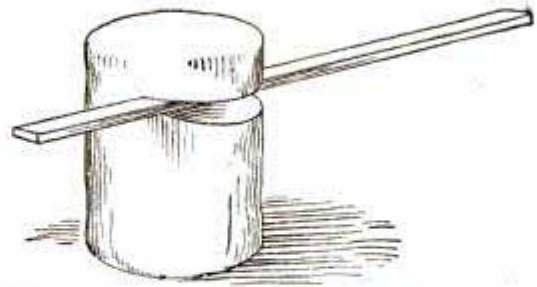

Block for Holding Firewood for Breaking It Up into Stove Lengths

should be fastened solidly.—Contributed by John V. Loeffler, Evansville, Indiana.

A Wood Scraper

A useful wood scraper and stencil-mark remover can be made by attaching a handle of the desired shape to a discarded safety-razor blade. The tool will be found very handy in a cabinet shop. The opening for the blade should be a close fit, so that a new one can be

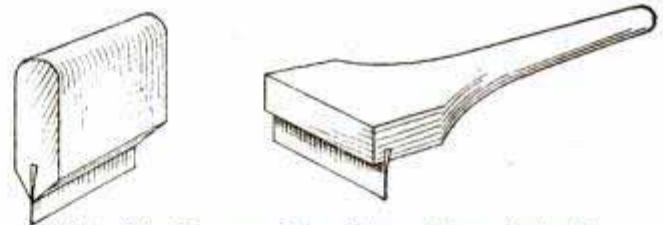

The Handles may be of Any Shape Suitable for the Work at Hand

easily inserted when necessary.—Contributed by W. A. Jaquythe, San Diego, Cal.

Soft Faces for a Hammer

The head of the hammer is made of soft steel with threaded ferrules, A A, to hold the soft faces B B. The ferrules are knurled to make them easily turned with the fingers. Any kind

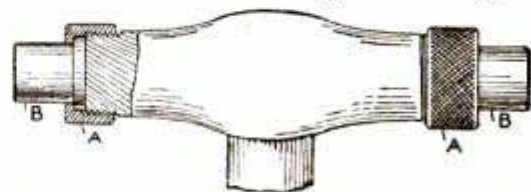

Any Kind of Soft Metal Face can be Used on the Hammer Head

of a soft face made of fiber, leather, copper, or brass can be turned up and kept on hand for different work.

An Automatic Pressure-Gauge Alarm

Any ordinary pressure gauge may be easily equipped with a simple, home-made contact device operated by the needle on the gauge, which may be

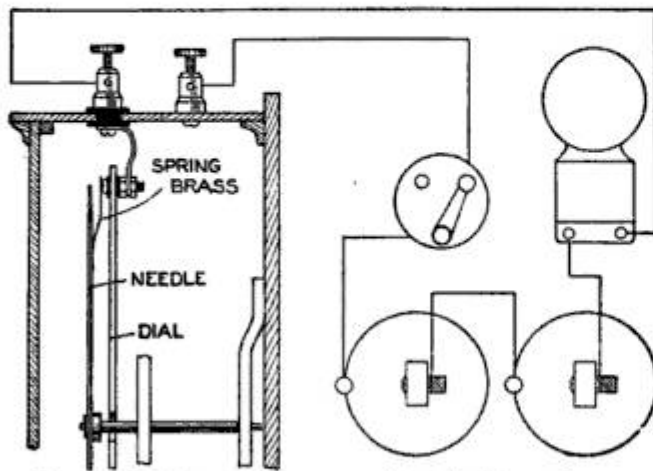

Contact Points as They are Attached to a Gauge for Closing a Bell Circuit

connected in series with a vibrating bell and battery, so that the combination will serve as an automatic alarm, giving the engineer an audible signal when the pressure has exceeded or dropped below a previously determined value. A contact device for this purpose may be constructed as follows:

Carefully remove the glass front of the gauge, and then the needle from its spindle. The end of the shaft upon which the needle or pointer is mounted is usually tapered and the needle simply forced on, so that great care should be exercised in removing the needle to make sure the shaft is not bent, nor its bearings or other parts of the gauge injured. Then, on the under side and at the outer end of the pointed end of the needle, fasten a very light piece of spring brass that is to wipe over a contact to be mounted on the face of the instrument. This contact is fastened on the face in such a position that the spring on the needle is in contact with it, when the needle indicates a pressure corresponding to the value at which the alarm is to be given; and it should, of course, be insulated from the dial and in turn connected to a binding post mounted on the outside of the frame, or containing case, of the gauge and insulated from it. A second binding post is mounted

on the case and electrically connected to it. These two posts form the terminals of the contact device and are connected in series with the bell battery and a small single-pole switch.

In remounting the needle make sure that it occupies the same position on the dial when there is no pressure acting on the gauge that it did before it was removed. The spring on the under side of the needle should be very light and flexible, and so adjusted that it will wipe over the contact on the dial with a minimum friction. It would, no doubt, be best to mount a small piece of platinum both on the end of the spring and on the contact where they touch each other, to reduce the trouble due to corrosion and arcing.

A diagrammatic sketch of the contact device and circuit is shown herewith. One or more additional contacts may be mounted on the dial and connected to other binding posts, which in turn may be connected in series with bells of different tones. If two contacts are used, one may indicate an excessive pressure and the other a reduced pressure.

A Bench Stool on Wheels

In my regular work, consisting in repairing electric fans, smoothing irons and other small appliances, I find that walking back and forth in front of a 22-ft. bench to get certain tools and materials required for the particular work in hand becomes more tiresome than the work itself. To remedy this, I conceived the idea of putting my stool on small flanged wheels to roll on a hardwood track laid on the floor in front of the bench. It is now an easy matter to reach the test set, at one end of the bench, or the vise, at the other, without leaving my seat. To insure steadiness and permit rapid rolling, the wheel base should be about 3 ft. long.—Contributed by Chas. K. Theobald, Vicksburg, Miss.

ⒸNever rub a polished varnished surface with a dry chamois skin, as it will surely scratch it.

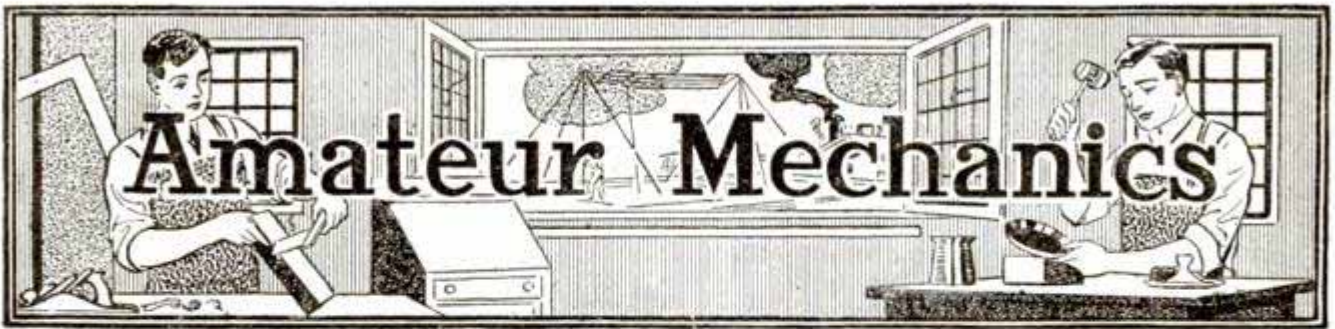

A Cyclemobile

By FRANK PFEFFERLE

The cyclemobile is of the three-wheeled type and can be easily constructed in the home workshop with ordinary tools. The main frame is built up of two sidepieces, AA, Fig. 1, each 2 in. thick, 4 in. wide, and 7 ft. long, joined together at the front end with a crosspiece, B, of the same material, 17 in. long. The sides are placed slightly tapering so that the rear ends are 11 in. apart at the point where they are joined together with the blocks and rear-wheel attachments. A crosspiece, C, 13 in. long, is fastened in the center of the frame.

The place for the seat is cut out of each sidepiece, as shown by the notches at D, which are 2 ft. from the rear ends. Two strips of wood, E, $\frac{1}{2}$

in. thick, 4 in. wide, and 22 in. long, are fastened with nails to the rear ends of the sides, as shown. The rear wheel

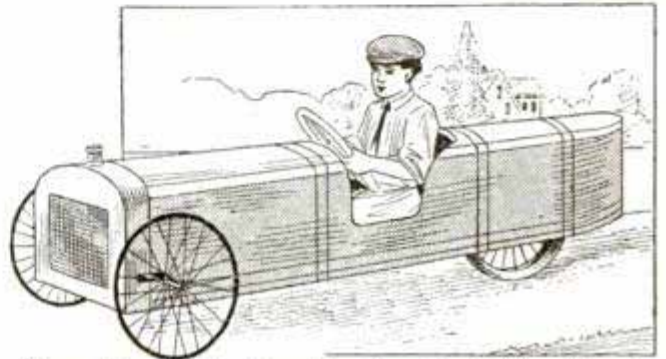

Three-Wheeled Cyclemobile Propelled Like a Bicycle and Steered as an Automobile

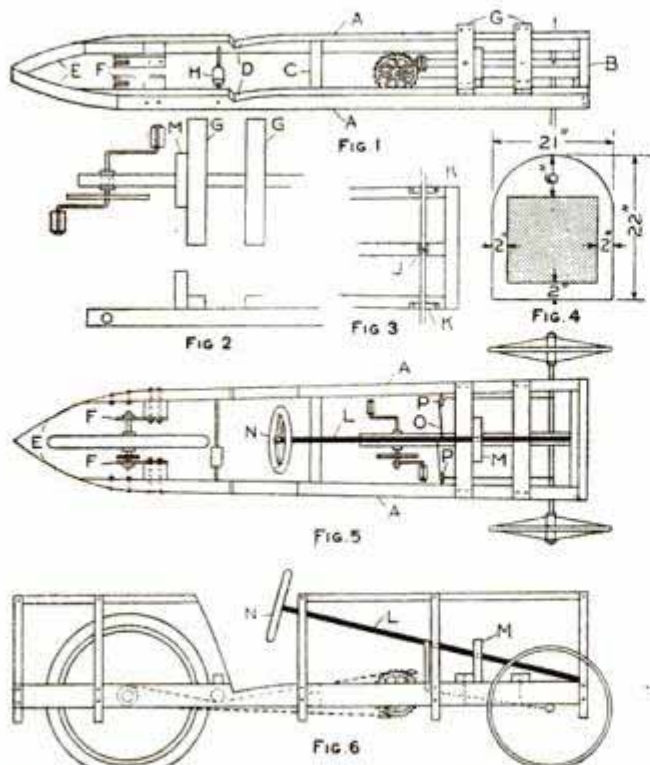

Detail of the Parts for Constructing an Automobile-Type Foot-Power Car

is a bicycle wheel, which can be taken from an old bicycle, or a wheel may be purchased cheaply at a bicycle store. It is held in place with two pieces of strap iron, F, shaped similar to the rear forks on a bicycle, and each piece is bolted to a block of wood 3 in. thick, 4 in. wide, and 6 in. long, which is fastened to the sidepiece with the same bolts that hold the strap iron in place. The blocks are located 20 in. from the rear ends of the sidepieces.

The pedal arrangement, Fig. 2, consists of an ordinary bicycle hanger, with cranks and sprocket wheel set into the end of a piece of wood, 2 in. thick, 4 in. wide and 33 in. long, at a point 4 in. from one end. The pieces GG are nailed on across the frame at the front end of the car, to hold the hanger piece in the center between the sidepieces, as shown in Fig. 1. A small pulley, H, is made to run loosely on a shaft fastened between the sidepieces. This is used as an idler to keep the upper part of the chain below the seat.

The front axle is 30 in. long, pivoted as shown at J, Fig. 3, 6 in. from the front end of the main frame. Two small brass plates, KK, are fastened with screws on the under edge of each sidepiece, as shown, to provide a bearing for the axle. The front wheels are taken from a discarded baby carriage and are about 21 in. in diameter.

A good imitation radiator can be made by cutting a board to the dimensions given in Fig. 4. A large-mesh screen is fastened to the rear side to imitate the water cells.

The steering gear L, Fig. 5, is made of a broom handle, one end of which passes through the support M and fits into a hole bored into the lower part of the imitation radiator board. A

steering wheel, N, is attached to the upper end of the broom handle. The center part of a rope, O, is given a few turns around the broom handle, and the ends are passed through the openings in screweyes, PP, turned into the inner surfaces of the sidepieces AA, and tied to the front axle.

The seat is constructed of $\frac{1}{2}$ -in. lumber and is built in the notches cut in the main frame shown at D, Fig. 1. The body frame is made of lath, or other thin strips of wood, that can be bent in the shape of the radiator and nailed to the sidepieces, as shown in Fig. 6. These are braced at the top with a longitudinal strip. The frame is then covered with canvas and painted as desired.

How to Make a Humidor

The humidor is an ideal gift for any person who smokes. The wood for making one, as shown in the illustra-

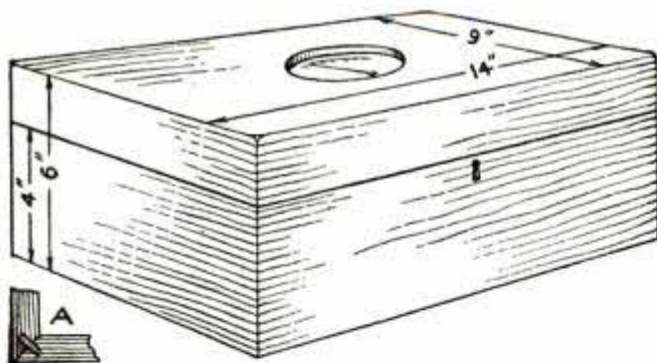

The Amount of Moisture within the Box is Shown on the Dial in the Cover

tion, may be of Spanish cedar, mahogany, or quartered oak, as the builder desires. The box and cover are made and glued together in one piece, then the cover is sawed off to insure a perfect fit. A strong corner connection is shown at A. A piece of a strawberry box or peach basket makes a good key to glue in the grooves. Care must be taken to run the grain with the width and not with the length of the strip.

Finish the outside of the box with two coats of the desired stain, then cover with a coat of wax, shellac, or varnish. The inside should be finished with one coat of white lead and two or

three coats of white enamel, to make the wood impervious to moisture.

In the center of the cover top is set a piece of glass and to the under side of the latter a hygrometer is attached with a little glue. This instrument tells the relative humidity, or the amount of moisture, in the air within. The moisture may be regulated by adding a few drops of water, as needed, to a piece of ordinary blotting paper placed on the inside.—Contributed by James T. Gaffney, Chicago.

Telephoto Attachment for a Hand Camera

It is not necessary to purchase an expensive telephoto lens for a box or hand camera if the owner has a pair of

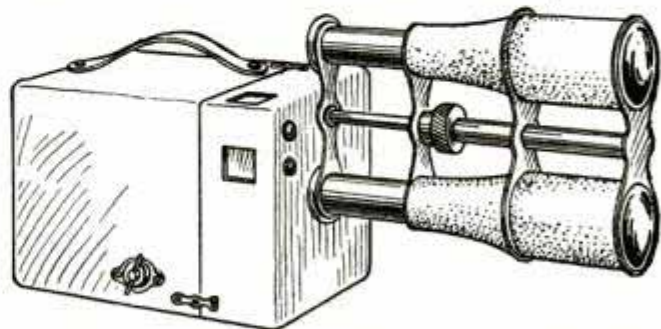

A Field Glass Placed in Front of a Camera Lens will Increase the Diameter of the Photograph

opera or field glasses. First focus the glasses on the distant object to be

photographed and then set the camera. One of the glasses is placed directly in line with and in front of the camera lens, as shown in the sketch. If the camera is of the focusing type, it is focused in the ordinary manner. Box and other cameras are set as usual.

The glasses should be well supported in front of the camera lens, as any slight move will be quite perceptible on the ground glass. As the light rays are largely reduced in passing through the field glass and camera lens, it is necessary to give a much longer exposure. This can only be determined by trying it out, as lenses have different speeds.—Contributed by Charles Leonard, St. John, Can.

A Turn Feeding Table for Birds

Never in the past has the public at large taken so great an interest in protecting and furthering the well-being of birds as at present. In addition to protective legislation, clubs everywhere are organizing to promote bird life and many citizens, old and young, are making bird houses and feeding tables.

One of the best forms of feeding tables which I have ever seen is shown in the sketch. It possesses a great advantage over the average table in being turned automatically, whirling about by the action of the winds and always keeping its open front on the lee or protected quarter. This is a good feature especially in the fall and winter, the very time when birds need and seek protection from storms and cold winds.

To make such a feed table almost any kind of boards can be utilized. The shelter may be of any shape or size to suit the tastes of the maker, but one constructed to the dimensions given will be found to work well in most localities. Along the center of the roof is attached a wing, A, which is an active aid in causing the wind to keep the open front turned away. The shelter turns upon a wood or iron rod which passes from the end of a post up through the central bottom

and central roof of the structure. If wood is used for the rod, it should be about 1 in. in diameter and of hard

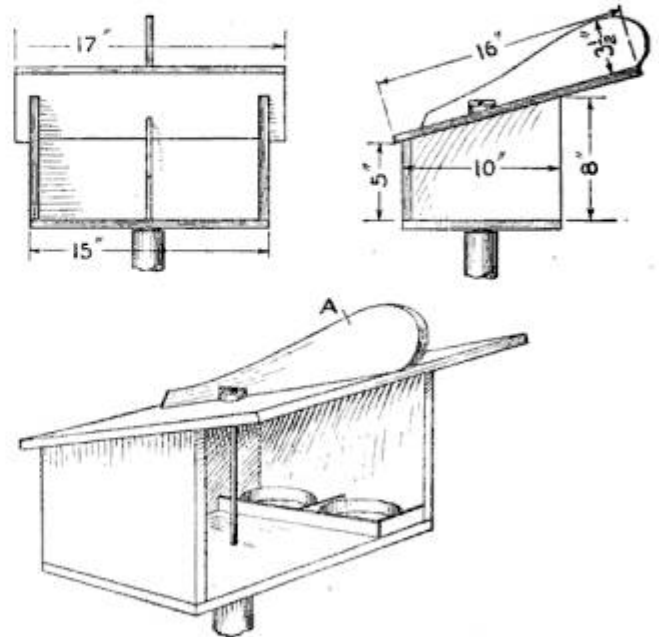

A Feeding Table for Birds That will Keep Its Open Side Protected from the Storms

stock. An iron rod may be somewhat smaller. Keep the holes well greased.

The house should be given a couple of coats of white, red, or green paint, and the post painted to correspond. Feed and water are placed in shallow dishes on the floor and they should be blocked to keep them from sliding out.—Contributed by C. C. Fraser, Saginaw, Mich.

A Sack Holder

An old granite kettle or tin pail with the bottom cut out and three 8-penny wire nails bent and fastened on with rivets, as shown at A, makes as good a sack holder as one could desire. A

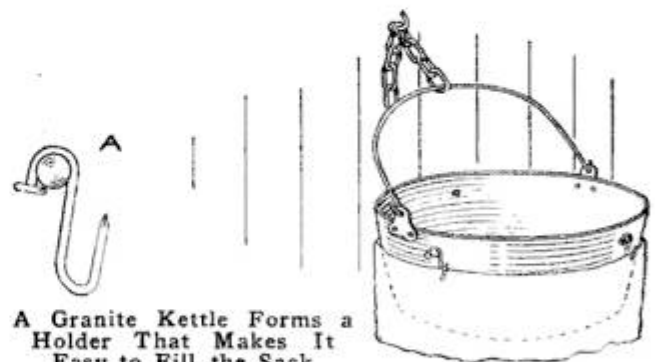

A Granite Kettle Forms a Holder That Makes It Easy to Fill the Sack

chain attached to the handle makes it conveniently adjustable to the proper height for the sack.

Rubber-Band-Change Trick

The trick of changing a rubber band from the first and second fingers to the third and fourth, if done quickly, can

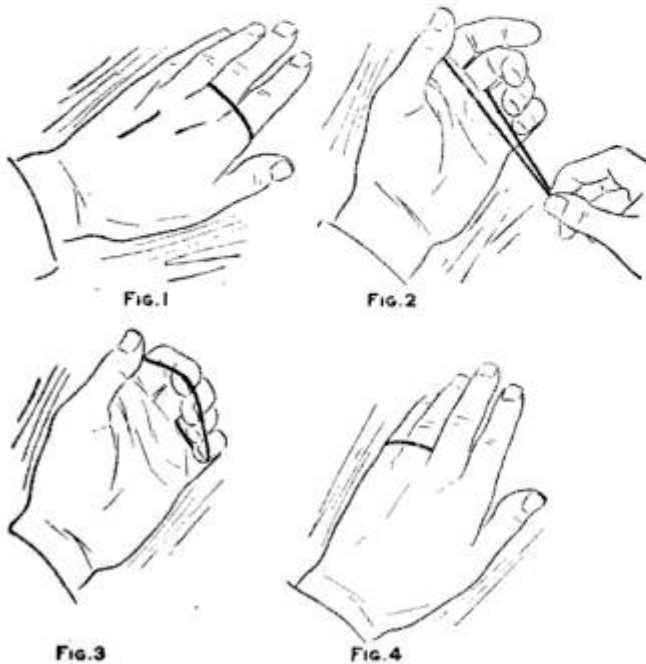

FIG. 3
FIG. 4
Transferring Rubber Band from the First Two Fingers to the Last Pair, Like Magic

be performed without detection by any one. The band on the first two fingers is shown to the spectator as in Fig. 1, with the back of the hand up. The hand is then turned over and the band drawn out quickly, as shown in Fig. 2, in a manner as to give the impression that the band is whole and on the two fingers. While doing this, quickly fold all the fingers so that their ends enter the band, and turn the hand over and let go the band, then show the back with the fingers doubled up. In reality the fingers will be in the band, as in Fig. 3, and the back will still show the band on the first two fingers. Quickly straighten out all the fingers, and the band will snap over the last two fingers, as shown in Fig. 4.—Contributed by E. K. Marshall, Oak Park, Ill.

A Swinging Electric-Light Bracket

The light bracket shown is both ornamental and useful and can be swung from one side of the room to the other in an instant, a feature that is of great value in a dimly lighted kitchen. It can be made of either brass or soft iron, but, for the sake of convenience, the

description will be for one made of brass.

Procure four pieces of brass, 1 in. wide, $\frac{1}{8}$ in. thick and 7 in. long, and bend them to the shape shown at A. These are to form the ceiling bracket. A $\frac{3}{16}$ -in. hole is drilled in the end of each piece to be against the ceiling. The other end is bent slightly concave and soldered to a brass collar, B, which is threaded on the inside. This collar must be of such a size that it will screw on the end of a brass pipe, C, 1 in. in outside diameter. The length of this pipe should be 18 or 20 inches.

The base D of the bracket is made of a brass bar, $\frac{1}{8}$ in. thick, $\frac{1}{2}$ in. wide and 45 in. long, a scroll being turned on 6 in. of its length at the globe end, and 3 in. of the other end turned up at right angles and soldered to a ring made of $\frac{1}{8}$ -in. brass that acts as a bearing around the pipe.

The upper brace E is made of $\frac{1}{8}$ -in. brass, the same width as the base piece and about 48 in. in length. Each end is turned into a scroll and then riveted or soldered to the base D and to the upper brass ring. The space between the base D, the brace E, and the pipe C is filled with any style of scroll or other brace that may suit the taste of the

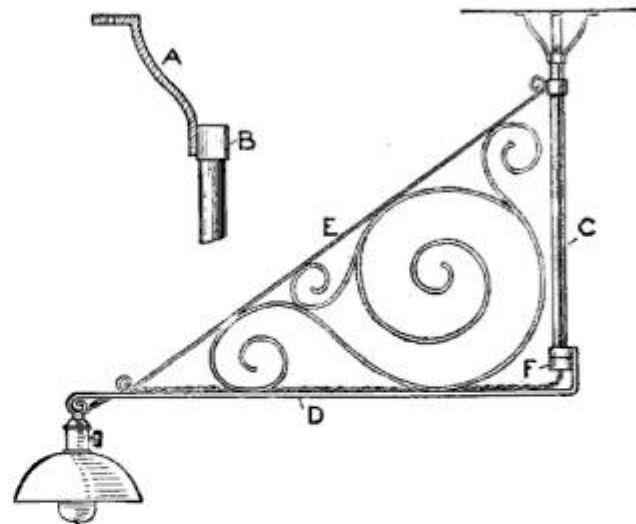

A Bracket Forming a Pendant and Swinging Arm to Change the Location of the Electric Light

maker, but the base D must be at right angles to the pipe C before the scroll is fastened in place.

A cap, F, is screwed to the lower end of the pipe, to keep the bracket in place. Ordinary flexible light cord is

used to connect to the light which is swung to the scroll end of the base.—Contributed by F. L. Matter, Portland, Oregon.

Match Safe to Deliver One Match at a Time

A match safe that will deliver only one match at a time is constructed of two parts, the box or holder and the base, with slider. The box is diamond-shaped and of the size shown by the dimensions. The base, with slider, consists of two pieces, the baseboard and a standard which runs through the box diagonally on the longest dimension in a vertical position. A thumb-tack is inserted in the standard near the top to prevent the box from being lifted entirely from the base.

The matches are filled into the box

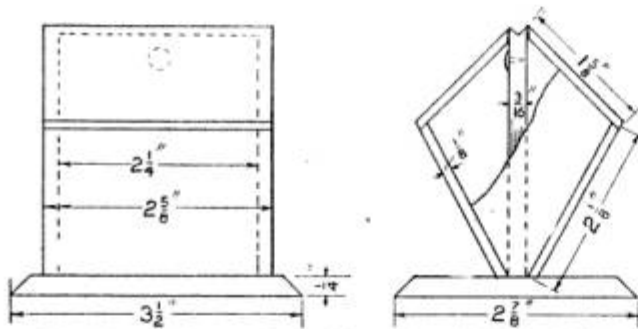

The Box Delivers Only One Match When It is Raised and Lowered on the Standard

on both sides of the standard. When a match is wanted, lift the box up and let it down again, and one match will be caught in the notch and raised out of the box. To prevent the box from tipping sideways when it is raised up, small pieces can be glued to the box ends on the inside and on both sides of the standard.—Contributed by A. S. Barrows, New Britain, Conn.

Cartridge Shells Used for Electrical Contacts

In making small switchboards, rheostats, and other electrical devices, I found a good use for old center-fire cartridge shells as shown in the sketch. A hole a little smaller than the diameter of the shell is made in the board and the shell is forced in. The proper wires are then soldered to

the metal on the inside, or the wire may be placed inside of the shell and

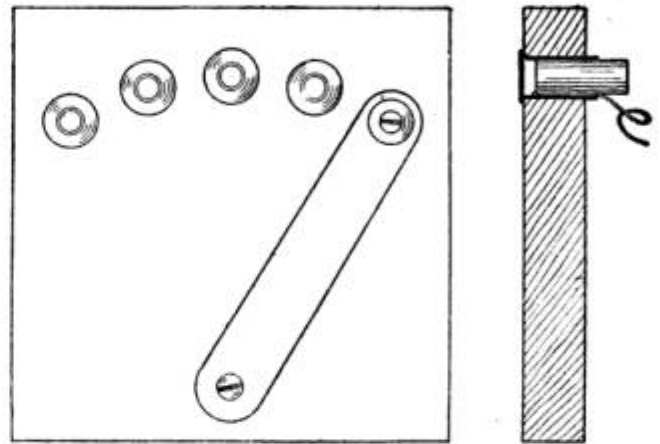

The Heads of the Cartridge Shells Make Good Contacts for a Switch Lever

held in contact by driving a wood plug in as indicated.—Contributed by W. O. Nettleton, Washington, D. C.

A Dowel-Turning Tool

The owner of a wood or metal lathe can easily construct a tool that will turn dowels of any size quickly. This tool, as described by a correspondent of Work, London, consists of a block of wood, shaped as shown at A, and a plane bit, B, attached with a wood screw. The hole in the collet C must be of such size that it will admit the rough stock freely but also prevent it from wobbling as the stick turns. The

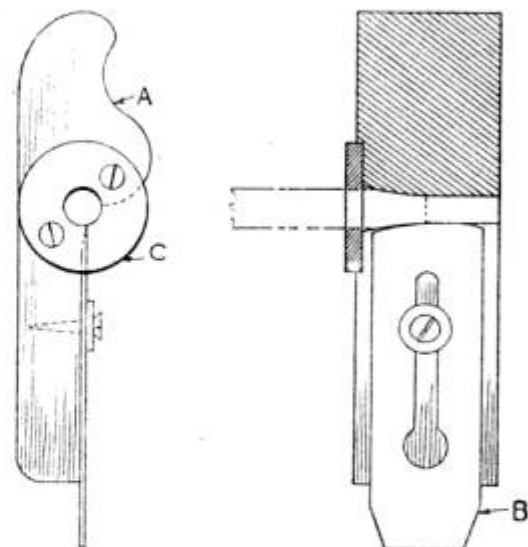

The Tool is Very Similar to a Plane and is Used with a Lathe for Turning Dowels

stock is chucked in the ordinary manner and the tool is run on the outer end.

Falling Leaves in a Nature Scene

Use an ordinary pasteboard box, a shoe box or larger, and cut out one end. Fasten the box to the ceiling by

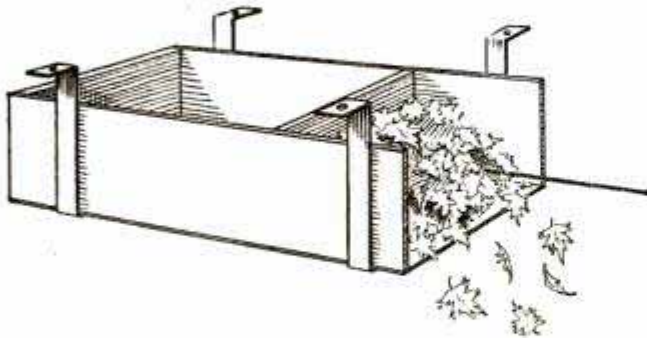

The Box as It is Prepared to Fasten on the Ceiling for Dropping the Leaves

means of pasteboard strips. One end of these strips is pasted on the bottom of the box and the other ends tacked to the ceiling. Fit a piece of board, $\frac{1}{2}$ in. thick, into the open end of the box so that it will slide easily back and forth on the inside. Place this slide in the back of the box, attach a string to it and run this through double tacks placed in the ceiling and to the side wings.

Have the box almost full of autumn leaves, and when the slide is pulled slowly by the operator, they will be pushed, one or two at a time, out of the open end, and will drift down to the stage as naturally as if falling from trees, making quite a realistic scene.—Contributed by Miss S. E. Jocelyn, New Haven, Conn.

Home or Traveling Utility Bed Pocket

The pocket is made of cretonne with wire hooks attached on the upper edge.

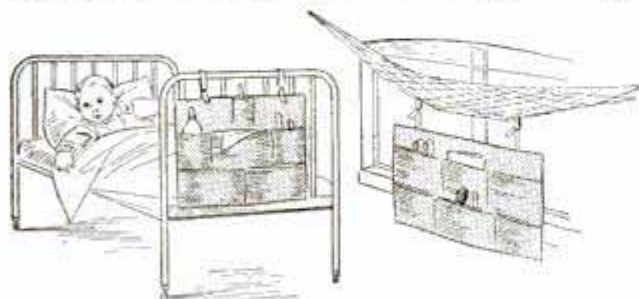

Various Pockets for the Change Garments for Use at Home or in Traveling

The compartments are arranged as needs may require. It can be hooked

on the head, foot or side rail of the bed or used, as shown, in a sleeping car. It provides a place to keep the slippers, gown and other necessities, and can be rolled up and put in a bag.—Contributed by Harriette I. Lockwood, Philadelphia, Pa.

A Paper Perforator

In an emergency an ordinary hack-saw blade may be made to serve very acceptably as a paper perforator. The toothed edge is applied to the paper and the reverse edge tapped with a mallet or hammer. A considerable number of sheets may be perforated at one time, depending of course on the thickness and softness of the paper.

Turning Brass Rings

Occasionally an amateur has need of brass rings of round cross section, and if their construction is not understood, the task is a difficult one. If a piece of brass tubing, an old bushing or a cored piece is at hand, a part of the work is already done. If not, a piece of stock with large enough outside diameter should be chucked in the lathe and drilled out with the right size of drill. A tin or pasteboard template should be prepared the size of the ring section—a half circle is best, and it is easiest made by drilling a hole in the tin and cutting it in two. An inside boring tool and a turning tool are necessary. It is preferable to shape the inside first, cutting it out roughly and checking up with the template. The amount of inside cutting is shown in the drawing. A hard scraper and emery cloth may be used for smoothing and polishing.

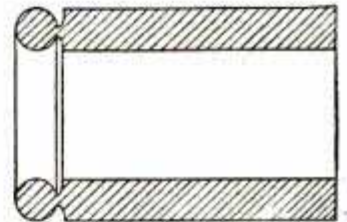

Turn and polish the outside and finally turn as far down on the inner quarter as can be done without cutting off the finish, then polish and cut it off. It only requires a little filing to smooth up the rim of rough metal left.

How to Make a Small Series Motor

The motor here described has been constructed and found to give very good results. It is simple to build and the materials required can be easily obtained. The armature core and field, or frame, are made of laminated iron, instead of being cast as is often done by the manufacturers, which is a decided advantage, as certain losses are thereby reduced, and its operation will be improved by this type of construction especially if used on an alternating-current circuit.

The machine will be divided into three main parts, the construction of each of which will be taken up in turn and the method of procedure discussed in detail. These parts are the completed armature, the field and bearings, and the brushes together with suitable terminals and connections.

The armature core is constructed from a number of pieces, having dimensions that correspond to those given in A, Fig. 1. These pieces are cut from thin annealed sheet iron, in sufficient number to make a pile, $\frac{3}{4}$ in. high, when placed on top of each other and firmly clamped. It would, no doubt, be best to first lay out one of these pieces very carefully and then cut it out and mark out the other pieces with the first one as a pattern, being careful to file off all the rough edges on each piece.

Now obtain a piece of $\frac{1}{4}$ -in. iron or brass rod, $3\frac{1}{4}$ in. long, that is to serve as a shaft upon which to mount the armature and commutator. This rod is threaded for a distance of $\frac{7}{8}$ in. on one end and $1\frac{7}{8}$ in. on the other. Procure five brass nuts, $\frac{1}{8}$ in. in thickness, to fit the threads on the rod. If possible have the ends of the rod centered before the threads are cut, for reasons to be given later. Place one of the nuts on that end of the shaft that is threaded for $\frac{7}{8}$ in., and in such a position that its inner surface is $\frac{3}{4}$ in. from the end of the rod. Solder this nut to the rod when it is in the proper place and remove all extra solder. Drill a $\frac{1}{4}$ -in. hole in each of the

armature stampings and place them on the shaft, clamping them together with three small clamps, one on each ex-

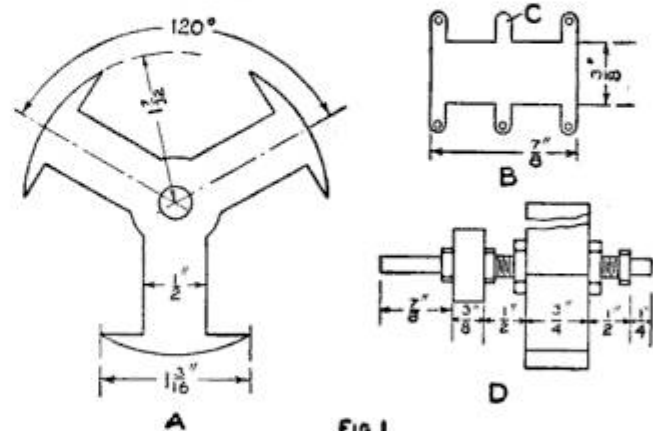

FIG. 1
Details of the Armature Laminations and the Commutator Segments, and the Method of Mounting Armature Core and Commutator

tension or pole. Then place a second nut on the shaft and draw it up tight against the last stamping placed in position, and solder it to the shaft. Next wind two or three layers of good strong tape around each of the rectangular portions of the armature and then remove the clamps. Make sure that all the edges of the different laminations are perfectly even before applying the tape.

The shaft is then placed between two centers to determine whether the core is approximately balanced and runs true. If the armature core is unbalanced or not true, the trouble should be corrected before proceeding with the remainder of the armature construction. The armature winding is not to be put on the core until the commutator has been constructed and mounted on the shaft.

The commutator consists of three pieces of thin sheet brass similar to that shown at B, Fig 1, mounted on the surface of a cylinder of insulating material, $\frac{3}{8}$ in. long and $\frac{7}{8}$ in. in diameter. A $\frac{1}{4}$ -in. hole is drilled lengthwise through the cylinder of insulating material. Bend the pieces of brass around the outside of the cylinder, and turn all the lugs, except the center one, marked C, over at right angles and put a small nail or screw through the holes in the ends of the

upper holes in the field frame and place a nut on each end and draw them tight, leaving an equal length of rod protruding from each side.

Obtain two pieces of $\frac{1}{8}$ -in. brass, $\frac{5}{8}$ in. wide, one $4\frac{3}{4}$ in. long and the other $5\frac{3}{4}$ in. long. Bend these pieces into the forms shown at A, Fig. 3. Drill a $\frac{1}{16}$ -in. hole in each end of both pieces so that they may be mounted upon the ends of the rods protruding from the field frame. The exact center of the space the armature is to occupy is then marked on each of these pieces, and a hole is drilled in each, having the same diameter as the ends of the armature shaft.

The extensions on the outside laminations are bent over at right angles to the main portion of the frame, thus forming a base upon which the motor may rest. Holes may be drilled in the extensions after they are bent over to be used in mounting the frame upon a wooden base.

Procure about $\frac{1}{2}$ lb. of No. 18 gauge single-cotton-covered copper wire and wind it on the lower center portion of the frame until the depth of the winding is about $\frac{1}{2}$ in. Be careful to insulate the winding well and, to insure mechanical protection, place a layer of adhesive tape outside. About 4 or 5 in. of wire is allowed at each end for making connections. It is best to have these ends terminate on the commutator side of the frame.

The brushes for the machine are made from some thin sheet copper or brass, and are shaped and dimensioned approximately as shown at B, Fig. 3. Two pieces of hard rubber, or fiber, $\frac{1}{2}$ in. square and $\frac{7}{8}$ in. long, serve as mountings for the brushes. These pieces of insulation are mounted in the corners of the armature support, at the commutator end, by means of two small screws in each. Mount the brushes on these pieces so that their free ends bear on the commutator exactly opposite each other. One brush is mounted on the upper end of its support and the other brush on the lower end of its support. This is shown at C, Fig. 3. Two small binding posts

are mounted at the same time as the brushes, and are electrically connected to the brushes, thus affording an easy means of making a connection to the

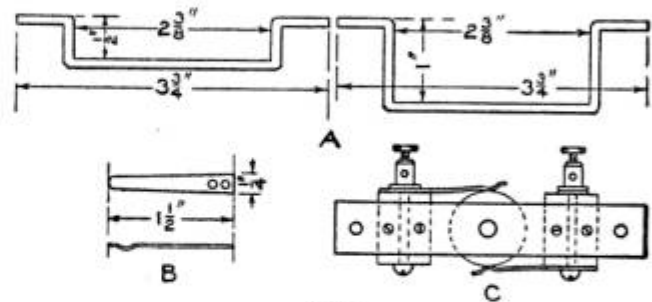

FIG. 3

Detail of the Armature Supports and the Brushes, and the Manner of Mounting the Brushes

armature. The brushes are so mounted as to bear firmly upon the commutator.

To operate the motor, connect the armature and field windings in series, and the combination to a source of electromotive force of several volts. If it is desired to reverse the direction of rotation, reverse the connections of either the armature or field windings, but not both. The motor may be mounted on a neat wooden base and the connections all brought down to a reversing switch, which may also be mounted on the same base as the motor. The speed can be varied by changing the impressed voltage, or by connecting a variable resistance in the armature circuit, such as a wire rheostat.

A small pulley may be made and attached to the armature shaft so that the motor may be used in driving various kinds of toys.

Cooler for Milk and Butter

An earthen jar or crock, with a cover, set in a box containing moist sand will keep butter and milk in hot weather better than a refrigerator. The sand must be kept moist at all times. — Edwin J. Bachman, Jr., Fullerton, Pa.

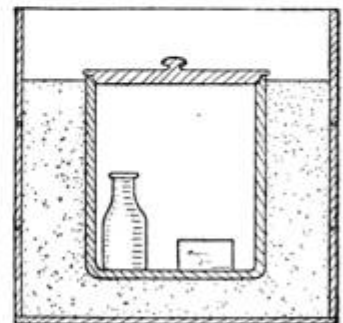

Gate Fasteners

Buttons on gates or small doors are apt to become loose and then drop down, thereby allowing the gate or door to become unfastened. The ordinary button is shown at A where it is loose and turned by its own weight. If the button is cut as shown at B, it will remain fastened, even if it is loose on the screw or nail.—Contributed by A. S. Thomas, Amherstburg, Ont.

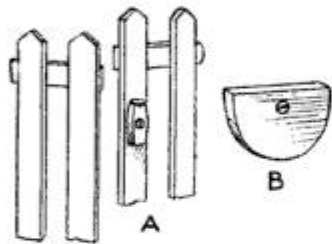

A Compensating Siphon

The homemade siphon shown in the sketch consists of two rubber corks and a glass tube with a rubber hose connected to it. The cork A is used as a bearing and support on the edge of the tank. The position of the cork B on the tube determines the distance that the mouth of the tube will be under the surface of the liquid, also to some extent the sensitiveness of the apparatus. However, the principle of the device is the buoyant effect of the

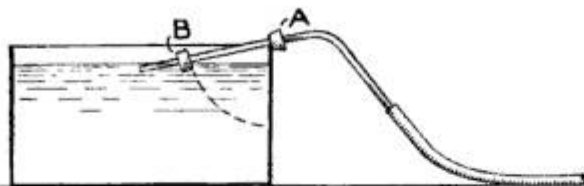

The End of the Pipe is Kept Just under the Surface of the Liquid at all Times

water and the lever action of the rubber tube which is attached.

The one that I made had a tube 14 in. long, and the cork B was $1\frac{3}{4}$ in. in diameter, 1 in. thick, and weighed about $\frac{1}{10}$ of a pound. The practical application of this siphon will be found in sieve tests where it is necessary to collect the residue on the bottom of the tank while drawing off the liquid at the surface, also in oil-storage tanks where it is not wished to disturb the dirt or other residue which collects on the bottom of the tank.—Contributed by James Hemphill, Jr., Duquesne, Pennsylvania.

A Polarity Indicator

Lines in a cable or the ends of connections at a distance from the battery must be tested to determine the polarity. Where a large amount of this work is to be done, as in automobile and motorboat repairing, it is necessary to have an indicator to save time. A cheap indicator for this purpose can be made of a 6-in. test tube having its ends sealed and inclosing a saturated solution of ammonium chloride (sal ammoniac) and water. The sealed ends are made by inserting a piece of wire through a cork and, after forcing this tightly into the end of the test tube, covering it with sealing wax.

To use, connect the terminals to the

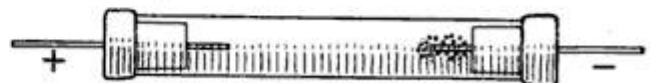

A Simple Pocket Indicator for Finding the Negative Wire in Battery Cable Lines

battery lines, and the end of the wire in the solution giving off bubbles is the negative wire.—Contributed by H. S. Parker, Brooklyn, N. Y.

Small Steam-Engine Cylinders Made from Seamless Brass Tubing

In making a small steam engine it was desired to use seamless brass tubing for the cylinders. To have them exactly alike a piece of tubing of the right size and of sufficient length for both cylinders was fitted on a wood mandrel, A, and the ends trued up in a lathe. As these cylinders were to fit into holes bored in a steel bedplate, it was necessary to have a flange at one end. A groove was turned in the tubing B in the center, and as a final operation a parting tool was used on the

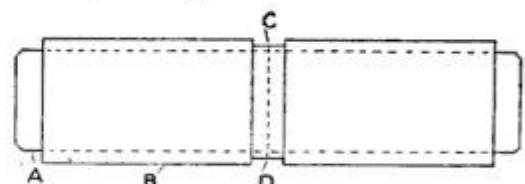

A Wood Mandrel Used to Face the Ends and Turn Flanges on Tubing for Cylinders

line CD. This resulted in a pair of cylinders flanged to fit the bedplate.—Contributed by Harry F. Lowe, Washington, D. C.

An Electric-Light Bulb as Barometer

To use a discarded electric bulb as a fairly reliable barometer the point is broken off with a pair of pliers while holding the bulb under water. As the bulb is a vacuum, it completely fills with water. If the bulb is now suspended from a wire or thread fastened at the socket end, the water will not run out of it in fair weather when the atmospheric pressure is normal or high, but if the pressure falls, as happens when bad weather is approaching, the water will begin to bulge out of the small opening and sometimes a small drop may even fall off. When, with returning fair weather, the atmospheric pressure increases, the water can no longer bulge or drop out of the bulb.

A Swinging-Pendulum Trick

To swing a pendulum, picked out from a number of them at random, without touching it is a very puzzling trick. The articles necessary are a medium-sized table and a number of pendulums, some of which are suspended from a rod with their lower weighted ends inside of water and wine glasses placed on the table, and others attached to corks so that they will hang inside of bottles.

The spectators gather around the table which can be in full light. The performer sits at one side of the table with his hands flat on the top. A person may pick out any pendulum and ask him to swing it, which he will proceed to do without touching it, also making it strike the glass while it swings. Another pendulum may be pointed out and he will start that one apparently by looking at it, while the other one stops.

This may seem to be impossible, yet it is very easy. It will be seen that no two pendulums have the same length. A pendulum makes a certain number of swings in a given time, depending on its length. A long pendulum requires more time to complete its swing and will, therefore, make a less number of swings than a short one

in the same time. It is only necessary to move the table slightly and watch the pendulum picked out until it be-

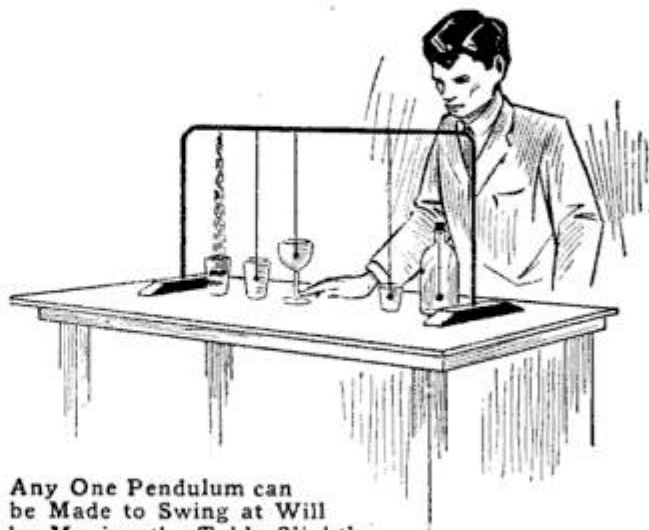

Any One Pendulum can be Made to Swing at Will by Moving the Table Slightly

gins to swing independently of the others, which soon happens. To make the longer pendulums swing, longer movements of the table top must be made. With a little practice anyone can become a skilled medium in pendulum swinging.—Contributed by James A. Hart, Philadelphia, Pa.

Applying a Strap Hinge

An ordinary strap hinge can be applied to a door or box cover in such a way that only one wing will show. Ordinarily the hinge opens as at A, and, on reversing it, the hinge will open to the limit as shown at B. If one wing is bent toward the other, as shown at C, the hinge may be applied as shown

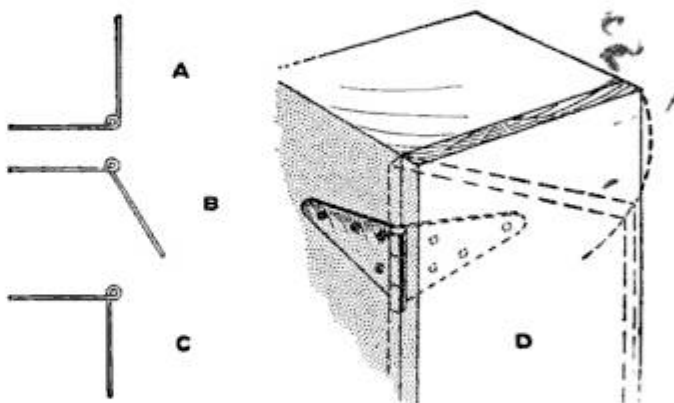

Reversing a Strap Hinge So That When It is Applied Only One Wing will Show

at D. As this process reverses the hinge, the screw holes must be countersunk on the opposite side.

INTERESTING NEW PATENTS

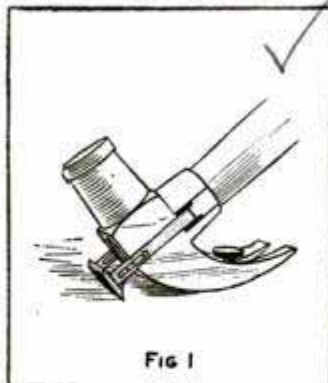

FIG 1

HAMMER FOR DRAWING LONG NAILS (Fig. 1)—The ordinary claw hammer is ill adapted to pulling long nails because it does not have a good fulcrum. This hammer has an extension on the head with a sharp point which makes a secure fulcrum for drawing nails, long or short. The extension is U-shaped and straddles the head so that it can be pushed back and held by a spring pawl when not in use.



FIG 3

EGG-CUP HOLDER (Fig. 2; British patent by an Italian)—This egg cup is made of metal and is intended to be fastened to the edge of a porcelain plate. The end of the handle is bent in the form of a hook to slip over the edge of the plate, and a metal tongue cut from the handle holds it in place.



FIG. 2

AEROPLANE PARACHUTE (Fig. 3)—Many parachutes have been designed to save a birdman when his flying machine becomes disabled. Here is one which is intended to save the aeroplane as well as its pilot. When not in use it is carried in a little box over the pilot's head with ropes attached to the ends of the wings and the frame, ready for instant use. If the aeroplane is disabled, the driver ejects the parachute from the box and it spreads out overhead to carry the machine gently to the earth.

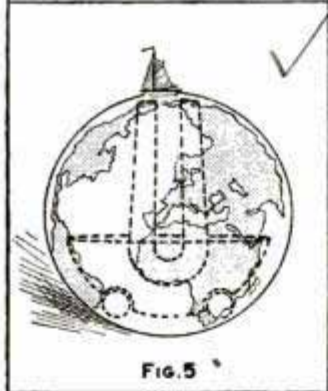

FIG. 5

KITCHEN REMINDER (Fig. 4)—No pencil is necessary with this kitchen reminder to make out the daily list of groceries. All of the common items are already printed on the list and also on metal flaps normally covering the items. Turning one or more flaps outward indicates that the commodities uncovered are wanted.

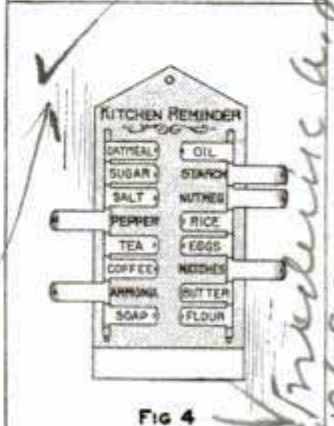

FIG 4

GEOGRAPHIC TOY (Fig. 5)—As the globe is turned in any direction, the little ship sails over the seas on its surface. It may sail over the land, also, for whatever position the globe is in, the ship is always directly on top. Inside the globe there is a strong magnet, mounted on ball bearings and ballasted so that its poles are always toward the top. The ship is the keeper of the magnet and stands still on top when the globe is turned.

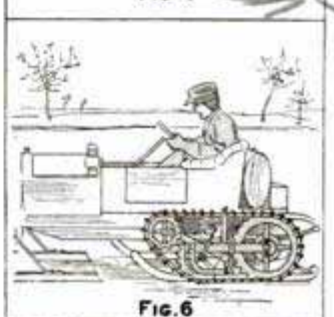

FIG. 6

SLED ATTACHMENT FOR AUTOMOBILES (Fig. 6)—A spiked-chain drive to propel an automobile mounted on sled runners is shown here. The sled runners slip over the ends of the axles after the wheels have been taken off, and the chain drive gets its power from the rear axle. The chain is carried on a rocking framework pivoted on the large sprocket which takes the place of the automobile wheel on the axle.

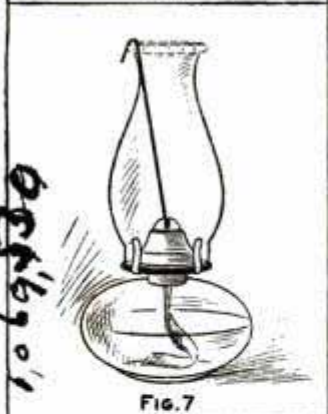

FIG. 7

LAMP LIGHTER (Fig. 7)—It is not necessary to remove the chimney to light a kerosene lamp with one of these lamp-lighting rods. The rod is made of some inflammable material, such as celluloid, and a flame is carried down to the wick as soon as a match touches the end of the rod bent over the top of the chimney.



FIG. 8

COMBINED TAPE AND PLUMB LINE (Fig. 8)—A plumb bob attached to the end of the tape and a brake applied to the spool inside adapt this spring tape line for use as a plumb line. When the brake is released the tape can be drawn out as far as desired. A little pressure on the brake button presses a wedge into a toothed wheel on the spool and holds the line securely.



FIG. 9

FOLDING PHONOGRAPH HORN (Fig. 9; U. S. patent by a Canadian)—This phonograph horn is arranged to telescope into a very small package for shipment. It is made of a number of sections with beads, or shoulders, at the end so that the sections fit together firmly.

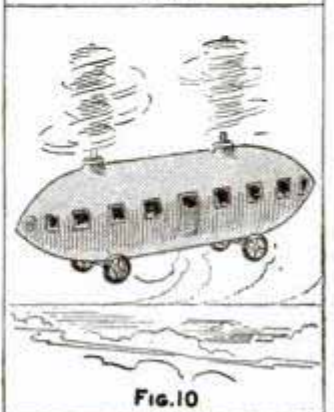

FIG. 10

FLYING MACHINE WITH HELICAL PROPELLERS (Fig. 10)—This is a new application of the helicopter, with spirals instead of bladed propellers to support it. Steering and maneuvering is accomplished by changing the angle of the propeller shafts. Each shaft extends into the body of the flying machine and its lower end is mounted so that it can be moved sideways or longitudinally. Flexible shafts connect the vertical shafts with the motor.

*Frank Wm. Howatson
Toronto, Ont., Can.
Hamilton
New Orleans, La.*

*1069642
758429
1069530*

*Frederic A. Barberman N.Y.
1068207*



FIG. 11

SNOW BICYCLE (Fig. 11)—Sled runners take the place of the two wheels on this velocipede so that it can travel on snow or ice. A spiked wheel with cranks on its shaft is mounted at one side of the front runner. The novel part of the driving mechanism is that the spiked wheel slides up and down in the fork so that it can be raised off the ground for coasting downhill.



FIG. 12

FOOT REST ON WHEELS (Fig. 12)—The foot rest of this rocking chair is mounted on wheels so that it moves back and forth with the rocking motion of the chair. It is made of telescoping rods and folds up under the chair when not in use. The chair's bottom has tracks for the rods to slide on, and there are two extra rungs near the front end of the rockers for the wheels to rest on.

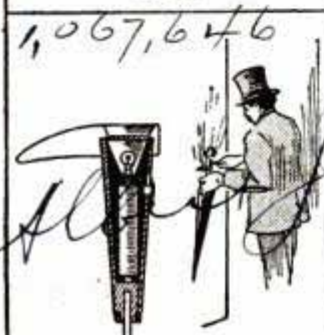

FIG. 13

BACK REST FOR INVALIDS (Fig. 13)—Here is a substitute for pillows to prop up an invalid in bed. The back rest is a broad strip of canvas gathered together at the ends and attached to straps which pass around the rods of the foot-board. A table for a tray or a book can be hooked over the top edges of the canvas over the sick person's lap.

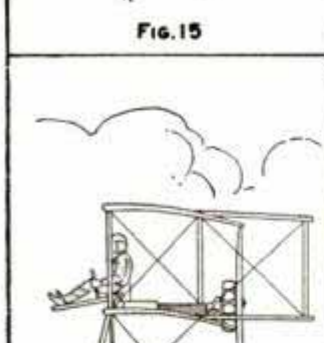

FIG. 14

FISH-HOOK ANIMAL TRAP (Fig. 14)—Attached to a flat, heavy base are two staggered rows of large barbed fish hooks for catching small animals. The hooks are so close together that the victim in trying to extricate itself from the hook becomes ensnared in several others and is held fast. The shape of the base makes it possible to conceal the snare in long grass more effectively than a spring trap, and it does not need to be baited.

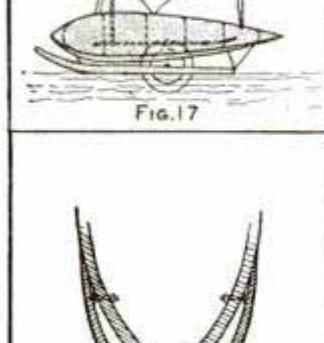

FIG. 15

UMBRELLA-HANDLE SEARCHLIGHT (Fig. 15)—A flashlight is imbedded in the handle of the umbrella so that it is always ready for use. The contact button is on one side close to the end directly under the little finger and the light shines out of the end of the handle. For opening up the lantern, a new battery or bulb, the crosspiece on the end unscrews from the handle.



FIG. 16

ADJUSTABLE BRACELET (Fig. 16)—This bracelet will slip over any hand and cling tightly to any arm without being unlocked or opened. It consists of two long narrow circlets hinged together like a pair of shears. Spiral springs in the two pivots normally spread the circlets far apart so that they cling to the arm. When the circlets are pressed together the diameter of the bracelet becomes large enough to pass over the hand.



FIG. 17

PONTOONS FOR FLYING BOATS (Fig. 17; British patent)—The usual floats attached to flying boats are not buoyant enough to support a flying machine and keep it from sinking when it is standing still on the surface of the water. These floats have pontoons attached to them to overcome the difficulty. The pontoons are cigar-shaped and filled with air. A number of compartments are arranged inside the pontoons so that a puncture will not disable them.

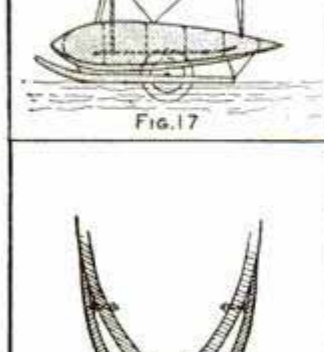

FIG. 18

DRINKING SPOUT FOR FAUCETS (Fig. 18)—Drinking from a water faucet is a difficult matter. This little device turns the stream of water upward to form a drinking jet. It is simply a semi-circular channel pivoted so that it can be swung under the stream.

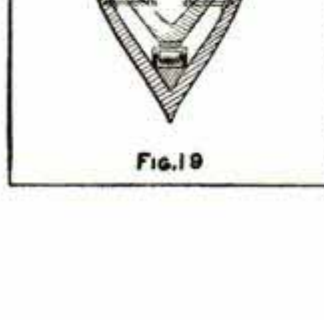

FIG. 19

DETACHABLE KEEL FOR SHIPS (Fig. 19; British patent)—When a vessel wearing one of these false keels runs aground it can extricate itself without assistance. The false keel covers the entire bottom of the vessel and is held in place by bolts which can be unscrewed from inside. If the ship runs aground, the false keel is released and the ship slides out of it on rollers under the ship's own bottom.

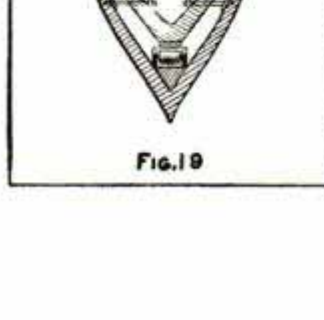

FIG. 20

CONVERTIBLE VISE (Fig. 20; German patent)—Reversible jaws fit this new vise for holding either flat or wedge-shaped objects. The two jaws slip out sideways from the cylindrical holders. In one position the faces of the jaws are parallel as in an ordinary vise; when they are reversed they form a wedge-shaped opening which automatically adjusts its angle to the shape of the object to be held in the vise.



FIG. 12

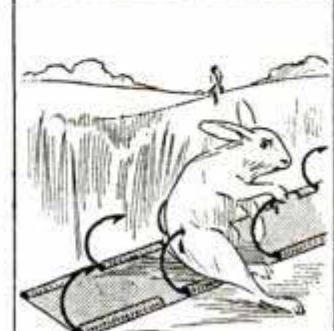

FIG. 14



FIG. 16

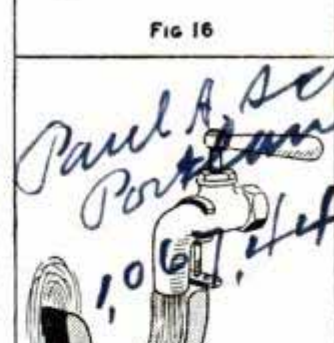

FIG. 18

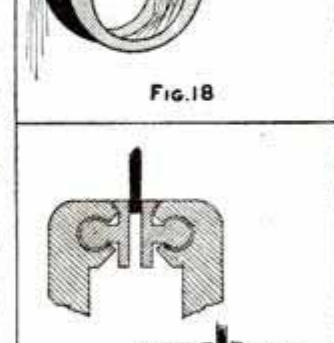

FIG. 19

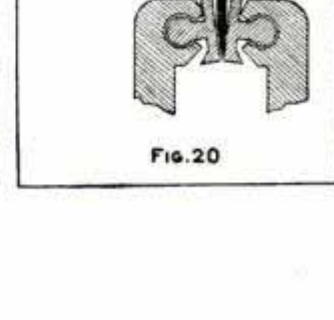

FIG. 20

card

*Paul A. Schuchman
Portland, Ore.
1,067,643*

"YES," said the quiet little man in the corner, as the conversation turned to sport, "I've had a good deal of experience in running, cycling, etc." "Ever had any luck?" asked an athletic-looking young man. "Oh, yes; once took the gold cup for ten miles running championship." "Anything else?" sneered the other. "At one meeting I took six cups; in fact, all the prizes that were offered." "Now, look here, mister," said the athlete, "you can't expect me to believe that." "It's a solemn fact, nevertheless," answered the little man. "You see, I'm a photographer."—*Australasian Traveler.*

"Come right on in, Sambo," the farmer called out. "He won't hurt you. You know a barking dog never bites."

"Sure, boss, ah knows dat," replied the cautious colored man, "but ah don't know how soon he's going to stop barkin'."—*Marine Journal.*

An Atlanta man tells of an amusing experience he had in a mountainous region in a southwestern state, where the inhabitants are notoriously shiftless. Arriving at a dilapidated shanty at the noon hour, he inquired as to the prospect for getting dinner.

The head of the family, who had been "resting" on a fallen tree in front of his dwelling, made reply to the effect that he "guessed ma'd hev suthin' onto the table putty soon."

With this encouragement the traveler dismounted. To his chagrin, however, he soon discovered that the food set before him was such that he could not possibly "make a meal." He made such excuses as he could for his lack of appetite, and finally be-thought himself of a kind of nourishment which he might venture to take and which was sure to be found in any locality. He asked for some milk.

"Don't have milk no more," said the head of the place. "The dawg's dead."

"The dog!" cried the stranger. "What on earth has the dog to do with it?"

"Well," explained the host meditatively, "them cows don't seem to know 'nough to come up an' be milked theirselves. The dawg, he used to go for 'em and fetch 'em up."—*Lippincott's.*

"How do you tell the difference between a yacht and a sailboat?" said the girl with the inquiring mind.

"By lookin' into the pantry," replied Captain Cleet. "If she carries plenty of refreshments and seegars, she's a yacht. If it's mostly plain victuals, she's a sailboat."

"My husband bought an automobile because he said he needed it in his business."

"What has he made with it?"

"Forty-five miles an hour is all, I think."—*Detroit Free Press.*

"When I was shipwrecked in South America," said Captain Bowsprit, "I came across a tribe of wild women who had no tongues."

"Mercy!" cried one of his listeners of the fair sex. "How could they talk?"

"They couldn't," snapped the old salt. "That's what made 'em wild."—*Pathfinder.*

Little Elizabeth and her mother were having luncheon together, and the mother, who always tried to impress facts upon her young daughter, said: "These little sardines, Elizabeth, are sometimes eaten by the larger fish."

Elizabeth gazed at the sardine in wonder, and then asked: "But, mother, how do the large fish get the cans open?"—*Judge.*

Dubbleigh's car lay flat on its side and deep in the mud in a freshly-plowed field, having skidded off the road, through the low stone wall, to get there.

"Ah!" cried a passer-by from the roadside. "Had an accident?"

Dubbleigh tried to hold his tongue, but the strain was too much for him.

"No, of course not," he replied coldly. "I have just bought a new car, and have brought my old one out here to bury it. Got a pickax and a shovel in your pocket you could lend me? I can't seem to dig very deep with my motor horn."—*Harper's Weekly.*

Mr. Slimson—Willie, didn't you go to the trunk-maker's yesterday and tell him to send round the trunk I ordered?

Willie—Yes, pa.

Mr. Slimson—Well, here is the trunk, but no strap.

Willie—Yes, pa; but I told him I thought you hadn't better have any strap.—*Philadelphia Inquirer.*

A colored man was on trial for felony. The judge asked him if he desired the appointment of a lawyer to defend him. "No, sah," said Sam. "I's gwine to throw myself on the ignorance of the co't."—*Youth's Companion.*

"What little boy can tell me the difference between the 'quick' and the 'dead'?" asked the Sunday-school teacher.

Willie waved his hand frantically.

"Well, Willie?"

"Please, ma'am, the 'quick' are the ones that get out of the way of automobiles; the 'dead' are the ones that don't."—*Ladies' Home Journal.*

On his teacher's request that he give the class his ideas on the subject of "Bravery," little Johnny delivered himself of the following:

"Some boys is brave because they always plays with little boys, and some boys is brave because their legs is too short to run away, but most boys is brave because somebody's lookin'."—*School Board Journal.*

"Now, this car is so constructed," said the agent, "that it can't possibly turn turtle."

"Well, I should say not!" said Jinks. "At the price you ask for it, it oughtn't to turn anything short of diamond-backed terrapin."

Father—Will our boy get any prize this year?

Teacher—Sure, he is going to get it in arithmetic.

Father—Thank God, then we will have some one in the family that can read the taximeter.—*Le Figaro.*

She—George, dear, here's a scientist who says the earth is wobbling on its axis. What do you suppose they can do about it?

George, absently—Open the muffler, reverse the lever, shut off the power, lubricate the bearings, and tighten the wheel cap.—*Cleveland Plain Dealer.*



"Don't mind these jolts, Auntie. You'll get used to them!"

—*Punch*

Johnson's Prepared Wax

A complete finish and polish
for all wood—*floors, wood-
work and furniture.*

Johnson's Wood Dye

In 17 shades—for
the artistic color-
ing of all wood—
soft and hard.

Use the coupon
for trial packages
and FREE In-
struction Book,
"THE PROPER
TREAT-
MENT OF
FLOORS,
WOOD-
WORK
AND
FURNITURE"

S. C. Johnson
& Son

"The Wood Finishing
Authorities"

Racine, Wisconsin



PRESENT THIS COUPON TO YOUR DEALER IN PAINTS

45c—Value FREE—45c

To Paint, Hardware or Drug Dealer: Furnish the
bearer, free of all expense, with

- 1—25c Instruction Book
- 1—10c Bottle Johnson's Wood Dye
- 1—10c Can Johnson's Prepared Wax

S. C. Johnson & Son, Racine, Wis.

(Must be presented by an adult.)

P.A.11

Startling Exclusive Improvements

Step Starter — Selective Two-Speed — Double — Folding Foot Boards — Ful-Floteing

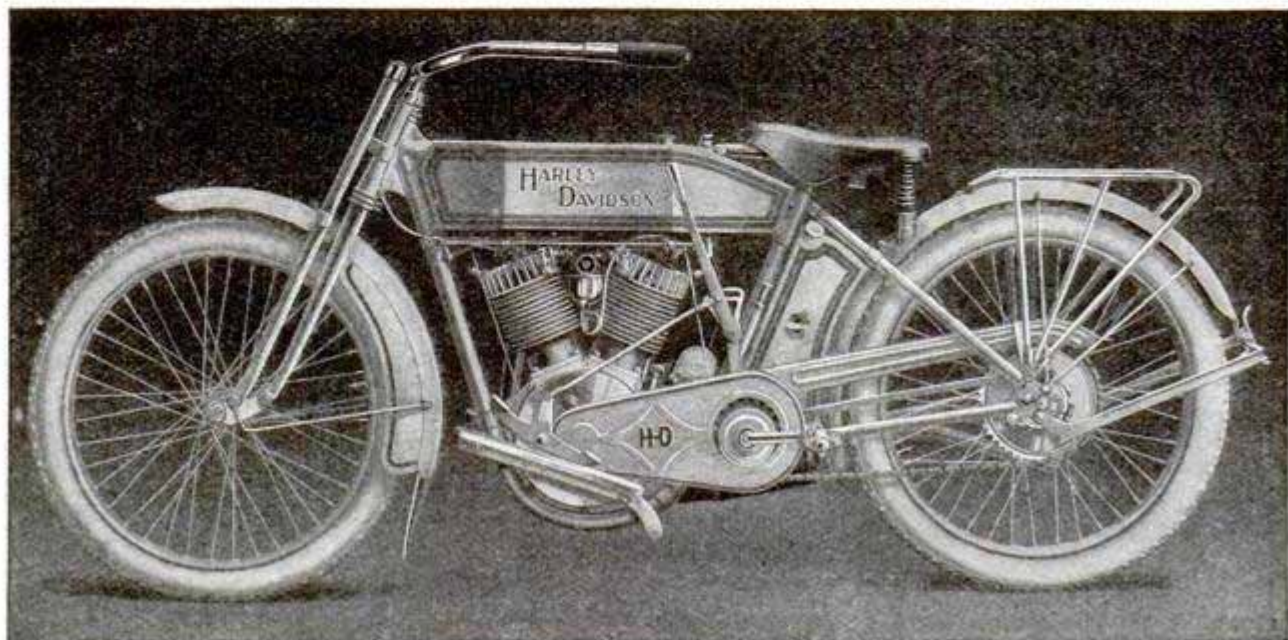

THE Harley-Davidson models for 1914 are marked for the innovations they present. Innovations, but not experiments, for every feature, every improvement, every refinement has stood the test of months and months of hard road service, for the makers of the Harley-Davidson never have and never will foist onto the public any so-called improvement in an experimental stage.

Step Starter Starts Machine With Rider in the Saddle and Both Wheels on the Ground.

The step starter—another new and exclusive feature of the Harley-Davidson furnishes the only practical method of starting a motorcycle yet offered to the public.

A downward push on either pedal spins the engine sufficiently to start it. This does away with the necessity of putting the machine on the stand to start, as the step starter can be used when both wheels are on the ground.

If the motor becomes stalled at any time it is no longer necessary to hold up traffic in a crowded street, find a level place in the road, get off in the mud, and set the machine on the stand to start it. A simple push on the pedal and the engine again begins to throb.

HARLEY-DAVIDSON MOTOR CO.
PRODUCERS OF HIGH GRADE MOTORCYCLES

Mark the 1914 Harley-Davidson

Brake Control—Double Control of Free Wheel Seat—Other Important Improvements.

Selective Type of Two-Speed

The Harley-Davidson selective type of two-speed we believe to be not only the most simple but the most compact and efficient that has been placed on the market. It is located inside the rear hub, thus avoiding dust, dirt or damage. Its speeds are selective and the rider can shift from low to high or high to low or to neutral at any time whether the machine is standing still or in motion. After thousands and thousands of miles of use on experimental models we are absolutely convinced that this is without question the most satisfactory type of two-speed that has ever been built.

Double Brake Control

The brake on the new Harley-Davidson can be operated either by a foot lever on the right foot board or by back pedaling on either pedal. All models are equipped with the Harley-Davidson band brake.

Double Control of Free Wheel

Free Wheel Control now can be operated either by foot lever on the left foot board or by a hand lever. The foot lever control is an innovation which does away with all fumbling or feeling for the control lever and permits a much more rapid engaging or dis-engaging of the Free Wheel Control by the rider.

Folding Foot Boards

All models are equipped with folding foot boards. In addition to the foot boards the pedals are retained. The foot boards are unusually long thus permitting a great variety of positions according to the height of the rider. This overcomes the great objection to the ordinary type of foot boards. They were built to fit the ordinary man and consequently the purchaser who was a little taller or a little shorter had to suffer from the uncomfortable position his height forced him to assume.

Ful-Floteing Seat

After building over 24,000 Harley-Davidsons incorporating the Ful-Floteing Seat, no possible method of improvement has suggested itself. This seat has proven itself absolutely to be the greatest comfort device ever offered. Floating, as it does, the weight of the rider between two concealed, compressed springs it assimilates all the jars and vibrations due to rough roads. It is equally sensitive to the small rut and big bump. It is impossible for it to strike bottom and there is no rebound.

We will be glad to send you descriptive literature giving full details of this and the many other important improvements together with the name of our dealer on request.

346 B Street, Milwaukee, Wisconsin
FOR MORE THAN TWELVE YEARS

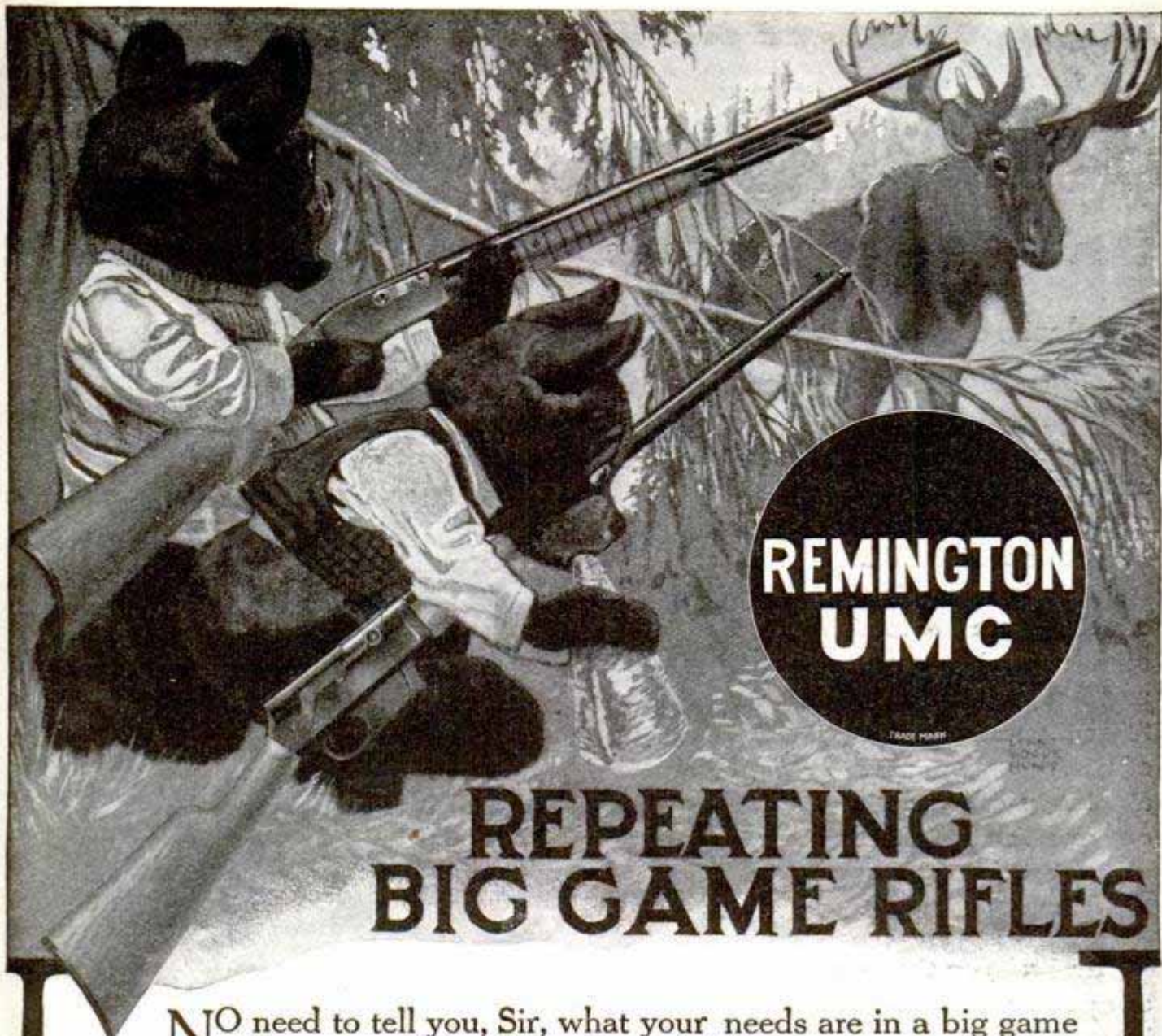

REPEATING BIG GAME RIFLES

NO need to tell you, Sir, what your needs are in a big game rifle—ease of handling, dependability, accuracy; repeating mechanism simple and positive in action; the balance and “feel” that all but snaps the rifle up to the shoulder of its own accord.

But on the question, *How can I be sure of getting these features*, we have a word or two of counsel to offer. In brief, it is—Get a *Remington-UMC*.

If you want a slide action repeater—Get the new *High Power Slide Action Remington-UMC*. This new Remington-UMC model originated with the suggestion of a group of big game hunters, and several hundred are already in use. It is made in .25, .30 and .32 Rem. calibers—Remington-UMC ordnance steel barrel and standard Remington-UMC slide action *specially designed for heavy service*.

Or if you prefer the autoloading principle—you should certainly know the Remington-UMC *Autoloader*. Five-shot repeaters, operated by the recoil. Always a shot ready for the emergency—for the cripple, for the deer that is getting away, or charging beast that threatens to be troublesome if you don't get him quick.

The point to remember is that *Remington-UMC* is the biggest name today in the world of arms and ammunition. Go to the leading dealer in your community and look over his Remington-UMC stock.



Remington Arms-Union Metallic Cartridge Co.
299 Broadway, New York Windsor, Ont., Canada

Why help wear out the stairs?

The elevated railroads, subways and public buildings are in constant search of stair covering which will withstand, for a reasonable length of time, the incessant tramp of human feet.

Ordinary stair coverings go to pieces very quickly under the pound and scrape of hard leather heels and iron nails, brought down with a force equal to the entire weight of the wearer.

THINK what this jar and friction, so hard on tough flooring, must do to sensitive bodies and nerves.

Wear O'Sullivan's Heels of New, Live Rubber. They take up the jolt and jar of walking. You won't wear out the stairs — and what is more important, you will save your nervous system the shock of pounding your whole weight down on hard leather. O'Sullivan's Heels make walking easy, save fatigue, and give you a brisk, alert step. Wear them for comfort, health and economy.

O'Sullivan's Heels cost but 50c a pair, attached. Some shoe manufacturers put them on their shoes before they leave the factory. All shoemakers and shoe dealers will attach them to your shoes when you buy them, or at any other time. If you prefer, send us 35c in stamps and a tracing of your heel, and we will mail you a pair. O'Sullivan Rubber Co., 131 Hudson St., New York.

For Men, Women and Children

O'Sullivan's
HEELS Of New
Live Rubber



Made by a Specialist

EVERY maker, we suppose, is producing the best car he knows how to build.

Yet no two makes are alike, and no two makes are of equal value. Some one maker knows better than any other maker how to produce small, cheap cars. Some one maker knows better than any other maker how to produce superb electric cars. And Alexander Winton knows better than any other maker how to produce the world's finest six-cylinder car.

Specialists Lead the World

There's nothing accidental about it. It isn't luck or genius, but hard work, concentration, and experience. We live in an age of specialists. Specialists lead the world, and easily outdistance the straddlers, the floppers, the men who do not know their own minds well enough to stick to *some one thing*.

Cars That Don't Make Good

It's so in every profession, every business, and especially in the complicated automobile business, where a single mistake can ruin a season's output. That's why some cars are up one year and down the next. Also, that's why so many makers are forced to announce sweeping changes from year to year.

How can you expect excellence in the car of any maker who switches and revises and discards his models so rapidly that he never has a chance to perfect any one of them? What sort of specialist is he? How can he hope to equal the Winton Six, which has been the *sole* product of the great Winton factory for seven consecutive years?

WINTON SIX

Long stroke motor, left drive, center control, electric lights, self-starter, finest mohair top, easily handled curtains, rain-vision glass front, best Warner speedometer, Waltham eight-day clock, Klaxon electric horn, tire carriers, four-cylinder tire pump, demountable rims, full set of tools, German silver radiator, metal parts nickel finished. **\$3250**
Fully equipped, - - -

One Maker's Method

Mr. Winton never tried to make more cars than any other maker. He never tried to see how many different models he could make. He did not flop around from one thing to another, trying to monopolize the entire automobile market. But, on the contrary, for longer than seven years, he has devoted himself to a single object — the perfection of one six-cylinder car, the Winton Six.

The Result Is Excellence

That's what has made Alexander Winton the world's most experienced six-cylinder specialist, and the Winton Six the world's standard six-cylinder car. No wonder the Winton Six won high-grade demand away from four-cylinder cars. No wonder the Winton Six holds the world's lowest repair expense record. No wonder it is a car of exceptional beauty and of goodness that stays good. For it is the one car in the world that has been most thoroughly proved, developed, and perfected — the most satisfying car that money can buy.

The Winton Motor Car Company

24 Berea Road, Cleveland, Ohio

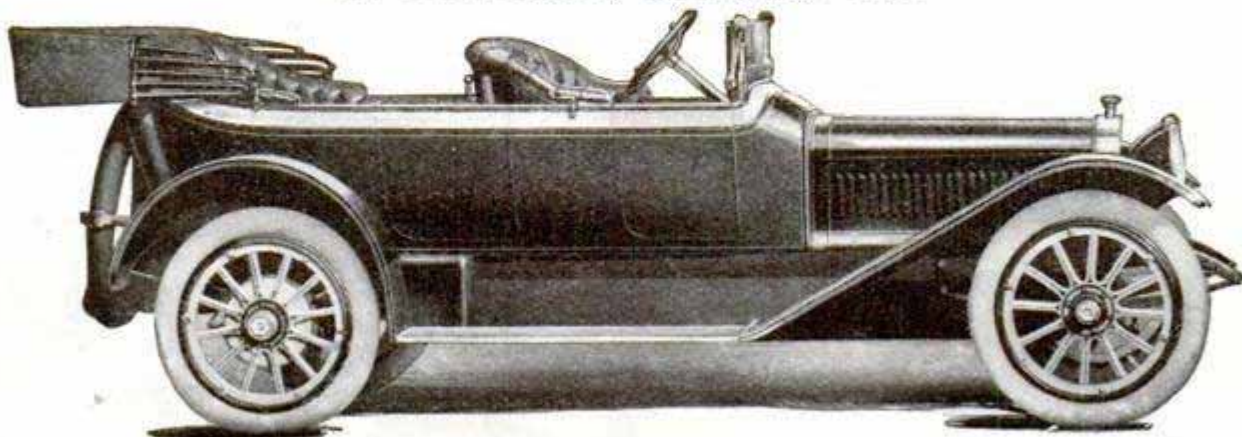

Our Book No. 18 tells automobile trade facts that you ought to know

3-IN-ONE OILS EVERYTHING

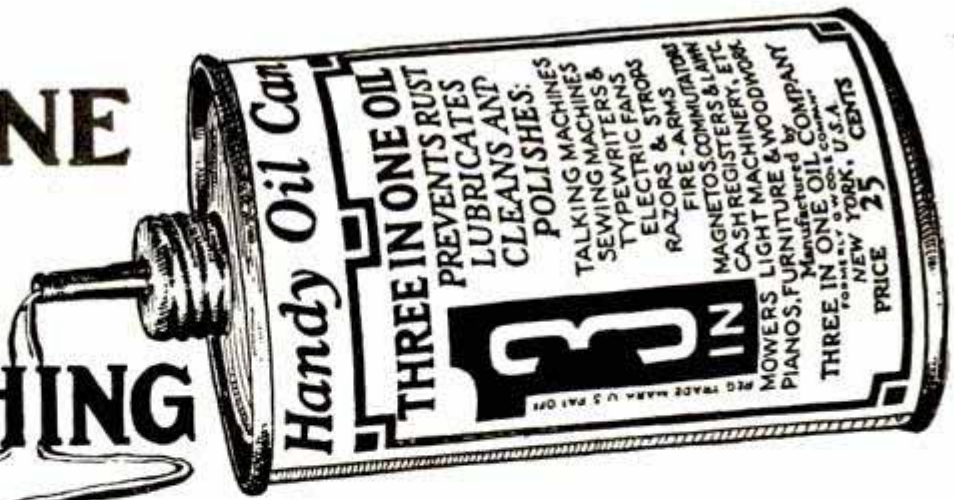

3-in-One is a pure oil compound that flows right to the heart of every bearing and friction point. It's light enough to oil a watch, yet has body enough to oil a lawn mower.

3-in-One Never Gums— Works Out All the Dirt

leaving the bearings sweet and clean and well lubricated. 3-in-One protects and preserves, prevents wear, tear and repair bills. It adds years of service to sewing machines, typewriters, guns, reels skates, bicycles, talking machines, adding machines and all office mechanisms, locks, clocks, bolts, catches, hinges and everything else that ever needs oil. 3-in-One contains no acid—is absolutely free from grease.

**U. S. Army and Navy, Great Railway Systems
and 17 Leading Gun Manufacturers
Use 3-in-One**

But the strongest argument of all will be your own test. *Make that test FREE, right now!* (Fill out the coupon below. Mail it today.)

3-in-One is sold at all department, hardware, sporting goods, drug, grocery and general stores in 3 size bottles. 1 oz., 10c; 3 oz., 25c; 8 oz., ½ pint, 50c. Also in patented Handy Oil Can, 3½ oz., 25c. If your dealer does not have Handy Oil Cans we will send you one full of good oil, by parcel post, for 30c.

Library Slip with every bottle

THREE-IN-ONE OIL CO.
42CNP Broadway, New York

Beware of substitute oils—get the original.

Three-in-One
Oil Co.
42CNP Broadway,
New York

Send to me, without one cent of cost, a generous free sample and the 3-in-One Dictionary.

Name.....

Street No.....

City.....

State.....

Please Mention Popular Mechanics

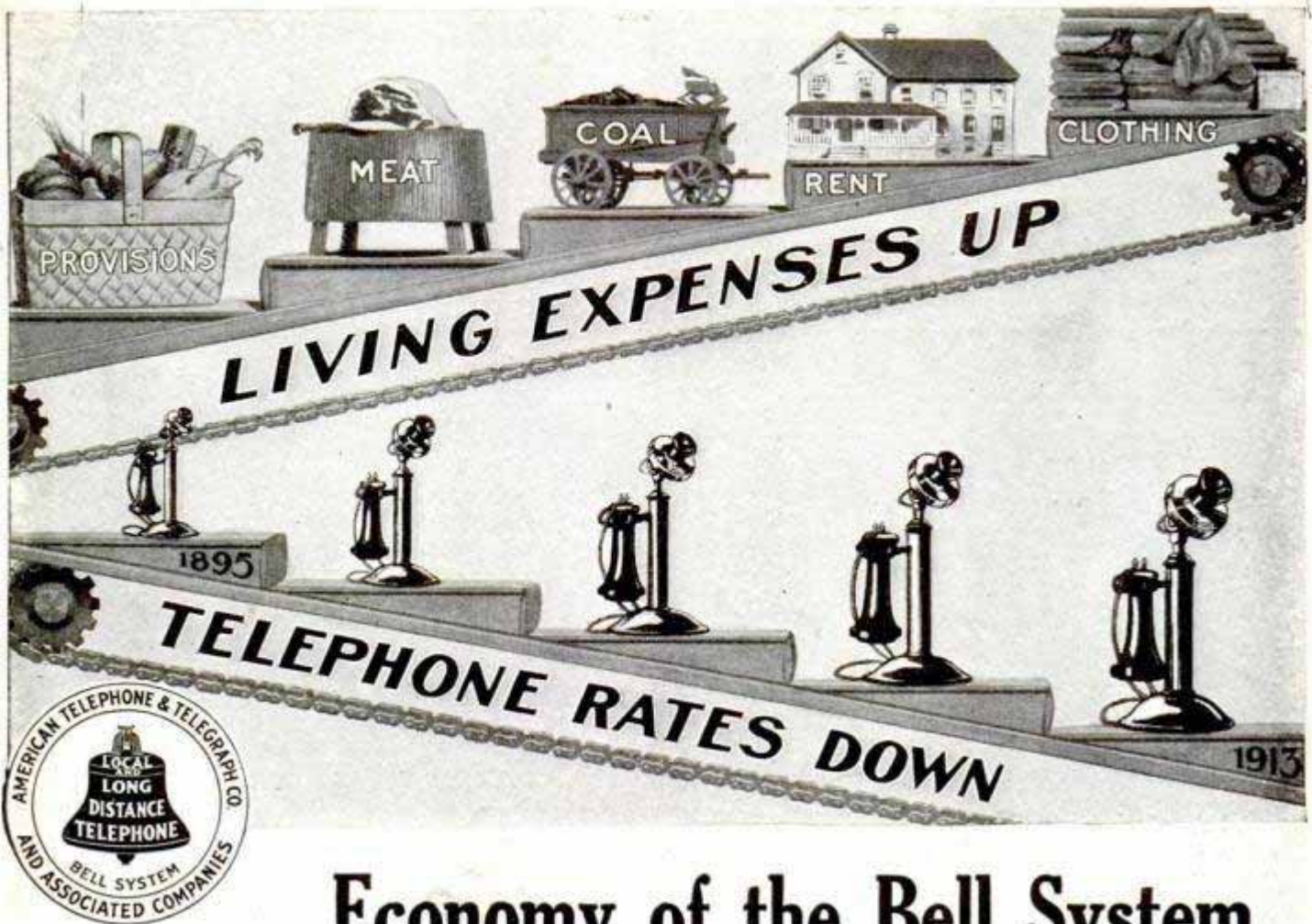

Economy of the Bell System

Consider this significant fact: While most of the necessities of life have gone up, the price of telephone service, which is one of the essential factors in our commercial and social life, has moved steadily downward.

Although a pound of these necessities still contains but sixteen ounces, the telephone user has been getting more and more service for less money.

On the average, the people of this country pay 49% more today for food, fuel and clothing than they did in 1895. Since then, the decrease in the average rates for telephone service has been more than one-half.

At the same time, the efficiency and value of the service to the subscriber has vastly increased. Today he can talk to an average of five times as many persons in each exchange as he could eighteen years ago.

This is the inevitable result of the comprehensive policy of the Bell System, which brings together the associated Bell companies and the communities they serve.

Through the very size and efficiency of their organization they accomplish improvements and effect economies which give the greatest service at the lowest rates.

**AMERICAN TELEPHONE AND TELEGRAPH COMPANY
AND ASSOCIATED COMPANIES**

One Policy

One System

Universal Service

Please Mention Popular Mechanics

Add the Price of Any Mounting Shown Below to the Price of Any Diamond

-  1/8 Carat \$8.25
-  1/4 Carat \$17.50
-  3/8 Carat \$31.25
-  1/2 Carat \$45.00
-  3/4 Carat \$67.50
-  1 Carat \$97.50
-  1 1/2 Carat \$146.25

GENUINE PERFECT CUT DIAMONDS DIRECT FROM IMPORTER \$97.50 PER CARAT

No. D1001. 14K Solitaire. This Mounting, \$3.75. Complete with 3/8c. Dia. \$35.00

No. D1002. 14K Tooth Ring Mounting, \$5.50. Complete with 3/8c. Dia. \$73.00

No. D1003. 14K Twin Ring Mounting, \$5.00. Complete with two 3/8c. Diamonds \$95.00

No. D1004. 14K Engraved Belcher Mounting, \$7.50. Complete with 3/8c. Dia. \$63.75

No. D1006. 14K Solitaire Stud Mounting, \$2.25. Complete with 3/8c. Diamond \$88.50

No. D1007. 14K Belcher Solitaire Mounting, \$4.75. Complete with 1/2c. Diamond \$49.75

No. D1008. Plat. Top. 14K. Pin Paved with 14 Perfect Cut Diamonds. Complete..... \$65.00

No. 1005. 14K Scarf Pin Mounting, \$5.00. Complete with 3/8c. Dia. \$72.50

No. D1009. Latest Gents' Solitaire 14K Mounting, \$14.00. Complete with 1c. Diamond... \$111.50

No. D1010. Diamond Set, 20-Year Gold Filled Hampden Full 7-Jewel Movement. Special Price \$13.75

No. D1011. 14K "Lion's Paw" Ring Mounting, only \$7.00. Complete with 3/8c. Diamond \$38.25

No. D1012. Cuff Buttons, Engraving Free. 10K Solid Gold, Pair \$1.50

No. D1013. Solid Gold Ring, Hand Carved Coral Cameo. 2 Diamonds. \$12.50

No. D1014. Signet Ring, 10K Solid Gold. Engraved Free \$1.75

No. D1017. New, Very Thin Model Watch, 20-Year Engraved Case, Elgin Movement, 12, 0 Size..... \$12.50

No. D1015. Tie Clasp, 10K Gold, 1 Diamond \$1.00

No. D1016. La Valliere, Solid Platinum, Including Chain, 3 Diamonds \$45.00

FREE EXAMINATION

Let us send you any DIAMOND in our million dollar stock; set in *your choice* of the thousands of mountings illustrated in our big DE LUXE Diamond Book! We allow you to examine, test, compare the quality all at our expense and without obligating you to buy! You will find that **Basch Importers' Prices** save you 30% to 35%, because the volume of our business justifies small profits; because *cash-methods* eliminate losses and wasteful expenses; and because by *importing direct to you* we save you the profits of many middlemen!

We Legally Guarantee to REFUND THE FULL PRICE IN CASH

less 10% any time within 2 years; to exchange our diamonds allowing the *full purchase price*, at any time! The exact *carat weight*, quality and value we legally certify in writing. This guarantee gives you absolute security against loss or dissatisfaction! Find out all that our Guarantee means to you in safeguarding your investment—do this before you buy another diamond!

 **Diamond Importers
Mfg. Jewelers
Established 1879**

35th successful year—the final word in RELIABILITY

Our hundreds of thousands of customers are found throughout the world, all over America—many right in *your city*. Let us refer you to them, let us convince you that *you* are as certain to receive the fullest value from BASCH as any diamond expert. Ask your banker to verify our great financial responsibility.



NEW 128p DE LUXE BASCH DIAMOND BOOK FREE!

The costliest, completest Diamond, Watch and Jewelry Guide ever produced. Illustrated with thousands of the latest fashions. Tells you all about Diamonds—how to judge Diamond qualities, how to compare values, how to buy a Diamond safely, intelligently, and at the right price. Our 35 years of experience as diamond specialists, has been written into this book for your benefit. Send your name and address *immediately*—or mail coupon NOW—so you will be sure to get your copy.

Please mail me at once one copy of your 128 page DE LUXE Diamond Book FREE!

Name.....
Address.....

L. BASCH & CO.,
Dept. H247, STATE & QUINCY STREETS,
CHICAGO, ILL.

Mail to L. BASCH & CO.,
Dept. H247 State & Quincy
Sts., Chicago, Ill.



Big Catalog FREE

408 Pages and 8000 Home Bargains

*Write for it
to-day*

HARTMAN'S 408 Page Catalog—Chicago



No. 1E515

The most luxurious Rocker ever placed on the market at this remarkably low price. It is magnificently upholstered with our famous "Imperial Leather," worked out in an artistic diamond tufted and ruffled design. Seat contains our guaranteed "Monsiech" all steel spring construction. Has heavy frame mounted on broad, stout runners. No. 1E515. Price only **\$5.65**
Terms—50c cash, 50c monthly

you, you'll find that this book will smooth the way to true home comforts for YOU, and you can

Save From 20% to 50%

Our enormous buying power enables us to sell high grade furniture from 20% to 50% lower than your home town dealer charges. We guarantee goods and safe delivery. If goods are unsatisfactory, you can return them within 30 days and we will refund your money and pay the freight charges both ways. We ask no questions—you are the only judge.

All the Newest Home Furnishings

For over half a century we have been furnishing American homes in every nook and corner of the United States. We have always given splendid satisfaction and remarkable values to all of our million customers. Suppose you sit down right now and drop us a postal with your name and address before you forget it. We'll send our catalogue—FREE. Better write now.

Credit to Everyone

OUR new, big, 408-page, color-illustrated, 1914 catalog of 8000 bargains in Home Furnishings is ready. Send your name and address and get your copy at once.

Buy what you want—pay later in small monthly sums. We will trust you for anything you need and

You Get Over One Year to Pay

We ask no security—no mortgage—no notes—no interest. We have no collectors—everything is strictly confidential. You can do all your shopping right from your own arm chair through our big book. Everything will be sent on approval. If your home really interests

No. 8E571
Our "Grand" Regent Oak Heater. At the price we quote this elegant heater, is a value absolutely beyond duplication, and is a great heat radiator. Very economical as to consumption of fuel. Is built of cold rolled steel and heavy ornamental cast iron. Has heavy grate and 14-inch fire pot of best material. Stands 50 in. high. Price only



\$895

Terms: \$1.00 Cash 75c Monthly

No. 8E571

HAVE Message THE KEY TO HOME HAPPINESS

Don't Wait

Write Today for This Big Catalog. Get Your Copy at Once. We Will Send It Postpaid

30 Days FREE
Examination
In Your Home

No. 4E443
A Bargain
Dining Room Set.

It consists of seven pieces. The pedestal extension table has a large 42-inch top and extends to 6 ft. It is finished in American quartered oak and shows the flaky grain of finest oak. Entire table is expertly polished to a mirror-like brightness. The six elegant panel back chairs are also finished in American quartered oak, strongly built and handsomely polished. This splendid set is a sample of the wonderful money-saving opportunities offered in our new free book. Price, set complete **\$15.65**

Terms, \$1.00 Cash, \$1.00 monthly.

Price of Table alone \$7.15

Terms, \$1.00 cash, 75c monthly

Price of Chairs alone \$8.50

Terms, \$1.00 cash, 75c monthly

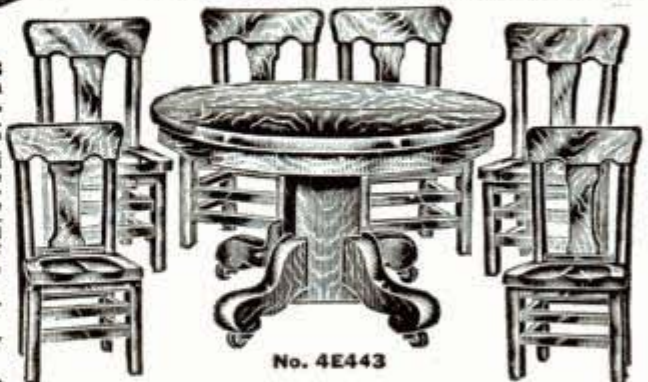

No. 4E443

HARTMAN

FURNITURE & CARPET CO.
3945 Wentworth Ave. CHICAGO, ILL.
Est. 1855—58 Years Success—22 Big Stores—1,000,000 Customers

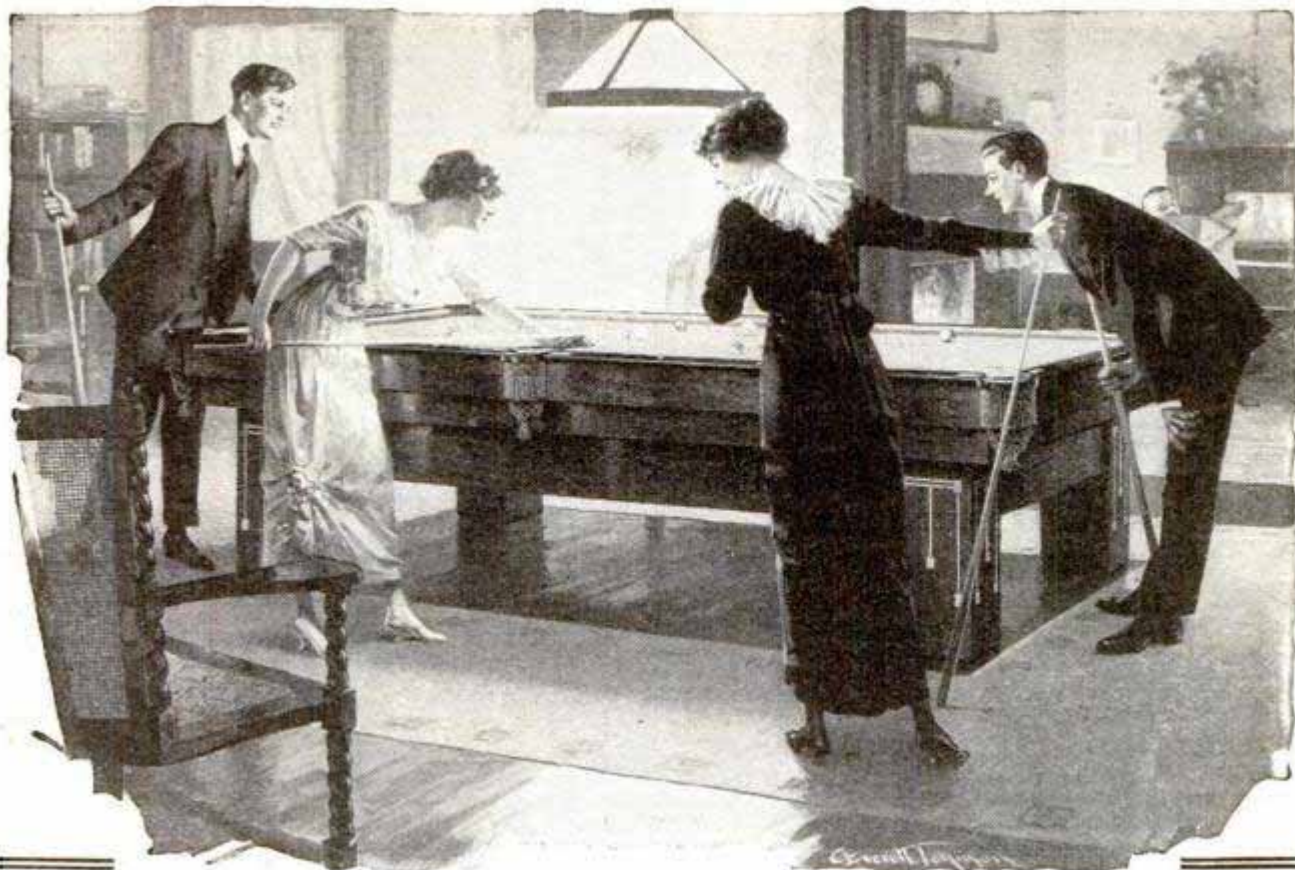

A Charming Game for Young Folks

In homes of refinement, billiards rank highest among all indoor amusements for young folks. This grand old game is ever new—ever replete with interest and charm.

It calls for skill and concentration, yet permits a running fire of repartee and jest—it is set to the music of laughter.

Why not have your young folks share the delights of this splendid game? Its fascination and fun will keep them happily at home, all through the long winter evenings.

The Brunswick "Baby Grand" Billiard or Pocket-Billiard Table

This superb billiard table is made of genuine San Domingo Mahogany, fitted with high-grade Slate Bed and the celebrated Monarch Cushions. Equal in accuracy of angle and cushion-action to our regulation tables, used exclusively by the world's cue experts.

The concealed Cue Rack and Accessory Drawer holds the entire playing equipment. Keeps the billiard room free from disorder when table is not in use.

The "Baby Grand" is furnished as a Carom Table, Pocket-Billiard Table or Combination Carom and Pocket-Billiard Table. Sizes: 3 x 6, 3½ x 7, 4 x 8.

Brunswick "Convertible" Styles

These ingenious Billiard or Pocket-Billiard Tables are made in three styles—Dining-Billiard Tables, Library-Billiard Tables and Davenport-Billiard Tables. No extra room needed. Unexcelled playing qualities.

Richly Illustrated Book Free

This beautiful book, "Billiards—the Home Magnet," describes and illustrates in actual colors the complete line of Brunswick Home Billiard and Pocket-Billiard Tables. Quotes lowest factory prices. Gives details of Easy Purchase Plan and other interesting and valuable information. Write for it today.

Over a Year to Pay Complete Playing Outfit Free

We sell Brunswick Home Billiard Tables on the Easy Purchase Plan—small payments spread over an entire year. The price of each table includes a complete, high-grade Playing Outfit, consisting of Cues, Balls, Cue Rack, Markers, Cover, Book of Rules, etc., etc. (133)

The Brunswick-Balke-Collender Co.
Dept. K. L., 623-633 S. Wabash Ave., Chicago
Please send to the address below, your book—
"Billiards—The Home Magnet"

Name.....
Street.....
Town..... State.....

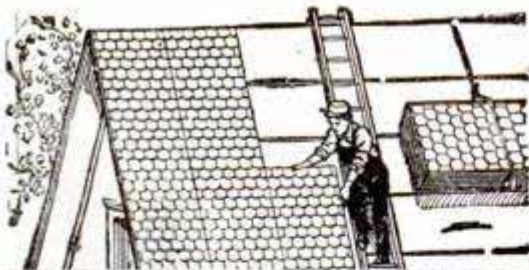

EDWARDS PATENT STEEL Shingles Beat WOOD

**Never Rot, Rust or Burn
Cost Less than Wood Shingles**

Steel Shingles are so far ahead of common wood shingles that there's simply no comparison. They last four times longer than wood shingles—are ten times easier to put on—and make a roof that will NEVER rot, rust, leak or catch fire. An Edwards Roof gives wonderful

Protection to Life and Property

Each Edwards Steel Shingle is galvanized all over. Edges are dipped in **MOLTEN ZINC**. No chance for rust to get in its work. Our patent Interlocking Device makes all joints **water tight** and takes care of expansion and contraction.

Steel shingles come in sheets of 100 or more—as easy to lay as a carpet—on sheathing or over old shingles.

**Lowest Factory Prices
All Freight Fully Prepaid**

We sell direct from factory. We pay the freight and give \$10,000 guarantee against lightning loss.

Join hands with over 100,000 owners of Edwards Roofs to save money, time and trouble.

WRITE! Send postal, at once, for world's greatest Roof Book, No. 1150, and Special Factory Prices on Edwards Steel Shingles. If possible, give dimensions of your roof, so we can quote prices on the complete job.

The Edwards Manufacturing Company
1100-1150 Lock Street, CINCINNATI, OHIO
Largest Makers of Sheet Metal Products in the World.

Xmas
1913

Shirley President Suspenders

50
¢

"A pair for every suit" makes a man's whole year happy. Try it and see! In beautiful gift boxes—12 different pictures. At stores or postpaid, 50c.

"Satisfaction or money back"
Be sure "Shirley President" is on buckles
The C. A. Edgarton Mfg. Co., Shirley, Mass.



Genuine Black Seal Grain Leather Billfold and Card Case

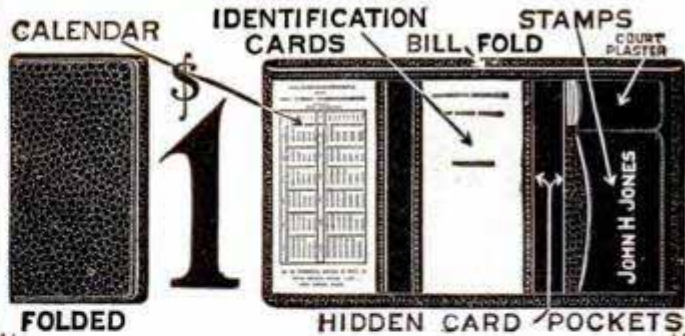

FOLDED

HIDDEN CARD POCKETS

With Your Name In Gold

The most remarkable offer ever made in high-class leather goods. A new three-fold combination case which it is absolutely impossible to duplicate elsewhere at anything like our direct-to-you factory price, \$1.00, prepaid. Made of genuine beautiful black seal grain leather with real moire lining. Most skillful workmanship. With your name stamped in pure gold leaf entirely free. Stamping alone would cost from 25 to 35 cents elsewhere. Measures 3 x 5 inches folded. Seven useful pockets with two transparent compartments. Emblem of any order stamped for 25c extra. We guarantee satisfaction or refund your money without question. If you want one of these \$1.00 billfolds, order it at once. Inclose \$1.00 or good postage stamps.

Guaranteed Leather Goods Our greatest asset is thousands of delighted customers all over the world. We guarantee every one of the many beautiful leather necessities and novelties which we manufacture. You must be more than satisfied or we are not satisfied.

FREE Book and Gift Calendar

Send us your name and address and we will mail you our beautiful free book on leather with a unique gift calendar. It will keep you in mind of birthdays, anniversaries, etc. which you might not remember. With this book it is easy to select suitable presents for all occasions. Send for the free book and calendar today.

U. S. Leather Goods Co., Dept. 1198, 240-2-4 N. Clark St., Chicago
Pioneers of the Exclusive Leather Goods Mail Order Business.

The foreign trade of the world increased more in 1912 than in any preceding year and reached the enormous sum of \$37,200,000,000, of which the imports amounted to over \$19,000,000,000, and the exports to over \$17,000,000,000.

PARENTS: GIVE BOYS

This Steel, Model-Building Toy

I know what boys like—so I made this to imitate real square steel girders like you see in bridges and buildings. It has 20% more parts than any other building toy. It's durable, strong and easy to build with. Prices \$1 to \$25 a set. Write for my new 24 page

FREE BOOK full of pictures, with text describing them. Give toy dealer's name. Toy dealers sell Mysto Erector—ask your dealer to show it.

A. C. GILBERT, Pres.
THE MYSTO MFG. CO.
53 Foote St. NEW HAVEN, CONN.
Dealers: Write for proposition



The Mysto
ERECTOR

Hello Boys!
MAKE LOTS OF TOYS

Build



Flying Boat

We have accurate scale drawings and knock-down parts of all man-carrying aeroplanes for class-room demonstrations, exhibition purposes, etc. Students of aeronautics, everyone with an inquiring turn of mind, should construct one of these fascinating models.
PRICES OF 3-FT. MODEL SCALE DRAWINGS—Curtiss Flying Boat, 25c; Niouport Monoplane, 25c; Bleriot Monoplane, 15c; Wright Biplane, 25c; Curtiss Convertible Hydro-aeroplane, 35c; Cecil Peoli Champion Racer, 25c.
Complete Set of Six \$1.25 Postpaid

For Immediate Sport Fly a "Blue Bird" Racing Aeroplane

Send \$1.50 for our Blue Bird Racing Aeroplane—the swiftest, most graceful flyer on the market. The first boy in every town to order a "BLUE BIRD" and send us the names of five friends will be appointed official starter of all BLUE BIRD Contests and a handsome badge will be given him free. 50 pp. Ideal Model Aeroplane Supply Catalog 5c.
IDEAL AEROPLANE & SUPPLY CO. 82-88 West Broadway, NEW YORK

Send Only \$1.00 For This ILLINOIS Watch If You Send Before Dec. 15

Never Again

We want to say frankly that never again shall we offer you a bargain like this.

You may deal with us for years—we hope that you will. We shall always offer wonderful bargains.

But never again a genuine Illinois watch—with 17 jewels and a 20-year gold-filled case—at \$13.75. And never again, in all probability, will anyone else offer you a like opportunity.

10,000 Watches

We are going to sell ten thousand of these watches at this amazing price. About half the number have already been sold.

They are made by the Illinois Watch Company, Springfield, Ill.—one of the greatest American watch makers. The best jewelry stores all over the country feature this Illinois watch.

The price is not below our cost. We make a trifling profit on each watch. But only because our order was the largest ever placed for a jeweled watch.

Our Object is This

We have an enormous Jewelry Department, and we want you to have an account with it. To get you started we offer this watch at a price which you can't refuse.

But this offer ends—and forever—when these 10,000 watches are sold. And none at this price, in any event, will be sold after Dec. 15th. So if you ever want a watch of the highest grade we urge you to order now.

Send Only \$1.00 — 30 Days' Trial

Send with your order only \$1.00. Then send us \$1.00 each month. We will trust you. Express will be prepaid.

Carry the watch for 30 days before you decide to keep it. If you don't want it then send it back to us, and your \$1.00 will be returned. But see if you want it. The only way to get this price is to send your order now. If the watch fails to meet your ideas of a fine watch you are welcome to send it back. Use this coupon. And, to make sure of the bargain, please send it at once.

Spiegel, May, Stern & Co.

3572 Wall Street, Chicago

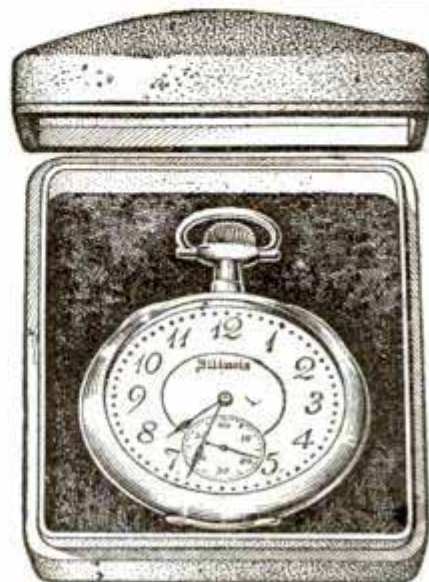

Our Price \$13⁷⁵ Only \$1.00 Down A Whole Year to Pay

This watch has a 17-jeweled movement—it is a perfect timekeeper. The price seems impossible. But we guarantee this watch to have 17 fine jewels, and to be a genuine Illinois watch, exactly the same as sold in jewelry stores.

The case is a 20-Year Gold-Filled Case. That is, it is warranted for 20 years. It is open-face and a beauty. The back is handsomely engraved. It has a screw back and bezel, so it is positively dust-proof.

The watch is guaranteed for 25 years. We send with this watch this guarantee certificate. Think of that—only \$13.75 for almost a lifetime of perfect watch service. The watch is a perfect timekeeper. No better timekeepers were ever made than the 17-jeweled Illinois. Every man who knows watches knows this.

If you want to sell this watch back to us, after 30 days' use, we will return every cent that you pay on it.

SPIEGEL, MAY, STERN CO.

3572 Wall Street, Chicago

I enclose first payment of \$1.00, for which send, express paid, the 17-jewel Illinois Watch No. X1277, described in your advertisement. If I keep it I will pay \$1.00 each month until \$13.75 has been paid. If I return it within the 30-day trial period you are to send me back n.y \$1.00.

Name.....

Postoffice.....

St. or Box No.....Date.....

JEWELRY CATALOG FREE—It contains everything that is new in watches, diamonds and jewelry—all sold on our easy credit plan. Just drop us a postal and it will be mailed you free. But don't fail to use the coupon and send us \$1.00, as this wonderful watch offer will never be made again. (442)

Typewriter Sensation

2 DOLLARS A MONTH
 Buys a genuine Standard No. 2
 SMITH-PREMIER Typewriter and at
 \$71.20 less than the manufacturer's price.

Never before has anything like this been attempted. Dealers get \$3.00 a month rent for this make of machine not nearly as perfect as the one we will send you, and you pay only **Two Dollars a Month and Own It.**

Send the Coupon and We Will Ship You This Smith-Premier Typewriter on Approval

When the typewriter arrives, deposit with the express agent \$8.80 and take the typewriter three days and try it. If you find it the best typewriter you ever saw, satisfactory in every respect, keep it and send us \$2.00 each month, until our special price of \$28.80 is paid. If you don't want to keep it, return it to the express agent, and he will give you back your \$8.80, and return the typewriter to us. We will pay the return express charges. You won't want to send this machine back after you have seen it and tried it. You can't imagine the perfection of these machines till you see one, and the price is \$71.20 less than the catalogue price, and it is guaranteed just as if you paid \$100.00.



Perfect machines only, complete outfit, nothing extra to buy, no strings of any kind to this offer. Just think of buying such a typewriter for \$8.80 down and \$2.00 a month. Thousands of people have paid \$100.00 cash for Smith-Premiers. It's standard, by many considered the best typewriter ever built. A key for each character, so each character is always the same; two color ribbon; a type brush for cleaning the type built into the machine; the tilting carriage throws all the previous writing in plain sight of the operator; comes to you with tools, rubber cover, complete operating instructions, everything ready. It runs beautifully. It's wonderfully simple and strong. It will last a lifetime. I sold a similar supply of these beautiful machines about a year ago to everybody's satisfaction.

Act Today to Be Sure

Only 200 typewriters can be shipped on this offer, so tear off coupon—mail it today—the typewriter will come to you promptly without any formalities. You can't lose and it's the greatest economical opportunity you will ever have. **Send Now—Today.**

COUPON

HARRY A. SMITH, Dept. P,

No. 180 North Dearborn Street, Chicago, Ill.

Ship me a No. 2 Smith-Premier l.o.b. Chicago, as described in this advertisement. I will pay you the \$20.00 balance of the special \$28.80 purchase price, at the rate of \$2.00 per month. The title to remain in you until fully paid for. It is understood that I have three days in which to examine and try the typewriter. If I choose not to keep it I will carefully repack it and return it to the express agent. It is understood that you give the standard guarantee for one year.

Name.....

Address.....

Shipping Point.....

THERE ARE TWO REASONS



Why we send our Daus' Improved Tip Top Duplicator on ten days' trial. **FIRST**—It proves OUR confidence in the machine. **SECOND**—By personal use you can positively tell, before buying, whether it meets your requirements. Each machine contains a roll of "Dausco" Oiled Parchment Back duplicating surface which can be used over and over again. 100 copies from pen-written and 50 copies from typewritten original. Complete Duplicator, cap size (prints 8 3/4 x 13 in.). Price **\$5.00**

Take advantage of our trial offer. **Felix A. L. Daus Duplicator Co., 113 John Street, New York**



Book Free—Write for 64 page illustrated catalog and book, "Story of Red Cedar." Write today.

Piedmont Red Cedar Chest Co., Dept. 358, Statesville, N. C.

Ideal Xmas Gift

A Piedmont Southern Red Cedar Chest is the ideal Xmas, birthday or wedding gift. **Protects furs, woolsens and plumes from moths, mice, dust and damp.** 15 days' free trial in your own home to prove its beauty and money saving value. Shipped direct from factory at low factory prices. Freight prepaid. Write for particulars of **Free Trial offer.**



TYPEWRITER BARGAINS

Don't buy a typewriter until you have sent for our price lists and see for yourself the big saving on all Standard Machines. All are **Factory**

Rebuilt and guaranteed for 2 years. Send for prices and terms.

The M & M Typewriter Co., 116 N. LaSalle St., Chicago

NOTE: All Edges Smooth When Detached
 Appearance of our neat card in case



BE SATISFIED WITH NOTHING BUT PERFECTION

Peerless Patent Book Form Cards are "Perfection in Cards." They meet every requirement of those business men who know what is the best and expect to have it.

They are invaluable because every card can be used, and every card has a smooth edge when detached. No card can be lost and every one is smooth and free from crushing. The engraving is approved by the users.

Write for a sample book, remove a card and note the edge, the neatness and the quality.

JOHN B. WIGGINS COMPANY, 62-64 Adams Street, CHICAGO
 Engravers, Embossers, Printers

IMMENSE SUGAR CONSUMPTION OF THE UNITED STATES—More sugar was brought into continental United States in the fiscal year 1913 than in any other year in the history of the country, according to the latest figures of the Bureau of Foreign and Domestic Commerce. The quantity of sugar entering from foreign countries and our own islands was 6,500.



TYPEWRITERS ALL MAKES

All the Standard Machines **SOLD or RENTED ANYWHERE** at 1/4 to 1/2 M.P.'S PRICES, allowing **RENTAL TO APPLY ON PRICE.** Shipped with privilege of examination. Write for Illustrated Catalog L. **TYPEWRITER EMPORIUM, 24-26 W. Lake St., CHICAGO**



TYPEWRITERS ALL MAKES

\$100.00 Underwoods, Smiths, Oliviers, Remingtons, etc., from \$10.00 up. Every machine in perfect condition, guaranteed two years, with privilege to exchange at any time. Three hundred typewriters at \$15.00 each.

while they last. Write for cut rate prices, and **Free Trial Offer**
ALL-MAKES TYPEWRITER EXCHANGE, 157 N. Clark St., CHICAGO, ILLINOIS

Over 80,000 in Use

Mostly sold by recommendation. **For Personal Desk or General Office.**

It checks mental calculations. Handsome Morocco case free. **Buy Thru Your Stationer.**

Write for 30 day trial offer.

E. Ganacher, A. A. N. Co., 119 W. Broadway, New York City.

Agents Wanted

Golden Gem \$10

Portable Adding Machine

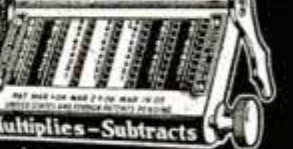

Multiplies - Subtracts

Pabst Extract American Girl Calendar

FOR 1914

To say that the original of this new Pabst Calendar is the work of C. Allan Gilbert is to make everybody want one, for the "Gilbert Girls" are known far and wide as the highest type of modern art. The figures are beautiful, attractive, winsome—the colorings artfully and harmoniously blended. To fully appreciate this beautiful work of art, you must see the calendar itself.

As usual, the calendar is absolutely *free from advertising* on the front, even the months being printed on the back.

The Calendar is FREE

All you have to do to obtain one is to send us 10c in stamps or silver (coin preferred) to cover the cost of packing and mailing. The demand for these beautiful calendars grows greater each year, so send for yours at once to avoid disappointment.

The illustration herewith gives but a faint idea of the beauty of this handsome calendar. Picture in your mind's eye, the *real* calendar in panel form, seven inches wide and thirty-six inches long, printed in twelve harmoniously blended colors. The shape lends itself to the decoration of those odd places so hard to fill; and the color scheme is sure to harmonize with the furnishings of any room. Framed or unframed it will prove an ornament to your home.



In past years the Pabst Extract American Girl Calendar has won the enthusiastic approval of lovers of things beautiful and the 1914 "American Girl" is sure to receive equally as hearty a reception because of its true artistic merit. We have one all ready to send you, merely awaiting your order. And in sending you this calendar we hope it will prove more than an ornament to your home. We want it to remind you, and others, that

Pabst Extract The Best Tonic

"brings the roses to your cheeks"—that it is a natural tonic which enriches the blood, rebuilds the wasted tissues of the body, steadies the nerves and tones the entire system. Being a perfect blending of choicest malt and hops, it is nature's own builder and reinvigorator—a splendid tonic, recommended by leading physicians for nursing mothers, convalescents, anaemics, all who are run down from any cause, and as a revitalizer for the aged.

The United States Government specifically classifies Pabst Extract as an article of medicine—not an alcoholic beverage.

Order a Dozen from
Your Druggist

Insist Upon It Being "Pabst"



Pabst Extract American Girl Calendar is now ready for mailing. Send ten cents in stamps or coin (coin preferred) and a copy will be promptly forwarded to you postpaid. Send request early to avoid disappointment.

PABST EXTRACT CO.

Dept. 1

MILWAUKEE, WIS.

Buy a Good Flannel Shirt

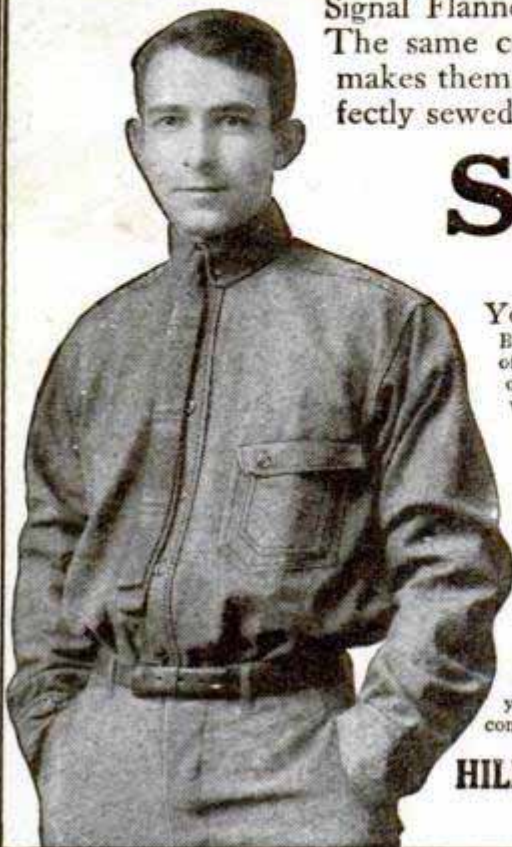

Signal Flannel Coatshirts are collar and shoulders above the others. The same company that manufactures the widely worn Signal line, makes them of first class, quality-tested flannels, carefully cut and perfectly sewed by expert union workmen.

Signal FLANNEL Coatshirts

UNION MADE

You know what these unusual, ingenious comfort features mean:

Big armholes, roomy elbows, full length sleeves, wide cuffs, and a gathered yoke at the back of each shoulder. You couldn't get greater arm-freedom with your shirt off. Flaps that overlap each other a full 3 inches in front. Combination watch and handkerchief pocket with a flap you can button. Cut coat style with full length body. Extra button at bottom of breast plait to prevent gaping. Satin-lined military collar.

Signal Flannel Coatshirts fit to perfection and give stylish appearance. Shirts can't be made to wear longer or feel more comfortable while you wear them.

Signal Flannel Coatshirts are sold in a variety of desirable patterns by most dealers at \$2.00, \$2.50, \$3.00 and \$3.50. Whatever you pay, figure on twice that much in money's worth.

Signal Workshirts at \$1.00 have the same comfort features as the Signal Flannels and are great for work. If your particular dealer doesn't carry Signals, give us his name and let us send you some sample swatches and a descriptive booklet. If you don't need shirts today you can't afford to forget that Signals mean twice what they cost in wear and comfort. So if you don't want to buy right away tear this out for a reminder.

HILKER-WIECHERS MFG. CO., *Manufacturers of Signal Service Shirts*
1256 Mound Avenue, Racine, Wis.



"THE TEXVELOUR" — a different velour.

An absolutely original design, worked out in finest velvet-velour, the hat-material of the hour. Stitched brim, silk lining; silk band—with bow at back. Colors: Dark Brown; Black; Dark Gray; Dark Green. Easily worth \$3. We charge \$2 PREPAID. Money back if you don't like it. Order now—simply state size and color and enclose \$2. Write for "1913 Fall and Winter Style Book"—FREE. **FRENCH CO., 271 Arch Street, Philadelphia, Pa.**

000,000 lb. and exceeded by 500,000,000 lb. the figures of the former high-record year, 1912. These figures indicate that the United States is clearly at the head of the list of sugar-consuming countries, the figures of

THIS BUNGALOW \$900 CAN BE BUILT FOR

This and many others in my new book, Building Plans for Modern Homes, will save you hundreds of dollars. One of the most complete and comprehensive books of plans ever published by any architect. Fifth edition just off the press. One hundred and fifty floor plans and photographs of bungalows, etc., costing from \$250 up; gives sizes and cost to build. Sent postpaid for \$1.00



FREDERICK H. GOWING ARCHITECT
18 Tremont St., BOSTON, MASS.

BARODA DIAMONDS

Flash Like Genuine
ANY CUTTING STYLE
For Years Supreme in Their Class

A true archetype of the genuine Diamond. Not manufactured stones, but mined like all true diamonds. Nature gives fire and life to its minerals more penetrating and beautiful than any devised by artificial methods. Baroda Diamonds are mined much cheaper than genuine diamonds and their intrinsic value is much less. However, they are mined and cut in identically the same manner; have fire and lasting qualities and can be bought for 1-60 the cost of genuine diamonds.

When you wear a Baroda Diamond you have the satisfaction of knowing you are wearing a genuine mined stone and set in solid gold. See special offers: 14k Ladies' Ring, Tiffany style, \$5.98; Men's Flat Belcher, \$6.98; Fancy Stud or Pin, \$4.98. Goods made and sent C.O.D. subject to inspection. Catalog showing full line on request. Patent ring measure included for 10 cents.

To Agents—When full amount is sent with order deduct 30 percent from prices and if goods are not satisfactory return in five days for exchange.

THE BARODA CO., 55, 4711 No. Clark St., CHICAGO, ILL.

Men's Special



KEITH'S \$1 Offer



No. 1550—\$3600 est. cost

To introduce Keith's, the recognized authoritative magazine on planning, building and decorating, we now offer for \$1.00 to enter a six months' subscription and mail you postpaid **Two Books of Plans** Homes Costing \$1,000 to \$2,500 Send today for this great value offer and get a splendid \$2 a year 80-page magazine for six months and two of Keith's Archt. Studies containing 200 plans.

M. L. KEITH, 829 McKnight Bldg., Minneapolis, Minn.

Used Piano Bargains

A good standard make used piano is a better investment than a cheap new piano. We carry a large stock of used standard make pianos, taken in exchange as part payment on new Starck Pianos and Player Pianos. Prices \$75.00 to \$195.00. 30 days' free trial; easiest payments; **50 FREE MUSIC LESSONS.**

WRITE TODAY FOR BARGAIN LIST.
P. A. STARCK PIANO CO., 388 Starck Building, Chicago, Ill.



Please Mention Popular Mechanics

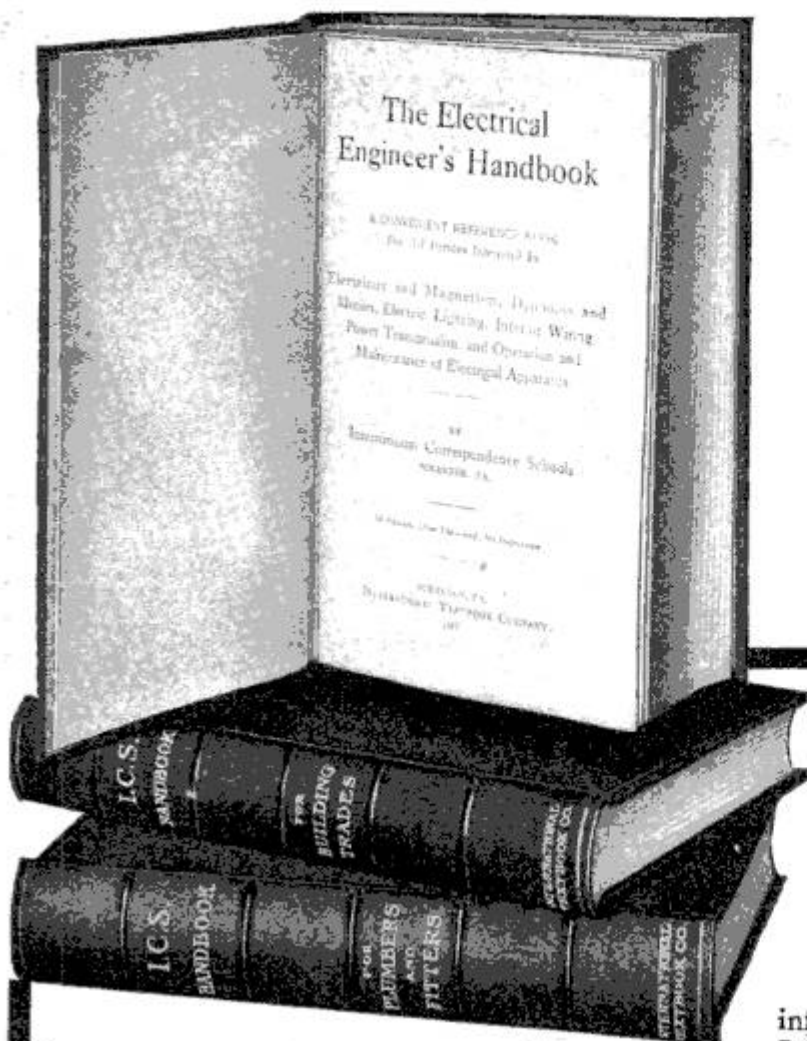

22 Handbooks of Practical Information

WHEN the boss asks a puzzling question—when an unusual piece of work comes along—THEN it pays to be able to put your finger on the exact rule, formula, or bit of information that holds the key to the situation. For it's at these critical moments that the boss finds out who is "onto his job"—who is in line for promotion.

No books in existence contain as much information in so small space as these I.C.S. Handbooks. One book is devoted to each trade or profession. They contain all the rules, formulas, and other data that you've got to have right off the bat. They are thoroughly indexed—any desired information can be located instantly. They have been compiled from the "Easy to Learn, Remember, and Apply Home-Study Courses" of the International Correspondence Schools. Every fact and formula is clearly stated. They are indispensable helps to quicker and better work. Bound in silk cloth they retail regularly for \$1.25 each.

Mechanics': Tables; formulas; measurements; belting; mechanical powers; hydromechanics; specific gravity; strength of materials; shafting; boiler design; care of boilers; power of boilers; chimneys; exhaust heating; machine design; machine tools; slide valve; pulleys; horsepower; cylinders and steam chests; pistons; gearing; dynamos and motors; batteries; transit surveying; curves; radii and deflections; earthwork; trackwork; etc. Contains 330 pages and 174 illustrations.

Electrical Engineers': Tables; chemistry; mechanics; electricity; electrical units, symbols and quantities; physical and electrical properties of metals and alloys; wire gauges; magnetism; dynamos and motors; armature winding; electrical batteries; alternating current apparatus; alternators; transformers; wattmeters; transmission; electric lamps; wiring; electric heating and welding; electromagnets; controllers; ear wiring; etc. Contains 414 pages and 238 illustrations.

Chemists': Definitions and fundamental laws; atomic weights; pressure; volume and temperature of gases; weights and measures; specific gravity; hydrochloric-acid, nitric-acid, and sulphuric-acid solutions; solubilities of chemical compounds; heat measurement; qualitative analysis; special tests of acids; general table for analysis; classification of rare metals; the spectroscope; nitrogen; blowpiping; determination of gold and silver ores; methods of assaying; composition of alloys; tables; antidotes of poisons, etc. Contains 332 pages and 11 illustrations.

Other Handbooks Now Ready

| | |
|----------------------|---------------------------|
| Automobile | Plumbers and Fitters' |
| Air Brake | Poultryman's |
| Civil Engineer's | Farmers |
| Steam Engineer's | Textile Worker's |
| Telegraph and | Business Man's |
| Telephone Engineers' | Bookkeeper's |
| Mariners' | Stenographers and Corres. |
| Coal Miner's | Salesman's |
| Concrete Engineer's | Advertiser's |
| Building Trades | Window Trimmer's |

International Textbook Co.
Box 872-F, Scranton, Pa.

Special Offer

For a limited time we will sell these regular \$1.25 Handbooks, durably bound in silk cloth in a convenient pocket size, at a price for each Handbook of only—

50c

International Textbook Co., Box 872-F, Scranton, Pa.

Enclosed find \$ _____
Handbooks _____

Name _____

St. & No. _____

Town _____

State _____

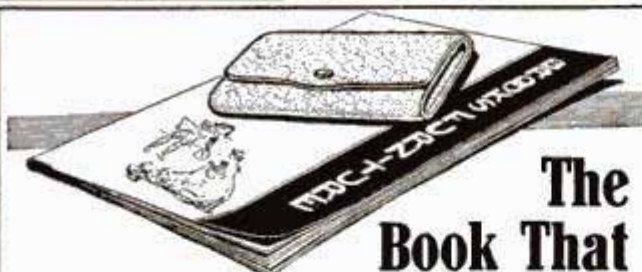

The Book That Helps Little Pocket Books Grow Big—Mailed FREE

We are not a mail order house, neither are we jobbers or wholesalers—we are simply straight manufacturers turning raw materials into a finished product and selling *direct*. We have perfected a plan of building our furniture in easily put together sections. Anyone without tools or experience can assemble any piece ready for use in ten minutes. This plan saves $\frac{2}{3}$ the freight, $\frac{1}{2}$ the cost of packing and crating and $\frac{1}{2}$ the ordinary factory floor space. It's the most efficient and economical method of making and marketing furniture ever devised and there's only one small profit between our factory and your home. All this saves you over half your furniture money.

Master-Built—The Highest Quality—The Lowest Price

Hundreds of dealers are assembling Brooks Furniture in their stores and selling it from forty to fifty per cent above our prices. We furnish government and state institutions where only the best is considered. For years we have been furnishing quarters of army and navy officers. We have furnished whole exposition buildings. We receive orders ranging from one dollar to three thousand. We ship from a single piece to carload lots. And in each and every instance our advertised prices are net regardless of the amount of the order.

Thousands of the best homes have been furnished in elegant style, yet with surprising economy with Brooks Quarter-Sawed Oak Furniture.

Mail a Postal for the Book

All pieces guaranteed. Money back if not satisfied. We are the oldest and largest factory of the kind in the world.

BROOKS MFG. CO.

2711 Sidney St.

Saginaw, Mich.



Dining Table No. 311
Brooks Price **\$2250**
Dealer's Price \$45
Height 30 inches, 54 in. top—
extends 90 inches, $\frac{3}{4}$ in. thick.

Dining Chair No. 13
Brooks Price **\$250**
Dealer's Price \$4
Height 39 inches, width 17 $\frac{1}{2}$
inches—Depth 18 inches.

Please Mention Popular Mechanics



Irons Better than the Flatiron

Hand or Power

YOU get through with your ironing in one-fourth the time, obtain a perfect, uniform finish with no liability of scorching and practically no expense for fuel when you use a

Simplex Ironer

"The Practical Household Machine"

Ease takes the place of tiring effort. It soon saves its cost. The Simplex does 80 per cent of the ironing and presses men's trousers to perfection. Runs by hand or any power. Heated by gas, gasoline or electricity. Sizes to suit needs of any family, institution or hotel.

Write today for FREE Catalog, 30 days' FREE Trial Offer and name of local dealer.

AMERICAN IRONING MACHINE CO.
526, 168 N. Michigan Ave. CHICAGO, ILL.

BUY PLUMBING and HEATING SUPPLIES
at **WHOLESALE** Will Save You 30%
Don't pay retail prices. Full stock on hand for prompt shipment. Send for free catalog.
B. P. KAROL, 768 to 772 W. Harrison St., CHICAGO

the current year suggesting a consumption of more than 8,000,000,000 lb. while the latest available figures indicate a consumption in India of about 6,000,000,000 lb.; in Great Britain, over 3,750,000,000 lb.; Russia, 3,000,000,000 lb. and Germany, 2,750,000,000 lb.

A Penny Pays the Bill
Heats It-Self
SUN IRON
Sold on trial and Guaranteed
Saves its cost in fuel alone over and over again, saves time and labor. Irons better and anywhere, no wires or tubes to connect, always ready.
We have a big money making Proposition for live Agents.
For Descriptive Circular and Special First Order Offer.
Write Us MODERN SPECIALTIES CO.
108 High Street South Bend, Ind.

8½ Pound Electric Suction Cleaner
At last a suction cleaner a woman can handle as easily as a carpet sweeper. Weighs no more. Takes up only two-thirds as much room. Can be packed away in small box. Rolls on rubber-tired wheels—moved without effort. More powerful than big unwieldy machines.
The **Morrow**
10 Days Free Trial

We take all the risk. Write today for our Free Book. Just send a postal with your name and address.

THE MORROW COMPANY, Dept. 1198, Waukegan, Ill.
Good Territory Still Open—Agents and Dealers Write

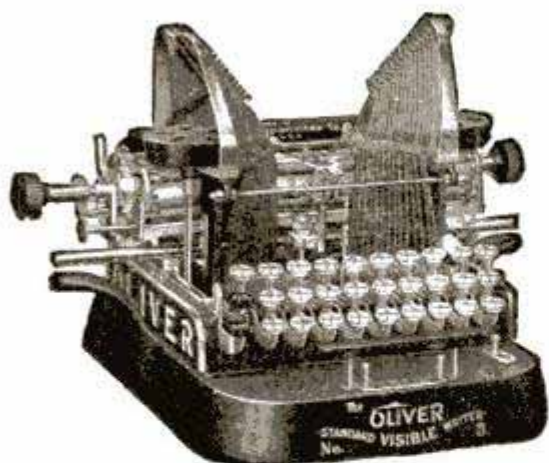

Free Trial Typewriter Offer!

No Money Down—13 Cents a Day

Get *this* offer on an Oliver *Visible* Typewriter before you spend even \$10 for some old-style, cumbersome, second-hand machine or some little cheap make.

Learn how 15,000 people have secured Oliver — *the great world-wide leader* of all machines — the \$100 kind — the typewriter that made others *adopt visible writing* — the typewriter that you see everywhere — the full size commercial machine.

Extraordinary Price

Our low price is a tremendous surprise to everybody — it seems impossible — but we have thousands of satisfied customers to testify that we live up to every claim.

Rent Money

Get the details of our wonderful Rental Purchase Plan. Learn how you can own a superb Visible Writing Oliver for a few pennies a day *and no money down*.

Life Guarantee

Read a copy of our record-breaking guarantee. Note how we have absolutely protected each purchaser for the entire life of the machine.

Read a few of our testimonial letters from customers and learn how generous and fair we are in our treatment — how we wait for payments in case of sickness or misfortune.

Half an Hour to Learn

People who had never written on a typewriter learned from our plain instructions in half an hour.

Let us tell you about the free trial privilege — how without advancing a cent to us you can have one of these fine machines in your office or home to *use free*. You won't

be urged to keep it unless you are more than pleased.

No Rent Tape

We have no collectors. We charge no interest. *We aim* to please you so thoroughly that you will tell your friends.

Interesting Catalog

Send your name today and get a remarkable book describing in detail the construction of the famous Model 3 Oliver, telling how it's made and the features which put it in the lead.

Creative Plan

Get full details of the most remarkable selling plan ever devised for the purpose of putting standard typewriters in the hands of those who need them.

Everything Is Free

Your name won't be followed up with a salesman — we have none. Just read about the typewriter, the low price, the easy terms, the life guarantee — that's all we ask. Please do it now.

This coupon is to make it convenient for you to send for our offer *now*. Just fill in your name and address, tear out and mail — a lead pencil will do.

Typewriter's Distributing Syndicate
166 J84 N. Michigan Blvd., Chicago

GENTLEMEN: You can send me your book and typewriter offer free. I am not buying anything or obligating myself in any way.

Name.....

Street.....

Town..... State.....

2c a Week Pays Wash Bill!

Write for
FREE Book

Electricity or Water-Power Does the Work

Just a "Twist of the Wrist" Starts or Stops the Machine!

The 1900 Motor Washers are now at work in thousands of homes. They are doing the work formerly done by women, at a cost of 2c a week for power! Saving thousands upon thousands of dollars in wash bills. Saving worlds of wash-day troubles. Leaving the women free to do other work while the machines are doing the washing.

The 1900 Motor Washer

1900 Water Motor Washer
Can be connected with
any water tap instantly

Washes a Tubful in Six Minutes!

Handles Heavy Blankets or Dainty Laces

The outfit consists of the famous 1900 Washer with either Electric Motor or Water Motor. You turn on the power as easily as you turn on the light, and back and forth goes the tub, washing the clothes for dear life. Then, turn a lever, and the washer does the wringing. All so simple and easy that it is mere child's play.

A Self-Working Wringer Sent With Every Washer!

The motor runs the washer and wringer. We guarantee the perfect working of both. No extra charge for wringer, which is one of the finest made. Write for **FREE BOOK** and **30 Days' FREE TRIAL OFFER!** Don't doubt! Don't say it can't be done. The free book proves that it can. But we do not ask you to take our word for it. We offer to send a 1900 Motor Washer on absolute **Free Trial** for an entire month to any responsible person. Not a cent of security—nor a promise to buy. Just your word that you will give it a test. We even agree to pay the freight, and will take it back if it fails to do all we claim for it. A postal card with your name and address sent to us today will bring you the book free by return mail. All correspondence should be addressed to

Doing the wringing with
1900 Electric Motor Washer



1900 WASHER CO., 6088 Court St., BINGHAMTON, N. Y.

OR, IF YOU LIVE IN CANADA, WRITE TO THE CANADIAN WASHER CO., 355 YONGE ST., TORONTO, CANADA.

(23)

GOING TO BUILD?

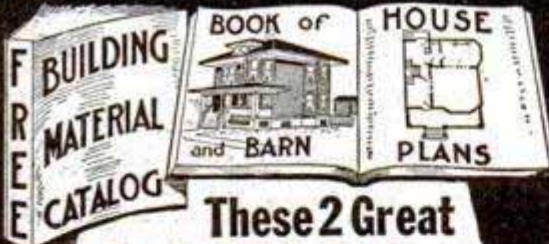

These 2 Great
Books Will Reduce
Your Building Expense

A big 224-page Catalog of Millwork and Building Material, containing cuts and net prices of 8,000 money-saving bargains. A handsome Plan Book of Modern Houses, bungalows, summer homes, barns and ready-built garages, showing 60 splendid exterior views with floor plans, priced from \$80 to \$4000. Don't pay dealers' prices—we sell direct, factory to user. You can save money.

STORM WINDOWS—STORM DOORS

Save their cost in coal bills. Makes home comfortable in winter.

Everything in lumber, flooring, roofing, doors, windows, moldings, porchwork, building paper, lawn and home furnishings, hardware, paints, plumbing, heating, fancy hardwood floors, metal ceilings, etc., all at wholesale prices.

Don't build, repair or remodel without these valuable books. We guarantee quality, safe delivery, satisfaction or money back. Write today for Catalog No. 103 and if you intend a new home, also get Plan Book No. 113. Both are Free.

CHICAGO MILLWORK SUPPLY CO.

AMERICA'S GREATEST SASH AND DOOR HOUSE

1444 West 37th St., Chicago, Ill.

Please Mention Popular Mechanics



FREE Catalog

illustrating True-Tone band and orchestra instruments, violins, drums, drummers' traps, etc., also

"HOW TO ORGANIZE A BAND"

ADDRESS, DEPT. 15

BUESCHER BAND INSTRUMENT CO.
ELKHART, INDIANA



Bargains in Band Instruments

We have a warehouse full of band instruments taken in exchange for our Lyon & Healy American Professional and Own Make Band Instruments. We are disposing of them at a grand clearing sale. Cornets \$3.00 and upward. Trombones \$6.00 and upward. Write for our big list if you can use a good instrument in perfect order at a nominal price. We will also send you (free) a copy of our Band Herald.

LYON & HEALY, 29-43 Adams Street, CHICAGO
World's Largest Music House

(187)

BAND INSTRUMENTS

WURLITZER

Catalog contains 282 pages, 788 illustrations, 67 color-plates, 2561 articles described—all musical instruments and supplies. Superb quality and lowest direct prices. Free trial and easy payments. We supply the United States Government. Mention what instrument you are most interested in. Write for the big **FREE CATALOG**

at 2 Points of Supply. Address the nearer one.

THE RUDOLPH WURLITZER CO.
101 E. 4th St., Cincinnati 308 S. Wabash Av., Chicago





WE SAVE YOU \$13.50 ON ELGIN'S MOST ELEGANT 17 JEWEL THIN MODEL GIFT WATCH \$3.00 A MONTH

THOUSANDS OF THRIFTY PEOPLE in all parts of the world buy all their WATCHES, DIAMONDS, AND JEWELRY on the HARRIS-GOAR Easy Payment Plan. Write or Wire for New 1914 Catalogue.

SANTA CLAUS STARTS FROM HERE NOV. 1st. WILL MAKE HIM STOP AT YOUR HOME. A POSTAL CARD FREE 1914 CATALOG NOW READY FOR DELIVERY WRITE FOR IT

Christmas Special!

Extra Fine, 17 Ruby Jewel Elgin



adjusted to Temperature, Isochronism and Three Positions; exposed pallet stones; compensating balance; Breguet hairspring; micrometric regulator; exposed winding wheels; patent recoiling click; patent self-locking setting device; double sunk dial; dust ring; damaskeened plates; finely finished throughout; fitted in double strata gold case, plain polished or hand engraved, guaranteed for 25 years, complete in silk velvet lined, solid mahogany box. Regular value, \$40. Cut to only.....

\$26⁵⁰

3 Books FREE!

I want to send you my three latest books—one the story of "The Diamond"—its discovery, where and how mined, cut and marketed—the other, "Facts vs. Fanc" or all about the Watch Business both at home and abroad, also our big Free Watch and Diamond Catalog. P. Stephen Harris, Pres.

Sent You on 30 Days Free Trial

No Money Down—**\$3 A MONTH**

While these Extra High-Grade \$40.00 Elgins last, this is an opportunity of a life-time to supply yourself or loved ones with this superb Elgin at a saving of exactly \$13.50 and on such easy terms that you will never miss the money.

This extra high-grade thin model Elgin was originally made to sell for \$40 and was intended for railroad purposes, but on account of it being stem wind and pendant set and an extra thin model, some of the railroads instructed their men to buy a heavier watch and that is why we have only a limited number of these fine watches to offer you at the

Big Saving of \$13.50

WRITE
or Wire for our Big
Free Catalogue

It's America's Finest Illustrated Watch, Diamond and Jewelry Book.

It tells all about Harris-Goar's world famous Easy payment plan. It gives you the Rock-Bottom price on every Elgin Watch made. It quotes you the lowest import prices on fine Diamonds and illustrates for you all the latest things in Solid Gold Jewelry.

HARRIS-GOAR JEWELRY CO., Dept. 1058, Kansas City, Mo.

The House that Sells More Elgin Watches than Any Other Firm in the World.



THE WATCH THAT IS BACKED BY 50 YEARS EXPERIENCE AND \$15,000,000 CAPITAL



"Am using your Tungsteel razor with splendid satisfaction. Would not take \$5.00 for it."

Tobin Hubbard

The "Curved" Shumate Tungsteel

embodies a new, scientific principle. The delicately curved blade gives the new double sliding stroke both in shaving and stropping. By holding the razor at the usual angle, you automatically obtain the stroke which insures a shave equaling that of the best barber.

The razor is full concaved, hand ground, honed and stropped; made of the very finest six temper Sheffield English razor steel. Price \$2.00.

Shave the *right* way

—use the **best** razor—and the **best type** of razor—the kind **real men** use—the only kind you would permit a barber to put on your face—the only kind that will give a clean, "smartless" shave.

Young man, your beard is soft now and any sort of a razor may do, but later on you will realize the necessity for a **regular** razor. Form the right shaving habit now—begin with and continue to use the

"Curved"
Shumate
Tungsteel

—the razor that is **guaranteed for life**. Any time it fails to give satisfaction, we will exchange it without a word.

The most prominent men in America are using this razor, and 40,000 dealers sell it under our guarantee. If your dealer cannot supply you, we'll send you the "Curved" Shumate Tungsteel postpaid for \$2.00

Dealers who are not selling Shumates should write at once regarding the line, and our special FREE DISPLAY CASE OFFER.

SHUMATE RAZOR CO. Established 1884
1022 Locust Street, ST. LOUIS, MO.



The Curve
makes you shave
right

\$513 Clear Profit First 51 Days From an Investment of \$175

is the result of operating one American Box Ball Alley. Four others took in \$8,540 first 16 months. Many pay for themselves first month. Go into this business yourself. You can start with \$75. No gambling device, but most practical and popular bowling game in existence. Splendid for high-class amusement and physical exercise. Liberal patronage by good people everywhere. Many sales to churches, schools, homes. Quickly installed—easily portable. No helpers required—really automatic—small expense—receipts nearly all profit. We sell only one person in each locality. Get this monopoly now. Easy payments. Catalog free. AMERICAN BOX BALL COMPANY, 116 Van Buren St., Indianapolis, Ind.



VELVET THE SMOOTHEST TOBACCO 10c

FISHING BY ELECTRIC LIGHT—A few experiments have been lately made in Norway to test the utility of the electric light in the sprat (or "brisling") fishery. One company fitted up on one of their motor-boats an electric lamp of 1,000 cp., which was lowered



I will send—as long as they last—my 25c Book
STRONG ARMS
For 10c in stamps or coin

Illustrated with 20 full-page half-tone cuts, showing exercises that will quickly develop, beautify, and gain great strength in your shoulders, arms, and hands, without any apparatus.

PROF. ANTHONY BARKER
648 Barker Bldg., 110 W. 42d Street, New York

Let Your Engine or Motor Do the Work

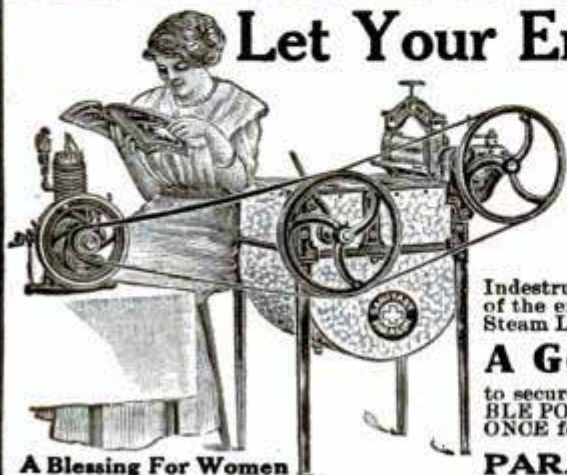

A Blessing For Women

and make an end to washday drudgery in YOUR home. Of course, NONE of the insanitary, old-fashioned wooden rotary washers will do. ONLY THE MOST UP-TO-DATE machine ought to be good enough for YOUR wife. EXPERTS will tell you that NO MORE DURABLE and PRACTICAL washer can be found than the famous

All Metal Sanitary Paragon Revolving Cylinder Power Laundry Machine

Indestructible. NO WOOD used in any part. The PARAGON is a true reproduction of the expensive and powerful Cylinder Washers exclusively and successfully used in Steam Laundries, Hotels and Hospitals. Over 100,000 Paragon Washers used in the U. S.

A Golden Opportunity for 30 Days Only

to secure one of these wonderful genuine laundry machines, complete with REVERSIBLE POWER WRINGER at a very considerable REDUCTION in price, if you write AT ONCE for Catalog No. 1 and further details of the most generous proposition made.

PARAGON MFG. CO., 2401-03 W. 14th St., CHICAGO



The Untrained Man



The Trained Man

Your Future Depends On Yourself

A few years hence, then what? Will you still be an untrained, underpaid laborer, or will you be a specialist in your chosen line of work where you can earn more in one day than the untrained man earns in a week?

Your future depends upon yourself. You must decide now. To hesitate, to put it off, or to be undecided means that you must plod the hard road of disappointment, poverty, and failure. To mark and mail the attached coupon is the first step to promotion and success.

The only way to keep out of the dollar-a-day class is to get the special training that will command the attention and a better salary from the man higher up. The International Correspondence Schools have shown to thousands the way to positions of power and increased salaries. They can do the same for you.

Your future is before you. Are you interested enough in it to learn how the I. C. S. can fit you for a real big job? No matter where you live, how little you earn, or what your previous education has been, the I. C. S. have a way of helping you. For over 21 years the I. C. S. have been helping young men to increase their earnings and to rise to positions that insure a better income.

The 400 or more letters that are sent to us every month reporting increased salaries, prove our ability to help you.

Choose a high-salaried future and

Mark and Mail the Coupon NOW.

International Correspondence Schools

Box 872, Scranton, Pa.

Please explain, without further obligation on my part, how I can qualify for a larger salary and advancement to the position, trade, or profession before which I have marked X.

Electrical Engineering
 Electric Lighting
 Electric Railways
 Electrician
 Electric Car Running
 Dynamo Foreman
 Wireman
 Mining Engineer
 Telephone Expert
 Surveyor
 Civil Engineer
 Automobile Running
 Agriculture

Mechanical Engineer
 Mechanical Draftsman
 R. R. Construction
 Concrete Construction
 Architect
 Contracting and Build'g
 Architectural Draftsman
 Plumbing and Heating
 Chemist
 Bookkeeper
 Advertising Man
 Civil Service Exams.
 Salesmanship

Name _____

St. and No. _____

City _____ State _____

Present Occupation _____

These Boys Learn While They Play

GET YOUR BOY THIS WONDERFUL NEW GAME

Besides delighting him, it will teach him mechanics—make him familiar with the great steel building operations of the day. The game is made of steel and brass, nicked, and consists of beams, girders, angle irons, wheels, bolts, etc., in miniature, exactly as used by the big steel builders; also the necessary tools with which to build. Your boy and his chums can build by the hour—hundreds of things shown in our book of models and instructions: aeroplanes, draw bridges, printing presses, power derricks, signal towers, etc., etc., with

The American Model Builder

Endorsed by leading educators everywhere. Used by schools and Y. M. C. A.'s on account of its great educational value. It's a quiet game—no noise in the house. Playmates won't quarrel. Outfits in seven sizes—\$1.00 up. Can be added to any time. For sale by leading department, sporting goods and toy stores. Write today for free illustrated catalog No 20 and name of nearest dealer.

The American Mechanical Toy Co.

420 East 1st Street, Dayton, Ohio.

NERLICH & CO., Toronto, Canada



Look for this Trade-Mark on every box

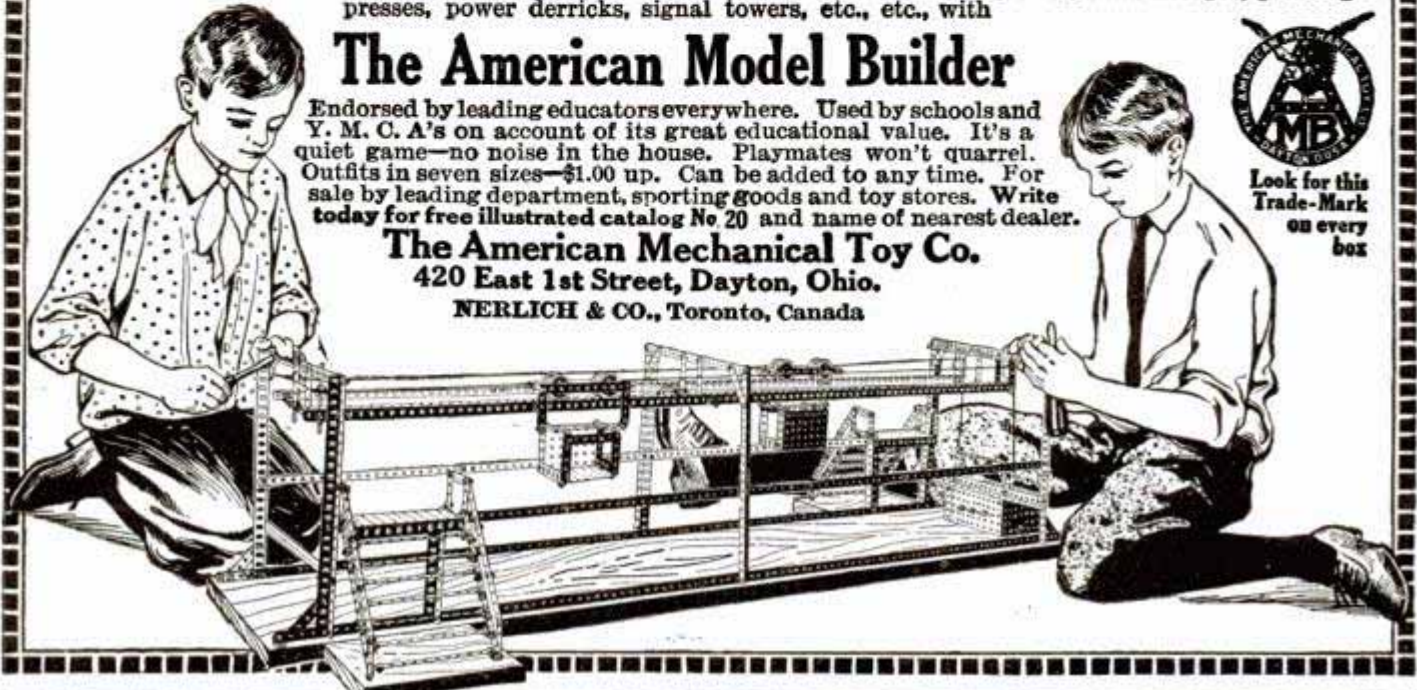

Successful Egg Farming



200 Eggs a Year Per Hen

HOW TO GET THEM

THE eighth edition of the book, "200 Eggs a Year Per Hen" is now ready. Revised, enlarged, and in part re-written, 96 pages. Contains among other things the method of feeding by which Mr. S. D. Fox, of Wolfboro, N. H., won the prize of \$100 in gold offered by the manufacturers of a well-known poultry food for the best egg record during the winter months. Simple as a. b. c.—and yet it will start hens to laying earlier and to induce them to lay more eggs than any other method under the sun. The book also contains a recipe for egg making food used by Mr. Fox, which brought him in one winter day 68 eggs from 72 hens; and for five days in succession from the same flock 64 eggs a day. Mr. E. F. Chamberlain, of Wolfboro, N. H., says: "By following the methods outlined in your book I obtained 1,496 eggs from 91 R. I. Reds in the month of January, 1902." From 14 pullets picked at random out of a farmer's flock the author got 2,999 eggs in one year—an average of over 214 eggs apiece. It has been my ambition in writing "200 Eggs a Year Per Hen" to make it the standard book on egg production and profits in poultry. Tells all there is to know, and tells it in a plain, common-sense way.

You can get this book with a year's subscription to the AMERICAN POULTRY ADVOCATE, both for 75 cents; two years' subscription and book for \$1.00, or given free as a premium for two yearly subscriptions at 50 cents each. Book alone for 50 cents.

Our paper is handsomely illustrated, 44 to 124 pages, 50 cents per year, 3 months' trial 10 cents. Sample Free. CATALOGUE of poultry books free.

AMERICAN POULTRY ADVOCATE
312 Hodgkins Block SYRACUSE, N. Y.

Please Mention Popular Mechanics

into the water to various depths down to 230 ft., and then, after a few hours, a "shot" was made with the purse seine around the place. Scarcely a single fish was caught, says the Fish Trades Gazette. Other experiments with lamps of 600 to 700 cp. had similar negative results, but young saithe were observed to approach



MAKE BIG INCOME

Men and Women can do this all the year at home growing mushrooms in cellars, stables, sheds, boxes, etc. Crop sells for \$.50 to \$1.00 a lb. \$20.00 a week easily made. Great demand, markets waiting. Start Now. Write for big 32 page Free Illustrated Booklet and learn how to do it.

NAT'L SPAWN CO., Dept. 12, BOSTON, MASS.



\$15.00 to \$35.00 Per Day Easily Made

Taking photographs with our **ONE MINUTE TINTYPE and POSTCARD CAMERAS**. Pictures made direct without use of negatives. Toned, fixed and developed in one solution. No experience or dark room necessary. Cameras from \$10.00 up to \$35.00 each. Complete photos cost 1c to 2c each, sell for 10c, 15c and 25c each.

Send for Free Catalogue and Price List today.

NEW YORK FERROTYPE CO., 168 Delancey St., New York City, Dept. III
Branch 1113 S. Halsted Street, Chicago, Ill.



MEN AND WOMEN. 100% PROFIT

Something new. Big Seller. Good repeater. No competition. Not sold in stores. Concentrated Non-Alcoholic Food Flavors. Over 50 kinds. Put up in collapsible tubes. Four drops go as far as a teaspoonful of bottle extract. Also Soaps, Perfumes and Toilet Preparations. Every home a possible customer. Hustlers should make \$6 to \$8 a day. Experience unnecessary. We teach you how. Little or no capital required. Fine sample case furnished to workers. Be first in your territory. Write today—a postal will do—for full particulars **FREE**

AMERICAN PRODUCTS CO., 5385 Sycamore St., CINCINNATI, O.

POWER for YOU!

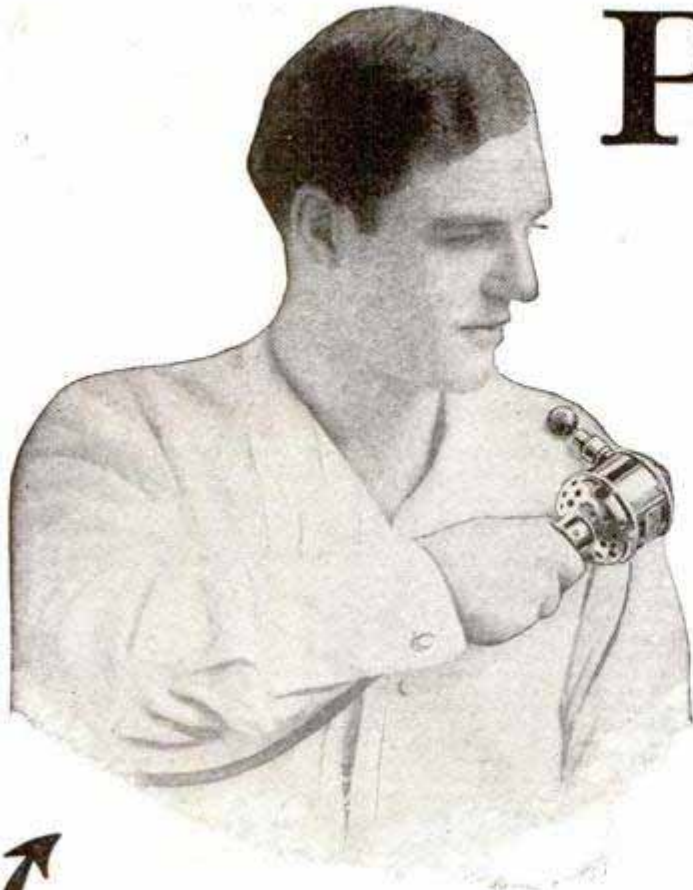

Power from within! Strength that is **more** than mere muscular strength—the strength of perfect health, abundant nerve force—the strength of the **perfect man** now within your reach through **Vibration!** Nine people out of every ten are only **half alive**. They exist—they do not really live. How about yourself. Listen—

All the Benefits of Life—Strength—Youth

may be returned to you through **Vibration**. For **Vibration is Life itself**. It will chase away the years like magic. Every nerve, every fibre in your whole body will fairly tingle with the force of your own **awakened power!** Stagnation simply cannot exist. You are made over—new—from head to foot. Your blood is sent humming along through every vein, artery and tiny capillary. Poisonous matters in your system are **washed away**. Your self-confidence—**your self-respect**—are increased a hundred fold. Yes, **Vibration** will do all this and more, **much more**. And it is within your reach. You can enjoy its wonder-working powers right at home, right in the privacy of your own room. You can give yourself the same identical treatments that you would receive in the offices of the world's most famous specialists—all without extra charge.

You may give yourself Swedish Movement, Vibrating Chair Treatments, Electric Baths, Faradic or Galvanic Electric Treatments—just such treatments as you would have to pay from \$2.00 to \$3.00 for—yours without charge through the White Cross Electric Vibrator.



The White Cross Electric Vibrator

is the result of years of work and experiment. It is absolutely perfect. If you have your house wired for electricity, you can connect it up as easily as an electric lamp; if not, it will run perfectly on its own batteries.

Special Offer for a Limited Time

For a short time only we are making a remarkable Special Introductory Offer on the White Cross Electric Vibrator, in order to place at least one of these splendid instruments in every city, town and village in the country—an amazing offer to those who write at once—amazing discounts—actual rock bottom prices direct if you act at once.

FREE BOOK Sign coupon and mail it today. Get our splendid big **FREE** book telling you all about the marvels of **Vibration**. Read what great scientists say. Post yourself on what it will do for you. Learn all about the **White Cross Electric Vibrator** and our limited offer. No obligations at all—send coupon, post card or letter today.

LINDSTROM-SMITH CO.

1100 S. Wabash Ave. Dept. 1198, Chicago

We also manufacture electric irons, electric hair driers, electric stoves, etc., etc.

Send for
This Book

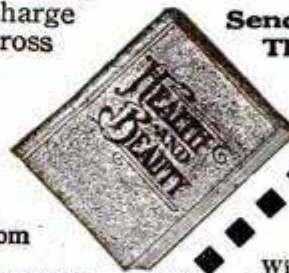

**FREE
BOOK COUPON**

**LINDSTROM,
SMITH CO.**

Dept 1198
1100 S. Wabash Ave.

Chicago, Ill.

Without any obligation at all, please send me, free and prepaid, your free book on **Vibration**, full particulars of the White Cross Vibrator and your Special 60 Day Offer.

NAME

ADDRESS

My Electrical Dealer's Name is



We Start You in the Motion Picture Business

With Our Assistance and Small Capital you can begin at once and share in the ever-increasing profits of the **GREATEST OF ALL INDUSTRIES**—

Motion Picture Business

Any man or woman can succeed in their home town, or as a traveling exhibitor. The business is still in its infancy—the possibilities unlimited.

\$35 to \$50 and More Daily Profit

We manufacture and furnish everything—**Machine, Film, Lighting, etc.**—and teach you the business. No experience necessary. Many good locations are just waiting for the right exhibitor to come.

We've Helped Make Hundreds Rich—Why Not YOU?

This is unquestionably the greatest money-making opportunity you will ever have. A postal card or letter is all it costs to get full particulars. **WRITE TODAY!**

ATLAS MOVING PICTURE COMPANY

Room 202, 508 S. Dearborn St., Chicago

Get Full Information by Return Mail

\$7.50
and
up



Here's Big Money for You

Hundreds of operators are making \$75 weekly. You can do as well with this wonderful **DIAMOND POST CARD GUN**

It makes three sizes post cards including mailing size, also photo buttons without plates or films. Finished pictures delivered on **The Spot in a Minute.**

No Dark Room Required—No canvassing, experience unnecessary—

Be Profit on Every Dime. Write today for samples of work and full description. Grasp this opportunity NOW. **INTERNATIONAL METAL & FERROTYPE CO.** Dept. 801 CHICAGO, ILL.

Your Picture in a Postal Card IN ONE MINUTE

The pictures are developed, toned and finished in a single developing solution. No experience is necessary. Price of machines \$7.50 and \$15.00—circulars describing our machines sent free. We are also headquarters for supplies for all minute picture machines.

AMERICAN MINUTE PHOTO COMPANY
Desk F 695, 2214 Ogden Ave., Chicago, Illinois
The largest manufacturers and distributors of minute picture machines and supplies in the world.



Be Your Own Boss

Do as many others have—Operate a Kingery Peanut Roaster and Corn Popper. Over 30 styles. Liberal terms, excellent profits. Kingery's book of possibilities and No. 41 catalog tell you all about it.

KINGERY MFG. CO., Pearl, east of Broadway, Cincinnati, Ohio

AGENTS—\$5.00 to \$25.00 a Day—It's Easy

Grand Invention. 150% Profit. Great Excitement
Recognized as most phenomenal seller

Experience Unnecessary. Spare time can be devoted if desired

LISTEN: One man's orders \$2,650.00 one month—profit \$1,650.00

Lowry, of Montana, who sold 25 dozen the first two weeks (without previous experience) and made \$187.50, enthusiastically writes: "Why, I could sell this

article blindfolded and with a gag in my

mouth." Mere boy in Pa. made \$9.00 in

2 1/4 hours. "I do not see how a better seller

could be manufactured," reports Parker J.

Townsend, Minn. "Started out at 10

a.m., sold 35 by four o'clock," says J. R.

Thomas, Colo. "Sold 131 in two days."

G. W. Handy, New York. See what a wonderful

opportunity. **These remarkable reports**

proven absolutely true by oath-covered evidence

—proven to satisfy you beyond a doubt. You can

make this money. Work for us and get rich.

We want representatives—Agents, Salesmen, Managers—

everywhere. Write today. Territory in

all sections of the United States, Canada,

Mexico and foreign countries to be

assigned. The New Easy Wringer Mop tremen-

dously in demand by housewives. Every

woman exclaims in delight: "Just what I

want!" No more tiresome, back-breaking,

miserable mopping days. Drudgery actually

transformed into pleasure. The greatest,

grandest, most necessary household article

ever invented. No need to recite selling

arguments. Talking hardly necessary

at all. Simply show—order's landed.

This is indeed a wonderful opportunity.

Establish yourself in

this business at once. Send your

name and address on a

postal note—right now.

U. S. MOP CO., 125 Main St., TOLEDO, OHIO

The
Easy
Wringer
Mop
(Patented)
Hands do
not touch
the
water.

Agents Marvelous new household invention.

Needed in every kitchen. Every woman will want it when she sees it. Light in weight, small and convenient to carry in quantities. Best 50c seller ever put on the market. Write today for description and special terms to agents. **WESTERN SUPPLY CO., Dept. 5243, New Hampton, Iowa**

\$15.00 TO \$20.00 PER DAY PROFIT FOR YOU!

Here is your chance to go in business and make **BIG MONEY this summer.** No knowledge or experience in photography required. **Photos made direct on POST CARDS or TIN TYPES** without the use of plates, negatives or dark room. Developed, toned and fixed in **ONE SOLUTION**, and delivered on the spot in **ONE MINUTE.** Don't miss this opportunity to become independent. Write today for our new catalogue and price list.

JAMESTOWN FERROTYPE COMPANY
Dept. 146, 1113 S. Halsted Street, Chicago, Ill.

\$100 to \$300 Weekly

GO INTO THE Moving Picture Business

We supply you with complete traveling and stationary outfits on our Easy Payment Plan. Our New 1914 Model Machine—a winner. Write for Free Catalog. **ACORN MOVING PICTURE CO.** Dept. 11C 173 N. Green St., Chicago



Only \$36.00 The Wonderful ILLUSTRATOR LANTERN

With our improved famous **ALCO RADIANT LIGHT.**

This new 1912 Model has many improvements and double brilliancy. Write for illustrated circular of this and Lanterns of all styles and lights at bottom prices. **IF YOU OWN A LANTERN** we should have your name to mail to you our regular announcements of new slides and lecture sets. 75,000 Lantern Slides to rent. **POST CARD MAGIC LANTERN** reflects image of postcard or any other picture or object. Prices, \$2.75, \$12.50, \$25.00, \$50.00, express paid.

WILLIAMS, BROWN & EARLE, Inc., 918 Chestnut St., Philadelphia, Pa., Lantern Dept. 20
Engineering, Microscope, Optical, Scientific, Photo Lantern Slide Supplies

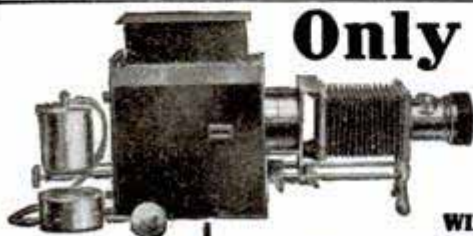

No need now to pay double price
for a good engine, or to take a
poor engine
kind of a
for any
price.

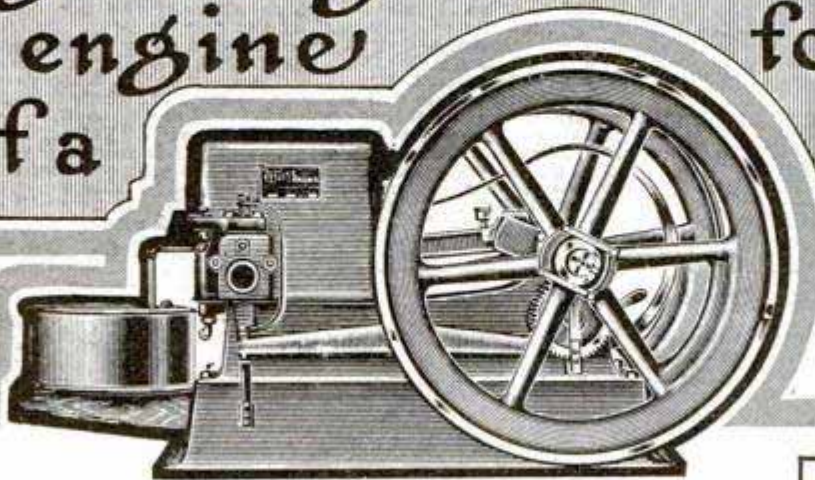

WITTE Engines Kerosene, Gasoline, & Gas

**60 Days'
Free Trial
Five-Year
Guaranty
Easy Payments**

I want to prove—

- 1st: Nobody can sell you a better engine.
2d: You can't beat my prices.

No matter who you are, or where you live, you can run a WITTE outfit **better** than any other.

With my own hands, 27 years ago, I made my first engine, and gave it my own name. Ever since, I have personally supervised the building of every WITTE engine. I know every engine, inside and out, that leaves my factory.

I am the only man in the U. S. who makes his own engines, in his own *debt-free* factory, from his own designs, using his own special machinery, and selling his whole output under **his own name—direct from factory to user only.**

A 6 H-P. Engine, NOW, \$99.35

A Genuine WITTE—all complete, ready to run—guaranteed, with a Free Trial to prove its worth. Other sizes proportionately low.

I furnish you the power of 30 men's work for only 80c a day; or 10 men's work for only 3¼c an hour. You can't work that cheap.

My FREE BOOK Explains It All

How you can make iron, steel, and the kerosene can do your drudgery—from the smallest tasks to the hardest kind of hard work. Steady and un-failing power, cheaper than the cheapest muscle there is.

Let me tell you the "inside" of the story of my **lower** prices over all others. Let me prove the **high standard** of my engine quality. You be the judge and jury together. Costs you nothing to get the full facts. Simply write, or mail me the Free Book coupon. Costs no more to do it now.

Ed. H. Witte, Desk B
WITTE IRON WORKS CO.
1749 Oakland Ave.
KANSAS CITY, MO.

Here's My Big, New Liberal Offer

LET me send you a WITTE engine. Select any of my 54 styles and size, from 1½ to 40 H-P., stationary, Skidded, Portable, or Sawrig styles. I will make you any reasonable, easy terms, so the engine can earn its own cost while you are paying for it.

I know the WITTE is at once, the most simple, and consequently, the most durable; it is more easily understood, and so more easily managed; and last but not least, it takes less fuel per horse-power hour—and practically no repairs.

I have reduced the *number* of wearing parts to the very fewest, and then reduced the *amount* of wear on the few parts, to the very lowest point. You can have 60 days' free use of any WITTE, to prove that to yourself, and then have five years' insurance against defects and any consequent faulty operation. You can't buy a WITTE and NOT get a square deal.

Ed. H. Witte.

COUPON TODAY

Free Book Coupon

ED. H. WITTE, Desk B
WITTE IRON WORKS CO.
1749 Oakland Ave., Kansas City, Mo.

Without any obligation or cost to me, send me your Free Book, and your **new plan**, under which you make it easy for any honest man, anywhere, to get a genuine WITTE engine for **less money** than that for which any other engine can be had.

FILL OUT, SIGN AND MAIL THIS

Name.....

Address.....

AGENTS—AMAZING INVENTION

Will Increase Your Income!



YOUR CHANCE for an honest, reliable, permanent money-making business is here—an article that is sold on this guarantee: "If not satisfactory, money refunded."

THE BLACKSTONE WATER-POWER VACUUM MASSAGE MACHINE for the home. Easy to operate, no cost. Lasts a life-time. Price within reach of all. Demonstration convinces the most skeptical person. Men and women—everybody stop, look and become amazed—want a trial—want to buy it. Brings back beauty, tints the flesh with nature's own color, and leaves the cuticle like velvet. Rounds out any part of the face or body. Delights women; men use it after shaving. Endorsed and recommended by professional people and masseurs.

AGENTS, SALESMEN, GENERAL AGENTS, WANTED AT ONCE. Wide market. New field. Large profit. Machine sells itself. No experience necessary. One sale will make ten—users tell their friends. Nothing like it. Does the work of electric machines costing \$20, \$35 and up to \$75. Low price and positive utility make it a marvelous seller. **IF YOU DOUBT YOUR OWN ABILITY** to make money at this business, get a sample outfit and solicit orders. If you are not satisfied that you can make enough to pay you to continue in the business, return the sample and your money will be refunded by next mail. Test yourself on this plan—you positively cannot lose.

FREE BOOK Write today for particulars and we will send you FREE our big book, "The Power and the Love of Beauty and Health." Act now. **THE BLACKSTONE MANUFACTURING CO., 792 Meredith Bldg., TOLEDO, OHIO**

FREE LOAN

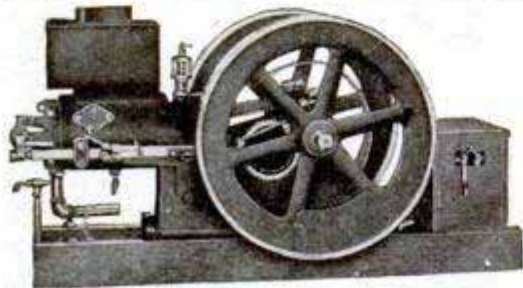

Save Your Engine Money
Get the facts about the wonderful Union Engine, 2 to 7 horse power. Get our **AMAZING FREE OFFER**

that is throwing engine makers into panic. No notes, mortgage or C. O. D.; just a free loan. Let the Union do your work at our expense. Pumping, shelling, grinding, runs cream separator, saw, hay press, ensilage cutter, dynamo, drills, wells, etc. Lowest priced and most perfect farm engine made. Absolutely guaranteed. Fully rated, skid mounted. 4 cycle, long stroke, slow speed, hopper cooled, water jacket, automatic mixer. This big factory has been making engines for 30 years. Simply send name today for full details of our great free offer.

UNION GAS ENGINE WORKS, Dept. 903, KANSAS CITY, MO.

Don't Buy an Engine

until you investigate the famous **TEMPLE Gasoline-Kerosene**, slow speed, heavy duty, all-purpose engines. Bulk and weight less than horizontal engines; cylinders built low, close to base, eliminating shock and vibration, increasing strength and durability, and giving scientifically correct distribution of strain. Pay for themselves in fuel saving alone. Have won five 1st premiums for low operating cost, stability and steady power. Old reliable pioneer concern (manufacturers for 61 years) guarantees these engines. Write today for catalog and particulars of 30-day trial offer.

THE TEMPLE ENGINE & PUMP CO., 435 Meagher St., Chicago, Ill.

**\$50
to
\$300
SAVED**

Just Write!

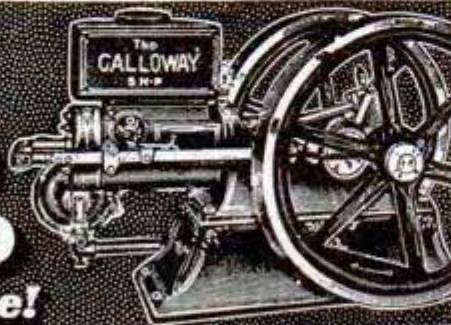

Get my prices—my new offers—get them right away. If you're going to buy an engine I'll put \$50 to \$300 in your pocket sure. All the dealers' profits cut off—you get them. You buy direct from my big factory.

30 Days' Free Trial Satisfaction guaranteed or your money back without a word. Any size from 1 3/4 to 15 H. P. Galloway Engines will run on gasoline, kerosene, naphtha, distillate, natural gas or motor spirits. Write for my Big Engine Book and Special Offers today.

William Galloway, Pres., WILLIAM GALLOWAY CO.
965 Galloway Station, Waterloo, Iowa 665



Amazing Profits In Mushrooms

Anybody can add \$8 to \$40 per week to their income, in spare time, entire year growing mushrooms in cellars, sheds, barns, boxes, etc. I tell you where to sell, at highest prices.

Free Illustrated Instruction Booklet

HIRAM BARTON

Desk 2, 329 W. 48th St., New York

I H C Gasoline Engines Make and Save Most Money

They are most dependable, simplest, most economical, most efficient, most durable and strongest, and they are adaptable to most kinds of work. I H C Gasoline Engines are made in all styles, 1 to 45-horse power. Write today for the I H C catalogue, and read about the I H C engine that meets your needs best.

Address, **INTERNATIONAL HARVESTER COMPANY of AMERICA (Incorporated)**
16 Harvester Building Chicago U S A

distance off shore and remains stationary, the light shining on the water, and the fishermen watching for the appearance of fish. When a signal is given, another boat with a net comes to the spot and makes a catch.

CHINESE TELEPHONE SERVICE—Very few cities in China have a telephone exchange with as many as 500 subscribers and the average exchange has less than 200.

5 HORSE POWER

HERE is the most reliable 5 H. P. Engine in America. The price is a world beater and can't be equaled by any dealer in the country. Sold under a positive iron clad

only \$89⁵⁰



guarantee, satisfaction or money back. If you want an engine any size, 1 1/2 to 12 1/2 H. P., write me today for Big 4-color Engine Catalog and Price List, lowest you ever heard of. Save you \$20.00 to \$100.00 sure. Do it now—today.

OTTAWA MFG. CO., 946 King St., Ottawa, Kans.

OTTO KEROSENE OIL AND DISTILLATE ENGINES

are built in just the size and type to suit your needs. Whether for the shop or farm, for pumping, hoisting or electric light service, an Otto will give you dependable power.

Costs the least of any in the long run. All sizes, 4-6-8-10 up to 120 H. P. Gas Engines up to 250 H. P. Catalog and bulletins free. Dealers wanted everywhere.

THE OTTO GAS ENGINE WORKS

3420 Walnut Street
PHILADELPHIA, PA.



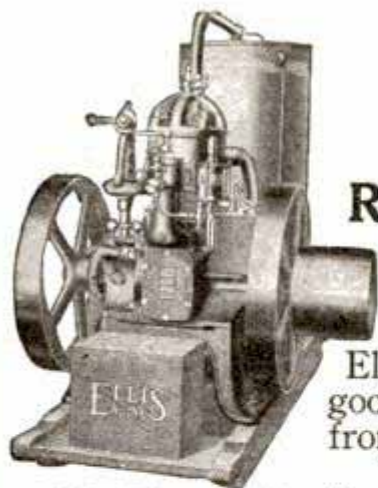

The Ellis "Six"

42c a Day

Runs this 6 H.P. Engine on Kerosene

This statement as to fuel cost is not a theory that we would like to realize, but is based on actual working conditions in our factory where Ellis Engines are used for our own power. Equally good results can be secured from other sizes, ranging from 3 to 12 H. P.

The big advantage of a **successful** kerosene engine lies in the fact that this fuel is not only much cheaper to buy per gallon, but it also contains one-sixth more power than gasoline; in other words it takes 7 gallons of gasoline to do as much work as 6 gallons of kerosene **when used in Ellis Engines.**

Don't miss the last five words, **"When used in Ellis Engines."** That's the secret of the low cost. It isn't the kerosene alone; it's kerosene **used in Ellis Engines.**

No engine will use kerosene successfully unless it was designed especially for that fuel. You can burn wood in a coal stove, but you can't burn coal in a wood stove; and it is equally true that while you can use gasoline in a kerosene engine, you can't use kerosene in a gasoline engine.

Other Strong Features

Every Ellis Engine is equipped with our own exclusive patent throttle giving you **three engines in one**; force-feed lubricator positively oiling all working parts; double duty cooling tank (a great convenience in severe weather); ball-bearing governor adjustable while running, and guaranteeing uniform speed; extended crank shaft suitable for any standard plain or clutch pulley; high-grade muffler; sight feed fuel supply; bearings die-cast of genuine Babbitt metal; bronze piston bushings, copper asbestos gaskets, and other special equipment.

And remember too, that while the Ellis Engine is light in weight, it is strong enough to last a lifetime; starts without cranking; has no cams, push rods or springs to cause trouble or wear out; is of very simple construction; runs with less vibration; will run equally well in either direction and can be reversed while running.

The larger sizes are equipped with Wico Igniter (better than any magneto), and device for injecting water with kerosene.

Sent on Approval

We are so confident our engines will more than satisfy any reasonable man, that we send them anywhere in America on **30 days' approval with freight prepaid**, and then the engine is backed by a binding and definite **10-year guarantee.**

Write today for big new catalog and opinions of satisfied users in all parts of the world.

Ellis Engine Company

64 Mullett Street

Detroit, Mich.

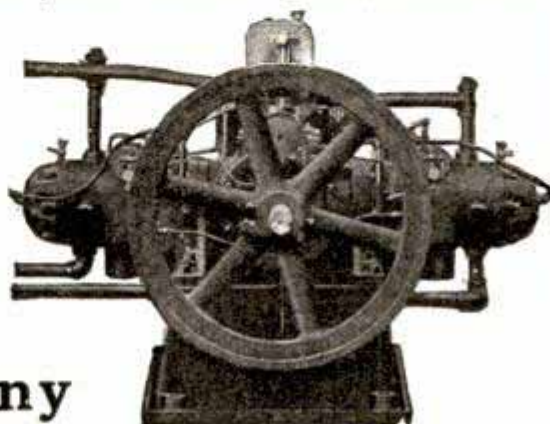

The Ellis 2-cylinder "Twelve"

Read What These Men Say

"I run my engine on kerosene which costs only half as much as gasoline and gives more power. It is one of the best engines I ever saw; so easy to operate."
W. M. Dixon, Landover, Md.

"Can get more power from 12½c worth of coal oil than from 30c worth of gasoline. The Ellis people are among the best with whom I have done business."
W. J. Wraith, Lucknow, Ontario

"After it is warmed up it runs fine on either Distillate or Coal Oil, and will do more work on a gallon of gasoline than any engine I have ever seen."
E. F. Showers, Ferndale, Wash.

"One turn of the fly wheel in the morning and it is off for the day. It is one of the most economical engines on the market."
R. C. Maurer, Elizabethtown, N. J.

"Have given the Ellis Engine a thorough trial on pure kerosene. It is simple to manage and the power is more than I expected, and am very much pleased with it."
T. Scandrett, Mullett Point, New Zealand

"The engine has big power. Runs on common lamp oil satisfactorily. Everyone who sees it says, 'I never saw the like.'"
J. J. Friesen, Meade, Kans.

"Even with kerosene at 22c a gallon, I am saving fully 50% of the expense I was put to when using my steam outfit."
Juan Long, M. D., Musquiz, Coah., Mexico

Thousands of others could say the same

5 Years To Pay

What other Piano Maker will ship a strictly high grade piano direct to your home without any obligations on your part whatever to buy—allow you a full month free trial and then, if you decide to keep it, give you **5 years to pay at the rate of only 10 cents a day?** We will do it. Others may offer you 2 or 3 years' time, but there are none who even approach the extreme liberality of our terms.

And, remember, the sweet-toned "**Schmoller and Mueller**" is not to be classed with the ordinary Pianos turned out by machinery in thousand lots to sell by "catalog houses." Our Pianos are built from carefully selected material in the good old-fashioned reliable way; made to your order just as you want them; any style case, any wood. Heavy, light, mellow or brilliant tone—as you prefer.



We Prepay the Freight

30 Days' Free Trial

We Give A **25-Year Guarantee**

with each **Schmoller and Mueller** sweet-toned Piano. Our guarantee is backed by over one million dollars capital and surplus. Ask any bank or commercial agency as to our responsibility.

We sell direct from-factory-to-home, at bed-rock prices—save you from \$100 to \$175 on your purchase. No difference how little ready money you have, our wonderful plan makes it easy for you to own one of these superb instruments. Mail coupon today or a letter or postal will do.

SCHMOLLER AND MUELLER PIANO CO., Dept. PM. 311, OMAHA, NEB.
Send me free Catalog checked below.

NAME.....

ADDRESS.....

Piano Catalog Player Piano Catalog

DON'T PAY TWO PRICES

Save \$8.00 to \$22.00 on **Hoosier Ranges and Heaters**

Why not buy the Best when you can buy them at such low, unheard-of Factory prices. Our new improvements absolutely surpass anything ever produced. Save enough on a single stove to buy your winter's fuel. Thirty days' free trial in your own home before you buy.

Send postal today for large free catalog and prices.

HOOSIER STOVE CO.
249 State St. Marion, Ind.



BUY YOUR FURNACE \$10 DOWN \$10 A MONTH

Our monthly payment plan of selling direct saves you the dealer's profits and charges for installation. The

Jahant Furnace

with the patented "Down Draft System" is best for residences, schools, hotels, churches, etc., because it delivers plenty of heat wherever and whenever desired at a saving of 1-3 to 1-2 in fuel bills. Install the Jahant yourself. We send complete outfit, freight prepaid with special plans, detailed instructions and all necessary tools for installation. Satisfaction guaranteed or money refunded.

Write for free illustrated book.

THE JAHANT HEATING CO.

168 Mill Street Akron, Ohio



This No. 1 Jahant Down-Draft Furnace (weight over 1000 lbs.) as it stands \$48.00 cash, delivered east of Omaha and north of Ohio River.

Save 1/3 to 1/2 on Fuel Bills

Expert's Plans Save Furnace Cost and Fuel

if you buy the Kalamazoo way and let a heating engineer study your home. Our expert will show you how to keep the entire house warm and snug on blizzard days—and keep down coal bills, too.

Buy from Factory—Book Free

tells all about the Kalamazoo furnace and our remarkable plan for direct sale—at an immense saving to you. Ask us for **Furnace Catalog No. 473** today.

We make a full line of Stoves, Ranges, Gas Stoves and Furnaces. We have three catalogs—please ask for the one you want.

Kalamazoo Stove Co., Mfrs., Kalamazoo, Mich.

"A Kalamazoo Direct to You" And Gas Stoves Too

30 Days' Trial FREE—A Year for a Test

\$25 to \$75 Less—Long Time To Pay



UNITED STATES NOW A BEEF-IMPORTING COUNTRY—Fresh beef from the south temperate zone is now an established factor in the import trade of the United States. Between 2,000,000 and 3,000,000 lb. of fresh beef, practically all of it from Australia and Argentina, has entered ports of the United States in the past three months, indicating that the imports of the current fiscal year will amount to more than 8,000,000 pounds.

BE YOUR OWN BOSS

Agents



Earn Big Money Selling Golden Rule genuine hand forged English razor Steels Knives,

that will cut and hold the edge. We will put any photo or lodge emblem on one side of the transparent handle and name and address on the other. We have a complete, fully guaranteed line of knives, razors, strops and cutlery specialties. Quick sales. Big Profits. Exclusive territory. Experience unnecessary. We teach you how. Write today for Catalog and Terms. **Golden Rule Cutlery Co., 552 W. Lake St., Dept. 208, Chicago**

A Stone Oven Bottom Range

DIRECT TO YOU WITH NO DEALER'S PROFIT TO PAY

We say the **IMPERIAL** is the best range on earth at ANY PRICE. If you find we're wrong, our iron-clad guarantee assures the return of every cent you've paid. Test our range 30 days at your home. The **IMPERIAL** includes features found in no other range—stone oven bottom, dustless ash sifter, odor-hood and oven thermometer. Praised by thousands of women.



Write for our stove and range book NOW. It's free.

The Imperial Steel Range Co.
369 Detroit Ave. Cleveland, O.

**BLUE WHITE
GENUINE
DIAMONDS
MODERATE PRICES
EASY
TERMS**

Buy direct from Importers and Save Dealer's Profits. Startling low prices—and pay in little amounts from time to time.

Certified Guarantee with every Diamond—guaranteeing its weight and quality. A safe way to buy and save money—no inconvenience—and have the Diamond now. Perfectly cut, blue white Diamonds, gleaming, sparkling, scintillating—genuine high quality. Not a cent to pay until you have examined the Diamond. We send you free magnifying glass. Any diamond in our

Beautifully Illustrated Diamond and Watch Free Catalog

will be sent for examination without obligation. This offer is open to every honest person—OPEN TO YOU. Note the wonderful values shown here—No. 40—1.2 kt.; No. 42—5.8 kt.; No. 45—3.4-1.16 kt.; No. 46—3.8 kt.; No. 47—5.8 kt.; No. 48—3.8, 1-16 kt.; No. 49—5.8, 1-16 kt. Compare these prices with others. We import the rough Diamonds, cut them here, save 33 percent duty. Give the saving to you. Write today for our

BIG CATALOG and SPECIAL WORLD-BEATING OFFER of

One Carat Diamonds for only \$100.

All Diamonds, also watches, on easy terms—no money first. Send for Catalog today.

**The Walker Edmund Co.,
DIAMOND IMPORTERS
Dept. C
State and
Madison Sts.,
Chicago,
Ill.**



**SHIPPED
FREE**

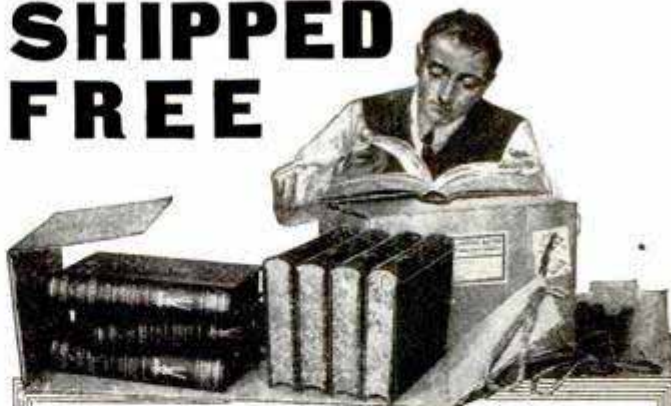

We will send this great civil engineering reference library to you, **Express Prepaid**, for seven days' free examination; returnable at our expense. If you decide to keep the books, you can buy them at almost half the regular price, payable in small monthly installments. Whether student, worker or expert, you can gain from these eight volumes an intimate knowledge of your work—knowledge which will eventually mean success and higher pay. **The work of twenty-seven experts**, this library is recognized as a standard reference work by technical schools, libraries and practical men throughout the country.

**The Complete Cyclopedia of
Civil Engineering**

contains 3,900 pages, 7x10 inches; 3,000 illustrations, full page plates, diagrams, etc.; hundreds of valuable tables and formulas; carefully cross-indexed for quick, easy reference. The books are substantially bound in half red morocco, gold stamped, and are printed in large, clear type on special quality paper.

Important Subjects Covered

Plane Surveying—Mechanical Drawing—Plotting and Topography—Railroad Engineering—Statics—Strength of Materials—Roof Trusses—Mill Building Construction—Cost Analysis in Relation to Engineering—Masonry and Reinforced Concrete—Steel Construction—Practical Problems in Construction—Bridge Engineering—Highway Construction—Hydraulics—Water Supply—Irrigation Engineering—Water Power Development—Sewers and Drains—House Drainage and Sanitation—River and Harbor Improvements.

Sent Absolutely Free—Express Prepaid

The complete eight volumes, not a sample volume, will be sent, express prepaid, for seven days' free examination; returnable at our expense if they fail to come up to your expectations. If you keep the books, pay \$2.00 seven days after receipt and then \$2.00 a month until you have paid the special introductory price of \$24.80. The regular price of this great Cyclopedia is \$40.00.

Just fill in and mail the coupon. It won't cost you a cent to examine these books. We know they'll be worth many times their cost to you. Mail the coupon now and you will receive your books promptly.

Another Great Free Offer!

With every set is included a year's Consulting Membership, regular value \$12.00, entitling you to the free advice of a staff of expert Civil Engineers. This will give you practical help in handling working problems which are too specific to be taken up in detail in the cyclopedia. There will be no limit to this service. A single problem solved for you might be worth more than the first cost of the books.

American Technical Society, Chicago, U.S.A.

FREE EXAMINATION COUPON

American Technical Society, Chicago, U.S.A.

Please send set Cyclopedia of Civil Engineering for 7 days' free examination. I will send \$2.00 within 7 days and \$2.00 a month until I have paid \$24.80, or notify you and hold the books subject to your order. Title not to pass until fully paid. Pop. Mech. 11-13

NAME.....
ADDRESS.....
OCCUPATION.....
REFERENCE.....

Please Mention Popular Mechanics

Boy Electrician with 75 illustrations for making Batteries, Dynamos, Motors,

Telegraph apparatus, Telephone, Lights, Bells, Alarms, Coils, "Wireless" Current Reverser, Electric Engine, Etc. By Electrical Experts so that anyone can understand it. With Cat. All 10c Ppd.

J. C. DORN, 705 So. Dearborn St., Dept. 21, Chicago, Ill.



Big Entertainer 320 Jokes and Riddles, 153 Parlor Games and Magic, 15 Tricks with Cards, 73 Toasts, 7

Comic Recitations, 3 Monologues, 22 Funny Readings. Also Checkers, Chess, Dominoes, Fox and Geese, 9 Men Morris. All 10c. postpaid.

J. C. DORN, 700 So. Dearborn Street, Dept. 17, Chicago, Ill.



Boys' Own Toy Maker

Tells how to make a Talking Machine, Camera, Electrical Motor, Bicycle Boat, Canoe, Boomerang, Bobbed, Wind Mill, Microscope, Water Wheel and Motor, Stilts, Toboggan, Snow Conster and Sail Boat, Telephone, Electric Bell, Railroad Wind Mobile, Paddle Raft, Traps, Kites, etc. All 10c, postpaid.

J. C. DORN, 707 So. Dearborn St., Dept. 38, Chicago, Ill.

Small Gas and Gasoline Engines

Air and Water Cooled. 1/4 - 1/2 and 1 H.P.

Unsurpassed for laboratory, experimental work and for operating washing machines and light machinery. Can be used for small individual electric light plants; complete circulars for stamp, also big catalogue of steam engines, boilers, pumps, electrical goods for 10 cents (coin preferred) refunded first order. If in need of an engine write today.

**AMATEUR MECHANICS SUPPLY CO.
860 G Monadnock Block, CHICAGO**



AERO-BOB

BOYS' MOTOR SLED

Goes like the wind on ice or snow or wheels in the summer. Simple design, easy and cheap to build. Send 25c for large working drawing, written instructions and directions for making propeller.



THE IDEA SHOP, Dept. I, BUFFALO, N. Y.



LB4901. 18K Lewy Solitaire, Platinum Setting. Violet Blue Diamond. \$48.50



LB4902. 14K. Twin Ring, Plat. Stg.. Two matched Blue White Diamond \$110.00



Platinum La Valliere. Paved with Steel Blue Diamonds
LB 4903. Platinum Chain. \$75.00

VIOLET BLUE DIAMONDS

WHITE Your choice from our **\$1,000,000.00** stock for **FREE EXAMINATION**

LEWY BROS. CO.
DIAMONDS

NOW IS THE TIME TO BUY A DIAMOND
The new tariff law raises the duty to 20%! Act quickly if you want a diamond at our present importers' prices!

DIAMONDS of QUALITY APPROVED BY OUR EXPERTS
Nothing in our stock less fine in color than the best **BLUE WHITE**; you are assured the utmost in **QUALITY** if your diamond comes from us. Our standards of Quality in selling to you are the same as followed by our experts when they buy in Europe. **STEEL BLUE** means **STEEL BLUE**; **PERFECT** means **PERFECT** with Lewy Bros. Co.

LEWY BROS. CO. GUARANTEE is in writing—tells you legally, color, perfection of every diamond. It guarantees to you **12% per year MORE THAN YOU PAID!** in exchange, any time. We are the only importers in the world who give you the full benefit of the 12% yearly rise in diamond values. Full price refunded if not satisfied. Protect your investment with our Guarantee.

WE SEND YOU ANY DIAMOND AT OUR EXPENSE, ALLOW EXAMINATION—NO OBLIGATION TO PURCHASE

FREE!

LEWY DIAMOND BOOK! Illustrated. Considered by experts the most practical, beautiful and costly book for the guidance of diamond buyers ever produced. Write for a free copy right away!—and learn facts about Diamond Qualities and values it has taken our experts 78 years to acquire.

Most Prominent Diamond House in Chicago—Founded 1835—79th Year
LEWY BROS. CO., DEPT. E27 STATE & CHICAGO ADAMS STS.

LB4904. Lewy Tooth Ring. 14K Solid Gold Mounting. Steel Blue Diamond. \$64.00



LB4905. Special Lewy Solitaire, Blue White Diamond. \$125.00



LB4906. 14K Solitaire Stud. Blue White Diamond. \$80.00



LB4907. 14K Solitaire Scarf Pin, Steel Blue Diamond. \$48.50

WASH WITH COMPRESSED AIR

THE RAPID VACUUM WASHER

THE NEW WAY

NO wear, no tear. Daintiest articles washed without injury. Tub of clothes washed in 5 to 10 minutes. A child can operate it. It is well made and as light as a washboard.

Price \$2.50 and \$3.00

Instantaneously attached to any stationary, ordinary wooden or sheet metal tub.

Send for 30 day trial offer and terms to agents.

STEWART-SKINNER CO.
26 Cherry Street, Worcester, Mass.

GOOD YEAR

AKRON, OHIO.

NO-RIM-CUT TIRES
10% Oversize—save half on tire bills—Write for latest Tire Book.

THE GOODYEAR TIRE & RUBBER COMPANY, Main Office and Factory, Akron, Ohio
Branches and Agencies in 103 Principal Cities. More Service Stations than Any Other Tire

Sealskins gathered this year from the government stations on St. George and St. Paul Islands, Alaska, amounted to 2,400, and are worth about \$1,000,000. Last year the catch was 5,000 sealskins. Seals are killed only to furnish food for the Eskimos of the islands.

TOLEDO MARINE MOTORS

"Nothing Cheap but the Price"

| | |
|-------------------------|----------|
| 3 H. P. 1 cyl. complete | \$ 65.00 |
| 6 H. P. 1 " " | 84.00 |
| 6 H. P. 2 " " | 125.00 |
| 12 H. P. 2 " " | 160.00 |
| 18 H. P. 3 " " | 250.00 |

Fully guaranteed by a responsible concern. 2 cycle, 2 port, 3 1/2 x 3 1/2 and 4 1/2 x 4 1/2. Send for free catalog "C."

THE UNIVERSAL MACHINE CO., Pike Ave., Bowling Green, O.



TERMS TO SUIT

Write for Catalogue A3

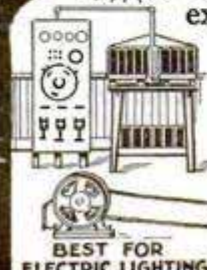

BEST FOR ELECTRIC LIGHTING

FREE TRIAL FOR 30 DAYS

NON-CRANKING KEROSENE ENGINE

"The Masterpiece of the Largest Manufacturers of Two-Cycle Engines in the World"

It is unusual to find in any one piece of machinery so many exclusive features as in the famous Bessemer Gaso-Kero engine.

The Wonderful Bessemer Gaso-Kero Engine

The Bessemer Universal Fuel Feeder automatically regulates the fuel feed for heavy or light load—the sensitive Bessemer governor absolutely prevents "racing"—the perfectly balanced Bessemer sub-base prevents vibration, the thing that wrecks many an engine. Thus, Gaso-Keros go to their work day in and day out, year in and year out, noiselessly, surely, economically. If you would like to know more about the "best little workers in the world," write us. 2 to 350 H. P.; two-cycle. 30 days free trial. Write for Catalog A3.

BESSEMER GAS ENGINE CO., Largest Makers of Two-Cycle Engines in the World



Immediate Shipment

121 Lincoln Ave., Grove City, Pa.

Patents

**Trade Marks and
Copyrights Secured
or Fee Returned**

Special Offer—Free Search of Patent Office Records

Send us a model or sketch and description of your invention, and we will make a *Free Search* of the *Patent Office Records* to ascertain if it is patentable. If we report the invention patentable, we will guarantee to obtain a patent or return our fee, and furnish a certificate of patentability backed by a bonded contract to that effect.

This Certificate of Patentability will protect the inventor and serve as proof of the invention until the case can be filed in the U. S. Patent Office.

Obtaining Assistance for Inventors

Our certificate is of great assistance to inventors who require financial aid to obtain patents.

Our Four Books Mailed Free

to any address. Send for these books—the finest publications ever issued for free distribution.

How to Obtain a Patent

Our illustrated eighty-page Guide Book is a book of reference for inventors, and contains 100 mechanical movements illustrated and described.

Fortunes in Patents

Tells how to invent for profit, and gives history of successful inventions.

What to Invent

Contains a valuable **LIST OF INVENTIONS WANTED** and suggestions concerning profitable fields of invention; also information regarding prizes offered for inventions, among which is

Prize of One Million Dollars

offered for one invention, and \$10,000 for others.

Patents That Pay

Contains letters from our clients who have built up profitable enterprises founded upon patents procured by us; also endorsements from prominent inventors, manufacturers, Senators, Congressmen, Governors, etc.

We Advertise Our Clients' Inventions Free

In a list of Sunday newspapers with two million circulation, in manufacturers' journals and in the *World's Progress*. Sample Copy Free. We save you time and money in securing patents. After the patent is granted we assist you **TO SELL YOUR PATENT**.

Foreign Patents

WE HAVE DIRECT AGENCIES IN ALL THE PRINCIPAL FOREIGN COUNTRIES and secure **FOREIGN PATENTS** in the shortest possible **TIME** and at the **LOWEST COST**. Write for our Illustrated Guide Book on Foreign Patents, sent free to any address.

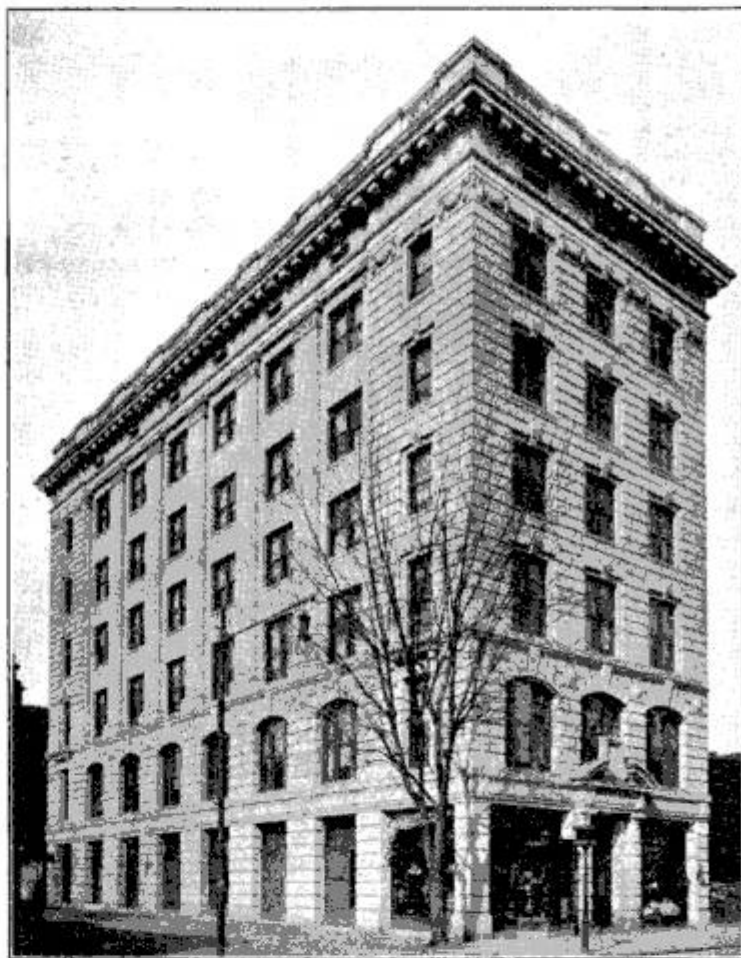

VICTOR BUILDING

Our new \$150,000 building opposite U. S. Patent Office
SPECIALLY ERECTED by us for OUR own use

WANTED NEW IDEAS

Send for **LIST OF PATENT BUYERS** who consult us when purchasing patents. Contains requests from **MANUFACTURERS, MAIL ORDER HOUSES** and **PROMOTERS** for patents secured by us, and suggestions as to **New Ideas** they wish to purchase. We invite **manufacturers and promoters** to address our Sales Department regarding the purchase or leasing of a number of meritorious patents secured by us.

REFERENCES

Second National Bank, Washington, D. C.

Union Savings Bank, Washington, D. C.

Chamber of Commerce, Washington, D. C.

Pitner Gasoline Lighting Co., Chicago, Ill.

National Savings and Trust Co., Washington, D. C.

R. G. Dun & Co., Washington, D. C.

Smethport Glass Co., Smethport, Pa.

The Melvin Gauge and Signal Co., Scranton, Pa.

M. Winter Lumber Co., Sheboygan, Wis.

VICTOR J. EVANS & CO., Patent Attorneys

NEW YORK OFFICES: 132 Nassau St.

PHILADELPHIA OFFICES: 1429 Chestnut St.

Main Offices: 724-726 9th St., N. W., WASHINGTON, D. C.

PATENT YOUR IDEAS

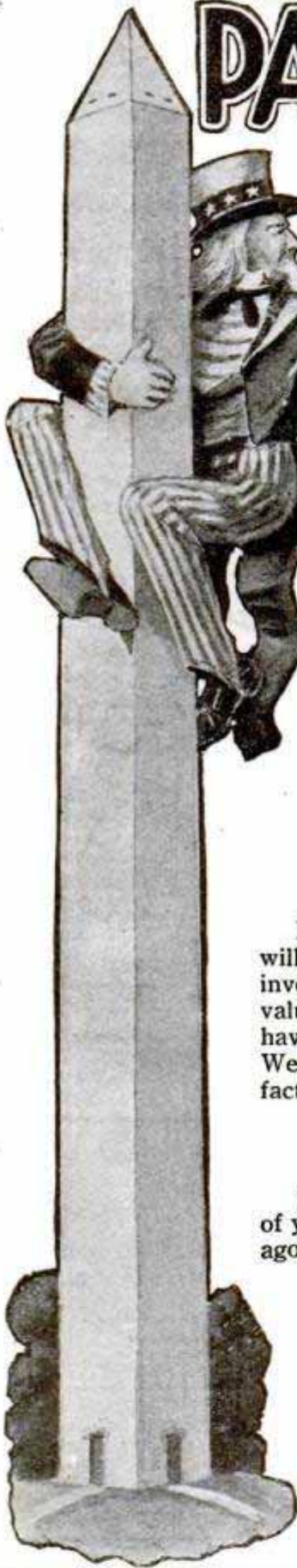

*—There is a Constant Demand
for Good Inventions*

Thousands of the biggest money-making inventions have been the "little" things that have made people wonder why they were never thought of before.

"WHAT TO INVENT"

and

"HOW TO OBTAIN A PATENT"

These Books Sent Free

If you have an invention send us a sketch, photograph or model of it. We will give you a report as to its patentability absolutely free. If you have no invention send for our book, "What to Invent." It contains hundreds of valuable suggestions. We are recognized authorities on patent matters and have helped hundreds to find a ready and profitable market for their ideas. We can prove it. If you wish to sell your patent we will advertise it in manufacturers' journals at our expense.

Don't Wait—Find Out NOW!

Your idea will never do you any good if some one else patents it ahead of you. Act quick! Let the other fellow say "he thought of it a long time ago." You reap the profit. Let the others wish they had.

Advice Free—All Matters Confidential

We have secured patents for thousands of inventors and have many letters proving the value of our services. Write us. Send rough drawing or model of your invention for our opinion. We will guard it carefully and report quickly. You are under no obligations to proceed further. Our plan is simply a square deal to all. Our books, "What to Invent" and "How to Obtain a Patent" are the best publications written for the man who has an idea to patent, or who is of an inventive turn of mind. They show just how to proceed with your idea and tell of hundreds of things to invent. We gladly send these books free. The sooner you write for them the sooner you will know all about patents and the many different lines in which new inventions or improvements may be made.

If you have an invention send us a sketch of it for report and ask for the books at the same time.

CHANDLEE & CHANDLEE, 945 F Street, Washington, D. C.

REGISTERED ATTORNEYS

(Combined with H. Ellis Chandlee & Co.)

PATENTS THAT PROTECT and PAY

Advice free. Terms reasonable. Highest references. Best results.

Send sketch or model for FREE examination and opinion.

Recommended Patent Lawyer in the Bankers' Register and special list of selected lawyers. Also in Martindale's Law Directory, Sharp and Alleman's Directory of Lawyers, The Gast-Paul Directory of Lawyers, and Kime's International Law Directory.

ALL BUSINESS GIVEN PROMPT AND PROPER ATTENTION

A large list of strong recommendations furnished free

WATSON E. COLEMAN, Patent Lawyer, 622 F St., N.W., Washington, D.C.

PATENTS OF FULL VALUE OBTAINED OR ALL FEES BACK

Write us at once for particulars, and proof that we will aid you most to get most money for your invention.
E. S. & A. B. LACEY, Dept. M, Washington, D. C. Estab. 1869.

PATENTS

C. L. PARKER
Formerly Member Examining
Corps, U. S. Patent Office
PATENT LAWYER
210 MCGILL BLDG.
WASHINGTON, D. C.

Patents, Trade Marks, Copyrights, Patent Litigation

Handbook for Inventors, "Protecting, Exploiting and Selling Inventions" sent free upon request.

There is a man in Wall Street who, for thirty years, has invested or speculated in mining stocks on a system, and has not yet cashed a bet. He bought only the cheapest stocks, paying in no case more than fifteen

PATENTS THAT PAY— \$561,530 Made

by clients. Patent Book—"What and How to Invent—Proof of Fortunes in Patents"—FREE. 112 page guide.
E. E. VROOMAN, Pat. Atty., 871 F St., Washington, D. C.

LEARN HOW A PATENT MAY BE MADE VALUABLE

Send for This **FREE BOOK** which tells you **What You Should Know What To Invent What NOT To Invent How To Sell Your Patent**

Copies of nearest Patents and report in every case without charge
H. L. WOODWARD, 9th & G Sts., Washington, D.C.



Quality

is of course the most essential requisite of a lathe for **Garage work**, as well as for **Automobile and general repair work**. We have it in our lathes, but we have kept the **price very low**.

We would be glad of an opportunity of convincing you that we offer both **high quality and low price** in the **Sebastian Lathe**. Our catalog free.

The Sebastian Lathe Co.

107 Culvert Street CINCINNATI, OHIO

PATENT POINTERS

Things to know before applying for a patent:

1. Is my invention perfected or complete?
2. Is it new and patentable? If so, what will a patent cost?
3. Does it infringe any patent?
4. Is there a demand for such an invention?
5. Can a demand be created at reasonable expense?
6. What will it cost to demonstrate the utility of and demand for my invention?
7. Who are likely to be interested in the manufacture and sale of such inventions?
8. Where can I get reliable information and advice on the above points?

We will be glad to demonstrate to your satisfaction that we can render the service required to fully post you upon the above points.

BENJAMIN AND BASSETT

Patent Attorneys and Mechanical Experts

Provident Savings Bank Bldg., WASHINGTON, D. C.

MOTOR AND DYNAMO BARGAINS

Send for Bulletin 22

If you do not read our Monthly Bargain Bulletin, you are overlooking many good things. Ask for it today. It's free.

We Buy and Sell Electrical Machinery of All Kinds paying cash for anything you may have outgrown, or giving you a liberal allowance on either new or rebuilt apparatus carrying our ironclad guaranty. Prompt repairs—nation-wide service—pleased patrons everywhere.



WE DO NOT HANDLE NOVELTIES OR TOYS

THE F. BISSELL CO., 226 Huron St., Toledo, Ohio



A PRIVATE WATER SYSTEM

at low first cost and no operating expense is supplied by a

RIFE RAM

This ram will pump and deliver where you want it, either into a pneumatic or open tank, any quantity of water.

It operates automatically with the overflow from a stream, artesian well or spring amounting to 3 or more gallons per minute and a head or slanting fall of 3 or more feet.



If you haven't these conditions, we can supply the best gasoline-engine pumping system

Free booklet on request

RIFE ENGINE COMPANY

2131 Trinity Bldg., NEW YORK CITY

JARVIS POWER PUMP

An absolute necessity for country and suburban homes. Furnishes an endless supply of water from any ordinary well and does away with hand-pumping. Can be operated by electric motor or gasoline engine. Once started, needs no further attention except oiling occasionally. The cost of operation is a mere trifle. Easily and quickly installed by anyone. We supply everything necessary—pipe fittings, fixtures, etc. Send today for catalog No. 20, which is a valuable guide on water supply systems.

DEALERS—Write for our interesting proposition.

Jarvis Engine & Machine Works
Lansing, Mich.

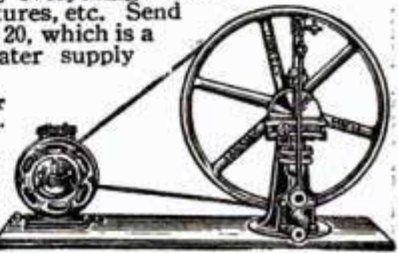

would a share, expecting, of course, that most of them would prove worthless, but hoping that some few might appreciate in value, and make the speculation, as a whole, a winning one. The net result of his opera-



MECHANICAL SUPPLIES AND MATERIAL of all kinds. EXPERIMENTAL AND LIGHT MACHINE WORK to order. 132 MILK STREET. BOSTON



BRASS GEARS

Cut by an entirely new process. The most accurate made and at prices that cannot be equaled by others. Every gear has a hub, center painted ebony black, edges turned true, highest grade red brass, and much heavier than others. We carry the largest stock in the world and every gear listed is always shipped on date of order.

SEND FOR CIRCULARS
CHICAGO STOCK GEAR WORKS
16 S. Fifth Av. Chicago

DO YOU HAVE KNIVES TO GRIND, SILVER TO POLISH, SMALL TOOLS TO OPERATE, WASHING MACHINES OR WRINGERS TO RUN? LET THE RED DEVIL

DO YOUR WORK

Attached to any water faucet will develop up to 3 Horse Power according to size of pipe and water pressure. Only perfect small motor made. Improved bucket wheel construction.

6 in. Motor for Mechanics and Tradesmen. Washing Machine, 1/2 H. P., on 1/2 in. pipe, 80 lbs. water pressure; 1 H. P., on 60 lbs. pressure, 2 in. pipe. Net price \$55, cash with order.

No. 1482—4 in. Motor for grinding, polishing, fans, sewing machines; for Doctors, Dentists, Druggists, etc., with emery, buffing wheel, silver polish and pulley, \$3.

No. 1493—4 in. Motor and pulley only \$2.50, cash with order. Money back for any reason. Order your motor from dealer or from us. Send your water pressure and size of supply pipe. Active Agents wanted. Catalog free.

Only Motor to do this work



DIVINE WATER MOTOR CO
DEPT P. UTICA, N.Y.



The Crescent UNIVERSAL WOOD WORKER

is complete, substantial, and durable. It consists of hand saw, jointer, saw table, shaper, borer, panel raiser, tenoner, moulder, mortiser, knife grinder, disk grinder, and will do all the work in the average wood shop. Ask for catalog giving complete description and telling about our line of band saws, jointers, saw tables, planers, shapers, disk grinders, swing saws, planers and matchers, variety wood workers.

THE CRESCENT MACHINE CO.
93 Columbia St. LEETONIA, OHIO

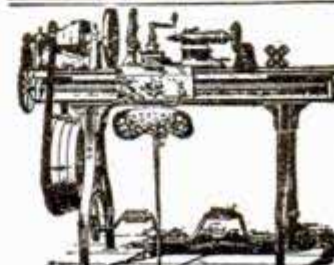

LATHES

9 to 13-inch Swing
List price \$75 and up according to size. When ready to buy send for Lathe Catalog and prices.

W. F. & John Barnes Co.
100 Ruby Street, ROCKFORD, ILL.

Superior Woodworking Machinery

A modern line of woodworking machinery for Furniture Factories—Piano Factories—Box Factories—Cabinet Shops—Pattern Shops—Carpenter Shops—Wagon Shops—Repair Shops—Contractors—Manual Training Schools, etc. If interested write for our catalogue and net prices.

Largest manufacturers of woodworking machinery in Chicago.

Jones Superior Machine Co.
1266 W. North Ave., CHICAGO

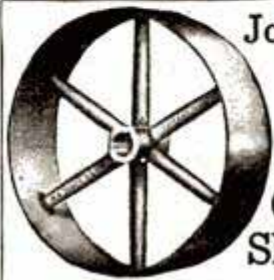
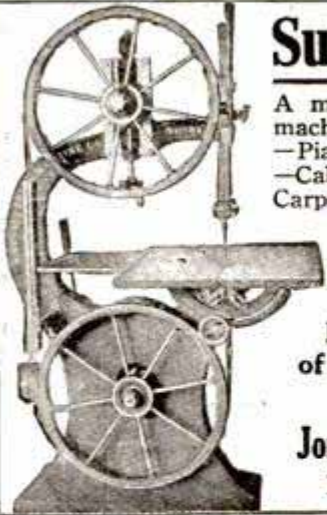

Jones Machine Moulded
PULLEYS
and **GEARS**
Clutches, Sprockets
Shafting and Hangers

THE LARGEST LINE OF
Power Transmitting Appliances
IN THE COUNTRY

SEND FOR GENERAL CATALOGUE A18

W. A. JONES FOUNDRY & MACHINE CO.
1400 North Ave. CHICAGO

BAR BENDERS

For Concrete Reinforcements

WRITE FOR OUR
BENDING TOOL
CATALOGUE.

Wallace Supply Co. 121 No. Jefferson St., Chicago
233 Broadway New York City



Tool Cases for Machinists & Toolmakers

You need one of the many styles shown in our free catalogue. They are the best built and most practical on the market and it's the up-to-date way to keep tools in good condition and orderly arranged. We ship direct to you and guarantee complete satisfaction.

J. Gerstner & Sons

Mfrs. of Mechanics' High Grade Tool Cases
818 Germantown Street, DAYTON, OHIO



PIONEER TRUST and SAVINGS BANK

The enormous, rapid development of Wyoming makes it safe for us to pay 6 per cent—the highest savings bank interest rate—because legal interest rate in Wyoming is 8 to 12 per cent. Our stringent banking laws give you the same protection you get at home. Why be content with 3 to 4 per cent when we will pay you 6 per cent? Write today for booklet, also how to get miniature bank FREE.
Pioneer Trust & Savings Bank, 12 Pioneer Bldg., Basin, Wyo.

INVENTORS Our Brain Belongs to You. Our Ideas Are Free of Charge.

All we want in return is to build your model, special machinery, dies, tools and jigs to manufacture sheet metal goods, etc. We are expert mechanics, over thirty years experience and have one of the best equipped shops in the country. Ask for Booklet No. 17. Consultation free. Experimental work strictly confidential.

A. NACKE & SON
236-242 S. 9th St., Philadelphia, Pa.



Active Powers of Inventive Genius

Stanley Tools



Stanley Edge Trimming Plane

☞ A unique and comparatively new Plane that is rapidly finding its way into the "kits" of those who pride themselves upon having an up-to-date set of tools.

☞ It is designed especially for trimming or smoothing the ends of boards, such as sidings, shelving, etc., for a square or close fit. It has a right angle rest or guide from the cutter edge and the cutter works on a skew giving an easy shaving cut. In the rest or guide are two screw holes to which wood blocks of various bevels may be attached enabling the user to make a slanting cut.

☞ The cutter is made of high grade English steel and the entire Plane is neatly japanned.

Price \$1.15

☞ If you cannot procure this tool from your Hardware Dealer, we will forward same, postage prepaid, to any part of the United States.

ADDRESS

STANLEY RULE & LEVEL CO.
NEW BRITAIN, CONN. U.S.A.



THE Whole Bit Looks Right When He Sees the IRWIN Stamp

He has learned from Irwin users that "Irwin" means quality in service, because of quality in manufacture. He knows every Irwin bit is guaranteed; price refunded if not satisfactory. And these are the reasons for universal satisfaction.

The only solid-center-stem auger bit made in all sizes and styles for every purpose—6,500 to choose from so you are sure to find just exactly what is best suited to your purpose in the Irwin line.

A bit that will not break when boring into the side or end of the hardest wood—that will not tear the softest wood.

A bit that will not choke because made with but one crimp.

A bit of uniform strength, made of one piece of flawless, extra high-grade crucible auger-bit steel, and tempered by the secret Irwin Process. The Irwin will not bend, but cuts clean, rapid and true for an indefinite period.

If you can't get an Irwin at your dealer's, write us.

The Irwin Auger Bit Co.

Station K12, Wilmington, O.

Largest in the World.

The IRWIN BIT

THE MASTER SLIDE RULE,



the only **RULE IN THE WORLD** whereby inside measurements of doors and windows, etc., can be taken rapidly and accurately. Also superior to any other rule for outside measurements of walls and ceilings, etc., as it can be extended and closed instantly. **MECHANICS, BUILDERS, AND ARCHITECTS, TRY ONE TODAY! DON'T WAIT.** Ask hardware dealer for it. On receipt of 15 cents per lineal foot, a 4, 5, 6 or 8 foot rule will be sent to you prepaid. Large profits to agents. Write for circulars and particulars. **DAHL MFG. CO. 51-A East 42nd St. NEW YORK CITY**

tions is that, in the period of thirty years, he has accumulated 1,298,404 shares of 155 different varieties of mining stocks, that the stocks stand him in \$125,000, that none of them ever paid a dividend, and that there is now a bid price for only four of the 155 varieties. His holdings of these four he could sell for approximately \$250.—Wall Street Journal.

GASOLINE SOLDERING IRON BLOW TORCH

A Savage Heat in 60 Seconds. Write today.  **EMMELMANN BROS. MFG. CO., INDIANAPOLIS, IND., U.S.A.**

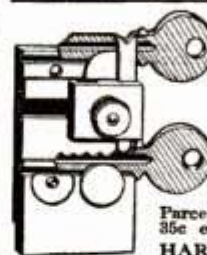

Duplicate Keys for all Pin Tumbler Locks can be made in a minute with The Harrison M. I. P. Key Filing Machine

Invaluable for Machinists, Building Superintendents, Hardware and Repair Shops, Locksmiths, Carpenters, Electricians, Garages, etc. Anyone can make a perfect duplicate key without injuring the original. A customer writes: "We made 55 keys in one hour and 15 minutes. Can you beat it?" Every machine unconditionally guaranteed, money refunded if not entirely satisfactory. Price \$3.00 net. Send us P. O. order or N. Y. draft and receive the complete machine by return Parcel Post. Special diamond shaped files for angular keys 35c each or 4 for \$1.00. Testimonials sent on application. **HARRISON & COMPANY, 81 1/2 New Street, NEW YORK**

A New LUFKIN RULE

THE "ALLEN" 6" MACHINISTS' SCALE

An Absolutely New Idea. One side in 16ths and 32nds. Other side graduated odd 64ths.

Only 16 Lines to the Inch and yet Measures Down to 64ths

Very easy to read and sure to be read right.

Price: 50 Cents Each, Postpaid

THE LUFKIN RULE CO. Saginaw, Mich. New York

Portable Cases

FOR TOOL MAKERS AND MACHINISTS

Twelve styles, felt lined drawers, solid brass trimmings, best of material, beautiful finish, low prices, satisfaction guaranteed. Ask for booklet of cases built for service.

The Pilliod Lumber Co. SWANTON, OHIO



SIDE VIEW



TOP VIEW

NEW IMPROVEMENTS WITH COMPASS NOW MAKE

The American Combined Level and Grade Finder Most Practical, Durable and Convenient Instrument Made

At one glance you can get the true slant on any line or grade either in degrees, inches or percentage, or all at the same time, and will at once give the exact distance needed to plumb up to a true level. The additional spirit level glass now placed in middle of instrument with points on dial will give 3 grades for leveling. The longitudinal recess shown in cut is well worth the low price of the instrument. Write AT ONCE for circular and Testimonials. Special Introductory Price given to First Applicants with privilege of taking Agency. Address **EDWARD HELB, Mfr., Box 75, RAILROAD, PENNA.**



On Delicate Apparatus where little screws cause so much bother, use a **Starrett Screw Holder and Driver**

☞ This is a screw-driver that everyone who works on fine mechanisms should have. It is just the thing for watchmakers, opticians, and electricians. You can hold and insert screws in all sorts of difficult places where you could not possibly use your fingers. It saves temper and finger nails. The jaws of the holder will pick up the head of the smallest screw and hold it in place. When not needed the holder may be slipped back on the blade out of the way.

Send for Catalog 20 AP

The L. S. Starrett Co., Athol, Mass.

NEW YORK

LONDON

CHICAGO

42-70



Grobet Swiss Files
and other high-class Tools
are shown in "THE TOOL-
MONGER" — it's 465 pages,
and will be mailed on receipt of 8 cents in stamps.
**MONTGOMERY & CO., 107 Fulton Street
NEW YORK CITY**

LONG JAPANESE RAILROAD BRIDGE—A rail-
road bridge 36,000 ft. long has just been completed in
central Japan at Teuryugawa at a cost of \$375,000. It
has been constructed entirely of Japanese materials.

\$1.00
Postpaid
Myers' Wonderful Sewing Awl
sews leather, canvas, shoes—anything, heavy or light. Complete
repair shop in itself. Saves many trips to town. Mends harness,
saddles, wagon covers, blankets, buggy tops, belts, etc. Can't get
out of order. Original and only awl with diamond point full grooved
needle to protect the thread. **BIG MONEY FOR AGENTS.**
C. A. MYERS CO., 6339 Lexington Ave., Chicago, Ill.



WHEN YOU WANT ANYTHING AND DON'T KNOW
WHERE TO FIND IT—WRITE BUREAU OF
INFORMATION, POPULAR MECHANICS, CHICAGO

\$5.00 CALCULATING MACHINE, \$2.50

There seems to be a misunderstanding about what the Slide Rule will accomplish, many think it an instrument, the use of which is applicable only to Engineers and Technical men. So frequently have I heard this remark that I have completely re-written and enlarged my instruction book, **The Slide Rule Simplified**, which shows the actual setting of the rule by 90 full size engravings, 52 pages 7x10, each illustration and example is explained and "written so you can understand it." In fact any person who has never seen a Slide Rule, and not a technical person, could not help but learn its use. The examples selected and shown by illustrations are those which frequently come up for solution by the Banker, Broker, Auditor, Inventory and Insurance Man, Cost Estimator, Printer, Paper Mfr., Contractor, Salesman, Time-Keeper, Bookkeeper, Lumber, Land, Marine, and other merchants too numerous to mention.

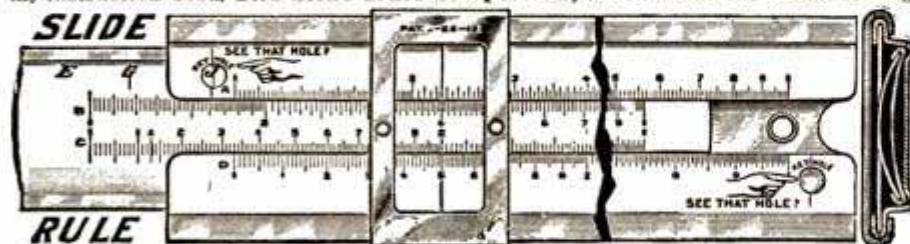

This Slide Rule will multiply, divide, add and subtract, solve proportion, extract the square and cube roots, find the decimal equivalent of vulgar fractions or "vice versa," calculate interest, percentage. Also the mensuration of superficies, and the rule of three. For Engineers, Electricians, Draftsmen, Superintendents, Master Mechanics, etc., the rule is indispensable in their work. It is one of the most valuable instruments ever offered to mankind. For Electricians it is a complete wire table in itself. The Richardson Direct Reading Slide Rule is specially designed for those who wish to learn its use, its operation being very simple. You simply place the key to the problem wanted in the keyhole (the key is printed in red on slide, see cut) and answer is given direct: such as the Horse Power of Engines, Pumps, Boilers, Belts, Water Falls; size of duct for ventilating; radiation and size grate, and steam main; change gear and pulley problems; areas, circumference and diameter of circles. This Rule is my 1914 type now on the market for the first time. Made in two sizes, coat and vest pocket 10"x1 1/2"x1/4" and 5 1/2"x1 1/4"x1/4". 10" has Sine, Log, and Tangent scales. No wood in their construction, scales white celluloid, printed from engine divided plates in two colors, and washable, secured by an improved locking device in an absolutely non-corrodible Monel Metal framing. Blackened to ease the eyes. Price of 10" Rule, ordinary case, \$2.50 Postpaid. Full leather case, 50c. extra. 5" rule and full leather case, \$2.50. 10" rule, bristol board scales, \$1.00. If ordered now the book, **The Slide Rule Simplified**, goes FREE with each rule. If interested in forming Clubs write for large list of tools GIVEN FREE.

Geo. W. Richardson

CONSULTING ENGINEER
Ex-Chief Electrician, U.S. Navy

4218 24th Place
CHICAGO, U. S. A.





Fits Any Screw

HERE'S a suggestion for a Christmas gift of real value and usefulness to the man who uses tools: This "Yankee" Magazine Ratchet Screw-driver fits any size screw from the great big fellows to the tiny ones.

The magazine in the handle carries four different size blades, $\frac{1}{8}$ ", $\frac{1}{4}$ ", $\frac{5}{16}$ " and $\frac{3}{8}$ ". They are quickly slipped in the slot at the end of the shank, and securely held by an ingenious "Yankee" device, yet are easily removable for changing.

Right hand and left hand ratchet; you drive or draw screws quickly and without changing your grip.

"Yankee" No. 65 Magazine Ratchet Screw-Driver

Made with the same care and precision and of the same high quality materials as are used in all "Yankee" tools.

This Driver is extremely strong and durable; made with six inch shank, as illustrated, also one inch shank to slip in your pocket.

"Yankee" No. 65

Price — 1 inch shank, 95c
6 inch shank, \$1.10

Your dealer can supply you

"Yankee" Tool Book" free for mechanics and householders — "Yankee" Tools in the Garage" free to automobilists.

North Bros.
Mfg. Co.
Philadelphia



"YANKEE" TOOLS
Make Better Mechanics

PETE TEACHES THE YOUNG TO USE Carborundum Sharpening Stones



PETE'S first advice to the budding carpenter or the student craftsman is:

"Learn to take the proper care of your tools, so, first of all, get a good oil stone. Get a stone that will cut the edge on the tool, not one that rubs it on. A stone that will cut quick, holds its shape, and not glaze."

The experienced workman, too, should heed Pete's advice. He means a Carborundum Sharpening Stone. Ask your hardware man to show you the rectangular or the round combination Carborundum Bench Stone.—They are the greatest stones for all around work you could ever put in your kit. For your gouges, get Carborundum gouge stones.

From your hardware dealer or order direct

The
Carborundum
Company
Niagara Falls, N. Y.





“Keep the Boys at Home”

Fit up a carpenter shop down in the basement this Fall—the boys will find it to be profitable as well as enjoyable.

A GRAND RAPIDS HOME BENCH

will give the proper working surface and enable them to do the work as it should be done—conveniently and satisfactorily.

This bench is built from Hard Maple with top having the double tongue and groove joint construction. It is 56 inches long, 32 inches high and 20 inches wide and furnished with or without storage cupboard.

Built and guaranteed by the largest manufacturers of Benches in the country.

Complete information of this and other benches for the Cabinet—Pattern—Carving and Metal-working shops given in our catalog. Write for copy.

GRAND RAPIDS HAND SCREW CO.
1620 Front Ave. GRAND RAPIDS, MICH.

PITTSBURGH LARGEST FUEL CONSUMER IN WORLD—Although Pittsburgh ranks fifth among the cities of the United States and has only about one-sixth the population of New York, its consumption of coal alone nearly equals that of the largest city in the country. Greater New York consumes between 18,000,000 and 20,000,000 tons of coal annually. The Pittsburgh district in 1912, according to the U. S. Geological Survey, consumed 17,721,783 tons of coal and about 5,000,000 tons of coke, or a total of about 22,700,000 tons, over 10 per cent more than all the boroughs of Greater New York.

Paper is Stronger Than Wood

Railroad car wheels have been made of paper, they are strong as steel. Wooden car wheels are never used. Wood splits. A genius has now invented indestructible paper file handles. They cannot split or splinter, are smooth and don't raise blisters. Hold the file tang with a grip many times as tight as that of wooden handles. Guarantee two new ones for every split handle returned. Remember that Elastic Grip Paper Handles will outlast a vast quantity of the ones you are using now. Low price—long life. Special offer: 50 ass't handles for one Dollar plus postage. Samples 10c prepaid. Ask your dealer. Agents wanted.

Schuchardt & Schutte, 90 West St., N. Y. 307 Coristine Bldg., Montreal, Can.



“Just apply and heat”
Use iron or torch
No acid—no rosin
Alcohol Torch
and 50c can
TINOL
Paste
Postpaid
\$1

SO EASY TO SOLDER WITH

the modern combined solder and non-acid flux
Paste and wire forms
Mends kitchen-ware instantly—A hundred uses in home, shop and laboratory

HESS & SON, Dept. F, Watkins Bldg., Phila., Pa.

Inseparable



—The practices of a first class machine shop and tools of WILLIAMS' QUALITY.

Better, because of removable swivel, toughened forgings, and tempered screws.



Better, because of knurled-screw-rapid-adjustment and toughened forgings.

You will find in them trustworthy provision for the holding and gripping of jobs, like ability for which, you, the vise and other equipment lack—inseparable tool-chest companions.

Get our prices for Superior Forgings to order



Better, because nut arrangement provides for minimum projection of dangerous screws.

Dependable Tools Catalog Free

J.H. Williams & Co.

47 Richards St. Brooklyn, N. Y. City

40 So. Clinton St. Chicago, Ill.

E. C. SIMMONS
KEEN KUTTER
TRADE MARK REG. CUTLERY U.S. PAT. OFF.
AND TOOLS

Guaranteed Tools

Perfect tools are not only an inspiration to do perfect work, but they are economical. Buy a Keen Kutter tool of any description and it will long outlast ordinary kinds because it is made of the right material. *It is built for long service.*

KEEN KUTTER Quality Tools

are backed by a trade mark famous for over 45 years. That trade mark is your lasting guarantee. Any tool that bears it you buy without hesitation, because it must be perfect or your dealer will give you a new tool or return your money.

"The Recollection of Quality Remains Long After the Price is Forgotten."
Trade Mark Registered. —E. C. SIMMONS.

If not at your dealer's, write us.
SIMMONS HARDWARE CO., Inc.
St. Louis New York Philadelphia
Toledo Minneapolis
Sioux City Wichita

Hand Saw, No. K58/26, Price \$2.00

Screw Driver
No. K50/8
Price \$0.50

Brace
No. KR12
Price \$2.35

Chisel
No. K8B1
Price \$0.75

You ought to have one of our Insured -VANDOR- Hammers



-VANDOR- Hammers are drop forged from Vanadium Steel, tempered in oil and are Warranted Against All Defects for a Lifetime

Attached to every **-VANDOR-** hammer is a numbered guarantee certificate, insuring lifetime service.

A **-VANDOR-** will bite and draw a headless nail that defies the claw of an ordinary hammer.

Sent by Parcel Post Anywhere — **-VANDOR-** —
Send us \$1 and your dealer's name. We'll ship the postpaid by return mail. Please state whether wanted for light or heavy work.

VAN DOREN MFG. CO., Dept. 108, CHICAGO HEIGHTS, ILL.
Reference 1st Nat. Bank, CHICAGO

STATEMENT OF OWNERSHIP, management, etc., of Popular Mechanics Magazine published monthly at Chicago, Ill., required by the Act of August 24, 1912:

Editor and business manager, H. H. Windsor; managing editor, F. P. Stockbridge; publisher, Popular Mechanics Co.; owner, H. H. Windsor. All at 318 W. Washington Street, Chicago, Ill. Bondholders, mortgagees and other security holders: None. (Signed) H. H. Windsor.

Sworn to and subscribed to before me this 22nd day of September, 1913. J. Graham, Notary Public.

FOR SEWING LEATHER

The Speedy Stitcher is the latest and best of anything ever offered for \$1.00.



Agents make over 200% profits.
Send at once for catalog and terms.

AUTOMATIC AWL CO., 26 Gardner Terrace, WORCESTER, MASS.

That's the Tool

in which you get more for your money than in any other tool of its class made, at the price.



Bench Drill Press No. 23

Readily attached to any bench; has Star chuck for shanks 0 to 3/8 in.; sensitive compound even feed; 6 1/2 in. between chuck and table; hand drive. A reliable tool for light work, and thoroughly well made throughout. The price — very low. If you need a good all-around bench drill, look this one up. We show this and many other styles in our Catalog, copy of which we shall be glad to send you.

MILLERS FALLS COMPANY, 28 Warren St., New York



Le Count's HEAVY STEEL Clamps

Extra heavy, with button on end of screw, hung on a ball in order to accommodate itself to irregularities without bending the screw. The foot of the clamp is planed. Illustrated Catalogue and prices on request. Manufactured over fifty years.

Wm. G. Le Count, Box 591, South Norwalk, Conn.

Rapid Floor Scraper \$28.00

Cash With Order
Money back if you don't like it. One man scrapes more floor than 3 by hand.



MONARCH MFG. CO.
5011 Shepard Bldg., Grand Rapids, Mich.

The B. & S. Line

"For the workman who cares,"—

Are you one of those workmen—one of those mechanics who admire a first-class job and strive to maintain the highest standard of workmanship?

We want to know you and want you to get acquainted with all **New B. & S. Tools.**

These latest additions and our other tools (with which you are no doubt familiar) are listed in the new Catalog No. 25.

Send your name today and we will mail you a copy of this new 365 page catalog.

BROWN & SHARPE MFG. CO.

Providence, R. I., U. S. A.

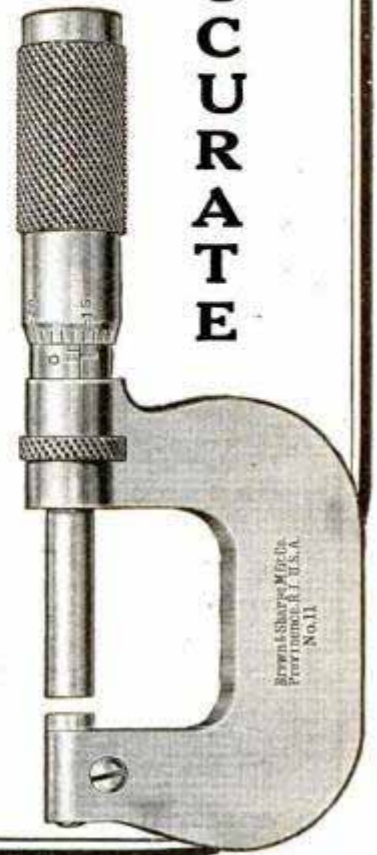

PATENTS BRING WEALTH; PROOF, BOOKS, ADVICE FREE
"PROFIT" Will teach you something about patents you never dreamed of. It's free also.
 A. J. Wederburn, Pat. Atty., Dept. 140, Washington, D. C.

Danda Leather Key-Purse



With Your Name Stamped In Gold
25c By Mail | **40c** With Pocket
 Postpaid | for Pen-Knife

It's convenient, prevents keys from rusting, saves the clothing and is a neat case for the pocket. Made of strong leather with key ring and your name handsomely embossed in gold letters on the purse. Write for illustrated Catalog of Danda leather goods and novelties.

Live-wire AGENTS Make Big Sales.
 DANDA P. S. MFG. CO., 82 JOHN ST., NEW YORK

PIPE-THREADING

8 sizes in one tool



BULL DOG
 No. 104 1/2

Handle all sizes of pipe from 1/2" to 2" in one die-stock.

This splendid range of sizes is combined with the Five Big Oster Features in the

OSTER DIE-STOCK

No. 104 1/2 of the famous **BULLDOG** line. Note these aids to quick, accurate and easy work. 1. Self-locking dies. 2. Self-locking guides. 3. No resetting. 4. No running back over newly cut threads. 5. No small breakable parts or loose bushings. Our booklet **The Bulldog Tale** explains each in detail. Yours by return mail.

THE OSTER MFG. CO.
 East 61st Street
 Cleveland
 Ohio
 (2100)



Kindly send "The Bulldog Tale."
 Name
 Address
 City
 State
 (2100)

REGISTERED

"Ohio" Edge Tools

are made from specially selected tool steel, by careful and skillful workmen. They are tempered by the most improved process and are sold with a money back guarantee.

Insist on "Ohio" Tools when buying Planes, Chisels, Drawing Knives, Auger Bits, Screw Drivers, etc.

CATALOGUE FREE
OHIO TOOL CO. (Dept. 3)
 Columbus, Ohio

As Much and More than 1/2 Saved On Unredeemed Pledges Diamonds and Watches

**Examine—If Satisfied, Pay—If Not, Return.
We Ship, Privilege of Examination**

Before buying a diamond or other jewelry let us prove by satisfied buyers the tremendous savings in our prices under dealers, mail order, retail or even wholesalers.

Our Big Bargain Bulletin tells the whole story—how as "Headquarters for Loans" for over 60 years, we have advanced money on fine diamonds, watches, etc. Our investment but a fraction of their real value. Thousands of unredeemed pledges—the necessity for disposing of which is a real reason back of the amazingly low prices. Send for free copy of illustrated listings fully described.

Worthwhile Christmas Gifts



No. 255984. 3/4-3/32 kt. solitaire blue-white perfect cut quality genuine diamond of most radiant brilliancy in ladies' ring. Try to match it at \$60. Offered with guaranteed loan **\$29.85** of \$25 at Unredeemed Price.

No. 341098. 3/4-3/16, 1/64 karat



guaranteed weight superb blue-white quality genuine perfect cut diamond gem in magnificent tigers claw mounting. Best proportion—shape brilliancy. Try to match it at \$150. Guaranteed loan \$68.

Unredeemed Price **\$79.40**
Will remount in ladies' ring \$2 less.
No. 341127. Famous 19-jeweled B. W. Raymond (Elgin) watch—adjusted five positions, guaranteed to pass railroad inspection. In genuine 20-year gold filled case. This unredeemed watch complete in brand new condition. Try to match it at \$40 to **\$18.55** UNREDEEMED PRICE.

Money-Back Guarantee—We pay expressage and run all risk of pleasing you in the examination. Your money back if any article should not be perfectly satisfactory to you, even though exactly as represented. This guarantee is backed by our \$750,000 capital. Sixty years in one location is proof of our reliability.

Jos. DeRoy & Sons

Smithfield Street 311 DeRoy Bldg., Pittsburgh, Pa.
References, by permission, Farmers' Deposit National Bank, Marine National Bank, Dun's, Bradstreet's

RIFLES and SHOT GUNS ON CREDIT

THIS ACCURATE, STRONG-SHOOTING, HAMMERLESS SHOT GUN

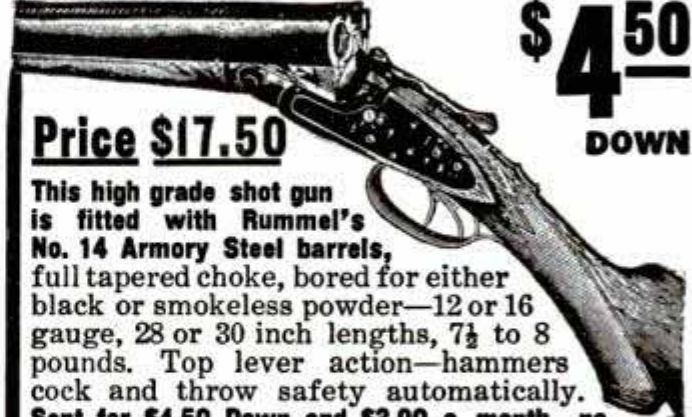

Price \$17.50

\$4.50 DOWN

This high grade shot gun is fitted with Rummel's No. 14 Armory Steel barrels, full tapered choke, bored for either black or smokeless powder—12 or 16 gauge, 28 or 30 inch lengths, 7 1/2 to 8 pounds. Top lever action—hammers cock and throw safety automatically. Sent for **\$4.50 Down and \$2.00 a month—no interest—no extras and you have 7 months in which to complete payment** on this gun that will compare favorably with any \$40 or \$60 gun made. Every man wants a good gun, but not every man can afford to pay the full amount cash down—therefore, we have just lately decided to sell high grade fire arms on

CONFIDENTIAL CREDIT

If you want a guaranteed shot gun or rifle why not open a credit account? We have been selling high grade guns for thirty-five years.

Write us for Complete Information and Catalog

A. J. RUMMEL ARMS COMPANY
303 St. Clair Street Toledo, Ohio

Asphalt production in the United States has been steadily increasing, California and Texas furnishing most of the output, which was 435,103 tons, worth \$4,487,813, last year, against 105,458 tons, worth \$765,048, 10 years ago.

LEIMAN BROS. ROTARY BLOWERS and VACUUM PUMPS

1 oz. to 10 lbs. pressure
1 to 20 inches Vacuum
4 to 338 cubic feet Capacity per minute



take up their own wear
Used with all Gas or Oil Burning Appliances and for

VACUUM CLEANING

WHERE TO BUY THEM

Albany, N. Y., Fairbanks Co. Anderson, Ind., Webb-Baxter Co. Ash-tahula, O., Mitchell Hdwe. Co. Baltimore, Fairbanks Co. Boston, T. Crowther & Co.; Holt, Shattuck & Co.; Taylor Machy. Co.; Hill, Clarke & Co. Buffalo, Root, Neal & Co. Chicago, Machinists Supply Co.; Manufacturers Sales Co., Cincinnati, E. A. Kinsey Co., Wm. T. Johnston Co., Cleveland, Strong, Carlisle & Hammond; W. M. Pattison Supply Co.; Cleveland Tool and Supply Co. Denver, Kettering Mercantile Co.; Scott Supply & Tool Co. Des Moines, Iowa, Iowa Machy. & Supply Co. Detroit, Chas. A. Strelinger Co. El Paso, Tex., Krakauer, Zork & Moyer. Erie, Pa., Baird Machy. Co. Hartford, Conn., Fairbanks Co. He-quiam, Wash., Lamb Machine Co. Indianapolis, Vonnegut Machy. Co. British Isles, Thos. Ashton, Ltd., Sheffield. Austria, White, Child & Beney. Vienna, Italy, White, Child & Beney. Moscow, Victoria, Australia, Eckersley & Sons, Melbourne. Montreal, Canada, Canada Machy. Agency; Williams & Wilson, Ltd.; International Agency; G. J. Lunn & Co. Toronto, A. R. Williams Machy. Co. Paris, France, Sang & Rafinesque. Charlottenburg, Germany, Victor Curstadt. New Zealand, B. Harkness, Stratford.
All Machinery Dealers and Export Houses

LEIMAN BROS., 62P John St., New York

I WILL START YOU

earning \$4 daily at home in spare time, silvering mirrors; no capital; send for free instructive booklet, giving plans of operation. G. F. REDMOND, Dept. 306-A, BOSTON, MASS.

Savo Air Moistener

Fill with water and hang on back of any Radiator Prevents air dryness. Makes it fit for the lungs, nose and throat. Saves furniture, pianos, books, wallpaper, paintings and plants. Money refunded if not satisfactory after 30 days' free trial. Order now, or write for free Booklet.

IN USE

Price \$2.00

Savo Mfg. Co., Dept. F, 5856 S. Park Ave., Chicago

Get a Broader View of Life in Bitter Root Valley

Arrange with us to join one of our coming low rate, first-class excursions and see with your own eyes the money making, health making and home making opportunities in this famous scenic environment, with good roads, hunting, fishing, and mountain climbing. Learn on the ground how you can obtain a return of \$200 an acre or more annually from a Bitter Root Valley fruit orchard. For excursion dates and particulars, address Robert S. Lemon, General Sales Manager, BITTER ROOT VALLEY IRRIGATION COMPANY, 849-855 First National Bank Building, Chicago, Ill.



LEARN TO DRAW PLANS

These books teach you to advance by easy steps from the first principles of drafting room practice to the complete work of an architect's office, including drawing to scale, tracing, detailing, lettering, rendering, designing, etc. No correspondence course necessary.

Set of Model Plans Free With each order for a set of "Radford's Drawing" we will include a set of Model Architectural Plans. These consist of twelve architect's drawings of a modern ten-room house. Price Complete \$3.00 Postpaid.
RADFORD ARCHITECTURAL CO., 178 W. Jackson Blvd., CHICAGO



The Constructor

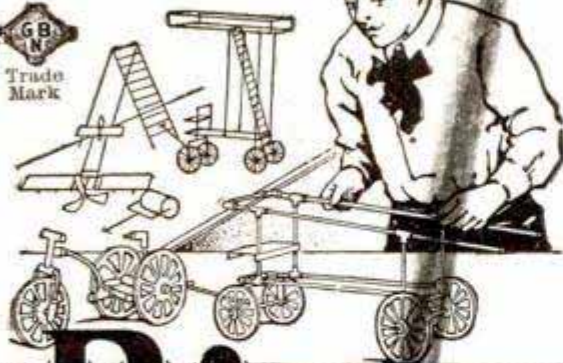

Bing TOYS

The Wonderful "Constructor"

The most remarkable and original engineering and construction outfit. Hundreds of designs and models possible. No nuts or screws used in any of the combinations. Nothing more fascinating or instructive for bright boys. A pastime that may develop the beginnings of a construction engineer.

On sale everywhere. Outfits from \$2 to \$60. Accessory Outfits of the "Constructor" can always be added. If your own dealer hasn't "Bing's Constructor," write us, and we will forward you a catalogue and see that you are supplied.

JOHN BING, 382 Fourth Ave., New York.

The AutoStrop Safety Razor
Guarantees 500 Shaves
 Ask Your Dealer About It



WHITE VALLEY GEMS

LOOK LIKE DIAMONDS

Stand acid and fire diamond test. So hard they easily scratch a file and will cut glass. Brilliancy guaranteed 25 years. Mounted in 14k solid gold diamond mountings. See them before paying.

Will send you any style ring, pin or stud for examination — all charges prepaid. No money in advance. Money refunded if not satisfactory. Write today for free catalog.

WHITE VALLEY GEM CO., 701 Wulsin Bldg., Indianapolis

OVER 65 YEARS' EXPERIENCE

PATENTS

TRADE MARKS
 DESIGNS
 COPYRIGHTS, &c.

Anyone sending a sketch and description may quickly ascertain our opinion free whether an invention is probably patentable. Communications strictly confidential. HANDBOOK on Patents sent free. Oldest agency for securing patents. Patents taken through Munn & Co. receive special notice, without charge, in the

Scientific American.

A handsomely illustrated weekly. Largest circulation of any scientific journal. Terms, \$3 a year; four months, \$1. Sold by all newsdealers.

MUNN & CO. 359 Broadway NEW YORK

Washington Office, 625 F St., Washington, D. C.



The New Edison!

Mr Edison's wonderful new instrument—the perfection of the Phonograph—now ready for shipment—on a wonderful sweeping offer DIRECT from us—shipped on

Free Trial!

I want you to see and hear this phonograph, to convince you of its enormous superiority over anything you have ever heard in the line of talking machines. I want your friends and neighbors to hear this superb product of Mr. Edison's skill. I will send you your choice of any of the new style instruments you select **without a penny down**—no deposit—no C. O. D., no obligations to buy. Take the instrument to your home—*hear all the latest up-to-date songs, the latest waltzes, two steps, vaudevilles and minstrel shows. Listen to the old fashioned hymns—the peal of the organ, crashing brass bands, orchestral concerts. Entertain your family and your friends with solos, duets, quartettes—the funniest comic sketches and the grandest symphonies. Then when you are through with all this entertainment, you may return the outfit at our expense.*

Why? We offer this free trial to convince you and to show you what the new Edison means. If you wish you may keep it at the rock-bottom price; the lowest price anybody is allowed to pay, and either for cash or on easiest terms; terms as low as \$2.00 a month. If you decide you don't want to keep it, we won't blame you in the least. We will be sure that after you have entertained your family and friends with this new instrument, we will have gained at least in letting the people know the superiority of this wonderful new Edison. Hence the free trial.

Our New Edison Book Sent Free

This is an important book. Besides listing the new Edison styles, and a complete list of the new wonderful Edison Blue Amberol Records, this book tells you how and where you can use the phonograph to the best advantage; how to use it in the home and at the dance — in private and in public. With this catalogue we give you full explanation of our remarkable free trial offer. Send postal or letter, or simply sign this coupon and the coupon alone will do. No obligation in getting the catalogue. Be the first in your town to get this new Edison, so write for the catalogue today.

F. K. Babson, Dept. 1198
 Edison Phonograph Distr.
 Edison Block, Chicago, Ill.

Western Office:
 65 Post St. San Francisco, Cal.
 Canadian Office:
 355 Portage Avenue
 Winnipeg, Manitoba.

Please send me, without any obligation, your New Edison Phonograph Catalogue, list of Amberol Records and Free Trial Certificate entitling me to your grand offer, all Free.

Coupon

F. K. Babson
 Edison Phonograph
 Distributors
 Dept. 1198 Edison Bldk.
 Chicago

Name.....

Address.....

Please Mention Popular Mechanics

\$1200.00 IN COLD CASH

Made, Paid and Banked in 30 Days, by Stoneman—\$15000.00 To Date

Reader, this offer is open to you—this money—the cold cash—can be yours. You and you alone by waiting too long can lose it. Investigate today—get the proof. Send your name and address—but NO MONEY—this very minute.

\$1000.00 PER MAN PER COUNTY

Don't worry—don't find excuses—no experience is necessary—business supplies the capital. You don't have to wait a month not even a week—payments can start the first day—and continue daily up to \$1,000.00 per month, per county. For years we have been quietly picking men from all walks of life, ministers, clerks, farmers, preachers, doctors, lawyers, teachers and so on—enabling them with our co-operation and \$50,000.00 appropriation to get what we here offer and can do for you—\$1,000.00 per man, per county. Some of these men you may know—possibly have envied without understanding the reason of their prosperity.



INVESTIGATE AND BE AMAZED Demand absolute proof—accept no other kind. Either we have the best thing that ever happened or we're colossal liars. Ask Schleicher, minister, whether it's true that he received

\$195 TWELVE HOURS AFTER APPOINTMENT

Langley, liveryman, \$115 first day; Rasp, agent, \$1,685 in 73 days; Beam, solicitor, \$164.25 weekly for 12 weeks; Korstad, farmer, \$2,212 in a few weeks; Zimmerman, farmer, \$3,856 in 30 days; Juell, clerk, \$6,800; Hart, farmer, \$5,000; Wilson, cashier, \$3,000 in 30 days. Let us refer you to these men, to the U. S. government, to banks, business houses, noted people at home and abroad. Heed this caution from Chas. Starr, of Mich., who writes: "Sorry this field is closed. Should have acted sooner but was skeptical. Your local man's great success has set everybody talking and proves I was a chump. Wonderful what a man can do with a real opportunity." Then read this from Lodewick who acted quickly: "Lucky I answered ad. It's great. Money coming fast." Which will you be, Starr, a victim of "neglected opportunities," or Lodewick, the "early bird." To escape Starr's fate, send your postal this very minute—

SPEND ONE CENT TO MAKE THOUSANDS

Strange invention startles world. Gives every home that long-desired blessing, a modern bathroom with hot and cold running water facilities for only \$6.50. No plumbing—no water works—self-heating. Only ten minutes to install. Gives cleansing plus friction, massage and shower baths in any room. Equivalent to any \$200 bathroom. Over 200,000 delighted users. Used by U. S. government.

More remarkable than this invention is our startling plan of universal distribution through special representatives who become virtually profit sharing partners in a business that's immense—exciting—fascinating—dignified—and above all, has enabled them, will enable you, to get \$1,000.00 per month, per county. Asking to be shown doesn't obligate you one bit. Investigate today by all means.

ALLEN MFG. CO., 3792 Allen Bldg., TOLEDO, O.

Deafness



Perfect hearing is now being restored in every condition of deafness or defective hearing from causes such as

Relaxed or Sunken Drums, Roaring or Hissing Sounds, Perforated, Partially Destroyed Drums, etc.

Wilson Common-Sense Ear Drums

"Little Wireless Phones for the Ears"—

require no medicine but effectively replace what is lacking or defective in the natural drums. They are simple devices, which the wearer easily fits into the ears where they are invisible. Soft, safe and comfortable to wear at all times.

Write today for our 168 page FREE book on DEAFNESS, giving you full particulars and plenty of testimonials.

WILSON EAR DRUM CO., Incorporated
234 Inter-Southern Building LOUISVILLE, KY.

Please Mention Popular Mechanics

HEALTH AND BEAUTY are yours when you use Tibbals' Electric \$7.50 Massage Machine



Complete, including battery, sponge electrode and brush attachment for hair and scalp treatment.

Here's sure relief for all ailments caused by imperfect circulation—a marvelous complexion beautifier, removing wrinkles and facial blemishes of all kinds quickly and pleasantly—invaluable for athletes, causes relaxation of tired muscles at once—the most convenient and inexpensive massage machine on the market today. After you've used it for a short while, you would not part with it for five times its cost.

It's so simple a child can use it—weighs only one pound—carries its own battery, so does not need outside current. Use it in the privacy of your home—you'll find it indispensable.

Send us \$7.50 and we'll send you the Tibbals' Electric Massage Machine complete, including battery. If you're not perfectly satisfied when you've tried it, we'll refund your money instantly. Order today.

Agents Wanted to sell this remarkable machine—liberal commission—big possibilities for aggressive workers—sit right down and write for our money making agents' proposition.

THOBAL ELECTRIC CO.
405 Broadway ST. LOUIS, MO.



TOBACCO HABIT BANISHED

In 48 to 72 Hours Yes, positively permanently banished almost before you know it. Pleasant, easy to take. Results quick, sure, lasting. No craving for tobacco in any form after first dose. Not a substitute. Harmless, no poisonous habit forming drugs. Satisfactory results guaranteed in every case or money refunded. *Tobacco Redeemer* is the only absolutely scientific and thoroughly dependable tobacco remedy ever discovered. Write for free booklet and positive proof.

NEWELL PHARMACAL CO., Dept. 25, ST. LOUIS, MO.

BRITISH FISHING INDUSTRY HAS RECORD YEAR—The year 1912 was the greatest fishing year in the history of Great Britain. The feature of last year's fishing was the great herring catch, amounting to over 580,000,000 lb. The total number of crabs landed was nearly 5,750,000, while over 33,000,000 oysters, between 600,000 and 700,000 lobsters and some 26,000 tons of other shellfish were taken. It is estimated that \$300,000,000 are invested and 350,000 persons employed in various branches of the fishing industry.

ERICKSON LEG

Arms, Braces, Wheel Chairs, Stockings.
SOLD ON EASY TERMS
E. H. ERICKSON ARTIFICIAL LIMB CO.,
17 Wash. Av. N., MINNEAPOLIS, MINN.

Does not chafe, overheat or draw end of stump.
SEND FOR CATALOG



GREAT MONEY MAKER FOR AGENTS



AGENTS

Sell Magnetic Combs and get rich; agents wild with success. They remove dandruff; stop falling hair; Relieve Headache; never break. Send 2c stamp for sample. PROF. LONG, 950 Ash St., PEKIN, ILLINOIS

NO MORE BALD HEADS



When our VACUUM CAP is used a few minutes daily. We accept no pay until you have tried the Cap 60 days and are satisfied. The Vacuum Cap is an appliance that draws the blood to the Hair Roots and starts a new healthy crop of hair. It stops Dandruff, stops the hair from falling out. Bought by Doctors and men who

know that it is the only reasonable HAIR GROWER known to science. No Drugs Used. Write for application blank, testimonials, and booklet on "HAIR," sent sealed in plain envelope, FREE.

THE MODERN VACUUM CAP CO.
Z. 559 BARCLAY, DENVER, COLO.

THEY'RE MADE TO MEASURE
Putman Boots & Shoes
 Go on like a glove and fit all over.



We originated the plan of selling made-to-measure Boots and Shoes direct from Factory to Consumer.

Putman Boots have been made for Sportsmen, Civil and Mining Engineers etc., longer than any others. They are sold all over the world and have justly earned the slogan, "The World's Standard." They are made-to-measure, water-proofed or not as ordered, any weight of uppers or soles, all heights, a variety of leathers and prices that you will find satisfactory. For Canoeing and Still Hunting we make Moosehide and Oil Tanned Moccasins that have no equal.

Made-to-Measure Shoes

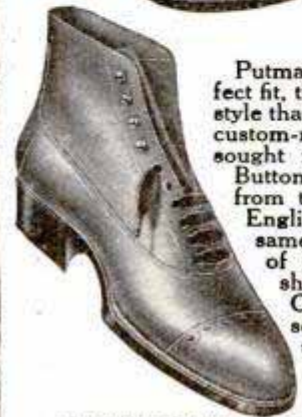

Putman bench-made Shoes have a perfect fit, the best of everything in quality, style that is "up-to-the-minute" and that custom-made individuality so much sought in all wearing apparel. Lace, Button or Oxford styles. Everything from the lightest Vici Kid to Heavy English "Hiking" Shoes at about the same price charged for a good quality of all machine-made, ready-made shoes.

Our FREE CATALOGUE and self measurement blanks are sent upon request. They are different from any others and will interest you. Send for them to day.

PUTMAN BOOT & SHOE CO.

122 Fifth St. N. E. Minneapolis, Minn.



The Truth About Mushrooms

Big, Quick Profits. Small Capital Now Is Best Time.

Biggest, quickest, surest and easiest money-maker is growing mushrooms. Bigger money is being made in mushrooms now than ever before, by those who are today putting in practice the great revolutionary improvement in mushroom culture explained in our new book, "The Truth About Mushrooms." Open your eyes to an opportunity you never realized. No matter what your occupation or location, you can now

Add \$10 to \$70 a Week to Your Income

without interference with present work. Small capital to start. Men and women can easily do it. Now is time to start. This great book explains everything from A to Z, and things which even many mushroom growers never knew before. Get first-hand information from the greatest practical authority. Start in the world's best-paying business now. Grow in cellars, sheds, boxes, etc., or increase your profits many fold if you are already a grower. Send for the free book today sure.

Bureau of Mushroom Industry, Dept. 83, 1342 N. Clark St., Chicago, Ill.



3,200 pages,
 7x10 inches,
 2,600 illustrations.

The Magic Wand

As the magician of old performed miracles with the aid of his magic wand, so does the magician of today—the electrician—achieve most wonderful results with a power as mysterious and invisible as that which came from the wand of the sorcerer. The field of Electricity is limitless—new uses for this great force are discovered daily and large salaries are paid to those who know how to handle it. Prepare yourself, then, to become a big man in this field; learn from these books all that is necessary for you to know. If a beginner, you can soon fit yourself to make your start in this fascinating work at a good salary. If a worker, engineer or expert, you can add to your knowledge and put yourself in line for a better job at bigger pay.

The Seven Volume Cyclopaedia of

Applied Electricity

is the greatest Electrical Reference Library in the World

Contains 3,200 pages, 7x10 inches; 2,600 illustrations, full page plates, diagrams, etc.; hundreds of valuable tables and formulas; carefully cross-indexed for quick, easy reference. The books are substantially bound in half red morocco, gold stamped, and are printed in large, clear type on special quality paper.

Important Subjects Covered

Theory, Calculation, Design and Construction of Generators and Motors—Electrical Measurements—Electric Wiring—Electric Welding—Types of Generators and Motors—Management of Generators and Motors—Storage Batteries—Electric Lighting—Alternating-Current Machinery—Station Appliances—Power Stations—Power Transmission—Central Station Engineering—Electric Railways, including Single-Phase—The Electric Telegraph—Telephone Equipment, Systems and Operation—Wireless Telegraph and Telephone—Telantograph, Telephonograph, etc.

NOW \$15 LESS The complete seven volumes, not a sample volume, will be sent, express prepaid, for seven days' free examination; returnable at our expense if the books do not contain the information you want. If you keep them, pay \$2.00 seven days after receipt and then \$2.00 a month until you have paid the special introductory price of \$19.80. The regular price of this great Cyclopaedia is \$35.00. Just fill in and mail the coupon. It won't cost you a cent to examine the books. We know they'll be worth many times their cost to you. Mail the coupon now and you'll receive your books promptly.

\$12.00 Consulting Membership Free

With every set is included a year's Consulting Membership, regular value \$12.00, entitling you to the free advice of a staff of Electrical Engineers. This will give you practical help in handling working problems which are too specific to be taken up in detail in the Cyclopaedia. There will be no limit to this service. A single problem solved for you might be worth more than the first cost of the books.

**AMERICAN TECHNICAL SOCIETY
 CHICAGO, U. S. A.**

7 DAY EXAMINATION COUPON

AMERICAN TECHNICAL SOCIETY, Chicago, U. S. A.

Please send me Cyclopaedia of Applied Electricity for seven days' free examination. I will send \$2.00 within seven days and \$2.00 a month until I have paid \$19.80; otherwise I will notify you and hold the books subject to your order. Title not to pass until fully paid. Pop. Mech. 11-13

NAME

ADDRESS

REFERENCE

Please Mention Popular Mechanics

New KEROSENE LIGHT BEATS ELECTRIC OR GASOLINE

10 Days FREE—Send No Money



We don't ask you to pay us a cent until you have used this wonderful modern light in your own home for ten days, then you may return it at our expense if not perfectly satisfied. We want you to prove for yourself that it gives five to fifteen times as much light as the ordinary oil lamp; beats electric, gasoline or acetylene. Lights and is put out just like the old oil lamp; costs

ONLY 1 CENT FOR 6 HOURS

Gives a powerful white light, burns common coal oil (kerosene), no odor, smoke or noise, simple, clean, won't explode. Guaranteed.

\$1000.00 REWARD

will be given to the person who shows us an oil lamp equal to this Aladdin in every way (details of offer given in our circular). Would we dare make such a challenge to the world if there was the slightest doubt as to the merits of the Aladdin? We want **one person in each locality** to whom we can refer customers. Write quick for our 10 Day Absolutely Free Trial Proposition, Agents' Wholesale Prices, and learn how to get **ONE FREE.**

MANTLE LAMP CO., 448 Aladdin Bldg., Chicago, Ill.

AGENTS WANTED

to demonstrate in territory where oil lamps are in use. Experience unnecessary. Many agents average five sales a day and make \$300.00 per month. One farmer cleared over \$800.00 in 6 weeks. You can make in one evening and spare time. Write quick for territory and sample.

Sunshine Lamp FREE!

300 Candle Power

To Try in Your Own Home

Turns night into day. Gives better light than gas, electricity or 18 ordinary lamps at one-tenth the cost. For Homes, Stores, Halls, Churches. A child can carry it. Makes its own light from common gasoline. Absolutely SAFE.

COSTS 1 CENT A NIGHT

We want one person in each locality to whom we can refer new customers. Take advantage of our SPECIAL FREE TRIAL OFFER. Agents Wanted.

SUNSHINE SAFETY LAMP CO.
611 Factory Bldg. Kansas City, Mo.



Triumph Light

We All Want Better Light Here It is

This new 100 to 700 candle power light turns up and down like gas. One-third cost of electricity, gas or kerosene. For home, church or store. Anyone can operate. Perfection guaranteed or money back. Write for catalog (P. O. P.), Dept. 1. **AGENTS WANTED. BRILLIANT GAS LAMP COMPANY** No. 1009 So. Wabash Ave., Chicago, Illinois



The "BEST" LIGHT

gives a clearer, cleaner, brighter illumination, at less cost, than any other lighting system possible to install in the private home. Every house has its own lighting plant—safe, sure and economical.

Agents Wanted
Write for Catalogue of 200 styles.
THE BEST LIGHT CO.
324 East 5th St., Canton, O.

AN EXPLORATION MOTOR CRAFT—As an instance of the increasing confidence which is placed in the reliability of motor-driven craft, the "La Curieuse," which is equipped with a 40-hp. engine, left Boulogne on a voyage which will not be completed for about 18 months, with the object of taking meteorological and astronomical observations in the southern seas, says Motor Ship and Motor Boat. After leaving Boulogne she went to

Agents Wanted Everywhere
A gold mine for crew managers. Make big money the year round.
Every Home Needs Our Specialties
Vacuum Sweepers, Gasoline Irons, Lamps and Lighting Systems
SECURE TERRITORY—WRITE TODAY
P. M. YALE MFG. CO., 20 S. Clinton St., CHICAGO

AGENTS STEADY INCOME
Wide Awake Men and Women. You can secure protected Territory to sell International Portable Lamps and Lighting Systems. Our Self-Heating Sad-Iron is positively the simplest and most practical Iron on the market. We challenge competition. **Your Chance.** Territory is being rapidly taken. If you want a good steady income write to us Today.
International Light, Novelty & Specialty Co., 311 River Street, Dept. 36, Chicago, Ill.

ANY PERSON CAN MAKE \$25.00 to \$60.00
weekly all or spare time with wonderful **WHITE FLAME BURNER.** Sells like wild fire. 6 to 8 in every house. **USERS DELIGHTED.** 35c stamps or coin gets complete sample and particulars. Satisfaction or money back. Exclusive Territory.
WHITE FLAME LIGHT CO., 206 Clark Bldg., Grand Rapids, Mich.

Beacon Burner FREE!
100 Candle Power Incandescent pure white light from (kerosene) coal oil. Beats either gas or electricity.
Fits Your Old Lamp
COSTS ONLY 1 CENT FOR 6 HOURS
one person in each locality to whom we can refer new customers. Take advantage of our Special Offer to secure a Beacon Burner FREE. Write today. **AGENTS WANTED.**
HOME SUPPLY CO., 11 Home Bldg., Kansas City, Mo.

A PERFECT LIGHT
Ninety-five per cent of fuel required is ordinary air, costing nothing. Beautiful white light of 400 candle power. Our eighteen years' experience is your guarantee that this lamp is perfect. **WRITE FOR CIRCULARS AND PRICES**
American Gas Machine Co. 318 Clark St., ALBERT LEA, MINN.

AGENTS WANTED

BOYS BUILD A REAL AUTO-OF YOUR OWN
Send 25 cts. for complete plans, large working drawing, plain instructions and list of parts, showing how any boy can build this wonderful shaft drive, four speed and reverse, 1913 model Motor-Hob, which will carry you anywhere you want to go. **THE IDEA SHOP, Dept. 1, Buffalo, N. Y.**

Big Pay For You



\$5⁰⁰
TO
\$8⁰⁰
Per Day
In any one
of the
following
trades:

Electricity Plumbing
Bricklaying
Mechanical Drawing
Moving Picture Operating
We Teach You
In a Short Time - At Small Expense!

For years we have trained men to become experts in **Electricity, Plumbing, Bricklaying, Mechanical Drawing and Moving Picture Operating.** These trades pay \$6.00 a day right here in Chicago and \$5.00 to \$8.00 a day EVERYWHERE. The demand for skilled men far exceeds the supply. Our students are always in demand the minute they graduate. We give our students the actual practical work to do right at School - no attention paid to needless theory. Our employment bureau secures good paying jobs for students FREE OF CHARGE. Our School is the

Oldest, Largest and Best Equipped Trade School in America

You can enter any time. Open all the year round - day and night classes. Tuition VERY LOW at this time - easy payments if desired. We will help you earn your way through School. Our instructors are all experts in their respective lines of work.

Guarantee

We guarantee that your Course of instruction will be the **VERY BEST** - that when you have completed a Course in our School you will be an expert in the trade you select.

Tools and Materials

FREE!

To those who enroll now we will furnish all the tools and materials used in taking our Courses **ABSOLUTELY FREE.** Write at once for full particulars of this offer and **FREE** catalog.

Send Coupon TODAY

Don't delay! Send the coupon or post card for full particulars of this offer and School catalog. Everything sent to you **Free** and **Prepaid.** **RIGHT NOW** is the time to write for this information. Send immediately while you think of it.

L. L. COOKE, Director
Coyne National Trade Schools
Dept. 9198
51 E. Illinois St.
Chicago, Ill.
Come to Chicago - the busiest city in the world

Free Coupon

L. L. COOKE, Director
COYNE NATIONAL TRADE SCHOOLS
Dept. 9198, 51 E. Illinois St.
Chicago, Illinois

Dear Sir: Please send me **FREE** AND **PREPAID** full particulars of your Offer together with your School catalog. I assume no obligations.

Name.....

Address.....

Please Mention Popular Mechanics

Remoh Gems

Look and Wear Like Diamonds



A Marvelous Synthetic Gem Not Imitation

-the greatest triumph of the electric furnace. Will cut glass - stands filing, fire and acid tests like a diamond - guaranteed to contain no glass. Remoh Gems have no paste, foil or backing - their brilliancy is guaranteed forever. One-thirtieth the cost of a diamond. These remarkable gems are set only in 14 Karat Solid Gold Mountings.

Sent On Approval Anywhere In U. S.

-your money cheerfully refunded if not perfectly satisfactory. Write for our 4-color

De Luxe Jewel Book - yours for the asking. Address

Remoh Jewelry Co.,
622 Washington Ave., St. Louis



Montevideo and then on to Kerguelen Island. She returns by way of Melbourne and the Pacific Islands, and then home via the Panama Canal, which, by that time, will be completed. She is 56 ft. long, 19 ft. beam, and has a depth of 11 ft.

CACHOO! Make the whole family and all your friends "just sneeze their heads off" without knowing why, with **CACHOO**, the new long distance harmless snuff. Sent anywhere for 10c. 3 for 25c. 90c a dozen. Catalog included **FREE.**



PEERLESS TRICK & NOVELTY CO., Dept. B, CHICAGO



\$1.00 Adder Accurate, rapid, durable, easily operated and set to zero. Capacity 8 columns. Over 20,000 sold. **Price \$1.00 Delivered.** Our **Self Indicating adder Price \$3.50 Delivered** is the **Best** low priced adding machine made. Remit with order or parcel post C.O.D. if you prefer. *Agents wanted. Order one now.* **J. H. Bassett & Co., Dept. 14-B, 5921 Indiana Ave., Chicago**



FACTORY TO YOU CLASS PINS

For College, School or Society

Catalog with attractive prices mailed free upon request. Special offer, either style of pins here illustrated with any three letters and figures, one or two colors of enamel. **STERLING SILVER, 30c each, \$3.00 dozen; SILVER PLATE, 15c each, \$1.50 dozen.**

BASTIAN BROS. CO., 278 Bastian Bldg., ROCHESTER, N. Y.



Den Photos

Of the cutest society girls we can find, all made recently.

No. 2 Ill. Cir. by mail..... 5c
Cir. "A," for artists' use specially (by express only)..... 50c
1, 5, 7 plain, mtd., of this picture "Roses," by mail..... 25c

Photos of No. 2 Cir. make beautiful Christmas presents. Send coin or 1c stamps.

MELLEN PHOTO CO., 102 No. 5th Avenue, CHICAGO

No. 13

DUCK'S CATALOG

Big 300 Page Electrical and Wireless

Supplies (including a big line of Xmas Novelties) Mailed for 6c

6c, stamps or coin, which you may deduct from first order of \$1.00. Great cost of catalog and low prices prohibit distribution except to those interested.

Most Elaborate Catalog in Its Line This is what 400 persons voluntarily wrote us in a period of only two weeks. There is something in

this catalog for everybody, and there is nothing but will be found to bear the stamp of highest quality. Just one example: Our toy and commercial motors embrace practically the complete output of five leading motor manufacturers. But the great impelling value of this complete catalog is in the attractive prices at which these high grade goods are sold.

20% to 33% is Saved in Purchasing from Us

On the single item of flash-lights we sell them to you at most dealers' cost price, and this is true of many other articles.

125 PP. Xmas Gifts (See brief contents opposite) will be found in this great catalog.

THE J. J. DUCK COMPANY, Empire Arcade, Toledo, Ohio

What Our Catalog Contains:

100 pages wireless insts. for commercial and amateur use, with over 30 diagrams; 10 pp. raw material for wireless insts.; 15 pp. telegraph insts.; 35 pp. toy and commercial motors; 15 pp. flash lights and miniature lamps and 125 pages ammeters, transformers, lighting plants, miniature railways, Xmas novelties, Mechanical Books, and general electrical supplies.

A Complete Wireless Station

\$9.65

Receives 1200 miles
Sends 12 to 15 miles

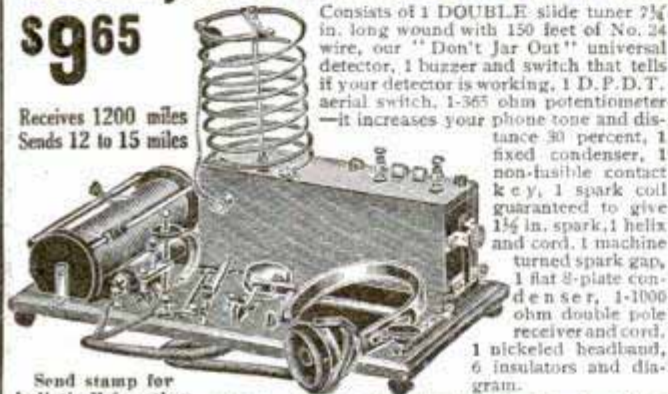

Send stamp for bulletin M for other remarkable values.

Nichols Electric Co., 35 Frankfort St., New York

Consists of 1 DOUBLE slide tuner $7\frac{3}{4}$ in. long wound with 150 feet of No. 24 wire, our "Don't Jar Out" universal detector, 1 buzzer and switch that tells if your detector is working, 1 D. P. D. T. aerial switch, 1-365 ohm potentiometer—it increases your phone tone and distance 30 percent, 1 fixed condenser, 1 non-fusible contact key, 1 spark coil guaranteed to give $1\frac{1}{2}$ in. spark, 1 helix and cord, 1 machine turned spark gap, 1 flat 8-plate condenser, 1-1000 ohm double pole receiver and cord, 1 nicked headband, 6 insulators and diagram.

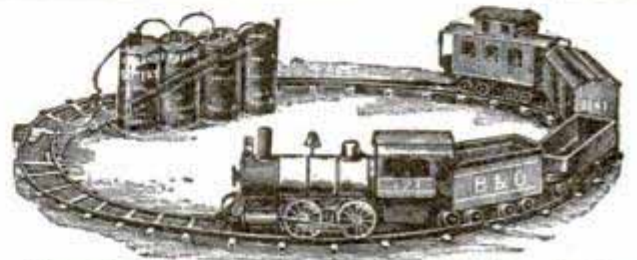

Electrical railways, tracks, switches, trolley cars, dynamos, motors, dynamo castings, gas engine castings, everything for the young electrician. Send for our complete catalog "B."

The Carlisle & Finch Co.

262 E. Clifton Ave.

Cincinnati, Ohio

ELECTRICITY

This is your "elbow book." It's the latest edition of the **VOLTAMP ELECTRIC Catalog**—128 pages full of cuts, complete description and prices of latest experimental apparatus—Dynamos, Motors, Rheostats, Transformers, Wireless Coils—Electrical Repair Material; Raw Materials; Telephone, Telegraph and Wireless Outfits; Handbooks; Miniature Electric Railways and parts, Toys, etc. 6c in stamps or coin will bring you this book (with valuable coupon)—you'll find it worth dollars. (No postals answered.)

VOLTAMP ELECTRIC MFG. CO.
Voltamp Block Baltimore, Md.

EXPERIMENTERS IN WIRELESS

Blue-print and working specifications for either $\frac{1}{2}$ -K. or 1-K. W.—Open or Closed Core Transformers, 50c. Send Money Order—not stamps. The 50c may be deducted from the first 2.00 order for Transformer parts within six months.

Send 2c stamp for **Wireless Catalogue**.
WINGER ELECTRIC & MANFG. CO., Successors to Dawson & Winger Elec. Co.
711 So. Dearborn St., CHICAGO, ILL.

MONMOUTH OUTFITS

COMPLETE—COMPACT—EFFICIENT

Send stamp for our Bulletin MC which contains codes. Expertly built outfits in many cases for less than you can make a set at home. Ready-for-use and of proved merit. Monmouth coils "exceed their guarantee"

MONMOUTH ELECTRIC CO., Inc.
92-94 Murray St. New York City

Send for Copy of Our New Wireless Manual P1

It contains 96 pages and tells how to erect and maintain wireless telegraph stations. Shows a number of diagrams. Has the Morse and Continental Telegraph Codes. Illustrates the best instruments to use; tells what they are for and how to use them. Do not wait until some other time, but sit down now and send your name and address, and get one. It costs you nothing.



Send for Our Pocket Catalog P26

It contains 212 pages, with over 1,000 illustrations and describes in plain, clear language all about Bells, Push Buttons, Batteries, Telephone and Telegraph Material, Electric Toys, Burglar and Fire Alarm Contrivances, Electric Call Bells, Electric Alarm Clocks, Medical Batteries, Motor Boat Horns, Electrically Heated Apparatus, Battery Connectors, Switches, Battery Gauges, Wireless Telegraph Instruments, Ignition Supplies, etc.

It Means Money Saved to You to have our Manual and our Catalog when you want to buy

MANHATTAN ELECTRICAL SUPPLY CO.

NEW YORK, 17 Park Place

CHICAGO, 114 S. Fifth Ave.

ST. LOUIS, 1106 Pine St.

SAN FRANCISCO, 604 Mission St.

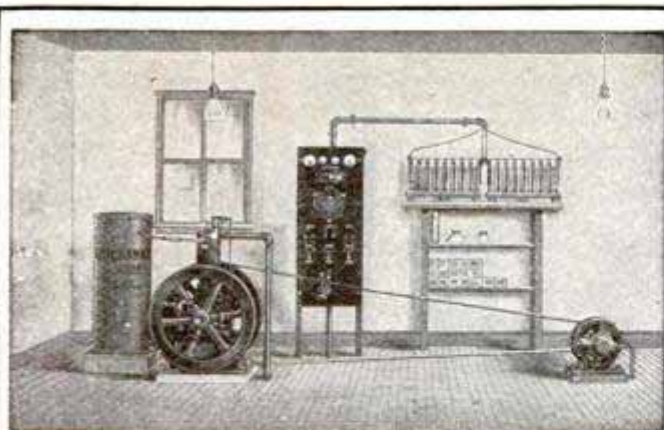

A Fairbanks-Morse Electric Plant

will give you all the lighting conveniences and health benefits that the city resident enjoys from the large central stations. No matter where you live you can have soft, clear electric light anywhere about your home or buildings at very slight cost.

Fairbanks-Morse Electric Plants are complete units consisting of Engine, Dynamo, Switchboard, Storage Battery, 50 Mazda Lamps and all the necessary shades and fixtures. All apparatus simple, strong, dependable.

Engine Runs on Kerosene, Gasoline or Distillate

Ample power to do other work in addition to running the dynamo. Cost of fuel practically covers all expense for lights. Write for Catalog No. 449WK.

Fairbanks, Morse & Co.

900 S. Wabash Ave. Chicago, Ill.

THE CLIMBING CATFISH OF SOUTH AMERICA—Catfish found in the creeks and rivers of the Andes Mountains in South America are noted for their ability to climb up perpendicular surfaces, several of the more active fish having been observed to ascend the steep bank of a pool, climbing 18 ft. vertically and even scaling overhanging projections, with only a thin film of water trickling down the surface of the bank.

ELECTRIC LIGHT PLANTS Complete gasoline engine, dynamo, switchboard and storage battery \$240. Agents wanted. American Battery Co., 1139 Fulton St., Chicago (Estab. 1889.)

ELECTRIC HOME, FARM, THEATER or STORE LIGHTING PLANTS Give Light Anywhere. Wonderful Economy & Convenience. Also Carriage & Bicycle Lights. **MOTION PICTURE THEATER COMPLETE EQUIPMENTS** Start YOU in the Most Profitable Business in America with **BIG ADVANTAGES**. Our Literature Explains. 3c Postage. **OHIO ELECTRIC WORKS, DS, CLEVELAND, O.**

MECHANICAL PERFECTION

in writing equipment is guaranteed in the World's Standard **WATERMAN'S IDEAL FOUNTAIN PEN.** **SOLD BY LEADING DEALERS EVERYWHERE.**

Independent Safety Fountain Pen

THE IDEAL PEN FOR GENERAL USE AT A MODERATE PRICE

Can be safely carried in any position. New idea cap locks pen when not in use. All pure rubber and 14 kt. pens. Two lengths, 4 and 5 in.

FREE

Liberal supply of ink free with each order.

Useful Xmas Gifts

J. C. Ullrich & Co.
27 Thames St., NEW YORK



No. 202 with No. 2 gold pen,

\$1.50

No. 205 with No. 4 gold pen, \$2.00.

AGENTS WANTED.

Wonderful Offer



30 Days' Trial FREE

A positively startling offer—tell your friends about it. For the first time—NOW—you can have a free home trial of any strictly high-grade violin or cello. Make your own choice from our famous collection—any one an instrument the best artists would be proud to own. Our large stock is carefully graded—not one ordinary violin of common quality.

Finest Collection in America

We offer you — at astonishing low prices — representative old and modern violins from the best of the foreign makers — Herman Todd, Joseph Corretelli, Ernest Roth, Wilhelm Duerer, J. F. Straube, Franz Weidler and others. These geniuses have made our name famous as their violins are honestly made and honestly sold.

Learn to Play Take advantage of the long Winter evenings to master the violin — the sweetest of all musical instruments. Choose a high-grade instrument at the price you would pay elsewhere for ordinary quality.

We MAKE and IMPORT all our Own instruments and SELL DIRECT, giving you the benefit of the regular middlemen's discounts.

Free Violin Book

Write Today for Free Copy of the new Lewis Catalog of Violins, Cellos, etc. Don't think of buying a Violin, Viola, Cello or other stringed instrument until you have seen this book. It will post you thoroughly on violin values; tells you how to judge a violin by the wood, varnish and construction, and why we send our instruments on free trial. Write now for this book. **Don't** pay enormous profits to jobbers, brokers and dealers. Every one of these gets part of your money when you buy a violin in the regular way.

Our instruments are all fine, hand made, **tone** violins for professional use, sold at exceptionally low prices. Some models are wonderful copies of celebrated old violins belonging to the greatest artists. They are far superior in quality and power of tone to the average old violin at four times the cost. We want you to test the instrument you choose, right in your own home and at our expense.

Violins of our own Chicago make sold so rapidly this past season that we fell far behind in orders. Try one and see for yourself why this statement is a fact.

Send Coupon NOW

DON'T DELAY — Send the Coupon NOW for our Free Violin Book. If you have an idea of ever buying a violin you need this book. Write NOW.

10 to 30 Days' Trial Free

Try any instrument in our stock before you decide to buy. *Don't buy* any kind of a musical instrument *any other way*. You can't tell anything from a printed description or a few minutes' trial in a show room. *We insist* that you shall be satisfied and we will pay the express charges both ways on all returned instruments.

WM. D. LEWIS & SON (Est. 1869)

Makers and Importers
225 So. Wabash Ave.
CHICAGO, ILL.

Wm. D. Lewis & Son (Est. 1869)
Makers and Importers
225 So. Wabash Ave.
Chicago, Ill.

Gentlemen: — With no obligation whatever upon me you may send me free and postpaid one copy of the new Lewis catalogue and full particulars of your Great Free Trial Offer on High Grade Violins.

Violin Makers — We make a specialty of Imported Woods, Varnishes and Tools.

Write Us Today

Name

Address

Please Mention Popular Mechanics

3 Years to Pay

for the Sweet-Toned

Meister

Piano

\$175

30 Days' Free Trial We Pay the Freight

You are not asked to deposit, or pay or advance a cent in any way until you write us and say that the MEISTER is entirely satisfactory and you wish to keep it. Then these are the terms of sale:

**\$1 a Week or
\$5 a Month**



No cash payment down. No interest on payments.
No extras of any kind. Piano stool and scarf free.

Sold direct from the maker to you at a guaranteed saving of \$100. No dealer's profit for you to pay. Send now for our beautiful Free Catalog, which shows eight styles of Meister Pianos. Our resources exceed \$4,000,000. We sell more pianos direct to the home than any other concern in the world.

Rothschild & Company
Dept. H 16, Chicago, Illinois

Mullins Steel Boats Can't Sink



Built of puncture-proof galvanized steel plates. One man control, never stall, silent under-water exhaust. Catalogue free.

THE W. H. MULLINS CO.
151 Franklin St., Salem, O.



WATKINS' SPECIAL MOTORS

3 H. P. Single Cylinder . . . 30 lbs.
6 H. P. Double Cylinder . . . 60 lbs.
12 H. P. Four Cylinder . . . 100 lbs.

A strictly HIGH GRADE Motor that will give CONSTANT and EFFICIENT service. Especially adapted for CANOES and LIGHT BOATS. Aluminum base, copper water jacket, steel shaft, bronze bearings.

THE WATKINS MOTOR CO.
837-839 West Sixth Street CINCINNATI, OHIO

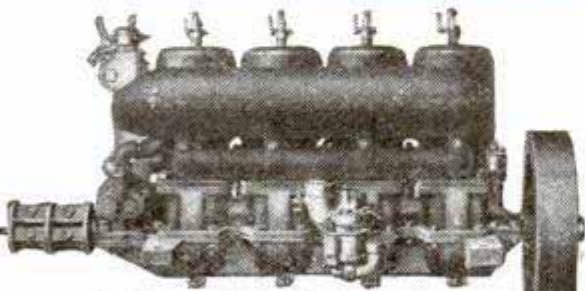

4-M 20-H. P. Marine Motor

There's a Roberts for Every Need

Marine, Aeroplane, Automobile, Speed or Work Boats, Flying Boats, Motor Cars, Gasoline or Kerosene.

CATALOG FREE

THE ROBERTS MOTOR CO., 1419 Columbus Ave. SANDUSKY, OHIO

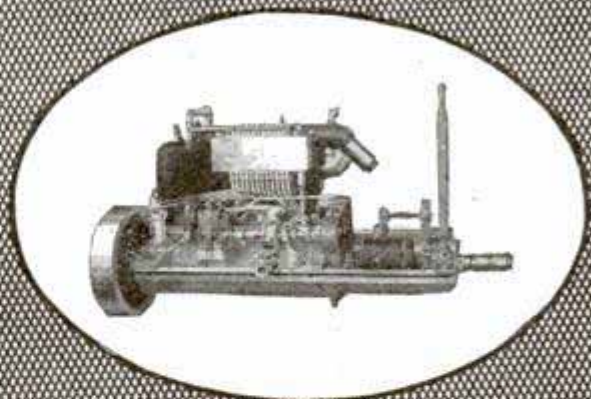

"Buffalo" Marine Engines

"Buffalo" four-cycle marine engines are built in 20 models—3 to 150 h. p.—in slow, medium and high speed designs, for powering work boats, speed boats, launches and cruisers of all kinds.

They can be operated on gasoline or kerosene.

The strong points of "Buffalo" engines are reliability and economy.

Shall we send you the "Buffalo" Book? It tells the whole story.

Buffalo Gasolene Motor Co.

1293-1305 Niagara St., Buffalo, N. Y.

This type of catfish resembles, in external appearance, the catfish or "bullhead" of North America. The skin is smooth and scaleless and they rarely attain a greater length than 12 in. Their climbing ability is due to the flat, suckerlike mouth surrounded by a broad flap and two peculiarly shaped projections on the belly that enable the fish to attach itself firmly to any convenient object. These projections, which resemble fins with broad, flattened ribs, are thickly studded with small, sharp teeth, that are used for propelling the

**POPULAR
PLEASURE
AND
PRICE**



IN THIS 16-Ft. Family Launch

SEND FOR OUR LIST OF BARGAINS

THE VALLEY BOAT & ENGINE CO. 1206 Hess Street SAGINAW, MICH.



GET THIS CATALOG
FULL OF VALUABLE INFORMATION TO EVERY
BOAT OWNER ON

**RACING PROPELLER WHEELS,
REVERSE GEARS AND
MARINE ACCESSORIES**

LARGE CATALOG FREE. SEND TODAY

MICHIGAN WHEEL CO.
1139 MONROE AVE., GRAND RAPIDS, MICH.



GRAY MOTORS FOR BOATS



Largest Builders of
2-cycle Motors in the
World. Over 1000
responsible dealers.

3 H.P. with Complete Outfit ready to install \$55
ALSO 4 & 10 36 HR

Guaranteed by a big responsible concern. Write for big catalog—tells and shows you all about these high grade motors and how they are made.

GRAY MOTOR CO., 1198 Gray Motor Bldg., Detroit, Mich.



THE SCRIPPS
MARINE POWER PLANT



Scripps Motors are made in 2, 4 and 6 cylinder sizes. Medium and Extra Heavy Duty Types. Send for catalogue and information about self-starters, kerosene motors, and the \$500 7-horsepower Scripps Midget, a High-Grade Tender Motor.

"Cares for Itself at All Speeds"

The combined experience of all Scripps owners seems to have established one fact in particular, namely: "The great dependability of the Scripps Marine Power Plant," as for instance:

"I have used a Model H Scripps for two years in a heavy 42-foot cabin boat, and have no fault to find with its work. I had the throttle and timer connected to the pilot house, along with the clutch; but I soon found the engine was flexible enough to care for itself at all speeds, and the only thing I have to watch now is the clutch and steering wheel. I think you already know my record of running for one year and a half on one set of 6 dry cells. After leaving these batteries in the boat for the second winter, they still had two volts of current, which shows that the ignition system of this engine uses about as little current as anything in the engine line. After leaving the engine in the boat all winter, it started off the first time I tried it this spring, and has been running all right ever since." NORMAN J. SMITH

SCRIPPS MOTOR COMPANY

637 Lincoln Ave., DETROIT, MICH.

SCRIPPS MOTORS ARE CARRIED IN STOCK BY

New York.....Bowler, Holmes & Hecker Co., 141 Liberty Street
Boston, Mass.....Walter H. Moreton, 218 State Street
Chicago, Ill.....O. L. Cosgrove & Co., 215-219 Englewood Ave.
Philadelphia.....W. E. Gochenaur, 631 Arch Street
Jacksonville, Fla.....Gibbs Gas Engine Co., Foot of Main Street
Seattle, Wash.....S. B. V. Miller, 72 Marion Street
San Francisco, Cal.....California Gas Engine & Motor Boat Co., 76 Clementina Street
Los Angeles, Cal.....Marine Engine & Supply Co., 109 East 7th Street
Duluth, Minn.....Kelley Hardware Co., 118-120 W. Superior Street
Toronto, Ont.....Schofield-Holden Machine Co., 2 Carlow Avenue
New Orleans, La.....Arthur Duvic, 130 Chartres Street

body, which is kept from slipping by the suction of the mouth on the surface over which the fish travels.

The world's production of petroleum approximated 15,000,000,000 gal. in 1911.

The Baldwin Lamp



No. 30

Price, \$1.00

Other Sizes Made

Projects a 14-candle power light 150 feet. Burns Acetylene gas. Weight, 6 oz.; height, 3 1/4 in. No oil, soot or glass. Absolutely safe and simple. Fifty hours' light costs 25c. Ideal for Night Fishing, Trapping, Hunting or for work about the farm or machinery. Useful as well to replace automobile tires in the dark. If your dealer cannot supply you write us direct and ask for catalogue and free instructive booklet, "Knots and How to Tie Them."

JOHN SIMMONS CO.

11 Franklin St., New York City

Makes Any Boat a Motor Boat

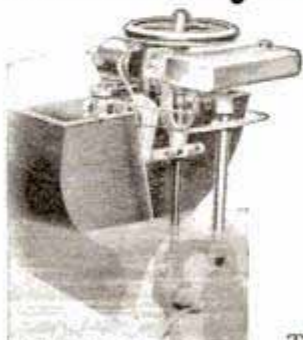

Write for catalogue of this and other Waterman motors.

This simple, light boat engine makes a motor boat of any boat in a jiffy—as quickly detached. Will take you 28 miles per gallon of gasoline in an 18 foot boat. *Seven miles an hour in a rowboat!*

The most Power for the Price.

The most Power for the Weight.

"PORTO"

2 Full H. P.—55 Lbs.

The original, portable motor—20,000 in use, guaranteed a year and sold on a month's trial.

Waterman Marine Motor Co., 230 Mt. Elliott Ave., Detroit, Mich.

LEARN ARCHITECTURAL DRAFTING

Never before was there such a tremendous demand for Architectural Draftsmen and Designers. Men who specialize in this line of work earn \$125 to \$400 per month. Plenty of good positions open and advancement rapid. I will teach you to be expert in a short time and at small expense. Every carpenter should learn Architectural Drafting. It will enable you to increase your earning power and build a big business of your own.

GREAT FREE OFFER!

Open For Limited Time

At this time I am making an astonishingly liberal offer to readers of this magazine. In order to give this special training to carpenters I am giving away a Scholarship—a reduction of \$25 from the regular price of my Course. Your expense will be nominal. I am also giving FREE a magnificent set of Drawing Instruments and Complete Drawing Outfit to those who enroll immediately. Write at once for this liberal offer.

LEARN AT HOME

Earn \$125 to \$300 per Month

GUARANTEE

I guarantee to coach you until in a position paying \$75 to \$200 a month—until you are expert in this work.

I will give you my personal instructions AT HOME—by mail. You do just the work done in the drafting room, and everything sent to you just as though you paid the regular price. Devote only your spare time to this work. LEARN while you EARN.

Send For Free Book "The Road to Success"

This book tells you how to become an expert Architectural Draftsman and Designer—explains my expert method of instruction—points out the remarkable opportunities open to carpenters who learn Architectural Drafting. Send for this book today.

MAIL COUPON AT ONCE

Don't delay. Sign and mail the coupon today. You obligate yourself in no way. Everything sent to you FREE AND PREPAID. Mail the coupon NOW—while my special offer is open.

Chicago Engineering Works Chief Engineer

Room 150, Engineering Bldg., Chicago, Ill.

FREE COUPON

Chicago Engineering Works, Chief Engineer,
Room 150, Engineering Bldg., Chicago, Ill.

Please send me your book, "The Road to Success," and full particulars of your Great Free Offer. I obligate myself in no way. Send everything FREE AND PREPAID.

Name.....

Address.....

Please Mention Popular Mechanics

7773- \$30.

7243- \$100.

7212- \$135.

7260- \$150.

7115- \$150.

7106- \$50.

7235- \$150.

7310- \$150.

7527- \$75.

7534- \$60.

7589- \$25.

7101- \$20.

7404- \$50.

7111- \$100.

7403- \$100.

7131- \$450.

7561- \$10.

7263- \$50.

7267- \$25.

7659- \$14.

7169- \$75.

7138- \$50.

7269- \$35.

Here are shown a few selections from our CATALOGUE which contains illustrations of the highest grade of Perfect Blue-white Diamonds, Watches, Jewelry and Silverware, and tells how they may be bought on easy payments under the well-known Lyon Method.

DIAMONDS ON CREDIT

Terms 20% down and 10% a month. 10% discount for cash. Transactions are confidential—no security required. A binding guarantee with each Diamond. May be exchanged any time at full purchase price. A Diamond makes a most acceptable gift or is an excellent medium for investment. For full particulars, write for Catalogue to Dept. 3

J.M. LYON & CO. (EST. 1843) 71-73 Nassau St. New York

WIRELESS

Static Machine 3 in. SPARK \$4.50

The "Interstate" Wireless Outfit, receives accurate messages 300 miles distant. Has tuning coil, Galena Detector, 75 ohm Receiver, Condenser, etc., ALL WIRED ready for use. Greatest bargain ever offered. Satisfaction guaranteed. Complete \$3.75

6V 60 Ampere Storage Battery \$8.00

Rheostat Regulator, rotary adjustment \$0.60

6 Volt, 6 Ampere Dynamo. Lights 12 Tungsten Lamps. \$3.70

Nine Inch Search Light. Gives 20,000 flashes. Best make \$0.70

75ohm Telephone Receiver. \$0.40

Vest Pocket Nickel Flashlight \$0.85

AGENTS WANTED

We want good agents in every county to sell our goods. Literature and complete information free. Write today. Make from \$50 to \$100 a week.

THE UNIVERSAL MFG. COMPANY
115 State St. FREMONT, OHIO

AGENTS—BIG MONEY

Selling guaranteed Steel Mantle Burners. Make coal oil produce gas. Every home buys. Experience unnecessary. Sample 25c. Particulars Free. Write Today.

STEEL MANTLE LIGHT CO., 396 Huron St., Toledo, O.

We have **NO AGENTS**

FREE This Big Book Of **BLACK AND BLUE WOOLENS**

of course you are going to have a black or blue suit this fall—but why pay \$20 to \$30 for merely ordinary ready-made garments when you can get a classy **MADE-TO-MEASURE, ALL-WOOL BLUE SERGE SUIT for only \$15** the greatest value ever offered in a high-grade blue serge suit, tailored to your individual measure, up to the minute in style, guaranteed perfect fitting, for only \$15.

Tailoring and Materials Guaranteed

We guarantee to please you absolutely or you don't pay us one cent. We want your business and to get it we are going to put in the best suit you order of us, a regular \$5

SATIN LINING FREE

Send today for our handsome big book of "blue and black" woolen samples and new fall styles, all **FREE**. Get our big special offers which can't be duplicated, as we are the only exclusive "blue and black" tailors in America.

We will save you BIG MONEY

BERNARD, HEWITT & CO., Tailors, 564 West Monroe Street Dept. PM, CHICAGO, ILL.

The above goods represent only a few articles from our famous comprehensive electrical cyclopedia, No. 11, containing over 450 illustrations and over 1600 electrical apparatus and supplies.

Send to-day 3c. postage for this wonderful book, the greatest money saver in the United States. With this book is furnished free 16 page "Treatise on Wireless Telegraphy," also a 16 page copy of the new magazine "THE ELECTRICAL EXPERIMENTER."

The Electro Importing Co., 233A Fulton St., N.Y.C.
"Everything for the Experimenter."

Please Mention Popular Mechanics

Get Your Canadian Home From the Canadian Pacific



The Home Maker

WE will make you a long-time loan - you will have 20 years to pay for the land and repay the loan - you can move on the land at once - and your Canadian farm will make you independent.

20 Years to Pay

Rich Canadian land for from \$11 to \$30 per acre. You pay only one-twentieth down - balance in 19 equal annual payments. Long before your final payment comes due your farm will have paid for itself over and over. This advertisement is directed only to farmers or to men who will occupy and improve the land.

We Lend You \$2000 for Improvements

The \$2,000 loan is used only for erecting your buildings, fencing, sinking well and breaking. You are given twenty years in which to fully repay this loan. You pay only the banking interest of 6 per cent.

Advance of Live Stock on Loan Basis

The Company, in case of approved land purchaser who is in a position and has the knowledge to take care of his stock, will advance cattle, sheep and hogs up to the value of \$1,000 on a loan basis, so as to enable the settler to get started from the first on the right basis of mixed farming. If you do not want to wait until you can complete your own buildings and cultivate your farm, select one of our Ready-Made farms - developed by C. P. R. Agricultural Experts - with buildings complete, land cultivated and in crop, and pay for it in 20 years. We give the valuable assistance of great demonstration farms - free.

This Great Offer Based on Good Land

Finest land on earth for grain growing, cattle, hog, sheep and horse raising, dairying, poultry, vegetables and general mixed farming, irrigated lands for intensive farming - non-irrigated lands with ample rainfall for mixed and grain farming. These lands are on or near established lines of railway, near established towns.

Ask for our handsome illustrated books on Manitoba, Saskatchewan and Alberta - mention the one you wish. Also maps with full information free. Write today.

G. E. THORNTON, Colonization Agent

Canadian Pacific Railway

Colonization Department 112 W. Adams St., Chicago

FOR SALE - Town lots in all growing towns - Ask for information concerning industrial and Business openings in all towns.

Seven volumes;
3,092 pages, 7 x 10 inches;
2,327 illustrations



NOW \$15 LESS

Here is your chance to buy the greatest mechanical reference library ever published at almost half the regular price, payable in small monthly installments. Yet we don't ask you to send us a cent until you have had the books in your home for an entire week and have examined them carefully at your leisure. Isn't this a liberal offer? Isn't it worth investigating?

This great work is planned for the use of every man who has to do with metals, tools, or machines. It covers the design, construction and operation of steam and gasoline engines, and of machines in general; and the manufacture and working of all metals used in the mechanical trades. The work of thirty-eight experts, this library is recognized as a standard reference work by technical schools, libraries, and practical men throughout the country.

The Complete Cyclopedic of Mechanical Engineering Gas Engine Operation and Modern Shop Practice

contains 3,092 pages, 7x10 inches, 2,327 illustrations, full page plates, diagrams, etc.; hundreds of valuable tables and formulas; carefully cross-indexed for quick, easy reference. The books are substantially bound in half red morocco, gold stamped, and are printed in large, clear type on special quality paper.

Important Subjects Covered

- Machine Shop Work—Vertical Milling Machine—Motor-Driven Shops—Shop Lighting
- Forging—Electric Welding—Tool Making—Metallurgy—Manufacture of Iron and Steel—High-Speed Steel—Flows in Castings—Electric Lifting Magnets—Magnetic Clutches—Making a Machinist—The Ideal Foreman—Pattern Making—Foundry Work
- Automatic Coal and Ore Handling Appliances—Machine Parts—Construction of Boilers—Types of Boilers—Boiler Accessories—Steam Pumps—Air Compressors—The Steam Engine—The Steam Turbine—Indicators—Valve Gears—Refrigeration—Gas Producers—Gas Engines—Automobiles—Elevators—Sheet Metal Work—Practical Problems in Mensuration—Mechanical Drawing—Drafting Room Organization—Machine Design.

Sent Absolutely Free - Express Prepaid

The complete seven volumes, not a sample volume, will be sent, express prepaid, for seven days' free examination; returnable at our expense if they do not contain the information you want. If you keep the books, pay \$2.00 seven days after receipt and then \$2.00 a month until you have paid the special introductory price of \$19.80. The regular price of this great Cyclopedic is \$35.00.

Just fill in and mail the coupon. It won't cost you a cent to examine these books. We know they'll be worth many times their cost to you. Mail the coupon now and you will receive your books promptly.

Another Great Free Offer

With every set is included a year's Consulting Membership, regular value \$12.00, entitling you to the free advice of a staff of expert Mechanical Engineers. This will give you practical help in handling your difficult working problems. There will be no limit to this service. A single problem solved for you might be worth more than the first cost of the books.

AMERICAN TECHNICAL SOCIETY, CHICAGO, U. S. A.

FREE EXAMINATION COUPON

American Technical Society, Chicago, U. S. A.

Please send set Cyclopedic of Mechanical Engineering for 7 days' free examination. I will send \$2.00 within 7 days and \$2.00 a month until I have paid \$19.80, or notify you and hold the books subject to your order. Title not to pass until fully paid.

Pop. Mech. 11-13

NAME.....
 ADDRESS.....
 OCCUPATION.....
 REFERENCE.....

Please Mention Popular Mechanics

WEAR
 Trade Mark Registered **B.V.D.** U. S. Patent Office and Foreign Countries
 UNDERWEAR

IF IT ISN'T
AN EASTMAN
 IT ISN'T A KODAK

DO IT NOW

Write us for circular and complete information. This wonderful little 3/4 HP Gas Engine complete ready to run for only \$19.50. Will run washing machine, small lathe, drill, grinder, etc. An ideal Christmas present for a boy. Shipped on trial and fully guaranteed. Our 1 HP and 1 1/2 HP for larger machines.

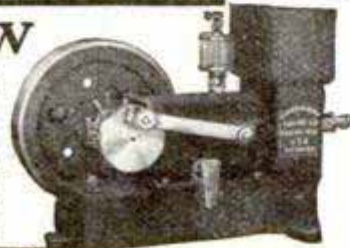

SIEVERKROPP ENGINE CO.
 1224-18th St. RACINE, WIS.

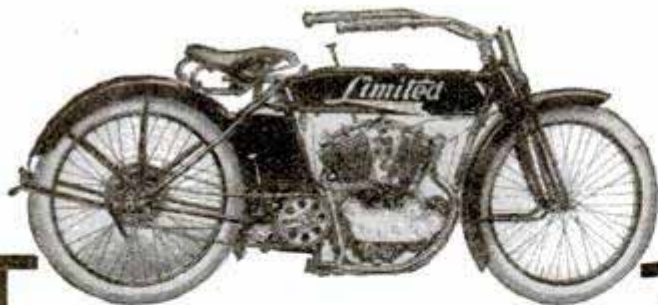

325 MILES IN ONE DAY

Running over Northern and Western Wisconsin roads, one rider recently covered 325 miles in one day without feeling the slightest fatigue, or having cause for repair of machine—a remarkable touring record and a great tribute to the comfort, power and durability of the Twin



The Big Brother of the Feilbach Limited

A machine of the same sterling qualities as the single cylinder Feilbach, but faster and more powerful. Has the same Rigid Frame, Spring Fork, Longitudinal Spring Seat Support and other features that have made the single cylinder Feilbach machine so popular. Cylinders 3-5/16 by 4, set at 45 degrees. Cam shafts supported by two large bearings, similar to the large bearing of the crank shaft. The quiet operation and power of its engine is one of the great features that have made the Feilbach Limited so popular.

Price \$290.00 "and Worth Every Cent of it"
Single Cylinder Feilbach, \$240.00

Write for circular giving full details of both Single and Twin Limited

FEILBACH MOTOR CO.

1148 Holton Street MILWAUKEE, WIS.



Convert Your Wheel Into a Motor-Cycle

Motor fits any wheel. BEST, MOST RELIABLE. Best Hill Climber. More STEFFEYS' in use than any others. Send stamp for circulars. STEFFEY MFG. CO., Girard Ave. and 30th St., Phila., Pa.

5 H. P. 1914 Peerless Motorcycle

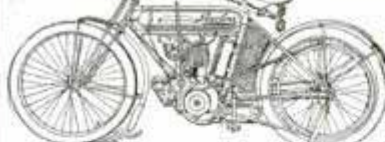

With Free Engine Idler and Bosch Magneto, together with the best there is in motorcycle construction—Power, Silence, Endurance, and those Wearing Qualities so essential for low cost of maintenance. 5 MILES FOR ONE CENT Agents Wanted—Liberal Discounts

PEERLESS MOTORCYCLE CO., 179 Huntington Ave., BOSTON, MASS.



\$40 Motorcycle

We have the largest line of new and used Motorcycles in the country at the lowest prices. We also have a thoroughly equipped repair department and are in position to furnish repairs for any machine. Send us your machine to be overhauled. We pay cash for second hand motorcycles. Send for Catalog. HARRY R. GEER CO., 888 McLaran Ave., ST. LOUIS, MO.

BUILD YOUR OWN IDEAL CYCLECAR For \$300



One or two passenger Practical, economical, simple in design, 10-H. P. twin motor, two speed and reverse transmission. Complete plans showing how to build the IDEAL CYCLECAR, consisting of large working blue prints, giving all necessary details and dimensions, plain written instructions, specifications, pictures and lists of parts. Price \$2.00, or send stamp for circular.

THE IDEA SHOP, Dept. I, BUFFALO, N. Y.

MAKE YOUR BIKE A MOTORCYCLE



at a small cost, by using our attachable outfit. Fits any Bicycle. Easily attached. No special tools required.

"It is Cheap Riding"

Mr. Greenfield, of Texas, writes: "The motor I ordered from you some time ago has given good satisfaction. Carries me up any hill and against any wind. It is cheap riding." Mr. Dunning, of Illinois, writes: "The motor I received from you last fall has given perfect satisfaction and is all and more than you claim it to be. I am a man weighing 180 lbs., and it takes me anywhere that could be expected. It took me seven miles over rough and hilly roads in fifteen minutes. I'll be glad to recommend it to anyone."

FREE BOOK Write today for bargain list and free booklet, fully describing the SHAW Bicycle Motor Attachment. Motorcycles all makes, new and second-hand, \$35.00 up. **SHAW MANUFACTURING CO.** Dept. 6 GALESBURG, KANSAS



Ten Days' Free Trial

allowed on every bicycle we sell. We Ship on Approval and trial to anyone in the U. S. and prepay the freight. If you are not satisfied with the bicycle after using it ten days, ship it back and don't pay a cent.

FACTORY PRICES Do not buy a bicycle or a pair of tires from anyone at any price until you receive our latest Art Catalog of high grade bicycles and sundries and learn our unheard-of prices and marvelous new special offers.

IT ONLY COSTS a cent to write a postal and everything will be sent you FREE by return mail. You will get much valuable information. Do Not Wait; write it NOW!

TIRES, Coaster-Brake, rear wheels, lamps, parts, repairs and sundries of all kinds at half usual prices. **MEAD CYCLE CO.** Dept. R108 CHICAGO

PENNSYLVANIA Oilproof VACUUM CUP TIRES

The total bonded indebtedness of New York City is 25 per cent more than the entire national debt. On March 31st, this year, it was \$1,228,150,747, as against \$963,776,770 for the total national debt.



Morgan Gas Lighter

Agents wanted everywhere to handle this Specialty.

LARGE PROFITS Increasing Demand. Send for Territory and Sample.

B. MORGAN, Bellevue St., Newport, R. I.



Schickel VALVELESS TWO-STROKE Motorcycle

SIMPLE-NEAT SERVICEABLE

Send postal for catalog

THE SCHICKEL MOTOR CO., 69 Garden St., STAMFORD, CONN.



WE SELL YOU AT WHOLESALE

Agents' Price One **AMERICAN Motorcycle or Bicycle**

Honest hand-made machines at factory cost. Write now for catalog. Say whether interested in Motorcycle or Bicycle. **\$139.65** **\$18.65** AMERICAN MOTOR CYCLE CO., 1011 American Bldg., CHICAGO



The Finest Motorcycle in the World

IS

THE FLYING MERKEL
THE ONLY SELF-STARTING MOTORCYCLE

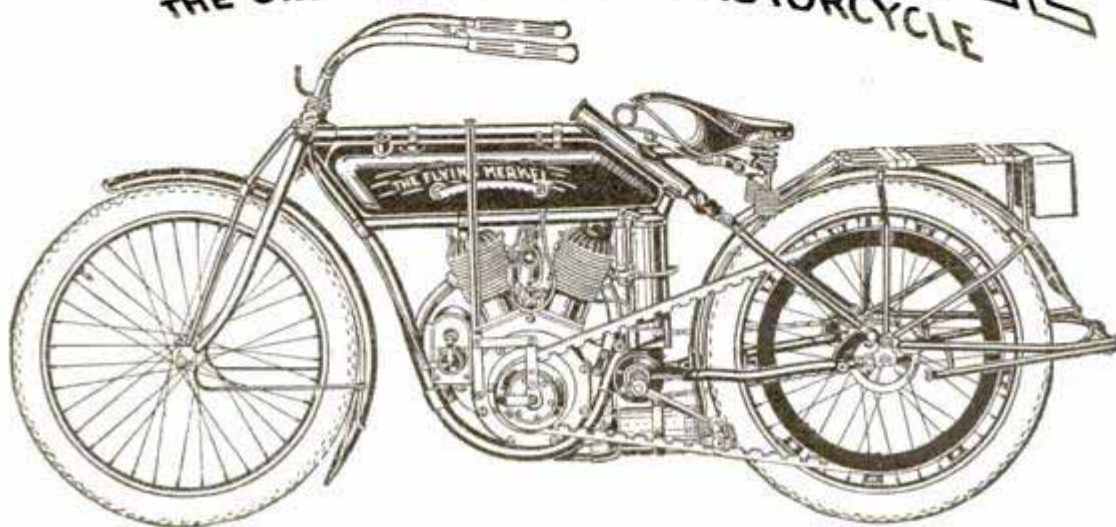

One reason for the success of the Flying Merkel motorcycle, is because its power plant is universally recognized as the most powerful engine ever built into a motorcycle. Full Hess-Bright ball bearings, mechanical adjustable valves, special Schebler carburetor, the finest materials possible to procure, and the finest workmanship in the world all contribute to the final triumph. Although mathematically rated at only 7 horse power, exhaustive tests at the laboratory of the University of Cincinnati by disinterested experts showed conclusively that this wonderful little twin cylinder motor

Actually Produced 13.9 Brake Horse Power

There are many other features to commend the 1914 Flying Merkel. It is the only motorcycle in the world with a Self-Starter. It is the original and only successful spring frame motorcycle, which makes it the world's most comfortable power vehicle.

Write today for full descriptive art catalog Free—and if we have no agent in your town—write for agency application blank. A Flying Merkel pennant FREE if you include 5c in stamps to pay cost of mailing. Remember—

“If it passes you, it's a Flying Merkel.”

The Miami Cycle & Mfg. Co. 350 Hanover Street
MIDDLETOWN, OHIO, U. S. A.

This Starts Any Motor—Any Time— On First Quarter Turn

Open needle valve slightly (you needn't remove glove) and inject gasoline. Passing



through its own channel to plug base, it vaporizes directly at spark point.

New steel needle valve hardened and ground to a perfect compression tight seat. Steel cone lock washer holds valve securely against vibration.

Champion Priming Plugs will start your automobile, motorcycle or engine **any time and every time** on the first quarter turn, because they insure both a hot, fat spark and a rich mixture right at the plug's firing point. Absolutely necessary in cold weather for **most cars, motorcycles and motor boats**—highly desirable the year round on **all** of them.

When your cylinders are stone cold, the gasoline can't vaporize upward. You must prime your motor to produce the initial explosion at the top of the cylinder. Only a few drops of gasoline, at the right place, are needed to start your motor instantly.

Champion Priming Plugs put those few drops just where you want them—and a **Champion spark** does the rest.

Champion Priming Plugs do what priming cocks can't do: create gas right at the firing point.

Champion Spark Plugs are now factory equipment on three-fourths of all the automobiles made in America.

The **Champion Priming Plugs** is a perfect spark plug plus a perfect primer. **Champion Priming Plugs for motor car, motorcycle, motor boat or other motors, \$1.25 each.**

If your dealer is not ready to supply you with **CHAMPION PRIMING PLUGS**, don't delay. Remit to us in any safe, convenient form for the number of priming plugs you need and we will send them to you—guaranteed and prepaid—the day your order is received.

Champion Spark Plug Company, 140 Avondale Ave., Toledo, Ohio

\$3,000.00 IN ONE YEAR

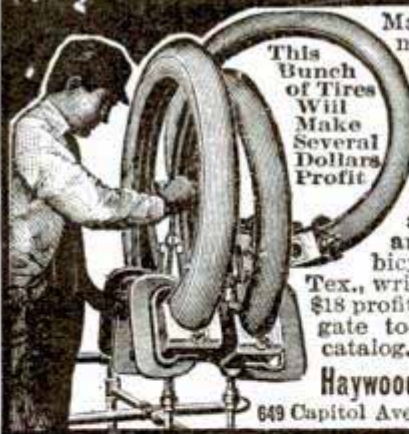

This Bunch of Tires Will Make Several Dollars Profit

Make it repairing automobile tires. Punctures and blow-outs are common. Tires need retreading and vulcanizing.

EACH AUTO SOLD MEANS MORE TIRES TO MEND.

Auto tire repair field a hundred times bigger and better than old bicycle days. Johnson,

Tex., writes, "I made as high as \$18 profit in one day." Investigate today Ask for FREE catalog.

Haywood Tire & Equipment Co.
649 Capitol Ave. Indianapolis, Ind.

Save 25%

by buying your motorcycle sundries and parts from us. Send for our book of

motorcycle supplies. Absolutely free to all riders for the asking.

MOTORCYCLE CO-OPERATIVE CO., 471 Woodward Ave., DETROIT



THE GREAT AMERICAN
Eagle

9-12 H.P. Chain Drive Twin

Send for catalog and prices.

EAGLE MOTOR CO.
(P.M.) Brockton, Mass.

INDIAN MOTOCYCLES

CRADLE SPRING FRAME. SEND FOR CATALOG.

HENDEE MFG. CO., 911 State Street, Springfield, Mass.

The latest census report shows that the value of the export of agricultural implements increased from \$3,800,000 in 1890, and \$16,000,000, in 1900, to \$25,600,000 in 1909.



Solar Motorcycle Lamps

are the neatest looking, strongest and most efficient lamps made. The product of light specialists, makers of 90% of the automobile lamps used on the high grade cars of America. Catalog shows many styles—gas, oil and electric. Write for it today.

BADGER BRASS MFG. CO.

Kenosha, Wis. New York City, N. Y.

YOU CAN NOW GET

Diamond Automobile Squeegee Tread Tires

ON YOUR MOTORCYCLE OR BICYCLE

You have exactly the same tire problems as the automobilist. Realizing this, we have built for you a tire made of the same Vitalized Rubber, the same fabric, the same principle of construction, and built in exactly the same manner as the automobile tire. Diamond Vitalized Rubber Motorcycle Tires are made with the Squeegee or Studded Tread and Perfect 3-Point Rim Contact; also the "More Mileage" Strip on the tread, an exclusive Diamond feature. They "won't slip—won't slide—won't skid—but grip and hold."

YOUR DEALER CAN SUPPLY YOU

EDWARDS FIREPROOF STEEL

GARAGES

For Automobiles and Motorcycles

\$30 and Up

Easy to put up. Portable.

All sizes. Postal brings

latest illustrated catalog.

THE EDWARDS MFG. CO., 320-370 Eggleston Ave., Cincinnati, O.

Be Well Dressed We Trust You

Send your name and address for our big new 1913-1914 **Fall and Winter Style Book**. It's absolutely **FREE FOR THE ASKING** and contains all the newest fashions and free samples for this season's wear.

WRITE TODAY

Our Prices Lower Than Cash Tailors

We guarantee you'll save big money, for our prices are **ABSOLUTELY LOWER** than those asked by cash tailors; and we'll give you all the credit you want. We help you dress like the best.

Made to Order to Your Own Measure

Our garments are all made-to-order—**MADE FOR YOU YOURSELF**, from the measurements you send us. They're not "ready-mades" altered to meet your requirements. **COMPARISON**

PROVES the superiority of our wools and tailoring.

Shipped On Approval

You run no risk whatever. You're sure to be **pleased in every way**. We guarantee to **fit you perfectly** and thoroughly satisfy you or you get your money back.

Six Months to Pay

No matter where you live, we trust you. Your simple promise to pay us in six months is sufficient. Our confidential charge account **credit plan** is one of the most modern conveniences of the day.

Get Our Big New Style Book

Now don't delay—write for our big encyclopedia of Fall Fashions **TODAY**—**GET YOUR POSTAL RIGHT OFF IN THE MAIL**—We will send the book postpaid as soon as we receive your name and address. **WRITE TO**

STANLEY-ROGERS COMPANY

526-536 So. Clark Street Chicago, Illinois
World's Foremost Credit Tailors for Men

The forest service of India has demonstrated that teakwood grown on plantations is just as strong as that grown in natural forests.



\$7.95 Brings You

prepaid, this 2-piece German silver drawing set in silk-lined morocco pocket book case. \$1.00 value anywhere. Order today. Money back if not satisfactory. Get a copy of our

Money Saving Message

and buy all your draughting supplies at rock-bottom prices. 10 Yd. Roll 30" Blue Print Paper, 55c. Start the postal today that will save you dollars.

Rohan & Rohan, 205 6th St., Racine, Wis.

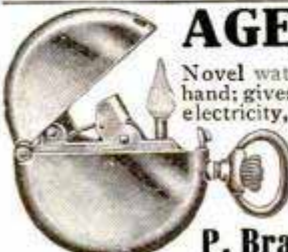

AGENTS A BRAND NEW LIGHTER

Novel watch-shaped lighter. Operated with one hand; gives an instantaneous light every time. No electricity, no battery, no wires, non-explosive; does away with matches. Lights your pipe, cigar, cigarette, gas jet, etc. Dandy thing for the end of your chain. Tremendous seller. Write quick for wholesale terms and prices.

P. Brandt Lighter Co., 148 Duane St. N.Y.

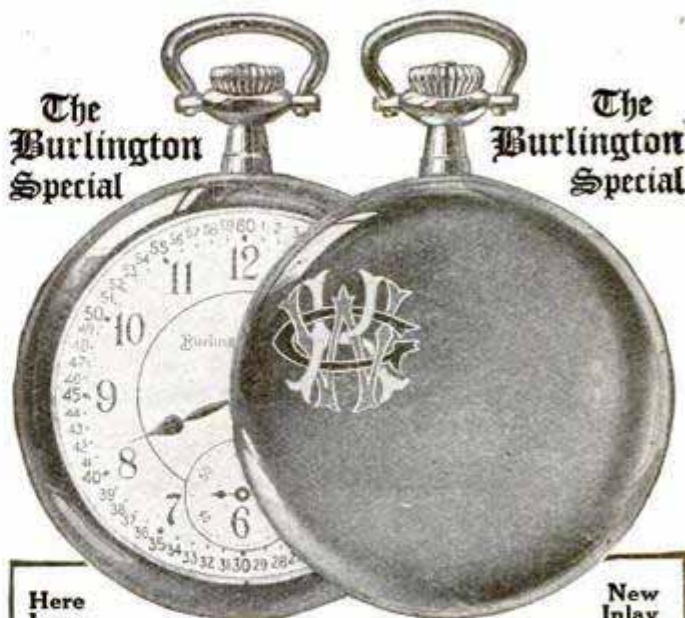

The Burlington Special

The Burlington Special

Here is an Exquisite Design

New Inlay Monogram

The latest idea in watch cases. Superbly beautiful. Your own monogram in handsome enamel design, (many colors to choose from) inlaid in superb gold strata case. The newest thing—just conceived and offered direct to you.

Just Out!

"Inlay Enamel" Monogram

New Ideas in Watch Cases!

Open face or hunting case, ladies' or gentlemen's sizes. These can be had in the newest ideas: **Block and Ribbon Monograms, Diamond Set, Lodge, French Art and Dragon Designs, Etc.** Imagine a beautiful hunting case with your own monogram on one side and the emblem of your lodge or any emblem on the other side. Our catalog shows complete illustrations. See coupon below.

Special Offer!

The superb Burlington Special now at the **DIRECT** rock-bottom price—the same price that even the **wholesale jeweler** must pay. You may secure one of these superb timepieces—a watch of the very latest model, the popular new thin design, adjusted to the second—19 jewels—adjusted to positions AND temperature AND isochronism—the most perfect product of the **world's** most expert watch manufacturers—at the price that even **wholesale jewelers** must pay—and in order to encourage everybody to secure this watch at once pay this rock-bottom price, either for cash or \$2.50 a month! We send the watch on approval, **prepaid**. You risk absolutely nothing—you pay nothing—not one cent, unless you want this **exceptional** offer after seeing and thoroughly inspecting the watch. Read the coupon below.

Write for Free Watch Book

Learn the inside facts about watch prices, and the many superior points of the Burlington over double-priced products. Just send the coupon or a letter or a postal. Get this offer while it lasts.

FREE Book Coupon

Burlington Watch Co.
19th Street and Marshall Blvd. Dept. 9198 Chicago, Ill.
Please send me (without obligation and prepaid) your free book on watches and a copy of your \$1.00 challenge, with full explanation of your cash or \$2.50 a month offer on the Burlington Watch.

Name.....

Address.....

Please Mention Popular Mechanics

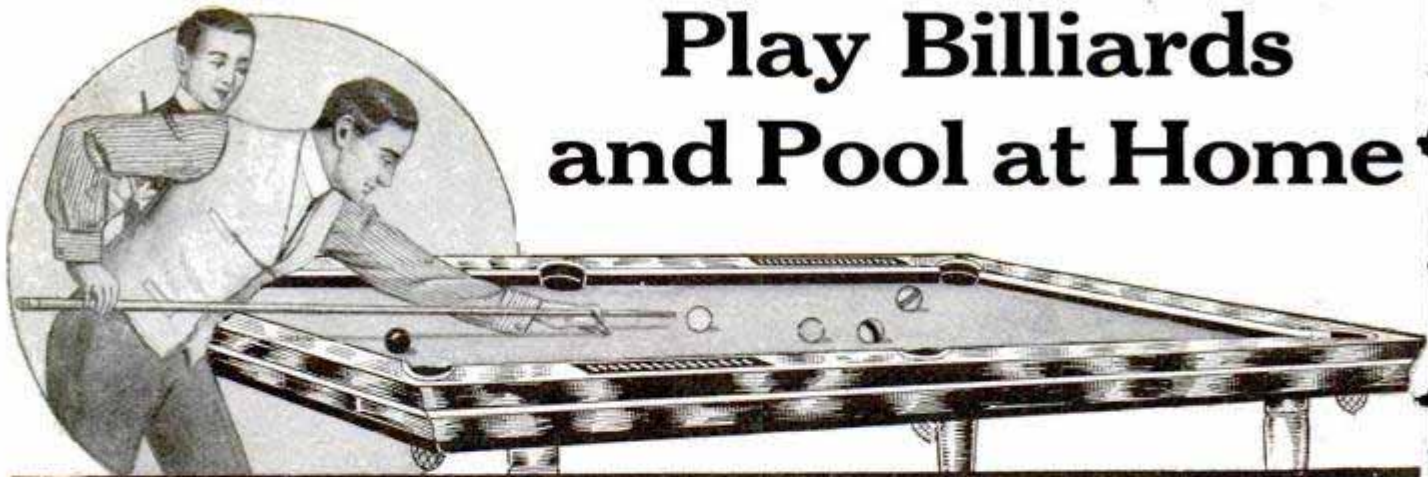

Play Billiards and Pool at Home

BURROWES Billiard and Pool Table

Used by Experts

Burrowes Tables are beautifully constructed, scientifically correct to the smallest detail. The most delicate shots, calling for skill of the highest type, can be executed with the utmost accuracy. No special room is needed. The Burrowes Table can be set up in a minute on dining-room or library table or on its own legs or stand, and instantly put aside when not in use.

\$1⁰⁰ DOWN

You will be astonished to find how little it will cost to have your own Burrowes Table, and how easy the purchase is made by our monthly payment plan. The prices are from \$15 up, on easy terms of \$1 or more down (depending on size and style selected), and a small amount each month. Balls, cues and other necessary playing equipment free.

FREE TRIAL—NO RED TAPE—Catalog contains order blank and full instructions for ordering. On receipt of first installment we ship table. Play on it one week. If unsatisfactory return it, and on its receipt we will refund your deposit. This insures you a free trial. Write for the catalog to-day.

THE E. T. BURROWES CO.

161 Spring Street, Portland, Maine

Sent FREE on Trial— VICTOR Talking Machine



VICTOR

You need not send me one cent. I will send you a genuine Victor or Victrola—any one you may choose from my complete, illustrated catalog; with six double faced records (12 pieces to play), for a free trial. Then if you decide to keep it I will sell it to you on My Easy Payment Plan. Just say which machine you want and send list of records. Give it a fair trial before you decide to keep it. As little as \$2.00 a month will buy a Victor or Victrola on My Easy Payment Plan and on almost every machine you have as long as

One Year to Pay

No catches or conditions—this is a straightforward offer that makes it possible for anyone to own a Victor or

VICTROLA

The best entertainment in the world at a price easily within your means, and there's no risk. If you don't want the instrument after the Free Trial, send it back at my expense. You pay no more on this easy payment plan than if you paid cash down, and I charge you no interest.

My Complete Free Catalog

will be sent at your request. Handsomely and completely illustrated with detailed descriptions of all machines and lists of records. A card will bring it absolutely free. Write now.



VICTROLA

Peter Goodwin, Pres., Peter Goodwin Mercantile Co.,
Victor and Victrola Distributors, 1122 Century Bldg., St. Louis, Mo.

Use This Genuine Folding Naco Camera 10 Days FREE

Don't send us a penny—just your name and address, and we will send the wonderful Naco camera on ten days' free trial. Take pictures of your family—of your friends; of scenes you will treasure in future years. Test it in every way, note the famous Woolensack "Victus" shutter and high grade rapid symmetrical lens; the easy method of inserting roll films in daylight. The Naco camera is post card size and retails for \$20.00 cash the world over. If after a thorough trial you decide it is just the camera you want, send us \$2.00 a month for ten months. If you don't want it, return it at our expense. You take no risk. Send today for this camera and our free film developing offer.

NATIONAL CAMERA CO., 901 Lucas Ave., ST. LOUIS



Will drill Iron, Steel or
Rock with Bit Brace

"Red Devil"

Self-Feeding Chain Drill

Send this to us with \$1.50 and we will deliver to your nearest express office. Ask about our 3,000 R. D. Tools.

SMITH & HEMENWAY CO.
148 Chambers Street, New York City, N.Y., U.S.A.

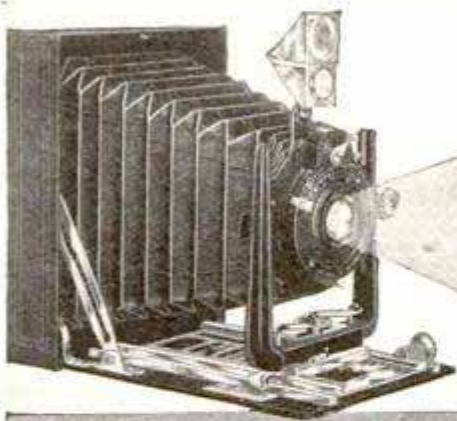

No Action is Too Speedy for a Goerz

Human events and incidents transpire quickly—but not too quickly for a Goerz Camera fitted with a Goerz Lens.

When perfect first exposures are imperative—when you must depend on your camera, not on the sun or weather—when you must be sure of strength and detail—use a Goerz. For a compact folding hand camera the

GOERZ TENAX CAMERA

is conceded the best for all-around photography. A Goerz Lens in an ordinary camera will make twice as good results.

Send for Special Catalog on High Grade "Lenses and Cameras"

C. F. GOERZ AMERICAN OPTICAL CO.
3221 East 34th Street, New York



SATISFACTION GUARANTEED



Massachusetts—\$2,323.70

Your order for an Aladdin house is placed under an **absolute and signed guarantee** of complete satisfaction. Every Aladdin house shown in our big 100 page catalogue (mailed free on request) is backed by an absolute written guarantee to give 100 per cent satisfaction to the owner besides **cutting 1/3 to 1/2 off the cost of building the house you want.** Aladdin Read-Cut houses can be put up in much shorter time than the ordinary dwelling. All material necessary (except chimney and masonry) is furnished—even the paint and nails. The lumber is all cut to size in the mills and numbered, accompanied with complete detailed instructions and illustrations. You can see how your house will look before it is built.



Gretna—\$399.95



Portland—\$797.05

Safe arrival of all material in perfect condition is also guaranteed. Send today for catalogue No. R.

NORTH AMERICAN CONSTRUCTION CO.
385 Aladdin Avenue, BAY CITY, MICHIGAN
Canadian Branch: Sovereign Construction Co., C. P. R. Building, Toronto, Ontario

REO THE FIFTH Final and crowning achievement of R. E. Olds, pioneer designer of Autos. A standard size 30 to 35 horsepower four cylinder car of modern refinements priced at only \$1,095.

R. M. OWEN & CO., General Sales Agents
REO MOTOR CAR CO. LANSING, MICH.

It won't leak

\$250 AND UP

MOORE'S THE ORIGINAL NON-LEAKABLE FOUNTAIN PEN

To be perfectly satisfactory a Fountain Pen must write at the first stroke and continue to write freely and evenly. It must have a large ink capacity; it must fill easily and most important of all, it must be absolutely non-leakable, no matter how it is carried.

In other words, it must be a Moore's, the first fountain pen to which the word non-leakable could be accurately applied and today the one pen that you can thoroughly trust to be true to its name. There's a Moore to suit every hand. For sale by dealers everywhere.

Every part of every Moore's is unconditionally guaranteed.

American Fountain Pen Co., Manufacturers
Adams, Cushing & Foster, Selling Agents
168 Devonshire Street BOSTON, MASS.

SAVE 1/2 ON JEWELRY

Buy direct from manufacturer. Save middleman's profit. Immense catalog **Free**. Send 10c to cover postage, packing, etc. **Special Offer:** Genuine Arabian Diamond Stud or Pin (Retail at \$1) sent with catalog free. **CHAS. CUMINGS CO., 206 Lowell Bldg., CHICAGO**

No. 57
83c

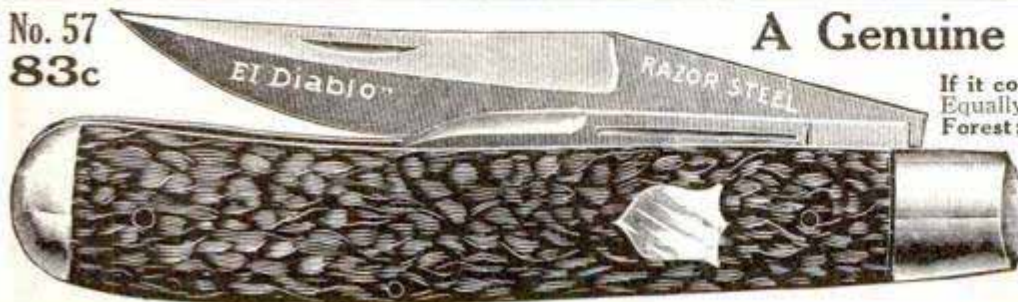

A Genuine \$2 Knife for 83c

If it cost \$10 it could not be made better. Equally good in the Shop, the Farm, or Forest; light but extra strong; resharpened easily. Stag handle, German silver finish; blades file tested, hand forged razor steel and warranted. Sample 83c, 3 for \$2, postpaid. **Choicest Pearl \$2 each.**

Send for 80-page Free List and "How to Use a Razor"
MAHER & GROSH CO.
106 A Street TOLEDO, OHIO

Do You Want *The Glow* of Perfect Health? Vibration Renews Life

If you are nervous, fagged out and tired, with lassitude and that "all in" feeling, write for our Free 80-page Book "Vibratory Massage" that tells the remarkable story of how many men and women have restored their health and become strong, vigorous and glowing with energy and vitality by using the scientific

Arnold Massage Vibrator "The Original"—Costs Less Than Imitations

It combines all the benefits of massage, vibration, Swedish movements and Osteopathy—stimulates the circulation and makes the whole body glow with vitality. A good circulation gives good health—be strong and well, round out the shrunken muscles and chase away the wrinkles by vibratory massage. Physicians endorse the Arnold Vibrator and use it in their practice. We guarantee satisfaction.

Write For The Free 80-Page Book

and let us explain why the Arnold Vibrator gives so much better results than inferior, unscientific vibrators. The Arnold is always ready to use and is so simple it cannot get out of order. It's the original electric vibrator and costs less than the unscientific imitations.

Reliable Dealers Sell Arnold Vibrators

We Want Good Dealers Where we are not Represented

Standard Electric Works, 1209 12th St., Racine, Wis., U. S. A.

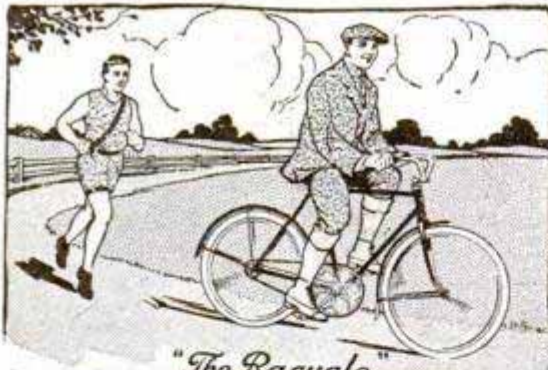
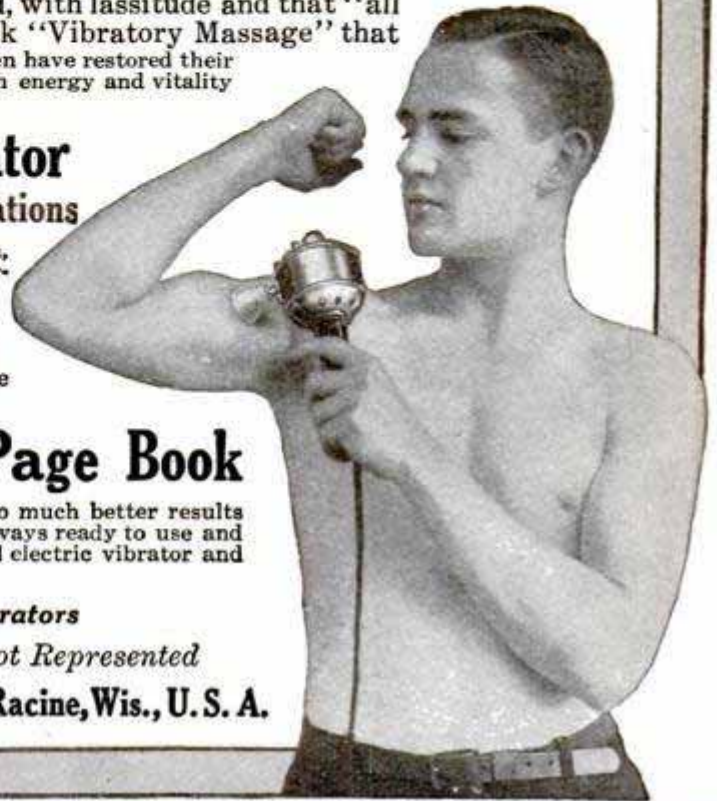

"The Racycle"

"The PACEMAKER of them all"

Is the easiest running bicycle in the world

The secret lies in the wonderful ball bearing crank hanger—which requires 27.9% less pressure on the bearings than is necessary to pedal an ordinary bicycle. It is a mechanical masterpiece. Nothing but the finest materials enter into the construction of a Racycle. That's why we give an absolute guarantee of 5 years to every purchaser of a Racycle. Thousands of Racycles bought 15 years ago are still doing daily service as good as ever.

Write today and send 5c in stamps to pay cost of mailing, and we will send you our Free Art Catalog, a Beautiful Pennant Free, and special Introductory offer.

The Miami Cycle & Mfg. Co.
53 Grand Ave. MIDDLETOWN, OHIO

FREE



Yes, we will send you a genuine Lachnite Gem for you to wear for 10 full days absolutely free. This is the most astounding jewelry offer ever made. See a genuine Lachnite for yourself. Wear it for 10 days. Then if you can tell it from a genuine diamond send it back at our expense. They are cut by the world renowned diamond cutters of Europe and their dazzling fire lasts forever. A superb synthetic gem without a peer. Write today for our big new catalog.

Open An Account

Don't save up your money for months and months before you wear beautiful jewelry. Open an account with us. Have all the genuine Lachnites and other handsome jewelry you want. Write today for the big new catalog. We trust you. No red tape. Your credit is good.

Pay As You Wish

Just a small amount down. Take your time about paying for the rest. Your choice of any of the superb Lachnites and all sorts of other superb, elegant jewelry. All at the rock bottom price. Astounding prices never equalled before. Pay as you are able. The most liberal terms. Get the free book that tells you all about it. Write today—now.

Free Book—Write Today

Do not delay an instant. Put your name and address on a postal or a letter and send it in to us at once. We'll send you our big new catalogue of elegant jewelry absolutely free. Find out about genuine Lachnites. Find out how you can wear one of these superb gems for 10 days absolutely free. Do not delay an instant. Send in your name and get the big new jewelry book absolutely free.

HAROLD LACHMAN CO.
Dept. 1198, 12 N. Michigan Ave., Chicago, Ill.



Diamonds Watches

on Credit

2000 CHRISTMAS SUGGESTIONS



CATALOG

SEND FOR CHRISTMAS CATALOG

FOR HER CHRISTMAS PRESENT

CHRISTMAS SPECIAL



DIAMONDS WITH HEARTS

THE IDEAL CHRISTMAS GIFT

This handsome 100-page illustrated Catalog is brim full of suggestions for Christmas presents, as well as for personal wear. All the new, popular styles in Jewelry—gorgeously beautiful Diamonds, artistic solid gold and platinum mountings—exquisite things—ideal gifts—that sell in some cash stores at double our prices. Select anything desired and let us **Send it to You on Approval.** If satisfactory, send us one-fifth of purchase price as first payment, balance divided into eight equal amounts, payable monthly. We pay all delivery charges. Send for Catalog.

The Loftis "Perfection" Diamond Ring is our great special. It stands alone as the most perfect Diamond Ring ever produced. Only the finest quality pure white diamonds, perfect in cut and full of fiery brilliancy, are used. Skillfully mounted in our famous Loftis "Perfection" 14k solid gold 6-prong ring, which possesses every line of delicate grace and beauty. Sent in velvet ring box, ready for presentation. **\$50**

Credit Terms: \$5 a Month
The Loftis Credit System is a great convenience at Christmas time. By opening a charge account with us you can make a very little ready money supply handsome, lasting gifts for all.

LOFTIS BROS. & CO., Diamonds, Watches, etc.
Dept. F894, 101 to 108 N. State St., CHICAGO, ILL.
(Established 1868) STORES IN PITTSBURGH; ST. LOUIS; OMAHA. (55 Years of Success)

Rent This Level 9 Months— Then It's Yours

BUILDERS—ARCHITECTS—SURVEYORS

High price and cash payments are eliminated. For the first time it is possible to obtain a high grade Level on terms so easy that you can not afford to be without one.



For more than fifty years Aloe's surveying instruments have been recognized as standard instruments. This Level is offered to you with an absolute guarantee that is backed by a **ten day free trial offer.**

Has 18-inch telescope, erecting eye piece, rack and pinion movement, 8-inch spirit level and all latest improvements.

A. S. Aloe Co., 515 Olive St., St. Louis, Mo.

FULL PARTICULARS and description of this Level and details of our extraordinary selling plan will be sent on request.

A new invention in greenhouses



Keeps plants so warm that even in zero weather artificial heat is seldom needed.

It is made of the wonderful Sunlight Double Glass Sash, which has two layers of glass with a 3/8" air space between. This dry, still air is the best non-conductor of heat and cold known. All these sashes are readily removable to use in season for hot-beds and cold-frames.

It comes in sections ready to set up and is not expensive. Size, 11 x 12 feet.

Glass always pays—for it makes its own weather, admitting the sunlight and holding it to its work in spite of zero outside. It insures early and profitable crops.

Write today for our free catalog and also for information on our Sunlight Double Glass Sash for hot-beds and cold-frames.

Sunlight Double Glass Sash Co.
981 E. Broadway, Louisville, Ky.

SAVE money on your diamonds, watches and jewelry by buying from our new Catalogue de luxe, which explains our easy payment system. We are Importers and guarantee you every advantage in price and quality. **20% DOWN and 10% MONTHLY.** Guarantee certificate with each diamond. Full credit allowed on exchange. Transactions strictly confidential. Write today for Catalogue No. 6.

L. W. SWEET & CO. 2 and 4 Maiden Lane NEW YORK CITY

STAMPS

I have a big collection of rare stamps for sale, among which are old Canadian stamps of great value. This is a fine opportunity for people interested in stamp collections. Circumstances oblige me to sell. Address at once,

G. A. TARDIF, 23 Napoleon, St. Sauveur, Quebec, Canada

\$2850 NEW VIM ENGINE



No valves, cams, gears, or complicated parts. Has sensitive governor, silent muffler, hopper cooled cylinder, automatic lubrication, nothing to get out of order. Runs washing machines, churns, separators, spray pumps, pump jacks, light farm and shop machinery, etc. 15 days' free trial. Money back if not satisfactory.

Write today for catalog. Agents and jobbers wanted.
THE VIM MOTOR CO., 111 Water St., SANDUSKY, OHIO

TOY ELECTRIC Aeroplane



The most interesting and instructive toy made. Runs on 4 to 8 dry batteries or on electric light current with suitable means of reducing voltage. It is equipped with our AERO motor, with aluminum propeller, etc., and will fly up to 15 miles per hour. It is made of metal and beautifully enameled. Spread of planes 10 inches, weight packed ready to ship, 10 pounds.

A Great Window Attraction
Price complete, \$12.00

If your electrical or toy dealer don't have them, order direct.

A. J. Rittenhouse Co.
Honeyoye Falls, N. Y.

"It's a portable machine-shop"



It drills, taps, sharpens tools, and grinds valves. Weight 11 lbs., capacity 3/8". Designed to give a clear view of the drill point. Attaches to any lamp socket, (A.C. or D.C.).

TEMCO ELECTRIC DRILL

MODEL B—PORTABLE

is ready at a moment's notice for emergency jobs in any part of the shop. Get one for yourself or your workmen on a Ten-Day Trial at our expense and risk. Use the coupon now to get our Free Trial Plan.

kindly send me your catalog and Free Trial Offer.

Name.....
Address.....
City.....
State..... (??)

THE TEMCO ELECTRIC MOTOR CO.
77 Sugar St., Leipsic, O.

JAP-A-LAC

RENEWS
A Household Necessity
Sold Everywhere

FALL house-cleaning time is a good time to renew floors, woodwork, furniture and entire rooms with JAP-A-LAC. Our booklet tells you *how to do it*.
THE GLIDDEN VARNISH COMPANY CLEVELAND, O., and TORONTO, ONT.

Makers of Glidden's Green Label Varnishes, White Enamels, Endurance (Mission) Wood Stains, Waterproof Flat Wall Finishes and Cement Coatings.

Get Into The MOTION PICTURE BUSINESS

THERE'S NO LIMIT to the Money You Can Earn

in this business. It's the greatest money making business the world has ever known, and the field offers better opportunities to the exhibitor today than ever before. Our book explains everything pertaining to this business—how to conduct it profitably and illustrates and describes the proper machines and outfits to use. It tells you

A Little Bit of Money Will Start You
It's a regular guide for anyone contemplating engaging in the motion picture business. Send for it and learn how

Our Big Offer Will Double Your Profits

A guaranteed professional Motion Picture Camera Frog With Every Motion Picture Machine. Think—what it means to have a motion picture camera. It means a greater chance to make money than the exhibitor has ever had. It will enable you to give the most attractive exhibitions and to overcome all competition. It will open up the way to the film producing business, the branch of the motion picture industry in which the greatest fortunes have been made.

This Offer Is Good For a Limited Time Only

Therefore act quickly and be the first in your locality to make and show your own pictures and reap the big harvest of dollars.

No Experience Necessary—We Teach You

You need no experience to embark in the motion picture business or to take pictures. We teach you everything. With our help you begin earning money at the start and can compete with the oldest and most experienced exhibitors.

P. & W. SALES COMPANY

838 Como Building CHICAGO

FREE THIS COMPLETE MANUAL
Of The
MOTION PICTURE BUSINESS

You Can't
Beat It For
Making
BIG
MONEY
QUICK

New Typewriter \$18

in U. S. A.

A remarkable typewriter, carried in grip or overcoat pocket. Standard keyboard. Does all that higher-priced machines do. Over 31,000 in use. Has less than 250 parts against 1700 to 3700 in others—that is the secret of our \$18 price. All important improvements,

\$18 visible writing, indestructible type, reversible ribbon, etc.

Handiest typewriter built. Easy to operate. Built in famous Elliott-Fisher Billing Machine factory, sold on money-back-unless-satisfied guaranty. Guaranteed one year. Weight 4½ lbs. You can carry for home use, business, trips, or anywhere. Send for catalog and

AGENTS' PROPOSITION.
Q. I. Bennett Typewriter Co., 366 Broadway, New York



South Bend Lathes

9 to 18" Swing
Foot Power, Steam Power
Electric Motor Drive
Straight or Gap Bed

\$7500

and up

Write for Catalog and Price
SOUTH BEND MACHINE TOOL CO.
423 Madison St., South Bend, Ind.

Health? Take Turkish Bath at Home—Only 2 Cents



Physicians are abandoning drugs for this new treatment. If your mind or body is tired, open your pores and feel the rapid change in your condition, at cost of 2c a bath. The Robinson Bath Cabinet is the only scientifically constructed bath cabinet ever made for the home. Great \$2 Book Sent Free—"The Philosophy of Health and Beauty." Write today. Agents Wanted. ROBINSON MFG. CO., 650 Robinson Bldg., Toledo, O.



"AMERICAN"
Key Cutter

A Steady Income—Independence—for You!

\$5.00 to \$10.00 a day with little effort and small investment. Others are doing it—so can you.

Why not establish yourself in this immensely profitable business? We show you how and supply everything—everything but a little enterprise; that's up to you! Our two unique machines do the trick. The "American" is the only machine that sharpens, hones, and strops razors, and all kinds razor blades, scissors, clippers, pocket knives, surgical instruments, etc. No previous experience necessary. The "American" Key Cutter is a little wonder, cuts any shape slot. Booklet of information furnished FREE.

State Agents wanted

AMERICAN SHARPENING MACHINE CO., Inc.
Dept. 11, 184 W. Washington St. CHICAGO

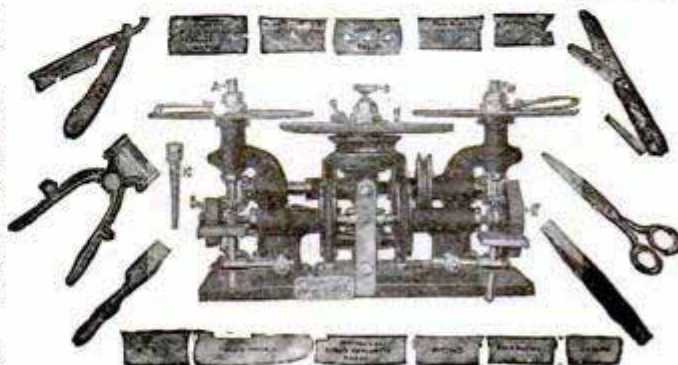

KEROSENE AND GASOLINE

LIGHTING SYSTEMS

Our WIZARD and "DREADNAUGHT" lamps and lighting systems are constructed to burn kerosene and gasoline.

The lamps constructed to burn kerosene are an achievement surpassing all other known methods of artificial lighting. Besides being very attractive in design and of very simple construction, same are very convenient to operate and reliable.

The cost of operating a kerosene lamp is very small, as a single mantle inverted lamp will only consume one gallon of kerosene in about 62 hours.

Our gasoline lamps are the most perfect and up-to-date on the market, while certain styles can be lit with an ordinary match and operated with almost the same convenience as city gas.

For exclusive agency and further particulars, also complete illustrated catalog, describing the above and other styles of lamps and systems, address

The Nagel-Chase Mfg. Co., The largest manufacturers of artificial lighting devices in the world. 158 E. Erie St., Chicago



How FESLER Agents Build Up an Equity For Themselves

DOES an income of 5% on \$37,500.00 appeal to you? The FESLER FOUNTAIN SHAVING BRUSH Sales Plan will increase your earnings, make you independent, and give you an interest in a rapidly growing business. It means an Equity and Cash return of at least \$48,750.00 for you in only five years.

Branch Managers Needed

The growing demand for the FESLER FOUNTAIN SHAVING BRUSH necessitates the appointment of live representatives in several open territories without delay. We want ambitious men who can sell themselves and direct men to work under them. The new principle of the FESLER FOUNTAIN SHAVING BRUSH and the terms we offer will appeal to you.

\$2.00 Will Start You

Simply send \$2.00 for Agents' Introductory Outfit and full details of this splendid opportunity. You will want to be a Branch Manager the minute you know what it means to you. If you prefer to try a brush first we will send one prepaid for only \$1. If not satisfied upon receipt, return it and we'll refund your money.

Don't Delay — Act Now

Wherever you are — whatever you earn — you cannot afford to neglect this opening. Some enterprising man in your town will profit by our offer — why not you? In any event write for full particulars today.

FESLER SALES COMPANY

258 West Twenty-third Street

New York



UNCLE SAM WANTS YOU



Parcel Post

Positions Open

Government Examinations for Many Positions Everywhere

During the Fall and Spring

Rapid advancement to higher Government Positions. No "Layoffs" because of STRIKES, FINANCIAL FLURRIES or THE WHIMS OF SOME PETTY BOSS. THE POSITION IS YOURS FOR LIFE. Country residents and city residents stand the same chance for immediate appointment.

Common sense education sufficient. Political influence NOT REQUIRED.

We will Prepare 25 Candidates Free of Charge

Write immediately for schedule showing the places of the Fall and Spring examinations. Don't delay. Every day you lose means the loss of just so much coaching before the rapidly approaching examinations.

FREE COACHING COUPON

FRANKLIN INSTITUTE, Dept. A 174, Rochester, N. Y.

The coupon, properly filled out, entitles the sender to free sample questions; a free copy of our valuable copyrighted book, "GOVERNMENT POSITIONS AND HOW TO OBTAIN THEM," and to consideration for FREE COACHING for the Civil Service Examination here checked.

- ... Railway Mail Clerk (\$900 to \$1800)
- ... Postoffice Clerk (\$800 to \$1200)
- ... Postoffice Carrier (\$800 to \$1200)
- ... Rural Mail Carrier (\$600 to \$1100)
- ... Customs Positions (\$600 to \$1500)
- ... Internal Revenue (\$700 to \$1800)
- ... Stenographer (\$800 to \$1500)
- ... Clerk in the Departments at Washington (\$800 to \$1500)

Name.....

Address.....

Use this before you lose it. Write plainly.

Most Wonderful of Toys



Richter's Anchor Blocks

Castles, Towers, Bridges, Forts, Battlements, rise by magic under the child's hand. These remarkable indestructible building blocks fascinate and delight the children. Made of eternal stone in beautiful, soft, permanent colors. Scientifically accurate. Mathematically exact. Every block is a perfect fitting part of buildings of every style and design the imagination may fancy. All the information you want about these wonderful stone building blocks will be sent you free.

Just send the coupon below. Or you can order at once by Parcel Post

Model of St. Agnes' Church, N. Y., made with Richter's Anchor Blocks



And their fascination grows with the child. These great toys develop the artistic instinct and bring out latent talent for design.

FUN for the FAMILY

These wonderful stone building blocks furnish unending fun for the entire family, grown ups as well as children. The splendid models that can be created with these beautiful toys are a constant source of delight. Richter's Anchor Blocks are the finest Christmas Gift for any child. They last forever.

Special Parcel Post Opportunity

If you cannot get Richter's Anchor Blocks at your dealer's send your order direct and we will fill it through a dealer near you or will ship the blocks direct by Parcel Post. If you want to get a set by Christmas at this price you must order before Dec. 15th. After that date we will be obliged to send at a different zone rate, postage 52 cents on each set. After Dec. 15th, Set No. 6, \$2.52, Set No. 5, \$2.77. If we can send to you from convenient dealer we will refund postage. Places you under no obligations whatever. If you do not find Anchor Blocks more attractive than we say, you can return them at our expense and we will refund your money.

Outfit No. 6

\$2.15 Outfit No. 5

\$2.40



Size 12 3/4 x 8 3/4 x 2 inches. Contains 106 Anchor Blocks, 3 books of designs, 6 sheets of figures, 1 packing design and 1 ground plan. Outfit weighs 8 lbs. 3 oz. Price \$2.00. Parcel Post \$2.15, postage paid.

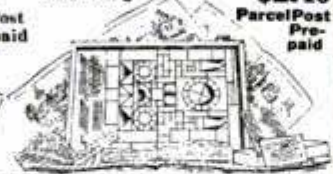

This outfit contains metal parts which are very popular. Size 14 x 9 3/8 x 2 inches. 101 Anchor Blocks, 1 box of 15 metal parts, designs, figures, packing design and floor plan. Weight 8 lbs. Price \$2.25. Parcel Post \$2.40, postage paid.

Colored Pictures Free

Free Coupon

F. Ad. Richter & Co.
Dept. 1198
74-80 Washington St.
New York

Gentlemen—With no obligations whatever to me, you may send me free and postpaid, your descriptive circular, in colors, and full particulars of Richter's Anchor Blocks.

Name

Address

If you want to get either of these sets right away send price

If your dealer does not carry Richter's Anchor Blocks be sure to send the coupon and we will send you the beautiful colored pictures of the different sets and illustrations of handsome models built with them. Don't fail to investigate these remarkable toys. Simply write your name and address on the coupon and mail it to us today.

F. AD. RICHTER
& COMPANY
74-80 Washington St.
Dept. 1198
NEW YORK, N. Y.

Please Mention Popular Mechanics

SAVE 30% TO 50% ON YOUR FURNITURE

Build it in your own home from finished sections bought direct from our factory—at actual factory prices.

All you need is a screw-driver and your spare time. All you pay is for actual value of materials and workmanship.

We build the complete "Come-Packt" line of high quality living, dining, bedroom and den

furniture in sections, finished to your order—your choice of eight shades—hand rubbed polish—and ship direct to you with full directions so that you can set up any piece right in your home in just your spare time and save from 30 per cent to 50 per cent of what you would pay for common, old style furniture elsewhere.

SECTIONAL
"COME-PACKT"
FURNITURE

SOLD ON A FULL YEAR'S TRIAL

When you buy your furniture on this new plan—this new idea that has surprised the furniture world—you get 100 per cent quality, because you see each piece in sections before they are assembled. Nothing can be covered up—you get actual quality.

Every piece of Come-Packt Furniture is of pure quarter-sawn WHITE oak—not red oak, or any other cheap grade of oak or imitation—it has the character that befits and distinguishes the home of quality. It is guaranteed—and sold upon a full year's free trial. Learn all about the

Library
Table
No. 300

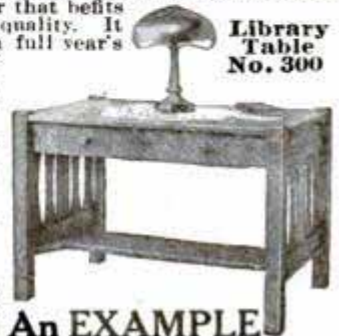

SOLID WORTH AND BEAUTIFUL CREA- TIONS OF COME- PACKT CRAFTS- MANSHIP

If you love beautiful things in the home—furniture of actual quality in choice designs—solid worth and character throughout—then send for our big new catalog today and learn how this great, new idea of furniture built in sections and shipped direct from factory to you will save you one-half in price and will offer you a choice of designs and finishes that will give your home an atmosphere of harmony and taste.

Take this beautiful Mission Library Table, for instance, measure out its dimensions with a tape measure. Compare it with any piece equally good at any dealer's. It saves you more than one-half—and it is sold to you on a full year's money-back guarantee.

Although our business is comparatively new, we are now supplying regularly over 30,000 American homes who appreciate the wisdom of buying quality at less than is usually paid for ordinary grades of furniture.

An EXAMPLE of Come-Packt Bargains

This handsome table is Quarter-Sawn White Oak, with rich, deep, natural markings; honestly made; beautifully finished to your order, shipped completely stained—your choice of eight shades—hand rubbed polish. Height, 30 inches; top, 44x28 inches; legs, 2 1/2 inches square. Two drawers; choice of Old Brass or Wood Knobs. It comes to you in four sections, packed in a compact crate, shipped at knock-down rates—shipping weight 150 lbs.

With a screw-driver and just your spare time you have a table that would ordinarily sell for \$25.00!

Our Factory Price, Shipped in Finished Sections, Only \$11.75

SEND FOR THIS NEW CATALOG TODAY

Our advance 1914 catalog is ready for distribution. It is the most beautiful furniture book ever given away—tells all the details—gives you a choice of over 400 pieces in living, dining and bedroom furniture—color plates showing the exquisite finish and upholstery—factory prices. Write for this beautiful big book today—it is free—prepaid.

COME-PACKT FURNITURE CO., 1101 Fernwood Ave., TOLEDO, O.

We have for sale some used old style engines that we will sell for \$7.50 each as long as they last.

GET CIRCULAR X

ELGIN WHEEL & ENGINE COMPANY, ELGIN, ILL.



EXPERIMENTERS

This is the Experimenter's Reference Book

It's the latest edition of the famous Amco Catalogue, 120 pages, fully illustrated, complete description and prices of the latest electrical and experimental apparatus—Storage

Batteries, Rectifiers, Transformers, Induction Coils, Wireless Apparatus, Lamps, Flashlights, Meters, X-Rays, Clocks, Tools, Electric Railways, Steam Engine, Water Motors, Dynamos, Motors, Telegraphs, Telephones, Electrical Supplies, Model Aeroplanes, and Parts for building your own apparatus. The stamps will bring you this wonderful book. The best catalogue of Wireless Apparatus, etc., published.

ADAMS-MORGAN CO. "The Experimenter's Supply House" Box 72M, Upper Montclair, N. J.



I SMASH The Terms

Watches on CREDIT

16 Size Thin Model

ELGIN
HAMILTON
HOWARD
ILLINOIS
Any Watch You Want

on

30 Days' Free Trial

No Money Down

Express Prepaid in Advance by Me

That's the way I smash terms. That's the reason why I am doing the greatest credit watch and jewelry business. I am "Square Deal" Miller and I trust the people.

I do business on your terms, send you what you want. Suppose it is a watch. I have it for you, **no money down**, express prepaid by me, and a full month to carry it in your pocket. **That's the test that tells.** All these watches

Guaranteed 25 Years

Now for Business: Send me your name and address and I will send you my

Costly Catalog FREE

I want you to have our catalog. It is a gem, it illustrates all kinds of valuable watches, diamonds and jewelry on the easiest and most liberal terms ever offered.

You Take no Chance My terms are made to suit your convenience. I assume all the risk, you are the sole judge of value and quality. I prepay the charges, trust you, give you the easiest, best and squarest terms and live up to my title as "Square Deal" Miller. Write for this catalog today and get a letter from me that will make you a friend of mine from the start.

"Square Deal" MILLER, Pres.
MILLER-HOEFER CO., 211 Miller Building., Detroit, Michigan

SAVE THE DEALER'S PROFIT

\$36.25 on any of our 6 models, with outfits complete. Lockwood-Ash Motors sold only from factory to user, and every one guaranteed for a year.

30 DAYS' TRIAL

Will Ship at Once freight paid. It must please you or send it back at our expense. 1½ H.P. motor and outfit complete, \$36.25—a clear saving of \$13.25. Post yourself on motor boating and the best way to buy motors by sending today for our beautiful 1913 catalog.

LOCKWOOD-ASH MOTOR CO.
208 Horton Street, JACKSON, MICH.

1½ H.P. Outfit Complete

Are You Going Deaf?

UNLESS long neglect has brought about complete paralysis of the congested parts there is every chance that the power to hear—clearly and distinctly—can be saved or restored. You owe it to yourself to investigate. Send the coupon for the free booklet. You will not be obligated in any way.



New Four-Tone Mears Earphone

A tiny, highly sensitive telephonic hearing device of extraordinary powers. With its aid all except those "stone" deaf are able to hear at once ordinary conversational tones. More important—the **exercise of actually hearing** strengthens the afflicted organs, reduces the congestion and tones up the auditory nerve and the **natural** hearing powers return. This remarkable invention corrects the causes of deafness just as spectacles correct faulty vision. But its powers are even greater because they are **selective**; it has **FOUR** different "tones" or strengths, where the spectacle lens, or ordinary telephone, has only one strength. Your finger-tip chooses the proper strength to meet any condition of your ear or to catch clearly any sound. You can adjust it so you can hear clearly an ordinary conversation on the other side of the room—then by merely turning the tiny switch at your finger tips you can adjust it to hear a lecture or a sermon.

Sent on Trial

We are so sure of the superiority of the new 4-tone Mears Earphone that we do not hesitate to send it out on 15 days' free trial. Test the instrument out for yourself before you decide to buy. Hear low toned conversations, lectures and sermons just as perfectly as you used to. Go to the theatre. Put the Earphone to every test you can think of for 15 full days. Then—if you aren't more than satisfied—if you are not convinced that the new 4-tone Mears Earphone is going to materially improve your hearing—**send it back to us.** Don't pay us a cent for the free trial. If you decide to keep the instrument pay only the rock bottom direct price. Send the coupon for the booklet that tells you all about this great offer and our direct from the laboratory price reduction. **Send the Coupon.**

Send the Coupon for New Booklet

Put your name and address in the free coupon and send to us at once. (Or in a letter or on a postal.) We will send you absolutely free and prepaid our new booklet that tells you more about the great new 4-Tone Mears Earphone and the startling offer we are making. Get our direct from the laboratory prices. Write today. This offer may be withdrawn in the very near future.

Mears Earphone Company
Suite 1198
45 West 34th St.
New York City

COUPON
Mears Earphone Co.
Suite 1198
45 West 34th Street
New York, N. Y.

GENTLEMEN: Please mail me, free and postpaid, your Mears Earphone Booklet and particulars of your Special Introductory Offer on your new model Four-Tone Mears Earphone and Free Trial Offer.

Name.....
Address.....

Great Camera Offer

Complete Picture Taking Outfit

With enough supplies to make 16 finished post card photographs

\$5.00

A second
to take 'em—
A minute
to make 'em

Greatest
Camera
Invention
of This
Age



Here at last! Most wonderful camera invention of the age. A photographic innovation—the camera the world has waited for—the very camera you have always wanted.

The "Mandel-ette"

A One Minute Camera

The only "sure-shot" picture taker. A one minute camera that takes pictures direct on paper post cards and finishes them in a minute's time without using films, plates, printing or dark-room. Eliminates all fuss, muss, tanks, trays and trouble. No more expensive camera accessories. No developer worries. Everything so simple a child can operate it.

No Experience Necessary

The "Mandel-ette" takes and finishes post card photographs right within the camera in one minute. To make a picture you just snap the button, send the card down into the developer cup and—PRESTO—in one minute the picture is ready to see, completely finished. The pictures are made at a cost of only 1½¢ per picture—just a tenth of what it costs with the ordinary camera.

The "Mandel-ette" weighs about 24 ounces—no more than the ordinary camera; its size is about 4x4½x6 inches; size of pictures, 2½ x 3½ inches; semi-automatic; loads in daylight with either 16 or 50 cards at one time; high grade, universal focus lens; perfect working shutter; one or several pictures may be developed at a time—while one develops you take another; no over-development; plain instructions enable you to start making finished pictures at once.

GREAT CHRISTMAS OFFER

\$5.00 Complete Outfit \$5.00

(50c extra by Parcels Post)

This is the most amazing camera offer ever made. Nothing so ideal for a Christmas gift as a "Mandel-ette" Camera Outfit. Only \$5.00 gets this outfit, which consists of the camera, 16 sensitized post cards, and a one pint can of liquid developer, all ready to use. (Additional post cards, 25c per package of 16.) Send for this outfit today and get real "picture taking joys." Make pictures of the baby in every possible pose, of the old folks, your friends and neighbors. No end of sport making finished pictures in one minute with the "Mandel-ette." Send money order, draft or check—only \$5.00 for the outfit, 50c extra by Parcels Post, and 25c per package of additional cards. BOOKLET FREE. Address either office.

THE CHICAGO FERROTYPE COMPANY
A 83 Ferrotyping Bldg., Congress & Laflin Sts., CHICAGO, ILL.

Dept. A83, 89-91 Delancey St., NEW YORK, N. Y.

PRICES SMASHED!

GREATEST WATCH BARGAINS KNOWN We have knocked the day-lights out of watch prices—everybody's prices—killed competition—revolutionized the watch business—set a wonderful example—we have made it simple and easy for YOU to own at a low price the best watch made.

WE BEAT THEM ALL No matter what style of men's or ladies' watch you want—no matter what price you intended paying—The Freddro Watch Co. can save you money. No other house can do it—you get SQUARE TREATMENT from US. You can't duplicate our prices for high-grade watches any place else in the world. Everybody wonders how we can do it—and still let you take your own time to pay us. We sell you on credit

THE BEST WATCHES ON EARTH

and save you money. We give you ours and the big manufacturers' ironclad 25 year GUARANTEE with each watch for accuracy, quality of material and perfect workmanship. You can't buy better watches at any price if you search the whole earth. You can get any style you want from us and be sure it is perfect. We sell

DIRECT TO YOU

and save you all middlemen's profits. This is the only way you should buy a watch. We beat them all because we are one of the largest direct watch houses in the world and buy in large quantities. We SELL to you as CHEAP as any DEALER can BUY—you save his profits—enjoy his buying advantage.

ON CREDIT We let you try any watch for 30 days, deliver it to your door CHARGES PREPAID. It's our way—no red tape. DON'T confuse us with other houses—we make no statement we can't fulfill—we have been selling watches over 36 years—we are big, reliable.

NO MONEY DOWN

That's how we do business—that's how we trust you. Get our big catalog, order any watch, and you need not pay a single penny down. Your risk nothing with US. Take your own time to pay—we make it easy for

ANY man or woman to own and wear the handsomest, finest watch made. Nobody can afford to be without one now.

WRITE FOR FREE

catalog—see the many men's and ladies' handsome guaranteed gold watches we offer you at price-busting savings—read our easy terms—liberal offers, iron-clad guarantees and why we are THE house to buy your watch from. Send a postal NOW—see how easy we make it for you to own a watch.

FREDDRO WATCH CO., Dept. 315, St. Louis, Mo.

FREE TRIAL
We let you actually try—wear—any watch in our massive catalog—30 whole days before you decide to keep it.

This is a wonderful, big, friend making offer. You risk nothing. Get our big FREE catalog of handsome watches and read details of this liberal offer. Don't wait

—don't be without a watch—we make it easy for you. We send on approval, express pre-paid.



AGENTS

EARN \$3

TO \$9

a Day



BIG PROFITS IN

SCIENTIFICALLY TEMPERED KNIVES AND RAZORS

with your photo, name and address, lodge emblem, etc., in handles. Great opportunity! Work full time or spare hours. No experience necessary. We show you how to make money. Write today for special outfit offer. Territory going fast.

CANTON CUTLERY CO., Dept. 259, Canton, O.

HOME OIL OUTFIT

Bottle of Oil — Sharpening Stone — Oil Can

The handiest oiling and sharpening outfit ever put out for household use. An oil stone that sharpens shears and knives in a jiffy; an oil can that gets at those hard-to-oil places and a big bottle of HOME OIL—the best oil for everything that needs oiling.

Complete outfit—stone, can, bottle of HOME OIL—at your dealers or by mail postpaid only 25c.

Buffalo Specialty Company
The LIQUID VENEER People
Buffalo, N. Y.

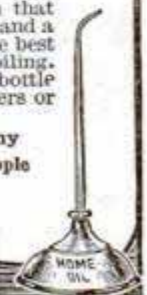

The Kind that Lasts a Lifetime

Isn't that the furniture you are looking for, particularly when it means an unlimited selection of the world's best market and a big saving in dollars and cents. This is what Quality furniture offers. It is sold direct to you from the Quality factory at the wholesale factory price. Send for our new

Arts and Crafts Furniture Catalogue Free

All furniture is shipped at our risk, for your approval. If not completely satisfied return to us. We pay all expenses.

Write for this Arts and Crafts Catalogue today. It will save you time and money.

Quality Furniture Co.
1219 Quality Building
Grand Rapids, Mich.



Choice Rocker, quarter-sawed white oak, any standard finish; padded Morocco leather, spring seat. Special price, \$8.25



Mission Desk, quarter-sawed oak, any standard finish. Large drawer, wooden knobs. Low shelf. Height 43 in., width 29 in., depth 16 in. Special price - \$14.70



Mission Table, quartered white oak, any standard finish. Top 44 x 120 inches. One drawer; good casters. Christmas price . . . \$12.60



HOW MUCH MONEY Do YOU Need?

If \$100 to \$500 a month will satisfy you, we don't know any better way to make it than by acting as agent in your territory for the famous

ROWE Sanitary Washstand

Gives all the advantages of running water in any room without a cent's worth of

plumbing. Replaces the old insanitary slop-bowl and jar.

Don't pass this up as the stereotyped "bunk" handed to agents. We've been selling thousands of these Washstands by mail-order every year. If we could, we'd prefer to keep on selling that way. The business has grown too big, the demand too widespread—that's all.

So there's a dandy opportunity for the right man—or woman—in every locality. Homes, stores, offices, factories are quick customers. One hotel bought sixty-three. Exclusive territory—no competition. And we turn over all inquiries to you.

Write quick for free booklet and terms.

ROWE SANITARY LAVATORY COMPANY
Dept. B, DETROIT, MICHIGAN



One of the 33 Styles

Superb Wing Piano Shipped on 4 Weeks' Free Trial

Yes, we will ship you on 4 weeks' absolutely free trial a Genuine highest-grade Wing piano or player-piano **DIRECT** from our own factory **freight prepaid**. The most amazing piano offer ever made. We will allow you to use any Wing piano—you choice of 33 superb new styles—in your own home for 4 full weeks at our expense.

No Money Down—Freight Prepaid

We ask no money down—no security—no bank deposit—no C. O. D.—no obligations. Just choose any Wing from our large catalog. We'll ship the instrument no money down, *freight prepaid*. Use it just as if you owned it. Let your friends play it. At the end of 4 weeks' trial, if you wish, you may *return it at our expense*. You alone are the judge. We employ no salesmen to visit and annoy you.

Rock-Bottom DIRECT Offer

You will be amazed at our rock-bottom direct-from-our-factory proposition on the genuine highest-grade Wing, guaranteed 40 years. No other manufacturers dared to meet our baffling offer. Let us quote you prices that local dealers cannot approach. Cash or easiest monthly payments as you prefer—but first four weeks' free trial. Since 1868—for 45 years—we have been building Wing pianos—renowned everywhere for their sweetness of tone and sterling merit. The Wing has all the fine qualities and every improvement of any strictly high-grade piano and a superior tone.

Valuable Book on Pianos Free

"The Book of Complete Information About Pianos"

The N. Y. World says: "This is a book of educational interest every one should own." Tells you all about pianos, how to judge the fine points of quality and price in buying a piano. You will be astonished at the amount of information about piano quality and piano prices, and how to answer the arguments of piano salesmen. **The Coupon brings this 136-page book FREE.** This magnificent book, a complete encyclopedia on the piano, posts you on the making of a piano from start to finish. Free and prepaid, provided you write **at once**. With this piano book we will send free our beautiful catalog showing new art styles and full explanation of our Rock-Bottom Prices on the Wing Piano. Just drop a postal or a letter, or mail the coupon—today.

WING & SON, Dept. 1198, (Estab. 1868)

Wing Bldg., 9th Ave. and 13th St.

New York
N. Y.

Piano Book
COUPON

WING & SON (Est. 1868) Wing Bldg.
9th Ave. & 13th St. Dept 1198, New York, N. Y.

Gentlemen:—With the understanding that I am not buying anything, you may send me the 136-page Piano Book containing the ten tests, also your free shipment offer on the Wing Piano.

Name

Address

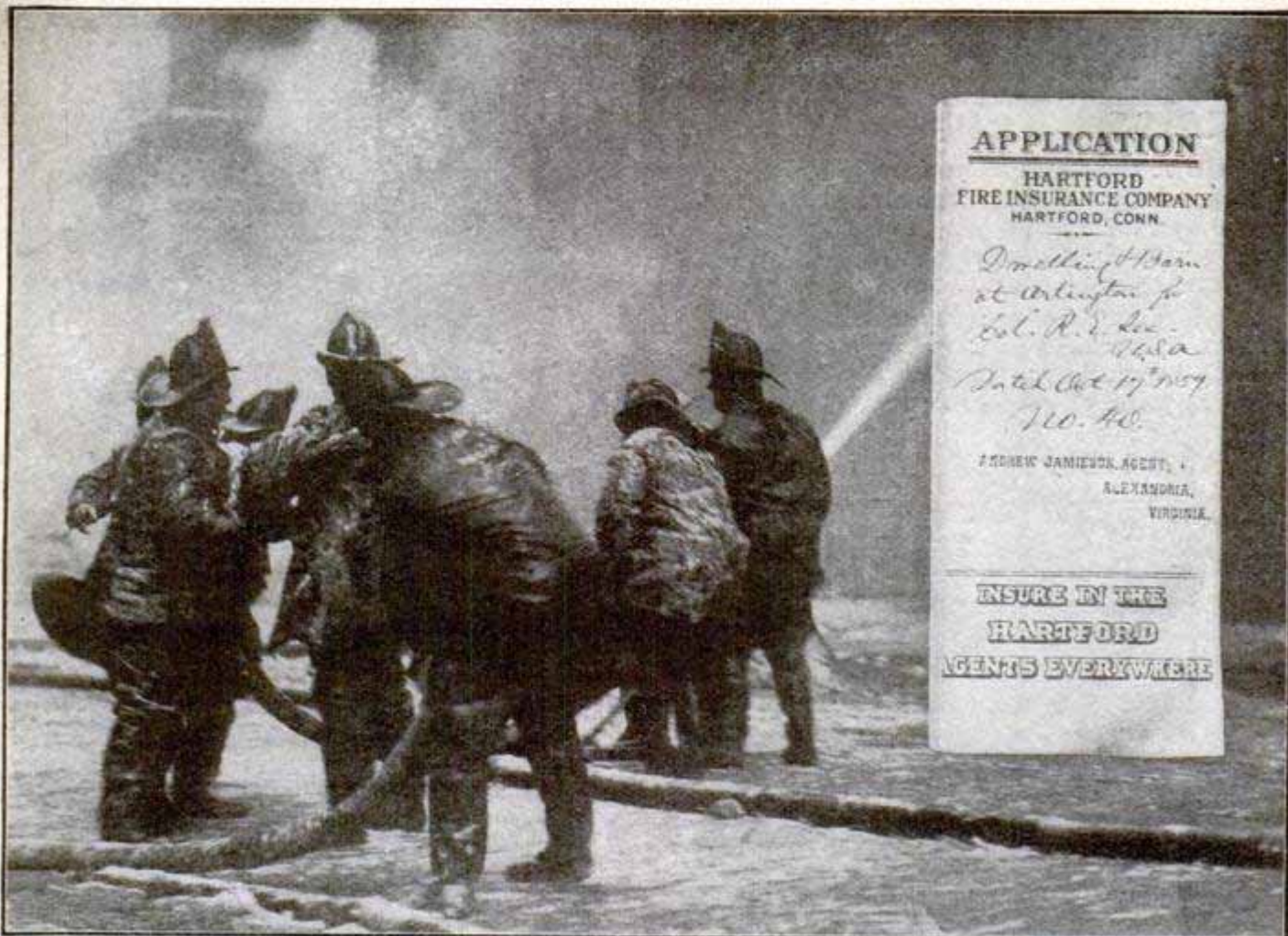

APPLICATION
HARTFORD
FIRE INSURANCE COMPANY
HARTFORD, CONN.
Smelling Alarm
at Arlington for
Col. R. J. Lee
11/18/07
Hotel Oct 17 1907
110-40
 ANDREW JAMIESON, AGENT,
 ALEXANDRIA,
 VIRGINIA.
INSURE IN THE
HARTFORD
AGENTS EVERYWHERE

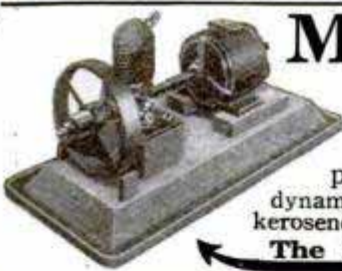

Make Dollars From Dimes

By charging storage batteries with our little direct connected sets. Or, light your house, barn, or garage, the only satisfactory way. Plants from $\frac{1}{4}$ to 1 horse-power, good for from **6 to 25 Lights** without battery. Complete sets or engines and dynamos separate. The engines can be used for any power purpose. They operate on gas, gasoline, kerosene or alcohol. They are inexpensive, simple and reliable. A child can run them. Send for our bulletin M-1.

The Elgin Wheel & Engine Co. Dept. 148 Elgin, Illinois



SANTIAGO GEMS C. O. D. GENUINE DIAMONDS

They look and wear and none but an expert can tell them from. They are not imitations of diamonds, but a genuine stone, cut and faceted by skilled diamond cutters exactly like a diamond; stand filing, fire and acid tests like a diamond. Contains no glass, paste or foil backing. It sparkles just like a diamond and on account of their great hardness will retain their brilliancy forever. To advertise these Santiago Gems we will for a short time send your choice of the above Solid Gold rings C. O. D., \$5.00 for the Ladies' with $\frac{1}{4}$ carat or \$10.00 for the Gents' with $\frac{1}{2}$ carat Santiago Gems by mail or express. Give it any test you desire and if you find it is not all we claim return it at our expense. Send your exact size and order at once, as this Special Offer is for a short time only.

DIAMOND JEWELRY CO. Dept. 21, 189 W. Madison St. CHICAGO, ILLINOIS



Record-Breaking — Trust-Busting — Prices

Induction A. C. Motors on 30 Days' Free Trial Sold Direct from Our Factory to Your Hands Prices that Talk for Themselves

| | |
|---|---------|
| Our New 1/8 H. P. Alternating Current Motor, Complete | \$16.75 |
| Our New 1/6 H. P. Alternating Current Motor, Complete | 19.25 |
| Our New 1/4 H. P. Alternating Current Motor, Complete | 21.50 |
| Our New 1/2 H. P. Alternating Current Motor, Complete | 39.00 |

The above Motors are 1750 R. P. M., Single Phase, 110 Volts, 60 Cycles Induction A. C. Motors.

These Motors are especially adapted to run Washing Machines, Sewing Machines, Electric Pianos, Butter Churns, Dentists' Lathes, Jewelers' Lathes, Printing Presses, Drill Presses, Blacksmiths' Forges, Wireless Instruments or anything where small power is required. These Motors can be run off of the Electric Light Socket, and are Self-Starting.

Thousands of Them in Use To-Day. Quality Equal to Any Motor on the Market.

Our Motors are sold with a Boia-Fide Written Guarantee for Two (2) Years to be free from Electrical and Mechanical defects. The above prices are Net Cash, f. o. b. Chicago. Send Check and Order to-day. We carry a Full and Complete stock (all sizes) of Dynamos, Motors and Fans.

The Best Guarantee on Earth: — We will ship to you any size Dynamo or Motor desired, on a 30 day free trial basis, and after you have used and tested same for that length of time and find that same is not satisfactory, you can return the Motor or Dynamo to us, Freight Prepaid, and we will Promptly Refund your Money without question. Checks or P. O. Money Orders must accompany order.

MONEY REFUNDED IF NOT SATISFIED

Standard Electric Motor Company, 118-120-122-124 South Clinton Street Chicago, Ill.

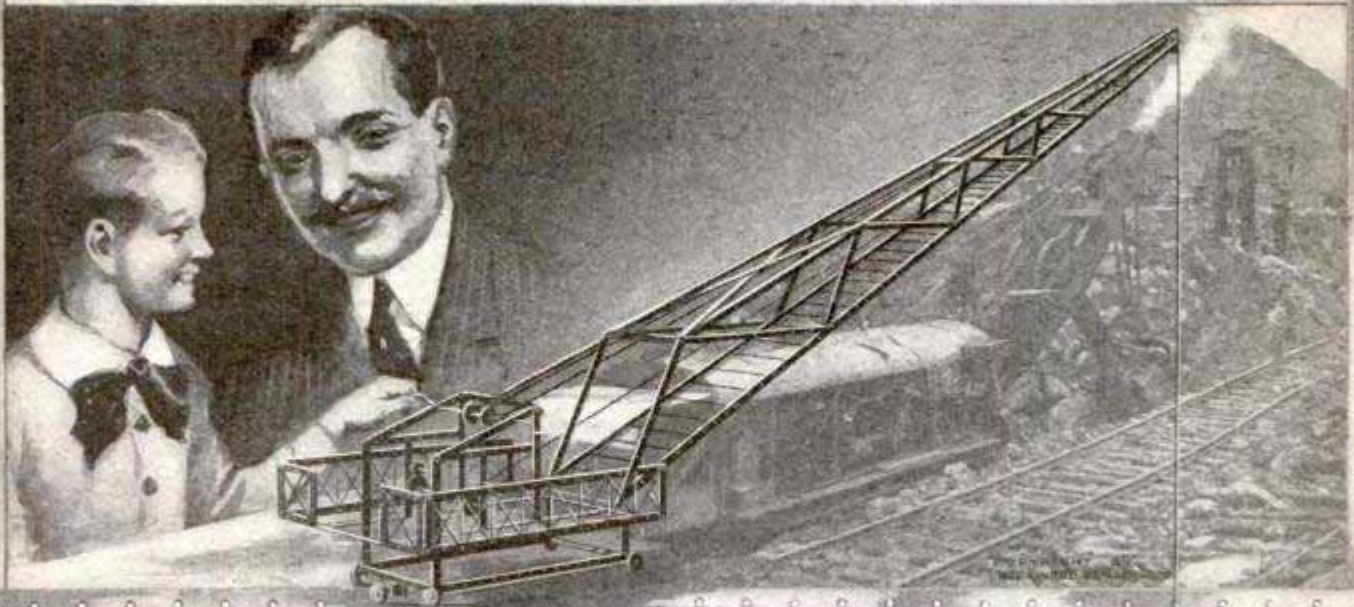

BUILDER OF THE CANAL

The boy's constructive instinct that is developed in erecting and working a crane or derrick of Meccano today foreshadows the man's genius that may be building a canal or performing some other great engineering work tomorrow. With these wonderful pieces of brass and nicked steel, with real bolts and nuts, any boy can make bridges, towers, trucks, etc.—many with movable parts. The possibilities are unlimited.

Get that boy
you are
interested in
a set of

MECCANO

Parents write that Meccano is "the best toy for any boy." It teaches while it amuses—teaches the principles that have made our nation the nation of builders.

Boys find Meccano a source of delight the year round. No other joy and pride can compare with that of seeing the product of their own handiwork. A single set may be used again and again in hundreds of different designs. Our book gives many; you are sure to think up others.

Do not wait for Christmas. There's many an evening before the holidays that can be spent profitably and delightfully with one of these outfits. Most good toy stores and dealers in sporting goods have Meccano.

Be sure the name Meccano is on the box. Examine a set and glance through the manual of instructions. Write for our free booklet, which shows what can be built and the different building sets. We want you to know all about Meccano.

THE EMBOSSEING COMPANY
15 Church Street, ALBANY, N. Y.

MAKERS OF
Toys that Teach

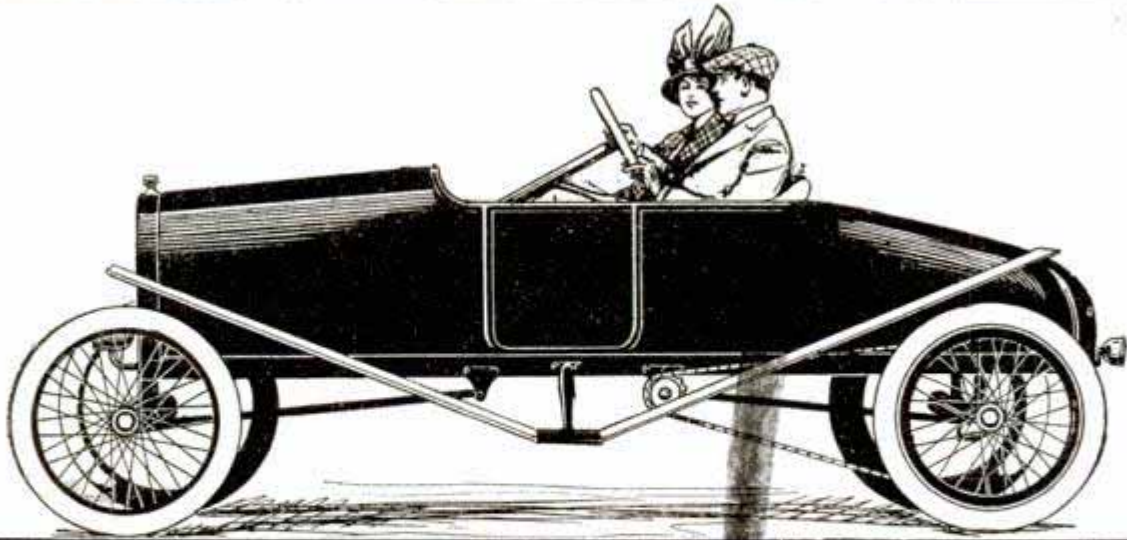

Rayfield Cyclecar

A real automobile for only \$375

Carries two passengers comfortably, seated side by side. Has standard tread—56 inches—same as the biggest cars. Wheelbase 96 inches. Big, liberal springs insure easy riding on rough roads. Wire wheels and pneumatic tires 28 x 2½ inches. Left side drive; center control. Two speeds forward; one reverse. Air cooled motor, two cylinders, 9-12 horsepower. Speed 2 to 50 miles per hour—30 to 40 miles on a gallon of gasoline. Silent chain drive. Road clearance 12 inches. Weight 450 lbs. Climbs any hill with ease. Price includes lamps and tools. Made by a concern of known responsibility and having years of experience in making motors and cars.

Agents! Magnificent Opportunity!

Eager Buyers Waiting in Untouched Field

The cyclecar has taken Europe by storm. America is now awake to it. Everybody can afford a cyclecar and everybody wants one. Here is the only perfected cyclecar made in America. We have facilities for making quantities of them. We are ready for you and you can

our profits with you on a plan never before offered to car agents. If you want to establish a big profitable business of your own

**Be Our Distributor
in Your Locality**

if you act quickly enough. Our agents' proposition is unusual and extremely liberal. It will permit you to establish sub-agents in your territory on a profitable basis. We even share

**Get Our Proposition
Write or Wire Us Today**

There is no time to lose. Don't write us unless you want to be our distributor in your territory and can get the money to swing it—say \$500. If you can do that tell us **today, now**, before some other wide-awake man beats you to it. Write or wire now. Just say: "Send agency proposition for _____ county."

Rayfield Motor Company

Write us at the General Office, 1710 FISHER BLDG., CHICAGO **Factory:** CHRISMAN, ILLINOIS

GROW MUSHROOMS



**It's Easy to Add \$5.00 to \$60.00
a Week to Your Income**

**Here is What You Have Been Looking For
You Can Start with Practically Nothing
Your Whole Family will Be Interested
Little Care Necessary—It will Not Interfere
with Your Regular Occupation**

1. Mushrooms bring 50c to \$2.00 a pound, and 100 pounds raised on beds 5x10 feet, which cost practically nothing to start. You can readily see the profits in this business.
2. The demand always exceeds the supply, and I tell you how and where to market them.
3. I have started more people in this business and made more successful growers than any man in the world.
4. I have seen people start at home with little beds in basements, barns, sheds, etc., and increase their planting until they got to a point where they devoted their entire time to the mushroom business.
5. Beginners with my instructions often have better crops than old experienced growers. If you can read English, you can by my method grow mushrooms successfully.

Women succeed in mushroom business as well as men. Mrs. Mary Bonar, Ohio, writes: "I know a woman can raise mushrooms successfully, for I have tried it and succeeded." Mrs. Guillaumne, Wis., says: "Can sell all I have at 80 cents per pound." Boys find a "sure enough" gold mine in mushrooms. Herbert Fickenworth, 12 years old, Chicago, writes: "I am picking and selling mushrooms every day." Webster Jones, aged 14 years, Little Rock, Ark., says: "Any boy who is willing to follow directions can learn to grow mushrooms. Growing mushrooms is just the kind of work a boy likes, and I know I can make more money out of it than anything else."

MUSHROOMS MAKE MONEY

Just read these extracts from letters such as I am receiving every day:

1. "From my first bed of 50 square feet, I raised 80 pounds of mushrooms which I sold at 70c a pound." It cost \$2.00 to spawn this bed and this customer sold \$56.00 worth of mushrooms, leaving a profit of \$54.00 on an investment of \$2.00.
2. "From the last \$20 worth of spawn I bought of you I sold \$300 worth of mushrooms."
3. A customer who started in 1910 writes me in 1913: "I have never failed yet to grow mushrooms by your method and with your spawn."
4. One of the oldest and largest growers in England writes as follows: "I have read everything that I could find on mushroom growing and I congratulate you most heartily on having produced the best book, in my opinion, on the subject, ever published."
5. Every State Agricultural School in the United States has my book of instructions as a reference book. One of the biggest crops that I ever heard of was grown at one of the Experimental Stations by my method of growing and with my spawn.
6. Two of my customers in Arlington Heights, Ill., last year invested \$75 in the mushroom business and raised \$680 worth of mushrooms in the basements of their homes, leaving a clear profit of \$605 on an investment of \$75.

I Will Tell You the Facts About This Business

I spent 20 years in the mushroom business. I owned and operated for years the largest plant in America, and I am now associated with the biggest Mushroom Company in the world. We have spent up to date \$100,000.00 building and equipping our plant for growing mushrooms.

I know how to grow them and I can show you how to make larger profits on smaller investments, growing mushrooms, than anything else you can take up.

I have put the facts about this business into a beautifully illustrated booklet, entitled "Money in Mushrooms," telling you when, where and how to start, the kind of spawn (or seed) to plant, etc. Information worth many dollars to you, sent absolutely free.

Put your name and address on coupon and mail to:

A. V. JACKSON

FALMOUTH MUSHROOM CELLARS, Inc.

129 Gifford St.

FALMOUTH, MASS.

**A. V.
Jackson
Falmouth
Mushroom
Cellars, Inc.
129 Gifford St.
Falmouth, Mass.**

Please mail me your book "How to Make Money in Mushrooms," and also give me full information as to the best way to start, cost, etc. All this to be entirely without cost or obligation on my part.

Name.....

Address.....

Town.....

State.....

TEAR OFF THIS COUPON AND MAIL TODAY

PROOF!

For four years I have been telling Popular Mechanics' readers of the money-making possibilities in my Popcorn Crispette Machine. I herewith submit the proof from men, women, and boys.

F. C. Thompson, Ore., "The big popper sits up by the window and thro' us out an aroma that stops everyone who passes. I took in \$575 first 27 days, and this month am doing as well."



Mrs. L. E. Fuller, Tenn. "I have been using the little popper since January and like it better and better. Thank you very much for your kind information."



Mr. Jackson, of Ohio, says, "My boy is getting along fine. Saturday he got his first batch of 120 packages. Sold them all, Monday 140, Tuesday 180, all gone."



Oscar Johnson, Montevideo, Uruguay, Aug. 16, '12. "I am doing fine with your popcorn crispette outfit. Send me one of your latest catalogues as I want more outfits in a short time. Please send me a lot of formulas for candy also."

Dr. L. F. Inman, Nev. "It has been one month since I started to manufacture. I have not wasted any material and make the crispettes in full batches. The people seem to be satisfied with my goods. I have good success with the popper. I have not wasted or burned any corn and think on the whole I am not so slow to pick up a new business as some others. Everything works well with me, and for a small town am selling as much as could be expected."

Raymond W. Hekox, N. Y. "Am well pleased with crispettes because everyone who has tried them claim they are perfect and never had anything better, and I can say that myself."

C. M. Pinkston, Ga. "I am adding candies and would be glad if you would send me the formulas for making peanut and cocoanut candies. I am getting along nicely with crispettes. Several parties said they knew the crispettes were made on a Long machine."

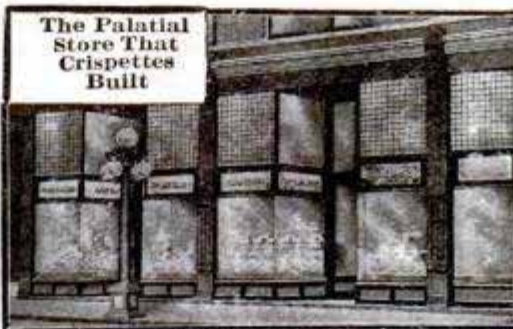

A Recent Picture of My Big Store in Springfield

George Sutherland, Idaho. "Had fine demonstration of crispettes at leading grocery, served it with milk. Business is developing finely. I may need another outfit to set up 3 miles from here."

W. A. Furlong, Pa., Pop. 2,000. "I want to tell you, your machine is all right. Popped all of the 160 pounds of corn the first week."

John Byrod, Pa., bought a machine and placed it in a shoe store. Tells us the business paid for the machine in quick time. He states he is going to quit the shoe business and sell crispettes only. Mr. Byrod invites our prospects to come to Sunbury.

We shipped a machine to Rochester. The man never saw a machine before. Writes as follows about his first attempt. "I must have followed your directions pretty good. The crowd blocked the sidewalk and many came in the store. They bought as fast as two of us could wrap. Say, it is like a circus. Every one who tasted said, best they ever ate."

Crispettes Built This "Big Store" for me and made me wealthy—
W. Z. Long



Crispette Machine and Long's Secret Formula—

To the man of limited means the Crispette business is a safe, strong and proven foundation for rapid mounting to influence and fortune. I have numerous letters on file to bear out this statement. It is clean, dignified, requires no canvassing. **You become a merchant**—the entire community your patrons. It is a business which with my complete system and great secret formula, needs no other experience or other expense, to make it successful.

Follow Carefully the Amazing Facts

Answer to Yourself These Pertinent Questions

What salary do you **earn**? What do you **get**? Stop a minute and consider. You know that what you receive from your employer represents but a small portion of what you really earn. Get on the other side! If your earning power amounts to thousands every year—then **earn it—and keep it yourself.**

Come to Springfield at MY expense. Let me **PROVE** every word in this advertisement.

STOP! You have followed the rut too long. You have accepted only what others care to give. Get on the other side. Take only **WHAT YOU WANT!**

Palmer, Pa., cleared \$500.00 last Labor Day. E. H. H. Penn., sold 12,000 rolls in two weeks, etc. Just a sample of the letters received from "Crispette" merchants from all parts of the country. Our greatest money barons began with a far less advantage than I offer you today. So write **NOW**—for my handsome illustrated 48 page free booklet, "How To Make Money In The Crispette Business," or

Send a Card Today to
W. Z. LONG
794 High St., Springfield, Ohio

Almost the Enormous Profit of 400%

\$1.00 in cash returned you for every 20 cents spent. NOT theory! NOT "guess work"! NOT "imagination"! But the actual, bona fide, proven record of profits of "Crispette" producers, from Coney Island to Oregon and from Canada to the Argentine Republic in South America.

\$100.00 a day made by this machine.

There is Room for One of these Crispette Machines in every city and town of 500 population in U. S.

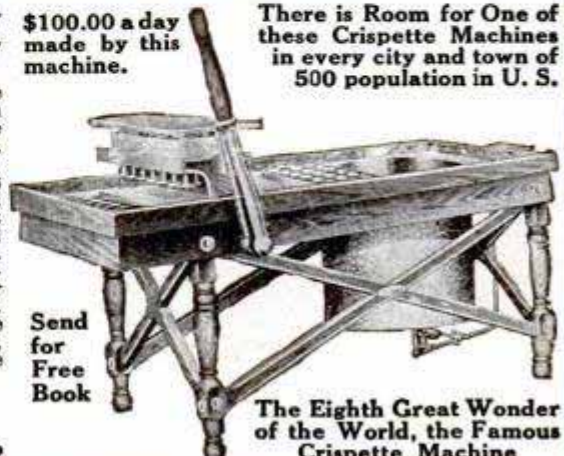

Send for Free Book

The Eighth Great Wonder of the World, the Famous Crispette Machine



What's the Matter?

SOMEBODY HURT. An automobile turning a corner struck a man crossing the street who had become confused and did not get out of the way. The crowd is gathering to see the ambulance carry the man away.

Every hour of the day such accidents are happening on the streets. The carelessness of others and your own hurry puts you in constant danger of accidental injury.

There are a thousand causes of accident. Not the least numerous are those at home, office, travel and recreation.

A \$3,000 accumulative accident policy, the best on the market, costs at the rate of about 4 cents a day.

You need accident insurance. You need it now.



MORAL: Insure in The TRAVELERS

The TRAVELERS INSURANCE CO., Hartford, Conn.

Pop. Mech. N

Tear off

Please send me particulars regarding Accident Insurance. My name, address and date of birth are written below:

1914 HENDERSON

Ready for you now

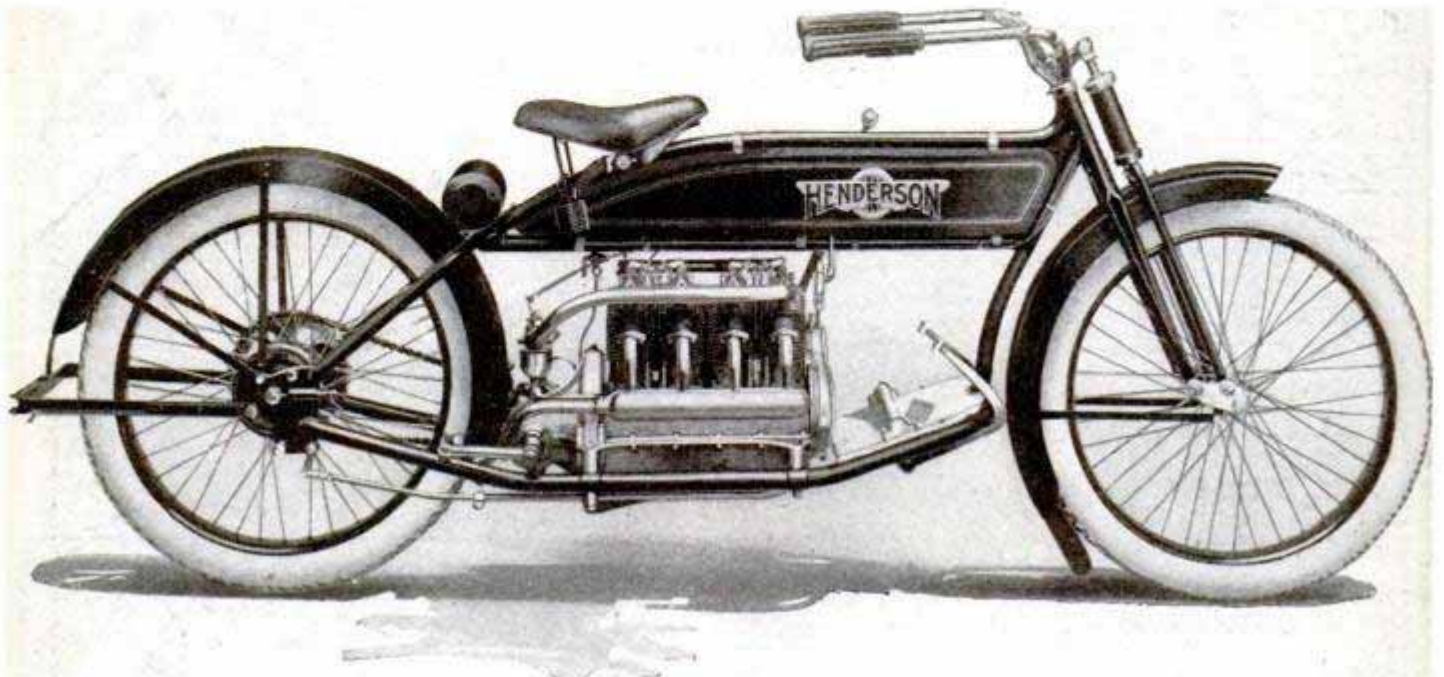

8 H. P., 4 cylinders, \$325. Two-speed model with Thor two-speed Hub, \$365. Tandem attachment complete, \$20.

Next to the news about the machine itself, the best thing about this 1914 Henderson announcement is that you can have immediate delivery of the new model.

We have delayed our announcement until the new models should be ready for shipment in quantities and each Henderson dealer have a specimen.

The 1914 Henderson is differentiated from every other motorcycle by its four cylinder design, its freedom from motor vibration and stuttering power, its long wheel-base and low center of gravity, its three-inch tires and powerful brake, and its general comfort and easy riding, which are admittedly unsurpassed.

These are fully described in the catalog, which we will be glad to send, or can be seen at the Henderson dealers'.

A marked advantage, in addition to these, is the saddle adjusting plate, which enables every rider to vary the saddle spring tension to suit his own weight and requirements.

The friction surface of the clutch having been almost doubled, smoother action and a saving of power result.

The motor speed and flexibility are increased because each piston has been lightened; and no automobile has finer crank-shaft and connecting rod bearings of babbitt-lined bronze than those that distinguish the Henderson.

There are other improvements the details of which we cannot give here, but which will serve to emphasize and increase the Henderson's leadership among the more careful motorcycle buyers.

Henderson Motorcycle Company, 1158 ^{Dept. C} Cass Avenue Detroit, Mich.

AETNA-IZED?

WHEN some Engineer runs past a signal and many lives are lost in the wreck, that is the time to remember that railroad travel is not the most important hazard against which the average man needs accident insurance.

The AETNA COMBINATION POLICY
Furnishes Insurance Protection against the multitude of hazards every man runs every day

\$3,250 INSURANCE FOR \$10

In extent and variety of protection this policy is exclusive and without a rival.

For \$10 a year (in "Preferred" Occupations) this Policy pays:

- \$2,000** for death from Travel, Elevator or Burning Building Accident.
- \$1,000** for death from Ordinary Accident.
- \$2,000** for loss of limbs or sight as a result of Travel Accident.
- \$1,000** for loss of limbs or sight as a result of Ordinary Accident.

The above amounts accumulate Ten Per Cent. each year for five years without additional cost.

\$250 FOR DEATH FROM ANY CAUSE
(No Medical Examination Required.)

The Accumulations, Double Benefits and Life Insurance provided by this Ten Dollar Combination make possible the payment of \$3,250 at a cost of less than **THREE CENTS A DAY** in addition to weekly indemnity for total or partial disability from accident.

SEND IN THE COUPON TO-DAY

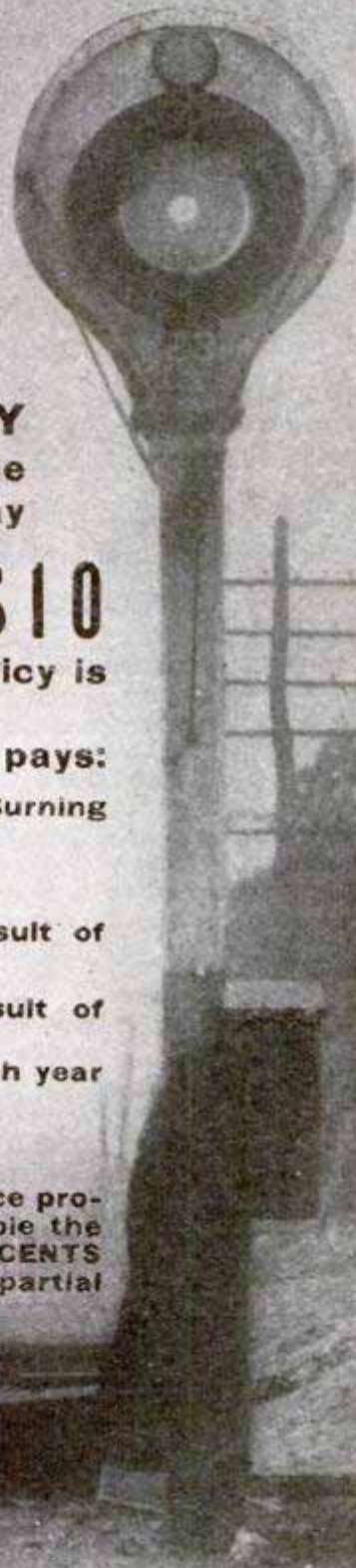

AETNA LIFE INSURANCE CO., (Drawer 1341), Hartford, Conn.

Pop. Mech.

I am under 55 years of age and in good health. Tell me about Aetna \$10 Combination. My name, business address and occupation are written below.

Young Men Wanted

To **Become Draftsmen and Designers** At Once

The constant demand for trained men always exceeds the supply. Positions paying Big Money are open now. Some weeks over 250 positions paying the highest salary in all parts of the country stay open. Let me send you one of my regular weekly "Draftsmen Wanted" lists. You can have one of these positions. I'll give you just the training you need.

\$125 to \$175 Per Month to Start

You can make it. I have trained the highest priced draftsmen and know exactly the kind of training those men need who draw the biggest salaries. Send the coupon.



Chief Draftsman Will Train You Personally and Instruct You Properly

On practical Drafting room work until you are absolutely competent in every respect as a first-class Draftsman and until you are in a permanent paying position at a salary paying at least \$125 per month. This is a most exceptional opportunity for just a limited few selected ambitious men, between the ages of 16 and 40, whom I will train personally and give individual instruction as required in order to fill the constant demand for properly trained men in this line. I give each of my

students my own personal attention—therefore, I limit the number of my students and if you desire such an opportunity then get busy now and write to me at once. Don't wait till tomorrow, do it today. You can earn more than I charge for my time and personal training.

I Guarantee

To instruct you until competent and in a permanent paying position at a regular Draftsman's salary of at least \$125 to \$175 per month and guarantee to furnish you free the complete Draftsman's working outfit at once from the start.

This \$15.00 Draftsman's Working Outfit Free

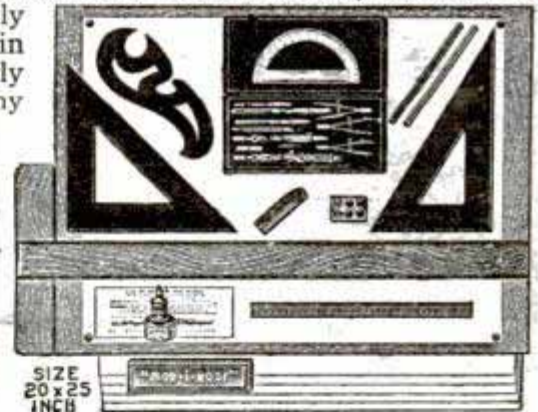

These are regular working instruments—the kind I use myself. I give them free to you if you enroll at once. Send the Free Coupon today.

You Can Earn While Learning

Yes, that's exactly what I mean. As soon as you become my student you can begin earning a handsome income while learning at home. I mean just what I say. This is a special offer I am making. Absolutely no obligations of any kind in sending the coupon. But you must write at once, as I will take the names in the order I receive them.

Mail FREE Coupon at once for my book "Successful Draftsmanship," also list of open positions and for the free offer to be earning good money at once while learning at home. This offer is positively limited and in order to benefit thereby you must act at once.

CHIEF DRAFTSMAN
ENGINEER'S EQUIPMENT CO. (Inc.)
Div. 9198 CHICAGO

FREE BOOK and EARNING while LEARNING OFFER COUPON

Chief Draftsman,
Engineer's Equipment Co.
Div. 9198 Chicago, Ill.

Without any obligation to me whatsoever, please mail your book "Successful Draftsmanship" and full particulars of your liberal "Personal Instruction" offer to a few students. It is understood that I am obligated in no way whatever.

Name

Address

Makes Tool Sharpening Speedy, Easy and Accurate

No other hand tool grinder can compare with Luther's "BEST MAIDE" in efficiency. It is the speediest, smoothest, quietest, most accurate and easiest running tool sharpener possible to produce. The secret of its success lies in its wonderful DIMO-GRIT wheel, its ball-bearings, its worm gear and shaft and the tilting frame.

Ball Bearing

The worm gear and shaft on the Luther "BEST MAIDE" Grinder are perfect in every detail. We cut them from solid steel with special machines of our own designing. Not even the very highest priced cream separators are supplied with better or smoother gears. "BEST MAIDE" gears and shafts are of extra large diameter, which means greater wearing surface. The grinding wheel held by this extra heavy shaft must run true and without vibration. Ball bearings are used to take up all end thrust and give as perfect and easy running a piece of mechanism as it is possible to build.

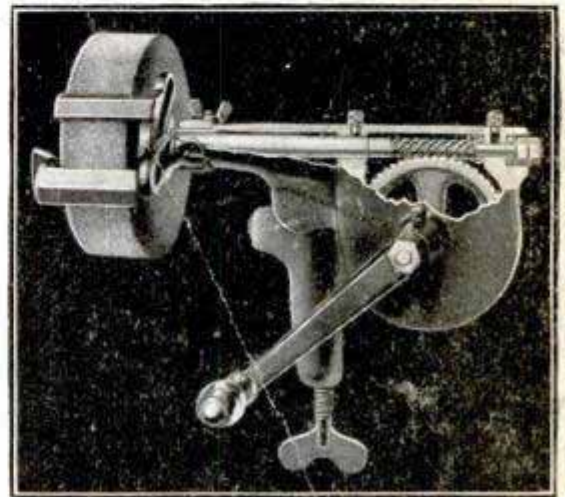

Horizontal Position—Sectional View
Showing Worm Gear and Shaft

Tilting Frame

The Luther "BEST MAIDE" Grinder can be tilted so that any side of the grinding wheel can be utilized. No matter how awkward a tool may be to "get at," it is easy to sharpen it with this adjusting feature. Our new patented arrangement for swivelling the frame allows quick and accurate adjustment to ANY ANGLE—horizontal or vertical—and holds the machine rigidly in any position.



Upright

Double Faced Sharpening Wheel

The "BEST MAIDE" has a double-faced sharpening wheel. The body is of medium grit for quickly bringing a tool to an edge. The smooth and keen edge finishing is done on the side face of the wheel, which is of very fine grit, like a finishing hone. This "two in one" feature is exclusive with the "BEST MAIDE" Grinder.



With Chisel and
Plane Bit Guide

Dimo-Grit Wheels

DIMO-GRIT, the wonderful new artificial diamond sharpening substance, used in the "BEST MAIDE" Grinder Wheels, cuts steel as emery cuts soft copper. It makes tool sharpening so easy that your tools are always in perfect edge, your work speeds up and production is increased. Will outwear any number of emery wheels. No water needed—no danger of spoiling a tool as DIMO-GRIT will not draw temper. Guaranteed for 5 years.

Carried by Leading Hardware Stores

Luther's "BEST MAIDE" Grinders are on sale by leading Dealers everywhere. If, after inquiry, you find your Dealer does not handle them, and you will write us stating why he does not; and will also give us the name of the line of grinders he does carry, we will send you—FREE—a handy little Dimo-Grit Pocket Hone in handsome leather case. Descriptive Folder of "BEST MAIDE" Grinder Free on request.

Luther Grinder Mfg. Co.

715 Point Street Milwaukee, Wis.

Mail this FREE Coupon

Luther Grinder Mfg. Co., 715 Point St., Milwaukee, Wis.

Please send me Free your Special Folder illustrating and describing Luther's "BEST MAIDE" Tool Grinders.

Name.....

Address.....

SPECIAL FREE HONE COUPON

In compliance with your condition for Free Hone, I make the following report:.....

.....

Dealer's Name.....

Grinder Handled.....



The minute-men of to-day are in the army of **Good Teeth-- Good Health**

Boys and girls—men and women—
—who wish to guard their health,
give their teeth a minute's care
twice-a-day. These minute-men—
and women—are ready to do their
best at work or play.

Enroll to-day—make the common-
sense care of your teeth a pleasure by
using Colgate's Ribbon Dental Cream.

There should be a tube for every
member of your household—just as there
is a tooth-brush for each. Get it at your
dealer's or send 4c for a generous trial tube.

COLGATE & CO.

Dept. 81 199 Fulton Street New York City

Makers of Cashmere Bouquet Soap—curious, lasting, refined

*Colgate Preparations are most
acceptable as Christmas Gifts*

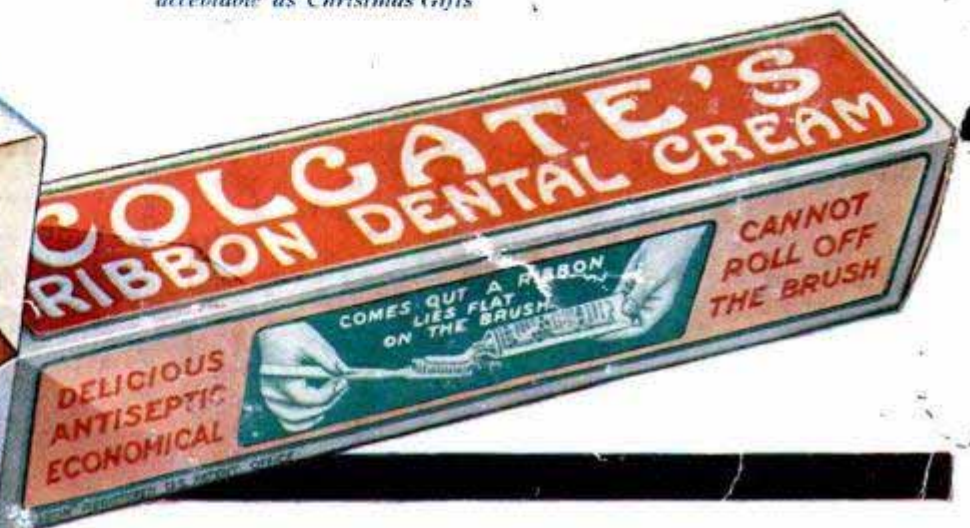

PRINCE ALBERT

*the national
joy smoke -*

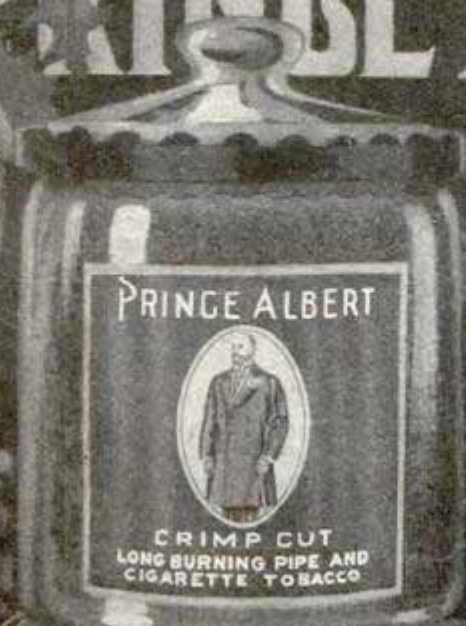

THE others are going to give him neckties and slippers and handkerchiefs and what not. If *you* are stumped and just don't know *what* to get, take this little tip from Santa Claus—just you slip around to any tobacco shop and tell the man you want a one-pound glass humidor full of Prince Albert. He will fix you up a spanking fine Christmas package and you can slip it on the mantel *for Him*. Maybe you don't know what a crackerjack Christmas present P. A. makes, but take it from your Uncle Nicholas—that father, husband, brother or sweetheart of yours will make a mental note that “there's one woman who understands a man.” The pungent, spicy aroma of P. A. adds to the Christmasy smell of the house. *He* will be glad you chose P. A., because he knows he can smoke all he wants during his holiday without a burned tongue or parched throat. Prince Albert can't bite anyone's tongue. Our patented process removes the bite. Buy that package now while the stores have plenty.

P. A. is also sold in 10c tidy red tins; 5c toppy red bags and in pound and half-pound tin humidors.

R. J. REYNOLDS TOBACCO CO., Winston-Salem, N. C.



This box was made by a society girl of New Orleans

can be *made by yourself* into scores of useful and uniquely beautiful things for Christmas Giving at the mere cost of a few thin boards of Cypress, "the wood eternal," and "a little pleasant labor lovingly done."

Why Not Make HIM a "SUGI" Cypress Box?

—to keep his cigars in? Or, why should not **YOU** put in a little time and a little easy and *interesting* work and make **HER** a royal serving tray of Sugi Cypress—that will add real distinction to your dining room and delight her more than any conventional gift of greater cost. First thing to do is to

Get the 64-page Cypress "SUGI" Book:

(incl. 2 inserts in India Tint.) "The Most Usable Free Book Ever Printed for Folks Like You and Us" It tells not only *how you* can reproduce perfectly the rare and coveted Antique Japanese Driftwood effects by *scorching* and *brushing off* a piece of Cypress (working in your own kitchen or cellar) but also why Cypress is **the only wood the Sugi treatment will work on**. You do no designing, tracing or coloring—simply *bring out the natural beauty* and distinction of Cypress. The book lists numberless suggestions as to What to Make—from glove box to library panelling.

DON'T DELAY. WRITE FOR VOL. 26—FREE

When planning a Mansion, a Bungalow, a Farm, a Sleeping-Porch, or just a Fence, remember— "With CYPRESS you BUILD BUT ONCE."

Let our "ALL-ROUND HELPS DEPARTMENT" help YOU. Our entire resources are at your service with Reliable Counsel.

SOUTHERN CYPRESS MANUFACTURERS' ASSOCIATION

1219 HIBERNIA BANK BUILDING, NEW ORLEANS, LA.

INSIST ON CYPRESS AT YOUR LOCAL DEALER'S. IF HE HASN'T IT, LET US KNOW IMMEDIATELY

CROSBY, CHICAGO

Build Her a Little Greenhouse: Now

Plenty of time to beat old Winter to it, if you start soon. Do not consider any material but Wood—nor any wood but CYPRESS, "The Wood Eternal." Any responsible greenhouse manufacturer will tell you *why*. With metal sash-bars and concrete benches you must use fuel enough to keep the temperature fully 5 degrees higher than if you build of wood in order to keep your soil at a given warmth. Greenhouse use is the most severe test to which you can put wood; CYPRESS has no rival in meeting it.



Vol. 20 of the famous Cypress Pocket Library (never **FREE** before advertised in this magazine) contains among many other items of special value, a Detailed Plan and Working Drawing, for a splendid little *practical* greenhouse (like picture at left) that *you can build yourself*. Don't miss this. Write tonight for Volume 20—also ask for Volume 3—all about greenhouses.

The John C. Moninger Company, Chicago, Greenhouse Builders, say:—"The greenhouses built by us of clear Cypress, free from sap, 21 years ago are being used today by their owners and the wood is perfectly preserved and *free of any decay or rot*."

Let our "ALL-ROUND HELPS DEPARTMENT" help YOU. Our entire resources are at your service.

SOUTHERN CYPRESS MANUFACTURERS' ASSOCIATION

1219 HIBERNIA BANK BUILDING, NEW ORLEANS, LA.

INSIST ON CYPRESS AT YOUR LOCAL DEALERS. IF HE HASN'T IT—LET US KNOW QUICK